

**Int. Cl.: 7**

**Prior U.S. Cls.: 13, 19, 21, 23, 31, 34 and 35**

**Reg. No. 3,393,764**

**United States Patent and Trademark Office**

**Registered Mar. 11, 2008**

---

**TRADEMARK  
PRINCIPAL REGISTER**

**STEALTH**

ASTEC INDUSTRIES, INC. (TENNESSEE COR-  
PORATION)  
POST OFFICE BOX 72787  
4101 JEROME AVENUE  
CHATTANOOGA, TN 37407

FIRST USE 4-30-1998; IN COMMERCE 8-31-1998.

SER. NO. 75-564,303, FILED 10-5-1998.

FOR: ASPHALT PAVING MACHINE, IN CLASS 7  
(U.S. CLS. 13, 19, 21, 23, 31, 34 AND 35).

EUGENIA MARTIN, EXAMINING ATTORNEY

**Int. Cl.: 25**

**Prior U.S. Cls.: 22 and 39**

**United States Patent and Trademark Office**

**Reg. No. 3,393,765**

**Registered Mar. 11, 2008**

**TRADEMARK  
PRINCIPAL REGISTER**

**DRAWZ KING OF UNDERWEAR**

WASHINGTON, TERRY ANDREW (UNITED STATES INDIVIDUAL)  
438 N 9TH STREET  
GREENVILLE, MS 38701

NO CLAIM IS MADE TO THE EXCLUSIVE RIGHT TO USE "DRAWERS" AND "UNDERWEAR", APART FROM THE MARK AS SHOWN.

FOR: CLOTHING, NAMELY, SHIRTS PANTS, UNDERWEAR, SOCKS, JACKETS, CAPS/HATS, IN CLASS 25 (U.S. CLS. 22 AND 39).

SER. NO. 75-607,607, FILED 12-17-1998.

FIRST USE 5-31-2007; IN COMMERCE 5-31-2007.

DANIEL CAPSHAW, EXAMINING ATTORNEY

**Int. Cl.: 36**

**Prior U.S. Cls.: 100, 101 and 102**

**United States Patent and Trademark Office**

**Reg. No. 3,393,766**

**Registered Mar. 11, 2008**

---

**SERVICE MARK  
PRINCIPAL REGISTER**

**AMERIFLEX**

AMERIFLEX, LLC (NEW JERSEY LTD LIAB CO)  
700 EAST GATE DRIVE, SUITE 510  
MOUNT LAUREL, NJ 08054

FIRST USE 12-0-1997; IN COMMERCE 12-0-1997.

SER. NO. 75-686,124, FILED 4-19-1999.

FOR: ADMINISTRATION OF EMPLOYEE BENEFIT PLANS, IN CLASS 36 (U.S. CLS. 100, 101 AND 102).

BRENDAN REGAN, EXAMINING ATTORNEY

**Int. Cl.: 16**

**Prior U.S. Cls.: 2, 5, 22, 23, 29, 37, 38 and 50**

**United States Patent and Trademark Office**

**Reg. No. 3,393,767**

**Registered Mar. 11, 2008**

**TRADEMARK  
PRINCIPAL REGISTER**

**THUMBPRINT MYSTERIES**

NTC/CONTEMPORARY PUBLISHING GROUP,  
INC. (ILLINOIS CORPORATION)  
4255 WEST TOUHY  
LINCOLNWOOD, IL 60646

FOR: MYSTERY BOOKS IN THE AREA OF  
EDUCATIONAL ADULT- LEVEL READING, IN  
CLASS 16 (U.S. CLS. 2, 5, 22, 23, 29, 37, 38 AND 50).

FIRST USE 1-4-1999; IN COMMERCE 1-4-1999.

NO CLAIM IS MADE TO THE EXCLUSIVE  
RIGHT TO USE "MYSTERIES", APART FROM  
THE MARK AS SHOWN.

SER. NO. 75-701,196, FILED 5-6-1999.

TRICIA SONNEBORN, EXAMINING ATTORNEY

**Int. Cl.: 35**

**Prior U.S. Cls.: 100, 101 and 102**

**United States Patent and Trademark Office**

**Reg. No. 3,393,768**

**Registered Mar. 11, 2008**

**SERVICE MARK  
PRINCIPAL REGISTER**

**TIME WARNER**

TIME WARNER INC. (DELAWARE CORPORATION)  
75 ROCKEFELLER PLAZA  
NEW YORK, NY 10019

FOR: COMPUTER ON-LINE RETAIL SERVICES, VIA A GLOBAL COMPUTER NETWORK, FEATURING PRE-RECORDED AUDIO AND VIDEO CASSETTES, COMPACT DISCS, CD-ROMS, DVDS AND COMPUTER SOFTWARE, GALLERY AND ANIMATION ARTWORK, BOOKS, MAGAZINES, COMIC BOOKS AND OTHER PUBLICATIONS, POSTERS, PHOTOGRAPHS, COLORING BOOKS, PRINTED MUSIC, TRADING CARDS, HOUSE PLANS, SCHOOL SUPPLIES, OFFICE SUPPLIES, PARTY SUPPLIES, RADIO AND ALARM CLOCKS WATCHES, JEWELRY, KEY CHAINS, GIFT BASKETS, FELT AND CLOTH PENNANTS, FLAGS, BANNERS, PET ACCESSORIES, HOME DECORATING PRODUCTS, INFLATABLE CHAIRS, STEEL LICENSE PLATES AND FRAMES, STEEL STREET SIGNS FOR DECORATIVE USE, COOKIE JARS, TEAPOTS, COFFEE MUGS, DINNERWARE, HAIR

ACCESSORIES, CLOTHING, FOOTWEAR, HEADGEAR, TOYS, DOLLS, GAMES PUZZLES, ELECTRONIC TOYS AND GAMES, INTERACTIVE TOYS, UMBRELLAS, BACKPACKS, TOTE BAGS, DIAPER BAGS, DUFFEL BAGS, BRIEFCASES, WALLETS, BED LINENS, LAMPS, INFANT MOBILES, SPORTS EQUIPMENT, AND SPORTS-RELATED COLLECTIBLES; TICKET AGENCY SERVICES FOR SPORTING EVENTS AND CONCERTS; LICENSING IN THE FIELD OF MOTION PICTURES, IN CLASS 35 (U.S. CLS. 100, 101 AND 102).

FIRST USE 10-19-1999; IN COMMERCE 10-19-1999.

OWNER OF U.S. REG. NOS. 1,816,474, 1,940,977 AND OTHERS.

SER. NO. 75-773,781, FILED 8-12-1999.

CIMMERIAN COLEMAN, EXAMINING ATTORNEY

**Int. Cl.: 12**

**Prior U.S. Cls.: 19, 21, 23, 31, 35 and 44**

**United States Patent and Trademark Office**

**Reg. No. 3,393,769**

**Registered Mar. 11, 2008**

**TRADEMARK  
PRINCIPAL REGISTER**

**DIRT MASTER**

L. DEVITT, MICHEAL (UNITED STATES INDIVIDUAL)  
140 EAST 14TH AVE.  
ESCONDIDO, CA 92025

FOR: BICYCLES; BICYCLE PARTS, NAMELY, BICYCLE FRAMES, HANDLEBARS, FORKS, STEMS, BICYCLE SAFETY PADS, RACING NUMBER PLATES, IN CLASS 12 (U.S. CLS. 19, 21, 23, 31, 35 AND 44).

FIRST USE 9-11-1973; IN COMMERCE 9-11-1973.

NO CLAIM IS MADE TO THE EXCLUSIVE RIGHT TO USE "DIRT", APART FROM THE MARK AS SHOWN.

SER. NO. 76-073,142, FILED 6-19-2000.

DAVID ELTON, EXAMINING ATTORNEY

**Int. Cl.: 16**

**Prior U.S. Cls.: 2, 5, 22, 23, 29, 37, 38 and 50**

**United States Patent and Trademark Office**

**Reg. No. 3,393,770**

**Registered Mar. 11, 2008**

**TRADEMARK  
PRINCIPAL REGISTER**

**TRUCK MART**

TRADER PUBLISHING COMPANY (VIRGINIA  
PARTNERSHIP)  
100 WEST PLUME STREET  
NORFOLK, VA 23510

FOR: PERIODICAL MAGAZINE FEATURING  
CLASSIFIED ADVERTISING, IN CLASS 16 (U.S.  
CLS. 2, 5, 22, 23, 29, 37, 38 AND 50).

FIRST USE 2-28-2000; IN COMMERCE 2-28-2000.

REGISTRATION LIMITED TO THE AREA COM-  
PRISING THE UNITED STATES, EXCLUDING THE  
FOLLOWING COUNTRIES IN WESTERN PENN-  
SYLVANIA: ALLEGHENY, ARMSTRONG, BEA-  
VER, BUTLER, CLARION, CAMBRIAN, CLEAR

FIELD, FAYETTE, GREENE, INDIANA, JEFFER-  
SON, LAWRENCE, MERCER, SOMERSET, WA-  
SHINGTON, WESTMORELAND AND VENANGO  
PURSUANT TO CONCURRENT USE PROCEEDING  
94002146. CONCURRENT REGISTRATION WITH  
THE JOSEPH COMPANY, INC. 1406 PITTSBURGH  
STREET, CHESWICK, PA 15024.

NO CLAIM IS MADE TO THE EXCLUSIVE  
RIGHT TO USE "TRUCK", APART FROM THE  
MARK AS SHOWN.

SER. NO. 76-075,444, FILED 6-22-2000.

MIDGE BUTLER, EXAMINING ATTORNEY

**Int. Cl.: 42**

**Prior U.S. Cls.: 100 and 101**

**United States Patent and Trademark Office**

**Reg. No. 3,393,771**

**Registered Mar. 11, 2008**

---

**SERVICE MARK  
PRINCIPAL REGISTER**

**ADEPTIA**

ADEPTIA INC. (DELAWARE CORPORATION)  
350 WEST HUBBARD, SUITE 400  
CHICAGO, IL 60610

BUSINESS DATA, IN THE FIELD OF DATA INTE-  
GRATION AND BUSINESS PROCESS MANAGE-  
MENT, IN CLASS 42 (U.S. CLS. 100 AND 101).

FOR: PROVIDING BUSINESS TO BUSINESS  
SOFTWARE DEVELOPMENT SERVICES FOR OTHERS,  
NAMESLY, DEVELOPMENT FOR OTHERS OF  
SOFTWARE PROGRAMS THAT FACILITATE THE  
FORMATTING, CONVERSION AND DELIVERY OF

FIRST USE 7-1-2000; IN COMMERCE 7-1-2000.

SER. NO. 76-079,893, FILED 6-27-2000.

KAREN M. STRYZ, EXAMINING ATTORNEY



**Int. Cl.: 9**

**Prior U.S. Cls.: 21, 23, 26, 36 and 38**

**United States Patent and Trademark Office**

**Reg. No. 3,393,772**

**Registered Mar. 11, 2008**

**TRADEMARK  
PRINCIPAL REGISTER**

**ENTUITY**

ENTUITY INC. (NEW YORK CORPORATION)  
245 PARK AVENUE, 24TH FLOOR  
NEW YORK, NY 10167

FOR: COMPUTER SOFTWARE AND HARDWARE FOR THE PURPOSE OF MANAGING COMPUTER NETWORK INFRASTRUCTURES, BUT EXCLUDING TELECOMMUNICATIONS PRODUCTS, NAMELY, TELECOMMUNICATIONS COMPUTER PROGRAMS AND HARDWARE FOR USE WITH A TELECOMMUNICATIONS SWITCH OR TELECOMMUNICATIONS CLIENT SERVER,

TO PROVIDE VOICE MAIL, VOICE MESSAGING AND RESPONSE, FACSIMILE MESSAGING AND RESPONSE, IMAGE MESSAGING AND RESPONSE, AND AN ELECTRONIC MAIL INTERFACE, IN CLASS 9 (U.S. CLS. 21, 23, 26, 36 AND 38).

FIRST USE 4-1-2000; IN COMMERCE 4-1-2000.

SER. NO. 76-109,211, FILED 8-15-2000.

BRENDAN REGAN, EXAMINING ATTORNEY

**Int. Cl.: 33**

**Prior U.S. Cls.: 47 and 49**

**United States Patent and Trademark Office**

**Reg. No. 3,393,773**

**Registered Mar. 11, 2008**

**TRADEMARK  
PRINCIPAL REGISTER**



PERNOD RICARD USA, LLC (INDIANA LTD  
LIAB CO)  
100 MANHATTANVILLE ROAD  
PURCHASE, NY 10577

FOR: DISTILLED SPIRIT SPECIALTY, NAMELY,  
A COCONUT RUM, IN CLASS 33 (U.S. CLS. 47 AND  
49).

FIRST USE 2-0-1983; IN COMMERCE 2-0-1983.

OWNER OF U.S. REG. NOS. 1,261,893 AND  
1,374,134.

NO CLAIM IS MADE TO THE EXCLUSIVE  
RIGHT TO USE THE OUTLINE OF THE BOTTLE  
CAP, APART FROM THE MARK AS SHOWN.

THE COLOR(S) WHITE, BROWN AND ORANGE  
IS/ARE CLAIMED AS A FEATURE OF THE MARK.

THE MARK CONSISTS OF THE WORD "MAL-  
IBU" AND THE DESIGN OF TWO PALM TREES  
WITH A SETTING SUN, ALL IN COMBINATION  
WITH A WHITE BOTTLE. THE COLOR WHITE IS A  
FEATURE OF THE MARK. THE DOTTED LINES  
ARE NOT A PART OF THE MARK AND MERELY  
SERVE TO SHOW THE PLACEMENT OF THE  
MARK ON THE CONTAINER FOR THE GOODS.  
THE LINING SHOWN IN THE DRAWING APPEARS  
TO SHOW THE SHAPE OF THE BOTTLE AND IS  
NOT INTENDED TO INDICATE COLOR. THE BOT-  
TLE IS WHITE; THE SUN IS ORANGE; AND THE  
PALM TREES, WORDING AND BOTTLE CAP ARE  
ALL BROWN.

SER. NO. 76-115,599, FILED 8-23-2000.

LINDA M. KING, EXAMINING ATTORNEY

**Int. Cls.: 38 and 42**

**Prior U.S. Cls.: 100, 101 and 104**

**United States Patent and Trademark Office**

**Reg. No. 3,393,774**

**Registered Mar. 11, 2008**

**SERVICE MARK  
PRINCIPAL REGISTER**

**WISI**

WILHELM SIHN JR. GMBH & CO. KG (FED REP  
GERMANY LIMITED PARTNERSHIP)  
PFORZHEIMER STR. 26  
D-75223 NIEFERN-OSCHELBRONN, FED REP GER-  
MANY

FOR: TELECOMMUNICATION SERVICES,  
NAMELY, CELLULAR TELEPHONE SERVICES, IN  
CLASS 38 (U.S. CLS. 100, 101 AND 104).

FOR: TELECOMMUNICATIONS CONSULTA-  
TION; DESIGN OF TELEPHONE COMMUNICA-  
TIONS SYSTEMS FOR OTHERS; DESIGN OF  
COMPUTER PROGRAMS FOR OTHERS FOR USE  
IN DATA PROCESSING AND INFORMATION PRO-  
CESSING IN THE FIELDS OF COMMUNICATION  
ENGINEERING, TELECOMMUNICATIONS, THE  
PRODUCTION OF ANTENNAS, AMPLIFIER TECH-  
NOLOGY, SATELLITE RECEIVERS AND TRANS-  
MITTERS, RADIO TRANSMISSION SYSTEMS,  
MOBILE TELEVISION TRANSMISSION SYSTEMS,

OPTICAL TRANSMISSION TECHNOLOGY; TECH-  
NICAL CONSULTANCY, NAMELY, COMPUTER  
CONSULTATION FOR THIRD PARTIES; DESIGN  
OF SYSTEMS AND EQUIPMENT, NAMELY, COM-  
PUTERS FOR USE IN THE FIELDS OF COMMU-  
N I C A T I O N   E N G I N E E R I N G ,  
TELECOMMUNICATIONS, ELECTRICAL ENGI-  
NEERING AND OF ELECTRONICS, IN CLASS 42  
(U.S. CLS. 100 AND 101).

PRIORITY CLAIMED UNDER SEC. 44(D) ON FED  
REP GERMANY APPLICATION NO. 001904747,  
FILED 9-28-2000, REG. NO. 001904747, DATED 8-18-  
2003, EXPIRES 9-28-2010.

OWNER OF U.S. REG. NO. 1,216,488.

SER. NO. 76-206,431, FILED 2-7-2001.

BARBARA GAYNOR, EXAMINING ATTORNEY

**Int. Cl.: 20**

**Prior U.S. Cls.: 2, 13, 22, 25, 32 and 50**

**United States Patent and Trademark Office**

**Reg. No. 3,393,775**

**Registered Mar. 11, 2008**

---

**TRADEMARK  
PRINCIPAL REGISTER**

**SIGNATURE SERIES**

BUDGET BLINDS, INC. (CALIFORNIA COR-  
PORATION)  
1927 NORTH GLASSELL STREET  
ORANGE, CA 92865

NO CLAIM IS MADE TO THE EXCLUSIVE  
RIGHT TO USE "SERIES", APART FROM THE  
MARK AS SHOWN.

FOR: WINDOW BLINDS, IN CLASS 20 (U.S. CLS. 2,  
13, 22, 25, 32 AND 50).

SER. NO. 76-229,138, FILED 3-21-2001.

FIRST USE 4-12-2001; IN COMMERCE 4-12-2001.

JENNIFER MARTIN, EXAMINING ATTORNEY

**Int. Cls.: 9, 37 and 45**

**Prior U.S. Cls.: 21, 23, 26, 36, 38, 100, 101, 103 and 106**

**United States Patent and Trademark Office**

**Reg. No. 3,393,776**

**Registered Mar. 11, 2008**

**TRADEMARK  
SERVICE MARK  
PRINCIPAL REGISTER**

**CHUBB SECURITY SYSTEMS**

CHUBB INTERNATIONAL HOLDINGS LIMITED  
(UNITED KINGDOM CORPORATION)  
PENTAGON HOUSE  
SIR FRANK WHITTLE ROAD  
DERBY, UNITED KINGDOM DE21 4XA

FOR: ELECTRONIC SECURITY PRODUCTS, NAMELY INTRUSION ALARM EQUIPMENT, INTRUSION AND FIRE MONITORING EQUIPMENT, INTRUDER DETECTION DEVICES, ACCESS CONTROL READERS AND SYSTEMS, CLOSED CIRCUIT VIDEO EQUIPMENT, ASSET AND VEHICLE TRACKING EQUIPMENT, PERSONAL PANIC AND LIFE SAFETY MONITORING EQUIPMENT AND COMPUTERS AND COMPUTER SOFTWARE TO MONITOR, CONTROL AND MANAGE ELECTRONIC SECURITY PRODUCTS, IN CLASS 9 (U.S. CLS. 21, 23, 26, 36 AND 38).

FOR: INSTALLATION OF ELECTRONIC SECURITY PRODUCTS, IN CLASS 37 (U.S. CLS. 100, 103 AND 106).

FOR: EMERGENCY RESPONSE AND MONITORING, SERVICING AND INSPECTION OF ELECTRONIC SECURITY PRODUCTS, AND SECURITY CONSULTATION, IN CLASS 45 (U.S. CLS. 100 AND 101).

PRIORITY CLAIMED UNDER SEC. 44(D) ON CANADA APPLICATION NO. 1119387, FILED 10-24-2001, REG. NO. TMA599277, DATED 1-13-2004, EXPIRES 1-13-2019.

NO CLAIM IS MADE TO THE EXCLUSIVE RIGHT TO USE "SECURITY SYSTEMS", APART FROM THE MARK AS SHOWN.

SER. NO. 76-333,302, FILED 11-2-2001.

MICHAEL ENGEL, EXAMINING ATTORNEY

**Int. Cl.: 29**

**Prior U.S. Cl.: 46**

**United States Patent and Trademark Office**

**Reg. No. 3,393,777**

**Registered Mar. 11, 2008**

**TRADEMARK  
PRINCIPAL REGISTER**



THE GROVE, INC. (LOUISIANA CORPORATION)  
3 WESTBROOK CORPORATE CENTER  
SUITE 500  
WESTCHESTER, IL 60154

OWNER OF U.S. REG. NO. 3,167,030.

SER. NO. 76-349,265, FILED 12-17-2001.

FOR: CANDIED FRUITS, IN CLASS 29 (U.S. CL.  
46).

FIRST USE 0-0-1986; IN COMMERCE 0-0-1986.

VIVIAN MICZNIK FIRST, EXAMINING ATTOR-  
NEY

**Int. Cl.: 43**

**Prior U.S. Cls.: 100 and 101**

**United States Patent and Trademark Office**

**Reg. No. 3,393,778**

**Registered Mar. 11, 2008**

**SERVICE MARK  
PRINCIPAL REGISTER**

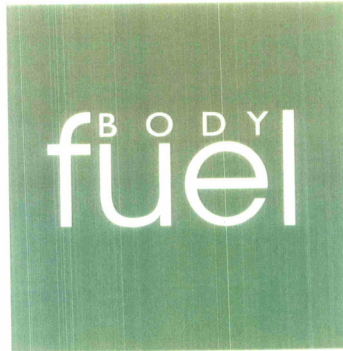

ADVANCED CONCEPT INVEST S.A. (GREECE CORPORATION)  
5, STADIOU STREET  
ATHENS 105 62, GREECE

FOR: RESTAURANT SERVICES, CAFÉ SERVICES, FAST FOOD RESTAURANT SERVICES AND CATERING SERVICES, ALL FEATURING HEALTH FOOD, IN CLASS 43 (U.S. CLS. 100 AND 101).

PRIORITY CLAIMED UNDER SEC. 44(D) ON GREECE APPLICATION NO. 160938, FILED 2-1-2002, REG. NO. 160938, DATED 10-17-2003, EXPIRES 2-1-2012.

OWNER OF ERPN CMNTY TM OFC REG. NO. 002612059, DATED 11-21-2003, EXPIRES 3-12-2012.

THE COLOR(S) GREEN AND WHITE IS/ARE CLAIMED AS A FEATURE OF THE MARK.

THE MARK COMPRISES THE WORDS BODY FUEL IN WHITE LETTERS SUPERIMPOSED ON A GREEN SQUARE.

SER. NO. 76-423,339, FILED 6-19-2002.

WENDY GOODMAN, EXAMINING ATTORNEY

**Int. Cl.: 36**

**Prior U.S. Cls.: 100, 101 and 102**

**United States Patent and Trademark Office**

**Reg. No. 3,393,779**

**Registered Mar. 11, 2008**

---

**SERVICE MARK  
PRINCIPAL REGISTER**

**REDDI-CHECKING**

NEVADA STATE BANK (NEVADA CORPORATION)  
POST OFFICE BOX 990  
LAS VEGAS, NV 89125

FIRST USE 6-1-1993; IN COMMERCE 6-1-1993.

SER. NO. 76-487,874, FILED 2-6-2003.

FOR: FINANCIAL SERVICES; NAMELY, BANKING; CHECKING ACCOUNTS, CHECKING ACCOUNT SERVICES, IN CLASS 36 (U.S. CLS. 100, 101 AND 102).

PRISCILLA MILTON, EXAMINING ATTORNEY



**Int. Cls.: 3 and 35**

**Prior U.S. Cls.: 1, 4, 6, 50, 51, 52, 100, 101 and 102**

**Reg. No. 3,393,780**

**United States Patent and Trademark Office**

**Registered Mar. 11, 2008**

**TRADEMARK  
SERVICE MARK  
PRINCIPAL REGISTER**

**POUT**

POUT LIMITED (UNITED KINGDOM CORPORATION)  
C/O EC COMMUNICATIONS LTD.  
80 CHARLOTTE STREET  
LONDON W1A 1AQ, UNITED KINGDOM 0

FOR: COSMETICS; MAKE-UP; COMPACTS CONTAINING MAKE-UP; MAKE-UP REMOVER; LIP GLOSS; LIP BALM; SKIN LOTIONS; AND SKIN MOISTURIZER, IN CLASS 3 (U.S. CLS. 1, 4, 6, 50, 51 AND 52).

FIRST USE 4-0-1997; IN COMMERCE 12-0-1997.

FOR: RETAIL STORE SERVICES FEATURING COSMETICS, MAKE-UP, COSMETIC BRUSHES, COMPACTS CONTAINING MAKE-UP, MAKE-UP REMOVER, LIP GLOSS, LIP BALM, SKIN LOTIONS, AND SKIN MOISTURIZER, IN CLASS 35 (U.S. CLS. 100, 101 AND 102).

FIRST USE 4-0-1997; IN COMMERCE 12-0-1997.

OWNER OF U.S. REG. NO. 3,081,118.

SER. NO. 76-494,875, FILED 3-10-2003.

BRIDGETT SMITH, EXAMINING ATTORNEY

**Int. Cl.: 35**

**Prior U.S. Cls.: 100, 101 and 102**

**United States Patent and Trademark Office**

**Reg. No. 3,393,781**

**Registered Mar. 11, 2008**

---

**SERVICE MARK  
PRINCIPAL REGISTER**



GLOBE ELECTRIC COMPANY INC. (CANADA CORPORATION)  
150 ONEIDA DRIVE  
POINTE-CLAIRE, QUEBEC, CANADA H9R 1A8

FOR: WHOLESALE DISTRIBUTORSHIPS FEATURING ELECTRIC BULBS, EXCLUDING SPHERICAL AND GLOBE SHAPED BULBS, AND ELECTRICAL SUPPLIES AND LIGHTING PRODUCTS, EXCLUDING ELECTRIC STRING LIGHTING SETS, IN CLASS 35 (U.S. CLS. 100, 101 AND 102).

PRIORITY CLAIMED UNDER SEC. 44(D) ON CANADA APPLICATION NO. 1,157,110, FILED 10-28-2002, REG. NO. TMA625737, DATED 11-17-2004, EXPIRES 11-17-2019.

OWNER OF U.S. REG. NOS. 2,431,982 AND 2,493,754.

SER. NO. 76-499,525, FILED 3-21-2003.

REBECCA SMITH, EXAMINING ATTORNEY

**Int. Cl.: 5**

**Prior U.S. Cls.: 6, 18, 44, 46, 51 and 52**

**United States Patent and Trademark Office**

**Reg. No. 3,393,782**

**Registered Mar. 11, 2008**

**TRADEMARK  
PRINCIPAL REGISTER**

**PERIOPATCH**

IZUN PHARMACEUTICALS CORPORATION  
(DELAWARE CORPORATION)  
P.O. BOX 4095  
JERUSALEM, ISRAEL

PRIORITY CLAIMED UNDER SEC. 44(D) ON  
ISRAEL APPLICATION NO. 162705, FILED 2-11-  
2003, REG. NO. 162705, DATED 5-5-2004, EXPIRES 2-  
11-2010.

FOR: PHARMACEUTICALS, NAMELY, TOPICAL  
DOSAGE FORMS CONTAINING PLANT-DERIVED  
COMPOSITIONS FOR THE TREATMENT OF GIN-  
GIVITIS, PERIODONTITIS AND OTHER ORAL LE-  
SIONS, IN CLASS 5 (U.S. CLS. 6, 18, 44, 46, 51 AND 52).

SER. NO. 76-535,278, FILED 8-7-2003.

SUSAN HAYASH, EXAMINING ATTORNEY

**Int. Cl.: 35**

**Prior U.S. Cls.: 100, 101 and 102**

**United States Patent and Trademark Office**

**Reg. No. 3,393,783**

**Registered Mar. 11, 2008**

**SERVICE MARK  
PRINCIPAL REGISTER**

**MINE THE VOTE**

NATIONAL MINING ASSOCIATION (DELA-  
WARE CORPORATION)  
101 CONSTITUTION AVENUE, N.W.  
SUITE 500 EAST  
WASHINGTON, DC 20001

FOR: PROVIDING ELECTION INFORMATION  
IN THE NATURE OF INFORMATION ON ABSEN-  
TEE BALLOTS, VOTER REGISTRATION, LEGISLA-  
TORS' VOTING RECORDS, AND OTHER  
MISCELLANEOUS ELECTION INFORMATION; AS-  
SOCIATION SERVICES, NAMELY PROMOTING  
REGULATORY, LEGISLATIVE, POLITICAL, AND  
LEGAL ISSUES OF INTEREST TO THE MINING  
INDUSTRY; PROVIDING AN ON-LINE DATABASE  
AND WEBSITE AND FEATURING ELECTION IN-

FORMATION, INCLUDING INFORMATION ON  
ABSENTEE BALLOTS, VOTER REGISTRATION,  
LEGISLATORS' VOTING RECORDS, AND OTHER  
MISCELLANEOUS ELECTION INFORMATION, IN  
CLASS 35 (U.S. CLS. 100, 101 AND 102).

FIRST USE 2-10-2004; IN COMMERCE 2-10-2004.

THE MARK CONSISTS OF STANDARD CHAR-  
ACTERS WITHOUT CLAIM TO ANY PARTICULAR  
FONT, STYLE, SIZE, OR COLOR.

SER. NO. 76-585,610, FILED 4-8-2004.

LAURIE MAYES, EXAMINING ATTORNEY

**Int. Cls.: 36 and 41**

**Prior U.S. Cls.: 100, 101, 102 and 107**

**United States Patent and Trademark Office**

**Reg. No. 3,393,784**

**Registered Mar. 11, 2008**

**SERVICE MARK  
PRINCIPAL REGISTER**

**RUSH PHILANTHROPIC**

RUSH PHILANTHROPIC ARTS FOUNDATION,  
INC. (NEW YORK CORPORATION)  
512 SEVENTH AVENUE, 43RD FLOOR  
NEW YORK, NY 10018

FOR: CHARITABLE FUND RAISING, FUND RAISING CEREMONIES AND CHARITABLE SERVICES, NAMELY PROVIDING CHARITABLE FUNDING FOR PROGRAMS RELATING TO THE ARTS, ART EXHIBITIONS, CLASSES, SEMINARS, PRESENTATIONS, WORKSHOPS, PANEL DISCUSSIONS, RALLIES AND SPEECHES RELATING TO THE ARTS, POLITICAL AWARENESS ISSUES AND VOTER REGISTRATION DRIVES, PERSONAL AWARENESS, PERSONAL DEVELOPMENT, LEGAL ISSUES, HIV/AIDS ISSUES, LITERACY, EDUCATION AND LEADERSHIP DEVELOPMENT ISSUES, ECONOMIC DEVELOPMENT AND ADVANCEMENT ISSUES, CULTURAL AND SOCIAL AWARENESS ISSUES; PROVIDING AN ONLINE WEBSITE CONTAINING INFORMATION IN THE AFOREMENTIONED CHARITABLE FUND RAISING SERVICES, IN CLASS 36 (U.S. CLS. 100, 101 AND 102).

FIRST USE 10-1-1995; IN COMMERCE 10-1-1995.

FOR: EDUCATIONAL SERVICES NAMELY ARRANGING AND CONDUCTING CLASSES, SEMINARS, PRESENTATIONS, WORKSHOPS,

EXHIBITIONS, ART EXHIBITIONS, PANEL DISCUSSIONS, CEREMONIES, RALLIES AND SPEECHES RELATING TO THE ARTS, POLITICAL AWARENESS ISSUES AND VOTER REGISTRATION DRIVES, PERSONAL AWARENESS, PERSONAL DEVELOPMENT, LEGAL ISSUES, HIV/AIDS ISSUES, LITERACY, EDUCATION AND LEADERSHIP DEVELOPMENT ISSUES, ECONOMIC DEVELOPMENT AND ADVANCEMENT ISSUES, CULTURAL AND SOCIAL AWARENESS ISSUES AND DISTRIBUTING COURSE MATERIALS IN CONNECTION THEREWITH; PROVIDING AN ONLINE WEBSITE CONTAINING INFORMATION IN THE AFOREMENTIONED EDUCATIONAL SERVICES, IN CLASS 41 (U.S. CLS. 100, 101 AND 107).

FIRST USE 10-1-1995; IN COMMERCE 10-1-1995.

THE MARK CONSISTS OF STANDARD CHARACTERS WITHOUT CLAIM TO ANY PARTICULAR FONT, STYLE, SIZE, OR COLOR.

NO CLAIM IS MADE TO THE EXCLUSIVE RIGHT TO USE "PHILANTHROPIC" , APART FROM THE MARK AS SHOWN.

SER. NO. 76-599,402, FILED 6-24-2004.

CAROLYN CATALDO, EXAMINING ATTORNEY

**Int. Cls.: 35 and 41**

**Prior U.S. Cls.: 100, 101, 102 and 107**

**United States Patent and Trademark Office**

**Reg. No. 3,393,785**

**Registered Mar. 11, 2008**

**SERVICE MARK  
PRINCIPAL REGISTER**

# RUSH ARTS GALLERY

RUSH PHILANTHROPIC ARTS FOUNDATION,  
INC. (NEW YORK CORPORATION)  
512 SEVENTH AVENUE, 43RD FLOOR  
NEW YORK, NY 10018

FOR: ART GALLERIES, IN CLASS 35 (U.S. CLS.  
100, 101 AND 102).

FIRST USE 11-1-1996; IN COMMERCE 11-1-1996.

FOR: ENTERTAINMENT SERVICE IN THE NAT-  
URE OF ARTISTIC PERFORMANCES, NAMELY,  
MUSICAL, THEATRICAL AND SPOKEN-WORD  
PERFORMANCES; EDUCATIONAL LECTURES IN  
THE FIELD OF ART; ART EXHIBITIONS, IN CLASS  
41 (U.S. CLS. 100, 101 AND 107).

FIRST USE 11-1-1996; IN COMMERCE 11-1-1996.

THE MARK CONSISTS OF STANDARD CHAR-  
ACTERS WITHOUT CLAIM TO ANY PARTICULAR  
FONT, STYLE, SIZE, OR COLOR.

NO CLAIM IS MADE TO THE EXCLUSIVE  
RIGHT TO USE ARTS GALLERY, APART FROM  
THE MARK AS SHOWN.

SER. NO. 76-599,404, FILED 6-24-2004.

CAROLYN CATALDO, EXAMINING ATTORNEY

**Int. Cls.: 16 and 17**

**Prior U.S. Cls.: 1, 2, 5, 12, 13, 22, 23, 29, 35, 37, 38 and 50**

**Reg. No. 3,393,786**

**United States Patent and Trademark Office**

**Registered Mar. 11, 2008**

**TRADEMARK  
PRINCIPAL REGISTER**



MASK-OFF COMPANY, INC. (CALIFORNIA CORPORATION)  
345 WEST MAPLE AVENUE  
MONROVIA, CA 91016

FOR: PRESSURE SENSITIVE PROTECTIVE PAPERS, NAMELY, MASKING PAPER USED AS A MASKING FOR SURFACE PROTECTION, IN CLASS 16 (U.S. CLS. 2, 5, 22, 23, 29, 37, 38 AND 50).

FIRST USE 6-23-2004; IN COMMERCE 6-23-2004.

FOR: PRESSURE SENSITIVE PROTECTIVE FILMS, NAMELY, PLASTIC FILMS USED AS A

MASKING FOR SURFACE PROTECTION, IN CLASS 17 (U.S. CLS. 1, 5, 12, 13, 35 AND 50).

FIRST USE 3-4-1953; IN COMMERCE 3-4-1953.

THE MARK CONSISTS OF A FANCIFUL DEPICTION OF THE LETTERS "MO", SUPERIMPOSED OVER EACH OTHER, WITH THE WORD "MASK-OFF" IN A SEMI-CIRCLE AT THE BASE OF THE "M".

SER. NO. 76-601,012, FILED 7-6-2004.

GEORGE LORENZO, EXAMINING ATTORNEY

**Int. Cl.: 36**

**Prior U.S. Cls.: 100, 101 and 102**

**United States Patent and Trademark Office**

**Reg. No. 3,393,787**

**Registered Mar. 11, 2008**

**SERVICE MARK  
PRINCIPAL REGISTER**

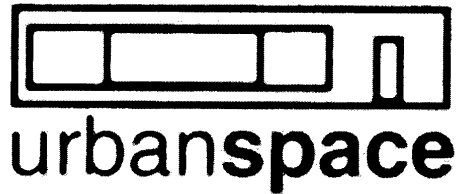

URBANSPEACE REALTORS, LLP (TEXAS LIMITED LIABILITY PARTNERSHIP)  
800 W. 5TH STREET, SUITE 100  
AUSTIN, TX 78703

FOR: REAL ESTATE AGENCY, BROKERAGE, CONSULTATION, LISTING, MANAGEMENT, AND VALUATION SERVICES, IN CLASS 36 (U.S. CLS. 100, 101 AND 102).

FIRST USE 8-0-2000; IN COMMERCE 8-0-2000.

SEC. 2(F) AS TO URBANSPEACE.

SER. NO. 76-614,159, FILED 9-29-2004.

SHARON MEIER, EXAMINING ATTORNEY



**Int. Cl.: 17**

**Prior U.S. Cls.: 1, 5, 12, 13, 35 and 50**

**United States Patent and Trademark Office**

**Reg. No. 3,393,788**

**Registered Mar. 11, 2008**

**TRADEMARK  
PRINCIPAL REGISTER**

# MOLD BLOCKER

ILLINOIS TOOL WORKS INC. (DELAWARE  
CORPORATION)  
3600 WEST LAKE AVENUE  
GLENVIEW, IL 60026

FOR: ADHESIVE SEALANTS FEATURING BIO-  
CIDE ADDITIVES FOR COATING PARTS OF AIR-  
CRAFT AND PARTS OF MAJOR APPLIANCES, FOR  
COATING PRODUCTS IN THE AEROSPACE IN-  
DUSTRY AND ARCHITECTURAL INDUSTRY,  
FOR COATING PLASTICS, AND FOR COATING  
RESIDENTIAL AND COMMERCIAL WEATHER  
RESISTIVE BARRIER PRODUCTS USED IN BUILD-  
ING CONSTRUCTION, NONE OF THE FOREGO-  
ING BEING FILLERS OR SEALERS FOR BRICK  
AND BLOCK, IN CLASS 17 (U.S. CLS. 1, 5, 12, 13, 35  
AND 50).

FIRST USE 10-0-2004; IN COMMERCE 1-0-2005.

THE MARK CONSISTS OF STANDARD CHAR-  
ACTERS WITHOUT CLAIM TO ANY PARTICULAR  
FONT, STYLE, SIZE, OR COLOR.

NO CLAIM IS MADE TO THE EXCLUSIVE  
RIGHT TO USE "MOLD" , APART FROM THE  
MARK AS SHOWN.

SER. NO. 76-615,595, FILED 10-13-2004.

MAUREEN DALL, EXAMINING ATTORNEY

Int. Cl.: 4

Prior U.S. Cls.: 1, 6 and 15

United States Patent and Trademark Office

Reg. No. 3,393,789

Registered Mar. 11, 2008

TRADEMARK  
PRINCIPAL REGISTER



TED SHRED'S ORIGINAL SURF WAX CANDLE  
CO., LTD. (NEW JERSEY CORPORATION)  
154 MONMOUTH STREET  
PO BOX 8535  
RED BANK, NJ 07701

FOR: CANDLES, IN CLASS 4 (U.S. CLS. 1, 6 AND 15).

FIRST USE 5-10-2004; IN COMMERCE 6-13-2004.

NO CLAIM IS MADE TO THE EXCLUSIVE RIGHT TO USE "ORIGINAL SURF WAX CANDLE" AND "CO. LTD.", APART FROM THE MARK AS SHOWN.

THE NAME TED SHRED'S IDENTIFIES A LIVING INDIVIDUAL WHOSE CONSENT IS OF RECORD. THE LIKENESS IN THE MARK DOES NOT IDENTIFY A LIVING INDIVIDUAL.

THE COLOR(S) BLACK, BLUE, AQUA, RED, WHITE AND YELLOW IS/ARE CLAIMED AS A FEATURE OF THE MARK.

THE COLOR BLACK APPEARS IN THE OUTLINE OF THE OVAL, THE OUTLINE OF THE WORDING TED SHRED'S, THE WORDING ORIGINAL SURF WAX CANDLE, AND HIGHLIGHTS IN THE VARIOUS DESIGN ELEMENTS, WHILE BLUE APPEARS ON THE OCEAN AND THE SKY, AQUA ON THE WAVE, THE RED ON THE FLOWERS, THE SETTING SUN, THE SURFBOARD AND THE BATHING SUIT, AND WHITE ON THE TOPS OF THE WAVE AND IN THE WORDING CO. LTD.

SER. NO. 76-616,686, FILED 10-19-2004.

BRIAN PINO, EXAMINING ATTORNEY

**Int. Cl.: 11**

**Prior U.S. Cls.: 13, 21, 23, 31 and 34**

**United States Patent and Trademark Office**

**Reg. No. 3,393,790**

**Registered Mar. 11, 2008**

**TRADEMARK  
PRINCIPAL REGISTER**

**MOISTURE FLUSH**

DRYAIR INC. (SASKATCHEWAN CORPORATION)  
BOX 126, 606 HIGHWAY DRIVE  
ST. BRIEUX, SASKATCHEWAN, CANADA S0K 3V0

FOR: HVAC SYSTEMS AND COMPONENTS, NAMELY PORTABLE OR STATIONARY HEATING SYSTEMS COMPRISING HEATERS OR HEAT EXCHANGERS FOR USE IN RESIDENTIAL, COMMERCIAL OR INDUSTRIAL APPLICATIONS; HEATING SYSTEMS COMPRISING HEATING UNITS AND CONDUITS FOR THE USE IN THAWING OF GROUND; AIR PURIFYING UNITS FOR DOMESTIC, COMMERCIAL AND INDUSTRIAL USE; FLUID COOLERS FOR CIRCULATING COOLED FLUID FOR USE IN COOLING BUILDINGS AND CURING CONCRETE; FLUID COOLING SYSTEMS COMPRISING FLUID COOLERS, CONDUITS AND HEAT EXCHANGERS FOR THE CIRCULATION OF COOLED FLUID IN THE COOLING OF BUILDINGS AND CURING OF CONCRETE; AIR CONDITIONING SYSTEMS NAMELY AIR CONDITIONERS OR COOLING UNITS FOR USE IN BUILDING ENVIRONMENTAL CONDITIONING

AND COOLING APPLICATIONS; HEATING SYSTEMS COMPRISING HEATING UNITS, CONDUITS AND HEAT EXCHANGERS FOR BUILDING DRY-OUT APPLICATIONS, RESTORATION OF WATER DAMAGED BUILDINGS AND CONTROLLING HUMIDITY IN BUILDING ENVIRONMENTS, IN CLASS 11 (U.S. CLS. 13, 21, 23, 31 AND 34).

THE MARK CONSISTS OF STANDARD CHARACTERS WITHOUT CLAIM TO ANY PARTICULAR FONT, STYLE, SIZE, OR COLOR.

OWNER OF CANADA REG. NO. 1236396, DATED 10-10-2007, EXPIRES 10-10-2022.

NO CLAIM IS MADE TO THE EXCLUSIVE RIGHT TO USE "MOISTURE", APART FROM THE MARK AS SHOWN.

SER. NO. 76-619,119, FILED 11-3-2004.

KAREN K. BUSH, EXAMINING ATTORNEY

**Int. Cls.: 16, 35, 36, 42 and 45**

**Prior U.S. Cls.: 2, 5, 22, 23, 29, 37, 38, 50, 100, 101 and 102**

**United States Patent and Trademark Office**

**Reg. No. 3,393,791**

**Registered Mar. 11, 2008**

**TRADEMARK  
SERVICE MARK  
PRINCIPAL REGISTER**

**THE POWER OF INCLUSIVE LEADERSHIP**

EXECUTIVE LEADERSHIP COUNCIL (D.C. CORPORATION)  
1001 N. FAIRFAX STREET  
SUITE 300  
ALEXANDRIA, VA 22314

FOR: PRINTED INSTRUCTIONAL, TEACHING AND EDUCATIONAL MATERIALS IN THE FIELD OF DIVERSITY IN THE WORKPLACE FOR BUSINESSES, COMMUNITIES AND OTHER ORGANIZATIONS, IN CLASS 16 (U.S. CLS. 2, 5, 22, 23, 29, 37, 38 AND 50).

FIRST USE 0-0-2004; IN COMMERCE 0-0-2004.

FOR: ASSOCIATION SERVICES, NAMELY, PROMOTING THE INTERESTS OF AFRICAN AMERICAN MANAGERS AND BUSINESS EXECUTIVES; PUBLIC ADVOCACY SERVICES, NAMELY, PROVIDING BUSINESS INFORMATION, ADVISORY AND CONSULTANCY SERVICES TO PROMOTE AWARENESS OF DIVERSITY IN THE WORKPLACE FOR BUSINESSES, COMMUNITIES AND OTHER ORGANIZATIONS; ARRANGING AND CONDUCTING BUSINESS CONFERENCES AND SEMINARS IN THE FIELD OF LEADERSHIP AND DIVERSITY IN THE WORKPLACE FOR BUSINESSES, COMMUNITIES AND OTHER ORGANIZATIONS, IN CLASS 35 (U.S. CLS. 100, 101 AND 102).

FIRST USE 0-0-2004; IN COMMERCE 0-0-2004.

FOR: CHARITABLE FUND RAISING; ACCEPTING AND ADMINISTERING MONETARY CHARITABLE CONTRIBUTIONS, IN CLASS 36 (U.S. CLS. 100, 101 AND 102).

FIRST USE 0-0-2004; IN COMMERCE 0-0-2004.

FOR: CHARITABLE SERVICES, NAMELY, DESIGN AND MAINTENANCE OF COMPUTER NETWORK ASSOCIATED WITH TECHNOLOGY INITIATIVES, IN CLASS 42 (U.S. CLS. 100 AND 101).

FIRST USE 0-0-2004; IN COMMERCE 0-0-2004.

FOR: PROVIDING INFORMATION ONLINE RELATING TO DIVERSE HUMAN CULTURE AND BELIEFS IN THE WORKPLACE, IN CLASS 45 (U.S. CLS. 100 AND 101).

FIRST USE 0-0-2004; IN COMMERCE 0-0-2004.

THE MARK CONSISTS OF STANDARD CHARACTERS WITHOUT CLAIM TO ANY PARTICULAR FONT, STYLE, SIZE, OR COLOR.

SER. NO. 76-628,904, FILED 1-27-2005.

JEFF DEFORD, EXAMINING ATTORNEY

**Int. Cls.: 16, 18, 20, 21, 24, 25, 27, 28 and 35**

**Prior U.S. Cls.: 1, 2, 3, 5, 13, 19, 20, 22, 23, 25, 29, 30, 32, 33, 37, 38, 39, 40, 41, 42, 50, 100, 101 and 102**

**Reg. No. 3,393,792**

**United States Patent and Trademark Office**

**Registered Mar. 11, 2008**

**TRADEMARK  
SERVICE MARK  
PRINCIPAL REGISTER**

**NC A&T AGGIES**

NORTH CAROLINA A&T STATE UNIVERSITY  
(NORTH CAROLINA EDUCATIONAL INSTITUTION)

1601 EAST MARKET STREET  
GREENSBORO, NC 27411

FOR: DECALS, STICKERS, NOTEBOOKS, FOLDERS, NOTEPADS, STATIONERY, ENVELOPES, GREETING CARDS, NOTE CARDS, DESK TOP BUSINESS CARD HOLDERS, PENS, PENCILS, BOOK COVERS, BOOKENDS, PEN AND PENCIL SETS, PAPER BAGS, POSTERS, POSTCARDS, PAPER BANNERS, BINDERS, NOTEPAD HOLDERS, NOTEBOOK FILLER PAPER, PAPER NAPKINS, PAPER PLACEMATS, PLANNERS, NAMELY, DAILY PLANNERS AND DESK TOP PLANNERS, PRINTED CERTIFICATES AND DIPLOMAS, NEWSLETTERS AND INFORMATIONAL MATERIAL, NAMELY, INFORMATIONAL SHEETS, INFORMATIONAL FLYERS, AND NEWSPAPERS CONCERNING UNIVERSITY ACTIVITIES AND EVENTS, PAPER COASTERS, IN CLASS 16 (U.S. CLS. 2, 5, 22, 23, 29, 37, 38 AND 50).

FIRST USE 7-1-2003; IN COMMERCE 7-1-2003.

FOR: TRUNKS FOR TRAVELING, TRAVEL BAGS, GYM BAGS, TOILETRY CASES SOLD EMPTY, BACKPACKS, WALLETS, CHANGE PURSES, IN CLASS 18 (U.S. CLS. 1, 2, 3, 22 AND 41).

FIRST USE 7-1-2003; IN COMMERCE 7-1-2003.

FOR: CASKETS, BURIAL URNS, PICTURE FRAMES, CHAIRS, END TABLES, COFFEE TABLES, FOLDING TABLES, NON-METAL KEY CHAINS, DECORATIVE WALL PLAQUES, PILLOWS, PLASTIC NOVELTY LICENSE PLATES, PLASTIC BANNERS, DECORATIVE FIGURINES AND STATUES OF PLASTER, PLASTIC AND WOOD, IN CLASS 20 (U.S. CLS. 2, 13, 22, 25, 32 AND 50).

FIRST USE 7-1-2003; IN COMMERCE 7-1-2003.

FOR: DRINKING GLASSES, MUGS, SHOT GLASSES, SQUIRT BOTTLES, NAMELY, SQUEEZE BOTTLES SOLD EMPTY, THERMAL INSULATED BEVERAGE CONTAINERS, PITCHERS, VASES, PLASTIC AND LEATHER COASTERS, DECORATIVE FIGURINES AND STATUES MADE OF CHINA, CRYSTAL, EARTHENWARE, PORCELAIN, AND GLASS, TANKARDS, BOWLS, AND CUPS, IN CLASS 21 (U.S. CLS. 2, 13, 23, 29, 30, 33, 40 AND 50).

FIRST USE 7-1-2003; IN COMMERCE 7-1-2003.

FOR: TABLECLOTHS NOT OF PAPER, BLANKETS, NAMELY BED BLANKETS AND SPORTS BLANKETS FOR OUTDOOR USE, CLOTH FLAGS AND BANNERS, BEDSPREADS, TOWELS, CLOTH COASTERS, IN CLASS 24 (U.S. CLS. 42 AND 50).

FIRST USE 7-1-2003; IN COMMERCE 7-1-2003.

FOR: SHIRTS, T-SHIRTS, JACKETS, SWEATERS, CAPS, SHORTS, ATHLETIC UNIFORMS, NAMELY, CHEERLEADING OUTFITS, SLEEPWEAR, ATHLETIC JERSEYS, SWEATSHIRTS, SWEATPANTS, VISORS, HATS, PARKAS, JOGGING SUITS, NECKTIES, SPORT COATS, SOCKS, BELTS, FOOTWEAR, HEADBANDS, SWEATBANDS, AND VESTS, IN CLASS 25 (U.S. CLS. 22 AND 39).

FIRST USE 7-1-2003; IN COMMERCE 7-1-2003.

FOR: RUGS, IN CLASS 27 (U.S. CLS. 19, 20, 37, 42 AND 50).

FIRST USE 7-1-2003; IN COMMERCE 7-1-2003.

FOR: FOOTBALLS, CHRISTMAS TREE ORNAMENTS, IN CLASS 28 (U.S. CLS. 22, 23, 38 AND 50).

FIRST USE 7-1-2003; IN COMMERCE 7-1-2003.

FOR: RETAIL STORE SERVICES AND ONLINE RETAIL STORE SERVICES IN THE FIELD OF CLOTHING, FURNITURE, TOYS, GAMES, SPORTS

EQUIPMENT, SCHOOL AND OFFICE SUPPLIES, EDUCATIONAL MATERIALS, COMPUTERS, BOOKS, PHOTOGRAPHY, HOUSEWARES, TOWELS, FLOOR COVERINGS, JEWELRY, STATIONERY, PRINTS, PENNANTS, DECALS BEARING NORTH CAROLINA A AND T STATE UNIVERSITY OR ITS STUDENTS, FACILITY OR CAMPUS, IN CLASS 35 (U.S. CLS. 100, 101 AND 102).

FIRST USE 7-1-2003; IN COMMERCE 7-1-2003.

THE MARK CONSISTS OF STANDARD CHARACTERS WITHOUT CLAIM TO ANY PARTICULAR FONT, STYLE, SIZE, OR COLOR.

SER. NO. 76-634,286, FILED 3-24-2005.

ALLISON SCHRODY, EXAMINING ATTORNEY

**Int. Cl.: 9**

**Prior U.S. Cls.: 21, 23, 26, 36 and 38**

**United States Patent and Trademark Office**

**Reg. No. 3,393,793**

**Registered Mar. 11, 2008**

**TRADEMARK  
PRINCIPAL REGISTER**

**EXXE**

MEGANERYUTSUSENTA CO., LTD (JAPAN CORPORATION)  
7-14, HIRAKAWAHONMACHI 3-CHOME  
TOYOHASHI-SHI, AICHI, 440-0038, JAPAN

FOR: GLASSES, NAMELY, OPTICAL GLASSES, PROTECTIVE GLASSES, READING GLASSES, SKI GLASSES, SPECTACLE GLASSES, SPORTS GLASSES, AND FRAMES FOR GLASSES, IN CLASS 9 (U.S. CLS. 21, 23, 26, 36 AND 38).

THE MARK CONSISTS OF STANDARD CHARACTERS WITHOUT CLAIM TO ANY PARTICULAR FONT, STYLE, SIZE, OR COLOR.

PRIORITY CLAIMED UNDER SEC. 44(D) ON JAPAN APPLICATION NO. 2004-107629, FILED 11-25-2004, REG. NO. 4968090, DATED 7-7-2006, EXPIRES 7-7-2016.

SER. NO. 76-638,190, FILED 5-9-2005.

MATTHEW MCDOWELL, EXAMINING ATTORNEY

Int. Cl.: 5

Prior U.S. Cls.: 6, 18, 44, 46, 51 and 52

United States Patent and Trademark Office

Reg. No. 3,393,794

Registered Mar. 11, 2008

TRADEMARK  
PRINCIPAL REGISTER

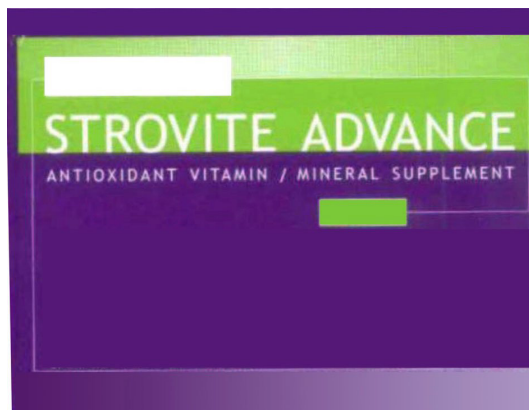

EVERETT LABORATORIES, INC. (NEW JERSEY CORPORATION)  
29 SPRING STREET  
WEST ORANGE, NJ 07052

FOR: PRESCRIPTION VITAMIN AND MINERAL SUPPLEMENT, IN CLASS 5 (U.S. CLS. 6, 18, 44, 46, 51 AND 52).

FIRST USE 5-1-2001, THE MARK WAS FIRST USED ANYWHERE IN A DIFFERENT FORM OTHER THAN THAT SOUGHT TO BE REGISTERED ON 03/19/1985.; IN COMMERCE 5-1-2001, THE MARK WAS FIRST USED IN A DIFFERENT FORM OTHER THAN THAT SOUGHT TO BE REGISTERED IN COMMERCE ON 03/19/1985..

OWNER OF U.S. REG. NOS. 1,824,880, 2,447,856, AND 2,455,180.

NO CLAIM IS MADE TO THE EXCLUSIVE RIGHT TO USE "ANTIOXIDANT VITAMIN" AND

"MINERAL SUPPLEMENT", APART FROM THE MARK AS SHOWN.

THE COLOR(S) GREEN, PURPLE AND WHITE IS/ ARE CLAIMED AS A FEATURE OF THE MARK.

THE MARK CONSISTS OF DISTINCTIVE TRADE DRESS CHARACTERIZING THE PACKAGING FOR OWNER'S PRODUCT. THE COLOR GREEN APPEARS AS TWO RECTANGULAR BARS. THE COLOR PURPLE APPEARS AS BACKGROUND TO THE ENTIRE DRAWING. THE COLOR WHITE APPEARS IN THE WORDING STROVITE ADVANCE ANTI-OXIDANT VITAMIN MINERAL SUPPLEMENT, IN A RECTANGULAR BAR, AND AS LINING TO THE ENTIRE DRAWING.

SER. NO. 76-639,011, FILED 11-1-2004.

TIMOTHY FINNEGAN, EXAMINING ATTORNEY



**Int. Cl.: 44**

**Prior U.S. Cls.: 100 and 101**

**United States Patent and Trademark Office**

**Reg. No. 3,393,795**

**Registered Mar. 11, 2008**

**SERVICE MARK  
PRINCIPAL REGISTER**

**SKINRX**

PATEL, EVA (UNITED STATES INDIVIDUAL)  
1340 SPECIALTY DRIVE - STE. "F"  
VISTA, CA 92081

FOR: MEDICAL SERVICES; NAMELY, PROVID-  
ING SKIN CARE TREATMENT, IN CLASS 44 (U.S.  
CLS. 100 AND 101).

FIRST USE 3-1-1996; IN COMMERCE 6-1-1996.

THE MARK CONSISTS OF STANDARD CHAR-  
ACTERS WITHOUT CLAIM TO ANY PARTICULAR  
FONT, STYLE, SIZE, OR COLOR.

OWNER OF U.S. REG. NO. 2,341,979.

SEC. 2(F).

SER. NO. 76-640,630, FILED 6-7-2005.

MICHAEL WEBSTER, EXAMINING ATTORNEY

**Int. Cl.: 16**

**Prior U.S. Cls.: 2, 5, 22, 23, 29, 37, 38 and 50**

**Reg. No. 3,393,796**

**United States Patent and Trademark Office**

**Registered Mar. 11, 2008**

**TRADEMARK  
PRINCIPAL REGISTER**

**GO BASIC**

GO BASIC, INC. (COLORADO CORPORATION)  
55 EAST 4TH AVENUE, STE 103  
DENVER, CO 80203

THE MARK CONSISTS OF STANDARD CHAR-  
ACTERS WITHOUT CLAIM TO ANY PARTICULAR  
FONT, STYLE, SIZE, OR COLOR.

FOR: PENCIL POUCHES; AND PENCIL POU-  
CHES WITH BOOKMARKERS, SOLD AS A UNIT,  
IN CLASS 16 (U.S. CLS. 2, 5, 22, 23, 29, 37, 38 AND 50).

SER. NO. 76-642,817, FILED 7-14-2005.

FIRST USE 5-23-2002; IN COMMERCE 5-23-2002.

BARBARA RUTLAND, EXAMINING ATTORNEY

**Int. Cl.: 25**

**Prior U.S. Cls.: 22 and 39**

**United States Patent and Trademark Office**

**Reg. No. 3,393,797**

**Registered Mar. 11, 2008**

**TRADEMARK  
PRINCIPAL REGISTER**

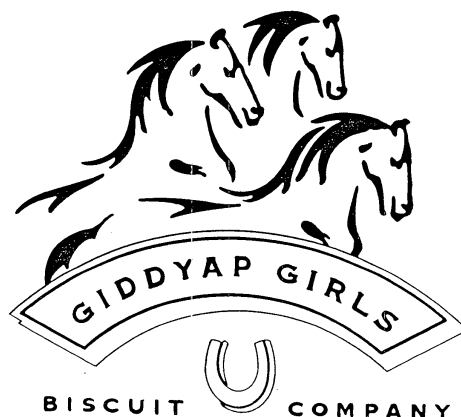

GIDDYAP GIRLS BISCUIT COMPANY, INC.  
(CALIFORNIA CORPORATION)  
817 W. 17TH STREET, #3  
COSTA MESA, CA 92627

FOR: HATS, POLO SHIRTS, T-SHIRTS, OVER-ALLS, SWEATSHIRTS, JEAN JACKETS, FLEECE VESTS, AND FLEECE PULLOVERS, IN CLASS 25 (U.S. CLS. 22 AND 39).

FIRST USE 9-0-1998; IN COMMERCE 9-0-1998.

OWNER OF U.S. REG. NO. 2,402,517.

NO CLAIM IS MADE TO THE EXCLUSIVE RIGHT TO USE "COMPANY", APART FROM THE MARK AS SHOWN.

SER. NO. 76-644,420, FILED 8-5-2005.

AMY MCMENAMIN, EXAMINING ATTORNEY

Int. Cls.: 35 and 42

Prior U.S. Cls.: 100, 101 and 102

United States Patent and Trademark Office

Reg. No. 3,393,798

Registered Mar. 11, 2008

SERVICE MARK  
PRINCIPAL REGISTER



TELESIS CORPORATION (MARYLAND CORPORATION)  
1700 ROCKVILLE PIKE, SUITE 370  
ROCKVILLE, MD 20852

FOR: RECORDS MANAGEMENT SERVICES, NAMELY, DOCUMENT INDEXING FOR OTHERS; MANAGEMENT AND COMPILATION OF COMPUTERIZED DATABASES; COMPUTERIZED RECORDS DATABASE MANAGEMENT; AND LOGISTICS MANAGEMENT IN THE FIELD OF COMPUTER NETWORKS, IN CLASS 35 (U.S. CLS. 100, 101 AND 102).

FIRST USE 11-21-2000; IN COMMERCE 11-21-2000.

FOR: INFORMATION TECHNOLOGY SERVICES AND SOLUTIONS, NAMELY, DOCUMENT DATA TRANSFER FROM ONE COMPUTER FORMAT TO ANOTHER AND CROSS-PLATFORM CONVERSION OF DIGITAL CONTENT INTO OTHER FORMS OF DIGITAL CONTENT; DATA CONVERSION OF COMPUTER PROGRAM DATA OR INFORMATION, IN CLASS 42 (U.S. CLS. 100 AND 101).

FIRST USE 11-21-2000; IN COMMERCE 11-21-2000.

SER. NO. 76-646,488, FILED 9-8-2005.

KELLY BOULTON, EXAMINING ATTORNEY

**Int. Cls.: 38, 39, 42 and 45**

**Prior U.S. Cls.: 100, 101, 104 and 105**

**United States Patent and Trademark Office**

**Reg. No. 3,393,799**

**Registered Mar. 11, 2008**

**SERVICE MARK  
PRINCIPAL REGISTER**

# NetworkSolutions

NETWORK SOLUTIONS, LLC (DELAWARE LTD  
LIAB CO)  
13861 SUNRISE VALLEY DRIVE, SUITE 300  
HERNDON, VA 20171

FOR: ELECTRONIC MAIL SERVICES; EMAIL  
AND WEBSITE FORWARDING SERVICES; PRO-  
VIDING MULTIPLE-USER ACCESS TO A GLOBAL  
COMPUTER INFORMATION NETWORK, IN  
CLASS 38 (U.S. CLS. 100, 101 AND 104).

FIRST USE 8-1-2005; IN COMMERCE 8-1-2005.

FOR: ELECTRONIC STORAGE OF MESSAGES,  
IN CLASS 39 (U.S. CLS. 100 AND 105).

FIRST USE 8-1-2005; IN COMMERCE 8-1-2005.

FOR: COMPUTER SERVICES, NAMELY, DE-  
SIGNING, IMPLEMENTING AND MANAGING  
WEB SITES FOR OTHERS; PROVIDING TEMPOR-  
ARY USE OF ON-LINE NON-DOWNLOADABLE  
COMPUTER SOFTWARE DEVELOPMENT TOOLS  
FOR CREATING WEB SITES AND CREATING  
ELECTRONIC BULLETIN BOARDS FOR THE  
TRANSMISSION OF MESSAGES AMONG COMPU-  
TER USERS; COMPUTER WEB SITE CONSULTA-  
TION; REDIRECTING ELECTRONIC MAIL TO  
CHANGED PERSONAL ELECTRONIC ADDRES-  
SES; HOSTING THE WEB SITES OF OTHERS ON A  
COMPUTER SERVER FOR A GLOBAL COMPUTER  
NETWORK; DOMAIN NAME REGISTRATION FOR  
IDENTIFICATION OF USERS ON A GLOBAL COM-  
PUTER NETWORK, RENEWAL AND ACCOUNT  
MANAGEMENT SERVICES; DOMAIN NAME

SEARCHING SERVICES; COMPUTER VIRUS DE-  
TECTION AND REMOVAL; SPAM FILTERING ON  
A GLOBAL COMPUTER INFORMATION NET-  
WORK, NAMELY, FILTERING OF UNWANTED  
ELECTRONIC MAIL MESSAGES ON A GLOBAL  
COMPUTER INFORMATION NETWORK; COMPU-  
TER SERVICES, NAMELY, ACTING AS AN APPLI-  
CATION SERVICE PROVIDER IN THE FIELD OF  
KNOWLEDGE MANAGEMENT TO HOST COMPU-  
TER APPLICATION SOFTWARE FOR THE COL-  
LECTION, STORAGE AND SHARING OF DATA  
AND INFORMATION IN THE NATURE OF E-MAIL  
ADDRESSES OF OTHERS; TECHNICAL SUPPORT,  
NAMELY, MONITORING AND REPORTING OF  
WEB SITE TRAFFIC, IN CLASS 42 (U.S. CLS. 100  
AND 101).

FIRST USE 8-1-2005; IN COMMERCE 8-1-2005.

FOR: WEBSITE SECURITY SERVICES, NAMELY,  
MONITORING OF COMPUTER SYSTEMS FOR  
SECURITY PURPOSES, IN CLASS 45 (U.S. CLS. 100  
AND 101).

FIRST USE 8-1-2005; IN COMMERCE 8-1-2005.

OWNER OF U.S. REG. NOS. 1,330,193, 2,873,572,  
AND 2,873,573.

SEC. 2(F).

SER. NO. 76-646,732, FILED 9-13-2005.

ELLEN PERKINS, EXAMINING ATTORNEY

**Int. Cls.: 38, 39, 42 and 45**

**Prior U.S. Cls.: 100, 101, 104 and 105**

**United States Patent and Trademark Office**

**Reg. No. 3,393,800**

**Registered Mar. 11, 2008**

**SERVICE MARK  
PRINCIPAL REGISTER**

The logo for NetworkSolutions, featuring the word "Network" in a light gray sans-serif font and "Solutions" in a bold, dark green sans-serif font, all contained within a light green rectangular background.

NETWORK SOLUTIONS, LLC (DELAWARE LTD  
LIAB CO)  
13861 SUNRISE VALLEY DRIVE, SUITE 300  
HERNDON, VA 20171

FOR: ELECTRONIC MAIL SERVICES; EMAIL  
AND WEBSITE FORWARDING SERVICES; PRO-  
VIDING MULTIPLE-USER ACCESS TO A GLOBAL  
COMPUTER INFORMATION NETWORK, IN  
CLASS 38 (U.S. CLS. 100, 101 AND 104).

FIRST USE 8-1-2005; IN COMMERCE 8-1-2005.

FOR: ELECTRONIC STORAGE OF MESSAGES,  
IN CLASS 39 (U.S. CLS. 100 AND 105).

FIRST USE 8-1-2005; IN COMMERCE 8-1-2005.

FOR: COMPUTER SERVICES, NAMELY, DE-  
SIGNING, IMPLEMENTING AND MANAGING  
WEB SITES FOR OTHERS; PROVIDING TEMPOR-  
ARY USE OF ON-LINE NON-DOWNLOADABLE  
COMPUTER SOFTWARE DEVELOPMENT TOOLS  
FOR CREATING WEB SITES AND CREATING  
ELECTRONIC BULLETIN BOARDS FOR THE  
TRANSMISSION OF MESSAGES AMONG COMPU-  
TER USERS; COMPUTER WEB SITE CONSULTA-  
TION; REDIRECTING ELECTRONIC MAIL TO  
CHANGED PERSONAL ELECTRONIC ADDRES-  
SES; HOSTING THE WEB SITES OF OTHERS ON A  
COMPUTER SERVER FOR A GLOBAL COMPUTER  
NETWORK; DOMAIN NAME REGISTRATION FOR  
IDENTIFICATION OF USERS ON A GLOBAL COM-  
PUTER NETWORK, RENEWAL AND ACCOUNT  
MANAGEMENT SERVICES; DOMAIN NAME  
SEARCHING SERVICES; COMPUTER VIRUS DE-  
TECTION AND REMOVAL; SPAM FILTERING ON  
A GLOBAL COMPUTER INFORMATION NET-  
WORK, NAMELY, FILTERING OF UNWANTED  
ELECTRONIC MAIL MESSAGES ON A GLOBAL

COMPUTER INFORMATION NETWORK; COMPU-  
TER SERVICES, NAMELY, ACTING AS AN APPLI-  
CATION SERVICE PROVIDER IN THE FIELD OF  
KNOWLEDGE MANAGEMENT TO HOST COMPU-  
TER APPLICATION SOFTWARE FOR THE COL-  
LECTION, STORAGE AND SHARING OF DATA  
AND INFORMATION IN THE NATURE OF EMAIL  
ADDRESSES OF OTHERS; TECHNICAL SUPPORT,  
NAMELY, MONITORING AND REPORTING OF  
WEB SITE TRAFFIC, IN CLASS 42 (U.S. CLS. 100  
AND 101).

FIRST USE 8-1-2005; IN COMMERCE 8-1-2005.

FOR: WEBSITE SECURITY SERVICES, NAMELY,  
MONITORING OF COMPUTER SYSTEMS FOR  
SECURITY PURPOSES, IN CLASS 45 (U.S. CLS. 100  
AND 101).

FIRST USE 8-1-2005; IN COMMERCE 8-1-2005.

OWNER OF U.S. REG. NOS. 1,330,193, 2,873,572,  
AND 2,873,573.

THE COLOR(S) GREEN AND GRAY IS/ARE  
CLAIMED AS A FEATURE OF THE MARK.

THE COLOR GRAY APPEARS IN THE LETTERS  
N, E, T, W, O, R AND K, AND THE COLOR GREEN  
APPEARS IN THE LETTERS S, O, L, U, T, I, O, N  
AND S.

SEC. 2(F).

SER. NO. 76-646,758, FILED 9-14-2005.

ELLEN PERKINS, EXAMINING ATTORNEY

**Int. Cls.: 29, 30 and 43**

**Prior U.S. Cls.: 46, 100 and 101**

**United States Patent and Trademark Office**

**Reg. No. 3,393,801**

**Registered Mar. 11, 2008**

**TRADEMARK  
SERVICE MARK  
PRINCIPAL REGISTER**



KOKORIKO S.A. (COLOMBIA CORPORATION)  
CALLE 42 NO. 87-51  
BOGOTA D.C., COLOMBIA

FOR: MEAT, FISH, POULTRY AND GAME;  
MEAT EXTRACTS; PRESERVED, DRIED AND  
COOKED FRUITS AND VEGETABLES, MILK AND  
OTHER DAIRY PRODUCTS, EXCLUDING ICE  
CREAM, ICE MILK AND FROZEN YOGURT; ED-  
IBLE OILS AND FATS, IN CLASS 29 (U.S. CL. 46).

FOR: COFFEE, TEA, COCOA, SUGAR, FLOUR,  
BREAD, BISCUITS, CAKES, PASTRY AND CON-  
FECTIONERY, NAMELY CANDIES AND FROZEN  
CONFECTIONS, FLAVORED ICES; HONEY, SALT,  
MUSTARD, PEPPER, VINEGAR, SAUCES, SPICES,  
ICE AND DAIRY PRODUCTS, NAMELY ICE  
CREAM, ICE MILK AND FROZEN YOGURT, IN  
CLASS 30 (U.S. CL. 46).

FOR: RESTAURANTS, IN CLASS 43 (U.S. CLS. 100  
AND 101).

PRIORITY CLAIMED UNDER SEC. 44(D) ON  
COLOMBIA APPLICATION NO. 05054749, FILED 6-  
7-2005, REG. NO. 309185, DATED 12-23-2005, EX-  
PIRES 12-23-2015.

PRIORITY CLAIMED UNDER SEC. 44(D) ON  
COLOMBIA APPLICATION NO. 05054747, FILED 6-  
7-2005, REG. NO. 309184, DATED 12-23-2005, EX-  
PIRES 12-23-2015.

PRIORITY CLAIMED UNDER SEC. 44(D) ON  
COLOMBIA APPLICATION NO. 05054745, FILED 6-  
7-2005, REG. NO. 309188, DATED 12-23-2005, EX-  
PIRES 12-23-2015.

OWNER OF U.S. REG. NOS. 2,443,981 AND  
2,447,369.

SER. NO. 76-647,619, FILED 9-28-2005.

ANNE FARRELL, EXAMINING ATTORNEY

**Int. Cls.: 16 and 25**

**Prior U.S. Cls.: 2, 5, 22, 23, 29, 37, 38, 39 and 50**

**Reg. No. 3,393,802**

**United States Patent and Trademark Office**

**Registered Mar. 11, 2008**

---

**TRADEMARK  
PRINCIPAL REGISTER**

**ENDANGERED PLANET**

ENDANGERED PLANET, L.L.C. (CALIFORNIA CORPORATION)  
384 FOREST AVE., GALLERY XIII  
LAGUNA BEACH, CA 92651

FOR: PAINTINGS, DRAWINGS, ART PRINTS, LITHOGRAPHIC PRINTS, PHOTOGRAPHS, PHOTOGRAPHIC PRINTS OF DIGITAL IMAGES, IN CLASS 16 (U.S. CLS. 2, 5, 22, 23, 29, 37, 38 AND 50).

FIRST USE 3-0-2005; IN COMMERCE 3-0-2005.

FOR: HATS, SHIRTS, SWEATSHIRTS, JACKETS, PANTS, VESTS, IN CLASS 25 (U.S. CLS. 22 AND 39).

FIRST USE 3-10-2005; IN COMMERCE 3-10-2005.

THE MARK CONSISTS OF STANDARD CHARACTERS WITHOUT CLAIM TO ANY PARTICULAR FONT, STYLE, SIZE, OR COLOR.

SER. NO. 76-648,950, FILED 10-21-2005.

LINDA LAVACHE, EXAMINING ATTORNEY



**Int. Cls.: 29, 30 and 32**

**Prior U.S. Cls.: 45, 46 and 48**

**United States Patent and Trademark Office**

**Reg. No. 3,393,803**

**Registered Mar. 11, 2008**

**TRADEMARK  
PRINCIPAL REGISTER**



WHOLESOME CHOICE MARKET, INC. (CALI-  
FORNIA CORPORATION)  
2332 BARRANCA PARKWAY  
IRVINE, CA 92606

FOR: DRIED AND COOKED FRUITS AND VE-  
GETABLES, JAMS, MILK PRODUCTS, NAMELY,  
MILK, CHOCOLATE MILK, HALF AND HALF,  
CHEESE, BUTTER, WHIPPING CREAM AND YO-  
GURT, AND EDIBLE OILS AND FATS, IN CLASS 29  
(U.S. CL. 46).

FIRST USE 8-0-2003; IN COMMERCE 8-0-2003.

FOR: COFFEE, TEA, SUGAR, RICE, BREAD,  
PASTRY, AND CONFECTIONARY, NAMELY,  
CAKES, CHOCOLATES, COOKIES, CANDIES, HON-  
EY, YEAST, SALT, VINEGAR, AND SPICES AND  
SAUCES MADE FROM FRUIT, IN CLASS 30 (U.S.  
CL. 46).

FIRST USE 8-0-2003; IN COMMERCE 8-0-2003.

FOR: NONALCOHOLIC SOFT, POP, AND ISO-  
TONIC DRINKS, FRUIT DRINKS, FRUIT JUICE,  
AND SYRUPS FOR MAKING SAME, IN CLASS 32  
(U.S. CLS. 45, 46 AND 48).

FIRST USE 8-0-2003; IN COMMERCE 8-0-2003.

OWNER OF U.S. REG. NO. 2,971,569.

NO CLAIM IS MADE TO THE EXCLUSIVE  
RIGHT TO USE "WHOLESOME", APART FROM  
THE MARK AS SHOWN.

SER. NO. 76-649,366, FILED 10-28-2005.

ADA HAN, EXAMINING ATTORNEY

Int. Cl.: 5

Prior U.S. Cls.: 6, 18, 44, 46, 51 and 52

United States Patent and Trademark Office

Reg. No. 3,393,804

Registered Mar. 11, 2008

TRADEMARK  
PRINCIPAL REGISTER

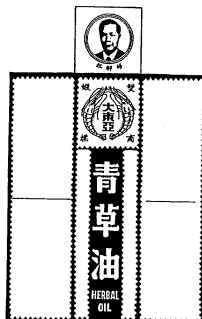

TAI TONG AH CO (PTE) LTD (SINGAPORE CORPORATION)  
BLOCK 1 ALEXANDRA DISTRI PARK, #07-26  
PASIR PANJANG ROAD  
SINGAPORE 118478

FOR: MEDICATED HERBAL OIL FOR THE TREATMENT OF TOOTHACHE, INSECT STINGS AND BITES, SKIN ERUPTIONS, MINOR CUTS, BURNS AND ABRASIONS, ITCHING AND SWELLING, IN CLASS 5 (U.S. CLS. 6, 18, 44, 46, 51 AND 52).

FIRST USE 1-10-1972; IN COMMERCE 8-11-2005.

OWNER OF SINGAPORE REG. NO. T7253722F, DATED 1-10-1972, EXPIRES 1-10-2013.

NO CLAIM IS MADE TO THE EXCLUSIVE RIGHT TO USE "HERBAL OIL", NON-LATIN CHARACTERS THAT MEAN GREEN GRASS OIL AND "EAST ASIA", APART FROM THE MARK AS SHOWN.

THE NAME "YANG LIU JIANG" THAT APPEARS IN NON-LATIN CHARACTERS IN THE MARK DOES NOT IDENTIFY A LIVING INDIVIDUAL.

THE PORTRAIT IN THE MARK DOES NOT DEPICT A LIVING INDIVIDUAL.

THE NON-LATIN CHARACTERS BELOW THE PORTRAIT IN THE MARK TRANSLITERATE TO "YANG LIU JIANG" WHICH DOES NOT HAVE ANY MEANING IN ENGLISH AS IT IS THE NAME OF THE PERSON APPEARING IN THE PORTRAIT. THE NON-LATIN CHARACTERS INSERTED BETWEEN THE DEVICE OF SHRIMP TRANSLITERATE TO "DA DONG YA" AND THIS MEANS "GREAT EAST ASIA" IN ENGLISH. THE NON-LATIN CHARACTERS APPEARING SURROUNDING THE DEVICE OF SHRIMP TRANSLITERATE TO "SHUANG XIA" AND THIS MEANS "DOUBLE SHRIMP" IN ENGLISH. THE NON-LATIN CHARACTERS APPEARING HORIZONTALLY IN THE MARK TRANSLITERATE TO "QING CAO YU" AND THIS MEANS "GREEN GRASS OIL" IN ENGLISH.

SER. NO. 76-653,089, FILED 1-9-2006.

HEATHER THOMPSON, EXAMINING ATTORNEY

**Int. Cls.: 16 and 42**

**Prior U.S. Cls.: 2, 5, 22, 23, 29, 37, 38, 50, 100 and 101**

**United States Patent and Trademark Office**

**Reg. No. 3,393,805**

**Registered Mar. 11, 2008**

**TRADEMARK  
SERVICE MARK  
PRINCIPAL REGISTER**

**AUTO ADVISORY SERVICES**

AUTO ADVISORY SERVICES, INC. (CALIFORNIA CORPORATION)  
14771 PLAZA DRIVE, SUITE A  
TUSTIN, CA 92780

FOR: PUBLICATIONS, NAMELY, BOOKS, NEWSLETTERS AND BOOKLETS DESIGNED TO INFORM, GUIDE AND ADVISE MOTOR VEHICLE DEALERS WITH RESPECT TO COMPLYING WITH THE RELEVANT STATE AND FEDERAL LAWS AND PENDING LEGISLATION, IN CLASS 16 (U.S. CLS. 2, 5, 22, 23, 29, 37, 38 AND 50).

FIRST USE 1-1-1978; IN COMMERCE 4-1-2000.

FOR: PROVIDING INFORMATION, GUIDANCE AND ADVICE TO MOTOR VEHICLE DEALERS WITH RESPECT TO RELEVANT STATE AND FED-

ERAL LAWS AND PENDING LEGISLATION, IN CLASS 42 (U.S. CLS. 100 AND 101).

FIRST USE 1-1-1978; IN COMMERCE 4-1-2000.

THE MARK CONSISTS OF STANDARD CHARACTERS WITHOUT CLAIM TO ANY PARTICULAR FONT, STYLE, SIZE, OR COLOR.

NO CLAIM IS MADE TO THE EXCLUSIVE RIGHT TO USE "ADVISORY SERVICES", APART FROM THE MARK AS SHOWN.

SEC. 2(F).

SER. NO. 76-654,147, FILED 1-27-2006.

SUE LAWRENCE, EXAMINING ATTORNEY

**Int. Cls.: 9, 16 and 41**

**Prior U.S. Cls.: 2, 5, 21, 22, 23, 26, 29, 36, 37, 38, 50,  
100, 101 and 107**

**Reg. No. 3,393,806**

**United States Patent and Trademark Office**

**Registered Mar. 11, 2008**

**TRADEMARK  
SERVICE MARK  
PRINCIPAL REGISTER**

**REMODEL YOUR REALITY**

COMPASS LIFE AND BUSINESS DESIGNS, INC.  
(CALIFORNIA CORPORATION)  
5686 LA SEYNE PLACE  
SAN JOSE, CA 95138

FOR: SELF-HELP MERCHANDISE, NAMELY, PRE-RECORDED CDS, VIDEOTAPES, DVDS AND DOWNLOADABLE AUDIO AND VIDEO FILES FEATURING INTERVIEWS, INFORMATION, PRESENTATIONS, LECTURES, COURSES, AND SEMINARS, AND COMMENTARY IN THE FIELD OF BEAUTY AND STYLE, CAREER TRANSITIONS, PERSONAL AND PROFESSIONAL FINANCIAL GOALS, HOUSEHOLD MANAGEMENT, HEALTH AND FITNESS, MOTHERHOOD AND PARENTING, ENTREPRENEURIAL SKILLS, AND SPIRITUAL GROWTH, IN CLASS 9 (U.S. CLS. 21, 23, 26, 36 AND 38).

FIRST USE 11-0-2005; IN COMMERCE 11-0-2005.

FOR: BOOKS IN THE FIELD OF BEAUTY AND STYLE, CAREER TRANSITIONS, PERSONAL AND PROFESSIONAL FINANCIAL GOALS, HOUSEHOLD MANAGEMENT, HEALTH AND FITNESS, MOTHERHOOD AND PARENTING, ENTREPRENEURIAL SKILLS, AND SPIRITUAL GROWTH, IN CLASS 16 (U.S. CLS. 2, 5, 22, 23, 29, 37, 38 AND 50).

FIRST USE 11-0-2005; IN COMMERCE 11-0-2005.

FOR: PROFESSIONAL COACHING SERVICES, NAMELY, PROVIDING A PROFESSIONAL COACHING PROGRAM IN THE FIELD OF BEAUTY AND STYLE, CAREER TRANSITIONS, PERSONAL AND PROFESSIONAL FINANCIAL GOALS, HOUSEHOLD MANAGEMENT, HEALTH AND FITNESS, MOTHERHOOD AND PARENTING, ENTREPRENEURIAL SKILLS, AND SPIRITUAL GROWTH; PROFESSIONAL TRAINING SERVICES, NAMELY, PROVIDING A PROFESSIONAL COACHING PROGRAM IN THE FIELD OF BEAUTY AND STYLE, CAREER TRANSITIONS, PERSONAL AND PROFESSIONAL FINANCIAL GOALS, HOUSEHOLD MANAGEMENT, HEALTH AND FITNESS, MOTHERHOOD AND PARENTING, ENTREPRENEURIAL SKILLS, AND SPIRITUAL GROWTH, IN CLASS 41 (U.S. CLS. 100, 101 AND 107).

FIRST USE 11-0-2005; IN COMMERCE 11-0-2005.

THE MARK CONSISTS OF STANDARD CHARACTERS WITHOUT CLAIM TO ANY PARTICULAR FONT, STYLE, SIZE, OR COLOR.

SER. NO. 76-654,250, FILED 1-30-2006.

MARY MUNSON, EXAMINING ATTORNEY

Int. Cl.: 29

Prior U.S. Cl.: 46

United States Patent and Trademark Office

Reg. No. 3,393,807

Registered Mar. 11, 2008

TRADEMARK  
PRINCIPAL REGISTER



LIBERTY IMPORT & EXPORT CORP. (UNITED STATES CORPORATION)  
10217 SERENE MEADOW DRIVE  
BOCA RATON, FL 33428

FOR: FROZEN FRUIT PULP SNACK, MADE WITH ACAI, ACEROLA, STRAWBERRY, OR GUARANA PULP, IN CLASS 29 (U.S. CL. 46).

FIRST USE 9-5-2005; IN COMMERCE 9-8-2005.

NO CLAIM IS MADE TO THE EXCLUSIVE RIGHT TO USE "ACAI" AND "SPORTS NUTRITION", APART FROM THE MARK AS SHOWN.

THE COLOR(S) RED, YELLOW, ORANGE, AND WHITE IS/ARE CLAIMED AS A FEATURE OF THE MARK.

THE COLORS YELLOW AND ORANGE APPEAR IN THE X IN THE BACKGROUND AND IT IS OUTLINED IN RED. THE TERM ACAI APPEARS IN RED WITH WHITE OUTLINING WHERE IT IS OVER THE X. THE TERM XTREME APPEARS IN WHITE AND IS OUTLINED IN RED, AND THE PHRASE SPORTS NUTRITION APPEARS IN RED AND IS OUTLINED IN WHITE

SER. NO. 76-655,615, FILED 2-24-2006.

ALYSSA PALADINO, EXAMINING ATTORNEY

**Int. Cl.: 9**

**Prior U.S. Cls.: 21, 23, 26, 36 and 38**

**Reg. No. 3,393,808**

**United States Patent and Trademark Office**

**Registered Mar. 11, 2008**

**TRADEMARK  
PRINCIPAL REGISTER**



ESO SOLUTIONS, INC. (TEXAS CORPORATION)  
3005 SOUTH LAMAR AVE, SUITE D109-372  
AUSTIN, TX 78704

FIRST USE 9-1-2004; IN COMMERCE 9-1-2004.

FOR: COMPUTER SOFTWARE FOR RECORD-  
ING, PROCESSING, ARCHIVING, EVALUATING,  
AND TRANSMITTING PATIENT MEDICAL DIAG-  
NOSIS, CONDITION, STATUS AND OTHER MEDI-  
CAL DATA, IN CLASS 9 (U.S. CLS. 21, 23, 26, 36 AND  
38).

NO CLAIM IS MADE TO THE EXCLUSIVE  
RIGHT TO USE "SOLUTIONS", APART FROM  
THE MARK AS SHOWN.

SER. NO. 76-656,270, FILED 3-8-2006.

DEIRDRE ROBERTSON, EXAMINING ATTORNEY

**Int. Cl.: 9**

**Prior U.S. Cls.: 21, 23, 26, 36 and 38**

**Reg. No. 3,393,809**

**United States Patent and Trademark Office**

**Registered Mar. 11, 2008**

---

**TRADEMARK  
PRINCIPAL REGISTER**

**ESO SOLUTIONS**

ESO SOLUTIONS, INC. (TEXAS CORPORATION)  
3005 SOUTH LAMAR AVE, SUITE D109-372  
AUSTIN, TX 78704

THE MARK CONSISTS OF STANDARD CHARACTERS WITHOUT CLAIM TO ANY PARTICULAR FONT, STYLE, SIZE, OR COLOR.

FOR: COMPUTER SOFTWARE FOR RECORDING, PROCESSING, ARCHIVING, EVALUATING, AND TRANSMITTING PATIENT MEDICAL DIAGNOSIS, CONDITION, STATUS AND OTHER MEDICAL DATA, IN CLASS 9 (U.S. CLS. 21, 23, 26, 36 AND 38).

NO CLAIM IS MADE TO THE EXCLUSIVE RIGHT TO USE "SOLUTIONS", APART FROM THE MARK AS SHOWN.

SER. NO. 76-656,271, FILED 3-8-2006.

FIRST USE 9-1-2004; IN COMMERCE 9-1-2004.

DEIRDRE ROBERTSON, EXAMINING ATTORNEY

**Int. Cl.: 35**

**Prior U.S. Cls.: 100, 101 and 102**

**United States Patent and Trademark Office**

**Reg. No. 3,393,810**

**Registered Mar. 11, 2008**

**SERVICE MARK  
PRINCIPAL REGISTER**

**THE TRENDS RESEARCH INSTITUTE**

SOCIO-ECONOMIC RESEARCH INSTITUTE OF  
AMERICA, THE (NEW YORK CORPORATION)

P.O. BOX 660  
SALISBURY TURNPIKE  
RHINEBECK, NY 12572

FOR: CONDUCTING SOCIAL, ECONOMIC, POLITICAL AND BUSINESS RESEARCH AND SURVEYS; AND BUSINESS CONSULTATION SERVICES, NAMELY, FORECASTING AND ANALYSIS OF SOCIO-ECONOMIC AND POLITICAL TRENDS, IN CLASS 35 (U.S. CLS. 100, 101 AND 102).

FIRST USE 8-0-1992; IN COMMERCE 8-0-1992.

THE MARK CONSISTS OF STANDARD CHARACTERS WITHOUT CLAIM TO ANY PARTICULAR FONT, STYLE, SIZE, OR COLOR.

NO CLAIM IS MADE TO THE EXCLUSIVE RIGHT TO USE "RESEARCH INSTITUTE", APART FROM THE MARK AS SHOWN.

SEC. 2(F).

SER. NO. 76-656,899, FILED 3-20-2006.

SEAN CROWLEY, EXAMINING ATTORNEY



**Int. Cls.: 16 and 17**

**Prior U.S. Cls.: 1, 2, 5, 12, 13, 22, 23, 29, 35, 37, 38 and 50**

**Reg. No. 3,393,811**

**United States Patent and Trademark Office**

**Registered Mar. 11, 2008**

**TRADEMARK  
PRINCIPAL REGISTER**

**KURAR|STER**

KURARAY CO., LTD. (JAPAN CORPORATION)  
1621, SAKAZU  
KURASHIKI CITY, OKAYAMA PREFECTURE, JAPAN

FOR: PLASTIC MATERIALS FOR PACKAGING AND WRAPPING, NAMELY, PLASTIC FILMS NOT FOR COMMERCIAL OR INDUSTRIAL USE, PLASTIC SHEETS, NAMELY, PLASTIC WRAP, PLASTIC SACKS, PLASTIC BAGS, AND PLASTIC BUBBLE PACKS, IN CLASS 16 (U.S. CLS. 2, 5, 22, 23, 29, 37, 38 AND 50).

FOR: PLASTICS SEMI-WORKED PRODUCTS, NAMELY, EXTRUDED PLASTICS AND CASTED PLASTICS IN THE FORM OF FIBERS, THREADS, YAMS, STRIPS, BARS, BLOCKS, PELLETS, RODS, FILMS, SHEETS AND TUBES FOR USE IN MANUFACTURING; CHEMICAL FIBER NOT FOR TEXTILE USE; CHEMICAL FIBER YARNS AND

THREAD NOT FOR TEXTILE USE; PLASTIC FILMS USED AS PACKAGING FOR FOOD; PLASTIC FILMS FOR INDUSTRIAL AND COMMERCIAL PACKING USE; ADHESIVE-COATED PLASTIC SHEETS, IN CLASS 17 (U.S. CLS. 1, 5, 12, 13, 35 AND 50).

PRIORITY CLAIMED UNDER SEC. 44(D) ON JAPAN APPLICATION NO. 2006-018568, FILED 3-2-2006, REG. NO. 4984107, DATED 9-1-2006, EXPIRES 9-1-2016.

PRIORITY CLAIMED UNDER SEC. 44(D) ON JAPAN APPLICATION NO. 2006-018569, FILED 3-2-2006, REG. NO. 4984108, DATED 9-1-2006, EXPIRES 9-1-2016.

SER. NO. 76-658,106, FILED 4-7-2006.

DAVID HOFFMAN, EXAMINING ATTORNEY

**Int. Cl.: 30**

**Prior U.S. Cl.: 46**

**United States Patent and Trademark Office**

**Reg. No. 3,393,812**

**Registered Mar. 11, 2008**

**TRADEMARK  
PRINCIPAL REGISTER**

**JORDAN'S GOURMET DELIGHTS**

JORDAN'S GOURMET DELIGHTS, INC. (FLOR-  
IDA CORPORATION)  
10871 N.W. 52ND STREET, SUITE 6  
SUNRISE, FL 33351

FOR: GOURMET BAKERY GOODS AND  
TREATS, NAMELY, BISCOTTI, SHORTBREAD, SPE-  
CIALTY BREADS, AND CANDIES, NAMELY  
SWEETS, IN CLASS 30 (U.S. CL. 46).

FIRST USE 1-0-2006; IN COMMERCE 1-0-2006.

THE MARK CONSISTS OF STANDARD CHAR-  
ACTERS WITHOUT CLAIM TO ANY PARTICULAR  
FONT, STYLE, SIZE, OR COLOR.

NO CLAIM IS MADE TO THE EXCLUSIVE  
RIGHT TO USE GOURMET, APART FROM THE  
MARK AS SHOWN.

SER. NO. 76-658,368, FILED 4-13-2006.

VERNA BETH RIRIE, EXAMINING ATTORNEY

**Int. Cl.: 35**

**Prior U.S. Cls.: 100, 101 and 102**

**United States Patent and Trademark Office**

**Reg. No. 3,393,813**

**Registered Mar. 11, 2008**

---

**SERVICE MARK  
PRINCIPAL REGISTER**

**CAROLINA LANTERNS**

CAROLINA LANTERNS & ACCESSORIES, INC.  
(SOUTH CAROLINA CORPORATION)  
917 HOUSTON NORTHCUTT BLVD.  
MOUNT PLEASANT, SC 29464

FOR: RETAIL STORE SERVICES, COMPUTER-  
IZED ON-LINE RETAIL STORE AND ON-LINE  
RETAIL STORE SERVICES, ALL IN THE FIELD  
OF LANTERNS, CHANDELIERS, LIGHT FIX-  
TURES, AND LAMPS, IN CLASS 35 (U.S. CLS. 100,  
101 AND 102).

FIRST USE 7-0-2000; IN COMMERCE 7-0-2000.

OWNER OF U.S. REG. NO. 3,016,904.

NO CLAIM IS MADE TO THE EXCLUSIVE  
RIGHT TO USE "LANTERNS", APART FROM THE  
MARK AS SHOWN.

SEC. 2(F).

SER. NO. 76-658,938, FILED 4-24-2006.

LA TONIA FISHER, EXAMINING ATTORNEY

**Int. Cl.: 11**

**Prior U.S. Cls.: 13, 21, 23, 31 and 34**

**Reg. No. 3,393,814**

**United States Patent and Trademark Office**

**Registered Mar. 11, 2008**

**TRADEMARK  
PRINCIPAL REGISTER**



UNIVERSAL DYNAMICS, INC. (VIRGINIA CORPORATION)  
13600 DABNEY ROAD  
WOODBIDGE, VA 22191

NO CLAIM IS MADE TO THE EXCLUSIVE RIGHT TO USE "AUTODRY MATERIAL DRYING SYSTEMS", APART FROM THE MARK AS SHOWN.

FOR: PROCESS DRYER FOR GRANULAR MATERIAL, NAMELY, PLASTIC PELLETS, IN CLASS 11 (U.S. CLS. 13, 21, 23, 31 AND 34).

SER. NO. 76-659,491, FILED 5-2-2006.

FIRST USE 0-0-2001; IN COMMERCE 0-0-2001.

SIMON TENG, EXAMINING ATTORNEY

**Int. Cl.: 7**

**Prior U.S. Cls.: 13, 19, 21, 23, 31, 34 and 35**

**Reg. No. 3,393,815**

**United States Patent and Trademark Office**

**Registered Mar. 11, 2008**

**TRADEMARK  
PRINCIPAL REGISTER**

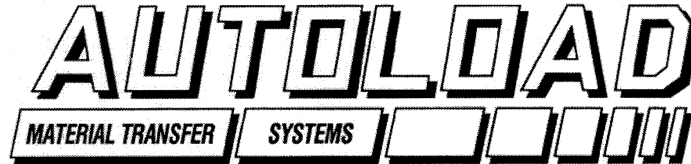

UNIVERSAL DYNAMICS, INC. (VIRGINIA CORPORATION)  
13600 DABNEY ROAD  
WOODBIDGE, VA 22191

NO CLAIM IS MADE TO THE EXCLUSIVE RIGHT TO USE "AUTOLOAD MATERIAL TRANSFER SYSTEMS", APART FROM THE MARK AS SHOWN.

FOR: PNEUMATIC CONVEYING DEVICES, NAMELY, CONVEYORS FOR PLASTIC PELLETS, IN CLASS 7 (U.S. CLS. 13, 19, 21, 23, 31, 34 AND 35).

SER. NO. 76-659,492, FILED 5-2-2006.

FIRST USE 0-0-1998; IN COMMERCE 0-0-1998.

KAREN K. BUSH, EXAMINING ATTORNEY

**Int. Cl.: 36**

**Prior U.S. Cls.: 100, 101 and 102**

**United States Patent and Trademark Office**

**Reg. No. 3,393,816**

**Registered Mar. 11, 2008**

**SERVICE MARK  
PRINCIPAL REGISTER**

**FAMILY PROTECTOR**

MASELAN, JAMES P. (UNITED STATES INDIVIDUAL)  
MASELAN & JONES, P.C.  
ONE INTERNATIONAL PLACE 8TH FLOOR  
BOSTON, MA 02110

FOR: CONSULTING SERVICES IN THE FINANCIAL AND WEALTH MANAGEMENT FIELDS FEATURING EVALUATION, ANALYSIS, INDEPENDENT SELECTION AND COORDINATION OF FINANCIAL INSTRUMENTS FOR INDIVIDUALS AND INSTITUTIONS, AND DISTRIBUTING PRINTED MATERIALS IN CONNECTION THEREWITH, IN CLASS 36 (U.S. CLS. 100, 101 AND 102).

FIRST USE 2-7-2006; IN COMMERCE 2-7-2006.

THE MARK CONSISTS OF STANDARD CHARACTERS WITHOUT CLAIM TO ANY PARTICULAR FONT, STYLE, SIZE, OR COLOR.

NO CLAIM IS MADE TO THE EXCLUSIVE RIGHT TO USE "FAMILY", APART FROM THE MARK AS SHOWN.

SER. NO. 76-660,155, FILED 5-17-2006.

RUSS HERMAN, EXAMINING ATTORNEY

**Int. Cls.: 9 and 28**

**Prior U.S. Cls.: 21, 22, 23, 26, 36, 38 and 50**

**United States Patent and Trademark Office**

**Reg. No. 3,393,817**

**Registered Mar. 11, 2008**

**TRADEMARK  
PRINCIPAL REGISTER**

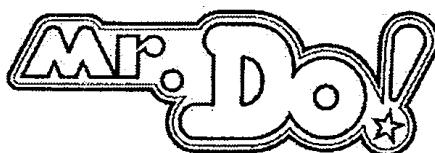

ARUZE CORPORATION (JAPAN CORPORATION)  
1-25, ARIAKE 3-CHOME  
KOTOKU, TOKYO, JAPAN

FOR: VIDEO GAMING MACHINES FOR BUSINESS USE; VIDEO GAMING MACHINES FOR BUSINESS USE CONTAINING VIDEO GAME SOFTWARE; VIDEO GAMING MACHINES FOR BUSINESS USE CONTAINING VIDEO GAME PROGRAMS; SLOT MACHINES; VIDEO GAMING MACHINES CONTAINING MEDIA STORAGE COMPUTER PROGRAMS; PRE-RECORDED CDS, VIDEOTAPES, LASER DISKS AND DVDS FEATURING COMPUTER GAME PROGRAMS FOR HOME USE ADAPTED FOR USE WITH TELEVISION RECEIVERS ONLY; DOWNLOADABLE ELECTRONIC GAMES VIA THE INTERNET AND WIRELESS DEVICES FOR HOME USE ADAPTED FOR USE WITH TELEVISION RECEIVERS ONLY; PRE-RECORDED CDS, VIDEOTAPES, LASER DISKS AND DVDS FEATURING COMPUTER PROGRAMS FOR

HOME USE ADAPTED FOR HANDHELD GAMES WITH LIQUID CRYSTAL DISPLAYS, IN CLASS 9 (U.S. CLS. 21, 23, 26, 36 AND 38).

FOR: STAND ALONE VIDEO GAME MACHINES FOR ARCADE USE AND THE STRUCTURAL REPLACEMENT PARTS THEREOF; AMUSEMENT GAME MACHINES, HANDHELD GAMES WITH LIQUID CRYSTAL DISPLAYS, IN CLASS 28 (U.S. CLS. 22, 23, 38 AND 50).

OWNER OF JAPAN REG. NO. 2456130, DATED 9-30-1992, EXPIRES 9-30-2012.

OWNER OF JAPAN REG. NO. 1821728, DATED 11-29-1985, EXPIRES 11-29-2015.

SER. NO. 76-661,986, FILED 6-22-2006.

DAWN HAN, EXAMINING ATTORNEY

**Int. Cl.: 21**

**Prior U.S. Cls.: 2, 13, 23, 29, 30, 33, 40 and 50**

**United States Patent and Trademark Office**

**Reg. No. 3,393,818**

**Registered Mar. 11, 2008**

**TRADEMARK  
PRINCIPAL REGISTER**

**DURAPALM**

KURARAY CO., LTD. (JAPAN CORPORATION)  
1621, SAKAZU  
KURASHIKI CITY, OKAYAMA PREFECTURE, JAPAN

FOR: GLOVES FOR HOUSEHOLD PURPOSES; WORKING GLOVES, NAMELY, GARDENING GLOVES, GENERAL USE GLOVES FOR HOME MAINTENANCE, AND GLOVES FOR GENERAL HOUSEHOLD USE; GENERAL USE GLOVES FOR CAR MAINTENANCE; GENERAL USE GLOVES FOR HOME CARPENTRY; POLISHING GLOVES, IN CLASS 21 (U.S. CLS. 2, 13, 23, 29, 30, 33, 40 AND 50).

THE MARK CONSISTS OF STANDARD CHARACTERS WITHOUT CLAIM TO ANY PARTICULAR FONT, STYLE, SIZE, OR COLOR.

PRIORITY CLAIMED UNDER SEC. 44(D) ON JAPAN APPLICATION NO. 2006-036205, FILED 4-19-2006, REG. NO. 4997048, DATED 10-20-2006, EXPIRES 10-20-2016.

SER. NO. 76-663,026, FILED 7-14-2006.

AMY MCMENAMIN, EXAMINING ATTORNEY



**Int. Cl.: 25**

**Prior U.S. Cls.: 22 and 39**

**United States Patent and Trademark Office**

**Reg. No. 3,393,819**

**Registered Mar. 11, 2008**

**TRADEMARK  
PRINCIPAL REGISTER**

**DURAPALM**

KURARAY CO., LTD. (JAPAN CORPORATION)  
1621, SAKAZU  
KURASHIKI CITY, OKAYAMA PREFECTURE, JAPAN

FOR: CLOTHING, NAMELY, EVENING DRESSES, SCHOOL UNIFORMS, CHILDREN'S WEAR, NAMELY JUMPERS, INFANT AND TODDLER ONE PIECE CLOTHING, AND INFANT SLEEPERS; UNIFORMS; JACKETS; JOGGING PANTS; SWEAT PANTS; SUITS; SKIRTS; SKI JACKETS; SKI PANTS; TROUSERS; SMOCKS; FORMALWEAR, NAMELY BOWTIES, CUMMERBUNDS, TUXEDOS AND GOWNS; CARDIGANS; SWEATERS; VESTS; OPEN-NECKED SHIRTS; CUFFS; COLLARS; SPORTS SHIRTS; BLOUSES; POLO SHIRTS; SHIRTS; OUTERWEAR, NAMELY, OVERCOATS, COATS, CLOAKS AND RAINCOATS; NIGHTWEAR; UNDERWEAR; SWIMWEAR; JAPANESE TRADITIONAL CLOTHING, NAMELY, KIMONOS; APRONS; WEARABLE COLLAR PROTECTORS; SOCKS AND STOCKINGS; PUTTEES AND GAITERS; FUR STOLES; SHAWLS; SCARVES; BABIES' DIAPERS OF TEXTILE; NECKTIES; NECKERCHIEFS; BANDANAS; WARMTH-KEEPING SUPPORTERS; MUFFLERS; EAR MUFFS; HOODS; NIGHTCAPS;

HEADGEAR, NAMELY, HATS AND CAPS; GLOVES AND MITTENS; GLOVES FOR OPERATING BICYCLES, MOTORCYCLES AND AUTOMOBILES; GARTERS; SOCK SUSPENDERS; SUSPENDERS; WAISTBANDS; BELTS FOR CLOTHING; FOOTWEAR; MASQUERADE COSTUMES; CLOTHES FOR SPORTS, NAMELY, SHORTS, SHIRTS, ANORAKS, WIND RESISTANT JACKETS, SKI SUITS, VESTS, SPORTS TEAM UNIFORMS, HOSIERY AND STOCKINGS, WRISTBANDS AND GYMNAS-TIC WEAR, NAMELY, TIGHTS AND PULLOVERS, ALL FOR SPORTS; BOOTS AND SHOES FOR SPORTS, IN CLASS 25 (U.S. CLS. 22 AND 39).

THE MARK CONSISTS OF STANDARD CHARACTERS WITHOUT CLAIM TO ANY PARTICULAR FONT, STYLE, SIZE, OR COLOR.

PRIORITY CLAIMED UNDER SEC. 44(D) ON JAPAN APPLICATION NO. 2006-036205, FILED 4-19-2006, REG. NO. 4997048, DATED 10-20-2006, EXPIRES 10-20-2016.

SER. NO. 76-663,027, FILED 7-14-2006.

AMY MCMENAMIN, EXAMINING ATTORNEY

**Int. Cl.: 42**

**Prior U.S. Cls.: 100 and 101**

**United States Patent and Trademark Office**

**Reg. No. 3,393,820**

**Registered Mar. 11, 2008**

**SERVICE MARK  
PRINCIPAL REGISTER**

# **My Law Corporation**

MICHAEL S. YU, A LAW CORPORATION (CALIFORNIA CORPORATION)  
2 E. VALLEY BLVD., SUITE 270  
ALHAMBRA, CA 91801

OWNER OF U.S. REG. NOS. 2,833,506 AND 2,866,037.

FOR: LEGAL SERVICES, IN CLASS 42 (U.S. CLS. 100 AND 101).

NO CLAIM IS MADE TO THE EXCLUSIVE RIGHT TO USE "LAW CORPORATION", APART FROM THE MARK AS SHOWN.

FIRST USE 1-6-2000; IN COMMERCE 9-5-2005.

SER. NO. 76-663,241, FILED 7-17-2006.

THE MARK CONSISTS OF STANDARD CHARACTERS WITHOUT CLAIM TO ANY PARTICULAR FONT, STYLE, SIZE, OR COLOR.

DAVID H. STINE, EXAMINING ATTORNEY

**Int. Cls.: 9, 22, 37, 41 and 42**

**Prior U.S. Cls.: 1, 2, 7, 19, 21, 22, 23, 26, 36, 38, 42, 50,  
100, 101, 103, 106 and 107**

**Reg. No. 3,393,821**

**United States Patent and Trademark Office**

**Registered Mar. 11, 2008**

**TRADEMARK  
SERVICE MARK  
PRINCIPAL REGISTER**

**RESPIREX**

RESPIREX INTERNATIONAL LIMITED (UNITED KINGDOM LIMITED COMPANY)  
UNIT F, KINGSFIELD BUSINESS CENTRE  
PHILANTHROPIC ROAD, REDHILL  
SURREY, RH1 4DP, UNITED KINGDOM

FOR: CHEMICAL PROTECTIVE AND AIR SUPPLIED CLOTHING, FOOTWEAR, HEADWEAR, AND HAND GEAR, NAMELY, SUITS, VESTS, JACKETS, PANTS, COVERALLS, BLOUSES, BOOTS, HOODS, AND GLOVES ALL FOR CHEMICAL PROTECTION, HAZARDOUS MATERIAL HANDLING, EMERGENCY RESPONSE, PHARMACEUTICAL HIGH RISK APPLICATIONS, AND NUCLEAR PROTECTION, IN CLASS 9 (U.S. CLS. 21, 23, 26, 36 AND 38).

FOR: DECONTAMINATION EQUIPMENT, NAMELY, BODY BAGS, FOR CHEMICAL PROTECTION, HAZARDOUS MATERIAL HANDLING, EMERGENCY RESPONSE, PHARMACEUTICAL HIGH RISK APPLICATIONS, AND NUCLEAR PROTECTION, IN CLASS 22 (U.S. CLS. 1, 2, 7, 19, 22, 42 AND 50).

FOR: REPAIR OF CHEMICAL PROTECTIVE AND AIR SUPPLIED CLOTHING, FOOTWEAR, HEADWEAR, AND HAND GEAR, NAMELY, SUITS, VESTS, JACKETS, PANTS, COVERALLS, BLOUSES, BOOTS, HOODS, AND GLOVES ALL FOR CHEMICAL PROTECTION, HAZARDOUS MATERIAL HANDLING, EMERGENCY RESPONSE, PHARMACEUTICAL HIGH RISK APPLICATIONS, AND NUCLEAR PROTECTION, IN CLASS 37 (U.S. CLS. 100, 103 AND 106).

FOR: TRAINING IN THE USE OF CHEMICAL PROTECTIVE AND AIR SUPPLIED CLOTHING, FOOTWEAR, HEADWEAR, AND HAND GEAR, NAMELY, SUITS, VESTS, JACKETS, PANTS, COVERALLS, BLOUSES, BOOTS, HOODS, AND GLOVES ALL FOR CHEMICAL PROTECTION, HAZARDOUS MATERIAL HANDLING, EMERGENCY RESPONSE, PHARMACEUTICAL HIGH RISK APPLICATIONS, AND NUCLEAR PROTECTION, IN CLASS 41 (U.S. CLS. 100, 101 AND 107).

FOR: MATERIAL TESTING AND EVALUATION OF CHEMICAL PROTECTIVE AND AIR SUPPLIED CLOTHING, FOOTWEAR, HEADWEAR, AND HAND GEAR, NAMELY, SUITS, VESTS, JACKETS, PANTS, COVERALLS, BLOUSES, BOOTS, HOODS, AND GLOVES ALL FOR CHEMICAL PROTECTION, HAZARDOUS MATERIAL HANDLING, EMERGENCY RESPONSE, PHARMACEUTICAL HIGH RISK APPLICATIONS, AND NUCLEAR PROTECTION, IN CLASS 42 (U.S. CLS. 100 AND 101).

THE MARK CONSISTS OF STANDARD CHARACTERS WITHOUT CLAIM TO ANY PARTICULAR FONT, STYLE, SIZE, OR COLOR.

OWNER OF UNITED KINGDOM REG. NO. 2405716, DATED 11-4-2005, EXPIRES 11-4-2015.

SER. NO. 76-664,511, FILED 8-11-2006.

LINDA E. BLOHM, EXAMINING ATTORNEY

**Int. Cl.: 14**

**Prior U.S. Cls.: 2, 27, 28 and 50**

**United States Patent and Trademark Office**

**Reg. No. 3,393,822**

**Registered Mar. 11, 2008**

**TRADEMARK  
PRINCIPAL REGISTER**

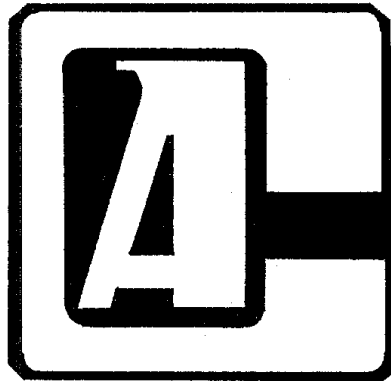

CRAFT ART CO., LTD. (THAILAND CORPORATION)  
6/6 MOO 6 CHINNAKET NGAM WONG WAN RD.  
TUNG SONG HONG  
LAK SI, BANGKOK 10210, THAILAND

FIRST USE 11-0-2003; IN COMMERCE 11-0-2003.

SER. NO. 76-665,537, FILED 9-1-2006.

FOR: JEWELRY, IN CLASS 14 (U.S. CLS. 2, 27, 28 AND 50).

AMY GEARIN, EXAMINING ATTORNEY

**Int. Cls.: 1, 2, 9, 17 and 19**

**Prior U.S. Cls.: 1, 5, 6, 10, 11, 12, 13, 16, 21, 23, 26, 33, 35, 36, 38, 46 and 50**

**Reg. No. 3,393,823**

**United States Patent and Trademark Office**

**Registered Mar. 11, 2008**

**TRADEMARK  
PRINCIPAL REGISTER**

**SINAK**

SINAK CORPORATION (CALIFORNIA CORPORATION)  
1949 W. WALNUT AVE.  
SAN DIEGO, CA 92101

FOR: CHEMICAL COMPOUNDS FOR CURING CONCRETE, WATERPROOFING CHEMICAL COMPOSITIONS FOR ARTICLES OF MASONRY, WOOD AND OTHER BUILDING AND/OR CONSTRUCTION, WATERPROOFING CHEMICAL COMPOSITIONS, SYNTHETIC POLYMER MODIFIED RESIN COMPOUND FOR USE IN CEMENTITIOUS REPAIRS, IN CLASS 1 (U.S. CLS. 1, 5, 6, 10, 26 AND 46).

FIRST USE 9-6-1983; IN COMMERCE 9-6-1983.

FOR: CONCRETE MOISTURE BARRIER COATING, EPOXY COATING FOR USE ON CONCRETE INDUSTRIAL FLOORS, IN CLASS 2 (U.S. CLS. 6, 11 AND 16).

FIRST USE 9-6-1983; IN COMMERCE 9-6-1983.

FOR: APPARATUS FOR TESTING GAS, LIQUIDS AND SOLIDS, IN CLASS 9 (U.S. CLS. 21, 23, 26, 36 AND 38).

FIRST USE 9-6-1983; IN COMMERCE 9-6-1983.

FOR: WEATHERIZING MEMBRANES AND VAPOR BARRIERS; RAPID CURE, HIGH STRENGTH, POLYMER-BASED CONCRETE PATCHING COMPOUND, IN CLASS 17 (U.S. CLS. 1, 5, 12, 13, 35 AND 50).

FIRST USE 9-6-1983; IN COMMERCE 9-6-1983.

FOR: FLOOR PATCHING MATERIALS, NAMELY, CONCRETE SEALERS, CEMENT MIXES, IN CLASS 19 (U.S. CLS. 1, 12, 33 AND 50).

FIRST USE 9-6-1983; IN COMMERCE 9-6-1983.

THE MARK CONSISTS OF STANDARD CHARACTERS WITHOUT CLAIM TO ANY PARTICULAR FONT, STYLE, SIZE, OR COLOR.

SER. NO. 76-666,646, FILED 9-26-2006.

GINA HAYES, EXAMINING ATTORNEY

**Int. Cls.: 1, 2, 9, 17 and 19**

**Prior U.S. Cls.: 1, 5, 6, 10, 11, 12, 13, 16, 21, 23, 26, 33, 35, 36, 38, 46 and 50**

**Reg. No. 3,393,824**

**United States Patent and Trademark Office**

**Registered Mar. 11, 2008**

**TRADEMARK  
PRINCIPAL REGISTER**



SINAK CORPORATION (CALIFORNIA CORPORATION)  
1949 W. WALNUT AVE.  
SAN DIEGO, CA 92101

FOR: CHEMICAL COMPOUNDS FOR CURING CONCRETE, WATERPROOFING CHEMICAL COMPOSITIONS FOR ARTICLES OF MASONRY, WOOD AND OTHER BUILDING AND/OR CONSTRUCTION, WATERPROOFING CHEMICAL COMPOSITIONS, SYNTHETIC POLYMER MODIFIED RESIN COMPOUND FOR USE IN CEMENTITIOUS REPAIRS, IN CLASS 1 (U.S. CLS. 1, 5, 6, 10, 26 AND 46).

FIRST USE 9-6-1983; IN COMMERCE 9-6-1983.

FOR: CONCRETE MOISTURE BARRIER COATING, EPOXY COATING FOR USE ON CONCRETE INDUSTRIAL FLOORS, IN CLASS 2 (U.S. CLS. 6, 11 AND 16).

FIRST USE 9-6-1983; IN COMMERCE 9-6-1983.

FOR: APPARATUS FOR TESTING GAS, LIQUIDS AND SOLIDS , IN CLASS 9 (U.S. CLS. 21, 23, 26, 36 AND 38).

FIRST USE 9-6-1983; IN COMMERCE 9-6-1983.

FOR: WEATHERIZING MEMBRANES AND VAPOR BARRIERS; RAPID CURE, HIGH STRENGTH, POLYMER-BASED CONCRETE PATCHING COMPOUND, IN CLASS 17 (U.S. CLS. 1, 5, 12, 13, 35 AND 50).

FIRST USE 9-6-1983; IN COMMERCE 9-6-1983.

FOR: FLOOR PATCHING MATERIALS, NAMELY, CONCRETE SEALERS, CEMENT MIXES, IN CLASS 19 (U.S. CLS. 1, 12, 33 AND 50).

FIRST USE 9-6-1983; IN COMMERCE 9-6-1983.

SER. NO. 76-666,647, FILED 9-26-2006.

GINA HAYES, EXAMINING ATTORNEY

**Int. Cl.: 41**

**Prior U.S. Cls.: 100, 101 and 107**

**United States Patent and Trademark Office**

**Reg. No. 3,393,825**

**Registered Mar. 11, 2008**

**SERVICE MARK  
PRINCIPAL REGISTER**

**COMMUNITY DEFINED HEALTH**

CENTER FOR HEALTH PROFESSIONS (MICHIGAN NOT FOR PROFIT CORPORATION),  
DBA HEALTHY COMMUNITY PARTNERS  
800 S. WASHINGTON STREET  
SAGINAW, MI 48601

FOR: EDUCATIONAL SERVICES, NAMELY, ORGANIZING AND CONDUCTING DISCUSSIONS IN THE NATURE OF CLASSES, SEMINARS, DISCUSSION GROUPS, AND WORKSHOPS AMONG MEMBERS OF COMMUNITIES AND PROFESSIONAL HEALTH PERSONNEL IN DEFINING AND PROMOTING THE HEALTH OF FAMILY AND INDIVIDUAL RESIDENTS OF SUCH COMMUNITIES, IN CLASS 41 (U.S. CLS. 100, 101 AND 107).

FIRST USE 8-0-1998; IN COMMERCE 3-0-2000.

THE MARK CONSISTS OF STANDARD CHARACTERS WITHOUT CLAIM TO ANY PARTICULAR FONT, STYLE, SIZE, OR COLOR.

SEC. 2(F).

SER. NO. 76-666,778, FILED 9-29-2006.

SCOTT SISUN, EXAMINING ATTORNEY

**Int. Cl.: 35**

**Prior U.S. Cls.: 100, 101 and 102**

**United States Patent and Trademark Office**

**Reg. No. 3,393,826**

**Registered Mar. 11, 2008**

**SERVICE MARK  
PRINCIPAL REGISTER**



UNITED TRANSPORTATION UNION (OHIO UN-  
INC. ASSOCIATION)  
14600 DETROIT AVENUE  
CLEVELAND, OH 44107

FOR: POLITICAL ACTION COMMITTEE SERVI-  
CES, NAMELY, PROMOTING THE INTERESTS OF  
TRANSPORTATION WORKERS IN THE FIELD OF  
POLITICS, IN CLASS 35 (U.S. CLS. 100, 101 AND 102).

FIRST USE 10-1-2003; IN COMMERCE 10-1-2003.

OWNER OF U.S. REG. NOS. 1,056,971, 2,677,339  
AND OTHERS.

NO CLAIM IS MADE TO THE EXCLUSIVE  
RIGHT TO USE "PAC", APART FROM THE MARK  
AS SHOWN.

THE MARK CONSISTS OF THE LITERAL ELE-  
MENT UTU PAC, WHICH APPEARS IN TWO DIF-  
FERENT FONTS, AND IS PARTIALLY CLOSED BY  
A COMET DESIGN.

SER. NO. 76-667,111, FILED 10-6-2006.

Laurie Kaufman, Examining Attorney



Int. Cl.: 29

Prior U.S. Cl.: 46

United States Patent and Trademark Office

Reg. No. 3,393,827

Registered Mar. 11, 2008

TRADEMARK  
PRINCIPAL REGISTER



*"Island Pride"*

TAIWAN SEAFOOD & FISH CORPORATION  
(CALIFORNIA CORPORATION)  
733 S. GLADYS AVE.  
LOS ANGELES, CA 90021

THE MARK CONSISTS OF THE WORDS "ISLAND PRIDE" AND THE DESIGN OF A FISH ENCASED IN A SQUARE WITH THE TAIL OF THE FISH EXTENDING OUTSIDE THE SQUARE.

FOR: FROZEN SEAFOOD AND FROZEN FISH,  
IN CLASS 29 (U.S. CL. 46).

SER. NO. 76-667,195, FILED 10-10-2006.

FIRST USE 5-15-2003; IN COMMERCE 5-15-2003.

KIMBERLY FRYE, EXAMINING ATTORNEY

Int. Cl.: 33

Prior U.S. Cls.: 47 and 49

United States Patent and Trademark Office

Reg. No. 3,393,828

Registered Mar. 11, 2008

TRADEMARK  
PRINCIPAL REGISTER



WILKINS, PAUL (UNITED STATES INDIVIDUAL)  
6525 DOMINION ROAD  
SANTA MARIA, CA 93454 AND  
ONTIVEROS, JAMES (UNITED STATES INDIVIDUAL)  
6525 DOMINION ROAD  
SANTA MARIA, CA 93454

FOR: WINE, IN CLASS 33 (U.S. CLS. 47 AND 49).

FIRST USE 12-1-2005; IN COMMERCE 12-1-2005.

NO CLAIM IS MADE TO THE EXCLUSIVE RIGHT TO USE "VINEYARDS", APART FROM THE MARK AS SHOWN.

THE COLOR(S) BLACK, WHITE, LIGHT GRAY, GRAY AND DARK GRAY IS/ARE CLAIMED AS A FEATURE OF THE MARK.

THE MARK CONSISTS OF THE WORDING ALTA MARIA VINEYARDS AND THE SMALL DECORATIVE ARROWS ADJACENT TO THIS WORDING ARE IN BLACK; THE SCRIPT INITIALS A M ARE IN LIGHT GRAY; THE PRAYING GIRL IS WEARING A ROBE AND HEADPIECE IN VARYING SHADES OF LIGHT GRAY AND GRAY; HER FACE, NECK AND HAND ARE GRAY; HER EYES, EYEBROWS AND HAIR ARE DARK GRAY AND BLACK. THE ENTIRE MARK IS SET AGAINST A WHITE BACKGROUND.

THE TRANSLATION OF THE WORD "ALTA" IS HIGH.

SER. NO. 76-667,216, FILED 10-10-2006.

TOBY BULLOFF, EXAMINING ATTORNEY

**Int. Cl.: 10**

**Prior U.S. Cls.: 26, 39 and 44**

**United States Patent and Trademark Office**

**Reg. No. 3,393,829**

**Registered Mar. 11, 2008**

**TRADEMARK  
PRINCIPAL REGISTER**



LETCHER, WILLIAM (UNITED STATES INDIVIDUAL)  
5522 SOUTH LEWIS AVE  
TULSA, OK 74105

THE MARK CONSISTS OF THE WORDS FIXT-TEETH WITH A STYLIZED "X".

FOR: DENTURES, ARTIFICIAL TEETH, IN CLASS 10 (U.S. CLS. 26, 39 AND 44).

SER. NO. 76-667,804, FILED 10-20-2006.

FIRST USE 10-11-2006; IN COMMERCE 10-11-2006.

JANICE KIM, EXAMINING ATTORNEY

**Int. Cl.: 37**

**Prior U.S. Cls.: 100, 103 and 106**

**United States Patent and Trademark Office**

**Reg. No. 3,393,830**

**Registered Mar. 11, 2008**

**SERVICE MARK  
PRINCIPAL REGISTER**



RUBBER SIDE DOWN, LLC (OHIO LTD LIAB  
CO)  
725 STATE ROUTE 121  
NEW PARIS, OH 45347

FOR: BUFFING AND POLISHING, IN CLASS 37  
(U.S. CLS. 100, 103 AND 106).

FIRST USE 6-3-2006; IN COMMERCE 6-3-2006.

NO CLAIM IS MADE TO THE EXCLUSIVE  
RIGHT TO USE "RIM TECHNOLOGIES", APART  
FROM THE MARK AS SHOWN.

THE COLOR(S) BLUE, SILVER, GRAY, WHITE,  
TAN, BLACK, RED, AND GOLD IS/ARE CLAIMED  
AS A FEATURE OF THE MARK.

THE COLORS START AT THE TOP OF THE RIM  
LETTERING (STRETCHING ACROSS ALL LET-  
TERS IN A STRIPING FASHION) WITH BLUE,  
FADING INTO SILVER, THEN GRAY, THEN  
WHITE, THEN TAN, FINALLY ENDING IN GOLD,  
EACH IN EQUAL MEASURE. THE LETTERS ARE  
OUTLINED IN GRAY WITH BLACK TRIM. THE  
WORD TECHNOLOGIES APPEARS IN BLACK BE-  
LOW THE WORD RIM. TO THE RIGHT OF BOTH  
WORDS IS A GRAY SEMICIRCLE WITH A RED  
ARROW POINT.

SER. NO. 76-667,903, FILED 10-23-2006.

DAVID ELTON, EXAMINING ATTORNEY

Int. Cl.: 9

Prior U.S. Cls.: 21, 23, 26, 36 and 38

United States Patent and Trademark Office

Reg. No. 3,393,831

Registered Mar. 11, 2008

TRADEMARK  
PRINCIPAL REGISTER

***Dome Test***

SINAK CORPORATION (CALIFORNIA CORPORATION)  
1949 W. WALNUT AVE.  
SAN DIEGO, CA 92101

FOR: APPARATUS FOR TESTING GAS, LIQUIDS AND SOLIDS, IN CLASS 9 (U.S. CLS. 21, 23, 26, 36 AND 38).

FIRST USE 1-24-2000; IN COMMERCE 1-24-2000.

THE MARK CONSISTS OF STANDARD CHARACTERS WITHOUT CLAIM TO ANY PARTICULAR FONT, STYLE, SIZE, OR COLOR.

NO CLAIM IS MADE TO THE EXCLUSIVE RIGHT TO USE "TEST", APART FROM THE MARK AS SHOWN.

SER. NO. 76-667,919, FILED 10-23-2006.

GINA HAYES, EXAMINING ATTORNEY

**Int. Cl.: 41**

**Prior U.S. Cls.: 100, 101 and 107**

**United States Patent and Trademark Office**

**Reg. No. 3,393,832**

**Registered Mar. 11, 2008**

**SERVICE MARK  
PRINCIPAL REGISTER**

ASPECT MEDIA INC. (VIRGINIA CORPORATION)  
163 PLEASANT VIEW ROAD  
STAUNTON, VA 24401

FOR: PRODUCTION SERVICES FOR INTERACTIVE VIDEOS FOR MULTIMEDIA PLATFORMS FOR USE IN TRAINING, NAMELY, PRODUCTION OF VIDEO DISCS, TAPES, AND RECORDINGS FOR OTHERS FOR USE IN TRAINING, IN CLASS 41 (U.S. CLS. 100, 101 AND 107).

FIRST USE 9-0-2006; IN COMMERCE 9-0-2006.

THE MARK CONSISTS OF STANDARD CHARACTERS WITHOUT CLAIM TO ANY PARTICULAR FONT, STYLE, SIZE, OR COLOR.

SER. NO. 76-668,777, FILED 11-9-2006.

TINA BROWN, EXAMINING ATTORNEY

Int. Cl.: 11

Prior U.S. Cls.: 13, 21, 23, 31 and 34

United States Patent and Trademark Office

Reg. No. 3,393,833

Registered Mar. 11, 2008

TRADEMARK  
PRINCIPAL REGISTER

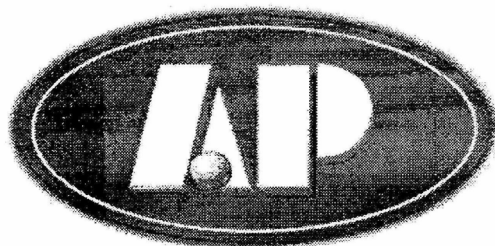

AUTO PARTS INDUSTRIAL LTD. (TAIWAN CORPORATION)  
NO.50-1, 7 LIN, KWO LING LI  
JUNG-LI CITY  
TAO-YUAN HSIEN, TAIWAN 320

FOR: AUTOMOBILE LIGHTS, VEHICLE HEAD LIGHTS, FOG LAMPS, BRAKE LIGHTS FOR VEHICLES, TAIL LIGHTS FOR VEHICLES, SIDE LIGHTS FOR VEHICLES, TURN SIGNAL LAMPS, LIGHT-BULBS, REVERSING LIGHTS FOR VEHICLES, PARKING LIGHTS FOR VEHICLES, ANTI-DAZZLE DEVICES FOR AUTOMOBILE LAMPS, NAMELY, ANTI-DAZZLE FOG LAMPS FOR AUTOMOBILES, ANTI-DAZZLE HEADLIGHTS FOR AUTOMOBILES, ANTI-DAZZLE BRAKE LIGHTS FOR AUTOMOBILES, ANTI-DAZZLE TAIL LIGHTS FOR AUTOMOBILES, ANTI-DAZZLE SIDE LIGHTS FOR AUTOMOBILES, ANTI-DAZZLE TURN SIGNALS FOR AUTOMOBILES, ANTI-DAZZLE REVERSING LIGHTS FOR AUTOMOBILES, ANTI-DAZZLE PARKING LIGHTS FOR AUTOMOBILES,

ANTI-DAZZLE DEVICES FOR VEHICLES LAMPS, NAMELY, ANTI-DAZZLE FOG LAMPS FOR VEHICLES, ANTI-DAZZLE HEADLIGHTS FOR VEHICLES, ANTI-DAZZLE BRAKE LIGHTS FOR VEHICLES, ANTI-DAZZLE TAIL LIGHTS FOR VEHICLES, ANTI-DAZZLE SIDE LIGHTS FOR VEHICLES, ANTI-DAZZLE TURN SIGNALS FOR VEHICLES, ANTI-DAZZLE REVERSING LIGHTS FOR VEHICLES, AND ANTI-DAZZLE FOR PARKING LIGHTS FOR VEHICLES, IN CLASS 11 (U.S. CLS. 13, 21, 23, 31 AND 34).

FIRST USE 7-1-2006; IN COMMERCE 7-1-2006.

NO CLAIM IS MADE TO THE EXCLUSIVE RIGHT TO USE "AP" , APART FROM THE MARK AS SHOWN.

SER. NO. 76-668,786, FILED 11-9-2006.

TINA BROWN, EXAMINING ATTORNEY

**Int. Cl.: 12**

**Prior U.S. Cls.: 19, 21, 23, 31, 35 and 44**

**Reg. No. 3,393,834**

**United States Patent and Trademark Office**

**Registered Mar. 11, 2008**

**TRADEMARK  
PRINCIPAL REGISTER**

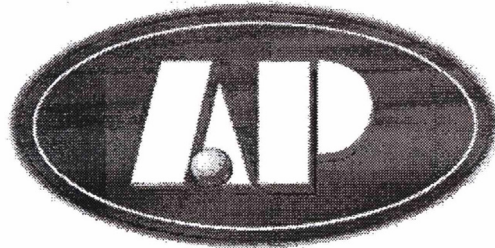

AUTO PARTS INDUSTRIAL LTD. (TAIWAN CORPORATION)  
NO.50-1, 7 LIN, KWO LING LI  
JUNG-LI CITY  
TAO-YUAN HSIEN, TAIWAN 320

FIRST USE 7-1-2006; IN COMMERCE 7-1-2006.

FOR: AUTOMOBILES BODIES; BRAKE LININGS FOR LAND VEHICLES; BRAKE SEGMENTS FOR LAND VEHICLES; BRAKES FOR VEHICLES; AND BUMPERS FOR AUTOMOBILES, IN CLASS 12 (U.S. CLS. 19, 21, 23, 31, 35 AND 44).

NO CLAIM IS MADE TO THE EXCLUSIVE RIGHT TO USE "AP", APART FROM THE MARK AS SHOWN.

SER. NO. 76-668,787, FILED 11-9-2006.

TINA BROWN, EXAMINING ATTORNEY



**Int. Cl.: 9**

**Prior U.S. Cls.: 21, 23, 26, 36 and 38**

**Reg. No. 3,393,835**

**United States Patent and Trademark Office**

**Registered Mar. 11, 2008**

---

**TRADEMARK  
PRINCIPAL REGISTER**

MEDIA ASPECT, INC. (VIRGINIA CORPORATION)  
163 PLEASANT VIEW ROAD  
STAUNTON, VA 24401

FIRST USE 9-0-2006; IN COMMERCE 9-0-2006.

FOR: MODULARIZED INTERACTIVE VIDEO TAPES, RECORDINGS AND DISCS FOR MULTIMEDIA PLATFORMS FOR USE IN TRAINING PROGRAMS FOR THE DEPARTMENT OF DEFENSE AND HOMELAND SECURITY, IN CLASS 9 (U.S. CLS. 21, 23, 26, 36 AND 38).

THE MARK CONSISTS OF STANDARD CHARACTERS WITHOUT CLAIM TO ANY PARTICULAR FONT, STYLE, SIZE, OR COLOR.

SER. NO. 76-668,918, FILED 11-13-2006.

TINA BROWN, EXAMINING ATTORNEY

**Int. Cl.: 44**

**Prior U.S. Cls.: 100 and 101**

**United States Patent and Trademark Office**

**Reg. No. 3,393,836**

**Registered Mar. 11, 2008**

**SERVICE MARK  
PRINCIPAL REGISTER**

**SKINETICS**

SKINETICS INC (UNITED STATES CORPORATION)  
2458 NEWPORT BLVD STE 333  
COSTA MESA, CA 92627

FOR: SKIN CARE SALON SERVICES AND CONSULTING SERVICES IN THE FIELD OF SKIN CARE; SKIN CARE TREATMENT SERVICES, NAMELY, COSMETIC PEELS FOR THE FACE AND BODY, BODY WAXING SERVICES, FACIALS, AND CONSULTATION PROVIDED IN CONNECTION THEREWITH, IN CLASS 44 (U.S. CLS. 100 AND 101).

FIRST USE 11-0-2003; IN COMMERCE 11-0-2003.

THE MARK CONSISTS OF STANDARD CHARACTERS WITHOUT CLAIM TO ANY PARTICULAR FONT, STYLE, SIZE, OR COLOR.

SER. NO. 76-669,147, FILED 11-17-2006.

BARBARA A. GOLD, EXAMINING ATTORNEY

**Int. Cl.: 30**

**Prior U.S. Cl.: 46**

**United States Patent and Trademark Office**

**Reg. No. 3,393,837**

**Registered Mar. 11, 2008**

**TRADEMARK  
PRINCIPAL REGISTER**

**OLD SAVANNAH SPICE CO.**

REED, STEPHEN J. (UNITED STATES INDIVIDUAL)  
202 SALISBURY RD.  
SAVANNAH, GA 31410

NO CLAIM IS MADE TO THE EXCLUSIVE RIGHT TO USE "SPICE CO.", APART FROM THE MARK AS SHOWN.

FOR: SPICES, SAUCES, IN CLASS 30 (U.S. CL. 46).

SEC. 2(F) AS TO "SAVANNAH".

FIRST USE 10-5-1994; IN COMMERCE 10-5-1994.

SER. NO. 76-670,127, FILED 12-8-2006.

THE MARK CONSISTS OF STANDARD CHARACTERS WITHOUT CLAIM TO ANY PARTICULAR FONT, STYLE, SIZE, OR COLOR.

DAYNA BROWNE, EXAMINING ATTORNEY

**Int. Cl.: 42**

**Prior U.S. Cls.: 100 and 101**

**United States Patent and Trademark Office**

**Reg. No. 3,393,838**

**Registered Mar. 11, 2008**

**SERVICE MARK  
PRINCIPAL REGISTER**

**SHAPE UP AMERICA!**

SHAPE UP AMERICA! (ILLINOIS NOT-FOR-PROFIT CORPORATION)  
506 BRACKETT CREEK ROAD  
CLYDE PARK, MT 59018

THE MARK CONSISTS OF STANDARD CHARACTERS WITHOUT CLAIM TO ANY PARTICULAR FONT, STYLE, SIZE, OR COLOR.

FOR: PROMOTING PUBLIC AWARENESS OF THE NEED AND IMPORTANCE OF ACHIEVING AND MAINTAINING A HEALTHY BODY WEIGHT AND PHYSICAL FITNESS, IN CLASS 42 (U.S. CLS. 100 AND 101).

OWNER OF U.S. REG. NO. 2,731,294.

SER. NO. 76-670,251, FILED 12-11-2006.

FIRST USE 11-2-1994; IN COMMERCE 11-2-1994.

KIMBERLY FRYE, EXAMINING ATTORNEY

**Int. Cl.: 25**

**Prior U.S. Cls.: 22 and 39**

**United States Patent and Trademark Office**

**Reg. No. 3,393,839**

**Registered Mar. 11, 2008**

**TRADEMARK  
PRINCIPAL REGISTER**

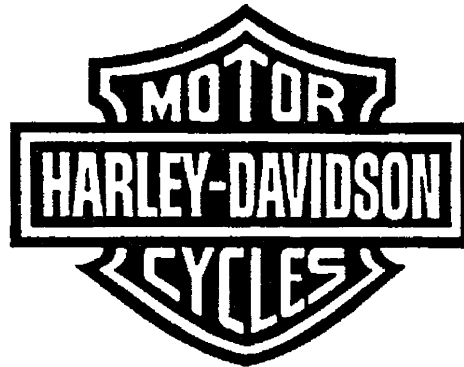

H-D MICHIGAN, INC. (MICHIGAN CORPORATION)  
315 W. HURON, SUITE 400  
ANN ARBOR, MI 48103

FOR: HOUSE MARK FOR A FULL LINE OF CLOTHING, FOOTWEAR AND HEADWEAR, IN CLASS 25 (U.S. CLS. 22 AND 39).

FIRST USE 0-0-1981; IN COMMERCE 0-0-1981.

OWNER OF U.S. REG. NOS. 1,660,539, 3,185,946 AND OTHERS.

NO CLAIM IS MADE TO THE EXCLUSIVE RIGHT TO USE "MOTORCYCLES", APART FROM THE MARK AS SHOWN.

SER. NO. 76-670,350, FILED 12-14-2006.

SANDRA MANIOS, EXAMINING ATTORNEY

**Int. Cl.: 25**

**Prior U.S. Cls.: 22 and 39**

**United States Patent and Trademark Office**

**Reg. No. 3,393,840**

**Registered Mar. 11, 2008**

**TRADEMARK  
PRINCIPAL REGISTER**

**HARLEY-DAVIDSON**

H-D MICHIGAN, INC. (MICHIGAN CORPORATION)  
315 W. HURON, SUITE 400  
ANN ARBOR, MI 48103

FOR: HOUSE MARK FOR A FULL LINE OF CLOTHING, FOOTWEAR AND HEADWEAR, IN CLASS 25 (U.S. CLS. 22 AND 39).

FIRST USE 12-15-1915; IN COMMERCE 12-15-1915.

THE MARK CONSISTS OF STANDARD CHARACTERS WITHOUT CLAIM TO ANY PARTICULAR FONT, STYLE, SIZE, OR COLOR.

OWNER OF U.S. REG. NOS. 1,234,404, 1,450,348 AND OTHERS.

SER. NO. 76-670,351, FILED 12-14-2006.

SANDRA MANIOS, EXAMINING ATTORNEY

**Int. Cl.: 38**

**Prior U.S. Cls.: 100, 101 and 104**

**United States Patent and Trademark Office**

**Reg. No. 3,393,841**

**Registered Mar. 11, 2008**

**SERVICE MARK  
PRINCIPAL REGISTER**

**iPling**

MONROY, MANUEL (UNITED STATES INDIVIDUAL)  
1079 HACIENDA DR.  
WALNUT CREEK, CA 94598

FOR: PROVIDING ELECTRONIC TELECOMMUNICATIONS CONNECTIONS, NAMELY, AN ELECTRONIC MATCH REQUEST SERVICE WHERE A MOBILE DEVICE USES A RADIO SIGNAL, THE CELLULAR NETWORKS, OTHER AVAILABLE WIRELESS NETWORKS, THE INTERNET, AND GLOBAL POSITIONING SYSTEMS TO SEARCH FOR USERS THAT SIGNAL BACK BASED ON THEIR PROFILE, LOCATION AND GRANTED

PERMISSIONS, IN CLASS 38 (U.S. CLS. 100, 101 AND 104).

FIRST USE 12-16-2006; IN COMMERCE 12-16-2006.

THE MARK CONSISTS OF STANDARD CHARACTERS WITHOUT CLAIM TO ANY PARTICULAR FONT, STYLE, SIZE, OR COLOR.

SER. NO. 76-670,921, FILED 12-29-2006.

ANTHONY RINKER, EXAMINING ATTORNEY

**Int. Cl.: 1**

**Prior U.S. Cls.: 1, 5, 6, 10, 26 and 46**

**Reg. No. 3,393,842**

**United States Patent and Trademark Office**

**Registered Mar. 11, 2008**

**TRADEMARK  
PRINCIPAL REGISTER**

**PREFERENTIAL TREATMENT**

BETTY'S AZALEA RANCH, INC. (VIRGINIA  
CORPORATION)  
12507 LEE HIGHWAY  
FAIRFAX, VA 22030

FOR: GARDENING PRODUCTS, NAMELY, SOIL  
CONDITIONING PREPARATIONS, IN CLASS 1 (U.S.  
CLS. 1, 5, 6, 10, 26 AND 46).

FIRST USE 7-24-2003; IN COMMERCE 7-24-2003.

THE MARK CONSISTS OF STANDARD CHAR-  
ACTERS WITHOUT CLAIM TO ANY PARTICULAR  
FONT, STYLE, SIZE, OR COLOR.

NO CLAIM IS MADE TO THE EXCLUSIVE  
RIGHT TO USE "TREATMENT", APART FROM  
THE MARK AS SHOWN.

SER. NO. 76-671,013, FILED 1-4-2007.

STEVEN JACKSON, EXAMINING ATTORNEY



**Int. Cl.: 26**

**Prior U.S. Cls.: 37, 39, 40, 42 and 50**

**United States Patent and Trademark Office**

**Reg. No. 3,393,843**

**Registered Mar. 11, 2008**

**TRADEMARK  
PRINCIPAL REGISTER**

**SWEET INSPIRATIONS**

SULYN INDUSTRIES, INC. (FLORIDA CORPORATION)  
11927 WEST SAMPLE ROAD  
CORAL SPRINGS, FL 33071

FOR: NOVELTY ITEMS, NAMELY, BEADS AND FINDINGS IN THE NATURE OF PLASTIC, GLASS, AND METAL BEADS AND FINDINGS FORMED WITH DECORATIVE FEATURES, NAMELY, LETTERS OF THE ALPHABET, SPARKLES, HEARTS, WOOD TONES, AND ANIMAL SHAPES, IN CLASS 26 (U.S. CLS. 37, 39, 40, 42 AND 50).

FIRST USE 10-0-2004; IN COMMERCE 10-0-2004.

THE MARK CONSISTS OF STANDARD CHARACTERS WITHOUT CLAIM TO ANY PARTICULAR FONT, STYLE, SIZE, OR COLOR.

SER. NO. 76-671,089, FILED 1-8-2007.

ELLEN PERKINS, EXAMINING ATTORNEY

**Int. Cl.: 44**

**Prior U.S. Cls.: 100 and 101**

**United States Patent and Trademark Office**

**Reg. No. 3,393,844**

**Registered Mar. 11, 2008**

**SERVICE MARK  
PRINCIPAL REGISTER**



SINOUNITED HEALTH INC. (NEW YORK COR-  
PORATION)  
943 LEXINGTON AVENUE  
NEW YORK, NY 10021

FIRST USE 9-0-2003; IN COMMERCE 9-0-2003.

SER. NO. 76-672,085, FILED 2-1-2007.

FOR: MEDICAL SERVICES, IN CLASS 44 (U.S.  
CLS. 100 AND 101).

ANDREA SAUNDERS, EXAMINING ATTORNEY

**Int. Cl.: 2**

**Prior U.S. Cls.: 6, 11 and 16**

**United States Patent and Trademark Office**

**Reg. No. 3,393,845**

**Registered Mar. 11, 2008**

**TRADEMARK  
PRINCIPAL REGISTER**

**SaniKOTE**

SANIGLAZE INTERNATIONAL, LLC (FLORIDA  
LTD LIAB CO)  
115 PARK STREET, P.O. BOX 40486  
JACKSONVILLE, FL 322030486

FOR: SEALER COATING IN THE FORM OF A  
LIQUID FOR USE IN PROTECTING CERAMIC TILE  
GROUT JOINTS FROM MOISTURE, DIRT, STAINS  
AND OTHER CONTAMINANTS , IN CLASS 2 (U.S.  
CLS. 6, 11 AND 16).

FIRST USE 1-29-2007; IN COMMERCE 1-29-2007.

OWNER OF U.S. REG. NOS. 2,171,325 AND  
2,640,189.

SER. NO. 76-672,886, FILED 2-20-2007.

STEVEN PEREZ, EXAMINING ATTORNEY

**Int. Cl.: 3**

**Prior U.S. Cls.: 1, 4, 6, 50, 51 and 52**

**Reg. No. 3,393,846**

**United States Patent and Trademark Office**

**Registered Mar. 11, 2008**

---

**TRADEMARK  
PRINCIPAL REGISTER**

**TIDYPEARL**

ADVANTAGE MARKETING ASSOCIATES, INC.  
(ILLINOIS CORPORATION)  
1636 CALHOUN AVENUE  
RIPON, CA 95366

THE MARK CONSISTS OF STANDARD CHAR-  
ACTERS WITHOUT CLAIM TO ANY PARTICULAR  
FONT, STYLE, SIZE, OR COLOR.

FOR: LIQUID HAND SOAP, IN CLASS 3 (U.S. CLS.  
1, 4, 6, 50, 51 AND 52).

SER. NO. 76-673,403, FILED 3-1-2007.

FIRST USE 0-0-1995; IN COMMERCE 0-0-1995.

ANNE MADDEN, EXAMINING ATTORNEY

**Int. Cls.: 9 and 16**

**Prior U.S. Cls.: 2, 5, 21, 22, 23, 26, 29, 36, 37, 38 and 50**

**Reg. No. 3,393,847**

**United States Patent and Trademark Office**

**Registered Mar. 11, 2008**

**TRADEMARK  
PRINCIPAL REGISTER**

**CURRICULUM OF CHRISTLIKENESS**

INTERNATIONAL PENTECOSTAL HOLINESS  
CHURCH, INC. (OKLAHOMA CORPORATION)  
7300 NW 39TH EXPRESSWAY  
BETHANY, OK 73008

FOR: ELECTRONIC EDUCATIONAL MATERIALS AND PUBLICATIONS, NAMELY, WORKBOOKS, TEXTBOOKS AND EDUCATIONAL PROGRAMS IN THE FIELD OF BIBLE STUDY FOR SUNDAY SCHOOL STUDENTS OF ALL AGES RECORDED ON COMPUTER AUDIO/VISUAL MEDIA, NAMELY CDS AND DVDS, IN CLASS 9 (U.S. CLS. 21, 23, 26, 36 AND 38).

FIRST USE 2-0-2000; IN COMMERCE 2-0-2000.

FOR: PRINTED EDUCATIONAL MATERIALS AND PUBLICATIONS, NAMELY, WORKBOOKS

AND TEXTBOOKS IN THE FIELD OF BIBLE STUDY FOR SUNDAY SCHOOL STUDENTS OF ALL AGES, IN CLASS 16 (U.S. CLS. 2, 5, 22, 23, 29, 37, 38 AND 50).

FIRST USE 2-0-2000; IN COMMERCE 2-0-2000.

THE MARK CONSISTS OF STANDARD CHARACTERS WITHOUT CLAIM TO ANY PARTICULAR FONT, STYLE, SIZE, OR COLOR.

NO CLAIM IS MADE TO THE EXCLUSIVE RIGHT TO USE "CURRICULUM", APART FROM THE MARK AS SHOWN.

SER. NO. 76-674,131, FILED 3-15-2007.

GISSELLE AGOSTO, EXAMINING ATTORNEY

Int. Cl.: 43

Prior U.S. Cls.: 100 and 101

United States Patent and Trademark Office

Reg. No. 3,393,848

Registered Mar. 11, 2008

**SERVICE MARK  
PRINCIPAL REGISTER**



AURELIO'S PIZZA, INC. (ILLINOIS CORPORATION)  
18162 HARWOOD AVENUE  
HOMEWOOD, IL 60430

OWNER OF U.S. REG. NOS. 1,054,871, 1,862,660  
AND OTHERS.

FOR: RETAIL RESTAURANT SERVICES SPECIALIZING IN PIZZA PIES AND PIZZA RELATED FINISHED FOOD PRODUCTS FOR IN-HOUSE CONSUMPTION AS WELL AS CARRY-OUT SERVICES, IN CLASS 43 (U.S. CLS. 100 AND 101).

NO CLAIM IS MADE TO THE EXCLUSIVE RIGHT TO USE "PIZZA", APART FROM THE MARK AS SHOWN.

SER. NO. 76-675,261, FILED 4-9-2007.

FIRST USE 11-1-1974; IN COMMERCE 11-1-1974.

DARRYL SPRUILL, EXAMINING ATTORNEY

**Int. Cl.: 9**

**Prior U.S. Cls.: 21, 23, 26, 36 and 38**

**United States Patent and Trademark Office**

**Reg. No. 3,393,849**

**Registered Mar. 11, 2008**

**TRADEMARK  
PRINCIPAL REGISTER**

**BRAVOMAN**

NAMCO BANDAI GAMES INC. (JAPAN CORPORATION)  
2-1-21 YAGUCHI, OTA-KU  
TOKYO, JAPAN 146-8655

THE MARK CONSISTS OF STANDARD CHARACTERS WITHOUT CLAIM TO ANY PARTICULAR FONT, STYLE, SIZE, OR COLOR.

FOR: VIDEO GAME CARTRIDGES, COMPUTER GAME PROGRAMS, IN CLASS 9 (U.S. CLS. 21, 23, 26, 36 AND 38).

SER. NO. 76-675,287, FILED 4-10-2007.

FIRST USE 9-28-1990; IN COMMERCE 9-28-1990.

KAPIL BHANOT, EXAMINING ATTORNEY

**Int. Cl.: 5**

**Prior U.S. Cls.: 6, 18, 44, 46, 51 and 52**

**Reg. No. 3,393,850**

**United States Patent and Trademark Office**

**Registered Mar. 11, 2008**

**TRADEMARK  
PRINCIPAL REGISTER**

# RepliVAX

BOARD OF REGENTS OF THE UNIVERSITY OF  
TEXAS SYSTEM (TEXAS STATE AGENCY)  
301 UNIVERSITY BOULEVARD  
GALVESTON, TX 775550926

THE MARK CONSISTS OF STANDARD CHAR-  
ACTERS WITHOUT CLAIM TO ANY PARTICULAR  
FONT, STYLE, SIZE, OR COLOR.

FOR: PHARMACEUTICAL VACCINE USING  
PSEUDOINFECTIOUS VIRAL PARTICLES, IN  
CLASS 5 (U.S. CLS. 6, 18, 44, 46, 51 AND 52).

SER. NO. 76-675,806, FILED 4-23-2007.

FIRST USE 11-1-2006; IN COMMERCE 11-1-2006.

DAWN FELDMAN, EXAMINING ATTORNEY



**Int. Cl.: 40**

**Prior U.S. Cls.: 100, 103 and 106**

**United States Patent and Trademark Office**

**Reg. No. 3,393,851**

**Registered Mar. 11, 2008**

**SERVICE MARK  
PRINCIPAL REGISTER**

**LIBERTY BUILDING FORENSICS GROUP**

LIBERTY DIAGNOSTICS, LLC (FLORIDA LTD  
LIAB CO)  
530 N. COMMONWEALTH AVENUE  
POLK CITY, FL 33868

FOR: MOLD REMEDIATION SERVICES; MOLD  
PREVENTION TREATMENT OF BUILDINGS AND  
BUILDING MATERIALS, IN CLASS 40 (U.S. CLS.  
100, 103 AND 106).

FIRST USE 4-13-2007; IN COMMERCE 4-13-2007.

THE MARK CONSISTS OF STANDARD CHAR-  
ACTERS WITHOUT CLAIM TO ANY PARTICULAR  
FONT, STYLE, SIZE, OR COLOR.

NO CLAIM IS MADE TO THE EXCLUSIVE  
RIGHT TO USE "BUILDING FORENSICS GROUP",  
APART FROM THE MARK AS SHOWN.

SER. NO. 76-675,969, FILED 4-25-2007.

DAVID TOOLEY, EXAMINING ATTORNEY

**Int. Cl.: 16**

**Prior U.S. Cls.: 2, 5, 22, 23, 29, 37, 38 and 50**

**Reg. No. 3,393,852**

**United States Patent and Trademark Office**

**Registered Mar. 11, 2008**

**TRADEMARK  
PRINCIPAL REGISTER**

**GALILEO PRESS**

GALILEO PRESS GMBH (FED REP GERMANY  
LTD LIAB CO)  
RHEINWERKALLEE 4  
53227 BONN, FED REP GERMANY

FOR: PRINTED MATTER, NAMELY, BOOKS, GUIDES, NEWSLETTERS, MAGAZINES, REPORTS, JOURNALS AND TECHNICAL INSTRUCTION MANUALS DEALING PRIMARILY WITH ONE OR MORE OF THE FOLLOWING SUBJECTS: PHOTOGRAPHY, GRAPHIC DESIGN, VIDEO AND AUDIO PRODUCTION, TECHNICAL AND BUSINESS-RELATED ENTERPRISE RESOURCE PLANNING (ERP) SYSTEMS TOPICS, AND THE DESIGN, DEVELOPMENT, IMPLEMENTATION, SUPPORT, MANAGEMENT, AND/OR USE OF INFORMATION TECHNOLOGY; BUT EXCLUDING ALL OF THE FOLLOWING: BOOKS, GUIDES, NEWSLETTERS, MAGAZINES, REPORTS AND OTHER PRINTED PUBLICATIONS DEALING PRIMARILY WITH OR USED PRIMARILY FOR ON-LINE OR OTHER TYPES OF TRAVEL RESERVATIONS, TRAVEL ARRANGEMENTS, TRAVEL ACCOMMODATIONS, TRAVEL BOOKINGS, TRAVEL MANAGEMENT OR TRAVEL ADMINISTRATION, THE RESERVATION AND BOOKING OF TRAVEL ARRANGEMENTS, THE MAKING OF RESERVATIONS AND BOOKING FOR TRANSPORTATION, TRAVEL, LODGING, ENTERTAINMENT, AUTO LEASING OR TRAVEL SERVICES, AND TRAVEL AGENCY OPERATIONS AND TRAVEL AGENCY MANAGEMENT, INFORMATION, PHOTOGRAPHS AND GRAPHICS IN THE FIELD OF WEATHER FOR USE PRIMARILY BY WEATHER PRESENTERS,

FORECASTERS AND PROFESSIONALS, GLOBAL POSITIONING SYSTEMS, THE PROVIDING OF COMPREHENSIVE MONITORING OF MEDIA OUTLETS, INSTRUCTION ON ETHICAL SALES TECHNIQUES, CHILDREN'S BOOKS, CHILDREN'S GAMES, CHILDREN'S EDUCATIONAL MATERIALS, CHILDREN'S ENTERTAINMENT, CHILDREN'S LEARNING ACTIVITIES, AND FILMS AND IMAGES FOR CHILDREN, MANAGING THE LESSONS, ACHIEVEMENTS, DEVELOPMENTS, OBSERVATIONS, ACTIVITIES AND REPORTS OF CHILDREN, THE PROCESSING, RATING AND CODING OF INSURANCE POLICIES, MEASUREMENT SYSTEMS FOR USE IN QUALITY CONTROL AND MANUFACTURING, IN VITRO EXPERIMENTS IN THE PHARMACEUTICAL INDUSTRY, DIVE COMPUTERS, AND DIGITAL LOUD SPEAKER MANAGEMENT SYSTEMS, IN CLASS 16 (U.S. CLS. 2, 5, 22, 23, 29, 37, 38 AND 50).

FIRST USE 9-9-2002; IN COMMERCE 9-9-2002.

THE MARK CONSISTS OF STANDARD CHARACTERS WITHOUT CLAIM TO ANY PARTICULAR FONT, STYLE, SIZE, OR COLOR.

NO CLAIM IS MADE TO THE EXCLUSIVE RIGHT TO USE "PRESS", APART FROM THE MARK AS SHOWN.

SER. NO. 76-676,122, FILED 4-27-2007.

SUSAN STIGLITZ, EXAMINING ATTORNEY

**Int. Cl.: 16**

**Prior U.S. Cls.: 2, 5, 22, 23, 29, 37, 38 and 50**

**United States Patent and Trademark Office**

**Reg. No. 3,393,853**

**Registered Mar. 11, 2008**

**TRADEMARK  
PRINCIPAL REGISTER**



GALILEO PRESS GMBH (FED REP GERMANY  
LTD LIAB CO)  
RHEINWERKALLEE 4  
53227 BONN, FED REP GERMANY

FOR: PRINTED MATTER, NAMELY, BOOKS, GUIDES, NEWSLETTERS, MAGAZINES, REPORTS, JOURNALS AND TECHNICAL INSTRUCTION MANUALS DEALING PRIMARILY WITH ONE OR MORE OF THE FOLLOWING SUBJECTS: PHOTOGRAPHY, GRAPHIC DESIGN, VIDEO AND AUDIO PRODUCTION, TECHNICAL AND BUSINESS-RELATED ENTERPRISE RESOURCE PLANNING (ERP) SYSTEMS TOPICS, AND THE DESIGN, DEVELOPMENT, IMPLEMENTATION, SUPPORT, MANAGEMENT, AND/OR USE OF INFORMATION TECHNOLOGY; BUT EXCLUDING ALL OF THE FOLLOWING: BOOKS, GUIDES, NEWSLETTERS, MAGAZINES, REPORTS AND OTHER PRINTED PUBLICATIONS DEALING PRIMARILY WITH OR USED PRIMARILY FOR ON-LINE OR OTHER TYPES OF TRAVEL RESERVATIONS, TRAVEL ARRANGEMENTS, TRAVEL ACCOMMODATIONS, TRAVEL BOOKINGS, TRAVEL MANAGEMENT OR TRAVEL ADMINISTRATION, THE RESERVATION AND BOOKING OF TRAVEL ARRANGEMENTS, THE MAKING OF RESERVATIONS AND BOOKING FOR TRANSPORTATION, TRAVEL, LODGING, ENTERTAINMENT, AUTO LEASING OR TRAVEL SERVICES, AND TRAVEL AGENCY

OPERATIONS AND TRAVEL AGENCY MANAGEMENT, INFORMATION, PHOTOGRAPHS AND GRAPHICS IN THE FIELD OF WEATHER FOR USE PRIMARILY BY WEATHER PRESENTERS, FORECASTERS AND PROFESSIONALS, GLOBAL POSITIONING SYSTEMS, THE PROVIDING OF COMPREHENSIVE MONITORING OF MEDIA OUTLETS, INSTRUCTION ON ETHICAL SALES TECHNIQUES, CHILDREN'S BOOKS, CHILDREN'S GAMES, CHILDREN'S EDUCATIONAL MATERIALS, CHILDREN'S ENTERTAINMENT, CHILDREN'S LEARNING ACTIVITIES, AND FILMS AND IMAGES FOR CHILDREN, MANAGING THE LESSONS, ACHIEVEMENTS, DEVELOPMENTS, OBSERVATIONS, ACTIVITIES AND REPORTS OF CHILDREN, THE PROCESSING, RATING AND CODING OF INSURANCE POLICIES, MEASUREMENT SYSTEMS FOR USE IN QUALITY CONTROL AND MANUFACTURING, IN VITRO EXPERIMENTS IN THE PHARMACEUTICAL INDUSTRY, DIVE COMPUTERS, AND DIGITAL LOUD SPEAKER MANAGEMENT SYSTEMS, IN CLASS 16 (U.S. CLS. 2, 5, 22, 23, 29, 37, 38 AND 50).

FIRST USE 9-9-2002; IN COMMERCE 9-9-2002.

SER. NO. 76-676,137, FILED 4-27-2007.

SUSAN STIGLITZ, EXAMINING ATTORNEY

Int. Cl.: 41

Prior U.S. Cls.: 100, 101 and 107

United States Patent and Trademark Office

Reg. No. 3,393,854

Registered Mar. 11, 2008

SERVICE MARK  
PRINCIPAL REGISTER



UNIVISION COMMUNICATIONS INC. (DELA-  
WARE CORPORATION)  
5999 CENTER DRIVE  
LOS ANGELES, CA 90045

NO CLAIM IS MADE TO THE EXCLUSIVE  
RIGHT TO USE "ESCOLAR", APART FROM THE  
MARK AS SHOWN.

FOR: EDUCATION AND ENTERTAINMENT  
SERVICES, NAMELY, ONGOING TELEVISED PUB-  
LIC SERVICE ANNOUNCEMENTS PROMOTING  
THE BENEFITS OF EDUCATION AND AWARDED  
OF SCHOLASTIC SCHOLARSHIPS, IN CLASS 41  
(U.S. CLS. 100, 101 AND 107).

THE ENGLISH TRANSLATION OF "EXITO ES-  
COLAR" IS "SCHOLASTIC SUCCESS".

SER. NO. 76-676,195, FILED 4-30-2007.

FIRST USE 7-0-1988; IN COMMERCE 7-0-1988.

KAPIL BHANOT, EXAMINING ATTORNEY

**Int. Cl.: 35**

**Prior U.S. Cls.: 100, 101 and 102**

**United States Patent and Trademark Office**

**Reg. No. 3,393,855**

**Registered Mar. 11, 2008**

**SERVICE MARK  
PRINCIPAL REGISTER**



**The Vitamin & Herb Stores**

TURCHIANO, RALPH (UNITED STATES INDIVIDUAL)

214 E. HIGHWAY 246 S#101

BUELLTON, CA 93427

FOR: RETAIL STORE SERVICES IN THE FIELD OF VITAMINS, HERBS, ESSENTIAL OILS, FOOD POWDERS, SUPPLEMENTS, HEALTH FOODS, AND OTHER NUTRACEUTICALS; ONLINE ORDERING SERVICES FEATURING VITAMINS, HERBS, ESSENTIAL OILS, FOOD POWDERS, SUPPLEMENTS, HEALTH FOODS, AND OTHER NUTRACEUTICALS, IN CLASS 35 (U.S. CLS. 100, 101 AND 102).

FIRST USE 12-7-1998; IN COMMERCE 12-7-1998.

NO CLAIM IS MADE TO THE EXCLUSIVE RIGHT TO USE "THE VITAMIN AND HERB STORES", APART FROM THE MARK AS SHOWN.

THE COLOR(S) WHITE, BLACK AND BLUE IS/ ARE CLAIMED AS A FEATURE OF THE MARK.

THE MARK CONSISTS OF A WHITE CIRCLE WITH BLACK OUTLINE, BLACK LETTERING OF THE WORDS THE VITAMIN AND HERB STORES, AND THE LETTERS V H IN THE CIRCLE HAVING A BLUE "V H".

SER. NO. 76-676,815, FILED 5-14-2007.

LINDA MICKLEBURGH, EXAMINING ATTORNEY

**Int. Cls.: 31 and 35**

**Prior U.S. Cls.: 1, 46, 100, 101 and 102**

**United States Patent and Trademark Office**

**Reg. No. 3,393,856**

**Registered Mar. 11, 2008**

**TRADEMARK  
SERVICE MARK  
PRINCIPAL REGISTER**



QUALITY CHRISTMAS TREE, LTD. (TEXAS LIMITED PARTNERSHIP)

P.O. BOX 273179

HOUSTON, TX 77277

FOR: LIVE PLANTS, LIVE FLOWERS, LIVE TREES, AND LIVE SHRUBS, IN CLASS 31 (U.S. CLS. 1 AND 46).

FIRST USE 1-1-1996; IN COMMERCE 1-1-1996.

FOR: RETAIL STORE SERVICES FEATURING LIVE PLANTS, LIVE FLOWERS, LIVE TREES, LIVE SHRUBS, SEEDS, DIRT, SOIL, MULCH, FERTILIZER, AND EQUIPMENT AND SUPPLIES FOR LAWN, GARDEN, AND PLANT CARE, IN CLASS 35 (U.S. CLS. 100, 101 AND 102).

FIRST USE 1-1-1996; IN COMMERCE 1-1-1996.

NO CLAIM IS MADE TO THE EXCLUSIVE RIGHT TO USE "HOUSTON GARDEN CENTERS", APART FROM THE MARK AS SHOWN.

THE COLOR(S) RED, YELLOW, AND BLACK IS/ ARE CLAIMED AS A FEATURE OF THE MARK.

THE COLOR RED APPEARS IN THE UMBRELLA. THE COLOR YELLOW APPEARS IN ALTERNATING PANELS OF THE UMBRELLA. THE COLOR BLACK APPEARS IN THE TEXT, "HOUSTON" APPEARING ABOVE THE UMBRELLA, THE TEXT "GARDEN CENTERS" APPEARING BELOW THE UMBRELLA, AND OUTLINES THE EXTERIOR AND PANELS OF THE UMBRELLA.

SER. NO. 76-677,517, FILED 5-29-2007.

NAPOLEON SHARMA, EXAMINING ATTORNEY

**Int. Cl.: 41**

**Prior U.S. Cls.: 100, 101 and 107**

**United States Patent and Trademark Office**

**Reg. No. 3,393,857**

**Registered Mar. 11, 2008**

**SERVICE MARK  
PRINCIPAL REGISTER**

**AKRON INSTITUTE**

HERZING OHIO, LLC (OHIO LTD LIAB CO)  
1600 SOUTH ARLINGTON STREET  
AKRON, OH 44306

FOR: EDUCATIONAL SERVICES, NAMELY,  
PROVIDING COURSES OF INSTRUCTION AT  
THE COLLEGE LEVEL IN THE FIELDS OF BUSI-  
NESS, HEALTH CARE AND TECHNOLOGY, IN  
CLASS 41 (U.S. CLS. 100, 101 AND 107).

FIRST USE 12-31-1996; IN COMMERCE 12-31-1996.

THE MARK CONSISTS OF STANDARD CHAR-  
ACTERS WITHOUT CLAIM TO ANY PARTICULAR  
FONT, STYLE, SIZE, OR COLOR.

NO CLAIM IS MADE TO THE EXCLUSIVE  
RIGHT TO USE "INSTITUTE", APART FROM THE  
MARK AS SHOWN.

SEC. 2(F).

SER. NO. 76-677,650, FILED 5-31-2007.

KATINA MISTER, EXAMINING ATTORNEY

**Int. Cl.: 9**

**Prior U.S. Cls.: 21, 23, 26, 36 and 38**

**United States Patent and Trademark Office**

**Reg. No. 3,393,858**

**Registered Mar. 11, 2008**

**TRADEMARK  
PRINCIPAL REGISTER**

**STREAMLINE**

GRIFFIN TECHNOLOGY, INC. (TENNESSEE  
CORPORATION)  
1930 AIR LANE DRIVE  
NASHVILLE, TN 37210

THE MARK CONSISTS OF STANDARD CHAR-  
ACTERS WITHOUT CLAIM TO ANY PARTICULAR  
FONT, STYLE, SIZE, OR COLOR.

FOR: ARMBAND WITHIN WHICH CAN BE  
HELD AN MP3 PLAYER DEVICE, IN CLASS 9 (U.S.  
CLS. 21, 23, 26, 36 AND 38).

SER. NO. 76-677,826, FILED 6-1-2007.

FIRST USE 2-22-2007; IN COMMERCE 4-3-2007.

ERNEST SHOSHO, EXAMINING ATTORNEY



**Int. Cl.: 43**

**Prior U.S. Cls.: 100 and 101**

**United States Patent and Trademark Office**

**Reg. No. 3,393,859**

**Registered Mar. 11, 2008**

**SERVICE MARK  
PRINCIPAL REGISTER**

**AZZA**

DEMAMA, LLC (NEW YORK LTD LIAB CO)  
135 EAST 55TH STREET  
NEW YORK, NY 10017

FOR: RESTAURANT AND COCKTAIL LOUNGE  
SERVICES, IN CLASS 43 (U.S. CLS. 100 AND 101).

FIRST USE 3-10-2007; IN COMMERCE 3-10-2007.

THE MARK CONSISTS OF STANDARD CHAR-  
ACTERS WITHOUT CLAIM TO ANY PARTICULAR  
FONT, STYLE, SIZE, OR COLOR.

THE NAME AZZA DOES NOT IDENTIFY A  
LIVING INDIVIDUAL.

SER. NO. 76-678,350, FILED 6-14-2007.

KAPIL BHANOT, EXAMINING ATTORNEY

**Int. Cl.: 35**

**Prior U.S. Cls.: 100, 101 and 102**

**United States Patent and Trademark Office**

**Reg. No. 3,393,860**

**Registered Mar. 11, 2008**

**SERVICE MARK  
PRINCIPAL REGISTER**

**STUPID FRIDAY DEALS**

VOGLER ENTERPRISES, INC. (MISSOURI CORPORATION)  
503 S. MCCLEARY ROAD  
EXCELSIOR SPRINGS, MO 64024

FOR: WHOLESALE DISTRIBUTORSHIPS FEATURING CONSUMER ELECTRONICS, IN CLASS 35 (U.S. CLS. 100, 101 AND 102).

FIRST USE 9-29-2006; IN COMMERCE 9-29-2006.

THE MARK CONSISTS OF STANDARD CHARACTERS WITHOUT CLAIM TO ANY PARTICULAR FONT, STYLE, SIZE, OR COLOR.

NO CLAIM IS MADE TO THE EXCLUSIVE RIGHT TO USE "FRIDAY DEALS", APART FROM THE MARK AS SHOWN.

SER. NO. 76-678,493, FILED 6-21-2007.

KELLY MCCOY, EXAMINING ATTORNEY

**Int. Cl.: 9**

**Prior U.S. Cls.: 21, 23, 26, 36 and 38**

**United States Patent and Trademark Office**

**Reg. No. 3,393,861**

**Registered Mar. 11, 2008**

**TRADEMARK  
PRINCIPAL REGISTER**

**SATORI SOFTWARE**

SATORI SOFTWARE (WASHINGTON CORPORATION)  
2815 SECOND AVENUE, SUITE 500  
SEATTLE, WA 98121

FOR: PRE-RECORDED COMPUTER PROGRAMS  
FOR MAILING LIST MANAGEMENT, PROJECT  
BILLING AND LEGAL BILLING, IN CLASS 9 (U.S.  
CLS. 21, 23, 26, 36 AND 38).

FIRST USE 7-0-1998; IN COMMERCE 7-0-1998.

THE MARK CONSISTS OF STANDARD CHARACTERS  
WITHOUT CLAIM TO ANY PARTICULAR  
FONT, STYLE, SIZE, OR COLOR.

OWNER OF U.S. REG. NO. 1,495,686.

NO CLAIM IS MADE TO THE EXCLUSIVE  
RIGHT TO USE "SOFTWARE", APART FROM THE  
MARK AS SHOWN.

THE WORDING SATORI HAS NO MEANING IN  
ENGLISH

SER. NO. 76-678,560, FILED 6-22-2007.

ANDREA SAUNDERS, EXAMINING ATTORNEY

**Int. Cl.: 9**

**Prior U.S. Cls.: 21, 23, 26, 36 and 38**

**United States Patent and Trademark Office**

**Reg. No. 3,393,862**

**Registered Mar. 11, 2008**

**TRADEMARK  
PRINCIPAL REGISTER**

**SATORI SOFTWARE**

SATORI SOFTWARE (WASHINGTON CORPORATION)  
2815 SECOND AVENUE, SUITE 500  
SEATTLE, WA 98121

FOR: PRE-RECORDED COMPUTER PROGRAMS  
FOR MAILING LIST PROCESSING, ADDRESS  
MANAGEMENT AND DATA PROCESSING, IN  
CLASS 9 (U.S. CLS. 21, 23, 26, 36 AND 38).

FIRST USE 5-0-1982; IN COMMERCE 11-10-1982.

THE MARK CONSISTS OF STANDARD CHARACTERS WITHOUT CLAIM TO ANY PARTICULAR FONT, STYLE, SIZE, OR COLOR.

OWNER OF U.S. REG. NO. 1,495,686.

NO CLAIM IS MADE TO THE EXCLUSIVE RIGHT TO USE "SOFTWARE", APART FROM THE MARK AS SHOWN.

THE WORDING SATORI HAS NO MEANING IN ENGLISH

SER. NO. 76-678,570, FILED 6-22-2007.

ANDREA SAUNDERS, EXAMINING ATTORNEY

**Int. Cl.: 41**

**Prior U.S. Cls.: 100, 101 and 107**

**United States Patent and Trademark Office**

**Reg. No. 3,393,863**

**Registered Mar. 11, 2008**

**SERVICE MARK  
PRINCIPAL REGISTER**

**MIUNICAST.COM**

UNIVISION COMMUNICATIONS INC. (DELA-  
WARE CORPORATION)  
5999 CENTER DRIVE  
LOS ANGELES, CA 90045

FOR: PODCASTING SERVICES, NAMELY, MAK-  
ING PRE-RECORDED INFORMATIONAL, EDUCA-  
TIONAL AND ENTERTAINMENT PROGRAMS  
AVAILABLE FOR DOWNLOAD FROM A WEBSITE  
ON THE WORLD WIDE WEB , IN CLASS 41 (U.S.  
CLS. 100, 101 AND 107).

FIRST USE 10-0-2005; IN COMMERCE 10-0-2005.

THE MARK CONSISTS OF STANDARD CHAR-  
ACTERS WITHOUT CLAIM TO ANY PARTICULAR  
FONT, STYLE, SIZE, OR COLOR.

SER. NO. 76-678,578, FILED 6-22-2007.

DAVID C. REIHNER, EXAMINING ATTORNEY

**Int. Cls.: 35 and 41**

**Prior U.S. Cls.: 100, 101, 102 and 107**

**United States Patent and Trademark Office**

**Reg. No. 3,393,864**

**Registered Mar. 11, 2008**

**SERVICE MARK  
PRINCIPAL REGISTER**

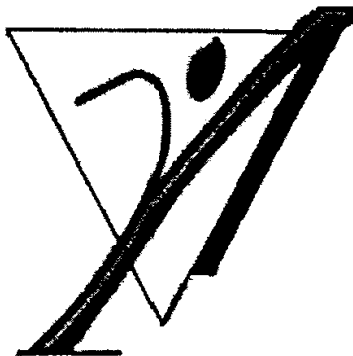

THE UNITED METHODIST PUBLISHING  
HOUSE (ILLINOIS CORPORATION)  
201 EIGHTH AVENUE SOUTH  
NASHVILLE, TN 37202

FOR: COMPUTERIZED ONLINE ORDERING  
SERVICES IN THE FIELD OF PUBLICATIONS IN  
THE FIELD OF RELIGION, CHRISTIANITY AND  
FAMILY VALUES , IN CLASS 35 (U.S. CLS. 100, 101  
AND 102).

FIRST USE 1-0-2000; IN COMMERCE 1-0-2001.

FOR: PROVIDING AN ONLINE COMPUTER DA-  
TABASE FEATURING EDUCATIONAL INFORMA-  
TION REGARDING YOUTH MINISTRY, NAMELY,  
ARTICLES, PLANNING GUIDES, RESOURCE CAT-  
ALOGUES, TRAINING, AND EDUCATIONAL  
EVENTS IN THE FIELD OF RELIGION, CHRIS-

TIANITY AND FAMILY VALUES; ONLINE PUBLI-  
CATION OF PAMPHLETS, BROCHURES,  
ARTICLES AND BOOKS IN THE FIELD OF RELI-  
GION, CHRISTIANITY AND FAMILY VALUES;  
EDUCATIONAL SERVICES, NAMELY, CONDUCT-  
ING INFORMAL PROGRAMS IN THE FIELD OF  
RELIGION, CHRISTIANITY AND FAMILY VA-  
LUES, USING ONLINE ACTIVITIES, INTERACTIVE  
EXHIBITS AND PRINTABLE MATERIALS DIS-  
TRIBUTED THEREWITH, IN CLASS 41 (U.S. CLS.  
100, 101 AND 107).

FIRST USE 1-0-2000; IN COMMERCE 1-0-2001.

SER. NO. 76-678,755, FILED 6-26-2007.

CHRISTINE COOPER, EXAMINING ATTORNEY

**Int. Cls.: 37 and 44**

**Prior U.S. Cls.: 100, 101, 103 and 106**

**United States Patent and Trademark Office**

**Reg. No. 3,393,865**

**Registered Mar. 11, 2008**

**SERVICE MARK  
PRINCIPAL REGISTER**



FMI SERVICES GROUP, INC. (SOUTH CAROLINA CORPORATION)  
1983 TECHNOLOGY DRIVE  
CHARLESTON, SC 29492

FOR: STREET, ROADWAY, AND PARKING LOT MAINTENANCE, NAMELY, SWEEPING, CLEANING, AND PARKING SPACE PAINT STRIPING SERVICES; LITTER AND GRAFFITI REMOVAL, PRESSURE WASHING OF STREETS, SIDEWALKS AND OUTDOOR PROPERTY; INSTALLATION AND MAINTENANCE OF IRRIGATION SYSTEMS AND INSTALLING OF SOD, IN CLASS 37 (U.S. CLS. 100, 103 AND 106).

FIRST USE 4-12-2007; IN COMMERCE 4-12-2007.

FOR: LANDSCAPING SERVICES, NAMELY, LAWN CARE, FERTILIZATION, TREE CARE, LAWN MOWING, SEASONAL CLEAN UP, TREE SURGERY, LAWN MAINTENANCE, TURF MAINTENANCE, MULCHING, TREE AND SHRUB PRUNING, SEASONAL GROUNDS MAINTENANCE

AND LAWN, PLANT AND TREE PLANTING, IN CLASS 44 (U.S. CLS. 100 AND 101).

FIRST USE 4-12-2007; IN COMMERCE 4-12-2007.

NO CLAIM IS MADE TO THE EXCLUSIVE RIGHT TO USE "LANDSCAPE MANAGEMENT", APART FROM THE MARK AS SHOWN.

THE COLOR(S) GREEN, BLACK AND ORANGE IS/ARE CLAIMED AS A FEATURE OF THE MARK.

THE WORDS "LANDSCAPE MANAGEMENT" ARE BLACK. THE REMAINING WORDING AND THE TWO OUTER LEAVES IN THE DESIGN ARE DARK GREEN. THE CENTER LEAF IS ORANGE.

SER. NO. 76-678,814, FILED 6-27-2007.

PAUL F. GAST, EXAMINING ATTORNEY

**Int. Cl.: 45**

**Prior U.S. Cls.: 100 and 101**

**United States Patent and Trademark Office**

**Reg. No. 3,393,866**

**Registered Mar. 11, 2008**

**SERVICE MARK  
PRINCIPAL REGISTER**

**IT'S LIKE HAVING US IN YOUR OWN BACKYARD**

GOLDBERG & SIMPSON, P.S.C. (KENTUCKY  
PROFESSIONAL SERVICES CORPORATION)  
9301 DAYFLOWER STREET  
LOUISVILLE, KY 40059

THE MARK CONSISTS OF STANDARD CHAR-  
ACTERS WITHOUT CLAIM TO ANY PARTICULAR  
FONT, STYLE, SIZE, OR COLOR.

FOR: LEGAL SERVICES, IN CLASS 45 (U.S. CLS.  
100 AND 101).

SER. NO. 76-678,825, FILED 6-28-2007.

FIRST USE 6-1-2007; IN COMMERCE 6-1-2007.

JOHN DALIER, EXAMINING ATTORNEY



**Int. Cl.: 45**

**Prior U.S. Cls.: 100 and 101**

**United States Patent and Trademark Office**

**Reg. No. 3,393,867**

**Registered Mar. 11, 2008**

**SERVICE MARK  
PRINCIPAL REGISTER**

**A LAW FIRM THAT REALLY MOVES**

GOLDBERG & SIMPSON, P.S.C. (KENTUCKY  
PROFESSIONAL SERVICES CORPORATION)  
9301 DAYFLOWER STREET  
LOUISVILLE, KY 40059

THE MARK CONSISTS OF STANDARD CHAR-  
ACTERS WITHOUT CLAIM TO ANY PARTICULAR  
FONT, STYLE, SIZE, OR COLOR.

FOR: LEGAL SERVICES, IN CLASS 45 (U.S. CLS.  
100 AND 101).

SER. NO. 76-678,826, FILED 6-28-2007.

FIRST USE 6-1-2007; IN COMMERCE 6-1-2007.

JOHN DALIER, EXAMINING ATTORNEY

**Int. Cl.: 45**

**Prior U.S. Cls.: 100 and 101**

**United States Patent and Trademark Office**

**Reg. No. 3,393,868**

**Registered Mar. 11, 2008**

**SERVICE MARK  
PRINCIPAL REGISTER**

**GOLDBERG SIMPSON**

GOLDBERG & SIMPSON, P.S.C. (KENTUCKY  
PROFESSIONAL SERVICES CORPORATION)  
9301 DAYFLOWER STREET  
LOUISVILLE, KY 40059

THE MARK CONSISTS OF STANDARD CHAR-  
ACTERS WITHOUT CLAIM TO ANY PARTICULAR  
FONT, STYLE, SIZE, OR COLOR.

FOR: LEGAL SERVICES, IN CLASS 45 (U.S. CLS.  
100 AND 101).

SER. NO. 76-678,827, FILED 6-28-2007.

FIRST USE 1-1-1981; IN COMMERCE 1-1-1981.

JOHN DALIER, EXAMINING ATTORNEY

**Int. Cl.: 30**

**Prior U.S. Cl.: 46**

**United States Patent and Trademark Office**

**Reg. No. 3,393,869**

**Registered Mar. 11, 2008**

**TRADEMARK  
PRINCIPAL REGISTER**

# **HOT TAMALES ICE**

JUST BORN, INC. (PENNSYLVANIA CORPORATION)

1300 STEFKO BOULEVARD

BETHLEHEM, PA 180176672

FOR: CANDIES, IN CLASS 30 (U.S. CL. 46).

FIRST USE 8-31-2006; IN COMMERCE 8-31-2006.

THE MARK CONSISTS OF STANDARD CHARACTERS WITHOUT CLAIM TO ANY PARTICULAR FONT, STYLE, SIZE, OR COLOR.

OWNER OF U.S. REG. NO. 759,781.

SER. NO. 76-679,097, FILED 7-5-2007.

STEVEN R. FINE, EXAMINING ATTORNEY

**Int. Cl.: 39**

**Prior U.S. Cls.: 100 and 105**

**United States Patent and Trademark Office**

**Reg. No. 3,393,870**

**Registered Mar. 11, 2008**

**SERVICE MARK  
PRINCIPAL REGISTER**



KELLY CONTAINER, INC. (CONNECTICUT CORPORATION)  
911 SOUTH STREET  
SUFFIELD, CT 06078

FOR: RENTAL OF FREEZERS AND REFRIGERATORS FOR COMMERCIAL USE, IN CLASS 39 (U.S. CLS. 100 AND 105).

FIRST USE 6-1-2007; IN COMMERCE 6-1-2007.

NO CLAIM IS MADE TO THE EXCLUSIVE RIGHT TO USE "REFRIGERATION AND FREEZER," "A DIVISION OF" OR "INC.", APART FROM THE MARK AS SHOWN.

THE COLOR(S) DARK BLUE, MEDIUM BLUE, LIGHT BLUE, WHITE AND BLACK IS/ARE CLAIMED AS A FEATURE OF THE MARK.

THE MARK CONSISTS OF THE WORDING KELLY REFRIGERATION AND FREEZER A DIVISION OF KELLY CONTAINER, INC. THE COLOR DARK BLUE APPEARS IN THE "K" IN "KELLY;" THE COLOR MEDIUM BLUE APPEARS IN THE "E" AND THE FIRST "L" IN "KELLY;" THE COLOR LIGHT BLUE APPEARS IN THE SECOND "L" IN "KELLY," AND THE COLOR WHITE APPEARS IN THE "Y" IN "KELLY". THE COLOR BLACK APPEARS IN THE WORDING "REFRIGERATION AND FREEZER," "A DIVISION OF KELLY CONTAINER, INC.," THE OUTLINE OF THE WORDING "KELLY" AND THE UNDERLINE AND OVER LINE OF THE LETTERS "ELLY."

SER. NO. 76-679,106, FILED 7-5-2007.

KATHERINE CONNOLLY, EXAMINING ATTORNEY

**Int. Cl.: 35**

**Prior U.S. Cls.: 100, 101 and 102**

**United States Patent and Trademark Office**

**Reg. No. 3,393,871**

**Registered Mar. 11, 2008**

**SERVICE MARK  
PRINCIPAL REGISTER**



ACQUA DEPOT, INC. (FLORIDA CORPORATION)  
1380 MCNEAL ROAD  
SPRING HILL, FL 34608

FOR: RETAIL STORE AND ONLINE RETAIL SERVICES FEATURING POOL AND SPA SUPPLIES, IN CLASS 35 (U.S. CLS. 100, 101 AND 102).

FIRST USE 6-16-2007; IN COMMERCE 6-16-2007.

THE COLOR(S) LIGHT BLUE, DARK BLUE, BLACK AND WHITE IS/ARE CLAIMED AS A FEATURE OF THE MARK.

THE HEAD AND BODY ARE LIGHT BLUE, THE MOUTH AND EYEBROWS ARE DARK BLUE, THE GLOVES ARE WHITE AND THE EYES ARE WHITE WITH BLACK PUPILS.

SER. NO. 76-679,163, FILED 7-6-2007.

JOHN WILKE, EXAMINING ATTORNEY

**Int. Cl.: 35**

**Prior U.S. Cls.: 100, 101 and 102**

**United States Patent and Trademark Office**

**Reg. No. 3,393,872**

**Registered Mar. 11, 2008**

**SERVICE MARK  
PRINCIPAL REGISTER**

**ACQUA DEPOT**

ACQUA DEPOT, INC. (FLORIDA CORPORATION)

1380 MCNEAL ROAD  
SPRING HILL, FL 34608

FOR: RETAIL STORE AND ONLINE RETAIL SERVICES FEATURING POOL AND SPA SUPPLIES, IN CLASS 35 (U.S. CLS. 100, 101 AND 102).

FIRST USE 6-16-2007; IN COMMERCE 6-16-2007.

THE MARK CONSISTS OF STANDARD CHARACTERS WITHOUT CLAIM TO ANY PARTICULAR FONT, STYLE, SIZE, OR COLOR.

NO CLAIM IS MADE TO THE EXCLUSIVE RIGHT TO USE "DEPOT", APART FROM THE MARK AS SHOWN.

SER. NO. 76-679,164, FILED 7-6-2007.

JOHN WILKE, EXAMINING ATTORNEY

**Int. Cl.: 18**

**Prior U.S. Cls.: 1, 2, 3, 22 and 41**

**United States Patent and Trademark Office**

**Reg. No. 3,393,873**

**Registered Mar. 11, 2008**

**TRADEMARK  
PRINCIPAL REGISTER**

**CABRIO**

DOONEY & BOURKE, INC. (CONNECTICUT CORPORATION)  
ONE REGENT STREET  
P.O. BOX 841  
NORWALK, CT 06856

FOR: HANDBAGS, BRIEFCASES, LUGGAGE, WALLETS, TOTE BAGS, BACKPACKS, AND COIN PURSES, IN CLASS 18 (U.S. CLS. 1, 2, 3, 22 AND 41).

FIRST USE 7-1-1997; IN COMMERCE 7-1-1997.

THE MARK CONSISTS OF STANDARD CHARACTERS WITHOUT CLAIM TO ANY PARTICULAR FONT, STYLE, SIZE, OR COLOR.

OWNER OF U.S. REG. NO. 2,321,773.

SER. NO. 76-679,202, FILED 7-9-2007.

CHRISTINA SOBRAL, EXAMINING ATTORNEY

**Int. Cls.: 18 and 24**

**Prior U.S. Cls.: 1, 2, 3, 22, 41, 42 and 50**

**United States Patent and Trademark Office**

**Reg. No. 3,393,874**

**Registered Mar. 11, 2008**

**TRADEMARK  
PRINCIPAL REGISTER**

**CABRIOLET**

DOONEY & BOURKE, INC. (CONNECTICUT CORPORATION)  
ONE REGENT STREET  
P.O. BOX 841  
NORWALK, CT 06856

FOR: HANDBAGS, BRIEFCASES, LUGGAGE, WALLETS, TOTE BAGS, BACKPACKS, AND COIN PURSES, IN CLASS 18 (U.S. CLS. 1, 2, 3, 22 AND 41).

FIRST USE 7-1-1997; IN COMMERCE 7-1-1997.

FOR: FABRIC FOR THE MANUFACTURE OF HANDBAGS, BRIEFCASES, LUGGAGE, WALLETS,

TOTE BAGS, BACKPACKS, KEY FOBS, COIN PURSES AND EYEGLASS CASES, IN CLASS 24 (U.S. CLS. 42 AND 50).

FIRST USE 3-0-1997; IN COMMERCE 8-1-1997.

THE MARK CONSISTS OF STANDARD CHARACTERS WITHOUT CLAIM TO ANY PARTICULAR FONT, STYLE, SIZE, OR COLOR.

SER. NO. 76-679,203, FILED 7-9-2007.

CHRISTINA SOBRAL, EXAMINING ATTORNEY



**Int. Cl.: 16**

**Prior U.S. Cls.: 2, 5, 22, 23, 29, 37, 38 and 50**

**Reg. No. 3,393,875**

**United States Patent and Trademark Office**

**Registered Mar. 11, 2008**

---

**TRADEMARK  
PRINCIPAL REGISTER**

**SHINE FROM THE INSIDE OUT**

ZOASIS CORPORATION (DELAWARE CORPORATION)  
1500 OLYMPIC BOULEVARD  
SANTA MONICA, CA 90404

THE MARK CONSISTS OF STANDARD CHARACTERS WITHOUT CLAIM TO ANY PARTICULAR FONT, STYLE, SIZE, OR COLOR.

FOR: MAGAZINES FEATURING DENTAL PRODUCTS AND INFORMATION RELATED THERETO, IN CLASS 16 (U.S. CLS. 2, 5, 22, 23, 29, 37, 38 AND 50).

SER. NO. 76-679,208, FILED 7-9-2007.

FIRST USE 9-4-2006; IN COMMERCE 9-4-2006.

JAMES MACFARLANE, EXAMINING ATTORNEY

Int. Cl.: 9

Prior U.S. Cls.: 21, 23, 26, 36 and 38

United States Patent and Trademark Office

Reg. No. 3,393,876

Registered Mar. 11, 2008

TRADEMARK  
PRINCIPAL REGISTER

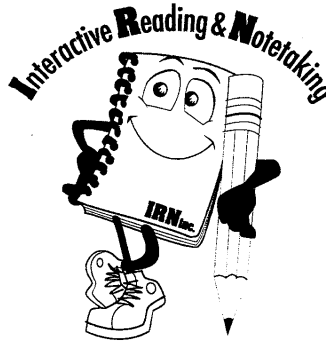

IRN, INC. (VIRGINIA CORPORATION)  
229 OLD OAKS TERRACE  
CHESAPEAKE, VA 23322

FOR: DIGITAL MATERIALS, NAMELY, CDS FEATURING TEACHER GUIDES AND ASSOCIATED STUDENT WORKBOOK PAGES FOR THE ACADEMIC SUBJECTS OF SCIENCE, SOCIAL STUDIES, MATH AND READING, IN CLASS 9 (U.S. CLS. 21, 23, 26, 36 AND 38).

FIRST USE 5-25-2007; IN COMMERCE 5-25-2007.

NO CLAIM IS MADE TO THE EXCLUSIVE RIGHT TO USE "INTERACTIVE READING & NOTETAKING" AND "INC.", APART FROM THE MARK AS SHOWN.

SER. NO. 76-679,222, FILED 7-9-2007.

LINDA M. KING, EXAMINING ATTORNEY

Int. Cl.: 41

Prior U.S. Cls.: 100, 101 and 107

United States Patent and Trademark Office

Reg. No. 3,393,877

Registered Mar. 11, 2008

**SERVICE MARK  
PRINCIPAL REGISTER**

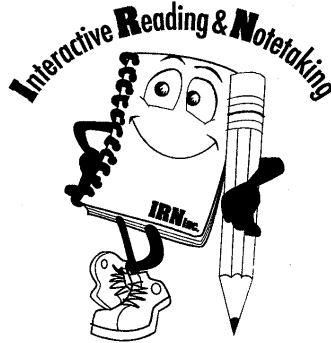

IRN, INC. (VIRGINIA CORPORATION)  
229 OLD OAKS TERRACE  
CHESAPEAKE, VA 23322

FOR: EDUCATIONAL SERVICES, NAMELY,  
CONDUCTING WORKSHOPS IN THE FIELD OF  
TEACHING STRATEGIES, IN CLASS 41 (U.S. CLS.  
100, 101 AND 107).

FIRST USE 5-25-2007; IN COMMERCE 5-25-2007.

NO CLAIM IS MADE TO THE EXCLUSIVE  
RIGHT TO USE "INTERACTIVE READING & NO-  
TETAKING" AND "INC.", APART FROM THE  
MARK AS SHOWN.

SER. NO. 76-679,223, FILED 7-9-2007.

LINDA M. KING, EXAMINING ATTORNEY

Int. Cl.: 7

Prior U.S. Cls.: 13, 19, 21, 23, 31, 34 and 35

United States Patent and Trademark Office

Reg. No. 3,393,878

Registered Mar. 11, 2008

TRADEMARK  
PRINCIPAL REGISTER

**RHOM**

H&L TOOTH COMPANY (CALIFORNIA CORPORATION)  
10055 EAST 56TH ST. NORTH  
TULSA, OK 741174016

FOR: GROUND ENGAGING EQUIPMENT, NAMELY, GROUND ENGAGING TEETH AND ATTACHING DEVICES FOR SECURING SUCH TEETH ON EARTH EXCAVATING AND DIGGING MACHINERY, IN CLASS 7 (U.S. CLS. 13, 19, 21, 23, 31, 34 AND 35).

FIRST USE 9-14-1998; IN COMMERCE 12-15-1998.

THE MARK CONSISTS OF STANDARD CHARACTERS WITHOUT CLAIM TO ANY PARTICULAR FONT, STYLE, SIZE, OR COLOR.

OWNER OF U.S. REG. NO. 2,551,315.

SEC. 2(F).

SER. NO. 76-679,344, FILED 7-10-2007.

KATINA MISTER, EXAMINING ATTORNEY

**Int. Cl.: 3**

**Prior U.S. Cls.: 1, 4, 6, 50, 51 and 52**

**United States Patent and Trademark Office**

**Reg. No. 3,393,879**

**Registered Mar. 11, 2008**

**TRADEMARK  
PRINCIPAL REGISTER**

**SPRAY IT STRAIGHT**

ALLEGHANY PHARMACAL CORPORATION  
(NEW YORK CORPORATION)  
277 NORTHERN BOULEVARD  
GREAT NECK, NY 10021

THE MARK CONSISTS OF STANDARD CHAR-  
ACTERS WITHOUT CLAIM TO ANY PARTICULAR  
FONT, STYLE, SIZE, OR COLOR.

FOR: HAIR STYLING AND CONDITIONING  
PREPARATIONS FOR HUMAN HAIR, IN CLASS 3  
(U.S. CLS. 1, 4, 6, 50, 51 AND 52).

SER. NO. 76-679,363, FILED 7-11-2007.

FIRST USE 10-14-1998; IN COMMERCE 4-30-1999.

COLLEEN DOMBROW, EXAMINING ATTORNEY

**Int. Cl.: 16**

**Prior U.S. Cls.: 2, 5, 22, 23, 29, 37, 38 and 50**

**United States Patent and Trademark Office**

**Reg. No. 3,393,880**

**Registered Mar. 11, 2008**

**TRADEMARK  
PRINCIPAL REGISTER**

**LIFE:BEAUTIFUL**

GREY DOG MEDIA, LLC (IOWA LTD LIAB CO)  
10676 JUSTIN DRIVE  
URBANDALE, IA 50322

THE MARK CONSISTS OF STANDARD CHAR-  
ACTERS WITHOUT CLAIM TO ANY PARTICULAR  
FONT, STYLE, SIZE, OR COLOR.

FOR: GENERAL FEATURE MAGAZINES, IN  
CLASS 16 (U.S. CLS. 2, 5, 22, 23, 29, 37, 38 AND 50).

SER. NO. 76-679,374, FILED 7-11-2007.

FIRST USE 5-14-2007; IN COMMERCE 5-14-2007.

ALICIA COLLINS, EXAMINING ATTORNEY

**Int. Cl.: 21**

**Prior U.S. Cls.: 2, 13, 23, 29, 30, 33, 40 and 50**

**United States Patent and Trademark Office**

**Reg. No. 3,393,881**

**Registered Mar. 11, 2008**

**TRADEMARK  
PRINCIPAL REGISTER**

**DISPATCH**

CALTECH INDUSTRIES, INC. (MICHIGAN CORPORATION)  
4520 E. ASHMAN RD., STE. C  
MIDLAND, MI 48642

FOR: IMPREGNATED TOWEL CLEANING CLOTHS FOR HOSPITAL USE; IMPREGNATED CLOTH TOWEL CLEANING CLOTHS FOR HOSPITAL USE; IMPREGNATED NONWOVEN CLOTH TOWEL CLEANING CLOTHS FOR HOSPITAL USE; BLEACH-IMPREGNATED TOWEL, CLOTH TOWEL, AND NONWOVEN CLOTH TOWEL CLEANING CLOTHS FOR HOSPITAL USE; PRE-MOISTENED BLEACH-IMPREGNATED TOWEL, CLOTH TOWEL, AND NONWOVEN CLOTH TO-

WEL CLEANING CLOTHS FOR HOSPITAL USE, IN CLASS 21 (U.S. CLS. 2, 13, 23, 29, 30, 33, 40 AND 50).

FIRST USE 1-0-1999; IN COMMERCE 1-0-1999.

THE MARK CONSISTS OF STANDARD CHARACTERS WITHOUT CLAIM TO ANY PARTICULAR FONT, STYLE, SIZE, OR COLOR.

OWNER OF U.S. REG. NOS. 1,053,161, 2,509,537 AND OTHERS.

SER. NO. 76-679,378, FILED 7-11-2007.

WANDA KAY PRICE, EXAMINING ATTORNEY

**Int. Cl.: 21**

**Prior U.S. Cls.: 2, 13, 23, 29, 30, 33, 40 and 50**

**United States Patent and Trademark Office**

**Reg. No. 3,393,882**

**Registered Mar. 11, 2008**

**TRADEMARK  
PRINCIPAL REGISTER**



CALTECH INDUSTRIES, INC. (MICHIGAN CORPORATION)  
4520 E. ASHMAN RD., STE. C  
MIDLAND, MI 48642

FOR: IMPREGNATED TOWEL CLEANING CLOTHS FOR HOSPITAL USE; IMPREGNATED CLOTH TOWEL CLEANING CLOTHS FOR HOSPITAL USE; IMPREGNATED NONWOVEN CLOTH TOWEL CLEANING CLOTHS FOR HOSPITAL USE; BLEACH-IMPREGNATED TOWEL, CLOTH TOWEL, AND NONWOVEN CLOTH TOWEL CLEANING CLOTHS FOR HOSPITAL USE; PRE-

MOISTENED BLEACH-IMPREGNATED TOWEL, CLOTH TOWEL, AND NONWOVEN CLOTH TOWEL CLEANING CLOTHS FOR HOSPITAL USE, IN CLASS 21 (U.S. CLS. 2, 13, 23, 29, 30, 33, 40 AND 50).

FIRST USE 1-0-1999; IN COMMERCE 1-0-1999.

OWNER OF U.S. REG. NO. 2,558,317.

SER. NO. 76-679,379, FILED 7-11-2007.

WANDA KAY PRICE, EXAMINING ATTORNEY



**Int. Cl.: 21**

**Prior U.S. Cls.: 2, 13, 23, 29, 30, 33, 40 and 50**

**United States Patent and Trademark Office**

**Reg. No. 3,393,883**

**Registered Mar. 11, 2008**

**TRADEMARK  
PRINCIPAL REGISTER**

**CALTECH**

CALTECH INDUSTRIES, INC. (MICHIGAN CORPORATION)  
4520 E. ASHMAN RD., STE. C  
MIDLAND, MI 48642

FOR: IMPREGNATED TOWEL CLEANING CLOTHS FOR HOSPITAL USE; IMPREGNATED CLOTH TOWEL CLEANING CLOTHS FOR HOSPITAL USE; IMPREGNATED NONWOVEN CLOTH TOWEL CLEANING CLOTHS FOR HOSPITAL USE; BLEACH-IMPREGNATED TOWEL, CLOTH TOWEL, AND NONWOVEN CLOTH TOWEL CLEANING CLOTHS FOR HOSPITAL USE; PRE-MOISTENED BLEACH-IMPREGNATED TOWEL, CLOTH TOWEL, AND NONWOVEN CLOTH TO-

WEL CLEANING CLOTHS FOR HOSPITAL USE, IN CLASS 21 (U.S. CLS. 2, 13, 23, 29, 30, 33, 40 AND 50).

FIRST USE 6-23-1988; IN COMMERCE 6-23-1988.

THE MARK CONSISTS OF STANDARD CHARACTERS WITHOUT CLAIM TO ANY PARTICULAR FONT, STYLE, SIZE, OR COLOR.

OWNER OF U.S. REG. NOS. 2,297,625, 2,552,157, AND 2,552,158.

SER. NO. 76-679,380, FILED 7-11-2007.

WANDA KAY PRICE, EXAMINING ATTORNEY

**Int. Cl.: 21**

**Prior U.S. Cls.: 2, 13, 23, 29, 30, 33, 40 and 50**

**Reg. No. 3,393,884**

**United States Patent and Trademark Office**

**Registered Mar. 11, 2008**

**TRADEMARK  
PRINCIPAL REGISTER**



CALTECH INDUSTRIES, INC. (MICHIGAN CORPORATION)  
4520 E. ASHMAN RD., STE. C  
MIDLAND, MI 48642

FOR: IMPREGNATED TOWEL CLEANING CLOTHS FOR HOSPITAL USE; IMPREGNATED CLOTH TOWEL CLEANING CLOTHS FOR HOSPITAL USE; IMPREGNATED NONWOVEN CLOTH TOWEL CLEANING CLOTHS FOR HOSPITAL USE; BLEACH-IMPREGNATED TOWEL, CLOTH TOWEL, AND NONWOVEN CLOTH TOWEL CLEANING CLOTHS FOR HOSPITAL USE; PRE-MOISTENED BLEACH-IMPREGNATED TOWEL,

CLOTH TOWEL, AND NONWOVEN CLOTH TOWEL CLEANING CLOTHS FOR HOSPITAL USE, IN CLASS 21 (U.S. CLS. 2, 13, 23, 29, 30, 33, 40 AND 50).

FIRST USE 6-23-1988; IN COMMERCE 6-23-1988.

OWNER OF U.S. REG. NOS. 2,297,625, 2,552,157, AND 2,552,158.

SER. NO. 76-679,381, FILED 7-11-2007.

WANDA KAY PRICE, EXAMINING ATTORNEY

**Int. Cl.: 16**

**Prior U.S. Cls.: 2, 5, 22, 23, 29, 37, 38 and 50**

**United States Patent and Trademark Office**

**Reg. No. 3,393,885**

**Registered Mar. 11, 2008**

**TRADEMARK  
PRINCIPAL REGISTER**

**LIFE:BEAUTIFUL  
FAITH FOR YOUR JOURNEY**

GREY DOG MEDIA, LLC (IOWA LTD LIAB CO)  
10676 JUSTIN DRIVE  
URBANDALE, IA 50322

THE MARK CONSISTS OF STANDARD CHAR-  
ACTERS WITHOUT CLAIM TO ANY PARTICULAR  
FONT, STYLE, SIZE, OR COLOR.

FOR: GENERAL FEATURE MAGAZINES, IN  
CLASS 16 (U.S. CLS. 2, 5, 22, 23, 29, 37, 38 AND 50).

SER. NO. 76-679,384, FILED 7-11-2007.

FIRST USE 5-14-2007; IN COMMERCE 5-14-2007.

ALICIA COLLINS, EXAMINING ATTORNEY

**Int. Cls.: 18 and 21**

**Prior U.S. Cls.: 1, 2, 3, 13, 22, 23, 29, 30, 33, 40, 41 and 50**

**United States Patent and Trademark Office**

**Reg. No. 3,393,886**

**Registered Mar. 11, 2008**

**TRADEMARK  
PRINCIPAL REGISTER**

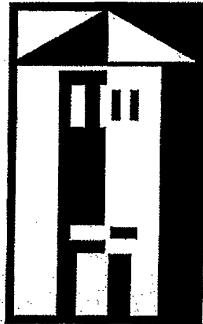

AMERICAN NEWLAND COMMUNITIES, L.P.  
(DELAWARE LIMITED PARTNERSHIP)  
9820 TOWNE CENTRE DRIVE  
SAN DIEGO, CA 92121

FOR: TOTE BAGS, IN CLASS 18 (U.S. CLS. 1, 2, 3, 22 AND 41).

FIRST USE 5-30-2006; IN COMMERCE 5-30-2006.

FOR: INSULATING SLEEVE HOLDER FOR BEVERAGES, IN CLASS 21 (U.S. CLS. 2, 13, 23, 29, 30, 33, 40 AND 50).

FIRST USE 5-30-2006; IN COMMERCE 5-30-2006.

SER. NO. 76-679,403, FILED 7-11-2007.

WILLIAM VERHOSEK, EXAMINING ATTORNEY

**Int. Cls.: 9 and 16**

**Prior U.S. Cls.: 2, 5, 21, 22, 23, 26, 29, 36, 37, 38 and 50**

**Reg. No. 3,393,887**

**United States Patent and Trademark Office**

**Registered Mar. 11, 2008**

**TRADEMARK  
PRINCIPAL REGISTER**

**THE QUALITY MINUTES**

JURAN INSTITUTE, INC. (DELAWARE CORPORATION)

555 HERITAGE ROAD

SOUTHBURY, CT 06488 AND

SMARTPROS LTD. (DELAWARE CORPORATION)

56 LAFAYETTE AVENUE

NORTH WHITE PLAINS, NY 10604

FOR: PRERECORDED CD-ROMS, VIDEO TAPES AND DVDS IN THE FIELD OF BUSINESS MANAGEMENT, IN CLASS 9 (U.S. CLS. 21, 23, 26, 36 AND 38).

FIRST USE 10-22-1993; IN COMMERCE 10-22-1993.

FOR: PRINTED MATTER, NAMELY, DISCUSSION GUIDES FOR USE WITH PRERECORDED VIDEO TAPES AND DVDS IN THE FIELD OF BUSINESS MANAGEMENT, IN CLASS 16 (U.S. CLS. 2, 5, 22, 23, 29, 37, 38 AND 50).

FIRST USE 10-22-1993; IN COMMERCE 10-22-1993.

THE MARK CONSISTS OF STANDARD CHARACTERS WITHOUT CLAIM TO ANY PARTICULAR FONT, STYLE, SIZE, OR COLOR.

SER. NO. 76-679,416, FILED 7-12-2007.

KAREN K. BUSH, EXAMINING ATTORNEY

**Int. Cl.: 25**

**Prior U.S. Cls.: 22 and 39**

**United States Patent and Trademark Office**

**Reg. No. 3,393,888**

**Registered Mar. 11, 2008**

**TRADEMARK  
PRINCIPAL REGISTER**

**VINE STREET**

VINE STREET APPAREL, INC. (CALIFORNIA CORPORATION)  
6150 VIA HUERTO COURT  
ATASCADERO, CA 93422

THE MARK CONSISTS OF STANDARD CHARACTERS WITHOUT CLAIM TO ANY PARTICULAR FONT, STYLE, SIZE, OR COLOR.

FOR: WOMEN'S APPAREL, NAMELY, PANTS, TOPS, HOODED JACKETS AND JACKETS, IN CLASS 25 (U.S. CLS. 22 AND 39).

SER. NO. 76-679,426, FILED 7-12-2007.

FIRST USE 5-0-2004; IN COMMERCE 5-0-2004.

CYNTHIA SLOAN, EXAMINING ATTORNEY

**Int. Cl.: 25**

**Prior U.S. Cls.: 22 and 39**

**United States Patent and Trademark Office**

**Reg. No. 3,393,889**

**Registered Mar. 11, 2008**

**TRADEMARK  
PRINCIPAL REGISTER**

**POOL PARTY**

MYSTIC APPAREL, LLC. (NEW YORK LTD LIAB  
CO)  
20 WEST 33RD STREET, 4TH FLOOR  
NEW YORK, NY 10001

THE MARK CONSISTS OF STANDARD CHAR-  
ACTERS WITHOUT CLAIM TO ANY PARTICULAR  
FONT, STYLE, SIZE, OR COLOR.

FOR: SWIMWEAR, NAMELY, SWIMSUITS AND  
COVERUPS FOR BATHING SUITS, IN CLASS 25  
(U.S. CLS. 22 AND 39).

SER. NO. 76-679,455, FILED 7-12-2007.

FIRST USE 3-0-2003; IN COMMERCE 3-0-2003.

JENNY PARK, EXAMINING ATTORNEY

Int. Cl.: 25

Prior U.S. Cls.: 22 and 39

United States Patent and Trademark Office

Reg. No. 3,393,890

Registered Mar. 11, 2008

TRADEMARK  
PRINCIPAL REGISTER



VINE STREET APPAREL, INC. (CALIFORNIA  
CORPORATION)  
6150 VIA HUERTO COURT  
ATASCADERO, CA 93422

FIRST USE 5-0-2004; IN COMMERCE 5-0-2004.

SER. NO. 76-679,456, FILED 7-12-2007.

FOR: WOMEN'S APPAREL, NAMELY, PANTS,  
TOPS, HOODED JACKETS AND JACKETS, IN  
CLASS 25 (U.S. CLS. 22 AND 39).

CYNTHIA SLOAN, EXAMINING ATTORNEY



**Int. Cls.: 1, 40 and 42**

**Prior U.S. Cls.: 1, 5, 6, 10, 26, 46, 100, 101, 103 and 106**

**United States Patent and Trademark Office**

**Reg. No. 3,393,891**

**Registered Mar. 11, 2008**

**TRADEMARK  
SERVICE MARK  
PRINCIPAL REGISTER**



CODEXIS, INC. (DELAWARE CORPORATION)  
200 PENOBSCOT DRIVE  
REDWOOD CITY, CA 94063

FOR: CHEMICALS, BIOCHEMICALS, ENZYMES, AND BIOCATALYSTS FOR USE IN SCIENTIFIC RESEARCH, MEDICAL RESEARCH, AND COMMERCIAL APPLICATIONS PERTAINING TO CHEMISTRY, PHARMACEUTICALS, INDUSTRIAL CHEMICALS, AND BIOFUELS, IN CLASS 1 (U.S. CLS. 1, 5, 6, 10, 26 AND 46).

FIRST USE 2-28-2007; IN COMMERCE 2-28-2007.

FOR: DIRECTED EVOLUTION SERVICES, NAMELY, THE CUSTOM MANUFACTURE OF CHEMICALS, BIOCHEMICALS, ENZYMES, AND BIOCATALYSTS FOR USE IN SCIENTIFIC RESEARCH, MEDICAL RESEARCH, AND COMMERCIAL APPLICATIONS PERTAINING TO

CHEMISTRY, PHARMACEUTICALS, INDUSTRIAL CHEMICALS, AND BIOFUELS, IN CLASS 40 (U.S. CLS. 100, 103 AND 106).

FIRST USE 2-28-2007; IN COMMERCE 2-28-2007.

FOR: CHEMICAL RESEARCH SERVICES; SCIENTIFIC RESEARCH SERVICES; RESEARCH, PRODUCT DEVELOPMENT, AND PROCESS DEVELOPMENT SERVICES FOR OTHERS IN THE FIELDS OF CHEMISTRY, PHARMACEUTICALS, INDUSTRIAL CHEMICALS, AND BIOFUELS, IN CLASS 42 (U.S. CLS. 100 AND 101).

FIRST USE 2-28-2007; IN COMMERCE 2-28-2007.

SER. NO. 76-679,500, FILED 7-12-2007.

LINDA ORNDORFF, EXAMINING ATTORNEY

**Int. Cl.: 44**

**Prior U.S. Cls.: 100 and 101**

**United States Patent and Trademark Office**

**Reg. No. 3,393,892**

**Registered Mar. 11, 2008**

**SERVICE MARK  
PRINCIPAL REGISTER**

**PENN EYE CARE**

THE TRUSTEES OF THE UNIVERSITY OF  
PENNSYLVANIA (PENNSYLVANIA NON-  
PROFIT CORPORATION)  
OFFICE OF THE GENERAL COUNSEL  
133 S. 36TH STREET, SUITE 300  
PHILADELPHIA, PA 19104

FOR: MEDICAL SERVICES, IN CLASS 44 (U.S.  
CLS. 100 AND 101).

FIRST USE 9-0-1999; IN COMMERCE 9-0-1999.

THE MARK CONSISTS OF STANDARD CHAR-  
ACTERS WITHOUT CLAIM TO ANY PARTICULAR  
FONT, STYLE, SIZE, OR COLOR.

OWNER OF U.S. REG. NOS. 1,773,257, 2,744,279  
AND OTHERS.

NO CLAIM IS MADE TO THE EXCLUSIVE  
RIGHT TO USE "EYE CARE", APART FROM THE  
MARK AS SHOWN.

SEC. 2(F) PENN.

SER. NO. 76-679,502, FILED 7-12-2007.

STEVEN JACKSON, EXAMINING ATTORNEY

**Int. Cl.: 9**

**Prior U.S. Cls.: 21, 23, 26, 36 and 38**

**United States Patent and Trademark Office**

**Reg. No. 3,393,893**

**Registered Mar. 11, 2008**

**TRADEMARK  
PRINCIPAL REGISTER**

**CODESONAR**

GRAMMATECH, INC. (NEW YORK CORPORATION)  
317 NORTH AURORA STREET  
ITHACA, NY 14850

FOR: COMPUTER SOFTWARE FOR USE IN DEVELOPMENT, ANALYSIS AND MAINTENANCE OF SOFTWARE, IN CLASS 9 (U.S. CLS. 21, 23, 26, 36 AND 38).

FIRST USE 3-8-2005; IN COMMERCE 3-8-2005.

THE MARK CONSISTS OF STANDARD CHARACTERS WITHOUT CLAIM TO ANY PARTICULAR FONT, STYLE, SIZE, OR COLOR.

OWNER OF U.S. REG. NO. 2,438,940.

SER. NO. 76-679,505, FILED 7-12-2007.

SALLY SHIH, EXAMINING ATTORNEY

**Int. Cl.: 35**

**Prior U.S. Cls.: 100, 101 and 102**

**United States Patent and Trademark Office**

**Reg. No. 3,393,894**

**Registered Mar. 11, 2008**

**SERVICE MARK  
PRINCIPAL REGISTER**

**TIP**

OUTCOMES PHARMACEUTICAL HEALTH  
CARE, L.C. (IOWA LTD LIAB CO)  
601 E. LOCUST, SUITE 200  
DES MOINES, IA 50309

FOR: HEALTH CARE CASE MANAGEMENT;  
HEALTH CARE UTILIZATION MANAGEMENT  
AND UTILIZATION REVIEW SERVICES; ADMIN-  
ISTERING PHARMACY REIMBURSEMENT PRO-  
GRAMS AND SERVICES; COST MANAGEMENT  
FOR THE HEALTH CARE BENEFIT PLANS OF  
OTHERS; HEALTH CARE COST CONTAINMENT;  
HEALTH CARE COST REVIEW; MANAGED CARE  
SERVICES, NAMELY, ELECTRONIC PROCESSING

OF HEALTH CARE INFORMATION, IN CLASS 35  
(U.S. CLS. 100, 101 AND 102).

FIRST USE 5-5-2007; IN COMMERCE 5-5-2007.

THE MARK CONSISTS OF STANDARD CHAR-  
ACTERS WITHOUT CLAIM TO ANY PARTICULAR  
FONT, STYLE, SIZE, OR COLOR.

SER. NO. 76-679,510, FILED 7-13-2007.

CHRIS WELLS, EXAMINING ATTORNEY

**Int. Cl.: 36**

**Prior U.S. Cls.: 100, 101 and 102**

**United States Patent and Trademark Office**

**Reg. No. 3,393,895**

**Registered Mar. 11, 2008**

**SERVICE MARK  
PRINCIPAL REGISTER**

**ANGELS FOR ANIMALS**

ANGELS FOR ANIMALS (OHIO CORPORATION)  
4750 STATE ROUTE 165  
CANFIELD, OH 44406

FOR: CHARITABLE FUNDRAISING TO PRO-  
VIDE CARE FOR NEEDY ANIMALS, IN CLASS 36  
(U.S. CLS. 100, 101 AND 102).

FIRST USE 1-30-2000; IN COMMERCE 1-30-2000.

THE MARK CONSISTS OF STANDARD CHAR-  
ACTERS WITHOUT CLAIM TO ANY PARTICULAR  
FONT, STYLE, SIZE, OR COLOR.

NO CLAIM IS MADE TO THE EXCLUSIVE  
RIGHT TO USE "ANIMALS", APART FROM THE  
MARK AS SHOWN.

SER. NO. 76-680,138, FILED 8-1-2007.

EDWARD NELSON, EXAMINING ATTORNEY

**Int. Cl.: 9**

**Prior U.S. Cls.: 21, 23, 26, 36 and 38**

**United States Patent and Trademark Office**

**Reg. No. 3,393,896**

**Registered Mar. 11, 2008**

**TRADEMARK  
PRINCIPAL REGISTER**

**DREAM LIFE**

HASBRO, INC. (RHODE ISLAND CORPORATION)  
1027 NEWPORT AVENUE  
PAWTUCKET, RI 02862

FOR: ELECTRONIC GAMES, NAMELY PORTABLE GAMING SYSTEM FOR USE WITH TELEVISIONS COMPRISED PRIMARILY OF A HANDHELD UNIT FOR PLAYING ELECTRONIC GAMES, IN CLASS 9 (U.S. CLS. 21, 23, 26, 36 AND 38).

FIRST USE 10-4-2004; IN COMMERCE 10-4-2004.

THE MARK CONSISTS OF STANDARD CHARACTERS WITHOUT CLAIM TO ANY PARTICULAR FONT, STYLE, SIZE, OR COLOR.

SER. NO. 76-680,283, FILED 8-2-2007.

JULIE GUTTADAURO, EXAMINING ATTORNEY

**Int. Cl.: 36**

**Prior U.S. Cls.: 100, 101 and 102**

**United States Patent and Trademark Office**

**Reg. No. 3,393,897**

**Registered Mar. 11, 2008**

**SERVICE MARK  
PRINCIPAL REGISTER**



CYSTIC FIBROSIS FOUNDATION (DELAWARE  
CORPORATION)  
6931 ARLINGTON ROAD  
BETHESDA, MD 20814

OWNER OF U.S. REG. NOS. 2,132,596, 2,846,135  
AND OTHERS.

FOR: CHARITABLE FUNDRAISING, IN CLASS  
36 (U.S. CLS. 100, 101 AND 102).

SER. NO. 76-680,299, FILED 8-3-2007.

FIRST USE 7-0-2007; IN COMMERCE 7-0-2007.

KELLY MCCOY, EXAMINING ATTORNEY

**Int. Cl.: 9**

**Prior U.S. Cls.: 21, 23, 26, 36 and 38**

**United States Patent and Trademark Office**

**Reg. No. 3,393,898**

**Registered Mar. 11, 2008**

**TRADEMARK  
PRINCIPAL REGISTER**

**BANDLER**

LA VALLE, JOHN (UNITED STATES INDIVIDUAL)  
P.O. BOX 424  
HOPATCONG, NJ 07843

FOR: PRERECORDED COMPACT DISCS AND DVDS FEATURING SEMINARS IN THE FIELD OF HUMAN DEVELOPMENT AND HUMAN DEVELOPMENT CONSULTING SERVICES, IN CLASS 9 (U.S. CLS. 21, 23, 26, 36 AND 38).

FIRST USE 3-0-1999; IN COMMERCE 3-0-1999.

THE MARK CONSISTS OF STANDARD CHARACTERS WITHOUT CLAIM TO ANY PARTICULAR FONT, STYLE, SIZE, OR COLOR.

OWNER OF U.S. REG. NO. 2,407,603.

SEC. 2(F).

SER. NO. 76-680,660, FILED 8-13-2007.

ANDREW RHIM, EXAMINING ATTORNEY



**Int. Cl.: 36**

**Prior U.S. Cls.: 100, 101 and 102**

**United States Patent and Trademark Office**

**Reg. No. 3,393,899**

**Registered Mar. 11, 2008**

**SERVICE MARK  
PRINCIPAL REGISTER**

**THE MILESTONES CLUB**

CYSTIC FIBROSIS FOUNDATION (DELAWARE  
CORPORATION)

6931 ARLINGTON ROAD

BETHESDA, MD 20814

FOR: CHARITABLE FUNDRAISING, IN CLASS  
36 (U.S. CLS. 100, 101 AND 102).

FIRST USE 12-0-2006; IN COMMERCE 12-0-2006.

THE MARK CONSISTS OF STANDARD CHAR-  
ACTERS WITHOUT CLAIM TO ANY PARTICULAR  
FONT, STYLE, SIZE, OR COLOR.

NO CLAIM IS MADE TO THE EXCLUSIVE  
RIGHT TO USE "CLUB", APART FROM THE MARK  
AS SHOWN.

SER. NO. 76-680,713, FILED 8-15-2007.

KELLY MCCOY, EXAMINING ATTORNEY

**Int. Cl.: 36**

**Prior U.S. Cls.: 100, 101 and 102**

**United States Patent and Trademark Office**

**Reg. No. 3,393,900**

**Registered Mar. 11, 2008**

**SERVICE MARK  
PRINCIPAL REGISTER**

**MILESTONES TO A CURE**

CYSTIC FIBROSIS FOUNDATION (DELAWARE  
CORPORATION)

6931 ARLINGTON ROAD

BETHESDA, MD 20814

FOR: CHARITABLE FUNDRAISING, IN CLASS  
36 (U.S. CLS. 100, 101 AND 102).

FIRST USE 7-0-2004; IN COMMERCE 7-0-2004.

THE MARK CONSISTS OF STANDARD CHAR-  
ACTERS WITHOUT CLAIM TO ANY PARTICULAR  
FONT, STYLE, SIZE, OR COLOR.

NO CLAIM IS MADE TO THE EXCLUSIVE  
RIGHT TO USE "CURE", APART FROM THE MARK  
AS SHOWN.

SER. NO. 76-680,714, FILED 8-15-2007.

KELLY MCCOY, EXAMINING ATTORNEY

**Int. Cl.: 36**

**Prior U.S. Cls.: 100, 101 and 102**

**United States Patent and Trademark Office**

**Reg. No. 3,393,901**

**Registered Mar. 11, 2008**

**SERVICE MARK  
PRINCIPAL REGISTER**

  
T H E  
**Milestones  
Club**

CYSTIC FIBROSIS FOUNDATION (DELAWARE  
CORPORATION)  
6931 ARLINGTON ROAD  
BETHESDA, MD 20814

NO CLAIM IS MADE TO THE EXCLUSIVE  
RIGHT TO USE "CLUB", APART FROM THE MARK  
AS SHOWN.

FOR: CHARITABLE FUNDRAISING, IN CLASS  
36 (U.S. CLS. 100, 101 AND 102).

SER. NO. 76-680,768, FILED 8-16-2007.

FIRST USE 12-0-2006; IN COMMERCE 12-0-2006.

KELLY MCCOY, EXAMINING ATTORNEY

**Int. Cl.: 25**

**Prior U.S. Cls.: 22 and 39**

**United States Patent and Trademark Office**

**Reg. No. 3,393,902**

**Registered Mar. 11, 2008**

**TRADEMARK  
PRINCIPAL REGISTER**

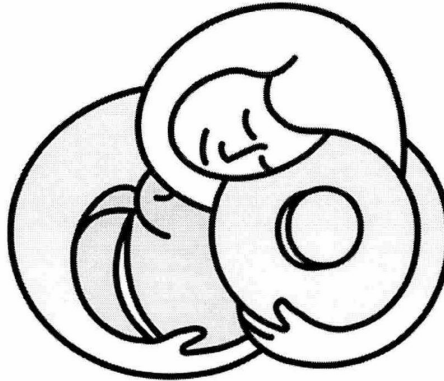

MODERN BONNETS COLLECTIONS, INC. (CANADA CORPORATION)  
3505 BAYCREST AVE.  
COQUITLAM, B.C. V3B 2W7, CANADA

FIRST USE 1-11-2007; IN COMMERCE 1-11-2007.

SER. NO. 76-680,862, FILED 8-20-2007.

FOR: NURSING APPAREL, NAMELY, BREAST FEEDING HATS FOR INFANTS; INFANT WEAR, IN CLASS 25 (U.S. CLS. 22 AND 39).

LINDA ORNDORFF, EXAMINING ATTORNEY

**Int. Cl.: 25**

**Prior U.S. Cls.: 22 and 39**

**United States Patent and Trademark Office**

**Reg. No. 3,393,903**

**Registered Mar. 11, 2008**

**TRADEMARK  
PRINCIPAL REGISTER**

**SUPER SURF CAMP**

CALIFORNIA JUNIOR LIFEGUARD PRO-  
GRAMS, INC. (CALIFORNIA CORPORATION)  
2220 EAST CHAPMAN AVENUE #30  
FULLERTON, CA 92831

FOR: CLOTHING, NAMELY, T-SHIRTS, SHORTS,  
SHIRTS, NAMELY, T-BACKS, HATS, SWEAT-  
SHIRTS, SHOES, NAMELY, FLIP-FLOPS AND SAN-  
DALS AND RASH GUARDS, NAMELY, POLYMER  
FABRIC T-SHIRTS WORN UNDER A WET SUIT, IN  
CLASS 25 (U.S. CLS. 22 AND 39).

FIRST USE 4-30-1992; IN COMMERCE 7-13-1993.

THE MARK CONSISTS OF STANDARD CHAR-  
ACTERS WITHOUT CLAIM TO ANY PARTICULAR  
FONT, STYLE, SIZE, OR COLOR.

SER. NO. 76-978,447, FILED 8-4-2004.

ROBERT C. CLARK JR., EXAMINING ATTORNEY

**Int. Cl.: 18**

**Prior U.S. Cls.: 1, 2, 3, 22 and 41**

**United States Patent and Trademark Office**

**Reg. No. 3,393,904**

**Registered Mar. 11, 2008**

**TRADEMARK  
PRINCIPAL REGISTER**



COTTON COUNCIL INTERNATIONAL (TEN-  
NESSEE CORPORATION)  
1521 NEW HAMPSHIRE AVENUE, N.W.  
WASHINGTON, DC 20036

FOR: ALL PURPOSE CARRY BAGS, IN CLASS 18  
(U.S. CLS. 1, 2, 3, 22 AND 41).

FIRST USE 10-0-1991; IN COMMERCE 10-0-1991.

OWNER OF U.S. REG. NO. 1,853,968.

NO CLAIM IS MADE TO THE EXCLUSIVE  
RIGHT TO USE "COTTON", APART FROM THE  
MARK AS SHOWN.

SEC. 2(F) AS TO "COTTON USA".

SER. NO. 76-978,684, FILED 2-22-2005.

DAVID ELTON, EXAMINING ATTORNEY

**Int. Cl.: 30**

**Prior U.S. Cl.: 46**

**United States Patent and Trademark Office**

**Reg. No. 3,393,905**

**Registered Mar. 11, 2008**

**TRADEMARK  
PRINCIPAL REGISTER**

**BUBBLE GUM BASEBALL**

PASTIME SPORTS, LTD. (PENNSYLVANIA CORPORATION)

P.O. BOX 111

LEWISBURG, PA 17837

FOR: CONFECTIONERIES, NAMELY, BUBBLE GUM, IN CLASS 30 (U.S. CL. 46).

FIRST USE 4-15-2004; IN COMMERCE 4-15-2004.

THE MARK CONSISTS OF STANDARD CHARACTERS WITHOUT CLAIM TO ANY PARTICULAR FONT, STYLE, SIZE, OR COLOR.

NO CLAIM IS MADE TO THE EXCLUSIVE RIGHT TO USE "BUBBLE GUM", APART FROM THE MARK AS SHOWN.

SER. NO. 76-978,700, FILED S.R. 6-13-2005 AM. P.R. 9-7-2007.

DANIEL CAPSHAW, EXAMINING ATTORNEY

**Int. Cl.: 35**

**Prior U.S. Cls.: 100, 101 and 102**

**United States Patent and Trademark Office**

**Reg. No. 3,393,906**

**Registered Mar. 11, 2008**

**SERVICE MARK  
PRINCIPAL REGISTER**

**KEYING ON IMAGE**

DATAMARK INCORPORATED (TEXAS CORPORATION)  
43 BUTTERFIELD CIRCLE  
EL PASO, TX 79906

FOR: ADMINISTRATIVE FORMS PROCESSING SERVICES, NAMELY, INBOUND MAIL PROCESSING, DOCUMENT REPRODUCTION, NAMELY, DOCUMENT SCANNING, DATA PROCESSING SERVICES, NAMELY, DATA ENTRY, COLLECTION AND PROCESSING SERVICES OF BUSINESS INFORMATION, DATA, STATISTICS AND INDICES, MANAGEMENT OF CALL CENTERS FOR

OTHERS, ORDER FULFILLMENT SERVICES, IN CLASS 35 (U.S. CLS. 100, 101 AND 102).

FIRST USE 6-0-1994; IN COMMERCE 6-0-1994.

THE MARK CONSISTS OF STANDARD CHARACTERS WITHOUT CLAIM TO ANY PARTICULAR FONT, STYLE, SIZE, OR COLOR.

SER. NO. 76-978,706, FILED 11-9-2005.

DAVID MURRAY, EXAMINING ATTORNEY



**Int. Cl.: 7**

**Prior U.S. Cls.: 13, 19, 21, 23, 31, 34 and 35**

**United States Patent and Trademark Office**

**Reg. No. 3,393,907**

**Registered Mar. 11, 2008**

**TRADEMARK  
PRINCIPAL REGISTER**



SIMPSON-DELCO, LLC (DELAWARE LTD LIAB  
CO)  
1825 GREENWOOD  
ELK GROVE VILLAGE, IL 60007

FOR: MULTI-PURPOSE HIGH PRESSURE WASH-  
ERS, IN CLASS 7 (U.S. CLS. 13, 19, 21, 23, 31, 34 AND  
35).

FIRST USE 0-0-1980; IN COMMERCE 0-0-1980.

OWNER OF U.S. REG. NO. 1,672,397.

NO CLAIM IS MADE TO THE EXCLUSIVE  
RIGHT TO USE "WATER BLASTER", APART FROM  
THE MARK AS SHOWN.

THE COLOR(S) BLACK, RED, BLUE, WHITE  
AND YELLOW IS/ARE CLAIMED AS A FEATURE  
OF THE MARK.

THE MARK CONSISTS OF A BULL'S-EYE WITH  
THE OUTERMOST RING IN BLACK AND, MOV-  
ING TOWARD THE CENTER, CONCENTRIC  
RINGS IN THE COLORS BLUE, RED AND YEL-  
LOW, WITH THE CENTER RING RED AND EACH  
RING OUTLINED IN BLACK, AND THE WORDS  
WATER BLASTER APPEARING IN WHITE, OUT-  
LINED IN BLACK.

SER. NO. 77-001,671, FILED 9-18-2006.

EUGENIA MARTIN, EXAMINING ATTORNEY

**Int. Cl.: 19**

**Prior U.S. Cls.: 1, 12, 33 and 50**

**Reg. No. 3,393,908**

**United States Patent and Trademark Office**

**Registered Mar. 11, 2008**

---

**TRADEMARK  
PRINCIPAL REGISTER**

**CLEAR CHOICE**

THERM O VENT MANUFACTURING, INC.  
(OHIO CORPORATION)  
1213 MEDINA ROAD  
MEDINA, OH 44256

THE MARK CONSISTS OF STANDARD CHARACTERS WITHOUT CLAIM TO ANY PARTICULAR FONT, STYLE, SIZE, OR COLOR.

FOR: GLASS BLOCKS FOR BUILDING, IN CLASS 19 (U.S. CLS. 1, 12, 33 AND 50).

SER. NO. 77-002,353, FILED 9-19-2006.

FIRST USE 1-1-2001; IN COMMERCE 1-1-2001.

MARK RADEMACHER, EXAMINING ATTORNEY

**Int. Cl.: 3**

**Prior U.S. Cls.: 1, 4, 6, 50, 51 and 52**

**Reg. No. 3,393,909**

**United States Patent and Trademark Office**

**Registered Mar. 11, 2008**

---

**TRADEMARK  
PRINCIPAL REGISTER**

# Restore Toothpaste

CHANNEL DISTRIBUTION (CALIFORNIA CORPORATION)

26229 ENTERPRISE COURT

LAKE FOREST, CA 92630

FOR: TOOTHPASTE; TOOTHPASTES, IN CLASS 3  
(U.S. CLS. 1, 4, 6, 50, 51 AND 52).

FIRST USE 9-1-2006; IN COMMERCE 9-1-2006.

THE MARK CONSISTS OF STANDARD CHARACTERS WITHOUT CLAIM TO ANY PARTICULAR FONT, STYLE, SIZE, OR COLOR.

NO CLAIM IS MADE TO THE EXCLUSIVE RIGHT TO USE "TOOTHPASTE", APART FROM THE MARK AS SHOWN.

SER. NO. 77-002,473, FILED 9-19-2006.

MICHAEL WIENER, EXAMINING ATTORNEY

**Int. Cl.: 38**

**Prior U.S. Cls.: 100, 101 and 104**

**United States Patent and Trademark Office**

**Reg. No. 3,393,910**

**Registered Mar. 11, 2008**

**SERVICE MARK  
PRINCIPAL REGISTER**

# Entice.TV

ENTICE.TV, INC. (NEVADA CORPORATION)  
251 JEANELL DRIVE, SUITE 3  
CARSON CITY, NV 88703

FIRST USE 12-22-2004; IN COMMERCE 12-22-2004.

FOR: BROADCAST OF TELEVISION, MOVIE  
AND FILM PROGRAMMING OVER TELEVISION,  
THE INTERNET, COMPUTERS, SATELLITE,  
AUDIO AND VIDEO MEDIA, IN CLASS 38 (U.S.  
CLS. 100, 101 AND 104).

THE MARK CONSISTS OF STANDARD CHAR-  
ACTERS WITHOUT CLAIM TO ANY PARTICULAR  
FONT, STYLE, SIZE, OR COLOR.

SER. NO. 77-002,587, FILED 9-19-2006.

CHRIS WELLS, EXAMINING ATTORNEY

**Int. Cl.: 25**

**Prior U.S. Cls.: 22 and 39**

**United States Patent and Trademark Office**

**Reg. No. 3,393,911**

**Registered Mar. 11, 2008**

**TRADEMARK  
PRINCIPAL REGISTER**

**Working Class Hero**

HARVEY LEEDS (UNITED STATES INDIVIDUAL)  
592 MCCULLOCH PLACE  
HAWORTH, NJ 076411505

THE MARK CONSISTS OF STANDARD CHARACTERS WITHOUT CLAIM TO ANY PARTICULAR FONT, STYLE, SIZE, OR COLOR.

FOR: HATS; PANTS; SHIRTS; SWEATERS, IN CLASS 25 (U.S. CLS. 22 AND 39).

SER. NO. 77-004,392, FILED 9-21-2006.

FIRST USE 1-9-2006; IN COMMERCE 1-9-2006.

LINDA E. BLOHM, EXAMINING ATTORNEY

**Int. Cl.: 35**

**Prior U.S. Cls.: 100, 101 and 102**

**United States Patent and Trademark Office**

**Reg. No. 3,393,912**

**Registered Mar. 11, 2008**

**SERVICE MARK  
PRINCIPAL REGISTER**

**HEAVYMETALDAD**

SILVASY, MICHAEL K. (UNITED STATES INDIVIDUAL)  
12972 EMERALD BAY DR.  
SODDY DAISY, TN 37379

THE MARK CONSISTS OF STANDARD CHARACTERS WITHOUT CLAIM TO ANY PARTICULAR FONT, STYLE, SIZE, OR COLOR.

FOR: RETAIL APPAREL STORES, IN CLASS 35 (U.S. CLS. 100, 101 AND 102).

SER. NO. 77-005,251, FILED 9-22-2006.

FIRST USE 6-8-2005; IN COMMERCE 5-1-2006.

ROBIN CHOSID, EXAMINING ATTORNEY

**Int. Cls.: 35, 36, 37 and 43**

**Prior U.S. Cls.: 100, 101, 102, 103 and 106**

**United States Patent and Trademark Office**

**Reg. No. 3,393,913**

**Registered Mar. 11, 2008**

**SERVICE MARK  
PRINCIPAL REGISTER**

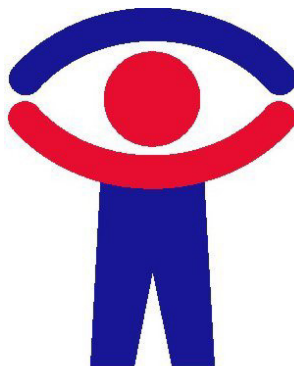

FOCUS LODGING GROUP, LLC (OHIO LTD  
LIAB CO)  
4887 SAWMILL ROAD  
COLUMBUS, OH 43235

FOR: HOTEL AND RESORT MANAGEMENT  
FOR OTHERS; BUSINESS MANAGEMENT SERVI-  
CES FOR OTHERS IN THE FIELD OF HOTEL AND  
RESORT OPERATION, ADMINISTRATION, AND  
DEVELOPMENT; CONSULTING IN THE FIELD OF  
HOTEL AND RESORT MARKETING, ACCOUNT-  
ING, AND HUMAN RESOURCES, IN CLASS 35 (U.S.  
CLS. 100, 101 AND 102).

FIRST USE 10-31-2004; IN COMMERCE 10-31-2004.

FOR: CONSULTING IN THE FIELD OF HOTEL  
AND RESORT BROKERAGE; CONSULTING IN  
THE FIELD OF HOTEL AND RESORT REAL ES-  
TATE PURCHASING, IN CLASS 36 (U.S. CLS. 100, 101  
AND 102).

FIRST USE 10-31-2004; IN COMMERCE 10-31-2004.

FOR: PROVIDING CONSULTING REGARDING  
HOTEL AND RESORT CONSTRUCTION AND RE-  
NOVATION , IN CLASS 37 (U.S. CLS. 100, 103 AND  
106).

FIRST USE 10-31-2004; IN COMMERCE 10-31-2004.

FOR: CONSULTING SERVICES IN THE FIELD  
OF HOSPITALITY; CONSULTING IN THE FIELDS  
OF HOTELS AND RESORT HOTEL SERVICES, IN  
CLASS 43 (U.S. CLS. 100 AND 101).

FIRST USE 10-31-2004; IN COMMERCE 10-31-2004.

THE COLOR(S) RED AND BLUE IS/ARE  
CLAIMED AS A FEATURE OF THE MARK.

"THE MARK CONSISTS OF A STICK FIGURE  
THAT CAN BE SEEN AS EITHER A STICK FIGURE  
OF A PERSON WITH ARMS RAISED, OR AS AN  
EYE. THE COLOR BLUE APPEARS IN THE LEGS  
AND TORSO OF THE STICK FIGURE, AND ABOVE  
THE STICK FIGURE, FORMING THE UPPER EYE-  
LID OF THE EYE. THE COLOR RED APPEARS IN  
THE HEAD AND ARMS OF THE STICK FIGURE,  
WHICH ALSO SERVES AS THE BOTTOM OF THE  
EYELID AND IRIS OF THE EYE."

SER. NO. 77-005,990, FILED 9-23-2006.

CORY BOONE, EXAMINING ATTORNEY

**Int. Cl.: 35**

**Prior U.S. Cls.: 100, 101 and 102**

**United States Patent and Trademark Office**

**Reg. No. 3,393,914**

**Registered Mar. 11, 2008**

**SERVICE MARK  
PRINCIPAL REGISTER**



DRUG FREE CLUBS OF AMERICA, INC. (OHIO  
NON-PROFIT CORPORATION)  
10361 SPARTAN DRIVE  
CINCINNATI, OH 45215

FOR: ADMINISTRATION OF A SUBSTANCE  
ABUSE PREVENTION PROGRAM, IN CLASS 35  
(U.S. CLS. 100, 101 AND 102).

FIRST USE 4-1-2006; IN COMMERCE 4-1-2006.

NO CLAIM IS MADE TO THE EXCLUSIVE  
RIGHT TO USE "DRUG FREE CLUBS OF AMER-  
ICA", APART FROM THE MARK AS SHOWN.

THE MARK CONSISTS OF STARS AND STRIPES  
TOGETHER WITH THE WORDS DRUG FREE  
CLUBS OF AMERICA.

SER. NO. 77-006,806, FILED 9-25-2006.

LESLEY LAMOTHE, EXAMINING ATTORNEY



**Int. Cls.: 9 and 41**

**Prior U.S. Cls.: 21, 23, 26, 36, 38, 100, 101 and 107**

**United States Patent and Trademark Office**

**Reg. No. 3,393,915**

**Registered Mar. 11, 2008**

**TRADEMARK  
SERVICE MARK  
PRINCIPAL REGISTER**



HIGH-REZ PHOTOGRAPHY INC. (NEVADA CORPORATION)  
1890 SAN LORENZO  
RENO, NV 89521

FOR: ONLINE DOWNLOADABLE COMPUTER GAME SOFTWARE; MULTI-MEDIA SOFTWARE RECORDED ON CD-ROM FEATURING FEMALE MODELS PLAYING STRIP POKER , IN CLASS 9 (U.S. CLS. 21, 23, 26, 36 AND 38).

FIRST USE 5-19-2000; IN COMMERCE 6-26-2000.

FOR: ENTERTAINMENT SERVICES, NAMELY, PROVIDING AN ONLINE COMPUTER GAME, IN CLASS 41 (U.S. CLS. 100, 101 AND 107).

FIRST USE 5-19-2000; IN COMMERCE 6-26-2000.

THE MARK CONSISTS OF A DIAMOND, CLUB, HEART, SPADE, AND THE STYLIZED TEXT OF THE WORDING "POKERGIRLS".

SER. NO. 77-007,105, FILED 9-25-2006.

RENEE SERVANCE, EXAMINING ATTORNEY

**Int. Cl.: 35**

**Prior U.S. Cls.: 100, 101 and 102**

**United States Patent and Trademark Office**

**Reg. No. 3,393,916**

**Registered Mar. 11, 2008**

**SERVICE MARK  
PRINCIPAL REGISTER**

**LIFE ELEMENTS**

LIFE ELEMENTS, INC. (CALIFORNIA CORPORATION)  
9555 SAUSALITO ROAD  
ATASCADERO, CA 93422

THE MARK CONSISTS OF STANDARD CHARACTERS WITHOUT CLAIM TO ANY PARTICULAR FONT, STYLE, SIZE, OR COLOR.

FOR: WHOLESALE, MAIL ORDER AND ONLINE RETAIL STORE SERVICES IN THE FIELD OF PERSONAL CARE PRODUCTS, BATH AND BODY PRODUCTS, AND CLOTHING, IN CLASS 35 (U.S. CLS. 100, 101 AND 102).

SER. NO. 77-007,425, FILED 9-26-2006.

FIRST USE 1-1-2001; IN COMMERCE 7-1-2001.

VIVIAN MICZNIK FIRST, EXAMINING ATTORNEY

**Int. Cl.: 42**

**Prior U.S. Cls.: 100 and 101**

**United States Patent and Trademark Office**

**Reg. No. 3,393,917**

**Registered Mar. 11, 2008**

**SERVICE MARK  
PRINCIPAL REGISTER**

**QwikRef**

RUSTY ACREE, LLC (DELAWARE LTD LIAB  
CO)  
193 FRONT STREET  
SHARPS, VA 22548

FOR: PROVIDING TEMPORARY USE OF ON-  
LINE, NON-DOWNLOADABLE SOFTWARE FOR  
COLLECTING, COLLATING, REPORTING AND  
MANAGING COLLEGE FOOTBALL PENALTY  
DATA FOR COLLEGE FOOTBALL REFEREES, OF-  
FICIALS, REFEREE OR OFFICIAL COORDINA-  
TORS OR SUPERVISORS, CONFERENCE  
COMMISSIONERS OR EXECUTIVE DIRECTORS,  
REFEREE OR OFFICIAL GRADERS OR EVALUA-

TORS, TECHNICAL ASSISTANTS, AND COACHES,  
IN CLASS 42 (U.S. CLS. 100 AND 101).

FIRST USE 8-0-2001; IN COMMERCE 8-0-2001.

THE MARK CONSISTS OF STANDARD CHAR-  
ACTERS WITHOUT CLAIM TO ANY PARTICULAR  
FONT, STYLE, SIZE, OR COLOR.

SER. NO. 77-009,424, FILED 9-28-2006.

JILL C. ALT, EXAMINING ATTORNEY

**Int. Cls.: 35 and 41**

**Prior U.S. Cls.: 100, 101, 102 and 107**

**United States Patent and Trademark Office**

**Reg. No. 3,393,918**

**Registered Mar. 11, 2008**

**SERVICE MARK  
PRINCIPAL REGISTER**

**WEDDING PARTY**

SARKESIAN, MARCUS (UNITED STATES INDIVIDUAL)  
43311 JOY RD., #152  
CANTON, MI 48187

FOR: PROVIDING A WEB SITE WHICH FEATURES ADVERTISEMENTS FOR THE GOODS AND SERVICES IN THE FIELD OF WEDDINGS OF OTHERS ON A GLOBAL COMPUTER NETWORK; RETAIL STORE SERVICES, AVAILABLE THROUGH COMPUTER COMMUNICATIONS, FEATURING WEDDING-RELATED ITEMS, IN CLASS 35 (U.S. CLS. 100, 101 AND 102).

FIRST USE 7-16-1996; IN COMMERCE 7-16-1996.

FOR: PROVIDING INFORMATION IN THE FIELD OF WEDDING PARTY PLANNING, IN CLASS 41 (U.S. CLS. 100, 101 AND 107).

FIRST USE 7-16-1996; IN COMMERCE 7-16-1996.

THE MARK CONSISTS OF STANDARD CHARACTERS WITHOUT CLAIM TO ANY PARTICULAR FONT, STYLE, SIZE, OR COLOR.

SEC. 2(F).

SER. NO. 77-010,106, FILED 9-28-2006.

NAPOLEON SHARMA, EXAMINING ATTORNEY

**Int. Cl.: 1**

**Prior U.S. Cls.: 1, 5, 6, 10, 26 and 46**

**United States Patent and Trademark Office**

**Reg. No. 3,393,919**

**Registered Mar. 11, 2008**

**TRADEMARK  
PRINCIPAL REGISTER**

**LIGHTSTAR**

NISSAN CHEMICAL INDUSTRIES, LTD. (JAPAN CORPORATION)  
CHIYODA-KU  
7-1, KANDA-NISHIKI-CHO 3-CHOME,  
TOKYO, JAPAN 101-0054

FOR: SOL MIXTURES OF MAGNESIUM FLUORIDE AND SODIUM FLUORIDE, FOR USE IN THE MANUFACTURE OF HARD COATINGS, PAINTS, POLYMER COMPOUNDS AND RESINS; SOL MIXTURES OF MAGNESIUM FLUORIDE, SODIUM FLUORIDE AND SILICON DIOXIDES, FOR USE IN THE MANUFACTURE OF HARD COATINGS, PAINTS, POLYMER COMPOUNDS AND RESINS, IN CLASS 1 (U.S. CLS. 1, 5, 6, 10, 26 AND 46).

THE MARK CONSISTS OF STANDARD CHARACTERS WITHOUT CLAIM TO ANY PARTICULAR FONT, STYLE, SIZE, OR COLOR.

PRIORITY CLAIMED UNDER SEC. 44(D) ON JAPAN APPLICATION NO. 2006-080812, FILED 8-30-2006, REG. NO. 5031041, DATED 3-9-2007, EXPIRES 3-9-2017.

SER. NO. 77-011,640, FILED 10-2-2006.

DAVID MURRAY, EXAMINING ATTORNEY

**Int. Cl.: 33**

**Prior U.S. Cls.: 47 and 49**

**United States Patent and Trademark Office**

**Reg. No. 3,393,920**

**Registered Mar. 11, 2008**

**TRADEMARK  
PRINCIPAL REGISTER**

**PUERTO VALLARTA**

FRANK-LIN DISTILLERS PRODUCTS, LTD. (CALIFORNIA CORPORATION)  
PO BOX 610877  
SAN JOSE, CA 95161

FOR: TEQUILA, IN CLASS 33 (U.S. CLS. 47 AND 49).

FIRST USE 3-17-1966; IN COMMERCE 3-17-1966.

THE MARK CONSISTS OF STANDARD CHARACTERS WITHOUT CLAIM TO ANY PARTICULAR FONT, STYLE, SIZE, OR COLOR.

SEC. 2(F).

SER. NO. 77-012,155, FILED 10-3-2006.

TARAH HARDY, EXAMINING ATTORNEY

**Int. Cl.: 16**

**Prior U.S. Cls.: 2, 5, 22, 23, 29, 37, 38 and 50**

**United States Patent and Trademark Office**

**Reg. No. 3,393,921**

**Registered Mar. 11, 2008**

**TRADEMARK  
PRINCIPAL REGISTER**

**start here**

START HERE INC. (NEW YORK CORPORATION)  
226-230 EAST 12TH STREET SUITE 7-E  
NEW YORK, NY 10003

FOR: OFFICE STATIONARY PRODUCTS, NAME-  
LY, SYSTEMS OF INTERLOCKING BLANK NOTE-  
BOOKS, BLANK CALENDARS, BLANK DAILY  
PLANNERS, BLANK SKETCHBOOKS, BLANK DIA-  
RIES, BLANK PAPER AND FOLDERS, IN CLASS 16  
(U.S. CLS. 2, 5, 22, 23, 29, 37, 38 AND 50).

FIRST USE 9-1-2006; IN COMMERCE 9-1-2006.

THE MARK CONSISTS OF STANDARD CHAR-  
ACTERS WITHOUT CLAIM TO ANY PARTICULAR  
FONT, STYLE, SIZE, OR COLOR.

SER. NO. 77-013,350, FILED 10-4-2006.

SOPHIA S. KIM, EXAMINING ATTORNEY

**Int. Cl.: 28**

**Prior U.S. Cls.: 22, 23, 38 and 50**

**United States Patent and Trademark Office**

**Reg. No. 3,393,922**

**Registered Mar. 11, 2008**

**TRADEMARK  
PRINCIPAL REGISTER**

**SILVER STREAK**

WOLVERINE TACKLE, INC. (MICHIGAN CORPORATION)  
3354 WARDS POINT  
ORCHARD LAKE, MI 48324

FOR: FISHING LURES, NAMELY, SPOONS, IN CLASS 28 (U.S. CLS. 22, 23, 38 AND 50).

FIRST USE 2-23-1999; IN COMMERCE 2-23-1999.

THE MARK CONSISTS OF STANDARD CHARACTERS WITHOUT CLAIM TO ANY PARTICULAR FONT, STYLE, SIZE, OR COLOR.

OWNER OF U.S. REG. NO. 2,226,189.

SER. NO. 77-013,397, FILED 10-4-2006.

KIM SAITO, EXAMINING ATTORNEY



**Int. Cl.: 39**

**Prior U.S. Cls.: 100 and 105**

**United States Patent and Trademark Office**

**Reg. No. 3,393,923**

**Registered Mar. 11, 2008**

**SERVICE MARK  
PRINCIPAL REGISTER**

**TRAFFICWORLD**

COMMONWEALTH BUSINESS MEDIA, INC.  
(DELAWARE CORPORATION)  
400 WINDSOR CORPORATE PARK  
50 MILLSTONE ROAD, SUITE 200  
EAST WINDSOR, NJ 08520

FOR: PROVIDING TRANSPORTATION NEWS  
AND INFORMATION VIA THE INTERNET, IN  
CLASS 39 (U.S. CLS. 100 AND 105).

FIRST USE 12-30-1996; IN COMMERCE 12-30-1996.

THE MARK CONSISTS OF STANDARD CHAR-  
ACTERS WITHOUT CLAIM TO ANY PARTICULAR  
FONT, STYLE, SIZE, OR COLOR.

OWNER OF U.S. REG. NO. 2,397,966.

SER. NO. 77-014,963, FILED 10-5-2006.

CAROLYN CATALDO, EXAMINING ATTORNEY

**Int. Cl.: 36**

**Prior U.S. Cls.: 100, 101 and 102**

**United States Patent and Trademark Office**

**Reg. No. 3,393,924**

**Registered Mar. 11, 2008**

**SERVICE MARK  
PRINCIPAL REGISTER**

**TEMPO**

TEMPO PAYMENTS, INC. (DELAWARE CORPORATION)  
951 MARINERS ISLAND BOULEVARD  
SUITE 330  
SAN MATEO, CA 94404

FOR: FINANCIAL SERVICES, NAMELY, PROVIDING CREDIT CARD SERVICES, ELECTRONIC CREDIT CARD TRANSACTION SERVICES, DEBIT CARD SERVICES, ELECTRONIC DEBIT TRANSACTION SERVICES, AND TRANSACTION AUTHORIZATION AND SETTLEMENT SERVICES; PREPAID PURCHASE CARD SERVICES NAMELY, PROCESSING ELECTRONIC PAYMENTS MADE

THROUGH PREPAID CARDS, IN CLASS 36 (U.S. CLS. 100, 101 AND 102).

FIRST USE 11-28-2006; IN COMMERCE 11-28-2006.

THE MARK CONSISTS OF STANDARD CHARACTERS WITHOUT CLAIM TO ANY PARTICULAR FONT, STYLE, SIZE, OR COLOR.

SER. NO. 77-016,368, FILED 10-7-2006.

SUSAN RICHARDS, EXAMINING ATTORNEY

**Int. Cls.: 29 and 30**

**Prior U.S. Cl.: 46**

**United States Patent and Trademark Office**

**Reg. No. 3,393,925**

**Registered Mar. 11, 2008**

**TRADEMARK  
PRINCIPAL REGISTER**

**FIORE DI PASTA, INC.**

FIORE DI PASTA, INC. (CALIFORNIA CORPORATION)  
4776 EAST JENSEN AVENUE  
FRESNO, CA 93725

FOR: SOUPS- FROZEN, PREPARED AND PACKAGED ENTREES CONSISTING PRIMARILY OF MEAT, FISH, POULTRY, AND VEGETABLES, IN CLASS 29 (U.S. CL. 46).

FIRST USE 5-0-1994; IN COMMERCE 5-0-1994.

FOR: PASTA; SAUCES; FROZEN, PREPARED AND PACKAGED ENTREES CONSISTING PRIMARILY OF PASTA, IN CLASS 30 (U.S. CL. 46).

FIRST USE 5-0-1994; IN COMMERCE 5-0-1994.

THE MARK CONSISTS OF STANDARD CHARACTERS WITHOUT CLAIM TO ANY PARTICULAR FONT, STYLE, SIZE, OR COLOR.

NO CLAIM IS MADE TO THE EXCLUSIVE RIGHT TO USE "PASTA, INC.", APART FROM THE MARK AS SHOWN.

THE FOREIGN WORDING IN THE MARK TRANSLATES INTO ENGLISH AS FLOWER OF PASTA.

SER. NO. 77-017,964, FILED 10-10-2006.

TASNEEM HUSSAIN, EXAMINING ATTORNEY

Int. Cl.: 36

Prior U.S. Cls.: 100, 101 and 102

United States Patent and Trademark Office

Reg. No. 3,393,926

Registered Mar. 11, 2008

**SERVICE MARK  
PRINCIPAL REGISTER**



HUNGATE, JANET S. (UNITED STATES INDIVIDUAL)  
3905 IXORA COURT  
RIVERVIEW, FL 33569

FOR: REAL ESTATE CONSULTATION; REAL ESTATE LISTING, IN CLASS 36 (U.S. CLS. 100, 101 AND 102).

FIRST USE 11-1-2005; IN COMMERCE 11-1-2005.

NO CLAIM IS MADE TO THE EXCLUSIVE RIGHT TO USE "TEAM", APART FROM THE MARK AS SHOWN.

THE COLOR(S) GOLD AND RED. IS/ARE CLAIMED AS A FEATURE OF THE MARK.

THE MARK CONSISTS OF THE REAL TEAM WITH "THE" AND "TEAM" IN GOLD AND "REAL" IN RED WITH A ROOF AND CHIMNEY IN GOLD OVER THE WORD REAL WITH 2 RED PALM TREES TO THE LEFT SIDE AND A BORDER ENCLOSING THE WORDS RESPONSIVE. EXPERIENCED . ATTENTIVE . LOYAL - WORDS IN RED, BORDER IN GOLD.

SER. NO. 77-018,280, FILED 10-11-2006.

EDWARD NELSON, EXAMINING ATTORNEY

**Int. Cl.: 28**

**Prior U.S. Cls.: 22, 23, 38 and 50**

**United States Patent and Trademark Office**

**Reg. No. 3,393,927**

**Registered Mar. 11, 2008**

**TRADEMARK  
PRINCIPAL REGISTER**

**Crimson Croc**

2XJ ENTERPRISES, INC. (DELAWARE COR-  
PORATION)  
320 OLD ZION ROAD  
NORTH EAST, MD 21901

FOR: HUNTING ARROW POINTS, IN CLASS 28  
(U.S. CLS. 22, 23, 38 AND 50).

FIRST USE 1-1-2005; IN COMMERCE 1-1-2005.

THE MARK CONSISTS OF STANDARD CHAR-  
ACTERS WITHOUT CLAIM TO ANY PARTICULAR  
FONT, STYLE, SIZE, OR COLOR.

OWNER OF U.S. REG. NO. 2,935,497.

SER. NO. 77-018,869, FILED 10-11-2006.

JANICE KIM, EXAMINING ATTORNEY

**Int. Cls.: 9 and 10**

**Prior U.S. Cls.: 21, 23, 26, 36, 38, 39 and 44**

**United States Patent and Trademark Office**

**Reg. No. 3,393,928**

**Registered Mar. 11, 2008**

**TRADEMARK  
PRINCIPAL REGISTER**

**SAFESTAR**

DRÄGER MEDICAL AG & CO. KG (FED REP  
GERMANY CORPORATION)  
MOISLINGER ALLEE 53-55  
LÜBECK, FED REP GERMANY 23558

PRIORITY CLAIMED UNDER SEC. 44(D) ON  
ERPNTY TM OFC APPLICATION NO.  
005363445, FILED 10-6-2006, REG. NO. 005363445,  
DATED 7-23-2007, EXPIRES 10-6-2016.

FOR: FILTERS FOR RESPIRATORY MASKS,  
NAMESLY, BREATHING FILTERS, IN CLASS 9  
(U.S. CLS. 21, 23, 26, 36 AND 38).

THE MARK CONSISTS OF THE WORD SAFE-  
STAR.

FOR: MEDICAL INSTRUMENTS FOR USE IN  
ANESTHESIA AND RESPIRATION, NAMESLY,  
BREATHING FILTERS FOR ANESTHESIA MA-  
CHINES, MEDICAL RESPIRATORS, AND MEDI-  
CAL VENTILATORS, IN CLASS 10 (U.S. CLS. 26, 39  
AND 44).

SER. NO. 77-019,350, FILED 10-12-2006.

SHARON MEIER, EXAMINING ATTORNEY

**Int. Cl.: 41**

**Prior U.S. Cls.: 100, 101 and 107**

**United States Patent and Trademark Office**

**Reg. No. 3,393,929**

**Registered Mar. 11, 2008**

**SERVICE MARK  
PRINCIPAL REGISTER**

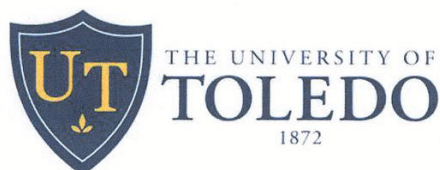

THE UNIVERSITY OF TOLEDO (OHIO AN INSTRUMENTALITY OF THE STATE OF OHIO)  
MAIL STOP #943  
TOLEDO, OH 436063390

FOR: EDUCATIONAL SERVICES, NAMELY, PROVIDING COURSES OF INSTRUCTION AT THE COLLEGE LEVEL AND EDUCATION-RELATED ENTERTAINMENT SERVICES, NAMELY, CONDUCTING AND SPONSORING COLLEGIATE ATHLETIC COMPETITIONS AND ACTIVITIES; ENTERTAINMENT IN THE NATURE OF COLLEGE SPORTING EVENTS, NAMELY, FOOTBALL, BASKETBALL, BASEBALL, SOFTBALL, CROSS COUNTRY, GOLF, TENNIS, SOCCER, SWIMMING AND DIVING, TRACK AND FIELD, AND VOLLEYBALL GAMES; LECTURES AND EXHIBITIONS IN THE FIELD OF ART, GRAPHIC AND COMMERCIAL ART, PAINTING, CERAMICS, SCULPTURE, MUSIC, THEATER, BEHAVIORAL, ENVIRONMENTAL AND POLITICAL ISSUES AND GENERAL TOPICAL ISSUES OF PUBLIC INTEREST; RECREATION PROGRAMS, NAMELY, INTRAMURAL SPORTS, FITNESS CLASSES, CONCERTS AND THEATRICAL EVENTS, NAMELY, PLAYS, POETRY AND LITERATURE READINGS, MUSICALS AND MUSICAL EVENTS, IN CLASS 41 (U.S. CLS. 100, 101 AND 107).

FIRST USE 9-26-2006; IN COMMERCE 9-26-2006.

OWNER OF U.S. REG. NOS. 1,087,857, 1,383,721, AND 2,876,533.

NO CLAIM IS MADE TO THE EXCLUSIVE RIGHT TO USE "1872", APART FROM THE MARK AS SHOWN.

THE COLOR(S) BLUE AND YELLOW IS/ARE CLAIMED AS A FEATURE OF THE MARK.

THE MARK CONSISTS OF A BLUE SHIELD DESIGN WITHIN WHICH ARE THE THE LETTERS UT AND A FLEUR-DE-LIS DESIGN IN YELLOW; AND THE WORDING THE UNIVERSITY OF TOLEDO 1872 IN BLUE.

SEC. 2(F) AS TO "UNIVERSITY OF TOLEDO".

SER. NO. 77-019,882, FILED 10-12-2006.

RONALD AIKENS, EXAMINING ATTORNEY

**Int. Cl.: 11**

**Prior U.S. Cls.: 13, 21, 23, 31 and 34**

**United States Patent and Trademark Office**

**Reg. No. 3,393,930**

**Registered Mar. 11, 2008**

**TRADEMARK  
PRINCIPAL REGISTER**

**PERROT**

REGNERBAU CALW GMBH (FED REP GERMA-  
NY CORPORATION)  
INDUSTRIESTRASSE 19-29  
ALTHENGSTETT, FED REP GERMANY 75382

FOR: AGRICULTURAL MACHINES IN THE  
FORM OF LAWN SPRINKLING SYSTEMS, NAME-  
LY, SPRINKLERS, POP-UP SPRINKLERS, FULL  
AND PART-CIRCLE SPRINKLERS, SPRAY NOZ-  
ZLES AND HOSE-DRUM SPRINKLERS, IN CLASS  
11 (U.S. CLS. 13, 21, 23, 31 AND 34).

FIRST USE 6-30-1999; IN COMMERCE 6-30-1999.

THE MARK CONSISTS OF STANDARD CHAR-  
ACTERS WITHOUT CLAIM TO ANY PARTICULAR  
FONT, STYLE, SIZE, OR COLOR.

OWNER OF U.S. REG. NO. 3,086,956.

SEC. 2(F).

SER. NO. 77-020,996, FILED 10-13-2006.

DAVID TAYLOR, EXAMINING ATTORNEY



**Int. Cl.: 9**

**Prior U.S. Cls.: 21, 23, 26, 36 and 38**

**Reg. No. 3,393,931**

**United States Patent and Trademark Office**

**Registered Mar. 11, 2008**

---

**TRADEMARK  
PRINCIPAL REGISTER**

**MY SPAM GONE**

ARLINGTON WEB SERVICES, INC. (OHIO CORPORATION)  
3857 NORTH HIGH STREET, SUITE 108  
COLUMBUS, OH 43214

FOR: DOWNLOADABLE COMPUTER SOFTWARE FOR SCREENING UNSOLICITED ELECTRONIC MESSAGES, IN CLASS 9 (U.S. CLS. 21, 23, 26, 36 AND 38).

FIRST USE 10-16-2006; IN COMMERCE 10-16-2006.

THE MARK CONSISTS OF STANDARD CHARACTERS WITHOUT CLAIM TO ANY PARTICULAR FONT, STYLE, SIZE, OR COLOR.

NO CLAIM IS MADE TO THE EXCLUSIVE RIGHT TO USE "SPAM", APART FROM THE MARK AS SHOWN.

SER. NO. 77-021,675, FILED 10-16-2006.

ALLISON SCHRODY, EXAMINING ATTORNEY

**Int. Cls.: 2 and 19**

**Prior U.S. Cls.: 1, 6, 11, 12, 16, 33 and 50**

**United States Patent and Trademark Office**

**Reg. No. 3,393,932**

**Registered Mar. 11, 2008**

**TRADEMARK  
PRINCIPAL REGISTER**



STONCOR GROUP, INC. (DELAWARE CORPORATION)  
ONE PARK AVENUE  
MAPLE SHADE, NJ 08052

FOR: HIGHWAY AND PAVEMENT STRIPING AND MARKING MEDIA, NAMELY, EPOXY-BASED AND POLYUREA-BASED COATING MATERIALS APPLIED IN A VISCOUS STATE FOR USE IN MARKING ROAD SURFACES, IN CLASS 2 (U.S. CLS. 6, 11 AND 16).

FIRST USE 2-28-2005; IN COMMERCE 2-28-2005.

FOR: HIGHWAY AND PAVEMENT STRIPING AND MARKING MEDIA, NAMELY, GLASS GRANULES FOR MARKING ROADS; CEMENTITIOUS COMPOSITIONS FOR STRIPING PAVEMENT, IN CLASS 19 (U.S. CLS. 1, 12, 33 AND 50).

FIRST USE 2-28-2005; IN COMMERCE 2-28-2005.

THE COLOR(S) ORANGE, YELLOW AND BLACK IS/ARE CLAIMED AS A FEATURE OF THE MARK.

THE MARK CONSISTS OF THE CONJOINED TERMS "GLO" AND "MARC", WITH A STYLIZED SUNBURST-STYLE RING OF FIRE AROUND THE TERM "GLO." THE COLORS ORANGE AND YELLOW APPEAR IN THE STYLIZED, SUNBURST STYLE RING OF FIRE AROUND THE TERM GLO WITH YELLOW AROUND THE CIRCULAR PERIPHERY AND AT THE INNER TIPS OF THE GENERALLY TRIANGULARLY SHAPED RADICALLY INWARDLY POINTING FLAMES. THE COLOR BLACK IS USED FOR THE WORDING "GLO-MARC". THE COLOR WHITE IS BACKGROUND AND IS NOT A PART OF THE MARK.

SER. NO. 77-023,147, FILED 10-17-2006.

AMY GEARIN, EXAMINING ATTORNEY

**Int. Cl.: 39**

**Prior U.S. Cls.: 100 and 105**

**United States Patent and Trademark Office**

**Reg. No. 3,393,933**

**Registered Mar. 11, 2008**

**SERVICE MARK  
PRINCIPAL REGISTER**



SMF ENERGY CORPORATION (DELAWARE CORPORATION)  
200 WEST CYPRESS CREEK ROAD, SUITE 400  
FORT LAUDERDALE, FL 33309

FOR: TRANSPORTATION AND STORAGE OF FUELS FOR VEHICLES OF OTHERS; DISTRIBUTION OF FUELS AND ENERGY; MOBILE FUELING AND VEHICLE EMERGENCY ASSISTANCE SERVICES, NAMELY, TRANSPORTATION AND DELIVERY OF EMERGENCY FUEL SUPPLIES BY TRUCK; DELIVERING FUEL TO VEHICLES AND TO POWER GENERATORS AND POWER SUPPLY SYSTEMS; FUEL USAGE AND DELIVERY MANAGEMENT SERVICES, NAMELY, EXPRESS DELIVERY OF FUEL TO OTHERS BY TRUCK; TRANSPORTATION OF LARGE INDUSTRIAL EQUIPMENT, CONSTRUCTION VEHICLES, AND

TOOLS OF OTHERS, IN CLASS 39 (U.S. CLS. 100 AND 105).

FIRST USE 1-6-2006; IN COMMERCE 1-6-2006.

THE COLOR(S) BLUE AND YELLOW IS/ARE CLAIMED AS A FEATURE OF THE MARK.

THE COLOR BLUE APPEARS IN THE LETTERS SMF, AND THE COLOR YELLOW APPEARS IN THE OVAL-SHAPED ARROW DESIGN OF THE MARK.

SER. NO. 77-025,325, FILED 10-19-2006.

ANDREW RHIM, EXAMINING ATTORNEY

**Int. Cl.: 41**

**Prior U.S. Cls.: 100, 101 and 107**

**United States Patent and Trademark Office**

**Reg. No. 3,393,934**

**Registered Mar. 11, 2008**

**SERVICE MARK  
PRINCIPAL REGISTER**

# Sista Pride

BOYS & GIRLS CLUBS OF GREATER MILWAU-  
KEE, INC. (WISCONSIN CORPORATION)  
1558 N 6TH STREET  
MILWAUKEE, WI 53212

FOR: EDUCATIONAL SERVICES FOR FEMALE  
YOUTHS, NAMELY, CONDUCTING WORKSHOPS,  
SEMINARS AND EVENTS IN THE FIELD OF  
CHARACTER DEVELOPMENT AND LEADERSHIP  
SKILLS, IN CLASS 41 (U.S. CLS. 100, 101 AND 107).

FIRST USE 3-0-2005; IN COMMERCE 3-0-2005.

THE MARK CONSISTS OF STANDARD CHAR-  
ACTERS WITHOUT CLAIM TO ANY PARTICULAR  
FONT, STYLE, SIZE, OR COLOR.

SER. NO. 77-025,385, FILED 10-19-2006.

JEAN IM, EXAMINING ATTORNEY

**Int. Cl.: 30**

**Prior U.S. Cl.: 46**

**United States Patent and Trademark Office**

**Reg. No. 3,393,935**

**Registered Mar. 11, 2008**

**TRADEMARK  
PRINCIPAL REGISTER**

**SNOWBALLS**

CONNOISSEUR HOUSE OF CHOCOLATES, INC.  
(WISCONSIN CORPORATION)  
N144 W5620 PIONEER ROAD  
CEDARBURG, WI 53012

FOR: WHITE CONFECTIONARY COATED PRE-  
TZELS, IN CLASS 30 (U.S. CL. 46).

FIRST USE 10-10-2006; IN COMMERCE 10-10-2006.

THE MARK CONSISTS OF STANDARD CHAR-  
ACTERS WITHOUT CLAIM TO ANY PARTICULAR  
FONT, STYLE, SIZE, OR COLOR.

SER. NO. 77-025,643, FILED 10-20-2006.

KENNETH E. SHARPERSON, EXAMINING ATTOR-  
NEY

**Int. Cl.: 5**

**Prior U.S. Cls.: 6, 18, 44, 46, 51 and 52**

**United States Patent and Trademark Office**

**Reg. No. 3,393,936**

**Registered Mar. 11, 2008**

**TRADEMARK  
PRINCIPAL REGISTER**



GRUPO SANNE, S.A. DE C.V. (MEXICO CORPORATION)  
AV. AVILA CAMACHO 270-7A, COL JACARANDAS  
ZAPOPAN, MEXICO 45160

THE MARK CONSISTS OF STYLIZED CAPITAL LETTERS WITH THE SHADE OF THREE MEN LIKE JUMPING ABOVE THE LETTER N.

FOR: DIETARY AND NUTRITIONAL SUPPLEMENTS, IN CLASS 5 (U.S. CLS. 6, 18, 44, 46, 51 AND 52).

SER. NO. 77-027,574, FILED 10-23-2006.

FIRST USE 9-19-2005; IN COMMERCE 9-19-2005.

RENEE SERVANCE, EXAMINING ATTORNEY

**Int. Cls.: 9 and 42**

**Prior U.S. Cls.: 21, 23, 26, 36, 38, 100 and 101**

**United States Patent and Trademark Office**

**Reg. No. 3,393,937**

**Registered Mar. 11, 2008**

**TRADEMARK  
SERVICE MARK  
PRINCIPAL REGISTER**

# 9Rays.Net

VICTOROV, VICTOR (RUSSIAN FED. INDIVIDUAL)  
PODOLSKAYA, 16/24  
SAINT-PETERSBURG, RUSSIAN FED. 198013

FOR: COMPUTER UTILITY SOFTWARE, DOWNLOADABLE COMPUTER SOFTWARE AND COMPUTER SOFTWARE FOR PROTECTING, RESEARCHING, MODELING, AND ANALYZING .NET ASSEMBLIES; COMPUTER SOFTWARE FOR THE CONTROL OF BOUND/UNBOUND/COMBINED DATA FOR USE IN DISPLAYING, EDITING AND BROWSING, IN CLASS 9 (U.S. CLS. 21, 23, 26, 36 AND 38).

FIRST USE 1-24-2002; IN COMMERCE 2-5-2002.

FOR: APPLICATION SERVICE PROVIDER FEATURING SOFTWARE FOR PROTECTING, RESEARCHING, MODELING, AND ANALYZING .NET ASSEMBLIES; APPLICATION SERVICE PROVIDER FEATURING SOFTWARE FOR USE IN THE

FIELD OF CUSTOMIZED DATA MANAGEMENT, NAMELY, MANAGEMENT OF TABULAR, NESTED AND HIERARCHICAL DATA; APPLICATION SERVICE PROVIDER FEATURING SOFTWARE FOR THE CONTROL OF BOUND/UNBOUND/COMBINED DATA FOR USE IN DISPLAYING, EDITING AND BROWSING; PROVIDING A WEBSITE FEATURING INTERACTIVE TECHNICAL SUPPORT SERVICES RELATING THERETO, IN CLASS 42 (U.S. CLS. 100 AND 101).

FIRST USE 1-24-2002; IN COMMERCE 3-24-2006.

THE MARK CONSISTS OF STANDARD CHARACTERS WITHOUT CLAIM TO ANY PARTICULAR FONT, STYLE, SIZE, OR COLOR.

SER. NO. 77-028,260, FILED 10-24-2006.

JAY FLOWERS, EXAMINING ATTORNEY

Int. Cl.: 43

Prior U.S. Cls.: 100 and 101

United States Patent and Trademark Office

Reg. No. 3,393,938

Registered Mar. 11, 2008

SERVICE MARK  
PRINCIPAL REGISTER



DAVID MELIUS INVESTMENTS, INC. (LOUISIANA CORPORATION)  
7538 MAPLE STREET  
NEW ORLEANS, LA 70118

FOR: BAR SERVICES, NAMELY, BAR SERVICES, TAVERN SERVICES AND PROVIDING OF ALCOHOLIC DRINKS, IN CLASS 43 (U.S. CLS. 100 AND 101).

FIRST USE 7-1-2006; IN COMMERCE 7-1-2006.

NO CLAIM IS MADE TO THE EXCLUSIVE RIGHT TO USE "TAVERN" OR "UPTOWN DRINKING PLACE SINCE 1934", APART FROM THE MARK AS SHOWN.

SER. NO. 77-028,541, FILED 10-24-2006.

JOHN KELLY, EXAMINING ATTORNEY



**Int. Cl.: 35**

**Prior U.S. Cls.: 100, 101 and 102**

**United States Patent and Trademark Office**

**Reg. No. 3,393,939**

**Registered Mar. 11, 2008**

**SERVICE MARK  
PRINCIPAL REGISTER**

**GRAPHITA**

GRAPHITA, INC. (CALIFORNIA CORPORATION)  
101 CHULA VISTA DRIVE  
SAN RAFAEL, CA 94901

FOR: PROMOTING THE GOODS AND SERVICES OF OTHERS BY PROVIDING A WEBSITE AT WHICH USERS CAN LINK TO VENDORS OFFERING SERVICES AND PRODUCTS RELATED TO DIGITAL IMAGARY, IN CLASS 35 (U.S. CLS. 100, 101 AND 102).

FIRST USE 7-10-2006; IN COMMERCE 7-10-2006.

THE MARK CONSISTS OF STANDARD CHARACTERS WITHOUT CLAIM TO ANY PARTICULAR FONT, STYLE, SIZE, OR COLOR.

SER. NO. 77-028,650, FILED 10-25-2006.

ASMAT KHAN, EXAMINING ATTORNEY

**Int. Cls.: 17 and 24**

**Prior U.S. Cls.: 1, 5, 12, 13, 35, 42 and 50**

**United States Patent and Trademark Office**

**Reg. No. 3,393,940**

**Registered Mar. 11, 2008**

**TRADEMARK  
PRINCIPAL REGISTER**



HO YU TEXTILE CO., LTD. (TAIWAN LIMITED  
PARTNERSHIP)  
P.O. BOX NO. 6-57  
JUNGHE CITY, TAIWAN

FOR: WATERPROOF, BREATHABLE MEMBRANES TO BE LAMINATED TO TEXTILES FOR THE MANUFACTURE OF ARTICLES OF FABRIC FOR COMMERCIAL OR DOMESTIC USE , IN CLASS 17 (U.S. CLS. 1, 5, 12, 13, 35 AND 50).

FIRST USE 4-1-2006; IN COMMERCE 4-1-2006.

FOR: TEXTILE FABRICS FOR THE MANUFACTURE OF CLOTHING; VINYL AND CLOTH TEXTILES FOR USE IN THE MANUFACTURE OF BAGS, CLOTHING, CURTAINS AND LUGGAGE; POLYESTER FABRIC; COTTON BASE MIXED FABRICS; SEMI-SYNTHETIC FIBER FABRICS; SYNTHETIC FIBER FABRICS; TEXTILE FILTER

CLOTH, NAMELY, CLOTH OF FILTERING LIQUID AND POWDER; FIREPROOF UPHOLSTERY FABRICS; GUMMED WATERPROOF CLOTH; WATERPROOF FABRIC FOR MANUFACTURING CLOTHING, FURNITURE AND AUTOMOBILE UPHOLSTERY, AND LUGGAGE; FABRICS FOR THE MANUFACTURE OF CLOTHING, ESPECIALLY WINDPROOF, BREATHABLE AND WATERPROOF FABRICS, IN CLASS 24 (U.S. CLS. 42 AND 50).

FIRST USE 4-1-2006; IN COMMERCE 4-1-2006.

THE MARK CONSISTS OF THE LETTERING CYCLEPET WITHIN AN OUTLINE OF A BOTTLE. TO THE RIGHT OF THE BOTTLE IS A LEAF.

SER. NO. 77-028,666, FILED 10-25-2006.

KAPIL BHANOT, EXAMINING ATTORNEY

**Int. Cl.: 35**

**Prior U.S. Cls.: 100, 101 and 102**

**United States Patent and Trademark Office**

**Reg. No. 3,393,941**

**Registered Mar. 11, 2008**

**SERVICE MARK  
PRINCIPAL REGISTER**



MICKEY IBARRA & ASSOCIATES, INC. (MARY-  
LAND CORPORATION)  
SUITE 1100  
1140 CONNECTICUT AVE., NW  
WASHINGTON, DC 20036

FOR: PROMOTING PUBLIC AWARENESS OF  
LATINO LEADERS IN THE FIELD OF SOCIAL  
AND ECONOMIC ACHIEVEMENT, IN CLASS 35  
(U.S. CLS. 100, 101 AND 102).

FIRST USE 9-6-2006; IN COMMERCE 9-6-2006.

NO CLAIM IS MADE TO THE EXCLUSIVE  
RIGHT TO USE "LATINO LEADERS NETWORK"  
AND "FOUNDER & CHAIRMAN", APART FROM  
THE MARK AS SHOWN.

THE NAME MICKEY IBARRA IDENTIFIES A  
LIVING INDIVIDUAL WHOSE CONSENT IS OF  
RECORD.

THE COLOR(S) BLACK AND GOLD IS/ARE  
CLAIMED AS A FEATURE OF THE MARK.

THE MARK CONSISTS OF THE FIRST WORD IS  
LATINO IN BLACK, THEN A GOLD SYMBOL OF A  
CURSIVE L WITH A LOOP ATTACHED TO IT,  
THEN THE WORD LEADERS IN BLACK. THE  
NEXT LINE HAS A GOLD TWIRLY SYMBOL  
FOLLOWED BY THE WORD NETWORK IN BLACK,  
FOLLOWED BY THE SAME GOLD TWIRL. BELOW  
THIS IS MICKEY IBARRA, FOUNDER & CHAIR  
IN BLACK LETTERS, ENCASED IN A BLACK LINE  
ABOVE AND BELOW.

SER. NO. 77-029,040, FILED 10-25-2006.

PETER B. BROMAGHIM, EXAMINING ATTORNEY

**Int. Cl.: 7**

**Prior U.S. Cls.: 13, 19, 21, 23, 31, 34 and 35**

**United States Patent and Trademark Office**

**Reg. No. 3,393,942**

**Registered Mar. 11, 2008**

**TRADEMARK  
PRINCIPAL REGISTER**

**MacDon**

MACDON INDUSTRIES LTD. (CANADA CORPORATION)  
680 MORAY STREET  
WINNIPEG, MANITOBA, CANADA R3J3S3

FOR: TRACTOR TOWED AGRICULTURAL IMPLEMENTS, NAMELY, WINDROWERS, PULL-TYPE MOWER CONDITIONERS, HAY AND FORAGE HEADERS, GRASS SEED HEADERS, AND DRAPER HEADERS , IN CLASS 7 (U.S. CLS. 13, 19, 21, 23, 31, 34 AND 35).

FIRST USE 7-31-2005; IN COMMERCE 7-31-2005.

OWNER OF U.S. REG. NOS. 1,717,527, 2,424,780, AND 2,426,412.

THE MARK CONSISTS OF AN UPPERCASE M, LOWERCASE AC, UPPERCASE D, LOWERCASE AC (ONE WORD).

SER. NO. 77-029,904, FILED 10-26-2006.

MORGAN WYNNE, EXAMINING ATTORNEY

**Int. Cl.: 42**

**Prior U.S. Cls.: 100 and 101**

**United States Patent and Trademark Office**

**Reg. No. 3,393,943**

**Registered Mar. 11, 2008**

**SERVICE MARK  
PRINCIPAL REGISTER**



EZANGA.COM, INC. (DELAWARE CORPORATION)  
219 CARTER DRIVE  
MIDDLETOWN, DE 19709

FOR: COMPUTER SERVICES, NAMELY, PROVIDING SEARCH ENGINES FOR OBTAINING DATA ON THIRD PARTY WEBSITES, IN CLASS 42 (U.S. CLS. 100 AND 101).

FIRST USE 11-9-2005; IN COMMERCE 11-9-2005.

THE COLOR(S) GREEN, GRAY AND BLACK IS/ARE CLAIMED AS A FEATURE OF THE MARK.

THE MARK CONSISTS OF A GREEN FROG BEHIND THE LETTER E AT THE BEGINNING OF THE LITERAL ELEMENT OF THE MARK, A GREEN CIRCLE BEHIND THE WORD GO!, AND A GREEN DOT AFTER THE A AT THE END OF THE LITERAL ELEMENT OF THE MARK, THE WORDING EZANGA AND HOP ON AND GO! ARE IN BLACK AND THE FROG AND WORDING ARE ON A GRAY BACKGROUND.

SER. NO. 77-032,020, FILED 10-30-2006.

NAAKWAMA ANKRAH, EXAMINING ATTORNEY

**Int. Cl.: 36**

**Prior U.S. Cls.: 100, 101 and 102**

**United States Patent and Trademark Office**

**Reg. No. 3,393,944**

**Registered Mar. 11, 2008**

**SERVICE MARK  
PRINCIPAL REGISTER**

*Our business is changing lives.*

GOODWILL INDUSTRIES OF THE COLUMBIA  
WILLAMETTE (OREGON NON-PROFIT COR-  
PORATION)  
1943 SE SIXTH AVENUE  
PORTLAND, OR 97214

FOR: CHARITABLE FUND RAISING SERVICES  
BY MEANS OF COLLECTING AND REDEEMING  
RECYCLABLES FOR DONATION OF REDEMP-  
TION PROCEEDS TO CHARITABLE ORGANIZA-  
TIONS, IN CLASS 36 (U.S. CLS. 100, 101 AND 102).

FIRST USE 1-1-2003; IN COMMERCE 1-1-2003.

THE MARK CONSISTS OF STANDARD CHAR-  
ACTERS WITHOUT CLAIM TO ANY PARTICULAR  
FONT, STYLE, SIZE, OR COLOR.

SER. NO. 77-032,139, FILED 10-30-2006.

WARREN L. OLANDRIA, EXAMINING ATTOR-  
NEY

**Int. Cl.: 36**

**Prior U.S. Cls.: 100, 101 and 102**

**United States Patent and Trademark Office**

**Reg. No. 3,393,945**

**Registered Mar. 11, 2008**

**SERVICE MARK  
PRINCIPAL REGISTER**

*Your purchases change lives.*

GOODWILL INDUSTRIES OF THE COLUMBIA  
WILLAMETTE (OREGON NON-PROFIT COR-  
PORATION)  
1934 SE SIXTH AVENUE  
PORTLAND, OR 97214

FOR: CHARITABLE FUND RAISING SERVICES  
BY MEANS OF COLLECTING AND REDEEMING  
RECYCLABLES FOR DONATION OF REDEMP-  
TION PROCEEDS TO CHARITABLE ORGANIZA-  
TIONS, IN CLASS 36 (U.S. CLS. 100, 101 AND 102).

FIRST USE 3-1-2006; IN COMMERCE 3-1-2006.

THE MARK CONSISTS OF STANDARD CHAR-  
ACTERS WITHOUT CLAIM TO ANY PARTICULAR  
FONT, STYLE, SIZE, OR COLOR.

SER. NO. 77-032,158, FILED 10-30-2006.

WARREN L. OLANDRIA, EXAMINING ATTOR-  
NEY

**Int. Cl.: 36**

**Prior U.S. Cls.: 100, 101 and 102**

**United States Patent and Trademark Office**

**Reg. No. 3,393,946**

**Registered Mar. 11, 2008**

**SERVICE MARK  
PRINCIPAL REGISTER**

*Your donations change lives.*

GOODWILL INDUSTRIES OF THE COLUMBIA  
WILLAMETTE (OREGON NON-PROFIT COR-  
PORATION)  
1934 SE SIXTH AVENUE  
PORTLAND, OR 97214

FOR: CHARITABLE FUND RAISING SERVICES  
BY MEANS OF COLLECTING AND REDEEMING  
RECYCLABLES FOR DONATION OF REDEMP-  
TION PROCEEDS TO CHARITABLE ORGANIZA-  
TIONS, IN CLASS 36 (U.S. CLS. 100, 101 AND 102).

FIRST USE 3-1-2006; IN COMMERCE 3-1-2006.

THE MARK CONSISTS OF STANDARD CHAR-  
ACTERS WITHOUT CLAIM TO ANY PARTICULAR  
FONT, STYLE, SIZE, OR COLOR.

SER. NO. 77-032,178, FILED 10-30-2006.

WARREN L. OLANDRIA, EXAMINING ATTOR-  
NEY



Int. Cl.: 37

Prior U.S. Cls.: 100, 103 and 106

United States Patent and Trademark Office

Reg. No. 3,393,947

Registered Mar. 11, 2008

SERVICE MARK  
PRINCIPAL REGISTER



TEMO, INC. (MICHIGAN CORPORATION)  
20400 HALL ROAD  
CLINTON TOWNSHIP, MI 48038

"THE COLOR(S) BLUE AND YELLOW IS/ARE CLAIMED AS A FEATURE OF THE MARK."

FOR: INSTALLATION, CONSTRUCTION, RENOVATION, REMODELING, REPAIR, AND CONSTRUCTION IMPROVEMENTS OF RESIDENTIAL, COMMERCIAL, AND INDUSTRIAL PROPERTIES, SUNROOMS, AND SUBTERRANEAN LIVING SPACES, IN CLASS 37 (U.S. CLS. 100, 103 AND 106).

THE MARK CONSISTS OF BLUE SHADED ARROW DESIGN CURVING UPWARDS ON TOP OF A YELLOW SHADED PARTIAL CIRCLE ABOVE THE BLUE-OUTLINED WORDING DESIGNER IN STYLISTED FONT OVER THE BLUE WORDING BASEMENTS THERMAL FINISHING SYSTEM, ALL CONTAINED WITHIN A SINGLE-LINE BLUE OUTLINE. BELOW THE OUTLINED PORTION OF THE MARK ARE THE WORDS BY TEMO IN BLUE.

FIRST USE 6-30-2006; IN COMMERCE 6-30-2006.

OWNER OF U.S. REG. NOS. 2,390,933 AND 2,812,407.

SER. NO. 77-032,387, FILED 10-30-2006.

NO CLAIM IS MADE TO THE EXCLUSIVE RIGHT TO USE "BASEMENTS THERMAL FINISHING SYSTEM", APART FROM THE MARK AS SHOWN.

ELLEN BURNS, EXAMINING ATTORNEY

**Int. Cl.: 35**

**Prior U.S. Cls.: 100, 101 and 102**

**United States Patent and Trademark Office**

**Reg. No. 3,393,948**

**Registered Mar. 11, 2008**

**SERVICE MARK  
PRINCIPAL REGISTER**

**WOMANAIRE**

HIATT, TINA (UNITED STATES INDIVIDUAL)  
23016 LAKE FOREST DR. A113  
LAGUNA HILLS, CA 92653

THE MARK CONSISTS OF STANDARD CHAR-  
ACTERS WITHOUT CLAIM TO ANY PARTICULAR  
FONT, STYLE, SIZE, OR COLOR.

FOR: ARRANGING AND CONDUCTING BUSI-  
NESS CONFERENCES, IN CLASS 35 (U.S. CLS. 100,  
101 AND 102).

SER. NO. 77-032,450, FILED 10-30-2006.

FIRST USE 1-18-2005; IN COMMERCE 2-21-2005.

KELLY CHOE, EXAMINING ATTORNEY

**Int. Cl.: 41**

**Prior U.S. Cls.: 100, 101 and 107**

**United States Patent and Trademark Office**

**Reg. No. 3,393,949**

**Registered Mar. 11, 2008**

**SERVICE MARK  
PRINCIPAL REGISTER**

# Wine Seduction

STEFANO'S NETWORK, INC (NEW YORK CORPORATION)

5 N  
300 WEST 55TH  
NEW YORK, NY 10019

FOR: ENTERTAINMENT SERVICES, NAMELY, WINE TASTINGS; EDUCATIONAL SERVICES, NAMELY, PROVIDING CLASSES AND SEMINARS IN THE FIELD OF WINE; PARTY PLANNING AND MEETING ARRANGEMENT FOR THE TASTING OF AND DISCUSSION OF WINE, IN ORDER TO ENCOURAGE SOCIAL NETWORKING, IN CLASS 41 (U.S. CLS. 100, 101 AND 107).

FIRST USE 5-25-2005; IN COMMERCE 5-25-2005.

THE MARK CONSISTS OF STANDARD CHARACTERS WITHOUT CLAIM TO ANY PARTICULAR FONT, STYLE, SIZE, OR COLOR.

NO CLAIM IS MADE TO THE EXCLUSIVE RIGHT TO USE "WINE", APART FROM THE MARK AS SHOWN.

SER. NO. 77-033,020, FILED 10-31-2006.

DEZMONA MIZELLE, EXAMINING ATTORNEY

**Int. Cl.: 35**

**Prior U.S. Cls.: 100, 101 and 102**

**United States Patent and Trademark Office**

**Reg. No. 3,393,950**

**Registered Mar. 11, 2008**

**SERVICE MARK  
PRINCIPAL REGISTER**

**LEVERAGE MEDIA**

LEVERAGE MEDIA, LLC (NEW YORK LTD  
LIAB CO)  
SUITE 321  
145 PALISADE STREET  
DOBBS FERRY, NY 10522

FOR: CUSTOM WRITING SERVICES COMPRIS-  
ING PUBLIC RELATIONS AND MARKETING MA-  
TERIALS FOR PROFESSIONAL SERVICE  
ORGANIZATIONS AND BUSINESSES; PUBLISH-  
ING OF ADVERTISING TEXTS, IN CLASS 35 (U.S.  
CLS. 100, 101 AND 102).

FIRST USE 8-25-2001; IN COMMERCE 8-25-2001.

THE MARK CONSISTS OF STANDARD CHAR-  
ACTERS WITHOUT CLAIM TO ANY PARTICULAR  
FONT, STYLE, SIZE, OR COLOR.

NO CLAIM IS MADE TO THE EXCLUSIVE  
RIGHT TO USE "MEDIA", APART FROM THE  
MARK AS SHOWN.

SER. NO. 77-033,265, FILED 10-31-2006.

BERNICE MIDDLETON, EXAMINING ATTORNEY

**Int. Cl.: 28**

**Prior U.S. Cls.: 22, 23, 38 and 50**

**United States Patent and Trademark Office**

**Reg. No. 3,393,951**

**Registered Mar. 11, 2008**

**TRADEMARK  
PRINCIPAL REGISTER**

**REKON**

SOL-EFFECT ENTERPRISES, INC. (CALIFORNIA CORPORATION)  
11878 CLARK STREET  
ARCADIA, CA 91006

FOR: SKATEBOARD, ROLLER SKATES AND RELATED ACCESSORIES, NAMELY, SKATEBOARD TRUCKS, SKATEBOARD AND ROLLER SKATE WHEELS, SKATEBOARD AND ROLLER SKATE BALL BEARINGS; SKATEBOARD AND ROLLER SKATE KNEE PADS, ELBOW PADS AND WRIST GUARDS, IN CLASS 28 (U.S. CLS. 22, 23, 38 AND 50).

FIRST USE 3-13-2003; IN COMMERCE 3-13-2003.

THE MARK CONSISTS OF STANDARD CHARACTERS WITHOUT CLAIM TO ANY PARTICULAR FONT, STYLE, SIZE, OR COLOR.

SER. NO. 77-034,468, FILED 11-1-2006.

JEFF DEFORD, EXAMINING ATTORNEY

**Int. Cl.: 10**

**Prior U.S. Cls.: 26, 39 and 44**

**United States Patent and Trademark Office**

**Reg. No. 3,393,952**

**Registered Mar. 11, 2008**

**TRADEMARK  
PRINCIPAL REGISTER**

**ETDRS**

PRECISION VISION, INC. (ILLINOIS CORPORATION)  
944 FIRST STREET  
LA SALLE, IL 61301

FOR: EYE TESTING MACHINES AND APPARATUS, IN CLASS 10 (U.S. CLS. 26, 39 AND 44).

FIRST USE 1-1-1994; IN COMMERCE 1-1-1994.

THE MARK CONSISTS OF STANDARD CHARACTERS WITHOUT CLAIM TO ANY PARTICULAR FONT, STYLE, SIZE, OR COLOR.

SEC. 2(F).

SER. NO. 77-034,620, FILED 11-1-2006.

GRETTA YAO, EXAMINING ATTORNEY

**Int. Cl.: 45**

**Prior U.S. Cls.: 100 and 101**

**United States Patent and Trademark Office**

**Reg. No. 3,393,953**

**Registered Mar. 11, 2008**

**SERVICE MARK  
PRINCIPAL REGISTER**

**EQUIPPING WORLD-CHANGING  
DISCIPLES**

GENERAL BOARD OF DISCIPLESHIP OF THE  
UNITED METHODIST CHURCH (TENNESSEE  
CORPORATION)  
1908 GRAND AVENUE  
NASHVILLE, TN 37212

FOR: MINISTERIAL SERVICES, NAMELY, PROVIDING INFORMATION IN THE FIELDS OF CHRISTIAN, RELIGIOUS AND SPIRITUAL DEVELOPMENT, CHRISTIAN DISCIPLESHIP, CHRISTIAN, RELIGIOUS AND SPIRITUAL MINISTRY, CHRISTIAN STEWARDSHIP, CHURCH DEVELOPMENT, CHURCH LEADERSHIP, CHURCH MINISTRY, CHURCH REVITALIZATION, CONGREGATIONAL DEVELOPMENT, CONGREGATIONAL LEADERSHIP, CONGREGATIONAL MINISTRY, CONGREGATIONAL, INSPIRATIONAL AND RELIGIOUS PROGRAMS, DEVOTIONAL TOPICS, EVANGELISM, FAITH, FAITH FORMATION, LAY MINISTRIES, CHRISTIAN, RELIGIOUS, AND SPIRITUAL LEADERSHIP, LEADERSHIP DEVELOPMENT, LEADERSHIP FORMATION, LEADERSHIP SKILLS, CHRISTIAN, RELIGIOUS, AND SPIRITUAL PERSONAL DEVELOPMENT, PERSONAL PIETY, PERSONAL TRANSFORMATION, PRAYER, RELIGION, RELIGIOUS CONGREGATIONS, RELIGIOUS LEADERSHIP, SPIRITUALITY, SPIRITUAL GROWTH, AND SPIRITUAL LEADERSHIP; AND, PROVIDING INFORMATION VIA ELECTRONIC COMMUNICATION NETWORKS IN THE FIELDS OF CHRISTIAN, RELIGIOUS AND SPIRITUAL DEVELOPMENT, CHRISTIAN DISCIPLESHIP, CHRISTIAN, RELIGIOUS AND SPIRITUAL MINISTRY, CHRISTIAN

STEWARDSHIP, CHURCH DEVELOPMENT, CHURCH LEADERSHIP, CHURCH MINISTRY, CHURCH REVITALIZATION, CONGREGATIONAL DEVELOPMENT, CONGREGATIONAL LEADERSHIP, CONGREGATIONAL MINISTRY, CONGREGATIONAL, INSPIRATIONAL AND RELIGIOUS PROGRAMS, DEVOTIONAL TOPICS, EVANGELISM, FAITH, FAITH FORMATION, LAY MINISTRIES, CHRISTIAN, RELIGIOUS, AND SPIRITUAL LEADERSHIP, LEADERSHIP DEVELOPMENT, LEADERSHIP FORMATION, LEADERSHIP SKILLS, CHRISTIAN, RELIGIOUS, AND SPIRITUAL PERSONAL DEVELOPMENT, PERSONAL PIETY, PERSONAL TRANSFORMATION, PRAYER, RELIGION, RELIGIOUS CONGREGATIONS, RELIGIOUS LEADERSHIP, SPIRITUALITY, SPIRITUAL GROWTH, AND SPIRITUAL LEADERSHIP, IN CLASS 45 (U.S. CLS. 100 AND 101).

FIRST USE 4-0-2006; IN COMMERCE 4-0-2006.

THE MARK CONSISTS OF STANDARD CHARACTERS WITHOUT CLAIM TO ANY PARTICULAR FONT, STYLE, SIZE, OR COLOR.

NO CLAIM IS MADE TO THE EXCLUSIVE RIGHT TO USE "DISCIPLES", APART FROM THE MARK AS SHOWN.

SER. NO. 77-035,335, FILED 11-2-2006.

WANDA KAY PRICE, EXAMINING ATTORNEY

**Int. Cl.: 10**

**Prior U.S. Cls.: 26, 39 and 44**

**United States Patent and Trademark Office**

**Reg. No. 3,393,954**

**Registered Mar. 11, 2008**

**TRADEMARK  
PRINCIPAL REGISTER**

COLENBRANDER MIXED CONTRAST

PRECISION VISION, INC. (ILLINOIS CORPORATION)

944 FIRST STREET

LA SALLE, IL 61301

FOR: EYE TESTING MACHINES AND APPARATUS, IN CLASS 10 (U.S. CLS. 26, 39 AND 44).

FIRST USE 9-3-2004; IN COMMERCE 9-3-2004.

THE MARK CONSISTS OF STANDARD CHARACTERS WITHOUT CLAIM TO ANY PARTICULAR FONT, STYLE, SIZE, OR COLOR.

NO CLAIM IS MADE TO THE EXCLUSIVE RIGHT TO USE "MIXED CONTRAST", APART FROM THE MARK AS SHOWN.

SER. NO. 77-035,477, FILED 11-2-2006.

GRETTA YAO, EXAMINING ATTORNEY



**Int. Cl.: 12**

**Prior U.S. Cls.: 19, 21, 23, 31, 35 and 44**

**United States Patent and Trademark Office**

**Reg. No. 3,393,955**

**Registered Mar. 11, 2008**

**TRADEMARK  
PRINCIPAL REGISTER**



INFINITE INNOVATIONS, INC. (MISSOURI CORPORATION)  
2881 N. LE COMPTE ROAD  
SPRINGFIELD, MO 658035730

FOR: TRAILER HITCH COUPLERS AND REPLACEMENT PARTS THEREFOR; METAL LOCKING DEVICE FOR TRAILER HITCH COUPLERS; VEHICLE TOWING EQUIPMENT AND STRUCTURAL PARTS THEREOF, NAMELY, HITCH BALLS, BALL MOUNTS, HITCH PINS, SAFETY CHAINS, S HOOKS, NAMELY, HOOKS USED TO ATTACH A SAFETY CHAIN FROM A TRAILER TO THE HITCH OF THE TOWING VEHICLE, AND QUICK LINKS, NAMELY, LINKS USED TO ATTACH A SAFETY CHAIN FROM A TRAILER TO THE HITCH OF THE TOWING VEHICLE; PARTS FOR TRAILERS, NAMELY, SHACKLE STRAPS FOR TRAILER SUSPENSIONS, ELECTRIC BRAKE SHOES, DISK BRAKE PADS, WHEEL BEARING KITS, BEARING PROTECTORS, GREASE CAPS, NAMELY, PROTECTIVE COVERINGS FOR THE CENTER OF A WHEEL TO KEEP DUST AND GRIME OUT OF THE WHEEL BEARINGS, AND PLUGS FOR GREASE CAPS, NAMELY, PLUGS USED TO CLOSE AN OPENING IN A GREASE CAP THROUGH WHICH WHEEL

BEARINGS CAN BE LUBRICATED; PARTS FOR VEHICLE WHEELS, NAMELY, LUG NUTS AND WHEEL BOLTS; SPARE TIRE CARRIERS FOR VEHICLES; CARGO CARRIERS FOR VEHICLES; STRUCTURAL PARTS OF VEHICLES, NAMELY, BED CAPS; SIDE SHIELDS AS STRUCTURAL PARTS OF VEHICLES; LAND VEHICLE ACCESSORIES, NAMELY, ACCENT TRIM; AUTOMOTIVE AND LAND VEHICLE PARTS AND ACCESSORIES, NAMELY, BED MATS AND TAILGATE MATS, IN CLASS 12 (U.S. CLS. 19, 21, 23, 31, 35 AND 44).

FIRST USE 8-4-2005; IN COMMERCE 9-12-2005.

NO CLAIM IS MADE TO THE EXCLUSIVE RIGHT TO USE "PRODUCTS", APART FROM THE MARK AS SHOWN.

THE MARK CONSISTS OF THE STYLIZED WORD URIAH WITH THE WORD PRODUCTS APPEARING ON ONE LEG OF THE CAPITAL R.

SER. NO. 77-035,533, FILED 11-2-2006.

SARA THOMAS, EXAMINING ATTORNEY

**Int. Cls.: 35 and 42**

**Prior U.S. Cls.: 100, 101 and 102**

**United States Patent and Trademark Office**

**Reg. No. 3,393,956**

**Registered Mar. 11, 2008**

**SERVICE MARK  
PRINCIPAL REGISTER**



INVESTIGATIVE REPORTERS AND EDITORS,  
INC. (INDIANA NON-PROFIT CORPORATION)  
MISSOURI SCHOOL OF JOURNALISM  
138 NEFF ANNEX  
COLOMBIA, MO 65211

FOR: ONLINE RETAIL STORE SERVICES FEATURING BOOKS, PERIODICALS, VIDEO AND AUDIO TAPES, CLOTHING AND HANDBAGS; PROVIDING INFORMATION ABOUT GOVERNMENT RECORDS; ASSOCIATION SERVICES, NAMELY, PROMOTING THE INTERESTS OF INVESTIGATIVE JOURNALISM, IN CLASS 35 (U.S. CLS. 100, 101 AND 102).

FIRST USE 11-6-1997; IN COMMERCE 11-6-1997.

FOR: COMPUTER SYSTEMS ANALYSIS, NAMELY, PROVIDING DATABASE ANALYSIS SERVICES, IN CLASS 42 (U.S. CLS. 100 AND 101).

FIRST USE 11-6-1997; IN COMMERCE 11-6-1997.

SER. NO. 77-035,773, FILED 11-2-2006.

LINDSEY RUBIN, EXAMINING ATTORNEY

**Int. Cl.: 24**

**Prior U.S. Cls.: 42 and 50**

**United States Patent and Trademark Office**

**Reg. No. 3,393,957**

**Registered Mar. 11, 2008**

**TRADEMARK  
PRINCIPAL REGISTER**

**LABELS FOR THE STUFF KIDS  
LOSE!**

MABEL'S LABELS INC. (CANADA CORPORATION)  
50 DUNDURN STREET SOUTH  
HAMILTON, CANADA L8P4X4

FOR: CLOTH LABELS, PRINTED TEXTILE LABELS, PRINTED VINYL LABELS, IN CLASS 24 (U.S. CLS. 42 AND 50).

THE MARK CONSISTS OF STANDARD CHARACTERS WITHOUT CLAIM TO ANY PARTICULAR FONT, STYLE, SIZE, OR COLOR.

PRIORITY CLAIMED UNDER SEC. 44(D) ON CANADA APPLICATION NO. 1323375, FILED 11-1-2006, REG. NO. TMA698127, DATED 10-10-2007, EXPIRES 10-10-2022.

SER. NO. 77-036,214, FILED 11-3-2006.

MARGERY A. TIERNEY, EXAMINING ATTORNEY

**Int. Cl.: 31**

**Prior U.S. Cls.: 1 and 46**

**United States Patent and Trademark Office**

**Reg. No. 3,393,958**

**Registered Mar. 11, 2008**

**TRADEMARK  
PRINCIPAL REGISTER**

**CALF CRISPIES**

C.S.D. NUTRITION, LLC (IOWA LTD LIAB CO)  
5101 HARBOR DRIVE, BOX 956  
SIOUX CITY, IA 51111

FOR: ANIMAL FEED, IN CLASS 31 (U.S. CLS. 1  
AND 46).

FIRST USE 10-1-2006; IN COMMERCE 10-1-2006.

THE MARK CONSISTS OF STANDARD CHAR-  
ACTERS WITHOUT CLAIM TO ANY PARTICULAR  
FONT, STYLE, SIZE, OR COLOR.

NO CLAIM IS MADE TO THE EXCLUSIVE  
RIGHT TO USE "CALF", APART FROM THE MARK  
AS SHOWN.

SER. NO. 77-036,374, FILED 11-3-2006.

RAMONA ORTIGA, EXAMINING ATTORNEY

**Int. Cl.: 24**

**Prior U.S. Cls.: 42 and 50**

**United States Patent and Trademark Office**

**Reg. No. 3,393,959**

**Registered Mar. 11, 2008**

**TRADEMARK  
PRINCIPAL REGISTER**

**LILLY GUMDROPS**

LILLY GUMDROPS, INC (CALIFORNIA CORPORATION)

9411 POWER DRIVE

HUNTINGTON BEACH, CA 92646

FOR: BURP CLOTHS AND CHILDREN'S BLANKETS, IN CLASS 24 (U.S. CLS. 42 AND 50).

FIRST USE 7-1-2005; IN COMMERCE 9-1-2005.

THE MARK CONSISTS OF STANDARD CHARACTERS WITHOUT CLAIM TO ANY PARTICULAR FONT, STYLE, SIZE, OR COLOR.

"THE NAME(S), PORTRAIT(S), AND/OR SIGNATURE(S) SHOWN IN THE MARK DOES NOT IDENTIFY A PARTICULAR LIVING INDIVIDUAL."

SER. NO. 77-036,471, FILED 11-3-2006.

LOURDES AYALA, EXAMINING ATTORNEY

**Int. Cl.: 41**

**Prior U.S. Cls.: 100, 101 and 107**

**United States Patent and Trademark Office**

**Reg. No. 3,393,960**

**Registered Mar. 11, 2008**

**SERVICE MARK  
PRINCIPAL REGISTER**

**The Time Travelin' MO-FO's**

BESSER, JOHN (UNITED STATES INDIVIDUAL)  
2182 CLOVE ROAD  
STATEN ISLAND, NY 10305

FOR: ENTERTAINMENT IN THE NATURE OF  
VISUAL AND AUDIO PERFORMANCES, NAMELY,  
MUSICAL BAND, ROCK GROUP, GYMNASTIC,  
DANCE, AND BALLET PERFORMANCES, IN  
CLASS 41 (U.S. CLS. 100, 101 AND 107).

FIRST USE 3-1-1996; IN COMMERCE 3-1-1996.

THE MARK CONSISTS OF STANDARD CHAR-  
ACTERS WITHOUT CLAIM TO ANY PARTICULAR  
FONT, STYLE, SIZE, OR COLOR.

SER. NO. 77-036,517, FILED 11-3-2006.

GEOFFREY FOSDICK, EXAMINING ATTORNEY

**Int. Cl.: 24**

**Prior U.S. Cls.: 42 and 50**

**United States Patent and Trademark Office**

**Reg. No. 3,393,961**

**Registered Mar. 11, 2008**

**TRADEMARK  
PRINCIPAL REGISTER**



LILLY GUMDROPS, INC (CALIFORNIA CORPORATION)  
9411 POWER DRIVE  
HUNTINGTON BEACH, CA 92646

FOR: BURP CLOTHS AND CHILDREN'S BLANKETS, IN CLASS 24 (U.S. CLS. 42 AND 50).

FIRST USE 7-1-2005; IN COMMERCE 9-1-2005.

"THE NAME(S), PORTRAIT(S), AND/OR SIGNATURE(S) SHOWN IN THE MARK DOES NOT IDENTIFY A PARTICULAR LIVING INDIVIDUAL."

THE MARK CONSISTS OF THE WORDS "LILLY GUMDROPS" WITH A FLOWER.

SER. NO. 77-036,557, FILED 11-3-2006.

LOURDES AYALA, EXAMINING ATTORNEY

**Int. Cl.: 42**

**Prior U.S. Cls.: 100 and 101**

**United States Patent and Trademark Office**

**Reg. No. 3,393,962**

**Registered Mar. 11, 2008**

**SERVICE MARK  
PRINCIPAL REGISTER**

**THE BIKER'S LAWYER**

LOBEL, ARTHUR M. (UNITED STATES INDIVIDUAL)

9TH FLOOR

230 S. BROAD STREET

PHILADELPHIA, PA 19102

FOR: LEGAL SERVICES FOR BIKERS AND MOTORCYCLISTS, IN CLASS 42 (U.S. CLS. 100 AND 101).

FIRST USE 12-31-1965; IN COMMERCE 12-31-1965.

THE MARK CONSISTS OF STANDARD CHARACTERS WITHOUT CLAIM TO ANY PARTICULAR FONT, STYLE, SIZE, OR COLOR.

NO CLAIM IS MADE TO THE EXCLUSIVE RIGHT TO USE "LAWYER", APART FROM THE MARK AS SHOWN.

SEC. 2(F).

SER. NO. 77-036,697, FILED 11-3-2006.

SCOTT SISUN, EXAMINING ATTORNEY



**Int. Cl.: 9**

**Prior U.S. Cls.: 21, 23, 26, 36 and 38**

**Reg. No. 3,393,963**

**United States Patent and Trademark Office**

**Registered Mar. 11, 2008**

**TRADEMARK  
PRINCIPAL REGISTER**

**Morbella**

UNION RICH DEVELOPMENT CORPORATION  
(TAIWAN CORPORATION)  
12F-9, NO.41, SEC.1  
JHONGSIAO W. RD., JHONGJHENG DIST.  
TAIPEI, TAIWAN

FOR: TFT-LCD TELEVISIONS; RANDOM ACCESS MEMORY MODULES; FLASH MEMORY HARDWARE, NAMELY, FLASH MEMORY CARDS; FLASH MEMORY CARD READERS; USB FLASH DRIVES TO TRANSFER INFORMATION BETWEEN DEVICES; ELECTRONIC COMPONENTS, NAMELY, USB PEN DRIVES; MEMORY CARDS; VGA CARDS; PLASMA DISPLAY PANELS; COMPUTER CHIPS; CHIP CARD READERS; AND WIRELESS LAN CARDS; SATELLITE NAVIGATIONAL SYSTEM, NAMELY, A GLOBAL POSITIONING SYSTEM (GPS); GLOBAL POSITIONING SYSTEM (GPS) CONSISTING OF COMPUTERS, COMPUTER SOFTWARE, TRANSMITTERS, RECEIVERS, AND NETWORK INTERFACE DEVICES; GPS DATA LOGGER FOR RECORDING TRIPS AND CLASSIFYING THEM INTO DIFFERENT ACCOUNTS; HARDWARE AND SOFTWARE ADAPTER FOR COUPLING A GPS RECEIVER TO THE MICROPHONE INPUT OF A DIGITAL CAMCORDER;

VEHICLE LOCATOR AND RECOVERY DEVICE PROGRAMMED TO USE GLOBAL POSITIONING SYSTEM (GPS) AND CELLULAR TELECOMMUNICATIONS; VEHICLE MOUNTED GPS SENSOR FOR DETERMINING THE RATE OF MOTION FOR A VEHICLE; ANTENNAS FOR GPS RECEIVERS; GPS MODULE; GPS TRACKERS, NAMELY, TRANSCIEVERS FOR GLOBAL SYSTEM MOBILE COMMUNICATIONS AND WIRELESS TELECOMMUNICATIONS SYSTEMS COMPRISING GPRS PROTOCOL RECEIVERS AND TRANSMITTERS, IN CLASS 9 (U.S. CLS. 21, 23, 26, 36 AND 38).

FIRST USE 10-1-2006; IN COMMERCE 10-1-2006.

THE MARK CONSISTS OF THE STYLIZED WORD "MARBELLA" WITH THE FIRST "A" HAVING A TRIANGLE CONTOUR EXTENDING INTO AND ABOVE THE "A" FORMING THE STYLIZATION.

SER. NO. 77-037,226, FILED 11-6-2006.

ROBIN MITTLER, EXAMINING ATTORNEY

**Int. Cls.: 1, 19, 31 and 35**

**Prior U.S. Cls.: 1, 5, 6, 10, 12, 26, 33, 46, 50, 100, 101  
and 102**

**Reg. No. 3,393,964**

**United States Patent and Trademark Office**

**Registered Mar. 11, 2008**

**TRADEMARK  
SERVICE MARK  
PRINCIPAL REGISTER**

**GARICK**

THE GARICK CORPORATION (OHIO CORPORATION)  
13600 BROADWAY AVENUE  
CLEVELAND, OH 44125

FOR: COMPOST; MANURE; PLANTING SOIL; POTTING SOIL; SOIL CONDITIONER FOR HORTICULTURAL, DOMESTIC, AND AGRICULTURAL USE; SOIL AMENDMENTS; GROWING MIX FOR HORTICULTURAL USE; PEAT HUMUS; CALCIUM CARBONATE MIXTURE FOR MARKING ATHLETIC FIELDS; AND CALCINED CLAY FOR USE AS A MOISTURE ABSORBENT FOR ATHLETIC FIELDS, IN CLASS 1 (U.S. CLS. 1, 5, 6, 10, 26 AND 46).

FIRST USE 0-0-1981; IN COMMERCE 0-0-1981.

FOR: LANDSCAPE STONE, NAMELY, LIMESTONE, PEA GRAVEL, SILICA PEBBLES, WHITE MARBLE, BRICK CHIPS, SHALE, AND VOLCANIC ROCK; SAND; LIMESTONE; AND AGGREGATE MATERIAL COMPOSED OF EXPANDED CLAY, MARBLE FINES, LIMESTONE, AND SAND FOR USE IN CONCRETE MASONRY; BASEBALL IN-FIELD MIX, NAMELY, A SAND, SILT, AND CLAY MIXTURE AND A SAND AND CLAY MIXTURE WITH OR WITHOUT A CALCINED CLAY DRYING AGENT, IN CLASS 19 (U.S. CLS. 1, 12, 33 AND 50).

FIRST USE 0-0-1981; IN COMMERCE 0-0-1981.

FOR: MULCH; WOOD FIBER SURFACING, NAMELY, A NATURAL WOOD BY-PRODUCT SPECIFICALLY DEVELOPED FOR USE AS A SAFETY SURFACE ON PLAYGROUNDS; WOOD CHIPS FOR USE AS GROUND COVER; PEAT MOSS; AND TOP SOIL, IN CLASS 31 (U.S. CLS. 1 AND 46).

FIRST USE 0-0-1981; IN COMMERCE 0-0-1981.

FOR: TRANSPORTATION LOGISTICS SERVICES, NAMELY, ARRANGING THE TRANSPORTATION OF GOODS FOR OTHERS; AND INVENTORY MANAGEMENT IN THE FIELD OF TRANSPORTATION OF BULK, BAGGED, AND PALLETIZED GOODS, IN CLASS 35 (U.S. CLS. 100, 101 AND 102).

FIRST USE 9-0-2005; IN COMMERCE 9-0-2005.

THE MARK CONSISTS OF STANDARD CHARACTERS WITHOUT CLAIM TO ANY PARTICULAR FONT, STYLE, SIZE, OR COLOR.

SER. NO. 77-037,860, FILED 11-6-2006.

SHARON MEIER, EXAMINING ATTORNEY

**Int. Cl.: 25**

**Prior U.S. Cls.: 22 and 39**

**United States Patent and Trademark Office**

**Reg. No. 3,393,965**

**Registered Mar. 11, 2008**

**TRADEMARK  
PRINCIPAL REGISTER**

**CURREN**

CURREN, TOM (UNITED STATES INDIVIDUAL)  
C/O KOENIG & ASSOCIATES  
226 EAST CANON PERDIDO ST., SUITE M  
SANTA BARBARA, CA 93101

FOR: CLOTHING, NAMELY, ACTIVEWEAR,  
NAMELY, SHIRTS AND HATS, SPORTSWEAR,  
NAMELY, SHIRTS AND HATS, SURFWEAR,  
NAMELY, SHIRTS AND HATS, AND OTHER  
CLOTHING, NAMELY, HATS, HEADGEAR, NAME-  
LY, BASEBALL CAPS, AND CAPS, HEADWEAR,  
SHIRTS, T-SHIRTS, AND TOPS, IN CLASS 25 (U.S.  
CLS. 22 AND 39).

FIRST USE 10-18-1996; IN COMMERCE 10-18-1996.

THE MARK CONSISTS OF STANDARD CHAR-  
ACTERS WITHOUT CLAIM TO ANY PARTICULAR  
FONT, STYLE, SIZE, OR COLOR.

OWNER OF U.S. REG. NO. 2,190,622.

SEC. 2(F).

SER. NO. 77-038,074, FILED 11-6-2006.

YAT SYE, LEE, EXAMINING ATTORNEY

**Int. Cl.: 9**

**Prior U.S. Cls.: 21, 23, 26, 36 and 38**

**United States Patent and Trademark Office**

**Reg. No. 3,393,966**

**Registered Mar. 11, 2008**

**TRADEMARK  
PRINCIPAL REGISTER**

**TELL-R-TV**

HAMILTON SAFE COMPANY (OHIO CORPORATION)  
3143 PRODUCTION DRIVE  
FAIRFIELD, OH 45014

FOR: AUDIO VISUAL COMMUNICATION SYSTEM CONSISTING OF A VIDEO DISPLAY, CAMERA AND AUDIO CONSOLE, IN CLASS 9 (U.S. CLS. 21, 23, 26, 36 AND 38).

FIRST USE 9-0-1994; IN COMMERCE 9-0-1994.

THE MARK CONSISTS OF STANDARD CHARACTERS WITHOUT CLAIM TO ANY PARTICULAR FONT, STYLE, SIZE, OR COLOR.

SER. NO. 77-038,192, FILED 11-7-2006.

LINDA ESTRADA, EXAMINING ATTORNEY

**Int. Cl.: 36**

**Prior U.S. Cls.: 100, 101 and 102**

**United States Patent and Trademark Office**

**Reg. No. 3,393,967**

**Registered Mar. 11, 2008**

**SERVICE MARK  
PRINCIPAL REGISTER**

**FIRST INDEPENDENT**

FIRST INDEPENDENT BANK (WASHINGTON CORPORATION)  
P.O. BOX 89094  
VANCOUVER, WA 98684

FOR: BANKING SERVICES; MORTGAGE SERVICES, NAMELY, COMMERCIAL AND RESIDENTIAL REAL ESTATE LENDING AND HOME EQUITY LOAN SERVICES; FINANCIAL SERVICES, NAMELY, FINANCIAL PLANNING SERVICES, RETIREMENT PLANNING SERVICES, TRUST AND INVESTMENT SERVICES AND ASSET MANAGEMENT SERVICES, IN CLASS 36 (U.S. CLS. 100, 101 AND 102).

FIRST USE 9-19-2006; IN COMMERCE 9-24-2006.

THE MARK CONSISTS OF STANDARD CHARACTERS WITHOUT CLAIM TO ANY PARTICULAR FONT, STYLE, SIZE, OR COLOR.

OWNER OF U.S. REG. NOS. 2,915,635, 3,025,063 AND OTHERS.

SEC. 2(F).

SER. NO. 77-038,316, FILED 11-7-2006.

JULIE WATSON, EXAMINING ATTORNEY

**Int. Cl.: 9**

**Prior U.S. Cls.: 21, 23, 26, 36 and 38**

**United States Patent and Trademark Office**

**Reg. No. 3,393,968**

**Registered Mar. 11, 2008**

**TRADEMARK  
PRINCIPAL REGISTER**

# HealthMap

GARNER, STEVEN D. (UNITED STATES INDIVIDUAL)  
2414 BAYOU DRIVE  
LEAGUE CITY, TX 77573

FOR: COMPUTER SOFTWARE FEATURING A DATABASE OF VETERINARY MEDICAL INFORMATION AND INTELLIGENTLY DESIGNED COMPUTER REPORTS TO ENABLE THE EDITING, ORGANIZING, MODIFYING, TRANSMISSION, STORAGE AND SHARING OF THE VETERINARY MEDICAL INFORMATION, DATA AND KNOWLEDGE, IN CLASS 9 (U.S. CLS. 21, 23, 26, 36 AND 38).

FIRST USE 9-1-2002; IN COMMERCE 9-1-2002.

THE MARK CONSISTS OF STANDARD CHARACTERS WITHOUT CLAIM TO ANY PARTICULAR FONT, STYLE, SIZE, OR COLOR.

SER. NO. 77-038,448, FILED 11-7-2006.

KATHERINE CHANG, EXAMINING ATTORNEY

**Int. Cl.: 30**

**Prior U.S. Cl.: 46**

**United States Patent and Trademark Office**

**Reg. No. 3,393,969**

**Registered Mar. 11, 2008**

**TRADEMARK  
PRINCIPAL REGISTER**

**WOLFE'S BAGELS**

WOLFBROTHERS BAKERY COMPANY, LLC  
(NEW MEXICO LTD LIAB CO)  
6241 MONTGOMERY BLVD NE  
ALBUQUERQUE, NM 871091414

NO CLAIM IS MADE TO THE EXCLUSIVE  
RIGHT TO USE "BAGELS", APART FROM THE  
MARK AS SHOWN.

FOR: BAGELS, IN CLASS 30 (U.S. CL. 46).

SEC. 2(F).

FIRST USE 8-1-1992; IN COMMERCE 8-1-1992.

SER. NO. 77-038,570, FILED 11-7-2006.

THE MARK CONSISTS OF STANDARD CHAR-  
ACTERS WITHOUT CLAIM TO ANY PARTICULAR  
FONT, STYLE, SIZE, OR COLOR.

KATHLEEN LORENZO, EXAMINING ATTORNEY

**Int. Cl.: 35**

**Prior U.S. Cls.: 100, 101 and 102**

**United States Patent and Trademark Office**

**Reg. No. 3,393,970**

**Registered Mar. 11, 2008**

**SERVICE MARK  
PRINCIPAL REGISTER**

**WOLFE'S BAGELS**

WOLFBROTHERS BAKERY COMPANY, LLC  
(NEW MEXICO LTD LIAB CO)  
6241 MONTGOMERY BLVD., NE  
ALBUQUERQUE, NM 91436

NO CLAIM IS MADE TO THE EXCLUSIVE  
RIGHT TO USE "BAGELS", APART FROM THE  
MARK AS SHOWN.

FOR: RETAIL STORES FEATURING BAGELS;  
WHOLESALE DISTRIBUTORSHIPS FEATURING  
BAGELS, IN CLASS 35 (U.S. CLS. 100, 101 AND 102).

SEC. 2(F).

FIRST USE 8-1-1992; IN COMMERCE 8-1-1992.

SER. NO. 77-038,630, FILED 11-7-2006.

THE MARK CONSISTS OF STANDARD CHAR-  
ACTERS WITHOUT CLAIM TO ANY PARTICULAR  
FONT, STYLE, SIZE, OR COLOR.

KATHLEEN LORENZO, EXAMINING ATTORNEY



**Int. Cls.: 36 and 45**

**Prior U.S. Cls.: 100, 101 and 102**

**United States Patent and Trademark Office**

**Reg. No. 3,393,971**

**Registered Mar. 11, 2008**

**SERVICE MARK  
PRINCIPAL REGISTER**

**ASPENWEALTH FIDUCIARY  
SERVICES**

CSD CAPITAL, LLC (DELAWARE LTD LIAB CO)  
9100 COLLEGE POINTE COURT  
C/O SHEPPARD, BRETT, STEWART, ET AL.  
FT. MEYERS, FL 33919

FOR: ADVISORY AND CONSULTING SERVICES  
IN THE FIELDS OF ASSET PROTECTION AND  
WEALTH MANAGEMENT; FIDUCIARY REPRESENTATIVES,  
NAMELY, FIDUCIARY TRUSTEE AND MANAGEMENT  
SERVICES TO BUSINESSES, IN CLASS 36 (U.S. CLS.  
100, 101 AND 102).

FIRST USE 1-3-2006; IN COMMERCE 1-3-2006.

FOR: ADVISORY AND CONSULTING SERVICES  
IN THE FIELD OF PRIVACY LAWS, REGULA-

TIONS, AND REQUIREMENTS, IN CLASS 45 (U.S.  
CLS. 100 AND 101).

FIRST USE 1-3-2006; IN COMMERCE 1-3-2006.

THE MARK CONSISTS OF STANDARD CHARACTERS  
WITHOUT CLAIM TO ANY PARTICULAR FONT, STYLE,  
SIZE, OR COLOR.

NO CLAIM IS MADE TO THE EXCLUSIVE RIGHT TO  
USE "FIDUCIARY SERVICES", APART FROM THE MARK  
AS SHOWN.

SER. NO. 77-038,644, FILED 11-7-2006.

TASNEEM HUSSAIN, EXAMINING ATTORNEY

**Int. Cls.: 35 and 42**

**Prior U.S. Cls.: 100, 101 and 102**

**United States Patent and Trademark Office**

**Reg. No. 3,393,972**

**Registered Mar. 11, 2008**

**SERVICE MARK  
PRINCIPAL REGISTER**

# MONITOR

MONITOR PREMIUMS, LLC (VERMONT LTD  
LIAB CO)  
431 PINE STREET  
BURLINGTON, VT 05401

FOR: ELECTRONIC CATALOG SERVICES AND CATALOG ORDERING SERVICES IN THE FIELD OF PROMOTIONAL PRODUCTS AND GIFTS IMPRINTED WITH THIRD PARTY LOGOS FOR USE OR DISTRIBUTION BY OTHERS; DISTRIBUTORSHIP SERVICES IN THE FIELD OF PROMOTIONAL PRODUCTS AND GIFTS IMPRINTED WITH THIRD PARTY LOGOS FOR USE OR DISTRIBUTION BY OTHERS; ORDER FULFILLMENT SERVICES IN THE FIELD OF PROMOTIONAL PRODUCTS AND GIFTS IMPRINTED WITH THIRD PARTY LOGOS FOR USE OR DISTRIBUTION BY OTHERS, IN CLASS 35 (U.S. CLS. 100, 101 AND 102).

FIRST USE 10-14-2004; IN COMMERCE 10-14-2004.

FOR: DESIGN FOR OTHERS IN THE FIELD OF PROMOTIONAL PRODUCTS AND PROMOTIONAL GIFTS IMPRINTED WITH THIRD PARTY LOGOS , IN CLASS 42 (U.S. CLS. 100 AND 101).

FIRST USE 10-14-2004; IN COMMERCE 10-14-2004.

THE MARK CONSISTS OF STANDARD CHARACTERS WITHOUT CLAIM TO ANY PARTICULAR FONT, STYLE, SIZE, OR COLOR.

SER. NO. 77-039,362, FILED 11-8-2006.

KATHLEEN LORENZO, EXAMINING ATTORNEY

**Int. Cl.: 42**

**Prior U.S. Cls.: 100 and 101**

**United States Patent and Trademark Office**

**Reg. No. 3,393,973**

**Registered Mar. 11, 2008**

**SERVICE MARK  
PRINCIPAL REGISTER**

**GLOBALIST**

GLOBALIST INTERNET TECHNOLOGIES, INC.  
(CALIFORNIA CORPORATION)  
16029 EAST ARROW HIGHWAY SUITE H  
IRWINDALE, CA 91706

FOR: DESIGNING, DEVELOPING AND HOSTING WEB SITES FOR OTHERS ON A GLOBAL COMPUTER NETWORK; PROVIDING E-MAIL AND SPAM FILTERING SERVICES; PROVIDING LEGAL SERVICES RELATED TO THE REGISTRATION OF COPYRIGHTS WITH THE FEDERAL GOVERNMENT USING ONLINE MEANS, IN CLASS 42 (U.S. CLS. 100 AND 101).

FIRST USE 11-16-1995; IN COMMERCE 12-31-1995.

THE MARK CONSISTS OF STANDARD CHARACTERS WITHOUT CLAIM TO ANY PARTICULAR FONT, STYLE, SIZE, OR COLOR.

SER. NO. 77-039,930, FILED 11-8-2006.

CARRIE GENOVESE, EXAMINING ATTORNEY

**Int. Cl.: 35**

**Prior U.S. Cls.: 100, 101 and 102**

**United States Patent and Trademark Office**

**Reg. No. 3,393,974**

**Registered Mar. 11, 2008**

**SERVICE MARK  
PRINCIPAL REGISTER**

**SWAN TILE & CABINETS**

SWIFT CORP. (NEW YORK CORPORATION)  
32-15 COLLEGE POINT BLVD  
FLUSHING, NY 11354

FOR: RETAIL STORES FEATURING KITCHEN  
AND BATH CABINETRY, APPLIANCES, FIX-  
TURES, COUNTERTOPS AND TILE, LIVING  
ROOM, HOME OFFICE, AND BEDROOM FURNI-  
TURE AND CABINETRY, IN CLASS 35 (U.S. CLS.  
100, 101 AND 102).

FIRST USE 5-22-2000; IN COMMERCE 5-22-2000.

THE MARK CONSISTS OF STANDARD CHAR-  
ACTERS WITHOUT CLAIM TO ANY PARTICULAR  
FONT, STYLE, SIZE, OR COLOR.

NO CLAIM IS MADE TO THE EXCLUSIVE  
RIGHT TO USE "TILE & CABINETS", APART FROM  
THE MARK AS SHOWN.

SER. NO. 77-039,946, FILED 11-8-2006.

AMOS T. MATTHEWS, JR., EXAMINING ATTOR-  
NEY

**Int. Cl.: 45**

**Prior U.S. Cls.: 100 and 101**

**United States Patent and Trademark Office**

**Reg. No. 3,393,975**

**Registered Mar. 11, 2008**

**SERVICE MARK  
PRINCIPAL REGISTER**



SECURITYHUNTER, INC. (MARYLAND CORPORATION)  
2622-L LORD BALTIMORE DRIVE  
BALTIMORE, MD 21244

THE MARK CONSISTS OF THE NAME SECURITYHUNTER WITH A TARGET SCOPE DESIGN.

FOR: CONSULTING SERVICES IN THE FIELD OF BUILDING, FACILITY AND PREMISES SECURITY, IN CLASS 45 (U.S. CLS. 100 AND 101).

SER. NO. 77-040,355, FILED 11-9-2006.

FIRST USE 4-1-2006; IN COMMERCE 4-1-2006.

PAUL CROWLEY, EXAMINING ATTORNEY

**Int. Cl.: 9**

**Prior U.S. Cls.: 21, 23, 26, 36 and 38**

**United States Patent and Trademark Office**

**Reg. No. 3,393,976**

**Registered Mar. 11, 2008**

**TRADEMARK  
PRINCIPAL REGISTER**

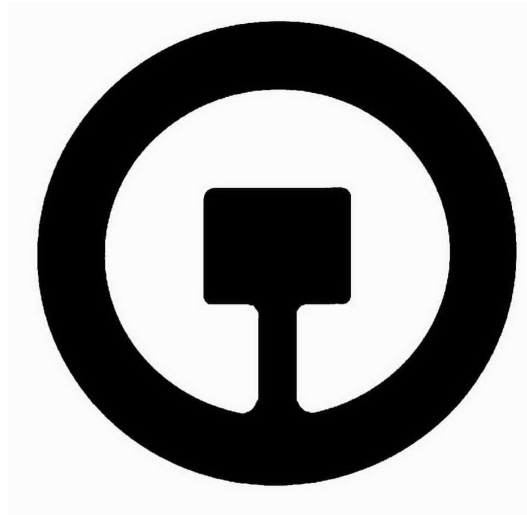

EMENUBOARD SYSTEMS LLC (NEW YORK  
LTD LIAB CO)  
SUITE 5H  
113-14 72ND ROAD  
FOREST HILLS, NY 11375

THE MARK CONSISTS OF A REPRESENTATION  
OF A RECTANGULAR BOARD ON A PEDESTAL  
INSIDE OF A CIRCLE.

FOR: INTERACTIVE ELECTRONIC TOUCH-  
SCREEN MENU AND INFORMATIONAL DISPLAY,  
IN CLASS 9 (U.S. CLS. 21, 23, 26, 36 AND 38).

SER. NO. 77-040,599, FILED 11-9-2006.

FIRST USE 9-0-2006; IN COMMERCE 9-0-2006.

KENNETH E. SHARPERSON, EXAMINING ATTOR-  
NEY

**Int. Cls.: 35 and 44**

**Prior U.S. Cls.: 100, 101 and 102**

**United States Patent and Trademark Office**

**Reg. No. 3,393,977**

**Registered Mar. 11, 2008**

**SERVICE MARK  
PRINCIPAL REGISTER**



APS HEALTHCARE BETHESDA, INC. (IOWA CORPORATION)  
SUITE 1600  
8403 COLESVILLE ROAD  
SILVER SPRING, MD 20910

FOR: PROVIDING EMPLOYEE ASSISTANCE PROGRAMS IN THE NATURE OF REFERRALS FOR BEHAVIORAL HEALTH COUNSELING AND REFERRALS FOR LEGAL RESOURCES AND SERVICES, IN CLASS 35 (U.S. CLS. 100, 101 AND 102).

FIRST USE 8-31-2006; IN COMMERCE 8-31-2006.

FOR: HEALTH CARE, NAMELY, DISEASE MANAGEMENT PROGRAMS AND HEALTH AND WELLNESS PROGRAMS; PROVIDING HEALTHCARE, MANAGED HEALTHCARE AND PREVENTIVE HEALTHCARE SERVICES; PROVIDING INFORMATION ABOUT HEALTHCARE; PROVIDING EMPLOYEE ASSISTANCE PROGRAMS IN THE NATURE OF BEHAVIORAL HEALTH COUNSELING, MANAGED BEHAVIORAL HEALTHCARE PROGRAMS AND BEHAVIORAL HEALTH WORK-LIFE PROGRAMS FOR EMPLOYERS, EMPLOYEES, GROUP MEMBERS, AND CONSUMERS; PROVIDING ON-LINE PSYCHOLOGICAL CONSULTATION AND TESTING SERVICES IN THE NATURE OF INTERACTIVE, ON-LINE SELF-ASSESSMENT,

AND SELF-HELP EVALUATION SERVICES, IN CLASS 44 (U.S. CLS. 100 AND 101).

FIRST USE 8-31-2006; IN COMMERCE 8-31-2006.

OWNER OF U.S. REG. NOS. 2,800,710, 2,998,524, AND 2,998,525.

NO CLAIM IS MADE TO THE EXCLUSIVE RIGHT TO USE HEALTHCARE, APART FROM THE MARK AS SHOWN.

THE COLOR(S) BLUE AND GRAY IS/ARE CLAIMED AS A FEATURE OF THE MARK.

THE COLOR BLUE APPEARS IN THE WORDING APS HEALTHCARE AND IN ONE OF THE CURVED FEATURES OF THE DESIGN; THE COLOR GRAY APPEARS IN THE WORDING HEALTHY TOGETHER AND IN ONE OF THE CURVED FEATURES OF THE DESIGN.

SER. NO. 77-040,863, FILED 11-9-2006.

CAROL SPILS, EXAMINING ATTORNEY

**Int. Cls.: 14, 25 and 35**

**Prior U.S. Cls.: 2, 22, 27, 28, 39, 50, 100, 101 and 102**

**United States Patent and Trademark Office**

**Reg. No. 3,393,978**

**Registered Mar. 11, 2008**

**TRADEMARK  
SERVICE MARK  
PRINCIPAL REGISTER**

edge of urge

EDGE OF URGE, INC. (NORTH CAROLINA CORPORATION)  
SUITE 4  
18 SOUTH WATER STREET  
WILMINGTON, NC 28401

FOR: JEWELRY, IN CLASS 14 (U.S. CLS. 2, 27, 28 AND 50).

FIRST USE 7-1-2002; IN COMMERCE 7-1-2002.

FOR: CLOTHING, NAMELY, WOMEN'S DRESSES; SKIRTS; WEDDING DRESSES; PROM DRESSES; BLOUSES; T-SHIRTS; TANK TOPS; PANTS; SLACKS; YOGA WEAR, NAMELY, YOGA PANTS, YOGA TANK TOPS, YOGA SHIRTS, YOGA LEG WARMERS AND YOGA TIGHTS; SWIM WEAR; KNITTED AND SILK SCARVES; HEAD WRAPS, NAMELY, HEAD SCARVES, KNITTED HEADBANDS, DO-RAGS, KERCHIEFS, BANDANNAS, AND TOBOGGAN HATS; ARM WARMERS;

SHAWLS; MEN'S T-SHIRTS; MEN'S SHIRTS; AND MEN'S SCARVES, IN CLASS 25 (U.S. CLS. 22 AND 39).

FIRST USE 7-1-2002; IN COMMERCE 7-1-2002.

FOR: RETAIL CLOTHING BOUTIQUES; ONLINE RETAIL STORE SERVICES FEATURING CLOTHING AND JEWELRY, IN CLASS 35 (U.S. CLS. 100, 101 AND 102).

FIRST USE 7-1-2002; IN COMMERCE 7-1-2002.

THE MARK CONSISTS OF STANDARD CHARACTERS WITHOUT CLAIM TO ANY PARTICULAR FONT, STYLE, SIZE, OR COLOR.

SER. NO. 77-041,247, FILED 11-10-2006.

WENDY GOODMAN, EXAMINING ATTORNEY



**Int. Cl.: 9**

**Prior U.S. Cls.: 21, 23, 26, 36 and 38**

**Reg. No. 3,393,979**

**United States Patent and Trademark Office**

**Registered Mar. 11, 2008**

---

**TRADEMARK  
PRINCIPAL REGISTER**

**ACS5000**

BRIVO SYSTEMS, LLC (DELAWARE LTD LIAB  
CO)  
4350 EAST-WEST HIGHWAY, SUITE 201  
BETHESDA, MD 20814

FOR: COMPUTER HARDWARE; COMPUTER  
SOFTWARE FOR MONITORING, PROVIDING  
AND RESTRICTING ACCESS TO ELECTRONICAL-  
LY MONITORED AND SECURED ENCLOSURES;  
COMPUTER SOFTWARE FOR TRANSMISSION OF  
DATE AND INFORMATION OF SYSTEM EVENTS,  
IN CLASS 9 (U.S. CLS. 21, 23, 26, 36 AND 38).

FIRST USE 7-1-2005; IN COMMERCE 7-1-2005.

THE MARK CONSISTS OF STANDARD CHAR-  
ACTERS WITHOUT CLAIM TO ANY PARTICULAR  
FONT, STYLE, SIZE, OR COLOR.

SER. NO. 77-041,303, FILED 11-10-2006.

CHARLOTTE CORWIN, EXAMINING ATTORNEY

**Int. Cl.: 11**

**Prior U.S. Cls.: 13, 21, 23, 31 and 34**

**Reg. No. 3,393,980**

**United States Patent and Trademark Office**

**Registered Mar. 11, 2008**

**TRADEMARK  
PRINCIPAL REGISTER**

**AVIVE Performance Panels**

AVIVE TECHNOLOGIES, LLC (DELAWARE LTD  
LIAB CO)  
8 WHEATLEY AVENUE  
ALBERTSON, NY 11507

FOR: REFRIGERATION EQUIPMENT, NAMELY,  
PANELS COMPOSED OF A NATURAL OCCUR-  
RING MINERAL THAT ABSORBS EXCESS HUMID-  
ITY AND ETHYLENE GAS PRODUCED BY FRUITS  
AND VEGETABLES, THEREBY INCREASING PRO-  
DUCE LONGEVITY AND SAVING ELECTRICITY  
BY REDUCING COMPRESSOR RUN RATES, IN  
CLASS 11 (U.S. CLS. 13, 21, 23, 31 AND 34).

FIRST USE 10-30-2006; IN COMMERCE 10-30-2006.

THE MARK CONSISTS OF STANDARD CHAR-  
ACTERS WITHOUT CLAIM TO ANY PARTICULAR  
FONT, STYLE, SIZE, OR COLOR.

NO CLAIM IS MADE TO THE EXCLUSIVE  
RIGHT TO USE "PERFORMANCE PANELS",  
APART FROM THE MARK AS SHOWN.

SER. NO. 77-041,651, FILED 11-10-2006.

KEVON CHISOLM, EXAMINING ATTORNEY

**Int. Cls.: 9 and 36**

**Prior U.S. Cls.: 21, 23, 26, 36, 38, 100, 101 and 102**

**United States Patent and Trademark Office**

**Reg. No. 3,393,981**

**Registered Mar. 11, 2008**

**TRADEMARK  
SERVICE MARK  
PRINCIPAL REGISTER**

# Building Wealth for Generations

THE ASPEN EQUITY GROUP, INC. (COLORADO CORPORATION)  
2000 S. 1ST ST., STE 1311  
WACO, TX 76706

FOR: COMPUTER HARDWARE AND COMPUTER SOFTWARE PROGRAMS FOR THE INTEGRATION OF TEXT, AUDIO, GRAPHICS, STILL IMAGE AND MOVING PICTURES INTO AN INTERACTIVE DELIVERY FOR MULTIMEDIA APPLICATIONS; COMPUTER SOFTWARE FOR THE COLLECTION, EDITING, ORGANIZING, MODIFYING, BOOK MARKING, TRANSMISSION, STORAGE AND SHARING OF DATA AND INFORMATION; COMPUTER SOFTWARE FOR USE IN CUSTOMER RELATIONSHIP MANAGEMENT (CRM); COMPUTER SOFTWARE PLATFORMS FOR USE IN COMMUNICATION, DISTRIBUTION AND COLLABORATION BETWEEN THE ADVISOR/CONSULTANT AND CLIENT/CUSTOMER WITHIN THE FINANCIAL SERVICES INDUSTRY; COMPUTER SOFTWARE THAT PROVIDES REAL-TIME, INTEGRATED BUSINESS MANAGEMENT INTELLIGENCE BY COMBINING INFORMATION FROM VARIOUS DATABASES AND PRESENTING IT IN AN EASY-TO-UNDERSTAND USER INTERFACE, IN CLASS 9 (U.S. CLS. 21, 23, 26, 36 AND 38).

FIRST USE 0-0-1998; IN COMMERCE 0-0-1998.

FOR: FINANCIAL ANALYSIS AND CONSULTATION; FINANCIAL CONSULTATION; FINANCIAL INFORMATION PROVIDED BY ELECTRONIC MEANS; FINANCIAL MANAGEMENT; FINANCIAL PLANNING; FINANCIAL PLANNING CONSULTATION; FINANCIAL PLANNING, NAMELY, THE CREATION OF PERSONALIZED STRATEGIES TO ACHIEVE FINANCIAL INDEPENDENCE; FINANCIAL PORTFOLIO MANAGEMENT; FINANCIAL RESEARCH, IN CLASS 36 (U.S. CLS. 100, 101 AND 102).

FIRST USE 0-0-1998; IN COMMERCE 0-0-1998.

THE MARK CONSISTS OF STANDARD CHARACTERS WITHOUT CLAIM TO ANY PARTICULAR FONT, STYLE, SIZE, OR COLOR.

SER. NO. 77-041,741, FILED 11-10-2006.

RICHARD WHITE, EXAMINING ATTORNEY

**Int. Cl.: 9**

**Prior U.S. Cls.: 21, 23, 26, 36 and 38**

**Reg. No. 3,393,982**

**United States Patent and Trademark Office**

**Registered Mar. 11, 2008**

**TRADEMARK  
PRINCIPAL REGISTER**

**EAGLE**

ACTIVANT SOLUTIONS INC. (DELAWARE CORPORATION)  
7683 SOUTHFRONT ROAD  
LIVERMORE, CA 94551

FOR: COMPUTER SOFTWARE FOR BUSINESS MANAGEMENT, NAMELY, SOFTWARE CONTAINING PROGRAMS FOR INVENTORY MANAGEMENT, TRACKING USAGE AND PRICE DATA, POINT OF SALE PROCESSING, ORDER ENTRY, MANAGEMENT OF PURCHASING AND RECEIVING RECORDS, DOCUMENT MANAGEMENT, MANAGEMENT OF EQUIPMENT RENTAL OPERATIONS; COMPUTER SOFTWARE FOR THE PRODUCTION OF AND AUTOMATED MAINTENANCE OF SALES CATALOGS; COMPUTER SOFTWARE FOR THE INTEGRATION AND MANAGEMENT OF SALES RECORDS, BILLING

AND CUSTOMER ACCOUNTS, VENDOR PAYMENTS; ACCOUNTS PAYABLE AND ACCOUNTS RECEIVABLE SOFTWARE AND INSTRUCTION MANUALS PROVIDED AS A UNIT THEREWITH, IN CLASS 9 (U.S. CLS. 21, 23, 26, 36 AND 38).

FIRST USE 5-1-1991; IN COMMERCE 5-1-1991.

THE MARK CONSISTS OF STANDARD CHARACTERS WITHOUT CLAIM TO ANY PARTICULAR FONT, STYLE, SIZE, OR COLOR.

SER. NO. 77-041,916, FILED 11-10-2006.

KATHERINE CONNOLLY, EXAMINING ATTORNEY

**Int. Cl.: 42**

**Prior U.S. Cls.: 100 and 101**

**United States Patent and Trademark Office**

**Reg. No. 3,393,983**

**Registered Mar. 11, 2008**

**SERVICE MARK  
PRINCIPAL REGISTER**

**SXIP**

SXIP NETWORKS SRL (BARBADOS CORPORATION)  
#101 LAURISTON HOUSE LWR COLLYMORE  
ROCK  
ST. MICHAEL, BARBADOS

FOR: COMPUTER SECURITY SERVICE, NAME-  
LY, RESTRICTING ACCESS TO AND BY COMPU-  
TER NETWORKS TO AND OF UNDESIRE WEB  
SITES, MEDIA AND INDIVIDUALS AND FACIL-  
ITIES; COMPUTER SERVICE, NAMELY, ACTING  
AS AN APPLICATION SERVICE PROVIDER IN THE  
FIELD OF KNOWLEDGE MANAGEMENT TO  
HOST COMPUTER APPLICATION SOFTWARE  
FOR THE COLLECTION, EDITING, ORGANIZING,  
MODIFYING, BOOK MARKING, TRANSMISSION,  
STORAGE AND SHARING OF DATA AND INFOR-  
MATION; COMPUTER SERVICES, NAMELY, MON-  
ITORING, TESTING, ANALYZING, AND  
REPORTING ON THE INTERNET TRAFFIC CON-  
TROL AND CONTENT CONTROL OF THE WEB-  
SITES OF OTHERS; COMPUTER SERVICES,  
NAMELY, FILTERING OF UNWANTED E-MAILS;  
COMPUTER SERVICES, NAMELY, REMOTE AND  
ON-SITE MANAGEMENT OF ELECTRONIC MES-  
SAGING SYSTEMS AND APPLICATIONS FOR OTH-  
ERS; COMPUTER SOFTWARE CONSULTATION;

COMPUTER SOFTWARE DESIGN FOR OTHERS;  
COMPUTER SOFTWARE DESIGN, COMPUTER  
PROGRAMMING, OR MAINTENANCE OF COM-  
PUTER SOFTWARE; COMPUTER SOFTWARE DE-  
VELOPMENT; COMPUTER SYSTEMS ANALYSIS;  
CONSULTATION SERVICES IN THE FIELDS OF  
SELECTION, IMPLEMENTATION AND USE OF  
COMPUTER HARDWARE AND SOFTWARE SYS-  
TEMS FOR OTHERS; CONSULTING SERVICES IN  
THE FIELD OF DESIGN, SELECTION, IMPLEMEN-  
TATION AND USE OF COMPUTER HARDWARE  
AND SOFTWARE SYSTEMS FOR OTHERS, IN  
CLASS 42 (U.S. CLS. 100 AND 101).

FIRST USE 7-28-2003; IN COMMERCE 5-27-2005.

THE MARK CONSISTS OF STANDARD CHAR-  
ACTERS WITHOUT CLAIM TO ANY PARTICULAR  
FONT, STYLE, SIZE, OR COLOR.

OWNER OF U.S. REG. NO. 3,142,899.

SER. NO. 77-041,923, FILED 11-10-2006.

DEBRA LEE, EXAMINING ATTORNEY

**Int. Cl.: 35**

**Prior U.S. Cls.: 100, 101 and 102**

**United States Patent and Trademark Office**

**Reg. No. 3,393,984**

**Registered Mar. 11, 2008**

**SERVICE MARK  
PRINCIPAL REGISTER**

**BUSINESS OF FASHION**

MEN'S APPAREL GUILD IN CALIFORNIA, INC.  
(CALIFORNIA CORPORATION)  
131 WEST FIRST STREET  
DULUTH, MN 55802

FOR: ARRANGING AND CONDUCTING TRADE  
SHOW EXHIBITIONS IN THE FIELD OF CLOTH-  
ING AND APPAREL ACCESSORIES, IN CLASS 35  
(U.S. CLS. 100, 101 AND 102).

FIRST USE 8-15-1998; IN COMMERCE 8-15-1998.

THE MARK CONSISTS OF STANDARD CHAR-  
ACTERS WITHOUT CLAIM TO ANY PARTICULAR  
FONT, STYLE, SIZE, OR COLOR.

OWNER OF U.S. REG. NO. 2,499,225.

SEC. 2(F).

SER. NO. 77-042,233, FILED 11-13-2006.

MARILYN IZZI, EXAMINING ATTORNEY

**Int. Cls.: 35 and 41**

**Prior U.S. Cls.: 100, 101, 102 and 107**

**United States Patent and Trademark Office**

**Reg. No. 3,393,985**

**Registered Mar. 11, 2008**

**SERVICE MARK  
PRINCIPAL REGISTER**

**ILLINOIS HEALTH CARE  
ASSOCIATION**

ILLINOIS HEALTH CARE ASSOCIATION (ILLINOIS CORPORATION)  
1029 SOUTH FOURTH STREET  
SPRINGFIELD, IL 627032224

FOR: ASSOCIATION SERVICES, NAMELY, PROMOTING THE INTERESTS OF HEALTH CARE PROVIDERS, IN CLASS 35 (U.S. CLS. 100, 101 AND 102).

FIRST USE 4-10-1975; IN COMMERCE 4-10-1975.

FOR: EDUCATION SERVICES, NAMELY, PROVIDING CLASSES, SEMINARS, WORKSHOPS IN THE FIELD OF HEALTH CARE, IN CLASS 41 (U.S. CLS. 100, 101 AND 107).

FIRST USE 4-10-1975; IN COMMERCE 4-10-1975.

THE MARK CONSISTS OF STANDARD CHARACTERS WITHOUT CLAIM TO ANY PARTICULAR FONT, STYLE, SIZE, OR COLOR.

NO CLAIM IS MADE TO THE EXCLUSIVE RIGHT TO USE "HEALTH CARE ASSOCIATION", APART FROM THE MARK AS SHOWN.

SEC. 2(F).

SER. NO. 77-042,709, FILED 11-13-2006.

JENNIFER VASQUEZ, EXAMINING ATTORNEY

**Int. Cl.: 16**

**Prior U.S. Cls.: 2, 5, 22, 23, 29, 37, 38 and 50**

**United States Patent and Trademark Office**

**Reg. No. 3,393,986**

**Registered Mar. 11, 2008**

**TRADEMARK  
PRINCIPAL REGISTER**

**Your Way Right Away**

HEALTH CARE LOGISTICS, INC. (OHIO CORPORATION)  
450 EAST TOWN STREET  
CIRCLEVILLE, OH 43113

THE MARK CONSISTS OF STANDARD CHARACTERS WITHOUT CLAIM TO ANY PARTICULAR FONT, STYLE, SIZE, OR COLOR.

FOR: CATALOGS IN THE FIELD OF SALES OF PROFESSIONAL GIFTS, IN CLASS 16 (U.S. CLS. 2, 5, 22, 23, 29, 37, 38 AND 50).

SER. NO. 77-043,218, FILED 11-14-2006.

FIRST USE 10-15-2006; IN COMMERCE 10-15-2006.

KIM SAITO, EXAMINING ATTORNEY



**Int. Cl.: 19**

**Prior U.S. Cls.: 1, 12, 33 and 50**

**United States Patent and Trademark Office**

**Reg. No. 3,393,987**

**Registered Mar. 11, 2008**

**TRADEMARK  
PRINCIPAL REGISTER**

**FASWALL**

K-X FASWALL INTERN. CORP. (GEORGIA CORPORATION)  
571 OAK RIDGE CLUB RD.  
HANS WALTER, PRESIDENT  
WINDSOR, SC 29856

FOR: INSULATING FORMS MADE OF A WOOD-CONCRETE MIXTURE FOR USE IN CASTING CONCRETE, IN CLASS 19 (U.S. CLS. 1, 12, 33 AND 50).

FIRST USE 5-15-1988; IN COMMERCE 6-16-1988.

THE MARK CONSISTS OF STANDARD CHARACTERS WITHOUT CLAIM TO ANY PARTICULAR FONT, STYLE, SIZE, OR COLOR.

SER. NO. 77-043,283, FILED 11-14-2006.

PAUL E. FAHRENKOPF, EXAMINING ATTORNEY

**Int. Cl.: 7**

**Prior U.S. Cls.: 13, 19, 21, 23, 31, 34 and 35**

**United States Patent and Trademark Office**

**Reg. No. 3,393,988**

**Registered Mar. 11, 2008**

**TRADEMARK  
PRINCIPAL REGISTER**

**ORCHID**

AMERICAN DYE SOURCE, INC. (CANADA  
CORPORATION)  
555, MORGAN BLVD.  
BAIE D'URFE, CANADA H9X3T6

FOR: LITHOGRAPHIC OFFSET PRINTING  
PLATES, IN CLASS 7 (U.S. CLS. 13, 19, 21, 23, 31, 34  
AND 35).

FIRST USE 9-2-2007; IN COMMERCE 9-2-2007.

THE MARK CONSISTS OF STANDARD CHAR-  
ACTERS WITHOUT CLAIM TO ANY PARTICULAR  
FONT, STYLE, SIZE, OR COLOR.

PRIORITY CLAIMED UNDER SEC. 44(D) ON  
CANADA APPLICATION NO. 1323822, FILED 11-10-  
2006.

SER. NO. 77-043,488, FILED 11-14-2006.

ANDREA BUTLER, EXAMINING ATTORNEY

**Int. Cl.: 7**

**Prior U.S. Cls.: 13, 19, 21, 23, 31, 34 and 35**

**United States Patent and Trademark Office**

**Reg. No. 3,393,989**

**Registered Mar. 11, 2008**

**TRADEMARK  
PRINCIPAL REGISTER**

**THE FUTURE OF INDUSTRIAL  
CLEANING**

1454624 ONTARIO INC. (CANADA CORPORATION)  
1370 SANDHILL DRIVE  
ANCASTER, CANADA L9G4V5

FOR: COMMERCIAL AND INDUSTRIAL DRY STEAM CLEANERS; DRY STEAM CLEANER ACCESSORIES, NAMELY, HANDLES, HANDGRIPS, BRUSH HOLDERS, WIPER BLADES, LANCES, SUCTION WIPERS, FURNISHING CLEANING BRUSHES, DRYING BRUSHES, IN CLASS 7 (U.S. CLS. 13, 19, 21, 23, 31, 34 AND 35).

THE MARK CONSISTS OF STANDARD CHARACTERS WITHOUT CLAIM TO ANY PARTICULAR FONT, STYLE, SIZE, OR COLOR.

PRIORITY CLAIMED UNDER SEC. 44(D) ON CANADA APPLICATION NO. 1,301,601, FILED 5-15-2006, REG. NO. 691574, DATED 7-6-2007, EXPIRES 7-6-2022.

SER. NO. 77-043,537, FILED 11-14-2006.

ANGELA M. MICHELI, EXAMINING ATTORNEY

**Int. Cl.: 38**

**Prior U.S. Cls.: 100, 101 and 104**

**United States Patent and Trademark Office**

**Reg. No. 3,393,990**

**Registered Mar. 11, 2008**

**SERVICE MARK  
PRINCIPAL REGISTER**

**URaTrip**

PROFANT, MARIE D. (CALIFORNIA LTD LIAB  
CO)  
741 MISSION CANYON ROAD  
SANTA BARBARA, CA 93105

THE MARK CONSISTS OF STANDARD CHAR-  
ACTERS WITHOUT CLAIM TO ANY PARTICULAR  
FONT, STYLE, SIZE, OR COLOR.

FOR: MOBILE MEDIA AND ENTERTAINMENT  
SERVICES IN THE NATURE OF ELECTRONIC  
TRANSMISSION OF ENTERTAINMENT MEDIA  
CONTENT, IN CLASS 38 (U.S. CLS. 100, 101 AND 104).

SER. NO. 77-043,687, FILED 11-14-2006.

FIRST USE 9-1-2006; IN COMMERCE 9-1-2006.

DAVID TAYLOR, EXAMINING ATTORNEY

**Int. Cl.: 9**

**Prior U.S. Cls.: 21, 23, 26, 36 and 38**

**Reg. No. 3,393,991**

**United States Patent and Trademark Office**

**Registered Mar. 11, 2008**

**TRADEMARK  
PRINCIPAL REGISTER**

**IRT**

HAMILTON SAFE COMPANY (OHIO CORPORATION)  
3143 PRODUCTION DRIVE  
FAIRFIELD, OH 45014

FIRST USE 2-0-2000; IN COMMERCE 5-0-2000.

FOR: INTERACTIVE REMOTE TELLER SYSTEM COMPOSED OF A VIDEO DISPLAY, CAMERA AND AUDIO CONSOLE WITH TWO-WAY AUDIO-VIDEO COMMUNICATION TO ALLOW AN ATTENDANT TO SERVE CUSTOMERS FROM A REMOTE LOCATION ALLOWING SERVICE THROUGH A PNEUMATIC TUBE SYSTEM, IN CLASS 9 (U.S. CLS. 21, 23, 26, 36 AND 38).

THE MARK CONSISTS OF STANDARD CHARACTERS WITHOUT CLAIM TO ANY PARTICULAR FONT, STYLE, SIZE, OR COLOR.

SER. NO. 77-044,174, FILED 11-15-2006.

LINDA ESTRADA, EXAMINING ATTORNEY

Int. Cl.: 25

Prior U.S. Cls.: 22 and 39

United States Patent and Trademark Office

Reg. No. 3,393,992

Registered Mar. 11, 2008

TRADEMARK  
PRINCIPAL REGISTER



PETTY, SHANE D (UNITED STATES INDIVIDUAL)  
10624 CALAVERAS  
WACO, TX 76708

FOR: HATS; PIQUE SHIRTS; POLO SHIRTS; SHIRTS; T-SHIRTS, IN CLASS 25 (U.S. CLS. 22 AND 39).

FIRST USE 8-16-2002; IN COMMERCE 8-11-2003.

NO CLAIM IS MADE TO THE EXCLUSIVE RIGHT TO USE "COLOR BY THE SUN", APART FROM THE MARK AS SHOWN.

THE COLOR(S) ORANGE, YELLOW, BLACK, AND BLUE IS/ARE CLAIMED AS A FEATURE OF THE MARK.

THE MARK CONSISTS OF A STYLIZED ORANGE AND YELLOW SUN WITH BLACK HIGHLIGHTS SET ABOVE THE WORDING COLOR BY THE SUN SURROUNDED BY A BLACK BORDER WITH ORANGE YELLOW AND BLUE HIGHLIGHTS. COLOR APPEARS IN BLUE, ORANGE AND YELLOW; BY IS IN BLUE; THE IS IN YELLOW; AND SUN IS IN ORANGE.

SER. NO. 77-044,185, FILED 11-15-2006.

ELLEN B. AWRICH, EXAMINING ATTORNEY

**Int. Cl.: 5**

**Prior U.S. Cls.: 6, 18, 44, 46, 51 and 52**

**United States Patent and Trademark Office**

**Reg. No. 3,393,993**

**Registered Mar. 11, 2008**

**TRADEMARK  
PRINCIPAL REGISTER**

**EMERFLU**

SANOFI PASTEUR (FRANCE SOCIETE ANON-  
YME)  
2 AVENUE PONT PASTEUR  
LYON, FRANCE 69007

FOR: VACCINES; PHARMACEUTICAL PRE-  
PARATIONS FOR THE TREATMENT OF FLU, IN  
CLASS 5 (U.S. CLS. 6, 18, 44, 46, 51 AND 52).

THE MARK CONSISTS OF STANDARD CHAR-  
ACTERS WITHOUT CLAIM TO ANY PARTICULAR  
FONT, STYLE, SIZE, OR COLOR.

PRIORITY CLAIMED UNDER SEC. 44(D) ON  
FRANCE APPLICATION NO. 063440073, FILED 7-  
11-2006, REG. NO. 063440073, DATED 7-11-2006, EX-  
PIRES 7-11-2016.

SER. NO. 77-044,233, FILED 11-15-2006.

BARBARA A. GOLD, EXAMINING ATTORNEY

**Int. Cl.: 5**

**Prior U.S. Cls.: 6, 18, 44, 46, 51 and 52**

**United States Patent and Trademark Office**

**Reg. No. 3,393,994**

**Registered Mar. 11, 2008**

**TRADEMARK  
PRINCIPAL REGISTER**

**HUMENZA**

SANOVI PASTEUR (FRANCE SOCIETE ANON-  
YME)  
2 AVENUE PONT PASTEUR  
LYON, FRANCE 69007

FOR: VACCINES; PHARMACEUTICAL PRE-  
PARATIONS FOR THE TREATMENT OF FLU, IN  
CLASS 5 (U.S. CLS. 6, 18, 44, 46, 51 AND 52).

THE MARK CONSISTS OF STANDARD CHAR-  
ACTERS WITHOUT CLAIM TO ANY PARTICULAR  
FONT, STYLE, SIZE, OR COLOR.

PRIORITY CLAIMED UNDER SEC. 44(D) ON  
FRANCE APPLICATION NO. 063440077, FILED 7-  
11-2006, REG. NO. 063440077, DATED 7-11-2006, EX-  
PIRES 7-11-2016.

SER. NO. 77-044,237, FILED 11-15-2006.

BARBARA A. GOLD, EXAMINING ATTORNEY



**Int. Cl.: 5**

**Prior U.S. Cls.: 6, 18, 44, 46, 51 and 52**

**United States Patent and Trademark Office**

**Reg. No. 3,393,995**

**Registered Mar. 11, 2008**

**TRADEMARK  
PRINCIPAL REGISTER**

**PANENZA**

SANOFI PASTEUR (FRANCE SOCIETE ANON-  
YME)  
2 AVENUE PONT PASTEUR  
LYON, FRANCE 69007

FOR: VACCINES; PHARMACEUTICAL PRE-  
PARATIONS FOR THE TREATMENT OF FLU, IN  
CLASS 5 (U.S. CLS. 6, 18, 44, 46, 51 AND 52).

THE MARK CONSISTS OF STANDARD CHAR-  
ACTERS WITHOUT CLAIM TO ANY PARTICULAR  
FONT, STYLE, SIZE, OR COLOR.

PRIORITY CLAIMED UNDER SEC. 44(D) ON  
FRANCE APPLICATION NO. 063440078, FILED 7-  
11-2006, REG. NO. 063440078, DATED 7-11-2006, EX-  
PIRES 7-11-2016.

SER. NO. 77-044,244, FILED 11-15-2006.

BARBARA A. GOLD, EXAMINING ATTORNEY

Int. Cl.: 24

Prior U.S. Cls.: 42 and 50

United States Patent and Trademark Office

Reg. No. 3,393,996

Registered Mar. 11, 2008

TRADEMARK  
PRINCIPAL REGISTER

*As know as  
de  
base*

KABUSHIKI KAISHA AS KNOW AS (JAPAN CORPORATION)  
NO. 25-16 JINGUMAE 6-CHOME, SHIBUYA-KU  
TOKYO, JAPAN

FOR: COTTON FABRIC, WOOL FABRIC, KNIT FABRICS, FELT CLOTH, OIL CLOTH, FILTER CLOTH, NAMELY, CHEESE CLOTH, FABRIC APPAREL ACCESSORIES, NAMELY, TOWELS, HANDKERCHIEFS AND TABLE NAPKINS OF TEXTILE, DISHCLOTHS, MOSQUITO NETS, BED SHEETS, QUILTS, QUILT COVERS, UNFITTED FUTON COVERS NOT OF PAPER, PILLOW COVERS, BLANKETS, NAMELY, BED BLANKETS, RECEIVING BLANKETS, SILK BLANKETS, CHAIR COVERS OF TEXTILE, TAPESTRIES OF TEXTILE, CURTAINS, SHOWER CURTAINS, TABLE CLOTHS NOT OF PAPER, TOILET SEAT COVERS OF TEXTILE, REMAINS COVERS, NAMELY, SHROUDS, BLACK

AND WHITE CURTAINS, RED AND WHITE CURTAINS, LABELS OF CLOTH, BILLIARD CLOTH AND FLAGS OF TEXTILE, IN CLASS 24 (U.S. CLS. 42 AND 50).

OWNER OF JAPAN REG. NO. 4232301, DATED 1-22-1999, EXPIRES 1-22-2009.

OWNER OF U.S. REG. NOS. 2,790,085, 3,122,401, AND 3,185,904.

THE MARK CONSISTS OF A STYLIZED PRESENTATION OF THE WORDS "AS KNOW AS DE BASE".

SER. NO. 77-044,328, FILED 11-15-2006.

CAROL SPILS, EXAMINING ATTORNEY

**Int. Cls.: 25 and 41**

**Prior U.S. Cls.: 22, 39, 100, 101 and 107**

**Reg. No. 3,393,997**

**United States Patent and Trademark Office**

**Registered Mar. 11, 2008**

**TRADEMARK  
SERVICE MARK  
PRINCIPAL REGISTER**

**NEW YORK CITY BREAKERS**

GLOBAL BASKETBALL CHAMPIONSHIP CORP.  
(NEW YORK CORPORATION)  
45 SPRUCE STREET  
YONKERS, NY 107014420

FOR: T-SHIRTS, IN CLASS 25 (U.S. CLS. 22 AND 39).

FIRST USE 1-1-1998; IN COMMERCE 1-1-1998.

FOR: ENTERTAINMENT SERVICES IN THE NATURE OF LIVE BREAK-DANCING PERFORMANCES, IN CLASS 41 (U.S. CLS. 100, 101 AND 107).

FIRST USE 1-1-1998; IN COMMERCE 1-1-1998.

THE MARK CONSISTS OF STANDARD CHARACTERS WITHOUT CLAIM TO ANY PARTICULAR FONT, STYLE, SIZE, OR COLOR.

NO CLAIM IS MADE TO THE EXCLUSIVE RIGHT TO USE "BREAKERS" AS TO CLASS 41, APART FROM THE MARK AS SHOWN.

SEC. 2(F).

SER. NO. 77-044,365, FILED 11-15-2006.

HEATHER BIDDULPH, EXAMINING ATTORNEY

Int. Cls.: 35 and 41

Prior U.S. Cls.: 100, 101, 102 and 107

United States Patent and Trademark Office

Reg. No. 3,393,998

Registered Mar. 11, 2008

**SERVICE MARK  
PRINCIPAL REGISTER**



KABOOSE COM INC. (DELAWARE CORPORATION)  
SUITE 1400  
505 UNIVERSITY AVENUE  
TORONTO, ONTARIO, CANADA M5G1X3

FOR: ONLINE RETAIL STORE SERVICES FEATURING PARTY SUPPLIES AND PARTYWARE, GAMES, CRAFTS, PARTY ACTIVITIES, BALLOONS, CANDY, STATIONERY, BANNERS, MAGNETS, STICKERS, LUGGAGE TAGS, BUTTONS, AND DECORATIONS, IN CLASS 35 (U.S. CLS. 100, 101 AND 102).

FIRST USE 8-31-2006; IN COMMERCE 8-31-2006.

FOR: PARTY PLANNING SERVICES; PROVIDING A WEB SITE FEATURING PARTY IDEAS, INFORMATION AND ADVICE, IN CLASS 41 (U.S. CLS. 100, 101 AND 107).

FIRST USE 8-31-2006; IN COMMERCE 8-31-2006.

OWNER OF U.S. REG. NO. 2,332,641.

THE MARK CONSISTS OF A BOX, BALLOON, PARTY HAT AND STARS.

SER. NO. 77-044,438, FILED 11-15-2006.

ERIN FALK, EXAMINING ATTORNEY

**Int. Cl.: 11**

**Prior U.S. Cls.: 13, 21, 23, 31 and 34**

**Reg. No. 3,393,999**

**United States Patent and Trademark Office**

**Registered Mar. 11, 2008**

**TRADEMARK  
PRINCIPAL REGISTER**

**zēnon**

LUMILITE INTERNATIONAL LTD. (HONG  
KONG CORPORATION)  
801 STAR HOUSE  
3 SALISBURY RD TSIM SHA TSUI  
KOWLOON, HONG KONG

FOR: ELECTRIC LANTERNS; FLASHLIGHTS, IN  
CLASS 11 (U.S. CLS. 13, 21, 23, 31 AND 34).

FIRST USE 4-0-2000; IN COMMERCE 4-0-2000.

NO CLAIM IS MADE TO THE EXCLUSIVE  
RIGHT TO USE "XENON", APART FROM THE  
MARK AS SHOWN.

THE MARK CONSISTS OF THE STYLIZED LET-  
TERS ZENON; THE LETTER Z IN STYLIZED UP-  
PERCASE, THE STYLIZED LOWERCASE LETTER E  
WITH A HORIZONTAL LINE DIRECTLY ABOVE  
IT, AND THE STYLIZED LOWERCASE LETTERS  
NON.

SER. NO. 77-044,450, FILED 11-15-2006.

WILLIAM P. SHANAHAN, EXAMINING ATTOR-  
NEY

**Int. Cl.: 35**

**Prior U.S. Cls.: 100, 101 and 102**

**United States Patent and Trademark Office**

**Reg. No. 3,394,000**

**Registered Mar. 11, 2008**

**SERVICE MARK  
PRINCIPAL REGISTER**

**ISLAND OASIS**

ISLAND OASIS FROZEN COCKTAIL COMPANY,  
INC. (MASSACHUSETTS CORPORATION)  
141 NORFOLK STREET  
WALPOLE, MA 02081

FOR: FOOD KIOSK SERVICES, STREET VENDOR  
SERVICES FEATURING SMOOTHIES AND OTHER  
BEVERAGES, IN CLASS 35 (U.S. CLS. 100, 101 AND  
102).

FIRST USE 12-31-1994; IN COMMERCE 12-31-1994.

THE MARK CONSISTS OF STANDARD CHAR-  
ACTERS WITHOUT CLAIM TO ANY PARTICULAR  
FONT, STYLE, SIZE, OR COLOR.

OWNER OF U.S. REG. NOS. 2,581,768, 3,099,578  
AND OTHERS.

SER. NO. 77-044,555, FILED 11-15-2006.

DANIEL CAPSHAW, EXAMINING ATTORNEY

**Int. Cl.: 45**

**Prior U.S. Cls.: 100 and 101**

**United States Patent and Trademark Office**

**Reg. No. 3,394,001**

**Registered Mar. 11, 2008**

**SERVICE MARK  
PRINCIPAL REGISTER**



LOWREY, JEREMY B. (UNITED STATES INDIVIDUAL)  
205 WEST SEVENTH  
SHERIDAN, AR 72150

FOR: RELIGIOUS SERVICES, NAMELY, EVANGELISM, MINISTRY AND MISSIONARY ACTIVITIES; PROVIDING RELIGIOUS INFORMATION BY MEANS OF THE INTERNET, IN CLASS 45 (U.S. CLS. 100 AND 101).

FIRST USE 10-20-2006; IN COMMERCE 10-20-2006.

THE COLOR(S) TEAL, WHITE, SILVER, BLACK IS/ARE CLAIMED AS A FEATURE OF THE MARK.

THE COLOR TEAL APPEARS IN THE WORDING CROSS-PURPOSES. THE COLOR WHITE APPEARS IN THE STYLIZED CROSS DESIGN. THE COLOR SILVER APPEARS IN THE SHADING OF THE WORDING AND THE CROSS DESIGN. THE COLOR BLACK APPEARS IN THE BACKGROUND.

SER. NO. 77-044,714, FILED 11-15-2006.

ALLISON HOLTZ, EXAMINING ATTORNEY

**Int. Cl.: 29**

**Prior U.S. Cl.: 46**

**United States Patent and Trademark Office**

**Reg. No. 3,394,002**

**Registered Mar. 11, 2008**

**TRADEMARK  
PRINCIPAL REGISTER**

**CORAZO**

VISTAR CORPORATION (COLORADO CORPORATION)  
BUILDING D  
12650 EAST ARAPAHOE ROAD  
CENTENNIAL, CO 80112

THE MARK CONSISTS OF STANDARD CHARACTERS WITHOUT CLAIM TO ANY PARTICULAR FONT, STYLE, SIZE, OR COLOR.

FOR: CHEESE SOLD TO MEXICAN RESTAURANTS, IN CLASS 29 (U.S. CL. 46).

SER. NO. 77-044,781, FILED 11-15-2006.

FIRST USE 12-28-2006; IN COMMERCE 12-28-2006.

SARA THOMAS, EXAMINING ATTORNEY



**Int. Cl.: 41**

**Prior U.S. Cls.: 100, 101 and 107**

**United States Patent and Trademark Office**

**Reg. No. 3,394,003**

**Registered Mar. 11, 2008**

**SERVICE MARK  
PRINCIPAL REGISTER**

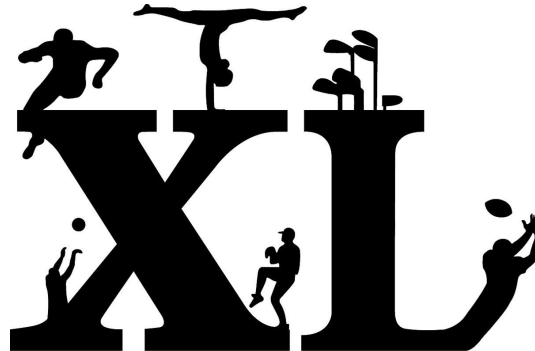

BELLIN HEALTH SYSTEMS, INC. (WISCONSIN CORPORATION)  
744 S. WEBSTER AVENUE  
GREEN BAY, WI 54301

THE MARK CONSISTS OF THE LETTERS XL SURROUNDED BY ATHLETES PLAYING SPORTS AND SPORTING EQUIPMENT.

FOR: PERSONAL TRAINING SERVICES, NAME-  
LY, STRENGTH AND CONDITIONING TRAINING  
FOR ATHLETIC PERFORMANCE ENHANCE-  
MENT, IN CLASS 41 (U.S. CLS. 100, 101 AND 107).

SER. NO. 77-044,847, FILED 11-15-2006.

FIRST USE 8-17-2006; IN COMMERCE 8-17-2006.

IRA J. GOODSAY, EXAMINING ATTORNEY

**Int. Cl.: 36**

**Prior U.S. Cls.: 100, 101 and 102**

**United States Patent and Trademark Office**

**Reg. No. 3,394,004**

**Registered Mar. 11, 2008**

**SERVICE MARK  
PRINCIPAL REGISTER**



TEMPO PAYMENTS, INC. (DELAWARE CORPORATION)  
951 MARINERS ISLAND BOULEVARD  
SUITE 330  
SAN MATEO, CA 94404

PAID PURCHASE CARD SERVICES NAMELY, PROCESSING ELECTRONIC PAYMENTS MADE THROUGH PREPAID CARDS, IN CLASS 36 (U.S. CLS. 100, 101 AND 102).

FOR: FINANCIAL SERVICES, NAMELY, PROVIDING CREDIT CARD SERVICES, ELECTRONIC CREDIT CARD TRANSACTION SERVICES, DEBIT CARD SERVICES, ELECTRONIC DEBIT TRANSACTION SERVICES, AND TRANSACTION AUTHORIZATION AND SETTLEMENT SERVICES; PRE-

FIRST USE 11-28-2006; IN COMMERCE 11-28-2006.

SER. NO. 77-045,259, FILED 11-16-2006.

SUSAN RICHARDS, EXAMINING ATTORNEY

**Int. Cl.: 20**

**Prior U.S. Cls.: 2, 13, 22, 25, 32 and 50**

**United States Patent and Trademark Office**

**Reg. No. 3,394,005**

**Registered Mar. 11, 2008**

**TRADEMARK  
PRINCIPAL REGISTER**

**Clip-N-Sip**

HOSPITALITY NETWORKS, INC. (SOUTH DA-  
KOTA CORPORATION)  
2522 WEST 41ST STREET  
SIOUX FALLS, SD 57105

THE MARK CONSISTS OF STANDARD CHAR-  
ACTERS WITHOUT CLAIM TO ANY PARTICULAR  
FONT, STYLE, SIZE, OR COLOR.

FOR: NON METAL CLIPS FOR BEVERAGE BOT-  
TLES, IN CLASS 20 (U.S. CLS. 2, 13, 22, 25, 32 AND 50).

SER. NO. 77-045,664, FILED 11-16-2006.

FIRST USE 3-1-2004; IN COMMERCE 12-20-2004.

RENEE SERVANCE, EXAMINING ATTORNEY

**Int. Cl.: 42**

**Prior U.S. Cls.: 100 and 101**

**United States Patent and Trademark Office**

**Reg. No. 3,394,006**

**Registered Mar. 11, 2008**

**SERVICE MARK  
PRINCIPAL REGISTER**

## Need Help Deciding?

GUIDESTER, INC. (FORMALLY DECIDIA, INC)  
(DELAWARE CORPORATION)  
123 WILLIAM ST, 22ND FLOOR  
NEW YORK, NY 10038

FOR: DESIGN AND IMPLEMENTATION OF  
COMPUTER SYSTEMS, FOR OTHERS, NAMELY  
THE DESIGN AND IMPLEMENTATION OF WEB-  
BASED COMPUTER SYSTEMS THAT ALLOW CON-  
SUMERS TO MAKE DECISIONS REGARDING  
FINDING THE RIGHT CONSUMER PRODUCT ON-  
LINE VIA A WIRELESS NETWORK, AN INTRANET,  
OR A GLOBAL COMMUNICATIONS INFORMA-  
TION NETWORK, IN CLASS 42 (U.S. CLS. 100 AND  
101).

FIRST USE 6-1-2001; IN COMMERCE 6-1-2001.

THE MARK CONSISTS OF STANDARD CHAR-  
ACTERS WITHOUT CLAIM TO ANY PARTICULAR  
FONT, STYLE, SIZE, OR COLOR.

SEC. 2(F).

SER. NO. 77-045,702, FILED 11-16-2006.

TRACY WHITTAKER-BROWN, EXAMINING AT-  
TORNEY

**Int. Cl.: 36**

**Prior U.S. Cls.: 100, 101 and 102**

**United States Patent and Trademark Office**

**Reg. No. 3,394,007**

**Registered Mar. 11, 2008**

**SERVICE MARK  
PRINCIPAL REGISTER**

**DELTA CAPITAL INVESTMENTS**

ANTHONY HANNON (CALIFORNIA SOLE PROPRIETORSHIP)  
1325 HOWARD AVENUE, #407  
BURLINGAME, CA 94010

FOR: INVESTMENT ADVISORY SERVICES FOR INDIVIDUALS, IN CLASS 36 (U.S. CLS. 100, 101 AND 102).

FIRST USE 1-2-1992; IN COMMERCE 1-2-1992.

THE MARK CONSISTS OF STANDARD CHARACTERS WITHOUT CLAIM TO ANY PARTICULAR FONT, STYLE, SIZE, OR COLOR.

NO CLAIM IS MADE TO THE EXCLUSIVE RIGHT TO USE "CAPITAL INVESTMENTS", APART FROM THE MARK AS SHOWN.

SER. NO. 77-045,823, FILED 11-16-2006.

GISELLE AGOSTO, EXAMINING ATTORNEY

**Int. Cls.: 40 and 42**

**Prior U.S. Cls.: 100, 101, 103 and 106**

**United States Patent and Trademark Office**

**Reg. No. 3,394,008**

**Registered Mar. 11, 2008**

**SERVICE MARK  
PRINCIPAL REGISTER**



TRS QUALITY, INC. (DELAWARE CORPORATION)  
MAIL STOP #CF4-101  
300 RADIOSHACK CIRCLE  
FORT WORTH, TX 76102

FOR: PROTOTYPE FABRICATION OF NEW PRODUCTS FOR OTHERS, NAMELY, THE CREATION OF THE THREE DIMENSIONAL EXPRESSION OF THE PRODUCT , IN CLASS 40 (U.S. CLS. 100, 103 AND 106).

FIRST USE 10-3-2007; IN COMMERCE 10-3-2007.

FOR: INDUSTRIAL DESIGN; PRODUCT RESEARCH AND DEVELOPMENT; MECHANICAL ENGINEERING; AND ENGINEERING SERVICES, NAMELY, DEVELOPMENT OF PROTOTYPES, AND

DESIGN OF PRODUCT PACKAGING, IN CLASS 42 (U.S. CLS. 100 AND 101).

FIRST USE 10-3-2007; IN COMMERCE 10-3-2007.

THE COLOR(S) RED AND GREY IS/ARE CLAIMED AS A FEATURE OF THE MARK.

THE MARK CONSISTS OF A CIRCLE CONSISTING OF 32 RED AXIAL DASHES AND THE GREY WORD IGNITION.

SER. NO. 77-045,832, FILED 11-16-2006.

RICHARD A. STRASER, EXAMINING ATTORNEY

**Int. Cl.: 41**

**Prior U.S. Cls.: 100, 101 and 107**

**United States Patent and Trademark Office**

**Reg. No. 3,394,009**

**Registered Mar. 11, 2008**

**SERVICE MARK  
PRINCIPAL REGISTER**

**MANDL THE COLLEGE OF  
ALLIED HEALTH**

MANDL, THE COLLEGE OF ALLIED HEALTH  
(NEW YORK CORPORATION)  
254 WEST 54TH STREET  
NEW YORK, NY 10019

FOR: EDUCATIONAL SERVICES, NAMELY,  
PROVIDING COURSES OF INSTRUCTION FOR  
PERSONS TO BECOME SURGICAL TECHNOLO-  
GISTS, REGISTERED MEDICAL ASSISTANTS, RE-  
GISTERED DENTAL ASSISTANTS, MEDICAL  
LABORATORY TECHNICIAN, ELECTROCARDIO-  
GRAPHY TECHNICIAN, PHLEBOTOMY TECHNI-  
CIAN, CERTIFIED OPTHAMALIC ASSISTANT,  
CERTIFIED NURSING AIDES, NURSE TECHNI-  
CIANS AND COURSES OF INSTRUCTION IN MED-  
ICAL BILLING AND CODING, IN CLASS 41 (U.S.  
CLS. 100, 101 AND 107).

FIRST USE 12-1-2005; IN COMMERCE 12-1-2005.

THE MARK CONSISTS OF STANDARD CHAR-  
ACTERS WITHOUT CLAIM TO ANY PARTICULAR  
FONT, STYLE, SIZE, OR COLOR.

NO CLAIM IS MADE TO THE EXCLUSIVE  
RIGHT TO USE "COLLEGE OF ALLIED HEALTH",  
APART FROM THE MARK AS SHOWN.

SER. NO. 77-045,985, FILED 11-16-2006.

DAWN FELDMAN, EXAMINING ATTORNEY

Int. Cls.: 12, 35 and 37

Prior U.S. Cls.: 19, 21, 23, 31, 35, 44, 100, 101, 102,  
103 and 106

Reg. No. 3,394,010

United States Patent and Trademark Office

Registered Mar. 11, 2008

TRADEMARK  
SERVICE MARK  
PRINCIPAL REGISTER



TIRE KINGDOM, INC. (FLORIDA CORPORATION)  
823 DONALD ROSS ROAD  
JUNO BEACH, FL 33408

FOR: TIRES, IN CLASS 12 (U.S. CLS. 19, 21, 23, 31, 35 AND 44).

FIRST USE 1-5-2006; IN COMMERCE 1-5-2006.

FOR: RETAIL TIRE STORES, IN CLASS 35 (U.S. CLS. 100, 101 AND 102).

FIRST USE 1-5-2006; IN COMMERCE 1-5-2006.

FOR: TIRE BALANCING; TIRE ROTATING AND BALANCING, IN CLASS 37 (U.S. CLS. 100, 103 AND 106).

FIRST USE 1-5-2006; IN COMMERCE 1-5-2006.

OWNER OF U.S. REG. NOS. 1,838,215, 2,864,332 AND OTHERS.

NO CLAIM IS MADE TO THE EXCLUSIVE RIGHT TO USE "TIRES IN AN HOUR OR LESS", APART FROM THE MARK AS SHOWN.

THE COLOR(S) RED, YELLOW, GRAY, BLACK, WHITE AND BLUE IS/ARE CLAIMED AS A FEATURE OF THE MARK.

THE COLORS RED AND WHITE AND BLACK APPEAR ON THE CROWN; THE COLORS RED AND GRAY APPEAR ON THE HANDS OF THE CLOCK; THE COLOR WHITE APPEARS ON THE FACE OF THE CLOCK; THE COLOR BLACK APPEARS ON THE NUMBERS 0, 15, 30 AND 45 ON THE FACE OF THE CLOCK; THE COLOR BLUE APPEARS ON THE WORDS "OR LESS . . ." AND THE OUTLINING OF THE WORDS "TIRES IN AN HOUR"; THE COLORS BLACK AND WHITE APPEAR ON THE TIRE TREAD; THE COLOR BLACK APPEARS ON THE OUTLINING OF ALL OF THE LETTERS; THE COLOR YELLOW APPEARS ON THE WORDS "NTB TIRES IN AN HOUR"; AND THE COLOR GRAY APPEARS IN THE BLOCK SHAPES IN THE BACKGROUND OF THE LOGO.

SER. NO. 77-046,141, FILED 11-16-2006.

COLLEEN DOMBROW, EXAMINING ATTORNEY



**Int. Cl.: 16**

**Prior U.S. Cls.: 2, 5, 22, 23, 29, 37, 38 and 50**

**Reg. No. 3,394,011**

**United States Patent and Trademark Office**

**Registered Mar. 11, 2008**

**TRADEMARK  
PRINCIPAL REGISTER**

**WHEN TRADITION MEETS  
TOMORROW**

BOY SCOUTS OF AMERICA (UNITED STATES A  
UNITED STATES CORPORATION CHAR-  
TERED BY ACT OF CONGRESS, 36 U.S.C.  
SECTION 21)  
1325 W. WALNUT HILL LN.  
P.O. BOX 152079  
IRVING, TX 750152079

FOR: PAMPHLETS, BROCHURES, CERTIFI-  
CATES, DIPLOMAS AND OTHER PRINTED MATE-  
RIALS, NAMELY, BOOKLETS AND STATIONERY,  
ALL IN THE FIELD OF A YOUTH ORGANIZATION  
FOR BOYS AND YOUNG MEN, IN CLASS 16 (U.S.  
CLS. 2, 5, 22, 23, 29, 37, 38 AND 50).

FIRST USE 5-25-2006; IN COMMERCE 5-25-2006.

THE MARK CONSISTS OF STANDARD CHAR-  
ACTERS WITHOUT CLAIM TO ANY PARTICULAR  
FONT, STYLE, SIZE, OR COLOR.

OWNER OF U.S. REG. NOS. 1,213,650, 1,215,939  
AND OTHERS.

SER. NO. 77-046,682, FILED 11-17-2006.

BRENDAN REGAN, EXAMINING ATTORNEY

**Int. Cl.: 14**

**Prior U.S. Cls.: 2, 27, 28 and 50**

**United States Patent and Trademark Office**

**Reg. No. 3,394,012**

**Registered Mar. 11, 2008**

**TRADEMARK  
PRINCIPAL REGISTER**

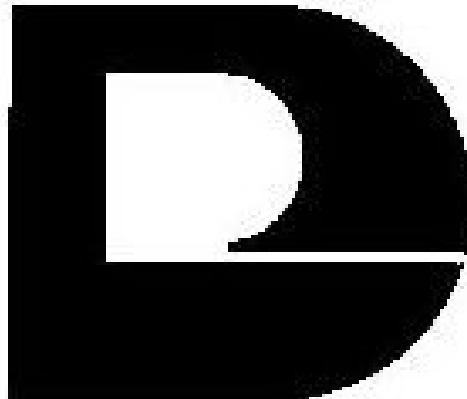

PVH SUPERBA/INSIGNIA NECKWEAR, INC.  
(DELAWARE CORPORATION)  
1735 SOUTH SANTE FE AVENUE  
LOS ANGELES, CA 90021 AND  
TBAC INVESTMENT TRUST (PENNSYLVANIA  
BUSINESS TRUST)  
690 EAST LAMAR BLVD., STE. 200  
ARLINGTON, TX 76011

FOR: CUFF LINKS, TIE CLIPS AND MEN'S  
ACCESSORY JEWELRY, IN CLASS 14 (U.S. CLS. 2,  
27, 28 AND 50).

FIRST USE 2-28-2002; IN COMMERCE 2-28-2002.

OWNER OF U.S. REG. NO. 2,763,803.

THE MARK CONSISTS OF THE LETTERS DL.

SER. NO. 77-046,738, FILED 11-17-2006.

DANNEAN HETZEL, EXAMINING ATTORNEY

Int. Cl.: 16

Prior U.S. Cls.: 2, 5, 22, 23, 29, 37, 38 and 50

United States Patent and Trademark Office

Reg. No. 3,394,013

Registered Mar. 11, 2008

**TRADEMARK  
PRINCIPAL REGISTER**

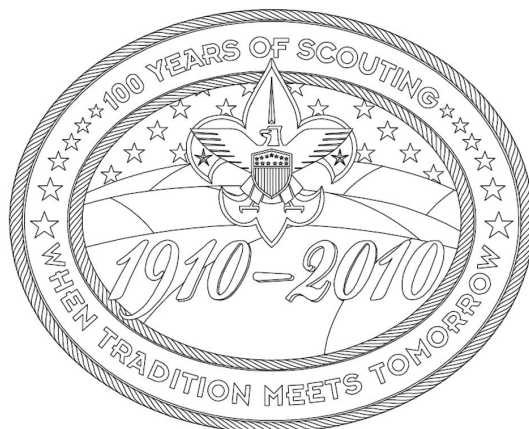

BOY SCOUTS OF AMERICA (UNITED STATES A  
UNITED STATES CORPORATION CHAR-  
TERED BY ACT OF CONGRESS, 36 U.S.C.  
SECTION 21)

1325 W. WALNUT HILL LN.  
P.O. BOX 152079  
IRVING, TX 750152079

FOR: PAMPHLETS, BROCHURES, CERTIFI-  
CATES, DIPLOMAS AND OTHER PRINTED MATE-  
RIALS, NAMELY, BOOKLETS AND STATIONERY,  
ALL IN THE FIELD OF A YOUTH ORGANIZATION  
FOR BOYS AND YOUNG MEN, IN CLASS 16 (U.S.  
CLS. 2, 5, 22, 23, 29, 37, 38 AND 50).

FIRST USE 5-25-2006; IN COMMERCE 5-25-2006.

OWNER OF U.S. REG. NOS. 1,213,650, 1,215,939  
AND OTHERS.

NO CLAIM IS MADE TO THE EXCLUSIVE  
RIGHT TO USE "100 YEARS" OR "1910-2010", APART  
FROM THE MARK AS SHOWN.

THE MARK CONSISTS OF AN EAGLE INSIDE A  
FLEUR-DE-LIS SURROUNDED BY THE STRIPED  
BACKGROUND WITH NUMBERS "1910-2010" ON IT  
ALL INSIDE AN OVAL FRAME WITH WORDS "100  
YEARS OF SCOUTING" AND "WHEN TRADITION  
MEETS TOMORROW".

SER. NO. 77-046,772, FILED 11-17-2006.

BRENDAN REGAN, EXAMINING ATTORNEY

**Int. Cl.: 9**

**Prior U.S. Cls.: 21, 23, 26, 36 and 38**

**United States Patent and Trademark Office**

**Reg. No. 3,394,014**

**Registered Mar. 11, 2008**

**TRADEMARK  
PRINCIPAL REGISTER**

**LYCEA**

FOLLETT CORPORATION (ILLINOIS CORPORATION)  
2233 WEST STREET  
RIVER GROVE, IL 60171

FOR: COMPUTER SOFTWARE FOR CONSTRUCTING, DEPLOYING AND MANAGING CUSTOMIZED ON-LINE TEACHING AND LEARNING APPLICATIONS, IN CLASS 9 (U.S. CLS. 21, 23, 26, 36 AND 38).

FIRST USE 7-0-2000; IN COMMERCE 7-0-2000.

THE MARK CONSISTS OF STANDARD CHARACTERS WITHOUT CLAIM TO ANY PARTICULAR FONT, STYLE, SIZE, OR COLOR.

SER. NO. 77-046,870, FILED 11-17-2006.

KATHERINE M. DUBRAY, EXAMINING ATTORNEY

**Int. Cls.: 9 and 42**

**Prior U.S. Cls.: 21, 23, 26, 36, 38, 100 and 101**

**United States Patent and Trademark Office**

**Reg. No. 3,394,015**

**Registered Mar. 11, 2008**

**TRADEMARK  
SERVICE MARK  
PRINCIPAL REGISTER**

**SABI**

SERVEON INC. (DELAWARE CORPORATION)  
1401 SILVERSIDE ROAD, SUITE C  
WILMINGTON, DE 19810

FOR: DATA COLLECTION SYSTEM COMPRISED OF PDA SOFTWARE AND DESKTOP SOFTWARE FOR OFFLINE DATA COLLECTION AND FOR UPLOADING DATA TO A WEBSITE, IN THE FIELD OF AGRONOMY AND AGRICULTURAL PESTS, IN CLASS 9 (U.S. CLS. 21, 23, 26, 36 AND 38).

FIRST USE 5-15-2006; IN COMMERCE 5-15-2006.

FOR: APPLICATION SERVICE PROVIDER (ASP), NAMELY, HOSTING COMPUTER SOFTWARE APPLICATIONS FOR OTHERS, NAMELY, COMPUTER APPLICATIONS FOR AGRICULTURAL PESTS AND

AGRONOMIC DATA COLLECTION, INCLUDING RECEIVING, COLLATING AND STORING DATA, AND PROVIDING ACCESS TO AGRONOMIC AND AGRICULTURAL SCOUTING/OBSERVATION DATA AND INFORMATION FOR OTHERS , IN CLASS 42 (U.S. CLS. 100 AND 101).

FIRST USE 5-15-2006; IN COMMERCE 5-15-2006.

THE MARK CONSISTS OF STANDARD CHARACTERS WITHOUT CLAIM TO ANY PARTICULAR FONT, STYLE, SIZE, OR COLOR.

SER. NO. 77-047,494, FILED 11-20-2006.

KATHRYN COWARD, EXAMINING ATTORNEY

**Int. Cls.: 9 and 38**

**Prior U.S. Cls.: 21, 23, 26, 36, 38, 100, 101 and 104**

**United States Patent and Trademark Office**

**Reg. No. 3,394,016**

**Registered Mar. 11, 2008**

**TRADEMARK  
SERVICE MARK  
PRINCIPAL REGISTER**



GAME THEORY LIMITED (MALTA COMPANY)  
125 THE STRAND  
GZIRA, MALTA GZR03

FOR: COMPUTER SOFTWARE FOR ELECTRONIC TRANSMISSION OF TEXT, GRAPHICS, AND DATA; COMPUTER SOFTWARE FOR PROVIDING AND FACILITATING REAL-TIME INTERACTION, NETWORKING, AND COMMUNICATION BETWEEN ONLINE COMPUTER USERS; COMPUTER SOFTWARE FOR PROVIDING REAL-TIME INFORMATION ABOUT, TRACKING OF AND SEARCHING FOR NETWORK USE AND ONLINE COMPUTER USERS AND FOR TRANSFERRING USERS TO THE ONLINE LOCATION(S) OF ANOTHER USER OR OTHER USERS OR TO OTHER ONLINE LOCATIONS; DOWNLOADABLE COMPUTER SOFTWARE FOR ACCESSING ONLINE CONTESTS AND GAMES OF CHANCE; INSTANT MESSAGING SOFTWARE, IN CLASS 9 (U.S. CLS. 21, 23, 26, 36 AND 38).

FIRST USE 1-24-2003; IN COMMERCE 1-24-2003.

FOR: ELECTRONIC TRANSMISSION OF TEXT, GRAPHICS, AND DATA; COMMUNICATION SERVICES, NAMELY, PROVIDING ONLINE FACIL-

ITIES FOR REAL-TIME INTERACTION BETWEEN ONLINE COMPUTER USERS CONCERNING ONLINE CONTESTS AND GAMES OF CHANCE; COMMUNICATION SERVICES, NAMELY, PROVIDING ACCESS TO AN ONLINE COMPUTER DATABASE FOR REAL-TIME TRACKING OF AND SEARCHING FOR NETWORK USE AND ONLINE COMPUTER USERS AND TRANSFERRING USERS TO THE ONLINE LOCATION(S) OF ANOTHER USER OR OTHER USERS OR OTHER ONLINE LOCATIONS; COMMUNICATION SERVICES, NAMELY, PROVIDING ONLINE FACILITIES FOR REAL-TIME INTERACTION BETWEEN ONLINE COMPUTER USERS FOR ARRANGING AND PLAYING ONLINE CONTESTS AND GAMES OF CHANCE; INSTANT MESSAGING SERVICES, IN CLASS 38 (U.S. CLS. 100, 101 AND 104).

FIRST USE 1-24-2003; IN COMMERCE 1-24-2003.

THE MARK CONSISTS OF A CLUB, DIAMOND, HEART AND SPADE OVER THE STYLIZED FIGURE OF A PERSON.

SER. NO. 77-048,003, FILED 11-20-2006.

KAPIL BHANOT, EXAMINING ATTORNEY

**Int. Cl.: 7**

**Prior U.S. Cls.: 13, 19, 21, 23, 31, 34 and 35**

**United States Patent and Trademark Office**

**Reg. No. 3,394,017**

**Registered Mar. 11, 2008**

**TRADEMARK  
PRINCIPAL REGISTER**



INTERNAL GRINDING ABRASIVES INC. (MI-  
CHIGAN CORPORATION)  
3011 HILLCROFT AVENUE S.W.  
GRAND RAPIDS, MI 49548

FOR: ABRASIVE PRODUCTS, NAMELY, GRIND-  
ING WHEELS IN THE NATURE OF POWER OPER-  
ATED GRINDING WHEELS, IN CLASS 7 (U.S. CLS.  
13, 19, 21, 23, 31, 34 AND 35).

FIRST USE 7-20-1959; IN COMMERCE 3-10-1960.

OWNER OF U.S. REG. NO. 796,190.

THE MARK CONSISTS OF LETTERS APPEAR-  
ING INSIDE A TRIANGLE.

SER. NO. 77-048,542, FILED 11-21-2006.

SCOTT SISUN, EXAMINING ATTORNEY

**Int. Cl.: 35**

**Prior U.S. Cls.: 100, 101 and 102**

**United States Patent and Trademark Office**

**Reg. No. 3,394,018**

**Registered Mar. 11, 2008**

**SERVICE MARK  
PRINCIPAL REGISTER**

**BE THE ONE**

NATIONAL MARROW DONOR PROGRAM  
(COLORADO CORPORATION)  
SUITE 500  
3001 BROADWAY STREET  
MINNEAPOLIS, MN 55413

FOR: PROMOTING PUBLIC AWARENESS OF  
THE BENEFITS OF THE DONATION OF CORD  
BLOOD AND BONE MARROW, IN CLASS 35 (U.S.  
CLS. 100, 101 AND 102).

FIRST USE 11-8-2006; IN COMMERCE 11-8-2006.

THE MARK CONSISTS OF STANDARD CHAR-  
ACTERS WITHOUT CLAIM TO ANY PARTICULAR  
FONT, STYLE, SIZE, OR COLOR.

SER. NO. 77-048,898, FILED 11-21-2006.

JACLYN KIDWELL, EXAMINING ATTORNEY



**Int. Cl.: 36**

**Prior U.S. Cls.: 100, 101 and 102**

**United States Patent and Trademark Office**

**Reg. No. 3,394,019**

**Registered Mar. 11, 2008**

**SERVICE MARK  
PRINCIPAL REGISTER**



**First Independent**

FIRST INDEPENDENT BANK (WASHINGTON CORPORATION)  
P.O. BOX 8904  
VANCOUVER, WA 98684

FOR: BANKING SERVICES; MORTGAGE SERVICES, NAMELY, COMMERCIAL AND RESIDENTIAL REAL ESTATE LENDING AND HOME EQUITY LOAN SERVICES; FINANCIAL SERVICES, NAMELY, FINANCIAL PLANNING SERVICES, RETIREMENT PLANNING SERVICES, TRUST AND INVESTMENT SERVICES AND ASSET MANAGEMENT SERVICES, IN CLASS 36 (U.S. CLS. 100, 101 AND 102).

FIRST USE 9-19-2006; IN COMMERCE 9-24-2006.

OWNER OF U.S. REG. NOS. 2,969,211, 3,025,063 AND OTHERS.

THE MARK CONSISTS OF THE WORDS "FIRST INDEPENDENT" NEXT TO A SIX-SIDED GEOMETRIC FIGURE WITH INTERNAL STEPS.

SEC. 2(F) "FIRST INDEPENDENT".

SER. NO. 77-049,994, FILED 11-22-2006.

JULIE WATSON, EXAMINING ATTORNEY

**Int. Cl.: 35**

**Prior U.S. Cls.: 100, 101 and 102**

**United States Patent and Trademark Office**

**Reg. No. 3,394,020**

**Registered Mar. 11, 2008**

**SERVICE MARK  
PRINCIPAL REGISTER**

**How Much Is Your Town  
Worth?**

AVALANCHE TRADING LIMITED (UNITED  
KINGDOM PRIVATE LIMITED COMPANY)  
NORTHUMBERLAND STREET  
THE MEDIA CENTRE  
HUDDERSFIELD, UNITED KINGDOM HD11RL

FOR: ADVERTISING SERVICES PROVIDED  
OVER THE INTERNET; ON-LINE ADVERTISING  
ON COMPUTER COMMUNICATION NETWORKS ,  
IN CLASS 35 (U.S. CLS. 100, 101 AND 102).

FIRST USE 9-26-2007; IN COMMERCE 9-26-2007.

THE MARK CONSISTS OF STANDARD CHAR-  
ACTERS WITHOUT CLAIM TO ANY PARTICULAR  
FONT, STYLE, SIZE, OR COLOR.

SER. NO. 77-050,401, FILED 11-24-2006.

SEAN CROWLEY, EXAMINING ATTORNEY

**Int. Cl.: 16**

**Prior U.S. Cls.: 2, 5, 22, 23, 29, 37, 38 and 50**

**Reg. No. 3,394,021**

**United States Patent and Trademark Office**

**Registered Mar. 11, 2008**

---

**TRADEMARK  
PRINCIPAL REGISTER**

VICTORY COMES IN ALL COLORS

NORTHERN NEW JERSEY MATERNAL/CHILD  
HEALTH CONSORTIUM, INC. (NEW JERSEY  
CORPORATION)  
17 ARCADIAN AVENUE  
PARAMUS, NJ 07652

FOR: PRINTED MATERIALS, NAMELY, NEWS-  
LETTERS AND PAMPHLETS ALL IN THE FIELD  
OF HEALTH CARE SERVICES, NAMELY, MATER-  
NAL AND CHILD CARE SERVICES, IN CLASS 16  
(U.S. CLS. 2, 5, 22, 23, 29, 37, 38 AND 50).

FIRST USE 6-9-2006; IN COMMERCE 6-9-2006.

THE MARK CONSISTS OF STANDARD CHAR-  
ACTERS WITHOUT CLAIM TO ANY PARTICULAR  
FONT, STYLE, SIZE, OR COLOR.

SER. NO. 77-050,425, FILED 11-24-2006.

GENE MACIOL, EXAMINING ATTORNEY

**Int. Cl.: 41**

**Prior U.S. Cls.: 100, 101 and 107**

**United States Patent and Trademark Office**

**Reg. No. 3,394,022**

**Registered Mar. 11, 2008**

**SERVICE MARK  
PRINCIPAL REGISTER**

# Cheese Chick

CHEESE CHICK, LLC (OREGON LTD LIAB CO)  
7950 SW EVERETT COURT  
BEAVERTON, OR 97007

FOR: EDUCATIONAL SERVICES, NAMELY,  
PROVIDING SEMINARS, CLASSES, WORKSHOPS,  
IN THE FIELDS OF CHEESE, WINE, AND CUL-  
TURE; ENTERTAINMENT SERVICES, NAMELY,  
WINE AND FOOD TASTINGS , IN CLASS 41 (U.S.  
CLS. 100, 101 AND 107).

FIRST USE 5-1-2005; IN COMMERCE 5-1-2005.

THE MARK CONSISTS OF STANDARD CHAR-  
ACTERS WITHOUT CLAIM TO ANY PARTICULAR  
FONT, STYLE, SIZE, OR COLOR.

NO CLAIM IS MADE TO THE EXCLUSIVE  
RIGHT TO USE "CHEESE", APART FROM THE  
MARK AS SHOWN.

SER. NO. 77-050,427, FILED 11-24-2006.

BILL DAWE, EXAMINING ATTORNEY

Int. Cl.: 36

Prior U.S. Cls.: 100, 101 and 102

United States Patent and Trademark Office

Reg. No. 3,394,023

Registered Mar. 11, 2008

**SERVICE MARK  
PRINCIPAL REGISTER**

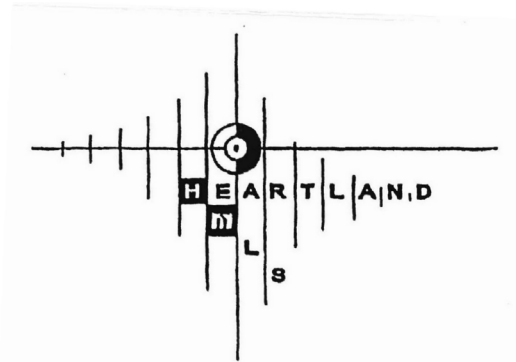

HEARTLAND MULTIPLE LISTING SERVICE,  
INC. (KANSAS CORPORATION)  
SUITE 125 11150 OVERBROOK ROAD  
LEAWOOD, KS 66211

FOR: REAL ESTATE LISTING AND BROKERAGE SERVICES; REAL ESTATE CONSULTING SERVICES; PROVIDING REAL ESTATE INFORMATIONAL AND DATABASE SERVICES FEATURING REAL ESTATE PROPERTIES, LISTINGS AND FINANCING FOR REAL ESTATE PROFESSIONALS ON AND VIA THE INTERNET THROUGH A WEB SITE; PROVIDING INFORMATION IN THE FIELD OF REAL ESTATE BY MEANS OF LINKING THE WEB SITE TO OTHER WEB SITES FEATURING REAL ESTATE INFORMATION; PROVIDING REAL ESTATE MULTIPLE LISTING SERVICES ACCESSIBLE VIA THE INTERNET WHICH FEATURE THE ACCUMULATION AND DISSEMINATION OF INFORMATION REGARDING REAL ESTATE LIST-

INGS TO ENABLE REAL ESTATE PROFESSIONALS TO MAKE BLANKET UNILATERAL OFFERS OF COOPERATION AND COMPENSATION, PREPARE APPRAISALS AND VALUATIONS OF PROPERTY AND ENABLE REAL ESTATE PROFESSIONALS TO BETTER SERVE THEIR CLIENTS AND CUSTOMERS, IN CLASS 36 (U.S. CLS. 100, 101 AND 102).

FIRST USE 1-1-1999; IN COMMERCE 1-1-1999.

OWNER OF U.S. REG. NO. 3,038,087.

THE MARK CONSISTS OF A DESIGN OF STYLIZED CROSSHAIRS WITH THE WORDING HEARTLAND MLS.

SER. NO. 77-050,692, FILED 11-26-2006.

PAULA MAHONEY, EXAMINING ATTORNEY

**Int. Cl.: 9**

**Prior U.S. Cls.: 21, 23, 26, 36 and 38**

**Reg. No. 3,394,024**

**United States Patent and Trademark Office**

**Registered Mar. 11, 2008**

---

**TRADEMARK  
PRINCIPAL REGISTER**

# Sylution

TOTHEROW, GEORGE KEVIN (UNITED STATES  
INDIVIDUAL)  
630 OLD WAYNESVILLE ROAD  
JESUP, GA 31546

FOR: COMPUTER SOFTWARE FOR APPLICATION AND DATABASE INTEGRATION; COMPUTER SOFTWARE THAT PROVIDES REAL-TIME, INTEGRATED BUSINESS MANAGEMENT INTELLIGENCE BY COMBINING INFORMATION FROM VARIOUS DATABASES AND PRESENTING IT IN AN EASY-TO-UNDERSTAND USER INTERFACE; ELECTRONIC ADVERTISEMENT AND MESSAGING DISPLAY UNIT WITH MULTI-NETWORK-

ING (TCP/IP) CAPABILITIES AND REMOTE CONNECTIVITY, IN CLASS 9 (U.S. CLS. 21, 23, 26, 36 AND 38).

FIRST USE 10-1-1999; IN COMMERCE 7-14-2000.

THE MARK CONSISTS OF STANDARD CHARACTERS WITHOUT CLAIM TO ANY PARTICULAR FONT, STYLE, SIZE, OR COLOR.

SER. NO. 77-051,717, FILED 11-28-2006.

DORITT L. CARROLL, EXAMINING ATTORNEY

**Int. Cl.: 41**

**Prior U.S. Cls.: 100, 101 and 107**

**United States Patent and Trademark Office**

**Reg. No. 3,394,025**

**Registered Mar. 11, 2008**

**SERVICE MARK  
PRINCIPAL REGISTER**

**NEW ENGLAND HEALTHCARE  
ASSEMBLY**

NEW ENGLAND HEALTHCARE ASSEMBLY  
(MASSACHUSETTS NON-PROFIT CORPORATION)  
5 NEW ENGLAND EXECUTIVE PARK  
BURLINGTON, MA 01803

FOR: EDUCATIONAL SERVICES, NAMELY,  
CONDUCTING CLASSES AND SEMINARS RELAT-  
ING TO THE PROVISION OF HEALTHCARE, IN  
CLASS 41 (U.S. CLS. 100, 101 AND 107).

FIRST USE 8-31-1999; IN COMMERCE 8-31-1999.

THE MARK CONSISTS OF STANDARD CHAR-  
ACTERS WITHOUT CLAIM TO ANY PARTICULAR  
FONT, STYLE, SIZE, OR COLOR.

SEC. 2(F).

SER. NO. 77-053,198, FILED 11-29-2006.

MARK T. MULLEN, EXAMINING ATTORNEY

**Int. Cl.: 20**

**Prior U.S. Cls.: 2, 13, 22, 25, 32 and 50**

**Reg. No. 3,394,026**

**United States Patent and Trademark Office**

**Registered Mar. 11, 2008**

---

**TRADEMARK  
PRINCIPAL REGISTER**

**Eventege**

THE HUGHES GROUP (MARYLAND CORPORATION)  
UNIT F  
9520 GERWIG LANE  
COLUMBIA, MD 21046

FOR: PORTABLE DISPLAY SYSTEMS COMPRISED PRIMARILY OF DISPLAY STANDS AND FABRIC GRAPHICS ATTACHED THERETO FOR USE IN SALES, MARKETING, INFORMATIONAL, TRADE SHOW, AND EDUCATIONAL DISPLAYS, IN CLASS 20 (U.S. CLS. 2, 13, 22, 25, 32 AND 50).

FIRST USE 5-3-2006; IN COMMERCE 5-3-2006.

THE MARK CONSISTS OF STANDARD CHARACTERS WITHOUT CLAIM TO ANY PARTICULAR FONT, STYLE, SIZE, OR COLOR.

SER. NO. 77-053,617, FILED 11-30-2006.

ALYSSA PALADINO, EXAMINING ATTORNEY



**Int. Cl.: 30**

**Prior U.S. Cl.: 46**

**United States Patent and Trademark Office**

**Reg. No. 3,394,027**

**Registered Mar. 11, 2008**

**TRADEMARK  
PRINCIPAL REGISTER**

GRAND AVENUE CHOCOLATES

GRAND AVENUE BRANDS, LLC (CALIFORNIA  
LTD LIAB CO)  
1021 DETROIT AVENUE  
CONCORD, CA 94518

FOR: CHOCOLATE CANDIES; CHOCOLATE  
COVERED NUTS; CHOCOLATE COVERED  
FRUITS; BAKERY GOODS, NAMELY, COOKIES;  
CANDY; CANDY-COATED APPLES; CARAMEL  
APPLES; GLAZED, CARAMEL AND CANDY-  
COATED POPCORN; CARAMELS; CHOCOLATE  
TRUFFLES; COCOA MIXES; MARSHMALLOWS;  
NUT BRITTLES; TOFFEES, IN CLASS 30 (U.S. CL.  
46).

FIRST USE 0-0-1986; IN COMMERCE 0-0-1986.

THE MARK CONSISTS OF STANDARD CHAR-  
ACTERS WITHOUT CLAIM TO ANY PARTICULAR  
FONT, STYLE, SIZE, OR COLOR.

NO CLAIM IS MADE TO THE EXCLUSIVE  
RIGHT TO USE "CHOCOLATES", APART FROM  
THE MARK AS SHOWN.

SER. NO. 77-054,404, FILED 11-30-2006.

SUSAN RICHARDS, EXAMINING ATTORNEY

**Int. Cl.: 25**

**Prior U.S. Cls.: 22 and 39**

**United States Patent and Trademark Office**

**Reg. No. 3,394,028**

**Registered Mar. 11, 2008**

**TRADEMARK  
PRINCIPAL REGISTER**

**DUNE GOOD**

REMMES, JOANNA (UNITED STATES INDIVIDUAL)  
5030 ALZEDA DRIVE  
LA MESA, CA 91941

THE MARK CONSISTS OF STANDARD CHARACTERS WITHOUT CLAIM TO ANY PARTICULAR FONT, STYLE, SIZE, OR COLOR.

FOR: SHIRTS, JACKETS, UNDERWEAR, SOCKS, STOCKING CAPS, HATS, SWEAT SHIRTS, COATS, HEADWEAR, PULLOVERS, SCARFS, TROUSER, PANTS, IN CLASS 25 (U.S. CLS. 22 AND 39).

SER. NO. 77-054,678, FILED 11-30-2006.

FIRST USE 1-1-2006; IN COMMERCE 1-1-2006.

DANIEL BRODY, EXAMINING ATTORNEY

Int. Cls.: 16, 35 and 41

Prior U.S. Cls.: 2, 5, 22, 23, 29, 37, 38, 50, 100, 101, 102  
and 107

Reg. No. 3,394,029

United States Patent and Trademark Office

Registered Mar. 11, 2008

TRADEMARK  
SERVICE MARK  
PRINCIPAL REGISTER



DELTA SIGMA THETA SORORITY, INCORPORATED (D.C. CORPORATION)  
1707 NEW HAMPSHIRE AVENUE, NW  
WASHINGTON, DC 20009

FOR: PUBLICATIONS, NAMELY, BROCHURES, BOOKLETS, AND TEACHING MATERIALS IN THE FIELD OF MENTORING, EDUCATIONAL ACTIVITIES, AND SERVICE LEARNING OPPORTUNITIES DIRECTED PRIMARILY TOWARD AFRICAN AMERICAN FEMALES ON THE TOPICS OF GOAL SETTING, FINANCIAL PLANNING, BUDGETING, DEBT MANAGEMENT, SAVING AND INVESTMENTS, RETIREMENT PLANNING, HOMEOWNERSHIP AND INSURANCE, IN CLASS 16 (U.S. CLS. 2, 5, 22, 23, 29, 37, 38 AND 50).

FIRST USE 5-22-2005; IN COMMERCE 5-22-2005.

FOR: CHARITABLE SERVICES, NAMELY, ORGANIZING AND CONDUCTING VOLUNTEER PROGRAMS AND COMMUNITY SERVICE PROJECTS AND PROVIDING INFORMATION RELATING THERETO THROUGH A GLOBAL COMPUTER NETWORK, IN CLASS 35 (U.S. CLS. 100, 101 AND 102).

FIRST USE 5-22-2005; IN COMMERCE 5-22-2005.

FOR: EDUCATIONAL SERVICES, NAMELY, CONDUCTING CLASSES, SEMINARS, CONFERENCES AND WORKSHOPS FOR AFRICAN AMERICAN FEMALES ON PERSONAL ECONOMIC DEVELOPMENT INCLUDING GOAL SETTING, FI-

NANCIAL PLANNING, BUDGETING, DEBT MANAGEMENT, SAVING AND INVESTMENTS, RETIREMENT PLANNING, HOMEOWNERSHIP AND INSURANCE AND DISTRIBUTION OF COURSE MATERIAL IN CONNECTION THEREWITH, IN CLASS 41 (U.S. CLS. 100, 101 AND 107).

FIRST USE 5-22-2005; IN COMMERCE 5-22-2005.

NO CLAIM IS MADE TO THE EXCLUSIVE RIGHT TO USE "FINANCIAL" AND "WOMAN", APART FROM THE MARK AS SHOWN.

THE COLOR(S) BLACK, RED, AND WHITE IS/ ARE CLAIMED AS A FEATURE OF THE MARK.

THE MARK CONSISTS OF A LADIES HEAD WITH A CURVED LINE APPEARING BELOW FORMING A FEMININE SILHOUETTE HOLDING A DELTA WITH A DOLLAR SIGN INSIDE. THE WORDS "FINANCIAL FORTITUDE FOR THE TOTAL WOMAN" APPEAR VERTICALLY LEFT OF CURVED LINE FOLLOWING THE CONTOURS OF THE CURVED LINE. THE COLOR BLACK APPEARS IN THE OUTLINE OF THE WOMAN, THE ARM OF THE WOMAN AND THE CURVED VERTICAL LINE; THE COLOR RED APPEARS IN THE WORDING OF THE MARK AND IN THE DOLLAR SIGN AND TRIANGLE AROUND THE DOLLAR SIGN, AND THE COLOR WHITE APPEARS IN THE INTERIOR OF THE TRIANGLE, AND THE FACE AND HAIR OF THE WOMAN DESIGN.

SER. NO. 77-055,201, FILED 12-1-2006.

SUNG IN, EXAMINING ATTORNEY

Int. Cl.: 43

Prior U.S. Cls.: 100 and 101

United States Patent and Trademark Office

Reg. No. 3,394,030

Registered Mar. 11, 2008

SERVICE MARK  
PRINCIPAL REGISTER

MAXIM'S  
DE  
PARIS

MAXIM'S LIMITED (UNITED KINGDOM COR-  
PORATION)  
N.E.M. HOUSE  
24 WORPLE ROAD  
WIMBLEDON, LONDON, UNITED KINGDOM  
SW194DH

FOR: HOTEL AND RESTAURANT SERVICES;  
CATERING, BAR AND TEA LOUNGE SERVICES,  
IN CLASS 43 (U.S. CLS. 100 AND 101).

OWNER OF FRANCE REG. NO. 1332220, DATED  
11-25-1985, EXPIRES 11-25-2015.

OWNER OF U.S. REG. NOS. 580,091, 1,423,405 AND  
OTHERS.

NO CLAIM IS MADE TO THE EXCLUSIVE  
RIGHT TO USE "DE PARIS", APART FROM THE  
MARK AS SHOWN.

THE NAME MAXIM DOES NOT IDENTIFY A  
LIVING INDIVIDUAL.

THE ENGLISH TRANSLATION OF THE WORD  
DE PARIS IN THE MARK IS OF PARIS.

SER. NO. 77-055,291, FILED 12-1-2006.

ESTHER A. BORSUK, EXAMINING ATTORNEY

Int. Cl.: 30

Prior U.S. Cl.: 46

United States Patent and Trademark Office

Reg. No. 3,394,031

Registered Mar. 11, 2008

TRADEMARK  
PRINCIPAL REGISTER



GRAND AVENUE BRANDS, LLC (CALIFORNIA  
LTD LIAB CO)  
1021 DETROIT AVENUE  
CONCORD, CA 94518

FOR: CHOCOLATE CANDIES; CHOCOLATE  
COVERED NUTS; CHOCOLATE COVERED  
FRUITS; BAKERY GOODS, NAMELY, COOKIES;  
CANDY; CANDY-COATED APPLES; CARAMEL  
APPLES; GLAZED, CARAMEL AND CANDY-  
COATED POPCORN; CARAMELS; CHOCOLATE  
TRUFFLES; COCOA MIXES; MARSHMALLOWS;  
NUT BRITTLES; TOFFEES, IN CLASS 30 (U.S. CL.  
46).

FIRST USE 0-0-1986; IN COMMERCE 0-0-1986.

NO CLAIM IS MADE TO THE EXCLUSIVE  
RIGHT TO USE "CHOCOLATES", APART FROM  
THE MARK AS SHOWN.

THE MARK CONSISTS OF AN OVAL CONTAIN-  
ING THE WORDS "GRAND AVENUE CHOCO-  
LATES" WITH SMALL STARS AND THE WORDS  
"OUR SEAL OF PERFECTION" AROUND THE  
CIRCUMFERENCE.

SER. NO. 77-055,613, FILED 12-1-2006.

SUSAN RICHARDS, EXAMINING ATTORNEY

**Int. Cl.: 44**

**Prior U.S. Cls.: 100 and 101**

**United States Patent and Trademark Office**

**Reg. No. 3,394,032**

**Registered Mar. 11, 2008**

**SERVICE MARK  
PRINCIPAL REGISTER**

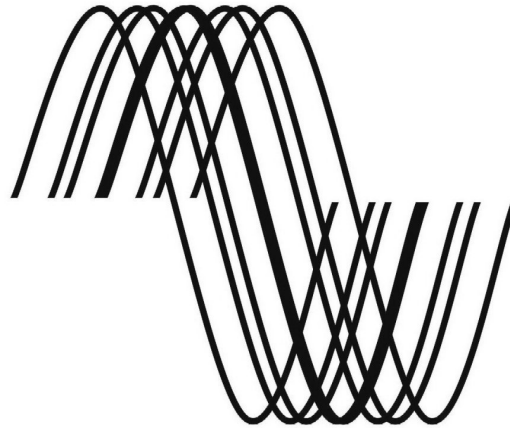

JAMES R. WEBB JR., M.D., P.C. (OKLAHOMA CORPORATION)  
9132 E 101ST PLACE  
TULSA, OK 74133

FOR: MEDICAL RADIOLOGY SERVICES, IN CLASS 44 (U.S. CLS. 100 AND 101).

FIRST USE 5-25-2006; IN COMMERCE 7-1-2006.

THE MARK CONSISTS OF SEVEN CURVED LINES IN A SINE WAVE PATTERN. THE LINES ARE IDENTICAL EXCEPT THAT THE MIDDLE LINE IS THICKER THAN THE OTHERS. SPACING IS IRREGULAR BUT SYMMETRIC CREATING A HELICAL PATTERN.

SER. NO. 77-055,851, FILED 12-2-2006.

TIMOTHY FINNEGAN, EXAMINING ATTORNEY

**Int. Cl.: 9**

**Prior U.S. Cls.: 21, 23, 26, 36 and 38**

**Reg. No. 3,394,033**

**United States Patent and Trademark Office**

**Registered Mar. 11, 2008**

---

**TRADEMARK  
PRINCIPAL REGISTER**

**UNI-MAX**

LASERMAX, INC. (NEW YORK CORPORATION)  
BUILDING B  
3495 WINTON PLACE  
ROCHESTER, NY 14623

THE MARK CONSISTS OF STANDARD CHAR-  
ACTERS WITHOUT CLAIM TO ANY PARTICULAR  
FONT, STYLE, SIZE, OR COLOR.

FOR: LASER POINTING SIGHTS FOR SMALL  
FIREARMS, IN CLASS 9 (U.S. CLS. 21, 23, 26, 36 AND  
38).

SER. NO. 77-056,533, FILED 12-4-2006.

FIRST USE 12-1-2006; IN COMMERCE 12-1-2006.

KELLY BOULTON, EXAMINING ATTORNEY



**Int. Cl.: 9**

**Prior U.S. Cls.: 21, 23, 26, 36 and 38**

**Reg. No. 3,394,034**

**United States Patent and Trademark Office**

**Registered Mar. 11, 2008**

---

**TRADEMARK  
PRINCIPAL REGISTER**

**J-MAX**

LASERMAX, INC. (NEW YORK CORPORATION)  
BUILDING B  
3495 WINTON PLACE  
ROCHESTER, NY 14623

THE MARK CONSISTS OF STANDARD CHAR-  
ACTERS WITHOUT CLAIM TO ANY PARTICULAR  
FONT, STYLE, SIZE, OR COLOR.

FOR: LASER POINTING SIGHTS FOR SMALL  
FIREARMS, IN CLASS 9 (U.S. CLS. 21, 23, 26, 36 AND  
38).

SER. NO. 77-056,537, FILED 12-4-2006.

FIRST USE 12-1-2006; IN COMMERCE 12-1-2006.

KELLY BOULTON, EXAMINING ATTORNEY

**Int. Cl.: 9**

**Prior U.S. Cls.: 21, 23, 26, 36 and 38**

**United States Patent and Trademark Office**

**Reg. No. 3,394,035**

**Registered Mar. 11, 2008**

**TRADEMARK  
PRINCIPAL REGISTER**

# GeniX

XENOCS S.A. (FRANCE CORPORATION)  
19, RUE FRANCOIS BLUMET  
SASSENAGE, FRANCE F-38360

FOR: APPARATUS AND INSTRUMENTS FOR GENERATING AND SUPPLYING ELECTROMAGNETIC RADIATION, IN PARTICULAR, SHORT-WAVE RADIATION, NAMELY, X-RAY SOURCE APPARATUS NOT FOR MEDICAL USE; COMPONENTS FOR AFORESAID APPARATUS AND INSTRUMENTS, NAMELY, OPTICAL MIRRORS FOR REFLECTING AND/OR INFLUENCING ELECTRO-

MAGNETIC RADIATION, NOT FOR MEDICAL USE, IN CLASS 9 (U.S. CLS. 21, 23, 26, 36 AND 38).

OWNER OF FRANCE REG. NO. 063432982, DATED 6-6-2006, EXPIRES 6-6-2016.

THE MARK CONSISTS OF CAPITAL "G", SMALL "ENI", CAPITAL "X".

SER. NO. 77-057,049, FILED 12-5-2006.

ANN E. SAPPENFIELD, EXAMINING ATTORNEY

**Int. Cl.: 7**

**Prior U.S. Cls.: 13, 19, 21, 23, 31, 34 and 35**

**United States Patent and Trademark Office**

**Reg. No. 3,394,036**

**Registered Mar. 11, 2008**

**TRADEMARK  
PRINCIPAL REGISTER**

# Multi-Max

FABRICATION FOR TECHNOLOGY (CALIFORNIA CORPORATION)  
P. O. BOX 573  
ATASCADERO, CA 93423

THE MARK CONSISTS OF STANDARD CHARACTERS WITHOUT CLAIM TO ANY PARTICULAR FONT, STYLE, SIZE, OR COLOR.

FOR: ATTACHMENTS FOR VEHICLES, NAME-  
LY, GRAPPLE BUCKETS AND BLADES FOR MOV-  
ING EARTH AND LOOSE OBJECTS, IN CLASS 7  
(U.S. CLS. 13, 19, 21, 23, 31, 34 AND 35).

SER. NO. 77-057,299, FILED 12-5-2006.

FIRST USE 6-15-2006; IN COMMERCE 6-15-2006.

JUSTINE D. PARKER, EXAMINING ATTORNEY

Prior U.S. Cl.: 200

United States Patent and Trademark Office

Reg. No. 3,394,037

Registered Mar. 11, 2008

COLLECTIVE MEMBERSHIP  
PRINCIPAL REGISTER



WARD, LAURI (UNITED STATES INDIVIDUAL)  
145 EAST 74TH STREET  
NEW YORK, NY 10021

FOR: INDICATING MEMBERSHIP IN A(N) ORGANIZATION OF INTERIOR DECORATORS, IN CLASS 200 (U.S. CL. 200).

FIRST USE 6-10-1996; IN COMMERCE 6-10-1996.

OWNER OF U.S. REG. NO. 3,251,187.

NO CLAIM IS MADE TO THE EXCLUSIVE RIGHT TO USE "INTERIOR," "CERTIFIED MEMBER" AND "NETWORK", APART FROM THE MARK AS SHOWN.

SER. NO. 77-057,461, FILED 12-5-2006.

RENEE MCCRAY, EXAMINING ATTORNEY

**Int. Cls.: 4, 25, 28, 35, 37, 39, 40 and 42**

**Prior U.S. Cls.: 1, 6, 15, 22, 23, 38, 39, 50, 100, 101, 102, 103, 105 and 106**

**Reg. No. 3,394,038**

**United States Patent and Trademark Office**

**Registered Mar. 11, 2008**

**TRADEMARK  
SERVICE MARK  
PRINCIPAL REGISTER**



HESS CORPORATION (DELAWARE CORPORATION)  
1185 AVENUE OF THE AMERICAS  
NEW YORK, NY 10036

FOR: PETROLEUM PRODUCTS, NAMELY, GASOLINE, DIESEL FUEL, FUEL OIL, MOTOR OIL, JET FUEL AND KEROSENE, HEATING OIL, AND NATURAL GAS; GENERAL PURPOSE GREASES; LIQUEFIED PETROLEUM GASES; INDUSTRIAL OILS; ALL PURPOSE LUBRICANTS; AND ILLUMINANTS FOR LAMPS AND CANDLES, IN CLASS 4 (U.S. CLS. 1, 6 AND 15).

FIRST USE 1-5-1961; IN COMMERCE 1-5-1961.

FOR: CLOTHING, NAMELY, SWEATSHIRTS, T-SHIRTS, SHIRTS, HATS AND CAPS, IN CLASS 25 (U.S. CLS. 22 AND 39).

FIRST USE 12-31-1996; IN COMMERCE 12-31-1996.

FOR: TOYS, NAMELY, TOY TRUCKS, CARS, MOTORCYCLES, HELICOPTERS, PLANES AND SHIPS, IN CLASS 28 (U.S. CLS. 22, 23, 38 AND 50).

FIRST USE 12-31-1964; IN COMMERCE 12-31-1964.

FOR: RETAIL GASOLINE SUPPLY SERVICES; CONSULTING SERVICES REGARDING THE MANAGING, THE TIMING AND THE QUANTITIES OF FUEL PURCHASES; BUSINESS MANAGEMENT CONSULTANCY AND ADVISORY SERVICES; AND RETAIL CONVENIENCE AND GROCERY STORE SERVICES, IN CLASS 35 (U.S. CLS. 100, 101 AND 102).

FIRST USE 12-31-1970; IN COMMERCE 12-31-1970.

FOR: GASOLINE STATION SERVICES, NAMELY, SERVICING OF AUTOMOBILES, TRUCKS, VANS, MOTORCYCLES AND OTHER MEANS OF CONVEYANCE; AND OIL, GAS AND MINERAL DRILLING AND EXTRACTION, IN CLASS 37 (U.S. CLS. 100, 103 AND 106).

FIRST USE 4-30-1961; IN COMMERCE 4-30-1961.

FOR: TRANSPORTATION, DISTRIBUTION AND STORAGE OF FUELS, OILS, GASES AND LUBRICANTS BY AIR, RAIL TRUCK, SHIP AND PIPELINE, IN CLASS 39 (U.S. CLS. 100 AND 105).

FIRST USE 12-31-1964; IN COMMERCE 12-31-1964.

FOR: OIL REFINING SERVICES; AND PROCESSING AND PRODUCTION OF PETROLEUM PRODUCTS, NAMELY, OIL, GAS, MINERALS AND FUELS, IN CLASS 40 (U.S. CLS. 100, 103 AND 106).

FIRST USE 12-31-1989; IN COMMERCE 12-31-1989.

FOR: OIL, GAS AND MINERAL EXPLORATION; GEOLOGICAL RESEARCH; GEOLOGICAL, OIL FIELD AND LAND SURVEYING; ENGINEERING; CONSULTATION SERVICES TO THE FIELD OF OIL, GAS AND MINERAL EXPLORATION AND PRODUCTION; ANALYSIS AND DESIGN OF COMPUTER AND DATA PROCESSING SYSTEMS; MATERIAL TESTING; AND SURVEYING, IN CLASS 42 (U.S. CLS. 100 AND 101).

FIRST USE 12-31-1984; IN COMMERCE 12-31-1984.

OWNER OF U.S. REG. NOS. 1,774,017, 1,789,473,  
AND 2,711,693.

THE COLOR(S) GREEN AND WHITE IS/ARE  
CLAIMED AS A FEATURE OF THE MARK.

THE MARK CONSISTS OF A SQUARE SUR-  
ROUNDING THE WORD HESS. THE BORDERS  
OF THE SQUARE AND THE WORD HESS IS  
GREEN; WITHIN THE SQUARE IS THE COLOR  
WHITE.

SER. NO. 77-057,802, FILED 12-6-2006.

BENJAMIN OKEKE, EXAMINING ATTORNEY

**Int. Cl.: 43**

**Prior U.S. Cls.: 100 and 101**

**United States Patent and Trademark Office**

**Reg. No. 3,394,039**

**Registered Mar. 11, 2008**

**SERVICE MARK  
PRINCIPAL REGISTER**

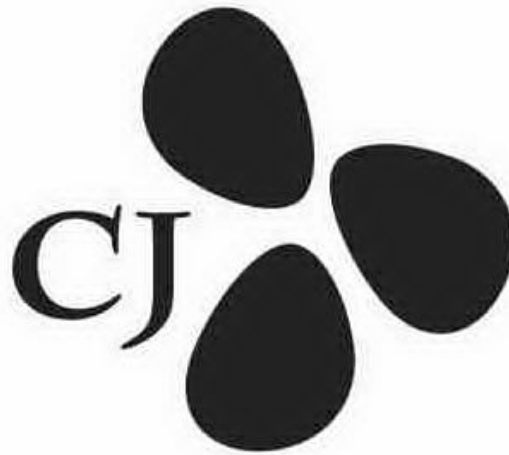

**CJ CORP. (REPUBLIC OF KOREA CORPORATION)  
500, 5GA, NAMDAEMOON-NO, CHUNG-KU  
SEOUL, REPUBLIC OF KOREA**

**FOR: RESTAURANTS; CAFETERIAS; SELF-SERVICE RESTAURANTS; SNACK-BARS; PROVIDING CAMPGROUND FACILITIES, IN CLASS 43 (U.S. CLS. 100 AND 101).**

**OWNER OF REPUBLIC OF KOREA REG. NO. 94364, DATED 12-10-2003, EXPIRES 12-10-2013.**

**OWNER OF U.S. REG. NOS. 3,033,390, 3,033,392 AND OTHERS.**

**SER. NO. 77-058,011, FILED 12-6-2006.**

**MAUREEN DALL, EXAMINING ATTORNEY**

**Int. Cl.: 45**

**Prior U.S. Cls.: 100 and 101**

**United States Patent and Trademark Office**

**Reg. No. 3,394,040**

**Registered Mar. 11, 2008**

**SERVICE MARK  
PRINCIPAL REGISTER**



THE SWANKO GROUP, LLC (FLORIDA LTD  
LIAB CO)  
SUITE C-109  
7757 SW 86TH STREET  
MIAMI, FL 33143

FOR: PROVIDING INFORMATION RELATING  
TO CHRISTIAN PRECEPTS VIA THE INTERNET, IN  
CLASS 45 (U.S. CLS. 100 AND 101).

FIRST USE 5-1-1995; IN COMMERCE 5-1-1995.

THE COLOR(S) GREEN AND WHITE IS/ARE  
CLAIMED AS A FEATURE OF THE MARK.

THE MARK CONSISTS OF THE COLOR GREEN  
APPEARING IN THE WORDING TRUMPETER  
AND THE COLOR WHITE APPEARING IN THE  
WORDING THE AND IN THE DESIGN OF THE  
WINGED FIGURE HOLDING A TRUMPET.

SER. NO. 77-058,214, FILED 12-6-2006.

LESLIE RICHARDS, EXAMINING ATTORNEY



**Int. Cl.: 9**

**Prior U.S. Cls.: 21, 23, 26, 36 and 38**

**United States Patent and Trademark Office**

**Reg. No. 3,394,041**

**Registered Mar. 11, 2008**

**TRADEMARK  
PRINCIPAL REGISTER**

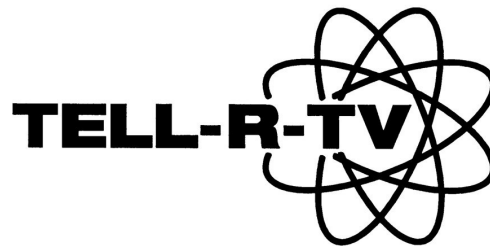

HAMILTON SAFE COMPANY (OHIO CORPORATION)  
3143 PRODUCTION DRIVE  
FAIRFIELD, OH 45014

FOR: AUDIOVISUAL COMMUNICATION SYSTEM COMPOSED OF A VIDEO DISPLAY, CAMERA AND AUDIO CONSOLE, IN CLASS 9 (U.S. CLS. 21, 23, 26, 36 AND 38).

FIRST USE 9-0-1994; IN COMMERCE 9-0-1994.

SER. NO. 77-058,401, FILED 12-6-2006.

LINDA ESTRADA, EXAMINING ATTORNEY

**Int. Cl.: 25**

**Prior U.S. Cls.: 22 and 39**

**United States Patent and Trademark Office**

**Reg. No. 3,394,042**

**Registered Mar. 11, 2008**

**TRADEMARK  
PRINCIPAL REGISTER**

**DOLLS and DIVAS**

L.G. SHLAFFER ASSOCIATES, LLC (NEW JERSEY  
LTD LIAB CO)  
526 W. 26ST STREET  
NEW YORK, NY 100015524

FOR: INFANT AND GIRLS' CLOTHING, NAME-  
LY, SKIRTS, TOPS, DRESSES, PANTS, SHIRTS,  
JACKETS, SOCKS, HATS, CAPS, T-SHIRTS, VESTS;  
OUTERWEAR, NAMELY, COATS; KNITWEAR,  
NAMELY SWEATERS; LEGGINGS, MITTENS,  
GLOVES, SLEEPWEAR, INFANT DIAPER COVERS,  
BODYSUITS, AND BOOTIES, IN CLASS 25 (U.S. CLS.  
22 AND 39).

FIRST USE 12-5-2006; IN COMMERCE 12-5-2006.

THE MARK CONSISTS OF STANDARD CHAR-  
ACTERS WITHOUT CLAIM TO ANY PARTICULAR  
FONT, STYLE, SIZE, OR COLOR.

SER. NO. 77-059,102, FILED 12-7-2006.

BARBARA GAYNOR, EXAMINING ATTORNEY

**Int. Cl.: 36**

**Prior U.S. Cls.: 100, 101 and 102**

**United States Patent and Trademark Office**

**Reg. No. 3,394,043**

**Registered Mar. 11, 2008**

**SERVICE MARK  
PRINCIPAL REGISTER**

**A HEALTHY DOSE OF  
INNOVATION**

WELLPOINT, INC. (INDIANA CORPORATION)  
120 MONUMENT CIRCLE  
INDIANAPOLIS, IN 46204

FOR: INSURANCE UNDERWRITING SERVICES IN THE FIELDS OF HEALTH, WORKER'S COMPENSATION, OCCUPATIONAL HEALTH, MENTAL HEALTH AND LIFE, PRE-PAID DENTAL AND HEALTH CARE PLANS, PREFERRED PROVIDER PLANS IN THE FIELD OF HEALTH, MENTAL HEALTH, BEHAVIORAL HEALTH AND DENTAL HEALTH CARE; INSURANCE UNDERWRITING SERVICES FOR PRE-PAID HEALTH AND DENTAL CARE PROVIDED VIA HEALTH MAINTENANCE ORGANIZATIONS AND PREFERRED PROVIDER ORGANIZATIONS; INSURANCE ADMINISTRATION SERVICES IN THE FIELDS OF HEALTH, WORKER'S COMPENSATION, OCCUPATIONAL HEALTH, MENTAL HEALTH AND LIFE, PRE-PAID DENTAL AND HEALTH CARE PLANS, PREFER-

RED PROVIDER PLANS IN THE FIELDS OF HEALTH, MENTAL HEALTH AND BEHAVIORAL HEALTH, AND PREFERRED PROVIDER PLANS IN THE FIELD OF DENTAL HEALTH CARE; INSURANCE ADMINISTRATION SERVICES FOR PRE-PAID HEALTH AND DENTAL CARE PROVIDED VIA HEALTH MAINTENANCE ORGANIZATIONS AND PREFERRED PROVIDER ORGANIZATIONS, IN CLASS 36 (U.S. CLS. 100, 101 AND 102).

FIRST USE 6-1-2003; IN COMMERCE 6-1-2003.

THE MARK CONSISTS OF STANDARD CHARACTERS WITHOUT CLAIM TO ANY PARTICULAR FONT, STYLE, SIZE, OR COLOR.

SER. NO. 77-059,534, FILED 12-7-2006.

JENNY PARK, EXAMINING ATTORNEY

**Int. Cl.: 33**

**Prior U.S. Cls.: 47 and 49**

**United States Patent and Trademark Office**

**Reg. No. 3,394,044**

**Registered Mar. 11, 2008**

**TRADEMARK  
PRINCIPAL REGISTER**

**THE CLIMBER**

CLIF BAR FAMILY WINERY AND FARM, LLC  
(CALIFORNIA LTD LIAB CO)  
1030 MAIN STREET, SUITE 300  
ST. HELENA, CA 94574

THE MARK CONSISTS OF STANDARD CHAR-  
ACTERS WITHOUT CLAIM TO ANY PARTICULAR  
FONT, STYLE, SIZE, OR COLOR.

FOR: WINE, IN CLASS 33 (U.S. CLS. 47 AND 49).

SER. NO. 77-059,548, FILED 12-7-2006.

FIRST USE 11-10-2006; IN COMMERCE 11-10-2006.

JAMES GRIFFIN, EXAMINING ATTORNEY

**Int. Cl.: 35**

**Prior U.S. Cls.: 100, 101 and 102**

**United States Patent and Trademark Office**

**Reg. No. 3,394,045**

**Registered Mar. 11, 2008**

**SERVICE MARK  
PRINCIPAL REGISTER**

**COASTLINE**

BAKER DISTRIBUTING COMPANY LLC (DELA-  
WARE LTD LIAB CO)  
SUITE 901  
2665 SOUTH BAYSHORE DRIVE  
COCONUT GROVE, FL 33133

FOR: DISTRIBUTORSHIP SERVICES IN THE  
FIELD OF REFRIGERATION, HEATING, VENTI-  
LATING AND AIR-CONDITIONING EQUIPMENT  
AND RELATED PARTS AND SUPPLIES , IN CLASS  
35 (U.S. CLS. 100, 101 AND 102).

FIRST USE 1-1-1992; IN COMMERCE 1-1-1992.

THE MARK CONSISTS OF STANDARD CHAR-  
ACTERS WITHOUT CLAIM TO ANY PARTICULAR  
FONT, STYLE, SIZE, OR COLOR.

SER. NO. 77-060,245, FILED 12-8-2006.

PAUL CROWLEY, EXAMINING ATTORNEY

**Int. Cl.: 41**

**Prior U.S. Cls.: 100, 101 and 107**

**United States Patent and Trademark Office**

**Reg. No. 3,394,046**

**Registered Mar. 11, 2008**

**SERVICE MARK  
PRINCIPAL REGISTER**

**SURROUND**

ESPN, INC. (DELAWARE CORPORATION)  
ESPN PLAZA  
BRISTOL, CT 06010

FOR: ENTERTAINMENT SERVICES IN THE NATURE OF ONGOING RADIO AND TELEVISION PROGRAMS FEATURING A VARIETY OF SPORTS; ENTERTAINMENT SERVICES, NAMELY, PROVIDING SPORTS-THEMED PROGRAMMING, INFORMATION RELATING TO SPORTS, SWEEPSTAKES RELATING TO SPORTS, WEBCAM FEEDS OF SPORTS, VIDEOS, FILM CLIPS AND OTHER MULTIMEDIA MATERIALS AND ON-LINE COMPUTER

VIDEO GAMES, ALL VIA INTERNET WEBSITES, TELEVISION, WIRELESS AND MOBILE DEVICES, IN CLASS 41 (U.S. CLS. 100, 101 AND 107).

FIRST USE 9-30-2006; IN COMMERCE 9-30-2006.

THE MARK CONSISTS OF STANDARD CHARACTERS WITHOUT CLAIM TO ANY PARTICULAR FONT, STYLE, SIZE, OR COLOR.

SER. NO. 77-060,289, FILED 12-8-2006.

GRETTA YAO, EXAMINING ATTORNEY

**Int. Cls.: 25 and 28**

**Prior U.S. Cls.: 22, 23, 38, 39 and 50**

**United States Patent and Trademark Office**

**Reg. No. 3,394,047**

**Registered Mar. 11, 2008**

**TRADEMARK  
PRINCIPAL REGISTER**

**SHINKENDO**

OBATA, TOSHISHIRO (UNITED STATES INDIVIDUAL)  
522 EAST SAXON AVENUE  
SAN GABRIEL, CA 91776

FOR: CLOTHING, NAMELY, MARTIAL ARTS UNIFORMS, PRACTICE UNIFORMS (DOGI), PLEADED SKIRTS FOR FORMAL KIMONOS (HAKAMA), SASH BANDS FOR KIMONO (OBI), JACKETS, VESTS (MACHI-GI), T-SHIRTS, SHIRTS, SWEATSHIRTS, JEANS, KIMONOS, JAPANESE STYLE SANDALS (ZORI), JAPANESE STYLE SOCKS (TABI), BASEBALL CAPS, VISORS, HEADSCARVES/BANDANA (HACHIMAKI), BANDANA (TENUGUI), IN CLASS 25 (U.S. CLS. 22 AND 39).

FIRST USE 1-1-1990; IN COMMERCE 1-1-1990.

FOR: SPORTING GOODS AND TRAINING EQUIPMENT FOR MARTIAL ARTS, NAMELY, WAXWOOD BOKUTO ("WAXWOOD SWORD"), WAXWOOD BO ("WAXWOOD LONG STICK"), BOKEN ("WOODEN SWORD"), PADDED SHINKENDO NITOKEN (PADDED DOUBLE SWORDS), CUT-

TING STAND FOR SWORD CUTTING TRAINING, IAITO ("UNSHARPENED SWORD FOR TRAINING"), SPARRING GEAR, SWORD HAND GUARD ("TSUBA"), SHINAI TRAINING EQUIPMENT (EQUIPMENT FOR SWORD TRAINING), SWORD BELT, IN CLASS 28 (U.S. CLS. 22, 23, 38 AND 50).

FIRST USE 1-1-1990; IN COMMERCE 1-1-1990.

THE MARK CONSISTS OF STANDARD CHARACTERS WITHOUT CLAIM TO ANY PARTICULAR FONT, STYLE, SIZE, OR COLOR.

OWNER OF U.S. REG. NOS. 1,967,826 AND 2,627,236.

THE FOREIGN WORDING IN THE MARK TRANSLATES INTO ENGLISH AS THE WAY OF THE REAL SWORD.

SER. NO. 77-060,707, FILED 12-9-2006.

Laurie Kaufman, Examining Attorney

**Int. Cl.: 9**

**Prior U.S. Cls.: 21, 23, 26, 36 and 38**

**United States Patent and Trademark Office**

**Reg. No. 3,394,048**

**Registered Mar. 11, 2008**

**TRADEMARK  
PRINCIPAL REGISTER**

**OPENMRS**

OPENMRS, LLC (INDIANA LTD LIAB CO)  
1050 WISHARD BLVD. RG6  
INDIANAPOLIS, IN 46202

FOR: COMPUTER SOFTWARE DEVELOPMENT  
TOOLS, IN CLASS 9 (U.S. CLS. 21, 23, 26, 36 AND 38).

FIRST USE 2-14-2006; IN COMMERCE 2-14-2006.

THE MARK CONSISTS OF STANDARD CHAR-  
ACTERS WITHOUT CLAIM TO ANY PARTICULAR  
FONT, STYLE, SIZE, OR COLOR.

NO CLAIM IS MADE TO THE EXCLUSIVE  
RIGHT TO USE "OPEN", APART FROM THE MARK  
AS SHOWN.

SER. NO. 77-061,321, FILED 12-11-2006.

ERIN FALK, EXAMINING ATTORNEY



**Int. Cl.: 35**

**Prior U.S. Cls.: 100, 101 and 102**

**United States Patent and Trademark Office**

**Reg. No. 3,394,049**

**Registered Mar. 11, 2008**

**SERVICE MARK  
PRINCIPAL REGISTER**



QUALITY BICYCLE PRODUCTS, INC. (MINNESOTA CORPORATION)  
6400 WEST 105TH STREET  
BLOOMINGTON, MN 55438

THE MARK CONSISTS OF A LOGO COMPRISING A STYLIZED LETTER Q AND Q-ACTIVE MARK.

FOR: WHOLESALE DISTRIBUTORSHIPS FEATURING PRODUCTS IN THE FIELDS OF CYCLING, RUNNING, TRIATHLONS, AND SKIING, IN CLASS 35 (U.S. CLS. 100, 101 AND 102).

SER. NO. 77-061,355, FILED 12-11-2006.

FIRST USE 9-1-2006; IN COMMERCE 9-1-2006.

ANDREA BUTLER, EXAMINING ATTORNEY

**Int. Cl.: 35**

**Prior U.S. Cls.: 100, 101 and 102**

**United States Patent and Trademark Office**

**Reg. No. 3,394,050**

**Registered Mar. 11, 2008**

**SERVICE MARK  
PRINCIPAL REGISTER**

**Q-ACTIVE**

QUALITY BICYCLE PRODUCTS, INC. (MINNESOTA CORPORATION)  
6400 WEST 105TH STREET  
BLOOMINGTON, MN 55438

THE MARK CONSISTS OF STANDARD CHARACTERS WITHOUT CLAIM TO ANY PARTICULAR FONT, STYLE, SIZE, OR COLOR.

FOR: WHOLESALE DISTRIBUTORSHIPS FEATURING PRODUCTS IN THE FIELDS OF CYCLING, RUNNING, TRIATHLONS, AND SKIING, IN CLASS 35 (U.S. CLS. 100, 101 AND 102).

SER. NO. 77-061,362, FILED 12-11-2006.

FIRST USE 9-1-2006; IN COMMERCE 9-1-2006.

ANDREA BUTLER, EXAMINING ATTORNEY

**Int. Cl.: 31**

**Prior U.S. Cls.: 1 and 46**

**United States Patent and Trademark Office**

**Reg. No. 3,394,051**

**Registered Mar. 11, 2008**

**TRADEMARK  
PRINCIPAL REGISTER**

**MINI-ME**

BALL HORTICULTURAL COMPANY (ILLINOIS  
CORPORATION)  
622 TOWN ROAD  
WEST CHICAGO, IL 60185

FOR: LIVE FLOWERING PLANTS AND SEEDS  
FOR HORTICULTURAL PURPOSES, IN CLASS 31  
(U.S. CLS. 1 AND 46).

FIRST USE 9-6-2007; IN COMMERCE 9-6-2007.

THE MARK CONSISTS OF STANDARD CHAR-  
ACTERS WITHOUT CLAIM TO ANY PARTICULAR  
FONT, STYLE, SIZE, OR COLOR.

SER. NO. 77-061,450, FILED 12-11-2006.

MATTHEW MCDOWELL, EXAMINING ATTOR-  
NEY

**Int. Cl.: 37**

**Prior U.S. Cls.: 100, 103 and 106**

**United States Patent and Trademark Office**

**Reg. No. 3,394,052**

**Registered Mar. 11, 2008**

**SERVICE MARK  
PRINCIPAL REGISTER**

# Universal Elevator

LUND, SAM (UNITED STATES INDIVIDUAL)  
P.O.BOX 848  
452 A YACHT CLUB DR.  
ROCKWALL, TX 75032

FOR: ELEVATOR INSTALLATION AND REPAIR;  
INSTALLATION SERVICES OF ELEVATORS AND  
LIFTS; REPAIR OR MAINTENANCE OF ELEVATORS,  
IN CLASS 37 (U.S. CLS. 100, 103 AND 106).

FIRST USE 7-29-1999; IN COMMERCE 7-29-1999.

THE MARK CONSISTS OF STANDARD CHARACTERS WITHOUT CLAIM TO ANY PARTICULAR FONT, STYLE, SIZE, OR COLOR.

NO CLAIM IS MADE TO THE EXCLUSIVE RIGHT TO USE "ELEVATOR", APART FROM THE MARK AS SHOWN.

SEC. 2(F) AS TO "UNIVERSAL"..

SER. NO. 77-062,194, FILED 12-12-2006.

SCOTT BIBB, EXAMINING ATTORNEY

**Int. Cl.: 9**

**Prior U.S. Cls.: 21, 23, 26, 36 and 38**

**United States Patent and Trademark Office**

**Reg. No. 3,394,053**

**Registered Mar. 11, 2008**

**TRADEMARK  
PRINCIPAL REGISTER**

**MDS POWER**

MDS POWER, INC. (CANADA CORPORATION)  
P.O. BOX 532  
CHAMPLAIN, NY 12919

THE MARK CONSISTS OF STANDARD CHARACTERS WITHOUT CLAIM TO ANY PARTICULAR FONT, STYLE, SIZE, OR COLOR.

FOR: ELECTRICAL AND ELECTRONIC EQUIPMENT, NAMELY POWER INVERTERS; BATTERY CHARGERS; DC-DC CONVERTERS; POWER SUPPLIES; RECTIFIERS; FREQUENCY CONVERTERS; POWER LINE CONDITIONERS; VOLTAGE SURGE PROTECTORS AND UNINTERRUPTED POWER SUPPLIES, IN CLASS 9 (U.S. CLS. 21, 23, 26, 36 AND 38).

NO CLAIM IS MADE TO THE EXCLUSIVE RIGHT TO USE POWER, APART FROM THE MARK AS SHOWN.

SER. NO. 77-062,200, FILED 12-12-2006.

FIRST USE 1-1-2006; IN COMMERCE 1-1-2006.

VERNA BETH RIRIE, EXAMINING ATTORNEY

**Prior U.S. Cl.: B**

**United States Patent and Trademark Office**

**Reg. No. 3,394,054**

Registered Mar. 11, 2008

**CERTIFICATION MARK  
PRINCIPAL REGISTER**

**INTERIOR REFINER**

LAURI WARD (UNITED STATES INDIVIDUAL)  
145 EAST 74TH STREET  
NEW YORK, NY 10021

FOR: INTERIOR DECORATING SERVICES, IN  
CLASS B (U.S. CL. B).

FIRST USE 0-0-1996; IN COMMERCE 0-0-1996.

THE MARK CONSISTS OF STANDARD CHAR-  
ACTERS WITHOUT CLAIM TO ANY PARTICULAR  
FONT, STYLE, SIZE, OR COLOR.

OWNER OF U.S. REG. NO. 3,251,187.

NO CLAIM IS MADE TO THE EXCLUSIVE  
RIGHT TO USE "INTERIOR", APART FROM THE  
MARK AS SHOWN.

THE CERTIFICATION MARK, AS USED BY  
PERSONS AUTHORIZED BY THE CERTIFIER,  
CERTIFIES THAT THE SERVICES PROVIDED  
HAVE BEEN PERFORMED BY PERSONS WHO  
HAVE SUCCESSFULLY COMPLETED AN INTER-  
IOR DECORATOR TRAINING PROGRAM ESTAB-  
LISHED BY THE CERTIFIER AND HAVE MET THE  
STANDARDS OF COMPETENCE SET BY THE CER-  
TIFIER.

SER. NO. 77-062,611, FILED 12-12-2006.

RENEE MCCRAY, EXAMINING ATTORNEY

**Int. Cls.: 35 and 41**

**Prior U.S. Cls.: 100, 101, 102 and 107**

**United States Patent and Trademark Office**

**Reg. No. 3,394,055**

**Registered Mar. 11, 2008**

**SERVICE MARK  
PRINCIPAL REGISTER**

# Do You Play?

SPORTS 4 GOOD, INC. (CALIFORNIA CORPORATION)  
660 4TH STREET #205  
SAN FRANCISCO, CA 94107

FOR: COORDINATION OF RECREATIONAL SPORTING OPPORTUNITIES FOR INDIVIDUALS WHO WISH TO PARTICIPATE IN TEAM LEAGUE SPORTS; ADMINISTRATION OF COMMUNITY RECREATIONAL SPORTS LEAGUES; PROVIDING A WEBSITE THAT PROVIDES RECREATIONAL SPORTS LEAGUE MANAGEMENT; MARKETING AND PROMOTING OF SPECIAL EVENTS AND SPORTING EVENTS OF OTHERS, IN CLASS 35 (U.S. CLS. 100, 101 AND 102).

FIRST USE 1-1-2005; IN COMMERCE 1-1-2005.

FOR: PROVIDING AMUSEMENT AND ENTERTAINMENT THROUGH THE MEDIUM OF SPORTS GAMES AND THE ORGANIZATION OF SPORTS GAMES, SOCIAL CLUBS IN THE NATURE OF A

SPORTS LEAGUE; PROVIDING AMUSEMENT AND ENTERTAINMENT THROUGH THE ORGANIZATION AND PRODUCTION OF SPORTS TOURNAMENTS; PROVIDING SPORTS TRAINING COURSES FOR IMPROVING SPORTS PERFORMANCE, IN CLASS 41 (U.S. CLS. 100, 101 AND 107).

FIRST USE 1-1-2005; IN COMMERCE 1-1-2005.

THE MARK CONSISTS OF STANDARD CHARACTERS WITHOUT CLAIM TO ANY PARTICULAR FONT, STYLE, SIZE, OR COLOR.

NO CLAIM IS MADE TO THE EXCLUSIVE RIGHT TO USE "PLAY", APART FROM THE MARK AS SHOWN.

SER. NO. 77-062,818, FILED 12-12-2006.

JOHN WILKE, EXAMINING ATTORNEY

**Int. Cl.: 25**

**Prior U.S. Cls.: 22 and 39**

**United States Patent and Trademark Office**

**Reg. No. 3,394,056**

**Registered Mar. 11, 2008**

**TRADEMARK  
PRINCIPAL REGISTER**

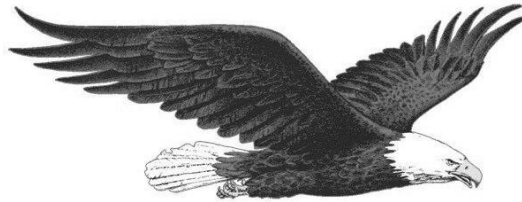

UNITED TECHNOLOGIES CORPORATION (DE-  
LAWARE CORPORATION)  
ONE FINANCIAL PLAZA  
HARTFORD, CT 06101

OWNER OF U.S. REG. NOS. 272,651 AND 790,295.

FOR: T-SHIRTS, IN CLASS 25 (U.S. CLS. 22 AND  
39).

SER. NO. 77-063,055, FILED 12-13-2006.

FIRST USE 7-4-1990; IN COMMERCE 7-4-1990.

BARBARA BROWN, EXAMINING ATTORNEY



**Int. Cl.: 35**

**Prior U.S. Cls.: 100, 101 and 102**

**United States Patent and Trademark Office**

**Reg. No. 3,394,057**

**Registered Mar. 11, 2008**

**SERVICE MARK  
PRINCIPAL REGISTER**

**ROCK THE BOAT**

AMERICA TRUE (CALIFORNIA CORPORATION)  
PIER 40  
SAN FRANCISCO, CA 94107

FOR: CHARITABLE SERVICES, NAMELY, ORGANIZING AND CONDUCTING COMMUNITY SERVICES EVENTS IN THE FIELD OF SAILING, IN CLASS 35 (U.S. CLS. 100, 101 AND 102).

FIRST USE 0-0-2000; IN COMMERCE 0-0-2000.

THE MARK CONSISTS OF STANDARD CHARACTERS WITHOUT CLAIM TO ANY PARTICULAR FONT, STYLE, SIZE, OR COLOR.

OWNER OF U.S. REG. NOS. 2,323,346, 2,342,995, AND 2,432,616.

SER. NO. 77-063,190, FILED 12-13-2006.

WON TEAK OH, EXAMINING ATTORNEY

**Int. Cl.: 45**

**Prior U.S. Cls.: 100 and 101**

**United States Patent and Trademark Office**

**Reg. No. 3,394,058**

**Registered Mar. 11, 2008**

**SERVICE MARK  
PRINCIPAL REGISTER**

**ALPINE CONCIERGE**

DESTINATION HOTELS & RESORTS (COLOR-  
ADO CORPORATION)  
SUITE 450  
10333 EAST DRY CREEK ROAD  
ENGLEWOOD, CO 80112

FOR: CONCIERGE SERVICES FOR OTHERS  
COMPRISING MAKING REQUESTED PERSONAL  
ARRANGEMENTS AND RESERVATIONS AND  
PROVIDING CUSTOMER-SPECIFIC INFORMA-  
TION TO MEET INDIVIDUAL NEEDS RENDERED  
TOGETHER IN A BUSINESS ESTABLISHMENTS,  
OFFICE BUILDINGS, HOTELS, RESIDENTIAL  
COMPLEXS AND HOMES, IN CLASS 45 (U.S. CLS.  
100 AND 101).

FIRST USE 11-22-2006; IN COMMERCE 11-22-2006.

THE MARK CONSISTS OF STANDARD CHAR-  
ACTERS WITHOUT CLAIM TO ANY PARTICULAR  
FONT, STYLE, SIZE, OR COLOR.

NO CLAIM IS MADE TO THE EXCLUSIVE  
RIGHT TO USE "CONCIERGE", APART FROM  
THE MARK AS SHOWN.

SER. NO. 77-063,559, FILED 12-13-2006.

LINDA POWELL, EXAMINING ATTORNEY

**Int. Cl.: 35**

**Prior U.S. Cls.: 100, 101 and 102**

**United States Patent and Trademark Office**

**Reg. No. 3,394,059**

**Registered Mar. 11, 2008**

**SERVICE MARK  
PRINCIPAL REGISTER**



BAKER DISTRIBUTING COMPANY LLC (DELA-  
WARE LTD LIAB CO)  
SUITE 901  
2665 SOUTH BAYSHORE DRIVE  
COCONUT GROVE, FL 33133

FIRST USE 1-1-1992; IN COMMERCE 1-1-1992.

OWNER OF U.S. REG. NO. 2,108,677.

FOR: DISTRIBUTORSHIP SERVICES IN THE  
FIELD OF REFRIGERATION, HEATING, VENTI-  
LATING AND AIR-CONDITIONING EQUIPMENT  
AND RELATED PARTS AND SUPPLIES , IN CLASS  
35 (U.S. CLS. 100, 101 AND 102).

SER. NO. 77-063,617, FILED 12-13-2006.

PAUL CROWLEY, EXAMINING ATTORNEY

**Int. Cl.: 9**

**Prior U.S. Cls.: 21, 23, 26, 36 and 38**

**Reg. No. 3,394,060**

**United States Patent and Trademark Office**

**Registered Mar. 11, 2008**

**TRADEMARK  
PRINCIPAL REGISTER**

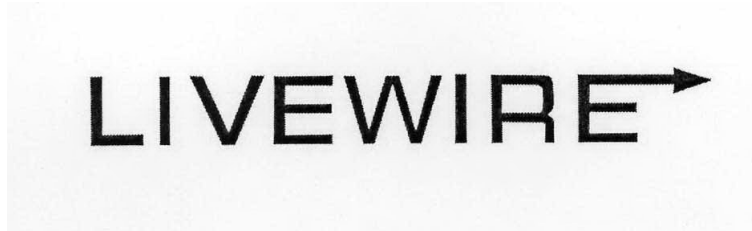

SCT, LLC (FLORIDA LTD LIAB CO)  
SUITE 1900  
975 FLORIDA CENTRAL PARKWAY  
LONGWOOD, FL 32750

FASTER, HAVE MORE HORSE POWER AND GET  
BETTER GAS MILEAGE, IN CLASS 9 (U.S. CLS. 21,  
23, 26, 36 AND 38).

FIRST USE 9-1-2006; IN COMMERCE 9-1-2006.

SER. NO. 77-063,675, FILED 12-13-2006.

FOR: ELECTRONIC AUTOMOTIVE TUNING DE-  
VICE, NAMELY, ELECTRONIC CONTROL HARD-  
WARE UNIT WHICH INTERFACES WITH A CAR'S  
DRIVE-TRAIN COMPUTER SYSTEM AND REPRO-  
GRAMS THE CAR'S MICROCHIP TO MAKE IT GO

ROBERT LAVACHE, EXAMINING ATTORNEY

**Int. Cl.: 16**

**Prior U.S. Cls.: 2, 5, 22, 23, 29, 37, 38 and 50**

**United States Patent and Trademark Office**

**Reg. No. 3,394,061**

**Registered Mar. 11, 2008**

**TRADEMARK  
PRINCIPAL REGISTER**

# In the Neighborhood

IN THE NEIGHBORHOOD (CALIFORNIA CORPORATION)  
9126 ELK GROVE BLVD.  
ELK GROVE, CA 95624

FOR: MAGAZINES FEATURING TOPICS OF INTEREST FOR RESIDENTIAL HOMEOWNERS; NEWSLETTERS IN THE FIELD OF TOPICS OF INTEREST FOR RESIDENTIAL HOMEOWNERS , IN CLASS 16 (U.S. CLS. 2, 5, 22, 23, 29, 37, 38 AND 50).

FIRST USE 3-1-2005; IN COMMERCE 2-1-2006.

THE MARK CONSISTS OF STANDARD CHARACTERS WITHOUT CLAIM TO ANY PARTICULAR FONT, STYLE, SIZE, OR COLOR.

SER. NO. 77-063,863, FILED 12-13-2006.

KRISTIN DAHLING, EXAMINING ATTORNEY

**Int. Cl.: 9**

**Prior U.S. Cls.: 21, 23, 26, 36 and 38**

**Reg. No. 3,394,062**

**United States Patent and Trademark Office**

**Registered Mar. 11, 2008**

**TRADEMARK  
PRINCIPAL REGISTER**

**FULL CIRCLE**

ACRONIS INC. (BR.VIRGIN ISLANDS COR-  
PORATION)  
C/O ACRONIS, INC.  
395 OYSTER POINT BLVD  
SOUTH SAN FRANCISCO, CA 94080

ENVIRONMENT TO ANOTHER; ALL OF THE  
ABOVE COMPUTER SOFTWARE SOLD TO DATA  
CENTERS AND HOSTING SERVICE PROVIDERS,  
IN CLASS 9 (U.S. CLS. 21, 23, 26, 36 AND 38).

FOR: COMPUTER SOFTWARE FOR USE IN  
SERVER MIGRATION; COMPUTER SOFTWARE  
FOR USE IN MIGRATION OF OPERATING SYS-  
TEMS, APPLICATIONS AND DATA FROM ONE  
COMPUTER TO ANOTHER; COMPUTER SOFT-  
WARE FOR USE IN MIGRATION OF OPERATING  
SYSTEM, APPLICATIONS AND DATA FROM ONE  
VIRTUAL ENVIRONMENT TO ANOTHER; AND  
COMPUTER SOFTWARE FOR USE IN CONVER-  
SION OF DATA DURING MIGRATION FROM ONE

FIRST USE 12-13-2006; IN COMMERCE 12-13-2006.

THE MARK CONSISTS OF STANDARD CHAR-  
ACTERS WITHOUT CLAIM TO ANY PARTICULAR  
FONT, STYLE, SIZE, OR COLOR.

SER. NO. 77-063,864, FILED 12-13-2006.

LINDSEY RUBIN, EXAMINING ATTORNEY

**Int. Cl.: 44**

**Prior U.S. Cls.: 100 and 101**

**United States Patent and Trademark Office**

**Reg. No. 3,394,063**

**Registered Mar. 11, 2008**

**SERVICE MARK  
PRINCIPAL REGISTER**

**GATEWAY HEALTH PLAN**

GATEWAY HEALTH PLAN, L.P. (PENNSYLVANIA LIMITED PARTNERSHIP)  
U.S. STEEL TOWER, 40TH FLOOR  
600 GRANT STREET  
PITTSBURGH, PA 15219

FOR: PROVIDING MANAGED HEALTH CARE SERVICES FOR MEMBERS, IN CLASS 44 (U.S. CLS. 100 AND 101).

FIRST USE 1-1-1993; IN COMMERCE 1-1-1993.

OWNER OF U.S. REG. NO. 2,526,416.

NO CLAIM IS MADE TO THE EXCLUSIVE RIGHT TO USE "HEALTH PLAN", APART FROM THE MARK AS SHOWN.

THE MARK CONSISTS OF A DRAWING OF A STEEL ARCH BRIDGE POSITIONED ABOVE THE WORDS GATEWAY HEALTH PLAN.

SER. NO. 77-063,871, FILED 12-13-2006.

STEVEN JACKSON, EXAMINING ATTORNEY

**Int. Cl.: 10**

**Prior U.S. Cls.: 26, 39 and 44**

**United States Patent and Trademark Office**

**Reg. No. 3,394,064**

**Registered Mar. 11, 2008**

**TRADEMARK  
PRINCIPAL REGISTER**

**RHS**

TORNIER (FRANCE SOCIETE PAR ACTIONS  
SIMPLIFEE)  
RUE DOYEN GOSSE  
SAINT ISMIER, FRANCE 38330

PRIORITY CLAIMED UNDER SEC. 44(D) ON  
FRANCE APPLICATION NO. 063440905, FILED 7-  
17-2006, REG. NO. 063440905, DATED 7-17-2006, EX-  
PIRES 7-16-2016.

FOR: ARTIFICIAL JOINTS, IN CLASS 10 (U.S.  
CLS. 26, 39 AND 44).

FIRST USE 6-2-2006; IN COMMERCE 6-2-2006.

SER. NO. 77-063,938, FILED 12-14-2006.

THE MARK CONSISTS OF STANDARD CHAR-  
ACTERS WITHOUT CLAIM TO ANY PARTICULAR  
FONT, STYLE, SIZE, OR COLOR.

JAY FLOWERS, EXAMINING ATTORNEY



**Int. Cl.: 35**

**Prior U.S. Cls.: 100, 101 and 102**

**United States Patent and Trademark Office**

**Reg. No. 3,394,065**

**Registered Mar. 11, 2008**

**SERVICE MARK  
PRINCIPAL REGISTER**

**VISUAL WATER**

THE WALDRON COMPANY, LLC (COLORADO  
LTD LIAB CO)  
PO BOX 1011  
CONIFER, CO 80433

FOR: ON-LINE RETAIL STORE SERVICES FEATURING WATER FEATURES, NAMELY, INDOOR AND OUTDOOR WATER FOUNTAINS, AND AQUARIUMS, IN CLASS 35 (U.S. CLS. 100, 101 AND 102).

FIRST USE 7-1-2006; IN COMMERCE 7-1-2006.

THE MARK CONSISTS OF STANDARD CHARACTERS WITHOUT CLAIM TO ANY PARTICULAR FONT, STYLE, SIZE, OR COLOR.

NO CLAIM IS MADE TO THE EXCLUSIVE RIGHT TO USE "WATER", APART FROM THE MARK AS SHOWN.

SER. NO. 77-064,248, FILED 12-14-2006.

JOHN DALIER, EXAMINING ATTORNEY

**Int. Cl.: 35**

**Prior U.S. Cls.: 100, 101 and 102**

**United States Patent and Trademark Office**

**Reg. No. 3,394,066**

**Registered Mar. 11, 2008**

**SERVICE MARK  
PRINCIPAL REGISTER**

**SUPPLYING THE WORLD ONE  
SLICE AT A TIME**

PIZZA EQUIPMENT SUPPLY, INC. (NORTH  
CAROLINA CORPORATION)  
1437 E FRANKLIN BLVD., SUITE 232  
GASTONIA, NC 28054

THE MARK CONSISTS OF STANDARD CHAR-  
ACTERS WITHOUT CLAIM TO ANY PARTICULAR  
FONT, STYLE, SIZE, OR COLOR.

FOR: RETAIL STORE AND WHOLESALE STORE  
SERVICES IN THE FIELD OF PIZZA MAKING  
EQUIPMENT, IN CLASS 35 (U.S. CLS. 100, 101 AND  
102).

SER. NO. 77-064,313, FILED 12-14-2006.

FIRST USE 8-1-2005; IN COMMERCE 8-1-2005.

GEORGE LORENZO, EXAMINING ATTORNEY

**Int. Cl.: 35**

**Prior U.S. Cls.: 100, 101 and 102**

**United States Patent and Trademark Office**

**Reg. No. 3,394,067**

**Registered Mar. 11, 2008**

**SERVICE MARK  
PRINCIPAL REGISTER**

**WORLD TRAVEL MARKET**

REED EXHIBITIONS LIMITED (UNITED KING-  
DOM CORPORATION)  
GATEWAY HOUSE  
28 THE QUADRANT  
RICHMOND,SURREY, UNITED KINGDOM TW91D

FOR: ORGANISATION, ARRANGING AND CON-  
DUCTING OF EXHIBITIONS, TRADE SHOWS AND  
EXPOSITIONS IN THE FIELD OF TRAVEL, IN  
CLASS 35 (U.S. CLS. 100, 101 AND 102).

FIRST USE 0-0-1998; IN COMMERCE 0-0-1998.

THE MARK CONSISTS OF STANDARD CHAR-  
ACTERS WITHOUT CLAIM TO ANY PARTICULAR  
FONT, STYLE, SIZE, OR COLOR.

NO CLAIM IS MADE TO THE EXCLUSIVE  
RIGHT TO USE "TRAVEL MARKET", APART  
FROM THE MARK AS SHOWN.

SER. NO. 77-064,331, FILED 12-14-2006.

SHAUNIA CARLYLE, EXAMINING ATTORNEY

Prior U.S. Cl.: B

United States Patent and Trademark Office

Reg. No. 3,394,068

Registered Mar. 11, 2008

**CERTIFICATION MARK  
PRINCIPAL REGISTER**



SHARON HAGGERTY (UNITED STATES INDIVIDUAL)  
ELEVEN EAST PARK AVENUE  
GREENVILLE, SC 296011629

FOR: CLINICAL ANAPLASTOLOGY, NAMELY, THE PREPARATION AND FITTING OF PROSTHETIC DEVICES, IN CLASS B (U.S. CL. B).

FIRST USE 6-30-2003; IN COMMERCE 6-30-2003.

NO CLAIM IS MADE TO THE EXCLUSIVE RIGHT TO USE "BOARD FOR CERTIFICATION IN

CLINICAL ANAPLASTOLOGY", APART FROM THE MARK AS SHOWN.

THE CERTIFICATION MARK, AS USED BY PERSONS AUTHORIZED BY THE CERTIFIER, CERTIFIES THAT THE PERSON DISPLAYING SAID MARK HAS COMPLETED TESTS ADMINISTERED BY THE CERTIFIER IN A SATISFACTORY MANNER AND IS COMPETENT IN THE FIELD OF CLINICAL ANAPLASTOLOGY.

SER. NO. 77-064,333, FILED 12-14-2006.

JOHN WILKE, EXAMINING ATTORNEY

**Int. Cls.: 9, 35 and 42**

**Prior U.S. Cls.: 21, 23, 26, 36, 38, 100, 101 and 102**

**United States Patent and Trademark Office**

**Reg. No. 3,394,069**

**Registered Mar. 11, 2008**

**TRADEMARK  
SERVICE MARK  
PRINCIPAL REGISTER**

# SOFTWARE

SOFTWARE LIMITED (UNITED KINGDOM CORPORATION)  
ROYAL TRUST HOUSE, 60 ATHOL STREET  
DOUGLAS, ISLE OF MAN, UNITED KINGDOM IM11JD

FOR: DOWNLOADABLE COMPUTER SOFTWARE VIA THE INTERNET, COMPUTER NETWORKS, OR CD ROM'S AND SOFTWARE AVAILABLE ON CD-ROM FOR USE IN ENCRYPTION; DOWNLOADABLE COMPUTER SOFTWARE VIA THE INTERNET, COMPUTER NETWORKS, OR CD ROM'S AND SOFTWARE AVAILABLE ON CD-ROM FOR USE IN THE FIELD OF MANAGEMENT OF INTELLECTUAL PROPERTY RIGHTS AND DIGITAL RIGHTS, IN CLASS 9 (U.S. CLS. 21, 23, 26, 36 AND 38).

FIRST USE 8-15-2000; IN COMMERCE 8-15-2000.

FOR: ONLINE RETAIL SERVICES FEATURING COMPUTER SOFTWARE; BUSINESS MANAGEMENT SERVICES IN THE FIELD OF MANAGEMENT OF INTELLECTUAL PROPERTY RIGHTS AND DIGITAL RIGHTS; DISTRIBUTORSHIP SER-

VICES IN THE FIELD OF COMPUTER SOFTWARE AND PRODUCTS REDUCED TO DIGITAL FORM, IN CLASS 35 (U.S. CLS. 100, 101 AND 102).

FIRST USE 8-15-2000; IN COMMERCE 8-15-2000.

FOR: DATA AND SOFTWARE ENCRYPTION SERVICES; PROVIDING USE OF NON-DOWNLOADABLE COMPUTER SOFTWARE FOR USE IN ENCRYPTION; PROVIDING USE OF NON-DOWNLOADABLE SOFTWARE FOR USE IN THE FIELD OF MANAGEMENT OF INTELLECTUAL PROPERTY AND DIGITAL RIGHTS, IN CLASS 42 (U.S. CLS. 100 AND 101).

FIRST USE 8-15-2000; IN COMMERCE 8-15-2000.

THE MARK CONSISTS OF STANDARD CHARACTERS WITHOUT CLAIM TO ANY PARTICULAR FONT, STYLE, SIZE, OR COLOR.

SER. NO. 77-064,338, FILED 12-14-2006.

JOHN WILKE, EXAMINING ATTORNEY

**Int. Cl.: 40**

**Prior U.S. Cls.: 100, 103 and 106**

**United States Patent and Trademark Office**

**Reg. No. 3,394,070**

**Registered Mar. 11, 2008**

**SERVICE MARK  
PRINCIPAL REGISTER**

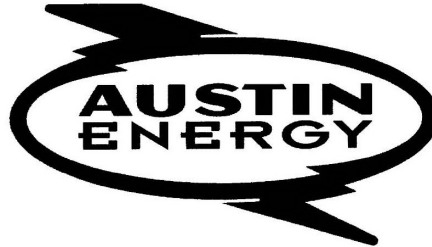

CITY OF AUSTIN, TEXAS, THE (TEXAS MUNICIPAL CORPORATION)  
721 BARTON SPRINGS ROAD  
P.O. BOX 1088  
AUSTIN, TX 78704

FOR: GENERATION AND PRODUCTION OF ELECTRIC POWER, IN CLASS 40 (U.S. CLS. 100, 103 AND 106).

FIRST USE 1-31-1998; IN COMMERCE 1-31-1998.

OWNER OF U.S. REG. NOS. 2,418,564, 2,585,631 AND OTHERS.

NO CLAIM IS MADE TO THE EXCLUSIVE RIGHT TO USE "ENERGY", APART FROM THE MARK AS SHOWN.

THE MARK CONSISTS OF AUSTIN ENERGY SURROUNDED BY AN OVAL AND LIGHTNING BOLT.

SEC. 2(F) "AUSTIN".

SER. NO. 77-064,342, FILED 12-14-2006.

BRIAN CALLAGHAN, EXAMINING ATTORNEY

**Int. Cl.: 36**

**Prior U.S. Cls.: 100, 101 and 102**

**United States Patent and Trademark Office**

**Reg. No. 3,394,071**

**Registered Mar. 11, 2008**

**SERVICE MARK  
PRINCIPAL REGISTER**

**ESSENTIAL STAFFCARE**

BCS INSURANCE COMPANY (OHIO CORPORATION)  
2 MID AMERICA PLAZA, SUITE 200  
OAK BROOK TERRACE, IL 60181

FOR: HEALTH CARE INSURANCE UNDER-  
WRITING SERVICES, IN CLASS 36 (U.S. CLS. 100,  
101 AND 102).

FIRST USE 8-30-2004; IN COMMERCE 8-30-2004.

THE MARK CONSISTS OF STANDARD CHAR-  
ACTERS WITHOUT CLAIM TO ANY PARTICULAR  
FONT, STYLE, SIZE, OR COLOR.

OWNER OF U.S. REG. NO. 3,080,423.

SER. NO. 77-064,570, FILED 12-14-2006.

BRIAN NEVILLE, EXAMINING ATTORNEY

**Int. Cl.: 36**

**Prior U.S. Cls.: 100, 101 and 102**

**United States Patent and Trademark Office**

**Reg. No. 3,394,072**

**Registered Mar. 11, 2008**

**SERVICE MARK  
PRINCIPAL REGISTER**



BCS INSURANCE COMPANY (OHIO CORPORATION)  
2 MID AMERICA PLAZA, SUITE 200  
OAK BROOK TERRACE, IL 60181

FOR: HEALTH CARE INSURANCE UNDER-  
WRITING SERVICES, IN CLASS 36 (U.S. CLS. 100,  
101 AND 102).

FIRST USE 8-30-2004; IN COMMERCE 8-30-2004.

OWNER OF U.S. REG. NO. 3,080,423.

SER. NO. 77-064,587, FILED 12-14-2006.

BRIAN NEVILLE, EXAMINING ATTORNEY



**Int. Cl.: 42**

**Prior U.S. Cls.: 100 and 101**

**United States Patent and Trademark Office**

**Reg. No. 3,394,073**

**Registered Mar. 11, 2008**

**SERVICE MARK  
PRINCIPAL REGISTER**

**HDIL**

BAKER HUGHES INCORPORATED (DELA-  
WARE CORPORATION)  
PO BOX 4740  
HOUSTON, TX 772104740

FOR: EXPLORATION AND SEARCHING OF OIL  
AND GAS; GAS EXPLORATION; GEOPHYSICAL  
EXPLORATION FOR THE OIL, GAS AND MINING  
INDUSTRIES; INSPECTION OF OIL FIELDS; MI-  
NERAL AND OIL ASSAYING; OIL EXPLORATION;  
OIL FIELD EXPLORATION; OIL FIELD SURVEY-  
ING; OIL PROSPECTING; OIL PROSPECTING,  
NAMELY, WELL LOGGING AND TESTING; OIL  
WELL TESTING; SURVEYING OF OIL BEDS AND

FIELDS; WIRELINING FOR OIL WELLS, IN CLASS  
42 (U.S. CLS. 100 AND 101).

FIRST USE 0-0-1997; IN COMMERCE 0-0-1997.

THE MARK CONSISTS OF STANDARD CHAR-  
ACTERS WITHOUT CLAIM TO ANY PARTICULAR  
FONT, STYLE, SIZE, OR COLOR.

SEC. 2(F).

SER. NO. 77-064,910, FILED 12-15-2006.

ALICIA COLLINS, EXAMINING ATTORNEY

**Int. Cl.: 6**

**Prior U.S. Cls.: 2, 12, 13, 14, 23, 25 and 50**

**Reg. No. 3,394,074**

**United States Patent and Trademark Office**

**Registered Mar. 11, 2008**

---

**TRADEMARK  
PRINCIPAL REGISTER**

**EquiBond**

CLARK, REUBEN E. (UNITED STATES INDIVIDUAL)  
313 BARTHEL DR.  
CARY, NC 27513

FOR: CASTINGS, FOILS, POWDER, AND ROLLED, DRAWN OR EXTRUDED SEMI-FINISHED ARTICLES OF COPPER OR ITS ALLOYS; TUBES OF COPPER ALLOYS, IN CLASS 6 (U.S. CLS. 2, 12, 13, 14, 23, 25 AND 50).

FIRST USE 12-14-2006; IN COMMERCE 12-14-2006.

THE MARK CONSISTS OF STANDARD CHARACTERS WITHOUT CLAIM TO ANY PARTICULAR FONT, STYLE, SIZE, OR COLOR.

SER. NO. 77-065,094, FILED 12-15-2006.

CAROLINE WOOD, EXAMINING ATTORNEY

**Int. Cl.: 3**

**Prior U.S. Cls.: 1, 4, 6, 50, 51 and 52**

**Reg. No. 3,394,075**

**United States Patent and Trademark Office**

**Registered Mar. 11, 2008**

**TRADEMARK  
PRINCIPAL REGISTER**

**FAVOR**

JILLINDA GLENN (UNITED STATES INDIVIDUAL)  
436 NORTH ARMISTEAD STREET, APT. 201  
ALEXANDRIA, VA 22312

FOR: COSMETIC LOTIONS, OILS, AND CREAMS FOR THE FEET, LEGS, BODY, ARMS, HANDS, NAILS, FACE, EYES, LIPS AND HAIR FOR MEN, WOMEN, AND CHILDREN; COSMETIC CLEANSERS FOR THE FEET, LEGS, BODY, ARMS, HANDS, AND NAILS FOR MEN, WOMEN, AND CHILDREN; COSMETIC CLEANSERS FOR THE FACE, EYES, LIPS, AND HAIR FOR MEN, WOMEN, AND CHILDREN, NAMELY, SOAPS, SCRUBS, TONERS, SHAMPOOS, AND MAKE UP REMOVERS; COSMETIC LOTIONS, OILS, CREAMS, AND CLEANSERS, NAMELY, BATH LOTION, BATH OIL, BATH CREAM, BATH SOAP, CUTICLE CREAM, COLD CREAM, EXFOLIANTS, LIP BALM, LIP CREAM, NIGHT CREAM, SHAVING LOTION, AND SHAVING CREAM; SHEA BUTTER BASED PRODUCTS, NAMELY, CREAMS AND LOTIONS FOR THE FEET, LEGS, BODY, ARMS, HANDS, NAILS, FACE,

EYES, LIPS AND HAIR FOR MEN, WOMEN, AND CHILDREN; HAIR CARE PRODUCTS NAMELY, SHAMPOO, CONDITIONER, STYLING GEL, STYLING MOUSSE, HAIR POMADE, HAIR GREASE, AND HAIR OIL FOR MEN, WOMEN, AND CHILDREN; NAIL CARE PRODUCTS NAMELY NAIL OIL, NAIL POLISH, NAIL POLISH REMOVER, AND CUTICLE LUBRICANTS FOR MEN, WOMEN, AND CHILDREN, IN CLASS 3 (U.S. CLS. 1, 4, 6, 50, 51 AND 52).

FIRST USE 1-0-2006; IN COMMERCE 1-0-2006.

THE MARK CONSISTS OF STANDARD CHARACTERS WITHOUT CLAIM TO ANY PARTICULAR FONT, STYLE, SIZE, OR COLOR.

SER. NO. 77-065,145, FILED 12-15-2006.

KATHERINE CONNOLLY, EXAMINING ATTORNEY

**Int. Cl.: 36**

**Prior U.S. Cls.: 100, 101 and 102**

**United States Patent and Trademark Office**

**Reg. No. 3,394,076**

**Registered Mar. 11, 2008**

**SERVICE MARK  
PRINCIPAL REGISTER**



**PATIENT ACCESS NETWORK FOUNDATION  
(D.C. NON-PROFIT CORPORATION)**

**PO BOX 221858**

**CHARLOTTE, NC 282221858**

**FOR: FOUNDATION SERVICES, NAMELY, PROVIDING FINANCIAL ASSISTANCE TO UNDERINSURED PATIENTS TO HELP MEET COST-SHARING OBLIGATIONS ASSOCIATED WITH PRESCRIPTION DRUG THERAPY FOR A WIDE RANGE OF DISEASE TYPES, IN CLASS 36 (U.S. CLS. 100, 101 AND 102).**

**FIRST USE 5-1-2004; IN COMMERCE 5-1-2004.**

**THE COLOR(S) BLUE, RED AND WHITE IS/ARE CLAIMED AS A FEATURE OF THE MARK.**

**THE MARK CONSISTS OF THE STYLIZED REPRESENTATION OF A FOUR BOX DESIGN FEATURING A STICK-FIGURE HUMAN DESIGN APPEARING IN THE COLOR WHITE SUPERIMPOSED ON A BLUE BOX IN THE UPPER LEFT CORNER OF THE MARK, A SUN DESIGN APPEARING IN THE COLOR WHITE SUPERIMPOSED ON A RED BOX IN THE UPPER RIGHT CORNER OF THE MARK, A GLOBE DESIGN APPEARING IN THE COLOR WHITE SUPERIMPOSED ON A RED BOX IN THE LOWER LEFT CORNER OF THE MARK AND A HAND DESIGN APPEARING IN THE COLOR WHITE SUPERIMPOSED ON A BLUE BOX IN THE LOWER RIGHT CORNER OF THE MARK.**

**SER. NO. 77-065,190, FILED 12-15-2006.**

**CHARISMA HAMPTON, EXAMINING ATTORNEY**

**Int. Cl.: 11**

**Prior U.S. Cls.: 13, 21, 23, 31 and 34**

**United States Patent and Trademark Office**

**Reg. No. 3,394,077**

**Registered Mar. 11, 2008**

**TRADEMARK  
PRINCIPAL REGISTER**

**FRESNELITE**

STRAND LIGHTING, INC. (DELAWARE CORPORATION)  
6603 DARIN WAY  
CYPRESS, CA 90630

FOR: ELECTRICALLY OPERATED LIGHT PROJECTORS FOR INDOOR AND OUTDOOR ILLUMINATION, NAMELY, SPOTLIGHTS AND STRUCTURAL PARTS THEREFOR, IN CLASS 11 (U.S. CLS. 13, 21, 23, 31 AND 34).

FIRST USE 11-11-1936; IN COMMERCE 11-11-1936.

THE MARK CONSISTS OF STANDARD CHARACTERS WITHOUT CLAIM TO ANY PARTICULAR FONT, STYLE, SIZE, OR COLOR.

SER. NO. 77-065,282, FILED 12-15-2006.

INGRID C. EULIN, EXAMINING ATTORNEY

**Int. Cl.: 9**

**Prior U.S. Cls.: 21, 23, 26, 36 and 38**

**United States Patent and Trademark Office**

**Reg. No. 3,394,078**

**Registered Mar. 11, 2008**

**TRADEMARK  
PRINCIPAL REGISTER**

**LIGHT PALETTE**

STRAND LIGHTING, INC. (DELAWARE CORPORATION)

6603 DARIN WAY

CYPRESS, CA 90630

FOR: PROGRAMMABLE COMPUTERIZED ELECTRONIC APPARATUS FOR CONTROLLING THEATRICAL AND TELEVISION LIGHTING, IN CLASS 9 (U.S. CLS. 21, 23, 26, 36 AND 38).

FIRST USE 6-7-1978; IN COMMERCE 6-7-1978.

THE MARK CONSISTS OF STANDARD CHARACTERS WITHOUT CLAIM TO ANY PARTICULAR FONT, STYLE, SIZE, OR COLOR.

OWNER OF U.S. REG. NO. 1,133,042.

NO CLAIM IS MADE TO THE EXCLUSIVE RIGHT TO USE "LIGHT", APART FROM THE MARK AS SHOWN.

SER. NO. 77-066,149, FILED 12-18-2006.

INGRID C. EULIN, EXAMINING ATTORNEY

Int. Cl.: 25

Prior U.S. Cls.: 22 and 39

United States Patent and Trademark Office

Reg. No. 3,394,079

Registered Mar. 11, 2008

TRADEMARK  
PRINCIPAL REGISTER



KIRSCHNER, JEFF (UNITED STATES INDIVIDUAL)  
10201 LINDLEY AVE K181  
NORTHRIDGE, CA 91325

FOR: HATS; JACKETS; LADIES' UNDERWEAR; PANTS; PULLOVERS; SHIRTS; SHOES; SHORT-SLEEVED OR LONG-SLEEVED T-SHIRTS; SOCKS; SWEATERS; T-SHIRTS; TANK TOPS, IN CLASS 25 (U.S. CLS. 22 AND 39).

FIRST USE 1-0-2004; IN COMMERCE 1-0-2004.

NO CLAIM IS MADE TO THE EXCLUSIVE RIGHT TO USE THREADS, APART FROM THE MARK AS SHOWN.

THE MARK CONSISTS OF A CIRCLE WITH AN ABSTRACT DESIGN AND THE STYLIZED TEXT OF THE WORDING "DISTRACTION THREADS".

SER. NO. 77-066,182, FILED 12-18-2006.

RONALD R. SUSSMAN, EXAMINING ATTORNEY

**Int. Cl.: 35**

**Prior U.S. Cls.: 100, 101 and 102**

**United States Patent and Trademark Office**

**Reg. No. 3,394,080**

**Registered Mar. 11, 2008**

**SERVICE MARK  
PRINCIPAL REGISTER**



CHAINDRUGSTORE.NET INCORPORATED (DE-  
LAWARE CORPORATION)  
413 NORTH LEE STREET  
ALEXANDRIA, VA 22314

FOR: COMPUTER SERVICES, NAMELY, PRO-  
VIDING ONLINE INFORMATION IN THE FIELD  
OF DRUG STORE AND PHARMACY MERCHAN-  
DISING FOR MANUFACTURERS, SERVICE PRO-  
VIDERS, AND RETAILERS IN THE DRUG STORE  
AND PHARMACY FIELD, IN CLASS 35 (U.S. CLS.  
100, 101 AND 102).

FIRST USE 7-1-2006; IN COMMERCE 7-1-2006.

OWNER OF U.S. REG. NOS. 2,540,042 AND  
2,568,687.

NO CLAIM IS MADE TO THE EXCLUSIVE  
RIGHT TO USE "PHARMACY", APART FROM  
THE MARK AS SHOWN.

THE MARK CONSISTS OF THE WORDS CHAIN-  
DRUGSTORE.NET THE LINK TO PHARMACY  
AND THE DESIGN OF TWO SQUARES HAVING  
ROUNDED CORNERS AND A SEMICIRCLE RE-  
MOVED FROM EACH SIDE OF EACH SQUARE  
FIGURE. THE TWO SQUARE FIGURES ARE SEPA-  
RATED BY A SMALL FILLED-IN CIRCLE WHICH  
APPEARS WITHIN THE SEMICIRCULAR CUTOUT  
PORTIONS OF THE OPPOSING SIDES OF EACH  
SQUARE FIGURE.

SEC. 2(F) AS TO "CHAINDRUGSTORE.NET".

SER. NO. 77-066,310, FILED 12-18-2006.

GEOFFREY FOSDICK, EXAMINING ATTORNEY



**Int. Cls.: 12 and 42**

**Prior U.S. Cls.: 19, 21, 23, 31, 35, 44, 100 and 101**

**United States Patent and Trademark Office**

**Reg. No. 3,394,081**

**Registered Mar. 11, 2008**

**TRADEMARK  
SERVICE MARK  
PRINCIPAL REGISTER**

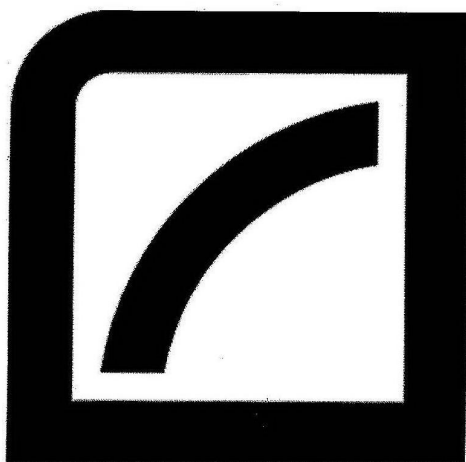

MORADIAN, NORICK B. (UNITED STATES INDIVIDUAL)  
2120 EUNICE STREET  
BERKELEY, CA 947091417

FOR: SUSPENSION SYSTEMS FOR VEHICLES IN THE NATURE OF SUSPENSION STABILIZATION DAMPING SYSTEMS; PARTS OF STEERING UNITS FOR LAND VEHICLES IN THE NATURE OF STEERING STABILIZATION DAMPING SYSTEMS; AND WHEEL SUSPENSION DAMPERS, IN CLASS 12 (U.S. CLS. 19, 21, 23, 31, 35 AND 44).

FIRST USE 1-10-2002; IN COMMERCE 1-10-2002.

FOR: ENGINEERING CONSULTANCY SERVICES, NAMELY, ENGINEERING FOR THE DESIGN AND MANUFACTURE OF TOROIDAL DAMPERS

AND DAMPER SYSTEMS, ENGINEERING FOR CUSTOM DAMPING SOLUTIONS AND SYSTEMS, CONSULTATION AND ENGINEERING SOLUTIONS ON HYDRAULIC, PNEUMATIC OR COMBINATION OF BOTH HYDRAULIC/PNEUMATIC DAMPERS AND DAMPER SYSTEMS, IN CLASS 42 (U.S. CLS. 100 AND 101).

FIRST USE 1-10-2002; IN COMMERCE 1-10-2002.

THE MARK CONSISTS OF A RADIAL QUARTER WITHIN A GENERALLY SQUARE BOX HAVING A ROUNDED UPPER LEFT HAND CORNER.

SER. NO. 77-066,376, FILED 12-18-2006.

B. PARADEWELAI, EXAMINING ATTORNEY

**Int. Cls.: 9 and 16**

**Prior U.S. Cls.: 2, 5, 21, 22, 23, 26, 29, 36, 37, 38 and 50**

**Reg. No. 3,394,082**

**United States Patent and Trademark Office**

**Registered Mar. 11, 2008**

**TRADEMARK  
PRINCIPAL REGISTER**

**INFORMATION TECHNOLOGIES  
FOR TOTAL BUSINESS  
SOLUTIONS**

COMPUTATA, INC. (PENNSYLVANIA CORPORATION)  
2701 COMMERCE WAY  
PHILADELPHIA, PA 19154

FOR: DOWNLOADABLE ELECTRONIC PUBLICATIONS, NAMELY, NEWSLETTERS IN THE FIELD OF INFORMATION TECHNOLOGY, IN CLASS 9 (U.S. CLS. 21, 23, 26, 36 AND 38).

FIRST USE 1-31-2003; IN COMMERCE 1-31-2003.

FOR: PRINTED PUBLICATIONS, NAMELY, NEWSLETTERS IN THE FIELD OF INFORMATION TECHNOLOGY, IN CLASS 16 (U.S. CLS. 2, 5, 22, 23, 29, 37, 38 AND 50).

FIRST USE 1-31-2003; IN COMMERCE 1-31-2003.

THE MARK CONSISTS OF STANDARD CHARACTERS WITHOUT CLAIM TO ANY PARTICULAR FONT, STYLE, SIZE, OR COLOR.

NO CLAIM IS MADE TO THE EXCLUSIVE RIGHT TO USE "INFORMATION TECHNOLOGIES", APART FROM THE MARK AS SHOWN.

SER. NO. 77-066,459, FILED 12-18-2006.

TEJBIR SINGH, EXAMINING ATTORNEY

**Int. Cl.: 5**

**Prior U.S. Cls.: 6, 18, 44, 46, 51 and 52**

**United States Patent and Trademark Office**

**Reg. No. 3,394,083**

**Registered Mar. 11, 2008**

**TRADEMARK  
PRINCIPAL REGISTER**

**VIRGAN**

LABORATOIRES THEA (FRANCE CORPORATION)  
12, RUE LOUIS BLERIOT  
CLERMONT-FERRAND, FRANCE 63100

FOR: OPHTHALMIC GELS FOR THE TREATMENT OF OCULAR HERPES, AVAILABLE ONLY VIA OPHTHALMOLOGISTS, IN CLASS 5 (U.S. CLS. 6, 18, 44, 46, 51 AND 52).

THE MARK CONSISTS OF STANDARD CHARACTERS WITHOUT CLAIM TO ANY PARTICULAR FONT, STYLE, SIZE, OR COLOR.

OWNER OF FRANCE REG. NO. 93456516, DATED 2-23-1993, EXPIRES 1-23-2013.

SER. NO. 77-066,514, FILED 12-18-2006.

ESTHER BELENKER, EXAMINING ATTORNEY

**Int. Cls.: 35 and 42**

**Prior U.S. Cls.: 100, 101 and 102**

**United States Patent and Trademark Office**

**Reg. No. 3,394,084**

**Registered Mar. 11, 2008**

**SERVICE MARK  
PRINCIPAL REGISTER**

**CONNECTING BRANDS WITH  
YOUTH**

FUSE LLC (VERMONT LTD LIAB CO)  
431 PINE STREET  
BURLINGTON, VT 05401

FOR: CONSULTING IN THE FIELD OF MARKETING, CONSULTING IN THE FIELD OF DEVELOPMENT OF CREATIVE ELEMENTS USED IN MARKETING, AND CONSULTING IN THE FIELD OF PRODUCT NAMING; DEVELOPMENT, MANAGEMENT AND IMPLEMENTATION OF MARKETING EVENTS FOR OTHERS; PUBLIC RELATIONS SERVICES; DEVELOPMENT, MANAGEMENT AND IMPLEMENTATION OF ADVERTISING AND PROMOTIONAL MEDIA EVENTS FOR OTHERS; WRITING ADVERTISING COPY FOR OTHERS, PLANNING AND PLACING ADVERTISING IN VARIOUS MEDIA FOR OTHERS, DESIGN OF ADVERTISEMENTS FOR OTHERS, ADVERTISING AGENCY SERVICES; MARKET RESEARCH IN SUPPORT OF MARKETING, PROMOTIONAL BRAND DEVELOPMENT SERVICES;

ADVERTISING SERVICES, CONDUCTING MARKETING EFFECTIVENESS EVALUATIONS FOR OTHERS RELATING TO POTENTIAL SPONSORSHIP OPPORTUNITIES, IN CLASS 35 (U.S. CLS. 100, 101 AND 102).

FIRST USE 8-1-2004; IN COMMERCE 8-1-2004.

FOR: GRAPHIC ART DESIGN SERVICES, AND DESIGN AND DEVELOPMENT OF WEB SITES FOR OTHERS, IN CLASS 42 (U.S. CLS. 100 AND 101).

FIRST USE 8-1-2004; IN COMMERCE 8-1-2004.

THE MARK CONSISTS OF STANDARD CHARACTERS WITHOUT CLAIM TO ANY PARTICULAR FONT, STYLE, SIZE, OR COLOR.

SER. NO. 77-066,674, FILED 12-18-2006.

DAVID H. STINE, EXAMINING ATTORNEY

**Int. Cl.: 25**

**Prior U.S. Cls.: 22 and 39**

**United States Patent and Trademark Office**

**Reg. No. 3,394,085**

**Registered Mar. 11, 2008**

**TRADEMARK  
PRINCIPAL REGISTER**



WIDGET MANAGEMENT, LLC (FLORIDA LTD  
LIAB CO)

265 SOUTH FEDERAL HIGHWAY #128

DEERFIELD BEACH, FL 33441

FOR: REMOVABLE ATTACHMENTS FOR  
STRAPLESS SHOES THAT ARE SOLD OVER THE  
INTERNET AND WHOLESAL TO DISTRIBUTORS  
FOR THE RETAIL MARKET, NAMELY, REMOVA-  
BLE STRAPS FOR SHOES , IN CLASS 25 (U.S. CLS. 22  
AND 39).

FIRST USE 12-31-2005; IN COMMERCE 2-28-2006.

NO CLAIM IS MADE TO THE EXCLUSIVE  
RIGHT TO USE "HEELSTRAPS.COM", APART  
FROM THE MARK AS SHOWN.

THE MARK CONSISTS OF THE STYLIZED  
WORDING "HEELSTRAPS.COM" HAVING THE  
DESIGN OF A SILHOUETTE OF A WOMAN SIT-  
TING ON TOP OF THE LETTER "H" AND HAVING  
HER LEGS BETWEEN THE LETTER "H" AND THE  
FIRST INSTANCE OF THE LETTER "E".

SER. NO. 77-066,916, FILED 12-18-2006.

JAY BESCH, EXAMINING ATTORNEY

**Int. Cl.: 41**

**Prior U.S. Cls.: 100, 101 and 107**

**United States Patent and Trademark Office**

**Reg. No. 3,394,086**

**Registered Mar. 11, 2008**

**SERVICE MARK  
PRINCIPAL REGISTER**

**INNOVATIVE MONKEY  
PRODUCTIONS**

CAMPUS CRUSADE FOR CHRIST, INC. (CALI-  
FORNIA CORPORATION)  
ATTN: GENERAL COUNSELS OFFICE  
100 LAKE HART DRIVE 3500  
ORLANDO, FL 328320100

FOR: ENTERTAINMENT SERVICES, NAMELY,  
FILM AND VIDEO PRODUCTION SERVICES; PRO-  
VISION OF MOTION PICTURES AND ON-LINE  
VIDEOS RELATING TO RELIGION, SPIRITUAL,  
CULTURAL AND RELIGIOUS ISSUES AND VA-  
LUES, IN CLASS 41 (U.S. CLS. 100, 101 AND 107).

FIRST USE 12-15-2006; IN COMMERCE 12-15-2006.

THE MARK CONSISTS OF STANDARD CHAR-  
ACTERS WITHOUT CLAIM TO ANY PARTICULAR  
FONT, STYLE, SIZE, OR COLOR.

NO CLAIM IS MADE TO THE EXCLUSIVE  
RIGHT TO USE "PRODUCTIONS", APART FROM  
THE MARK AS SHOWN.

SER. NO. 77-067,063, FILED 12-19-2006.

BRIAN NEVILLE, EXAMINING ATTORNEY

**Int. Cl.: 41**

**Prior U.S. Cls.: 100, 101 and 107**

**United States Patent and Trademark Office**

**Reg. No. 3,394,087**

**Registered Mar. 11, 2008**

---

**SERVICE MARK  
PRINCIPAL REGISTER**

**ABSINTHE**

RV ENTERTAINMENT LLC (NEW YORK LTD  
LIAB CO)  
22 WEST 19TH STREET, 5TH FLOOR  
NEW YORK, NY 10011

THE MARK CONSISTS OF STANDARD CHAR-  
ACTERS WITHOUT CLAIM TO ANY PARTICULAR  
FONT, STYLE, SIZE, OR COLOR.

FOR: ENTERTAINMENT IN THE NATURE OF  
LIVE MUSICAL, VARIETY, THEATER AND CIR-  
CUS PERFORMANCES, IN CLASS 41 (U.S. CLS. 100,  
101 AND 107).

SER. NO. 77-067,202, FILED 12-19-2006.

FIRST USE 7-10-2006; IN COMMERCE 7-10-2006.

DEIRDRE ROBERTSON, EXAMINING ATTORNEY

Prior U.S. Cl.: A

United States Patent and Trademark Office

Reg. No. 3,394,088

Registered Mar. 11, 2008

**CERTIFICATION MARK  
PRINCIPAL REGISTER**



Conforms to  
ASTM D 4236

THE ART & CREATIVE MATERIALS INSTITUTE, INC. (NEW YORK NON-PROFIT CORPORATION)  
2ND FLOOR  
1280 MAIN STREET  
HANSON, MA 02341

FOR: ART, CRAFT, AND CERAMIC MATERIALS, IN CLASS A (U.S. CL. A).

FIRST USE 11-24-1998; IN COMMERCE 12-31-1999.

NO CLAIM IS MADE TO THE EXCLUSIVE RIGHT TO USE "ART & CREATIVE MATERIALS INSTITUTE CERTIFIED" AND "CONFORMS TO ASTM D 4236", APART FROM THE MARK AS SHOWN.

THE CERTIFICATION MARK, AS USED BY AN AUTHORIZED PERSON, IDENTIFIES ARTS AND CRAFTS MATERIALS THAT ARE CERTIFIED IN A TOXICOLOGICAL EVALUATION BY A MEDICAL EXPERT TO CONTAIN NO MATERIALS IN SUFFICIENT QUANTITIES TO BE TOXIC OR INJURIOUS TO HUMANS, INCLUDING CHILDREN, OR TO CAUSE ACUTE OR CHRONIC HEALTH PROBLEMS.

SER. NO. 77-067,908, FILED 12-19-2006.

BERYL GARDNER, EXAMINING ATTORNEY



**Int. Cl.: 9**

**Prior U.S. Cls.: 21, 23, 26, 36 and 38**

**United States Patent and Trademark Office**

**Reg. No. 3,394,089**

**Registered Mar. 11, 2008**

**TRADEMARK  
PRINCIPAL REGISTER**

**CAMPUSTRAK**

MMI PROFESSIONAL SERVICES INC. (TEXAS  
CORPORATION)  
4717 FLETCHER AVE.  
FORT WORTH, TX 76107

FOR: COMPUTER PROGRAM FOR INSTITU-  
TIONS THAT WILL RETRIEVE, TRACK, ORGA-  
NIZE, AND DISTRIBUTE INFORMATION  
RELATED TO COMPLAINTS, SUGGESTIONS, IS-  
SUES, OR WORK TO BE PERFORMED, AND  
TRACK THE RESOLUTION OF SUCH AFTER  
BEING ASSIGNED TO A RESPONSIBLE PERSON,

OFFICE, OR DEPARTMENT, IN CLASS 9 (U.S. CLS.  
21, 23, 26, 36 AND 38).

FIRST USE 10-0-2005; IN COMMERCE 12-0-2005.

THE MARK CONSISTS OF STANDARD CHAR-  
ACTERS WITHOUT CLAIM TO ANY PARTICULAR  
FONT, STYLE, SIZE, OR COLOR.

SER. NO. 77-068,215, FILED 12-20-2006.

BARBARA A. GOLD, EXAMINING ATTORNEY

**Int. Cls.: 35 and 41**

**Prior U.S. Cls.: 100, 101, 102 and 107**

**United States Patent and Trademark Office**

**Reg. No. 3,394,090**

**Registered Mar. 11, 2008**

**SERVICE MARK  
PRINCIPAL REGISTER**

**U.S. WIN**

NUCLEAR ENERGY INSTITUTE, INC. (D.C. CORPORATION)  
1776 I STREET, N.W.  
WASHINGTON, DC 20006

FOR: ASSOCIATION SERVICES, NAMELY, PROMOTING THE INTERESTS OF PROFESSIONALS IN THE FIELD OF NUCLEAR POWER; GENERAL BUSINESS NETWORKING SERVICES ON BEHALF OF WOMEN AND MEN IN THE NUCLEAR ENERGY AND NUCLEAR TECHNOLOGY FIELDS, NAMELY, PROMOTING THE GOODS AND SERVICES OF OTHERS BY PASSING BUSINESS LEADS, REFERRALS, AND INFORMATION AMONG GROUP MEMBERS, IN CLASS 35 (U.S. CLS. 100, 101 AND 102).

FIRST USE 8-31-2001; IN COMMERCE 8-31-2001.

FOR: EDUCATIONAL SERVICES, NAMELY, PROVIDING CONFERENCES, SEMINARS AND EDUCATIONAL EXHIBITIONS COVERING VARIOUS TOPICS FOR PROFESSIONALS IN THE NU-

CLEAR ENERGY AND NUCLEAR TECHNOLOGIES FIELDS; ENTERTAINMENT SERVICES, NAMELY, CONDUCTING RECEPTIONS AND ORAL AND VISUAL PRESENTATIONS IN THE FIELDS OF NUCLEAR ENERGY AND NUCLEAR TECHNOLOGIES, IN CLASS 41 (U.S. CLS. 100, 101 AND 107).

FIRST USE 8-31-2001; IN COMMERCE 8-31-2001.

THE MARK CONSISTS OF STANDARD CHARACTERS WITHOUT CLAIM TO ANY PARTICULAR FONT, STYLE, SIZE, OR COLOR.

NO CLAIM IS MADE TO THE EXCLUSIVE RIGHT TO USE "U.S.", APART FROM THE MARK AS SHOWN.

SER. NO. 77-068,577, FILED 12-20-2006.

ANDREW RHIM, EXAMINING ATTORNEY

**Int. Cls.: 3 and 44**

**Prior U.S. Cls.: 1, 4, 6, 50, 51, 52, 100 and 101**

**United States Patent and Trademark Office**

**Reg. No. 3,394,091**

**Registered Mar. 11, 2008**

**TRADEMARK  
SERVICE MARK  
PRINCIPAL REGISTER**

The logo consists of the word "Zayzi" written in a fluid, cursive script. The letters are interconnected, with a prominent loop at the end of the final 'i'. The overall style is elegant and handwritten.

SEGRETTO, SALVATORE J. (UNITED STATES  
INDIVIDUAL)  
18 E HINSDALE AVENUE  
HINSDALE, IL 60521

FOR: HAIR GEL, HAIR CONDITIONING MIST,  
HAIR SPRAY, SHAMPOOS, HAIR CONDITIONER,  
BATH AND SHOWER SCRUB FOR THE FACE AND  
BODY, TINTED FOUNDATIONS, CREAMY FOUN-  
DATION, FOUNDATION MAKE-UP, LIQUID  
FOUNDATION, MAKE-UP FOUNDATIONS, SUN  
TAN LOTION, SKIN GELS FOR ACCELERATION,  
ENHANCING OR EXTENDING TANS, LIP GLOSS  
AND EYE SHADOW, IN CLASS 3 (U.S. CLS. 1, 4, 6, 50,  
51 AND 52).

FIRST USE 1-0-1983; IN COMMERCE 1-0-1983.

FOR: BEAUTY SALON SERVICES, NAMELY,  
FACIALS, MANICURES, MASSAGES AND PEDI-  
CURES; NAIL CARE SALONS; NAIL POLISHING  
SERVICE; MICRODERMABRASION, NAMELY, A  
TOPICAL SKIN TREATMENT INVOLVING ABRA-  
SION OF THE SKIN WITH A HIGH-PRESSURE  
FLOW OF CRYSTALS; DEPILATORY HAIR REMOV-  
-

AL AND REDUCTION; HAIR SALON SERVICES,  
NAMELY, TREATMENT TO PROTECT HAIR  
FROM EFFECTS OF EXPOSURE TO SUNLIGHT,  
HEAT, HUMIDITY AND CHLORINATED WATER,  
HAIR COLORING AND CUTTING, APPLICATION  
OF PERMANENT WAVE PREPARATIONS AND  
THERMAL HAIR WRAPS, AND HAIR STYLING;  
TANNING SALON; HEALTH SPA SERVICES,  
NAMELY, COSMETIC BODY CARE SERVICES;  
HEALTH SPA SERVICES FOR HEALTH AND  
WELLNESS OF THE BODY AND SPIRIT OFFERED  
AT A HEALTH RESORT; SERVICES OF A MAKE-UP  
ARTIST, NAMELY, MAKE-UP LESSONS AND  
MAKE-UP APPLICATION; MASSAGES; MASSAGE  
AND THERAPEUTIC SHIATSU MASSAGE, IN  
CLASS 44 (U.S. CLS. 100 AND 101).

FIRST USE 1-0-1979; IN COMMERCE 1-0-1979.

OWNER OF U.S. REG. NOS. 1,576,959 AND  
1,587,338.

SER. NO. 77-068,587, FILED 12-20-2006.

JEFF DEFORD, EXAMINING ATTORNEY

**Int. Cls.: 35 and 41**

**Prior U.S. Cls.: 100, 101, 102 and 107**

**United States Patent and Trademark Office**

**Reg. No. 3,394,092**

**Registered Mar. 11, 2008**

**SERVICE MARK  
PRINCIPAL REGISTER**

**U.S. WOMEN IN NUCLEAR**

NUCLEAR ENERGY INSTITUTE, INC. (D.C. CORPORATION)  
1776 I STREET, N.W.  
WASHINGTON, DC 20037

FOR: ASSOCIATION SERVICES, NAMELY, PROMOTING THE INTERESTS OF PROFESSIONALS IN THE FIELD OF NUCLEAR POWER; GENERAL BUSINESS NETWORKING SERVICES ON BEHALF OF WOMEN AND MEN IN THE NUCLEAR ENERGY AND NUCLEAR TECHNOLOGY FIELDS, NAMELY, PROMOTING THE GOODS AND SERVICES OF OTHERS BY PASSING BUSINESS LEADS, REFERRALS, AND INFORMATION AMONG GROUP MEMBERS, IN CLASS 35 (U.S. CLS. 100, 101 AND 102).

FIRST USE 8-31-2001; IN COMMERCE 8-31-2001.

FOR: EDUCATIONAL SERVICES, NAMELY, PROVIDING CONFERENCES, SEMINARS AND EDUCATIONAL EXHIBITIONS COVERING VAR-

IOUS TOPICS FOR PROFESSIONALS IN THE NUCLEAR ENERGY AND NUCLEAR TECHNOLOGIES FIELDS; ENTERTAINMENT SERVICES, NAMELY, CONDUCTING RECEPTIONS AND ORAL AND VISUAL PRESENTATIONS IN THE FIELDS OF NUCLEAR ENERGY AND NUCLEAR TECHNOLOGIES, IN CLASS 41 (U.S. CLS. 100, 101 AND 107).

FIRST USE 8-31-2001; IN COMMERCE 8-31-2001.

THE MARK CONSISTS OF STANDARD CHARACTERS WITHOUT CLAIM TO ANY PARTICULAR FONT, STYLE, SIZE, OR COLOR.

SEC. 2(F).

SER. NO. 77-068,620, FILED 12-20-2006.

ANDREW RHIM, EXAMINING ATTORNEY

Int. Cl.: 44

Prior U.S. Cls.: 100 and 101

United States Patent and Trademark Office

Reg. No. 3,394,093

Registered Mar. 11, 2008

**SERVICE MARK  
PRINCIPAL REGISTER**



THE WATTS GROUP, LLC (MARYLAND LTD  
LIAB CO)  
5802 NICHOLSON LANE, SUITE L05  
ROCKVILLE, MD 20852

FOR: MEDICAL EVALUATION SERVICES,  
NAMELY, FUNCTIONAL ASSESSMENT PRO-  
GRAM FOR PATIENTS WITH CHRONIC HEALTH  
CONDITIONS RECEIVING MEDICAL REHABILI-  
TATION SERVICES FOR PURPOSES OF GUIDING  
TREATMENT AND ASSESSING PROGRAM EFFEC-  
TIVENESS; HEALTH CARE CONSULTING, IN  
CLASS 44 (U.S. CLS. 100 AND 101).

FIRST USE 4-18-2006; IN COMMERCE 5-1-2006.

NO CLAIM IS MADE TO THE EXCLUSIVE  
RIGHT TO USE "HEALTH CONSULTING SERVI-  
CES" AND "GROUP.LLC", APART FROM THE  
MARK AS SHOWN.

THE COLOR(S) DARK PURPLE, LIGHT PURPLE,  
AND A MEDIUM SHADE OF PURPLE IS/ARE  
CLAIMED AS A FEATURE OF THE MARK.

THE STYLIZED "W" IS IN DARK PURPLE WITH  
TRIM IN LIGHT PURPLE. THE STYLIZED LETTER  
"A" AND STYLIZED FIRST LETTER "T" ARE IN  
LIGHT PURPLE WITH A DARK PURPLE BORDER.  
THE NEXT STYLIZED LETTER "T" IS IN DARK  
PURPLE. THE STYLIZED LETTER "S" IS IN LIGHT  
PURPLE WITH A DARK PURPLE BORDER. THE  
STYLIZED LETTER "G" IS IN DARK PURPLE WITH  
LIGHT PURPLE TRIM. THE STYLIZED LETTER  
"R" IS IN A MEDIUM SHADE OF PURPLE, WITH A  
DARK PURPLE BORDER. THE STYLIZED LETTER  
"O" IS IN LIGHT PURPLE WITH A DARK PURPLE  
BORDER. THE STYLIZED LETTER "U" IS IN DARK  
PURPLE. THE STYLIZED LETTER "P" IS IN LIGHT  
PURPLE, WITH A DARK PURPLE BORDER. THE  
WORDS "HEALTH CONSULTING SERVICES" AND  
". LLC" ARE IN DARK PURPLE.

SER. NO. 77-069,591, FILED 12-21-2006.

STEVEN R. FOSTER, EXAMINING ATTORNEY

**Int. Cls.: 14 and 25**

**Prior U.S. Cls.: 2, 22, 27, 28, 39 and 50**

**United States Patent and Trademark Office**

**Reg. No. 3,394,094**

**Registered Mar. 11, 2008**

**TRADEMARK  
PRINCIPAL REGISTER**

# Scare-Wear

TUTM ENTERTAINMENT, INC. (NEW JERSEY CORPORATION)  
RARITAN CENTER  
45 FERNWOOD AVENUE  
EDISON, NJ 08837

FOR: CHOKERS, IN CLASS 14 (U.S. CLS. 2, 27, 28 AND 50).

FIRST USE 8-15-2007; IN COMMERCE 8-15-2007.

FOR: HALLOWEEN COSTUME ACCESSORIES, NAMELY, WRISTBANDS, HEADBANDS, UNDER-

GARMENTS, SASHES, AND TIES, IN CLASS 25 (U.S. CLS. 22 AND 39).

FIRST USE 8-15-2007; IN COMMERCE 8-15-2007.

THE MARK CONSISTS OF STANDARD CHARACTERS WITHOUT CLAIM TO ANY PARTICULAR FONT, STYLE, SIZE, OR COLOR.

SER. NO. 77-069,832, FILED 12-21-2006.

DOMINICK J. SALEMI, EXAMINING ATTORNEY

**Int. Cls.: 38 and 41**

**Prior U.S. Cls.: 100, 101, 104 and 107**

**United States Patent and Trademark Office**

**Reg. No. 3,394,095**

**Registered Mar. 11, 2008**

---

**SERVICE MARK  
PRINCIPAL REGISTER**

**K-HITS**

FIRST BROADCASTING INVESTMENT PART-  
NERS, LLC (DELAWARE LTD LIAB CO)  
750 NORTH ST. PAUL, 10TH FLOOR  
DALLAS, TX 75201

FOR: RADIO BROADCASTING SERVICES; SA-  
TELLITE AND TERRESTRIAL RADIO BROAD-  
CASTING, WEBCASTING SERVICES; WIRELESS  
ELECTRONIC TRANSMISSION OF VOICE SIG-  
NALS, DATA FACSIMILES, IMAGES AND INFOR-  
MATION, IN CLASS 38 (U.S. CLS. 100, 101 AND 104).

FIRST USE 1-5-2007; IN COMMERCE 1-5-2007.

FOR: PRODUCTION OF RADIO PROGRAMS, IN  
CLASS 41 (U.S. CLS. 100, 101 AND 107).

FIRST USE 1-5-2007; IN COMMERCE 1-5-2007.

THE MARK CONSISTS OF STANDARD CHAR-  
ACTERS WITHOUT CLAIM TO ANY PARTICULAR  
FONT, STYLE, SIZE, OR COLOR.

SER. NO. 77-069,984, FILED 12-21-2006.

BILL DAWE, EXAMINING ATTORNEY

**Int. Cl.: 1**

**Prior U.S. Cls.: 1, 5, 6, 10, 26 and 46**

**Reg. No. 3,394,096**

**United States Patent and Trademark Office**

**Registered Mar. 11, 2008**

---

**TRADEMARK  
PRINCIPAL REGISTER**

**REVV**

EMD CROP BIOSCIENCE (DELAWARE CORPORATION)  
13100 WEST LISBON AVENUE, SUITE 600  
BROOKFIELD, WI 53005

FOR: BIOCHEMICALS, NAMELY, BIOLOGICAL SIGNAL MOLECULES THAT IMPROVE PLANT HEALTH AND ENHANCE GROWTH OF AGRICULTURAL AND HORTICULTURAL CROPS, IN CLASS 1 (U.S. CLS. 1, 5, 6, 10, 26 AND 46).

FIRST USE 8-0-2006; IN COMMERCE 8-0-2006.

THE MARK CONSISTS OF STANDARD CHARACTERS WITHOUT CLAIM TO ANY PARTICULAR FONT, STYLE, SIZE, OR COLOR.

SER. NO. 77-070,101, FILED 12-22-2006.

CHRISTINA SOBRAL, EXAMINING ATTORNEY



**Int. Cl.: 41**

**Prior U.S. Cls.: 100, 101 and 107**

**United States Patent and Trademark Office**

**Reg. No. 3,394,097**

**Registered Mar. 11, 2008**

**SERVICE MARK  
PRINCIPAL REGISTER**



NATIONAL ASSOCIATION OF MANUFACTURERS (NEW YORK CORPORATION)  
6TH FLOOR  
1331 PENNSYLVANIA AVENUE, N.W.  
WASHINGTON, DC 20004

FOR: ENTERTAINMENT, NAMELY, A CONTINUING NEWS SHOW BROADCAST OVER RADIO, SATELLITE, AUDIO, COMPUTER NETWORKS, AND VIDEO MEDIA ABOUT MANUFACTURING AND BUSINESS, IN CLASS 41 (U.S. CLS. 100, 101 AND 107).

FIRST USE 8-4-2006; IN COMMERCE 8-4-2006.

NO CLAIM IS MADE TO THE EXCLUSIVE RIGHT TO USE "AMERICA'S BUSINESS", APART FROM THE MARK AS SHOWN.

THE MARK CONSISTS OF THE WORDS AMERICA'S AND BUSINESS AND A MICROPHONE DESIGN.

SER. NO. 77-070,212, FILED 12-22-2006.

DAVID I, EXAMINING ATTORNEY

**Int. Cl.: 25**

**Prior U.S. Cls.: 22 and 39**

**United States Patent and Trademark Office**

**Reg. No. 3,394,098**

**Registered Mar. 11, 2008**

**TRADEMARK  
PRINCIPAL REGISTER**

**TARA KEELY**

JLM COUTURE, INC. (DELAWARE CORPORATION)

525 7TH AVENUE, SUITE 1703

NEW YORK, NY 10018

FOR: WEDDING DRESSES; WEDDING GOWNS,  
IN CLASS 25 (U.S. CLS. 22 AND 39).

FIRST USE 6-1-2006; IN COMMERCE 6-1-2006.

THE MARK CONSISTS OF STANDARD CHARACTERS WITHOUT CLAIM TO ANY PARTICULAR FONT, STYLE, SIZE, OR COLOR.

THE NAME(S), PORTRAIT(S), AND/OR SIGNATURE(S) SHOWN IN THE MARK DOES NOT IDENTIFY A PARTICULAR LIVING INDIVIDUAL.

SER. NO. 77-070,217, FILED 12-22-2006.

BILL DAWE, EXAMINING ATTORNEY

**Int. Cl.: 25**

**Prior U.S. Cls.: 22 and 39**

**United States Patent and Trademark Office**

**Reg. No. 3,394,099**

**Registered Mar. 11, 2008**

**TRADEMARK  
PRINCIPAL REGISTER**

**CORKSCREW**

SPORTS CAR RACING ASSOCIATION OF THE  
MONTEREY PENINSULA (CALIFORNIA  
NON-PROFIT CORPORATION)  
P. O. BOX SCRAM  
MONTEREY, CA 93942

FOR: CLOTHING, NAMELY, SHIRTS AND TANK  
TOPS, T-SHIRTS, LONGSLEEVE T-SHIRTS, POLO-  
SHIRTS, SWEATSHIRTS, SWEATPANTS, JACKETS,  
SHORTS, SWIMSUITS, BLOUSES, SOCKS, SWEAT-  
BANDS, CAPS, CLOTH BIBS, HATS, VESTS, VISORS,  
SWEATERS, GLOVES, TIES, AND JUMPSUITS, IN  
CLASS 25 (U.S. CLS. 22 AND 39).

FIRST USE 12-31-1965; IN COMMERCE 12-31-1965.

THE MARK CONSISTS OF STANDARD CHAR-  
ACTERS WITHOUT CLAIM TO ANY PARTICULAR  
FONT, STYLE, SIZE, OR COLOR.

SER. NO. 77-070,467, FILED 12-22-2006.

DAVID I, EXAMINING ATTORNEY

**Int. Cl.: 35**

**Prior U.S. Cls.: 100, 101 and 102**

**United States Patent and Trademark Office**

**Reg. No. 3,394,100**

**Registered Mar. 11, 2008**

**SERVICE MARK  
PRINCIPAL REGISTER**

**MARKETING IN MOTION**

SHARPER AGENT, LLC (COLORADO LTD LIAB  
CO)  
7555 E. HAMPDEN AVENUE, SUITE 104  
DENVER, CO 80231

FOR: PROVIDING AN ONLINE DATABASE, ACCESSIBLE BY SUBSCRIBERS ONLY, FEATURING ADVERTISING IDEAS, SAMPLES, IMAGES, TEMPLATES, FLYERS, NEWSLETTER TEMPLATES, ADVERTISING POSTCARD TEMPLATES, ADVERTISING GREETING CARD TEMPLATES, SPORTS SCHEDULES USED FOR ADVERTISING MAILINGS, ADVERTISING INDUSTRY REFERENCE MATERIALS, CUSTOMER CONTACT INFORMATION, AND CLIENT CONTACT INFORMATION, FOR USE IN CREATING AND SAVING ADVERTISEMENTS FOR ELECTRONIC, INTERNET AND E-MAIL USE; PROVIDING A DATABASE FEATURING SAMPLE ADVERTISEMENTS; DISSEMINATION OF ADVERTISING FOR OTHERS VIA E-

MAIL AND THE INTERNET; PROVIDING A DATABASE FEATURING CALENDARING CAPABILITIES, CONTACT INFORMATION, TASKS, CORRESPONDENCE HISTORY, MARKETING HISTORY AND APPOINTMENTS FOR DISSEMINATION OF ELECTRONIC MARKETING MATERIALS, IN CLASS 35 (U.S. CLS. 100, 101 AND 102).

FIRST USE 1-0-2007; IN COMMERCE 1-0-2007.

THE MARK CONSISTS OF STANDARD CHARACTERS WITHOUT CLAIM TO ANY PARTICULAR FONT, STYLE, SIZE, OR COLOR.

SER. NO. 77-070,718, FILED 12-22-2006.

MICHAEL SOUDERS, EXAMINING ATTORNEY

**Int. Cl.: 35**

**Prior U.S. Cls.: 100, 101 and 102**

**United States Patent and Trademark Office**

**Reg. No. 3,394,101**

**Registered Mar. 11, 2008**

**SERVICE MARK  
PRINCIPAL REGISTER**

**THE BATHROOM**

THE BATHROOM, LTD. (NEW YORK CORPORATION)  
94 CHARLES ST.  
NEW YORK, NY 10014

FOR: ON-LINE RETAIL STORE SERVICES FEATURING SKIN CARE PRODUCTS, HAIR CARE PRODUCTS, BODY CARE PRODUCTS, TOWELS, ROBES, BABY PRODUCTS, TOILETRIES; RETAIL OUTLETS FEATURING SKIN CARE PRODUCTS, HAIR CARE PRODUCTS, BODY CARE PRODUCTS, TOWELS, ROBES, TOILETRIES, IN CLASS 35 (U.S. CLS. 100, 101 AND 102).

FIRST USE 6-12-2000; IN COMMERCE 6-12-2000.

THE MARK CONSISTS OF STANDARD CHARACTERS WITHOUT CLAIM TO ANY PARTICULAR FONT, STYLE, SIZE, OR COLOR.

SER. NO. 77-070,796, FILED 12-22-2006.

MICHAEL SOUDERS, EXAMINING ATTORNEY

**Int. Cl.: 44**

**Prior U.S. Cls.: 100 and 101**

**United States Patent and Trademark Office**

**Reg. No. 3,394,102**

**Registered Mar. 11, 2008**

**SERVICE MARK  
PRINCIPAL REGISTER**



NICKELL, ROBERT P (UNITED STATES INDIVIDUAL)  
SUITE 1507  
381 VAN NESS AVE  
TORRANCE, CA 90501

FOR: DISPENSING OF PHARMACEUTICALS, IN CLASS 44 (U.S. CLS. 100 AND 101).

FIRST USE 11-1-2006; IN COMMERCE 11-1-2006.

NO CLAIM IS MADE TO THE EXCLUSIVE RIGHT TO USE "PHARMACEUTICALS" OR "RANCHO SANTA FE COMPOUNDING", APART FROM THE MARK AS SHOWN.

THE COLOR(S) BLACK, GREEN, AND WHITE IS/ARE CLAIMED AS A FEATURE OF THE MARK.

THE MARK CONSISTS OF A RECTANGULAR BLACK BOX SURROUND A COLOR SPLIT OF GREEN AND WHITE. RSF IS IN WHITE AND LAID OVER A GREEN BACKGROUND, PHARMACEUTICALS IS IN BLACK AND LAID OVER A WHITE BACKGROUND.

SER. NO. 77-071,033, FILED 12-24-2006.

THEODORE MCBRIDE, EXAMINING ATTORNEY

**Int. Cl.: 36**

**Prior U.S. Cls.: 100, 101 and 102**

**United States Patent and Trademark Office**

**Reg. No. 3,394,103**

**Registered Mar. 11, 2008**

**SERVICE MARK  
PRINCIPAL REGISTER**

**FINANCIAL HELP WHEN IT  
HURTS**

PLAINTIFF FUNDING CORPORATION (DELA-  
WARE CORPORATION)  
SUITE 1104  
26 COURT STREET  
BROOKLYN, NY 11242

FOR: FINANCING SERVICES, IN CLASS 36 (U.S.  
CLS. 100, 101 AND 102).

FIRST USE 8-1-1999; IN COMMERCE 8-1-1999.

THE MARK CONSISTS OF STANDARD CHAR-  
ACTERS WITHOUT CLAIM TO ANY PARTICULAR  
FONT, STYLE, SIZE, OR COLOR.

SER. NO. 77-071,165, FILED 12-26-2006.

KATHERINE CHANG, EXAMINING ATTORNEY

Int. Cl.: 27

Prior U.S. Cls.: 19, 20, 37, 42 and 50

United States Patent and Trademark Office

Reg. No. 3,394,104

Registered Mar. 11, 2008

TRADEMARK  
PRINCIPAL REGISTER



SEMERJIAN INC DBA RUGS EXPRESS.COM  
(CALIFORNIA CORPORATION)  
5610 HOLLISTER AVE  
GOLETA, CA 93117

FOR: RUGS, IN CLASS 27 (U.S. CLS. 19, 20, 37, 42  
AND 50).

FIRST USE 10-1-2006; IN COMMERCE 10-1-2006.

OWNER OF U.S. REG. NO. 2,656,628.

NO CLAIM IS MADE TO THE EXCLUSIVE  
RIGHT TO USE "RUGS", APART FROM THE MARK  
AS SHOWN.

THE COLOR(S) RED, WHITE, BLUE AND BLACK  
IS/ARE CLAIMED AS A FEATURE OF THE MARK.

THE MARK CONSISTS OF THE WORD "RUGS"  
WILL BE IN RED FONT. THE FLYING RUG WILL  
BE IN A BLUE FONT WITH THREE WHITE LINES  
IN THE MIDDLE OF THE RUG. THE BLUE RUG  
HAS A BLACK DROP SHADOW EFFECT. THE  
LINES TO THE LEFT OF THE RUG WILL BE IN  
BLACK FONT ALONG WITH THE WORDS "EX-  
PRESS" AND ".COM".

SER. NO. 77-071,532, FILED 12-27-2006.

SETH A. RAPPAPORT, EXAMINING ATTORNEY



**Int. Cl.: 16**

**Prior U.S. Cls.: 2, 5, 22, 23, 29, 37, 38 and 50**

**United States Patent and Trademark Office**

**Reg. No. 3,394,105**

**Registered Mar. 11, 2008**

**TRADEMARK  
PRINCIPAL REGISTER**

**COLLABETITION**

ODUNSI, TAIWO (UNITED STATES INDIVIDUAL)  
60 TURNER PLACE APT. #6L  
BROOKLYN, NY 11218

THE MARK CONSISTS OF STANDARD CHARACTERS WITHOUT CLAIM TO ANY PARTICULAR FONT, STYLE, SIZE, OR COLOR.

FOR: BOOKS AND PRINTED EDUCATIONAL MATERIALS IN THE FIELD OF PERSONAL AND CREATIVE DEVELOPMENT, IN CLASS 16 (U.S. CLS. 2, 5, 22, 23, 29, 37, 38 AND 50).

SER. NO. 77-071,996, FILED 12-27-2006.

FIRST USE 12-16-2006; IN COMMERCE 12-16-2006.

MARY BOAGNI, EXAMINING ATTORNEY

**Int. Cls.: 7 and 12**

**Prior U.S. Cls.: 13, 19, 21, 23, 31, 34, 35 and 44**

**United States Patent and Trademark Office**

**Reg. No. 3,394,106**

**Registered Mar. 11, 2008**

**TRADEMARK  
PRINCIPAL REGISTER**

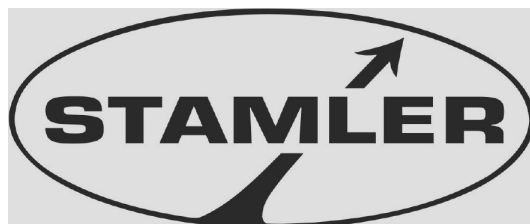

JOY MM DELAWARE, INC. (DELAWARE CORPORATION)  
2751 CENTERVILLE ROAD, SUITE 342  
WILMINGTON, DE 19808

FOR: UNDERGROUND AND SURFACE MINING MACHINERY, NAMELY BULLDOZERS; LOADING AND LOAD HANDLING EQUIPMENT, NAMELY, FRONT END LOADERS, FEEDER BREAKERS, BELT FEEDERS, RECLAIM BELT FEEDERS, AND CONTINUOUS HAULAGE MODULES; CONVEYORS, NAMELY MECHANICAL CONVEYORS AND HYDRAULIC CONVEYORS, IN CLASS 7 (U.S. CLS. 13, 19, 21, 23, 31, 34 AND 35).

FIRST USE 1-1-1969; IN COMMERCE 1-1-1969.

FOR: UNDERGROUND AND SURFACE MINING MACHINERY, NAMELY RAM CARS; SHUTTLE

CARS; DUMP TRUCKS; BREAKER CARS; AND VEHICLES, NAMELY BATTERY HAULERS, IN CLASS 12 (U.S. CLS. 19, 21, 23, 31, 35 AND 44).

FIRST USE 1-1-1969; IN COMMERCE 1-1-1969.

OWNER OF U.S. REG. NO. 3,075,094.

THE MARK CONSISTS OF STAMLER ENCLOSED IN AN OVAL WITH AN ARROW WITHIN THE OVAL AND PASSING UP AND TO THE RIGHT THROUGH THE M AND L IN STAMLER .

SER. NO. 77-072,083, FILED 12-27-2006.

CHRISTINA SOBRAL, EXAMINING ATTORNEY

**Int. Cls.: 8 and 40**

**Prior U.S. Cls.: 23, 28, 44, 100, 103 and 106**

**United States Patent and Trademark Office**

**Reg. No. 3,394,107**

**Registered Mar. 11, 2008**

**TRADEMARK  
SERVICE MARK  
PRINCIPAL REGISTER**

**WEAVER INDUSTRIES**

WEAVER INDUSTRIES, INC. (PENNSYLVANIA CORPORATION)  
425 SOUTH 4TH STREET  
DENVER, PA 17517

THE MARK CONSISTS OF STANDARD CHARACTERS WITHOUT CLAIM TO ANY PARTICULAR FONT, STYLE, SIZE, OR COLOR.

FOR: MALLETS, IN CLASS 8 (U.S. CLS. 23, 28 AND 44).

NO CLAIM IS MADE TO THE EXCLUSIVE RIGHT TO USE "INDUSTRIES", APART FROM THE MARK AS SHOWN.

FIRST USE 1-0-1982; IN COMMERCE 1-0-1982.

SEC. 2(F).

FOR: CUSTOM MOLDING OF PLASTIC, URETHANE AND POLYURETHANE PRODUCTS; CUSTOM MACHINING OF GRAPHITE, CARBON AND CARBON/CARBON PRODUCTS, IN CLASS 40 (U.S. CLS. 100, 103 AND 106).

SER. NO. 77-072,376, FILED 12-28-2006.

FIRST USE 5-0-1961; IN COMMERCE 5-0-1961.

CHRISTINA SOBRAL, EXAMINING ATTORNEY

**Int. Cl.: 17**

**Prior U.S. Cls.: 1, 5, 12, 13, 35 and 50**

**United States Patent and Trademark Office**

**Reg. No. 3,394,108**

**Registered Mar. 11, 2008**

**TRADEMARK  
PRINCIPAL REGISTER**

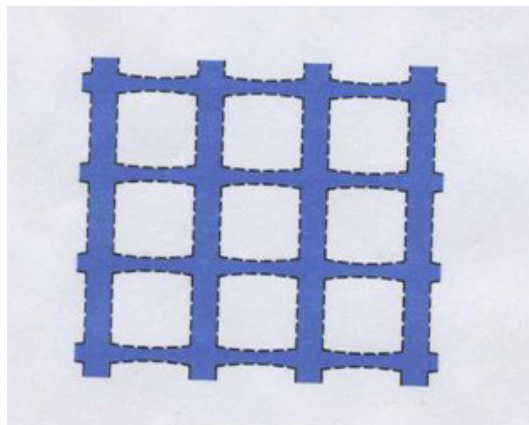

DRYVIT SYSTEMS, INC. (RHODE ISLAND CORPORATION)  
P.O. BOX 1014  
ONE ENERGY WAY  
WEST WARWICK, RI 02893

FOR: FIBERGLASS MESH SOLD AS A COMPONENT OF EXTERIOR FINISH SYSTEMS FOR USE IN BUILDING AND CONSTRUCTION, IN CLASS 17 (U.S. CLS. 1, 5, 12, 13, 35 AND 50).

FIRST USE 1-1-1970; IN COMMERCE 1-1-1970.

THE COLOR(S) BLUE (PANTONE # 299) IS/ARE CLAIMED AS A FEATURE OF THE MARK.

THE MARK CONSISTS OF THE COLOR BLUE AS APPLIED TO THE ENTIRETY OF THE GOODS. THE DOTTED OUTLINE OF THE MARK IS INTENDED TO SHOW THAT THE GOODS ARE OF INDETERMINATE SHAPE.

SEC. 2(F).

SER. NO. 77-072,886, FILED 12-28-2006.

VERNA BETH RIRIE, EXAMINING ATTORNEY

Int. Cl.: 36

Prior U.S. Cls.: 100, 101 and 102

United States Patent and Trademark Office

Reg. No. 3,394,109

Registered Mar. 11, 2008

**SERVICE MARK  
PRINCIPAL REGISTER**



JOHN GREEN CONSULTING, INC. (ILLINOIS CORPORATION)  
SUITE 302  
1229 N. NORTH BRANCH  
CHICAGO, IL 60622

FOR: ELECTRONIC COMMERCE PAYMENT SERVICES, NAMELY, ESTABLISHMENT OF FUNDED ACCOUNTS VIA PREPAID PURCHASE CARDS USED TO PURCHASE NEWS AND ENTERTAINMENT CONTENT ON THE INTERNET, IN CLASS 36 (U.S. CLS. 100, 101 AND 102).

FIRST USE 8-3-2006; IN COMMERCE 10-1-2006.

THE MARK CONSISTS OF A CIRCLE ENCLOSING A STYLIZED REPRESENTATION OF A STAR FOLLOWED BY A LOWER CASE LETTER "N". THE WORD "JOY" IS REPRESENTED IN STYLIZED SCRIPT. THE LETTERS "N," "O," AND "W" ARE UNDERNEATH THE WORD "JOY" AND DEPICTED IN SMALLER FONT AND ENCLOSED IN CIRCLES.

SER. NO. 77-073,020, FILED 12-28-2006.

DOMINICK J. SALEMI, EXAMINING ATTORNEY

**Int. Cl.: 41**

**Prior U.S. Cls.: 100, 101 and 107**

**United States Patent and Trademark Office**

**Reg. No. 3,394,110**

**Registered Mar. 11, 2008**

**SERVICE MARK  
PRINCIPAL REGISTER**

**ADVENTURES BY DISNEY**

DISNEY ENTERPRISES, INC. (DELAWARE CORPORATION)  
500 SOUTH BUENA VISTA STREET  
BURBANK, CA 91521

FOR: ENTERTAINMENT SERVICES IN THE NATURE OF ORGANIZATION OF ACTIVITIES IN THE NATURE OF SPORTING ACTIVITIES, WINE TASTING, BOATING, PUPPET SHOWS, ARTS AND CRAFTS, DANCING, SCAVENGER HUNTS, HORSEBACK RIDING, AND WALKING GUIDED TOURS OF WINERIES, AMUSEMENT PARKS, MUSEUMS, HISTORICAL MONUMENTS, NATIONAL MONUMENTS, NATIONAL PARKS, STATE PARKS, NATURE PRESERVES, BOTANICAL GARDENS, ZOOS, IN CLASS 41 (U.S. CLS. 100, 101 AND 107).

FIRST USE 5-11-2006; IN COMMERCE 5-11-2006.

THE MARK CONSISTS OF STANDARD CHARACTERS WITHOUT CLAIM TO ANY PARTICULAR FONT, STYLE, SIZE, OR COLOR.

OWNER OF U.S. REG. NOS. 2,240,945, 2,509,642 AND OTHERS.

NO CLAIM IS MADE TO THE EXCLUSIVE RIGHT TO USE "ADVENTURES", APART FROM THE MARK AS SHOWN.

SER. NO. 77-073,492, FILED 12-29-2006.

BRIDGETT SMITH, EXAMINING ATTORNEY

**Int. Cl.: 17**

**Prior U.S. Cls.: 1, 5, 12, 13, 35 and 50**

**Reg. No. 3,394,111**

**United States Patent and Trademark Office**

**Registered Mar. 11, 2008**

---

**TRADEMARK  
PRINCIPAL REGISTER**



ALTAFLO LLC (NEW JERSEY LTD LIAB CO)  
UNIT #9  
10 MILLPOND DRIVE  
LAFAYETTE, NJ 07848

FIRST USE 6-1-2006; IN COMMERCE 7-1-2006.

THE MARK CONSISTS OF STYLIZED LETTERS.

FOR: PLASTIC FLUOROPOLYMER TUBING  
AND PIPES FOR INDUSTRIAL OR COMMERCIAL  
USES, IN CLASS 17 (U.S. CLS. 1, 5, 12, 13, 35 AND 50).

SER. NO. 77-073,544, FILED 12-29-2006.

RICHARD A. STRASER, EXAMINING ATTORNEY

**Int. Cl.: 43**

**Prior U.S. Cls.: 100 and 101**

**United States Patent and Trademark Office**

**Reg. No. 3,394,112**

**Registered Mar. 11, 2008**

**SERVICE MARK  
PRINCIPAL REGISTER**

**TIEN-CHIN-RO**

WANOBA GROUP, INC. (CALIFORNIA CORPORATION)  
SUITE 235  
1815 W. 213TH STREET  
TORRANCE, CA 90501

FOR: RESTAURANT SERVICES, IN CLASS 43  
(U.S. CLS. 100 AND 101).

FIRST USE 9-23-2005; IN COMMERCE 9-23-2005.

THE MARK CONSISTS OF STANDARD CHARACTERS WITHOUT CLAIM TO ANY PARTICULAR FONT, STYLE, SIZE, OR COLOR.

THE ENGLISH TRANSLATION OF THE JAPANESE TERM TIEN IS HEAVEN. THE ENGLISH TRANSLATION OF THE JAPANESE TERM CHIN IS RARE OR GENUINE. THE ENGLISH TRANSLATION OF THE JAPANESE TERM RO IS TOWER OR BUILDING. THE TERM RO ALSO CREATES A JAPANESE CULTURAL ASSOCIATION WITH A CHINESE RESTAURANT BUT THE TERM DOES NOT TRANSLATE TO MEAN RESTAURANT.

SER. NO. 77-073,679, FILED 12-29-2006.

RUSS HERMAN, EXAMINING ATTORNEY



**Int. Cls.: 35 and 36**

**Prior U.S. Cls.: 100, 101 and 102**

**United States Patent and Trademark Office**

**Reg. No. 3,394,113**

**Registered Mar. 11, 2008**

**SERVICE MARK  
PRINCIPAL REGISTER**



AQUATIC CONCEPTS, INC (CALIFORNIA CORPORATION)  
8340 E CHATHAM TERRACE  
ORANGE, CA 92867

THE COLOR(S) DARK BLUE, LIGHT BLUE, AND BLACK IS/ARE CLAIMED AS A FEATURE OF THE MARK.

FOR: MARKETING CONSULTATION IN THE FIELD OF AQUATICS; OPERATING COMMERCIAL AQUATICS FACILITIES FOR OTHERS, IN CLASS 35 (U.S. CLS. 100, 101 AND 102).

THE MARK CONSISTS OF THE WORD "AQUATIC" IN DARK BLUE, WHILE THE OTHER WORDS ARE BLACK. THE LETTERS "A" AND "Q" ARE BISECTED BY A BLUE WAVE WHICH COMPLETES THE LETTERS. THE BLUE ON THE WAVE CONTAINS BOTH LIGHT BLUE AND DARK BLUE HUES.

FIRST USE 3-15-2005; IN COMMERCE 3-15-2005.

FOR: FINANCIAL CONSULTATION IN THE FIELD OF AQUATICS, IN CLASS 36 (U.S. CLS. 100, 101 AND 102).

FIRST USE 3-15-2005; IN COMMERCE 3-15-2005.

SER. NO. 77-073,684, FILED 12-29-2006.

NO CLAIM IS MADE TO THE EXCLUSIVE RIGHT TO USE "AQUATIC" AND "INC.", APART FROM THE MARK AS SHOWN.

KATHY DE JONGE, EXAMINING ATTORNEY

Int. Cl.: 43

Prior U.S. Cls.: 100 and 101

United States Patent and Trademark Office

Reg. No. 3,394,114

Registered Mar. 11, 2008

SERVICE MARK  
PRINCIPAL REGISTER



WANOBA GROUP, INC. (CALIFORNIA CORPORATION)  
SUITE 235  
1815 W. 213TH STREET  
TORRANCE, CA 90501

FOR: RESTAURANT SERVICES, IN CLASS 43  
(U.S. CLS. 100 AND 101).

FIRST USE 9-23-2005; IN COMMERCE 9-23-2005.

THE MARK CONSISTS OF JAPANESE CHARACTERS.

THE ENGLISH TRANSLATION OF THE JAPANESE TERM TIEN IS HEAVEN. THE ENGLISH

TRANSLATION OF THE JAPANESE TERM CHIN IS RARE OR GENUINE. THE ENGLISH TRANSLATION OF THE JAPANESE TERM RO IS TOWER OR BUILDING. THE TERM RO ALSO CREATES A JAPANESE CULTURAL ASSOCIATION WITH A CHINESE RESTAURANT BUT THE TERM DOES NOT TRANSLATE TO MEAN RESTAURANT.

THE NON-LATIN CHARACTERS IN THE MARK TRANSLITERATE TO "TIEN-CHIN-RO".

SER. NO. 77-073,690, FILED 12-29-2006.

RUSS HERMAN, EXAMINING ATTORNEY

**Int. Cl.: 45**

**Prior U.S. Cls.: 100 and 101**

**United States Patent and Trademark Office**

**Reg. No. 3,394,115**

**Registered Mar. 11, 2008**

**SERVICE MARK  
PRINCIPAL REGISTER**

**CALL-A-KEY**

LYNNE DAVIS (UNITED STATES INDIVIDUAL)  
3870 HIGH GREEN DRIVE  
MARIETTA, GA 30068

THE MARK CONSISTS OF STANDARD CHAR-  
ACTERS WITHOUT CLAIM TO ANY PARTICULAR  
FONT, STYLE, SIZE, OR COLOR.

FOR: SECURITY SERVICES FOR BUILDINGS,  
NAMELY, PROVIDING PHYSICAL ACCESS TO  
PROPERTIES VIA A REMOTE CALL-IN LOCKING  
DEVICE, IN CLASS 45 (U.S. CLS. 100 AND 101).

SER. NO. 77-074,548, FILED 1-2-2007.

FIRST USE 10-24-2007; IN COMMERCE 10-24-2007.

ALICE BENMAMAN, EXAMINING ATTORNEY

**Int. Cl.: 32**

**Prior U.S. Cls.: 45, 46 and 48**

**United States Patent and Trademark Office**

**Reg. No. 3,394,116**

**Registered Mar. 11, 2008**

**TRADEMARK  
PRINCIPAL REGISTER**

**FUELOCITY**

UNITED CITRUS PRODUCTS CORP (MASSA-  
CHUSETTS CORPORATION)  
P O BOX 10  
244 VANDERBILT AVE  
NORWOOD, MA 02062

THE MARK CONSISTS OF STANDARD CHAR-  
ACTERS WITHOUT CLAIM TO ANY PARTICULAR  
FONT, STYLE, SIZE, OR COLOR.

FOR: ENERGY DRINKS, IN CLASS 32 (U.S. CLS.  
45, 46 AND 48).

SER. NO. 77-074,687, FILED 1-2-2007.

FIRST USE 9-7-2006; IN COMMERCE 11-7-2006.

FRED CARL, EXAMINING ATTORNEY

**Int. Cl.: 36**

**Prior U.S. Cls.: 100, 101 and 102**

**United States Patent and Trademark Office**

**Reg. No. 3,394,117**

**Registered Mar. 11, 2008**

**SERVICE MARK  
PRINCIPAL REGISTER**

**CARMAX CAR BUYING CENTER**

CARMAX BUSINESS SERVICES, LLC (DELA-  
WARE LTD LIAB CO)  
12800 TUCKAHOE CREEK PARKWAY  
RICHMOND, VA 23238

FOR: AUTOMOBILE APPRAISAL, IN CLASS 36  
(U.S. CLS. 100, 101 AND 102).

FIRST USE 5-12-2006; IN COMMERCE 5-12-2006.

THE MARK CONSISTS OF STANDARD CHAR-  
ACTERS WITHOUT CLAIM TO ANY PARTICULAR  
FONT, STYLE, SIZE, OR COLOR.

OWNER OF U.S. REG. NOS. 1,954,468, 3,044,865  
AND OTHERS.

NO CLAIM IS MADE TO THE EXCLUSIVE  
RIGHT TO USE "CAR BUYING CENTER", APART  
FROM THE MARK AS SHOWN.

SER. NO. 77-075,119, FILED 1-3-2007.

H. M. FISHER, EXAMINING ATTORNEY

**Int. Cl.: 25**

**Prior U.S. Cls.: 22 and 39**

**United States Patent and Trademark Office**

**Reg. No. 3,394,118**

**Registered Mar. 11, 2008**

**TRADEMARK  
PRINCIPAL REGISTER**

**No Plain Janes**

DICKEY, LYNNE E. (UNITED STATES INDIVIDUAL)  
318 WEST 700 NORTH  
SALT LAKE CITY, UT 84103

THE MARK CONSISTS OF STANDARD CHARACTERS WITHOUT CLAIM TO ANY PARTICULAR FONT, STYLE, SIZE, OR COLOR.

FOR: APRONS; SMOCKS; TOPS, IN CLASS 25 (U.S. CLS. 22 AND 39).

SER. NO. 77-075,261, FILED 1-3-2007.

FIRST USE 8-5-2006; IN COMMERCE 8-5-2006.

LYDIA BELZER, EXAMINING ATTORNEY

**Int. Cl.: 5**

**Prior U.S. Cls.: 6, 18, 44, 46, 51 and 52**

**United States Patent and Trademark Office**

**Reg. No. 3,394,119**

**Registered Mar. 11, 2008**

**TRADEMARK  
PRINCIPAL REGISTER**

**DIAMICRON**

BIOFARMA (FRANCE SOCIETE PAR ACTIONS  
SIMPLIFEE)  
22, RUE GARNIER  
NEUILLY-SUR-SEINE, FRANCE 92200

OWNER OF FRANCE REG. NO. 808027, DATED  
10-13-1970, RENEWED AS REG. NO. 808027, DATED  
8-9-2000, EXPIRES 10-13-2010.

FOR: AN ANTIDIABETIC PHARMACEUTICAL  
PREPARATION, IN CLASS 5 (U.S. CLS. 6, 18, 44, 46, 51  
AND 52).

OWNER OF U.S. REG. NO. 2,452,539.

THE MARK CONSISTS OF STANDARD CHAR-  
ACTERS WITHOUT CLAIM TO ANY PARTICULAR  
FONT, STYLE, SIZE, OR COLOR.

SER. NO. 77-076,204, FILED 1-4-2007.

JENNIFER HETU, EXAMINING ATTORNEY

**Int. Cl.: 35**

**Prior U.S. Cls.: 100, 101 and 102**

**United States Patent and Trademark Office**

**Reg. No. 3,394,120**

**Registered Mar. 11, 2008**

**SERVICE MARK  
PRINCIPAL REGISTER**

**pinkyotto**

PINKYOTTO INC (NEW YORK CORPORATION)  
307 E.9TH STREET  
NEW YORK, NY 10003

FOR: RETAIL CLOTHING STORE SERVICES  
FEATURING PRIVATE LABEL CLOTHING, IN  
CLASS 35 (U.S. CLS. 100, 101 AND 102).

FIRST USE 1-1-2005; IN COMMERCE 1-1-2005.

THE COLOR(S) FUCHSIA IS/ARE CLAIMED AS A  
FEATURE OF THE MARK.

THE MARK CONSISTS OF THE STYLIZED  
WORD PINKYOTTO WITH PINKY WRITTEN IN  
TIMES NEW ROMAN FONT AND IN BOLD, AND  
OTTO IN CENTURY GOTHIC FONT, ALL IN  
FUCHSIA.

SER. NO. 77-076,658, FILED 1-5-2007.

ELISSA GARBER KON, EXAMINING ATTORNEY



**Int. Cl.: 35**

**Prior U.S. Cls.: 100, 101 and 102**

**United States Patent and Trademark Office**

**Reg. No. 3,394,121**

**Registered Mar. 11, 2008**

**SERVICE MARK  
PRINCIPAL REGISTER**



APPA (D.C. NON-PROFIT ORGANIZATION)  
1643 PRINCE STREET  
ALEXANDRIA, VA 223142818

FOR: CONDUCTING BUSINESS RESEARCH AND SURVEYS IN THE FIELD OF EDUCATIONAL FACILITIES MANAGEMENT, IN CLASS 35 (U.S. CLS. 100, 101 AND 102).

FIRST USE 2-1-2004; IN COMMERCE 2-1-2004.

NO CLAIM IS MADE TO THE EXCLUSIVE RIGHT TO USE "FACILITIES" AND "DATA SURVEY", APART FROM THE MARK AS SHOWN.

THE COLOR(S) PURPLE, GREEN, AND BLACK IS/ARE CLAIMED AS A FEATURE OF THE MARK.

THE MARK CONSISTS OF THE WORDING FACILITIES AND SURVEY DEPICTED IN THE COLOR BLACK, THE WORDING CORE DATA DEPICTED IN THE COLOR PURPLE, TWO CIRCLES DEPICTED IN THE COLOR GREEN, FOLLOWED BY TWO SETS OF THREE CIRCLES DEPICTED IN THE COLOR PURPLE AND TWO CIRCLES DEPICTED IN THE COLOR GREEN.

SER. NO. 77-076,665, FILED 1-5-2007.

LINDA ORNDORFF, EXAMINING ATTORNEY

**Int. Cls.: 35, 39 and 43**

**Prior U.S. Cls.: 100, 101, 102 and 105**

**United States Patent and Trademark Office**

**Reg. No. 3,394,122**

**Registered Mar. 11, 2008**

**SERVICE MARK  
PRINCIPAL REGISTER**

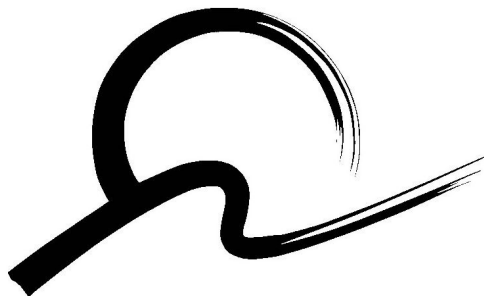

LAKE NORMAN CONVENTION & VISITORS  
BUREAU (NORTH CAROLINA NON-PROFIT  
CORPORATION)

SUITE 102  
19900 W. CATAWBA AVENUE  
CORNELIUS, NC 28031

FOR: VISITOR BUREAU SERVICES, NAMELY, PROMOTING BUSINESS AND TOURISM IN THE REGION SURROUNDING LAKE NORMAN, NORTH CAROLINA; ADVERTISING AND PROMOTION OF TOURISM AND CONVENTION SERVICES IN THE LAKE NORMAN AREA; DESTINATION MARKETING FOR THE LAKE NORMAN AREA IN ORDER TO ATTRACT CONVENTIONS, LEISURE TRAVELERS AND VISITORS; ADVERTISING SERVICES, NAMELY DISSEMINATING ADVERTISING AND INFORMATION ABOUT THE LAKE NORMAN AREA; RETAIL GIFT SHOPS FEATURING MEMENTOS AND SOUVENIRS OF THE LAKE NORMAN AREA AND THE STATE OF NORTH CAROLINA; MARKETING SERVICES, NAMELY, MARKETING PARTNERSHIPS, LEISURE AND INTERNATIONAL PROGRAMS TO BRING TOURISTS TO THE LAKE NORMAN AREA, IN CLASS 35 (U.S. CLS. 100, 101 AND 102).

FIRST USE 8-31-2005; IN COMMERCE 8-31-2005.

FOR: TRAVEL AND TOUR INFORMATION SERVICES PERTAINING TO THE REGION SURROUNDING LAKE NORMAN, NORTH CAROLINA, NAMELY, INFORMATION CENTER SERVICES FOR RESPONDING TO VISITOR AND PROSPECTIVE VISITOR INQUIRIES, IN CLASS 39 (U.S. CLS. 100 AND 105).

FIRST USE 8-31-2005; IN COMMERCE 8-31-2005.

FOR: CONVENTION SERVICES, NAMELY PROVIDING CONVENTION FACILITIES IN THE LAKE NORMAN AREA, IN CLASS 43 (U.S. CLS. 100 AND 101).

FIRST USE 8-31-2005; IN COMMERCE 8-31-2005.

THE MARK CONSISTS OF A DRAWING OF A SEMI CIRCLE WITH A WAVY LINE UNDERNEATH.

SER. NO. 77-077,994, FILED 1-8-2007.

RENEE SERVANCE, EXAMINING ATTORNEY

**Int. Cl.: 41**

**Prior U.S. Cls.: 100, 101 and 107**

**United States Patent and Trademark Office**

**Reg. No. 3,394,123**

**Registered Mar. 11, 2008**

**SERVICE MARK  
PRINCIPAL REGISTER**

**TO WHOM I MAY CONCERN**

MAUREEN MATTHEWS (UNITED STATES INDIVIDUAL), DBA TO WHOM I MAY CONCERN

279 GLENBROOK ROAD  
STAMFORD, CT 06906

FOR: ENTERTAINMENT SERVICES IN THE NATURE OF PRODUCTION, DIRECTING, AND SCRIPT WRITING OF LIVE PERFORMANCES DRAMATIZING THE EXPERIENCES OF PERSONS SUFFERING DEMENTIA AND OTHER DEBILITATING DISEASES AND DRAMATIZING THE EXPERIENCES

OF THEIR CAREGIVERS, IN CLASS 41 (U.S. CLS. 100, 101 AND 107).

FIRST USE 4-0-2006; IN COMMERCE 4-0-2006.

THE MARK CONSISTS OF STANDARD CHARACTERS WITHOUT CLAIM TO ANY PARTICULAR FONT, STYLE, SIZE, OR COLOR.

SER. NO. 77-078,102, FILED 1-8-2007.

MIDGE BUTLER, EXAMINING ATTORNEY

**Int. Cl.: 35**

**Prior U.S. Cls.: 100, 101 and 102**

**United States Patent and Trademark Office**

**Reg. No. 3,394,124**

**Registered Mar. 11, 2008**

**SERVICE MARK  
PRINCIPAL REGISTER**

**idea link**

IDEA LINK, INC. (MINNESOTA CORPORATION)  
3435 HERITAGE COURT  
STILLWATER, MN 55082

THE MARK CONSISTS OF STANDARD CHAR-  
ACTERS WITHOUT CLAIM TO ANY PARTICULAR  
FONT, STYLE, SIZE, OR COLOR.

FOR: BUSINESS CONSULTATION SERVICES IN  
THE FIELD OF GENERATING NEW PRODUCT  
IDEAS AND MARKETING FOR SUCH PRODUCT  
IDEAS, IN CLASS 35 (U.S. CLS. 100, 101 AND 102).

SER. NO. 77-078,285, FILED 1-8-2007.

FIRST USE 9-2-1994; IN COMMERCE 9-2-1994.

BARBARA BROWN, EXAMINING ATTORNEY

Int. Cl.: 37

Prior U.S. Cls.: 100, 103 and 106

United States Patent and Trademark Office

Reg. No. 3,394,125

Registered Mar. 11, 2008

SERVICE MARK  
PRINCIPAL REGISTER



PADGETT SERVICES, LLC (GEORGIA LTD LIAB  
CO)  
SUITE 100  
140 MOUNTAIN BROOK DRIVE  
CANTON, GA 30115

FOR: AIR CONDITIONING CONTRACTOR SERVICES; HEATING CONTRACTOR SERVICES; HVAC CONTRACTOR SERVICES; INSTALLATION AND REPAIR OF AIR CONDITIONING APPARATUS; INSTALLATION, REPAIR AND MAINTENANCE OF HEATING EQUIPMENT, IN CLASS 37 (U.S. CLS. 100, 103 AND 106).

FIRST USE 6-30-2005; IN COMMERCE 6-30-2005.

NO CLAIM IS MADE TO THE EXCLUSIVE RIGHT TO USE "GROUP", APART FROM THE MARK AS SHOWN.

THE COLOR(S) RED, GREEN, BLUE, BLACK AND WHITE IS/ARE CLAIMED AS A FEATURE OF THE MARK.

THE COLOR BLACK APPEARS IN THE WORDING PADGETT GROUP AND IN THE DESIGN OF A TRIANGLE WITH ROUNDED EDGES. THE BLACK TRIANGLE IS OUTLINED IN WHITE. THE COLOR RED APPEARS ON THE UPPER LEFT SIDE OF THE BLACK TRIANGLE AND WHITE OUTLINE. THE COLOR GREEN APPEARS ON THE UPPER RIGHT SIDE OF THE BLACK TRIANGLE WITH WHITE OUTLINE. THE COLOR BLUE APPEARS ON THE BOTTOM LEFT SIDE OF THE BLACK TRIANGLE WITH WHITE BORDER. THE COLOR WHITE APPEARS AT THE CENTER OF THE BLACK TRIANGLE, FORMING A SMALLER TRIANGLE. THE BACKGROUND IS TRANSPARENT.

SER. NO. 77-078,528, FILED 1-9-2007.

MORGAN WYNNE, EXAMINING ATTORNEY

**Int. Cl.: 35**

**Prior U.S. Cls.: 100, 101 and 102**

**United States Patent and Trademark Office**

**Reg. No. 3,394,126**

**Registered Mar. 11, 2008**

**SERVICE MARK  
PRINCIPAL REGISTER**

**eNETEASY**

E-NET ADVERTISING, LLC (PENNSYLVANIA  
LTD LIAB CO)  
331 WEST BOOT ROAD  
WEST CHESTER, PA 19380

THE MARK CONSISTS OF STANDARD CHAR-  
ACTERS WITHOUT CLAIM TO ANY PARTICULAR  
FONT, STYLE, SIZE, OR COLOR.

FOR: PROMOTING THE GOODS AND SERVICES  
OF OTHERS VIA A GLOBAL COMPUTER NET-  
WORK, IN CLASS 35 (U.S. CLS. 100, 101 AND 102).

SER. NO. 77-078,542, FILED 1-9-2007.

FIRST USE 4-26-2005; IN COMMERCE 4-26-2005.

JENNIFER VASQUEZ, EXAMINING ATTORNEY

**Int. Cl.: 45**

**Prior U.S. Cls.: 100 and 101**

**United States Patent and Trademark Office**

**Reg. No. 3,394,127**

**Registered Mar. 11, 2008**

**SERVICE MARK  
PRINCIPAL REGISTER**

**2+FACTOR**

US ENCODE CORPORATION (CALIFORNIA  
CORPORATION)  
5040 SHORAM PLACE, SUITE 150  
SAN DIEGO, CA 92122

FOR: IDENTIFICATION VERIFICATION SERVICES, NAMELY, PROVIDING AUTHENTICATION OF PERSONAL IDENTIFICATION INFORMATION VIA SECURE STORAGE AND TRANSMITTING SUCH INFORMATION VIA THE INTERNET, IN CLASS 45 (U.S. CLS. 100 AND 101).

FIRST USE 1-0-2003; IN COMMERCE 1-0-2003.

THE MARK CONSISTS OF STANDARD CHARACTERS WITHOUT CLAIM TO ANY PARTICULAR FONT, STYLE, SIZE, OR COLOR.

SER. NO. 77-079,109, FILED 1-9-2007.

AMOS T. MATTHEWS, JR., EXAMINING ATTORNEY

**Int. Cl.: 14**

**Prior U.S. Cls.: 2, 27, 28 and 50**

**United States Patent and Trademark Office**

**Reg. No. 3,394,128**

**Registered Mar. 11, 2008**

**TRADEMARK  
PRINCIPAL REGISTER**

**VIA ROMA**

A.G. & G. MANUFACTURING COMPANY  
(RHODE ISLAND CORPORATION)  
21 MILL ST.  
JOHNSTON, RI 02919

THE FOREIGN WORDING IN THE MARK  
TRANSLATES INTO ENGLISH AS ROMAN WAY  
OR ROME STREET.

FOR: COSTUME JEWELRY, IN CLASS 14 (U.S.  
CLS. 2, 27, 28 AND 50).

SER. NO. 77-082,143, FILED 1-12-2007.

FIRST USE 1-1-2001; IN COMMERCE 1-1-2001.

THE MARK CONSISTS OF STANDARD CHAR-  
ACTERS WITHOUT CLAIM TO ANY PARTICULAR  
FONT, STYLE, SIZE, OR COLOR.

ANDREA K. NADELMAN, EXAMINING ATTOR-  
NEY



**Int. Cl.: 2**

**Prior U.S. Cls.: 6, 11 and 16**

**United States Patent and Trademark Office**

**Reg. No. 3,394,129**

**Registered Mar. 11, 2008**

**TRADEMARK  
PRINCIPAL REGISTER**

**SUPER BUILD**

VOGEL PAINT & WAX COMPANY, INC. (IOWA CORPORATION)  
1110 ALBANY PLACE S.E.  
ORANGE CITY, IA 51041

FOR: PAINTS AND COATINGS IN THE NATURE OF INTERIOR PAINT, IN CLASS 2 (U.S. CLS. 6, 11 AND 16).

FIRST USE 7-0-2005; IN COMMERCE 7-0-2005.

THE MARK CONSISTS OF STANDARD CHARACTERS WITHOUT CLAIM TO ANY PARTICULAR FONT, STYLE, SIZE, OR COLOR.

NO CLAIM IS MADE TO THE EXCLUSIVE RIGHT TO USE "SUPER", APART FROM THE MARK AS SHOWN.

SER. NO. 77-082,876, FILED 1-15-2007.

IRA J. GOODSaid, EXAMINING ATTORNEY

Int. Cl.: 9

Prior U.S. Cls.: 21, 23, 26, 36 and 38

United States Patent and Trademark Office

Reg. No. 3,394,130

Registered Mar. 11, 2008

TRADEMARK  
PRINCIPAL REGISTER



BBQ TUNES, LLC (INDIANA LTD LIAB CO)  
721 WEST GORDON PIKE  
BLOOMINGTON, IN 47403

FOR: DIGITAL MATERIALS, NAMELY, PRERE-  
CORDED CDS FEATURING MUSIC, IN CLASS 9  
(U.S. CLS. 21, 23, 26, 36 AND 38).

FIRST USE 11-0-2006; IN COMMERCE 11-0-2006.

NO CLAIM IS MADE TO THE EXCLUSIVE  
RIGHT TO USE "TUNES", APART FROM THE  
MARK AS SHOWN.

THE MARK CONSISTS OF THE LETTERS BBQ  
RISING OVER THE WORD "TUNES".

SER. NO. 77-083,712, FILED 1-16-2007.

JORDAN BAKER, EXAMINING ATTORNEY

**Int. Cl.: 3**

**Prior U.S. Cls.: 1, 4, 6, 50, 51 and 52**

**United States Patent and Trademark Office**

**Reg. No. 3,394,131**

**Registered Mar. 11, 2008**

**TRADEMARK  
PRINCIPAL REGISTER**

**DOGGONE**

CHEMCO CORPORATION (MASSACHUSETTS  
CORPORATION)  
300 CANAL STREET  
LAWRENCE, MA 01840

THE MARK CONSISTS OF STANDARD CHAR-  
ACTERS WITHOUT CLAIM TO ANY PARTICULAR  
FONT, STYLE, SIZE, OR COLOR.

FOR: CLEANING PREPARATIONS CONTAIN-  
ING A SANITIZING COMPONENT FOR USE ON  
ROLLER GRILLS, IN CLASS 3 (U.S. CLS. 1, 4, 6, 50, 51  
AND 52).

SER. NO. 77-085,021, FILED 1-17-2007.

FIRST USE 4-7-2007; IN COMMERCE 4-7-2007.

ROBIN MITTLER, EXAMINING ATTORNEY

**Int. Cl.: 8**

**Prior U.S. Cls.: 23, 28 and 44**

**United States Patent and Trademark Office**

**Reg. No. 3,394,132**

**Registered Mar. 11, 2008**

**TRADEMARK  
PRINCIPAL REGISTER**

# CHIX CAN FIX

CHIX CAN FIX, LLC (NEVADA LTD LIAB CO)  
1443 PALM DRIVE  
LAUGHLIN, NV 89029

FOR: ABRADING TOOLS; BITS FOR HAND DRILLS; BLADES FOR HAND SAWS; CENTER PUNCHES; CHISELS; DRILL BITS FOR HAND DRILLS; EXTENSION BARS FOR HAND TOOLS; EXTENSIONS FOR HAND TOOLS; FILES; GARDENING TOOLS, NAMELY, WEED, CLAW, SHOVEL, HOE; HAMMERS; HAND CABLE SPLICERS; HAND HELD CUTTING TOOLS; HAND HOOKS; HAND OPERATED LIFTING JACKS; HAND OPERATED PLUMBING SNAKES; HAND SAWS, NAMELY, HACK SAWS; HAND SAWS, NAMELY, MITER SAWS; HAND SAWS, NAMELY, WOOD SAWS; HAND TOOLS, NAMELY, AUGERS; HAND TOOLS, NAMELY, AWLS; HAND TOOLS, NAMELY, CLAMPS; HAND TOOLS, NAMELY, DRILLS; HAND TOOLS, NAMELY, FILES; HAND TOOLS, NAMELY, HAMMERS; HAND TOOLS, NAMELY, HAND JACKS; HAND TOOLS, NAMELY, MANUALLY-OPERATED GRINDING WHEELS; HAND TOOLS, NAMELY, MANUALLY-OPERATED GRINDSTONES; HAND TOOLS, NAMELY, MANUALLY-OPERATED SHARPENING WHEELS; HAND TOOLS, NAMELY, MITRE BOXES; HAND TOOLS, NAMELY, PICKS; HAND TOOLS, NAMELY, PINNERS; HAND TOOLS, NAMELY, PLANERS; HAND TOOLS, NAMELY, PUNCHES; HAND TOOLS, NAMELY, RATCHET WRENCHES; HAND TOOLS, NAMELY, REAMERS; HAND TOOLS, NAMELY, SAWS; HAND TOOLS, NAMELY, SCRAPERS; HAND TOOLS, NAMELY, SCREWDRIVERS; HAND TOOLS, NAMELY, SOCKET SETS; HAND TOOLS, NAMELY, SQUARES; HAND TOOLS, NAMELY, WRENCHES; HAND TOOLS, NAMELY, PLIERS, UTILITY KNIFE; HAND TOOLS, NAMELY, BOLT CUTTERS; HAND TOOLS, NAMELY, CHALK LINE

REELS; HAND TOOLS, NAMELY, HATCHETS; HAND TOOLS, NAMELY, HEX KEYS WRENCHES; HAND TOOLS, NAMELY, KNIFE SHARPENERS; HAND TOOLS, NAMELY, LAWN AERATORS; HAND TOOLS, NAMELY, LOPPERS; HAND TOOLS, NAMELY, MITER BOXES; HAND TOOLS, NAMELY, NAIL SETS; HAND TOOLS, NAMELY, NIPPERS; HAND TOOLS, NAMELY, NUT DRIVERS; HAND TOOLS, NAMELY, PAINT SCRAPERS; HAND TOOLS, NAMELY, PRUNERS; HAND TOOLS, NAMELY, PUNCHES; HAND TOOLS, NAMELY, PUTTY KNIVES; HAND TOOLS, NAMELY, RIPPING BARS; HAND TOOLS, NAMELY, SANDERS; HAND TOOLS, NAMELY, SOCKET WRENCHES; HAND TOOLS, NAMELY, VICES; HAND TOOLS, NAMELY, WIRE CUTTERS; HAND TOOLS, NAMELY, WIRE NIPPERS; HAND TOOLS, NAMELY, WIRE STRIPPERS; HAND-HELD TOOLS, NAMELY, CHISELS; HAND-OPERATED RIVETING TOOLS; HAND-OPERATED SHARPENING TOOLS AND INSTRUMENTS; HAND-OPERATED SHEARS; HAND-POWERED STAPLE GUNS; HAND-TOOLS, NAMELY, WIRE CRIMPERS; HOES; KNIVES; LAWN RAKES; MULTI-FUNCTION HAND TOOLS COMPRISED OF MULTI-BIT RATCHETING SCREW DRIVER, SCISSORS, FILE, PLIERS, KNIFE; REAMERS; SAWS; WRENCHES, IN CLASS 8 (U.S. CLS. 23, 28 AND 44).

FIRST USE 9-5-2006; IN COMMERCE 1-5-2007.

THE MARK CONSISTS OF STANDARD CHARACTERS WITHOUT CLAIM TO ANY PARTICULAR FONT, STYLE, SIZE, OR COLOR.

SER. NO. 77-085,279, FILED 1-18-2007.

JORDAN BAKER, EXAMINING ATTORNEY

**Int. Cl.: 35**

**Prior U.S. Cls.: 100, 101 and 102**

**United States Patent and Trademark Office**

**Reg. No. 3,394,133**

**Registered Mar. 11, 2008**

**SERVICE MARK  
PRINCIPAL REGISTER**

# MyTroops

WANDER, LLC (D.C. LTD LIAB CO)  
3220 N. STREET NW, #110  
WASHINGTON, DC 20007

FIRST USE 1-15-2007; IN COMMERCE 1-15-2007.

FOR: PROMOTING THE GOODS AND SERVICES OF OTHERS THROUGH ALL PUBLIC COMMUNICATIONS MEANS VIA GLOBAL COMPUTER NETWORK; CONTESTS AND INVENTIVE AWARD PROGRAMS TO PROMOTE THE SALE OF PRODUCTS AND SERVICES OF OTHERS, IN CLASS 35 (U.S. CLS. 100, 101 AND 102).

THE MARK CONSISTS OF STANDARD CHARACTERS WITHOUT CLAIM TO ANY PARTICULAR FONT, STYLE, SIZE, OR COLOR.

SER. NO. 77-085,430, FILED 1-18-2007.

INGRID C. EULIN, EXAMINING ATTORNEY

Int. Cl.: 36

Prior U.S. Cls.: 100, 101 and 102

United States Patent and Trademark Office

Reg. No. 3,394,134

Registered Mar. 11, 2008

**SERVICE MARK  
PRINCIPAL REGISTER**



PATE, G. THOMAS, JR (UNITED STATES INDIVIDUAL)  
296 FOXCROFT LN  
WINTERVILLE, NC 28590

FOR: FINANCIAL PLANNING CONSULTATION; FINANCIAL PLANNING, NAMELY, THE CREATION OF PERSONALIZED STRATEGIES TO ACHIEVE FINANCIAL INDEPENDENCE, IN CLASS 36 (U.S. CLS. 100, 101 AND 102).

FIRST USE 1-1-2004; IN COMMERCE 3-15-2004.

NO CLAIM IS MADE TO THE EXCLUSIVE RIGHT TO USE "GROUP", APART FROM THE MARK AS SHOWN.

THE COLOR(S) BLUE, GREEN, TAN, ORANGE, AND WHITE IS/ARE CLAIMED AS A FEATURE OF THE MARK.

THE COLOR BLUE COMPRISES THE SKY PORTION OF THE MARK. THE COLOR GREEN COMPRISES THE GRASS PORTION OF THE MARK. THE COLOR TAN COMPRISES THE PATH RUNNING ACROSS THE GREEN GRASS PORTION OF THE MARK TOWARDS THE SUN DESIGN. THE COLOR WHITE APPEARS IN THE LETTER 'J' AND 'URNEYS' AND IS THE OUTLINE OF THE SUN, WHICH APPEARS IN ORANGE AND FORMS THE LETTER 'O'. THE COLOR GREEN ALSO APPEARS IN THE WORD "THE" AND THE COLOR BLUE APPEARS IN THE WORD "GROUP."

SER. NO. 77-086,599, FILED 1-19-2007.

LINDSEY RUBIN, EXAMINING ATTORNEY

**Int. Cl.: 2**

**Prior U.S. Cls.: 6, 11 and 16**

**United States Patent and Trademark Office**

**Reg. No. 3,394,135**

**Registered Mar. 11, 2008**

**TRADEMARK  
PRINCIPAL REGISTER**

**TANALITH**

ARCH TIMBER PROTECTION LIMITED (UNI-  
TED KINGDOM PRIVATE LIMITED COMPA-  
NY)

WHELDON ROAD, CASTLEFORD

WEST YORKSHIRE, UNITED KINGDOM WF102JT

FOR: WOOD PRESERVATIVES, IN CLASS 2 (U.S.  
CLS. 6, 11 AND 16).

THE MARK CONSISTS OF STANDARD CHAR-  
ACTERS WITHOUT CLAIM TO ANY PARTICULAR  
FONT, STYLE, SIZE, OR COLOR.

OWNER OF UNITED KINGDOM REG. NO.  
609359, DATED 10-11-1939, EXPIRES 10-11-2012.

SER. NO. 77-086,813, FILED 1-19-2007.

CHARLOTTE CORWIN, EXAMINING ATTORNEY

**Int. Cl.: 9**

**Prior U.S. Cls.: 21, 23, 26, 36 and 38**

**Reg. No. 3,394,136**

**United States Patent and Trademark Office**

**Registered Mar. 11, 2008**

**TRADEMARK  
PRINCIPAL REGISTER**

**IWATSU VOICE NETWORKS**

IWATSU VOICE NETWORKS (NEW JERSEY CORPORATION)  
8001 JETSTAR DRIVE  
IRVING, TX 75063

FOR: KEY TELEPHONES; PRIVATE BRANCH AUTOMATIC TELEPHONE EXCHANGES; MULTIPLE LINE TELEPHONE SYSTEM ATTENDANT CONSOLES; COMPUTER SOFTWARE PROGRAMS FOR OPERATING AND MANAGING TELEPHONE SYSTEMS, VOICE MAIL, CALL ACCOUNTING, AND CALL MANAGEMENT FOR USE IN VOICE AND DATA COMMUNICATIONS; DIRECT STATION SELECTION UNITS FOR TELEPHONES; VOICE MAIL SYSTEMS COMPRISING AN INTEGRATED MESSAGE SYSTEM, NAMELY, A SYSTEM CONSISTING OF AN EXTERNAL COMMUNICATION SERVER, AN INTERNAL COMMUNICATION SERVER AND COMPUTER THAT UNIFY MESSAGING IN THE NATURE OF INTEGRATING VOICE, TEXT, AND E-MAIL MESSAGES IN ONE LOCATION; TELEPHONES; TELEPHONE ANSWERING APPARATUS, NAMELY, EQUIPMENT FOR AUTOMATICALLY ANSWERING TELEPHONES IN THE ABSENCE OF HUMAN INTERVENTION AND TO RECEIVE, RECORD, PLAY BACK, AND FORWARD VOICE MESSAGES SO RECEIVED AND/OR TO TRANSMIT MESSAGES OVER THE TELEPHONE; RADIO PAGING SYSTEMS COMPRISING A HANDSET, BASE STATION, REPEATER, PORTABLE MOBILE RADIO STATION, SWITCHING CONTROLLER; VOICE OVER INTERNET PROTOCOL (VOIP) PHONES; INTERNET AND

H323 PHONES; LAN/WAN NETWORKS PROVIDING VOICE AND VIDEO COMMUNICATION, NAMELY, COMPUTER HARDWARE AND SOFTWARE FOR SETTING UP AND CONFIGURING LOCAL AREA NETWORKS; COMPUTER HARDWARE AND SOFTWARE FOR SETTING UP AND CONFIGURING WIDE AREA NETWORKS; COMPUTER NETWORK ADAPTERS; COMPUTER NETWORK HUBS, SWITCHES AND ROUTERS; LAN (LOCAL AREA NETWORK) ACCESS POINTS FOR CONNECTING NETWORK COMPUTER USERS; LAN (LOCAL AREA NETWORK) COMPUTER CARDS FOR CONNECTING PORTABLE COMPUTER DEVICES TO COMPUTER NETWORKS; LAN (LOCAL AREA NETWORK) OPERATING SOFTWARE AND HARDWARE; OR WAN (WIDE AREA NETWORK) OPERATING SOFTWARE AND HARDWARE, IN CLASS 9 (U.S. CLS. 21, 23, 26, 36 AND 38).

FIRST USE 6-0-2004; IN COMMERCE 6-0-2004.

THE MARK CONSISTS OF STANDARD CHARACTERS WITHOUT CLAIM TO ANY PARTICULAR FONT, STYLE, SIZE, OR COLOR.

NO CLAIM IS MADE TO THE EXCLUSIVE RIGHT TO USE "VOICE NETWORKS", APART FROM THE MARK AS SHOWN.

SER. NO. 77-087,005, FILED 1-19-2007.

TINA BROWN, EXAMINING ATTORNEY



**Int. Cl.: 41**

**Prior U.S. Cls.: 100, 101 and 107**

**United States Patent and Trademark Office**

**Reg. No. 3,394,137**

**Registered Mar. 11, 2008**

**SERVICE MARK  
PRINCIPAL REGISTER**

{BS} theBrandshow

TWO WEST, INC. (MISSOURI CORPORATION)  
LOFT 2W  
514 WEST 26TH STREET  
KANSAS CITY, MO 64108

FIRST USE 5-11-2005; IN COMMERCE 5-11-2005.

NO CLAIM IS MADE TO THE EXCLUSIVE  
RIGHT TO USE "THE BRAND SHOW", APART  
FROM THE MARK AS SHOWN.

FOR: EDUCATIONAL AND ENTERTAINMENT  
SERVICES TO HELP BUSINESSES CREATE, BUILD  
AND MANAGE THEIR BRANDS, NAMELY, PRO-  
VIDING A RADIO PROGRAM FOR LISTENING TO  
VIA THE RADIO AND THE INTERNET, IN CLASS  
41 (U.S. CLS. 100, 101 AND 107).

SER. NO. 77-087,103, FILED 1-19-2007.

JASON LOTT, EXAMINING ATTORNEY

**Int. Cl.: 5**

**Prior U.S. Cls.: 6, 18, 44, 46, 51 and 52**

**United States Patent and Trademark Office**

**Reg. No. 3,394,138**

**Registered Mar. 11, 2008**

**TRADEMARK  
PRINCIPAL REGISTER**

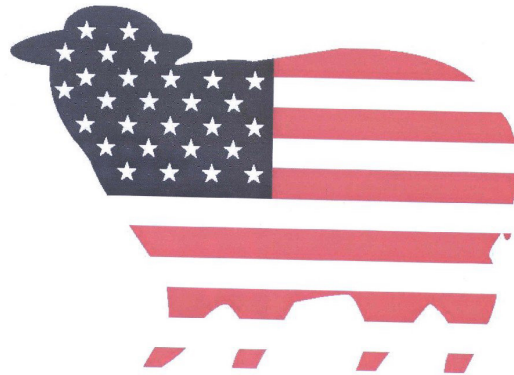

SCHERING-PLOUGH ANIMAL HEALTH COR-  
PORATION (DELAWARE CORPORATION)  
556 MORRIS AVENUE  
SUMMIT, NJ 07901

FOR: SHEEP VACCINE, IN CLASS 5 (U.S. CLS. 6,  
18, 44, 46, 51 AND 52).

FIRST USE 11-30-1997; IN COMMERCE 11-30-1997.

THE COLOR(S) RED, WHITE AND BLUE IS/ARE  
CLAIMED AS A FEATURE OF THE MARK.

THE MARK CONSISTS OF SHEEP DESIGN WITH  
WHITE STARS IN DARK BLUE BACKGROUND IN  
TOP LEFT CORNER OF THE SHEEP AND RED  
AND WHITE STRIPES IN REMAINDER OF DE-  
SIGN.

SER. NO. 77-087,595, FILED 1-22-2007.

STEVEN PEREZ, EXAMINING ATTORNEY

**Int. Cl.: 30**

**Prior U.S. Cl.: 46**

**United States Patent and Trademark Office**

**Reg. No. 3,394,139**

**Registered Mar. 11, 2008**

**TRADEMARK  
PRINCIPAL REGISTER**

**PUG'S**

E.A. SWEEN COMPANY (MINNESOTA COR-  
PORATION)  
16101 W. 78TH STREET  
EDEN PRAIRIE, MN 55344

THE MARK CONSISTS OF STANDARD CHAR-  
ACTERS WITHOUT CLAIM TO ANY PARTICULAR  
FONT, STYLE, SIZE, OR COLOR.

FOR: SANDWICHES, IN CLASS 30 (U.S. CL. 46).

SER. NO. 77-087,880, FILED 1-22-2007.

FIRST USE 9-26-1989; IN COMMERCE 9-26-1989.

FRANK LATTUCA, EXAMINING ATTORNEY

**Int. Cl.: 18**

**Prior U.S. Cls.: 1, 2, 3, 22 and 41**

**United States Patent and Trademark Office**

**Reg. No. 3,394,140**

**Registered Mar. 11, 2008**

**TRADEMARK  
PRINCIPAL REGISTER**

**POSH PAPOOSE**

POSH PAPOOSE LLC (CALIFORNIA LTD LIAB  
CO)  
608 SANTA CLARA AVENUE, SUITE 4  
VENICE, CA 90291

FOR: BAGS FOR CARRYING BABIES' ACCES-  
SORIES; INFANT CARRIERS WORN ON THE  
BODY; SLINGS FOR CARRYING INFANTS, IN  
CLASS 18 (U.S. CLS. 1, 2, 3, 22 AND 41).

FIRST USE 9-1-2004; IN COMMERCE 9-1-2004.

THE MARK CONSISTS OF STANDARD CHAR-  
ACTERS WITHOUT CLAIM TO ANY PARTICULAR  
FONT, STYLE, SIZE, OR COLOR.

NO CLAIM IS MADE TO THE EXCLUSIVE  
RIGHT TO USE "PAPOOSE", APART FROM THE  
MARK AS SHOWN.

SER. NO. 77-088,073, FILED 1-22-2007.

CARYN GLASSER, EXAMINING ATTORNEY

**Int. Cl.: 7**

**Prior U.S. Cls.: 13, 19, 21, 23, 31, 34 and 35**

**United States Patent and Trademark Office**

**Reg. No. 3,394,141**

**Registered Mar. 11, 2008**

**TRADEMARK  
PRINCIPAL REGISTER**

**ROVER**

DRI-EAZ PRODUCTS, INC. (WASHINGTON  
CORPORATION)  
15180 JOSH WILSON ROAD  
BURLINGTON, WA 98233

THE MARK CONSISTS OF STANDARD CHAR-  
ACTERS WITHOUT CLAIM TO ANY PARTICULAR  
FONT, STYLE, SIZE, OR COLOR.

FOR: RESTORATIVE DRYING EQUIPMENT,  
NAMELY, VACUUM MACHINES FOR REMOVING  
LIQUID FROM FLOOR SURFACES, IN CLASS 7  
(U.S. CLS. 13, 19, 21, 23, 31, 34 AND 35).

SER. NO. 77-088,101, FILED 1-22-2007.

FIRST USE 9-18-2006; IN COMMERCE 9-18-2006.

TIMOTHY FINNEGAN, EXAMINING ATTORNEY

**Int. Cls.: 7, 9, 37, 38 and 42**

**Prior U.S. Cls.: 13, 19, 21, 23, 26, 31, 34, 35, 36, 38,  
100, 101, 103, 104 and 106**

**Reg. No. 3,394,142**

**United States Patent and Trademark Office**

**Registered Mar. 11, 2008**

**TRADEMARK  
SERVICE MARK  
PRINCIPAL REGISTER**

# Cubelix

ADS-TEC AUTOMATION DATEN- UND SYSTEMTECHNIK GMBH (FED REP GERMANY GMBH)

RAIFFEISENSTRASSE 14  
LEINFELDEN-ECHTERDINGE, FED REP GERMAN Y D-70771

FOR: CONVEYORS, MACHINES FOR CONVEYING SOLIDS, PARTS OF THE AFOREMENTIONED GOODS, IN CLASS 7 (U.S. CLS. 13, 19, 21, 23, 31, 34 AND 35).

FOR: COMPUTER HARDWARE; COMPUTER PERIPHERALS; COMPUTER OPERATING PROGRAMS; COMPUTER INTERFACE BOARDS, UPI (UNIVERSAL PERIPHERAL INTERFACE) SOFTWARE AND HARDWARE; ELECTRIC NAVIGATIONAL INSTRUMENTS; ELECTRICAL CONTROLLING DEVICES AND ELECTRONIC CONTROL SYSTEMS FOR MACHINES, IN CLASS 9 (U.S. CLS. 21, 23, 26, 36 AND 38).

FOR: INSTALLATION, MAINTENANCE AND REPAIR OF AUTOMATION AND CONTROLLING MACHINERY, IN CLASS 37 (U.S. CLS. 100, 103 AND 106).

FOR: TRANSMISSION OF DATA BY TELECOMMUNICATION NETWORKS, IN CLASS 38 (U.S. CLS. 100, 101 AND 104).

FOR: DESIGN, DEVELOPMENT, IMPLEMENTATION AND MAINTENANCE OF COMPUTER SOFTWARE; DESIGN AND DEVELOPMENT OF SOFTWARE AND HARDWARE IN THE FIELDS OF AUTOMATION AND CONTROL SYSTEMS FOR MACHINES, DATA PROCESSING TECHNOLOGY AND SYSTEM TECHNOLOGY FOR PRODUCTION, LOGISTICS AND FACILITY CONTROL; DESIGN AND DEVELOPMENT OF NETWORKS; TECHNICAL SUPPORT SERVICES, NAMELY, COMPUTER PROJECT MANAGEMENT SERVICES; TECHNICAL CONSULTANCY IN THE FIELD OF THE DESIGN AND DEVELOPMENT OF TELECOMMUNICATION NETWORKS, IN CLASS 42 (U.S. CLS. 100 AND 101).

THE MARK CONSISTS OF STANDARD CHARACTERS WITHOUT CLAIM TO ANY PARTICULAR FONT, STYLE, SIZE, OR COLOR.

PRIORITY CLAIMED UNDER SEC. 44(D) ON FED REP GERMANY APPLICATION NO. 30664297207, FILED 10-19-2006, REG. NO. 30664297, DATED 3-2-2007, EXPIRES 10-31-2016.

SER. NO. 77-088,351, FILED 1-22-2007.

DAVID ELTON, EXAMINING ATTORNEY

**Int. Cl.: 38**

**Prior U.S. Cls.: 100, 101 and 104**

**United States Patent and Trademark Office**

**Reg. No. 3,394,143**

**Registered Mar. 11, 2008**

**SERVICE MARK  
PRINCIPAL REGISTER**

**103.9 WTDA**

NORTH AMERICAN BROADCASTING COMPAN-  
NY, INC. (OHIO CORPORATION)  
1458 DUBLIN RD.  
COLUMBUS, OH 43215

NO CLAIM IS MADE TO THE EXCLUSIVE  
RIGHT TO USE "103.9", APART FROM THE MARK  
AS SHOWN.

FOR: RADIO BROADCASTING, IN CLASS 38 (U.S.  
CLS. 100, 101 AND 104).

SER. NO. 77-088,935, FILED 1-23-2007.

FIRST USE 11-5-2004; IN COMMERCE 11-5-2004.

THE MARK CONSISTS OF STANDARD CHAR-  
ACTERS WITHOUT CLAIM TO ANY PARTICULAR  
FONT, STYLE, SIZE, OR COLOR.

JOHN SCHUYLER YARD, EXAMINING ATTOR-  
NEY

**Int. Cl.: 9**

**Prior U.S. Cls.: 21, 23, 26, 36 and 38**

**Reg. No. 3,394,144**

**United States Patent and Trademark Office**

**Registered Mar. 11, 2008**

**TRADEMARK  
PRINCIPAL REGISTER**

# Pronix

LEBRO INDUSTRIAL CO., LTD. (TAIWAN CORPORATION)  
11F-1, NO.185, SUNG CHIANG RD.  
TAIPEI, TAIWAN

FOR: INTEGRATED CIRCUIT MEMORY, INTEGRATED CIRCUIT WAFERS AND CHIPS, INTEGRATED CIRCUITS DEVICES, SEMICONDUCTOR COMPONENTS, NAMELY, SEMICONDUCTOR CHIPS, INTEGRATED CIRCUITS, ACCELERATOR CARDS, COMPUTER OPERATING SYSTEMS, PERSONAL COMPUTER SYSTEM, NAMELY, DESKTOP PC AND LAPTOP PC, INTERFACE CARDS, DYNAMIC RANDOM ACCESS MEMORY COMPONENTS AND MODULES, MASS STORAGE MEDIAS FOR AUDIO AND VIDEO APPLICATIONS, NAMELY, FLOPPY DISCS, HARD DISCS, CD DRIVES AND FLASH MEMORY USB DRIVER, SECURITY DIGITAL CARD(SD CARD), SOLID STATE DRIVER FOR COMPUTER, DIGITAL PHOTO FRAMES, MEMORY CARDS, DIGITAL AUDIO AND VIDEO PLAYERS, SECURITY SYSTEMS USED FOR HOMES, OFFICE AND AUTOMOBILES, COM-

PRISING WIRELESS CONTROLLERS, CONTROLLED DEVICES, AND SOFTWARE FOR SECURITY, SAFETY, AND OTHER HOME AND OFFICE MONITORING CONTROL APPLICATIONS, COMBINATION ELECTRIC LOCK FOR COMPUTERS, CONSTRUCTION EQUIPMENT FOR INTERNET; FINGERPRINT IDENTIFICATION EQUIPMENT, NAMELY, COMPUTERIZED TIME CLOCK WITH FINGERPRINT RECOGNITION, SOLID STATE DRIVE, COMPUTER MOUSE, UNIVERSAL SERIAL BUS DRIVERS, PERSONAL DIGITAL ASSISTANT, IN CLASS 9 (U.S. CLS. 21, 23, 26, 36 AND 38).

FIRST USE 1-11-2006; IN COMMERCE 1-11-2006.

THE MARK CONSISTS OF STANDARD CHARACTERS WITHOUT CLAIM TO ANY PARTICULAR FONT, STYLE, SIZE, OR COLOR.

SER. NO. 77-089,758, FILED 1-24-2007.

NAKIA HENRY, EXAMINING ATTORNEY



**Int. Cls.: 41 and 42**

**Prior U.S. Cls.: 100, 101 and 107**

**United States Patent and Trademark Office**

**Reg. No. 3,394,145**

**Registered Mar. 11, 2008**

**SERVICE MARK  
PRINCIPAL REGISTER**

**KARMANOS CANCER INSTITUTE**

BARBARA ANN KARMANOS CANCER INSTI-  
TUTED (MICHIGAN NON-PROFIT COR-  
PORATION), DBA KARMANOS CANCER  
INSTITUTE  
4100 JOHN R  
DETROIT, MI 48201

FOR: EDUCATIONAL SERVICES FOR MEDICAL  
STUDENTS AND CANCER SCIENTISTS, NAMELY,  
CONDUCTING CLASSES, SEMINARS, WORK-  
SHOPS, CONFERENCES AND COURSES IN THE  
FIELD OF CANCER PREVENTION, DETECTION,  
TREATMENT AND RESEARCH; EDUCATIONAL  
SERVICES, NAMELY, EDUCATIONAL PROGRAMS  
FOR PATIENTS AND THEIR FAMILIES IN THE  
NATURE OF CLASSES, SEMINARS, WORKSHOPS,  
CONFERENCES AND COURSES DESIGNED TO  
HELP IN THE PREVENTION AND EARLY DETEC-  
TION OF CANCER AND TO PROVIDE EDUCA-  
TIONAL INFORMATION REGARDING CANCER  
TREATMENT, IN CLASS 41 (U.S. CLS. 100, 101 AND  
107).

FIRST USE 7-21-1995; IN COMMERCE 7-21-1995.

FOR: MEDICAL AND SCIENTIFIC CANCER RE-  
SEARCH IN THE FIELD OF CANCER DETECTION,  
TREATMENT AND PREVENTION, IN CLASS 42  
(U.S. CLS. 100 AND 101).

FIRST USE 7-21-1995; IN COMMERCE 7-21-1995.

THE MARK CONSISTS OF STANDARD CHAR-  
ACTERS WITHOUT CLAIM TO ANY PARTICULAR  
FONT, STYLE, SIZE, OR COLOR.

OWNER OF U.S. REG. NOS. 2,513,554 AND  
2,548,978.

NO CLAIM IS MADE TO THE EXCLUSIVE  
RIGHT TO USE "CANCER INSTITUTE", APART  
FROM THE MARK AS SHOWN.

SER. NO. 77-090,205, FILED 1-24-2007.

PRISCILLA MILTON, EXAMINING ATTORNEY

**Int. Cl.: 16**

**Prior U.S. Cls.: 2, 5, 22, 23, 29, 37, 38 and 50**

**United States Patent and Trademark Office**

**Reg. No. 3,394,146**

**Registered Mar. 11, 2008**

**TRADEMARK  
PRINCIPAL REGISTER**

**GOING GLOBAL**

MARY ANNE THOMPSON (UNITED STATES  
INDIVIDUAL)  
258 COLLEGE LANE  
MOBILE, AL 36608

FOR: PUBLICATIONS, NAMELY, BROCHURES,  
BOOKLETS, AND TEACHING MATERIALS IN THE  
FIELD OF LIVING AND WORKING IN INTERNA-  
TIONAL LOCATIONS, IN CLASS 16 (U.S. CLS. 2, 5,  
22, 23, 29, 37, 38 AND 50).

FIRST USE 1-1-2000; IN COMMERCE 1-1-2000.

THE MARK CONSISTS OF STANDARD CHAR-  
ACTERS WITHOUT CLAIM TO ANY PARTICULAR  
FONT, STYLE, SIZE, OR COLOR.

NO CLAIM IS MADE TO THE EXCLUSIVE  
RIGHT TO USE "GLOBAL", APART FROM THE  
MARK AS SHOWN.

SER. NO. 77-090,745, FILED 1-25-2007.

MICHAEL GAAFAR, EXAMINING ATTORNEY

**Int. Cls.: 36 and 42**

**Prior U.S. Cls.: 100, 101 and 102**

**United States Patent and Trademark Office**

**Reg. No. 3,394,147**

**Registered Mar. 11, 2008**

**SERVICE MARK  
PRINCIPAL REGISTER**

**SHAREX**

BNY CONVERGEX GROUP, LLC (DELAWARE  
LTD LIAB CO)  
1633 BROADWAY  
NEW YORK, NY 10019

FOR: FINANCIAL SERVICES, NAMELY, TRADING COMMISSION MANAGEMENT SERVICES; FINANCIAL SERVICES, NAMELY, MANAGING TRADING COMMISSION SHARING ARRANGEMENTS IN THE NATURE OF BROKERAGE COMMISSIONS FOR SECURITIES TRADE EXECUTION; FINANCIAL SERVICES, NAMELY, ADMINISTERING AND MANAGING TRADING COMMISSIONS BY RECEIVING CLIENTS' TRADING COMMISSIONS FROM EXECUTING BROKERS AND DEALERS AND PAYING FOR RESEARCH AND SERVICES ON BEHALF OF THOSE CLIENTS; PAYMENT MANAGEMENT SERVICES, NAMELY, PROVIDING AND ADMINISTERING A CLIENT ACCOUNT TO COLLECT AND AGGREGATE TRADING COMMISSIONS AND PAY FOR RESEARCH FROM RESEARCH FIRMS AND BROKERAGES; PAYMENT MANAGEMENT SERVICES, NAMELY, MANAGING PAYMENTS TO THIRD PARTY RESEARCH PROVIDERS; PROVIDING FINANCIAL INFORMATION, NAMELY, MAKING A CLIENT'S TRADING COMMISSION INFORMATION AND PAYMENTS FOR RESEARCH AVAIL-

ABLE VIA AN ONLINE ELECTRONIC NETWORK, IN CLASS 36 (U.S. CLS. 100, 101 AND 102).

FIRST USE 11-1-2006; IN COMMERCE 11-1-2006.

FOR: PROVIDING TEMPORARY USE OF ONLINE NON-DOWNLOADABLE FINANCIAL SOFTWARE, NAMELY, AN INTERACTIVE COMMISSION MANAGEMENT PORTAL THAT ALLOWS CUSTOMERS TO MANAGE THEIR SECURITIES TRANSACTION COMMISSION BALANCES, APPROVE AND PAY INVOICES FOR SERVICES RENDERED, OBTAIN ACCOUNT BALANCES FOR COMMISSION REVENUE, DISPLAY ACCOUNT STATEMENTS, REVIEW REGULATORY LIBRARIES AND COMMUNICATE VIA ONLINE ELECTRONIC BULLETIN BOARDS, IN CLASS 42 (U.S. CLS. 100 AND 101).

FIRST USE 11-1-2006; IN COMMERCE 11-1-2006.

THE MARK CONSISTS OF STANDARD CHARACTERS WITHOUT CLAIM TO ANY PARTICULAR FONT, STYLE, SIZE, OR COLOR.

SER. NO. 77-091,246, FILED 1-25-2007.

AMEETA JORDAN, EXAMINING ATTORNEY

**Int. Cl.: 41**

**Prior U.S. Cls.: 100, 101 and 107**

**United States Patent and Trademark Office**

**Reg. No. 3,394,148**

**Registered Mar. 11, 2008**

**SERVICE MARK  
PRINCIPAL REGISTER**

**LA MADRASTRA**

TELEVISA, S.A. DE C.V. (MEXICO CORPORATION)  
EDIFICIO A, PISO 4  
AVENIDA VASCO DE QUIROGA 2000  
COLONIA ZEDEC SANTA FE, MEXICO 01210

FOR: ENTERTAINMENT SERVICES, NAMELY,  
AN ONGOING DRAMATIC TELEVISION PROGRAM,  
IN CLASS 41 (U.S. CLS. 100, 101 AND 107).

FIRST USE 2-7-2005; IN COMMERCE 3-21-2005.

THE MARK CONSISTS OF STANDARD CHARACTERS WITHOUT CLAIM TO ANY PARTICULAR FONT, STYLE, SIZE, OR COLOR.

THE FOREIGN WORDING IN THE MARK TRANSLATES INTO ENGLISH AS "THE STEPMOTHER".

SER. NO. 77-091,899, FILED 1-26-2007.

MICHAEL WEBSTER, EXAMINING ATTORNEY

**Int. Cl.: 41**

**Prior U.S. Cls.: 100, 101 and 107**

**United States Patent and Trademark Office**

**Reg. No. 3,394,149**

**Registered Mar. 11, 2008**

---

**SERVICE MARK  
PRINCIPAL REGISTER**

**RUBÍ**

TELEVISA, S.A. DE C.V. (MEXICO CORPORATION)  
EDIFICIO A, PISO 4  
AVENIDA VASCO DE QUIROGA 2000  
COLONIA ZEDEC SANTA FE, MEXICO 01210

THE MARK CONSISTS OF STANDARD CHARACTERS WITHOUT CLAIM TO ANY PARTICULAR FONT, STYLE, SIZE, OR COLOR.

FOR: ENTERTAINMENT SERVICES, NAMELY, AN ONGOING DRAMATIC TELEVISION PROGRAM, IN CLASS 41 (U.S. CLS. 100, 101 AND 107).

SER. NO. 77-091,942, FILED 1-26-2007.

FIRST USE 5-17-2004; IN COMMERCE 9-20-2004.

MICHAEL WEBSTER, EXAMINING ATTORNEY

**Int. Cl.: 37**

**Prior U.S. Cls.: 100, 103 and 106**

**United States Patent and Trademark Office**

**Reg. No. 3,394,150**

**Registered Mar. 11, 2008**

**SERVICE MARK  
PRINCIPAL REGISTER**



BONDED CONCRETE, INC. (NEW YORK CORPORATION)

303 WATERVLIET SHAKER ROAD  
WATERVLIET, NY 12189 AND

CENTURY ACQUISITION, INC. (NEW YORK CORPORATION)

303 WATERVLIET SHAKER ROAD  
WATERVLIET, NY 12189 AND

TWENTY-FIRST CENTURY CONCRETE, INC.  
(NEW YORK CORPORATION)

303 WATERVLIET SHAKER ROAD  
WATERVLIET, NY 12189

THE COLOR(S) BLUE, ORANGE AND WHITE IS/  
ARE CLAIMED AS A FEATURE OF THE MARK.

THE MARK CONSISTS OF A CENTRAL SOLID  
BLUE CIRCLE WITH A SOLID ORANGE STAR  
OVER IT. THE AFOREMENTIONED SOLID BLUE  
CIRCLE AND STAR ARE IN THE CENTER OF A  
WHITE CIRCLE BORDERED BY A BLUE LINE.

FOR: ROAD CONSTRUCTION, IN CLASS 37 (U.S.  
CLS. 100, 103 AND 106).

SER. NO. 77-092,246, FILED 1-26-2007.

FIRST USE 4-1-1964; IN COMMERCE 4-1-1964.

LINDA ORNDORFF, EXAMINING ATTORNEY

**Int. Cl.: 35**

**Prior U.S. Cls.: 100, 101 and 102**

**United States Patent and Trademark Office**

**Reg. No. 3,394,151**

**Registered Mar. 11, 2008**

**SERVICE MARK  
PRINCIPAL REGISTER**



ELIZABETH QUINTANILLA (PERU INDIVIDUAL)  
1521 COLONIAL DRIVE, APT. T3  
WOODBIDGE, VA 22192

FOR: ENTERTAINMENT MARKETING SERVICES, NAMELY, MARKETING, PROMOTION AND ADVERTISING FOR INDEPENDENT RECORDING ARTISTS, NAMELY MUSICAL BANDS; COMPUTERIZED ON-LINE RETAIL AND ORDERING SERVICES IN THE FIELDS OF SOUND AND MUSIC VIDEO RECORDINGS PROVIDED BY MEANS OF A GLOBAL COMPUTER NETWORK; TALENT AGENCY SERVICES EMPLOYMENT AND MANAGEMENT SERVICES, NAMELY MUSICAL ARTIST

DEVELOPMENT, MANAGEMENT AND TALENT SCOUTING, IN CLASS 35 (U.S. CLS. 100, 101 AND 102).

FIRST USE 12-31-2005; IN COMMERCE 12-31-2005.

THE MARK CONSISTS OF AN INTERTWINED STYLIZED LETTER A AND A STYLIZED NUMBER 3.

SER. NO. 77-092,465, FILED 1-26-2007.

ANDREA BUTLER, EXAMINING ATTORNEY

**Int. Cl.: 5**

**Prior U.S. Cls.: 6, 18, 44, 46, 51 and 52**

**United States Patent and Trademark Office**

**Reg. No. 3,394,152**

**Registered Mar. 11, 2008**

**TRADEMARK  
PRINCIPAL REGISTER**

**ANIMED**

AHC PRODUCTS, INC. (NEVADA CORPORATION)  
301 WEST BROADWAY  
WINCHESTER, KY 40391

FOR: FEED SUPPLEMENTS FOR DOMESTIC ANIMALS AND LIVESTOCK; NUTRITIONAL SUPPLEMENTS FOR ANIMALS; NUTRITIONAL ADDITIVES FOR LIVESTOCK FEED; ANIMAL FEED ADDITIVE FOR USE AS A NUTRITIONAL SUPPLEMENT; HERBAL AND BOTANICAL FEED SUPPLEMENTS FOR ANIMALS; NUTRACEUTICAL DIETARY SUPPLEMENTS FOR ANIMALS; PHARMACEUTICAL PREPARATIONS FOR ANIMALS, NAMELY, ANTITUSSIVES, ANTIHISTAMINES, ANTIPYRETICS, AND ANTI-INFLAMMATORIES; VETERINARY PREPARATIONS, NAMELY, ANTITUSSIVES, ANTIHISTAMINES, ANTIPYRE-

TICS, AND ANTI-INFLAMMATORIES; VETERINARY MEDICATIONS FOR TREATING CUTS ON ANIMALS; AND WOUND DRESSINGS FOR ANIMALS, IN CLASS 5 (U.S. CLS. 6, 18, 44, 46, 51 AND 52).

FIRST USE 2-0-1999; IN COMMERCE 2-0-1999.

THE MARK CONSISTS OF STANDARD CHARACTERS WITHOUT CLAIM TO ANY PARTICULAR FONT, STYLE, SIZE, OR COLOR.

OWNER OF U.S. REG. NO. 2,956,982.

SER. NO. 77-093,457, FILED 1-29-2007.

TARAH HARDY, EXAMINING ATTORNEY



**Int. Cl.: 5**

**Prior U.S. Cls.: 6, 18, 44, 46, 51 and 52**

**United States Patent and Trademark Office**

**Reg. No. 3,394,153**

**Registered Mar. 11, 2008**

**TRADEMARK  
PRINCIPAL REGISTER**

**IT'S ALL ABOUT THE ANIMALS**

AHC PRODUCTS, INC. (NEVADA CORPORATION)  
301 WEST BROADWAY  
WINCHESTER, KY 40391

FOR: FEED SUPPLEMENTS FOR DOMESTIC ANIMALS AND LIVESTOCK; NUTRITIONAL SUPPLEMENTS FOR ANIMALS; NUTRITIONAL ADDITIVES FOR LIVESTOCK FEED; ANIMAL FEED ADDITIVE FOR USE AS A NUTRITIONAL SUPPLEMENT; HERBAL AND BOTANICAL FEED SUPPLEMENTS FOR ANIMALS; NUTRACEUTICAL DIETARY SUPPLEMENTS FOR ANIMALS; PHARMACEUTICAL PREPARATIONS FOR ANIMALS, NAMELY, ANTITUSSIVES, ANTIHISTAMINES, ANTI-PYRETICS, AND ANTI-INFLAMMATORIES; VETERINARY PREPARATIONS, NAMELY,

ANTITUSSIVES, ANTIHISTAMINES, ANTI-PYRETICS, AND ANTI-INFLAMMATORIES; VETERINARY MEDICATIONS FOR TREATING CUTS ON ANIMALS; AND WOUND DRESSINGS FOR ANIMALS, IN CLASS 5 (U.S. CLS. 6, 18, 44, 46, 51 AND 52).

FIRST USE 2-0-1999; IN COMMERCE 2-0-1999.

THE MARK CONSISTS OF STANDARD CHARACTERS WITHOUT CLAIM TO ANY PARTICULAR FONT, STYLE, SIZE, OR COLOR.

SER. NO. 77-093,469, FILED 1-29-2007.

TARAH HARDY, EXAMINING ATTORNEY

**Int. Cls.: 9 and 10**

**Prior U.S. Cls.: 21, 23, 26, 36, 38, 39 and 44**

**United States Patent and Trademark Office**

**Reg. No. 3,394,154**

**Registered Mar. 11, 2008**

**TRADEMARK  
PRINCIPAL REGISTER**

# LASERDOT

EUROPEAN AERONAUTIQUE DEFENCE AND  
SPACE COMPANY EADS FRANCE (FRANCE  
SIMPLIFIED JOINT STOCK COMPANY)  
37, BOULEVARD DE MONTMORENCY  
PARIS, FRANCE 75116

FOR: LASER DEVICES FOR NON-MEDICAL USE,  
NAMELY, SOLID-STATE LASERS, NEODYMIUM-  
YTTRIUM-ALUMINIUM-GARNET LASERS, LI-  
QUID LASERS, COLORED LIQUID LASERS, GAS  
LASERS, CO<sub>2</sub> LASERS, SEMICONDUCTOR LA-  
SERS, PARAMETRAL LASERS, EXCIMER LASERS,  
CHEMICAL LASERS, PULSED CHEMICAL LA-  
SERS, X-RAY PRE-IONIZATION SOURCES SOLD  
AS A COMPONENT FOR HYDROFLUORIC ACID  
LASERS, LASER HEADS, LASER DIODES, LASER  
DIODES FOR PUMPING LASERS, PUMPING DE-  
VICES FOR ACTIVATION OF LASERS AND OP-  
TRONICS EQUIPMENT, NAMELY, BINOCULARS,  
RANGE FINDERS, GUIDANCE AND LANDING  
SYSTEMS COMPRISING LIGHT BEAM GENERA-  
TORS FOR AIRCRAFT; OPTICAL GUIDANCE AND

LANDING AID SYSTEMS COMPRISING LIGHT  
BEAM GENERATORS FOR SEA-BASED HELICOP-  
TERS; LASER GUIDANCE AND TARGETING AP-  
PARATUS FOR MISSILES, IN CLASS 9 (U.S. CLS. 21,  
23, 26, 36 AND 38).

FOR: LASER DEVICES FOR SURGICAL, MEDI-  
CAL, AND PARAMEDICAL USE, IN CLASS 10 (U.S.  
CLS. 26, 39 AND 44).

THE MARK CONSISTS OF STANDARD CHAR-  
ACTERS WITHOUT CLAIM TO ANY PARTICULAR  
FONT, STYLE, SIZE, OR COLOR.

OWNER OF FRANCE REG. NO. 1550518, DATED  
6-10-1999, EXPIRES 9-12-2009.

SER. NO. 77-093,674, FILED 1-29-2007.

INGA ERVIN, EXAMINING ATTORNEY

**Int. Cl.: 36**

**Prior U.S. Cls.: 100, 101 and 102**

**United States Patent and Trademark Office**

**Reg. No. 3,394,155**

**Registered Mar. 11, 2008**

**SERVICE MARK  
PRINCIPAL REGISTER**

**COLUMBIA DAILY DEPOSIT**

COLUMBIA STATE BANK (WASHINGTON CORPORATION)  
MARKETING DEPARTMENT  
1301 A STREET  
TACOMA, WA 98402

FOR: BANKING SERVICES, NAMELY ELECTRONIC PROCESSING AND CONVERSION OF CHECKS TO ELECTRONIC DEPOSITS, IN CLASS 36 (U.S. CLS. 100, 101 AND 102).

FIRST USE 2-7-2007; IN COMMERCE 2-7-2007.

THE MARK CONSISTS OF STANDARD CHARACTERS WITHOUT CLAIM TO ANY PARTICULAR FONT, STYLE, SIZE, OR COLOR.

OWNER OF U.S. REG. NO. 2,479,271.

NO CLAIM IS MADE TO THE EXCLUSIVE RIGHT TO USE "DAILY DEPOSIT", APART FROM THE MARK AS SHOWN.

SEC. 2(F).

SER. NO. 77-093,906, FILED 1-29-2007.

CARYN GLASSER, EXAMINING ATTORNEY

**Int. Cls.: 16 and 41**

**Prior U.S. Cls.: 2, 5, 22, 23, 29, 37, 38, 50, 100, 101 and 107**

**United States Patent and Trademark Office**

**Reg. No. 3,394,156**

**Registered Mar. 11, 2008**

**TRADEMARK  
SERVICE MARK  
PRINCIPAL REGISTER**

**212° the extra degree**

PARKER, SAMUEL, LEET (VIRGINIA SOLE PROPRIETORSHIP)  
412 GASLIGHT TERRACE  
RICHMOND, VA 23229

FOR: BOOKS, WORKSHOPS AND MANUALS IN THE FIELD OF PERSONAL AND PROFESSIONAL DEVELOPMENT; PRESENTATION MATERIAL, NAMELY, PRESENTATION BOARDS AND FOLDERS; MOTIVATIONAL PRODUCTS, NAMELY, MOTIVATIONAL CARDS AND POSTERS, IN CLASS 16 (U.S. CLS. 2, 5, 22, 23, 29, 37, 38 AND 50).

FIRST USE 8-1-2002; IN COMMERCE 8-1-2002.

FOR: EDUCATION SERVICES, NAMELY, CONDUCTING WORKSHOPS, CLASSES AND SEMINARS FOR PERSONAL AND PROFESSIONAL

DEVELOPMENT; AND EDUCATION SERVICES, NAMELY, CONDUCTING WORKSHOPS, CLASSES AND SEMINARS FOR PERSONAL AND PROFESSIONAL DEVELOPMENT VIA INTERACTIVE E-LEARNING OVER A GLOBAL COMPUTER NETWORK, IN CLASS 41 (U.S. CLS. 100, 101 AND 107).

FIRST USE 2-16-2006; IN COMMERCE 2-16-2006.

THE MARK CONSISTS OF STANDARD CHARACTERS WITHOUT CLAIM TO ANY PARTICULAR FONT, STYLE, SIZE, OR COLOR.

SER. NO. 77-094,060, FILED 1-29-2007.

SAMUEL E. SHARPER JR., EXAMINING ATTORNEY

**Int. Cls.: 11 and 19**

**Prior U.S. Cls.: 1, 12, 13, 21, 23, 31, 33, 34 and 50**

**United States Patent and Trademark Office**

**Reg. No. 3,394,157**

**Registered Mar. 11, 2008**

**TRADEMARK  
PRINCIPAL REGISTER**



**HYDROPOOL**  
hot tubs • swim spas

HYDROPOOL INDUSTRIES INC. (CANADA  
CORPORATION)  
SUITE 2700  
40 KING STREET WEST  
TORONTO, ONTARIO, CANADA M5H 3Y2

FOR: HOT TUBS, SPAS IN THE NATURE OF  
HEATED POOLS, WHIRLPOOL BATHS, SPAS IN  
THE NATURE OF HEATED POOLS THAT ALLOWS  
THE SWIMMER TO SWIM IN PLACE AGAINST AN  
ADJUSTABLE CURRENT, SAUNAS; SWIMMING  
POOL WATER CLEANING AND FILTERING  
UNITS, IN CLASS 11 (U.S. CLS. 13, 21, 23, 31 AND 34).

FIRST USE 7-1-2005; IN COMMERCE 7-1-2005.

FOR: GAZEBOS NOT PRIMARILY OF METAL, IN  
CLASS 19 (U.S. CLS. 1, 12, 33 AND 50).

FIRST USE 7-1-2005; IN COMMERCE 7-1-2005.

OWNER OF U.S. REG. NO. 3,212,293.

NO CLAIM IS MADE TO THE EXCLUSIVE  
RIGHT TO USE "HOT TUBS" AND "SWIM SPAS",  
APART FROM THE MARK AS SHOWN.

SER. NO. 77-094,141, FILED 1-30-2007.

DAVID HOFFMAN, EXAMINING ATTORNEY

**Int. Cls.: 11 and 19**

**Prior U.S. Cls.: 1, 12, 13, 21, 23, 31, 33, 34 and 50**

**United States Patent and Trademark Office**

**Reg. No. 3,394,158**

**Registered Mar. 11, 2008**

**TRADEMARK  
PRINCIPAL REGISTER**



**HYDROPOOL**  
serenity hot tubs

HYDROPOOL INDUSTRIES INC. (CANADA  
CORPORATION)  
SUITE 2700  
40 KING STREET WEST  
TORONTO, ONTARIO, CANADA M5H 3Y2

FOR: HOT TUBS, SPAS IN THE NATURE OF  
HEATED POOLS, WHIRLPOOL BATHS, SPAS IN  
THE NATURE OF HEATED POOLS THAT ALLOWS  
THE SWIMMER TO SWIM IN PLACE AGAINST AN  
ADJUSTABLE CURRENT, SAUNAS; SWIMMING  
POOL WATER CLEANING AND FILTERING  
UNITS, IN CLASS 11 (U.S. CLS. 13, 21, 23, 31 AND 34).

FIRST USE 7-1-2005; IN COMMERCE 7-1-2005.

FOR: GAZEBOS NOT PRIMARILY OF METAL, IN  
CLASS 19 (U.S. CLS. 1, 12, 33 AND 50).

FIRST USE 7-1-2005; IN COMMERCE 7-1-2005.

OWNER OF U.S. REG. NO. 3,212,293.

NO CLAIM IS MADE TO THE EXCLUSIVE  
RIGHT TO USE "HOT TUBS", APART FROM THE  
MARK AS SHOWN.

SER. NO. 77-094,144, FILED 1-30-2007.

DAVID HOFFMAN, EXAMINING ATTORNEY

**Int. Cls.: 11 and 19**

**Prior U.S. Cls.: 1, 12, 13, 21, 23, 31, 33, 34 and 50**

**United States Patent and Trademark Office**

**Reg. No. 3,394,159**

**Registered Mar. 11, 2008**

**TRADEMARK  
PRINCIPAL REGISTER**



**HYDROPOOL**  
swim spas

HYDROPOOL INDUSTRIES INC. (CANADA  
CORPORATION)  
SUITE 2700  
40 KING STREET WEST  
TORONTO, ONTARIO, CANADA M5H 3Y2

FOR: HOT TUBS, SPAS IN THE NATURE OF  
HEATED POOLS, WHIRLPOOL BATHS, SPAS IN  
THE NATURE OF HEATED POOLS THAT ALLOWS  
THE SWIMMER TO SWIM IN PLACE AGAINST AN  
ADJUSTABLE CURRENT, SAUNAS; SWIMMING  
POOL WATER CLEANING AND FILTERING  
UNITS, IN CLASS 11 (U.S. CLS. 13, 21, 23, 31 AND 34).

FIRST USE 7-1-2005; IN COMMERCE 7-1-2005.

FOR: GAZEBOS NOT PRIMARILY OF METAL, IN  
CLASS 19 (U.S. CLS. 1, 12, 33 AND 50).

FIRST USE 7-1-2005; IN COMMERCE 7-1-2005.

OWNER OF U.S. REG. NO. 3,212,293.

NO CLAIM IS MADE TO THE EXCLUSIVE  
RIGHT TO USE "SWIM SPAS", APART FROM THE  
MARK AS SHOWN.

SER. NO. 77-094,146, FILED 1-30-2007.

DAVID HOFFMAN, EXAMINING ATTORNEY

**Int. Cls.: 16, 35 and 40**

**Prior U.S. Cls.: 2, 5, 22, 23, 29, 37, 38, 50, 100, 101, 102, 103 and 106**

**Reg. No. 3,394,160**

**United States Patent and Trademark Office**

**Registered Mar. 11, 2008**

**TRADEMARK  
SERVICE MARK  
PRINCIPAL REGISTER**



NISSHA USA, INC. (CALIFORNIA CORPORATION)  
SUITE 630  
1515 WOODFIELD ROAD  
SCHAUMBURG, IL 60173

FOR: HIGH QUALITY ART REPRODUCTIONS, IN CLASS 16 (U.S. CLS. 2, 5, 22, 23, 29, 37, 38 AND 50).

FIRST USE 12-8-2006; IN COMMERCE 12-8-2006.

FOR: ON-LINE RETAIL STORE SERVICES FEATURING HIGH QUALITY ART REPRODUCTIONS AND LIMITED EDITION PRINTS, IN CLASS 35 (U.S. CLS. 100, 101 AND 102).

FIRST USE 11-22-2006; IN COMMERCE 11-22-2006.

FOR: CONSULTING SERVICES USED IN CONNECTION WITH CREATING ART REPRODUC-

TIONS FOR SALE AT SPECIAL EXHIBITS, IN CLASS 40 (U.S. CLS. 100, 103 AND 106).

FIRST USE 11-22-2006; IN COMMERCE 11-22-2006.

NO CLAIM IS MADE TO THE EXCLUSIVE RIGHT TO USE HOMEMUSEUM.COM, APART FROM THE MARK AS SHOWN.

THE MARK CONSISTS OF TRIANGULAR DESIGN ELEMENTS NEXT TO THE WORDS "HOMEMUSEUM.COM".

SER. NO. 77-094,891, FILED 1-30-2007.

LEIGH CAROLINE CASE, EXAMINING ATTORNEY



**Int. Cl.: 41**

**Prior U.S. Cls.: 100, 101 and 107**

**United States Patent and Trademark Office**

**Reg. No. 3,394,161**

**Registered Mar. 11, 2008**

**SERVICE MARK  
PRINCIPAL REGISTER**



**BAY AREA WOMENS SPORTS INITIATIVE, INC  
(CALIFORNIA CHARITABLE CORPORATION)**

**1345 NEWHALL STREET  
SAN JOSE, CA 951261302**

**FOR: ENCOURAGING AMATEUR SPORTS AND  
PHYSICAL EDUCATION AND FITNESS BY AD-  
MINISTERING, CONDUCTING, SPONSORING  
AND ORGANIZING SPORTS AND FITNESS PRO-  
GRAMS AND ACTIVITIES, IN CLASS 41 (U.S. CLS.  
100, 101 AND 107).**

**FIRST USE 9-0-2005; IN COMMERCE 9-0-2005.**

**NO CLAIM IS MADE TO THE EXCLUSIVE  
RIGHT TO USE "BAY AREA WOMEN'S SPORTS**

**INITIATIVE", APART FROM THE MARK AS  
SHOWN.**

**THE MARK CONSISTS OF THE DESIGN OF A  
WOMAN RUNNING WITH THE BACKGROUND  
OF A SKYLINE, A BRIDGE, AND CLOUDS ALL  
WITHIN THE OUTLINE OF A RECTANGLE, HAV-  
ING THE STYLIZED WORDING "BAWSI" ABOVE  
THE DESIGN, AND THE STYLIZED WORDING  
"BAY AREA WOMEN'S SPORTS INITIATIVE" BE-  
LOW THE DESIGN.**

**SER. NO. 77-094,965, FILED 1-30-2007.**

**JAY BESCH, EXAMINING ATTORNEY**

**Int. Cl.: 41**

**Prior U.S. Cls.: 100, 101 and 107**

**United States Patent and Trademark Office**

**Reg. No. 3,394,162**

**Registered Mar. 11, 2008**

**SERVICE MARK  
PRINCIPAL REGISTER**

**BAWSI**

BAY AREA WOMEN'S SPORTS INITIATIVE, INC  
(CALIFORNIA CHARITABLE CORPORATION)  
1345 NEWHALL STREET  
SAN JOSE, CA 951261302

FOR: ENCOURAGING AMATEUR SPORTS AND  
PHYSICAL EDUCATION AND FITNESS BY AD-  
MINISTERING, CONDUCTING, SPONSORING  
AND ORGANIZING SPORTS AND FITNESS PRO-  
GRAMS AND ACTIVITIES, IN CLASS 41 (U.S. CLS.  
100, 101 AND 107).

FIRST USE 9-0-2005; IN COMMERCE 9-0-2005.

THE MARK CONSISTS OF STANDARD CHAR-  
ACTERS WITHOUT CLAIM TO ANY PARTICULAR  
FONT, STYLE, SIZE, OR COLOR.

SER. NO. 77-095,022, FILED 1-30-2007.

JAY BESCH, EXAMINING ATTORNEY

**Int. Cl.: 41**

**Prior U.S. Cls.: 100, 101 and 107**

**United States Patent and Trademark Office**

**Reg. No. 3,394,163**

**Registered Mar. 11, 2008**

**SERVICE MARK  
PRINCIPAL REGISTER**



BAY AREA WOMEN'S SPORTS INITIATIVE, INC  
(CALIFORNIA CHARITABLE CORPORATION)  
1345 NEWHALL STREET  
SAN JOSE, CA 951261302

FIRST USE 9-0-2005; IN COMMERCE 9-0-2005.

THE MARK CONSISTS OF THE DESIGN OF A  
FEMALE RUNNER.

FOR: ENCOURAGING AMATEUR SPORTS AND  
PHYSICAL EDUCATION AND FITNESS BY AD-  
MINISTERING, CONDUCTING, SPONSORING  
AND ORGANIZING SPORTS AND FITNESS PRO-  
GRAMS AND ACTIVITIES, IN CLASS 41 (U.S. CLS.  
100, 101 AND 107).

SER. NO. 77-095,050, FILED 1-30-2007.

JAY BESCH, EXAMINING ATTORNEY

**Int. Cl.: 35**

**Prior U.S. Cls.: 100, 101 and 102**

**United States Patent and Trademark Office**

**Reg. No. 3,394,164**

**Registered Mar. 11, 2008**

**SERVICE MARK  
PRINCIPAL REGISTER**

**SME Women in Business**

SME SALES AND MARKETING EXECUTIVES,  
INC. OF SIOUX FALLS (SOUTH DAKOTA  
CORPORATION)  
PO BOX 90310  
SIOUX FALLS, SD 571090310

FOR: PROMOTING, ARRANGING AND CON-  
DUCTING OF TRADE FAIR FOR BUSINESS AND  
ADVERTISING PURPOSES, IN CLASS 35 (U.S. CLS.  
100, 101 AND 102).

FIRST USE 4-25-1972; IN COMMERCE 4-25-1972.

THE MARK CONSISTS OF STANDARD CHAR-  
ACTERS WITHOUT CLAIM TO ANY PARTICULAR  
FONT, STYLE, SIZE, OR COLOR.

NO CLAIM IS MADE TO THE EXCLUSIVE  
RIGHT TO USE "WOMEN IN BUSINESS", APART  
FROM THE MARK AS SHOWN.

SER. NO. 77-095,394, FILED 1-31-2007.

FLORENTINA BLANDU, EXAMINING ATTORNEY

**Int. Cl.: 3**

**Prior U.S. Cls.: 1, 4, 6, 50, 51 and 52**

**United States Patent and Trademark Office**

**Reg. No. 3,394,165**

**Registered Mar. 11, 2008**

**TRADEMARK  
PRINCIPAL REGISTER**

**SILKY SKIN BLANC BY IU**

IU COSMETICS S.A. DE C.V. (MEXICO CORPORATION)  
BLVD. JUAN ALONSO DE TORRES NO. 106  
FRACC. SAN JERONIMO  
LEON GTO, MEXICO 37204

FOR: SOAPS FOR PERSONAL USE, PERFUME, ESSENTIAL OILS, COSMETICS AND HAIR LOTIONS, IN CLASS 3 (U.S. CLS. 1, 4, 6, 50, 51 AND 52).

THE MARK CONSISTS OF STANDARD CHARACTERS WITHOUT CLAIM TO ANY PARTICULAR FONT, STYLE, SIZE, OR COLOR.

PRIORITY CLAIMED UNDER SEC. 44(D) ON MEXICO APPLICATION NO. 800978, FILED 8-17-2006, REG. NO. 984446, DATED 8-17-2006, EXPIRES 8-17-2016.

THE FOREIGN WORDING IN THE MARK TRANSLATES INTO ENGLISH AS WHITE.

SER. NO. 77-095,991, FILED 1-31-2007.

EMILY CARLSEN, EXAMINING ATTORNEY

**Int. Cl.: 32**

**Prior U.S. Cls.: 45, 46 and 48**

**United States Patent and Trademark Office**

**Reg. No. 3,394,166**

**Registered Mar. 11, 2008**

**TRADEMARK  
PRINCIPAL REGISTER**

**SPECIAL PILSNER**

CAPITAL BREWERY COMPANY, INC. (WISCONSIN CORPORATION)  
7734 TERRACE AVENUE  
MIDDLETON, WI 535620185

NO CLAIM IS MADE TO THE EXCLUSIVE RIGHT TO USE "PILSNER", APART FROM THE MARK AS SHOWN.

FOR: BEER, IN CLASS 32 (U.S. CLS. 45, 46 AND 48).

SEC. 2(F).

FIRST USE 5-1-1997; IN COMMERCE 5-1-1997.

SER. NO. 77-095,998, FILED 1-31-2007.

THE MARK CONSISTS OF STANDARD CHARACTERS WITHOUT CLAIM TO ANY PARTICULAR FONT, STYLE, SIZE, OR COLOR.

RICHARD WHITE, EXAMINING ATTORNEY

**Int. Cl.: 41**

**Prior U.S. Cls.: 100, 101 and 107**

**United States Patent and Trademark Office**

**Reg. No. 3,394,167**

**Registered Mar. 11, 2008**

**SERVICE MARK  
PRINCIPAL REGISTER**

**INTERNATIONAL BUSINESS  
TRAINING**

INTERMART, INC. (MINNESOTA CORPORATION)  
P.O. BOX 22267  
EAGAN, MN 55122

FOR: EDUCATIONAL SERVICES, NAMELY, CONDUCTING CLASSES AND SEMINARS IN THE FIELDS OF EXPORTING, IMPORTING, TRADE AGREEMENTS AND REGULATIONS, AND DISTRIBUTION OF COURSE MATERIALS IN CONNECTION THEREWITH; ON-LINE PUBLICATION IN THE NATURE OF NEWSLETTER ARTICLES IN THE FIELD OF INTERNATIONAL TRADE; PUBLICATION OF EDUCATIONAL AND REFERENCE BOOKS; EDUCATIONAL TESTING; PROVIDING EDUCATIONAL CERTIFICATION PROGRAMS IN THE FIELD OF INTERNATIONAL TRADE, IN CLASS 41 (U.S. CLS. 100, 101 AND 107).

FIRST USE 8-6-1999; IN COMMERCE 8-6-1999.

THE MARK CONSISTS OF STANDARD CHARACTERS WITHOUT CLAIM TO ANY PARTICULAR FONT, STYLE, SIZE, OR COLOR.

NO CLAIM IS MADE TO THE EXCLUSIVE RIGHT TO USE "TRAINING", APART FROM THE MARK AS SHOWN.

SEC. 2(F).

SER. NO. 77-097,070, FILED 2-1-2007.

JACLYN KIDWELL, EXAMINING ATTORNEY

**Int. Cl.: 35**

**Prior U.S. Cls.: 100, 101 and 102**

**United States Patent and Trademark Office**

**Reg. No. 3,394,168**

**Registered Mar. 11, 2008**

**SERVICE MARK  
PRINCIPAL REGISTER**

**INTERNATIONAL BUSINESS  
TRAINING**

INTERMART, INC. (MINNESOTA CORPORATION)  
P.O. BOX 22267  
EAGAN, MN 55122

FOR: BUSINESS CONSULTING SERVICES IN THE FIELDS OF IMPORTING, EXPORTING, AND TRADE AGREEMENTS AND REGULATIONS; MAIL ORDER CATALOG SERVICES FEATURING PRODUCTS, NAMELY, BOOKS AND SEMINAR MATERIALS IN THE FIELDS OF EXPORTING AND IMPORTING; PROVIDING REGISTRATION SERVICES THROUGH MAIL ORDER CATALOGS FOR SEMINARS IN THE FIELDS OF EXPORTING AND IMPORTING; ON-LINE ORDERING SERVICES FEATURING PRODUCTS, NAMELY, BOOKS; PROVIDING ONLINE REGISTRATION SERVICES

FOR SEMINARS IN THE FIELDS OF EXPORTING AND IMPORTING, IN CLASS 35 (U.S. CLS. 100, 101 AND 102).

FIRST USE 8-6-1999; IN COMMERCE 8-6-1999.

THE MARK CONSISTS OF STANDARD CHARACTERS WITHOUT CLAIM TO ANY PARTICULAR FONT, STYLE, SIZE, OR COLOR.

SEC. 2(F).

SER. NO. 77-097,078, FILED 2-1-2007.

JACLYN KIDWELL, EXAMINING ATTORNEY



**Int. Cl.: 16**

**Prior U.S. Cls.: 2, 5, 22, 23, 29, 37, 38 and 50**

**United States Patent and Trademark Office**

**Reg. No. 3,394,169**

**Registered Mar. 11, 2008**

**TRADEMARK  
PRINCIPAL REGISTER**

**INTERNATIONAL BUSINESS  
TRAINING**

INTERMART, INC. (MINNESOTA CORPORATION)  
P.O. BOX 22267  
EAGAN, MN 55122

FOR: PRINTED EDUCATIONAL AND REFERENCE BOOKS FEATURING INFORMATION CONCERNING EXPORTING, IMPORTING, AND TRADE AGREEMENTS AND REGULATIONS; AND CATALOGS IN THE FIELD OF TRADE , IN CLASS 16 (U.S. CLS. 2, 5, 22, 23, 29, 37, 38 AND 50).

FIRST USE 8-6-1999; IN COMMERCE 8-6-1999.

THE MARK CONSISTS OF STANDARD CHARACTERS WITHOUT CLAIM TO ANY PARTICULAR FONT, STYLE, SIZE, OR COLOR.

SEC. 2(F).

SER. NO. 77-097,392, FILED 2-1-2007.

JACLYN KIDWELL, EXAMINING ATTORNEY

**Int. Cl.: 31**

**Prior U.S. Cls.: 1 and 46**

**United States Patent and Trademark Office**

**Reg. No. 3,394,170**

**Registered Mar. 11, 2008**

**TRADEMARK  
PRINCIPAL REGISTER**

**FLUKER'S**

FLUKER, DAVID (UNITED STATES INDIVIDUAL)  
1333 PLANTATION ROAD  
PORT ALLEN, LA 70767

FOR: LIVE ANIMALS, NAMELY, INSECTS AND REPTILES, FOOD STUFF FOR ANIMALS, IN CLASS 31 (U.S. CLS. 1 AND 46).

FIRST USE 1-13-1997; IN COMMERCE 1-13-1997.

THE MARK CONSISTS OF STANDARD CHARACTERS WITHOUT CLAIM TO ANY PARTICULAR FONT, STYLE, SIZE, OR COLOR.

SEC. 2(F).

SER. NO. 77-097,617, FILED 2-2-2007.

MORGAN WYNNE, EXAMINING ATTORNEY

**Int. Cl.: 42**

**Prior U.S. Cls.: 100 and 101**

**United States Patent and Trademark Office**

**Reg. No. 3,394,171**

**Registered Mar. 11, 2008**

**SERVICE MARK  
PRINCIPAL REGISTER**

**SCHEDULEFM SCHEDULING  
FOR FACILITY MANAGEMENT**

WITTREICH, WILLIAM P. (UNITED STATES  
INDIVIDUAL)  
UNIT 1E  
2525 15TH STREET  
DENVER, CO 80211

FOR: APPLICATION SERVICE PROVIDER (ASP)  
FEATURING SOFTWARE FOR SCHEDULING USE  
OF SPACE AND ASSETS, IN CLASS 42 (U.S. CLS. 100  
AND 101).

FIRST USE 6-8-2000; IN COMMERCE 6-8-2000.

THE MARK CONSISTS OF STANDARD CHAR-  
ACTERS WITHOUT CLAIM TO ANY PARTICULAR  
FONT, STYLE, SIZE, OR COLOR.

NO CLAIM IS MADE TO THE EXCLUSIVE  
RIGHT TO USE "SCHEDULING FOR FACILITY  
MANAGEMENT", APART FROM THE MARK AS  
SHOWN.

SER. NO. 77-098,869, FILED 2-4-2007.

EMILY CHUO, EXAMINING ATTORNEY

**Int. Cl.: 38**

**Prior U.S. Cls.: 100, 101 and 104**

**United States Patent and Trademark Office**

**Reg. No. 3,394,172**

**Registered Mar. 11, 2008**

**SERVICE MARK  
PRINCIPAL REGISTER**

**LaTiendaMexicano.com and  
MexicanAmericanStore.com**

KAC PROPERTIES LLC (FLORIDA LTD LIAB  
CO)  
PO BOX 3035  
BRANDON, FL 33509

FOR: PROVIDING ON-LINE COMMUNICA-  
TIONS LINKS WHICH TRANSFER THE WEBSITE  
USER TO OTHER LOCAL AND GLOBAL WEB  
PAGES, IN CLASS 38 (U.S. CLS. 100, 101 AND 104).

FIRST USE 11-11-2006; IN COMMERCE 11-11-2006.

THE MARK CONSISTS OF STANDARD CHAR-  
ACTERS WITHOUT CLAIM TO ANY PARTICULAR  
FONT, STYLE, SIZE, OR COLOR.

THE ENGLISH TRANSLATION OF THE WORD-  
ING LA TIENDA MEXICANO IN THE MARK IS  
THE MEXICAN STORE.

SER. NO. 77-099,213, FILED 2-5-2007.

MORGAN WYNNE, EXAMINING ATTORNEY

**Int. Cl.: 16**

**Prior U.S. Cls.: 2, 5, 22, 23, 29, 37, 38 and 50**

**United States Patent and Trademark Office**

**Reg. No. 3,394,173**

**Registered Mar. 11, 2008**

**TRADEMARK  
PRINCIPAL REGISTER**

**LOVLY**

SCA CONSUMIDOR MEXICO Y CENTROAMERICA SA DE CV (MEXICO CORPORATION)  
JAVIER BARROS SIERRA NO. 555 PISO 5  
COLONIA ZEDEC, MEXICO MX-55090

FOR: TOILET PAPER, PAPER NAPKINS, DISPOSABLE PAPER HANDKERCHIEFS, FACIAL TISSUE, PAPER TOWELS, IN CLASS 16 (U.S. CLS. 2, 5, 22, 23, 29, 37, 38 AND 50).

FIRST USE 10-23-1997; IN COMMERCE 10-23-1997.

THE MARK CONSISTS OF STANDARD CHARACTERS WITHOUT CLAIM TO ANY PARTICULAR FONT, STYLE, SIZE, OR COLOR.

SER. NO. 77-099,476, FILED 2-5-2007.

LEIGH CAROLINE CASE, EXAMINING ATTORNEY

**Int. Cl.: 28**

**Prior U.S. Cls.: 22, 23, 38 and 50**

**Reg. No. 3,394,174**

**United States Patent and Trademark Office**

**Registered Mar. 11, 2008**

---

**TRADEMARK  
PRINCIPAL REGISTER**

**GROWING UP GLAM**

MATTEL, INC. (DELAWARE CORPORATION)  
MAIL STOP M1-1518  
333 CONTINENTAL BOULEVARD  
EL SEGUNDO, CA 90245

THE MARK CONSISTS OF STANDARD CHAR-  
ACTERS WITHOUT CLAIM TO ANY PARTICULAR  
FONT, STYLE, SIZE, OR COLOR.

FOR: TOYS, GAMES AND PLAYTHINGS, IN  
CLASS 28 (U.S. CLS. 22, 23, 38 AND 50).

SER. NO. 77-100,181, FILED 2-6-2007.

FIRST USE 5-4-2007; IN COMMERCE 5-4-2007.

TASHIA BUNCH, EXAMINING ATTORNEY

**Int. Cl.: 28**

**Prior U.S. Cls.: 22, 23, 38 and 50**

**United States Patent and Trademark Office**

**Reg. No. 3,394,175**

**Registered Mar. 11, 2008**

---

**TRADEMARK  
PRINCIPAL REGISTER**

**LICENSE TO SPARKLE**

MATTEL, INC. (DELAWARE CORPORATION)  
MAIL STOP M1-1518  
333 CONTINENTAL BOULEVARD  
EL SEGUNDO, CA 90245

FOR: TOYS, GAMES AND PLAYTHINGS, NAME-  
LY, TOY VEHICLES, TOY FIGURES, AND ACCES-  
SORIES FOR ALL OF THE FOREGOING, IN CLASS  
28 (U.S. CLS. 22, 23, 38 AND 50).

FIRST USE 10-8-2007; IN COMMERCE 10-8-2007.

THE MARK CONSISTS OF STANDARD CHAR-  
ACTERS WITHOUT CLAIM TO ANY PARTICULAR  
FONT, STYLE, SIZE, OR COLOR.

SER. NO. 77-100,182, FILED 2-6-2007.

TASHIA BUNCH, EXAMINING ATTORNEY

**Int. Cl.: 28**

**Prior U.S. Cls.: 22, 23, 38 and 50**

**United States Patent and Trademark Office**

**Reg. No. 3,394,176**

**Registered Mar. 11, 2008**

**TRADEMARK  
PRINCIPAL REGISTER**

**PARTY IN PINK**

MATTEL, INC. (DELAWARE CORPORATION)  
MAIL STOP M1-1518  
333 CONTINENTAL BOULEVARD  
EL SEGUNDO, CA 90245

FOR: TOYS, GAMES AND PLAYTHINGS, NAME-  
LY, TOY VEHICLES, TOY FIGURES, AND ACCES-  
SORIES FOR ALL OF THE FOREGOING, IN CLASS  
28 (U.S. CLS. 22, 23, 38 AND 50).

FIRST USE 5-25-2007; IN COMMERCE 5-25-2007.

THE MARK CONSISTS OF STANDARD CHAR-  
ACTERS WITHOUT CLAIM TO ANY PARTICULAR  
FONT, STYLE, SIZE, OR COLOR.

SER. NO. 77-100,187, FILED 2-6-2007.

MICHAEL LITZAU, EXAMINING ATTORNEY



**Int. Cl.: 28**

**Prior U.S. Cls.: 22, 23, 38 and 50**

**United States Patent and Trademark Office**

**Reg. No. 3,394,177**

**Registered Mar. 11, 2008**

**TRADEMARK  
PRINCIPAL REGISTER**

**YELLOW-LICIOUS**

MATTEL, INC. (DELAWARE CORPORATION)  
MAIL STOP M1-1518  
333 CONTINENTAL BOULEVARD  
EL SEGUNDO, CA 90245

FIRST USE 5-25-2007; IN COMMERCE 5-25-2007.

THE MARK CONSISTS OF STANDARD CHARACTERS WITHOUT CLAIM TO ANY PARTICULAR FONT, STYLE, SIZE, OR COLOR.

FOR: TOYS, GAMES AND PLAYTHINGS, NAME-  
LY, TOY VEHICLES, TOY FIGURES, AND ACCES-  
SORIES FOR ALL OF THE FOREGOING, IN CLASS  
28 (U.S. CLS. 22, 23, 38 AND 50).

SER. NO. 77-100,195, FILED 2-6-2007.

TASHIA BUNCH, EXAMINING ATTORNEY

**Int. Cl.: 32**

**Prior U.S. Cls.: 45, 46 and 48**

**United States Patent and Trademark Office**

**Reg. No. 3,394,178**

**Registered Mar. 11, 2008**

**TRADEMARK  
PRINCIPAL REGISTER**

**TARPON SPOON**

ANHEUSER-BUSCH, INCORPORATED (MIS-  
SOURI CORPORATION)  
202-6  
ONE BUSCH PLACE  
ST. LOUIS, MO 63118

THE MARK CONSISTS OF STANDARD CHAR-  
ACTERS WITHOUT CLAIM TO ANY PARTICULAR  
FONT, STYLE, SIZE, OR COLOR.

FOR: BEER, IN CLASS 32 (U.S. CLS. 45, 46 AND 48).

SER. NO. 77-100,607, FILED 2-6-2007.

FIRST USE 4-16-2007; IN COMMERCE 4-16-2007.

KEVIN CORWIN, EXAMINING ATTORNEY

**Int. Cl.: 41**

**Prior U.S. Cls.: 100, 101 and 107**

**United States Patent and Trademark Office**

**Reg. No. 3,394,179**

**Registered Mar. 11, 2008**

**SERVICE MARK  
PRINCIPAL REGISTER**

**SPIRITUAL PARTNERSHIP**

ZUKAV, GARY (UNITED STATES INDIVIDUAL)  
155 TIMBERLAKE DRIVE  
ASHLAND, OR 97520

FOR: EDUCATION SERVICES, NAMELY, PROVIDING CLASSES, CONFERENCES, RETREATS, SEMINARS, AND WORKSHOPS IN THE FIELD OF SPIRITUALITY, SELF-EMPOWERMENT, AND SELF-IMPROVEMENT , IN CLASS 41 (U.S. CLS. 100, 101 AND 107).

FIRST USE 3-24-1990; IN COMMERCE 3-24-1990.

THE MARK CONSISTS OF STANDARD CHARACTERS WITHOUT CLAIM TO ANY PARTICULAR FONT, STYLE, SIZE, OR COLOR.

NO CLAIM IS MADE TO THE EXCLUSIVE RIGHT TO USE "SPIRITUAL", APART FROM THE MARK AS SHOWN.

SER. NO. 77-101,275, FILED 2-7-2007.

ZACHARY BELLO, EXAMINING ATTORNEY

**Int. Cls.: 9 and 18**

**Prior U.S. Cls.: 1, 2, 3, 21, 22, 23, 26, 36, 38 and 41**

**United States Patent and Trademark Office**

**Reg. No. 3,394,180**

**Registered Mar. 11, 2008**

**TRADEMARK  
PRINCIPAL REGISTER**



JULIETTE FASSETT INC. (OREGON CORPORATION)  
SUITE 760  
1801 NW UPSHUR  
PORTLAND, OR 97209

OWNER OF U.S. REG. NO. 3,227,241.

FOR: LAPTOP CARRYING CASES, IN CLASS 9  
(U.S. CLS. 21, 23, 26, 36 AND 38).

THE MARK CONSISTS OF THE STYLIZED LETTERS "MXX" WITH PART OF THE FIRST LETTER "X" FORMING A LOWERCASE LETTER "I", AND THE DOT OF THE LETTER "I" HAVING FOUR OVALS AROUND IT CONSISTING OF A FLOWER DESIGN.

FIRST USE 1-10-2006; IN COMMERCE 1-10-2006.

FOR: TOTE BAGS AND BRIEFCASES, IN CLASS 18  
(U.S. CLS. 1, 2, 3, 22 AND 41).

SER. NO. 77-102,036, FILED 2-7-2007.

FIRST USE 1-10-2006; IN COMMERCE 1-10-2006.

GEORGE LORENZO, EXAMINING ATTORNEY

**Int. Cl.: 28**

**Prior U.S. Cls.: 22, 23, 38 and 50**

**United States Patent and Trademark Office**

**Reg. No. 3,394,181**

**Registered Mar. 11, 2008**

**TRADEMARK  
PRINCIPAL REGISTER**

**S.B.D. 3000**

MATTEL, INC. (DELAWARE CORPORATION)  
MAIL STOP M1-1518  
333 CONTINENTAL BOULEVARD  
EL SEGUNDO, CA 90245

FOR: TOYS, GAMES AND PLAYTHINGS, NAME-  
LY, TOY BANKS, TOY ROBOTS, TOY FIGURES  
AND TALKING TOYS, IN CLASS 28 (U.S. CLS. 22, 23,  
38 AND 50).

FIRST USE 9-11-2007; IN COMMERCE 9-11-2007.

THE MARK CONSISTS OF STANDARD CHAR-  
ACTERS WITHOUT CLAIM TO ANY PARTICULAR  
FONT, STYLE, SIZE, OR COLOR.

SER. NO. 77-102,428, FILED 2-8-2007.

ANDREA SAUNDERS, EXAMINING ATTORNEY

**Int. Cl.: 35**

**Prior U.S. Cls.: 100, 101 and 102**

**United States Patent and Trademark Office**

**Reg. No. 3,394,182**

**Registered Mar. 11, 2008**

**SERVICE MARK  
PRINCIPAL REGISTER**



AUTOKOTE SYSTEMS LLC (ALABAMA LTD  
LIAB CO)  
1330 HARTFORD HWY SUITE 1  
DOTHAN, AL 36301

THE MARK CONSISTS OF THE TERM ARC  
WITH A CIRCLE ROUND IT.

FOR: WHOLESALE DISTRIBUTORSHIPS FEATURING  
AUTOMOTIVE REFINISHING PRODUCTS, IN CLASS 35 (U.S. CLS. 100, 101 AND 102).

SER. NO. 77-103,897, FILED 2-9-2007.

FIRST USE 12-1-2006; IN COMMERCE 12-31-2006.

KELLY MCCOY, EXAMINING ATTORNEY

Int. Cl.: 34

Prior U.S. Cls.: 2, 8, 9 and 17

**United States Patent and Trademark Office**

**Reg. No. 3,394,183**

Registered Mar. 11, 2008

**TRADEMARK  
PRINCIPAL REGISTER**

**R1**

REEMTSMA CIGARETTENFABRIKEN GMBH  
(FED REP GERMANY CORPORATION)  
MAX-BORN-STRASSE 4  
HAMBURG, FED REP GERMANY 22761

FOR: TOBACCO; TOBACCO PRODUCTS, NAME-  
LY, SMOKING TOBACCO, TOBACCO GRINDERS,  
TOBACCO FILTERS, TOBACCO SPITTOONS, TO-  
BACCO TUBES, AND TOBACCO POUCHES; TO-  
BACCO SUBSTITUTES; CIGARS; CIGARETTES;  
CIGARETTE PAPERS; MATCHES; AND SMOKERS'  
ARTICLES, NAMELY, LIGHTERS, ASHTRAYS, CI-  
GARETTE CASES, MADE OF NON-PRECIOUS ME-  
TAL, IN CLASS 34 (U.S. CLS. 2, 8, 9 AND 17).

THE MARK CONSISTS OF STANDARD CHAR-  
ACTERS WITHOUT CLAIM TO ANY PARTICULAR  
FONT, STYLE, SIZE, OR COLOR.

OWNER OF ERPN CMNTY TM OFC REG. NO.  
003484938, DATED 6-8-2005, EXPIRES 10-30-2013.

OWNER OF U.S. REG. NO. 2,465,088.

SER. NO. 77-105,875, FILED 2-13-2007.

TRICIA SONNEBORN, EXAMINING ATTORNEY

**Int. Cl.: 35**

**Prior U.S. Cls.: 100, 101 and 102**

**United States Patent and Trademark Office**

**Reg. No. 3,394,184**

**Registered Mar. 11, 2008**

---

**SERVICE MARK  
PRINCIPAL REGISTER**

**EASY TO FIND THE GIFT SHE  
LOVES!**

COLUMBIA INSURANCE COMPANY (NEBRASKA CORPORATION)  
3024 HARNEY STREET  
OMAHA, NE 68131

THE MARK CONSISTS OF STANDARD CHARACTERS WITHOUT CLAIM TO ANY PARTICULAR FONT, STYLE, SIZE, OR COLOR.

FOR: RETAIL JEWELRY STORE SERVICES, IN CLASS 35 (U.S. CLS. 100, 101 AND 102).

SER. NO. 77-106,123, FILED 2-13-2007.

FIRST USE 2-8-2007; IN COMMERCE 2-8-2007.

SETH A. RAPPAPORT, EXAMINING ATTORNEY



**Int. Cl.: 3**

**Prior U.S. Cls.: 1, 4, 6, 50, 51 and 52**

**United States Patent and Trademark Office**

**Reg. No. 3,394,185**

**Registered Mar. 11, 2008**

**TRADEMARK  
PRINCIPAL REGISTER**

**AMPLISSIME**

LANCOME PARFUMS ET BEAUTE & CIE  
(FRANCE SOCIETE EN NOM COLLECTIF)  
29, RUE DU FAUBOURG SAINT-HONORE  
PARIS, FRANCE 75008

FOR: COSMETICS, NAMELY, CREAMS, GELS,  
MILKS, POWDERS AND LOTIONS FOR THE FACE,  
BODY AND HANDS; MAKE-UP PRODUCTS,  
NAMELY, MASCARA, EYE LINER, EYE SHADOW,  
EYEBROW PENCIL, LIPSTICKS, NAIL POLISH,  
BLUSH, FOUNDATION CREAMS AND POWDER;  
BODY DEODORANTS; SUN CARE PREPARA-  
TIONS, NAMELY, TANNING AND AFTER-SUN  
MILKS, GELS AND OILS, IN CLASS 3 (U.S. CLS. 1,  
4, 6, 50, 51 AND 52).

THE MARK CONSISTS OF STANDARD CHAR-  
ACTERS WITHOUT CLAIM TO ANY PARTICULAR  
FONT, STYLE, SIZE, OR COLOR.

PRIORITY CLAIMED UNDER SEC. 44(D) ON  
FRANCE APPLICATION NO. 073479666, FILED 2-6-  
2007, REG. NO. 073479666, DATED 2-6-2007, EXPIRES  
2-6-2017.

SER. NO. 77-106,979, FILED 2-14-2007.

BRIAN PINO, EXAMINING ATTORNEY

**Int. Cl.: 28**

**Prior U.S. Cls.: 22, 23, 38 and 50**

**United States Patent and Trademark Office**

**Reg. No. 3,394,186**

**Registered Mar. 11, 2008**

**TRADEMARK  
PRINCIPAL REGISTER**

**CAT CAVERN**

FOSTER & SMITH, INC. (WISCONSIN CORPORATION)  
2253 AIR PARK ROAD  
RHINELANDER, WI 54501

FOR: CAT SCRATCHER PRODUCT, NAMELY, A CAT SCRATCHER MADE OF SEVERAL CORRUGATED LAYERS FOR CATS, IN CLASS 28 (U.S. CLS. 22, 23, 38 AND 50).

FIRST USE 5-17-2007; IN COMMERCE 5-17-2007.

THE MARK CONSISTS OF STANDARD CHARACTERS WITHOUT CLAIM TO ANY PARTICULAR FONT, STYLE, SIZE, OR COLOR.

NO CLAIM IS MADE TO THE EXCLUSIVE RIGHT TO USE "CAT", APART FROM THE MARK AS SHOWN.

SER. NO. 77-107,835, FILED 2-14-2007.

SUSAN LESLIE DUBOIS, EXAMINING ATTORNEY

**Int. Cl.: 41**

**Prior U.S. Cls.: 100, 101 and 107**

**United States Patent and Trademark Office**

**Reg. No. 3,394,187**

**Registered Mar. 11, 2008**

**SERVICE MARK  
PRINCIPAL REGISTER**

**SKYHORSE PUBLISHING**

SKYHORSE PUBLISHING CO., INC. (NEW YORK CORPORATION)  
SUITE 903  
555 8TH AVENUE  
NEW YORK, NY 10018

FOR: BOOK PUBLISHING, NAMELY, PRODUCTION OF BOOKS, IN CLASS 41 (U.S. CLS. 100, 101 AND 107).

FIRST USE 9-30-2006; IN COMMERCE 9-30-2006.

THE MARK CONSISTS OF STANDARD CHARACTERS WITHOUT CLAIM TO ANY PARTICULAR FONT, STYLE, SIZE, OR COLOR.

NO CLAIM IS MADE TO THE EXCLUSIVE RIGHT TO USE "PUBLISHING", APART FROM THE MARK AS SHOWN.

SER. NO. 77-108,500, FILED 2-15-2007.

LAURIE MAYES, EXAMINING ATTORNEY

**Int. Cl.: 9**

**Prior U.S. Cls.: 21, 23, 26, 36 and 38**

**United States Patent and Trademark Office**

**Reg. No. 3,394,188**

**Registered Mar. 11, 2008**

**TRADEMARK  
PRINCIPAL REGISTER**

**ELECTROSTOP**

PREMIER SHEEP SUPPLIES, LTD. (IOWA CORPORATION)  
2031 300TH STREET  
WASHINGTON, IA 52353

FOR: ELECTRIC FENCES, IN CLASS 9 (U.S. CLS. 21, 23, 26, 36 AND 38).

FIRST USE 3-0-1994; IN COMMERCE 3-0-1994.

THE MARK CONSISTS OF STANDARD CHARACTERS WITHOUT CLAIM TO ANY PARTICULAR FONT, STYLE, SIZE, OR COLOR.

SER. NO. 77-110,517, FILED 2-19-2007.

JANICE L. MCMORROW, EXAMINING ATTORNEY

**Int. Cl.: 9**

**Prior U.S. Cls.: 21, 23, 26, 36 and 38**

**United States Patent and Trademark Office**

**Reg. No. 3,394,189**

**Registered Mar. 11, 2008**

**TRADEMARK  
PRINCIPAL REGISTER**

**ELECTRONET**

PREMIER SHEEP SUPPLIES, LTD. (IOWA CORPORATION)  
2031 300TH STREET  
WASHINGTON, IA 52353

FOR: ELECTRIC FENCES, IN CLASS 9 (U.S. CLS. 21, 23, 26, 36 AND 38).

FIRST USE 3-0-1994; IN COMMERCE 3-0-1994.

THE MARK CONSISTS OF STANDARD CHARACTERS WITHOUT CLAIM TO ANY PARTICULAR FONT, STYLE, SIZE, OR COLOR.

SER. NO. 77-110,554, FILED 2-19-2007.

JANICE L. MCMORROW, EXAMINING ATTORNEY

**Int. Cls.: 35 and 37**

**Prior U.S. Cls.: 100, 101, 102, 103 and 106**

**United States Patent and Trademark Office**

**Reg. No. 3,394,190**

**Registered Mar. 11, 2008**

**SERVICE MARK  
PRINCIPAL REGISTER**

**NO DRAWING-SENSORY MARK**

LUNA CARPET & BLINDS CO., INC. (ILLINOIS CORPORATION)  
9827 W. FARRAGUT  
ROSEMONT, IL 60018

FOR: TELEPHONE ORDERING SERVICES, RETAIL STORE AND ON-LINE RETAIL STORE SERVICES IN THE FIELDS OF CARPETING, FLOORING, AND WINDOW TREATMENTS, IN CLASS 35 (U.S. CLS. 100, 101 AND 102).

FIRST USE 5-0-1996; IN COMMERCE 5-0-1996.

FOR: INSTALLATION SERVICES IN THE FIELDS OF CARPETING, FLOORING, AND WINDOW TREATMENTS, IN CLASS 37 (U.S. CLS. 100, 103 AND 106).

FIRST USE 5-0-1996; IN COMMERCE 5-0-1996.

THE MARK IS A SOUND. THE MARK CONSISTS OF A VOICE SINGING "SEVEN SEVEN THREE,

TWO OH TWO LUNA". THE PHRASE "SEVEN SEVEN THREE" CONSISTS OF TWO EIGHTH NOTES E ASCENDING TO TWO EIGHTH NOTES G, DOWN TO A HALF NOTE C. THE PHRASE "TWO OH TWO" CONSISTS OF AN EIGHTH NOTE DOWN TO C, A QUARTER NOTE UP TO D, AND A EIGHTH NOTE TIED INTO A HALF NOTE DOWN TO G. THE WORD "LUNA" IS HEARD AS TWO SYLLABLES, THE FIRST A QUARTER NOTE UP TO A B AND THEN FINALLY A SECOND HALF NOTE UP TO C. DIRECTLY PRECEDING THE WORD "LUNA" IS HEARD FOUR DUAL-TONE MULTI-FREQUENCY (TELEPHONE TOUCH PAD) TONES IN QUICK SUCCESSION SUGGESTING DIALING OF A PHONE.

SER. NO. 77-110,646, FILED 2-19-2007.

JASON BLAIR, EXAMINING ATTORNEY

**Int. Cl.: 36**

**Prior U.S. Cls.: 100, 101 and 102**

**United States Patent and Trademark Office**

**Reg. No. 3,394,191**

**Registered Mar. 11, 2008**

**SERVICE MARK  
PRINCIPAL REGISTER**

**FREEDOM SAVINGS PLANS**

BENEFIT PLANS ADMINISTRATIVE SERVICES,  
INC. (NEW YORK CORPORATION), DBA  
BPA-HARBRIDGE  
SUITE 7  
6 RHOADS DRIVE  
UTICA, NY 135026374

FOR: ADMINISTRATION OF EMPLOYEE PEN-  
SION PLANS, IN CLASS 36 (U.S. CLS. 100, 101 AND  
102).

FIRST USE 2-7-2007; IN COMMERCE 2-7-2007.

THE MARK CONSISTS OF STANDARD CHAR-  
ACTERS WITHOUT CLAIM TO ANY PARTICULAR  
FONT, STYLE, SIZE, OR COLOR.

NO CLAIM IS MADE TO THE EXCLUSIVE  
RIGHT TO USE "SAVINGS PLANS", APART FROM  
THE MARK AS SHOWN.

SER. NO. 77-111,060, FILED 2-20-2007.

PATRICIA EVANKO, EXAMINING ATTORNEY

**Int. Cl.: 6**

**Prior U.S. Cls.: 2, 12, 13, 14, 23, 25 and 50**

**Reg. No. 3,394,192**

**United States Patent and Trademark Office**

**Registered Mar. 11, 2008**

**TRADEMARK  
PRINCIPAL REGISTER**

**ALLIED TUBE & CONDUIT**

ALLIED TUBE & CONDUIT CORPORATION  
(DELAWARE CORPORATION)  
16100 SOUTH LATHROP AVENUE  
HARVEY, IL 60426

FOR: BARBED METAL TAPE, NAMELY, RAZOR WIRE FOR FENCING, BARRIERS, AND SECURITY PROTECTION; METAL CONDUITS; METAL FENCE POSTS, RAIL AND STAYS; METAL TUBING; METAL ROLL FORM SHAPES AND ANGLES FOR USE IN CONSTRUCTION AND METAL FABRICATION; METAL PIPES; METAL POSTS, IN CLASS 6 (U.S. CLS. 2, 12, 13, 14, 23, 25 AND 50).

FIRST USE 11-16-1959; IN COMMERCE 11-16-1959.

THE MARK CONSISTS OF STANDARD CHARACTERS WITHOUT CLAIM TO ANY PARTICULAR FONT, STYLE, SIZE, OR COLOR.

NO CLAIM IS MADE TO THE EXCLUSIVE RIGHT TO USE "TUBE & CONDUIT", APART FROM THE MARK AS SHOWN.

SER. NO. 77-111,074, FILED 2-20-2007.

THEODORE MCBRIDE, EXAMINING ATTORNEY



**Int. Cl.: 44**

**Prior U.S. Cls.: 100 and 101**

**United States Patent and Trademark Office**

**Reg. No. 3,394,193**

**Registered Mar. 11, 2008**

**SERVICE MARK  
PRINCIPAL REGISTER**



Community Hospital of the Monterey Peninsula

COMMUNITY HOSPITAL OF THE MONTEREY  
PENINSULA (CALIFORNIA CORPORATION)  
P.O. BOX H  
MONTEREY, CA 93940

FOR: MEDICAL SERVICES, IN CLASS 44 (U.S.  
CLS. 100 AND 101).

FIRST USE 2-25-1966; IN COMMERCE 2-25-1966.

OWNER OF U.S. REG. NOS. 2,460,966, 2,629,683  
AND OTHERS.

NO CLAIM IS MADE TO THE EXCLUSIVE  
RIGHT TO USE "COMMUNITY HOSPITAL",  
APART FROM THE MARK AS SHOWN.

THE MARK CONSISTS OF THE WORDS "COM-  
MUNITY HOSPITAL OF THE MONTEREY PENIN-  
SULA" AND A CONCENTRIC SQUARE DESIGN  
IMMEDIATELY ABOVE THE WORDS "OF THE".

SEC. 2(F) AS TO "COMMUNITY HOSPITAL OF  
THE MONTEREY PENINSULA".

SER. NO. 77-111,649, FILED 2-20-2007.

RON FAIRBANKS, EXAMINING ATTORNEY

**Int. Cls.: 38 and 41**

**Prior U.S. Cls.: 100, 101, 104 and 107**

**United States Patent and Trademark Office**

**Reg. No. 3,394,194**

**Registered Mar. 11, 2008**

**SERVICE MARK  
PRINCIPAL REGISTER**

**IT'S COMCASTIC**

COMCAST CORPORATION (PENNSYLVANIA  
CORPORATION)  
1500 MARKET STREET  
PHILADELPHIA, PA 19102

FOR: PROVIDING HIGH SPEED ACCESS TO A  
GLOBAL COMPUTER INFORMATION NETWORK;  
CABLE TELEVISION BROADCASTING SERVICES;  
VOICE OVER INTERNET PROTOCOL (VOIP) SER-  
VICES , IN CLASS 38 (U.S. CLS. 100, 101 AND 104).

FIRST USE 10-17-2005; IN COMMERCE 10-17-2005.

FOR: DISTRIBUTION OF TELEVISION PRO-  
GRAMMING TO CABLE TELEVISION SYSTEMS;

PRODUCTION OF CABLE TELEVISION PRO-  
GRAMS, IN CLASS 41 (U.S. CLS. 100, 101 AND 107).

FIRST USE 10-17-2005; IN COMMERCE 10-17-2005.

THE MARK CONSISTS OF STANDARD CHAR-  
ACTERS WITHOUT CLAIM TO ANY PARTICULAR  
FONT, STYLE, SIZE, OR COLOR.

OWNER OF U.S. REG. NOS. 1,421,433, 3,202,492  
AND OTHERS.

SER. NO. 77-113,226, FILED 2-22-2007.

ZHALEH DELANEY, EXAMINING ATTORNEY

**Int. Cl.: 35**

**Prior U.S. Cls.: 100, 101 and 102**

**United States Patent and Trademark Office**

**Reg. No. 3,394,195**

**Registered Mar. 11, 2008**

**SERVICE MARK  
PRINCIPAL REGISTER**

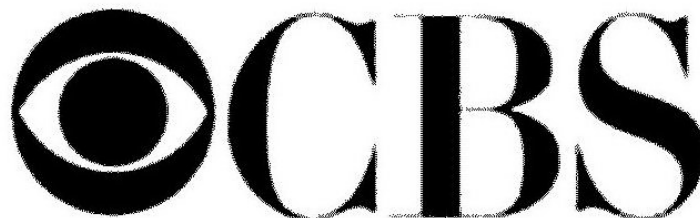

CBS BROADCASTING INC. (NEW YORK CORPORATION)  
51 WEST 52ND STREET  
NEW YORK, NY 10019

FOR: ADVERTISING AND PROMOTION SERVICES; COMMERCIAL INFORMATION AND DIRECTORY AGENCIES; PUBLICITY AGENCIES; MARKETING RESEARCH AND MARKET RESEARCH STUDIES; PUBLIC RELATIONS; PUBLICATION OF PUBLICITY TEXTS; BILL-POSTING; PUBLICITY MATERIAL RENTAL; UPDATING OF ADVERTISING MATERIAL; RENTAL SALE OF ADVERTISING SPACE; ORGANIZATION OF EXHIBITIONS FOR THIRD PARTIES' PROMOTION AND SALES OF GOODS AND SERVICES; OUTDOOR ADVERTISING, NAMELY, DISSEMINATION OF ADVERTISING FOR OTHERS VIA BILLBOARDS, BUSES, BUS SHELTERS; STREET BENCHES, STREET FURNITURE, STANDS, FLOWER STANDS, LOTTERY STANDS, NEWSPAPER STANDS, TRAINS, TRAIN PLATFORMS, TERMINALS IN COMMUTER RAIL SYSTEMS, POSTERS, DISPLAY SIGNS, DISPLAY CASES AND PHONE BOOTHS, BANNERS, MASTS AND FLAGS; ADVERTISING BY MAIL ORDER; DIRECT MAIL ADVERTISING; ON-

LINE ADVERTISING ON A COMPUTER NETWORK; PROVIDING ONLINE INFORMATION AND DATA CONCERNING AVAILABILITY AND RENTAL OF ADVERTISING SPACE; PRODUCING AUDIO AND VISUAL INFOMERCIALS FOR TELEVISION, CABLE AND SATELLITE, RADIO, INTERNET, MOBILE AND WIRELESS COMMUNICATION DEVICES; RENTAL OF ADVERTISING TIME ON COMMUNICATION MEDIA; AND INTERACTIVE ADVERTISING FOR OTHERS VIA MOBILE PHONES AND OTHER PERSONAL DIGITAL EQUIPMENT, IN CLASS 35 (U.S. CLS. 100, 101 AND 102).

FIRST USE 1-3-2006; IN COMMERCE 1-3-2006.

OWNER OF U.S. REG. NOS. 852,481, 2,928,976 AND OTHERS.

THE MARK CONSISTS OF CBS EYE LOGO.

SER. NO. 77-114,503, FILED 2-23-2007.

WON TEAK OH, EXAMINING ATTORNEY

**Int. Cl.: 20**

**Prior U.S. Cls.: 2, 13, 22, 25, 32 and 50**

**United States Patent and Trademark Office**

**Reg. No. 3,394,196**

**Registered Mar. 11, 2008**

**TRADEMARK  
PRINCIPAL REGISTER**



THOMPSON, GUY STEVEN (UNITED STATES  
JOINT APPLICANTS)  
SUITE 292  
1482 E. VALLEY ROAD  
SANTA BARBARA, CA 93108 AND  
THOMPSON, CAROLINE ROSE (UNITED STATES  
JOINT APPLICANTS)  
SUITE 292  
1482 E. VALLEY ROAD  
SANTA BARBARA, CA 93108

FIRST USE 10-1-2005; IN COMMERCE 10-1-2005.

THE MARK CONSISTS OF A CIRCLE CONTAIN-  
ING THE LETTERS C AND H WITH THE LETTER H  
PARTIALLY INSERTED INTO THE OPENING OF  
THE LETTER C.

SER. NO. 77-115,392, FILED 2-24-2007.

FOR: FURNITURE , IN CLASS 20 (U.S. CLS. 2, 13,  
22, 25, 32 AND 50).

ANNE MADDEN, EXAMINING ATTORNEY

**Int. Cl.: 20**

**Prior U.S. Cls.: 2, 13, 22, 25, 32 and 50**

**Reg. No. 3,394,197**

**United States Patent and Trademark Office**

**Registered Mar. 11, 2008**

**TRADEMARK  
PRINCIPAL REGISTER**



THOMPSON, GUY STEVEN (UNITED STATES  
JOINT APPLICANTS)  
SUITE 292  
1482 E. VALLEY ROAD  
SANTA BARBARA, CA 93108 AND  
THOMPSON, CAROLINE ROSE (UNITED STATES  
JOINT APPLICANTS)  
SUITE 292  
1482 E. VALLEY ROAD  
SANTA BARBARA, CA 93108

NO CLAIM IS MADE TO THE EXCLUSIVE  
RIGHT TO USE "HOME", APART FROM THE  
MARK AS SHOWN.

THE MARK CONSISTS OF AN OUTER CIRCLE  
SURROUNDING INTERNAL LETTERS C AND H  
WITH THE ITALICIZED WORD CABANA PRECED-  
ING THE CIRCLE AND HOME AFTER THE CIR-  
CLE.

FOR: FURNITURE , IN CLASS 20 (U.S. CLS. 2, 13,  
22, 25, 32 AND 50).

SER. NO. 77-115,393, FILED 2-24-2007.

FIRST USE 10-1-2005; IN COMMERCE 10-1-2005.

ANNE MADDEN, EXAMINING ATTORNEY

**Int. Cls.: 3 and 5**

**Prior U.S. Cls.: 1, 4, 6, 18, 44, 46, 50, 51 and 52**

**United States Patent and Trademark Office**

**Reg. No. 3,394,198**

**Registered Mar. 11, 2008**

**TRADEMARK  
PRINCIPAL REGISTER**

**REHARMONY**

SCHEFFER, MECHTHILD (FED REP GERMANY  
INDIVIDUAL)  
EPPENDORFER LANDSTRASSE 32  
HAMBURG, FED REP GERMANY 20249

FOR: DEODORANT SOAP OR SKIN SOAPS,  
PERFUME, BODY CREAM, HAIR LOTIONS,  
TOOTHPASTES AND DENTIFRICES, DEODOR-  
ANTS FOR PERSONAL USE, ESSENTIAL OILS  
EXTRACTED FROM VARIOUS PLANTS FOR PER-  
SONAL USE, IN CLASS 3 (U.S. CLS. 1, 4, 6, 50, 51 AND  
52).

FOR: DENTAL ABRASIVES, DIETARY FOOD  
SUPPLEMENTS FOR MEDICINAL PURPOSES,

ALL PURPOSE DISINFECTANTS, IN CLASS 5 (U.S.  
CLS. 6, 18, 44, 46, 51 AND 52).

THE MARK CONSISTS OF STANDARD CHAR-  
ACTERS WITHOUT CLAIM TO ANY PARTICULAR  
FONT, STYLE, SIZE, OR COLOR.

OWNER OF FED REP GERMANY REG. NO.  
39405077, DATED 6-2-1995, EXPIRES 12-31-2014.

SER. NO. 77-116,705, FILED 2-26-2007.

HEATHER THOMPSON, EXAMINING ATTORNEY

**Int. Cls.: 8 and 21**

**Prior U.S. Cls.: 2, 13, 23, 28, 29, 30, 33, 40, 44 and 50**

**United States Patent and Trademark Office**

**Reg. No. 3,394,199**

**Registered Mar. 11, 2008**

**TRADEMARK  
PRINCIPAL REGISTER**

**SMARTGROOM**

WAHL CLIPPER CORPORATION (ILLINOIS CORPORATION)  
P.O. BOX 578  
STERLING, IL 610810578

FOR: PET PRODUCTS, NAMELY, ELECTRIC HAIR TRIMMERS, HAND-OPERATED SHEARS, NAIL TRIMMERS, IN CLASS 8 (U.S. CLS. 23, 28 AND 44).

FIRST USE 5-0-2006; IN COMMERCE 5-0-2006.

FOR: PET PRODUCTS, NAMELY, BRUSHES, COMBS, SWEAT SCRAPERS, AND HOOF PICK/

BRUSH COMBOS, IN CLASS 21 (U.S. CLS. 2, 13, 23, 29, 30, 33, 40 AND 50).

FIRST USE 5-0-2006; IN COMMERCE 5-0-2006.

THE MARK CONSISTS OF STANDARD CHARACTERS WITHOUT CLAIM TO ANY PARTICULAR FONT, STYLE, SIZE, OR COLOR.

SER. NO. 77-117,406, FILED 2-27-2007.

SANI KHOURI, EXAMINING ATTORNEY

**Int. Cl.: 16**

**Prior U.S. Cls.: 2, 5, 22, 23, 29, 37, 38 and 50**

**Reg. No. 3,394,200**

**United States Patent and Trademark Office**

**Registered Mar. 11, 2008**

---

**TRADEMARK  
PRINCIPAL REGISTER**

**ARBUS**

ARBUS, INC. (FLORIDA CORPORATION)  
1816 LONDON AVENUE  
JACKSONVILLE, FL 32207

FIRST USE 12-31-1995; IN COMMERCE 12-31-1995.

FOR: PRINTED PUBLICATIONS, NAMELY, MAGAZINES, IN THE FIELD OF ARCHITECTURE, ART, BUSINESS, CHILDREN'S ISSUES, CONSERVATION EFFORTS, CULTURAL EVENTS, DINING VENUES, THE ENVIRONMENT, MEDICINE AND REAL ESTATE, IN CLASS 16 (U.S. CLS. 2, 5, 22, 23, 29, 37, 38 AND 50).

THE MARK CONSISTS OF STANDARD CHARACTERS WITHOUT CLAIM TO ANY PARTICULAR FONT, STYLE, SIZE, OR COLOR.

SER. NO. 77-117,445, FILED 2-27-2007.

CHERYL CLAYTON, EXAMINING ATTORNEY



**Int. Cl.: 41**

**Prior U.S. Cls.: 100, 101 and 107**

**United States Patent and Trademark Office**

**Reg. No. 3,394,201**

**Registered Mar. 11, 2008**

**SERVICE MARK  
PRINCIPAL REGISTER**

**SHREDITORIUM**

AOL LLC (DELAWARE LTD LIAB CO)  
22000 AOL WAY  
DULLES, VA 20166

FOR: ENTERTAINMENT SERVICES IN THE NATURE OF PROVIDING PRE-RECORDED VIDEOS IN THE FIELD OF SPORTS VIA COMPUTER NETWORKS; PROVIDING INFORMATION IN THE FIELD OF SPORTS VIA COMPUTER NETWORKS , IN CLASS 41 (U.S. CLS. 100, 101 AND 107).

FIRST USE 2-2-2007; IN COMMERCE 2-2-2007.

THE MARK CONSISTS OF STANDARD CHARACTERS WITHOUT CLAIM TO ANY PARTICULAR FONT, STYLE, SIZE, OR COLOR.

SER. NO. 77-117,970, FILED 2-28-2007.

DOMINICK J. SALEMI, EXAMINING ATTORNEY

**Int. Cls.: 16 and 28**

**Prior U.S. Cls.: 2, 5, 22, 23, 29, 37, 38 and 50**

**United States Patent and Trademark Office**

**Reg. No. 3,394,202**

**Registered Mar. 11, 2008**

**TRADEMARK  
PRINCIPAL REGISTER**



ATHLEISURE, INC., A CALIFORNIA CORPORATION (CALIFORNIA CORPORATION)  
2105 RUTHERFORD ROAD  
CARLSBAD, CA 92008

FOR: STICKERS, DECALS, AND BOOKS FEATURING THE SUBJECTS OF SPORTS, FASHION, AND ENTERTAINMENT, BOOK COVERS, AND CALENDARS, IN CLASS 16 (U.S. CLS. 2, 5, 22, 23, 29, 37, 38 AND 50).

FIRST USE 2-10-2005; IN COMMERCE 12-1-2006.

FOR: SURFBOARDS, BODYBOARDS, KNEEBOARDS, WAKEBOARDS, SAILBOARDS, SURF SKIS, SNOWBOARDS, SNOW SKIS, WATER-SKIS, SKATEBOARDS, KITE BOARDS; SPORTING ACCESSORIES, NAMELY, LEG ROPES AND SECURITY LEASHES FOR SPORTING APPARATUS, SPORTING APPARATUS BEING ROPES ESPECIALLY ADAPTED AND FITTED AS TOW-IN ROPES AND SKIING ROPES, SKI AND SNOWBOARD BINDINGS, SURFBOARD DECK GRIPS, WEB GLOVES USED IN SURFING; SWIM FINS, NAMELY, SWIM FINS FOR BODYBOARDING, WAX FOR SKIS AND SURFBOARDS; COVERS AND PROTECTIVE BAGS FOR SPORTING APPARATUS, NAME-

LY, BAGS FOR SURFBOARDS, BODYBOARDS, KNEEBOARDS, WAKEBOARDS, SAILBOARDS, SURF SKIS, SNOWBOARDS, SNOW SKIS, WATER-SKIS, SKATEBOARDS AND KITEBOARDS; WAKEBOARD BINDINGS; SNOWBOARD BINDINGS; BINDINGS FOR SKIS; AND WAX COMBS FOR USE WITH APPLICATION OF WAX FOR SURFBOARDS, IN CLASS 28 (U.S. CLS. 22, 23, 38 AND 50).

FIRST USE 2-10-2005; IN COMMERCE 12-1-2006.

OWNER OF U.S. REG. NOS. 2,205,596 AND 2,218,570.

NO CLAIM IS MADE TO THE EXCLUSIVE RIGHT TO USE "BOARDSHOPS", APART FROM THE MARK AS SHOWN.

THE MARK CONSISTS OF STYLIZED CAPITAL LETTER S WITHIN A RECTANGLE SHAPE ON TOP OF THE STYLIZED WORDS SUN DIEGO BOARDSHOPS.

SER. NO. 77-119,127, FILED 2-28-2007.

MICHAEL LEWIS, EXAMINING ATTORNEY

**Int. Cl.: 3**

**Prior U.S. Cls.: 1, 4, 6, 50, 51 and 52**

**United States Patent and Trademark Office**

**Reg. No. 3,394,203**

**Registered Mar. 11, 2008**

**TRADEMARK  
PRINCIPAL REGISTER**



SABA CHEMICAL, CORP. (NEW YORK CORPORATION)  
18 STEWART STREET  
BROOKLYN, NY 11207

FOR: ALL-PURPOSE CLEANERS; DEGREASING PREPARATIONS FOR HOUSEHOLD CLEANING PURPOSES; GLASS CLEANERS; SCENTED FABRIC REFRESHER SPRAY; STAIN REMOVERS; TOILET BOWL DETERGENTS, IN CLASS 3 (U.S. CLS. 1, 4, 6, 50, 51 AND 52).

FIRST USE 1-0-2007; IN COMMERCE 1-0-2007.

NO CLAIM IS MADE TO THE EXCLUSIVE RIGHT TO USE 1 STEP, APART FROM THE MARK AS SHOWN.

THE MARK CONSISTS OF THE WORD MARK 1 STEP CLEAN LIKE THE PROFESSIONALS IN AN ELLIPSE.

SER. NO. 77-120,017, FILED 3-1-2007.

LESLEY LAMOTHE, EXAMINING ATTORNEY

**Int. Cl.: 36**

**Prior U.S. Cls.: 100, 101 and 102**

**United States Patent and Trademark Office**

**Reg. No. 3,394,204**

**Registered Mar. 11, 2008**

**SERVICE MARK  
PRINCIPAL REGISTER**



BUYSELL4U LLC (UTAH LTD LIAB CO)  
1290 W 1700 S  
SYRACUSE, UT 84075

FOR: REAL ESTATE BROKERAGE, IN CLASS 36  
(U.S. CLS. 100, 101 AND 102).

FIRST USE 2-26-2007; IN COMMERCE 2-26-2007.

THE COLOR(S) RED, BLACK AND WHITE IS/  
ARE CLAIMED AS A FEATURE OF THE MARK.

THE MARK CONSISTS OF A SOLID RED STY-  
LIZED HOUSE WITH A CONNECTING RED BASE-  
LINE EXTENDING TO THE RIGHT AND A  
CURVED, TAPERED BLACK UNDERSCORE. THE  
WORDING BUYSELL4U AND ENOUGH SAID IS  
WRITTEN IN BLACK AND SOLD IN WHITE ON A  
BLACK BACKGROUND SUPPORTED BY A RED  
SIGN POST.

SER. NO. 77-120,192, FILED 3-1-2007.

KYLE PEETE, EXAMINING ATTORNEY

**Int. Cl.: 11**

**Prior U.S. Cls.: 13, 21, 23, 31 and 34**

**United States Patent and Trademark Office**

**Reg. No. 3,394,205**

**Registered Mar. 11, 2008**

**TRADEMARK  
PRINCIPAL REGISTER**

**STAR 2007**

STAR HEADLIGHT & LANTERN CO., INC. (NEW  
YORK CORPORATION)  
455 ROCHESTER STREET  
AVON, NY 14414

FOR: ELECTRIC LANTERNS, IN CLASS 11 (U.S.  
CLS. 13, 21, 23, 31 AND 34).

FIRST USE 12-0-2006; IN COMMERCE 1-23-2007.

THE MARK CONSISTS OF STANDARD CHAR-  
ACTERS WITHOUT CLAIM TO ANY PARTICULAR  
FONT, STYLE, SIZE, OR COLOR.

OWNER OF U.S. REG. NOS. 1,276,812, 2,177,249  
AND OTHERS.

NO CLAIM IS MADE TO THE EXCLUSIVE  
RIGHT TO USE "2007", APART FROM THE MARK  
AS SHOWN.

SER. NO. 77-120,857, FILED 3-2-2007.

SALLY SHIH, EXAMINING ATTORNEY

Int. Cl.: 4

Prior U.S. Cls.: 1, 6 and 15

United States Patent and Trademark Office

Reg. No. 3,394,206

Registered Mar. 11, 2008

TRADEMARK  
PRINCIPAL REGISTER



PORRAZZO, JOSEPH (UNITED STATES INDIVIDUAL)  
3613 WEST ADAMS BOULEVARD, #1  
LOS ANGELES, CA 90018

FOR: CANDLES, IN CLASS 4 (U.S. CLS. 1, 6 AND 15).

FIRST USE 12-6-2006; IN COMMERCE 12-6-2006.

NO CLAIM IS MADE TO THE EXCLUSIVE RIGHT TO USE "VELON SUPREMO" , APART FROM THE MARK AS SHOWN.

THE MARK CONSISTS OF LETTER V INTER-TWINED WITH LETTER S INSIDE AN INNER

CIRCLE WITH WORD VELON IMMEDIATELY ABOVE AND WORD SUPREMO IMMEDIATELY BELOW INSIDE AN OUTER CIRCLE WITH DESIGN ELEMENTS, DIAMONDS WITHIN CIRCLES WITH CROSSES WITHIN SMALLER CIRCLES ON EACH SIZE, CONTAINED WITHIN BOTH CIRCLES.

THE ENGLISH TRANSLATION OF THE WORDING VELON SUPREMO IN THE MARK IS SUPREME OR FANCY DRESSED PILLAR CANDLE.

SER. NO. 77-120,952, FILED 3-2-2007.

KATHRYN COWARD, EXAMINING ATTORNEY

**Int. Cl.: 9**

**Prior U.S. Cls.: 21, 23, 26, 36 and 38**

**United States Patent and Trademark Office**

**Reg. No. 3,394,207**

**Registered Mar. 11, 2008**

**TRADEMARK  
PRINCIPAL REGISTER**



CHARGE ANYWHERE, LLC (DELAWARE LTD  
LIAB CO)  
SUITE A-B  
9693 GERWIG LANE  
COLUMBIA, MD 21046

FOR: DOWNLOADABLE SOFTWARE FOR ELEC-  
TRONIC TRANSACTION PROCESSING, IN CLASS 9  
(U.S. CLS. 21, 23, 26, 36 AND 38).

FIRST USE 5-1-2007; IN COMMERCE 5-1-2007.

OWNER OF U.S. REG. NO. 2,670,586.

NO CLAIM IS MADE TO THE EXCLUSIVE  
RIGHT TO USE "CHARGE ANYWHERE", APART  
FROM THE MARK AS SHOWN.

THE COLOR(S) BLACK AND BLUE IS/ARE  
CLAIMED AS A FEATURE OF THE MARK.

THE MARK CONSISTS OF THE WORD CHARGE  
OVER THE WORD ANYWHERE IN BLACK NEXT  
TO A BLUE STAR.

SER. NO. 77-120,995, FILED 3-2-2007.

REBECCA SMITH, EXAMINING ATTORNEY

**Int. Cl.: 35**

**Prior U.S. Cls.: 100, 101 and 102**

**United States Patent and Trademark Office**

**Reg. No. 3,394,208**

**Registered Mar. 11, 2008**

**SERVICE MARK  
PRINCIPAL REGISTER**

**The Food Bank For New York  
City Food For Survival Cafe  
S.H.A.K.E.**

FOOD BANK FOR NEW YORK CITY, FOOD  
FOR SURVIVAL (NEW YORK CORPORATION)  
HUNTS POINT COOPERATIVE MARKET  
355 FOOD CENTER DRIVE  
BRONX, NY 10474

FOR: CHARITABLE SERVICES, NAMELY, PROMOTING PUBLIC AWARENESS FOR THE HEALTH AND WELLNESS OF CHILDREN AND FAMILIES THROUGH PHYSICAL ACTIVITY AND HEALTHY LIFESTYLE, IN CLASS 35 (U.S. CLS. 100, 101 AND 102).

FIRST USE 7-12-2006; IN COMMERCE 7-12-2006.

THE MARK CONSISTS OF STANDARD CHARACTERS WITHOUT CLAIM TO ANY PARTICULAR FONT, STYLE, SIZE, OR COLOR.

OWNER OF U.S. REG. NOS. 2,806,437 AND 2,980,140.

NO CLAIM IS MADE TO THE EXCLUSIVE RIGHT TO USE "THE FOOD BANK FOR NEW YORK CITY", APART FROM THE MARK AS SHOWN.

SER. NO. 77-121,024, FILED 3-2-2007.

KELLY BOULTON, EXAMINING ATTORNEY



**Int. Cl.: 44**

**Prior U.S. Cls.: 100 and 101**

**United States Patent and Trademark Office**

**Reg. No. 3,394,209**

**Registered Mar. 11, 2008**

**SERVICE MARK  
PRINCIPAL REGISTER**

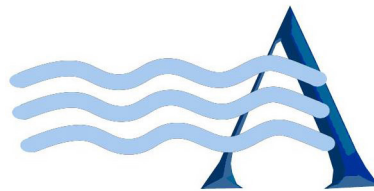

ARMANDEUS GROUP CORP. (FLORIDA CORPORATION)  
8726 N.W. 26TH STREET, SUITE 7  
MIAMI, FL 33172

FOR: BEAUTY SALONS; HAIR SALON SERVICES, NAMELY, TREATMENTS TO PROTECT HAIR FROM AFFECTS OF EXPOSURE TO SUNLIGHT, HEAT, HUMIDITY AND CHLORINATED WATER; HAIRDRESSING SALONS; NAIL CARE SALONS, IN CLASS 44 (U.S. CLS. 100 AND 101).

FIRST USE 4-4-2003; IN COMMERCE 4-4-2003.

THE COLOR() BLUE IS/ARE CLAIMED AS A FEATURE OF THE MARK.

THE MARK CONSISTS OF A STYLIZED DARK BLUE CAPITAL LETTER "A" OVERLAPPED BY THREE LIGHT BLUE UNDULATING OR WAVY LINES AS THE LINES MOVE FROM LEFT TO RIGHT.

SER. NO. 77-121,396, FILED 3-2-2007.

WANDA KAY PRICE, EXAMINING ATTORNEY

**Int. Cl.: 9**

**Prior U.S. Cls.: 21, 23, 26, 36 and 38**

**United States Patent and Trademark Office**

**Reg. No. 3,394,210**

**Registered Mar. 11, 2008**

**TRADEMARK  
PRINCIPAL REGISTER**

**BNR RECORDS**

LEWIS, DIONDRE R. (UNITED STATES INDIVIDUAL)

120 N. CEDAR ST., #3521

CHARLOTTE, NC 28202

FOR: MUSICAL SOUND RECORDINGS, IN CLASS 9 (U.S. CLS. 21, 23, 26, 36 AND 38).

FIRST USE 1-1-2002; IN COMMERCE 1-1-2002.

THE MARK CONSISTS OF STANDARD CHARACTERS WITHOUT CLAIM TO ANY PARTICULAR FONT, STYLE, SIZE, OR COLOR.

NO CLAIM IS MADE TO THE EXCLUSIVE RIGHT TO USE "RECORDS", APART FROM THE MARK AS SHOWN.

SER. NO. 77-122,397, FILED 3-5-2007.

NICHOLAS ALTREE, EXAMINING ATTORNEY

**Int. Cl.: 3**

**Prior U.S. Cls.: 1, 4, 6, 50, 51 and 52**

**United States Patent and Trademark Office**

**Reg. No. 3,394,211**

**Registered Mar. 11, 2008**

**TRADEMARK  
PRINCIPAL REGISTER**

# CYCLADES

LANCOME PARFUMS ET BEAUTE & CIE  
(FRANCE SOCIETE EN NOM COLLECTIF)  
29, RUE DU FAUBOURG SAINT-HONORE  
PARIS, FRANCE 75008

FOR: PERFUMERY PRODUCTS, NAMELY, PERFUMES, EAU DE COLOGNE, PERFUMED WATER, SKIN LOTIONS, SOAPS, BATH AND SHOWER FOAMING COMPOSITIONS AND GELS; COSMETICS, NAMELY, CREAMS, GELS, MILKS, POWDERS AND LOTIONS FOR THE FACE, THE BODY AND THE HANDS; MAKEUP PRODUCTS, NAMELY, MASCARA, EYE LINER, EYE SHADOW, EYEBROW PENCIL, LIPSTICKS, NAIL POLISH, BLUSH, FOUNDATION CREAMS AND POWDER, BODY DEODORANTS; SUN CARE PREPARATIONS, NAMELY, TANNING AND AFTER-SUN MILKS, GELS AND OILS; ESSENTIAL OILS FOR PERSONAL USE; GELS, SPRAYS AND BALMS FOR THE HAIR STY-

LING AND HAIR CARE; HAIR LACQUERS; SHAMPOOS, CONDITIONERS, TREATMENTS, SERUMS, MASQUES AND MOUSSE FOR THE HAIR, IN CLASS 3 (U.S. CLS. 1, 4, 6, 50, 51 AND 52).

THE MARK CONSISTS OF STANDARD CHARACTERS WITHOUT CLAIM TO ANY PARTICULAR FONT, STYLE, SIZE, OR COLOR.

PRIORITY CLAIMED UNDER SEC. 44(D) ON FRANCE APPLICATION NO. 073482982, FILED 2-20-2007, REG. NO. 073482982, DATED 2-20-2007, EXPIRES 2-20-2017.

SER. NO. 77-123,703, FILED 3-6-2007.

BRIAN PINO, EXAMINING ATTORNEY

**Int. Cl.: 41**

**Prior U.S. Cls.: 100, 101 and 107**

**United States Patent and Trademark Office**

**Reg. No. 3,394,212**

**Registered Mar. 11, 2008**

**SERVICE MARK  
PRINCIPAL REGISTER**

**THE NORTHWEST SCHOOL FOR  
BOTANICAL STUDIES**

THE NORTHWEST SCHOOL FOR BOTANICAL  
STUDIES (CALIFORNIA SOLE PROPRIETOR-  
SHIP)  
36 KINGSTON ROAD  
FIELDBROOK, CA 95519

FOR: EDUCATION SERVICES, NAMELY, PRO-  
VIDING CLASSES, SEMINARS AND WORKSHOPS  
IN THE FIELDS OF HERBALISM AND BOTANICAL  
MEDICINE, IN CLASS 41 (U.S. CLS. 100, 101 AND  
107).

FIRST USE 8-0-1997; IN COMMERCE 8-0-1997.

THE MARK CONSISTS OF STANDARD CHAR-  
ACTERS WITHOUT CLAIM TO ANY PARTICULAR  
FONT, STYLE, SIZE, OR COLOR.

NO CLAIM IS MADE TO THE EXCLUSIVE  
RIGHT TO USE "SCHOOL FOR BOTANICAL STU-  
DIES", APART FROM THE MARK AS SHOWN.

SER. NO. 77-124,947, FILED 3-7-2007.

ROSELLE HERRERA, EXAMINING ATTORNEY

**Int. Cl.: 35**

**Prior U.S. Cls.: 100, 101 and 102**

**United States Patent and Trademark Office**

**Reg. No. 3,394,213**

**Registered Mar. 11, 2008**

**SERVICE MARK  
PRINCIPAL REGISTER**



[www.piggita.com](http://www.piggita.com)

HSING, MIHEE KELLY (UNITED STATES INDIVIDUAL)

APT 208

1701 TALMADGE STREET

LOS ANGELES, CA 90027

FOR: RETAIL ONLINE STORE SERVICES FEATURING COSMETICS, EYEWEAR, NAMELY, SUNGLASSES, JEWELRY, NAMELY, BRACELETS, EARRINGS, NECKLACES, RINGS, WATCHES, ACCESSORIES, SHOES, HANDBAGS, AND CLOTHING, NAMELY, PANTS, SHIRTS, JACKETS, SKIRTS, DRESSES, SWEATERS, HATS, GOWNS, SCARVES, BELTS, ROBES, PAJAMAS, VESTS AND HATS, TUBE TOPS, TANK TOPS, CORSETS, BRAS,

UNDERWEAR AND SHAWLS, IN CLASS 35 (U.S. CLS. 100, 101 AND 102).

FIRST USE 4-28-2006; IN COMMERCE 4-28-2006.

THE COLOR(S) PINK IS/ARE CLAIMED AS A FEATURE OF THE MARK.

THE MARK CONSISTS OF A PIG FACE AND TAIL IN PINK.

SER. NO. 77-126,338, FILED 3-9-2007.

AMY MCMENAMIN, EXAMINING ATTORNEY

**Int. Cl.: 20**

**Prior U.S. Cls.: 2, 13, 22, 25, 32 and 50**

**United States Patent and Trademark Office**

**Reg. No. 3,394,214**

**Registered Mar. 11, 2008**

**TRADEMARK  
PRINCIPAL REGISTER**

**Push Pull Open Close**

PUSH PULL OPEN CLOSE INCORPORATED  
(TEXAS CORPORATION)  
P.O. BOX 41706  
AUSTIN, TX 78704

FOR: PLASTIC DOORKNOBS; WOOD DOOR-  
KNOBS; DRAWER PULLS OF PLASTIC OR WOOD,  
CORK, REED, CANE, WICKER, HORN, BONE,  
IVORY, WHALEBONE, SHELL, AMBER, MOTHER-  
OF-PEARL, MEERSCHAUM AND SUBSTITUTES  
FOR ALL THESE MATERIALS, IN CLASS 20 (U.S.  
CLS. 2, 13, 22, 25, 32 AND 50).

FIRST USE 9-15-2003; IN COMMERCE 9-15-2003.

THE MARK CONSISTS OF STANDARD CHAR-  
ACTERS WITHOUT CLAIM TO ANY PARTICULAR  
FONT, STYLE, SIZE, OR COLOR.

SER. NO. 77-126,551, FILED 3-9-2007.

TASHIA BUNCH, EXAMINING ATTORNEY

Int. Cl.: 12

Prior U.S. Cls.: 19, 21, 23, 31, 35 and 44

United States Patent and Trademark Office

Reg. No. 3,394,215

Registered Mar. 11, 2008

TRADEMARK  
PRINCIPAL REGISTER



COSTA, VINCE (UNITED STATES INDIVIDUAL)  
15572 COMPUTER LANE  
HUNTINGTON BEACH, CA 92649

FOR: BRAKE DISCS FOR MOTORCYCLES; HUBS FOR VEHICLE WHEELS (MOTORCYCLES); MOTORCYCLE ACCESSORIES, NAMELY, FRONT AND SIDE PLATES; MOTORCYCLE ACCESSORIES, NAMELY, GAS TANK AND RADIATOR SHROUDS; MOTORCYCLE AND AUTOMOBILE STRUCTURAL PARTS, NAMELY, SUMP GUARDS; MOTORCYCLE ENGINES; MOTORCYCLE GRIP TAPE; MOTORCYCLE KICKSTANDS; MOTORCYCLE PARTS, NAMELY, CHROMED SAFETY PADS; MOTORCYCLE PARTS, NAMELY, HEEL GUARDS; MOTORCYCLE SADDLEBAGS; MOTORCYCLE SIDECARS; MOTORCYCLE TRIKE CONVERSION KITS FOR CONVERTING A TWO-WHEELED MOTORCYCLE INTO A THREE-WHEELED MOTORCYCLE; MOTORCYCLES; MOTORCYCLES AND STRUCTURAL PARTS THEREFOR; MOTORCYCLES FOR MOTOCROSS; PANNIER BAGS FOR MOTORCYCLES; PARTS OF MOTORCYCLES, NAMELY HANDLE BAR THROTTLES; PARTS OF MOTORCYCLES, NAMELY, BRAKE CABLES; PARTS OF MOTORCYCLES, NAMELY, BRAKE CALIPERS; PARTS OF MOTORCYCLES, NAMELY, BRAKE PEDALS; PARTS OF MOTORCYCLES, NAMELY, BRAKE ROTORS; PARTS OF MOTORCYCLES, NAMELY, CLUTCH CABLES; PARTS OF MOTORCYCLES, NAMELY, FORK BEARINGS AND RACES; PARTS OF MOTORCYCLES, NAME-

LY, FORK DUST BOOTS; PARTS OF MOTORCYCLES, NAMELY, FORK SEALS; PARTS OF MOTORCYCLES, NAMELY, FRONT DASH PANELS; PARTS OF MOTORCYCLES, NAMELY, FRONT SPACERS; PARTS OF MOTORCYCLES, NAMELY, HANDLE BAR CONTROL LEVERS; PARTS OF MOTORCYCLES, NAMELY, HANDLE BAR DAMPERS; PARTS OF MOTORCYCLES, NAMELY, HANDLE BAR GRIPS; PARTS OF MOTORCYCLES, NAMELY, HANDLE BARS; PARTS OF MOTORCYCLES, NAMELY, HEADLIGHT MOUNTS; PARTS OF MOTORCYCLES, NAMELY, SHIFT LEVERS; PNEUMATIC TYRES AND INNER TUBES FOR MOTORCYCLES; STRUCTURAL PARTS FOR MOTORCYCLES, IN CLASS 12 (U.S. CLS. 19, 21, 23, 31, 35 AND 44).

FIRST USE 7-7-1998; IN COMMERCE 7-7-1998.

NO CLAIM IS MADE TO THE EXCLUSIVE RIGHT TO USE "SUSPENSION", APART FROM THE MARK AS SHOWN.

THE MARK CONSISTS OF THE WORDS AMERICAN SUSPENSION AROUND A STAR.

SEC. 2(F).

SER. NO. 77-128,562, FILED 3-12-2007.

DAVID TAYLOR, EXAMINING ATTORNEY

**Int. Cl.: 28**

**Prior U.S. Cls.: 22, 23, 38 and 50**

**United States Patent and Trademark Office**

**Reg. No. 3,394,216**

**Registered Mar. 11, 2008**

**TRADEMARK  
PRINCIPAL REGISTER**

**DOG-GONE FUN!**

MATTEL, INC. (DELAWARE CORPORATION)  
M1-1518  
333 CONTINENTAL BLVD.  
EL SEGUNDO, CA 90245

FOR: TOYS, GAMES AND PLAYTHINGS, NAME-  
LY, DOLLS, DOLL CLOTHING AND DOLL ACCES-  
SORIES, TOY FIGURES, TOY ANIMALS, AND  
ACCESSORIES FOR ALL OF THE FOREGOING, IN  
CLASS 28 (U.S. CLS. 22, 23, 38 AND 50).

FIRST USE 7-25-2007; IN COMMERCE 7-25-2007.

THE MARK CONSISTS OF STANDARD CHAR-  
ACTERS WITHOUT CLAIM TO ANY PARTICULAR  
FONT, STYLE, SIZE, OR COLOR.

SER. NO. 77-128,653, FILED 3-12-2007.

JAMES A. RAUEN, EXAMINING ATTORNEY



**Int. Cl.: 39**

**Prior U.S. Cls.: 100 and 105**

**United States Patent and Trademark Office**

**Reg. No. 3,394,217**

**Registered Mar. 11, 2008**

**SERVICE MARK  
PRINCIPAL REGISTER**



AIRSAGE, INC. (GEORGIA CORPORATION)  
SUITE 100  
400 EMBASSY ROW  
ATLANTA, GA 30328

FOR: TRAVELER INFORMATION SERVICES,  
NAMELY, PROVIDING TRAFFIC INFORMATION,  
OPTIMAL TRAVEL ROUTING, TRAFFIC ALERTS,  
TRAFFIC PATTERNS, AND ROADWAY INCIDENT  
DETECTION, IN CLASS 39 (U.S. CLS. 100 AND 105).

FIRST USE 5-31-2005; IN COMMERCE 5-31-2005.

OWNER OF U.S. REG. NO. 3,245,036.

THE COLOR(S) BLUE, GRAY AND WHITE IS/  
ARE CLAIMED AS A FEATURE OF THE MARK.

THE WORDING IN THE MARK IS BLUE, AND  
THE HIGHWAY DESIGN IS GRAY WITH WHITE  
CENTER STRIPES.

SER. NO. 77-129,303, FILED 3-13-2007.

ALICE SUE CARRUTHERS, EXAMINING ATTOR-  
NEY

**Int. Cl.: 9**

**Prior U.S. Cls.: 21, 23, 26, 36 and 38**

**Reg. No. 3,394,218**

**United States Patent and Trademark Office**

**Registered Mar. 11, 2008**

---

**TRADEMARK  
PRINCIPAL REGISTER**

**LATTCO**

CHRONIM INVESTMENTS, INC. (TEXAS CORPORATION)  
2305 CEDAR SPRINGS ROAD  
DALLAS, TX 75201

THE MARK CONSISTS OF STANDARD CHARACTERS WITHOUT CLAIM TO ANY PARTICULAR FONT, STYLE, SIZE, OR COLOR.

FOR: COMPUTER SOFTWARE FOR PROCESSING SECURITIES POSITIONS, ACCESSED THROUGH A REMOTE SERVER, IN CLASS 9 (U.S. CLS. 21, 23, 26, 36 AND 38).

SER. NO. 77-129,898, FILED 3-13-2007.

FIRST USE 2-0-2005; IN COMMERCE 2-0-2005.

ALICE SUE CARRUTHERS, EXAMINING ATTORNEY

**Int. Cl.: 35**

**Prior U.S. Cls.: 100, 101 and 102**

**United States Patent and Trademark Office**

**Reg. No. 3,394,219**

**Registered Mar. 11, 2008**

**SERVICE MARK  
PRINCIPAL REGISTER**

**CREATIVE PEOPLE. SMART  
SOLUTIONS.**

DPRA, INCORPORATED (KANSAS CORPORATION)  
200 RESEARCH DRIVE  
MANHATTAN, KS 66503

FOR: BUSINESS SERVICES IN THE NATURE OF BUSINESS MANAGEMENT, ADMINISTRATION AND MANAGEMENT, CONSULTANCY, BUSINESS INFORMATION MANAGEMENT, ORGANIZATION AND OPERATION CONSULTANCY, AND HUMAN RESOURCE MANAGEMENT, ALL PROVIDED TO OTHERS IN THE FIELD OF PLANNING AND LOGISTICS; RECORDS MANAGEMENT, NAMELY, DOCUMENT INDEXING FOR OTHERS, ADVICE RELATING TO THE ORGANIZATION AND MANAGEMENT OF BUSINESS; AND MANAGEMENT OF ENVIRONMENTAL REMEDIATION

AND COMPLIANCE, NAMELY, MANAGING RECORDS FOR OTHERS RELATING TO REMEDIATION ACTIVITIES AND COMPLIANCE WITH GOVERNMENT REGULATIONS RELATED TO THE REMEDIATION ACTIVITIES, IN CLASS 35 (U.S. CLS. 100, 101 AND 102).

FIRST USE 2-6-2007; IN COMMERCE 2-6-2007.

THE MARK CONSISTS OF STANDARD CHARACTERS WITHOUT CLAIM TO ANY PARTICULAR FONT, STYLE, SIZE, OR COLOR.

SER. NO. 77-130,269, FILED 3-13-2007.

ELISSA GARBER KON, EXAMINING ATTORNEY

**Int. Cl.: 9**

**Prior U.S. Cls.: 21, 23, 26, 36 and 38**

**United States Patent and Trademark Office**

**Reg. No. 3,394,220**

**Registered Mar. 11, 2008**

**TRADEMARK  
PRINCIPAL REGISTER**

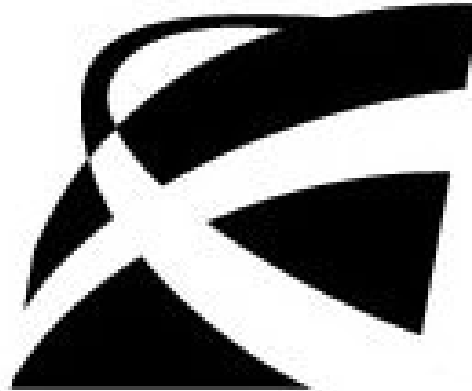

DPRA, INCORPORATED (KANSAS CORPORATION)  
200 RESEARCH DRIVE  
MANHATTAN, KS 66503

FOR: CUSTOM COMPUTER SOFTWARE PROVIDED TO OTHERS VIA ONLINE DOWNLOADS AND BY INSTALLATION ON THE COMPUTERS OF OTHERS FOR MODELING, ANALYSIS, AND DATA MANAGEMENT IN THE FIELDS OF PLANNING AND LOGISTICS, GEOGRAPHICAL INFORMATION MANAGEMENT AND INTEGRATION; LABORATORY SCIENCE ANALYSIS IN THE NATURE

OF ENVIRONMENTAL FORENSICS AND GEOCHEMISTRY ANALYSIS; RECORDS MANAGEMENT; ENVIRONMENTAL PLANNING, COMPLIANCE, AND REMEDIATION; AND ORGANIZATIONAL MANAGEMENT AND SUPPORT, IN CLASS 9 (U.S. CLS. 21, 23, 26, 36 AND 38).

FIRST USE 2-6-2007; IN COMMERCE 2-6-2007.

SER. NO. 77-130,285, FILED 3-13-2007.

ELISSA GARBER KON, EXAMINING ATTORNEY

**Int. Cl.: 9**

**Prior U.S. Cls.: 21, 23, 26, 36 and 38**

**Reg. No. 3,394,221**

**United States Patent and Trademark Office**

**Registered Mar. 11, 2008**

**TRADEMARK  
PRINCIPAL REGISTER**

**DPRA**

DPRA, INCORPORATED (KANSAS CORPORATION)  
200 RESEARCH DRIVE  
MANHATTAN, KS 66503

FOR: CUSTOM COMPUTER SOFTWARE PROVIDED TO OTHERS VIA ONLINE DOWNLOADS AND BY INSTALLATION ON THE COMPUTERS OF OTHERS FOR MODELING, ANALYSIS, AND DATA MANAGEMENT IN THE FIELDS OF PLANNING AND LOGISTICS, GEOGRAPHICAL INFORMATION MANAGEMENT AND INTEGRATION; LABORATORY SCIENCE ANALYSIS IN THE NATURE OF ENVIRONMENTAL FORENSICS AND GEO-CHEMISTRY ANALYSIS; RECORDS MANAGE-

MENT; ENVIRONMENTAL PLANNING, COMPLIANCE, AND REMEDIATION; AND ORGANIZATIONAL MANAGEMENT AND SUPPORT, IN CLASS 9 (U.S. CLS. 21, 23, 26, 36 AND 38).

FIRST USE 5-2-1988; IN COMMERCE 5-2-1988.

THE MARK CONSISTS OF STANDARD CHARACTERS WITHOUT CLAIM TO ANY PARTICULAR FONT, STYLE, SIZE, OR COLOR.

SER. NO. 77-130,294, FILED 3-13-2007.

ELISSA GARBER KON, EXAMINING ATTORNEY

Int. Cl.: 18

Prior U.S. Cls.: 1, 2, 3, 22 and 41

United States Patent and Trademark Office

Reg. No. 3,394,222

Registered Mar. 11, 2008

TRADEMARK  
PRINCIPAL REGISTER



MITCHELL, DENISE (UNITED STATES INDIVIDUAL)  
516 N. GUADALUPE AVE  
REDONDO BCH., CA 90277

FOR: HORSESHOES, IN CLASS 18 (U.S. CLS. 1, 2, 3, 22 AND 41).

FIRST USE 4-15-2006; IN COMMERCE 4-15-2006.

NO CLAIM IS MADE TO THE EXCLUSIVE RIGHT TO USE FILLY , APART FROM THE MARK AS SHOWN.

THE MARK CONSISTS OF STYLIZED TEXT AND A HORSESHOE.

SER. NO. 77-130,636, FILED 3-14-2007.

CHARLOTTE CORWIN, EXAMINING ATTORNEY

**Int. Cl.: 5**

**Prior U.S. Cls.: 6, 18, 44, 46, 51 and 52**

**Reg. No. 3,394,223**

**United States Patent and Trademark Office**

**Registered Mar. 11, 2008**

---

**TRADEMARK  
PRINCIPAL REGISTER**

# Health Solute Ions

MINERAL RESOURCES INTERNATIONAL, INC.  
(UTAH CORPORATION)  
1990 WEST 3300 SOUTH  
OGDEN, UT 84401

FOR: ANIMAL FEED SUPPLEMENTS; DIETARY  
AND NUTRITIONAL SUPPLEMENTS FOR HUMAN  
CONSUMPTION, IN CLASS 5 (U.S. CLS. 6, 18, 44, 46,  
51 AND 52).

FIRST USE 2-21-2007; IN COMMERCE 2-21-2007.

THE MARK CONSISTS OF STANDARD CHAR-  
ACTERS WITHOUT CLAIM TO ANY PARTICULAR  
FONT, STYLE, SIZE, OR COLOR.

NO CLAIM IS MADE TO THE EXCLUSIVE  
RIGHT TO USE "HEALTH", APART FROM THE  
MARK AS SHOWN.

SER. NO. 77-131,328, FILED 3-14-2007.

AHSEN KHAN, EXAMINING ATTORNEY

**Int. Cl.: 9**

**Prior U.S. Cls.: 21, 23, 26, 36 and 38**

**United States Patent and Trademark Office**

**Reg. No. 3,394,224**

**Registered Mar. 11, 2008**

**TRADEMARK  
PRINCIPAL REGISTER**

**SNAPWAVE**

COLORLINK, INC. (COLORADO CORPORATION)  
5335 STERLING DRIVE, SUITE B  
BOULDER, CO 80301

FOR: OPTICAL COMPONENTS, NAMELY, OPTICAL FILTERS COMBINED WITH LIQUID CRYSTAL CELLS TO ELECTRONICALLY CONTROL THE TRANSMISSION OF SPECIFIC COLORS, NAMELY, REDS, GREENS AND BLUES AND BLOCK OTHER WAVELENGTHS ON DEMAND PRIMARILY FOR USE IN THE FIELD OF IMAGE CAPTURE, BY MEANS OF CAMERAS AND VIDEO

RECORDERS, IN CLASS 9 (U.S. CLS. 21, 23, 26, 36 AND 38).

FIRST USE 1-18-2006; IN COMMERCE 3-30-2006.

THE MARK CONSISTS OF STANDARD CHARACTERS WITHOUT CLAIM TO ANY PARTICULAR FONT, STYLE, SIZE, OR COLOR.

SER. NO. 77-131,457, FILED 3-15-2007.

EDWARD NELSON, EXAMINING ATTORNEY



**Int. Cl.: 28**

**Prior U.S. Cls.: 22, 23, 38 and 50**

**United States Patent and Trademark Office**

**Reg. No. 3,394,225**

**Registered Mar. 11, 2008**

**TRADEMARK  
PRINCIPAL REGISTER**

**RAINBOW LIGHTS FAIRY**

MATTEL, INC. (DELAWARE CORPORATION)  
M1-1518  
333 CONTINENTAL BLVD.  
EL SEGUNDO, CA 90245

FOR: TOYS, GAMES AND PLAYTHINGS, NAME-  
LY, DOLLS, DOLL CLOTHING AND DOLL ACCES-  
SORIES, TOY FIGURES AND ACCESSORIES  
THEREFOR, IN CLASS 28 (U.S. CLS. 22, 23, 38 AND  
50).

FIRST USE 6-20-2007; IN COMMERCE 6-20-2007.

THE MARK CONSISTS OF STANDARD CHAR-  
ACTERS WITHOUT CLAIM TO ANY PARTICULAR  
FONT, STYLE, SIZE, OR COLOR.

NO CLAIM IS MADE TO THE EXCLUSIVE  
RIGHT TO USE "LIGHTS", APART FROM THE  
MARK AS SHOWN.

SER. NO. 77-131,575, FILED 3-15-2007.

MICHELE SWAIN, EXAMINING ATTORNEY

**Int. Cl.: 28**

**Prior U.S. Cls.: 22, 23, 38 and 50**

**United States Patent and Trademark Office**

**Reg. No. 3,394,226**

**Registered Mar. 11, 2008**

**TRADEMARK  
PRINCIPAL REGISTER**

**MOODLES**

EMOTIONALLIE, LLC (CALIFORNIA LTD LIAB  
CO)  
SUITE 780  
409 N. PACIFIC COAST HIGHWAY  
REDONDO BEACH, CA 90277

FOR: PLUSH TOYS; SOFT SCULPTURE DOLLS;  
SOFT SCULPTURE PLUSH TOYS; SOFT SCULP-  
TURE TOYS, IN CLASS 28 (U.S. CLS. 22, 23, 38 AND  
50).

FIRST USE 3-14-2007; IN COMMERCE 3-14-2007.

THE MARK CONSISTS OF STANDARD CHAR-  
ACTERS WITHOUT CLAIM TO ANY PARTICULAR  
FONT, STYLE, SIZE, OR COLOR.

SER. NO. 77-131,775, FILED 3-15-2007.

THEODORE MCBRIDE, EXAMINING ATTORNEY

**Int. Cl.: 5**

**Prior U.S. Cls.: 6, 18, 44, 46, 51 and 52**

**Reg. No. 3,394,227**

**United States Patent and Trademark Office**

**Registered Mar. 11, 2008**

---

**TRADEMARK  
PRINCIPAL REGISTER**

**ALKAFLEX**

JOSEPH CHRISTY (UNITED STATES INDIVIDUAL)  
1895 S LOS FELIZ DRIVE  
TEMPE, AZ 85281

THE MARK CONSISTS OF STANDARD CHARACTERS WITHOUT CLAIM TO ANY PARTICULAR FONT, STYLE, SIZE, OR COLOR.

FOR: DIETARY SUPPLEMENTS, IN CLASS 5 (U.S. CLS. 6, 18, 44, 46, 51 AND 52).

SER. NO. 77-132,174, FILED 3-15-2007.

FIRST USE 1-1-2007; IN COMMERCE 1-1-2007.

SARA THOMAS, EXAMINING ATTORNEY

**Int. Cl.: 41**

**Prior U.S. Cls.: 100, 101 and 107**

**United States Patent and Trademark Office**

**Reg. No. 3,394,228**

**Registered Mar. 11, 2008**

---

**SERVICE MARK  
PRINCIPAL REGISTER**

**THE FREEDOM EQUATION**

PSALMS ONE, LLC (GEORGIA LTD LIAB CO)  
1041 HONEY CREEK ROAD, SUITE 276  
CONYERS, GA 30013

FOR: PERSONAL COACHING SERVICES SPECIFICALLY IN THE FIELD OF REAL ESTATE; EDUCATIONAL SERVICES, NAMELY PROVIDING SEMINARS SPECIFICALLY IN THE FIELD OF REAL ESTATE, IN CLASS 41 (U.S. CLS. 100, 101 AND 107).

FIRST USE 3-9-2007; IN COMMERCE 3-9-2007.

THE MARK CONSISTS OF STANDARD CHARACTERS WITHOUT CLAIM TO ANY PARTICULAR FONT, STYLE, SIZE, OR COLOR.

SER. NO. 77-132,277, FILED 3-15-2007.

NELSON SNYDER, EXAMINING ATTORNEY

Int. Cl.: 36

Prior U.S. Cls.: 100, 101 and 102

United States Patent and Trademark Office

Reg. No. 3,394,229

Registered Mar. 11, 2008

**SERVICE MARK  
PRINCIPAL REGISTER**



TOP TEN FUND RAISERS, INC. (TEXAS CORPORATION)  
210 ADELL ROAD  
SUNNYVALE, TX 75182

FOR: CHARITABLE FUND RAISING SERVICES FEATURING A FAMILY AND SCHOOL HOLIDAY SHOPPING FAIR OFFERED AT ELEMENTARY SCHOOLS DURING WHICH SCHOOL CHILDREN CAN SHOP AT SCHOOL FOR HOLIDAY GIFTS FOR FAMILY AND FRIENDS WITH PROCEEDS BENEFITING THE SCHOOL, IN CLASS 36 (U.S. CLS. 100, 101 AND 102).

FIRST USE 12-0-1991; IN COMMERCE 12-0-1991.

NO CLAIM IS MADE TO THE EXCLUSIVE RIGHT TO USE "HOLIDAY FAIR" AND "PRESENTED BY" AND "FUND RAISERS, INC.", APART FROM THE MARK AS SHOWN.

THE COLOR(S) RED, YELLOW, ORANGE, BLUE, GREEN, WHITE, LIGHT BLUE AND PURPLE IS/ARE CLAIMED AS A FEATURE OF THE MARK.

"THE MARK CONSISTS OF THE WORDING HOLIDAY FAIR AND TOP TEN FUND RAISERS, INC. IN WHITE LETTERING AND THE WORDING PRESENTED BY IN RED LETTERING, WITH ALL THE WORDING SUPERIMPOSED ON A PURPLE BACKGROUND AND FRAMED WITHIN A LIGHT BLUE OVAL, WITH TWO WHITE SNOWFLAKES ON EITHER SIDE, AND A GREEN STRING OF RED, YELLOW, ORANGE AND BLUE CHRISTMAS LIGHTS ARRANGED IN AN UNDULATING, OVAL PATTERN."

SER. NO. 77-132,591, FILED 3-15-2007.

NICHOLAS ALTREE, EXAMINING ATTORNEY

**Int. Cl.: 44**

**Prior U.S. Cls.: 100 and 101**

**United States Patent and Trademark Office**

**Reg. No. 3,394,230**

**Registered Mar. 11, 2008**

**SERVICE MARK  
PRINCIPAL REGISTER**

**VISTA GRANDE INN**

MONTEZUMA COUNTY HOSPITAL DISTRICT  
(COLORADO COLORADO SPECIAL DISTRICT)

P.O. BOX 1034  
CORTEZ, CO 81321

FOR: NURSING HOMES, IN CLASS 44 (U.S. CLS. 100 AND 101).

FIRST USE 1-1-1970; IN COMMERCE 1-1-1970.

THE MARK CONSISTS OF STANDARD CHARACTERS WITHOUT CLAIM TO ANY PARTICULAR FONT, STYLE, SIZE, OR COLOR.

NO CLAIM IS MADE TO THE EXCLUSIVE RIGHT TO USE "INN", APART FROM THE MARK AS SHOWN.

SER. NO. 77-132,661, FILED 3-16-2007.

DEZMONA MIZELLE, EXAMINING ATTORNEY

**Int. Cls.: 9, 16 and 42**

**Prior U.S. Cls.: 2, 5, 21, 22, 23, 26, 29, 36, 37, 38, 50,  
100 and 101**

**Reg. No. 3,394,231**

**United States Patent and Trademark Office**

**Registered Mar. 11, 2008**

**TRADEMARK  
SERVICE MARK  
PRINCIPAL REGISTER**

# BARRACUDA

CPFD SOFTWARE, LLC (NEW MEXICO LTD  
LIAB CO)  
10899 MONTGOMERY BLVD, N.E.  
ALBUQUERQUE, NM 87111

FOR: COMPUTER SOFTWARE AND COMPUTER  
PROGRAMS FOR USE IN ENGINEERING AND  
INDUSTRIAL PROCESS EQUIPMENT DESIGN,  
ANALYSIS AND RESEARCH, IN CLASS 9 (U.S.  
CLS. 21, 23, 26, 36 AND 38).

FIRST USE 7-5-2006; IN COMMERCE 7-5-2006.

FOR: PRINTED COMPUTER MANUALS AND  
PRINTED INSTRUCTIONAL MATERIALS IN THE  
FIELD OF INDUSTRIAL PROCESS EQUIPMENT  
DESIGN, ANALYSIS, AND RESEARCH, IN CLASS  
16 (U.S. CLS. 2, 5, 22, 23, 29, 37, 38 AND 50).

FIRST USE 7-5-2006; IN COMMERCE 7-5-2006.

FOR: ENGINEERING; DESIGN OF INDUSTRIAL  
PROCESS EQUIPMENT FOR OTHERS; ANALYSIS

OF INDUSTRIAL FLUID-PARTICLE PROCESSES  
AND SYSTEMS, NAMELY PETROCHEMICAL,  
CHEMICAL, POWER-GENERATING, METAL  
CASTING, PHARMACEUTICAL, ENVIRONMEN-  
TAL, AND GEOHYDROLOGY; RESEARCH CON-  
SULTING SERVICES IN THE FIELD OF  
INDUSTRIAL FLUID-PARTICLE PROCESSES AND  
SYSTEMS, NAMELY PETROCHEMICAL, CHEMI-  
CAL, POWER-GENERATING, METAL CASTING,  
PHARMACEUTICAL, ENVIRONMENTAL, AND  
GEOHYDROLOGY, IN CLASS 42 (U.S. CLS. 100  
AND 101).

FIRST USE 7-5-2006; IN COMMERCE 7-5-2006.

THE MARK CONSISTS OF STANDARD CHAR-  
ACTERS WITHOUT CLAIM TO ANY PARTICULAR  
FONT, STYLE, SIZE, OR COLOR.

SER. NO. 77-135,062, FILED 3-20-2007.

ALLISON HOLTZ, EXAMINING ATTORNEY

**Int. Cl.: 16**

**Prior U.S. Cls.: 2, 5, 22, 23, 29, 37, 38 and 50**

**Reg. No. 3,394,232**

**United States Patent and Trademark Office**

**Registered Mar. 11, 2008**

**TRADEMARK  
PRINCIPAL REGISTER**

**VETSOURCE**

STRATEGIC PHARMACEUTICAL SOLUTIONS,  
INC. (OREGON CORPORATION)  
17014 NE SANDY BLVD.  
PORTLAND, OR 97230

FOR: CATALOGUES IN THE FIELD OF ITEMS  
OF INTEREST TO VETERINARIANS; STATION-  
ERY, POSTAL CARDS, BLANK AND PARTIALLY  
PRINTED PAPER LABELS, ADDRESS LABELS,  
ARTIST'S DRAWINGS AND PICTURES, IN CLASS  
16 (U.S. CLS. 2, 5, 22, 23, 29, 37, 38 AND 50).

FIRST USE 9-0-1993; IN COMMERCE 9-0-1993.

THE MARK CONSISTS OF STANDARD CHAR-  
ACTERS WITHOUT CLAIM TO ANY PARTICULAR  
FONT, STYLE, SIZE, OR COLOR.

SER. NO. 77-135,217, FILED 3-20-2007.

TASNEEM HUSSAIN, EXAMINING ATTORNEY



**Int. Cls.: 9 and 36**

**Prior U.S. Cls.: 21, 23, 26, 36, 38, 100, 101 and 102**

**United States Patent and Trademark Office**

**Reg. No. 3,394,233**

**Registered Mar. 11, 2008**

**TRADEMARK  
SERVICE MARK  
PRINCIPAL REGISTER**

**PRIMATICS**

PRIMATICS FINANCIAL LLC (VIRGINIA LTD  
LIAB CO)  
8TH FLOOR  
1600 TYSONS BLVD.  
MCLEAN, VA 22102

FOR: PRODUCTS FOR USE BY FINANCIAL  
SERVICES COMPANIES, NAMELY, COMPUTER  
SOFTWARE FOR USE IN LOAN AND FIXED  
INCOME SECURITIES PORTFOLIO MANAGE-  
MENT AND LOAN AND SECURITIES ACCOUNT-  
ING, IN CLASS 9 (U.S. CLS. 21, 23, 26, 36 AND 38).

FIRST USE 1-1-2007; IN COMMERCE 1-1-2007.

FOR: PROVIDING FINANCIAL PORTFOLIO  
MANAGEMENT AND CONSULTATION SERVICES  
TO FINANCIAL INSTITUTIONS, IN CLASS 36 (U.S.  
CLS. 100, 101 AND 102).

FIRST USE 1-1-2007; IN COMMERCE 1-1-2007.

THE MARK CONSISTS OF THE WORD PRIMATICS, WITH A STYLIZED FORM OF THE LETTER A, THE A APPEARING IN THE SHAPE OF A TRIANGLE DIVIDED INTO TWO HALFS, THE RIGHT HALF OF THE TRIANGLE BEING FILLED IN, AND THE LEFT HALF OF THE TRIANGLE CONSISTING OF THREE SMALLER FILLED-IN TRIANGLES.

PRIMATICS HAS NO MEANING IN A FOREIGN LANGUAGE.

SER. NO. 77-135,288, FILED 3-20-2007.

TINA L. SNAPP, EXAMINING ATTORNEY

**Int. Cl.: 41**

**Prior U.S. Cls.: 100, 101 and 107**

**United States Patent and Trademark Office**

**Reg. No. 3,394,234**

**Registered Mar. 11, 2008**

**SERVICE MARK  
PRINCIPAL REGISTER**



BOGATIN ENTERPRISES, L.L.C. (KANSAS LTD  
LIAB CO)  
26235 W. 110TH TERRACE  
OLATHE, KS 66061

OWNER OF U.S. REG. NO. 3,123,632.

FOR: EDUCATIONAL SERVICES, NAMELY,  
PROVIDING IN-PERSON AND ONLINE WORK-  
SHOPS, CONFERENCES, PUBLIC TRAINING  
COURSES, SEMINARS AND CLASSES IN THE  
FIELD OF SIGNAL INTEGRITY AND INTERCON-  
NECT DESIGN, IN CLASS 41 (U.S. CLS. 100, 101 AND  
107).

THE MARK CONSISTS OF THE WORDS "BE THE  
SIGNAL" WRITTEN AT A 45 DEGREE ANGLE  
WITH A SIGN WAVE DRAWN THROUGH THE  
WORDS.

SER. NO. 77-135,512, FILED 3-20-2007.

FIRST USE 1-0-2005; IN COMMERCE 1-0-2005.

TINA KUAN, EXAMINING ATTORNEY

**Int. Cl.: 43**

**Prior U.S. Cls.: 100 and 101**

**United States Patent and Trademark Office**

**Reg. No. 3,394,235**

**Registered Mar. 11, 2008**

**SERVICE MARK  
PRINCIPAL REGISTER**



**Sonnenalp Resort  
of Vail**

SONNENALP PROPERTIES, INC. (COLORADO CORPORATION)  
20 VAIL ROAD  
VAIL, CO 81657

FOR: RESORT HOTELS; HOTEL, BAR AND RESTAURANT SERVICES, IN CLASS 43 (U.S. CLS. 100 AND 101).

FIRST USE 8-31-1979; IN COMMERCE 8-31-1979.

NO CLAIM IS MADE TO THE EXCLUSIVE RIGHT TO USE "RESORT" AND "VAIL", APART FROM THE MARK AS SHOWN.

THE MARK CONSISTS OF SUN LOGO WITH THE WORDS SONNENALP RESORT OF VAIL WRITTEN BELOW.

THE ENGLISH TRANSLATION OF THE TERM "SONNENALP" IN THE MARK IS "SUN ON THE MOUNTAINS".

SER. NO. 77-135,791, FILED 3-20-2007.

NATALIE POLZER, EXAMINING ATTORNEY

**Int. Cl.: 35**

**Prior U.S. Cls.: 100, 101 and 102**

**United States Patent and Trademark Office**

**Reg. No. 3,394,236**

**Registered Mar. 11, 2008**

**SERVICE MARK  
PRINCIPAL REGISTER**

**MGO**

MACIAS, GINI & O'CONNELL LLP (CALIFORNIA LIMITED LIABILITY PARTNERSHIP)  
3000 S STREET, SUITE 300  
SACRAMENTO, CA 95816

FOR: ACCOUNTING SERVICES; ACCOUNTING CONSULTATION; BUSINESS INFORMATION IN THE FIELD OF ACCOUNTING; ACCOUNTING ADVISORY SERVICES; BUSINESS MANAGEMENT CONSULTING AND ADVISORY SERVICES, IN CLASS 35 (U.S. CLS. 100, 101 AND 102).

FIRST USE 7-1-2006; IN COMMERCE 7-1-2006.

THE MARK CONSISTS OF STANDARD CHARACTERS WITHOUT CLAIM TO ANY PARTICULAR FONT, STYLE, SIZE, OR COLOR.

SER. NO. 77-136,026, FILED 3-20-2007.

DAVID YONTEF, EXAMINING ATTORNEY

**Int. Cl.: 28**

**Prior U.S. Cls.: 22, 23, 38 and 50**

**United States Patent and Trademark Office**

**Reg. No. 3,394,237**

**Registered Mar. 11, 2008**

**TRADEMARK  
PRINCIPAL REGISTER**

**SHELL SHOCK**

MATTEL, INC. (DELAWARE CORPORATION)  
333 CONTINENTAL BLVD., M1-1518  
EL SEGUNDO, CA 90245

FOR: TOY VEHICLES, IN CLASS 28 (U.S. CLS. 22,  
23, 38 AND 50).

FIRST USE 9-26-2007; IN COMMERCE 9-26-2007.

THE MARK CONSISTS OF STANDARD CHAR-  
ACTERS WITHOUT CLAIM TO ANY PARTICULAR  
FONT, STYLE, SIZE, OR COLOR.

OWNER OF U.S. REG. NO. 3,178,059.

SER. NO. 77-136,275, FILED 3-21-2007.

MICHELE SWAIN, EXAMINING ATTORNEY

**Int. Cls.: 19, 40 and 42**

**Prior U.S. Cls.: 1, 12, 33, 50, 100, 101, 103 and 106**

**Reg. No. 3,394,238**

**United States Patent and Trademark Office**

**Registered Mar. 11, 2008**

---

**TRADEMARK  
SERVICE MARK  
PRINCIPAL REGISTER**

**STONEIMPRESSIONS**

PHOTOSTONE, LLC (CALIFORNIA LTD LIAB  
CO)  
4600 SANTA FE STREET  
SAN DIEGO, CA 92109

FOR: DECORATIVE MURALS AND BORDERS  
MADE OF STONE TILES, DECORATIVE STONE  
TILES, IN CLASS 19 (U.S. CLS. 1, 12, 33 AND 50).

FIRST USE 4-4-2003; IN COMMERCE 4-4-2003.

FOR: PRINTING, IN CLASS 40 (U.S. CLS. 100, 103  
AND 106).

FIRST USE 4-4-2003; IN COMMERCE 4-4-2003.

FOR: GRAPHIC ART DESIGN, IN CLASS 42 (U.S.  
CLS. 100 AND 101).

FIRST USE 4-4-2003; IN COMMERCE 4-4-2003.

THE MARK CONSISTS OF STANDARD CHAR-  
ACTERS WITHOUT CLAIM TO ANY PARTICULAR  
FONT, STYLE, SIZE, OR COLOR.

SER. NO. 77-136,490, FILED 3-21-2007.

GEORGIA CARTY, EXAMINING ATTORNEY

**Int. Cl.: 35**

**Prior U.S. Cls.: 100, 101 and 102**

**United States Patent and Trademark Office**

**Reg. No. 3,394,239**

**Registered Mar. 11, 2008**

**SERVICE MARK  
PRINCIPAL REGISTER**

CELEBRATE FOOD CELEBRATE  
LIFE

RALEY'S TM, INC. (CALIFORNIA CORPORATION)  
500 WEST CAPITOL AVENUE  
WEST SACRAMENTO, CA 95605

THE MARK CONSISTS OF STANDARD CHARACTERS WITHOUT CLAIM TO ANY PARTICULAR FONT, STYLE, SIZE, OR COLOR.

FOR: RETAIL GROCERY STORES, IN CLASS 35 (U.S. CLS. 100, 101 AND 102).

SER. NO. 77-136,543, FILED 3-21-2007.

FIRST USE 10-18-2006; IN COMMERCE 10-18-2006.

GIANCARLO CASTRO, EXAMINING ATTORNEY

**Int. Cl.: 33**

**Prior U.S. Cls.: 47 and 49**

**United States Patent and Trademark Office**

**Reg. No. 3,394,240**

**Registered Mar. 11, 2008**

**TRADEMARK  
PRINCIPAL REGISTER**

**SWEET DESIRE**

ST. GOTTARDI GMBH (FED REP GERMANY  
GMBH)  
RIEGELGRUBE 13  
BAD KREUZNACH, FED REP GERMANY D-55543

FOR: RED WINE, WHITE WINE, WINE, AND  
WINES, IN CLASS 33 (U.S. CLS. 47 AND 49).

THE MARK CONSISTS OF STANDARD CHAR-  
ACTERS WITHOUT CLAIM TO ANY PARTICULAR  
FONT, STYLE, SIZE, OR COLOR.

PRIORITY CLAIMED UNDER SEC. 44(D) ON  
ERPNTY TM OFC APPLICATION NO.  
005455647, FILED 11-10-2006, REG. NO. 005455647,  
DATED 9-4-2007, EXPIRES 11-10-2016.

SER. NO. 77-136,744, FILED 3-21-2007.

DEZMONA MIZELLE, EXAMINING ATTORNEY



**Int. Cl.: 20**

**Prior U.S. Cls.: 2, 13, 22, 25, 32 and 50**

**United States Patent and Trademark Office**

**Reg. No. 3,394,241**

**Registered Mar. 11, 2008**

**TRADEMARK  
PRINCIPAL REGISTER**

**DREAMSACKS**

DREAMSACKS, INC. (OREGON CORPORATION)  
125 CLEAR CREEK DRIVE  
ASHLAND, OR 97520

FOR: FURNITURE; SLEEPING BAGS AND  
SLEEPING BAG LINERS, IN CLASS 20 (U.S. CLS. 2,  
13, 22, 25, 32 AND 50).

FIRST USE 6-15-1996; IN COMMERCE 10-27-1997.

THE MARK CONSISTS OF STANDARD CHAR-  
ACTERS WITHOUT CLAIM TO ANY PARTICULAR  
FONT, STYLE, SIZE, OR COLOR.

OWNER OF U.S. REG. NO. 2,288,632.

SER. NO. 77-136,849, FILED 3-21-2007.

SUSAN RICHARDS, EXAMINING ATTORNEY

**Int. Cls.: 35 and 39**

**Prior U.S. Cls.: 100, 101, 102 and 105**

**United States Patent and Trademark Office**

**Reg. No. 3,394,242**

**Registered Mar. 11, 2008**

**SERVICE MARK  
PRINCIPAL REGISTER**



CRUISESHIPCENTERS INTERNATIONAL INC.  
(CANADA CORPORATION)  
400 - 1055 WEST HASTINGS STREET  
VANCOUVER, CANADA V6E2E9

FOR: FRANCHISING SERVICES, NAMELY, OFFERING TECHNICAL ASSISTANCE IN THE ESTABLISHMENT AND OPERATION OF TRAVEL AGENCIES, IN CLASS 35 (U.S. CLS. 100, 101 AND 102).

FIRST USE 11-0-2006; IN COMMERCE 11-0-2006.

FOR: TRAVEL AGENCY SERVICES, NAMELY, MAKING RESERVATIONS AND BOOKINGS FOR TRANSPORTATION; TRAVEL ARRANGEMENT SERVICES, IN CLASS 39 (U.S. CLS. 100 AND 105).

FIRST USE 11-0-2006; IN COMMERCE 11-0-2006.

THE MARK CONSISTS OF A SHIP SAILING OUT OF A MARINER'S COMPASS.

SER. NO. 77-136,998, FILED 3-21-2007.

BENJAMIN ALLEN, EXAMINING ATTORNEY

**Int. Cl.: 42**

**Prior U.S. Cls.: 100 and 101**

**United States Patent and Trademark Office**

**Reg. No. 3,394,243**

**Registered Mar. 11, 2008**

**SERVICE MARK  
PRINCIPAL REGISTER**

**TELESTO**

**"Believe in Success"**

NAIR, RAKESH (INDIA INDIVIDUAL)  
230 LUCILLE AVE  
ELMONT, NY 11432

THE MARK CONSISTS OF STYLIZED TEXT  
WITH A CURVED LINE.

FOR: INFORMATION TECHNOLOGY CONSULTATION, IN CLASS 42 (U.S. CLS. 100 AND 101).

SER. NO. 77-137,120, FILED 3-21-2007.

FIRST USE 3-1-2004; IN COMMERCE 3-1-2004.

BRIAN NEVILLE, EXAMINING ATTORNEY

**Int. Cl.: 35**

**Prior U.S. Cls.: 100, 101 and 102**

**United States Patent and Trademark Office**

**Reg. No. 3,394,244**

**Registered Mar. 11, 2008**

**SERVICE MARK  
PRINCIPAL REGISTER**

# Sports Frenzy

SPUNKA, INC. (NEVADA CORPORATION)  
4712 ADMIRALTY WAY, SUITE 128  
MARINA DEL REY, CA 90292

FOR: ARRANGING AND CONDUCTING TRADE  
SHOW EXPOSITIONS AT WHICH SPORTS-RELA-  
TED PRODUCTS AND SERVICES ARE DISPLAYED  
AND SOLD, IN CLASS 35 (U.S. CLS. 100, 101 AND  
102).

FIRST USE 3-20-2007; IN COMMERCE 3-20-2007.

THE MARK CONSISTS OF STANDARD CHAR-  
ACTERS WITHOUT CLAIM TO ANY PARTICULAR  
FONT, STYLE, SIZE, OR COLOR.

NO CLAIM IS MADE TO THE EXCLUSIVE  
RIGHT TO USE "SPORTS", APART FROM THE  
MARK AS SHOWN.

SER. NO. 77-137,123, FILED 3-21-2007.

BRIAN NEVILLE, EXAMINING ATTORNEY

**Int. Cl.: 42**

**Prior U.S. Cls.: 100 and 101**

**United States Patent and Trademark Office**

**Reg. No. 3,394,245**

**Registered Mar. 11, 2008**

**SERVICE MARK  
PRINCIPAL REGISTER**

**BLUD DIRECT**

IMMUCOR, INC. (GEORGIA CORPORATION)  
3130 GATEWAY DRIVE  
NORCROSS, GA 30071

FOR: PROVIDING TECHNICAL SUPPORT FOR  
USERS OF PRETRANSFUSION BLOOD ANALY-  
ZERS, NAMELY, LABORATORY CONSULTATION  
SERVICES REGARDING CONTROL FLUIDS, SAM-  
PLE HANDLING, AND SAMPLE CONDITION AND  
TROUBLESHOOTING OF BLOOD ANALYZER  
COMPUTER HARDWARE AND SOFTWARE PRO-  
BLEMS, IN CLASS 42 (U.S. CLS. 100 AND 101).

FIRST USE 2-19-2007; IN COMMERCE 2-19-2007.

THE MARK CONSISTS OF STANDARD CHAR-  
ACTERS WITHOUT CLAIM TO ANY PARTICULAR  
FONT, STYLE, SIZE, OR COLOR.

NO CLAIM IS MADE TO THE EXCLUSIVE  
RIGHT TO USE "BLOOD", APART FROM THE  
MARK AS SHOWN.

SER. NO. 77-137,529, FILED 3-22-2007.

JULIE WATSON, EXAMINING ATTORNEY

Int. Cl.: 18

Prior U.S. Cls.: 1, 2, 3, 22 and 41

United States Patent and Trademark Office

Reg. No. 3,394,246

Registered Mar. 11, 2008

TRADEMARK  
PRINCIPAL REGISTER



WRAP'N WEAR LLC (UTAH LTD LIAB CO)  
1506 N 2400 W  
CLINTON, UT 84015

THE STIPLING IS FOR SHADING PURPOSES ONLY.

FOR: BABY CARRIERS WORN ON THE BODY,  
IN CLASS 18 (U.S. CLS. 1, 2, 3, 22 AND 41).

THE MARK CONSISTS OF BABY IN SLING WITH  
A BALL AND WORDS "WRAP'N WEAR".

FIRST USE 1-15-2007; IN COMMERCE 1-15-2007.

SER. NO. 77-137,553, FILED S.R. 3-22-2007 AM. P.R.  
10-4-2007.

NO CLAIM IS MADE TO THE EXCLUSIVE  
RIGHT TO USE "WRAP AND WEAR" , APART  
FROM THE MARK AS SHOWN.

MICHAEL WEBSTER, EXAMINING ATTORNEY

Int. Cl.: 44

Prior U.S. Cls.: 100 and 101

United States Patent and Trademark Office

Reg. No. 3,394,247

Registered Mar. 11, 2008

SERVICE MARK  
PRINCIPAL REGISTER



UNITED PIONEER HOME, INC. (WISCONSIN CORPORATION)  
210 E PARK AVE  
LUCK, WI 54853

FOR: NURSING CARE; NURSING HOMES, IN CLASS 44 (U.S. CLS. 100 AND 101).

FIRST USE 2-25-2004; IN COMMERCE 2-25-2004.

NO CLAIM IS MADE TO THE EXCLUSIVE RIGHT TO USE "HOME" AND "A PROVIDER OF SENIOR CARE AND HEALTH SERVICES SINCE 1953", APART FROM THE MARK AS SHOWN.

THE COLOR(S) RED, WHITE, AND BLUE IS/ARE CLAIMED AS A FEATURE OF THE MARK.

THE MARK CONSISTS OF A BLUE OVAL, WHICH IS NOT SOLID BLUE BUT HAS WHITE ANGULAR LINES SHOWING THROUGH AS IF SKETCHED, THE LETTERS WHICH ARE OUTSIDE AND TO THE RIGHT OF THE BLUE OVAL ARE BLUE AND THE LETTERS BELOW THE OVAL ARE ALSO BLUE; THE COLOR RED APPEARS ON THE HEART IN THE LEFT SIDE OF THE BLUE OVAL AND THE CROSS WHICH IS TO THE LEFT OF THE SMALL BLUE LETTERING BELOW THE BLUE OVAL, THE LETTERS ON THE BLUE OVAL ARE WHITE AND THE RED HEART HAS TWO WHITE REFLECTION LINES, ONE ON THE BOTTOM LEFT SIDE AND ONE ON THE TOP LEFT INDENT.

SER. NO. 77-138,506, FILED 3-23-2007.

MICHAEL WEBSTER, EXAMINING ATTORNEY

**Int. Cl.: 5**

**Prior U.S. Cls.: 6, 18, 44, 46, 51 and 52**

**United States Patent and Trademark Office**

**Reg. No. 3,394,248**

**Registered Mar. 11, 2008**

**TRADEMARK  
PRINCIPAL REGISTER**

**RIP. MIX. DRINK.**

BIOPHARMA SCIENTIFIC, INC. (NEVADA CORPORATION)  
5375 MIRA SORRENTO PLACE, SUITE 100  
SAN DIEGO, CA 92121

THE MARK CONSISTS OF STANDARD CHARACTERS WITHOUT CLAIM TO ANY PARTICULAR FONT, STYLE, SIZE, OR COLOR.

FOR: DIETARY SUPPLEMENT IN THE NATURE OF FRUIT, VEGETABLE AND PHYTONUTRIENT BLENDS IN THE FORM OF POWDERS, IN CLASS 5 (U.S. CLS. 6, 18, 44, 46, 51 AND 52).

SER. NO. 77-138,636, FILED 3-23-2007.

FIRST USE 2-17-2007; IN COMMERCE 2-17-2007.

STEVEN R. FINE, EXAMINING ATTORNEY



**Int. Cls.: 3 and 44**

**Prior U.S. Cls.: 1, 4, 6, 50, 51, 52, 100 and 101**

**United States Patent and Trademark Office**

**Reg. No. 3,394,249**

**Registered Mar. 11, 2008**

**TRADEMARK  
SERVICE MARK  
PRINCIPAL REGISTER**

**SE' MO' HAIR**

DAVIS, SHERRIE (UNITED STATES INDIVIDUAL)  
1353 INVERNESS DR.  
ELGIN, IL 60193

FOR: HAIR CONDITIONER, HAIR CREAM, HAIR SHAMPOO, HAIR COLORING PREPARATIONS, HAIR DYES, HAIR GELS, HAIR MOUSSE, HAIR LOTIONS, HAIR OILS, HAIR RELAXING PREPARATIONS, HAIR STRAIGHTENING PREPARATIONS, HAIR SPRAY, SKIN LOTION, SKIN SOAP, EXFOLIANTS FOR SKIN, SKIN TONERS, SHOWER GELS, FACIAL SCRUBS, BODY SCRUB, BATH OIL, BODY OIL, COSMETICS, NAIL POLISH, PERFUME, FACIAL CLEANSERS, SKIN MOISTURIZER, NON-MEDICATED FOOT CREAM, LIQUID SOAP USED IN FOOT BATH, FALSE EYELASHES,

ADHESIVES FOR FALSE EYELASHES, HAIR AND NAILS, IN CLASS 3 (U.S. CLS. 1, 4, 6, 50, 51 AND 52).

FIRST USE 1-1-2003; IN COMMERCE 1-1-2003.

FOR: BEAUTY SALONS, IN CLASS 44 (U.S. CLS. 100 AND 101).

FIRST USE 1-1-2003; IN COMMERCE 1-1-2003.

THE MARK CONSISTS OF STANDARD CHARACTERS WITHOUT CLAIM TO ANY PARTICULAR FONT, STYLE, SIZE, OR COLOR.

SER. NO. 77-139,385, FILED 3-23-2007.

BERYL GARDNER, EXAMINING ATTORNEY

**Int. Cls.: 35 and 43**

**Prior U.S. Cls.: 100, 101 and 102**

**United States Patent and Trademark Office**

**Reg. No. 3,394,250**

**Registered Mar. 11, 2008**

**SERVICE MARK  
PRINCIPAL REGISTER**

**AEX CONVENTION SERVICES**

AEX CONVENTION SERVICES, LLC (TEXAS  
LTD LIAB CO)  
3089 ENGLISH CREEK AVENUE  
EGG HARBOR TOWNSHIP, NJ 08234

FOR: BUSINESS SERVICES, NAMELY, PROVID-  
ING CONSULTING, PLANNING AND ORGANIZA-  
TIONAL SERVICES TO OTHERS IN CONNECTION  
WITH CONVENTIONS, EXPOSITIONS, TRADE  
SHOWS, EXHIBITIONS AND CONFERENCES FOR  
COMMERCIAL PURPOSES; RENTAL OF EXHIBI-  
TION BOOTHS INCLUDING RESPECTIVE EQUIP-  
MENT FOR CONVENTIONS, EXPOSITIONS,  
TRADE SHOWS, EXHIBITIONS AND CONFEREN-  
CES, IN CLASS 35 (U.S. CLS. 100, 101 AND 102).

FIRST USE 12-1-2003; IN COMMERCE 12-1-2003.

FOR: PROVIDING RENTAL OF FURNITURE  
FOR CONVENTIONS, EXPOSITIONS, TRADE  
SHOWS, EXHIBITIONS AND CONFERENCES, IN  
CLASS 43 (U.S. CLS. 100 AND 101).

FIRST USE 12-1-2003; IN COMMERCE 12-1-2003.

THE MARK CONSISTS OF STANDARD CHAR-  
ACTERS WITHOUT CLAIM TO ANY PARTICULAR  
FONT, STYLE, SIZE, OR COLOR.

NO CLAIM IS MADE TO THE EXCLUSIVE  
RIGHT TO USE "CONVENTION SERVICES",  
APART FROM THE MARK AS SHOWN.

SER. NO. 77-139,966, FILED 3-26-2007.

BERNICE MIDDLETON, EXAMINING ATTORNEY

**Int. Cl.: 9**

**Prior U.S. Cls.: 21, 23, 26, 36 and 38**

**Reg. No. 3,394,251**

**United States Patent and Trademark Office**

**Registered Mar. 11, 2008**

**TRADEMARK  
PRINCIPAL REGISTER**

**RAPID**

INFORMATIX, INC. (CALIFORNIA CORPORATION)  
101 MONTGOMERY ST. SUITE 2600  
SAN FRANCISCO, CA 94104

FOR: COMPUTER SOFTWARE FOR ELECTRONIC PAYMENT PROCESSING, NAMELY, PROCESSING CREDIT CARDS, DEBIT CARDS, ELECTRONICALLY-SCANNED CHECKS, ELECTRONIC FUNDS TRANSFERS AND ELECTRONIC BILL PAYMENTS, IN CLASS 9 (U.S. CLS. 21, 23, 26, 36 AND 38).

FIRST USE 8-2-2004; IN COMMERCE 8-2-2004.

THE MARK CONSISTS OF STANDARD CHARACTERS WITHOUT CLAIM TO ANY PARTICULAR FONT, STYLE, SIZE, OR COLOR.

SER. NO. 77-140,416, FILED 3-26-2007.

DAWN FELDMAN, EXAMINING ATTORNEY

Int. Cl.: 45

Prior U.S. Cls.: 100 and 101

United States Patent and Trademark Office

Reg. No. 3,394,252

Registered Mar. 11, 2008

**SERVICE MARK  
PRINCIPAL REGISTER**



REITH, DEBRA (UNITED STATES INDIVIDUAL)  
461 MCILVANE ROAD  
BENTLEYVILLE, PA 153141986

FOR: PREPARATION OF CUSTOMIZED GIFT BASKETS CONTAINING FOOD, BEVERAGES, PAPER PARTY DECORATIONS, STATIONERY, DISHWARE, DRINKING UTENSILS, CANDLES AND DECORATIVE CONTAINERS WITH SELECTED THEMES REGARDING A PARTICULAR OCCASION OR THEME, IN CLASS 45 (U.S. CLS. 100 AND 101).

FIRST USE 7-12-2006; IN COMMERCE 12-15-2006.

NO CLAIM IS MADE TO THE EXCLUSIVE RIGHT TO USE "SURPRISE PARTY BOX", APART FROM THE MARK AS SHOWN.

THE MARK CONSISTS OF STYLIZED WORDS "THE SURPRISE PARTY BOX" WITHIN A STYLIZED GIFT BOX CONTAINING A BOW ON TOP.

SER. NO. 77-141,578, FILED 3-27-2007.

ELLEN B. AWRICH, EXAMINING ATTORNEY

**Int. Cl.: 35**

**Prior U.S. Cls.: 100, 101 and 102**

**United States Patent and Trademark Office**

**Reg. No. 3,394,253**

**Registered Mar. 11, 2008**

**SERVICE MARK  
PRINCIPAL REGISTER**

# Octopus Open

DEUTSCHE TELEKOM AG (FED REP GERMA-  
NY CORPORATION)  
FRIEDRICH-EBERT-ALLEE 140  
BONN, FED REP GERMANY 53113

FOR: TELEPHONE DIRECTORY ASSISTANCE SERVICES; ADVERTISING SERVICES, NAMELY, PREPARING AND PLACING ADVERTISEMENTS FOR OTHERS PROMOTING THE GOODS AND SERVICES OF OTHERS THROUGH PRINTED ADVERTISING, PRINTED DIRECTORIES, THROUGH ENCODED MEDIA, THROUGH THE DISSEMINATION OF PROMOTIONAL MATERIALS, THROUGH DIRECT MAIL ADVERTISING, THROUGH ELECTRONIC BILLBOARD ADVERTISING, PREPARING AUDIO-VISUAL PRESENTATIONS FOR USE IN ADVERTISING; BUSINESS MANAGEMENT SERVICES, NAMELY, BUSINESS APPRAISALS, BUSINESS AUDITING, PROVIDING BUSINESS INFORMATION, NAMELY, PREPARING BUSINESS REPORTS AND CONDUCTING BUSINESS RESEARCH, ANALYSIS AND SURVEYS, BUSINESS MANAGEMENT PLANNING, BUSINESS MANAGEMENT CONSULTATION, BUSINESS MANAGEMENT SUPERVISION, CONDUCTING

BUSINESS NETWORKING FOR OTHERS; BUSINESS MANAGEMENT AND CONSULTING SERVICES, EXCLUDING AGRICULTURAL BUSINESS MANAGEMENT AND CONSULTING SERVICES; PROVIDING INFORMATION VIA THE TELEPHONE AND THE GLOBAL COMMUNICATION NETWORKS IN THE FIELD OF ADVERTISING AND BUSINESS MARKETING; PROFESSIONAL CONSULTANCY IN THE FIELD OF DATA PROCESSING; RENTAL OF AUTOMATIC VENDING MACHINES; RENTAL OF DATA PROCESSING EQUIPMENT; ORGANIZING JOB FAIRS, IN CLASS 35 (U.S. CLS. 100, 101 AND 102).

THE MARK CONSISTS OF STANDARD CHARACTERS WITHOUT CLAIM TO ANY PARTICULAR FONT, STYLE, SIZE, OR COLOR.

OWNER OF FED REP GERMANY REG. NO. 30620822, DATED 2-9-2007, EXPIRES 4-30-2016.

SER. NO. 77-141,740, FILED 3-27-2007.

LINDA ORNDORFF, EXAMINING ATTORNEY

**Int. Cl.: 33**

**Prior U.S. Cls.: 47 and 49**

**United States Patent and Trademark Office**

**Reg. No. 3,394,254**

**Registered Mar. 11, 2008**

**TRADEMARK  
PRINCIPAL REGISTER**

**HobNob**

LES VINS GEORGES DUBOEUF (FRANCE SOCI-  
ETE ANONYME)  
ROMANECHÉ-THORINS  
LA CHAPELLE DE GUINCHAY, FRANCE 71570

FOR: WINES, IN CLASS 33 (U.S. CLS. 47 AND 49).

THE MARK CONSISTS OF STANDARD CHAR-  
ACTERS WITHOUT CLAIM TO ANY PARTICULAR  
FONT, STYLE, SIZE, OR COLOR.

PRIORITY CLAIMED UNDER SEC. 44(D) ON  
FRANCE APPLICATION NO. 073487505, FILED 3-  
12-2007, REG. NO. 073487505, DATED 3-12-2007, EX-  
PIRES 3-11-2017.

SER. NO. 77-142,564, FILED 3-28-2007.

GRETТА YAO, EXAMINING ATTORNEY

**Int. Cl.: 36**

**Prior U.S. Cls.: 100, 101 and 102**

**United States Patent and Trademark Office**

**Reg. No. 3,394,255**

**Registered Mar. 11, 2008**

**SERVICE MARK  
PRINCIPAL REGISTER**

**The Honest Mortgage Company**

CALIFORNIA OAK EQUITIES INC (CALIFORNIA CORPORATION)

12925 POMERADO ROAD, SUITE G

POWAY, CA 92064

FOR: MORTGAGE BROKERAGE, IN CLASS 36 (U.S. CLS. 100, 101 AND 102).

FIRST USE 3-27-2007; IN COMMERCE 3-27-2007.

THE MARK CONSISTS OF STANDARD CHARACTERS WITHOUT CLAIM TO ANY PARTICULAR FONT, STYLE, SIZE, OR COLOR.

NO CLAIM IS MADE TO THE EXCLUSIVE RIGHT TO USE "MORTGAGE COMPANY", APART FROM THE MARK AS SHOWN.

SER. NO. 77-143,157, FILED 3-28-2007.

BRIAN CALLAGHAN, EXAMINING ATTORNEY

**Int. Cl.: 41**

**Prior U.S. Cls.: 100, 101 and 107**

**United States Patent and Trademark Office**

**Reg. No. 3,394,256**

**Registered Mar. 11, 2008**

**SERVICE MARK  
PRINCIPAL REGISTER**

**Linguistic Lighthouse**

PRICE, BRYSON H. (UNITED STATES INDIVIDUAL)  
2510 SIR PERCIVAL LN.  
LEWISVILLE, TX 75056

FOR: LANGUAGE INTERPRETATION; LANGUAGE INTERPRETING; LANGUAGE SCHOOLS FEATURING SPANISH AND PORTUGUESE; LANGUAGE TRANSLATION; LANGUAGE INSTRUCTION, IN CLASS 41 (U.S. CLS. 100, 101 AND 107).

FIRST USE 2-15-2003; IN COMMERCE 3-7-2007.

THE MARK CONSISTS OF STANDARD CHARACTERS WITHOUT CLAIM TO ANY PARTICULAR FONT, STYLE, SIZE, OR COLOR.

NO CLAIM IS MADE TO THE EXCLUSIVE RIGHT TO USE "LINGUISTIC", APART FROM THE MARK AS SHOWN.

SER. NO. 77-143,612, FILED 3-29-2007.

BRIAN CALLAGHAN, EXAMINING ATTORNEY



**Int. Cls.: 37 and 40**

**Prior U.S. Cls.: 100, 103 and 106**

**United States Patent and Trademark Office**

**Reg. No. 3,394,257**

**Registered Mar. 11, 2008**

**SERVICE MARK  
PRINCIPAL REGISTER**

**THE POWER OF YELLOW**

PELLA CORPORATION (IOWA CORPORATION)  
102 MAIN STREET  
PELLA, IA 50219

FOR: INSTALLATION OF WINDOWS AND DOORS; COMMERCIAL BUILDING CONSTRUCTION SERVICES IN THE FIELD OF WINDOWS AND DOORS, IN CLASS 37 (U.S. CLS. 100, 103 AND 106).

FIRST USE 1-0-2006; IN COMMERCE 1-0-2006.

FOR: CUSTOM CONSTRUCTION OF WINDOWS AND DOORS, IN CLASS 40 (U.S. CLS. 100, 103 AND 106).

FIRST USE 1-0-2006; IN COMMERCE 1-0-2006.

THE MARK CONSISTS OF STANDARD CHARACTERS WITHOUT CLAIM TO ANY PARTICULAR FONT, STYLE, SIZE, OR COLOR.

SER. NO. 77-143,854, FILED 3-29-2007.

AISHA SALEM, EXAMINING ATTORNEY

**Int. Cl.: 41**

**Prior U.S. Cls.: 100, 101 and 107**

**United States Patent and Trademark Office**

**Reg. No. 3,394,258**

**Registered Mar. 11, 2008**

**SERVICE MARK  
PRINCIPAL REGISTER**

**WIESNERMEDIA**

WIESNERMEDIA, LLC (COLORADO LTD LIAB  
CO)  
SUITE 200  
7009 SOUTH POTOMAC STREET  
CENTENNIAL, CO 80112

FOR: PUBLICATION OF MAGAZINES, NEWS-  
LETTERS, DIRECTORIES, ARTICLES, COLUMNS,  
REPORTS, AND ARTICLES IN PRINT AND ON-  
LINE AND IN OTHER MULTIMEDIA FORMS , IN  
CLASS 41 (U.S. CLS. 100, 101 AND 107).

FIRST USE 3-30-2007; IN COMMERCE 3-30-2007.

THE MARK CONSISTS OF STANDARD CHAR-  
ACTERS WITHOUT CLAIM TO ANY PARTICULAR  
FONT, STYLE, SIZE, OR COLOR.

OWNER OF U.S. REG. NOS. 2,906,237 AND  
3,231,556.

SER. NO. 77-144,670, FILED 3-30-2007.

JOHN DALIER, EXAMINING ATTORNEY

**Int. Cl.: 19**

**Prior U.S. Cls.: 1, 12, 33 and 50**

**United States Patent and Trademark Office**

**Reg. No. 3,394,259**

**Registered Mar. 11, 2008**

**TRADEMARK  
PRINCIPAL REGISTER**

**DAVINCI ROOFSCAPES**

DAVINCI ROOFSCAPES, L.L.C. (KANSAS LTD  
LIAB CO)  
1413 OSAGE AVENUE  
KANSAS CITY, KS 66105

THE MARK CONSISTS OF STANDARD CHAR-  
ACTERS WITHOUT CLAIM TO ANY PARTICULAR  
FONT, STYLE, SIZE, OR COLOR.

FOR: SYNTHETIC NON-METAL ROOFING  
TILES, SHINGLES AND PANELS, IN CLASS 19  
(U.S. CLS. 1, 12, 33 AND 50).

SER. NO. 77-144,718, FILED 3-30-2007.

FIRST USE 8-13-2002; IN COMMERCE 8-13-2002.

ROBERT LAVACHE, EXAMINING ATTORNEY

**Int. Cl.: 1**

**Prior U.S. Cls.: 1, 5, 6, 10, 26 and 46**

**Reg. No. 3,394,260**

**United States Patent and Trademark Office**

**Registered Mar. 11, 2008**

---

**TRADEMARK  
PRINCIPAL REGISTER**

**EZSTART**

HYDROPOOL INDUSTRIES INC. (CANADA  
CORPORATION)  
40 KING STREET WEST  
SUITE 2700  
TORONTO, ONTARIO M5H 3Y2

FOR: CHEMICALS, NAMELY, WATER TREAT-  
MENT, SOFTENING, AND PURIFYING PRODUCTS  
FOR SWIMMING POOLS AND SPAS, IN CLASS 1  
(U.S. CLS. 1, 5, 6, 10, 26 AND 46).

FIRST USE 1-1-2007; IN COMMERCE 1-1-2007.

THE MARK CONSISTS OF STANDARD CHAR-  
ACTERS WITHOUT CLAIM TO ANY PARTICULAR  
FONT, STYLE, SIZE, OR COLOR.

SER. NO. 77-144,724, FILED 3-30-2007.

TINA KUAN, EXAMINING ATTORNEY

**Int. Cl.: 1**

**Prior U.S. Cls.: 1, 5, 6, 10, 26 and 46**

**Reg. No. 3,394,261**

**United States Patent and Trademark Office**

**Registered Mar. 11, 2008**

---

**TRADEMARK  
PRINCIPAL REGISTER**

**EZBOOST**

HYDROPOOL INDUSTRIES INC. (CANADA  
CORPORATION)  
40 KING STREET WEST  
SUITE 2700  
TORONTO, ONTARIO M5H 3Y2

FOR: CHEMICALS, NAMELY, WATER TREAT-  
MENT, SOFTENING, AND PURIFYING PRODUCTS  
FOR SWIMMING POOLS AND SPAS, IN CLASS 1  
(U.S. CLS. 1, 5, 6, 10, 26 AND 46).

FIRST USE 1-1-2007; IN COMMERCE 1-1-2007.

THE MARK CONSISTS OF STANDARD CHAR-  
ACTERS WITHOUT CLAIM TO ANY PARTICULAR  
FONT, STYLE, SIZE, OR COLOR.

SER. NO. 77-144,734, FILED 3-30-2007.

TINA KUAN, EXAMINING ATTORNEY

**Int. Cl.: 1**

**Prior U.S. Cls.: 1, 5, 6, 10, 26 and 46**

**Reg. No. 3,394,262**

**United States Patent and Trademark Office**

**Registered Mar. 11, 2008**

---

**TRADEMARK  
PRINCIPAL REGISTER**

**EZBANK**

HYDROPOOL INDUSTRIES INC. (CANADA  
CORPORATION)  
40 KING STREET WEST  
SUITE 2700  
TORONTO, ONTARIO M5H 3Y2

FOR: CHEMICALS, NAMELY, WATER TREAT-  
MENT, SOFTENING, AND PURIFYING PRODUCTS  
FOR SWIMMING POOLS AND SPAS, IN CLASS 1  
(U.S. CLS. 1, 5, 6, 10, 26 AND 46).

FIRST USE 1-1-2007; IN COMMERCE 1-1-2007.

THE MARK CONSISTS OF STANDARD CHAR-  
ACTERS WITHOUT CLAIM TO ANY PARTICULAR  
FONT, STYLE, SIZE, OR COLOR.

SER. NO. 77-144,743, FILED 3-30-2007.

TINA KUAN, EXAMINING ATTORNEY

**Int. Cl.: 37**

**Prior U.S. Cls.: 100, 103 and 106**

**United States Patent and Trademark Office**

**Reg. No. 3,394,263**

**Registered Mar. 11, 2008**

**SERVICE MARK  
PRINCIPAL REGISTER**

# Headlight Guys

ZULUAGA, ROBERT A. (UNITED STATES INDIVIDUAL)  
P.O. BOX 36565  
PHOENIX, AZ 85067

FOR: RESTORATION AND CLEANING OF PLASTIC VEHICLE COMPONENTS, IN CLASS 37 (U.S. CLS. 100, 103 AND 106).

FIRST USE 11-16-2004; IN COMMERCE 11-16-2004.

THE MARK CONSISTS OF STANDARD CHARACTERS WITHOUT CLAIM TO ANY PARTICULAR FONT, STYLE, SIZE, OR COLOR.

NO CLAIM IS MADE TO THE EXCLUSIVE RIGHT TO USE "HEADLIGHT", APART FROM THE MARK AS SHOWN.

SER. NO. 77-145,336, FILED 3-30-2007.

ELIZABETH KAJUBI, EXAMINING ATTORNEY

**Int. Cl.: 19**

**Prior U.S. Cls.: 1, 12, 33 and 50**

**United States Patent and Trademark Office**

**Reg. No. 3,394,264**

**Registered Mar. 11, 2008**

**TRADEMARK  
PRINCIPAL REGISTER**

**DIAMOND PIER**

GAGLIANO, RICHARD J. (UNITED STATES IN-  
DIVIDUAL)  
PIN FOUNDATIONS INC.  
8607 58TH AVE. NW  
GIG HARBOR, WA 983328419

FOR: PREFABRICATED CONCRETE COMPO-  
NENTS DESIGNED TO BE INTEGRATED WITH  
OR ATTACHED TO PIN PILES IN THE CONSTRUC-  
TION OF MINIMIZED-SITE-DISTURBANCE FOUN-  
DATIONS FOR BUILDINGS AND OTHER  
STRUCTURES, IN CLASS 19 (U.S. CLS. 1, 12, 33  
AND 50).

FIRST USE 3-8-1996; IN COMMERCE 3-8-1996.

THE MARK CONSISTS OF STANDARD CHAR-  
ACTERS WITHOUT CLAIM TO ANY PARTICULAR  
FONT, STYLE, SIZE, OR COLOR.

NO CLAIM IS MADE TO THE EXCLUSIVE  
RIGHT TO USE "PIER", APART FROM THE MARK  
AS SHOWN.

SEC. 2(F).

SER. NO. 77-147,290, FILED 4-3-2007.

JORDAN BAKER, EXAMINING ATTORNEY



**Int. Cl.: 35**

**Prior U.S. Cls.: 100, 101 and 102**

**United States Patent and Trademark Office**

**Reg. No. 3,394,265**

**Registered Mar. 11, 2008**

**SERVICE MARK  
PRINCIPAL REGISTER**

**PROFILELINK**

SENDSIDE NETWORKS, INC. (UTAH CORPORATION)  
SUITE 200  
495 EAST 4500 SOUTH  
SALT LAKE CITY, UT 84107

FOR: PROVIDING ONLINE BUSINESS NETWORKING SERVICE TO LINK, EXCHANGE AND AUTOMATICALLY UPDATE PROFILE AND CONTACT INFORMATION OVER A SECURE GLOBAL NETWORK , IN CLASS 35 (U.S. CLS. 100, 101 AND 102).

FIRST USE 3-19-2007; IN COMMERCE 3-19-2007.

THE MARK CONSISTS OF STANDARD CHARACTERS WITHOUT CLAIM TO ANY PARTICULAR FONT, STYLE, SIZE, OR COLOR.

SER. NO. 77-147,893, FILED 4-3-2007.

LESLEY LAMOTHE, EXAMINING ATTORNEY

**Int. Cls.: 6 and 24**

**Prior U.S. Cls.: 2, 12, 13, 14, 23, 25, 42 and 50**

**United States Patent and Trademark Office**

**Reg. No. 3,394,266**

**Registered Mar. 11, 2008**

**TRADEMARK  
PRINCIPAL REGISTER**

**ON THE RIGHT TRACK**

ON THE RIGHT TRACK SYSTEMS, INC. (NEW YORK CORPORATION)  
174 HUDSON STREET  
NEW YORK, NY 10013

FOR: MODULAR PRIVACY SYSTEM COMPRISED OF CEILING SUPPORTED TRACK MODULES, NAMELY, TRACKS MADE PREDOMINATELY OF METAL, WITH CONNECTION PIECES AND END CAPS MADE OF PLASTIC USED FOR HOLDING PRIVACY CURTAINS, IN CLASS 6 (U.S. CLS. 2, 12, 13, 14, 23, 25 AND 50).

FIRST USE 4-23-2007; IN COMMERCE 4-23-2007.

FOR: MODULAR PRIVACY SYSTEM COMPRISED OF PRIVACY CURTAINS SUPPORTED BY CEILING SUPPORTED TRACK MODULES USED IN CONNECTION WITH MEDICAL AND SHOWER FACILITIES, IN CLASS 24 (U.S. CLS. 42 AND 50).

FIRST USE 4-23-2007; IN COMMERCE 4-23-2007.

THE MARK CONSISTS OF STANDARD CHARACTERS WITHOUT CLAIM TO ANY PARTICULAR FONT, STYLE, SIZE, OR COLOR.

SER. NO. 77-148,530, FILED 4-4-2007.

WILLIAM ROSSMAN, EXAMINING ATTORNEY

**Int. Cl.: 29**

**Prior U.S. Cl.: 46**

**United States Patent and Trademark Office**

**Reg. No. 3,394,267**

**Registered Mar. 11, 2008**

**TRADEMARK  
PRINCIPAL REGISTER**

**BELLE FLEUR**

DAIRYFOOD USA, INC. (WISCONSIN COR-  
PORATION)  
2819 HWY F SOUTH  
PO BOX 7  
BLUE MOUNDS, WI 53517

FOR: CHEESE, IN CLASS 29 (U.S. CL. 46).

FIRST USE 6-16-1958; IN COMMERCE 6-16-1958.

THE MARK CONSISTS OF STANDARD CHAR-  
ACTERS WITHOUT CLAIM TO ANY PARTICULAR  
FONT, STYLE, SIZE, OR COLOR.

THE ENGLISH TRANSLATION OF BELLE  
FLEUR IS BEAUTIFUL FLOWER.

SER. NO. 77-149,112, FILED 4-5-2007.

LESLEY LAMOTHE, EXAMINING ATTORNEY

**Int. Cl.: 7**

**Prior U.S. Cls.: 13, 19, 21, 23, 31, 34 and 35**

**United States Patent and Trademark Office**

**Reg. No. 3,394,268**

**Registered Mar. 11, 2008**

**TRADEMARK  
PRINCIPAL REGISTER**

**REGEN**

VYCON, INC. (DELAWARE CORPORATION)  
12880 MOORE STREET  
CERRITOS, CA 90703

THE MARK CONSISTS OF STANDARD CHAR-  
ACTERS WITHOUT CLAIM TO ANY PARTICULAR  
FONT, STYLE, SIZE, OR COLOR.

FOR: FLYWHEEL ENERGY STORAGE SYSTEM  
COMPRISED PRIMARILY OF A FLYWHEEL AND  
MOTOR-GENERATOR, IN CLASS 7 (U.S. CLS. 13, 19,  
21, 23, 31, 34 AND 35).

SER. NO. 77-149,152, FILED 4-5-2007.

FIRST USE 4-4-2007; IN COMMERCE 4-4-2007.

RENEE SERVANCE, EXAMINING ATTORNEY

Int. Cl.: 35

Prior U.S. Cls.: 100, 101 and 102

United States Patent and Trademark Office

Reg. No. 3,394,269

Registered Mar. 11, 2008

SERVICE MARK  
PRINCIPAL REGISTER



ROOFERS COMPETE, LLC (DELAWARE LTD  
LIAB CO)  
437 WHITTENDON STREET  
TAUNTON, MA 02780

FOR: BUSINESS SERVICES, NAMELY, MATCH-  
ING CONSUMERS WITH POTENTIAL CONTRAC-  
TORS IN THE FIELD OF ROOFING AND ROOF  
CONTRACTING VIA A COMPUTER NETWORK, IN  
CLASS 35 (U.S. CLS. 100, 101 AND 102).

FIRST USE 2-8-2007; IN COMMERCE 2-8-2007.

NO CLAIM IS MADE TO THE EXCLUSIVE  
RIGHT TO USE "ROOFERS" AND ".COM", APART  
FROM THE MARK AS SHOWN.

THE COLOR(S) DARK BLUE, LIGHT BLUE, AND  
BLACK IS/ARE CLAIMED AS A FEATURE OF THE  
MARK.

THE LEFT SIDE OF THE HOUSE DESIGN, THE  
CHIMNEY DESIGN, AND THE WORD "ROOFERS"  
ARE DISPLAYED IN DARK BLUE. THE REMAIN-  
DER OF THE ROOF DESIGN, AND THE LAN-  
GUAGE "COMPETE" AND ".COM" ARE  
DISPLAYED IN LIGHT BLUE. THE PHRASE  
"WHEN ROOFERS COMPETE...YOU SAVE!" IS DIS-  
PLAYED IN BLACK.

SER. NO. 77-149,189, FILED 4-5-2007.

STEVEN R. FOSTER, EXAMINING ATTORNEY

**Int. Cl.: 35**

**Prior U.S. Cls.: 100, 101 and 102**

**United States Patent and Trademark Office**

**Reg. No. 3,394,270**

**Registered Mar. 11, 2008**

**SERVICE MARK  
PRINCIPAL REGISTER**



ALA CARTE ENTERTAINMENT, INC. (ILLINOIS CORPORATION)  
2330 N. HAMMOND DR., STE. G  
SCHAUMBURG, IL 60173

FOR: PROVIDING ACCOUNTING, ADVERTISING AND PROMOTIONAL SERVICES, AND GENERAL BUSINESS CONSULTING SERVICES TO RESTAURANTS, IN CLASS 35 (U.S. CLS. 100, 101 AND 102).

FIRST USE 11-11-1998; IN COMMERCE 11-11-1998.

OWNER OF U.S. REG. NOS. 2,064,374 AND 2,068,289.

SER. NO. 77-149,305, FILED 4-5-2007.

CAROLYN CATALDO, EXAMINING ATTORNEY

**Int. Cl.: 36**

**Prior U.S. Cls.: 100, 101 and 102**

**United States Patent and Trademark Office**

**Reg. No. 3,394,271**

**Registered Mar. 11, 2008**

**SERVICE MARK  
PRINCIPAL REGISTER**

**FOUNDED ON SERVICE**

HEMISPHERE NATIONAL BANK (FLORIDA NA-  
TIONAL BANKING ASSOCIATION)  
8600 N.W. 36 STREET, STE. 800  
MIAMI, FL 33166

THE MARK CONSISTS OF STANDARD CHAR-  
ACTERS WITHOUT CLAIM TO ANY PARTICULAR  
FONT, STYLE, SIZE, OR COLOR.

FOR: BANKING SERVICES, IN CLASS 36 (U.S.  
CLS. 100, 101 AND 102).

SER. NO. 77-149,656, FILED 4-5-2007.

FIRST USE 2-0-2007; IN COMMERCE 2-0-2007.

RICHARD A. STRASER, EXAMINING ATTORNEY

**Int. Cl.: 25**

**Prior U.S. Cls.: 22 and 39**

**United States Patent and Trademark Office**

**Reg. No. 3,394,272**

**Registered Mar. 11, 2008**

**TRADEMARK  
PRINCIPAL REGISTER**



BODO DESIGNS, LLC (ARIZONA LTD LIAB CO)  
SUITE 8-200  
2925 E. RIGGS ROAD  
CHANDLER, AZ 85249

THE MARK CONSISTS OF THE COLOR RED  
APPEARING IN THE CIRCLE WITH THE DEVIL'S  
HORN AND ON THE HALO ON TOP OF THE  
CIRCLE.

FOR: CLOTHING, NAMELY, SHIRTS, IN CLASS  
25 (U.S. CLS. 22 AND 39).

SER. NO. 77-150,152, FILED 4-5-2007.

FIRST USE 2-9-2007; IN COMMERCE 2-9-2007.

THE COLOR(S) RED IS/ARE CLAIMED AS A  
FEATURE OF THE MARK.

RAUL CORDOVA, EXAMINING ATTORNEY



**Int. Cl.: 9**

**Prior U.S. Cls.: 21, 23, 26, 36 and 38**

**Reg. No. 3,394,273**

**United States Patent and Trademark Office**

**Registered Mar. 11, 2008**

---

**TRADEMARK  
PRINCIPAL REGISTER**

# DRI Online

DEFENSE RESEARCH INSTITUTE, INC. (ILLINOIS CORPORATION)  
SUITE 300  
150 NORTH MICHIGAN AVENUE  
CHICAGO, IL 60601

FOR: ELECTRONIC PUBLICATIONS, NAMELY, ASSOCIATION PUBLICATIONS IN THE NATURE OF BOOKS, NEWSLETTERS, COMMITTEE NEWSLETTERS AND SEMINAR MATERIALS, SPECIFICALLY, BOOKS AND NEWSLETTERS, ALL FEATURING LEGAL MATERIALS OF INTEREST TO DEFENSE LAWYERS RECORDED ON COMPUTER MEDIA, IN CLASS 9 (U.S. CLS. 21, 23, 26, 36 AND 38).

FIRST USE 5-31-2005; IN COMMERCE 5-31-2005.

THE MARK CONSISTS OF STANDARD CHARACTERS WITHOUT CLAIM TO ANY PARTICULAR FONT, STYLE, SIZE, OR COLOR.

NO CLAIM IS MADE TO THE EXCLUSIVE RIGHT TO USE "ONLINE", APART FROM THE MARK AS SHOWN.

SER. NO. 77-150,393, FILED 4-6-2007.

DAVID COLLIER, EXAMINING ATTORNEY

**Int. Cl.: 41**

**Prior U.S. Cls.: 100, 101 and 107**

**United States Patent and Trademark Office**

**Reg. No. 3,394,274**

**Registered Mar. 11, 2008**

**SERVICE MARK  
PRINCIPAL REGISTER**

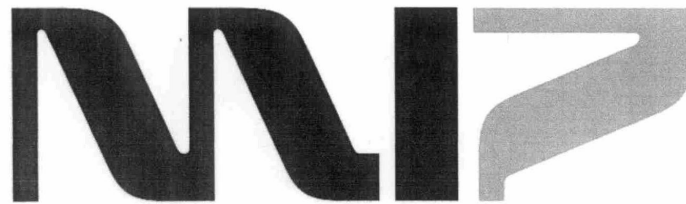

MI-SEVEN AKTIEBOLAG (SWEDEN CORPORATION)  
ADELGATAN 19  
MALMÖ, SWEDEN SE-21122

FIRST USE 1-1-2005; IN COMMERCE 1-1-2005.

THE MARK CONSISTS OF THE LETTERS MI7 IN  
STYLIZED FORMAT.

FOR: PROVIDING A WEBSITE FEATURING  
PRERECORDED DIGITAL MUSIC PERFORMANCES  
VIA A GLOBAL COMPUTER NETWORK, IN  
CLASS 41 (U.S. CLS. 100, 101 AND 107).

SER. NO. 77-150,845, FILED 4-6-2007.

DANNEAN HETZEL, EXAMINING ATTORNEY

**Int. Cl.: 29**

**Prior U.S. Cl.: 46**

**United States Patent and Trademark Office**

**Reg. No. 3,394,275**

**Registered Mar. 11, 2008**

**TRADEMARK  
PRINCIPAL REGISTER**

**KEETER'S**

KEETER'S MEAT COMPANY, L.L.C. (TEXAS  
LTD LIAB CO)  
901 S. HWY 87, P.O. BOX 41  
TULIA, TX 79088

FOR: JERKY; SAUSAGES, IN CLASS 29 (U.S. CL.  
46).

FIRST USE 9-0-1971; IN COMMERCE 9-0-1971.

THE MARK CONSISTS OF STANDARD CHAR-  
ACTERS WITHOUT CLAIM TO ANY PARTICULAR  
FONT, STYLE, SIZE, OR COLOR.

SEC. 2(F).

SER. NO. 77-151,525, FILED 4-9-2007.

MICHAEL GAAFAR, EXAMINING ATTORNEY

**Int. Cl.: 14**

**Prior U.S. Cls.: 2, 27, 28 and 50**

**United States Patent and Trademark Office**

**Reg. No. 3,394,276**

**Registered Mar. 11, 2008**

**TRADEMARK  
PRINCIPAL REGISTER**

**DORON ISAAK**

ISAAK, DORON (UNITED STATES INDIVIDUAL)  
9401 WILSHIRE BLVD, SUITE 501  
BEVERLY HILLS, CA 90212

THE MARK CONSISTS OF STANDARD CHARACTERS WITHOUT CLAIM TO ANY PARTICULAR FONT, STYLE, SIZE, OR COLOR.

FOR: JEWELRY, IN CLASS 14 (U.S. CLS. 2, 27, 28 AND 50).

SER. NO. 77-152,290, FILED 4-9-2007.

FIRST USE 6-1-2001; IN COMMERCE 6-1-2001.

JOHN E. MICHOS, EXAMINING ATTORNEY

**Int. Cl.: 43**

**Prior U.S. Cls.: 100 and 101**

**United States Patent and Trademark Office**

**Reg. No. 3,394,277**

**Registered Mar. 11, 2008**

**SERVICE MARK  
PRINCIPAL REGISTER**

**RAY'S THE BAR**

LANDRUM, MICHAEL (UNITED STATES INDIVIDUAL)  
8606 COLESVILLE ROAD  
SILVER SPRING, MD 20910

OWNER OF U.S. REG. NO. 3,049,407.

FOR: RESTAURANT AND BAR SERVICES, IN CLASS 43 (U.S. CLS. 100 AND 101).

THE NAME SHOWN IN THE MARK DOES NOT IDENTIFY A LIVING INDIVIDUAL.

FIRST USE 7-0-2004; IN COMMERCE 8-0-2006.

SER. NO. 77-152,434, FILED 4-9-2007.

THE MARK CONSISTS OF STANDARD CHARACTERS WITHOUT CLAIM TO ANY PARTICULAR FONT, STYLE, SIZE, OR COLOR.

JASON TURNER, EXAMINING ATTORNEY

**Int. Cl.: 7**

**Prior U.S. Cls.: 13, 19, 21, 23, 31, 34 and 35**

**United States Patent and Trademark Office**

**Reg. No. 3,394,278**

**Registered Mar. 11, 2008**

**TRADEMARK  
PRINCIPAL REGISTER**



THE RELIZON COMPANY (DELAWARE COR-  
PORATION)  
220 EAST MONUMENT STREET  
DAYTON, OH 45402

THE MARK CONSISTS OF 3 INCOMPLETE SHA-  
DED OVALS WITH PS MAILERS TO THE RIGHT OF  
THE CENTER INCOMPLETE OVAL.

FOR: PRESSURE SEAL FOLDING AND SEALING  
MACHINES FOR INDUSTRIAL PURPOSES, IN  
CLASS 7 (U.S. CLS. 13, 19, 21, 23, 31, 34 AND 35).

SER. NO. 77-152,551, FILED 4-10-2007.

FIRST USE 8-31-2005; IN COMMERCE 8-31-2005.

ANTHONY RINKER, EXAMINING ATTORNEY

**Int. Cls.: 18, 20 and 25**

**Prior U.S. Cls.: 1, 2, 3, 13, 22, 25, 32, 39, 41 and 50**

**United States Patent and Trademark Office**

**Reg. No. 3,394,279**

**Registered Mar. 11, 2008**

**TRADEMARK  
PRINCIPAL REGISTER**



LOEW-CORNELL, INC. (NEW JERSEY CORPORATION)

400 SYLVAN AVENUE

ENGLEWOOD CLIFFS, NJ 06532

FOR: BACKPACKS, DUFFLE BAGS, TOTE BAGS, WRIST MOUNTED PURSES, IN CLASS 18 (U.S. CLS. 1, 2, 3, 22 AND 41).

FIRST USE 5-31-2005; IN COMMERCE 5-31-2005.

FOR: CANVAS WALL ORGANIZERS, IN CLASS 20 (U.S. CLS. 2, 13, 22, 25, 32 AND 50).

FIRST USE 5-31-2005; IN COMMERCE 5-31-2005.

FOR: APRONS, IN CLASS 25 (U.S. CLS. 22 AND 39).

FIRST USE 5-31-2005; IN COMMERCE 5-31-2005.

SER. NO. 77-152,887, FILED 4-10-2007.

ELLEN BURNS, EXAMINING ATTORNEY

**Int. Cl.: 35**

**Prior U.S. Cls.: 100, 101 and 102**

**United States Patent and Trademark Office**

**Reg. No. 3,394,280**

**Registered Mar. 11, 2008**

**SERVICE MARK  
PRINCIPAL REGISTER**

**SUPPLIER REVIEW EXCHANGE**

THE CORPORATE EXECUTIVE BOARD COMPAN-  
NY (DELAWARE CORPORATION)  
SUITE 6000  
2000 PENNSYLVANIA AVENUE NW  
WASHINGTON, DC 20006

FOR: PROVIDING A SUBSCRIPTION-BASED,  
SEARCHABLE, ONLINE DATABASE OF VENDORS  
OF PRODUCTS AND SERVICES, WHICH DATA-  
BASE FEATURES PEER-GENERATED VENDOR  
RATINGS AND EVALUATIONS BASED ON PRO-  
JECT TYPE, GEOGRAPHIC SCOPE, AND INDUS-  
TRY, IN CLASS 35 (U.S. CLS. 100, 101 AND 102).

FIRST USE 3-15-2007; IN COMMERCE 3-15-2007.

THE MARK CONSISTS OF STANDARD CHAR-  
ACTERS WITHOUT CLAIM TO ANY PARTICULAR  
FONT, STYLE, SIZE, OR COLOR.

NO CLAIM IS MADE TO THE EXCLUSIVE  
RIGHT TO USE "SUPPLIER REVIEW", APART  
FROM THE MARK AS SHOWN.

SER. NO. 77-153,174, FILED 4-10-2007.

MICHAEL LITZAU, EXAMINING ATTORNEY



**Int. Cls.: 36, 37, 39 and 42**

**Prior U.S. Cls.: 100, 101, 102, 103, 105 and 106**

**United States Patent and Trademark Office**

**Reg. No. 3,394,281**

**Registered Mar. 11, 2008**

**SERVICE MARK  
PRINCIPAL REGISTER**

**APPROACH RESOURCES INC.**

APPROACH RESOURCES INC. (DELAWARE  
CORPORATION)  
SUITE 1107  
6300 RIDGLEA PLACE  
FORT WORTH, TX 76116

FOR: LAND ACQUISITION, NAMELY, THE AC-  
QUISITION OF OIL AND GAS PROPERTIES, IN  
CLASS 36 (U.S. CLS. 100, 101 AND 102).

FIRST USE 9-12-2002; IN COMMERCE 1-1-2003.

FOR: OIL AND GAS WELL DRILLING, IN CLASS  
37 (U.S. CLS. 100, 103 AND 106).

FIRST USE 9-12-2002; IN COMMERCE 1-1-2003.

FOR: THE TRANSMISSION OF OIL AND GAS  
THROUGH PIPELINES, IN CLASS 39 (U.S. CLS. 100  
AND 105).

FIRST USE 9-12-2002; IN COMMERCE 1-1-2003.

FOR: OIL AND GAS EXPLORATION SERVICES,  
IN CLASS 42 (U.S. CLS. 100 AND 101).

FIRST USE 9-12-2002; IN COMMERCE 1-1-2003.

THE MARK CONSISTS OF STANDARD CHAR-  
ACTERS WITHOUT CLAIM TO ANY PARTICULAR  
FONT, STYLE, SIZE, OR COLOR.

NO CLAIM IS MADE TO THE EXCLUSIVE  
RIGHT TO USE "RESOURCES INC.", APART FROM  
THE MARK AS SHOWN.

SER. NO. 77-153,483, FILED 4-10-2007.

GIANCARLO CASTRO, EXAMINING ATTORNEY

**Int. Cl.: 41**

**Prior U.S. Cls.: 100, 101 and 107**

**United States Patent and Trademark Office**

**Reg. No. 3,394,282**

**Registered Mar. 11, 2008**

**SERVICE MARK  
PRINCIPAL REGISTER**

**Revolution Lacrosse Camp**

PREMIER SPORTS CAMPS, INC. (OHIO CORPORATION)  
4885 SHACKELFORD CT.  
COLUMBUS, OH 43220

FOR: EDUCATION SERVICES, NAMELY, PROVIDING SPORTS CAMPS IN THE FIELD OF LACROSSE; EDUCATIONAL SERVICES, NAMELY, CONDUCTING PROGRAMS IN THE FIELD OF LACROSSE, IN CLASS 41 (U.S. CLS. 100, 101 AND 107).

FIRST USE 8-1-2006; IN COMMERCE 8-1-2006.

THE MARK CONSISTS OF STANDARD CHARACTERS WITHOUT CLAIM TO ANY PARTICULAR FONT, STYLE, SIZE, OR COLOR.

NO CLAIM IS MADE TO THE EXCLUSIVE RIGHT TO USE "LACROSSE CAMP", APART FROM THE MARK AS SHOWN.

SER. NO. 77-153,708, FILED 4-11-2007.

STEVEN R. FOSTER, EXAMINING ATTORNEY

**Int. Cl.: 36**

**Prior U.S. Cls.: 100, 101 and 102**

**United States Patent and Trademark Office**

**Reg. No. 3,394,283**

**Registered Mar. 11, 2008**

**SERVICE MARK  
PRINCIPAL REGISTER**

**First Midwest Securities,  
Inc.**

THE INVESTMENT COMPANY, INC. (WISCONSIN CORPORATION)  
207 W. JEFFERSON ST., SUITE 102  
BLOOMINGTON, IL 61701

FOR: FINANCIAL SERVICES, NAMELY ASSISTING OTHERS WITH THE COMPLETION OF FINANCIAL TRANSACTIONS FOR STOCKS, BONDS, SECURITIES AND EQUITIES , IN CLASS 36 (U.S. CLS. 100, 101 AND 102).

FIRST USE 3-2-1987; IN COMMERCE 3-2-1987.

THE MARK CONSISTS OF STANDARD CHARACTERS WITHOUT CLAIM TO ANY PARTICULAR FONT, STYLE, SIZE, OR COLOR.

OWNER OF U.S. REG. NO. 2,456,186.

NO CLAIM IS MADE TO THE EXCLUSIVE RIGHT TO USE "SECURITIES, INC.", APART FROM THE MARK AS SHOWN.

SER. NO. 77-153,892, FILED 4-11-2007.

TIMOTHY FINNEGAN, EXAMINING ATTORNEY

**Int. Cl.: 45**

**Prior U.S. Cls.: 100 and 101**

**United States Patent and Trademark Office**

**Reg. No. 3,394,284**

**Registered Mar. 11, 2008**

**SERVICE MARK  
PRINCIPAL REGISTER**



BAILEY LAW GROUP, P.C. (D.C. CORPORATION)  
1615 L STREET, NW, SUITE 1350  
WASHINGTON, DC 20036

FOR: LEGAL SERVICES, IN CLASS 45 (U.S. CLS. 100 AND 101).

FIRST USE 3-1-2006; IN COMMERCE 3-1-2006.

OWNER OF U.S. REG. NO. 3,063,141.

NO CLAIM IS MADE TO THE EXCLUSIVE RIGHT TO USE "LAW GROUP", APART FROM THE MARK AS SHOWN.

THE COLOR(S) BLUE AND BEIGE IS/ARE CLAIMED AS A FEATURE OF THE MARK.

THE MARK CONSISTS OF BLG BACKGROUND WATERMARK IN BEIGE, BAILEY LAW GROUP IN BLUE.

SER. NO. 77-154,823, FILED 4-12-2007.

ANTHONY RINKER, EXAMINING ATTORNEY

**Int. Cls.: 35 and 43**

**Prior U.S. Cls.: 100, 101 and 102**

**United States Patent and Trademark Office**

**Reg. No. 3,394,285**

**Registered Mar. 11, 2008**

**SERVICE MARK  
PRINCIPAL REGISTER**



TDHC, LLC (UTAH LTD LIAB CO)  
1526 WEST BLOOMINGTON DRIVE SOUTH  
ST. GEORGE, UT 84790

FOR: FOOD KIOSK SERVICES, IN CLASS 35 (U.S.  
CLS. 100, 101 AND 102).

FIRST USE 2-15-2007; IN COMMERCE 2-15-2007.

FOR: RESTAURANT SERVICES, IN CLASS 43  
(U.S. CLS. 100 AND 101).

FIRST USE 2-15-2007; IN COMMERCE 2-15-2007.

OWNER OF U.S. REG. NO. 3,147,495.

THE MARK CONSISTS OF A HUMAN HAND  
HOLDING AN ANIMATED HOT DOG WITH THE  
WORDS THE DOGFATHER.

SER. NO. 77-155,089, FILED 4-12-2007.

BRIAN PINO, EXAMINING ATTORNEY

**Int. Cl.: 41**

**Prior U.S. Cls.: 100, 101 and 107**

**United States Patent and Trademark Office**

**Reg. No. 3,394,286**

**Registered Mar. 11, 2008**

**SERVICE MARK  
PRINCIPAL REGISTER**

**NEA AWARDS**

NIGERIA IMAGE AWARDS (NIA) LLC (DELA-  
WARE LTD LIAB CO)  
PO 1307  
WILMINGTON, DE 198991307

FOR: ENTERTAINMENT IN THE NATURE OF  
LIVE PERFORMANCES BY NIGERIAN ARTISTS,  
IN CLASS 41 (U.S. CLS. 100, 101 AND 107).

FIRST USE 6-15-2006; IN COMMERCE 6-15-2006.

THE MARK CONSISTS OF STANDARD CHAR-  
ACTERS WITHOUT CLAIM TO ANY PARTICULAR  
FONT, STYLE, SIZE, OR COLOR.

NO CLAIM IS MADE TO THE EXCLUSIVE  
RIGHT TO USE "AWARDS", APART FROM THE  
MARK AS SHOWN.

SER. NO. 77-155,629, FILED 4-12-2007.

RONALD MCMORROW, EXAMINING ATTORNEY

**Int. Cl.: 9**

**Prior U.S. Cls.: 21, 23, 26, 36 and 38**

**United States Patent and Trademark Office**

**Reg. No. 3,394,287**

**Registered Mar. 11, 2008**

**TRADEMARK  
PRINCIPAL REGISTER**

**VIZIBRITE**

VIZIBRITE, INC. (NEW YORK CORPORATION)  
4 HOWARD STREET  
SELDEN, NY 11784

FOR: REFLECTIVE CLOTHING FOR SAFETY PURPOSES, NAMELY, SHIRTS, T-SHIRTS, WORKSHIRTS, SWEATSHIRTS, SWEATPANTS, HEADGEAR, NAMELY, SKULL CAPS AND FACE MASKS, AND OUTERWEAR, NAMELY, JACKETS, WIND RESISTANT JACKETS, VESTS, COATS, OVERCOATS, PARKAS, DENIM JACKETS AND

WIND SHIRTS, IN CLASS 9 (U.S. CLS. 21, 23, 26, 36 AND 38).

FIRST USE 7-22-2003; IN COMMERCE 1-27-2004.

THE MARK CONSISTS OF STANDARD CHARACTERS WITHOUT CLAIM TO ANY PARTICULAR FONT, STYLE, SIZE, OR COLOR.

SER. NO. 77-155,813, FILED 4-13-2007.

KIMBERLY PERRY, EXAMINING ATTORNEY

**Int. Cl.: 35**

**Prior U.S. Cls.: 100, 101 and 102**

**United States Patent and Trademark Office**

**Reg. No. 3,394,288**

**Registered Mar. 11, 2008**

**SERVICE MARK  
PRINCIPAL REGISTER**

# RateAustin

JONES, DANIEL (UNITED STATES INDIVIDUAL)  
7208 TRACE CHAIN DR.  
AUSTIN, TX 78749

FOR: PROVIDING A WEB SITE WHERE USERS CAN POST RATINGS, REVIEWS AND RECOMMENDATIONS ON PRODUCTS AND SERVICES, IN CLASS 35 (U.S. CLS. 100, 101 AND 102).

FIRST USE 9-10-2002; IN COMMERCE 9-10-2002.

THE MARK CONSISTS OF STANDARD CHARACTERS WITHOUT CLAIM TO ANY PARTICULAR FONT, STYLE, SIZE, OR COLOR.

SEC. 2(F).

SER. NO. 77-155,870, FILED 4-13-2007.

TASHIA BUNCH, EXAMINING ATTORNEY



**Int. Cl.: 9**

**Prior U.S. Cls.: 21, 23, 26, 36 and 38**

**United States Patent and Trademark Office**

**Reg. No. 3,394,289**

**Registered Mar. 11, 2008**

**TRADEMARK  
PRINCIPAL REGISTER**

**MAGIC ON HOLD**

AVAYA INC. (DELAWARE CORPORATION)  
211 MOUNT AIRY ROAD  
BASKING RIDGE, NJ 07920

FOR: AUDIO RECORDERS, STORAGE DRIVES,  
AND PLAYER DEVICES FOR PROVIDING BACK-  
GROUND MUSIC AND MESSAGES, IN CLASS 9  
(U.S. CLS. 21, 23, 26, 36 AND 38).

FIRST USE 9-25-2000; IN COMMERCE 9-25-2000.

THE MARK CONSISTS OF STANDARD CHAR-  
ACTERS WITHOUT CLAIM TO ANY PARTICULAR  
FONT, STYLE, SIZE, OR COLOR.

OWNER OF U.S. REG. NOS. 1,372,962 AND  
2,054,241.

SER. NO. 77-155,924, FILED 4-13-2007.

SANDRA MANIOS, EXAMINING ATTORNEY

**Int. Cl.: 18**

**Prior U.S. Cls.: 1, 2, 3, 22 and 41**

**United States Patent and Trademark Office**

**Reg. No. 3,394,290**

**Registered Mar. 11, 2008**

**TRADEMARK  
PRINCIPAL REGISTER**



**SHEDRAIN CORPORATION (OREGON CORPORATION)  
8303 NE KILLINGSWORTH  
PORTLAND, OR 97220**

**FIRST USE 2-15-2007; IN COMMERCE 2-15-2007.**

**SER. NO. 77-155,985, FILED 4-13-2007.**

**FOR: UMBRELLAS, IN CLASS 18 (U.S. CLS. 1, 2, 3,  
22 AND 41).**

**DANNEAN HETZEL, EXAMINING ATTORNEY**

**Int. Cl.: 41**

**Prior U.S. Cls.: 100, 101 and 107**

**United States Patent and Trademark Office**

**Reg. No. 3,394,291**

**Registered Mar. 11, 2008**

**SERVICE MARK  
PRINCIPAL REGISTER**

**Total Success in Real  
Estate**

BAKER, ALICE (UNITED STATES INDIVIDUAL)  
6235 MILBROOK RD  
BRENTWOOD, TN 37027

FOR: TRAINING SERVICES IN THE FIELD OF  
REAL ESTATE, IN CLASS 41 (U.S. CLS. 100, 101 AND  
107).

FIRST USE 11-16-2006; IN COMMERCE 11-16-2006.

THE MARK CONSISTS OF STANDARD CHAR-  
ACTERS WITHOUT CLAIM TO ANY PARTICULAR  
FONT, STYLE, SIZE, OR COLOR.

NO CLAIM IS MADE TO THE EXCLUSIVE  
RIGHT TO USE "REAL ESTATE", APART FROM  
THE MARK AS SHOWN.

SER. NO. 77-156,032, FILED 4-13-2007.

LAURIE MAYES, EXAMINING ATTORNEY

**Int. Cl.: 35**

**Prior U.S. Cls.: 100, 101 and 102**

**United States Patent and Trademark Office**

**Reg. No. 3,394,292**

**Registered Mar. 11, 2008**

---

**SERVICE MARK  
PRINCIPAL REGISTER**

# Heinsight

HEINSIGHT, INC. (NEBRASKA CORPORATION)  
2435 STOCKWELL STREET  
LINCOLN, NE 68502

THE MARK CONSISTS OF STANDARD CHAR-  
ACTERS WITHOUT CLAIM TO ANY PARTICULAR  
FONT, STYLE, SIZE, OR COLOR.

FOR: EXECUTIVE SEARCH AND PLACEMENT  
SERVICES; BUSINESS CONSULTING AND INFOR-  
MATION SERVICES, IN CLASS 35 (U.S. CLS. 100, 101  
AND 102).

SER. NO. 77-156,332, FILED 4-13-2007.

FIRST USE 5-10-2006; IN COMMERCE 5-10-2006.

PAUL MORENO, EXAMINING ATTORNEY

Int. Cl.: 36

Prior U.S. Cls.: 100, 101 and 102

United States Patent and Trademark Office

Reg. No. 3,394,293

Registered Mar. 11, 2008

**SERVICE MARK  
PRINCIPAL REGISTER**



MARINA STAR ESTATES INC. (NEW YORK CORPORATION)  
485 PELHAMDALE AVENUE  
PELHAM, NY 10803

FOR: REAL ESTATE BROKERAGE, IN CLASS 36  
(U.S. CLS. 100, 101 AND 102).

FIRST USE 4-12-2007; IN COMMERCE 4-12-2007.

NO CLAIM IS MADE TO THE EXCLUSIVE RIGHT TO USE "ESTATES", APART FROM THE MARK AS SHOWN.

THE COLOR(S) BLACK, GRAY, RED, LIGHT YELLOW, LIGHT GRAY IS/ARE CLAIMED AS A FEATURE OF THE MARK.

THE MARK CONSISTS OF A GRAY PIECE OF BROKEN WOOD WITH A WOOD GRAIN EFFECT. THE PIECE OF WOODS HAS A BLACK BORDER WITH A BLACK SHADOW BEHIND IT. A RED STARFISH IS IN THE CENTER OF LOGO WITH A BLACK OUTLINE; INSIDE OF THE STARFISH IS A BLACK OUTLINE OF THE INSIDES OF THE STARFISH. THE TOP CENTER OF THE LOGO HAS A LIGHT GRAY SHADOW OF A NAIL. THE LETTERING "MARINA STAR ESTATES" IS LIGHT YELLOW WITH MARINA STAR ABOVE THE STARFISH AND ESTATES BELOW THE STARFISH.

SER. NO. 77-156,905, FILED 4-14-2007.

TASHIA BUNCH, EXAMINING ATTORNEY

**Int. Cl.: 9**

**Prior U.S. Cls.: 21, 23, 26, 36 and 38**

**Reg. No. 3,394,294**

**United States Patent and Trademark Office**

**Registered Mar. 11, 2008**

---

**TRADEMARK  
PRINCIPAL REGISTER**



VOICECOW, INC. (NEW JERSEY CORPORATION)  
16 SOUTH JEFFERSON ROAD  
WHIPPANY, NJ 07981

WORK INFRASTRUCTURES AND COMMUNICATIONS PROTOCOLS, IN CLASS 9 (U.S. CLS. 21, 23, 26, 36 AND 38).

FOR: COMPUTER HARDWARE FOR TELECOMMUNICATIONS; TELECOMMUNICATIONS AND DATA NETWORKING HARDWARE, NAMELY, DEVICES FOR TRANSPORTING AND AGGREGATING VOICE, DATA, AND VIDEO COMMUNICATIONS ACROSS MULTIPLE NET-

FIRST USE 11-22-2006; IN COMMERCE 11-22-2006.

SER. NO. 77-157,394, FILED 4-16-2007.

MICHAEL WEBSTER, EXAMINING ATTORNEY

**Int. Cl.: 39**

**Prior U.S. Cls.: 100 and 105**

**United States Patent and Trademark Office**

**Reg. No. 3,394,295**

**Registered Mar. 11, 2008**

**SERVICE MARK  
PRINCIPAL REGISTER**

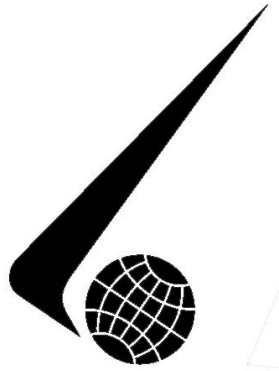

WORLD AIRWAYS, INC. (GEORGIA CORPORATION)  
101 WORLD DRIVE  
PEACHTREE CITY, GA 30269

FOR: AIR TRANSPORTATION OF PASSENGERS  
AND FREIGHT, IN CLASS 39 (U.S. CLS. 100 AND  
105).

FIRST USE 3-29-1948; IN COMMERCE 3-29-1948.

OWNER OF U.S. REG. NOS. 1,321,285, 1,321,286,  
AND 2,228,546.

THE MARK CONSISTS OF A GLOBE DESIGN.

SER. NO. 77-157,718, FILED 4-16-2007.

SCOTT SISUN, EXAMINING ATTORNEY

**Int. Cl.: 30**

**Prior U.S. Cl.: 46**

**United States Patent and Trademark Office**

**Reg. No. 3,394,296**

**Registered Mar. 11, 2008**

**TRADEMARK  
PRINCIPAL REGISTER**

**CA PHE CAO NGUYEN**

PREMIUM FOOD IMPORTS, INC. (CALIFORNIA  
CORPORATION)  
44875 INDUSTRIAL DR. #J  
FREMONT, CA 94538

FOR: COFFEE, IN CLASS 30 (U.S. CL. 46).

FIRST USE 4-30-1988; IN COMMERCE 4-30-1988.

THE MARK CONSISTS OF STANDARD CHAR-  
ACTERS WITHOUT CLAIM TO ANY PARTICULAR  
FONT, STYLE, SIZE, OR COLOR.

NO CLAIM IS MADE TO THE EXCLUSIVE  
RIGHT TO USE "CA PHE", APART FROM THE  
MARK AS SHOWN.

THE FOREIGN WORDING IN THE MARK  
TRANSLATES INTO ENGLISH AS HIGHLAND  
COFFEE.

SER. NO. 77-158,095, FILED 4-17-2007.

ARETHA SOMERVILLE, EXAMINING ATTORNEY



**Int. Cls.: 35 and 38**

**Prior U.S. Cls.: 100, 101, 102 and 104**

**United States Patent and Trademark Office**

**Reg. No. 3,394,297**

**Registered Mar. 11, 2008**

**SERVICE MARK  
PRINCIPAL REGISTER**

# NIENSENPEDIA

CZT/ACN TRADEMARKS, L.L.C. (DELAWARE  
LTD LIAB CO)  
150 NORTH MARTINGALE ROAD  
SCHAUMBURG, IL 601732076

FOR: PROVIDING A WEB SITE WHERE USERS  
CAN POST, SEARCH, AND LINK INFORMATION  
REGARDING MARKET RESEARCH AND MEDIA  
RESEARCH PRODUCTS, SERVICES AND INFOR-  
MATION, LINKS BETWEEN SAID INFORMATION,  
AND REPORTS RELATING THERETO, IN CLASS 35  
(U.S. CLS. 100, 101 AND 102).

FIRST USE 3-7-2007; IN COMMERCE 3-7-2007.

FOR: PROVIDING ONLINE COMMUNITIES FOR  
TRANSMISSION AND POSTING OF MESSAGES

AMONG COMPUTER USERS WHICH ALLOWS  
FOR DEVELOPMENT OF COLLABORATION AND  
WIKI SITES RELATED TO MARKET AND MEDIA  
RESEARCH SERVICES AND PRODUCTS, IN CLASS  
38 (U.S. CLS. 100, 101 AND 104).

FIRST USE 3-7-2007; IN COMMERCE 3-7-2007.

THE MARK CONSISTS OF STANDARD CHAR-  
ACTERS WITHOUT CLAIM TO ANY PARTICULAR  
FONT, STYLE, SIZE, OR COLOR.

SER. NO. 77-158,327, FILED 4-17-2007.

PAM WILLIS, EXAMINING ATTORNEY

**Int. Cl.: 41**

**Prior U.S. Cls.: 100, 101 and 107**

**United States Patent and Trademark Office**

**Reg. No. 3,394,298**

**Registered Mar. 11, 2008**

**SERVICE MARK  
PRINCIPAL REGISTER**

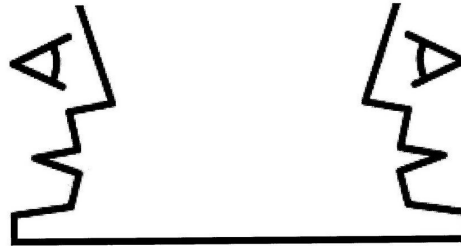

THE MULVANEY GROUP, INC. (MINNESOTA CORPORATION)  
EMPIRE STATE BUILDING  
350 FIFTH AVENUE - SUITE 3304  
NEW YORK, NY 10118

FIRST USE 4-30-2006; IN COMMERCE 4-30-2006.

THE MARK CONSISTS OF SINGLE LINE FACING PROFILES CONNECTED BY A LINE.

FOR: EDUCATIONAL; SEMINARS CONCERNING HUMAN RESOURCES AND EMPLOYEE RELATION ISSUES, IN CLASS 41 (U.S. CLS. 100, 101 AND 107).

SER. NO. 77-158,450, FILED 4-17-2007.

RENEE SERVANCE, EXAMINING ATTORNEY

**Int. Cls.: 9 and 42**

**Prior U.S. Cls.: 21, 23, 26, 36, 38, 100 and 101**

**United States Patent and Trademark Office**

**Reg. No. 3,394,299**

**Registered Mar. 11, 2008**

**TRADEMARK  
SERVICE MARK  
PRINCIPAL REGISTER**

**acrolinx**

ACROLINX GMBH (FED REP GERMANY LTD  
LIAB CO)  
4TH FLOOR  
ROSENSTRASSE 2  
BERLIN, FED REP GERMANY 10115

FOR: DOWNLOADABLE COMPUTER SOFTWARE FOR LINGUISTIC ANALYSIS, IN CLASS 9 (U.S. CLS. 21, 23, 26, 36 AND 38).

FIRST USE 0-0-2003; IN COMMERCE 0-0-2003.

FOR: CUSTOM DESIGN OF COMPUTER SOFTWARE FOR LINGUISTIC ANALYSIS FOR OTHERS AND FOR LINGUISTIC ANALYSIS REPORTING FOR OTHERS, IN CLASS 42 (U.S. CLS. 100 AND 101).

FIRST USE 0-0-2003; IN COMMERCE 0-0-2003.

THE MARK CONSISTS OF STANDARD CHARACTERS WITHOUT CLAIM TO ANY PARTICULAR FONT, STYLE, SIZE, OR COLOR.

THE WORD "ACROLINX" HAS NO MEANING IN A FOREIGN LANGUAGE.

SER. NO. 77-159,227, FILED 4-18-2007.

SIMON TENG, EXAMINING ATTORNEY

**Int. Cl.: 35**

**Prior U.S. Cls.: 100, 101 and 102**

**United States Patent and Trademark Office**

**Reg. No. 3,394,300**

**Registered Mar. 11, 2008**

**SERVICE MARK  
PRINCIPAL REGISTER**

**TRAININGPROS**

TRAININGPROS, INC. (GEORGIA CORPORATION)  
3571 HABERSHAM ROAD NW  
ATLANTA, GA 30305

THE MARK CONSISTS OF STANDARD CHARACTERS WITHOUT CLAIM TO ANY PARTICULAR FONT, STYLE, SIZE, OR COLOR.

FOR: BUSINESS CONSULTATION SERVICES IN THE FIELD OF HUMAN PERFORMANCE AND ASSESSMENT CAPABILITIES AND STAFFING, IN CLASS 35 (U.S. CLS. 100, 101 AND 102).

SER. NO. 77-159,579, FILED 4-18-2007.

FIRST USE 1-1-2001; IN COMMERCE 1-1-2001.

STEPHEN AQUILA, EXAMINING ATTORNEY

**Int. Cls.: 35, 38, 41 and 42**

**Prior U.S. Cls.: 100, 101, 102, 104 and 107**

**United States Patent and Trademark Office**

**Reg. No. 3,394,301**

**Registered Mar. 11, 2008**

**SERVICE MARK  
PRINCIPAL REGISTER**

**KENTUCKY.COM**

MCCLATCHY U.S.A., INC. (DELAWARE CORPORATION)  
2100 Q STREET  
SACRAMENTO, CA 95816

FOR: PROMOTING THE GOODS, SERVICES, AND WEBSITES OF OTHERS BY PLACING ADVERTISEMENTS AND PROMOTIONAL DISPLAYS IN AN ELECTRONIC SITE ACCESSED THROUGH COMPUTER NETWORKS; ONLINE RETAIL AND MAIL ORDER SERVICES IN THE FIELD OF GENERAL CONSUMER MERCHANDISE; ONLINE DIRECTORY SERVICES TO HELP LOCATE PEOPLE, PLACES, ORGANIZATIONS, PHONE NUMBERS, HOME PAGES AND ELECTRONIC MAIL ADDRESSES, IN CLASS 35 (U.S. CLS. 100, 101 AND 102).

FIRST USE 10-31-1999; IN COMMERCE 10-31-1999.

FOR: COMMUNICATIONS AND TELECOMMUNICATIONS SERVICES, NAMELY, ELECTRONIC MAIL SERVICES; PROVIDING MULTIPLE-USER ACCESS TO THE INTERNET; ELECTRONIC TRANSMISSION OF DATA, IMAGES, AND DOCUMENTS VIA COMPUTER TERMINALS AND NETWORKS; PROVIDING AN ON-LINE CHAT ROOM FOR THE TRANSMISSION OF MESSAGES AMONG COMPUTER USERS CONCERNING TOPICS OF GENERAL INTEREST, IN CLASS 38 (U.S. CLS. 100, 101 AND 104).

FIRST USE 10-31-1999; IN COMMERCE 10-31-1999.

FOR: PUBLICATION OF ELECTRONIC NEWSPAPERS ACCESSIBLE VIA A GLOBAL COMPUTER NETWORK, IN CLASS 41 (U.S. CLS. 100, 101 AND 107).

FIRST USE 10-31-1999; IN COMMERCE 10-31-1999.

FOR: ONLINE COMPUTER SERVICES, NAMELY, CREATING INDEXES OF INFORMATION, SITES, AND OTHER RESOURCES AVAILABLE ON COMPUTER NETWORKS; PROVIDING INFORMATION AT THE SPECIFIC REQUEST OF END-USERS BY MEANS OF GLOBAL COMPUTER NETWORKS; PROVIDING GENERAL AND CUSTOMIZED INFORMATION AT THE SPECIFIC REQUEST OF OTHERS IN A WIDE VARIETY OF FIELDS INCLUDING INFORMATION IN THE FIELDS OF NEWS, POLITICS, POLICY, SPORTS, BUSINESS, TECHNOLOGY, ENTERTAINMENT, ARTS, LEISURE, AND TRAVEL; COMPUTER SERVICES, NAMELY, DESIGNING, CREATING AND MAINTAINING WEBSITES FOR OTHERS; HOSTING THE WEB SITES OF OTHERS ON A COMPUTER SERVER FOR A GLOBAL COMPUTER NETWORK; TECHNICAL CONSULTATION SERVICES IN THE FIELD OF ONLINE WEBSITES; AND TECHNICAL SUPPORT SERVICES, NAMELY, TROUBLESHOOTING OF COMPUTER HARDWARE AND SOFTWARE PROBLEMS RELATING TO ONLINE COMMERCE WEBSITES, IN CLASS 42 (U.S. CLS. 100 AND 101).

FIRST USE 10-31-1999; IN COMMERCE 10-31-1999.

THE MARK CONSISTS OF STANDARD CHARACTERS WITHOUT CLAIM TO ANY PARTICULAR FONT, STYLE, SIZE, OR COLOR.

OWNER OF U.S. REG. NO. 2,720,175.

SEC. 2(F).

SER. NO. 77-161,084, FILED 4-19-2007.

DANIEL CAPSHAW, EXAMINING ATTORNEY

**Int. Cls.: 19 and 35**

**Prior U.S. Cls.: 1, 12, 33, 50, 100, 101 and 102**

**United States Patent and Trademark Office**

**Reg. No. 3,394,302**

**Registered Mar. 11, 2008**

**TRADEMARK  
SERVICE MARK  
PRINCIPAL REGISTER**

**THE DIFFERENCE IS CLEAR!**

SUNRISE WINDOWS, LTD (OHIO LTD LIAB CO)  
200 ENTERPRISE DRIVE  
TEMPERANCE, MI 481829500

FOR: NON-METAL SLIDING DOORS; VINYL  
WINDOWS, IN CLASS 19 (U.S. CLS. 1, 12, 33 AND 50).

FIRST USE 9-30-2000; IN COMMERCE 9-30-2000.

FOR: DISTRIBUTORSHIPS IN THE FIELD OF  
VINYL WINDOWS AND NON-METAL SLIDING  
DOORS, IN CLASS 35 (U.S. CLS. 100, 101 AND 102).

FIRST USE 6-30-1999; IN COMMERCE 6-30-1999.

THE MARK CONSISTS OF STANDARD CHAR-  
ACTERS WITHOUT CLAIM TO ANY PARTICULAR  
FONT, STYLE, SIZE, OR COLOR.

SER. NO. 77-161,995, FILED 4-20-2007.

DAVID H. STINE, EXAMINING ATTORNEY

**Int. Cl.: 16**

**Prior U.S. Cls.: 2, 5, 22, 23, 29, 37, 38 and 50**

**United States Patent and Trademark Office**

**Reg. No. 3,394,303**

**Registered Mar. 11, 2008**

**TRADEMARK  
PRINCIPAL REGISTER**



DEPARTMENT OF DEFENSE (UNITED STATES  
AGENCY OF THE UNITED STATES GOVERN-  
MENT)

TRICARE MGT ACTIVITY  
5111 LEESBURG PIKE, STE. 810  
FALLS CHURCH, VA 22041

FOR: COASTERS MADE OF PAPER; DECALS;  
POSTERS; STICKERS; TEMPORARY TATTOOS, IN  
CLASS 16 (U.S. CLS. 2, 5, 22, 23, 29, 37, 38 AND 50).

FIRST USE 12-1-2006; IN COMMERCE 12-1-2006.

THE MARK CONSISTS OF THE UNIVERSAL "DO  
NOT ENTER" SYMBOL FORMED FROM A CIRCLE

WITH A STRAIGHT LINE DRAWN AT AN ANGLE  
FROM OF TOP OF THE CIRCLE TO THE BOTTOM.  
THE STACKED WORDS THAT GUY ARE PRINTED  
IN BLOCK CAPITAL LETTER IN FRONT OF THE  
CIRCLE COVERING THE RIGHT AND LEFT SIDES  
OF THE CIRCLE, BUT BEHIND THE LINE GOING  
THROUGH THE CIRCLE. THE CIRCLE AND LINE  
ALL CONTAIN SMALL ROUND LIGHT COLORED  
CIRCLES SIMULATING LIGHTS.

SER. NO. 77-162,494, FILED 4-21-2007.

ALICIA COLLINS, EXAMINING ATTORNEY

**Int. Cl.: 35**

**Prior U.S. Cls.: 100, 101 and 102**

**United States Patent and Trademark Office**

**Reg. No. 3,394,304**

**Registered Mar. 11, 2008**

**SERVICE MARK  
PRINCIPAL REGISTER**

**RESCUING RECESS**

THE CARTOON NETWORK, INC. (DELAWARE CORPORATION)  
C/O TURNER BROADCASTING SYSTEM, INC.  
ONE CNN CENTER, 13 NORTH  
ATLANTA, GA 30303

FOR: PROVIDING INFORMATION AND NEWS PROMOTING THE PUBLIC AWARENESS OF THE PHYSICAL, SOCIAL AND EMOTIONAL BENEFITS OF PHYSICAL EDUCATION AND PHYSICAL ACTIVITY; PROVIDING A CONTINUING SERIES OF PUBLIC SERVICE CAMPAIGNS PROMOTING PUBLIC AWARENESS OF THE PHYSICAL, SOCIAL AND EMOTIONAL BENEFITS OF PHYSICAL EDUCATION AND PHYSICAL ACTIVITY VIA ALL FORMS OF MEDIA, INCLUDING TELEVISION,

LIVE EVENTS, PRINT AND THE INTERNET, IN CLASS 35 (U.S. CLS. 100, 101 AND 102).

FIRST USE 12-1-2005; IN COMMERCE 12-1-2005.

THE MARK CONSISTS OF STANDARD CHARACTERS WITHOUT CLAIM TO ANY PARTICULAR FONT, STYLE, SIZE, OR COLOR.

NO CLAIM IS MADE TO THE EXCLUSIVE RIGHT TO USE "RECESS", APART FROM THE MARK AS SHOWN.

SER. NO. 77-162,715, FILED 4-23-2007.

RAMONA ORTIGA, EXAMINING ATTORNEY



**Int. Cl.: 40**

**Prior U.S. Cls.: 100, 103 and 106**

**United States Patent and Trademark Office**

**Reg. No. 3,394,305**

**Registered Mar. 11, 2008**

---

**SERVICE MARK  
PRINCIPAL REGISTER**

**SIGNICAST**

SIGNICAST CORPORATION (WISCONSIN CORPORATION)  
1800 INNOVATION WAY  
HARTFORD, WI 53027

FOR: CUSTOM MANUFACTURE OF METAL CAST PARTS AND METAL COMPONENTS USING THE INVESTMENT CASTING PROCESS, IN CLASS 40 (U.S. CLS. 100, 103 AND 106).

FIRST USE 1-1-1969; IN COMMERCE 1-1-1969.

THE MARK CONSISTS OF STANDARD CHARACTERS WITHOUT CLAIM TO ANY PARTICULAR FONT, STYLE, SIZE, OR COLOR.

SER. NO. 77-163,165, FILED 4-23-2007.

BENJAMIN OKEKE, EXAMINING ATTORNEY

**Int. Cls.: 35, 36, 42 and 45**

**Prior U.S. Cls.: 100, 101 and 102**

**United States Patent and Trademark Office**

**Reg. No. 3,394,306**

**Registered Mar. 11, 2008**

**SERVICE MARK  
PRINCIPAL REGISTER**

# Climate Check

CLIMATE CHECK CORPORATION (CANADA CORPORATION)  
11 PINELAND AVENUE  
OTTAWA, CANADA K2G0E5

FOR: MANAGEMENT AND BUSINESS CONSULTING SERVICES IN THE FIELDS OF PROVIDING SOLUTIONS TO CUSTOMERS FOR THEIR CLIMATE CHANGE ACTIVITIES AND ASSERTIONS, IN CLASS 35 (U.S. CLS. 100, 101 AND 102).

FIRST USE 2-20-2007; IN COMMERCE 3-12-2007.

FOR: PROVIDING CONSULTING SERVICES RELATING TO BROKERAGE IN THE FIELD OF GHG EMISSIONS ALLOWANCES, IN CLASS 36 (U.S. CLS. 100, 101 AND 102).

FIRST USE 2-20-2007; IN COMMERCE 3-12-2007.

FOR: ENGINEERING, TECHNOLOGY AND TECHNICAL MANAGEMENT SERVICES IN THE FIELDS OF PROVIDING SOLUTIONS TO CUSTOMERS FOR THEIR CLIMATE CHANGE ACTIVITIES AND ASSERTIONS, IN CLASS 42 (U.S. CLS. 100 AND 101).

FIRST USE 2-20-2007; IN COMMERCE 3-12-2007.

FOR: REVIEW AND VERIFICATION OF ENVIRONMENTAL STANDARDS TO ASSURE COMPLIANCE WITH ENVIRONMENTAL LAWS AND REGULATIONS, IN CLASS 45 (U.S. CLS. 100 AND 101).

FIRST USE 2-20-2007; IN COMMERCE 3-12-2007.

THE MARK CONSISTS OF STANDARD CHARACTERS WITHOUT CLAIM TO ANY PARTICULAR FONT, STYLE, SIZE, OR COLOR.

NO CLAIM IS MADE TO THE EXCLUSIVE RIGHT TO USE "CLIMATE", APART FROM THE MARK AS SHOWN.

SER. NO. 77-163,516, FILED 4-23-2007.

EMILY CHUO, EXAMINING ATTORNEY

**Int. Cl.: 9**

**Prior U.S. Cls.: 21, 23, 26, 36 and 38**

**Reg. No. 3,394,307**

**United States Patent and Trademark Office**

**Registered Mar. 11, 2008**

---

**TRADEMARK  
PRINCIPAL REGISTER**

**IHLP**

VISHAY DALE ELECTRONICS, INC. (DELA-  
WARE CORPORATION)  
1122 23RD STREET  
COLUMBUS, NE 68601

THE MARK CONSISTS OF STANDARD CHAR-  
ACTERS WITHOUT CLAIM TO ANY PARTICULAR  
FONT, STYLE, SIZE, OR COLOR.

FOR: ELECTRICAL INDUCTORS, IN CLASS 9  
(U.S. CLS. 21, 23, 26, 36 AND 38).

SER. NO. 77-163,893, FILED 4-24-2007.

FIRST USE 12-31-1999; IN COMMERCE 12-31-1999.

NAAKWAMA ANKRAH, EXAMINING ATTORNEY

**Int. Cl.: 31**

**Prior U.S. Cls.: 1 and 46**

**United States Patent and Trademark Office**

**Reg. No. 3,394,308**

**Registered Mar. 11, 2008**

---

**TRADEMARK  
PRINCIPAL REGISTER**

**BLISS**

ARBUSTA CIA. LTDA (ECUADOR LIMITED  
PARTNERSHIP)  
RIO COCA 1825 Y GENOVESA  
QUITO, ECUADOR

THE MARK CONSISTS OF STANDARD CHAR-  
ACTERS WITHOUT CLAIM TO ANY PARTICULAR  
FONT, STYLE, SIZE, OR COLOR.

FOR: ROSES, IN CLASS 31 (U.S. CLS. 1 AND 46).

SER. NO. 77-164,344, FILED 4-24-2007.

FIRST USE 12-5-2005; IN COMMERCE 12-5-2005.

KAREN BRACEY, EXAMINING ATTORNEY

**Int. Cl.: 43**

**Prior U.S. Cls.: 100 and 101**

**United States Patent and Trademark Office**

**Reg. No. 3,394,309**

**Registered Mar. 11, 2008**

**SERVICE MARK  
PRINCIPAL REGISTER**

**Kazoopy's**

TREYMARK FRANCHISING LLC (MICHIGAN  
LTD LIAB CO)  
837 EDISON ST.  
KALAMAZOO, MI 49004

THE MARK CONSISTS OF STANDARD CHAR-  
ACTERS WITHOUT CLAIM TO ANY PARTICULAR  
FONT, STYLE, SIZE, OR COLOR.

FOR: RESTAURANT SERVICES FEATURING  
HOME DELIVERY OF SANDWICHES, PASTA SAL-  
ADS, SOUPS, BAKERY DESSERTS, AND FRUIT  
BEVERAGES, IN CLASS 43 (U.S. CLS. 100 AND 101).

SER. NO. 77-164,423, FILED 4-24-2007.

FIRST USE 4-21-2007; IN COMMERCE 4-21-2007.

SIMON TENG, EXAMINING ATTORNEY

**Int. Cl.: 31**

**Prior U.S. Cls.: 1 and 46**

**United States Patent and Trademark Office**

**Reg. No. 3,394,310**

**Registered Mar. 11, 2008**

**TRADEMARK  
PRINCIPAL REGISTER**

**DAZZLING ROSES**

ARBUSTA CIA. LTDA (ECUADOR LIMITED  
PARTNERSHIP)  
RIO COCA 1825 Y GENOVESA  
QUITO, ECUADOR

NO CLAIM IS MADE TO THE EXCLUSIVE  
RIGHT TO USE "ROSES", APART FROM THE  
MARK AS SHOWN.

FOR: ROSES, IN CLASS 31 (U.S. CLS. 1 AND 46).

FIRST USE 12-5-2005; IN COMMERCE 12-5-2005.

SER. NO. 77-164,449, FILED 4-24-2007.

THE MARK CONSISTS OF STANDARD CHAR-  
ACTERS WITHOUT CLAIM TO ANY PARTICULAR  
FONT, STYLE, SIZE, OR COLOR.

KAREN BRACEY, EXAMINING ATTORNEY

**Int. Cl.: 36**

**Prior U.S. Cls.: 100, 101 and 102**

**United States Patent and Trademark Office**

**Reg. No. 3,394,311**

**Registered Mar. 11, 2008**

**SERVICE MARK  
PRINCIPAL REGISTER**



STERLING & STERLING, INC. (NEW YORK CORPORATION)  
135 CROSSWAYS PARK DRIVE  
P.O. BOX 9017  
WOODBURY, NY 11797

FIRST USE 6-30-2006; IN COMMERCE 6-30-2006.

FOR: INSURANCE CONSULTING AND PLANNING; DEVELOPMENT OF INSURANCE RISK MANAGEMENT PLANS; PROVIDING INFORMATION IN INSURANCE MATTERS, IN CLASS 36 (U.S. CLS. 100, 101 AND 102).

NO CLAIM IS MADE TO THE EXCLUSIVE RIGHT TO USE "REDUCE RISK", APART FROM THE MARK AS SHOWN.

SER. NO. 77-164,524, FILED 4-24-2007.

COLLEEN DOMBROW, EXAMINING ATTORNEY

**Int. Cl.: 31**

**Prior U.S. Cls.: 1 and 46**

**United States Patent and Trademark Office**

**Reg. No. 3,394,312**

**Registered Mar. 11, 2008**

**TRADEMARK  
PRINCIPAL REGISTER**

**BLISS DAZZLING ROSES**

ARBUSTA CIA. LTDA (ECUADOR LIMITED  
PARTNERSHIP)  
RIO COCA 1825 Y GENOVESA  
QUITO, ECUADOR

NO CLAIM IS MADE TO THE EXCLUSIVE  
RIGHT TO USE "ROSES", APART FROM THE  
MARK AS SHOWN.

FOR: ROSES, IN CLASS 31 (U.S. CLS. 1 AND 46).

FIRST USE 12-5-2005; IN COMMERCE 12-5-2005.

SER. NO. 77-164,557, FILED 4-24-2007.

THE MARK CONSISTS OF STANDARD CHAR-  
ACTERS WITHOUT CLAIM TO ANY PARTICULAR  
FONT, STYLE, SIZE, OR COLOR.

KAREN BRACEY, EXAMINING ATTORNEY



**Int. Cl.: 41**

**Prior U.S. Cls.: 100, 101 and 107**

**United States Patent and Trademark Office**

**Reg. No. 3,394,313**

**Registered Mar. 11, 2008**

**SERVICE MARK  
PRINCIPAL REGISTER**

**Little Feet Photography**

KORALESKY, KRISTIN DIANE (UNITED STATES INDIVIDUAL)  
10767 SANCTUARY DRIVE  
BLAINE, MN 55449

FOR: PHOTOGRAPHY SERVICES; PORTRAIT PHOTOGRAPHY, IN CLASS 41 (U.S. CLS. 100, 101 AND 107).

FIRST USE 8-1-2004; IN COMMERCE 8-1-2004.

THE MARK CONSISTS OF STANDARD CHARACTERS WITHOUT CLAIM TO ANY PARTICULAR FONT, STYLE, SIZE, OR COLOR.

NO CLAIM IS MADE TO THE EXCLUSIVE RIGHT TO USE "PHOTOGRAPHY", APART FROM THE MARK AS SHOWN.

SER. NO. 77-165,313, FILED 4-25-2007.

STEPHEN AQUILA, EXAMINING ATTORNEY

**Int. Cl.: 18**

**Prior U.S. Cls.: 1, 2, 3, 22 and 41**

**United States Patent and Trademark Office**

**Reg. No. 3,394,314**

**Registered Mar. 11, 2008**

**TRADEMARK  
PRINCIPAL REGISTER**

**APOGEE**

GIATI DESIGNS, INC. (CALIFORNIA CORPORATION)  
220 WEST MONTECITO STREET  
SANTA BARBARA, CA 93101

THE MARK CONSISTS OF STANDARD CHARACTERS WITHOUT CLAIM TO ANY PARTICULAR FONT, STYLE, SIZE, OR COLOR.

FOR: PATIO UMBRELLAS, IN CLASS 18 (U.S. CLS. 1, 2, 3, 22 AND 41).

SER. NO. 77-166,438, FILED 4-26-2007.

FIRST USE 2-15-2007; IN COMMERCE 2-15-2007.

YAT SYE, LEE, EXAMINING ATTORNEY

**Int. Cl.: 20**

**Prior U.S. Cls.: 2, 13, 22, 25, 32 and 50**

**United States Patent and Trademark Office**

**Reg. No. 3,394,315**

**Registered Mar. 11, 2008**

**TRADEMARK  
PRINCIPAL REGISTER**

**APRIO**

GIATI DESIGNS, INC. (CALIFORNIA CORPORATION)  
220 WEST MONTECITO STREET  
SANTA BARBARA, CA 93101

THE MARK CONSISTS OF STANDARD CHARACTERS WITHOUT CLAIM TO ANY PARTICULAR FONT, STYLE, SIZE, OR COLOR.

FOR: FURNITURE FOR HOUSE, OFFICE AND GARDEN, IN CLASS 20 (U.S. CLS. 2, 13, 22, 25, 32 AND 50).

SER. NO. 77-166,627, FILED 4-26-2007.

FIRST USE 1-31-2007; IN COMMERCE 1-31-2007.

YAT SYE, LEE, EXAMINING ATTORNEY

**Int. Cl.: 43**

**Prior U.S. Cls.: 100 and 101**

**United States Patent and Trademark Office**

**Reg. No. 3,394,316**

**Registered Mar. 11, 2008**

**SERVICE MARK  
PRINCIPAL REGISTER**



AVADO BRANDS, INC. (DELAWARE CORPORATION)  
150 HANCOCK STREET  
MADISON, GA 30650

FOR: RESTAURANT AND BAR SERVICES, IN  
CLASS 43 (U.S. CLS. 100 AND 101).

FIRST USE 3-15-2007; IN COMMERCE 3-15-2007.

THE MARK CONSISTS OF THE WORDS BIG TEX  
FOLLOWED BY THE DESIGN OF A STAR THEN  
FOLLOWED BY THE WORDS BOLD MEX BOR-  
DERED ON THE TOP AND BOTTOM BY A LINE.

SER. NO. 77-166,655, FILED 4-26-2007.

HANNO RITTNER, EXAMINING ATTORNEY

**Int. Cl.: 35**

**Prior U.S. Cls.: 100, 101 and 102**

**United States Patent and Trademark Office**

**Reg. No. 3,394,317**

**Registered Mar. 11, 2008**

**SERVICE MARK  
PRINCIPAL REGISTER**



SCHWARTZ & CO., LLC (MINNESOTA LTD  
LIAB CO)  
BOX 300140  
MINNEAPOLIS, MN 55403

THE MARK CONSISTS OF A BROWN RECTAN-  
GULAR OVAL OUTLINED IN BLACK WITH THE  
WORDS COPIER CAREERS IN WHITE IN THE  
CENTER OF THE OVAL.

FOR: EMPLOYMENT HIRING, RECRUITING,  
PLACEMENT, STAFFING AND CAREER NET-  
WORKING SERVICES, IN CLASS 35 (U.S. CLS. 100,  
101 AND 102).

SEC. 2(F) AS TO "COPIER CAREERS".

FIRST USE 4-0-2007; IN COMMERCE 4-0-2007.

SER. NO. 77-167,634, FILED 4-27-2007.

THE COLOR(S) BLACK, BROWN AND WHITE IS/  
ARE CLAIMED AS A FEATURE OF THE MARK.

STEVEN R. FINE, EXAMINING ATTORNEY

**Int. Cls.: 9 and 41**

**Prior U.S. Cls.: 21, 23, 26, 36, 38, 100, 101 and 107**

**United States Patent and Trademark Office**

**Reg. No. 3,394,318**

**Registered Mar. 11, 2008**

**TRADEMARK  
SERVICE MARK  
PRINCIPAL REGISTER**

# BullEx

BULLEX, INC. (DELAWARE CORPORATION)  
105 JORDAN ROAD  
TROY, NY 12180

FOR: FIRE EXTINGUISHER TRAINING SYSTEMS COMPRISED OF A BURN UNIT, NAMELY, A METAL TRAY-LIKE CONTAINER THAT CREATES A CONTROLLABLE FLAME, A CONTROLLER FOR CONTROLLING THE BURN UNIT, AND A FIRE EXTINGUISHER; SIMULATED FIRE EXTINGUISHERS FOR USE IN FIRE EXTINGUISHER TRAINING; AND SIMULATED FIRE EXTINGUISHER TRAINING SYSTEMS COMPRISED OF A COMPUTERIZED, CONTROLLABLE LIGHT EMITTING DIODE (LED) SCREEN FOR CREATING AN IMAGE OF A FIRE ON THE SCREEN, A CONTROLLER FOR THE LED SCREEN AND A SIMULATED FIRE EXTINGUISHER, IN CLASS 9 (U.S. CLS. 21, 23, 26, 36 AND 38).

FIRST USE 8-23-2005; IN COMMERCE 8-23-2005.

FOR: FIRE EXTINGUISHER TRAINING SERVICES, NAMELY, TRAINING PEOPLE ON TECHNIQUES FOR USING FIRE EXTINGUISHERS AND USING FIRE EXTINGUISHER TRAINING EQUIPMENT AND SYSTEMS, IN CLASS 41 (U.S. CLS. 100, 101 AND 107).

FIRST USE 6-13-2006; IN COMMERCE 6-13-2006.

THE MARK CONSISTS OF STANDARD CHARACTERS WITHOUT CLAIM TO ANY PARTICULAR FONT, STYLE, SIZE, OR COLOR.

SER. NO. 77-167,646, FILED 4-27-2007.

ESTHER BELENKER, EXAMINING ATTORNEY

**Int. Cl.: 16**

**Prior U.S. Cls.: 2, 5, 22, 23, 29, 37, 38 and 50**

**Reg. No. 3,394,319**

**United States Patent and Trademark Office**

**Registered Mar. 11, 2008**

**TRADEMARK  
PRINCIPAL REGISTER**

# Lets Get Dirty

DIRT WEAR INC. (CALIFORNIA CORPORATION)  
6351 RUBY CREST WAY  
MIRA LOMA, CA 91752

FOR: PRINTED MATERIALS, NAMELY, STATIONERY, ENVELOPES, BUSINESS CARDS, POSTCARDS; PENS; PENCILS; RULERS, NAMELY, UNGRADUATED RULERS; POSTERS; CATALOGS IN THE FIELD OF CLOTHING AND SUNGLASSES; BROCHURES ABOUT CLOTHING AND SUNGLASSES; FOLDERS; BOOKS, NAMELY, COLORING BOOKS, AUTOGRAPH BOOKS, BLANK JOURNAL BOOKS, COMIC BOOKS, COMPOSITION BOOKS; STICKERS, NAMELY, BUMPER STICKERS, DECORATIVE STICKERS; DECALS; PAPER BANNERS; SCHOOL SUPPLY KITS CONTAINING VARIOUS COMBINATIONS OF SELECTED SCHOOL SUPPLIES, NAMELY, WRITING INSTRUMENTS, PENS, PENCILS, MECHANICAL PENCILS, ERASERS, MARKERS, CRAYONS, HIGHLIGHTERS, FOLDERS, NOTEBOOKS, PAPER, PROTRACTORS, PA-

PER CLIPS, PENCIL SHARPENERS, WRITING GRIPS, GLUE AND BOOK MARKS; PRINTED AWARD CERTIFICATES; BOOKMARKS; MARKERS; BOOK COVER PAPER; CARDBOARD BOXES; SHIPPING LABELS; PRICE TAGS; COUPONS; GIFT CARDS; PENCIL BOXES; PENCIL CASES; FLASHCARDS; GREETING CARDS; CALENDARS; CARDBOARD BOXES FOR HOLDING CHALK; DICTIONARIES, IN CLASS 16 (U.S. CLS. 2, 5, 22, 23, 29, 37, 38 AND 50).

FIRST USE 0-0-1998; IN COMMERCE 0-0-2003.

THE MARK CONSISTS OF STANDARD CHARACTERS WITHOUT CLAIM TO ANY PARTICULAR FONT, STYLE, SIZE, OR COLOR.

SER. NO. 77-168,313, FILED 4-28-2007.

JENNIFER HETU, EXAMINING ATTORNEY

**Int. Cl.: 38**

**Prior U.S. Cls.: 100, 101 and 104**

**United States Patent and Trademark Office**

**Reg. No. 3,394,320**

**Registered Mar. 11, 2008**

**SERVICE MARK  
PRINCIPAL REGISTER**

**ANYTHING & EVERYTHING ON  
THE NETWORK**

VON WORLDWIDE, INC. (CONNECTICUT CORPORATION)  
1 BARNES PARK SOUTH  
WALLINGFORD, CT 06492

FOR: WIRELESS PBX SERVICES; PBX DIALING SERVICES; VOICE OVER INTERNET PROTOCOL (VOIP) SERVICES; NETWORK CONFERENCING SERVICES; TELECOMMUNICATION SERVICES, NAMELY, LOCAL AND LONG DISTANCE TRANSMISSION OF VOICE, DATA, GRAPHICS BY MEANS OF TELEPHONE, TELEGRAPHIC, CABLE, AND SATELLITE TRANSMISSIONS; TELECOMMUNICATIONS RESELLER SERVICES, NAMELY, PROVIDING LONG DISTANCE TELECOMMUNICATION SERVICES; LOCAL AND LONG DISTANCE TELEPHONE SERVICES; PROVIDING FACILITIES AND EQUIPMENT FOR VI-

DEO CONFERENCING; ELECTRONIC TRANSMISSION OF MESSAGES AND DATA; INTERNET SERVICE PROVIDER (ISP); INTERNET TELEPHONY SERVICES; PROVIDING MULTIPLE USER DIAL-UP AND DEDICATED ACCESS TO THE INTERNET, IN CLASS 38 (U.S. CLS. 100, 101 AND 104).

FIRST USE 3-0-2007; IN COMMERCE 3-0-2007.

THE MARK CONSISTS OF STANDARD CHARACTERS WITHOUT CLAIM TO ANY PARTICULAR FONT, STYLE, SIZE, OR COLOR.

SER. NO. 77-168,948, FILED 4-30-2007.

ESTHER A. BORSUK, EXAMINING ATTORNEY



**Int. Cl.: 19**

**Prior U.S. Cls.: 1, 12, 33 and 50**

**United States Patent and Trademark Office**

**Reg. No. 3,394,321**

**Registered Mar. 11, 2008**

**TRADEMARK  
PRINCIPAL REGISTER**

**CARTER'S GROVE**

THE COLONIAL WILLIAMSBURG FOUNDATION (VIRGINIA NON-STOCK CORPORATION)  
POST OFFICE BOX 1776  
WILLIAMSBURG, VA 23187

FOR: NON-METAL DECORATIVE MOLDINGS FOR USE IN BUILDING CONSTRUCTION, NAMELY, ARCHITECTURAL MOLDING NAMELY CHAIR RAIL, IN CLASS 19 (U.S. CLS. 1, 12, 33 AND 50).

FIRST USE 0-0-1983; IN COMMERCE 0-0-1983.

THE MARK CONSISTS OF STANDARD CHARACTERS WITHOUT CLAIM TO ANY PARTICULAR FONT, STYLE, SIZE, OR COLOR.

OWNER OF U.S. REG. NO. 1,132,230.

SER. NO. 77-169,634, FILED 5-1-2007.

KATHERINE E. HALMEN, EXAMINING ATTORNEY

**Int. Cl.: 8**

**Prior U.S. Cls.: 23, 28 and 44**

**United States Patent and Trademark Office**

**Reg. No. 3,394,322**

**Registered Mar. 11, 2008**

**TRADEMARK  
PRINCIPAL REGISTER**

**XTRA-BITS**

LOGGERHEAD TOOLS LLC (ILLINOIS LTD  
LIAB CO)  
8310 WEST 127TH STREET  
PALOS PARK, IL 60464

THE MARK CONSISTS OF STANDARD CHAR-  
ACTERS WITHOUT CLAIM TO ANY PARTICULAR  
FONT, STYLE, SIZE, OR COLOR.

FOR: BITS FOR HAND TOOLS, IN CLASS 8 (U.S.  
CLS. 23, 28 AND 44).

SER. NO. 77-169,987, FILED 5-1-2007.

FIRST USE 6-0-2007; IN COMMERCE 6-0-2007.

KELLY MCCOY, EXAMINING ATTORNEY

**Int. Cl.: 28**

**Prior U.S. Cls.: 22, 23, 38 and 50**

**United States Patent and Trademark Office**

**Reg. No. 3,394,323**

**Registered Mar. 11, 2008**

**TRADEMARK  
PRINCIPAL REGISTER**

**Jet**

ABEC 11, INC. (CALIFORNIA CORPORATION)  
306 18TH STREET  
HUNTINGTON BEACH, CA 92648

FOR: SKATEBOARDS, SKATEBOARD ACCESSORIES AND STRUCTURAL PARTS FOR SKATEBOARDS, NAMELY, WHEELS, TRUCKS, BEARINGS, MOUNTING HARDWARE, NAMELY, SCREWS, BOLTS, NUTS, AND WASHERS USED TO FASTEN SKATEBOARD TRUCKS TO THE DECK, ATHLETIC PROTECTIVE PADS FOR SKATEBOARDING; RECREATIONAL EQUIPMENT, NAMELY, SURFBOARDS, SKIMBOARDS, WAKEBOARDS, SNOWBOARDS, SNOWBOARD BINDINGS, SNOW SKIS, SKI BINDINGS, ROLLER SKATES, IN-LINE SKATES, MOUNTAINBOARDS,

DIRTBOARDS, SANDBOARDS, SAILBOARDS, BODYBOARDS, NAMELY, EXTRA LONG SKATEBOARDS FOR USE ON VARIOUS TERRAIN AND SURFACES, IN CLASS 28 (U.S. CLS. 22, 23, 38 AND 50).

FIRST USE 10-8-2002; IN COMMERCE 10-8-2002.

THE MARK CONSISTS OF STANDARD CHARACTERS WITHOUT CLAIM TO ANY PARTICULAR FONT, STYLE, SIZE, OR COLOR.

SER. NO. 77-171,353, FILED 5-2-2007.

SUSAN LESLIE DUBOIS, EXAMINING ATTORNEY

**Int. Cl.: 36**

**Prior U.S. Cls.: 100, 101 and 102**

**United States Patent and Trademark Office**

**Reg. No. 3,394,324**

**Registered Mar. 11, 2008**

**SERVICE MARK  
PRINCIPAL REGISTER**

**Credit Justice Services**

CREDIT JUSTICE SERVICES, INC. (FLORIDA CORPORATION)  
234 OCEANWAY AVENUE  
JACKSONVILLE, FL 32218

FOR: CONSUMER CREDIT CONSULTATION FEATURING CONSULTATION ON RESTORATION OF ONES CREDIT AND NEGOTIATING OF CREDIT TERMS WITH CREDITORS, IN CLASS 36 (U.S. CLS. 100, 101 AND 102).

FIRST USE 1-1-2006; IN COMMERCE 1-1-2006.

THE MARK CONSISTS OF STANDARD CHARACTERS WITHOUT CLAIM TO ANY PARTICULAR FONT, STYLE, SIZE, OR COLOR.

NO CLAIM IS MADE TO THE EXCLUSIVE RIGHT TO USE "CREDIT" AND "SERVICES", APART FROM THE MARK AS SHOWN.

SER. NO. 77-171,634, FILED 5-3-2007.

LESLIE RICHARDS, EXAMINING ATTORNEY

**Int. Cl.: 9**

**Prior U.S. Cls.: 21, 23, 26, 36 and 38**

**Reg. No. 3,394,325**

**United States Patent and Trademark Office**

**Registered Mar. 11, 2008**

---

**TRADEMARK  
PRINCIPAL REGISTER**

**WEP CLOAKING**

AIRDEFENSE, INC. (GEORGIA CORPORATION)  
SUITE 100  
4800 NORTH POINT PARKWAY  
ALPHARETTA, GA 30022

FOR: COMPUTER SOFTWARE FOR ASSESSING AND PROTECTING WIRELESS COMPUTER NETWORKS AGAINST ATTACK, INTRUSION AND MISUSE; COMPUTER SOFTWARE FOR PROTECTING DATA/INFORMATION STORED ON AND/OR TRANSMITTED ACROSS WIRELESS NETWORKS AGAINST ATTACK, INTRUSION AND MISUSE, IN CLASS 9 (U.S. CLS. 21, 23, 26, 36 AND 38).

FIRST USE 3-30-2007; IN COMMERCE 3-30-2007.

THE MARK CONSISTS OF STANDARD CHARACTERS WITHOUT CLAIM TO ANY PARTICULAR FONT, STYLE, SIZE, OR COLOR.

NO CLAIM IS MADE TO THE EXCLUSIVE RIGHT TO USE WEP, APART FROM THE MARK AS SHOWN.

SER. NO. 77-171,759, FILED 5-3-2007.

VIVIAN MICZNIK FIRST, EXAMINING ATTORNEY

Int. Cl.: 42

Prior U.S. Cls.: 100 and 101

United States Patent and Trademark Office

Reg. No. 3,394,326

Registered Mar. 11, 2008

**SERVICE MARK  
PRINCIPAL REGISTER**

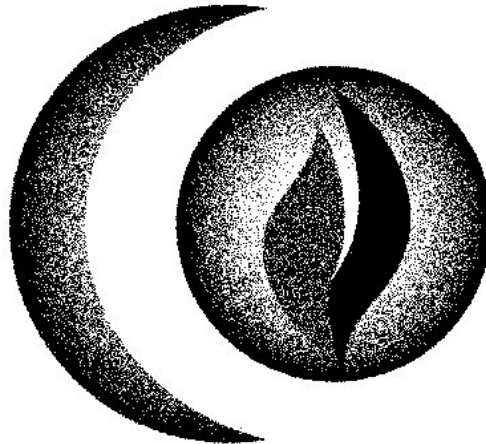

LEE, SPIDEY (UNITED STATES INDIVIDUAL)  
125 JAMEY COURT  
CARROLLTON, GA 30117

FOR: RESEARCH AND DEVELOPMENT AND  
CONSULTATION RELATED THERETO IN THE  
FIELD OF GLOBAL WARMING, IN CLASS 42 (U.S.  
CLS. 100 AND 101).

FIRST USE 5-1-2007; IN COMMERCE 6-3-2007.

THE STIPPLING IS FOR SHADING PURPOSES  
ONLY.

THE MARK CONSISTS OF A QUARTER MOON  
SHAPE ON THE LEFT AND A SPHERE SHAPE  
IMAGE SLIGHTLY TO THE RIGHT OF THAT  
IMAGE. ON THE SPHERE THERE ARE TWO WAVY  
IMAGES THAT TOUCH.

SER. NO. 77-171,908, FILED 5-3-2007.

CAROL SPILS, EXAMINING ATTORNEY

**Int. Cls.: 37 and 42**

**Prior U.S. Cls.: 100, 101, 103 and 106**

**United States Patent and Trademark Office**

**Reg. No. 3,394,327**

**Registered Mar. 11, 2008**

**SERVICE MARK  
PRINCIPAL REGISTER**

THE COMPANY YOU CAN BUILD  
ON

TENSAR INTERNATIONAL CORPORATION  
(GEORGIA CORPORATION)  
5883 GLENRIDGE DRIVE  
SUITE 200  
ATLANTA, GA 30328

FOR: REAL ESTATE SITE SELECTION SERVICES; CONSTRUCTION PLANNING SERVICES, IN CLASS 37 (U.S. CLS. 100, 103 AND 106).

FIRST USE 2-0-1996; IN COMMERCE 2-0-1996.

FOR: ENGINEERING SERVICES, IN CLASS 42 (U.S. CLS. 100 AND 101).

FIRST USE 2-0-1996; IN COMMERCE 2-0-1996.

THE MARK CONSISTS OF STANDARD CHARACTERS WITHOUT CLAIM TO ANY PARTICULAR FONT, STYLE, SIZE, OR COLOR.

OWNER OF U.S. REG. NO. 2,183,291.

SER. NO. 77-172,035, FILED 5-3-2007.

WENDY GOODMAN, EXAMINING ATTORNEY

Int. Cl.: 30

Prior U.S. Cl.: 46

United States Patent and Trademark Office

Reg. No. 3,394,328

Registered Mar. 11, 2008

TRADEMARK  
PRINCIPAL REGISTER



CAT DADDY LLC (OREGON LTD LIAB CO)  
22 SW 3RD AVE.  
PORTLAND, OR 97204

FOR: DOUGHNUTS, IN CLASS 30 (U.S. CL. 46).

FIRST USE 6-27-2002; IN COMMERCE 8-15-2002.

NO CLAIM IS MADE TO THE EXCLUSIVE  
RIGHT TO USE "DOUGHNUT", APART FROM  
THE MARK AS SHOWN.

THE MARK CONSISTS OF WIZARD WEARING  
TOP HAT IN THE HOLE OF A GLAZED DOUGH-  
NUT HOLDING A WAND TOPPED BY ANOTHER  
DOUGHNUT THAT IS PIERCED BY NEEDLES. A  
RIBBON BANNER CROSSES THE BOTTOM OF THE  
DOUGHNUT.

SER. NO. 77-172,419, FILED 5-3-2007.

TAMARA FRAZIER, EXAMINING ATTORNEY



**Int. Cl.: 21**

**Prior U.S. Cls.: 2, 13, 23, 29, 30, 33, 40 and 50**

**Reg. No. 3,394,329**

**United States Patent and Trademark Office**

**Registered Mar. 11, 2008**

---

**TRADEMARK  
PRINCIPAL REGISTER**

**Metaluxe**

DECORATIVE PLANT CONTAINERS, INC.  
(FLORIDA CORPORATION)  
301 FIGUEROA STREET  
WILMINGTON, CA 90744

THE MARK CONSISTS OF STANDARD CHAR-  
ACTERS WITHOUT CLAIM TO ANY PARTICULAR  
FONT, STYLE, SIZE, OR COLOR.

FOR: PLANTERS FOR FLOWERS AND PLANTS,  
IN CLASS 21 (U.S. CLS. 2, 13, 23, 29, 30, 33, 40 AND 50).

SER. NO. 77-173,308, FILED 5-4-2007.

FIRST USE 1-1-2007; IN COMMERCE 1-1-2007.

MARIAM MAHMOUDI, EXAMINING ATTORNEY

**Int. Cl.: 37**

**Prior U.S. Cls.: 100, 103 and 106**

**United States Patent and Trademark Office**

**Reg. No. 3,394,330**

**Registered Mar. 11, 2008**

**SERVICE MARK  
PRINCIPAL REGISTER**

**FAITH TECHNOLOGIES**

FAITH TECHNOLOGIES, INC. (WISCONSIN CORPORATION)

P.O. BOX 627

APPLETON, WI 549120627

FOR: ELECTRICAL CONTRACTING SERVICES,  
IN CLASS 37 (U.S. CLS. 100, 103 AND 106).

FIRST USE 6-0-2004; IN COMMERCE 6-0-2004.

THE MARK CONSISTS OF STANDARD CHARACTERS WITHOUT CLAIM TO ANY PARTICULAR FONT, STYLE, SIZE, OR COLOR.

NO CLAIM IS MADE TO THE EXCLUSIVE RIGHT TO USE "TECHNOLOGIES", APART FROM THE MARK AS SHOWN.

SER. NO. 77-173,373, FILED 5-4-2007.

MICHAEL WIENER, EXAMINING ATTORNEY

**Int. Cls.: 9, 35 and 42**

**Prior U.S. Cls.: 21, 23, 26, 36, 38, 100, 101 and 102**

**United States Patent and Trademark Office**

**Reg. No. 3,394,331**

**Registered Mar. 11, 2008**

**TRADEMARK  
SERVICE MARK  
PRINCIPAL REGISTER**

# JUST ONEPLACE

JUST ONEPLACE PTY LTD (AUSTRALIA COMPANY)  
9 OXFORD STREET  
SOUTH YARRA, VICTORIA, AUSTRALIA 3141

FOR: COMPUTER PROGRAMS, NAMELY, PROCESS MANAGEMENT SOFTWARE, PRODUCT DEVELOPMENT MANAGEMENT SOFTWARE, WEB-ENABLED SUPPLY CHAIN MANAGEMENT SOFTWARE AND APPLICATION SERVICE PROVIDER SOFTWARE FOR PRODUCT LIFE CYCLE MANAGEMENT, HUMAN AND PROCESS-RELATED SUPPLY CHAIN MANAGEMENT, WORKFLOW AUTOMATION, INTEGRATION INTO ENTERPRISE RESOURCE PLANNING SYSTEMS FOR MANUFACTURING INDUSTRIES, THE RETAIL SECTOR AND WHOLESALE DISTRIBUTION INDUSTRY, IN PARTICULAR, THE APPAREL AND TEXTILE INDUSTRY, IN CLASS 9 (U.S. CLS. 21, 23, 26, 36 AND 38).

FOR: BUSINESS MANAGEMENT AND COMMERCIAL AND INDUSTRIAL MANAGEMENT AS-

SISTANCE IN THE FIELDS OF MANUFACTURE, RETAIL SECTOR AND WHOLESALE DISTRIBUTION INDUSTRY, IN PARTICULAR, THE APPAREL AND TEXTILE INDUSTRY, IN CLASS 35 (U.S. CLS. 100, 101 AND 102).

FOR: COMPUTER CONSULTATION SERVICES AND APPLICATION SERVICE PROVIDER (ASP), NAMELY, HOSTING COMPUTER SOFTWARE APPLICATIONS OF OTHERS, IN CLASS 42 (U.S. CLS. 100 AND 101).

THE MARK CONSISTS OF STANDARD CHARACTERS WITHOUT CLAIM TO ANY PARTICULAR FONT, STYLE, SIZE, OR COLOR.

OWNER OF AUSTRALIA REG. NO. 1109634, DATED 4-19-2006, EXPIRES 4-19-2016.

SER. NO. 77-173,522, FILED 5-4-2007.

DOMINIC FATHY, EXAMINING ATTORNEY

**Int. Cl.: 9**

**Prior U.S. Cls.: 21, 23, 26, 36 and 38**

**United States Patent and Trademark Office**

**Reg. No. 3,394,332**

**Registered Mar. 11, 2008**

**TRADEMARK  
PRINCIPAL REGISTER**



GODLAN, INC. (MICHIGAN CORPORATION)  
30061 SCHOENHERR ROAD, SUITE B  
WARREN, MI 48088

FOR: COMPUTER SOFTWARE FOR ALLOWING SALES AND FIELD SERVICE EMPLOYEES TO UPDATE AND RECEIVE DATA STORED IN AN ENTERPRISE'S COMPUTER DATABASES IN REAL TIME, USING A MOBILE DEVICE, WITH FULL TELEPHONY INTEGRATION WITH THE TELEPHONE AND/OR SOFTWARE FEATURES OF THE MOBILE DEVICE, IN CLASS 9 (U.S. CLS. 21, 23, 26, 36 AND 38).

FIRST USE 3-30-2006; IN COMMERCE 3-30-2006.

OWNER OF U.S. REG. NO. 3,268,084.

NO CLAIM IS MADE TO THE EXCLUSIVE RIGHT TO USE "ANYWHERE", APART FROM THE MARK AS SHOWN.

THE MARK CONSISTS OF THE WORD "INSYNC", IN LOWER-CASE LETTERS, WITH 3 WAVES EMANATING FROM THE LETTER "I", AS IF IT WERE A RADIO TOWER. BELOW THAT WORD IS THE WORD "ANYWHERE", IN SMALLER, UPPER-CASE LETTERS.

SER. NO. 77-174,769, FILED 5-7-2007.

INGRID C. EULIN, EXAMINING ATTORNEY

Int. Cl.: 41

Prior U.S. Cls.: 100, 101 and 107

United States Patent and Trademark Office

Reg. No. 3,394,333

Registered Mar. 11, 2008

**SERVICE MARK  
PRINCIPAL REGISTER**



FLORIDA FLYWHEELERS ANTIQUE ENGINE  
CLUB, INC. (FLORIDA CORPORATION)  
7000 AVON PARK CUTOFF RD.  
FT MEADE, FL 33841

FOR: ORGANIZING EXHIBITIONS FOR AN-  
TIQUE ENGINE AND AGRICULTURAL EQUIP-  
MENT SHOWS FOR EDUCATIONAL PURPOSES,  
IN CLASS 41 (U.S. CLS. 100, 101 AND 107).

FIRST USE 0-0-1972; IN COMMERCE 0-0-1972.

NO CLAIM IS MADE TO THE EXCLUSIVE  
RIGHT TO USE "FLORIDA FLYWHEELERS AN-  
TIQUE ENGINE CLUB", APART FROM THE MARK  
AS SHOWN.

THE MARK CONSISTS OF MAP OF FLORIDA  
WITH SIX-SPOKED FLYWHEEL POSITIONED  
WITH THE HUB OVER POLK COUNTY.

SER. NO. 77-174,848, FILED 5-7-2007.

REBECCA SMITH, EXAMINING ATTORNEY

**Int. Cl.: 9**

**Prior U.S. Cls.: 21, 23, 26, 36 and 38**

**United States Patent and Trademark Office**

**Reg. No. 3,394,334**

**Registered Mar. 11, 2008**

**TRADEMARK  
PRINCIPAL REGISTER**

**RIGHT-SUITE**

WRIGHTSOFT CORPORATION (MASSACHU-  
SETTS CORPORATION)  
131 HARTWELL AVE  
LEXINGTON, MA 02421

FOR: INTEGRATED COMPUTER SOFTWARE  
PROGRAMS FOR USE IN DESIGNING AND SELL-  
ING COMPREHENSIVE HVAC SYSTEMS FOR RE-  
SIDENTIAL AND COMMERCIAL BUILDINGS, IN  
CLASS 9 (U.S. CLS. 21, 23, 26, 36 AND 38).

FIRST USE 12-0-1996; IN COMMERCE 8-0-1997.

THE MARK CONSISTS OF STANDARD CHAR-  
ACTERS WITHOUT CLAIM TO ANY PARTICULAR  
FONT, STYLE, SIZE, OR COLOR.

SER. NO. 77-175,334, FILED 5-8-2007.

STEVEN R. FINE, EXAMINING ATTORNEY

**Int. Cl.: 4**

**Prior U.S. Cls.: 1, 6 and 15**

**United States Patent and Trademark Office**

**Reg. No. 3,394,335**

**Registered Mar. 11, 2008**

**TRADEMARK  
PRINCIPAL REGISTER**

THE ZERO PERCENT PROMISE

DCI 1965 LLC (COLORADO LTD LIAB CO)  
8654 THUNDERHEAD DRIVE  
BOULDER, CO 80301

THE MARK CONSISTS OF STANDARD CHAR-  
ACTERS WITHOUT CLAIM TO ANY PARTICULAR  
FONT, STYLE, SIZE, OR COLOR.

FOR: CANDLES; CANDLES FOR LIGHTING;  
SCENTED CANDLES, IN CLASS 4 (U.S. CLS. 1, 6  
AND 15).

SER. NO. 77-175,944, FILED 5-8-2007.

FIRST USE 1-17-2007; IN COMMERCE 1-31-2007.

HOWARD SMIGA, EXAMINING ATTORNEY

**Int. Cl.: 4**

**Prior U.S. Cls.: 1, 6 and 15**

**United States Patent and Trademark Office**

**Reg. No. 3,394,336**

**Registered Mar. 11, 2008**

**TRADEMARK  
PRINCIPAL REGISTER**

**PURE PRODUCTS FOR LIVING**

DCI 1965 LLC (COLORADO LTD LIAB CO)  
8654 THUNDERHEAD DRIVE  
BOULDER, CO 80301

FOR: CANDLES; CANDLES FOR LIGHTING;  
PERFUMED CANDLES; SCENTED CANDLES, IN  
CLASS 4 (U.S. CLS. 1, 6 AND 15).

FIRST USE 1-17-2007; IN COMMERCE 1-31-2007.

THE MARK CONSISTS OF STANDARD CHAR-  
ACTERS WITHOUT CLAIM TO ANY PARTICULAR  
FONT, STYLE, SIZE, OR COLOR.

NO CLAIM IS MADE TO THE EXCLUSIVE  
RIGHT TO USE "PURE PRODUCTS", APART FROM  
THE MARK AS SHOWN.

SER. NO. 77-175,948, FILED 5-8-2007.

HOWARD SMIGA, EXAMINING ATTORNEY



**Int. Cl.: 41**

**Prior U.S. Cls.: 100, 101 and 107**

**United States Patent and Trademark Office**

**Reg. No. 3,394,337**

**Registered Mar. 11, 2008**

**SERVICE MARK  
PRINCIPAL REGISTER**

**Wild Women Entrepreneurs**

WILD WOMEN ENTREPRENEURS LLC (MAS-  
SACHUSETTS LTD LIAB CO)

#2

46 HILLSDALE ROAD  
MEDFORD, MA 02155

FOR: PROVIDING ON-LINE TRAINING WORK-  
SHOPS IN THE FIELD OF BUSINESS AND ENTRE-  
PRENEURSHIP; TRAINING SERVICES IN THE  
FIELD OF BUSINESS AND ENTREPRENEURSHIP;  
BUSINESS TRAINING; ARRANGING PROFES-  
SIONAL WORKSHOP AND TRAINING COURSES,  
IN CLASS 41 (U.S. CLS. 100, 101 AND 107).

FIRST USE 5-30-2005; IN COMMERCE 5-30-2005.

THE MARK CONSISTS OF STANDARD CHAR-  
ACTERS WITHOUT CLAIM TO ANY PARTICULAR  
FONT, STYLE, SIZE, OR COLOR.

NO CLAIM IS MADE TO THE EXCLUSIVE  
RIGHT TO USE "WOMEN ENTREPRENEURS",  
APART FROM THE MARK AS SHOWN.

SER. NO. 77-176,535, FILED 5-9-2007.

GEOFFREY FOSDICK, EXAMINING ATTORNEY

**Int. Cl.: 18**

**Prior U.S. Cls.: 1, 2, 3, 22 and 41**

**United States Patent and Trademark Office**

**Reg. No. 3,394,338**

**Registered Mar. 11, 2008**

**TRADEMARK  
PRINCIPAL REGISTER**



DESIGNER DUDS FOR DOGS, LLC (WASHING-  
TON LTD LIAB CO)  
6536 102ND PLACE NE  
KIRKLAND, WA 98033

NO CLAIM IS MADE TO THE EXCLUSIVE  
RIGHT TO USE "DUDS FOR DOGS", APART FROM  
THE MARK AS SHOWN.

FOR: DOG ACCESSORY ITEMS, NAMELY, DOG  
COLLARS, TIES, BOWTIES, BANDANAS, SCARVES,  
CLOTHING AND APPAREL, IN CLASS 18 (U.S. CLS.  
1, 2, 3, 22 AND 41).

SER. NO. 77-176,587, FILED 5-9-2007.

FIRST USE 11-1-2005; IN COMMERCE 11-1-2005.

MICHAEL ENGEL, EXAMINING ATTORNEY

**Int. Cl.: 10**

**Prior U.S. Cls.: 26, 39 and 44**

**United States Patent and Trademark Office**

**Reg. No. 3,394,339**

**Registered Mar. 11, 2008**

**TRADEMARK  
PRINCIPAL REGISTER**

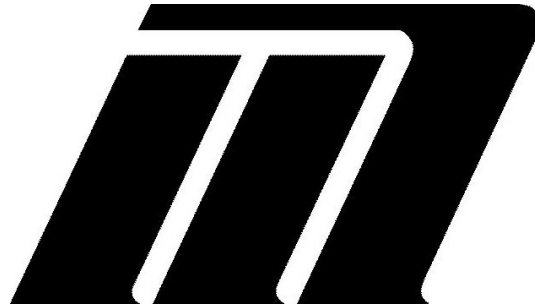

MARCO OPHTHALMIC, INC. (FLORIDA CORPORATION)  
11825 CENTRAL PARKWAY  
JACKSONVILLE, FL 32224

FOR: OPHTHALMOLOGIC DIAGNOSTIC EQUIPMENT, NAMELY, EXAM CHAIRS, INSTRUMENT STANDS, SLIT LAMP MICROSCOPES, EYE TESTING CHART PROJECTORS, REFRACTORS, LENS-METERS, KERATOMETERS, NON-CONTACT TONOMETERS, WAVEFRONT ABERROMETER, AUTO REFRACTORS, CORNEAL TOPOGRAPHER,

AUTO LENSMETERS AND NON-CONTACT TONOMETERS, IN CLASS 10 (U.S. CLS. 26, 39 AND 44).

FIRST USE 5-11-1973; IN COMMERCE 5-11-1973.

OWNER OF U.S. REG. NO. 2,169,538.

THE MARK CONSISTS OF STYLIZED M.

SER. NO. 77-176,659, FILED 5-9-2007.

SCOTT BIBB, EXAMINING ATTORNEY

**Int. Cl.: 10**

**Prior U.S. Cls.: 26, 39 and 44**

**United States Patent and Trademark Office**

**Reg. No. 3,394,340**

**Registered Mar. 11, 2008**

**TRADEMARK  
PRINCIPAL REGISTER**

**MARCO**

MARCO OPHTHALMIC, INC. (FLORIDA CORPORATION)  
11825 CENTRAL PARKWAY  
JACKSONVILLE, FL 32224

FOR: OPHTHALMOLOGIC DIAGNOSTIC EQUIPMENT, NAMELY, EXAM CHAIRS, INSTRUMENT STANDS, SLIT LAMP MICROSCOPES, EYE TESTING CHART PROJECTORS, REFRACTORS, LENS-METERS, KERATOMETERS, NON-CONTACT TONOMETERS, WAVEFRONT ABERROMETERS, AUTO REFRACTORS, CORNEAL TOPOGRAPHERS, AUTO LENSMETERS AND NON-CONTACT TONOMETERS, IN CLASS 10 (U.S. CLS. 26, 39 AND 44).

FIRST USE 5-11-1973; IN COMMERCE 5-11-1973.

THE MARK CONSISTS OF STANDARD CHARACTERS WITHOUT CLAIM TO ANY PARTICULAR FONT, STYLE, SIZE, OR COLOR.

OWNER OF U.S. REG. NO. 2,169,538.

SER. NO. 77-176,677, FILED 5-9-2007.

SCOTT BIBB, EXAMINING ATTORNEY

**Int. Cls.: 3, 16, 18, 20, 25 and 26**

**Prior U.S. Cls.: 1, 2, 3, 4, 5, 6, 13, 22, 23, 25, 29, 32, 37, 38, 39, 40, 41, 42, 50, 51 and 52**

**Reg. No. 3,394,341**

**United States Patent and Trademark Office**

**Registered Mar. 11, 2008**

**TRADEMARK  
PRINCIPAL REGISTER**

**BLUE MAN GROUP**

BLUE MAN PRODUCTIONS, INC. (NEW YORK CORPORATION)  
599 BROADWAY  
NEW YORK, NY 10012

FOR: BREATH MINTS, IN CLASS 3 (U.S. CLS. 1, 4, 6, 50, 51 AND 52).

FIRST USE 3-0-2003; IN COMMERCE 5-16-2005.

FOR: CALENDARS; BLANK JOURNAL BOOKS; ARTS AND CRAFTS PAINT KITS; ARTS AND CRAFTS KITS COMPRISING COLORED PENCILS AND PADS, IN CLASS 16 (U.S. CLS. 2, 5, 22, 23, 29, 37, 38 AND 50).

FIRST USE 10-0-2004; IN COMMERCE 7-17-2005.

FOR: BUSINESS CARD CASES; WALLETS; LUGGAGE TAGS; TOTE BAGS; COSMETICS BAGS, SOLD EMPTY; KEY CASES, IN CLASS 18 (U.S. CLS. 1, 2, 3, 22 AND 41).

FIRST USE 10-0-2005; IN COMMERCE 11-5-2005.

FOR: POCKET MIRRORS, IN CLASS 20 (U.S. CLS. 2, 13, 22, 25, 32 AND 50).

FIRST USE 10-0-2005; IN COMMERCE 11-16-2005.

FOR: PAJAMAS; YOGA SUITS FOR MEN AND WOMEN; LONG SLEEVED SHIRTS; T-SHIRTS FOR CHILDREN, IN CLASS 25 (U.S. CLS. 22 AND 39).

FIRST USE 9-20-2002; IN COMMERCE 9-20-2002.

FOR: CLOTH PATCHES FOR CLOTHING, IN CLASS 26 (U.S. CLS. 37, 39, 40, 42 AND 50).

FIRST USE 11-15-2005; IN COMMERCE 11-15-2005.

THE MARK CONSISTS OF STANDARD CHARACTERS WITHOUT CLAIM TO ANY PARTICULAR FONT, STYLE, SIZE, OR COLOR.

OWNER OF U.S. REG. NOS. 2,438,222, 2,617,550 AND OTHERS.

SER. NO. 77-176,871, FILED 5-9-2007.

DORITT L. CARROLL, EXAMINING ATTORNEY

**Int. Cl.: 26**

**Prior U.S. Cls.: 37, 39, 40, 42 and 50**

**United States Patent and Trademark Office**

**Reg. No. 3,394,342**

**Registered Mar. 11, 2008**

**TRADEMARK  
PRINCIPAL REGISTER**

# Celebrate

SSS PTY. LIMITED (AUSTRALIA CORPORATION)

16 VALEDICTION RD

KINGS PARK, AUSTRALIA 2148

FOR: RIBBON SOLD FOR USE BY HOME SEWERS AND PAPER CRAFTERS, IN CLASS 26 (U.S. CLS. 37, 39, 40, 42 AND 50).

THE MARK CONSISTS OF STANDARD CHARACTERS WITHOUT CLAIM TO ANY PARTICULAR FONT, STYLE, SIZE, OR COLOR.

OWNER OF AUSTRALIA REG. NO. 1112280, DATED 5-8-2006, EXPIRES 5-8-2016.

SER. NO. 77-177,322, FILED 5-10-2007.

DAVID H. STINE, EXAMINING ATTORNEY

**Int. Cls.: 9, 14, 16, 25, 38 and 41**

**Prior U.S. Cls.: 2, 5, 21, 22, 23, 26, 27, 28, 29, 36, 37, 38, 39, 50, 100, 101, 104 and 107**

**Reg. No. 3,394,343**

**United States Patent and Trademark Office**

**Registered Mar. 11, 2008**

**TRADEMARK  
SERVICE MARK  
PRINCIPAL REGISTER**

**NFL**

NATIONAL FOOTBALL LEAGUE (NEW YORK  
UNINC. ASSOCIATION)  
280 PARK AVENUE  
NEW YORK, NY 10017

FOR: FOOTBALL HELMETS, CELL PHONE COVERS, SPECIAL HOLSTERS AND ACCESSORIES IN CONNECTION THEREOF FOR CARRYING CELLULAR TELEPHONES, CELL PHONE FACE PLATES, MAGNETIC CODED CHARGE CARDS, DECORATIVE MAGNETS, PRERECORDED COMPACT DISCS, AUDIO TAPES, VIDEOTAPES AND DVDS FEATURING THE SPORT OF FOOTBALL, COMPUTER GAME SOFTWARE AND DISKS, COMPUTER MOUSE PADS, SUNGLASSES, EYEGLASS CASES, AND CD STORAGE CASES, IN CLASS 9 (U.S. CLS. 21, 23, 26, 36 AND 38).

FIRST USE 1-1-1970; IN COMMERCE 1-1-1970.

FOR: JEWELRY, CLOCKS, PINS, BRACELETS, CHARMS, RINGS, COLLECTIBLE COINS, COMMEMORATIVE COINS, COINS OF PRECIOUS METAL, PENDANTS AND KEY CHAINS MADE OF PRECIOUS METAL, IN CLASS 14 (U.S. CLS. 2, 27, 28 AND 50).

FIRST USE 1-1-1980; IN COMMERCE 1-1-1980.

FOR: POSTERS, CALENDARS, TRADING CARDS, SERIES OF BOOKS RELATING TO FOOTBALL, MAGAZINES RELATING TO FOOTBALL, NEWSLETTERS RELATING TO FOOTBALL, NOTE-PADS, STICKERS, BUMPER STICKERS, PAPER PENNANTS AND GREETING CARDS; PRINTED TICKETS TO SPORTS GAMES AND EVENTS; NOTE PAPER, PICTORIAL PRINTS, PICTURE POSTCARDS, ART PICTURES, STATIONERY, ENVELOPES, STATIONERY-TYPE PORTFOLIOS, CHECKBOOK COVERS, TISSUE PAPER, WRAP-

PING PAPER, PAPER TABLE CLOTHS, PAPER NAPKINS, PAPER PARTY INVITATIONS, PAPER GIFT CARDS; PAPER GIFT BAGS, PAPER DECORATIONS; COLLECTIBLE CARDS; COLLECTIBLE CARD AND MEMORABILIA HOLDERS; SOUVENIR PROGRAMS FOR SPORTS EVENTS; MONEY CLIPS, IN CLASS 16 (U.S. CLS. 2, 5, 22, 23, 29, 37, 38 AND 50).

FIRST USE 1-1-1970; IN COMMERCE 1-1-1970.

FOR: MEN'S, WOMEN'S AND CHILDREN'S CLOTHING, NAMELY, FLEECE TOPS AND BOTTOMS, HEADWEAR, CAPS, KNIT HATS, T-SHIRTS, SHIRTS, TURTLENECKS, SWEATSHIRTS, SHORTS, TANK TOPS, SWEATERS, PANTS, JACKETS, GOLF SHIRTS, KNIT SHIRTS, JERSEYS, WRISTBANDS, WARM UP SUITS, GLOVES, TIES, CLOTH BIBS; SLEEPWEAR, NAMELY, BATHROBES, NIGHT SHIRTS AND PAJAMAS; UNDERWEAR, SOCKS; TOWELS; FOOTWEAR; SNEAKERS, IN CLASS 25 (U.S. CLS. 22 AND 39).

FIRST USE 10-15-1941; IN COMMERCE 10-15-1941.

FOR: TELEVISION BROADCASTING SERVICES; TELEVISION TRANSMISSION SERVICES; CABLE TELEVISION BROADCASTING; RADIO BROADCASTING; BROADCASTING PROGRAMMING ON THE INTERNET; INFORMATION TRANSMISSION VIA ELECTRONIC COMMUNICATIONS NETWORKS; TRANSMISSION OF INFORMATION THROUGH VIDEO COMMUNICATION SYSTEMS; COMMUNICATION SERVICES, NAMELY, AUDIO AND VIDEO BROADCASTING; BROADCASTING SERVICES AND PROVISION OF TELECOMMUNICATION ACCESS TO VIDEO AND AUDIO CONTENT PROVIDED VIA A VIDEO ON DEMAND; STREAMING OF AUDIO MATERIAL ON THE

INTERNET; STREAMING OF VIDEO MATERIAL AND PODCASTS ON THE INTERNET; ELECTRONIC DELIVERY OF IMAGES AND PHOTOS VIA A GLOBAL COMPUTER NETWORK; PROVIDING MULTIPLE-USER ACCESS TO A GLOBAL COMPUTER INFORMATION NETWORK FOR THE PURPOSE OF PARTICIPATING IN INTERACTIVE POLLING IN THE FIELD OF FOOTBALL; WIRELESS COMMUNICATIONS SERVICES, NAMELY, TRANSMISSION OF TEXT, GRAPHICS, DATA, AND ENTERTAINMENT INFORMATION TO MOBILE PHONES; MOBILE MEDIA AND ENTERTAINMENT SERVICES IN THE NATURE OF ELECTRONIC TRANSMISSION OF ENTERTAINMENT MEDIA CONTENT, IN CLASS 38 (U.S. CLS. 100, 101 AND 104).

FIRST USE 6-1-1941; IN COMMERCE 6-1-1941.

FOR: EDUCATION AND ENTERTAINMENT SERVICES IN THE NATURE OF PROFESSIONAL FOOTBALL GAMES AND EXHIBITIONS; PROVIDING SPORTS AND ENTERTAINMENT INFORMATION VIA A GLOBAL COMPUTER NETWORK OR A COMMERCIAL ON-LINE COMPUTER SERVICE OR BY CABLE, SATELLITE, TELEVISION AND RADIO; ARRANGING AND CONDUCTING ATHLETIC COMPETITIONS, NAMELY, PROFESSIONAL FOOTBALL GAMES AND EXHIBITIONS;

FOOTBALL FAN CLUB SERVICES; ENTERTAINMENT SERVICES, NAMELY, MUSICAL AND DANCE PERFORMANCES PROVIDED DURING INTERVALS AT SPORTS EVENTS; EDUCATIONAL SERVICES, NAMELY, PHYSICAL EDUCATION PROGRAMS; PRODUCTION OF RADIO AND TELEVISION PROGRAMS; LIVE SHOWS FEATURING FOOTBALL GAMES, EXHIBITIONS, COMPETITIONS, AND MUSICAL AND DANCE PERFORMANCES; SPORTING AND CULTURAL ACTIVITIES; PUBLICATION OF TEXTS OTHER THAN PUBLICITY TEXTS; DISTRIBUTION OF TELEVISION PROGRAMMING TO CABLE AND SATELLITE TELEVISION SYSTEMS; DISTRIBUTION OF TELEVISION PROGRAMS FOR OTHERS, IN CLASS 41 (U.S. CLS. 100, 101 AND 107).

FIRST USE 6-1-1941; IN COMMERCE 6-1-1941.

THE MARK CONSISTS OF STANDARD CHARACTERS WITHOUT CLAIM TO ANY PARTICULAR FONT, STYLE, SIZE, OR COLOR.

OWNER OF U.S. REG. NOS. 886,055, 2,919,270 AND OTHERS.

SER. NO. 77-177,753, FILED 5-10-2007.

STEPHANIE ALI, EXAMINING ATTORNEY



Int. Cl.: 41

Prior U.S. Cls.: 100, 101 and 107

United States Patent and Trademark Office

Reg. No. 3,394,344

Registered Mar. 11, 2008

SERVICE MARK  
PRINCIPAL REGISTER



DIANE, NAMM (UNITED STATES INDIVIDUAL)  
4940 LATIGO CANYON  
MALIBU, CA 90265

FOR: ENTERTAINMENT IN THE NATURE OF  
THEATER PRODUCTIONS, IN CLASS 41 (U.S. CLS.  
100, 101 AND 107).

FIRST USE 10-14-2006; IN COMMERCE 10-14-2006.

NO CLAIM IS MADE TO THE EXCLUSIVE  
RIGHT TO USE "BROADWAY" AND "A THEATER

COMPANY", APART FROM THE MARK AS  
SHOWN.

THE MARK CONSISTS OF A BOX WITH SCAL-  
LOPED BORDERLINE INCLUDING A SQUARE  
WITH A PALM TREE AND THE WORDS WEST OF  
BROADWAY OFF CENTER AND THE WORDS A  
THEATER COMPANY AT THE BOTTOM.

SER. NO. 77-178,058, FILED 5-10-2007.

ALICE BENMAMAN, EXAMINING ATTORNEY

Int. Cl.: 41

Prior U.S. Cls.: 100, 101 and 107

United States Patent and Trademark Office

Reg. No. 3,394,345

Registered Mar. 11, 2008

SERVICE MARK  
PRINCIPAL REGISTER



DIANE, NAMM (UNITED STATES INDIVIDUAL)  
4940 LATIGO CANYON  
MALIBU, CA 90017

FOR: ENTERTAINMENT IN THE NATURE OF  
THEATER PRODUCTIONS, IN CLASS 41 (U.S. CLS.  
100, 101 AND 107).

FIRST USE 11-15-2006; IN COMMERCE 11-15-2006.

NO CLAIM IS MADE TO THE EXCLUSIVE  
RIGHT TO USE "BROADWAY" AND "A THEATER

COMPANY", APART FROM THE MARK AS  
SHOWN.

THE MARK CONSISTS OF TREE IN FRONT OF A  
CIRCLE THAT HAS TWO STREET SIGNS ON  
EITHER SIDE OF THE TREE AND THE WORDS  
WEST OF BROADWAY AND BELOW THAT THE  
WORDS A THEATER COMPANY.

SER. NO. 77-178,088, FILED 5-10-2007.

ALICE BENMAMAN, EXAMINING ATTORNEY

**Int. Cl.: 30**

**Prior U.S. Cl.: 46**

**United States Patent and Trademark Office**

**Reg. No. 3,394,346**

**Registered Mar. 11, 2008**

**TRADEMARK  
PRINCIPAL REGISTER**

# Light of the Heart

DAUNTAIN, AMY S (UNITED STATES INDIVIDUAL), DBA LIGHT OF THE HEART  
3616 KINGDOM COURT  
VIRGINIA BEACH, VA 23452

THE MARK CONSISTS OF STANDARD CHARACTERS WITHOUT CLAIM TO ANY PARTICULAR FONT, STYLE, SIZE, OR COLOR.

FOR: CANDY BARS WITH PERSONALIZED PRE-PRINTED LABELS FOR USE AT EVENTS, IN CLASS 30 (U.S. CL. 46).

SER. NO. 77-178,817, FILED 5-11-2007.

FIRST USE 2-28-2007; IN COMMERCE 2-28-2007.

KELLEY WELLS, EXAMINING ATTORNEY

**Int. Cl.: 30**

**Prior U.S. Cl.: 46**

**United States Patent and Trademark Office**

**Reg. No. 3,394,347**

**Registered Mar. 11, 2008**

**TRADEMARK  
PRINCIPAL REGISTER**

**Start With A Little  
Add To Your Desire!**

THE SAUCE ENHANCER CO. (WASHINGTON  
CORPORATION)  
6008 119TH STREET SW  
LAKEWOOD, WA 984991214

THE MARK CONSISTS OF STANDARD CHAR-  
ACTERS WITHOUT CLAIM TO ANY PARTICULAR  
FONT, STYLE, SIZE, OR COLOR.

FOR: CHILI SAUCE; HOT SAUCE, IN CLASS 30  
(U.S. CL. 46).

SER. NO. 77-179,053, FILED 5-11-2007.

FIRST USE 7-4-2006; IN COMMERCE 7-4-2006.

LAURIE KAUFMAN, EXAMINING ATTORNEY

**Int. Cl.: 30**

**Prior U.S. Cl.: 46**

**United States Patent and Trademark Office**

**Reg. No. 3,394,348**

**Registered Mar. 11, 2008**

**TRADEMARK  
PRINCIPAL REGISTER**



MAZZIO'S CORPORATION (OKLAHOMA CORPORATION)

4441 SOUTH 72ND EAST AVENUE

TULSA, OK 741454692

FOR: A COMBINATION OF FOOD ITEMS SELECTED FROM A MENU OF FOOD ITEMS, NAMELY, PIZZA, PASTA AND SANDWICHES, IN CLASS 30 (U.S. CL. 46).

FIRST USE 2-27-2007; IN COMMERCE 2-27-2007.

NO CLAIM IS MADE TO THE EXCLUSIVE RIGHT TO USE "MEALS", APART FROM THE MARK AS SHOWN.

THE MARK CONSISTS OF THE WORDS "SOLO MEALS" WITH AN EXCLAMATION POINT AFTER THE WORD "SOLO." A DEPICTION OF A PIZZA REPRESENTS THE CIRCULAR PORTION OF THE EXCLAMATION POINT.

SER. NO. 77-179,113, FILED 5-11-2007.

TIMOTHY FINNEGAN, EXAMINING ATTORNEY

**Int. Cl.: 42**

**Prior U.S. Cls.: 100 and 101**

**United States Patent and Trademark Office**

**Reg. No. 3,394,349**

**Registered Mar. 11, 2008**

**SERVICE MARK  
PRINCIPAL REGISTER**

# FactoryDNA

FACTORYDNA, INC. (TEXAS CORPORATION)  
3925 W. BRAKER LAN  
AUSTIN, TX 78759

FOR: PROVIDING TEMPORARY USE OF ON-LINE DOWNLOADABLE SOFTWARE FOR USE IN DATABASE MANAGEMENT IN THE FIELDS OF INVENTORY, LOGISTICS, AND SUPPLY CHAIN MANAGEMENT; PROVIDING TEMPORARY USE OF NON-DOWNLOADABLE COMPUTER SOFTWARE FOR TRACKING DOCUMENTS RELATING TO INVENTORY, LOGISTICS AND SUPPLY CHAIN MANAGEMENT VIA THE INTERNET; DESIGN, DEVELOPMENT AND IMPLEMENTATION OF COMPUTER SOFTWARE AND CONSULTING SERVICES IN THE FIELD OF COMPUTER SOFTWARE DEVELOPMENT; COMPUTER SERVICES, NAME-

LY, ELECTRONICALLY GATHERING, ANALYZING AND FORMATTING DATA TO TRACK, LOCATE, MONITOR AND LOG OPERATIONS REPORTS RELATED TO MANUFACTURING AND INVENTORY MANAGEMENT, IN CLASS 42 (U.S. CLS. 100 AND 101).

FIRST USE 10-24-2004; IN COMMERCE 10-24-2004.

THE MARK CONSISTS OF STANDARD CHARACTERS WITHOUT CLAIM TO ANY PARTICULAR FONT, STYLE, SIZE, OR COLOR.

SER. NO. 77-179,270, FILED 5-11-2007.

BERYL GARDNER, EXAMINING ATTORNEY

**Int. Cl.: 35**

**Prior U.S. Cls.: 100, 101 and 102**

**United States Patent and Trademark Office**

**Reg. No. 3,394,350**

**Registered Mar. 11, 2008**

---

**SERVICE MARK  
PRINCIPAL REGISTER**

**The Grey Dove**

SHARLEXJAM CORP. (NEW JERSEY CORPORATION)  
159 SOUTH LIVINGSTON AVENUE  
LIVINGSTON, NJ 07039

THE MARK CONSISTS OF STANDARD CHARACTERS WITHOUT CLAIM TO ANY PARTICULAR FONT, STYLE, SIZE, OR COLOR.

FOR: RETAIL GIFT SHOPS, IN CLASS 35 (U.S. CLS. 100, 101 AND 102).

SER. NO. 77-179,793, FILED 5-14-2007.

FIRST USE 9-1-1981; IN COMMERCE 9-1-1981.

ELISSA GARBER KON, EXAMINING ATTORNEY

**Int. Cls.: 35 and 36**

**Prior U.S. Cls.: 100, 101 and 102**

**United States Patent and Trademark Office**

**Reg. No. 3,394,351**

**Registered Mar. 11, 2008**

**SERVICE MARK  
PRINCIPAL REGISTER**

**THE HARVEY FELLOWS**

MUSTARD SEED FOUNDATION (SOUTH CAROLINA CORPORATION)  
SUITE 100  
3330 N. WASHINGTON BOULEVARD  
ARLINGTON, VA 22201

FOR: PROMOTING THE INTERESTS OF PEOPLE INVOLVED AND CONCERNED WITH INTEGRATING THEIR FAITH AND VOCATION AND PURSUING LEADERSHIP POSITIONS IN STRATEGIC FIELDS WHERE CHRISTIANS TEND TO BE UNDER-REPRESENTED, IN CLASS 35 (U.S. CLS. 100, 101 AND 102).

FIRST USE 3-1-1992; IN COMMERCE 3-1-1992.

FOR: PROVIDING FINANCIAL SPONSORSHIP TO GRADUATE STUDENTS FOR EDUCATIONAL FEES, IN CLASS 36 (U.S. CLS. 100, 101 AND 102).

FIRST USE 3-1-1992; IN COMMERCE 3-1-1992.

THE MARK CONSISTS OF STANDARD CHARACTERS WITHOUT CLAIM TO ANY PARTICULAR FONT, STYLE, SIZE, OR COLOR.

SER. NO. 77-180,141, FILED 5-14-2007.

LINDA MICKLEBURGH, EXAMINING ATTORNEY



**Int. Cls.: 36 and 37**

**Prior U.S. Cls.: 100, 101, 102, 103 and 106**

**United States Patent and Trademark Office**

**Reg. No. 3,394,352**

**Registered Mar. 11, 2008**

**SERVICE MARK  
PRINCIPAL REGISTER**

**PIERSON-GIBBS**

PIERSON-GIBBS HOMES, INC. (MICHIGAN CORPORATION)  
PO BOX 488  
8706 GRATIOT AVE.  
RICHMOND, MI 48062

FOR: CONSTRUCTION LOAN FINANCING SERVICES, IN CLASS 36 (U.S. CLS. 100, 101 AND 102).

FIRST USE 6-1-1984; IN COMMERCE 6-1-1984.

FOR: CONSTRUCTING RESIDENTIAL HOMES FOR OTHERS; CUSTOM HOME CONSTRUCTION SERVICES; CONSULTING SERVICES IN CONNECTION WITH CONSTRUCTING RESIDENTIAL

HOMES FOR OTHERS; CUSTOM HOME CONSTRUCTION CONSULTING SERVICES, IN CLASS 37 (U.S. CLS. 100, 103 AND 106).

FIRST USE 6-1-1984; IN COMMERCE 6-1-1984.

THE MARK CONSISTS OF STANDARD CHARACTERS WITHOUT CLAIM TO ANY PARTICULAR FONT, STYLE, SIZE, OR COLOR.

SER. NO. 77-181,438, FILED 5-15-2007.

REBECCA EISINGER, EXAMINING ATTORNEY

**Int. Cls.: 36 and 37**

**Prior U.S. Cls.: 100, 101, 102, 103 and 106**

**United States Patent and Trademark Office**

**Reg. No. 3,394,353**

**Registered Mar. 11, 2008**

**SERVICE MARK  
PRINCIPAL REGISTER**

**PIERSON-GIBBS HOMES**

PIERSON-GIBBS HOMES, INC. (MICHIGAN CORPORATION)  
PO BOX 488  
8706 GRATIOT AVE.  
RICHMOND, MI 48062

FOR: CONSTRUCTION LOAN FINANCING SERVICES, IN CLASS 36 (U.S. CLS. 100, 101 AND 102).

FIRST USE 6-1-1984; IN COMMERCE 6-1-1984.

FOR: CONSTRUCTING RESIDENTIAL HOMES FOR OTHERS; CUSTOM HOME CONSTRUCTION SERVICES; CONSULTING SERVICES IN CONNECTION WITH CONSTRUCTING RESIDENTIAL HOMES FOR OTHERS; CUSTOM HOME CON-

STRUCTION CONSULTING SERVICES, IN CLASS 37 (U.S. CLS. 100, 103 AND 106).

FIRST USE 6-1-1984; IN COMMERCE 6-1-1984.

THE MARK CONSISTS OF STANDARD CHARACTERS WITHOUT CLAIM TO ANY PARTICULAR FONT, STYLE, SIZE, OR COLOR.

NO CLAIM IS MADE TO THE EXCLUSIVE RIGHT TO USE "HOMES", APART FROM THE MARK AS SHOWN.

SER. NO. 77-181,452, FILED 5-15-2007.

REBECCA EISINGER, EXAMINING ATTORNEY

**Int. Cl.: 33**

**Prior U.S. Cls.: 47 and 49**

**United States Patent and Trademark Office**

**Reg. No. 3,394,354**

**Registered Mar. 11, 2008**

**TRADEMARK  
PRINCIPAL REGISTER**

**HANNAH NICOLE VINEYARDS**

HANNAH NICOLE VINEYARDS, INC. (CALI-  
FORNIA CORPORATION)  
P.O. BOX 309  
6740 BALFOUR ROAD  
BRENTWOOD, CA 94513

FOR: WINES, IN CLASS 33 (U.S. CLS. 47 AND 49).

FIRST USE 5-15-2001; IN COMMERCE 5-1-2003.

THE MARK CONSISTS OF STANDARD CHAR-  
ACTERS WITHOUT CLAIM TO ANY PARTICULAR  
FONT, STYLE, SIZE, OR COLOR.

NO CLAIM IS MADE TO THE EXCLUSIVE  
RIGHT TO USE "VINEYARDS", APART FROM  
THE MARK AS SHOWN.

THE NAME(S), PORTRAIT(S), AND/OR SIGNA-  
TURE(S) SHOWN IN THE MARK DOES NOT IDEN-  
TIFY A PARTICULAR LIVING INDIVIDUAL.

SER. NO. 77-181,757, FILED 5-15-2007.

PETER B. BROMAGHIM, EXAMINING ATTORNEY

**Int. Cls.: 16 and 24**

**Prior U.S. Cls.: 2, 5, 22, 23, 29, 37, 38, 42 and 50**

**United States Patent and Trademark Office**

**Reg. No. 3,394,355**

**Registered Mar. 11, 2008**

**TRADEMARK  
PRINCIPAL REGISTER**

# CherryTreeArt

BAUMBUSCH, CHERRY (UNITED STATES INDIVIDUAL)  
1436 HIGHWOOD DRIVE  
MCLEAN, VA 22101

FOR: ART PRINTS; WORKS OF ART MADE FROM CUSTOM MANUFACTURED PAPER; PRINTED ART REPRODUCTIONS; ART ETCHINGS; GRAPHIC ART REPRODUCTIONS; ART PICTURES, IN CLASS 16 (U.S. CLS. 2, 5, 22, 23, 29, 37, 38 AND 50).

FIRST USE 4-1-2007; IN COMMERCE 4-30-2007.

FOR: GIFT WRAP OF TEXTILE; TEXTILE FABRICS FOR HOME AND COMMERCIAL INTERIORS;

TEXTILE FABRICS FOR LINGERIE; TEXTILE FABRICS FOR THE MANUFACTURE OF CLOTHING; TEXTILE WALL HANGINGS, IN CLASS 24 (U.S. CLS. 42 AND 50).

FIRST USE 4-1-2007; IN COMMERCE 4-30-2007.

THE MARK CONSISTS OF STANDARD CHARACTERS WITHOUT CLAIM TO ANY PARTICULAR FONT, STYLE, SIZE, OR COLOR.

SER. NO. 77-182,245, FILED 5-16-2007.

AMY MCMENAMIN, EXAMINING ATTORNEY

Int. Cl.: 35

Prior U.S. Cls.: 100, 101 and 102

United States Patent and Trademark Office

Reg. No. 3,394,356

Registered Mar. 11, 2008

SERVICE MARK  
PRINCIPAL REGISTER



READY TO HIRE, INC. (PENNSYLVANIA LIMITED PARTNERSHIP)  
630 FITZWATERTOWN RD, BLDG B-1  
WILLOW GROVE, PA 19090

FOR: PROVIDING AN ON-LINE COMPUTER DATABASE FEATURING PRE-SCREENED AND PRE-QUALIFIED PROFESSIONALS FOR POTENTIAL EMPLOYMENT, IN CLASS 35 (U.S. CLS. 100, 101 AND 102).

FIRST USE 2-22-2007; IN COMMERCE 2-22-2007.

THE COLOR(S) RED, GREEN, BLACK AND WHITE IS/ARE CLAIMED AS A FEATURE OF THE MARK.

THE MARK CONSISTS OF A RED CHECK SITTING ON TOP OF A BULLS-EYE. THE BULLS-EYE CONSISTS OF A GREEN CIRCLE AT THE MIDDLE WITH A WHITE RING OUTSIDE OF THAT AND A RED RING FORMING THE OUTERMOST BORDER. BELOW THAT ARE THE WORDS "READY TO" IN BLACK AND "HIRE" IN GREEN. BELOW THAT IS THE PHRASE "MEET THE ELITE." IN BLACK.

SER. NO. 77-182,467, FILED 5-16-2007.

JESSICA A. POWERS, EXAMINING ATTORNEY

Int. Cl.: 32

Prior U.S. Cls.: 45, 46 and 48

United States Patent and Trademark Office

Reg. No. 3,394,357

Registered Mar. 11, 2008

TRADEMARK  
PRINCIPAL REGISTER

**MASH**  
A W A T E R D R I N K  
C I T R U S  
Z I N G

BOYLAN BOTTLING CO. (DELAWARE CORPORATION)  
7 PURCELL COURT  
MOONACHIE, NJ 07074

FOR: NON-ALCOHOLIC BEVERAGES, NAMELY, CARBONATED BEVERAGES; SYRUPS FOR MAKING SOFT DRINKS, IN CLASS 32 (U.S. CLS. 45, 46 AND 48).

FIRST USE 4-23-2007; IN COMMERCE 4-23-2007.

NO CLAIM IS MADE TO THE EXCLUSIVE RIGHT TO USE "MASH A WATER DRINK CITRUS", APART FROM THE MARK AS SHOWN.

THE MARK CONSISTS OF THE WORDING MASH A WATER DRINK CITRUS ZING.

SER. NO. 77-183,338, FILED 5-17-2007.

LINDA E. BLOHM, EXAMINING ATTORNEY

**Int. Cl.: 35**

**Prior U.S. Cls.: 100, 101 and 102**

**United States Patent and Trademark Office**

**Reg. No. 3,394,358**

**Registered Mar. 11, 2008**

**SERVICE MARK  
PRINCIPAL REGISTER**

# All-Area Sports

ALL-AREA SPORTS, LLC (ILLINOIS LTD LIAB  
CO)  
703 EASTWOOD CENTER DR.  
MAHOMET, IL 61853

FOR: RETAIL STORES FEATURING LOGO WEAR, NAMELY, SPORTSWEAR, INCLUDING PULLOVERS, JACKETS, SWEATSUITS, T SHIRTS, POLOS, SHORTS, CASUAL WEAR, PHYSICAL EDUCATION OUTFITS, JERSEYS, UNIFORMS, PRACTICE GEAR, AND WARM-UP SUITS, AND HEADWEAR, INCLUDING CAPS, HATS, BEANIES, WINTERWEAR, AND HEADBANDS; AND LOGO ITEMS, NAMELY, JEWELRY, SPORTS BOOKS, PENS, PENCILS, MUGS, GLASSWARE, FLAGS, STATIC CLINGS, BUMPER STICKERS, LICENSE PLATE FRAMES, INSULATED SLEEVE HOLDERS FOR BEVERAGES, SPORTS COLLECTIBLES AND NOVELTY ITEMS, ALL FOR SPORTS TEAMS; AND GENERAL SPORTING MERCHANDISE, NAMELY, PROTECTIVE GEAR AND MEDICAL ITEMS SUCH AS ATHLETIC TAPE, BRACES, PROTECTIVE SUP-

PORTERS, MOUTH GUARDS, SLIDING PADS, KNEE PADS, GIRDLE PADS, AND CATCHER'S GEAR, AND EQUIPMENT SUCH AS BALLS, BATS, BASES, PHYSICAL EDUCATION AND RECESS SUPPLIES AND GLOVES, IN CLASS 35 (U.S. CLS. 100, 101 AND 102).

FIRST USE 8-1-2004; IN COMMERCE 1-1-2006.

THE MARK CONSISTS OF STANDARD CHARACTERS WITHOUT CLAIM TO ANY PARTICULAR FONT, STYLE, SIZE, OR COLOR.

NO CLAIM IS MADE TO THE EXCLUSIVE RIGHT TO USE "SPORTS", APART FROM THE MARK AS SHOWN.

SER. NO. 77-183,847, FILED 5-17-2007.

KEVIN DINALLO, EXAMINING ATTORNEY

**Int. Cl.: 6**

**Prior U.S. Cls.: 2, 12, 13, 14, 23, 25 and 50**

**United States Patent and Trademark Office**

**Reg. No. 3,394,359**

**Registered Mar. 11, 2008**

**TRADEMARK  
PRINCIPAL REGISTER**

**INFINITY**

OPSTOCK, INC. (MICHIGAN CORPORATION)  
4250 TRAIL EAST DRIVE, NE  
ADA, MI 49301

THE MARK CONSISTS OF STANDARD CHAR-  
ACTERS WITHOUT CLAIM TO ANY PARTICULAR  
FONT, STYLE, SIZE, OR COLOR.

FOR: METAL CONSTRUCTION MATERIALS,  
NAMELY, AIR GRATES USED IN RAISED FLOOR  
SYSTEMS, IN CLASS 6 (U.S. CLS. 2, 12, 13, 14, 23, 25  
AND 50).

SER. NO. 77-186,040, FILED 5-21-2007.

FIRST USE 9-1-2006; IN COMMERCE 9-1-2006.

TINA L. SNAPP, EXAMINING ATTORNEY



**Int. Cl.: 25**

**Prior U.S. Cls.: 22 and 39**

**United States Patent and Trademark Office**

**Reg. No. 3,394,360**

**Registered Mar. 11, 2008**

**TRADEMARK  
PRINCIPAL REGISTER**



GIRLEE BIKER WEAR, LLC (CALIFORNIA LTD  
LIAB CO)  
9631 POLLACK DRIVE  
HUNTINGTON BEACH, CA 92646

FOR: WOMEN'S CLOTHING AND APPAREL,  
NAMELY, BLOUSES, TANK TOPS, CAMISOLES,  
SHIRTS, SWEATSHIRTS, HATS, AND JACKETS, IN  
CLASS 25 (U.S. CLS. 22 AND 39).

FIRST USE 11-0-2001; IN COMMERCE 9-0-2005.

NO CLAIM IS MADE TO THE EXCLUSIVE  
RIGHT TO USE "BIKER WEAR", APART FROM  
THE MARK AS SHOWN.

THE COLOR(S) PINK, WHITE AND BLACK IS/  
ARE CLAIMED AS A FEATURE OF THE MARK.

THE MARK CONSISTS OF A STYLIZED WHITE  
SKULL AND CROSSBONES DESIGN ON THE  
BLACK BACKGROUND WITH A PINK BOW, AND  
THE WORDING GIRLEE BIKER WEAR IN BLACK  
IN THE CROSSBONES.

SER. NO. 77-186,059, FILED 5-21-2007.

FLORENTINA BLANDU, EXAMINING ATTORNEY

**Int. Cl.: 41**

**Prior U.S. Cls.: 100, 101 and 107**

**United States Patent and Trademark Office**

**Reg. No. 3,394,361**

**Registered Mar. 11, 2008**

**SERVICE MARK  
PRINCIPAL REGISTER**

**WESTERCON**

LOS ANGELES SCIENCE FANTASY SOCIETY,  
INC. (CALIFORNIA CORPORATION)  
11513 BURBANK BLVD.  
N. HOLLYWOOD, CA 91601

THE MARK CONSISTS OF STANDARD CHAR-  
ACTERS WITHOUT CLAIM TO ANY PARTICULAR  
FONT, STYLE, SIZE, OR COLOR.

FOR: ORGANIZING EXHIBITIONS FOR SCI-  
ENCE FICTION AND FANTASY CONVENTIONS,  
IN CLASS 41 (U.S. CLS. 100, 101 AND 107).

SER. NO. 77-186,441, FILED 5-21-2007.

FIRST USE 1-1-1990; IN COMMERCE 1-1-1990.

JUDITH HELFMAN, EXAMINING ATTORNEY

**Int. Cls.: 9 and 42**

**Prior U.S. Cls.: 21, 23, 26, 36, 38, 100 and 101**

**United States Patent and Trademark Office**

**Reg. No. 3,394,362**

**Registered Mar. 11, 2008**

**TRADEMARK  
SERVICE MARK  
PRINCIPAL REGISTER**



MYTRAK HEALTH SYSTEM INC. (CANADA CORPORATION)  
UNIT 10  
3250 RIDGEWAY DRIVE  
MISSISSAUGA, CANADA L5L5Y6

FOR: COMPUTER HARDWARE AND SOFTWARE FOR ESTIMATING AND DISPLAYING A GRAPHICAL SUMMARY OF WEIGHT GAIN AND WEIGHT LOSS SCENARIOS ARISING AS A RESULT OF AN EXERCISE AND DIETARY REGIME, FEATURING A PERSONAL DIGITAL ASSISTANT (PDA) FOR MONITORING CALORIC EXPENDITURE AND RECORDING DIETARY INTAKE, COMPUTER SOFTWARE FOR ANALYZING AND DISPLAYING PROJECTED WEIGHT GAIN AND WEIGHT LOSS SCENARIOS ARISING AS A RESULT OF THE MONITORED CALORIC EXPENDITURE AND RECORDED DIETARY INTAKE; COMPUTER HARDWARE AND SOFTWARE FOR CONTINUOUSLY ANALYZING THE FUNCTIONAL BEHAVIORS OF THE MUSCULOSKELETAL AND CARDIOVASCULAR SYSTEMS OF A PERSON ENGAGED IN AN EXERCISE PROGRAM, FEATURING A PERSONAL DIGITAL ASSISTANT (PDA) FOR MONITORING PHYSICAL ACTIVITY AND DISPLAYING FEEDBACK ON THE PDA SCREEN WHICH GUIDES THE USER THROUGH THE EXERCISE PROGRAM, IN CLASS 9 (U.S. CLS. 21, 23, 26, 36 AND 38).

FIRST USE 1-0-2005; IN COMMERCE 11-0-2005.

FOR: SUBSCRIPTION-BASED APPLICATION SERVICE PROVIDER (ASP) SERVICES FEATURING COMPUTER SOFTWARE FOR ESTIMATING AND DISPLAYING A GRAPHICAL SUMMARY OF WEIGHT GAIN AND WEIGHT LOSS SCENARIOS ARISING AS A RESULT OF AN EXERCISE AND

DIETARY REGIME, COMPUTER SOFTWARE TO BE USED WITH A PERSONAL DIGITAL ASSISTANT (PDA) FOR MONITORING CALORIC EXPENDITURE AND RECORDING DIETARY INTAKE, COMPUTER SOFTWARE FOR ANALYZING AND DISPLAYING PROJECTED WEIGHT GAIN AND WEIGHT LOSS SCENARIOS ARISING AS A RESULT OF THE MONITORED CALORIC EXPENDITURE AND RECORDED DIETARY INTAKE, AND COMPUTER SOFTWARE FOR THE DISPLAY AND MONITORING OF THE PROJECTED WEIGHT GAIN AND WEIGHT LOSS SCENARIOS OF ONE OR MORE INDIVIDUALS PARTICIPATING IN EXERCISE, WEIGHT-LOSS AND OBESITY, OR WELLNESS PROGRAMS; SUBSCRIPTION-BASED APPLICATION SERVICE PROVIDER (ASP) SERVICES FEATURING COMPUTER SOFTWARE FOR CONTINUOUSLY ANALYZING THE FUNCTIONAL BEHAVIORS OF THE MUSCULOSKELETAL AND CARDIOVASCULAR SYSTEMS OF A PERSON ENGAGED IN AN EXERCISE PROGRAM, COMPUTER SOFTWARE TO BE USED WITH A PERSONAL DIGITAL ASSISTANT (PDA) FOR MONITORING PHYSICAL ACTIVITY AND DISPLAYING FEEDBACK ON THE PDA SCREEN WHICH GUIDES THE USER THROUGH THE EXERCISE PROGRAM; APPLICATION SERVICE PROVIDER (ASP) SERVICES FEATURING A HUMAN PERFORMANCE COMPUTER DATABASE ACCESSIBLE BY A PERSON ENGAGED IN AN EXERCISE AND DIETARY REGIME VIA A WEBSITE ACCESSIBLE BY MEANS OF A LOCAL AREA NETWORK OR THE INTERNET, AND FEATURING THE GRAPHICAL SUMMARY AND DISPLAY OF THE PROJECTED WEIGHT GAIN AND WEIGHT LOSS SCENARIOS OF ONE OR MORE INDIVIDUALS PARTICIPATING IN EXERCISE, WEIGHT LOSS AND OBESITY OR WELLNESS PROGRAMS, IN CLASS 42 (U.S. CLS. 100 AND 101).

FIRST USE 1-0-2005; IN COMMERCE 11-0-2005.

SER. NO. 77-186,955, FILED 5-22-2007.

THE MARK CONSISTS OF THE WORD MYTRAK  
IN STYLIZED FORM WITH THE LETTER Y CON-  
SISTING OF A STYLIZED HUMAN FIGURE.

MICHAEL LITZAU, EXAMINING ATTORNEY

**Int. Cl.: 43**

**Prior U.S. Cls.: 100 and 101**

**United States Patent and Trademark Office**

**Reg. No. 3,394,363**

**Registered Mar. 11, 2008**

**SERVICE MARK  
PRINCIPAL REGISTER**

# Rise Lounge

GERBER GROUP LIMITED PARTNERSHIP  
(NEW YORK LIMITED PARTNERSHIP)  
12TH FLOOR  
145 E 57TH STREET  
NEW YORK, NY 10022

FOR: RESTAURANT AND BAR SERVICES, IN  
CLASS 43 (U.S. CLS. 100 AND 101).

FIRST USE 5-22-2007; IN COMMERCE 5-22-2007.

THE MARK CONSISTS OF STANDARD CHAR-  
ACTERS WITHOUT CLAIM TO ANY PARTICULAR  
FONT, STYLE, SIZE, OR COLOR.

NO CLAIM IS MADE TO THE EXCLUSIVE  
RIGHT TO USE "LOUNGE", APART FROM THE  
MARK AS SHOWN.

SER. NO. 77-187,145, FILED 5-22-2007.

JESSICA A. POWERS, EXAMINING ATTORNEY

**Int. Cl.: 12**

**Prior U.S. Cls.: 19, 21, 23, 31, 35 and 44**

**United States Patent and Trademark Office**

**Reg. No. 3,394,364**

**Registered Mar. 11, 2008**

**TRADEMARK  
PRINCIPAL REGISTER**

**EQUIPTER**

AARON JAY BEILER (UNITED STATES INDIVIDUAL)  
11 TOWNSHIP DR.  
PARADISE, PA 17562

THE MARK CONSISTS OF STANDARD CHARACTERS WITHOUT CLAIM TO ANY PARTICULAR FONT, STYLE, SIZE, OR COLOR.

FOR: SELF PROPELLED ROAD TRAILERS FOR USE IN CONSTRUCTION, ROOFING, LANDSCAPING, AND TRASH REMOVAL, IN CLASS 12 (U.S. CLS. 19, 21, 23, 31, 35 AND 44).

SER. NO. 77-187,193, FILED 5-22-2007.

FIRST USE 9-4-2006; IN COMMERCE 9-15-2006.

LESLEY LAMOTHE, EXAMINING ATTORNEY

**Int. Cl.: 35**

**Prior U.S. Cls.: 100, 101 and 102**

**United States Patent and Trademark Office**

**Reg. No. 3,394,365**

**Registered Mar. 11, 2008**

**SERVICE MARK  
PRINCIPAL REGISTER**

**CLEAN**

FUSION BRANDS INTERNATIONAL SRL (BARBADOS COMPANY)  
GROVE, 21 PINE ROAD  
BELLEVILLE ST. MICHAEL, BARBADOS BB11113

THE MARK CONSISTS OF STANDARD CHARACTERS WITHOUT CLAIM TO ANY PARTICULAR FONT, STYLE, SIZE, OR COLOR.

FOR: ONLINE RETAIL STORE SERVICES FEATURING BEAUTY PRODUCTS, IN CLASS 35 (U.S. CLS. 100, 101 AND 102).

SER. NO. 77-187,747, FILED 5-22-2007.

FIRST USE 2-0-2003; IN COMMERCE 2-0-2003.

JESSICA A. POWERS, EXAMINING ATTORNEY

**Int. Cl.: 29**

**Prior U.S. Cl.: 46**

**United States Patent and Trademark Office**

**Reg. No. 3,394,366**

**Registered Mar. 11, 2008**

**TRADEMARK  
PRINCIPAL REGISTER**

**BURGUNDY PASTURE BEEF**

BURGUNDY PASTURE BEEF (TEXAS PART-  
NERSHIP)

800 MCDUFF AVE

GRANDVIEW, TX 76050

FOR: PROCESSED MEAT, NAMELY, BEEF;  
BEEF, IN CLASS 29 (U.S. CL. 46).

FIRST USE 1-1-2002; IN COMMERCE 1-1-2002.

THE MARK CONSISTS OF STANDARD CHAR-  
ACTERS WITHOUT CLAIM TO ANY PARTICULAR  
FONT, STYLE, SIZE, OR COLOR.

NO CLAIM IS MADE TO THE EXCLUSIVE  
RIGHT TO USE "PASTURE BEEF", APART FROM  
THE MARK AS SHOWN.

SER. NO. 77-188,243, FILED 5-23-2007.

STEPHANIE ALI, EXAMINING ATTORNEY



**Int. Cl.: 36**

**Prior U.S. Cls.: 100, 101 and 102**

**United States Patent and Trademark Office**

**Reg. No. 3,394,367**

**Registered Mar. 11, 2008**

**SERVICE MARK  
PRINCIPAL REGISTER**

**MetWest International**

METROPOLITAN LIFE INSURANCE COMPANY  
(NEW YORK CORPORATION)  
1 METLIFE PLAZA, 27-01 QUEENS PLAZA NO.  
LONG ISLAND CITY, NY 11101

FOR: REAL ESTATE LEASING AND MANAGE-  
MENT SERVICES, IN CLASS 36 (U.S. CLS. 100, 101  
AND 102).

FIRST USE 5-17-2007; IN COMMERCE 5-17-2007.

THE MARK CONSISTS OF STANDARD CHAR-  
ACTERS WITHOUT CLAIM TO ANY PARTICULAR  
FONT, STYLE, SIZE, OR COLOR.

NO CLAIM IS MADE TO THE EXCLUSIVE  
RIGHT TO USE "INTERNATIONAL", APART  
FROM THE MARK AS SHOWN.

SER. NO. 77-188,480, FILED 5-23-2007.

PAUL MORENO, EXAMINING ATTORNEY

**Int. Cls.: 35 and 39**

**Prior U.S. Cls.: 100, 101, 102 and 105**

**United States Patent and Trademark Office**

**Reg. No. 3,394,368**

**Registered Mar. 11, 2008**

**SERVICE MARK  
PRINCIPAL REGISTER**



NEWPORT LEASE AND RENTAL (CALIFORNIA CORPORATION)  
7400 CENTER DRIVE, SUITE 105  
HUNTINGTON BEACH, CA 92647

FOR: RETAIL STORE SERVICES FEATURING USED AUTO PARTS THAT HAVE BEEN SALVAGED BY CUSTOMERS, IN CLASS 35 (U.S. CLS. 100, 101 AND 102).

FIRST USE 11-26-1987; IN COMMERCE 11-26-1987.

FOR: AUTO SALVAGE YARD SERVICES, IN CLASS 39 (U.S. CLS. 100 AND 105).

FIRST USE 11-26-1987; IN COMMERCE 11-26-1987.

SER. NO. 77-188,691, FILED 5-23-2007.

JUDITH HELFMAN, EXAMINING ATTORNEY

**Int. Cl.: 36**

**Prior U.S. Cls.: 100, 101 and 102**

**United States Patent and Trademark Office**

**Reg. No. 3,394,369**

**Registered Mar. 11, 2008**

**SERVICE MARK  
PRINCIPAL REGISTER**

**CVHOC High School Benefit  
Show**

CONEJO VALLEY HARMONY OAKS CHORUS,  
INC. (CALIFORNIA CORPORATION)  
5624 FAUST AVENUE  
WOODLAND HILLS, CA 91367

FOR: CHARITABLE FUND RAISING SERVICES  
BY MEANS OF A MUSICAL AND VARIETY PRO-  
GRAM TO SOLICIT FUNDS FROM CONTRIBU-  
TORS IN ORDER TO ADVANCE HIGH SCHOOL  
CHORAL PROGRAMS THROUGH EDUCATING  
AND TRAINING TEACHERS AND STUDENTS  
ALIKE, IN CLASS 36 (U.S. CLS. 100, 101 AND 102).

FIRST USE 3-6-2007; IN COMMERCE 5-1-2007.

THE MARK CONSISTS OF STANDARD CHAR-  
ACTERS WITHOUT CLAIM TO ANY PARTICULAR  
FONT, STYLE, SIZE, OR COLOR.

NO CLAIM IS MADE TO THE EXCLUSIVE  
RIGHT TO USE "HIGH SCHOOL BENEFIT SHOW",  
APART FROM THE MARK AS SHOWN.

SER. NO. 77-189,336, FILED 5-24-2007.

KATHERINE CONNOLLY, EXAMINING ATTOR-  
NEY

**Int. Cl.: 35**

**Prior U.S. Cls.: 100, 101 and 102**

**United States Patent and Trademark Office**

**Reg. No. 3,394,370**

**Registered Mar. 11, 2008**

**SERVICE MARK  
PRINCIPAL REGISTER**

# CalcuL8

LEUTZINGER, JOSEPH A. (UNITED STATES  
INDIVIDUAL)  
P.O. BOX 241434  
OMAHA, NE 681245434 AND  
CHENOWETH, DAVID H. (UNITED STATES INDI-  
VIDUAL)  
P.O. BOX 241434  
OMAHA, NE 681245434

FOR: BUSINESS EVALUATION OF HEALTH  
STATUS AND PRODUCTIVITY , IN CLASS 35 (U.S.  
CLS. 100, 101 AND 102).

FIRST USE 6-1-2006; IN COMMERCE 9-1-2006.

THE MARK CONSISTS OF STANDARD CHAR-  
ACTERS WITHOUT CLAIM TO ANY PARTICULAR  
FONT, STYLE, SIZE, OR COLOR.

SER. NO. 77-189,355, FILED 5-24-2007.

FRANK LATTUCA, EXAMINING ATTORNEY

**Int. Cl.: 45**

**Prior U.S. Cls.: 100 and 101**

**United States Patent and Trademark Office**

**Reg. No. 3,394,371**

**Registered Mar. 11, 2008**

**SERVICE MARK  
PRINCIPAL REGISTER**

**We're ClientCentric**

IRWIN FRITCHIE URQUHART & MOORE LLC  
(LOUISIANA LTD LIAB CO)  
400 POYDRAS STREET, SUITE 2700  
NEW ORLEANS, LA 70130

THE MARK CONSISTS OF STANDARD CHAR-  
ACTERS WITHOUT CLAIM TO ANY PARTICULAR  
FONT, STYLE, SIZE, OR COLOR.

FOR: LEGAL SERVICES, IN CLASS 45 (U.S. CLS.  
100 AND 101).

SER. NO. 77-189,906, FILED 5-24-2007.

FIRST USE 5-22-2006; IN COMMERCE 5-22-2006.

WON TEAK OH, EXAMINING ATTORNEY

**Int. Cl.: 35**

**Prior U.S. Cls.: 100, 101 and 102**

**United States Patent and Trademark Office**

**Reg. No. 3,394,372**

**Registered Mar. 11, 2008**

**SERVICE MARK  
PRINCIPAL REGISTER**

**diversity recruitment solution**

IHISPANO.COM, LLC (ILLINOIS LTD LIAB CO)  
SUITE 300  
4265 NORTH KNOX AVENUE  
CHICAGO, IL 60641

FOR: PERSONNEL PLACEMENT AND RE-  
CRUITMENT, IN CLASS 35 (U.S. CLS. 100, 101 AND  
102).

FIRST USE 6-0-2006; IN COMMERCE 6-0-2006.

NO CLAIM IS MADE TO THE EXCLUSIVE  
RIGHT TO USE "DIVERSITY RECRUITMENT",  
APART FROM THE MARK AS SHOWN.

THE MARK CONSISTS OF THE LETTERS DRS  
AND THE WORDS DIVERSITY RECRUITMENT  
SOLUTION. THE MARK IS NOT IN COLOR.

SER. NO. 77-190,108, FILED 5-24-2007.

DOMINICK J. SALEMI, EXAMINING ATTORNEY

Int. Cl.: 32

Prior U.S. Cls.: 45, 46 and 48

United States Patent and Trademark Office

Reg. No. 3,394,373

Registered Mar. 11, 2008

TRADEMARK  
PRINCIPAL REGISTER

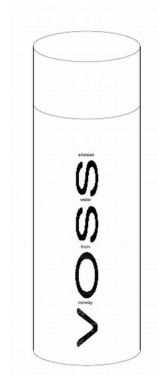

VOSS OF NORWAY ASA (NORWAY CORPORATION)  
HOVFARET 17A  
OSLO, NORWAY 0275

NO CLAIM IS MADE TO THE EXCLUSIVE  
RIGHT TO USE "ARTESIAN WATER FROM NOR-  
WAY", APART FROM THE MARK AS SHOWN.

FOR: DRINKING WATER, IN CLASS 32 (U.S. CLS.  
45, 46 AND 48).

SEC. 2(F) AS TO THE BOTTLE DESIGN.

FIRST USE 11-18-2000; IN COMMERCE 11-18-2000.

SER. NO. 77-190,585, FILED 5-25-2007.

OWNER OF U.S. REG. NOS. 2,696,925, 3,259,981  
AND OTHERS.

KAREN SEVERSON, EXAMINING ATTORNEY

**Int. Cl.: 41**

**Prior U.S. Cls.: 100, 101 and 107**

**United States Patent and Trademark Office**

**Reg. No. 3,394,374**

**Registered Mar. 11, 2008**

**SERVICE MARK  
PRINCIPAL REGISTER**

# KEYS TO BE

PAUL COLLOM INVESTMENTS, INC. (MICHIGAN CORPORATION)  
3320 BOURBON STREET  
ENGLEWOOD, FL 34224

FOR: ENTERTAINMENT SERVICES IN THE NATURE OF LIVE VOCAL AND INSTRUMENTAL MUSICAL PERFORMANCES, IN CLASS 41 (U.S. CLS. 100, 101 AND 107).

FIRST USE 4-28-2007; IN COMMERCE 4-28-2007.

THE MARK CONSISTS OF STANDARD CHARACTERS WITHOUT CLAIM TO ANY PARTICULAR FONT, STYLE, SIZE, OR COLOR.

SER. NO. 77-191,172, FILED 5-26-2007.

CAROLYN CATALDO, EXAMINING ATTORNEY



**Int. Cls.: 35 and 41**

**Prior U.S. Cls.: 100, 101, 102 and 107**

**United States Patent and Trademark Office**

**Reg. No. 3,394,375**

**Registered Mar. 11, 2008**

**SERVICE MARK  
PRINCIPAL REGISTER**

# CASINOTES

PROJECTSTORY, INC. (ILLINOIS CORPORATION)  
308 SOUTH GROVE AVENUE  
OAK PARK, IL 60302

FOR: BUSINESS MANAGEMENT SERVICES, NAMELY, PROVIDING BUSINESS DOCUMENTATION SERVICES FOR OTHERS IN THE NATURE OF WEB-BASED AND PAPER-BASED OPERATIONAL AND CORRESPONDING BUSINESS WORKFLOW AND PROCEDURE DOCUMENTATION FOR THE GAMING INDUSTRY, IN CLASS 35 (U.S. CLS. 100, 101 AND 102).

FIRST USE 9-7-2007; IN COMMERCE 9-7-2007.

FOR: BUSINESS TRAINING IN THE FIELD OF WEB-BASED AND PAPER-BASED OPERATIONAL AND CORRESPONDING BUSINESS WORKFLOW AND PROCEDURE FOR THE GAMING INDUSTRY, IN CLASS 41 (U.S. CLS. 100, 101 AND 107).

FIRST USE 9-7-2007; IN COMMERCE 9-7-2007.

THE MARK CONSISTS OF STANDARD CHARACTERS WITHOUT CLAIM TO ANY PARTICULAR FONT, STYLE, SIZE, OR COLOR.

SER. NO. 77-191,632, FILED 5-29-2007.

PAM WILLIS, EXAMINING ATTORNEY

**Int. Cl.: 35**

**Prior U.S. Cls.: 100, 101 and 102**

**United States Patent and Trademark Office**

**Reg. No. 3,394,376**

**Registered Mar. 11, 2008**

**SERVICE MARK  
PRINCIPAL REGISTER**



PERERA, ANDRES (CANADA INDIVIDUAL)  
5985 SIDMOUTH STREET  
MISSISSAUGA, CANADA L5V2Z5

NO CLAIM IS MADE TO THE EXCLUSIVE  
RIGHT TO USE "THE PHOTO STORAGE", APART  
FROM THE MARK AS SHOWN.

FOR: OPERATING AN ONLINE SHOPPING SITE  
IN THE FIELD OF FILES AND PRINTS FROM FILM  
AND DIGITAL PHOTOGRAPHY, VIDEOS, VECTOR  
ILLUSTRATIONS, FLASH, TRAGA AND SEQUEN-  
CES ANIMATIONS, AND GRAPHIC TEMPLATES  
FOR WEB AND PRINT, IN CLASS 35 (U.S. CLS. 100,  
101 AND 102).

THE MARK CONSISTS OF A DEPICTION OF AN  
OPENED EMPTY BOX WITH THE WORDS "THE-  
PHOTOSTORAGE" RIGHT NEXT TO IT.

SER. NO. 77-191,645, FILED 5-29-2007.

FIRST USE 6-6-2005; IN COMMERCE 6-6-2005.

CARYN GLASSER, EXAMINING ATTORNEY

Int. Cl.: 32

Prior U.S. Cls.: 45, 46 and 48

United States Patent and Trademark Office

Reg. No. 3,394,377

Registered Mar. 11, 2008

TRADEMARK  
PRINCIPAL REGISTER

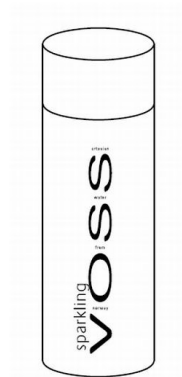

VOSS OF NORWAY ASA (NORWAY CORPORATION)  
DRAMMENSVEIEN 123  
N-0277 OSLO, NORWAY

FOR: DRINKING WATER, IN CLASS 32 (U.S. CLS. 45, 46 AND 48).

FIRST USE 11-18-2000; IN COMMERCE 11-18-2000.

OWNER OF U.S. REG. NOS. 2,696,925, 3,259,981 AND OTHERS.

NO CLAIM IS MADE TO THE EXCLUSIVE RIGHT TO USE "SPARKLING" AND "ARTESIAN WATER FROM NORWAY", APART FROM THE MARK AS SHOWN.

SEC. 2(F) AS TO THE BOTTLE DESIGN.

SER. NO. 77-192,175, FILED 5-29-2007.

KAREN SEVERSON, EXAMINING ATTORNEY

**Int. Cl.: 41**

**Prior U.S. Cls.: 100, 101 and 107**

**United States Patent and Trademark Office**

**Reg. No. 3,394,378**

**Registered Mar. 11, 2008**

**SERVICE MARK  
PRINCIPAL REGISTER**



SARASOTA INSTITUTE OF LIFETIME LEARNING, INC. (FLORIDA CORPORATION)  
1001 BOULEVARD OF THE ARTS  
SARASOTA, FL 34236

FOR: EDUCATIONAL SERVICES, NAMELY, PROVIDING LECTURES AND SEMINARS FOR ADULTS IN THE FIELDS OF MUSIC, ARTS AND HUMANITIES, CONTEMPORARY DOMESTIC POLICY ISSUES AND INTERNATIONAL RELATIONS ISSUES, IN CLASS 41 (U.S. CLS. 100, 101 AND 107).

FIRST USE 11-30-1992; IN COMMERCE 11-30-1992.

THE MARK CONSISTS OF THE LETTERS SILL IN STYLIZED FONT WHEREIN THE LOWER CASE LETTER I IS DOTTED WITH A STAR DESIGN AND THE SECOND L APPEARS WITHIN THE BEND FORMED BY THE FIRST L AND WHEREIN THE LITERAL PORTION OF THE MARK APPEARS ABOVE AN OPEN BOOK DESIGN.

SER. NO. 77-192,387, FILED 5-29-2007.

KIM SAITO, EXAMINING ATTORNEY

**Int. Cl.: 1**

**Prior U.S. Cls.: 1, 5, 6, 10, 26 and 46**

**United States Patent and Trademark Office**

**Reg. No. 3,394,379**

**Registered Mar. 11, 2008**

**TRADEMARK  
PRINCIPAL REGISTER**



KIRNS CHEMICAL LTD. (CHINA CORPORATION)  
27 B, 208 XIANGJIAN ROAD, CHANGSHA  
HUNAN, CHINA 410081

FOR: SULPHATES; CARBONATES; SODIUM BICARBONATE; COPPER SULPHATE; FERROUS SULFATES AGAINST YELLOWING OF PLANT LEAVES; MANGANESE SULPHATE; ZINC SULPHATE; SPECIALTY CHEMICALS, NAMELY, CHEMICAL ADDITIVES FOR GENERAL INDUSTRIAL USE IN THE MANUFACTURE OF A WIDE VARIETY OF GOODS; WATER PURIFYING CHEMICALS FOR SWIMMING POOLS; CHEMICAL PREPARATIONS FOR USE IN AGRICULTURE, HORTICUL-

TURE AND FORESTRY, NAMELY, CHEMICAL PREPARATIONS FOR THE TREATMENT OF SEEDS; ZINC OXIDE; MANGANOUS OXIDE; WASTE WATER TREATMENT CHEMICALS FOR INDUSTRIAL USE; CHEMICALS FOR USE IN INDUSTRY, IN CLASS 1 (U.S. CLS. 1, 5, 6, 10, 26 AND 46).

FIRST USE 3-25-2006; IN COMMERCE 3-25-2006.

SER. NO. 77-192,562, FILED 5-29-2007.

MICHAEL TANNER, EXAMINING ATTORNEY

**Int. Cl.: 34**

**Prior U.S. Cls.: 2, 8, 9 and 17**

**United States Patent and Trademark Office**

**Reg. No. 3,394,380**

**Registered Mar. 11, 2008**

**TRADEMARK  
PRINCIPAL REGISTER**

**REDLANDS**

SPECIALTY TOBACCO INC. (DELAWARE COR-  
PORATION)  
14670 E. FIRESTONE BOULEVARD #412  
LA MIRANDA, CA 90638

THE MARK CONSISTS OF STANDARD CHAR-  
ACTERS WITHOUT CLAIM TO ANY PARTICULAR  
FONT, STYLE, SIZE, OR COLOR.

FOR: CIGARS, IN CLASS 34 (U.S. CLS. 2, 8, 9 AND  
17).

SER. NO. 77-193,013, FILED 5-30-2007.

FIRST USE 4-27-2007; IN COMMERCE 4-27-2007.

WENDY GOODMAN, EXAMINING ATTORNEY

**Int. Cl.: 9**

**Prior U.S. Cls.: 21, 23, 26, 36 and 38**

**Reg. No. 3,394,381**

**United States Patent and Trademark Office**

**Registered Mar. 11, 2008**

**TRADEMARK  
PRINCIPAL REGISTER**

**ZEUS**

AIRLOGICA CORPORATION (TEXAS CORPORATION)  
SUITE 615, 275 W. CAMPBELL ROAD  
RICHARDSON, TX 75080

FOR: AUTOMATED SYSTEMS, NAMELY SOFTWARE, HARDWARE AND COMMUNICATIONS DEVICES FOR PLANNING, SCHEDULING, CONTROLLING, MONITORING AND PROVIDING INFORMATION ON TRANSPORTATION ASSETS AND PARTS THEREOF; COMPUTER SOFTWARE FOR APPLICATION AND DATABASE INTEGRATION; COMPUTER SOFTWARE FOR CREATING SEARCHABLE DATABASES OF INFORMATION AND DATA; COMPUTER SOFTWARE FOR PROVIDING AN ON-LINE DATABASE IN THE FIELD OF TRANSACTION PROCESSING TO UPLOAD TRANSACTIONAL DATA, PROVIDE STATISTICAL ANALYSIS, AND PRODUCE NOTIFICATIONS AND

REPORTS; COMPUTER SOFTWARE THAT PROVIDES REAL-TIME, INTEGRATED BUSINESS MANAGEMENT INTELLIGENCE BY COMBINING INFORMATION FROM VARIOUS DATABASES AND PRESENTING IT IN AN EASY-TO-UNDERSTAND USER INTERFACE, IN CLASS 9 (U.S. CLS. 21, 23, 26, 36 AND 38).

FIRST USE 1-1-2001; IN COMMERCE 1-1-2001.

THE MARK CONSISTS OF STANDARD CHARACTERS WITHOUT CLAIM TO ANY PARTICULAR FONT, STYLE, SIZE, OR COLOR.

SER. NO. 77-193,246, FILED 5-30-2007.

GISELLE AGOSTO, EXAMINING ATTORNEY

**Int. Cl.: 14**

**Prior U.S. Cls.: 2, 27, 28 and 50**

**United States Patent and Trademark Office**

**Reg. No. 3,394,382**

**Registered Mar. 11, 2008**

**TRADEMARK  
PRINCIPAL REGISTER**

**QuickFit**

KURDZIONAK, THERESA A. (UNITED STATES  
INDIVIDUAL)  
379 MAIN STREET  
STONEHAM, MA 02180

THE MARK CONSISTS OF STANDARD CHAR-  
ACTERS WITHOUT CLAIM TO ANY PARTICULAR  
FONT, STYLE, SIZE, OR COLOR.

FOR: PARTS FOR WATCHES; PARTS FOR  
CLOCKS, IN CLASS 14 (U.S. CLS. 2, 27, 28 AND 50).

SER. NO. 77-194,447, FILED 5-31-2007.

FIRST USE 10-1-2006; IN COMMERCE 10-1-2006.

CAROLINE WOOD, EXAMINING ATTORNEY



**Int. Cl.: 37**

**Prior U.S. Cls.: 100, 103 and 106**

**United States Patent and Trademark Office**

**Reg. No. 3,394,383**

**Registered Mar. 11, 2008**

**SERVICE MARK  
PRINCIPAL REGISTER**

AMERICAN RENEWABLE ENERGY

AMERICAN RENEWABLE ENERGY, LLC (DE-  
LAWARE LTD LIAB CO)  
848 DODGE AVENUE, SUITE 388  
EVANSTON, IL 60202

FOR: INSTALLATION OF ELECTRICAL SYS-  
TEMS; INSTALLATION OF ELECTRICAL AND  
GENERATING MACHINERY; INSTALLATION OF  
RENEWABLE ENERGY SYSTEMS FOR HYDRO,  
SOLAR, WIND AND FUEL CELL ENERGY COL-  
LECTION AND DISPERSION, IN CLASS 37 (U.S.  
CLS. 100, 103 AND 106).

FIRST USE 0-0-2001; IN COMMERCE 0-0-2001.

THE MARK CONSISTS OF STANDARD CHAR-  
ACTERS WITHOUT CLAIM TO ANY PARTICULAR  
FONT, STYLE, SIZE, OR COLOR.

NO CLAIM IS MADE TO THE EXCLUSIVE  
RIGHT TO USE "RENEWABLE ENERGY", APART  
FROM THE MARK AS SHOWN.

SEC. 2(F).

SER. NO. 77-194,960, FILED 5-31-2007.

LINDA E. BLOHM, EXAMINING ATTORNEY

**Int. Cl.: 25**

**Prior U.S. Cls.: 22 and 39**

**United States Patent and Trademark Office**

**Reg. No. 3,394,384**

**Registered Mar. 11, 2008**

**TRADEMARK  
PRINCIPAL REGISTER**

**NEED 2 SPEED**

PODTETENIEFF BORIS A (UNITED STATES IN-  
DIVIDUAL)  
4043 CALLIOPE CT.  
REDDING, CA 96002

FOR: MEN'S AND WOMEN'S CLOTHING,  
NAMELY, SWIMWEAR, BATHING SUITS, BIKINIS,  
COVER-UPS, TANK TOPS, SHIRTS, SKIRTS, DRES-  
SES, SHORTS, JUMPERS, CAPRIS, LEGGINGS, PA-  
JAMAS, ROBES, JERSEYS, SOCKS, UNDERWEAR,  
GLOVES, BELTS, TIES, VESTS; HEADWEAR,  
NAMELY, CAPS AND VISORS; AND FOOTWEAR,  
NAMELY, SANDALS, SLIPPERS, BOOTS, AND

ATHLETIC SHOES, IN CLASS 25 (U.S. CLS. 22 AND  
39).

FIRST USE 7-6-1999; IN COMMERCE 3-13-2000.

THE MARK CONSISTS OF STANDARD CHAR-  
ACTERS WITHOUT CLAIM TO ANY PARTICULAR  
FONT, STYLE, SIZE, OR COLOR.

SER. NO. 77-195,082, FILED 6-1-2007.

KEVON CHISOLM, EXAMINING ATTORNEY

Int. Cl.: 44

Prior U.S. Cls.: 100 and 101

United States Patent and Trademark Office

Reg. No. 3,394,385

Registered Mar. 11, 2008

SERVICE MARK  
PRINCIPAL REGISTER



Shoreline Vision

*Vision Care. For Life.*

SHORELINE OPHTHALMOLOGY, PLC (MICHIGAN LTD LIAB CO)  
1266 E. SHERMAN BLVD.  
MUSKEGON, MI 49444

FOR: OPHTHALMOLOGY SERVICES, IN CLASS 44 (U.S. CLS. 100 AND 101).

FIRST USE 4-30-2006; IN COMMERCE 4-30-2006.

NO CLAIM IS MADE TO THE EXCLUSIVE RIGHT TO USE "VISION" AND "VISION CARE", APART FROM THE MARK AS SHOWN.

THE COLOR(S) BLUE AND TAN IS/ARE CLAIMED AS A FEATURE OF THE MARK.

THE MARK CONSISTS OF THREE BLUE AND TAN CURVED LINES, TWO CURVED DOWNWARD AT EACH END AND ONE DIRECTLY BELOW THE OTHER TWO CURVED UPWARD AT EACH END, WITH THE WORDS "SHORELINE VISION" IN BLUE DIRECTLY BELOW THE LINES AND A STRAIGHT BLUE LINE BELOW SUCH WORDS WHICH SEPARATES THE WORDS "VISION CARE. FOR LIFE." ALSO IN BLUE.

SER. NO. 77-195,580, FILED 6-1-2007.

SANI KHOURI, EXAMINING ATTORNEY

**Int. Cl.: 44**

**Prior U.S. Cls.: 100 and 101**

**United States Patent and Trademark Office**

**Reg. No. 3,394,386**

**Registered Mar. 11, 2008**

**SERVICE MARK  
PRINCIPAL REGISTER**



**Shoreline Vision**

SHORELINE OPHTHALMOLOGY, PLC (MICHIGAN LTD LIAB CO)  
1266 E. SHERMAN BLVD.  
MUSKEGON, MI 49444

FOR: OPHTHALMOLOGY SERVICES, IN CLASS 44 (U.S. CLS. 100 AND 101).

FIRST USE 4-30-2006; IN COMMERCE 4-30-2006.

NO CLAIM IS MADE TO THE EXCLUSIVE RIGHT TO USE "VISION" , APART FROM THE MARK AS SHOWN.

THE COLOR(S) BLUE AND TAN IS/ARE CLAIMED AS A FEATURE OF THE MARK.

THE MARK CONSISTS OF THREE BLUE AND TAN CURVED LINES, TWO CURVED DOWNWARD AT EACH END AND ONE DIRECTLY BELOW THE OTHER TWO CURVED UPWARD AT EACH END, WITH THE WORDS SHORELINE VISION IN BLUE DIRECTLY BELOW THE LINES.

SER. NO. 77-195,722, FILED 6-1-2007.

SANI KHOURI, EXAMINING ATTORNEY

**Int. Cl.: 41**

**Prior U.S. Cls.: 100, 101 and 107**

**United States Patent and Trademark Office**

**Reg. No. 3,394,387**

**Registered Mar. 11, 2008**

**SERVICE MARK  
PRINCIPAL REGISTER**

**MEMBERS CLUBHOUSE**

AMERICAN EXPRESS MARKETING & DEVELOPMENT CORP. (DELAWARE CORPORATION)  
200 VESEY STREET  
NEW YORK, NY 10285

FOR: PROVIDING INFORMATION IN THE FIELD OF GOLF TO CARDMEMBERS ABOUT SPECIAL GOLF ENTERTAINMENT EVENTS, IN CLASS 41 (U.S. CLS. 100, 101 AND 107).

FIRST USE 5-31-2007; IN COMMERCE 5-31-2007.

THE MARK CONSISTS OF STANDARD CHARACTERS WITHOUT CLAIM TO ANY PARTICULAR FONT, STYLE, SIZE, OR COLOR.

NO CLAIM IS MADE TO THE EXCLUSIVE RIGHT TO USE "MEMBERS", APART FROM THE MARK AS SHOWN.

SER. NO. 77-196,482, FILED 6-4-2007.

RICHARD A. STRASER, EXAMINING ATTORNEY

**Int. Cl.: 7**

**Prior U.S. Cls.: 13, 19, 21, 23, 31, 34 and 35**

**United States Patent and Trademark Office**

**Reg. No. 3,394,388**

**Registered Mar. 11, 2008**

**TRADEMARK  
PRINCIPAL REGISTER**

**SAFEWASHER**

CINTAS HOLDINGS LLC (OHIO LTD LIAB CO)  
6800 CINTAS BOULEVARD, P.O. BOX 625737  
CINCINNATI, OH 452625737

THE MARK CONSISTS OF STANDARD CHAR-  
ACTERS WITHOUT CLAIM TO ANY PARTICULAR  
FONT, STYLE, SIZE, OR COLOR.

FOR: INDUSTRIAL PARTS CLEANING MA-  
CHINE, IN CLASS 7 (U.S. CLS. 13, 19, 21, 23, 31, 34  
AND 35).

SER. NO. 77-197,023, FILED 6-4-2007.

FIRST USE 5-14-2007; IN COMMERCE 5-14-2007.

TASNEEM HUSSAIN, EXAMINING ATTORNEY

**Int. Cl.: 44**

**Prior U.S. Cls.: 100 and 101**

**United States Patent and Trademark Office**

**Reg. No. 3,394,389**

**Registered Mar. 11, 2008**

**SERVICE MARK  
PRINCIPAL REGISTER**



VACCINATION SERVICES OF AMERICA, INC.  
(NEBRASKA CORPORATION)  
9320 H COURT  
OMAHA, NE 68127

FOR: HEALTH CARE SERVICES, NAMELY, VACCINATION SERVICES, WELLNESS TESTING, AND HEALTH FAIRS, IN CLASS 44 (U.S. CLS. 100 AND 101).

FIRST USE 1-1-2006; IN COMMERCE 1-1-2006.

NO CLAIM IS MADE TO THE EXCLUSIVE RIGHT TO USE "VACCINATION SERVICES OF

AMERICA", APART FROM THE MARK AS SHOWN.

THE MARK CONSISTS OF HALF OF AN APPLE WITH STEM AND LEAF THEN A SPACE THAT APPEARS BETWEEN THE HALF OF APPLE AND A BOX OR SQUARE THEN THE LITERAL ELEMENTS VACCINATION SERVICES OF AMERICA.

SER. NO. 77-197,539, FILED 6-5-2007.

JANET LEE, EXAMINING ATTORNEY

**Int. Cl.: 29**

**Prior U.S. Cl.: 46**

**United States Patent and Trademark Office**

**Reg. No. 3,394,390**

**Registered Mar. 11, 2008**

**TRADEMARK  
PRINCIPAL REGISTER**

**SHRIMPER'S HEAVEN**

BUBBA GUMP SHRIMP CO. (DELAWARE CORPORATION)  
209 AVENIDA FABRICANTE, STE. #200  
SAN CLEMENTE, CA 92672

THE MARK CONSISTS OF STANDARD CHARACTERS WITHOUT CLAIM TO ANY PARTICULAR FONT, STYLE, SIZE, OR COLOR.

FOR: PREPARED ENTREES CONSISTING PRIMARILY OF SHRIMP FOR CONSUMPTION ON AND OFF THE PREMISES, IN CLASS 29 (U.S. CL. 46).

SER. NO. 77-197,998, FILED 6-5-2007.

FIRST USE 5-31-2006; IN COMMERCE 5-31-2006.

ALYSSA PALADINO, EXAMINING ATTORNEY



**Int. Cl.: 41**

**Prior U.S. Cls.: 100, 101 and 107**

**United States Patent and Trademark Office**

**Reg. No. 3,394,391**

**Registered Mar. 11, 2008**

**SERVICE MARK  
PRINCIPAL REGISTER**

**OPINIONATED WITH CHRIS  
DIMARCO**

XM SATELLITE RADIO INC. (DELAWARE CORPORATION)  
1500 ECKINGTON PLACE, N.E.  
WASHINGTON, DC 20002

FOR: ENTERTAINMENT SERVICES, NAMELY  
AN ONGOING RADIO PROGRAM IN THE FIELD  
OF GOLF, IN CLASS 41 (U.S. CLS. 100, 101 AND 107).

FIRST USE 6-19-2007; IN COMMERCE 6-19-2007.

THE MARK CONSISTS OF STANDARD CHARACTERS WITHOUT CLAIM TO ANY PARTICULAR FONT, STYLE, SIZE, OR COLOR.

"THE NAME(S), PORTRAIT(S), AND/OR SIGNATURE(S) SHOWN IN THE MARK IDENTIFIES CHRISTIAN DEAN DIMARCO, WHOSE CONSENT(S) TO REGISTER IS SUBMITTED."

SER. NO. 77-198,144, FILED 6-5-2007.

WARREN L. OLANDRIA, EXAMINING ATTORNEY

**Int. Cl.: 34**

**Prior U.S. Cls.: 2, 8, 9 and 17**

**United States Patent and Trademark Office**

**Reg. No. 3,394,392**

**Registered Mar. 11, 2008**

**TRADEMARK  
PRINCIPAL REGISTER**

**GANDALF**

THE SAUL ZAENTZ COMPANY DBA TOLKIEN  
ENTERPRISES (DELAWARE CORPORATION)  
2600 TENTH STREET  
BERKELEY, CA 94710

FOR: COLLECTIBLE TOBACCO PIPES, IN CLASS  
34 (U.S. CLS. 2, 8, 9 AND 17).

FIRST USE 5-10-2007; IN COMMERCE 5-10-2007.

THE MARK CONSISTS OF STANDARD CHAR-  
ACTERS WITHOUT CLAIM TO ANY PARTICULAR  
FONT, STYLE, SIZE, OR COLOR.

OWNER OF U.S. REG. NOS. 2,484,069, 2,925,665  
AND OTHERS.

SER. NO. 77-198,433, FILED 6-5-2007.

LINDA E. BLOHM, EXAMINING ATTORNEY

**Int. Cl.: 12**

**Prior U.S. Cls.: 19, 21, 23, 31, 35 and 44**

**United States Patent and Trademark Office**

**Reg. No. 3,394,393**

**Registered Mar. 11, 2008**

**TRADEMARK  
PRINCIPAL REGISTER**

# PatrolBot

MOBILEROBOTS INC (NEW HAMPSHIRE COR-  
PORATION)  
19 COLUMBIA DRIVE  
AMHERST, NH 03031

THE MARK CONSISTS OF STANDARD CHAR-  
ACTERS WITHOUT CLAIM TO ANY PARTICULAR  
FONT, STYLE, SIZE, OR COLOR.

FOR: AUTOMATIC GUIDED VEHICLES, IN  
CLASS 12 (U.S. CLS. 19, 21, 23, 31, 35 AND 44).

SER. NO. 77-198,871, FILED 6-6-2007.

FIRST USE 4-10-2002; IN COMMERCE 4-10-2002.

JASON TURNER, EXAMINING ATTORNEY

**Int. Cl.: 35**

**Prior U.S. Cls.: 100, 101 and 102**

**United States Patent and Trademark Office**

**Reg. No. 3,394,394**

**Registered Mar. 11, 2008**

**SERVICE MARK  
PRINCIPAL REGISTER**

**westobou**

WESTOBOU (GEORGIA LTD LIAB CO)  
2635 WASHINGTON RD  
AUGUSTA, GA 30904

THE MARK CONSISTS OF STANDARD CHAR-  
ACTERS WITHOUT CLAIM TO ANY PARTICULAR  
FONT, STYLE, SIZE, OR COLOR.

FOR: ADVERTISING, MARKETING AND PRO-  
MOTION SERVICES, IN CLASS 35 (U.S. CLS. 100, 101  
AND 102).

SER. NO. 77-198,960, FILED 6-6-2007.

FIRST USE 2-24-2004; IN COMMERCE 3-0-2004.

JOHN GARTNER, EXAMINING ATTORNEY

**Int. Cl.: 35**

**Prior U.S. Cls.: 100, 101 and 102**

**United States Patent and Trademark Office**

**Reg. No. 3,394,395**

**Registered Mar. 11, 2008**

**SERVICE MARK  
PRINCIPAL REGISTER**

**GOLDEN ASP**

GOLDEN ASP, INC. (PENNSYLVANIA CORPORATION)  
2438 PASQUALONE BOULEVARD  
BENSALEM, PA 19020

THE MARK CONSISTS OF STANDARD CHARACTERS WITHOUT CLAIM TO ANY PARTICULAR FONT, STYLE, SIZE, OR COLOR.

FOR: RETAIL STORE SERVICES FEATURING WOMEN'S CLOTHING, IN CLASS 35 (U.S. CLS. 100, 101 AND 102).

SER. NO. 77-199,333, FILED 6-6-2007.

FIRST USE 7-31-1969; IN COMMERCE 7-31-1969.

KAREN BRACEY, EXAMINING ATTORNEY

**Int. Cls.: 9, 25 and 41**

**Prior U.S. Cls.: 21, 22, 23, 26, 36, 38, 39, 100, 101 and 107**

**United States Patent and Trademark Office**

**Reg. No. 3,394,396**

**Registered Mar. 11, 2008**

**TRADEMARK  
SERVICE MARK  
PRINCIPAL REGISTER**

**KINKY WIZARDS**

MANUEL, MARTY LYN (UNITED STATES INDIVIDUAL)  
2804 87TH STREET  
LUBBOCK, TX 79423

FOR: COMPACT DISCS FEATURING MUSICAL SOUND RECORDINGS AND MUSICAL VIDEO RECORDINGS, IN CLASS 9 (U.S. CLS. 21, 23, 26, 36 AND 38).

FIRST USE 4-20-2006; IN COMMERCE 5-19-2007.

FOR: T-SHIRTS; TANK TOPS, IN CLASS 25 (U.S. CLS. 22 AND 39).

FIRST USE 8-1-2006; IN COMMERCE 5-19-2007.

FOR: ENTERTAINMENT, NAMELY, LIVE PERFORMANCES BY A MUSICAL BAND; ENTERTAINMENT SERVICES, NAMELY, PERSONAL APPEARANCES BY A MUSICAL BAND, IN CLASS 41 (U.S. CLS. 100, 101 AND 107).

FIRST USE 1-28-2001; IN COMMERCE 5-19-2007.

THE MARK CONSISTS OF STANDARD CHARACTERS WITHOUT CLAIM TO ANY PARTICULAR FONT, STYLE, SIZE, OR COLOR.

SER. NO. 77-199,537, FILED 6-6-2007.

WILLIAM VERHOSEK, EXAMINING ATTORNEY

**Int. Cl.: 35**

**Prior U.S. Cls.: 100, 101 and 102**

**United States Patent and Trademark Office**

**Reg. No. 3,394,397**

**Registered Mar. 11, 2008**

**SERVICE MARK  
PRINCIPAL REGISTER**



**GULF SOUTH  
HOME HEALTH SOLUTIONS**

GULF SOUTH MEDICAL SUPPLY, INC. (FLORIDA CORPORATION)  
4345 SOUTHPOINT BOULEVARD  
JACKSONVILLE, FL 32216

FOR: ON-LINE RETAIL STORE SERVICES FEATURING MEDICAL PRODUCTS AND SUPPLIES FOR USE IN HOME HEALTH CARE; RETAIL SERVICES BY DIRECT SOLICITATION BY SALES AGENTS IN THE FIELD OF MEDICAL PRODUCTS AND SUPPLIES FOR USE IN HOME HEALTH CARE; CATALOG ORDERING SERVICE FEATURING MEDICAL PRODUCTS AND SUPPLIES FOR USE IN HOME HEALTH CARE, IN CLASS 35 (U.S. CLS. 100, 101 AND 102).

FIRST USE 6-6-2007; IN COMMERCE 6-6-2007.

NO CLAIM IS MADE TO THE EXCLUSIVE RIGHT TO USE "HOME HEALTH SOLUTIONS", APART FROM THE MARK AS SHOWN.

THE MARK CONSISTS OF THE WORDING GULF SOUTH HOME HEALTH SOLUTIONS TO THE RIGHT OF THE OUTLINE OF A HOUSE THE BASE OF WHICH COULD BE AN UPPERCASE H AND WHICH IS ENCOMPASSED BY A SQUARE.

SER. NO. 77-200,403, FILED 6-7-2007.

AMY HELLA, EXAMINING ATTORNEY

**Int. Cl.: 35**

**Prior U.S. Cls.: 100, 101 and 102**

**United States Patent and Trademark Office**

**Reg. No. 3,394,398**

**Registered Mar. 11, 2008**

**SERVICE MARK  
PRINCIPAL REGISTER**

**VENDOR KNOWLEDGE EXCHANGE**

THE CORPORATE EXECUTIVE BOARD COMPAN-  
NY (DELAWARE CORPORATION)  
SUITE 6000  
2000 PENNSYLVANIA AVENUE NW  
WASHINGTON, DC 20006

FOR: PROVIDING A SUBSCRIPTION-BASED,  
SEARCHABLE, ONLINE DATABASE OF VENDORS  
OF PRODUCTS AND SERVICES, WHICH DATA-  
BASE FEATURES PEER-GENERATED VENDOR  
RATINGS AND EVALUATIONS BASED ON PRO-  
JECT TYPE, GEOGRAPHIC SCOPE, AND INDUS-  
TRY, IN CLASS 35 (U.S. CLS. 100, 101 AND 102).

FIRST USE 9-0-2005; IN COMMERCE 9-0-2005.

THE MARK CONSISTS OF STANDARD CHAR-  
ACTERS WITHOUT CLAIM TO ANY PARTICULAR  
FONT, STYLE, SIZE, OR COLOR.

NO CLAIM IS MADE TO THE EXCLUSIVE  
RIGHT TO USE "VENDOR KNOWLEDGE", APART  
FROM THE MARK AS SHOWN.

SER. NO. 77-200,435, FILED 6-7-2007.

MICHAEL LITZAU, EXAMINING ATTORNEY



**Int. Cl.: 25**

**Prior U.S. Cls.: 22 and 39**

**United States Patent and Trademark Office**

**Reg. No. 3,394,399**

**Registered Mar. 11, 2008**

**TRADEMARK  
PRINCIPAL REGISTER**



WRANGLER APPAREL CORP. (DELAWARE CORPORATION)  
3411 SILVERSIDE RD.  
WILMINGTON, DE 19810

NO CLAIM IS MADE TO THE EXCLUSIVE RIGHT TO USE "WORK WEAR", APART FROM THE MARK AS SHOWN.

FOR: CLOTHING, NAMELY, SHIRTS, JACKETS, PANTS, OVERALLS AND COVERALLS, AND FOOTWEAR, IN CLASS 25 (U.S. CLS. 22 AND 39).

THE MARK CONSISTS OF THE WORDS, "WORK WEAR BY WRANGLER", IN A STYLIZED FORM.

FIRST USE 9-30-1998; IN COMMERCE 9-30-1998.

SER. NO. 77-201,458, FILED 6-8-2007.

OWNER OF U.S. REG. NOS. 849,477, 2,998,129 AND OTHERS.

SCOTT SISUN, EXAMINING ATTORNEY

**Int. Cls.: 16 and 41**

**Prior U.S. Cls.: 2, 5, 22, 23, 29, 37, 38, 50, 100, 101 and 107**

**United States Patent and Trademark Office**

**Reg. No. 3,394,400**

**Registered Mar. 11, 2008**

**TRADEMARK  
SERVICE MARK  
PRINCIPAL REGISTER**



LA SUBASTA, INC. (TEXAS CORPORATION)  
6120 TARNEF, SUITE 110  
HOUSTON, TX 77074

FOR: SYNDICATED NEWSPAPER IN SPANISH LANGUAGE FOR GENERAL CIRCULATION FEATURING A LISTING OF ITEMS FOR SALE AIMED AT THE HISPANIC COMMUNITY, IN CLASS 16 (U.S. CLS. 2, 5, 22, 23, 29, 37, 38 AND 50).

FIRST USE 8-16-1981; IN COMMERCE 8-16-1981.

FOR: ONLINE NEWSPAPER IN SPANISH LANGUAGE FEATURING A LISTING OF ITEMS FOR SALE AIMED AT THE HISPANIC COMMUNITY, IN CLASS 41 (U.S. CLS. 100, 101 AND 107).

FIRST USE 8-16-1981; IN COMMERCE 8-16-1981.

OWNER OF U.S. REG. NO. 1,731,035.

THE COLOR(S) ORANGE IS/ARE CLAIMED AS A FEATURE OF THE MARK.

THE MARK CONSISTS OF LOWER-CASE LETTERS, ALL IN ORANGE.

THE FOREIGN WORDING IN THE MARK TRANSLATES INTO ENGLISH AS AUCTION OR THE AUCTION SALE.

SEC. 2(F).

SER. NO. 77-202,653, FILED 6-11-2007.

KIMBERLY PERRY, EXAMINING ATTORNEY

Int. Cl.: 30

Prior U.S. Cl.: 46

United States Patent and Trademark Office

Reg. No. 3,394,401

Registered Mar. 11, 2008

TRADEMARK  
PRINCIPAL REGISTER



ENCINAL, INC. (PUERTO RICO CORPORATION)  
URB IND BO PALMAS CARR 869 KM 2  
CATAÑO, PUERTO RICO 00962

FOR: FROZEN BREADS; FROZEN CONFECTIONS; FROZEN ENTREES CONSISTING PRIMARILY OF PASTA OR RICE; FROZEN MEALS CONSISTING PRIMARILY OF PASTA OR RICE, IN CLASS 30 (U.S. CL. 46).

FIRST USE 3-23-2006; IN COMMERCE 3-23-2006.

THE MARK CONSISTS OF THE STYLIZED PHRASE "CHEF FACTORY" WITH FOUR UNARRANGED STARS UNDER IT, SUPERIMPOSED UPON AN OVAL, ALL OF WHICH IS LOCATED UNDER THE IMAGE OF A CHEF WITH A MUSTACHE COMING OUT OF A KITCHEN ENTRYWAY, FROM WHICH SOMKE IS ALSO COMING OUT.

SER. NO. 77-202,982, FILED 6-11-2007.

CURTIS FRENCH, EXAMINING ATTORNEY

Int. Cl.: 41

Prior U.S. Cls.: 100, 101 and 107

United States Patent and Trademark Office

Reg. No. 3,394,402

Registered Mar. 11, 2008

**SERVICE MARK  
PRINCIPAL REGISTER**

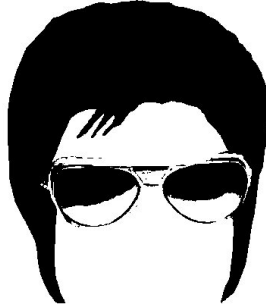

*Tribute Experience  
Productions*

TRIBUTE EXPERIENCE PRODUCTIONS LLC  
(NEVADA LTD LIAB CO)  
PO BOX 464  
HELENDALE, CA 92342

FOR: ENTERTAINMENT SERVICES, NAMELY,  
ORGANIZING AND CONDUCTING SHOWS,  
NAMELY MUSICAL SHOWS; ORGANIZING AND  
CONDUCTING FESTIVALS, NAMELY MUSICAL  
FESTIVALS, IN CLASS 41 (U.S. CLS. 100, 101 AND  
107).

FIRST USE 1-10-2007; IN COMMERCE 1-10-2007.

NO CLAIM IS MADE TO THE EXCLUSIVE  
RIGHT TO USE "PRODUCTIONS", APART FROM  
THE MARK AS SHOWN.

THE LIKENESS (OR, "PORTRAIT") IN THE  
MARK DOES NOT IDENTIFY A LIVING INDIVI-  
DUAL.

SER. NO. 77-204,478, FILED 6-12-2007.

SUZANNE BLANE, EXAMINING ATTORNEY

**Int. Cls.: 25 and 41**

**Prior U.S. Cls.: 22, 39, 100, 101 and 107**

**United States Patent and Trademark Office**

**Reg. No. 3,394,403**

**Registered Mar. 11, 2008**

**TRADEMARK  
SERVICE MARK  
PRINCIPAL REGISTER**



ST. IGNATIUS HIGH SCHOOL OF CLEVELAND  
(OHIO CORPORATION)  
1911 W. 30TH STREET  
CLEVELAND, OH 44113

FOR: CLOTHING, NAMELY, SHIRTS, SHORTS,  
SWEATSHIRTS, SWEATPANTS, PANTS, JACKETS,  
COATS, CAPS AND HATS, IN CLASS 25 (U.S. CLS. 22  
AND 39).

FIRST USE 1-1-1991; IN COMMERCE 1-1-1991.

FOR: EDUCATIONAL SERVICES, NAMELY,  
PROVIDING COURSES OF INSTRUCTION AT  
THE SECONDARY LEVEL, IN CLASS 41 (U.S. CLS.  
100, 101 AND 107).

FIRST USE 1-1-1991; IN COMMERCE 1-1-1991.

NO CLAIM IS MADE TO THE EXCLUSIVE  
RIGHT TO USE "HIGH SCHOOL" AND "CLEVE-  
LAND" AND "1886", APART FROM THE MARK AS  
SHOWN.

THE MARK CONSISTS, IN PART, OF TWO  
WOLVES WITH THEIR PAWS ON A CAULDRON.

SER. NO. 77-204,644, FILED 6-13-2007.

JOHN KELLY, EXAMINING ATTORNEY

**Int. Cl.: 14**

**Prior U.S. Cls.: 2, 27, 28 and 50**

**United States Patent and Trademark Office**

**Reg. No. 3,394,404**

**Registered Mar. 11, 2008**

**TRADEMARK  
PRINCIPAL REGISTER**

**ANNTAYLOR CELEBRATIONS**

ANNCO, INC. (DELAWARE CORPORATION)  
476 WHEELERS FARMS ROAD  
MILFORD, CT 06461

OWNER OF U.S. REG. NOS. 1,789,470, 3,148,208  
AND OTHERS.

FOR: JEWELRY, IN CLASS 14 (U.S. CLS. 2, 27, 28  
AND 50).

THE NAME "ANN TAYLOR" DOES NOT IDENTIFY  
A LIVING INDIVIDUAL.

FIRST USE 8-22-2005; IN COMMERCE 8-22-2005.

SER. NO. 77-204,809, FILED 6-13-2007.

THE MARK CONSISTS OF STANDARD CHARACTERS  
WITHOUT CLAIM TO ANY PARTICULAR FONT,  
STYLE, SIZE, OR COLOR.

STEVEN JACKSON, EXAMINING ATTORNEY

**Int. Cl.: 16**

**Prior U.S. Cls.: 2, 5, 22, 23, 29, 37, 38 and 50**

**United States Patent and Trademark Office**

**Reg. No. 3,394,405**

**Registered Mar. 11, 2008**

**TRADEMARK  
PRINCIPAL REGISTER**

**BEVERAGE WORLD**

IDEAL MEDIA LLC (DELAWARE LTD LIAB CO)  
23RD FLOOR  
303 E. WACKER DRIVE  
CHICAGO, IL 60601

FOR: MAGAZINES PROVIDING INFORMATION  
IN THE NATURE OF NEWS AND ANALYSIS,  
FEATURES OF BEST INDUSTRY PRACTICES,  
AND PROFILES OF LEADING COMPANIES AND  
EXECUTIVES TO GLOBAL BEVERAGE SERVICE  
INDUSTRIES, IN CLASS 16 (U.S. CLS. 2, 5, 22, 23, 29,  
37, 38 AND 50).

FIRST USE 11-0-1973; IN COMMERCE 11-0-1973.

THE MARK CONSISTS OF STANDARD CHAR-  
ACTERS WITHOUT CLAIM TO ANY PARTICULAR  
FONT, STYLE, SIZE, OR COLOR.

OWNER OF U.S. REG. NO. 3,012,857.

NO CLAIM IS MADE TO THE EXCLUSIVE  
RIGHT TO USE "BEVERAGE", APART FROM THE  
MARK AS SHOWN.

SEC. 2(F).

SER. NO. 77-204,952, FILED 6-13-2007.

RONALD MCMORROW, EXAMINING ATTORNEY

**Int. Cl.: 16**

**Prior U.S. Cls.: 2, 5, 22, 23, 29, 37, 38 and 50**

**United States Patent and Trademark Office**

**Reg. No. 3,394,406**

**Registered Mar. 11, 2008**

**TRADEMARK  
PRINCIPAL REGISTER**

**ADVANTEDGE TECHNOLOGY**

SPINNAKER COATING, LLC (DELAWARE LTD  
LIAB CO)  
518 EAST WATER STREET  
TROY, OH 45373

FOR: LABEL PAPER, PRESSURE-SENSITIVE AD-  
HESIVE LABEL STOCK, DIE-CUT LABEL STOCK,  
IN CLASS 16 (U.S. CLS. 2, 5, 22, 23, 29, 37, 38 AND 50).

FIRST USE 3-19-2007; IN COMMERCE 3-19-2007.

THE MARK CONSISTS OF STANDARD CHAR-  
ACTERS WITHOUT CLAIM TO ANY PARTICULAR  
FONT, STYLE, SIZE, OR COLOR.

NO CLAIM IS MADE TO THE EXCLUSIVE  
RIGHT TO USE "TECHNOLOGY", APART FROM  
THE MARK AS SHOWN.

SER. NO. 77-205,008, FILED 6-13-2007.

KEVON CHISOLM, EXAMINING ATTORNEY



Int. Cl.: 35

Prior U.S. Cls.: 100, 101 and 102

United States Patent and Trademark Office

Reg. No. 3,394,407

Registered Mar. 11, 2008

SERVICE MARK  
PRINCIPAL REGISTER

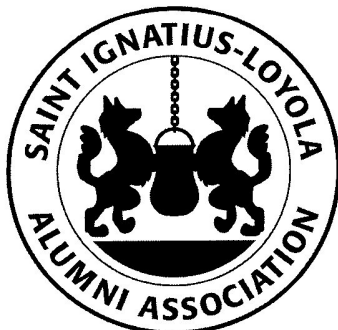

*Ad Majorem Dei Gloriam*

ST. IGNATIUS HIGH SCHOOL OF CLEVELAND  
(OHIO CORPORATION)  
1911 W. 30TH STREET  
CLEVELAND, OH 44113

FOR: ASSOCIATION SERVICES, NAMELY PROMOTING THE INTERESTS OF SAINT IGNATIUS HIGH SCHOOL AND ITS ALUMNI, IN CLASS 35 (U.S. CLS. 100, 101 AND 102).

FIRST USE 1-1-2007; IN COMMERCE 1-1-2007.

NO CLAIM IS MADE TO THE EXCLUSIVE RIGHT TO USE "ALUMNI ASSOCIATION", APART FROM THE MARK AS SHOWN.

THE MARK CONSISTS, IN PART, OF TWO WOLVES WITH THEIR PAWS ON A CAULDRON.

THE FOREIGN WORDING IN THE MARK TRANSLATES INTO ENGLISH AS TO THE GREATER GLORY OF GOD.

SER. NO. 77-205,047, FILED 6-13-2007.

JOHN KELLY, EXAMINING ATTORNEY

**Int. Cls.: 24 and 25**

**Prior U.S. Cls.: 22, 39, 42 and 50**

**United States Patent and Trademark Office**

**Reg. No. 3,394,408**

**Registered Mar. 11, 2008**

**TRADEMARK  
PRINCIPAL REGISTER**



ST. IGNATIUS HIGH SCHOOL OF CLEVELAND  
(OHIO CORPORATION)  
1911 W. 30TH STREET  
CLEVELAND, OH 44113

FOR: FABRIC FLAGS, FELT PENNANTS AND  
BED BLANKETS, IN CLASS 24 (U.S. CLS. 42 AND 50).

FIRST USE 1-1-1984; IN COMMERCE 1-1-1984.

FOR: CLOTHING, NAMELY, SHIRTS, SHORTS,  
SWEATSHIRTS, SWEATPANTS, PANTS, JACKETS,

COATS, HATS, CAPS, GLOVES, AND SCARVES, IN  
CLASS 25 (U.S. CLS. 22 AND 39).

FIRST USE 1-1-1984; IN COMMERCE 1-1-1984.

THE MARK CONSISTS OF A BLOCK LETTER I  
AND THE HEAD OF A WILDCAT.

SER. NO. 77-205,066, FILED 6-13-2007.

JOHN KELLY, EXAMINING ATTORNEY

**Int. Cl.: 19**

**Prior U.S. Cls.: 1, 12, 33 and 50**

**United States Patent and Trademark Office**

**Reg. No. 3,394,409**

**Registered Mar. 11, 2008**

**TRADEMARK  
PRINCIPAL REGISTER**

**AVR**

AVR, INC. (MINNESOTA CORPORATION)  
14698 GALAXIE AVENUE  
APPLE VALLEY, MN 55124

THE MARK CONSISTS OF STANDARD CHAR-  
ACTERS WITHOUT CLAIM TO ANY PARTICULAR  
FONT, STYLE, SIZE, OR COLOR.

FOR: READY-MIX CONCRETE, IN CLASS 19 (U.S.  
CLS. 1, 12, 33 AND 50).

SER. NO. 77-205,426, FILED 6-13-2007.

FIRST USE 12-31-1966; IN COMMERCE 12-31-1984.

BARBARA BROWN, EXAMINING ATTORNEY

**Int. Cl.: 35**

**Prior U.S. Cls.: 100, 101 and 102**

**United States Patent and Trademark Office**

**Reg. No. 3,394,410**

**Registered Mar. 11, 2008**

**SERVICE MARK  
PRINCIPAL REGISTER**

**LOOKWEVEMOVED.COM**

JEFF SAVAGE D/B/A LOOKWEVEMOVED.COM  
(UNITED STATES INDIVIDUAL)  
P.O. BOX 2095  
ROCKWALL, TX 75032

FOR: PROVIDING REAL ESTATE MARKETING SERVICES; DISTRIBUTORSHIPS IN THE FIELD OF GIFT PACKS FEATURING CUSTOMER RELOCATION INFORMATION; PROVIDING ONLINE REAL ESTATE MARKETING SERVICES; ONLINE ORDERING SERVICES FEATURING GIFT PACKS THAT INCLUDE CUSTOMER RELOCATION IN-

FORMATION, IN CLASS 35 (U.S. CLS. 100, 101 AND 102).

FIRST USE 3-0-2007; IN COMMERCE 3-0-2007.

THE MARK CONSISTS OF STANDARD CHARACTERS WITHOUT CLAIM TO ANY PARTICULAR FONT, STYLE, SIZE, OR COLOR.

SER. NO. 77-205,533, FILED 6-13-2007.

SHANNON TWOHIG, EXAMINING ATTORNEY

**Int. Cl.: 36**

**Prior U.S. Cls.: 100, 101 and 102**

**United States Patent and Trademark Office**

**Reg. No. 3,394,411**

**Registered Mar. 11, 2008**

**SERVICE MARK  
PRINCIPAL REGISTER**



AMERILOSS PUBLIC ADJUSTING, CORP.  
(FLORIDA CORPORATION)  
SUITE 210  
1440 J. F. KENNEDY CAUSEWAY  
NORTH BAY VILLAGE, FL 33141

FOR: CLAIMS ADJUSTMENT IN THE FIELD OF  
INSURANCE, IN CLASS 36 (U.S. CLS. 100, 101 AND  
102).

FIRST USE 7-0-2003; IN COMMERCE 7-0-2003.

NO CLAIM IS MADE TO THE EXCLUSIVE  
RIGHT TO USE "PUBLIC ADJUSTING CORP.",  
APART FROM THE MARK AS SHOWN.

THE MARK CONSISTS OF THE WORDS AMER-  
ILOSS PUBLIC ADJUSTING CORP. WITH AN EA-  
GLE WITH WINGS SPREAD AND STARS.

SER. NO. 77-205,791, FILED 6-14-2007.

PAUL E. FAHRENKOPF, EXAMINING ATTORNEY

**Int. Cl.: 9**

**Prior U.S. Cls.: 21, 23, 26, 36 and 38**

**Reg. No. 3,394,412**

**United States Patent and Trademark Office**

**Registered Mar. 11, 2008**

---

**TRADEMARK  
PRINCIPAL REGISTER**

**NxLearn**

LOCKHEED MARTIN CORPORATION (MARY-  
LAND CORPORATION)  
6801 ROCKLEDGE DRIVE  
BETHESDA, MD 20817

FOR: COMPUTER SOFTWARE FOR TRAINING  
IN THE USE OF COMPLEX ELECTRONIC SYS-  
TEMS, FOR DEVELOPMENT AND ASSEMBLY OF  
LESSONS AND COURSES, AND FOR MONITOR-  
ING OF STUDENT PROGRESS , IN CLASS 9 (U.S.  
CLS. 21, 23, 26, 36 AND 38).

FIRST USE 12-0-2006; IN COMMERCE 12-0-2006.

THE MARK CONSISTS OF STANDARD CHAR-  
ACTERS WITHOUT CLAIM TO ANY PARTICULAR  
FONT, STYLE, SIZE, OR COLOR.

SER. NO. 77-205,877, FILED 6-14-2007.

IRA J. GOODSaid, EXAMINING ATTORNEY

**Int. Cl.: 9**

**Prior U.S. Cls.: 21, 23, 26, 36 and 38**

**United States Patent and Trademark Office**

**Reg. No. 3,394,413**

**Registered Mar. 11, 2008**

**TRADEMARK  
PRINCIPAL REGISTER**

# NxSchedule

LOCKHEED MARTIN CORPORATION (MARY-  
LAND CORPORATION)  
6801 ROCKLEDGE DRIVE  
BETHESDA, MD 20817

FOR: COMPUTER SOFTWARE FOR MANAGE-  
MENT OF TRAINING, NAMELY, FOR CREATING  
PROGRAM TIMETABLES AND AGENDAS, FOR  
OPTIMIZATION OF TRAINING RESOURCES,  
EQUIPMENT AND MAINTENANCE, FOR EVA-  
LUATION, PROGRESSION AND PERFORMANCE  
TRACKING, AND FOR DEVISING INSTRUCTOR

AND STUDENT ACTIVITIES, IN CLASS 9 (U.S. CLS.  
21, 23, 26, 36 AND 38).

FIRST USE 8-4-2006; IN COMMERCE 8-4-2006.

THE MARK CONSISTS OF STANDARD CHAR-  
ACTERS WITHOUT CLAIM TO ANY PARTICULAR  
FONT, STYLE, SIZE, OR COLOR.

SER. NO. 77-206,114, FILED 6-14-2007.

IRA J. GOODSaid, EXAMINING ATTORNEY

**Int. Cl.: 43**

**Prior U.S. Cls.: 100 and 101**

**United States Patent and Trademark Office**

**Reg. No. 3,394,414**

**Registered Mar. 11, 2008**

**SERVICE MARK  
PRINCIPAL REGISTER**

**UTOPIA WORLD CUISINE &  
LOUNGE**

EATERTAINMENT, INC. (TEXAS CORPORATION)  
SUITE 208  
4444 CORONA DRIVE  
CORPUS CHRISTI, TX 78411

FOR: RESTAURANT SERVICES, IN CLASS 43  
(U.S. CLS. 100 AND 101).

FIRST USE 4-4-2005; IN COMMERCE 4-4-2005.

THE MARK CONSISTS OF STANDARD CHARACTERS WITHOUT CLAIM TO ANY PARTICULAR FONT, STYLE, SIZE, OR COLOR.

NO CLAIM IS MADE TO THE EXCLUSIVE RIGHT TO USE "WORLD CUISINE & LOUNGE", APART FROM THE MARK AS SHOWN.

SER. NO. 77-206,425, FILED 6-14-2007.

BRENDAN REGAN, EXAMINING ATTORNEY



**Int. Cl.: 20**

**Prior U.S. Cls.: 2, 13, 22, 25, 32 and 50**

**United States Patent and Trademark Office**

**Reg. No. 3,394,415**

**Registered Mar. 11, 2008**

**TRADEMARK  
PRINCIPAL REGISTER**



STREET PLAYERS HOLDING CORP. (CALIFORNIA CORPORATION)  
826 MAJORCA PLACE  
LOS ANGELES, CA 90049

FOR: HOUSEHOLD PET BEDS, IN CLASS 20 (U.S. CLS. 2, 13, 22, 25, 32 AND 50).

FIRST USE 1-14-2007; IN COMMERCE 1-14-2007.

NO CLAIM IS MADE TO THE EXCLUSIVE RIGHT TO USE "PET SHOP", APART FROM THE MARK AS SHOWN.

THE COLOR(S) BLACK, WHITE, RED IS/ARE CLAIMED AS A FEATURE OF THE MARK.

THE COLOR RED APPEARS IN THE WORD STYLE AND IN THE OUTLINE OF THE SQUARE DESIGN. THE COLOR BLACK APPEARS IN THE WORDING PET SHOP AND IN THE OVAL DELINEATED BY A CHAIN DESIGN THAT SURROUNDS THE WORDING PET SHOP STYLE. THE COLOR WHITE APPEARS IN THE BACKGROUND IN THE INSIDE OF THE OVAL DESIGN, AND IN A THIN WHITE LINE INSIDE THE RED OUTLINE OF THE SQUARE DESIGN. THE COLORS BLACK AND WHITE ALSO APPEAR IN THE COLLAGE OF ANIMAL PHOTOGRAPHS.

SER. NO. 77-206,595, FILED 6-14-2007.

NANCY CLARKE, EXAMINING ATTORNEY

**Int. Cl.: 38**

**Prior U.S. Cls.: 100, 101 and 104**

**United States Patent and Trademark Office**

**Reg. No. 3,394,416**

**Registered Mar. 11, 2008**

**SERVICE MARK  
PRINCIPAL REGISTER**

**BLUE COLLAR COMPUTING**

THE OHIO STATE UNIVERSITY (OHIO EDUCATIONAL INSTITUTION)  
190 NORTH OVAL MALL  
COLUMBUS, OH 43210

FOR: PROVIDING PRIVATE AND SECURE REAL TIME ELECTRONIC COMMUNICATION OVER A COMPUTER NETWORK, IN CLASS 38 (U.S. CLS. 100, 101 AND 104).

FIRST USE 11-16-2004; IN COMMERCE 11-16-2004.

THE MARK CONSISTS OF STANDARD CHARACTERS WITHOUT CLAIM TO ANY PARTICULAR FONT, STYLE, SIZE, OR COLOR.

NO CLAIM IS MADE TO THE EXCLUSIVE RIGHT TO USE "COMPUTING", APART FROM THE MARK AS SHOWN.

SER. NO. 77-207,339, FILED 6-15-2007.

ANGELA M. MICHELI, EXAMINING ATTORNEY

**Int. Cl.: 16**

**Prior U.S. Cls.: 2, 5, 22, 23, 29, 37, 38 and 50**

**United States Patent and Trademark Office**

**Reg. No. 3,394,417**

**Registered Mar. 11, 2008**

**TRADEMARK  
PRINCIPAL REGISTER**



MADE MAGAZINE INC. (NEW JERSEY CORPORATION)  
36 S MARTINE AVE  
FANWOOD, NJ 07023

NO CLAIM IS MADE TO THE EXCLUSIVE RIGHT TO USE "MAGAZINE" AND "INC.", APART FROM THE MARK AS SHOWN.

FOR: MAGAZINES FEATURING YOUNG ENTREPRENEURS AND SELF MADE PEOPLE, IN CLASS 16 (U.S. CLS. 2, 5, 22, 23, 29, 37, 38 AND 50).

SER. NO. 77-207,741, FILED 6-15-2007.

FIRST USE 5-22-2007; IN COMMERCE 5-22-2007.

DAWN HAN, EXAMINING ATTORNEY

Prior U.S. Cl.: B

United States Patent and Trademark Office

Reg. No. 3,394,418

Registered Mar. 11, 2008

CERTIFICATION MARK  
PRINCIPAL REGISTER

CFS

WILLIAMSON, GORDON K. (UNITED STATES  
INDIVIDUAL)  
7911 HERSCHEL AVENUE, SUITE 201  
LA JOLLA, CA 92037

FOR: FINANCIAL SERVICES, IN CLASS B (U.S.  
CL. B).

FIRST USE 3-1-1988; IN COMMERCE 3-1-1988.

THE MARK CONSISTS OF STANDARD CHAR-  
ACTERS WITHOUT CLAIM TO ANY PARTICULAR  
FONT, STYLE, SIZE, OR COLOR.

THE CERTIFICATION MARK, AS USED BY  
AUTHORIZED PERSONS, CERTIFIES THAT THE

PERSON DISPLAYING SAID MARK HAS COMPLE-  
TED EDUCATIONAL COURSE WORK REQUIRE-  
MENT; WORK EXPERIENCE REQUIREMENTS  
AND EXAMINATIONS ADMINISTERED BY THE  
CERTIFIERS AND HAS AGREED TO ADHERE TO  
THE CERTIFIER'S STANDARDS FOR PROFES-  
SIONAL RESPONSIBILITY, CONTINUING EDUCA-  
TION AND OTHER POST CERTIFICATION  
REQUIREMENTS.

SER. NO. 77-208,492, FILED 6-18-2007.

KAPIL BHANOT, EXAMINING ATTORNEY

**Int. Cls.: 9 and 11**

**Prior U.S. Cls.: 13, 21, 23, 26, 31, 34, 36 and 38**

**United States Patent and Trademark Office**

**Reg. No. 3,394,419**

**Registered Mar. 11, 2008**

**TRADEMARK  
PRINCIPAL REGISTER**

# BELLOWSEAL

FLEXTech INDUSTRIES, LTD. (MISSOURI CORPORATION)  
948 EAST NUSBAUM PLACE  
CLINTON, MO 64735

FOR: AUTOMATICALLY ACTIVATED GUILLOTINE DAMPERS THAT HAVE A SEALING MECHANISM FOR A SLIDING DAMPER PLATE AND ARE USED INDUSTRIALLY TO CONTROL GAS FLOW IN A DUCT, AND PARTS THEREFOR, IN CLASS 9 (U.S. CLS. 21, 23, 26, 36 AND 38).

FIRST USE 9-30-2002; IN COMMERCE 9-30-2002.

FOR: MANUALLY OPERATED GUILLOTINE DAMPERS THAT HAVE A SEALING MECHANISM FOR A SLIDING DAMPER PLATE AND ARE USED INDUSTRIALLY TO CONTROL GAS FLOW IN A

DUCT, AND PARTS THEREFORE, IN CLASS 11 (U.S. CLS. 13, 21, 23, 31 AND 34).

FIRST USE 9-30-2002; IN COMMERCE 9-30-2002.

THE MARK CONSISTS OF STANDARD CHARACTERS WITHOUT CLAIM TO ANY PARTICULAR FONT, STYLE, SIZE, OR COLOR.

OWNER OF U.S. REG. NOS. 1,428,191 AND 1,574,438.

SEC. 2(F).

SER. NO. 77-208,901, FILED 6-18-2007.

FRED MANDIR, EXAMINING ATTORNEY

**Int. Cls.: 35 and 41**

**Prior U.S. Cls.: 100, 101, 102 and 107**

**United States Patent and Trademark Office**

**Reg. No. 3,394,420**

**Registered Mar. 11, 2008**

**SERVICE MARK  
PRINCIPAL REGISTER**

KG  
2  
MUSIC

KG2 MUSIC, LLC (CALIFORNIA LTD LIAB CO)  
17530 VENTURA BLVD., SUITE 201  
ENCINO, CA 91316

FOR: MUSIC PROMOTION SERVICES, NAMELY,  
MARKETING AND ADVERTISING FOR RECORD-  
ING ARTISTS AND PROMOTING THE AUDIO  
RECORDINGS AND MUSICAL SERVICES OF OTH-  
ERS , IN CLASS 35 (U.S. CLS. 100, 101 AND 102).

FIRST USE 10-30-2006; IN COMMERCE 5-4-2007.

FOR: MUSIC PRODUCTION SERVICES, IN  
CLASS 41 (U.S. CLS. 100, 101 AND 107).

FIRST USE 10-30-2006; IN COMMERCE 5-4-2007.

THE MARK CONSISTS OF STANDARD CHAR-  
ACTERS WITHOUT CLAIM TO ANY PARTICULAR  
FONT, STYLE, SIZE, OR COLOR.

NO CLAIM IS MADE TO THE EXCLUSIVE  
RIGHT TO USE "MUSIC", APART FROM THE  
MARK AS SHOWN.

SER. NO. 77-209,000, FILED 6-18-2007.

NAKIA HENRY, EXAMINING ATTORNEY

**Int. Cl.: 41**

**Prior U.S. Cls.: 100, 101 and 107**

**United States Patent and Trademark Office**

**Reg. No. 3,394,421**

**Registered Mar. 11, 2008**

**SERVICE MARK  
PRINCIPAL REGISTER**



KILPATRICK, SR., TIMOTHY B. (UNITED STATES INDIVIDUAL)

7003 COHASSET CIRCLE

RIVERVIEW, FL 33569

FOR: NURSERY SCHOOLS; EDUCATION SERVICES, NAMELY, PROVIDING CLASSES, SEMINARS, WORKSHOPS, TUTORING, AND MENTORING IN THE FIELD OF MIDDLE AND HIGH SCHOOL REFORM; EDUCATIONAL PROGRAMS, NAMELY, PRE-SCHOOLS; PROVIDING AFTER SCHOOL EDUCATIONAL PROGRAMS FOR CHILDREN IN GRADES CONSISTING OF PRE-K THRU 5TH, IN CLASS 41 (U.S. CLS. 100, 101 AND 107).

FIRST USE 3-1-2003; IN COMMERCE 3-1-2003.

THE COLOR(S) BROWN, GOLD, BURGUNDY, BLACK AND GREEN IS/ARE CLAIMED AS A FEATURE OF THE MARK.

THE COLOR BROWN APPEARS IN THE BOOKS, IN THE BOOKENDS AND IN PORTIONS OF THE GLOBE DESIGNS. THE COLOR GOLD APPEARS IN THE LETTERS KCC, AND IN SEVERAL HORIZONTAL LINES ON THE BOOK BINDINGS. THE COLORS BROWN, GOLD, BURGUNDY AND GREEN APPEAR IN THE GLOBE DESIGNS. THE COLOR BLACK APPEARS AS SHADING ON THE GLOBE DESIGNS.

SER. NO. 77-209,281, FILED 6-19-2007.

NANCY CLARKE, EXAMINING ATTORNEY

**Int. Cl.: 37**

**Prior U.S. Cls.: 100, 103 and 106**

**United States Patent and Trademark Office**

**Reg. No. 3,394,422**

**Registered Mar. 11, 2008**

**SERVICE MARK  
PRINCIPAL REGISTER**

**NO DRAWING-SENSORY MARK**

GENERAL MOTORS CORPORATION (DELA-  
WARE CORPORATION)  
P.O. BOX 300  
300 RENAISSANCE CENTER  
DETROIT, MI 482653000

FOR: MAINTENANCE AND REPAIR SERVICES  
FOR MOTOR LAND VEHICLES, IN CLASS 37 (U.S.  
CLS. 100, 103 AND 106).

FIRST USE 1-29-2007; IN COMMERCE 1-29-2007.

THE MARK IS A SOUND. THE MARK CONSISTS  
OF A METALLIC RESONATING SOUND, FOL-  
LOWED BY TWO ELECTRONIC BEEPS, THE FIRST  
HIGHER THAN THE SECOND. THE BEEPS ARE  
THEN FOLLOWED BY A MECHANICAL RATCH-  
ETING SOUND, INCREASING IN FREQUENCY.

SER. NO. 77-209,567, FILED 6-19-2007.

JASON BLAIR, EXAMINING ATTORNEY



**Int. Cl.: 45**

**Prior U.S. Cls.: 100 and 101**

**United States Patent and Trademark Office**

**Reg. No. 3,394,423**

**Registered Mar. 11, 2008**

**SERVICE MARK  
PRINCIPAL REGISTER**

**POM OFFENDER LOCATOR**

VISION 20/20 INC. (NEVADA CORPORATION)  
SUITE 1300  
11757 KATY FREEWAY  
HOUSTON, TX 77079

FOR: SECURITY SERVICES, NAMELY, SEXUAL  
OFFENDER REGISTRY AND LOCATOR SERVICE,  
IN CLASS 45 (U.S. CLS. 100 AND 101).

FIRST USE 4-15-2007; IN COMMERCE 4-15-2007.

THE MARK CONSISTS OF STANDARD CHAR-  
ACTERS WITHOUT CLAIM TO ANY PARTICULAR  
FONT, STYLE, SIZE, OR COLOR.

NO CLAIM IS MADE TO THE EXCLUSIVE  
RIGHT TO USE "OFFENDER LOCATOR", APART  
FROM THE MARK AS SHOWN.

SER. NO. 77-209,589, FILED 6-19-2007.

PAUL CROWLEY, EXAMINING ATTORNEY

**Int. Cl.: 9**

**Prior U.S. Cls.: 21, 23, 26, 36 and 38**

**United States Patent and Trademark Office**

**Reg. No. 3,394,424**

**Registered Mar. 11, 2008**

**TRADEMARK  
PRINCIPAL REGISTER**



**PARALLEL SYSTEMS**

PARALLEL SYSTEMS, INC. (NEW JERSEY CORPORATION)

208 MYRTLE AVENUE

TURNERSVILLE, NJ 08012

FOR: COMPUTER HARDWARE, IN CLASS 9 (U.S. CLS. 21, 23, 26, 36 AND 38).

FIRST USE 8-10-1981; IN COMMERCE 12-9-1981.

NO CLAIM IS MADE TO THE EXCLUSIVE RIGHT TO USE "PARALLEL SYSTEMS", APART FROM THE MARK AS SHOWN.

THE MARK CONSISTS OF THE WORDS PARALLEL SYSTEMS WITH HORIZONTAL LINES ABOVE AND BELOW THE WORDS.

SER. NO. 77-209,773, FILED 6-19-2007.

SCOTT SISUN, EXAMINING ATTORNEY

Int. Cl.: 35

Prior U.S. Cls.: 100, 101 and 102

United States Patent and Trademark Office

Reg. No. 3,394,425

Registered Mar. 11, 2008

SERVICE MARK  
PRINCIPAL REGISTER



BLAIR, EARL (UNITED STATES INDIVIDUAL)  
1528 HARVARD ST.  
HOUSTON, TX 77008

FOR: ON-LINE RETAIL STORE SERVICES FEATURING VIDEOS, DVDS, MOVIE MEMORABILIA, COLLECTIBLES, TOYS AND BOOKS; RETAIL STORE SERVICES FEATURING VIDEOS, DVDS, MOVIE MEMORABILIA, COLLECTIBLES, TOYS AND BOOKS, IN CLASS 35 (U.S. CLS. 100, 101 AND 102).

FIRST USE 1-1-1989; IN COMMERCE 1-1-1989.

THE NAME SHOWN IN THE MARK DOES NOT IDENTIFY A PARTICULAR LIVING INDIVIDUAL.

THE MARK CONSISTS OF A CIRCULAR LOGO WITH THE LARGE LETTER CB IN THE CENTER AND THE WORDS "CAPTAIN BIJOU" AND "WWW.CAPTAINBIJOU.COM" AROUND THE EDGE.

SER. NO. 77-210,179, FILED 6-19-2007.

ELIZABETH HUGHITT, EXAMINING ATTORNEY

Int. Cl.: 36

Prior U.S. Cls.: 100, 101 and 102

United States Patent and Trademark Office

Reg. No. 3,394,426

Registered Mar. 11, 2008

SERVICE MARK  
PRINCIPAL REGISTER



AMIGOS TOGETHER FOR KIDS, INC. (FLORIDA NON-PROFIT CORPORATION)  
SUITE 200  
815 PONCE DE LEON  
CORAL GABLES, FL 33134

FOR: CHARITABLE FUND RAISING SERVICES FOR THE BENEFIT OF ABUSED, ABANDONED AND NEGLECTED CHILDREN, IN CLASS 36 (U.S. CLS. 100, 101 AND 102).

FIRST USE 11-3-2006; IN COMMERCE 11-3-2006.

OWNER OF U.S. REG. NO. 2,761,096.

THE COLOR(S) PINK, GOLD, PURPLE, GREEN, BLUE, AND RED IS/ARE CLAIMED AS A FEATURE OF THE MARK.

THE MARK CONSISTS OF THE WORD AMIGOS ABOVE THE WORDS FOR KIDS NEXT TO A STYLIZED REPRESENTATION OF AN ADULT AND TWO CHILDREN. THE LETTER A IS PINK, THE LETTER M IS GOLD, THE LETTER I IS PURPLE WITH A RED HEART AS A DOT ON THE I, THE LETTER G IS GREEN, THE LETTER O IS BLUE AND THE LETTER S IS RED. THE WORDS FOR KIDS ARE PURPLE. THE ADULT FIGURE IS PURPLE, THE FEMALE CHILD IS GOLD AND THE MALE CHILD IS GREEN.

THE FOREIGN WORDING IN THE MARK TRANSLATES INTO ENGLISH AS FRIENDS.

SER. NO. 77-210,242, FILED 6-19-2007.

DANNEAN HETZEL, EXAMINING ATTORNEY

**Int. Cl.: 36**

**Prior U.S. Cls.: 100, 101 and 102**

**United States Patent and Trademark Office**

**Reg. No. 3,394,427**

**Registered Mar. 11, 2008**

**SERVICE MARK  
PRINCIPAL REGISTER**

**AMIGOS FOR KIDS**

AMIGOS TOGETHER FOR KIDS, INC. (FLORIDA  
NON-PROFIT CORPORATION)  
SUITE 200  
815 PONCE DE LEON  
CORAL GABLES, FL 33134

FOR: CHARITABLE FUND RAISING SERVICES  
FOR THE BENEFIT OF ABUSED, ABANDONED  
AND NEGLECTED CHILDREN, IN CLASS 36 (U.S.  
CLS. 100, 101 AND 102).

FIRST USE 11-3-2006; IN COMMERCE 11-3-2006.

THE MARK CONSISTS OF STANDARD CHAR-  
ACTERS WITHOUT CLAIM TO ANY PARTICULAR  
FONT, STYLE, SIZE, OR COLOR.

OWNER OF U.S. REG. NO. 2,761,096.

THE FOREIGN WORDING IN THE MARK  
TRANSLATES INTO ENGLISH AS FRIENDS.

SER. NO. 77-210,248, FILED 6-19-2007.

DANNEAN HETZEL, EXAMINING ATTORNEY

**Int. Cl.: 41**

**Prior U.S. Cls.: 100, 101 and 107**

**United States Patent and Trademark Office**

**Reg. No. 3,394,428**

**Registered Mar. 11, 2008**

**SERVICE MARK  
PRINCIPAL REGISTER**



GOLOZO LLC (CALIFORNIA LTD LIAB CO)

#D

7220D CALABRIA COURT  
SAN DIEGO, CA 92122

FOR: EDUCATION AND ENTERTAINMENT SERVICES, NAMELY, PROVIDING A WEBSITE FEATURING INFORMATION IN THE FIELD OF GENERAL INTEREST, AUDIO CLIPS, VIDEO CLIPS, MUSICAL PERFORMANCES, MUSICAL VIDEOS, FILM CLIPS, PHOTOGRAPHS, AND OTHER MULTIMEDIA MATERIALS; BLOGS FEATURING INFORMATION IN THE FIELD OF GENERAL INTEREST, AUDIO CLIPS, VIDEO CLIPS, MUSICAL

PERFORMANCES, MUSICAL VIDEOS, FILM CLIPS, PHOTOGRAPHS, AND OTHER MULTIMEDIA MATERIALS, IN CLASS 41 (U.S. CLS. 100, 101 AND 107).

FIRST USE 3-1-2007; IN COMMERCE 3-1-2007.

THE MARK CONSISTS OF A CARTOON BUG LOOKING FROM ABOVE THE STYLIZED TEXT "VIEWBUG.COM".

SER. NO. 77-210,289, FILED 6-20-2007.

ALEXANDER L. POWERS, EXAMINING ATTORNEY

**Int. Cl.: 35**

**Prior U.S. Cls.: 100, 101 and 102**

**United States Patent and Trademark Office**

**Reg. No. 3,394,429**

**Registered Mar. 11, 2008**

**SERVICE MARK  
PRINCIPAL REGISTER**

**CLIPPER**

CLIPPER DISTRIBUTING COMPANY, LLC (MISSOURI LTD LIAB CO)  
1302 SOUTH 59TH STREET  
ST. JOSEPH, MO 64507

FOR: WHOLESALE DISTRIBUTORSHIP OF VETERINARY PHARMACEUTICALS, IN CLASS 35 (U.S. CLS. 100, 101 AND 102).

FIRST USE 8-23-2002; IN COMMERCE 8-23-2002.

THE MARK CONSISTS OF STANDARD CHARACTERS WITHOUT CLAIM TO ANY PARTICULAR FONT, STYLE, SIZE, OR COLOR.

OWNER OF U.S. REG. NO. 2,846,755.

SER. NO. 77-210,779, FILED 6-20-2007.

LANA PHAM, EXAMINING ATTORNEY

**Int. Cl.: 35**

**Prior U.S. Cls.: 100, 101 and 102**

**United States Patent and Trademark Office**

**Reg. No. 3,394,430**

**Registered Mar. 11, 2008**

**SERVICE MARK  
PRINCIPAL REGISTER**

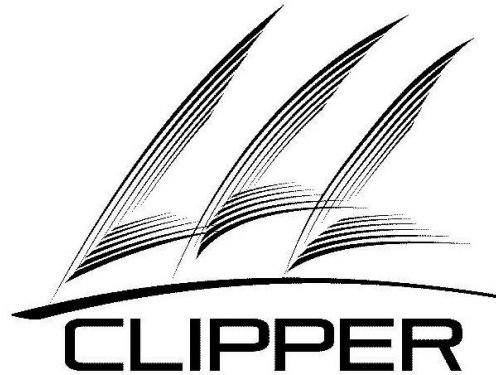

CLIPPER DISTRIBUTING COMPANY, LLC (MISSOURI LTD LIAB CO)  
1302 SOUTH 59TH STREET  
ST. JOSEPH, MO 64507

FOR: WHOLESAL DISTRIBUTORSHIP OF VETERINARY PHARMACEUTICALS, IN CLASS 35 (U.S. CLS. 100, 101 AND 102).

FIRST USE 4-16-2007; IN COMMERCE 4-16-2007.

OWNER OF U.S. REG. NO. 2,846,755.

SER. NO. 77-210,794, FILED 6-20-2007.

LANA PHAM, EXAMINING ATTORNEY



**Int. Cl.: 36**

**Prior U.S. Cls.: 100, 101 and 102**

**United States Patent and Trademark Office**

**Reg. No. 3,394,431**

**Registered Mar. 11, 2008**

---

**SERVICE MARK  
PRINCIPAL REGISTER**

**WALLSTRIP**

CBS INTERACTIVE INC. (DELAWARE CORPORATION)  
51 WEST 52ND STREET  
NEW YORK, NY 10019

FOR: PROVIDING FINANCIAL AND INVESTMENT NEWS AND INFORMATION VIA THE INTERNET, PORTABLE AND WIRELESS COMMUNICATION DEVICES, IN CLASS 36 (U.S. CLS. 100, 101 AND 102).

FIRST USE 10-16-2006; IN COMMERCE 10-16-2006.

THE MARK CONSISTS OF STANDARD CHARACTERS WITHOUT CLAIM TO ANY PARTICULAR FONT, STYLE, SIZE, OR COLOR.

SER. NO. 77-211,033, FILED 6-20-2007.

PAUL MORENO, EXAMINING ATTORNEY

**Int. Cl.: 25**

**Prior U.S. Cls.: 22 and 39**

**United States Patent and Trademark Office**

**Reg. No. 3,394,432**

**Registered Mar. 11, 2008**

**TRADEMARK  
PRINCIPAL REGISTER**



SEXE (FLORIDA PARTNERSHIP)  
2124 NEWMARK DRIVE  
DELTONA, FL 32738

FOR: LINGERIE, IN CLASS 25 (U.S. CLS. 22 AND 39).

FIRST USE 5-31-2006; IN COMMERCE 7-1-2006.

THE COLOR(S) MAGENTA HOT PINK IS/ARE CLAIMED AS A FEATURE OF THE MARK.

THE MARK CONSISTS OF SOLID MAGENTA HOT PINK.

SER. NO. 77-211,083, FILED 6-20-2007.

ELLEN PERKINS, EXAMINING ATTORNEY

**Int. Cl.: 16**

**Prior U.S. Cls.: 2, 5, 22, 23, 29, 37, 38 and 50**

**United States Patent and Trademark Office**

**Reg. No. 3,394,433**

**Registered Mar. 11, 2008**

**TRADEMARK  
PRINCIPAL REGISTER**



POLYVINYL FILMS, INC. (MASSACHUSETTS  
CORPORATION)  
19 DEPOT ST.  
SUTTON, MA 01590

FOR: FOOD WRAPPING PLASTIC FILM FOR  
HOUSEHOLD USE; PLASTIC WRAP, IN CLASS 16  
(U.S. CLS. 2, 5, 22, 23, 29, 37, 38 AND 50).

FIRST USE 1-1-1972; IN COMMERCE 1-1-1972.

OWNER OF U.S. REG. NO. 965,574.

THE COLOR(S) YELLOW AND BLUE IS/ARE  
CLAIMED AS A FEATURE OF THE MARK.

THE MARK CONSISTS OF THE WORDING  
STRETCH-TITE IN THE COLOR BLUE ON A YEL-  
LOW BACKGROUND.

SER. NO. 77-211,130, FILED 6-20-2007.

PAUL MORENO, EXAMINING ATTORNEY

**Int. Cl.: 16**

**Prior U.S. Cls.: 2, 5, 22, 23, 29, 37, 38 and 50**

**Reg. No. 3,394,434**

**United States Patent and Trademark Office**

**Registered Mar. 11, 2008**

---

**TRADEMARK  
PRINCIPAL REGISTER**

**THE SHADCHAN**

THE SIMCHA FOUNDATION, INC. (MARY-  
LAND CORPORATION)  
3214 NORTHBROOK ROAD  
BALTIMORE, MD 21208

FOR: PRINTED PERIODICALS IN THE FIELD OF  
RELATIONSHIPS IN THE ORTHODOX JEWISH  
COMMUNITY, IN CLASS 16 (U.S. CLS. 2, 5, 22, 23,  
29, 37, 38 AND 50).

FIRST USE 4-5-2006; IN COMMERCE 4-5-2006.

THE MARK CONSISTS OF STANDARD CHAR-  
ACTERS WITHOUT CLAIM TO ANY PARTICULAR  
FONT, STYLE, SIZE, OR COLOR.

THE FOREIGN WORDING IN THE MARK  
TRANSLATES INTO ENGLISH AS MARRIAGE  
BROKER.

SER. NO. 77-211,131, FILED 6-20-2007.

PAUL MORENO, EXAMINING ATTORNEY

**Int. Cl.: 16**

**Prior U.S. Cls.: 2, 5, 22, 23, 29, 37, 38 and 50**

**Reg. No. 3,394,435**

**United States Patent and Trademark Office**

**Registered Mar. 11, 2008**

---

**TRADEMARK  
PRINCIPAL REGISTER**

# Invisible Bridges

PROFESSIONAL RELATIONSHIP INSTITUTE  
(CALIFORNIA LTD LIAB CO)  
C/O E.HANSCOM 7395 PORTAGE WAY  
CARLSBAD, CA 92011

FOR: EDUCATIONAL BOOKS FEATURING INFORMATION ON PROFESSIONAL RELATIONSHIP BUILDING METHODS.; EDUCATIONAL PUBLICATIONS, NAMELY, EDUCATIONAL LEARNING CARDS, FLASH CARDS, ACTIVITY CARDS, WORKBOOKS, TEXTBOOKS, ACTIVITY BOOKS, STORY BOOKS, PUZZLE BOOKS, PUZZLES, TEACHER GUIDES, MANUALS, POSTERS, EDUCATIONAL CARD GAMES AND EDUCATIONAL

BOOKLETS IN THE FIELD OF PROFESSIONAL RELATIONSHIP BUILDING METHODS, IN CLASS 16 (U.S. CLS. 2, 5, 22, 23, 29, 37, 38 AND 50).

FIRST USE 6-1-2000; IN COMMERCE 6-1-2000.

THE MARK CONSISTS OF STANDARD CHARACTERS WITHOUT CLAIM TO ANY PARTICULAR FONT, STYLE, SIZE, OR COLOR.

SER. NO. 77-211,290, FILED 6-20-2007.

JANET LEE, EXAMINING ATTORNEY

**Int. Cl.: 3**

**Prior U.S. Cls.: 1, 4, 6, 50, 51 and 52**

**United States Patent and Trademark Office**

**Reg. No. 3,394,436**

**Registered Mar. 11, 2008**

**TRADEMARK  
PRINCIPAL REGISTER**

**Myxotica**

CLARKE, CANDACE (UNITED STATES INDIVIDUAL)  
886 HWY. 229  
SOCIAL CIRCLE, GA 30025

FOR: EYESHADOW, FOUNDATION, CONCEALER, FACE POWDER, MASCARA, SKIN CLEANSER, MAKE UP REMOVER, TONER, FRAGRANCE FOR PERSONAL USE, BLUSH, SKIN CREAM, IN CLASS 3 (U.S. CLS. 1, 4, 6, 50, 51 AND 52).

FIRST USE 2-1-1998; IN COMMERCE 1-25-2000.

THE MARK CONSISTS OF STANDARD CHARACTERS WITHOUT CLAIM TO ANY PARTICULAR FONT, STYLE, SIZE, OR COLOR.

SER. NO. 77-211,336, FILED 6-20-2007.

LAURIE MAYES, EXAMINING ATTORNEY

Int. Cl.: 5

Prior U.S. Cls.: 6, 18, 44, 46, 51 and 52

United States Patent and Trademark Office

Reg. No. 3,394,437

Registered Mar. 11, 2008

TRADEMARK  
PRINCIPAL REGISTER

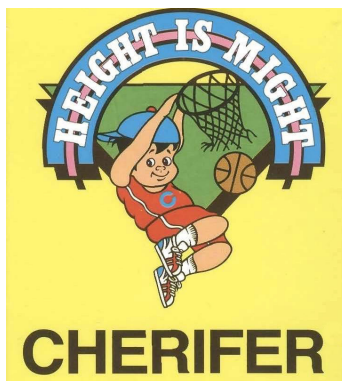

GRUPPO MEDICA, INCORPORATED (PHILIPPINES CORPORATION)  
INDUSTRYST.,MADRIGAL BUS.PK.AYALAALABANG  
16/F, THE PARAGON CORPORATE CENTRE  
MUNTINLUPA CITY, PHILIPPINES

FOR: VITAMINS; FOOD SUPPLEMENTS, IN CLASS 5 (U.S. CLS. 6, 18, 44, 46, 51 AND 52).

FIRST USE 3-31-1993; IN COMMERCE 10-31-2006.

THE COLOR(S) BLACK, YELLOW, WHITE, BLUE, GREEN, RED, PINK, TAN AND BROWN IS/ARE CLAIMED AS A FEATURE OF THE MARK.

THE MARK CONSISTS OF THE WORD CHERIFER IN BLACK AND THE DESIGN OF A BOY WITH BLACK HAIR AND TAN SKIN, A BLUE CAP,

A RED TOP AND RED SHORTS EACH WITH A WHITE VERTICAL STRIPE ALONG THE SIDE, WHITE SOCKS AND WHITE SNEAKERS WITH A BLUE HEEL PORTION AND RED STRIPES, THE BOY HOLDING ON TO A BLACK BASKETBALL HOOP WITH A BLACK NET AND A BROWN BASKETBALL UNDERNEATH, WITH A GREEN TRIANGLE BEHIND THE BOY WITH BLACK SHADING RESEMBLING A SHADOW, WITH A BLUE ARCH WITH A PINK STRIPE ABOVE THE BOY AND SUPERIMPOSED OVER THE GREEN TRIANGLE, WITH THE WORDS HEIGHT IS MIGHT SUPERIMPOSED IN WHITE IN SAID ARCH, AND A YELLOW BACKGROUND.

SER. NO. 77-211,532, FILED 6-21-2007.

DANNEAN HETZEL, EXAMINING ATTORNEY

**Int. Cl.: 7**

**Prior U.S. Cls.: 13, 19, 21, 23, 31, 34 and 35**

**United States Patent and Trademark Office**

**Reg. No. 3,394,438**

**Registered Mar. 11, 2008**

**TRADEMARK  
PRINCIPAL REGISTER**

# CABLE COP

DL MANUFACTURING, INC. (NEW YORK CORPORATION)  
340 GATEWAY PARK DRIVE  
NORTH SYRACUSE, NY 13212

FOR: ELECTRO-MECHANICAL UNIT TO DETECT AND CORRECT SLACK IN AN OVERHEAD DOOR CABLE, IN CLASS 7 (U.S. CLS. 13, 19, 21, 23, 31, 34 AND 35).

FIRST USE 5-23-2007; IN COMMERCE 5-23-2007.

THE MARK CONSISTS OF STANDARD CHARACTERS WITHOUT CLAIM TO ANY PARTICULAR FONT, STYLE, SIZE, OR COLOR.

NO CLAIM IS MADE TO THE EXCLUSIVE RIGHT TO USE CABLE, APART FROM THE MARK AS SHOWN.

SER. NO. 77-211,918, FILED 6-21-2007.

RAUL CORDOVA, EXAMINING ATTORNEY



**Int. Cl.: 43**

**Prior U.S. Cls.: 100 and 101**

**United States Patent and Trademark Office**

**Reg. No. 3,394,439**

**Registered Mar. 11, 2008**

**SERVICE MARK  
PRINCIPAL REGISTER**



LANGKAMP A CRAIG (UNITED STATES INDIVIDUAL)  
457 WEBSTER STREET  
MONTEREY, CA 93940

FOR: TRAVEL AGENCY SERVICES, NAMELY, MAKING RESERVATIONS AND BOOKING FOR TEMPORARY LODGING, IN CLASS 43 (U.S. CLS. 100 AND 101).

FIRST USE 1-1-1988; IN COMMERCE 1-1-1988.

OWNER OF U.S. REG. NOS. 2,442,224 AND 2,442,225.

NO CLAIM IS MADE TO THE EXCLUSIVE RIGHT TO USE "INNS OF CALIFORNIA" AND THE REPRESENTATION OF THE OUTLINE OF THE STATE OF CALIFORNIA, APART FROM THE MARK AS SHOWN.

THE COLOR(S) PURPLE, PLUM, AND GOLD IS/ ARE CLAIMED AS A FEATURE OF THE MARK.

THE COLOR PURPLE APPEARS IN THE BACKGROUND OF THE CIRCLE DESIGN, THE COLOR PLUM APPEARS IN THE BACKGROUND OF THE ROUNDED RECTANGLE DESIGN, AND THE COLOR GOLD APPEARS IN THE "INNS OF CALIFORNIA" WORDING, THE DESIGN OF THE STATE OF CALIFORNIA, THE OUTLINE OF THE CIRCLE DESIGN, AND THE OUTLINE OF THE ROUNDED RECTANGLE DESIGN. THE MARK CONSISTS OF THE WORDING "INNS OF CALIFORNIA" IN STYLIZED FORM, BENEATH A REPRESENTATION OF THE STATE OF CALIFORNIA WITHIN A CIRCLE, ALL ENCASED WITHIN A ROUNDED RECTANGLE DESIGN.

SER. NO. 77-212,063, FILED 6-21-2007.

JASON LOTT, EXAMINING ATTORNEY

**Int. Cls.: 7 and 20**

**Prior U.S. Cls.: 2, 13, 19, 21, 22, 23, 25, 31, 32, 34, 35  
and 50**

**Reg. No. 3,394,440**

**United States Patent and Trademark Office**

**Registered Mar. 11, 2008**

**TRADEMARK  
PRINCIPAL REGISTER**

# Ascent

LAFAYETTE VENETIAN BLIND, INC. (INDIANA CORPORATION)  
3000 KLONDIKE ROAD, P.O. BOX 2838  
WEST LAFAYETTE, IN 47906

FOR: MOTORS FOR WINDOW BLINDS, WINDOW SHADES, AND VENETIAN BLINDS; MOTORIZED LIFT AND TILT SYSTEM FOR WINDOW BLINDS, WINDOW SHADES, AND VENETIAN BLINDS CONSISTING OF SPOOLS, MOTOR, AND TRANSMISSION, IN CLASS 7 (U.S. CLS. 13, 19, 21, 23, 31, 34 AND 35).

FIRST USE 2-12-2007; IN COMMERCE 2-12-2007.

FOR: WINDOW BLINDS, WINDOW SHADES, AND VENETIAN BLINDS; LIFT AND TILT SYSTEM

FOR WINDOW BLINDS, WINDOW SHADES, AND VENETIAN BLINDS CONSISTING OF SPOOLS, MOTOR, AND TRANSMISSION SOLD AS A COMPONENT OF BLINDS AND SHADES, IN CLASS 20 (U.S. CLS. 2, 13, 22, 25, 32 AND 50).

FIRST USE 2-12-2007; IN COMMERCE 2-12-2007.

THE MARK CONSISTS OF STANDARD CHARACTERS WITHOUT CLAIM TO ANY PARTICULAR FONT, STYLE, SIZE, OR COLOR.

SER. NO. 77-212,297, FILED 6-21-2007.

INGRID C. EULIN, EXAMINING ATTORNEY

Int. Cl.: 35

Prior U.S. Cls.: 100, 101 and 102

United States Patent and Trademark Office

Reg. No. 3,394,441

Registered Mar. 11, 2008

SERVICE MARK  
PRINCIPAL REGISTER



GREELEY CHAMBER OF COMMERCE (COLOR-  
ADO CORPORATION)  
920 7TH AVENUE  
GREELEY, CO 80631

FOR: CHAMBER OF COMMERCE SERVICES,  
NAMELY, PROMOTING BUSINESS AND TOURISM  
IN THE GREELEY, COLORADO AREA, IN CLASS 35  
(U.S. CLS. 100, 101 AND 102).

FIRST USE 3-1-2007; IN COMMERCE 3-1-2007.

NO CLAIM IS MADE TO THE EXCLUSIVE  
RIGHT TO USE "GREELEY" AND "COLORADO",  
APART FROM THE MARK AS SHOWN.

THE COLOR(S) WHITE, GOLD, BLUE IS/ARE  
CLAIMED AS A FEATURE OF THE MARK.

THE MARK CONSISTS OF THE WORD "GREE-  
LEY" IN BLUE WITH THE WORD "COLORADO" IN  
GOLD OVER THE "Y" IN GREELEY. CURVED  
LINES IN GOLD ABOVE THE WORD "GREELEY"  
WITH A WHITE COWBOY HAT OUTLINED IN  
BLUE LOCATED IN THE MIDDLE OF THE LINES.  
BENEATH THE WORD "GREELEY" ARE THE  
WORDS "GREAT. FROM THE GROUND UP." IN  
GOLD.

SER. NO. 77-212,331, FILED 6-21-2007.

SCOTT BIBB, EXAMINING ATTORNEY

**Int. Cl.: 41**

**Prior U.S. Cls.: 100, 101 and 107**

**United States Patent and Trademark Office**

**Reg. No. 3,394,442**

**Registered Mar. 11, 2008**

---

**SERVICE MARK  
PRINCIPAL REGISTER**

# Ithaca Pictures

HARPER, WILLIAM (UNITED STATES INDIVIDUAL)  
APARTMENT 3H  
310 WEST 93RD STREET  
NEW YORK, NY 10025

FIRST USE 5-15-2007; IN COMMERCE 5-15-2007.

NO CLAIM IS MADE TO THE EXCLUSIVE RIGHT TO USE "PICTURES", APART FROM THE MARK AS SHOWN.

FOR: ENTERTAINMENT SERVICES, NAMELY, PRODUCTION AND DISTRIBUTION OF MOTION PICTURES AND TELEVISION PROGRAMS, IN CLASS 41 (U.S. CLS. 100, 101 AND 107).

SER. NO. 77-213,052, FILED 6-22-2007.

JORDAN BAKER, EXAMINING ATTORNEY

**Int. Cl.: 36**

**Prior U.S. Cls.: 100, 101 and 102**

**United States Patent and Trademark Office**

**Reg. No. 3,394,443**

**Registered Mar. 11, 2008**

**SERVICE MARK  
PRINCIPAL REGISTER**

**ProPay SplitPay**

PROPAY USA, INC. (UTAH CORPORATION)  
500 TIMPANOGOS CIRCLE  
OREM, UT 840976205

FOR: FINANCIAL SERVICES, NAMELY, EN-  
ABLING ONLINE OR HOME-BASED BUSINESSES  
TO MAKE AND RECEIVE PAYMENTS VIA TELE-  
PHONE, FACSIMILE, ONLINE AND WIRELESS  
APPLICATIONS, IN CLASS 36 (U.S. CLS. 100, 101  
AND 102).

FIRST USE 5-15-2007; IN COMMERCE 5-15-2007.

THE MARK CONSISTS OF STANDARD CHAR-  
ACTERS WITHOUT CLAIM TO ANY PARTICULAR  
FONT, STYLE, SIZE, OR COLOR.

OWNER OF U.S. REG. NO. 3,061,051.

NO CLAIM IS MADE TO THE EXCLUSIVE  
RIGHT TO USE "SPLIT PAY", APART FROM THE  
MARK AS SHOWN.

SER. NO. 77-213,088, FILED 6-22-2007.

HEATHER BIDDULPH, EXAMINING ATTORNEY

**Int. Cl.: 41**

**Prior U.S. Cls.: 100, 101 and 107**

**United States Patent and Trademark Office**

**Reg. No. 3,394,444**

**Registered Mar. 11, 2008**

**SERVICE MARK  
PRINCIPAL REGISTER**

**Savvy Event Designs LLC**

SAVVY EVENT DESIGNS LLC (NORTH CAROLINA LTD LIAB CO)  
9436 PALM BAY CIRCLE  
RALEIGH, NC 27617

FOR: SPECIAL EVENT PLANNING AND CONSULTATION, IN CLASS 41 (U.S. CLS. 100, 101 AND 107).

FIRST USE 4-18-2007; IN COMMERCE 4-30-2007.

THE MARK CONSISTS OF STANDARD CHARACTERS WITHOUT CLAIM TO ANY PARTICULAR FONT, STYLE, SIZE, OR COLOR.

NO CLAIM IS MADE TO THE EXCLUSIVE RIGHT TO USE "EVENT DESIGNS LLC", APART FROM THE MARK AS SHOWN.

SER. NO. 77-213,327, FILED 6-22-2007.

ALICE BENMAMAN, EXAMINING ATTORNEY

Int. Cl.: 12

Prior U.S. Cls.: 19, 21, 23, 31, 35 and 44

Reg. No. 3,394,445

United States Patent and Trademark Office

Registered Mar. 11, 2008

TRADEMARK  
PRINCIPAL REGISTER

SONORA  
EDITION

GULF COAST 4 STAR TRAILER SALES LLC  
(TEXAS LTD LIAB CO)  
17425 HWY 75  
WILLIS, TX 77378

NO CLAIM IS MADE TO THE EXCLUSIVE  
RIGHT TO USE "EDITION", APART FROM THE  
MARK AS SHOWN.

FOR: HORSE TRAILERS FEATURING BUILT IN  
CUSTOM MADE LIVING QUARTERS WITH ONE  
COMPARTMENT DESIGNED FOR TRANSPORT-  
ING HORSES AND THE OTHER COMPARTMENT  
CONSISTING OF LIVING QUARTERS WHICH ARE  
DESIGNED TO A SPECIFIC SIZE, LAYOUT, COM-  
BINATION OF CONSTRUCTION MATERIALS AND  
HARDWARE, IN CLASS 12 (U.S. CLS. 19, 21, 23, 31, 35  
AND 44).

THE MARK CONSISTS OF A STYLIZED FONT  
WITH THE WORDS SONORA EDITION, EDITION  
BEING SMALLER (50% OR SMALLER) AND CEN-  
TERED BELOW SONORA.

SER. NO. 77-213,377, FILED 6-22-2007.

FIRST USE 12-4-2006; IN COMMERCE 12-4-2006.

KYLE PEETE, EXAMINING ATTORNEY

**Int. Cl.: 12**

**Prior U.S. Cls.: 19, 21, 23, 31, 35 and 44**

**United States Patent and Trademark Office**

**Reg. No. 3,394,446**

**Registered Mar. 11, 2008**

**TRADEMARK  
PRINCIPAL REGISTER**

**BANDERA  
EDITION**

GULF COAST 4 STAR TRAILER SALES LLC  
(TEXAS LTD LIAB CO)  
17425 HWY 75  
WILLIS, TX 77378

NO CLAIM IS MADE TO THE EXCLUSIVE  
RIGHT TO USE "EDITION", APART FROM THE  
MARK AS SHOWN.

FOR: HORSE TRAILERS FEATURING BUILT IN  
CUSTOM MADE LIVING QUARTERS WITH ONE  
COMPARTMENT DESIGNED FOR TRANSPORT-  
ING HORSES AND THE OTHER COMPARTMENT  
CONSISTING OF LIVING QUARTERS WHICH ARE  
DESIGNED TO A SPECIFIC SIZE, LAYOUT, COM-  
BINATION OF CONSTRUCTION MATERIALS AND  
HARDWARE, IN CLASS 12 (U.S. CLS. 19, 21, 23, 31, 35  
AND 44).

THE MARK CONSISTS OF A STYLIZED FONT  
WITH THE WORDS BANDERA EDITION, EDITION  
BEING SMALLER AND CENTERED BELOW BAN-  
DERA.

SER. NO. 77-213,622, FILED 6-22-2007.

FIRST USE 10-28-2006; IN COMMERCE 10-28-2006.

KYLE PEETE, EXAMINING ATTORNEY



**Int. Cl.: 37**

**Prior U.S. Cls.: 100, 103 and 106**

**United States Patent and Trademark Office**

**Reg. No. 3,394,447**

**Registered Mar. 11, 2008**

**SERVICE MARK  
PRINCIPAL REGISTER**



3-F CONTRACTING, INC. (ARIZONA CORPORATION)

PMB 102

6517 S KINGS RANCH RD

GOLD CANYON, AZ 85218

FOR: CONSTRUCTION OF ROADS, UNDERGROUND UTILITIES, AND HOUSING PADS; CONSTRUCTION GRADING SERVICES, IN CLASS 37 (U.S. CLS. 100, 103 AND 106).

FIRST USE 3-0-2003; IN COMMERCE 3-0-2003.

THE COLOR(S) RED, GRAY, WHITE AND BLACK IS/ARE CLAIMED AS A FEATURE OF THE MARK.

THE MARK CONSISTS OF A GRAY SHADED OVAL SHAPE SURROUNDED BY TWO CONCENTRIC RINGS OF WHITE AND BLACK, WITH THE TERM "3-F" APPEARING IN RED SUPERIMPOSED OVER THE GRAY OVAL.

SER. NO. 77-213,632, FILED 6-22-2007.

KELLY MCCOY, EXAMINING ATTORNEY

**Int. Cl.: 29**

**Prior U.S. Cl.: 46**

**United States Patent and Trademark Office**

**Reg. No. 3,394,448**

**Registered Mar. 11, 2008**

**TRADEMARK  
PRINCIPAL REGISTER**



EVERYTHING RAW COMPANY (VIRGINIA CORPORATION)

PO BOX 1187

338 10TH ST. NW

CHARLOTTESVILLE, VA 22903

FOR: FRUIT-BASED ORGANIC FOOD BARS, ALSO CONTAINING FRUITS, DRIED FRUITS, FRUIT JUICE, GRAIN, VEGETABLES, NUTS, SEEDS, CHOCOLATE, IN CLASS 29 (U.S. CL. 46).

FIRST USE 1-24-2007; IN COMMERCE 1-24-2007.

THE COLOR(S) BLACK AND GREEN IS/ARE CLAIMED AS A FEATURE OF THE MARK.

THE MARK CONSISTS OF THE COLOR BLACK APPEARING IN THE WORDING EVERYTHING AND IN THE OUTLINE OF A LEAF; THE COLOR GREEN APPEARS IN THE WORDING RAW AND IN THE DESIGN OF A LEAF.

SER. NO. 77-213,684, FILED 6-22-2007.

AISHA SALEM, EXAMINING ATTORNEY

**Int. Cls.: 36 and 38**

**Prior U.S. Cls.: 100, 101, 102 and 104**

**United States Patent and Trademark Office**

**Reg. No. 3,394,449**

**Registered Mar. 11, 2008**

**SERVICE MARK  
PRINCIPAL REGISTER**

# PROCHARGE

ELECTRONIC PAYMENTS, INC. (DELAWARE CORPORATION)  
BUILDING 81B  
4062 GRUMMAN BLVD  
CALVERTON, NY 11933

FOR: CREDIT CARD TRANSACTION PROCESSING SERVICES; ELECTRONIC CREDIT CARD TRANSACTIONS, IN CLASS 36 (U.S. CLS. 100, 101 AND 102).

FIRST USE 12-15-2006; IN COMMERCE 6-9-2007.

FOR: PROVIDING ELECTRONIC TRANSMISSION OF CREDIT CARD TRANSACTION DATA AND ELECTRONIC PAYMENT DATA VIA A GLO-

BAL COMPUTER NETWORK, IN CLASS 38 (U.S. CLS. 100, 101 AND 104).

FIRST USE 12-15-2006; IN COMMERCE 6-9-2007.

THE MARK CONSISTS OF STANDARD CHARACTERS WITHOUT CLAIM TO ANY PARTICULAR FONT, STYLE, SIZE, OR COLOR.

THE MARK HAS NO MEANING OR SIGNIFICANCE IN THE TRADE OR INDUSTRY APART FROM THAT OF A TRADEMARK.

SER. NO. 77-213,714, FILED 6-22-2007.

EVELYN BRADLEY, EXAMINING ATTORNEY

**Int. Cl.: 39**

**Prior U.S. Cls.: 100 and 105**

**United States Patent and Trademark Office**

**Reg. No. 3,394,450**

**Registered Mar. 11, 2008**

**SERVICE MARK  
PRINCIPAL REGISTER**



M & K TOURS LTD. DBA 3KM (NEW YORK CORPORATION)  
SUITE 171  
3900 VETERANS MEMORIAL HWY  
BOHEMIA, NY 11716

FOR: TRAVEL AND TOUR TICKET RESERVATION SERVICE, IN CLASS 39 (U.S. CLS. 100 AND 105).

FIRST USE 5-1-2001; IN COMMERCE 5-1-2001.

THE COLOR(S) RED AND BLUE IS/ARE CLAIMED AS A FEATURE OF THE MARK.

THE MARK CONSISTS OF THE LOGO IS TWO COLORS, RED AND BLUE. THE ELLIPTICAL GLOBE DRAWN FROM RED LINES HAS ONE VERTICAL AND ONE HORIZONTAL LINE INTERSECT IN THE MIDDLE. THERE IS ONE LINE ON BOTH SIDES OF EACH OF THOSE LINES WHICH HAVE A SLIGHT CURVE TO THEM. IN THE MIDDLE THERE IS A NUMBER "3" WHICH TURNS INTO A "K" AT THE TOP FOLLOWED BY AN "M", THESE TWO LETTERS AND THE NUMBER THREE ARE BLUE.

SER. NO. 77-213,726, FILED 6-22-2007.

PAM WILLIS, EXAMINING ATTORNEY

**Int. Cl.: 36**

**Prior U.S. Cls.: 100, 101 and 102**

**United States Patent and Trademark Office**

**Reg. No. 3,394,451**

**Registered Mar. 11, 2008**

**SERVICE MARK  
PRINCIPAL REGISTER**

**Guiding businesses to  
greater success**

TRITON PACIFIC CAPITAL PARTNERS (CALI-  
FORNIA LTD LIAB CO)  
SUITE 2910  
2029 CENTURY PARK EAST  
LOS ANGELES, CA 90067

FOR: EQUITY CAPITAL INVESTMENT; MAN-  
AGEMENT OF PRIVATE EQUITY FUNDS; PRI-  
VATE EQUITY FUND INVESTMENT SERVICES,  
IN CLASS 36 (U.S. CLS. 100, 101 AND 102).

FIRST USE 2-5-2002; IN COMMERCE 2-5-2002.

THE MARK CONSISTS OF STANDARD CHAR-  
ACTERS WITHOUT CLAIM TO ANY PARTICULAR  
FONT, STYLE, SIZE, OR COLOR.

SER. NO. 77-214,447, FILED 6-25-2007.

DAVID ELTON, EXAMINING ATTORNEY

**Int. Cls.: 37 and 42**

**Prior U.S. Cls.: 100, 101, 103 and 106**

**United States Patent and Trademark Office**

**Reg. No. 3,394,452**

**Registered Mar. 11, 2008**

**SERVICE MARK  
PRINCIPAL REGISTER**



NEW TECHNOLOGY MANAGEMENT, INC.  
(VIRGINIA CORPORATION)  
SUITE 403  
1881 CAMPUS COMMONS DRIVE  
RESTON, VA 20191

FOR: INSTALLATION AND REPAIR OF SECURITY AND SURVEILLANCE SYSTEMS, NAMELY, SYSTEMS FOR MONITORING AND CONTROLLING ACCESS, WHICH MAY INTEGRATE SOME OR ANY OF THE FOLLOWING: DIGITAL AND ANALOG VIDEO CAMERAS, DIGITAL AND ANALOG VIDEO RECORDING DEVICES, DIGITAL AND ANALOG AUDIO RECORDING DEVICES, VIDEO AND AUDIO ELECTRONIC COMMUNICATION HARDWARE, WIRED AND WIRELESS LOCAL AREA NETWORK OR WIDE AREA NETWORK COMMUNICATION DEVICES, ANTI-INTRUSION DETECTORS, NAMELY OPTICAL, RADAR, OR SONAR DEVICES, ACCESS CONTROL READERS, DEVICES THAT COLLECT DATA AND CONTROL ACCESS THROUGH KEYPAD DATA ENTRY, MAGNETIC BADGE, PROXIMITY CARD, RADIO FREQUENCY IDENTIFICATION, FINGERPRINT AUTHENTICATION SCANNERS, RETINAL AUTHENTICATION SCANNERS, OR BIOMETRIC DEVICES, DIGITAL AND ANALOG VISUAL MONITORS, BARRIERS, GATES, BOLLARDS AND FENCING, IN CLASS 37 (U.S. CLS. 100, 103 AND 106).

FIRST USE 1-31-2007; IN COMMERCE 6-19-2007.

FOR: CUSTOM DESIGN AND CONSULTING SERVICES FOR OTHERS OF SECURITY AND ACCESS CONTROL SYSTEMS, NAMELY, CONFIGURATION AND INTEGRATION OF COMPUTER HARDWARE, COMPUTER SOFTWARE, VIDEO COLLECTION AND TRANSMISSION DEVICES, AUDIO COLLECTION AND TRANSMISSION DEVICES, ACCESS CONTROL DEVICES, LOCAL AREA

NETWORKS, AND/OR WIDE AREA NETWORKS; TECHNICAL CONSULTATION SERVICES FOR SECURITY, SURVEILLANCE, THREAT ASSESSMENT, AND ACCESS CONTROL DEVICES OR SYSTEMS; TECHNICAL CONSULTATION SERVICES FOR HARDWARE AND SOFTWARE USED IN CONNECTION WITH SECURITY AND ACCESS CONTROL SYSTEMS; CUSTOM DESIGN AND TECHNICAL CONSULTATION SERVICES FOR SECURE DATA TRANSMISSION, VIDEO AND AUDIO COMMUNICATION SOLUTIONS, AND NETWORKED COMPUTING SOLUTIONS, VIEWABLE AND ACCESSIBLE THROUGH WIRED AND/OR WIRELESS LOCAL AREA OR WIDE AREA NETWORKS; TECHNICAL INFORMATION ASSURANCE CONSULTATION SERVICES, NAMELY IDENTIFYING AND ASSESSING RISKS, THREATS, AND VULNERABILITY OF WIRED AND WIRELESS LOCAL AREA AND/OR WIDE AREA NETWORKS; TECHNICAL CONSULTATION FOR COMPLIANCE, CERTIFICATION, ACCREDITATION, VERIFICATION, AND VALIDATION OF LOCAL AREA AND/OR WIDE AREA NETWORK SECURITY STANDARDS; CUSTOM DESIGN AND CONSULTING SERVICES FOR WIRED AND WIRELESS LOCAL AREA AND/OR WIDE AREA SECURE NETWORK ARCHITECTURE, NAMELY THE PROVISION OF IDENTITY MANAGEMENT, SECURE MESSAGING, INTRUSION DETECTION, ANTI-VIRUS, PUBLIC KEY INFRASTRUCTURE, AND/OR VIRTUAL PRIVATE NETWORK SERVICES; TECHNICAL SUPPORT SERVICES, NAMELY TROUBLESHOOTING OF PROBLEMS WITH COMPUTER HARDWARE AND SOFTWARE USED IN CONNECTION WITH SECURITY AND ACCESS CONTROL SYSTEMS; TECHNICAL SUPPORT SERVICES FOR COMPUTER SYSTEMS, NAMELY TROUBLESHOOTING PROBLEMS WITH COMPUTER HARDWARE AND SOFTWARE, PROVIDING MAINTENANCE OF COMPUTER SOFTWARE AND

PROVIDING PERIODIC UPGRADES OF COMPUTER SOFTWARE FOR OTHERS, IN CLASS 42 (U.S. CLS. 100 AND 101).

FIRST USE 1-31-2007; IN COMMERCE 6-19-2007.

THE COLOR(S) RED AND BLACK IS/ARE CLAIMED AS A FEATURE OF THE MARK.

THE MARK CONSISTS OF THE NAME SENTRILION (IN BLACK LETTERS) ABOVE THE TERM PROFESSIONALS PROTECTING OUR WORLD (IN RED LETTERS) WITH RED ARCS ABOVE AND BELOW THE WORDS.

SER. NO. 77-214,745, FILED 6-25-2007.

ADA HAN, EXAMINING ATTORNEY

**Int. Cl.: 41**

**Prior U.S. Cls.: 100, 101 and 107**

**United States Patent and Trademark Office**

**Reg. No. 3,394,453**

**Registered Mar. 11, 2008**

**SERVICE MARK  
PRINCIPAL REGISTER**



ASSOCIATION OF INTERNATIONAL PRODUCT  
MARKETING & MANAGEMENT, INC. (NE-  
VADA CORPORATION), DBA AIPMM, INC.  
2533 NORTH CARSON STREET #1966  
CARSON CITY, NV 89706

FOR: EDUCATIONAL SERVICES, NAMELY,  
CONDUCTING CERTIFICATION TRAINING AND  
EXAMINATION IN THE FIELD OF PRODUCT  
MANAGEMENT AND PRODUCT MARKETING  
MANAGEMENT, IN CLASS 41 (U.S. CLS. 100, 101  
AND 107).

FIRST USE 2-1-2004; IN COMMERCE 2-1-2004.

THE COLOR(S) RED, WHITE, AND BLUE IS/ARE  
CLAIMED AS A FEATURE OF THE MARK.

THE MARK CONSISTS OF BLUE CIRCLE EN-  
COMPASSING THE WORDS IN WHITE LETTERS  
"CERTIFIED PRODUCT MANAGER, AIPMM". IN  
THE CENTER, THE WHITE CAPITAL LETTER A  
WITH RED SPOKES. THE WATERMARK A IS AN  
ELEMENT OF THE MARK.

SER. NO. 77-214,747, FILED 6-25-2007.

ADA HAN, EXAMINING ATTORNEY



Int. Cl.: 13

Prior U.S. Cls.: 2 and 9

United States Patent and Trademark Office

Reg. No. 3,394,454

Registered Mar. 11, 2008

TRADEMARK  
PRINCIPAL REGISTER



SAI INDUSTRIES (CALIFORNIA CORPORATION)

631 ALLEN AVENUE

GLENDALE, CA 91201

FOR: AMMUNITION CONVEYORS, NAMELY, AMMUNITION CHUTING FOR DELIVERING CARTRIDGES TO RAPID FIRING GUNS, IN CLASS 13 (U.S. CLS. 2 AND 9).

FIRST USE 4-23-1993; IN COMMERCE 4-23-1993.

NO CLAIM IS MADE TO THE EXCLUSIVE RIGHT TO USE "INDUSTRIES", APART FROM THE MARK AS SHOWN.

THE MARK CONSISTS OF THE WORD "SAI" APPEARS IN STYLIZED LETTERS ABOVE THE WORD "INDUSTRIES", AND AN OBLONG SHAPE WITH HORIZONTAL LINES APPEARS ABOVE THE LETTERS "A" AND "I" IN THE WORD "SAI".

SER. NO. 77-214,999, FILED 6-25-2007.

CARRIE GENOVESE, EXAMINING ATTORNEY

**Int. Cl.: 44**

**Prior U.S. Cls.: 100 and 101**

**United States Patent and Trademark Office**

**Reg. No. 3,394,455**

**Registered Mar. 11, 2008**

**SERVICE MARK  
PRINCIPAL REGISTER**

# Salon Angelique

POLIZZI, ANGELIQUE (UNITED STATES INDIVIDUAL)

159 CAROLINIAN DR

SUMMERVILLE, SC 29485

FOR: BEAUTY SALONS, IN CLASS 44 (U.S. CLS. 100 AND 101).

FIRST USE 11-1-2006; IN COMMERCE 11-1-2006.

THE MARK CONSISTS OF STANDARD CHARACTERS WITHOUT CLAIM TO ANY PARTICULAR FONT, STYLE, SIZE, OR COLOR.

NO CLAIM IS MADE TO THE EXCLUSIVE RIGHT TO USE "SALON", APART FROM THE MARK AS SHOWN.

SER. NO. 77-215,223, FILED 6-26-2007.

HEATHER BIDDULPH, EXAMINING ATTORNEY

**Int. Cl.: 5**

**Prior U.S. Cls.: 6, 18, 44, 46, 51 and 52**

**United States Patent and Trademark Office**

**Reg. No. 3,394,456**

**Registered Mar. 11, 2008**

**TRADEMARK  
PRINCIPAL REGISTER**

**QVB**

QUIDEL CORPORATION (DELAWARE CORPORATION)  
10165 MCKELLAR COURT  
SAN DIEGO, CA 92121

FOR: IN VITRO MEDICAL DIAGNOSTIC TEST KITS PRIMARILY CONTAINING REAGENTS AND DEVICES FOR DIAGNOSIS OF DISEASE OR CONDITION, IN CLASS 5 (U.S. CLS. 6, 18, 44, 46, 51 AND 52).

FIRST USE 2-0-2007; IN COMMERCE 2-0-2007.

THE MARK CONSISTS OF STANDARD CHARACTERS WITHOUT CLAIM TO ANY PARTICULAR FONT, STYLE, SIZE, OR COLOR.

SER. NO. 77-215,638, FILED 6-26-2007.

LINDSEY RUBIN, EXAMINING ATTORNEY

**Int. Cls.: 37, 40 and 42**

**Prior U.S. Cls.: 100, 101, 103 and 106**

**United States Patent and Trademark Office**

**Reg. No. 3,394,457**

**Registered Mar. 11, 2008**

**SERVICE MARK  
PRINCIPAL REGISTER**

# FB International

FB INTERNATIONAL, INC. (NEW YORK CORPORATION)  
46 PASSAIC STREET  
WOODRIDGE, NJ 07075

FOR: CONSTRUCTION IN THE FIELD OF BOOTH CONSTRUCTION FOR TRADE SHOWS AND EXHIBITIONS; INSTALLING CARPET, IN CLASS 37 (U.S. CLS. 100, 103 AND 106).

FIRST USE 6-2-1988; IN COMMERCE 6-2-1988.

FOR: PRINTING SERVICES, IN CLASS 40 (U.S. CLS. 100, 103 AND 106).

FIRST USE 6-2-1988; IN COMMERCE 6-2-1988.

FOR: COMPUTERIZED GRAPHIC ART DESIGN, IN CLASS 42 (U.S. CLS. 100 AND 101).

FIRST USE 6-2-1988; IN COMMERCE 6-2-1988.

THE MARK CONSISTS OF STANDARD CHARACTERS WITHOUT CLAIM TO ANY PARTICULAR FONT, STYLE, SIZE, OR COLOR.

NO CLAIM IS MADE TO THE EXCLUSIVE RIGHT TO USE "INTERNATIONAL", APART FROM THE MARK AS SHOWN.

SER. NO. 77-215,662, FILED 6-26-2007.

MARGERY A. TIERNEY, EXAMINING ATTORNEY

Int. Cl.: 32

Prior U.S. Cls.: 45, 46 and 48

United States Patent and Trademark Office

Reg. No. 3,394,458

Registered Mar. 11, 2008

TRADEMARK  
PRINCIPAL REGISTER



PIKE BREWING COMPANY (WASHINGTON CORPORATION)  
1415 FIRST AVENUE  
SEATTLE, WA 98101

FOR: BEER, IN CLASS 32 (U.S. CLS. 45, 46 AND 48).

FIRST USE 9-0-2006; IN COMMERCE 9-0-2006.

OWNER OF U.S. REG. NOS. 2,087,618, 2,091,299, AND 2,555,335.

NO CLAIM IS MADE TO THE EXCLUSIVE RIGHT TO USE "DOUBLE ALE", "MALT", "HOPS", "FAMILY OWNED", "SEATTLE", AND "BREWING CO.", APART FROM THE MARK AS SHOWN.

THE MARK CONSISTS OF THE WORDS PIKE TANDEM PROMINENTLY DISPLAYED BENEATH

A DESIGN OF CYCLISTS ON A TANDEM BICYCLE, IN THE FORGROUND OF RAYS OF LIGHT EMANATING FROM A COMMON BACKGROUND POINT INTENDED TO ILLUSTRATE A SUNSET, WITH LINE ILLUSTRATIONS OF MALT AND HOPS, ABOVE THE WORDS DOUBLE ALE, AND ABOVE A LOGO DESIGN FEATURING THE WORDS THE PIKE ABOVE A STAR SHAPE INTERWOVEN WITH THE LETTER P AND THE WORDS SEATTLE BREWING CO, FLANKED BY PAIRED RIBBONS INSCRIBED FAMILY AND OWNED, ALL ON A DIAMOND SHAPED AND OUTLINED FIELD.

SER. NO. 77-215,756, FILED 6-26-2007.

KAREN BRACEY, EXAMINING ATTORNEY

**Int. Cl.: 16**

**Prior U.S. Cls.: 2, 5, 22, 23, 29, 37, 38 and 50**

**United States Patent and Trademark Office**

**Reg. No. 3,394,459**

**Registered Mar. 11, 2008**

**TRADEMARK  
PRINCIPAL REGISTER**

# BizTeach

BIZTEACH INC. (COLORADO CORPORATION)  
4095 MOORHEAD AVE  
BOULDER, CO 80305

THE MARK CONSISTS OF STANDARD CHAR-  
ACTERS WITHOUT CLAIM TO ANY PARTICULAR  
FONT, STYLE, SIZE, OR COLOR.

FOR: PRINTED TEACHING MATERIALS IN THE  
FIELD OF BUSINESS, IN CLASS 16 (U.S. CLS. 2, 5, 22,  
23, 29, 37, 38 AND 50).

SER. NO. 77-215,891, FILED 6-26-2007.

FIRST USE 5-2-2007; IN COMMERCE 6-10-2007.

HEATHER SAPP, EXAMINING ATTORNEY

**Int. Cl.: 16**

**Prior U.S. Cls.: 2, 5, 22, 23, 29, 37, 38 and 50**

**United States Patent and Trademark Office**

**Reg. No. 3,394,460**

**Registered Mar. 11, 2008**

**TRADEMARK  
PRINCIPAL REGISTER**

## Guiding your success

BIZTEACH INC. (COLORADO CORPORATION)  
4095 MOORHEAD AVE  
BOULDER, CO 80305

THE MARK CONSISTS OF STANDARD CHAR-  
ACTERS WITHOUT CLAIM TO ANY PARTICULAR  
FONT, STYLE, SIZE, OR COLOR.

FOR: PRINTED TEACHING MATERIALS IN THE  
FIELD OF BUSINESS, IN CLASS 16 (U.S. CLS. 2, 5, 22,  
23, 29, 37, 38 AND 50).

SER. NO. 77-216,072, FILED 6-26-2007.

FIRST USE 5-2-2007; IN COMMERCE 6-10-2007.

HEATHER SAPP, EXAMINING ATTORNEY

**Int. Cl.: 3**

**Prior U.S. Cls.: 1, 4, 6, 50, 51 and 52**

**United States Patent and Trademark Office**

**Reg. No. 3,394,461**

**Registered Mar. 11, 2008**

**TRADEMARK  
PRINCIPAL REGISTER**

**LUCKY BAMBOO**

NEDBOY, ROBIN L. (UNITED STATES INDIVIDUAL)  
60 EAST 42ND STREET, SUITE 2320  
NEW YORK, NY 10165

FOR: BATH SOAPS CONTAINING BAMBOO EXTRACT IN LIQUID, SOLID OR GEL FORM; FRAGRANCES FOR PERSONAL USE CONTAINING BAMBOO EXTRACT; HAIR CARE PREPARATIONS CONTAINING BAMBOO EXTRACT; HOUSEHOLD CLEANING PREPARATIONS CONTAINING BAMBOO EXTRACT; NON-MEDICATED SKIN CARE PREPARATIONS CONTAINING BAMBOO EXTRACT, IN CLASS 3 (U.S. CLS. 1, 4, 6, 50, 51 AND 52).

FIRST USE 6-25-2007; IN COMMERCE 6-25-2007.

THE MARK CONSISTS OF STANDARD CHARACTERS WITHOUT CLAIM TO ANY PARTICULAR FONT, STYLE, SIZE, OR COLOR.

NO CLAIM IS MADE TO THE EXCLUSIVE RIGHT TO USE "BAMBOO", APART FROM THE MARK AS SHOWN.

SER. NO. 77-216,491, FILED 6-27-2007.

JENNIFER HETU, EXAMINING ATTORNEY



**Int. Cls.: 29 and 30**

**Prior U.S. Cl.: 46**

**United States Patent and Trademark Office**

**Reg. No. 3,394,462**

**Registered Mar. 11, 2008**

**TRADEMARK  
PRINCIPAL REGISTER**

# CCF BRANDS

W3 PARTNERS, LLC (ARKANSAS LTD LIAB CO)  
5509 WALSH LANE  
ROGERS, AR 72758

FOR: EGGS; LIQUID EGGS; RING-SHAPED CHICKEN NUGGETS; WHIPPED TOPPING; OMELET KITS CONSISTING PRIMARILY OF LIQUID EGGS, CUT VEGETABLES AND DRIED MEAT, IN CLASS 29 (U.S. CL. 46).

FIRST USE 10-6-2006; IN COMMERCE 10-6-2006.

FOR: BAGELS; PIE, NAMELY, FRUIT AND CUSTARD-FILLED PIE, CHEESECAKE; PIGS-IN-A-BLANKET; KOLACHE BUNS STUFFED WITH SAUSAGES, IN CLASS 30 (U.S. CL. 46).

FIRST USE 10-6-2006; IN COMMERCE 10-6-2006.

THE MARK CONSISTS OF STANDARD CHARACTERS WITHOUT CLAIM TO ANY PARTICULAR FONT, STYLE, SIZE, OR COLOR.

NO CLAIM IS MADE TO THE EXCLUSIVE RIGHT TO USE "BRANDS", APART FROM THE MARK AS SHOWN.

SER. NO. 77-216,916, FILED 6-27-2007.

WARREN L. OLANDRIA, EXAMINING ATTORNEY

Int. Cl.: 43

Prior U.S. Cls.: 100 and 101

United States Patent and Trademark Office

Reg. No. 3,394,463

Registered Mar. 11, 2008

SERVICE MARK  
PRINCIPAL REGISTER

**JUAN'S MEXICALI**

JUAN'S MEXICALI, INC. (COLORADO CORPORATION)

SUITE 310

S. JAMAICA CT.

AURORA, CO 80014

FOR: RESTAURANT SERVICES, IN CLASS 43  
(U.S. CLS. 100 AND 101).

FIRST USE 6-27-2007; IN COMMERCE 6-27-2007.

OWNER OF U.S. REG. NOS. 3,031,898 AND  
3,035,077.

NO CLAIM IS MADE TO THE EXCLUSIVE  
RIGHT TO USE "MEXICALI", APART FROM THE  
MARK AS SHOWN.

THE COLOR(S) GOLD, WHITE AND BLACK IS/  
ARE CLAIMED AS A FEATURE OF THE MARK.

THE MARK CONSISTS OF A GOLD JUAN'S  
ENCASED IN BLACK, A WHITE MEXICALI EN-  
CASED IN BLACK.

SER. NO. 77-217,800, FILED 6-28-2007.

ANGELA GAW, EXAMINING ATTORNEY

**Int. Cl.: 1**

**Prior U.S. Cls.: 1, 5, 6, 10, 26 and 46**

**United States Patent and Trademark Office**

**Reg. No. 3,394,464**

**Registered Mar. 11, 2008**

**TRADEMARK  
PRINCIPAL REGISTER**

**REILLEX**

VERTELLUS HEALTH & SPECIALTY PRO-  
DUCTS LLC (DELAWARE LTD LIAB CO)  
SUITE 1500  
300 NORTH MERIDIAN STREET  
INDIANAPOLIS, IN 46204

FOR: CHEMICAL INTERMEDIATES AND ADDI-  
TIVES, NAMELY, CROSS-LINKED POLY-4-VINYL  
PYRIDINE POLYMERS FOR USE IN THE AGRO-  
CHEMICAL, PHARMACEUTICAL, NUTRITION,  
HUMAN AND ANIMAL HEALTH, PERSONAL  
CARE, INDUSTRIAL AND ELECTRONICS INDUS-  
TRIES, IN CLASS 1 (U.S. CLS. 1, 5, 6, 10, 26 AND 46).

FIRST USE 1-1-1989; IN COMMERCE 1-1-1989.

THE MARK CONSISTS OF STANDARD CHAR-  
ACTERS WITHOUT CLAIM TO ANY PARTICULAR  
FONT, STYLE, SIZE, OR COLOR.

SER. NO. 77-217,868, FILED 6-28-2007.

DAWN FELDMAN, EXAMINING ATTORNEY

**Int. Cl.: 35**

**Prior U.S. Cls.: 100, 101 and 102**

**United States Patent and Trademark Office**

**Reg. No. 3,394,465**

**Registered Mar. 11, 2008**

**SERVICE MARK  
PRINCIPAL REGISTER**

**EVERYTHING HD**

WAL-MART STORES, INC. (DELAWARE CORPORATION)  
702 S.W. 8TH ST.  
BENTONVILLE, AR 727160520

FOR: RETAIL STORE SERVICES FEATURING ELECTRONICS; ON-LINE RETAIL STORE SERVICES FEATURING ELECTRONICS, IN CLASS 35 (U.S. CLS. 100, 101 AND 102).

FIRST USE 8-24-2007; IN COMMERCE 8-24-2007.

THE MARK CONSISTS OF STANDARD CHARACTERS WITHOUT CLAIM TO ANY PARTICULAR FONT, STYLE, SIZE, OR COLOR.

NO CLAIM IS MADE TO THE EXCLUSIVE RIGHT TO USE "HD", APART FROM THE MARK AS SHOWN.

SER. NO. 77-218,334, FILED 6-28-2007.

MICHAEL WIENER, EXAMINING ATTORNEY

**Int. Cl.: 42**

**Prior U.S. Cls.: 100 and 101**

**United States Patent and Trademark Office**

**Reg. No. 3,394,466**

**Registered Mar. 11, 2008**

**SERVICE MARK  
PRINCIPAL REGISTER**

**LIVELOT**

IMAGE202 ENTERTAINMENT (TEXAS SOLE  
PROPRIETORSHIP)  
1920A FOUNTAIN VIEW DR. #202  
HOUSTON, TX 77057

FOR: PROVIDING ON-LINE NON-DOWNLOAD-  
ABLE SOFTWARE FOR MOTOR VEHICLE, RV/  
MOTOR HOMES, BOAT, MOTORCYCLE, AND  
ATV INVENTORY MANAGEMENT AND CUSTO-  
MER RELATIONSHIP MANAGEMENT , IN CLASS  
42 (U.S. CLS. 100 AND 101).

FIRST USE 10-31-2005; IN COMMERCE 2-15-2006.

THE MARK CONSISTS OF STANDARD CHAR-  
ACTERS WITHOUT CLAIM TO ANY PARTICULAR  
FONT, STYLE, SIZE, OR COLOR.

SER. NO. 77-218,562, FILED 6-28-2007.

LINDA ESTRADA, EXAMINING ATTORNEY

**Int. Cl.: 36**

**Prior U.S. Cls.: 100, 101 and 102**

**United States Patent and Trademark Office**

**Reg. No. 3,394,467**

**Registered Mar. 11, 2008**

**SERVICE MARK  
PRINCIPAL REGISTER**



CENTRAL MINNESOTA FEDERAL CREDIT UNION (MINNESOTA CORPORATION)  
20 S 4TH AVE E  
MELROSE, MN 56352

FOR: CREDIT UNIONS, IN CLASS 36 (U.S. CLS. 100, 101 AND 102).

FIRST USE 8-1-2001; IN COMMERCE 8-1-2001.

THE COLOR(S) YELLOW, GREEN, AND BLUE IS/ ARE CLAIMED AS A FEATURE OF THE MARK.

THE MARK CONSISTS OF A DESIGN OF SUN WHICH APPEARS AS A STYLIZED C, TWO TREES OR PEAKS WHICH APPEAR AS A STYLIZED M AND A STREAM.

SER. NO. 77-218,748, FILED 6-29-2007.

DEZMONA MIZELLE, EXAMINING ATTORNEY

**Int. Cl.: 10**

**Prior U.S. Cls.: 26, 39 and 44**

**United States Patent and Trademark Office**

**Reg. No. 3,394,468**

**Registered Mar. 11, 2008**

**TRADEMARK  
PRINCIPAL REGISTER**

**SADER**

R & R HOLDINGS, LLC (VIRGINIA LTD LIAB  
CO)  
SUITE 115  
420 NORTH CENTER DRIVE  
NORFOLK, VA 23502

FOR: ORTHOTIC DEVICES, NAMELY, BRACES  
FOR LIMBS AND JOINTS, IN CLASS 10 (U.S. CLS. 26,  
39 AND 44).

FIRST USE 10-4-2001; IN COMMERCE 11-14-2001.

THE MARK CONSISTS OF STANDARD CHAR-  
ACTERS WITHOUT CLAIM TO ANY PARTICULAR  
FONT, STYLE, SIZE, OR COLOR.

SEC. 2(F).

SER. NO. 77-219,139, FILED 6-29-2007.

NICHOLAS ALTREE, EXAMINING ATTORNEY

**Int. Cl.: 41**

**Prior U.S. Cls.: 100, 101 and 107**

**United States Patent and Trademark Office**

**Reg. No. 3,394,469**

**Registered Mar. 11, 2008**

**SERVICE MARK  
PRINCIPAL REGISTER**

**your best friend behind  
the scenes**

PACIFIC NORTHWEST THEATRE ASSOCIATION (WASHINGTON CORPORATION)  
615 SOUTH ALASKA STREET  
SEATTLE, WA 98018

FOR: RENTAL OF LIGHTING EQUIPMENT, DRAPERIES, SET DESIGN ELEMENTS, SOUND EQUIPMENT, PROPS AND SUPPLIES FOR THEATRICAL AND OTHER CULTURAL PRODUCTIONS, NAMELY, DRAPERY, STAGING PLATFORMS, SHOW SCENERY, EXHIBITION AND STAGE SETS, IN CLASS 41 (U.S. CLS. 100, 101 AND 107).

FIRST USE 5-4-2005; IN COMMERCE 5-4-2005.

THE MARK CONSISTS OF STANDARD CHARACTERS WITHOUT CLAIM TO ANY PARTICULAR FONT, STYLE, SIZE, OR COLOR.

SER. NO. 77-219,436, FILED 6-29-2007.

ELIZABETH KAJUBI, EXAMINING ATTORNEY



**Int. Cl.: 9**

**Prior U.S. Cls.: 21, 23, 26, 36 and 38**

**Reg. No. 3,394,470**

**United States Patent and Trademark Office**

**Registered Mar. 11, 2008**

---

**TRADEMARK  
PRINCIPAL REGISTER**

**CROCPOND**

CROCODILES NOT WATERLILIES ENTERTAIN-  
MENT, LLC (CALIFORNIA LTD LIAB CO)  
58 MAIDEN LANE, 5TH FLOOR  
SAN FRANCISCO, CA 94108

THE MARK CONSISTS OF STANDARD CHAR-  
ACTERS WITHOUT CLAIM TO ANY PARTICULAR  
FONT, STYLE, SIZE, OR COLOR.

FOR: PRE-RECORDED DVDS FEATURING ANI-  
MATION, IN CLASS 9 (U.S. CLS. 21, 23, 26, 36 AND  
38).

SER. NO. 77-219,672, FILED 6-29-2007.

FIRST USE 10-7-2006; IN COMMERCE 10-7-2006.

ELIZABETH KAJUBI, EXAMINING ATTORNEY

**Int. Cl.: 9**

**Prior U.S. Cls.: 21, 23, 26, 36 and 38**

**Reg. No. 3,394,471**

**United States Patent and Trademark Office**

**Registered Mar. 11, 2008**

---

**TRADEMARK  
PRINCIPAL REGISTER**

**RINDIN**

CROCODILES NOT WATERLILIES ENTERTAIN-  
MENT, LLC (CALIFORNIA LTD LIAB CO)  
58 MAIDEN LANE, 5TH FLOOR  
SAN FRANCISCO, CA 94108

THE MARK CONSISTS OF STANDARD CHAR-  
ACTERS WITHOUT CLAIM TO ANY PARTICULAR  
FONT, STYLE, SIZE, OR COLOR.

FOR: PRE-RECORDED DVDS FEATURING ANI-  
MATION, IN CLASS 9 (U.S. CLS. 21, 23, 26, 36 AND  
38).

SER. NO. 77-219,689, FILED 6-29-2007.

FIRST USE 10-7-2006; IN COMMERCE 10-7-2006.

ELIZABETH KAJUBI, EXAMINING ATTORNEY

**Int. Cl.: 42**

**Prior U.S. Cls.: 100 and 101**

**United States Patent and Trademark Office**

**Reg. No. 3,394,472**

**Registered Mar. 11, 2008**

**SERVICE MARK  
PRINCIPAL REGISTER**

**SOLAVISTA**

SOLAVISTA, LLC (ARIZONA LTD LIAB CO)  
SUITE 1000  
14362 NORTH FRANK LLOYD WRIGHT BLVD.  
SCOTTSDALE, AZ 85260

FIRST USE 12-6-2000; IN COMMERCE 12-6-2000.

THE MARK CONSISTS OF STANDARD CHARACTERS WITHOUT CLAIM TO ANY PARTICULAR FONT, STYLE, SIZE, OR COLOR.

FOR: INFORMATION TECHNOLOGY CONSULTING, NAMELY, WEBSITE USABILITY TESTING; INFORMATION TECHNOLOGY CONSULTING SERVICES IN THE FIELD OF WEBSITE USABILITY; INFORMATION TECHNOLOGY RESEARCH IN THE FIELD OF WEBSITE USABILITY, IN CLASS 42 (U.S. CLS. 100 AND 101).

SER. NO. 77-219,707, FILED 6-29-2007.

TASHIA BUNCH, EXAMINING ATTORNEY

**Int. Cl.: 35**

**Prior U.S. Cls.: 100, 101 and 102**

**United States Patent and Trademark Office**

**Reg. No. 3,394,473**

**Registered Mar. 11, 2008**

**SERVICE MARK  
PRINCIPAL REGISTER**



PARALLEL 34 (CALIFORNIA SOLE PROPRIETORSHIP)  
PO BOX 480703  
LOS ANGELES, CA 90048

FOR: PERSONAL MANAGEMENT SERVICES FOR INDEPENDENT RECORDING ARTISTS; PROMOTING THE CONCERTS OF OTHERS, IN CLASS 35 (U.S. CLS. 100, 101 AND 102).

FIRST USE 1-1-2007; IN COMMERCE 1-1-2007.

THE COLOR(S) BLACK, RED, WHITE, BLUE AND YELLOW IS/ARE CLAIMED AS A FEATURE OF THE MARK.

THE MARK CONSISTS OF A THREE-DIMENSIONAL TYPE WORDING OF PARALLEL 34 CONSISTING OF A BLACK OUTLINE AND SHADOW, A RED HIGHLIGHT ON THE UNDERSIDE OF EACH CHARACTER, A WHITE INNER LINE ON THE FRONT OF EACH CHARACTER, AND AN INNER BEACH SUNSET IMAGE PRIMARILY MADE UP OF BLUES AND YELLOWS ON THE FRONT OF EACH CHARACTER.

SER. NO. 77-220,055, FILED 7-2-2007.

JOHN GARTNER, EXAMINING ATTORNEY

**Int. Cl.: 44**

**Prior U.S. Cls.: 100 and 101**

**United States Patent and Trademark Office**

**Reg. No. 3,394,474**

**Registered Mar. 11, 2008**

**SERVICE MARK  
PRINCIPAL REGISTER**



WOUND TREATMENT SERVICES OF AMERICA,  
LLC (ILLINOIS LTD LIAB CO)  
SUITE 240  
117 S. COOK STREET  
BARRINGTON, IL 60010

FOR: MEDICAL SERVICES, NAMELY, THE EVALUATION AND TREATMENT OF TRAUMA, IN CLASS 44 (U.S. CLS. 100 AND 101).

FIRST USE 5-1-2007; IN COMMERCE 5-1-2007.

NO CLAIM IS MADE TO THE EXCLUSIVE RIGHT TO USE "WOUND", APART FROM THE MARK AS SHOWN.

THE COLOR(S) GREEN AND WHITE IS/ARE CLAIMED AS A FEATURE OF THE MARK.

THE MARK CONSISTS OF A GREEN BANDAGE AT AN ANGLE ACUTE TO THE HORIZONTAL WITH THE WORDS "WOUND SQUAD" IN WHITE ON ITS RIGHT SIDE AND A SERIES OF WHITE DOTS REPRESENTING AIR HOLES IN THE BANDAGE ON ITS LEFT SIDE.

SER. NO. 77-220,150, FILED 7-2-2007.

STEPHEN AQUILA, EXAMINING ATTORNEY

Int. Cl.: 35

Prior U.S. Cls.: 100, 101 and 102

United States Patent and Trademark Office

Reg. No. 3,394,475

Registered Mar. 11, 2008

SERVICE MARK  
PRINCIPAL REGISTER



FAR CORNER CREATIONS (MARYLAND LTD  
LIAB CO)  
10816 TOWN CENTER BLVD, BOX 507  
DUNKIRK, MD 20754

THE COLOR(S) BLACK, PEWTER AND RED IS/  
ARE CLAIMED AS A FEATURE OF THE MARK.

FOR: DOCUMENT REPRODUCTION; CON-  
SULTANCY OF PERSONNEL RECRUITMENT; CON-  
SULTING SERVICES IN THE FIELD OF HUMAN  
RESOURCES DEVELOPMENT, NAMELY, FOR THE  
PROMOTION OF EMPLOYEE RETENTION, CA-  
REER GROWTH, AND INCREASED PRODUCTIV-  
ITY FOR EMPLOYEES AND EMPLOYERS;  
RESUME PREPARATION, IN CLASS 35 (U.S. CLS.  
100, 101 AND 102).

THE MARK CONSISTS OF THE STYLIZED  
WORDS "FAR CORNER CREATIONS." THE FIRST  
LETTER OF "FAR" IS IN BLACK, THE LETTERS "A"  
AND "R" ARE IN PEWTER COLOR. THE FIRST  
LETTER OF "CORNER" IS IN BLACK, THE LETTER  
"N" IS IN RED, AND THE LETTERS "O", "R", "E",  
AND "R" ARE IN PEWTER COLOR. THE FIRST  
LETTER OF "CREATIONS" IS IN BLACK. THE  
LETTERS "R", "E", "A", "T", "I", "O", "N", AND "S"  
IS IN PEWTER COLOR.

FIRST USE 3-15-2006; IN COMMERCE 3-15-2006.

SER. NO. 77-220,397, FILED 7-2-2007.

NO CLAIM IS MADE TO THE EXCLUSIVE  
RIGHT TO USE "CREATIONS", APART FROM  
THE MARK AS SHOWN.

SIMON TENG, EXAMINING ATTORNEY

**Int. Cl.: 3**

**Prior U.S. Cls.: 1, 4, 6, 50, 51 and 52**

**United States Patent and Trademark Office**

**Reg. No. 3,394,476**

**Registered Mar. 11, 2008**

**TRADEMARK  
PRINCIPAL REGISTER**

**CONTRACTORS' SOLUTION**

SUPREME CHEMICALS OF GEORGIA, INC.  
(GEORGIA CORPORATION)  
SUITE B  
1535 OAK INDUSTRIAL LANE  
CUMMING, GA 30041

FOR: CLEANING PREPARATIONS FOR THE  
REMOVAL OF ADHESIVE, CAULK, FOAM, MAS-  
TIC, SILICONE, TAR AND OTHER SUBSTANCES,  
IN CLASS 3 (U.S. CLS. 1, 4, 6, 50, 51 AND 52).

FIRST USE 6-19-2007; IN COMMERCE 6-19-2007.

THE MARK CONSISTS OF STANDARD CHAR-  
ACTERS WITHOUT CLAIM TO ANY PARTICULAR  
FONT, STYLE, SIZE, OR COLOR.

NO CLAIM IS MADE TO THE EXCLUSIVE  
RIGHT TO USE "CONTRACTORS", APART FROM  
THE MARK AS SHOWN.

SER. NO. 77-220,466, FILED 7-2-2007.

PRISCILLA MILTON, EXAMINING ATTORNEY

**Int. Cl.: 41**

**Prior U.S. Cls.: 100, 101 and 107**

**United States Patent and Trademark Office**

**Reg. No. 3,394,477**

**Registered Mar. 11, 2008**

**SERVICE MARK  
PRINCIPAL REGISTER**

**ONLINE PARTY**

IWIN, INC. (DELAWARE CORPORATION)  
SUITE 201  
625 SECOND STREET  
SAN FRANCISCO, CA 94107

FOR: ENTERTAINMENT SERVICES, SPECIFICALLY ONLINE MULTIPLAYER COMPUTER GAMES AND ONLINE COMMUNITY SERVICES THAT ENABLE USERS TO INTERACT, COMMUNICATE AND TRANSACT AS PART OF PLAYING A GAME INDIVIDUALLY, OR WITH OTHERS, ACROSS THE INTERNET, IN CLASS 41 (U.S. CLS. 100, 101 AND 107).

FIRST USE 12-1-2005; IN COMMERCE 12-1-2005.

THE MARK CONSISTS OF STANDARD CHARACTERS WITHOUT CLAIM TO ANY PARTICULAR FONT, STYLE, SIZE, OR COLOR.

NO CLAIM IS MADE TO THE EXCLUSIVE RIGHT TO USE ONLINE, APART FROM THE MARK AS SHOWN.

SER. NO. 77-220,507, FILED 7-2-2007.

JULIE WATSON, EXAMINING ATTORNEY



**Int. Cl.: 45**

**Prior U.S. Cls.: 100 and 101**

**United States Patent and Trademark Office**

**Reg. No. 3,394,478**

**Registered Mar. 11, 2008**

**SERVICE MARK  
PRINCIPAL REGISTER**

**FIRST TRAK**

DISASTER MANAGEMENT SOLUTIONS, INC.  
(CALIFORNIA CORPORATION)  
SUITE 240  
6980 SANTA TERESA BLVD  
SAN JOSE, CA 95119

FOR: TRACKING SERVICES FOR DISASTER RECOVERY PURPOSES, NAMELY, TRACKING PATIENTS, PERSONNEL, MASS VACCINATIONS, AND EMERGENCY RESCUE EQUIPMENT FOR THE PURPOSE OF LOCATING PERSONS, INFORMATION AND EQUIPMENT IN THE EVENT OF A NATURAL OR MAN-MADE DISASTER, IN CLASS 45 (U.S. CLS. 100 AND 101).

FIRST USE 5-1-2007; IN COMMERCE 5-1-2007.

THE MARK CONSISTS OF STANDARD CHARACTERS WITHOUT CLAIM TO ANY PARTICULAR FONT, STYLE, SIZE, OR COLOR.

NO CLAIM IS MADE TO THE EXCLUSIVE RIGHT TO USE "TRACK", APART FROM THE MARK AS SHOWN.

SER. NO. 77-220,640, FILED 7-2-2007.

KAREN SEVERSON, EXAMINING ATTORNEY

**Int. Cl.: 16**

**Prior U.S. Cls.: 2, 5, 22, 23, 29, 37, 38 and 50**

**United States Patent and Trademark Office**

**Reg. No. 3,394,479**

**Registered Mar. 11, 2008**

**TRADEMARK  
PRINCIPAL REGISTER**

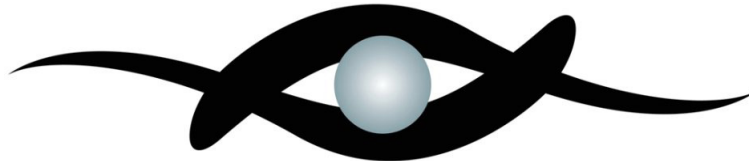

WHIMSICAL WIZARD, INC. (FLORIDA CORPORATION)  
4403 LOST FOREST ROAD  
SARASOTA, FL 34235

FOR: SERIES OF CHILDREN'S BOOKS, IN CLASS  
16 (U.S. CLS. 2, 5, 22, 23, 29, 37, 38 AND 50).

FIRST USE 7-1-2007; IN COMMERCE 7-1-2007.

THE COLOR(S) BLUE AND BLACK IS/ARE  
CLAIMED AS A FEATURE OF THE MARK.

THE MARK CONSISTS OF TWO INTERLOCKING EYELASH DESIGNS WHICH ARE BOTH BLACK IN COLOR AND WHICH FORM A SPACE WHEREIN AN IRIS-LIKE DESIGN APPEARS WHICH IS LIGHT BLUE IN COLOR BEING DARKER AT ITS PERIMETER THAN AT ITS CENTER. WHITE APPEARS IN THE DRAWING TO INDICATE TRANSPARENT BACKGROUND.

SER. NO. 77-220,722, FILED 7-2-2007.

REBECCA EISINGER, EXAMINING ATTORNEY

**Int. Cl.: 45**

**Prior U.S. Cls.: 100 and 101**

**United States Patent and Trademark Office**

**Reg. No. 3,394,480**

**Registered Mar. 11, 2008**

**SERVICE MARK  
PRINCIPAL REGISTER**

**DO MORE**

DISASTER MANAGEMENT SOLUTIONS, INC.  
(CALIFORNIA CORPORATION)  
SUITE 240  
6980 SANTA TERESA BLVD  
SAN JOSE, CA 95119

FOR: TRACKING SERVICES FOR DISASTER RECOVERY PURPOSES, NAMELY, TRACKING PATIENTS, PERSONNEL, MASS VACCINATIONS, AND EMERGENCY RESCUE EQUIPMENT FOR THE PURPOSE OF LOCATING PERSONS, INFORMATION AND EQUIPMENT IN THE EVENT OF A

NATURAL OR MAN-MADE DISASTER, IN CLASS 45 (U.S. CLS. 100 AND 101).

FIRST USE 3-1-2006; IN COMMERCE 3-1-2006.

THE MARK CONSISTS OF STANDARD CHARACTERS WITHOUT CLAIM TO ANY PARTICULAR FONT, STYLE, SIZE, OR COLOR.

SER. NO. 77-220,743, FILED 7-2-2007.

KAREN SEVERSON, EXAMINING ATTORNEY

**Int. Cl.: 42**

**Prior U.S. Cls.: 100 and 101**

**United States Patent and Trademark Office**

**Reg. No. 3,394,481**

**Registered Mar. 11, 2008**

**SERVICE MARK  
PRINCIPAL REGISTER**

SIMPLIFYING TECHNOLOGY FOR  
YOU

QUATRRO BPO SOLUTIONS (P) LTD. (INDIA  
CORPORATION)  
267 UDYOG VIHAR PHASE II  
GURGAON, HARYANA 12201, INDIA

THE MARK CONSISTS OF STANDARD CHAR-  
ACTERS WITHOUT CLAIM TO ANY PARTICULAR  
FONT, STYLE, SIZE, OR COLOR.

FOR: TECHNICAL SUPPORT SERVICES, NAME-  
LY, TROUBLESHOOTING OF COMPUTER SOFT-  
WARE PROBLEMS, IN CLASS 42 (U.S. CLS. 100 AND  
101).

SER. NO. 77-220,794, FILED 7-2-2007.

FIRST USE 6-1-2007; IN COMMERCE 6-1-2007.

SANJEEV VOHRA, EXAMINING ATTORNEY

**Int. Cl.: 9**

**Prior U.S. Cls.: 21, 23, 26, 36 and 38**

**United States Patent and Trademark Office**

**Reg. No. 3,394,482**

**Registered Mar. 11, 2008**

**TRADEMARK  
PRINCIPAL REGISTER**



SHARK EYES, INC. (CALIFORNIA CORPORATION)  
2240 E. WASHINGTON BLVD.  
LOS ANGELES, CA 90021

FOR: SUNGLASSES, READING GLASSES, IN CLASS 9 (U.S. CLS. 21, 23, 26, 36 AND 38).

FIRST USE 6-15-2005; IN COMMERCE 2-26-2006.

THE MARK IS NOT IN COLOR. THE MARK CONSISTS OF LOWER CASE G WITH A CAPITAL C SEMI-CONNECTING TO THE LOWER PART OF THE G.

SER. NO. 77-220,814, FILED 7-2-2007.

TRICIA SONNEBORN, EXAMINING ATTORNEY

**Int. Cl.: 3**

**Prior U.S. Cls.: 1, 4, 6, 50, 51 and 52**

**United States Patent and Trademark Office**

**Reg. No. 3,394,483**

**Registered Mar. 11, 2008**

**TRADEMARK  
PRINCIPAL REGISTER**

**PURE REVOLUTION**

TRACIE MARTYN INTERNATIONAL LLC (NEW  
YORK LTD LIAB CO)  
59 FIFTH AVENUE  
NEW YORK, NY 10003

THE MARK CONSISTS OF STANDARD CHAR-  
ACTERS WITHOUT CLAIM TO ANY PARTICULAR  
FONT, STYLE, SIZE, OR COLOR.

FOR: NON-MEDICATED SKIN CARE PREPARA-  
TIONS, IN CLASS 3 (U.S. CLS. 1, 4, 6, 50, 51 AND 52).

SER. NO. 77-221,138, FILED 7-3-2007.

FIRST USE 7-2-2007; IN COMMERCE 7-2-2007.

KAPIL BHANOT, EXAMINING ATTORNEY

**Int. Cl.: 35**

**Prior U.S. Cls.: 100, 101 and 102**

**United States Patent and Trademark Office**

**Reg. No. 3,394,484**

**Registered Mar. 11, 2008**

**SERVICE MARK  
PRINCIPAL REGISTER**

# The Traffic Guys

FURNITURE MARKETING SYSTEM LLC (UTAH  
LTD LIAB CO)  
663 EAST 5640 SOUTH  
SALT LAKE CITY, UT 84107

FOR: BUSINESS MARKETING AND BUSINESS  
CONSULTING SERVICES IN THE FURNITURE  
INDUSTRY, IN CLASS 35 (U.S. CLS. 100, 101 AND  
102).

FIRST USE 7-7-2006; IN COMMERCE 7-7-2006.

THE MARK CONSISTS OF STANDARD CHAR-  
ACTERS WITHOUT CLAIM TO ANY PARTICULAR  
FONT, STYLE, SIZE, OR COLOR.

NO CLAIM IS MADE TO THE EXCLUSIVE  
RIGHT TO USE "TRAFFIC", APART FROM THE  
MARK AS SHOWN.

SER. NO. 77-221,262, FILED 7-3-2007.

TINA KUAN, EXAMINING ATTORNEY

**Int. Cl.: 42**

**Prior U.S. Cls.: 100 and 101**

**United States Patent and Trademark Office**

**Reg. No. 3,394,485**

**Registered Mar. 11, 2008**

**SERVICE MARK  
PRINCIPAL REGISTER**

**ESCOS**

ESCO ENVIRONMENTAL SERVICES CO (MIN-  
NESOTA CORPORATION)  
1566 SUMTER AVE N  
GOLDEN VALLEY, MN 55427

FOR: CONSULTING SERVICES IN THE FIELD  
OF ENVIRONMENTAL ASSESSMENT, COMPLI-  
ANCE AND PLANNING; PREPARING ENVIRON-  
MENTAL COMPLIANCE REPORTS, IN CLASS 42  
(U.S. CLS. 100 AND 101).

FIRST USE 6-12-1992; IN COMMERCE 12-0-1994.

THE MARK CONSISTS OF STANDARD CHAR-  
ACTERS WITHOUT CLAIM TO ANY PARTICULAR  
FONT, STYLE, SIZE, OR COLOR.

SER. NO. 77-221,272, FILED 7-3-2007.

DAWN HAN, EXAMINING ATTORNEY



Int. Cl.: 40

Prior U.S. Cls.: 100, 103 and 106

United States Patent and Trademark Office

Reg. No. 3,394,486

Registered Mar. 11, 2008

SERVICE MARK  
PRINCIPAL REGISTER

The logo for "Spirit Bay" is rendered in a bold, cursive script. The word "Spirit" is on the left, and "Bay" is on the right. A stylized fish hook is integrated into the design, with its point extending from the top of the letter 'y' in "Bay" and curving back to the left, passing under the word "Spirit".

EMERALD COAST EXECUTIVE CHARTERS  
(FLORIDA CORPORATION)  
SUITE 230  
4300 LEGENDARY DRIVE  
DESTIN, FL 32541

THE MARK CONSISTS OF THE WORDS SPIRIT  
BAY WITH A STYLIZED FISH HOOK IMPOSED  
WITH THE NAME.

FOR: MANUFACTURING SERVICES FOR OTH-  
ERS IN THE FIELD OF BOATS, IN CLASS 40 (U.S.  
CLS. 100, 103 AND 106).

SER. NO. 77-221,273, FILED 7-3-2007.

FIRST USE 12-1-1970; IN COMMERCE 12-1-1970.

DAWN HAN, EXAMINING ATTORNEY

**Int. Cl.: 45**

**Prior U.S. Cls.: 100 and 101**

**United States Patent and Trademark Office**

**Reg. No. 3,394,487**

**Registered Mar. 11, 2008**

**SERVICE MARK  
PRINCIPAL REGISTER**

**Salty Sez**

ARNOLD I. BERSCHLER (UNITED STATES IN-  
DIVIDUAL)  
SUITE 810  
22 BATTERY STREET  
SAN FRANCISCO, CA 94111

THE MARK CONSISTS OF STANDARD CHAR-  
ACTERS WITHOUT CLAIM TO ANY PARTICULAR  
FONT, STYLE, SIZE, OR COLOR.

FOR: LEGAL SERVICES, IN CLASS 45 (U.S. CLS.  
100 AND 101).

SER. NO. 77-221,279, FILED 7-3-2007.

FIRST USE 12-6-2006; IN COMMERCE 12-6-2006.

DAWN HAN, EXAMINING ATTORNEY

Int. Cl.: 20

Prior U.S. Cls.: 2, 13, 22, 25, 32 and 50

United States Patent and Trademark Office

Reg. No. 3,394,488

Registered Mar. 11, 2008

TRADEMARK  
PRINCIPAL REGISTER



FLORIDABEACH INC. (NEW JERSEY CORPORATION)  
51 APACHE DR.  
MANALAPAN, NJ 07726

FIRST USE 3-1-2004; IN COMMERCE 3-1-2004.

SER. NO. 77-221,284, FILED 7-3-2007.

FOR: KITCHEN CABINETS, BATHROOM VANITIES, IN CLASS 20 (U.S. CLS. 2, 13, 22, 25, 32 AND 50).

DAWN HAN, EXAMINING ATTORNEY

**Int. Cl.: 25**

**Prior U.S. Cls.: 22 and 39**

**United States Patent and Trademark Office**

**Reg. No. 3,394,489**

**Registered Mar. 11, 2008**

**TRADEMARK  
PRINCIPAL REGISTER**

**Billy Rübin**

MATHEW, MATHEW A. (UNITED STATES IN-  
DIVIDUAL)

SUITE 390

1 TRANS AM PLAZA DRIVE

OAKBROOK TERRACE, IL 60181

FOR: PANTS, IN CLASS 25 (U.S. CLS. 22 AND 39).

FIRST USE 4-19-2006; IN COMMERCE 4-19-2006.

THE MARK CONSISTS OF STANDARD CHAR-  
ACTERS WITHOUT CLAIM TO ANY PARTICULAR  
FONT, STYLE, SIZE, OR COLOR.

THE NAME(S), PORTRAIT(S), AND/OR SIGNA-  
TURE(S) SHOWN IN THE MARK DOES NOT IDEN-  
TIFY A PARTICULAR LIVING INDIVIDUAL.

SER. NO. 77-221,296, FILED 7-3-2007.

COLLEEN DOMBROW, EXAMINING ATTORNEY

**Int. Cl.: 16**

**Prior U.S. Cls.: 2, 5, 22, 23, 29, 37, 38 and 50**

**United States Patent and Trademark Office**

**Reg. No. 3,394,490**

**Registered Mar. 11, 2008**

**TRADEMARK  
PRINCIPAL REGISTER**

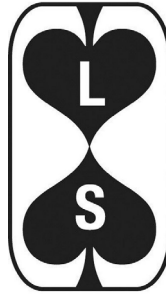

**LYLE  
STUART**

KENSINGTON PUBLISHING CORP. (NEW YORK CORPORATION)  
850 THIRD AVENUE  
NEW YORK, NY 100226222

FOR: SERIES OF NON-FICTION BOOKS IN THE FIELD OF GAMBLING, IN CLASS 16 (U.S. CLS. 2, 5, 22, 23, 29, 37, 38 AND 50).

FIRST USE 2-6-2006; IN COMMERCE 2-6-2006.

THE NAME LYLE STUART DOES NOT IDENTIFY A LIVING INDIVIDUAL.

THE MARK CONSISTS OF THE WORDS "LYLE STUART" BELOW THE STYLIZED DRAWING OF TWO SPADES, ONE PLACED DIRECTLY ABOVE THE OTHER. THE TOP SPADE IS UPSIDE DOWN AND HAS THE LETTER "L" SUPERIMPOSED OVER IT, AND THE BOTTOM SPADE HAS THE LETTER "S" SUPERIMPOSED OVER IT.

SER. NO. 77-221,570, FILED 7-3-2007.

PAULA MAHONEY, EXAMINING ATTORNEY

**Int. Cl.: 16**

**Prior U.S. Cls.: 2, 5, 22, 23, 29, 37, 38 and 50**

**United States Patent and Trademark Office**

**Reg. No. 3,394,491**

**Registered Mar. 11, 2008**

**TRADEMARK  
PRINCIPAL REGISTER**

**THE CHRISTIAN VOICE  
magazine**

WILDS, RANDALL (UNITED STATES INDIVIDUAL)  
17911 HWY 96  
KENNEDY, AL 35592

FOR: MAGAZINES FEATURING CHRISTIAN LIFE AND GOSPEL MUSIC, IN CLASS 16 (U.S. CLS. 2, 5, 22, 23, 29, 37, 38 AND 50).

FIRST USE 7-6-2006; IN COMMERCE 9-1-2006.

THE MARK CONSISTS OF STANDARD CHARACTERS WITHOUT CLAIM TO ANY PARTICULAR FONT, STYLE, SIZE, OR COLOR.

NO CLAIM IS MADE TO THE EXCLUSIVE RIGHT TO USE "CHRISTIAN" AND "MAGAZINE", APART FROM THE MARK AS SHOWN.

SER. NO. 77-221,739, FILED 7-3-2007.

MARGERY A. TIERNEY, EXAMINING ATTORNEY

**Int. Cls.: 3 and 25**

**Prior U.S. Cls.: 1, 4, 6, 22, 39, 50, 51 and 52**

**United States Patent and Trademark Office**

**Reg. No. 3,394,492**

**Registered Mar. 11, 2008**

**TRADEMARK  
PRINCIPAL REGISTER**



KAYSER-ROTH CORPORATION (DELAWARE CORPORATION)  
102 CORPORATE CENTER BOULEVARD  
GREENSBORO, NC 27408

FOR: LOTION, IN CLASS 3 (U.S. CLS. 1, 4, 6, 50, 51 AND 52).

FIRST USE 0-0-2005; IN COMMERCE 0-0-2005.

FOR: CLOTHING, NAMELY, SHEER HOSIERY, BRAS, PANTIES, SHAPEWEAR, NAMELY, FIGURE-SHAPING TIGHTS, LEGGINGS, PANTYHOSE, HOSIERY, MID-THIGH PANTYHOSE, SHAPERS, NAMELY, BODY SHAPERS, LEG SHAPERS, TUMMY SHAPERS, WAIST SHAPERS, AND BUTTOCKS SHAPERS, SLEEPWEAR, SKIRTS, TEE SHIRTS, TANK TOPS, SHORTS, PANTS, TIGHTS, SOCKS, TROUSER SOCKS, LINERS FOR FOOTWEAR, NAMELY, SOCK, SHEER, AND MESH LINERS

FOR FOOTWEAR, FOOT TUBES, NAMELY, TOE-LESS AND HEEL-LESS SOCK, SHEER, AND MESH LINERS FOR FOOTWEAR, INSOLES, NAMELY, PADS FOR SHOES, BALL OF FOOT CUSHIONS, AND HEEL CUSHIONS, SLIPPERS, FOOTWEAR, IN CLASS 25 (U.S. CLS. 22 AND 39).

FIRST USE 0-0-1999; IN COMMERCE 0-0-1999.

OWNER OF U.S. REG. NOS. 974,045, 990,470 AND OTHERS.

THE MARK CONSISTS OF THE WORDING "NO NONSENSE" AND DESIGN, NAMELY, A CURVY BAR-SHAPED DESIGN.

SER. NO. 77-221,878, FILED 7-3-2007.

WANDA KAY PRICE, EXAMINING ATTORNEY

**Int. Cl.: 35**

**Prior U.S. Cls.: 100, 101 and 102**

**United States Patent and Trademark Office**

**Reg. No. 3,394,493**

**Registered Mar. 11, 2008**

**SERVICE MARK  
PRINCIPAL REGISTER**

**SAFETY WITH STYLE**

SAFETY WITH STYLE, LLC (FLORIDA LTD  
LIAB CO)  
4535 DOMESTIC AVENUE, SUITE D  
NAPLES, FL 34104

THE MARK CONSISTS OF STANDARD CHAR-  
ACTERS WITHOUT CLAIM TO ANY PARTICULAR  
FONT, STYLE, SIZE, OR COLOR.

FOR: ONLINE RETAIL STORE SERVICES FEA-  
TURING PRODUCTS IN THE AREA OF HOME  
SAFETY, CHILD SAFETY, AND PET SAFETY, IN  
CLASS 35 (U.S. CLS. 100, 101 AND 102).

SER. NO. 77-221,928, FILED 7-3-2007.

FIRST USE 11-1-2006; IN COMMERCE 12-1-2006.

MICHAEL LITZAU, EXAMINING ATTORNEY



**Int. Cl.: 41**

**Prior U.S. Cls.: 100, 101 and 107**

**United States Patent and Trademark Office**

**Reg. No. 3,394,494**

**Registered Mar. 11, 2008**

**SERVICE MARK  
PRINCIPAL REGISTER**

**DREAM TAKE FLIGHT**

TURNER, LISA P. (UNITED STATES INDIVIDUAL)  
1358 FAIRFAX CIRCLE EAST  
BOYNTON BEACH, FL 334368612

THE MARK CONSISTS OF STANDARD CHARACTERS WITHOUT CLAIM TO ANY PARTICULAR FONT, STYLE, SIZE, OR COLOR.

FOR: EDUCATIONAL AND ENTERTAINMENT SERVICES, NAMELY, PROVIDING MOTIVATIONAL AND EDUCATIONAL SPEAKERS, IN CLASS 41 (U.S. CLS. 100, 101 AND 107).

SER. NO. 77-222,046, FILED 7-4-2007.

FIRST USE 2-13-2007; IN COMMERCE 2-18-2007.

MICHAEL ENGEL, EXAMINING ATTORNEY

**Int. Cl.: 41**

**Prior U.S. Cls.: 100, 101 and 107**

**United States Patent and Trademark Office**

**Reg. No. 3,394,495**

**Registered Mar. 11, 2008**

**SERVICE MARK  
PRINCIPAL REGISTER**

**CINEBUZZU**

CINEBUZZU LLC (COLORADO LTD LIAB CO)  
SUITE 6  
111 QUAIL CIRCLE  
GYPSUM, CO 81637

FIRST USE 7-4-2007; IN COMMERCE 7-4-2007.

THE COLOR(S) MAROON AND BLACK IS/ARE  
CLAIMED AS A FEATURE OF THE MARK.

FOR: PROVIDING AN ONLINE COMPUTER DA-  
TABASE FEATURING MOTION PICTURE FILM  
TRAILER RATINGS, AND MOTION PICTURE  
FILM TRAILER DATABASES; PROVIDING A WEB-  
SITE FEATURING MOTION PICTURE FILM TRAI-  
LER RATINGS, AND MOTION PICTURE FILM  
TRAILER DATABASES, IN CLASS 41 (U.S. CLS.  
100, 101 AND 107).

THE MARK CONSISTS OF MAROON LETTERS  
WITH A BLACK SHADOW.

SER. NO. 77-222,083, FILED 7-4-2007.

AMY GEARIN, EXAMINING ATTORNEY

**Int. Cl.: 41**

**Prior U.S. Cls.: 100, 101 and 107**

**United States Patent and Trademark Office**

**Reg. No. 3,394,496**

**Registered Mar. 11, 2008**

**SERVICE MARK  
PRINCIPAL REGISTER**

# Healing Race

CLARK JONES GROUP, LLC (NORTH CAROLINA LTD LIAB CO)  
1504 PORTER CREEK COURT  
WAKE FOREST, NC 27587

FOR: ENTERTAINMENT IN THE NATURE OF FITNESS RUNNING RACES, IN CLASS 41 (U.S. CLS. 100, 101 AND 107).

FIRST USE 1-1-2004; IN COMMERCE 10-1-2006.

THE MARK CONSISTS OF STANDARD CHARACTERS WITHOUT CLAIM TO ANY PARTICULAR FONT, STYLE, SIZE, OR COLOR.

NO CLAIM IS MADE TO THE EXCLUSIVE RIGHT TO USE "RACE", APART FROM THE MARK AS SHOWN.

SER. NO. 77-222,100, FILED 7-4-2007.

MARK PILARO, EXAMINING ATTORNEY

**Int. Cl.: 36**

**Prior U.S. Cls.: 100, 101 and 102**

**United States Patent and Trademark Office**

**Reg. No. 3,394,497**

**Registered Mar. 11, 2008**

**SERVICE MARK  
PRINCIPAL REGISTER**



RYAN ANDREW KAISER MEMORIAL FOUNDATION (NEW JERSEY FOUNDATION)  
7 OLDWICK CT.  
LEONARDO, NJ 07737

FOR: CHARITABLE FUND RAISING, IN CLASS 36 (U.S. CLS. 100, 101 AND 102).

FIRST USE 8-31-2003; IN COMMERCE 8-31-2003.

THE COLOR(S) BLACK, RED, BLUE AND WHITE IS/ARE CLAIMED AS A FEATURE OF THE MARK.

"THE MARK CONSISTS OF THE DESIGN OF TWO CHILDREN HOLDING HANDS WITH AN ADULT FIGURE, THE LEFT CHILD IS A GIRL HOLDING A BLUE BALLOON, THE ADULT FIGURE HAS A RED HEART, AND THE RIGHT CHILD IS A BOY, WHITE APPEARS FOR THE FILL COLORS OF THE FACES AND BELTS."

SER. NO. 77-222,407, FILED 7-5-2007.

ANTHONY RINKER, EXAMINING ATTORNEY

**Int. Cl.: 35**

**Prior U.S. Cls.: 100, 101 and 102**

**United States Patent and Trademark Office**

**Reg. No. 3,394,498**

**Registered Mar. 11, 2008**

**SERVICE MARK  
PRINCIPAL REGISTER**

**IMPACT MOMENTS**

EMPOWER MEDIAMARKETING, INC. (OHIO  
CORPORATION)  
1111 ST. GREGORY STREET  
CINCINNATI, OH 45202

FOR: BUSINESS MARKETING SERVICES; BUSI-  
NESS MARKETING CONSULTING SERVICES; DE-  
VELOPMENT OF MARKETING STRATEGIES AND  
CONCEPTS, IN CLASS 35 (U.S. CLS. 100, 101 AND  
102).

FIRST USE 7-11-2006; IN COMMERCE 7-11-2006.

THE MARK CONSISTS OF STANDARD CHAR-  
ACTERS WITHOUT CLAIM TO ANY PARTICULAR  
FONT, STYLE, SIZE, OR COLOR.

SER. NO. 77-222,610, FILED 7-5-2007.

KATHERINE CONNOLLY, EXAMINING ATTOR-  
NEY

**Int. Cl.: 18**

**Prior U.S. Cls.: 1, 2, 3, 22 and 41**

**United States Patent and Trademark Office**

**Reg. No. 3,394,499**

**Registered Mar. 11, 2008**

**TRADEMARK  
PRINCIPAL REGISTER**

**Cush n Shade**

BREE, JOAN M. (IRELAND INDIVIDUAL)  
137 HARCOURT GREEN  
DUBLIN, IRELAND

FOR: SUNBATHING ACCESSORY, NAMELY, A PLASTIC FRAME INCORPORATING A STRETCHED FABRIC SUNSHADE AND FABRIC COVERED INFLATABLE CUSHION, IN CLASS 18 (U.S. CLS. 1, 2, 3, 22 AND 41).

FIRST USE 10-2-2002; IN COMMERCE 2-21-2006.

NO CLAIM IS MADE TO THE EXCLUSIVE RIGHT TO USE "SHADE", APART FROM THE MARK AS SHOWN.

THE COLOR(S) BLUE, YELLOW AND ORANGE IS/ARE CLAIMED AS A FEATURE OF THE MARK.

THE MARK CONSISTS OF THE WORDS CUSH N SHADE WITH THE N APPEARING ON A YIN YANG DESIGN. THE TERMS CUSH, N, AND SHADE IN THE MARK APPEAR IN THE COLOR BLUE. IN THE CENTER OF THE MARK THERE IS A YIN YANG DESIGN ONE HALF OF WHICH APPEARS IN YELLOW WITH THE OTHER APPEARING IN ORANGE.

SER. NO. 77-222,708, FILED 7-5-2007.

JAMES A. RAUEN, EXAMINING ATTORNEY

Int. Cl.: 16

Prior U.S. Cls.: 2, 5, 22, 23, 29, 37, 38 and 50

United States Patent and Trademark Office

Reg. No. 3,394,500

Registered Mar. 11, 2008

TRADEMARK  
PRINCIPAL REGISTER



8 NET, INC (CALIFORNIA CORPORATION)  
13140 ALONDRA BLVD.  
CERRITOS, CA 90703

FOR: PRINTING PAPER; PRINTING PAPERS, IN  
CLASS 16 (U.S. CLS. 2, 5, 22, 23, 29, 37, 38 AND 50).

FIRST USE 6-26-2001; IN COMMERCE 6-26-2001.

NO CLAIM IS MADE TO THE EXCLUSIVE  
RIGHT TO USE "INC.", APART FROM THE MARK  
AS SHOWN.

THE COLOR(S) RED, WHITE, GREY AND BLACK  
IS/ARE CLAIMED AS A FEATURE OF THE MARK.

THE MARK CONSISTS OF THE LETTER N IN  
WHITE INSIDE A CIRCLE FILLED WITH GREY,  
THE LETTER T IN WHITE INSIDE A CIRCLE  
FILLED WITH GREY, THE NUMBER 8 IN RED  
BETWEEN THE TWO GREY CIRCLES, THE LET-  
TER "E" IN WHITE INSIDE THE BOTTOM HALF OF  
THE NUMBER 8, THE BLACK LETTERS I, N, C  
WITH A BLACK DOT LOCATED TO THE RIGHT OF  
THE GREY CIRCLE WITH THE LETTER T. THE  
COLOR WHITE IN THE CIRCLE LOCATED IN THE  
TOP HALF OF THE NUMBER 8 IS NOT A FEATURE  
OF THE MARK. RATHER, THE WHITE MERELY  
REFLECTS A TRANSPARENCY THROUGH TO  
THE BACKGROUND OF THE MARK.

SER. NO. 77-222,916, FILED 7-5-2007.

DAVID MURRAY, EXAMINING ATTORNEY

**Int. Cl.: 25**

**Prior U.S. Cls.: 22 and 39**

**United States Patent and Trademark Office**

**Reg. No. 3,394,501**

**Registered Mar. 11, 2008**

**TRADEMARK  
PRINCIPAL REGISTER**

**HAWAIIAN ISLAND CREATIONS**

CORAL HEAD, INC. (CALIFORNIA CORPORATION)  
1988 W. 169TH STREET  
GARDENA, CA 90247

FOR: CLOTHING, SPORTS WEAR, CASUAL WEAR, LEISURE WEAR, AND SURFING WEAR, NAMELY, BOARD SHORTS, DRESSES, JACKETS, JEANS, PANTS, RASH GUARDS, SHIRTS, SHORTS, SKIRTS, SWEATERS, SWEATSHIRTS, SWIMWEAR, T-SHIRTS, TANK TOPS, WALKING SHORTS, AND WET SUITS; FOOTWEAR, NAMELY, SLIPPERS; HEADGEAR, NAMELY, HATS AND VISORS, IN CLASS 25 (U.S. CLS. 22 AND 39).

FIRST USE 3-1-1997; IN COMMERCE 3-1-1997.

THE MARK CONSISTS OF STANDARD CHARACTERS WITHOUT CLAIM TO ANY PARTICULAR FONT, STYLE, SIZE, OR COLOR.

OWNER OF U.S. REG. NOS. 2,452,251, 2,475,043, AND 3,148,149.

SEC. 2(F).

SER. NO. 77-222,970, FILED 7-5-2007.

MARK PILARO, EXAMINING ATTORNEY



**Int. Cl.: 41**

**Prior U.S. Cls.: 100, 101 and 107**

**United States Patent and Trademark Office**

**Reg. No. 3,394,502**

**Registered Mar. 11, 2008**

**SERVICE MARK  
PRINCIPAL REGISTER**

# Ironhead

YEAGHER, ANGELA L. (UNITED STATES INDIVIDUAL)  
3665 - G HIGH MEADOWS DRIVE  
WINSTON-SALEM, NC 27106

THE MARK CONSISTS OF STANDARD CHARACTERS WITHOUT CLAIM TO ANY PARTICULAR FONT, STYLE, SIZE, OR COLOR.

FOR: ENTERTAINMENT, NAMELY, LIVE PERFORMANCES BY A MUSICAL BAND, IN CLASS 41 (U.S. CLS. 100, 101 AND 107).

SER. NO. 77-223,100, FILED 7-5-2007.

FIRST USE 1-1-2003; IN COMMERCE 1-1-2003.

CHRISTINA SOBRAL, EXAMINING ATTORNEY

**Int. Cls.: 41 and 42**

**Prior U.S. Cls.: 100, 101 and 107**

**United States Patent and Trademark Office**

**Reg. No. 3,394,503**

**Registered Mar. 11, 2008**

**SERVICE MARK  
PRINCIPAL REGISTER**



LAM-MENDIETA, VANESSA (UNITED STATES  
INDIVIDUAL)  
16041 S.W. 144 CT.  
MIAMI, FL 33177

OWNER OF U.S. REG. NO. 2,925,195.

FOR: PORTRAIT PHOTOGRAPHY; PHOTOGRAPHY SERVICES, IN CLASS 41 (U.S. CLS. 100, 101 AND 107).

THE COLOR(S) NAVY BLUE, GREY AND SILVER IS/ARE CLAIMED AS A FEATURE OF THE MARK.

FIRST USE 6-1-2007; IN COMMERCE 7-1-2007.

FOR: GRAPHIC ART DESIGN; GRAPHIC DESIGN SERVICES; DESIGNING WEBSITES FOR ADVERTISING PURPOSES; DEVELOPMENT, DESIGN AND UPDATING OF HOME PAGES; COMMERCIAL ART DESIGN, IN CLASS 42 (U.S. CLS. 100 AND 101).

THE MARK CONSISTS OF A BUTTERFLY ICON WITH THE WINGS SURROUNDING TWO CIRCLES RESEMBLING A LENS AND AN EYE. THE BUTTERFLY'S WINGS, ANTENNA AND CENTER CIRCLE ARE NAVY BLUE, WHILE THE OUTSIDE CENTER CIRCLE IS GREY. THE LETTERS VLM ARE IN NAVY BLUE AND STUDIOS IS IN SILVER WITH A BLUE DOT ON THE LETTER "I".

SER. NO. 77-223,128, FILED 7-6-2007.

FIRST USE 6-1-2007; IN COMMERCE 7-1-2007.

BENJAMIN OKEKE, EXAMINING ATTORNEY

**Int. Cl.: 8**

**Prior U.S. Cls.: 23, 28 and 44**

**Reg. No. 3,394,504**

**United States Patent and Trademark Office**

**Registered Mar. 11, 2008**

---

**TRADEMARK  
PRINCIPAL REGISTER**

**LENOX**

LENOX, INCORPORATED (NEW JERSEY CORPORATION)  
LEGAL DEPT.  
1414 RADCLIFFE STREET  
BRISTOL, PA 190075496

FOR: FLATWARE MADE OF STAINLESS STEEL, NAMELY, SPOONS, KNIVES AND FORKS, IN CLASS 8 (U.S. CLS. 23, 28 AND 44).

FIRST USE 5-1-1994; IN COMMERCE 5-1-1994.

THE MARK CONSISTS OF STANDARD CHARACTERS WITHOUT CLAIM TO ANY PARTICULAR FONT, STYLE, SIZE, OR COLOR.

OWNER OF U.S. REG. NOS. 1,611,141, 2,033,768 AND OTHERS.

SER. NO. 77-223,227, FILED 7-6-2007.

KAPIL BHANOT, EXAMINING ATTORNEY

Int. Cl.: 44

Prior U.S. Cls.: 100 and 101

United States Patent and Trademark Office

Reg. No. 3,394,505

Registered Mar. 11, 2008

SERVICE MARK  
PRINCIPAL REGISTER



PEDIATRIC PLASTIC SURGERY  
& CRANIOFACIAL ASSOCIATES

PEDIATRIC PLASTIC SURGERY & CRANIOFACIAL ASSOCIATES, P.A. (GEORGIA CORPORATION)

975 JOHNSON FERRY ROAD, N.E.  
ATLANTA, GA 30342

FOR: COSMETIC AND PLASTIC SURGERY, IN CLASS 44 (U.S. CLS. 100 AND 101).

FIRST USE 6-30-1995; IN COMMERCE 6-30-1995.

NO CLAIM IS MADE TO THE EXCLUSIVE RIGHT TO USE "PEDIATRIC PLASTIC SURGERY & CRANIOFACIAL ASSOCIATES", APART FROM THE MARK AS SHOWN.

THE MARK CONSISTS OF SILHOUETTE OF TWO CHILDREN.

SER. NO. 77-223,232, FILED 7-6-2007.

KAPIL BHANOT, EXAMINING ATTORNEY

**Int. Cl.: 45**

**Prior U.S. Cls.: 100 and 101**

**United States Patent and Trademark Office**

**Reg. No. 3,394,506**

**Registered Mar. 11, 2008**

**SERVICE MARK  
PRINCIPAL REGISTER**

**CALIFORNIAPSYCHICS.COM**

OUTLOOK AMUSEMENTS, INC. (CALIFORNIA  
CORPORATION)  
SUITE 500  
6725 SUNSET BOULEVARD  
LOS ANGELES, CA 90028

FOR: PSYCHIC AND ASTROLOGICAL READING  
SERVICES, IN CLASS 45 (U.S. CLS. 100 AND 101).

FIRST USE 5-23-2002; IN COMMERCE 5-23-2002.

THE MARK CONSISTS OF STANDARD CHAR-  
ACTERS WITHOUT CLAIM TO ANY PARTICULAR  
FONT, STYLE, SIZE, OR COLOR.

OWNER OF U.S. REG. NO. 3,074,896.

SEC. 2(F).

SER. NO. 77-223,242, FILED 7-6-2007.

BRIAN CALLAGHAN, EXAMINING ATTORNEY

**Int. Cl.: 25**

**Prior U.S. Cls.: 22 and 39**

**United States Patent and Trademark Office**

**Reg. No. 3,394,507**

**Registered Mar. 11, 2008**

**TRADEMARK  
PRINCIPAL REGISTER**

**WOLFGANG'S VAULT**

NORTON LLC (MINNESOTA LTD LIAB CO)  
380 JACKSON STREET  
ST. PAUL, MN 55101

FOR: CLOTHING, NAMELY, T-SHIRTS, NECK-TIES, SHORTS, SWEATSHIRTS, SWEATPANTS, HATS, JACKETS, ONE-PIECE UNDERGARMENTS FOR CHILDREN, IN CLASS 25 (U.S. CLS. 22 AND 39).

FIRST USE 12-15-2005; IN COMMERCE 12-15-2005.

THE MARK CONSISTS OF STANDARD CHARACTERS WITHOUT CLAIM TO ANY PARTICULAR FONT, STYLE, SIZE, OR COLOR.

OWNER OF U.S. REG. NOS. 2,906,299 AND 2,906,330.

THE NAME "WOLFGANG" DOES NOT IDENTIFY A LIVING INDIVIDUAL.

SER. NO. 77-223,264, FILED 7-6-2007.

MARK PILARO, EXAMINING ATTORNEY

**Int. Cl.: 41**

**Prior U.S. Cls.: 100, 101 and 107**

**United States Patent and Trademark Office**

**Reg. No. 3,394,508**

**Registered Mar. 11, 2008**

**SERVICE MARK  
PRINCIPAL REGISTER**

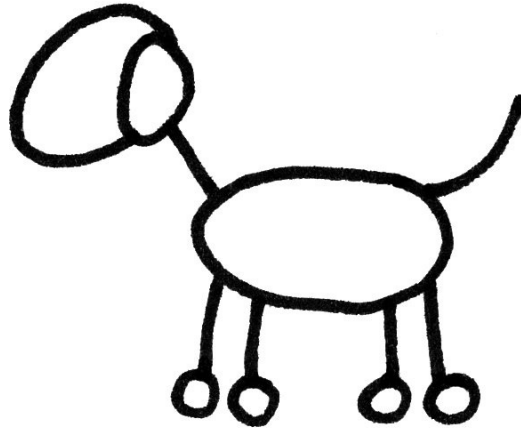

WEECOW ENTERPRISES, LTD. (NEW YORK  
LTD LIAB CO), DBA PETITE PICASSO  
4 BEARDSLEY LANE  
LLOYD HARBOR, NY 11743

FOR: PUBLISHING SERVICES, NAMELY, PUB-  
LICATION OF BOOKS FEATURING CHILDREN  
AUTHORED ART, IN CLASS 41 (U.S. CLS. 100, 101  
AND 107).

FIRST USE 5-1-2007; IN COMMERCE 5-1-2007.

THE MARK CONSISTS OF LINE DRAWING OF  
DOG.

SER. NO. 77-223,265, FILED 7-6-2007.

TEJBIR SINGH, EXAMINING ATTORNEY

**Int. Cls.: 9, 16, 25, 41 and 42**

**Prior U.S. Cls.: 2, 5, 21, 22, 23, 26, 29, 36, 37, 38, 39,  
50, 100, 101 and 107**

**Reg. No. 3,394,509**

**United States Patent and Trademark Office**

**Registered Mar. 11, 2008**

**TRADEMARK  
SERVICE MARK  
PRINCIPAL REGISTER**

**RES**

REAL ENTERPRISE SOLUTIONS NEDERLAND  
B.V. (NETHERLANDS CORPORATION)  
HET ZUIDERKRUIS 33  
5215 MV DEN BOSCH, NETHERLANDS

FOR: COMPUTER HARDWARE; COMPUTER SOFTWARE ENABLING TO STREAMLINE, CONFIGURE, SECURE AND MONITOR ALL DESKTOPS FROM ONE CENTRAL CONSOLE; COMPUTER SOFTWARE FOR REMOTE COMPUTER ASSISTANCE AND COMPUTER SCREEN ADOPTION AT DISTANCE, AND FOR SEARCHING AND DOWNLOADING INFORMATION; COMPUTER SOFTWARE FOR DOWNLOADING MESSAGES, IMAGES AND SOUND, IN CLASS 9 (U.S. CLS. 21, 23, 26, 36 AND 38).

FOR: PRINTED MATTER, NAMELY, MAGAZINES, LEAFLETS, PAPER WORK, NAMELY, MANUALS, BROCHURES AND BOOKS ALL FEATURING INFORMATION ABOUT COMPUTER HARDWARE AND COMPUTER SOFTWARE; STATIONERY; PRINTED INSTRUCTIONAL AND TEACHING MATERIALS IN THE FIELD OF COMPUTER SOFTWARE AND COMPUTER HARDWARE, IN CLASS 16 (U.S. CLS. 2, 5, 22, 23, 29, 37, 38 AND 50).

FOR: CLOTHING, NAMELY, FOOTWEAR, SHIRTS, T-SHIRTS, SWEAT-SHIRTS, JACKETS, WAISTCOATS, SHORT TROUSERS, TROUSERS, JOGGING SUITS, JOGGING TROUSERS, HATS, JACKETS, BRACES, LEATHER JACKETS, TENNIS SHOES, SWEATBANDS, COATS, PULLOVERS, SWEATERS, POLO SHIRTS, RUGBY SHIRTS, WRISTBANDS, SCARVES, TIES, SUN VISORS, GLOVES, UNDERWEAR AND SHOES; HEADGEAR, NAMELY, HATS AND CAPS, IN CLASS 25 (U.S. CLS. 22 AND 39).

FOR: PROVIDING TRAINING IN THE FIELD OF COMPUTERIZATION; ELECTRONIC PUBLISHING SERVICES, NAMELY, PUBLICATION OF TEXT AND GRAPHIC WORKS OF OTHERS ON CD, DVD, ONLINE AND ON CD ROM FEATURING COMPUTER HARDWARE AND COMPUTER SOFTWARE; PUBLISHING OF BOOKS, NEWSPAPERS, REVIEWS AND OTHER PRINTED MATTER AS WELL AS RELATED ELECTRONIC DATA CARRIERS, IN CLASS 41 (U.S. CLS. 100, 101 AND 107).

FOR: COMPUTER SERVICE, NAMELY, ACTING AS AN APPLICATION SERVICE PROVIDER IN THE FIELD OF KNOWLEDGE MANAGEMENT TO HOST COMPUTER APPLICATION SOFTWARE FOR SEARCHING AND RETRIEVING INFORMATION FROM DATABASES AND COMPUTER NETWORKS; COMPUTER PROGRAMMING FOR OTHERS; COMPUTER SOFTWARE DESIGN FOR OTHERS; TECHNOLOGICAL CONSULTATION IN THE TECHNOLOGY FIELD OF INFORMATION CONCERNING COMPUTER HARDWARE AND SOFTWARE; COMPUTER DIAGNOSTIC SERVICES; TECHNICAL SUPPORT SERVICES, NAMELY, TROUBLESHOOTING OF COMPUTER HARDWARE AND SOFTWARE PROBLEMS; SERVICES OF INFORMATION AND COMMUNICATION TECHNOLOGY SPECIALISTS ON SITE AND OFF SITE AND VIA ONLINE COMPUTER CONSULTATION AND COMPUTER DIAGNOSTIC SERVICES OF INFORMATION AND COMMUNICATION TECHNOLOGY SPECIALISTS IN THE FIELD OF ELECTRONIC COMMERCE; DEVELOPMENT OF DATA PROCESSING PROGRAMS BY ORDER OF THIRD PARTIES; COMPUTER HARDWARE DESIGN AND DEVELOPMENT; COMPUTER PROJECT MANAGEMENT SERVICES; COMPUTER CONSULTATION, NAMELY PROVIDING AUTOMATION ADVICE AND ADVICE RELATED TO COMPUTER



HARDWARE AND SOFTWARE AND COMPUTERIZATION CONSULTANCY ANALYSIS; COMPUTER CONSULTATION AND COMPUTER DIAGNOSTIC SERVICES OF INFORMATION AND COMMUNICATION TECHNOLOGY SPECIALISTS IN THE FIELD OF PROTECTING COMPUTER DATA TRAFFIC, IN CLASS 42 (U.S. CLS. 100 AND 101).

THE MARK CONSISTS OF STANDARD CHARACTERS WITHOUT CLAIM TO ANY PARTICULAR FONT, STYLE, SIZE, OR COLOR.

OWNER OF BENELUX REG. NO. 0814654, DATED 12-12-2006, EXPIRES 12-21-2016.

OWNER OF U.S. REG. NO. 2,711,206.

SER. NO. 77-223,272, FILED 7-6-2007.

TINA BROWN, EXAMINING ATTORNEY

**Int. Cl.: 33**

**Prior U.S. Cls.: 47 and 49**

**United States Patent and Trademark Office**

**Reg. No. 3,394,510**

**Registered Mar. 11, 2008**

**TRADEMARK  
PRINCIPAL REGISTER**

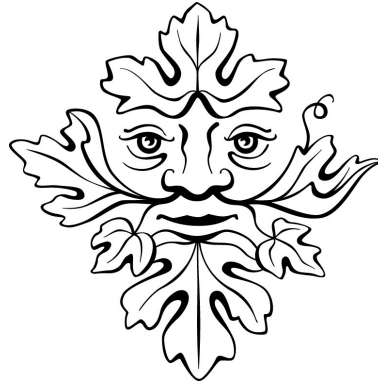

OLSEN AGRICULTURAL COMPANY, INC.  
(OREGON CORPORATION)  
8930 SUVER ROAD  
MONMOUTH, OR 97361

THE MARK CONSISTS OF A STYLIZED FACE  
SET AMONG LEAVES.

FOR: WINE, IN CLASS 33 (U.S. CLS. 47 AND 49).

SER. NO. 77-223,330, FILED 7-6-2007.

FIRST USE 8-7-2007; IN COMMERCE 8-7-2007.

FRED CARL, EXAMINING ATTORNEY

**Int. Cl.: 41**

**Prior U.S. Cls.: 100, 101 and 107**

**United States Patent and Trademark Office**

**Reg. No. 3,394,511**

**Registered Mar. 11, 2008**

**SERVICE MARK  
PRINCIPAL REGISTER**

**DJ VIBE**

HELLMAN, ZACHARY F (UNITED STATES IN-  
DIVIDUAL)  
APT. 2  
308 CLINTON AVENUE  
BROOKLYN, NY 11205

FOR: DISC JOCKEYS FOR PARTIES AND SPECIAL EVENTS; MULTIMEDIA ENTERTAINMENT SERVICES IN THE NATURE OF RECORDING, PRODUCTION AND POST-PRODUCTION SERVICES IN THE FIELDS OF MUSIC, VIDEO, AND FILMS; MUSIC PRODUCTION SERVICES; AUDIO RECORDING AND PRODUCTION; ENTERTAINMENT IN THE NATURE OF VISUAL AND AUDIO PERFORMANCES, AND MUSICAL, VARIETY, NEWS AND COMEDY SHOWS; ENTERTAINMENT, NAMELY, A CONTINUING MUSIC SHOW BROADCAST OVER TELEVISION, SATELLITE, AUDIO, AND VIDEO MEDIA; RECORD PRODUCTION;

RENTAL OF AUDIO-VISUAL EQUIPMENT, IN CLASS 41 (U.S. CLS. 100, 101 AND 107).

FIRST USE 1-1-2004; IN COMMERCE 1-1-2004.

THE MARK CONSISTS OF STANDARD CHARACTERS WITHOUT CLAIM TO ANY PARTICULAR FONT, STYLE, SIZE, OR COLOR.

NO CLAIM IS MADE TO THE EXCLUSIVE RIGHT TO USE "DJ", APART FROM THE MARK AS SHOWN.

THE NAME DJ VIBE IDENTIFIES A LIVING INDIVIDUAL WHOSE CONSENT IS OF RECORD.

SER. NO. 77-223,358, FILED 7-6-2007.

CAROLINE WOOD, EXAMINING ATTORNEY

Int. Cl.: 41

Prior U.S. Cls.: 100, 101 and 107

United States Patent and Trademark Office

Reg. No. 3,394,512

Registered Mar. 11, 2008

SERVICE MARK  
PRINCIPAL REGISTER



HELLMAN, ZACHARY F (UNITED STATES IN-  
DIVIDUAL)  
308 CLINTON AVENUE, APT. 2 APT. 2  
BROOKLYN, NY 11205

FOR: DISC JOCKEYS FOR PARTIES AND SPECIAL EVENTS; AUDIO RECORDING AND PRODUCTION; ENTERTAINMENT SERVICES, NAMELY, PROVIDING A WEBSITE FEATURING, PHOTOGRAPHIC, AUDIO, VIDEO AND PROSE PRESENTATIONS FEATURING MUSIC; ENTERTAINMENT IN THE NATURE OF VISUAL AND AUDIO PERFORMANCES, AND MUSICAL, VARIETY, NEWS AND COMEDY SHOWS; POST-PRODUCTION EDITING SERVICES IN THE FIELD OF MUSIC, VIDEOS AND FILMS; PRODUCTION AND DISTRIBUTION OF TELEVISION SHOWS AND MOVIES; PRODUCTION OF CLOSED CAPTION TELEVISION PROGRAMS; MUSIC PRODUCTION SERVICES; RECORD PRODUCTION; RENTAL OF

AUDIO-VISUAL EQUIPMENT, IN CLASS 41 (U.S. CLS. 100, 101 AND 107).

FIRST USE 1-1-2004; IN COMMERCE 1-1-2004.

NO CLAIM IS MADE TO THE EXCLUSIVE RIGHT TO USE "THE WORLD FAMOUS DJ", APART FROM THE MARK AS SHOWN.

THE NAME DJ VIBE IDENTIFIES A LIVING INDIVIDUAL WHOSE CONSENT IS OF RECORD.

THE MARK CONSISTS OF THE WORDING THE WORLD FAMOUS APPEARING IN A STYLIZED BANNER LOCATED ABOVE THE WORDING DJ VIBE.

SER. NO. 77-223,384, FILED 7-6-2007.

CAROLINE WOOD, EXAMINING ATTORNEY

**Int. Cls.: 6 and 7**

**Prior U.S. Cls.: 2, 12, 13, 14, 19, 21, 23, 25, 31, 34, 35  
and 50**

**Reg. No. 3,394,513**

**United States Patent and Trademark Office**

**Registered Mar. 11, 2008**

**TRADEMARK  
PRINCIPAL REGISTER**



TOTAL ACCESS DOOR CONTROLS, INC. (FLOR-  
IDA CORPORATION)  
6203 JOHNS ROAD, SUITE 12  
TAMPA, FL 33634

FOR: DOOR HARDWARE, NAMELY KEYS AND  
KEY CYLINDERS; METAL DOOR BOLTS; METAL  
DOOR LATCHES; METAL HANDLES FOR DOORS;  
METAL LOCKS FOR DOORS; METAL HINGES, IN  
CLASS 6 (U.S. CLS. 2, 12, 13, 14, 23, 25 AND 50).

FIRST USE 6-28-2007; IN COMMERCE 7-6-2007.

FOR: HYDRAULIC DOOR CLOSERS; PNEUMAT-  
IC DOOR CLOSERS, IN CLASS 7 (U.S. CLS. 13, 19, 21,  
23, 31, 34 AND 35).

FIRST USE 6-28-2007; IN COMMERCE 7-6-2007.

NO CLAIM IS MADE TO THE EXCLUSIVE  
RIGHT TO USE "DOOR CONTROLS", APART  
FROM THE MARK AS SHOWN.

THE MARK CONSISTS OF A STYLIZED CIRCLE  
WITH A SMALL HEXAGON IN THE CENTER, TWO  
ARROWS AND FOUR RECTANGLES FORM THE  
BODY OF THE CIRCLE, TWO THIN CRESENT  
SHAPED RULES FORM A PARTIAL OUTLINE  
ABOVE AND BELOW THE MAIN CIRCLE, THE  
WORDS TOTAL ACCESS DOOR CONTROLS AP-  
PEAR TO THE RIGHT OF THE CIRCLE IN SPECI-  
FIED TYPE STYLES AND SIZES.

SER. NO. 77-223,458, FILED 7-6-2007.

REBECCA SMITH, EXAMINING ATTORNEY

**Int. Cl.: 3**

**Prior U.S. Cls.: 1, 4, 6, 50, 51 and 52**

**United States Patent and Trademark Office**

**Reg. No. 3,394,514**

**Registered Mar. 11, 2008**

**TRADEMARK  
PRINCIPAL REGISTER**

**RESTORADERM**

COLLAGENEX PHARMACEUTICALS, INC. (DE-  
LAWARE CORPORATION)  
41 UNIVERSITY DRIVE  
NEWTOWN, PA 18940

FOR: NON-MEDICATED SKIN CARE PREPARA-  
TIONS, IN CLASS 3 (U.S. CLS. 1, 4, 6, 50, 51 AND 52).

FIRST USE 6-21-2007; IN COMMERCE 6-21-2007.

THE MARK CONSISTS OF STANDARD CHAR-  
ACTERS WITHOUT CLAIM TO ANY PARTICULAR  
FONT, STYLE, SIZE, OR COLOR.

OWNER OF U.S. REG. NO. 2,985,751.

SER. NO. 77-223,507, FILED 7-6-2007.

ELLEN B. AWRICH, EXAMINING ATTORNEY

**Int. Cl.: 41**

**Prior U.S. Cls.: 100, 101 and 107**

**United States Patent and Trademark Office**

**Reg. No. 3,394,515**

**Registered Mar. 11, 2008**

**SERVICE MARK  
PRINCIPAL REGISTER**

**QUALIFIED TRAINING!  
QUALIFIED RESULTS!**

SECURITY UNIVERSITY, LLC (CONNECTICUT  
LTD LIAB CO)  
109 WEED AVE  
STAMFORD, CT 06902

FOR: EDUCATIONAL AND TRAINING SERVICES, NAMELY, SEMINARS AND CLASSES RELATING TO COMPUTER SECURITY SYSTEMS, POLICIES AND PROCEDURES AND HOW TO EVALUATE AND SOLVE COMPUTER SECURITY PROBLEMS, IN CLASS 41 (U.S. CLS. 100, 101 AND 107).

FIRST USE 1-0-2005; IN COMMERCE 1-0-2005.

THE MARK CONSISTS OF STANDARD CHARACTERS WITHOUT CLAIM TO ANY PARTICULAR FONT, STYLE, SIZE, OR COLOR.

SER. NO. 77-223,579, FILED 7-6-2007.

KENNETH E. SHARPERSON, EXAMINING ATTORNEY

Int. Cl.: 45

Prior U.S. Cls.: 100 and 101

United States Patent and Trademark Office

Reg. No. 3,394,516

Registered Mar. 11, 2008

**SERVICE MARK  
PRINCIPAL REGISTER**



ROTHSTEIN ROSENFELDT ADLER, P.A. (FLOR-  
IDA CORPORATION)  
SUITE 1650  
401 EAST LAS OLAS BOULEVARD  
FORT LAUDERDALE, FL 33301

FOR: LEGAL SERVICES, IN CLASS 45 (U.S. CLS.  
100 AND 101).

FIRST USE 3-31-2005; IN COMMERCE 3-31-2005.

NO CLAIM IS MADE TO THE EXCLUSIVE  
RIGHT TO USE "ATTORNEYS AT LAW", APART  
FROM THE MARK AS SHOWN.

THE STIPPLING IS FOR SHADING PURPOSES  
ONLY.

THE COLOR(S) BLUE AND GRAY IS/ARE  
CLAIMED AS A FEATURE OF THE MARK.

THE COLOR BLUE APPEARS IN THE TOP POR-  
TION OF THE MARK, HORIZONTALLY GRADU-  
ATING TO THE COLOR GRAY APPEARING IN  
THE BOTTOM/WORDING PORTION OF THE  
MARK. COLOR IS NOT CLAIMED AS A FEATURE  
OF THE NEGATIVE ("RRA") SPACE IN THE MARK.

SER. NO. 77-223,588, FILED 7-6-2007.

BRENDAN REGAN, EXAMINING ATTORNEY



**Int. Cls.: 9 and 42**

**Prior U.S. Cls.: 21, 23, 26, 36, 38, 100 and 101**

**United States Patent and Trademark Office**

**Reg. No. 3,394,517**

**Registered Mar. 11, 2008**

**TRADEMARK  
SERVICE MARK  
PRINCIPAL REGISTER**



SOTERIA NETWORK TECHNOLOGIES LLC  
(MARYLAND LTD LIAB CO)  
2400 BOSTON STREET  
BALTIMORE, MD 21114

THE COLOR(S) ORANGE AND WHITE IS/ARE CLAIMED AS A FEATURE OF THE MARK.

FOR: COMPUTER SOFTWARE FOR INTERNET AND INTRANET NETWORK SECURITY, IN CLASS 9 (U.S. CLS. 21, 23, 26, 36 AND 38).

THE MARK CONSISTS OF A STYLIZED S, DEPICTED AS IF LAYING ON ITS SIDE. THE COLOR ORANGE APPEARS IN THE OUTER ENDS OF THE S, WHILE THE COLOR WHITE APPEARS IN THE CENTER OF THE S.

FIRST USE 2-28-2007; IN COMMERCE 2-28-2007.

FOR: COMPUTER SOFTWARE CONSULTATION AND DEVELOPMENT SERVICES IN THE AREA OF INTERNET AND INTRANET NETWORK SECURITY, IN CLASS 42 (U.S. CLS. 100 AND 101).

SER. NO. 77-223,618, FILED 7-6-2007.

FIRST USE 2-28-2007; IN COMMERCE 2-28-2007.

KATHERINE CONNOLLY, EXAMINING ATTORNEY

**Int. Cl.: 42**

**Prior U.S. Cls.: 100 and 101**

**United States Patent and Trademark Office**

**Reg. No. 3,394,518**

**Registered Mar. 11, 2008**

**SERVICE MARK  
PRINCIPAL REGISTER**

**MAIL ORDER BRIDE**

H2 OHH! (CALIFORNIA CORPORATION)  
1515 FOURTH ST.  
SANTA MONICA, CA 90401

FOR: DESIGN FOR OTHERS IN THE FIELD OF  
CLOTHING, IN CLASS 42 (U.S. CLS. 100 AND 101).

FIRST USE 6-1-2006; IN COMMERCE 6-1-2006.

THE MARK CONSISTS OF STANDARD CHAR-  
ACTERS WITHOUT CLAIM TO ANY PARTICULAR  
FONT, STYLE, SIZE, OR COLOR.

SER. NO. 77-223,674, FILED 7-6-2007.

ROBERT C. CLARK JR., EXAMINING ATTORNEY

**Int. Cl.: 9**

**Prior U.S. Cls.: 21, 23, 26, 36 and 38**

**United States Patent and Trademark Office**

**Reg. No. 3,394,519**

**Registered Mar. 11, 2008**

**TRADEMARK  
PRINCIPAL REGISTER**

**CONFECTIONS**

NATIONAL VISION, INC. (GEORGIA CORPORATION)  
ATTN: LEGAL DEPT. /CHARLES MINGLE  
296 GRAYSON HIGHWAY  
LAWRENCEVILLE, GA 300455750

THE MARK CONSISTS OF STANDARD CHARACTERS WITHOUT CLAIM TO ANY PARTICULAR FONT, STYLE, SIZE, OR COLOR.

FOR: EYEGLOSS FRAMES; EYEGASSES; OPTICAL FRAMES; SPECTACLE FRAMES, IN CLASS 9 (U.S. CLS. 21, 23, 26, 36 AND 38).

SER. NO. 77-223,701, FILED 7-6-2007.

FIRST USE 11-5-2006; IN COMMERCE 11-5-2006.

ROBERT C. CLARK JR., EXAMINING ATTORNEY

**Int. Cl.: 9**

**Prior U.S. Cls.: 21, 23, 26, 36 and 38**

**United States Patent and Trademark Office**

**Reg. No. 3,394,520**

**Registered Mar. 11, 2008**

**TRADEMARK  
PRINCIPAL REGISTER**



LAS VEGAS SANDS CORP. (NEVADA CORPORATION)  
3355 LAS VEGAS BOULEVARD SOUTH  
LAS VEGAS, NV 89109

FOR: CASES FOR MOBILE PHONES; DISPOSABLE CAMERAS; READING GLASSES, SUNGLASSES, IN CLASS 9 (U.S. CLS. 21, 23, 26, 36 AND 38).

FIRST USE 3-29-2007; IN COMMERCE 3-29-2007.

OWNER OF U.S. REG. NOS. 2,411,034, 2,542,999 AND OTHERS.

THE MARK CONSISTS OF A WINGED LION WITH A CREST CONTAINING THE LETTER "V".

SER. NO. 77-223,713, FILED 7-6-2007.

LINDA LAVACHE, EXAMINING ATTORNEY

**Int. Cl.: 35**

**Prior U.S. Cls.: 100, 101 and 102**

**United States Patent and Trademark Office**

**Reg. No. 3,394,521**

**Registered Mar. 11, 2008**

**SERVICE MARK  
PRINCIPAL REGISTER**

# Austin Lumber

AUSTIN LUMBER COMPANY, INC. (TEXAS  
CORPORATION)  
2415 EAST 5TH STREET  
AUSTIN, TX 78702

FOR: RETAIL STORE SERVICES FEATURING  
LUMBER, WOOD PRODUCTS, AND OTHER  
BUILDING MATERIALS, INCLUDING BUT NOT  
LIMITED TO DECKING, FENCING, MOULDINGS,  
MILLWORK AND RELATED HARDWARE, IN  
CLASS 35 (U.S. CLS. 100, 101 AND 102).

FIRST USE 0-0-1929; IN COMMERCE 0-0-1929.

THE MARK CONSISTS OF STANDARD CHAR-  
ACTERS WITHOUT CLAIM TO ANY PARTICULAR  
FONT, STYLE, SIZE, OR COLOR.

NO CLAIM IS MADE TO THE EXCLUSIVE  
RIGHT TO USE "LUMBER", APART FROM THE  
MARK AS SHOWN.

SEC. 2(F).

SER. NO. 77-223,715, FILED 7-6-2007.

ROBERT C. CLARK JR., EXAMINING ATTORNEY

**Int. Cl.: 16**

**Prior U.S. Cls.: 2, 5, 22, 23, 29, 37, 38 and 50**

**Reg. No. 3,394,522**

**United States Patent and Trademark Office**

**Registered Mar. 11, 2008**

**TRADEMARK  
PRINCIPAL REGISTER**



LAS VEGAS SANDS CORP. (NEVADA CORPORATION)  
3355 LAS VEGAS BOULEVARD SOUTH  
LAS VEGAS, NV 89109

OWNER OF U.S. REG. NOS. 2,411,034, 2,542,999  
AND OTHERS.

FOR: MONEY CLIPS; NEWSLETTERS IN THE  
FIELD OF CASINO SERVICES, ENTERTAINMENT  
SERVICES AND RESORT SERVICES; PENS; PEN-  
CILS; POSTCARDS , IN CLASS 16 (U.S. CLS. 2, 5, 22,  
23, 29, 37, 38 AND 50).

THE MARK CONSISTS OF A WINGED LION  
WITH A CREST CONTAINING THE LETTER "V".

SER. NO. 77-223,716, FILED 7-6-2007.

FIRST USE 3-29-2007; IN COMMERCE 3-29-2007.

LINDA LAVACHE, EXAMINING ATTORNEY

**Int. Cl.: 28**

**Prior U.S. Cls.: 22, 23, 38 and 50**

**United States Patent and Trademark Office**

**Reg. No. 3,394,523**

**Registered Mar. 11, 2008**

**TRADEMARK  
PRINCIPAL REGISTER**



LAS VEGAS SANDS CORP. (NEVADA CORPORATION)  
3355 LAS VEGAS BOULEVARD SOUTH  
LAS VEGAS, NV 89109

FOR: PLUSH TOYS; PLUSH ANIMALS; STUFFED TOYS; STUFFED ANIMALS; PLAYING CARDS, IN CLASS 28 (U.S. CLS. 22, 23, 38 AND 50).

FIRST USE 3-29-2007; IN COMMERCE 3-29-2007.

OWNER OF U.S. REG. NOS. 2,411,034, 2,542,999 AND OTHERS.

THE MARK CONSISTS OF A WINGED LION WITH A CREST CONTAINING THE LETTER "V".

SER. NO. 77-223,752, FILED 7-6-2007.

LINDA LAVACHE, EXAMINING ATTORNEY

**Int. Cl.: 45**

**Prior U.S. Cls.: 100 and 101**

**United States Patent and Trademark Office**

**Reg. No. 3,394,524**

**Registered Mar. 11, 2008**

**SERVICE MARK  
PRINCIPAL REGISTER**



LAS VEGAS SANDS CORP. (NEVADA CORPORATION)  
3355 LAS VEGAS BOULEVARD SOUTH  
LAS VEGAS, NV 89109

FOR: WEDDING CHAPEL SERVICES, IN CLASS  
45 (U.S. CLS. 100 AND 101).

FIRST USE 3-29-2007; IN COMMERCE 3-29-2007.

OWNER OF U.S. REG. NOS. 2,411,034, 2,542,999  
AND OTHERS.

THE MARK CONSISTS OF A WINGED LION  
WITH A CREST CONTAINING THE LETTER "V".

SER. NO. 77-223,760, FILED 7-6-2007.

LINDA LAVACHE, EXAMINING ATTORNEY



**Int. Cl.: 25**

**Prior U.S. Cls.: 22 and 39**

**United States Patent and Trademark Office**

**Reg. No. 3,394,525**

**Registered Mar. 11, 2008**

**TRADEMARK  
PRINCIPAL REGISTER**



LAS VEGAS SANDS CORP. (NEVADA CORPORATION)  
3355 LAS VEGAS BOULEVARD SOUTH  
LAS VEGAS, NV 89109

FOR: T-SHIRTS; POLO SHIRTS; GOLF SHIRTS;  
TANK TOPS; PULLOVERS; SKIRTS; ROBES;  
SCARVES; BELTS; HATS; CAPS; SWEATSHIRTS;  
SWEATPANTS, IN CLASS 25 (U.S. CLS. 22 AND 39).

FIRST USE 3-29-2007; IN COMMERCE 3-29-2007.

OWNER OF U.S. REG. NOS. 2,411,034, 2,542,999  
AND OTHERS.

THE MARK CONSISTS OF A WINGED LION  
WITH A CREST CONTAINING THE LETTER "V".

SER. NO. 77-223,766, FILED 7-6-2007.

LINDA LAVACHE, EXAMINING ATTORNEY

**Int. Cl.: 35**

**Prior U.S. Cls.: 100, 101 and 102**

**United States Patent and Trademark Office**

**Reg. No. 3,394,526**

**Registered Mar. 11, 2008**

**SERVICE MARK  
PRINCIPAL REGISTER**



ADAMS, MICHAEL S. (UNITED STATES INDIVIDUAL), DBA THE GOLF STOP  
12066 WEST 135TH STREET  
OVERLAND PARK, KS 66221

FOR: RETAIL STORE SERVICES FEATURING GOLF CLUBS, GOLFING EQUIPMENT AND GOLF CLOTHING, IN CLASS 35 (U.S. CLS. 100, 101 AND 102).

FIRST USE 3-0-2001; IN COMMERCE 3-0-2001.

NO CLAIM IS MADE TO THE EXCLUSIVE RIGHT TO USE "GOLF", APART FROM THE MARK AS SHOWN.

THE MARK CONSISTS OF THE WORDS THE GOLF STOP STYLIZED WITH EACH T REPRESENTED AS A GOLF TEE AND EACH O APPEARING AS A GOLF BALL.

SER. NO. 77-223,767, FILED 7-6-2007.

NATALIE POLZER, EXAMINING ATTORNEY

**Int. Cl.: 16**

**Prior U.S. Cls.: 2, 5, 22, 23, 29, 37, 38 and 50**

**United States Patent and Trademark Office**

**Reg. No. 3,394,527**

**Registered Mar. 11, 2008**

**TRADEMARK  
PRINCIPAL REGISTER**



FLORIDA ASSOCIATION OF CHRISTIAN COL-  
LEGES AND SCHOOLS (FLORIDA CORPORA-  
TION)

2873 SW 183 AVE  
MIRAMAR, FL 33029

FOR: PRINTED PERIODICALS IN THE FIELD OF  
CHRISTIAN EDUCATION, IN CLASS 16 (U.S. CLS. 2,  
5, 22, 23, 29, 37, 38 AND 50).

FIRST USE 9-1-2002; IN COMMERCE 9-1-2002.

THE MARK CONSISTS OF THE WORD "LIFE"  
APPEARING IN CAPITAL LETTERS TO THE LEFT  
OF A STYLED VERSION OF THE AT-SYMBOL  
WHEREBY THE FIGURE OF A CHILD IS DEPICTED  
IN THE CENTER, WITH THE WORD  
"SCHOOL" IN LOWER-CASE LETTERS APPEAR-  
ING TO THE RIGHT OF THE AT-SYMBOL.

SER. NO. 77-223,840, FILED 7-6-2007.

MICHAEL KAZAZIAN, EXAMINING ATTORNEY

**Int. Cl.: 25**

**Prior U.S. Cls.: 22 and 39**

**United States Patent and Trademark Office**

**Reg. No. 3,394,528**

**Registered Mar. 11, 2008**

**TRADEMARK  
PRINCIPAL REGISTER**



BECKLES, WILLIAM (UNITED STATES INDIVIDUAL)  
P.O. BOX 4283  
ORANGE, CA 92863

FOR: ATHLETIC SHOES; BANDANAS; BEANIES; BLOUSES; CAPS; GOLF SHIRTS; HALTER TOPS; HATS; JACKETS; JEANS; LEGGINGS; PANTS; SANDALS; SHIRTS; SHOES; SHORTS; SOCKS; SWEATBANDS; SWIMWEAR; T-SHIRTS; TANK TOPS; TOPS; TROUSERS; VESTS; VISORS, IN CLASS 25 (U.S. CLS. 22 AND 39).

FIRST USE 6-1-2005; IN COMMERCE 6-1-2005.

THE MARK CONSISTS OF INTEGRATED QUESTION MARK AND THE LETTER "Y" WITH A BASKETBALL AT THE BOTTOM. THERE ARE CURVED LINES AROUND THE BALL TO SIMULATE THE BALL SPINNING.

SER. NO. 77-223,880, FILED 7-6-2007.

GEORGE LORENZO, EXAMINING ATTORNEY

**Int. Cl.: 37**

**Prior U.S. Cls.: 100, 103 and 106**

**United States Patent and Trademark Office**

**Reg. No. 3,394,529**

**Registered Mar. 11, 2008**

**SERVICE MARK  
PRINCIPAL REGISTER**

# Rex Rod & Chassis

REX RODS, INC. (CALIFORNIA CORPORATION)  
122 TALBOT AVENUE  
SANTA ROSA, CA 95404

FOR: RESTORATION IN THE FIELD OF AUTOMOBILES; REBUILDING OF AUTOMOBILE ENGINES; AUTOMOBILE BODY REPAIR AND FINISHING FOR OTHERS; AUTOMOBILE CUSTOMIZATION SERVICES; AUTOMOBILE REPAIR AND MAINTENANCE, IN CLASS 37 (U.S. CLS. 100, 103 AND 106).

FIRST USE 1-9-2001; IN COMMERCE 1-0-2002.

THE MARK CONSISTS OF STANDARD CHARACTERS WITHOUT CLAIM TO ANY PARTICULAR FONT, STYLE, SIZE, OR COLOR.

NO CLAIM IS MADE TO THE EXCLUSIVE RIGHT TO USE "ROD & CHASSIS", APART FROM THE MARK AS SHOWN.

SER. NO. 77-223,994, FILED 7-6-2007.

JAMES A. RAUEN, EXAMINING ATTORNEY

**Int. Cl.: 40**

**Prior U.S. Cls.: 100, 103 and 106**

**United States Patent and Trademark Office**

**Reg. No. 3,394,530**

**Registered Mar. 11, 2008**

**SERVICE MARK  
PRINCIPAL REGISTER**

# Rex Rod & Chassis

REX RODS, INC. (CALIFORNIA CORPORATION)  
122 TALBOT AVENUE  
SANTA ROSA, CA 95404

FOR: CUSTOM MANUFACTURE OF AUTOMOBILES AND AUTOMOBILE CHASSIS; MANUFACTURE OF AUTOMOBILE CHASSIS TO ORDER AND/OR SPECIFICATION OF OTHERS, IN CLASS 40 (U.S. CLS. 100, 103 AND 106).

FIRST USE 1-9-2001; IN COMMERCE 1-0-2002.

THE MARK CONSISTS OF STANDARD CHARACTERS WITHOUT CLAIM TO ANY PARTICULAR FONT, STYLE, SIZE, OR COLOR.

NO CLAIM IS MADE TO THE EXCLUSIVE RIGHT TO USE "ROD & CHASSIS", APART FROM THE MARK AS SHOWN.

SER. NO. 77-223,996, FILED 7-6-2007.

JAMES A. RAUEN, EXAMINING ATTORNEY

**Int. Cl.: 33**

**Prior U.S. Cls.: 47 and 49**

**United States Patent and Trademark Office**

**Reg. No. 3,394,531**

**Registered Mar. 11, 2008**

**TRADEMARK  
PRINCIPAL REGISTER**

**STONY TERRACE**

BLACK KITE CELLARS, LLC (CALIFORNIA  
LTD LIAB CO)  
2767 CLAY STREET  
SAN FRANCISCO, CA 94115

THE MARK CONSISTS OF STANDARD CHAR-  
ACTERS WITHOUT CLAIM TO ANY PARTICULAR  
FONT, STYLE, SIZE, OR COLOR.

FOR: WINES, IN CLASS 33 (U.S. CLS. 47 AND 49).

SER. NO. 77-224,018, FILED 7-6-2007.

FIRST USE 11-24-2006; IN COMMERCE 2-7-2007.

GEORGE LORENZO, EXAMINING ATTORNEY

**Int. Cl.: 33**

**Prior U.S. Cls.: 47 and 49**

**United States Patent and Trademark Office**

**Reg. No. 3,394,532**

**Registered Mar. 11, 2008**

**TRADEMARK  
PRINCIPAL REGISTER**

**REDWOODS' EDGE**

BLACK KITE CELLARS, LLC (CALIFORNIA  
LTD LIAB CO)  
2767 CLAY STREET  
SAN FRANCISCO, CA 94115

THE MARK CONSISTS OF STANDARD CHAR-  
ACTERS WITHOUT CLAIM TO ANY PARTICULAR  
FONT, STYLE, SIZE, OR COLOR.

FOR: WINES, IN CLASS 33 (U.S. CLS. 47 AND 49).

SER. NO. 77-224,021, FILED 7-6-2007.

FIRST USE 11-24-2006; IN COMMERCE 12-21-2006.

GEORGE LORENZO, EXAMINING ATTORNEY



**Int. Cl.: 37**

**Prior U.S. Cls.: 100, 103 and 106**

**United States Patent and Trademark Office**

**Reg. No. 3,394,533**

**Registered Mar. 11, 2008**

**SERVICE MARK  
PRINCIPAL REGISTER**



ELECTRONIC CONTROL SYSTEMS, INC. (CALIFORNIA CORPORATION)  
12575 KIRKHAM COURT, SUITE 1  
POWAY, CA 92064

FIRST USE 3-12-1997; IN COMMERCE 4-30-1997.

THE COLOR(S) BLUE AND YELLOW IS/ARE CLAIMED AS A FEATURE OF THE MARK.

FOR: INSTALLATION, MAINTENANCE, AND REPAIR OF BUILDING SYSTEMS, NAMELY, HEATING, VENTILATION, AIR CONDITIONING, AND TEMPERATURE CONTROL SYSTEMS, FIRE ALARM SYSTEMS, COMMUNICATION SYSTEMS, ACCESS CONTROL SYSTEMS, AND BUILDING MECHANICAL SYSTEMS NOT TO INCLUDE LIGHTING SYSTEMS, IN CLASS 37 (U.S. CLS. 100, 103 AND 106).

THE MARK CONSISTS OF LARGE, BLUE BLOCK ECS LETTERING SUPERIMPOSED ON A YELLOW OBTUSE TRIANGLE.

SER. NO. 77-224,072, FILED 7-7-2007.

DAVID MURRAY, EXAMINING ATTORNEY

**Int. Cl.: 35**

**Prior U.S. Cls.: 100, 101 and 102**

**United States Patent and Trademark Office**

**Reg. No. 3,394,534**

**Registered Mar. 11, 2008**

**SERVICE MARK  
PRINCIPAL REGISTER**

# Optimistic Realism

LINDSAY, CABE E (UNITED STATES INDIVIDUAL)  
18023 WINDTOP LN  
DALLAS, TX 75287

FOR: ADVERTISING SERVICES, NAMELY, PROMOTING AND MARKETING THE GOODS AND SERVICES OF OTHERS THROUGH ALL PUBLIC COMMUNICATION MEANS; CREATIVE MARKETING DESIGN SERVICES, IN CLASS 35 (U.S. CLS. 100, 101 AND 102).

FIRST USE 1-14-2007; IN COMMERCE 2-22-2007.

THE MARK CONSISTS OF STANDARD CHARACTERS WITHOUT CLAIM TO ANY PARTICULAR FONT, STYLE, SIZE, OR COLOR.

SER. NO. 77-224,141, FILED 7-7-2007.

MICHAEL WIENER, EXAMINING ATTORNEY

**Int. Cl.: 42**

**Prior U.S. Cls.: 100 and 101**

**United States Patent and Trademark Office**

**Reg. No. 3,394,535**

**Registered Mar. 11, 2008**

**SERVICE MARK  
PRINCIPAL REGISTER**

**myEternia  
Gateway to Eternity**

ETERNIA, INC. (NEW MEXICO CORPORATION)  
P.O. BOX 302  
TESUQUE, NM 875740302

FIRST USE 4-19-2007; IN COMMERCE 7-7-2007.

FOR: APPLICATION SERVICE PROVIDER (ASP) FEATURING SOFTWARE FOR USE TO ENABLE UPLOADING, POSTING, SHOWING, DISPLAYING, TAGGING, BLOGGING, SHARING OR OTHERWISE PROVIDING ELECTRONIC MEDIA OR INFORMATION OVER THE INTERNET OR OTHER COMMUNICATIONS NETWORK, IN CLASS 42 (U.S. CLS. 100 AND 101).

THE MARK CONSISTS OF STANDARD CHARACTERS WITHOUT CLAIM TO ANY PARTICULAR FONT, STYLE, SIZE, OR COLOR.

SER. NO. 77-224,152, FILED 7-7-2007.

JOHN WILKE, EXAMINING ATTORNEY

**Int. Cl.: 9**

**Prior U.S. Cls.: 21, 23, 26, 36 and 38**

**United States Patent and Trademark Office**

**Reg. No. 3,394,536**

**Registered Mar. 11, 2008**

**TRADEMARK  
PRINCIPAL REGISTER**



CASTLE, JUDIANNA (UNITED STATES INDIVIDUAL)  
2700 N. CAHUENGA BLVD. E. #2204  
LOS ANGELES, CA 90068

FOR: PRE-RECORDED COMPACT DISCS, DVDS, AUDIOCASSETTES, AND VIDEOCASSETTES FEATURING CHILDREN'S SONGS AND MUSIC AND OTHER GENRES OF SONGS AND MUSIC; COMPACT DISC CASES INCORPORATING AN ELECTRONIC CHIP TO SING OR TALK, IN CLASS 9 (U.S. CLS. 21, 23, 26, 36 AND 38).

FIRST USE 2-14-1994; IN COMMERCE 2-14-1995.

THE COLOR(S) RED, PURPLE, GREEN, ORANGE, BLACK, AND WHITE IS/ARE CLAIMED AS A FEATURE OF THE MARK.

THE MARK CONSISTS OF THE WORD "CUPPY-CAKE" TILTED AT AN ANGLE TO RESEMBLE A RAINBOW; THERE ARE RED LETTERS "C", "Y" AND "E"; THERE ARE PURPLE LETTERS "U" AND "C"; THERE ARE GREEN LETTERS "P" AND "A"; AND THERE ARE ORANGE LETTERS "P" AND "K"; ALL LETTERS ARE OUTLINED IN BLACK AND THERE IS A WHITE SHADOW EFFECT ON ALL THE LETTERS.

SER. NO. 77-224,256, FILED 7-8-2007.

REBECCA EISINGER, EXAMINING ATTORNEY

**Int. Cl.: 41**

**Prior U.S. Cls.: 100, 101 and 107**

**United States Patent and Trademark Office**

**Reg. No. 3,394,537**

**Registered Mar. 11, 2008**

**SERVICE MARK  
PRINCIPAL REGISTER**

**INSIDER CHATTER**

PROMO INK (NEW YORK SOLE PROPRIETOR-  
SHIP)  
PO BOX 4157  
NEW YORK, NY 10163

THE MARK CONSISTS OF STANDARD CHAR-  
ACTERS WITHOUT CLAIM TO ANY PARTICULAR  
FONT, STYLE, SIZE, OR COLOR.

FOR: ON-LINE PUBLICATION OF NEWS AND  
ANALYSIS IN THE FIELD OF TECHNOLOGY, IN  
CLASS 41 (U.S. CLS. 100, 101 AND 107).

SER. NO. 77-224,264, FILED 7-8-2007.

FIRST USE 4-18-2007; IN COMMERCE 4-18-2007.

MICHAEL ENGEL, EXAMINING ATTORNEY

**Int. Cl.: 41**

**Prior U.S. Cls.: 100, 101 and 107**

**United States Patent and Trademark Office**

**Reg. No. 3,394,538**

**Registered Mar. 11, 2008**

**SERVICE MARK  
PRINCIPAL REGISTER**

**MODERN-DAY MEDITATION**

MIRACLE OF LOVE (CALIFORNIA CORPORATION)  
PO BOX 421080  
SAN DIEGO, CA 921421080

FOR: EDUCATIONAL SERVICES, NAMELY, PROVIDING SEMINARS, CLASSES AND INDIVIDUAL COURSES OF INSTRUCTION IN THE FIELDS OF SPIRITUAL GUIDANCE, SPIRITUAL TRAINING AND MEDITATION AND DISTRIBUTING COURSE MATERIAL IN CONNECTION THEREWITH, IN CLASS 41 (U.S. CLS. 100, 101 AND 107).

FIRST USE 1-2-2007; IN COMMERCE 1-2-2007.

THE MARK CONSISTS OF STANDARD CHARACTERS WITHOUT CLAIM TO ANY PARTICULAR FONT, STYLE, SIZE, OR COLOR.

NO CLAIM IS MADE TO THE EXCLUSIVE RIGHT TO USE "MEDITATION", APART FROM THE MARK AS SHOWN.

SER. NO. 77-224,288, FILED 7-8-2007.

KAPIL BHANOT, EXAMINING ATTORNEY

Int. Cl.: 7

Prior U.S. Cls.: 13, 19, 21, 23, 31, 34 and 35

United States Patent and Trademark Office

Reg. No. 3,394,539

Registered Mar. 11, 2008

TRADEMARK  
PRINCIPAL REGISTER



CREATIVE STEEL INC. (OREGON CORPORATION)  
488 HAWTHORNE AVE NE  
SALEM, OR 97301

FOR: CONSTRUCTION EQUIPMENT ATTACHMENT USED TO LIFT CONCRETE MANHOLE SECTIONS, IN CLASS 7 (U.S. CLS. 13, 19, 21, 23, 31, 34 AND 35).

FIRST USE 11-0-2006; IN COMMERCE 12-0-2006.

NO CLAIM IS MADE TO THE EXCLUSIVE RIGHT TO USE "SECTION LIFTER", APART FROM THE MARK AS SHOWN.

THE MARK CONSISTS OF THE WORDS "THE BEAR TRAP" WITH A CRANE-LIKE ARM THAT COMES OFF THE TOP OF THE LETTER "T" AND IS LIFTING THE LETTER "A" OFF THE GROUND WITH OUR CONCRETE ATTACHMENT. UNDER THE NAME ARE THE WORDS "SECTION LIFTER".

SER. NO. 77-224,574, FILED 7-9-2007.

JORDAN BAKER, EXAMINING ATTORNEY

**Int. Cl.: 16**

**Prior U.S. Cls.: 2, 5, 22, 23, 29, 37, 38 and 50**

**United States Patent and Trademark Office**

**Reg. No. 3,394,540**

**Registered Mar. 11, 2008**

**TRADEMARK  
PRINCIPAL REGISTER**



CUATRO COMMUNICATIONS, INC. (TEXAS CORPORATION)  
6120 TARNEF SUITE 110  
HOUSTON, TX 77074

FOR: SYNDICATED NEWSPAPER COLUMNS, BOOKLETS AND NEWSLETTERS IN SPANISH LANGUAGE DEALING WITH TELEVISION PROGRAMMING AND ENTERTAINMENT AIMED AT THE HISPANIC COMMUNITY, IN CLASS 16 (U.S. CLS. 2, 5, 22, 23, 29, 37, 38 AND 50).

FIRST USE 2-1-2007; IN COMMERCE 2-1-2007.

THE MARK CONSISTS OF AN UPPER CASE "TV" LOWER CASE "EO" WITH PAIR OF EYES AT TOP RIGHT SIDE OF THE "T". THE SHADED RECTANGLE APPEARING BEHIND THE MARK IS NOT CLAIMED AS A FEATURE OF THE MARK, BUT RATHER IS MERELY INTENDED TO DELINEATE THE ELEMENTS IN THE MARK.

THE FOREIGN WORDING IN THE MARK TRANSLATES INTO ENGLISH AS I SEE YOU.

SER. NO. 77-224,579, FILED 7-9-2007.

MARTHA FROMM, EXAMINING ATTORNEY



**Int. Cl.: 25**

**Prior U.S. Cls.: 22 and 39**

**United States Patent and Trademark Office**

**Reg. No. 3,394,541**

**Registered Mar. 11, 2008**

**TRADEMARK  
PRINCIPAL REGISTER**

**PAOLO CELLINI**

GIORGIO ROSSI, INC. (CALIFORNIA CORPORATION)  
830 SOUTH LOS ANGELES STREET  
LOS ANGELES, CA 90014

FOR: SHOES; TIES; PANTS; DRESS SHIRTS; SHIRTS; SPORTS SHIRTS; JACKETS; COATS; SPORT COATS; SUIT COATS; SOCKS; SUSPENDERS; FOOTWEAR FOR MEN; MEN'S SUITS; SLACKS; TROUSERS , IN CLASS 25 (U.S. CLS. 22 AND 39).

FIRST USE 1-1-1985; IN COMMERCE 1-1-1985.

THE MARK CONSISTS OF STANDARD CHARACTERS WITHOUT CLAIM TO ANY PARTICULAR FONT, STYLE, SIZE, OR COLOR.

THE NAME PAOLO CELLINI DOES NOT IDENTIFY A LIVING INDIVIDUAL.

SER. NO. 77-224,591, FILED 7-9-2007.

AMY GEARIN, EXAMINING ATTORNEY

**Int. Cl.: 41**

**Prior U.S. Cls.: 100, 101 and 107**

**United States Patent and Trademark Office**

**Reg. No. 3,394,542**

**Registered Mar. 11, 2008**

**SERVICE MARK  
PRINCIPAL REGISTER**



WORLDWIDE INTERACTIVE NETWORKS, INC  
(TENNESSEE CORPORATION)  
1000 WATERFORD PL  
KINGSTON, TN 37763

FOR: PADDLE SPORTS SAFETY TRAINING  
PROVIDED VIA THE INTERNET, IN CLASS 41  
(U.S. CLS. 100, 101 AND 107).

FIRST USE 3-1-2007; IN COMMERCE 3-15-2007.

NO CLAIM IS MADE TO THE EXCLUSIVE  
RIGHT TO USE "ONLINE", APART FROM THE  
MARK AS SHOWN.

THE MARK CONSISTS OF A PADDLE SPORT  
BOAT WITH PADDLER WITH THE WORDS IPAD-  
DLE ONLINE IN A STYLIZED TEXT.

SER. NO. 77-224,671, FILED 7-9-2007.

JESSICA A. POWERS, EXAMINING ATTORNEY

**Int. Cl.: 36**

**Prior U.S. Cls.: 100, 101 and 102**

**United States Patent and Trademark Office**

**Reg. No. 3,394,543**

**Registered Mar. 11, 2008**

**SERVICE MARK  
PRINCIPAL REGISTER**

**GIVING ACCOUNT**

THE TRUSTEES OF FIDELITY INVESTMENTS  
CHARITABLE GIFT FUND (MASSACHU-  
SETTS TRUST)

200 SEAPORT BOULEVARD, ZE7  
BOSTON, MA 02210

FOR: DONOR-ADVISED INVESTMENT OF  
FUNDS FOR CHARITABLE PURPOSES; CHARITA-  
BLE FUND RAISING SERVICES; FINANCIAL MAN-  
AGEMENT SERVICES; PROVIDING FINANCIAL  
INFORMATION BY ELECTRONIC MEANS, IN  
CLASS 36 (U.S. CLS. 100, 101 AND 102).

FIRST USE 7-28-2000; IN COMMERCE 7-28-2000.

THE MARK CONSISTS OF STANDARD CHAR-  
ACTERS WITHOUT CLAIM TO ANY PARTICULAR  
FONT, STYLE, SIZE, OR COLOR.

OWNER OF U.S. REG. NO. 2,626,849.

NO CLAIM IS MADE TO THE EXCLUSIVE  
RIGHT TO USE "ACCOUNT", APART FROM THE  
MARK AS SHOWN.

SEC. 2(F).

SER. NO. 77-224,703, FILED 7-9-2007.

KAPIL BHANOT, EXAMINING ATTORNEY

**Int. Cl.: 9**

**Prior U.S. Cls.: 21, 23, 26, 36 and 38**

**United States Patent and Trademark Office**

**Reg. No. 3,394,544**

**Registered Mar. 11, 2008**

**TRADEMARK  
PRINCIPAL REGISTER**

# ThermoIntelligence

BFG TECHNOLOGIES, INC. (ILLINOIS CORPORATION)  
28690 BALLARD DRIVE  
LAKE FOREST, IL 60045

FOR: COMPUTER HARDWARE AND PERIPHERALS, NAMELY, COOLING SYSTEMS COMPRISED OF INTERNAL COOLING FANS FOR COMPUTERS AND CENTRAL PROCESSING UNIT (CPU) COOLERS FOR USE IN CONNECTION WITH VIDEO CIRCUIT BOARD CARDS, PRINTER CIRCUIT BOARD CARDS, BLANK INTEGRATED AND ELECTRONIC CIRCUIT CARDS, INTEGRATED CIRCUIT CARDS AND ENCODED SMART CARDS CONTAINING PROGRAMMING USED WITH TEXT, AUDIO, VIDEO, VOICE AND IMAGE DATA, GRAPHICS CARDS, ELECTRONIC CHIP CARDS, SOUND CARDS, VIDEO CAPTURE AND DISPLAY CARDS, PRINTED CIRCUIT BOARDS, ADD-IN

CARDS FOR SOUND AND VIDEO CAPTURE AND DISPLAY INTERFACE FUNCTIONS ON PRINTED CIRCUIT BOARDS, GRAPHIC CIRCUIT BOARDS, OPTICAL DISC DRIVES, GAME TOUCH PADS, GAME SOFTWARE STORED ON CHIPCARDS, VIDEO CIRCUIT BOARDS, MEMORY BOARDS AND INTERFACE BOARDS FOR MASS STORAGE, IN CLASS 9 (U.S. CLS. 21, 23, 26, 36 AND 38).

FIRST USE 6-29-2007; IN COMMERCE 6-29-2007.

THE MARK CONSISTS OF STANDARD CHARACTERS WITHOUT CLAIM TO ANY PARTICULAR FONT, STYLE, SIZE, OR COLOR.

SER. NO. 77-224,772, FILED 7-9-2007.

DAVID YONTEF, EXAMINING ATTORNEY

**Int. Cl.: 41**

**Prior U.S. Cls.: 100, 101 and 107**

**United States Patent and Trademark Office**

**Reg. No. 3,394,545**

**Registered Mar. 11, 2008**

**SERVICE MARK  
PRINCIPAL REGISTER**



**Master Your Message**

ROESKE, KATHRYN ANN (ARIZONA INDIVIDUAL)  
5709 E. JOSHUA TREE LANE  
PARADISE VALLEY, AZ 85253

FOR: TRAINING SERVICES IN THE FIELD OF MEDIA INTERVIEWS AND PRESENTATION SKILLS, IN CLASS 41 (U.S. CLS. 100, 101 AND 107).

FIRST USE 5-1-2007; IN COMMERCE 5-1-2007.

THE COLOR(S) GREEN, BLUE, AND WHITE IS/ARE CLAIMED AS A FEATURE OF THE MARK.

THE MARK CONSISTS OF TWO CAPITAL LETTER "M" S IN BLUE, WITH A LIME GREEN CONVERSATION BUBBLE COMING OUT FROM BETWEEN THE "M" S. THE BUBBLE CUTS OFF A PORTION OF THE "M" S, FORMING THE LETTER "Y". THE TERM "MASTER YOUR MESSAGE" APPEARS IN GREEN. THE BACKGROUND IS WHITE.

SER. NO. 77-224,782, FILED 7-9-2007.

JIM RINGLE, EXAMINING ATTORNEY

**Int. Cls.: 36 and 41**

**Prior U.S. Cls.: 100, 101, 102 and 107**

**United States Patent and Trademark Office**

**Reg. No. 3,394,546**

**Registered Mar. 11, 2008**

**SERVICE MARK  
PRINCIPAL REGISTER**

**ADVENTURE KIDZ**

ADVENTURES FOR WISH KIDS, INC. (OHIO  
NON-PROFIT CORPORATION)  
6863 OAK CREEK DRIVE  
COLUMBUS, OH 43229

FOR: FUNDRAISING FOR CHILDREN WITH  
LIFE THREATENING ILLNESSES AND THEIR FA-  
MILIES, NOT INCLUDING FOR GENERAL CHILD  
CARE SERVICES , IN CLASS 36 (U.S. CLS. 100, 101  
AND 102).

FIRST USE 4-12-2007; IN COMMERCE 4-12-2007.

FOR: SPECIAL EVENTS PLANNING TO PRO-  
VIDE YEAR ROUND GROUP ACTIVITIES FOR  
CHILDREN WITH LIFE THREATENING ILLNES-  
SES AND THEIR FAMILIES, NOT INCLUDING FOR

GENERAL CHILD CARE SERVICES, IN CLASS 41  
(U.S. CLS. 100, 101 AND 107).

FIRST USE 4-12-2007; IN COMMERCE 4-12-2007.

THE MARK CONSISTS OF STANDARD CHAR-  
ACTERS WITHOUT CLAIM TO ANY PARTICULAR  
FONT, STYLE, SIZE, OR COLOR.

NO CLAIM IS MADE TO THE EXCLUSIVE  
RIGHT TO USE "KIDS", APART FROM THE MARK  
AS SHOWN.

SER. NO. 77-224,804, FILED 7-9-2007.

ELISSA GARBER KON, EXAMINING ATTORNEY

**Int. Cl.: 35**

**Prior U.S. Cls.: 100, 101 and 102**

**United States Patent and Trademark Office**

**Reg. No. 3,394,547**

**Registered Mar. 11, 2008**

**SERVICE MARK  
PRINCIPAL REGISTER**

# Capital Distributing

CAPITAL DISTRIBUTING INC (TEXAS CORPORATION)  
2910 N STEMMONS FRWY  
DALLAS, TX 75247

FOR: RETAIL STORES FEATURING HOUSEHOLD APPLIANCES, NAMELY, REFRIGERATORS, WASHERS AND DRYERS, RANGES, ICE MACHINES, TRASH COMPACTORS, OVENS INCLUDING MICROWAVE, CONVECTION, ROTISSERIE, STEAM, GAS, ELECTRIC, DUAL FUEL, AND ISLAND OVENS, COOK TOPS, HOODS AND VENTS, FREEZERS, DISHWASHERS, WATER FILTRATION SYSTEMS, DISPOSALS, SINKS, FAUCETS, OUTDOOR GRILLS, WARMING DRAWERS, REFRIGERATED WINE STORAGE, KITCHEN

BACKSPLASHES, APPLIANCE TRIM, COFFEE MAKERS, IN CLASS 35 (U.S. CLS. 100, 101 AND 102).

FIRST USE 0-0-1973; IN COMMERCE 0-0-1973.

THE MARK CONSISTS OF STANDARD CHARACTERS WITHOUT CLAIM TO ANY PARTICULAR FONT, STYLE, SIZE, OR COLOR.

NO CLAIM IS MADE TO THE EXCLUSIVE RIGHT TO USE "DISTRIBUTING", APART FROM THE MARK AS SHOWN.

SER. NO. 77-225,016, FILED 7-9-2007.

TANYA AMOS, EXAMINING ATTORNEY

**Int. Cl.: 36**

**Prior U.S. Cls.: 100, 101 and 102**

**United States Patent and Trademark Office**

**Reg. No. 3,394,548**

**Registered Mar. 11, 2008**

**SERVICE MARK  
PRINCIPAL REGISTER**

**WTB**

WASHINGTON TRUST BANK (WASHINGTON CORPORATION)  
717 WEST SPRAGUE AVENUE  
SPOKANE, WA 99201

FOR: BANKING SERVICES, MORTGAGE LENDING, MORTGAGE BANKING, MORTGAGE BROKERING, AND FINANCIAL SERVICES IN THE NATURE OF TRUST SERVICES, CREDIT CARD SERVICES, FINANCIAL PLANNING, ESTATE PLANNING AND SETTLEMENT, FINANCIAL ASSET MANAGEMENT SERVICES AND INVESTMENT SERVICES IN THE NATURE OF

SECURITIES AND MUTUAL FUNDS, IN CLASS 36 (U.S. CLS. 100, 101 AND 102).

FIRST USE 5-31-2002; IN COMMERCE 5-31-2002.

THE MARK CONSISTS OF STANDARD CHARACTERS WITHOUT CLAIM TO ANY PARTICULAR FONT, STYLE, SIZE, OR COLOR.

SER. NO. 77-225,090, FILED 7-9-2007.

NATALIE POLZER, EXAMINING ATTORNEY



**Int. Cl.: 36**

**Prior U.S. Cls.: 100, 101 and 102**

**United States Patent and Trademark Office**

**Reg. No. 3,394,549**

**Registered Mar. 11, 2008**

**SERVICE MARK  
PRINCIPAL REGISTER**

**UNCOMMON ACCESS**

WASHINGTON TRUST BANK (WASHINGTON CORPORATION)  
717 WEST SPRAGUE AVENUE  
SPOKANE, WA 99201

FOR: BANKING SERVICES, MORTGAGE LENDING, MORTGAGE BANKING, MORTGAGE BROKERING, AND FINANCIAL SERVICES IN THE NATURE OF TRUST SERVICES, CREDIT CARD SERVICES, FINANCIAL PLANNING, ESTATE PLANNING AND SETTLEMENT, FINANCIAL ASSET MANAGEMENT SERVICES AND INVESTMENT SERVICES IN THE NATURE OF

SECURITIES AND MUTUAL FUNDS, IN CLASS 36 (U.S. CLS. 100, 101 AND 102).

FIRST USE 4-10-2007; IN COMMERCE 4-10-2007.

THE MARK CONSISTS OF STANDARD CHARACTERS WITHOUT CLAIM TO ANY PARTICULAR FONT, STYLE, SIZE, OR COLOR.

SER. NO. 77-225,149, FILED 7-9-2007.

NATALIE POLZER, EXAMINING ATTORNEY

Int. Cl.: 16

Prior U.S. Cls.: 2, 5, 22, 23, 29, 37, 38 and 50

United States Patent and Trademark Office

Reg. No. 3,394,550

Registered Mar. 11, 2008

TRADEMARK  
PRINCIPAL REGISTER



BERNSTEIN, GABRIELLE (UNITED STATES INDIVIDUAL)  
213 WEST 13TH STREET, APT. D  
NEW YORK, NY 10011

FOR: A SERIES OF BOOKS, WRITTEN ARTICLES, HANDOUTS AND WORKSHEETS IN THE FIELD OF LIFESTYLE COACHING AS RELATED TO CAREER, ENVIRONMENT, SOCIAL BALANCE AND SELF ADVANCEMENT IN GENERAL; BOOK COVERS; BOOKS IN THE FIELD OF LIFESTYLE COACHING AS RELATED TO CAREER, ENVIRONMENT, SOCIAL BALANCE AND SELF ADVANCEMENT IN GENERAL; SERIES OF FICTION BOOKS; SERIES OF NON-FICTION BOOKS IN THE FIELD OF LIFESTYLE COACHING AS RELATED TO CAREER, ENVIRONMENT, SOCIAL BALANCE AND SELF ADVANCEMENT IN GENERAL, IN CLASS 16 (U.S. CLS. 2, 5, 22, 23, 29, 37, 38 AND 50).

FIRST USE 11-1-2006; IN COMMERCE 11-1-2006.

THE COLOR(S) RED AND WHITE IS/ARE CLAIMED AS A FEATURE OF THE MARK.

THE MARK CONSISTS OF RED BACKGROUND WITH WHITE STYLIZED LETTERS READING "FALLING IN LOVE" OVER THE WORDS "WITH YOUR FUTURE" WHICH BEGINS UNDERNEATH THE WORD "IN" FROM "FALLING IN LOVE".

SER. NO. 77-225,199, FILED 7-9-2007.

MARK T. MULLEN, EXAMINING ATTORNEY

**Int. Cls.: 9 and 41**

**Prior U.S. Cls.: 21, 23, 26, 36, 38, 100, 101 and 107**

**United States Patent and Trademark Office**

**Reg. No. 3,394,551**

**Registered Mar. 11, 2008**

**TRADEMARK  
SERVICE MARK  
PRINCIPAL REGISTER**

**KWONHO The Fist of Heroes**

VERTIGO GAMES, INC. (REPUBLIC OF KOREA CORPORATION)  
8TH FLOOR, SONGCHON BLDG.  
642-9 YEOKSAM-DONG, KANGNAM-GU  
SEOUL, REPUBLIC OF KOREA 135-910

FOR: COMPUTER GAME SOFTWARE AND COMPUTER GAME PROGRAMS THAT MAY BE DOWNLOADED FROM A GLOBAL COMPUTER NETWORK, IN CLASS 9 (U.S. CLS. 21, 23, 26, 36 AND 38).

FIRST USE 4-25-2005; IN COMMERCE 11-30-2006.

FOR: ENTERTAINMENT SERVICES, NAMELY, PROVIDING ON-LINE COMPUTER GAMES; PROVIDING A WEBSITE THROUGH WHICH ONLINE COMPUTER GAME PLAYERS CAN LOCATE

OTHER ONLINE COMPUTER GAME PLAYERS AND PLAY ONLINE GAMES OVER COMMUNICATIONS NETWORKS; PROVIDING A WEBSITE FEATURING COMPUTER GAMES; PROVIDING INFORMATION RELATING TO COMPUTER GAMES, IN CLASS 41 (U.S. CLS. 100, 101 AND 107).

FIRST USE 4-25-2005; IN COMMERCE 11-30-2006.

THE MARK CONSISTS OF STANDARD CHARACTERS WITHOUT CLAIM TO ANY PARTICULAR FONT, STYLE, SIZE, OR COLOR.

SER. NO. 77-225,200, FILED 7-9-2007.

MARK T. MULLEN, EXAMINING ATTORNEY

**Int. Cl.: 35**

**Prior U.S. Cls.: 100, 101 and 102**

**United States Patent and Trademark Office**

**Reg. No. 3,394,552**

**Registered Mar. 11, 2008**

**SERVICE MARK  
PRINCIPAL REGISTER**

**ELFA EVERYWHERE**

ELFA INTERNATIONAL AB (SWEDEN LTD  
LIAB JT ST CO)  
ELFAGATAN 5  
59387 VASTERVIK, SWEDEN

FOR: RETAIL STORE SERVICES IN THE FIELD  
OF HOUSEHOLD ACCESSORIES, STORAGE ITEMS,  
STORAGE SYSTEMS, SPACE ORGANIZERS, AND  
ORGANIZATION AND SPACE PLANNING SERVI-  
CES, IN CLASS 35 (U.S. CLS. 100, 101 AND 102).

FIRST USE 12-24-2006; IN COMMERCE 12-24-2006.

THE MARK CONSISTS OF STANDARD CHAR-  
ACTERS WITHOUT CLAIM TO ANY PARTICULAR  
FONT, STYLE, SIZE, OR COLOR.

OWNER OF U.S. REG. NOS. 1,131,621 AND  
2,814,662.

SER. NO. 77-225,230, FILED 7-9-2007.

GEORGE LORENZO, EXAMINING ATTORNEY

**Int. Cl.: 21**

**Prior U.S. Cls.: 2, 13, 23, 29, 30, 33, 40 and 50**

**United States Patent and Trademark Office**

**Reg. No. 3,394,553**

**Registered Mar. 11, 2008**

**TRADEMARK  
PRINCIPAL REGISTER**

**The Cupcake Courier**

GUNN DESIGNS, INC. (CALIFORNIA CORPORATION)  
731 E. MENDOCINO STREET  
ALTADENA, CA 91001

FOR: BAKEWARE; COOKWARE, NAMELY, CUPCAKE PANS, MUFFIN PANS AND COOKIE SHEETS; PLASTIC STORAGE CONTAINERS FOR DOMESTIC USE; PLASTIC AND GLASS STORAGE CONTAINERS FOR STORAGE OF FOOD ITEMS FOR DOMESTIC USE; MOLDS, PANS, METAL AND PLASTIC TRAYS, AND DOMESTIC USE PLASTIC, GLASS AND METAL STORAGE CONTAINERS FOR BAKE GOODS, NAMELY, CUPCAKES, COOKIES, CAKES AND MUFFINS, IN CLASS 21 (U.S. CLS. 2, 13, 23, 29, 30, 33, 40 AND 50).

FIRST USE 2-1-2005; IN COMMERCE 7-31-2006.

THE MARK CONSISTS OF STANDARD CHARACTERS WITHOUT CLAIM TO ANY PARTICULAR FONT, STYLE, SIZE, OR COLOR.

NO CLAIM IS MADE TO THE EXCLUSIVE RIGHT TO USE "CUPCAKE" , APART FROM THE MARK AS SHOWN.

SER. NO. 77-225,254, FILED 7-9-2007.

SIMON TENG, EXAMINING ATTORNEY

**Int. Cl.: 35**

**Prior U.S. Cls.: 100, 101 and 102**

**United States Patent and Trademark Office**

**Reg. No. 3,394,554**

**Registered Mar. 11, 2008**

**SERVICE MARK  
PRINCIPAL REGISTER**

**WHAT WOULD YOU LIKE TO  
BUY TODAY**

DEMICOM, INC. (CALIFORNIA CORPORATION)  
SUITE 102  
31328 VIA COLINAS  
WESTLAKE VILLAGE, CA 91362

FOR: DISTRIBUTORSHIP SERVICES IN THE  
FIELD OF ELECTRONIC COMPONENTS AND  
COMPUTER PRODUCTS; WHOLESALE DISTRIBUTORSHIPS FEATURING ELECTRONIC COMPONENTS AND COMPUTER PRODUCTS FROM ORIGINAL EQUIPMENT MANUFACTURERS AND MANUFACTURERS IN THE COMMERCIAL,

MEDICAL, INDUSTRIAL AND MILITARY MARKETS, IN CLASS 35 (U.S. CLS. 100, 101 AND 102).

FIRST USE 3-22-2006; IN COMMERCE 3-22-2006.

THE MARK CONSISTS OF STANDARD CHARACTERS WITHOUT CLAIM TO ANY PARTICULAR FONT, STYLE, SIZE, OR COLOR.

SER. NO. 77-225,283, FILED 7-9-2007.

JAY BESCH, EXAMINING ATTORNEY

Int. Cl.: 35

Prior U.S. Cls.: 100, 101 and 102

United States Patent and Trademark Office

Reg. No. 3,394,555

Registered Mar. 11, 2008

SERVICE MARK  
PRINCIPAL REGISTER

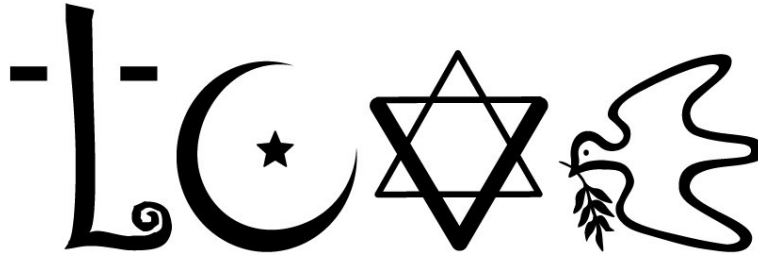

ELMIRA, INC. (CALIFORNIA CORPORATION)  
272 STANFORD AVENUE  
MENLO PARK, CA 94025

FOR: ONLINE RETAIL STORE SERVICES FEATURING CLOTHING, TOTE BAGS, STICKERS, GREETING CARDS, POSTERS, CLOCKS, MUGS, CALENDARS, BUTTONS, MAGNETS, IN CLASS 35 (U.S. CLS. 100, 101 AND 102).

FIRST USE 4-8-2005; IN COMMERCE 5-7-2005.

OWNER OF U.S. REG. NOS. 3,106,706 AND 3,127,610.

THE MARK CONSISTS OF STYLIZED LETTERS L, O, V, AND E TO SPELL THE WORD LOVE USING RELIGIOUS SYMBOLS OF CHRISTIANITY FOR THE L, ISLAM FOR THE O, AND JUDAISM FOR THE V COMBINED WITH THE PEACE LOVE FOR THE E.

SER. NO. 77-225,298, FILED 7-9-2007.

KATHLEEN M. VANSTON, EXAMINING ATTORNEY

Int. Cl.: 35

Prior U.S. Cls.: 100, 101 and 102

United States Patent and Trademark Office

Reg. No. 3,394,556

Registered Mar. 11, 2008

SERVICE MARK  
PRINCIPAL REGISTER

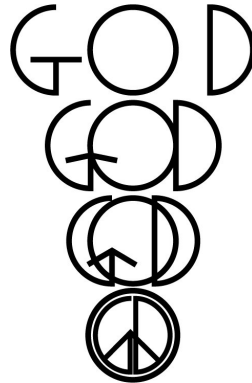

ELMIRA, INC. (CALIFORNIA CORPORATION)  
272 STANFORD AVENUE  
MENLO PARK, CA 94025

FOR: ONLINE RETAIL STORE SERVICES FEATURING CLOTHING, TOTE BAGS, STICKERS, POSTERS, GREETING CARDS, CLOCKS, MUGS, CALENDARS, BUTTONS, MAGNETS, IN CLASS 35 (U.S. CLS. 100, 101 AND 102).

FIRST USE 1-4-2006; IN COMMERCE 1-7-2006.

THE MARK CONSISTS OF THE WORD GOD TRANSFORMS INTO THE PEACE SYMBOL BY THE LETTERS G AND D MERGING INTO THE LETTER O.

SER. NO. 77-225,362, FILED 7-9-2007.

KATHLEEN M. VANSTON, EXAMINING ATTORNEY



**Int. Cl.: 39**

**Prior U.S. Cls.: 100 and 105**

**United States Patent and Trademark Office**

**Reg. No. 3,394,557**

**Registered Mar. 11, 2008**

**SERVICE MARK  
PRINCIPAL REGISTER**

**POSTAL+**

REYNOLDS, HARRY M. (UNITED STATES IN-  
DIVIDUAL)  
106 SOUTH ROBINSON STREET  
TEHACHAPI, CA 93561

FOR: POSTAL SERVICES, NAMELY, PARCEL  
DELIVERY, PACKAGING ARTICLES FOR TRANS-  
PORTATION, RENTAL OF MAIL BOXES; POSTAL  
SERVICES, NAMELY, PRESORTING, STUFFING,  
SEALING, POSTAGE METERING, BUNDLING,  
AND DELIVERING MAIL TO POST OFFICE, IN  
CLASS 39 (U.S. CLS. 100 AND 105).

FIRST USE 1-1-2007; IN COMMERCE 1-1-2007.

NO CLAIM IS MADE TO THE EXCLUSIVE  
RIGHT TO USE "POSTAL", APART FROM THE  
MARK AS SHOWN.

THE MARK CONSISTS OF POSTAL AND A +  
SIGN.

SER. NO. 77-225,378, FILED 7-9-2007.

MARIAM MAHMOUDI, EXAMINING ATTORNEY

**Int. Cl.: 36**

**Prior U.S. Cls.: 100, 101 and 102**

**United States Patent and Trademark Office**

**Reg. No. 3,394,558**

**Registered Mar. 11, 2008**

---

**SERVICE MARK  
PRINCIPAL REGISTER**

**COLLEGE POINTE**

COLLEGE POINTE LLC (SOUTH CAROLINA  
LTD LIAB CO)  
SUITE 115  
7901 STRICKLAND ROAD  
RALEIGH, NC 27615

THE MARK CONSISTS OF STANDARD CHAR-  
ACTERS WITHOUT CLAIM TO ANY PARTICULAR  
FONT, STYLE, SIZE, OR COLOR.

FOR: APARTMENT HOUSE MANAGEMENT;  
LEASING OF APARTMENTS; RENTAL OF APART-  
MENTS, IN CLASS 36 (U.S. CLS. 100, 101 AND 102).

SER. NO. 77-225,387, FILED 7-10-2007.

FIRST USE 12-31-2004; IN COMMERCE 12-31-2004.

LESLIE RICHARDS, EXAMINING ATTORNEY

**Int. Cl.: 41**

**Prior U.S. Cls.: 100, 101 and 107**

**United States Patent and Trademark Office**

**Reg. No. 3,394,559**

**Registered Mar. 11, 2008**

**SERVICE MARK  
PRINCIPAL REGISTER**

**Rawk Kandy**

GIBSON, JOSHUA NEIL (UNITED STATES INDIVIDUAL)  
169 CASCADE DRIVE  
FAIRFAX, CA 94930

THE MARK CONSISTS OF STANDARD CHARACTERS WITHOUT CLAIM TO ANY PARTICULAR FONT, STYLE, SIZE, OR COLOR.

FOR: ENTERTAINMENT, NAMELY, LIVE MUSIC CONCERTS, IN CLASS 41 (U.S. CLS. 100, 101 AND 107).

SER. NO. 77-225,472, FILED 7-10-2007.

FIRST USE 5-15-2007; IN COMMERCE 5-15-2007.

FRED MANDIR, EXAMINING ATTORNEY

**Int. Cl.: 43**

**Prior U.S. Cls.: 100 and 101**

**United States Patent and Trademark Office**

**Reg. No. 3,394,560**

**Registered Mar. 11, 2008**

**SERVICE MARK  
PRINCIPAL REGISTER**

# Smokey's Kitchen

SMOKEY'S VENTURES LLC (CALIFORNIA LTD  
LIAB CO)  
12036 DONNER PASS ROAD  
TRUCKEE, CA 96161

FOR: RESTAURANT SERVICES, IN CLASS 43  
(U.S. CLS. 100 AND 101).

FIRST USE 4-1-2006; IN COMMERCE 4-1-2006.

THE MARK CONSISTS OF STANDARD CHAR-  
ACTERS WITHOUT CLAIM TO ANY PARTICULAR  
FONT, STYLE, SIZE, OR COLOR.

NO CLAIM IS MADE TO THE EXCLUSIVE  
RIGHT TO USE "KITCHEN", APART FROM THE  
MARK AS SHOWN.

THE NAME "SMOKEY'S" DOES NOT IDENTIFY  
A LIVING INDIVIDUAL.

SER. NO. 77-225,500, FILED 7-10-2007.

SANDRA MANIOS, EXAMINING ATTORNEY

**Int. Cl.: 5**

**Prior U.S. Cls.: 6, 18, 44, 46, 51 and 52**

**United States Patent and Trademark Office**

**Reg. No. 3,394,561**

**Registered Mar. 11, 2008**

**TRADEMARK  
PRINCIPAL REGISTER**

**LEAN ROCK**

WHIP-MIX CORPORATION (KENTUCKY COR-  
PORATION)  
361 FARMINGTON AVE.  
LOUISVILLE, KY 40217

THE MARK CONSISTS OF STANDARD CHAR-  
ACTERS WITHOUT CLAIM TO ANY PARTICULAR  
FONT, STYLE, SIZE, OR COLOR.

FOR: DENTAL DIE STONE, DENTAL STONE  
COMPOSITIONS, IN CLASS 5 (U.S. CLS. 6, 18, 44, 46,  
51 AND 52).

SER. NO. 77-225,539, FILED 7-10-2007.

FIRST USE 6-27-2007; IN COMMERCE 6-27-2007.

SANDRA MANIOS, EXAMINING ATTORNEY

**Int. Cl.: 39**

**Prior U.S. Cls.: 100 and 105**

**United States Patent and Trademark Office**

**Reg. No. 3,394,562**

**Registered Mar. 11, 2008**

**SERVICE MARK  
PRINCIPAL REGISTER**

We put the "DRIVE" in  
DriveAway.

BENNETT DRIVEAWAY (GEORGIA LTD LIAB  
CO)  
1001 INDUSTRIAL PARKWAY  
MCDONOUGH, GA 30253

THE MARK CONSISTS OF STANDARD CHAR-  
ACTERS WITHOUT CLAIM TO ANY PARTICULAR  
FONT, STYLE, SIZE, OR COLOR.

FOR: AMBULANCE TRANSPORT; BUS TRANS-  
PORT; TRUCK TRANSPORT, IN CLASS 39 (U.S. CLS.  
100 AND 105).

SER. NO. 77-225,552, FILED 7-10-2007.

FIRST USE 1-1-1986; IN COMMERCE 1-1-1986.

ROBIN CHOSID, EXAMINING ATTORNEY

**Int. Cl.: 9**

**Prior U.S. Cls.: 21, 23, 26, 36 and 38**

**Reg. No. 3,394,563**

**United States Patent and Trademark Office**

**Registered Mar. 11, 2008**

**TRADEMARK  
PRINCIPAL REGISTER**



HSI FIRE & SAFETY GROUP LLC (ILLINOIS  
LTD LIAB CO)  
107 GARLISCH DRIVE  
ELK GROVE VILLAGE, IL 60007

OWNER OF U.S. REG. NO. 3,234,170.

FOR: ALARM TESTING DEVICE USED TO  
CHECK THE FUNCTION AND EFFECTIVENESS  
OF SMOKE, CARBON DIOXIDE, HEAT AND  
OTHER FIRE ALARM DETECTORS , IN CLASS 9  
(U.S. CLS. 21, 23, 26, 36 AND 38).

NO CLAIM IS MADE TO THE EXCLUSIVE  
RIGHT TO USE "FIRE & SAFETY GROUP", APART  
FROM THE MARK AS SHOWN.

SER. NO. 77-225,614, FILED 7-10-2007.

FIRST USE 8-14-2003; IN COMMERCE 8-14-2003.

SANDRA MANIOS, EXAMINING ATTORNEY

**Int. Cl.: 35**

**Prior U.S. Cls.: 100, 101 and 102**

**United States Patent and Trademark Office**

**Reg. No. 3,394,564**

**Registered Mar. 11, 2008**

**SERVICE MARK  
PRINCIPAL REGISTER**

**UNSUBCENTRAL**

UNSUBCENTRAL, INC. (TEXAS CORPORATION)  
SUITE 800  
701 BRAZOS  
AUSTIN, TX 78701

FOR: ADVERTISING AND MARKETING SERVICES FOR OTHERS, NAMELY, CONTROLLING AND REPORTING ON ALL ACCESS AND ACTIVITY ASSOCIATED WITH E-MAIL SUPPRESSION LISTS, IN CLASS 35 (U.S. CLS. 100, 101 AND 102).

FIRST USE 3-0-2004; IN COMMERCE 3-0-2004.

THE MARK CONSISTS OF STANDARD CHARACTERS WITHOUT CLAIM TO ANY PARTICULAR FONT, STYLE, SIZE, OR COLOR.

SER. NO. 77-225,629, FILED 7-10-2007.

SANDRA MANIOS, EXAMINING ATTORNEY



**Int. Cl.: 44**

**Prior U.S. Cls.: 100 and 101**

**United States Patent and Trademark Office**

**Reg. No. 3,394,565**

**Registered Mar. 11, 2008**

**SERVICE MARK  
PRINCIPAL REGISTER**

**His pain. Her fear.  
Their needs. Our job.**

HOSPICE OF THE RED RIVER VALLEY (NORTH  
DAKOTA NON-PROFIT CORPORATION)  
1701 38TH ST. S., SUITE 101  
FARGO, ND 581034499

THE MARK CONSISTS OF STANDARD CHAR-  
ACTERS WITHOUT CLAIM TO ANY PARTICULAR  
FONT, STYLE, SIZE, OR COLOR.

FOR: HOSPICE, IN CLASS 44 (U.S. CLS. 100 AND  
101).

SER. NO. 77-225,674, FILED 7-10-2007.

FIRST USE 4-19-2007; IN COMMERCE 4-19-2007.

LINDSEY RUBIN, EXAMINING ATTORNEY

**Int. Cl.: 42**

**Prior U.S. Cls.: 100 and 101**

**United States Patent and Trademark Office**

**Reg. No. 3,394,566**

**Registered Mar. 11, 2008**

**SERVICE MARK  
PRINCIPAL REGISTER**

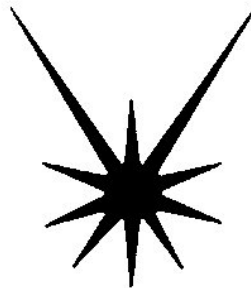

LEN, MARINELLA (UNITED STATES INDIVIDUAL)  
#H3  
2772 EAST 2ND STREET  
LONG BEACH, CA 90803

THE MARK CONSISTS OF THE LETTER "V" WITH A STARBURST CENTERED ON THE LOWER POINT OF THE LETTER "V".

FOR: GRAPHIC ART DESIGN; GRAPHIC DESIGN SERVICES, IN CLASS 42 (U.S. CLS. 100 AND 101).

SER. NO. 77-225,684, FILED 7-10-2007.

FIRST USE 10-14-2004; IN COMMERCE 10-14-2004.

MORGAN WYNNE, EXAMINING ATTORNEY

Int. Cl.: 44

Prior U.S. Cls.: 100 and 101

United States Patent and Trademark Office

Reg. No. 3,394,567

Registered Mar. 11, 2008

SERVICE MARK  
PRINCIPAL REGISTER

*DELACQUA*

BEDEROFF, ALEXANDER (UNITED STATES IN-  
DIVIDUAL)  
135 OCEANA DRIVE EAST, APT. PH1A  
BROOKLYN, NY 11235

FOR: BEAUTY SALONS; HEALTH SPA SERVI-  
CES, NAMELY, COSMETIC BODY CARE SERVICES,  
MASSAGE, AND AROMATHERAPY SERVICES, IN  
CLASS 44 (U.S. CLS. 100 AND 101).

FIRST USE 3-27-2003; IN COMMERCE 3-27-2003.

THE ENGLISH TRANSLATION OF THE WORD  
"DELACQUA" IN THE MARK IS "OF THE WATER."

SER. NO. 77-225,707, FILED 7-10-2007.

JAY BESCH, EXAMINING ATTORNEY

**Int. Cl.: 45**

**Prior U.S. Cls.: 100 and 101**

**United States Patent and Trademark Office**

**Reg. No. 3,394,568**

**Registered Mar. 11, 2008**

**SERVICE MARK  
PRINCIPAL REGISTER**

**REVGEN**

REVELATION GENERATION, INC. (NEW JERSEY NON-PROFIT CORPORATION)  
1 MAIN STREET  
FLEMINGTON, NJ 08822

THE MARK CONSISTS OF STANDARD CHARACTERS WITHOUT CLAIM TO ANY PARTICULAR FONT, STYLE, SIZE, OR COLOR.

FOR: MINISTERIAL SERVICES, NAMELY, HOLDING CHRISTIAN MUSIC FESTIVALS TO DEVELOP AND ENHANCE THE SPIRITUAL LIVES OF ATTENDEES, IN CLASS 45 (U.S. CLS. 100 AND 101).

SER. NO. 77-225,739, FILED 7-10-2007.

FIRST USE 3-0-2005; IN COMMERCE 3-0-2005.

VERNA BETH RIRIE, EXAMINING ATTORNEY

**Int. Cl.: 28**

**Prior U.S. Cls.: 22, 23, 38 and 50**

**United States Patent and Trademark Office**

**Reg. No. 3,394,569**

**Registered Mar. 11, 2008**

**TRADEMARK  
PRINCIPAL REGISTER**

# Tush Cush

BISE, AVA I. (UNITED STATES INDIVIDUAL)  
3515 GRIFFITH PARK. BL.  
LOS ANGELES, CA 90027

THE MARK CONSISTS OF STANDARD CHAR-  
ACTERS WITHOUT CLAIM TO ANY PARTICULAR  
FONT, STYLE, SIZE, OR COLOR.

FOR: ATHLETIC PROTECTIVE PADS FOR BUTT  
AND TAILBONE, IN CLASS 28 (U.S. CLS. 22, 23, 38  
AND 50).

SER. NO. 77-225,809, FILED 7-10-2007.

FIRST USE 3-20-2007; IN COMMERCE 3-20-2007.

JUDITH HELFMAN, EXAMINING ATTORNEY

**Int. Cl.: 41**

**Prior U.S. Cls.: 100, 101 and 107**

**United States Patent and Trademark Office**

**Reg. No. 3,394,570**

**Registered Mar. 11, 2008**

**SERVICE MARK  
PRINCIPAL REGISTER**

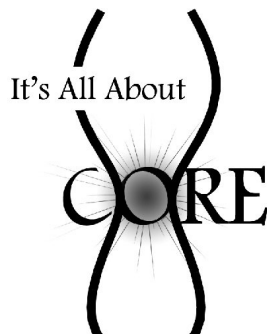

IT'S ALL ABOUT CORE, LLC (MAINE LTD LIAB  
CO)  
122 MIDDLE ROAD  
WOOLWICH, ME 04579

FOR: PERSONAL TRAINING SERVICES, NAME-  
LY, STRENGTH AND CONDITIONING TRAINING;  
PHYSICAL FITNESS CONDITIONING CLASSES;  
TRAINING SERVICES IN THE FIELD OF PILATES;  
PROVIDING ASSISTANCE, PERSONAL TRAINING  
AND PHYSICAL FITNESS CONSULTATION TO  
INDIVIDUALS TO HELP THEM MAKE PHYSICAL  
FITNESS, STRENGTH, CONDITIONING, AND EX-  
ERCISE IMPROVEMENT IN THEIR DAILY LIVING,  
IN CLASS 41 (U.S. CLS. 100, 101 AND 107).

FIRST USE 1-30-2007; IN COMMERCE 7-9-2007.

THE MARK CONSISTS OF OPPOSING SYMME-  
TRICAL CURVED LINES OVERLAID WITH THE  
WORDS IT'S ALL ABOUT CORE WHEREIN THE O  
IN CORE HAS A GRADIENT-SHADED BACK-  
GROUND AND IS SURROUNDED BY RADIANT  
LINES.

SER. NO. 77-225,823, FILED 7-10-2007.

JUDITH HELFMAN, EXAMINING ATTORNEY

**Int. Cl.: 14**

**Prior U.S. Cls.: 2, 27, 28 and 50**

**United States Patent and Trademark Office**

**Reg. No. 3,394,571**

**Registered Mar. 11, 2008**

**TRADEMARK  
PRINCIPAL REGISTER**

**X FRANZ XAVIER**

TFG 24 GOLD LLC (TEXAS LTD LIAB CO)  
12481 NW 44TH STREET  
CORAL SPRINGS, FL 33065

FOR: JEWELRY, IN CLASS 14 (U.S. CLS. 2, 27, 28  
AND 50).

FIRST USE 9-30-2004; IN COMMERCE 9-30-2004.

THE MARK CONSISTS OF STANDARD CHAR-  
ACTERS WITHOUT CLAIM TO ANY PARTICULAR  
FONT, STYLE, SIZE, OR COLOR.

THE NAME "X FRANZ XAVIER" DOES NOT  
IDENTIFY A LIVING INDIVIDUAL.

SER. NO. 77-225,836, FILED 7-10-2007.

JUDITH HELFMAN, EXAMINING ATTORNEY

**Int. Cl.: 41**

**Prior U.S. Cls.: 100, 101 and 107**

**United States Patent and Trademark Office**

**Reg. No. 3,394,572**

**Registered Mar. 11, 2008**

**SERVICE MARK  
PRINCIPAL REGISTER**



COLE, DANNY (UNITED STATES INDIVIDUAL)  
1123 4TH AVE., N.W.  
DILWORTH, MN 56529

FOR: CONDUCTING ENTERTAINMENT EXHIBITIONS IN THE NATURE OF THE DISPLAY OF WHITETAIL DEER MOUNTS, IN CLASS 41 (U.S. CLS. 100, 101 AND 107).

FIRST USE 8-15-2006; IN COMMERCE 8-15-2006.

NO CLAIM IS MADE TO THE EXCLUSIVE RIGHT TO USE "WHITETAILS", APART FROM THE MARK AS SHOWN.

THE MARK CONSISTS OF AN ANTLERED WHITETAIL DEER NEXT TO THE WORDS WILD WHITETAILS.

SER. NO. 77-225,837, FILED 7-10-2007.

CARRIE GENOVESE, EXAMINING ATTORNEY



**Int. Cl.: 36**

**Prior U.S. Cls.: 100, 101 and 102**

**United States Patent and Trademark Office**

**Reg. No. 3,394,573**

**Registered Mar. 11, 2008**

**SERVICE MARK  
PRINCIPAL REGISTER**

嘉豐

PACIFIC BANK (CALIFORNIA CHARTERED  
BANK)  
11010 ARTESIA BOULEVARD  
CERRITOS, CA 90703

FOR: BANKING, IN CLASS 36 (U.S. CLS. 100, 101  
AND 102).

FIRST USE 3-26-2007; IN COMMERCE 6-14-2007.

THE NON-LATIN CHARACTERS IN THE MARK  
TRANSLITERATE TO "JIA FENG." "JIA" MEANS  
"GOOD, FINE, BLESSED" AND "FENG" MEANS  
"ABUNDANT, PLENTIFUL" IN ENGLISH.

SER. NO. 77-225,859, FILED 7-10-2007.

CARRIE GENOVESE, EXAMINING ATTORNEY

**Int. Cl.: 45**

**Prior U.S. Cls.: 100 and 101**

**United States Patent and Trademark Office**

**Reg. No. 3,394,574**

**Registered Mar. 11, 2008**

**SERVICE MARK  
PRINCIPAL REGISTER**

**JUMP! KIDS**

ST. LOUIS FAMILY CHURCH (MISSOURI CORPORATION)  
17458 CHESTERFIELD AIRPORT ROAD  
CHESTERFIELD, MO 63005

FOR: RELIGIOUS SERVICES FOR CHILDREN, NAMELY, OPERATING PLACES OF ASSEMBLY FOR PRAYER AND WORSHIP; MINISTERIAL SERVICES FOR CHILDREN, IN CLASS 45 (U.S. CLS. 100 AND 101).

FIRST USE 6-1-2006; IN COMMERCE 6-1-2006.

THE MARK CONSISTS OF STANDARD CHARACTERS WITHOUT CLAIM TO ANY PARTICULAR FONT, STYLE, SIZE, OR COLOR.

NO CLAIM IS MADE TO THE EXCLUSIVE RIGHT TO USE "KIDS", APART FROM THE MARK AS SHOWN.

SER. NO. 77-225,895, FILED 7-10-2007.

AHSEN KHAN, EXAMINING ATTORNEY

**Int. Cl.: 45**

**Prior U.S. Cls.: 100 and 101**

**United States Patent and Trademark Office**

**Reg. No. 3,394,575**

**Registered Mar. 11, 2008**

**SERVICE MARK  
PRINCIPAL REGISTER**



ST. LOUIS FAMILY CHURCH (MISSOURI CORPORATION)

17458 CHESTERFIELD AIRPORT ROAD

CHESTERFIELD, MO 63005

FOR: RELIGIOUS SERVICES FOR CHILDREN, NAMELY, OPERATING PLACES OF ASSEMBLY FOR PRAYER AND WORSHIP; MINISTERIAL SERVICES FOR CHILDREN, IN CLASS 45 (U.S. CLS. 100 AND 101).

FIRST USE 6-1-2006; IN COMMERCE 6-1-2006.

NO CLAIM IS MADE TO THE EXCLUSIVE RIGHT TO USE "KIDS", APART FROM THE MARK AS SHOWN.

THE MARK CONSISTS OF A BURSTING SHAPE WITH NINE POINTS AROUND THE BURST. THE BURSTING SHAPE IS OUTLINED IN A THIN LINE AROUND THE SHAPE. THE WORD JUMP! IS LOCATED IN THE TOP OF THE BURST WITH THE WORD KIDS BELOW THE WORD JUMP.

SER. NO. 77-225,903, FILED 7-10-2007.

AHSEN KHAN, EXAMINING ATTORNEY

**Int. Cl.: 37**

**Prior U.S. Cls.: 100, 103 and 106**

**United States Patent and Trademark Office**

**Reg. No. 3,394,576**

**Registered Mar. 11, 2008**

**SERVICE MARK  
PRINCIPAL REGISTER**

**The Art and Science of  
Construction**

EDIFICE, INC. (NORTH CAROLINA CORPORATION)

1401 WEST MOREHEAD STREET

CHARLOTTE, NC 28208

FOR: GENERAL CONSTRUCTION CONTRACTING, IN CLASS 37 (U.S. CLS. 100, 103 AND 106).

FIRST USE 4-1-2007; IN COMMERCE 4-1-2007.

THE MARK CONSISTS OF STANDARD CHARACTERS WITHOUT CLAIM TO ANY PARTICULAR FONT, STYLE, SIZE, OR COLOR.

NO CLAIM IS MADE TO THE EXCLUSIVE RIGHT TO USE "CONSTRUCTION", APART FROM THE MARK AS SHOWN.

SER. NO. 77-226,054, FILED 7-10-2007.

REBECCA SMITH, EXAMINING ATTORNEY

**Int. Cl.: 9**

**Prior U.S. Cls.: 21, 23, 26, 36 and 38**

**United States Patent and Trademark Office**

**Reg. No. 3,394,577**

**Registered Mar. 11, 2008**

**TRADEMARK  
PRINCIPAL REGISTER**

**ADJUSTMENTHUB**

LEAN SOFTWARE SERVICES, INC. (CANADA  
CORPORATION)  
15 NORTHMOUNT AVENUE  
TORONTO, CANADA M3H1N5

THE MARK CONSISTS OF STANDARD CHAR-  
ACTERS WITHOUT CLAIM TO ANY PARTICULAR  
FONT, STYLE, SIZE, OR COLOR.

FOR: CUSTOMER RELATIONS MANAGEMENT  
SOFTWARE; CLAIMS MANAGEMENT SOFT-  
WARE, IN CLASS 9 (U.S. CLS. 21, 23, 26, 36 AND 38).

SER. NO. 77-226,083, FILED 7-10-2007.

FIRST USE 7-1-2004; IN COMMERCE 7-1-2004.

JILL PRATER, EXAMINING ATTORNEY

**Int. Cl.: 10**

**Prior U.S. Cls.: 26, 39 and 44**

**United States Patent and Trademark Office**

**Reg. No. 3,394,578**

**Registered Mar. 11, 2008**

**TRADEMARK  
PRINCIPAL REGISTER**

**SENOMARK**

SENORX, INC. (DELAWARE CORPORATION)  
11 COLUMBIA, SUITE A  
ALISO VIEJO, CA 92656

FOR: MEDICAL DEVICES, NAMELY, A SYRINGE WHICH INSERTS PELLETS INTO A BIOPSY CAVITY FOR EASY LOCATION OF THE BIOPSY CAVITY PERIPHERY, IN CLASS 10 (U.S. CLS. 26, 39 AND 44).

FIRST USE 7-14-2005; IN COMMERCE 7-14-2005.

THE MARK CONSISTS OF STANDARD CHARACTERS WITHOUT CLAIM TO ANY PARTICULAR FONT, STYLE, SIZE, OR COLOR.

OWNER OF U.S. REG. NOS. 2,368,380 AND 2,778,397.

SER. NO. 77-226,091, FILED 7-10-2007.

ELLEN BURNS, EXAMINING ATTORNEY

**Int. Cl.: 37**

**Prior U.S. Cls.: 100, 103 and 106**

**United States Patent and Trademark Office**

**Reg. No. 3,394,579**

**Registered Mar. 11, 2008**

**SERVICE MARK  
PRINCIPAL REGISTER**



HONEST-1 AUTO CARE (NEVADA CORPORATION)  
6767 W. TROPICANA  
LAS VEGAS, NV 89103

FOR: AUTOMOTIVE MAINTENANCE AND REPAIR, IN CLASS 37 (U.S. CLS. 100, 103 AND 106).

FIRST USE 1-5-1998; IN COMMERCE 1-5-1998.

THE MARK CONSISTS OF CARTOON MECHANIC.

SER. NO. 77-226,203, FILED 7-10-2007.

JANICE KIM, EXAMINING ATTORNEY

**Int. Cl.: 36**

**Prior U.S. Cls.: 100, 101 and 102**

**United States Patent and Trademark Office**

**Reg. No. 3,394,580**

**Registered Mar. 11, 2008**

**SERVICE MARK  
PRINCIPAL REGISTER**



STUDENT CAPITAL CORPORATION (CALIFORNIA CORPORATION)  
SUITE 100  
16855 W. BERNARDO DRIVE  
SAN DIEGO, CA 92127

FOR: BROKERAGE IN THE FIELD OF STUDENT LOANS; DEBT COUNSELING SERVICES; DEBT MANAGEMENT CONSULTATION; FINANCIAL LOAN CONSULTATION; FINANCIAL SERVICES, NAMELY, MONEY LENDING; INSTALLMENT LOANS; LOAN FINANCING; PROVIDING STUDENT LOAN INFORMATION; STUDENT LOAN

SERVICES; TEMPORARY LOANS; FINANCIAL CONSULTATION IN THE FIELD OF STUDENT LOANS, IN CLASS 36 (U.S. CLS. 100, 101 AND 102).

FIRST USE 11-30-2005; IN COMMERCE 11-30-2005.

NO CLAIM IS MADE TO THE EXCLUSIVE RIGHT TO USE "QUALITY SERVICE", APART FROM THE MARK AS SHOWN.

SER. NO. 77-226,251, FILED 7-10-2007.

BRIAN CALLAGHAN, EXAMINING ATTORNEY



Int. Cl.: 41

Prior U.S. Cls.: 100, 101 and 107

United States Patent and Trademark Office

Reg. No. 3,394,581

Registered Mar. 11, 2008

SERVICE MARK  
PRINCIPAL REGISTER



K-9'S IN MOTION (MISSOURI LTD LIAB CO)  
PMB 119  
790 W. 40 HWY  
BLUE SPRINGS, MO 64015

FOR: DOG TRAINING, IN CLASS 41 (U.S. CLS.  
100, 101 AND 107).

FIRST USE 6-0-2007; IN COMMERCE 6-0-2007.

NO CLAIM IS MADE TO THE EXCLUSIVE  
RIGHT TO USE "DOG AGILITY CENTER", APART  
FROM THE MARK AS SHOWN.

THE COLOR(S) BLUE AND GREEN IS/ARE  
CLAIMED AS A FEATURE OF THE MARK.

THE MARK CONSISTS OF THE WORD "K9'S" IS  
BLUE OUTLINED IN GREEN AND THE WORD  
"MOTION" IS GREEN OUTLINED IN BLUE, THE  
WORD "IN" IS GREEN AND THE PHRASE "DOG  
AGILITY CENTER" IS BLUE, AND THE LETTER  
"O" IN MOTION IS SHAPED LIKE A TIRE OBSTA-  
CLE WITH A DOG SILHOUETTE JUMPING  
THROUGH THE CENTER IT.

SER. NO. 77-226,260, FILED 7-10-2007.

JANICE KIM, EXAMINING ATTORNEY

**Int. Cl.: 35**

**Prior U.S. Cls.: 100, 101 and 102**

**United States Patent and Trademark Office**

**Reg. No. 3,394,582**

**Registered Mar. 11, 2008**

**SERVICE MARK  
PRINCIPAL REGISTER**



PLAYPHONE INC. (CALIFORNIA CORPORATION)  
224 AIRPORT PARKWAY, SUITE 300  
SAN JOSE, CA 95110

FOR: ONLINE AND WIRELESS RETAIL STORE SERVICES FEATURING ENTERTAINMENT DOWNLOADS, IN CLASS 35 (U.S. CLS. 100, 101 AND 102).

FIRST USE 7-10-2007; IN COMMERCE 7-10-2007.

THE MARK CONSISTS OF AN IMAGE OF A PHONE WITH DEVIL HORNS AND TAIL.

SER. NO. 77-226,308, FILED 7-10-2007.

ANDREA HACK, EXAMINING ATTORNEY

**Int. Cl.: 36**

**Prior U.S. Cls.: 100, 101 and 102**

**United States Patent and Trademark Office**

**Reg. No. 3,394,583**

**Registered Mar. 11, 2008**

**SERVICE MARK  
PRINCIPAL REGISTER**

STANDARD PACIFIC MORTGAGE

STANDARD PACIFIC CORP. (DELAWARE CORPORATION)

15326 ALTON PARKWAY

IRVINE, CA 92618

FOR: MORTGAGE BANKING SERVICES, IN CLASS 36 (U.S. CLS. 100, 101 AND 102).

FIRST USE 5-1-2007; IN COMMERCE 5-1-2007.

THE MARK CONSISTS OF STANDARD CHARACTERS WITHOUT CLAIM TO ANY PARTICULAR FONT, STYLE, SIZE, OR COLOR.

NO CLAIM IS MADE TO THE EXCLUSIVE RIGHT TO USE "MORTGAGE", APART FROM THE MARK AS SHOWN.

SER. NO. 77-226,336, FILED 7-10-2007.

MARGERY A. TIERNEY, EXAMINING ATTORNEY

**Int. Cl.: 35**

**Prior U.S. Cls.: 100, 101 and 102**

**United States Patent and Trademark Office**

**Reg. No. 3,394,584**

**Registered Mar. 11, 2008**

**SERVICE MARK  
PRINCIPAL REGISTER**

**THE MUD MASTERS GROUP**

THE MUD MASTERS GROUP, LLC (LOUISIANA  
LTD LIAB CO)  
740 JOLIMAR TRAIL SE  
SUMMIT, MS 39666

FOR: RETAIL SERVICES BY DIRECT SOLICITA-  
TION BY SALES AGENTS IN THE FIELD OF  
ADDITIVES FOR OIL AND GAS WELL DRILLING  
FLUIDS, IN CLASS 35 (U.S. CLS. 100, 101 AND 102).

FIRST USE 7-3-2007; IN COMMERCE 7-3-2007.

THE MARK CONSISTS OF STANDARD CHAR-  
ACTERS WITHOUT CLAIM TO ANY PARTICULAR  
FONT, STYLE, SIZE, OR COLOR.

NO CLAIM IS MADE TO THE EXCLUSIVE  
RIGHT TO USE "MUD" AND "GROUP", APART  
FROM THE MARK AS SHOWN.

SER. NO. 77-226,344, FILED 7-10-2007.

MARGERY A. TIERNEY, EXAMINING ATTORNEY

**Int. Cl.: 28**

**Prior U.S. Cls.: 22, 23, 38 and 50**

**United States Patent and Trademark Office**

**Reg. No. 3,394,585**

**Registered Mar. 11, 2008**

**TRADEMARK  
PRINCIPAL REGISTER**



ZWICKEL, DANIEL B. (UNITED STATES INDIVIDUAL)  
2150 GOFF AVENUE  
PITTSBURG, CA 945654735

THE MARK CONSISTS OF STYLIZED GOLD CAPITAL LETTERS H, E, X, A, D, E AND C OVER A DARK BLUE FIELD (BACKGROUND).

FOR: PLAYING CARDS, IN CLASS 28 (U.S. CLS. 22, 23, 38 AND 50).

SER. NO. 77-226,502, FILED 7-11-2007.

FIRST USE 6-6-1990; IN COMMERCE 6-6-1990.

THE COLOR(S) BLUE AND GOLD IS/ARE CLAIMED AS A FEATURE OF THE MARK.

MIDGE BUTLER, EXAMINING ATTORNEY

**Int. Cl.: 9**

**Prior U.S. Cls.: 21, 23, 26, 36 and 38**

**Reg. No. 3,394,586**

**United States Patent and Trademark Office**

**Registered Mar. 11, 2008**

**TRADEMARK  
PRINCIPAL REGISTER**



LEDMAN OPTOELECTRONIC CO., LTD. (CHINA CORPORATION)  
7/F, HAOYITONG BUILDING  
HI-TECH INDUSTRY GARDEN NORTH, NANSHAN  
SHENZHEN, GUANGDONG, CHINA

FOR: ELECTRONIC NOTICE BOARDS; SEMI-CONDUCTOR DEVICES; VIDEO SCREENS; COMPUTERS; COMPUTER NETWORK HUBS, SWITCHES AND ROUTERS; TELEVISION SETS; CAMERAS; MULTIMEDIA PROJECTORS; PHOTO-

METERS; BATTERY CHARGERS, IN CLASS 9 (U.S. CLS. 21, 23, 26, 36 AND 38).

FIRST USE 7-21-2004; IN COMMERCE 6-10-2006.

THE MARK CONSISTS OF THE WORD LEDMAN AND AN OVAL DRAWING.

SER. NO. 77-226,511, FILED 7-11-2007.

TEJBIR SINGH, EXAMINING ATTORNEY

**Int. Cl.: 16**

**Prior U.S. Cls.: 2, 5, 22, 23, 29, 37, 38 and 50**

**United States Patent and Trademark Office**

**Reg. No. 3,394,587**

**Registered Mar. 11, 2008**

**TRADEMARK  
PRINCIPAL REGISTER**



KITCHMART TRADING CORP (NEW YORK CORPORATION)  
WWW.KITCHMART.COM  
426 JOHNSON AVENUE  
BROOKLYN, NY 11237

FOR: BATHROOM TISSUE; BAGS FOR MICROWAVE COOKING; BIODEGRADABLE PAPER PULP-BASED TO-GO CONTAINERS FOR FOOD; DISPOSABLE NAPKINS; FOOD WRAPPERS; FOOD WRAPPING PLASTIC FILM FOR HOUSEHOLD USE; GARBAGE BAGS OF PLASTIC; GENERAL PURPOSE PLASTIC BAGS; NAPKIN PAPER; PAPER BAGS; PAPER BAGS AND SACKS; PAPER BAGS FOR PACKAGING; PAPER BOXES; PAPER CONTAINERS; PAPER ENVELOPES FOR PACKAGING; PAPER FOR WRAPPING AND PACKAGING; PAPER HAND-TOWELS; PAPER MATS; PAPER NAPKINS; PAPER SHOPPING BAGS; PAPER TABLE CLOTHS; PAPER TABLE LINENS; PAPER TAKE-OUT CARTONS FOR FOOD; PLASTIC BAGS FOR PACKAGING; PLASTIC BAGS FOR PACKING; PLASTIC FOOD STORAGE BAGS FOR HOUSEHOLD USE; PLASTIC GARBAGE BAGS; PLASTIC OR PAPER BAGS FOR HOUSEHOLD USE; PLASTIC OR PAPER BAGS FOR MERCHANDISE PACKAGING; PLASTIC SANDWICH BAGS; PLASTIC SHOPPING BAGS; PLASTIC TRASH BAGS; PLASTIC

WRAP; RECEIPT BOOKS; TABLE CLOTHS OF PAPER; TABLE LINENS OF PAPER; TABLE MATS OF PAPER; TABLE NAPKINS OF PAPER; TISSUE PAPER; TOILET PAPER; TOILET TISSUE; TRASH BAGS; TRASH CAN LINERS, IN CLASS 16 (U.S. CLS. 2, 5, 22, 23, 29, 37, 38 AND 50).

FIRST USE 2-1-2007; IN COMMERCE 2-1-2007.

THE COLOR(S) ORANGE IS/ARE CLAIMED AS A FEATURE OF THE MARK.

THE MARK CONSISTS OF ORANGE LOGO, WITH 2 KNIVES, 8 FORKS, AND 9 SPOONS INCLUDING ONE LARGE SPOON IN THE MIDDLE FORMING AN ARC/SEMI-CIRCLE, SEATING ON TOP OF THE WORK KITCHMART. AND BELOW KITCHMART IS A SIDE ANGLE OF A DINNER PLATE. THE COLOR ORANGE APPEARS IN THE WORDING AND DESIGN ELEMENTS OF THE MARK.

SER. NO. 77-226,571, FILED 7-11-2007.

DAVID MURRAY, EXAMINING ATTORNEY

**Int. Cl.: 36**

**Prior U.S. Cls.: 100, 101 and 102**

**United States Patent and Trademark Office**

**Reg. No. 3,394,588**

**Registered Mar. 11, 2008**

**SERVICE MARK  
PRINCIPAL REGISTER**

**Ask for 504**

CEN-TEX CERTIFIED DEVELOPMENT CORPORATION (TEXAS CORPORATION), DBA BCL OF TEXAS  
2212 S. CONGRESS AVE.  
AUSTIN, TX 78704

FOR: FINANCIAL LOAN CONSULTATION; LOAN FINANCING; FACILITATING AND ARRANGING FOR THE FINANCING OF COMMERCIAL REAL ESTATE; PROJECT FINANCING; COMMERCIAL LENDING SERVICES; REAL ESTATE LENDING SERVICES, IN CLASS 36 (U.S. CLS. 100, 101 AND 102).

FIRST USE 2-15-2007; IN COMMERCE 3-1-2007.

THE MARK CONSISTS OF STANDARD CHARACTERS WITHOUT CLAIM TO ANY PARTICULAR FONT, STYLE, SIZE, OR COLOR.

SER. NO. 77-226,616, FILED 7-11-2007.

JAMES MACFARLANE, EXAMINING ATTORNEY



**Int. Cl.: 42**

**Prior U.S. Cls.: 100 and 101**

**United States Patent and Trademark Office**

**Reg. No. 3,394,589**

**Registered Mar. 11, 2008**

**SERVICE MARK  
PRINCIPAL REGISTER**

**RADIXX**  
  
**INTERNATIONAL**

RADIXX SOLUTIONS INTERNATIONAL, INC.  
(DELAWARE CORPORATION)  
6310 HAZELTINE NATIONAL DRIVE  
ORLANDO, FL 32822

FOR: DESIGN, DEVELOPMENT AND IMPLEMENTATION OF COMPUTER SOFTWARE USED IN THE TRAVEL RESERVATION AND TRAVEL TICKET INVENTORY MANAGEMENT FIELDS; HOSTING THE WEBSITES OF OTHERS ON A COMPUTER SERVER FOR A GLOBAL COMPUTER NETWORK IN THE TRAVEL RESERVATION AND TRAVEL TICKET INVENTORY MANAGEMENT FIELDS, IN CLASS 42 (U.S. CLS. 100 AND 101).

FIRST USE 0-0-2004; IN COMMERCE 0-0-2004.

NO CLAIM IS MADE TO THE EXCLUSIVE RIGHT TO USE "INTERNATIONAL", APART FROM THE MARK AS SHOWN.

THE MARK CONSISTS OF THE WORD RADIXX OVER A STYLIZED ARROW OVER THE WORD INTERNATIONAL .

SER. NO. 77-226,623, FILED 7-11-2007.

MIDGE BUTLER, EXAMINING ATTORNEY

**Int. Cl.: 35**

**Prior U.S. Cls.: 100, 101 and 102**

**United States Patent and Trademark Office**

**Reg. No. 3,394,590**

**Registered Mar. 11, 2008**

**SERVICE MARK  
PRINCIPAL REGISTER**

**CHIBAKITA**

COASTAL CONCEPTS LTD-US, LLC (DELA-  
WARE LTD LIAB CO)  
4530 NORTH MAGNOLIA AVENUE, UNIT 3N  
CHICAGO, IL 60640

FOR: COMPUTERIZED ON-LINE ORDERING  
FEATURING GENERAL MERCHANDISE AND  
GENERAL CONSUMER GOODS, IN CLASS 35 (U.S.  
CLS. 100, 101 AND 102).

FIRST USE 4-12-2007; IN COMMERCE 4-12-2007.

THE MARK CONSISTS OF STANDARD CHAR-  
ACTERS WITHOUT CLAIM TO ANY PARTICULAR  
FONT, STYLE, SIZE, OR COLOR.

THE WORDING "CHIBAKITA" HAS NO MEAN-  
ING AS APPLIED TO THE IDENTIFIED SERVICES  
OTHER THAN TRADEMARK SIGNIFICANCE.

SER. NO. 77-226,629, FILED 7-11-2007.

MICHAEL GAAFAR, EXAMINING ATTORNEY

Int. Cl.: 5

Prior U.S. Cls.: 6, 18, 44, 46, 51 and 52

United States Patent and Trademark Office

Reg. No. 3,394,591

Registered Mar. 11, 2008

TRADEMARK  
PRINCIPAL REGISTER



CNS, INC. (DELAWARE CORPORATION)  
SUITE 400  
2711 CENTERVILLE ROAD  
WILMINGTON, DE 19808

FOR: DIETARY SUPPLEMENTS, IN CLASS 5 (U.S. CLS. 6, 18, 44, 46, 51 AND 52).

FIRST USE 3-1-2005; IN COMMERCE 3-1-2005.

OWNER OF U.S. REG. NO. 2,441,387.

NO CLAIM IS MADE TO THE EXCLUSIVE RIGHT TO USE "FIBER", APART FROM THE MARK AS SHOWN.

THE COLOR(S) BEIGE, DARK GREEN, GREEN, WHITE AND BLACK IS/ARE CLAIMED AS A FEATURE OF THE MARK.

THE COLOR BEIGE APPEARS IN THE OUTER OVAL DESIGN; THE COLOR DARK GREEN APPEARS IN THE MIDDLE OVAL DESIGN; THE COLOR GREEN APPEARS IN THE BACKGROUND OF THE INNER OVAL DESIGN; THE COLOR WHITE APPEARS IN THE WORDING FIBER CHOICE AND IN THE CURVED LINE DESIGN WITHIN THE INNER OVAL DESIGN; AND THE COLOR BLACK APPEARS IN THE SHADOWED OUTLINING OF THE WORDING FIBER CHOICE OF THE MARK.

SER. NO. 77-226,632, FILED 7-11-2007.

ANDREW RHIM, EXAMINING ATTORNEY

**Int. Cl.: 41**

**Prior U.S. Cls.: 100, 101 and 107**

**United States Patent and Trademark Office**

**Reg. No. 3,394,592**

**Registered Mar. 11, 2008**

**SERVICE MARK  
PRINCIPAL REGISTER**

**RARE LEARNING**

RARE LEARNING, INC. (TEXAS CORPORATION)  
210 LAIRDS DRIVE  
COPPELL, TX 75019

FOR: EDUCATION SERVICES, NAMELY, A PROGRAM TO PROMOTE READING, MATH AND SCIENCE SKILLS IN PRE-SCHOOL AND SCHOOL AGE CHILDREN, IN CLASS 41 (U.S. CLS. 100, 101 AND 107).

FIRST USE 11-1-2003; IN COMMERCE 11-1-2003.

THE MARK CONSISTS OF STANDARD CHARACTERS WITHOUT CLAIM TO ANY PARTICULAR FONT, STYLE, SIZE, OR COLOR.

NO CLAIM IS MADE TO THE EXCLUSIVE RIGHT TO USE "LEARNING", APART FROM THE MARK AS SHOWN.

SER. NO. 77-226,649, FILED 7-11-2007.

MICHAEL WEBSTER, EXAMINING ATTORNEY

**Int. Cl.: 35**

**Prior U.S. Cls.: 100, 101 and 102**

**United States Patent and Trademark Office**

**Reg. No. 3,394,593**

**Registered Mar. 11, 2008**

**SERVICE MARK  
PRINCIPAL REGISTER**

**GIGANTIC**

GIGANTIC MARKETING, INC. (NEW YORK CORPORATION)  
90 WEST STREET, SUITE 20K  
NEW YORK, NY 10006

THE MARK CONSISTS OF STANDARD CHARACTERS WITHOUT CLAIM TO ANY PARTICULAR FONT, STYLE, SIZE, OR COLOR.

FOR: CONSULTING SERVICES CONCERNING MARKETING, ADVERTISING AND BRAND MANAGEMENT, IN CLASS 35 (U.S. CLS. 100, 101 AND 102).

SER. NO. 77-226,659, FILED 7-11-2007.

FIRST USE 10-26-2005; IN COMMERCE 10-26-2005.

DAVID COLLIER, EXAMINING ATTORNEY

**Int. Cl.: 9**

**Prior U.S. Cls.: 21, 23, 26, 36 and 38**

**Reg. No. 3,394,594**

**United States Patent and Trademark Office**

**Registered Mar. 11, 2008**

---

**TRADEMARK  
PRINCIPAL REGISTER**

**NANOCOUNT**

LIGHTHOUSE WORLDWIDE SOLUTIONS (CALIFORNIA CORPORATION)  
46501 LANDING PARKWAY  
FREMONT, CA 94538

FOR: A LIQUID ANALYSIS INSTRUMENT, NAMELY, A SCIENTIFIC APPARATUS FOR ANALYZING AND MEASURING WATER QUALITY THROUGH PARTICLE EXAMINATION, IN CLASS 9 (U.S. CLS. 21, 23, 26, 36 AND 38).

FIRST USE 6-5-2007; IN COMMERCE 6-29-2007.

THE MARK CONSISTS OF STANDARD CHARACTERS WITHOUT CLAIM TO ANY PARTICULAR FONT, STYLE, SIZE, OR COLOR.

SER. NO. 77-226,660, FILED 7-11-2007.

TEJBIR SINGH, EXAMINING ATTORNEY

**Int. Cl.: 35**

**Prior U.S. Cls.: 100, 101 and 102**

**United States Patent and Trademark Office**

**Reg. No. 3,394,595**

**Registered Mar. 11, 2008**

**SERVICE MARK  
PRINCIPAL REGISTER**

**chibakita**

COASTAL CONCEPTS LTD-US, LLC (DELA-  
WARE LTD LIAB CO)  
4530 NORTH MAGNOLIA AVENUE, UNIT 3N  
CHICAGO, IL 60640

FIRST USE 4-12-2007; IN COMMERCE 4-12-2007.

FOR: COMPUTERIZED ON-LINE ORDERING  
FEATURING GENERAL MERCHANDISE AND  
GENERAL CONSUMER GOODS, IN CLASS 35 (U.S.  
CLS. 100, 101 AND 102).

SER. NO. 77-226,670, FILED 7-11-2007.

MICHAEL GAAFAR, EXAMINING ATTORNEY

**Int. Cl.: 42**

**Prior U.S. Cls.: 100 and 101**

**United States Patent and Trademark Office**

**Reg. No. 3,394,596**

**Registered Mar. 11, 2008**

**SERVICE MARK  
PRINCIPAL REGISTER**

**MAPNAV**

APEX, LLC (RHODE ISLAND LTD LIAB CO)  
100 MAIN STREET  
PAWTUCKET, RI 02860

FIRST USE 1-1-2001; IN COMMERCE 1-1-2001.

FOR: COMPUTER SERVICES, NAMELY, CREATING INDEXES OF INFORMATION, SITES AND OTHER RESOURCES AVAILABLE ON COMPUTER NETWORKS; COMPUTER SERVICES, NAMELY, PROVIDING SEARCH ENGINES FOR OBTAINING DATA ON A GLOBAL COMPUTER NETWORK, IN CLASS 42 (U.S. CLS. 100 AND 101).

THE MARK CONSISTS OF STANDARD CHARACTERS WITHOUT CLAIM TO ANY PARTICULAR FONT, STYLE, SIZE, OR COLOR.

SER. NO. 77-226,682, FILED 7-11-2007.

CHRISTINA SOBRAL, EXAMINING ATTORNEY



**Int. Cl.: 33**

**Prior U.S. Cls.: 47 and 49**

**United States Patent and Trademark Office**

**Reg. No. 3,394,597**

**Registered Mar. 11, 2008**

**TRADEMARK  
PRINCIPAL REGISTER**

**Experience an Italian Way  
of Life**

CASA LARGA VINEYARDS, INC. (NEW YORK  
CORPORATION)  
2287 TURK HILL ROAD  
FAIRPORT, NY 14450

THE MARK CONSISTS OF STANDARD CHAR-  
ACTERS WITHOUT CLAIM TO ANY PARTICULAR  
FONT, STYLE, SIZE, OR COLOR.

FOR: WINE, IN CLASS 33 (U.S. CLS. 47 AND 49).

SER. NO. 77-226,697, FILED 7-11-2007.

FIRST USE 7-1-2007; IN COMMERCE 7-1-2007.

ALYSSA PALADINO, EXAMINING ATTORNEY

**Int. Cl.: 9**

**Prior U.S. Cls.: 21, 23, 26, 36 and 38**

**Reg. No. 3,394,598**

**United States Patent and Trademark Office**

**Registered Mar. 11, 2008**

**TRADEMARK  
PRINCIPAL REGISTER**



RADIXX SOLUTIONS INTERNATIONAL, INC.  
(DELAWARE CORPORATION)  
6310 HAZELTINE NATIONAL DRIVE  
ORLANDO, FL 32822

NO CLAIM IS MADE TO THE EXCLUSIVE  
RIGHT TO USE "INTERNATIONAL", APART  
FROM THE MARK AS SHOWN.

FOR: COMPUTER APPLICATION SOFTWARE  
FOR USE IN THE TRAVEL RELATED RESERVA-  
TIONS AND TRAVEL RELATED INVENTORY  
MANAGEMENT FIELDS; AND DATABASE MAN-  
AGEMENT SOFTWARE FOR USE IN THE TRAVEL-  
RELATED RESERVATIONS FIELD AND THE TRA-  
VEL-RELATED INVENTORY MANAGEMENT  
FIELD, IN CLASS 9 (U.S. CLS. 21, 23, 26, 36 AND 38).

THE MARK CONSISTS OF THE WORD RADIXX  
OVER A STYLIZED ARROW OVER THE WORD  
INTERNATIONAL.

SER. NO. 77-226,700, FILED 7-11-2007.

FIRST USE 0-0-2004; IN COMMERCE 0-0-2004.

MIDGE BUTLER, EXAMINING ATTORNEY

**Int. Cl.: 6**

**Prior U.S. Cls.: 2, 12, 13, 14, 23, 25 and 50**

**Reg. No. 3,394,599**

**United States Patent and Trademark Office**

**Registered Mar. 11, 2008**

**TRADEMARK  
PRINCIPAL REGISTER**

**PORTELLA**

PORTELLA MANUFACTURING, LLC (ARIZONA  
LTD LIAB CO)  
#126  
21430 N. 15TH LANE  
PHOENIX, AZ 85027

FOR: METAL DOOR FRAMES; METAL DOOR  
PANELS; METAL DOOR UNITS; METAL DOORS,  
IN CLASS 6 (U.S. CLS. 2, 12, 13, 14, 23, 25 AND 50).

FIRST USE 7-1-2006; IN COMMERCE 7-1-2006.

THE MARK CONSISTS OF STANDARD CHAR-  
ACTERS WITHOUT CLAIM TO ANY PARTICULAR  
FONT, STYLE, SIZE, OR COLOR.

OWNER OF U.S. REG. NOS. 3,227,261 AND  
3,227,262.

SER. NO. 77-226,728, FILED 7-11-2007.

ALICE BENMAMAN, EXAMINING ATTORNEY

Int. Cls.: 25 and 35

Prior U.S. Cls.: 22, 39, 100, 101 and 102

United States Patent and Trademark Office

Reg. No. 3,394,600

Registered Mar. 11, 2008

TRADEMARK  
SERVICE MARK  
PRINCIPAL REGISTER



LEVI, GALIT (ISRAEL INDIVIDUAL)  
2 KAUFMAN STREET  
TEL AVIV, ISRAEL

FOR: CLOTHING, NAMELY, DRESSES, PANTS,  
SHIRTS, SWIMSUITS, HEADWEAR AND VEILS,  
GARTERS, GLOVES, AND SHOES, IN CLASS 25  
(U.S. CLS. 22 AND 39).

FIRST USE 2-1-2001; IN COMMERCE 4-1-2004.

FOR: RETAIL STORE SERVICES FEATURING  
DRESSES, PANTS, SHIRTS, SWIMSUITS, HEAD-  
WEAR AND VEILS, GARTERS, GLOVES, AND  
SHOES, IN CLASS 35 (U.S. CLS. 100, 101 AND 102).

FIRST USE 2-1-2001; IN COMMERCE 11-1-2006.

THE MARK CONSISTS OF A SMALLER INNER  
CIRCLE WITHIN A LARGER OUTER CIRCLE. THE  
WORDS GALIT LEVI APPEAR IN STYLIZED LET-  
TERING IN ENGLISH AND HEBREW BETWEEN  
THE OUTER CIRCLE AND THE INNER CIRCLE. IN  
THE CENTER OF THE INNER CIRCLE APPEAR  
THE STYLIZED LETTERS GL.

THE NON-LATIN CHARACTER(S) IN THE  
MARK TRANSLITERATE INTO GALIT LEVI, AND  
THIS MEANS THE NAME GALIT LEVI IN ENG-  
LISH.

SER. NO. 77-226,737, FILED 7-11-2007.

ALLISON SCHRODY, EXAMINING ATTORNEY

**Int. Cl.: 35**

**Prior U.S. Cls.: 100, 101 and 102**

**United States Patent and Trademark Office**

**Reg. No. 3,394,601**

**Registered Mar. 11, 2008**

**SERVICE MARK  
PRINCIPAL REGISTER**

**WRCA**

WORKING RANCH COWBOYS ASSOCIATION  
(TEXAS NON-PROFIT ASSOCIATION)  
2750 DUNIVEN CIRCLE  
AMARILLO, TX 79109

FOR: ASSOCIATION SERVICES, NAMELY, PROMOTING THE INTERESTS OF WORKING RANCH COWBOYS, IN CLASS 35 (U.S. CLS. 100, 101 AND 102).

FIRST USE 3-16-1995; IN COMMERCE 3-16-1995.

THE MARK CONSISTS OF STANDARD CHARACTERS WITHOUT CLAIM TO ANY PARTICULAR FONT, STYLE, SIZE, OR COLOR.

OWNER OF U.S. REG. NO. 3,274,474.

SER. NO. 77-226,754, FILED 7-11-2007.

DAVID MURRAY, EXAMINING ATTORNEY

**Int. Cl.: 35**

**Prior U.S. Cls.: 100, 101 and 102**

**United States Patent and Trademark Office**

**Reg. No. 3,394,602**

**Registered Mar. 11, 2008**

**SERVICE MARK  
PRINCIPAL REGISTER**

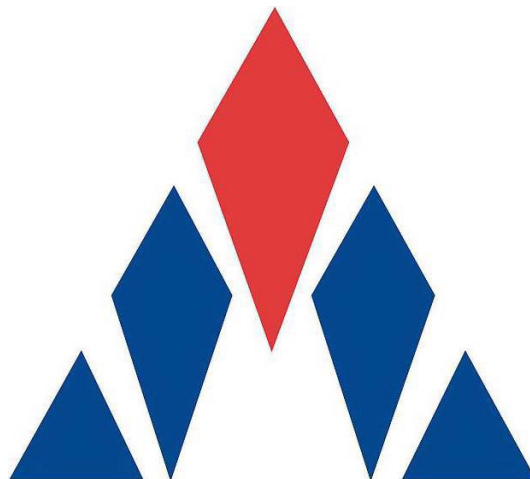

LEADERSHIP STRATEGIES GROUP, INC. (KENTUCKY CORPORATION)  
SUITE 110  
1711 DESTINY LANE  
BOWLING GREEN, KY 42104

FOR: BUSINESS CONSULTING SERVICES RELATING TO PRODUCT DISTRIBUTION, OPERATIONS MANAGEMENT SERVICES, LOGISTICS, REVERSE LOGISTICS, SUPPLY CHAIN, AND PRODUCTION SYSTEMS AND DISTRIBUTION SOLUTIONS; BUSINESS CONSULTING, MANAGEMENT, PLANNING AND SUPERVISION; BUSINESS MANAGEMENT AND CONSULTATION; BUSINESS MANAGEMENT CONSULTANCY AND ADVISORY SERVICES; BUSINESS MANAGEMENT CONSULTANCY AS WELL AS DEVELOPMENT OF PROCESSES FOR THE ANALYSIS AND THE IMPLEMENTATION OF STRATEGY PLANS AND MANAGEMENT PROJECTS; BUSINESS MANAGEMENT CONSULTANCY SERVICES; BUSINESS MANAGEMENT CONSULTATION; BUSINESS MANAGEMENT CONSULTATION IN THE FIELD OF EXECUTIVE AND LEADERSHIP DEVELOPMENT; BUSINESS MANAGEMENT CONSULTING WITH RELATION TO STRATEGY, MARKETING, PRODUCTION, PERSONNEL AND RETAIL SALE MATTERS; BUSINESS MERGER CONSULTATION; BUSINESS ORGANIZATION AND MANAGEMENT CONSULTING SERVICES; BUSINESS ORGANIZATION AND OPERATION CONSULTANCY; BUSINESS ORGANIZATIONAL CONSULTATION; CONSULTANCY OF PERSONNEL RECRUITMENT;

CONSULTANCY SERVICES REGARDING BUSINESS STRATEGIES; CONSULTATION SERVICES IN THE FIELD OF COMPANY, BUSINESS SECTOR AND INDUSTRY DATA AND RESEARCH; CONSULTING SERVICES IN BUSINESS ORGANIZATION AND MANAGEMENT; CONSULTING SERVICES IN THE FIELD OF HIGHER EDUCATION ADMINISTRATION; CONSULTING SERVICES IN THE FIELD OF HUMAN RESOURCES DEVELOPMENT, NAMELY, FOR THE PROMOTION OF EMPLOYEE RETENTION, CAREER GROWTH, AND INCREASED PRODUCTIVITY FOR EMPLOYEES AND EMPLOYERS; CONSULTING SERVICES RELATED TO THE ADMINISTRATIVE COORDINATION OF ORGANIZATIONS PROVIDING HUMANITARIAN ACTIVITIES; HUMAN RESOURCES CONSULTATION; INFORMATION, ADVISORY AND CONSULTANCY SERVICES RELATING TO BUSINESS AND MANAGEMENT OR BUSINESS ADMINISTRATION, INCLUDING SUCH SERVICES PROVIDED ON LINE OR VIA THE INTERNET; MARKET RESEARCH CONSULTATION; PERSONNEL MANAGEMENT CONSULTATION; PROFESSIONAL BUSINESS CONSULTATION; PROVIDING BUSINESS MANAGEMENT INFORMATION IN CONNECTION WITH CONSULTING AND ADVISORY SERVICES IN THE FIELD OF STRATEGIC PLANNING; PROVIDING ORGANIZATIONAL DEVELOPMENT CONSULTING SERVICES; BUSINESS MANAGEMENT CONSULTING AND ADVISORY SERVICES, IN CLASS 35 (U.S. CLS. 100, 101 AND 102).

FIRST USE 6-23-1997; IN COMMERCE 6-23-1997.

THE COLOR(S) RED AND BLUE IS/ARE CLAIMED AS A FEATURE OF THE MARK.

THE MARK CONSISTS OF THREE RECTANGULAR SHAPES AND TWO TRIANGULAR SHAPES TO FORM A BIG TRIANGLE. ONE OF THE THREE RECTANGULAR SHAPES FORMS THE TOP OF THE BIG TRIANGLE AND IS RED AND REST OF

THE RECTANGULAR SHAPES AND TRIANGLES ARE BLUE. THE TWO RECTANGLES ON EITHER SIDE OF THE RED RECTANGLE ARE BLUE. UNDERNEATH EACH BLUE RECTANGLE ARE TWO BLUE TRIANGLES MAKING THE BASE OF THE BIG TRIANGLE.

SER. NO. 77-226,798, FILED 7-11-2007.

AMY GEARIN, EXAMINING ATTORNEY

**Int. Cl.: 35**

**Prior U.S. Cls.: 100, 101 and 102**

**United States Patent and Trademark Office**

**Reg. No. 3,394,603**

**Registered Mar. 11, 2008**

**SERVICE MARK  
PRINCIPAL REGISTER**



CALIFORNIA ASSOCIATION OF HIGHWAY PATROLMEN (CALIFORNIA CORPORATION)  
2030 V STREET  
SACRAMENTO, CA 95762

FOR: LABOR UNIONS, IN CLASS 35 (U.S. CLS. 100, 101 AND 102).

FIRST USE 8-25-1920; IN COMMERCE 8-25-1920.

NO CLAIM IS MADE TO THE EXCLUSIVE RIGHT TO USE "CALIFORNIA ASS'N OF HIGHWAY PATROLMEN", APART FROM THE MARK AS SHOWN.

THE COLOR(S) BLUE, GOLD, BLACK AND WHITE IS/ARE CLAIMED AS A FEATURE OF THE MARK.

THE LETTERING IS GOLD AGAINST A BLUE BACKGROUND WITH GOLD AND BLACK PERIMETER LINES TO THE BACKGROUND. THE TIRE, WHEEL AND WINGS ARE BLACK WITH WHITE SHADING TO SHOW DETAIL.

SER. NO. 77-226,845, FILED 7-11-2007.

IRA J. GOODSaid, EXAMINING ATTORNEY



**Int. Cl.: 40**

**Prior U.S. Cls.: 100, 103 and 106**

**United States Patent and Trademark Office**

**Reg. No. 3,394,604**

**Registered Mar. 11, 2008**

---

**SERVICE MARK  
PRINCIPAL REGISTER**

# Spirit Bay

EMERALD COAST EXECUTIVE CHARTERS,  
INC. (FLORIDA CORPORATION)  
SUITE 230  
4300 LEGENDARY DRIVE  
DESTIN, FL 32541

THE MARK CONSISTS OF STANDARD CHAR-  
ACTERS WITHOUT CLAIM TO ANY PARTICULAR  
FONT, STYLE, SIZE, OR COLOR.

FOR: MANUFACTURING SERVICES FOR OTH-  
ERS IN THE FIELD OF BOATS, IN CLASS 40 (U.S.  
CLS. 100, 103 AND 106).

SER. NO. 77-226,847, FILED 7-11-2007.

FIRST USE 12-1-1970; IN COMMERCE 12-1-1970.

DAWN HAN, EXAMINING ATTORNEY

**Int. Cl.: 9**

**Prior U.S. Cls.: 21, 23, 26, 36 and 38**

**United States Patent and Trademark Office**

**Reg. No. 3,394,605**

**Registered Mar. 11, 2008**

**TRADEMARK  
PRINCIPAL REGISTER**

**TARIFFCONNECT**

BOURQUE DATA SYSTEMS, INC. (TEXAS CORPORATION)  
1610 WOODSTEAD COURT, SUITE 220  
THE WOODLANDS, TX 77380

FOR: SOFTWARE FOR INTEGRATION OF PUBLISHED RATES FOR SHIPPING AND TRANSPORTATION AND RELATED SHIPPING AND TRANSPORTATION PRICING WITH FREIGHT COSTING SYSTEMS OF SHIPPERS, IN CLASS 9 (U.S. CLS. 21, 23, 26, 36 AND 38).

FIRST USE 5-0-2005; IN COMMERCE 5-0-2005.

THE MARK CONSISTS OF STANDARD CHARACTERS WITHOUT CLAIM TO ANY PARTICULAR FONT, STYLE, SIZE, OR COLOR.

SER. NO. 77-226,850, FILED 7-11-2007.

JENNY PARK, EXAMINING ATTORNEY

**Int. Cl.: 42**

**Prior U.S. Cls.: 100 and 101**

**United States Patent and Trademark Office**

**Reg. No. 3,394,606**

**Registered Mar. 11, 2008**

**SERVICE MARK  
PRINCIPAL REGISTER**

**NAVMAP**

APEX, LLC (RHODE ISLAND LTD LIAB CO)  
100 MAIN STREET  
PAWTUCKET, RI 02860

FIRST USE 7-5-2007; IN COMMERCE 7-5-2007.

FOR: COMPUTER SERVICES, NAMELY, CREATING INDEXES OF INFORMATION, SITES AND OTHER RESOURCES AVAILABLE ON COMPUTER NETWORKS; COMPUTER SERVICES, NAMELY, PROVIDING SEARCH ENGINES FOR OBTAINING DATA ON A GLOBAL COMPUTER NETWORK, IN CLASS 42 (U.S. CLS. 100 AND 101).

THE MARK CONSISTS OF STANDARD CHARACTERS WITHOUT CLAIM TO ANY PARTICULAR FONT, STYLE, SIZE, OR COLOR.

SER. NO. 77-226,856, FILED 7-11-2007.

CHRISTINA SOBRAL, EXAMINING ATTORNEY

Int. Cl.: 36

Prior U.S. Cls.: 100, 101 and 102

**United States Patent and Trademark Office**

**Reg. No. 3,394,607**

Registered Mar. 11, 2008

**SERVICE MARK  
PRINCIPAL REGISTER**

**TheHealthQuote.com**

TRICOR FINANCIAL GROUP INC. (CALIFORNIA CORPORATION)  
101 PACIFICA #255  
IRVINE, CA 92618

FOR: INSURANCE BROKERAGE IN THE FIELD OF INDIVIDUAL & FAMILY HEALTH INSURANCE, KIDS HEALTH INSURANCE, STUDENT HEALTH INSURANCE, MEDICARE SUPPLEMENTS INSURANCE, SMALL BUSINESS HEALTH INSURANCE, LIFE INSURANCE, DENTAL & VI-

SION, AND TRAVEL HEALTH INSURANCE, IN CLASS 36 (U.S. CLS. 100, 101 AND 102).

FIRST USE 3-12-2005; IN COMMERCE 4-12-2005.

THE MARK CONSISTS OF THE WORDS THE-HEALTHQUOTE.COM IN A STYLIZED TEXT.

SER. NO. 77-226,864, FILED 7-11-2007.

GEOFFREY FOSDICK, EXAMINING ATTORNEY

**Int. Cl.: 25**

**Prior U.S. Cls.: 22 and 39**

**United States Patent and Trademark Office**

**Reg. No. 3,394,608**

**Registered Mar. 11, 2008**

**TRADEMARK  
PRINCIPAL REGISTER**

**HOUSE OF DREAD**

BLOISE, VICTOR (JAMAICA INDIVIDUAL)  
751 WYONA STREET  
BROOKLYN, NY 11207

THE MARK CONSISTS OF STANDARD CHAR-  
ACTERS WITHOUT CLAIM TO ANY PARTICULAR  
FONT, STYLE, SIZE, OR COLOR.

FOR: CAPS; DRESS SHIRTS; DRESSES; HATS;  
JACKETS; JEANS; SHIRTS; SKIRTS; SNEAKERS;  
SOCKS; SWEAT SHIRTS; SWEAT SUITS; T-SHIRTS;  
SHORTS, IN CLASS 25 (U.S. CLS. 22 AND 39).

SER. NO. 77-226,924, FILED 7-11-2007.

FIRST USE 7-0-2000; IN COMMERCE 7-0-2007.

KELLY CHOE, EXAMINING ATTORNEY

**Int. Cl.: 5**

**Prior U.S. Cls.: 6, 18, 44, 46, 51 and 52**

**United States Patent and Trademark Office**

**Reg. No. 3,394,609**

**Registered Mar. 11, 2008**

**TRADEMARK  
PRINCIPAL REGISTER**

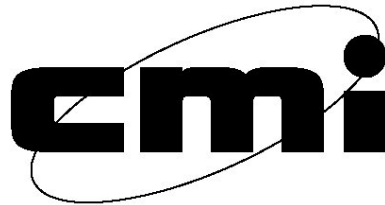

CELLULAR METABOLIC INNOVATIONS, INC.  
(DELAWARE CORPORATION)  
1953 NW 72ND WAY  
PEMBROKE PINES, FL 33024

FIRST USE 1-0-2006; IN COMMERCE 1-0-2006.

SER. NO. 77-226,939, FILED 7-11-2007.

FOR: NUTRITIONAL SUPPLEMENTS, IN CLASS  
5 (U.S. CLS. 6, 18, 44, 46, 51 AND 52).

MIDGE BUTLER, EXAMINING ATTORNEY

**Int. Cls.: 9 and 42**

**Prior U.S. Cls.: 21, 23, 26, 36, 38, 100 and 101**

**United States Patent and Trademark Office**

**Reg. No. 3,394,610**

**Registered Mar. 11, 2008**

**TRADEMARK  
SERVICE MARK  
PRINCIPAL REGISTER**

# PLANISWARE

PLANISWARE USA, INC. (CALIFORNIA CORPORATION)  
SUITE 790  
300 MONTGOMERY STREET  
SAN FRANCISCO, CA 94140

FOR: COMPUTER SOFTWARE FEATURING EXPERT PLANNING PROGRAMS FOR USE IN THE FIELD OF PROJECT MANAGEMENT, MAINTENANCE PLANNING AND RESOURCE ALLOCATION, IN CLASS 9 (U.S. CLS. 21, 23, 26, 36 AND 38).

FIRST USE 1-2-1996; IN COMMERCE 1-2-1996.

FOR: COMPUTER SOFTWARE DESIGN FOR OTHERS, NAMELY, DEVELOPING DATA PROCES-

SING PROGRAMS FOR USE IN EXPERT PLANNING PROJECT MANAGEMENT, MAINTENANCE PLANNING AND RESOURCE ALLOCATION, AND SOFTWARE IN CONJUNCTION THEREWITH, IN CLASS 42 (U.S. CLS. 100 AND 101).

FIRST USE 1-2-1996; IN COMMERCE 1-2-1996.

THE MARK CONSISTS OF STANDARD CHARACTERS WITHOUT CLAIM TO ANY PARTICULAR FONT, STYLE, SIZE, OR COLOR.

SER. NO. 77-226,956, FILED 7-11-2007.

BONNIE LUKEN, EXAMINING ATTORNEY

**Int. Cl.: 33**

**Prior U.S. Cls.: 47 and 49**

**United States Patent and Trademark Office**

**Reg. No. 3,394,611**

**Registered Mar. 11, 2008**

**TRADEMARK  
PRINCIPAL REGISTER**

**SINFUSION**

SEVILLE OPERATIONS LLC (MINNESOTA LTD  
LIAB CO)  
15 GLENWOOD AVENUE NORTH  
MINNEAPOLIS, MN 55403

THE MARK CONSISTS OF STANDARD CHAR-  
ACTERS WITHOUT CLAIM TO ANY PARTICULAR  
FONT, STYLE, SIZE, OR COLOR.

FOR: ALCOHOLIC BEVERAGE, NAMELY, VOD-  
KA INFUSED WITH FRESH FRUIT, IN CLASS 33  
(U.S. CLS. 47 AND 49).

SER. NO. 77-227,012, FILED 7-11-2007.

FIRST USE 3-25-2006; IN COMMERCE 3-25-2006.

ALEX KEAM, EXAMINING ATTORNEY



**Int. Cl.: 21**

**Prior U.S. Cls.: 2, 13, 23, 29, 30, 33, 40 and 50**

**United States Patent and Trademark Office**

**Reg. No. 3,394,612**

**Registered Mar. 11, 2008**

**TRADEMARK  
PRINCIPAL REGISTER**

**spray-roll**

MOORE, ALBERT E. (CANADA INDIVIDUAL)  
215 CH. GRAND PRE L'ACADIE CSP 10027  
ST-JEAN-SUR-RICHELIEU, CANADA J2Y1J6

THE MARK CONSISTS OF STANDARD CHAR-  
ACTERS WITHOUT CLAIM TO ANY PARTICULAR  
FONT, STYLE, SIZE, OR COLOR.

FOR: DISPENSERS FOR PAPER TOWELS, IN  
CLASS 21 (U.S. CLS. 2, 13, 23, 29, 30, 33, 40 AND 50).

SER. NO. 77-227,014, FILED 7-11-2007.

FIRST USE 7-1-2006; IN COMMERCE 7-1-2007.

JIM RINGLE, EXAMINING ATTORNEY

**Int. Cl.: 9**

**Prior U.S. Cls.: 21, 23, 26, 36 and 38**

**United States Patent and Trademark Office**

**Reg. No. 3,394,613**

**Registered Mar. 11, 2008**

**TRADEMARK  
PRINCIPAL REGISTER**

# Web Warrior

WEB WARRIOR, INC. (FLORIDA CORPORATION)  
67 S. DILLARD STREET  
WINTER GARDEN, FL 34787

FOR: SECURITY RELATED PRODUCTS, NAME-  
LY, CAMERAS, DIGITAL VIDEO RECORDERS,  
ACCESS CONTROL SYSTEMS, POWER SUPPLIES,  
ELECTRIC CABLES AND ELECTRIC CONNec-  
TORS, IN CLASS 9 (U.S. CLS. 21, 23, 26, 36 AND 38).

FIRST USE 3-30-2003; IN COMMERCE 3-30-2003.

THE MARK CONSISTS OF STANDARD CHAR-  
ACTERS WITHOUT CLAIM TO ANY PARTICULAR  
FONT, STYLE, SIZE, OR COLOR.

SER. NO. 77-227,030, FILED 7-11-2007.

ALEX KEAM, EXAMINING ATTORNEY

**Int. Cl.: 16**

**Prior U.S. Cls.: 2, 5, 22, 23, 29, 37, 38 and 50**

**United States Patent and Trademark Office**

**Reg. No. 3,394,614**

**Registered Mar. 11, 2008**

**TRADEMARK  
PRINCIPAL REGISTER**

**MINX**

MINX (NEW YORK PARTNERSHIP)  
1700 BROADWAY  
NEW YORK, NY 10019

THE MARK CONSISTS OF STANDARD CHAR-  
ACTERS WITHOUT CLAIM TO ANY PARTICULAR  
FONT, STYLE, SIZE, OR COLOR.

FOR: PRINTED PUBLICATIONS, NAMELY,  
GRAPHIC NOVELS, IN CLASS 16 (U.S. CLS. 2, 5, 22,  
23, 29, 37, 38 AND 50).

SER. NO. 77-227,035, FILED 7-11-2007.

FIRST USE 5-16-2007; IN COMMERCE 5-16-2007.

ALEX KEAM, EXAMINING ATTORNEY

**Int. Cl.: 44**

**Prior U.S. Cls.: 100 and 101**

**United States Patent and Trademark Office**

**Reg. No. 3,394,615**

**Registered Mar. 11, 2008**

**SERVICE MARK  
PRINCIPAL REGISTER**



KANSAS CITY UNIVERSITY OF MEDICINE  
AND BIOSCIENCES (MISSOURI NON-PROFIT  
CORPORATION)  
1750 INDEPENDENCE AVENUE  
KANSAS CITY, MO 64106

FOR: CONDUCTING HEALTH SCREENINGS OF  
ELEMENTARY SCHOOL CHILDREN AND PRO-  
VIDING THE RESULTS OF SUCH SCREENINGS TO  
PARENTS, SCHOOLS, RESEARCHERS, AND THE  
COMMUNITY BY WAY OF LETTERS, PERSONAL  
CONTACTS, WRITTEN REPORTS, STATISTICAL  
SUMMARIES, AND EXPLANATORY ANALYZES,  
IN CLASS 44 (U.S. CLS. 100 AND 101).

FIRST USE 0-0-2000; IN COMMERCE 0-0-2000.

NO CLAIM IS MADE TO THE EXCLUSIVE  
RIGHT TO USE "HEALTH", APART FROM THE  
MARK AS SHOWN.

THE MARK CONSISTS OF SEMICIRCULAR  
BANDS, ONE ABOVE THE OTHER, WITH A 1  
CENTERED THEREIN TRIANGULAR SHAPES  
ABOVE THE UPPER SEMICIRCULAR BANDS.

SER. NO. 77-227,069, FILED 7-11-2007.

DAWN FELDMAN, EXAMINING ATTORNEY

**Int. Cl.: 44**

**Prior U.S. Cls.: 100 and 101**

**United States Patent and Trademark Office**

**Reg. No. 3,394,616**

**Registered Mar. 11, 2008**

**SERVICE MARK  
PRINCIPAL REGISTER**

**SCORE 1 FOR HEALTH**

KANSAS CITY UNIVERSITY OF MEDICINE  
AND BIOSCIENCES (MISSOURI NON-PROFIT  
CORPORATION)  
1750 INDEPENDENCE AVENUE  
INDEPENDENCE, MO 64106

FOR: CONDUCTING HEALTH SCREENINGS OF  
ELEMENTARY SCHOOL CHILDREN AND PRO-  
VIDING THE RESULTS OF SUCH SCREENINGS TO  
PARENTS, SCHOOLS, RESEARCHERS, AND THE  
COMMUNITY BY WAY OF LETTERS, PERSONAL  
CONTACTS, WRITTEN REPORTS, STATISTICAL  
SUMMARIES, AND EXPLANATORY ANALYSES,  
IN CLASS 44 (U.S. CLS. 100 AND 101).

FIRST USE 0-0-1993; IN COMMERCE 0-0-1993.

THE MARK CONSISTS OF STANDARD CHAR-  
ACTERS WITHOUT CLAIM TO ANY PARTICULAR  
FONT, STYLE, SIZE, OR COLOR.

NO CLAIM IS MADE TO THE EXCLUSIVE  
RIGHT TO USE "HEALTH", APART FROM THE  
MARK AS SHOWN.

SER. NO. 77-227,099, FILED 7-11-2007.

DAWN FELDMAN, EXAMINING ATTORNEY

**Int. Cl.: 35**

**Prior U.S. Cls.: 100, 101 and 102**

**United States Patent and Trademark Office**

**Reg. No. 3,394,617**

**Registered Mar. 11, 2008**

**SERVICE MARK  
PRINCIPAL REGISTER**

WE'LL BEAT YOUR BEST DEAL  
REGARDLESS

BUTCH OUTSTALET, INC. (MISSISSIPPI COR-  
PORATION)  
9274 HWY 49  
GULFPORT, MS 35203

THE MARK CONSISTS OF STANDARD CHAR-  
ACTERS WITHOUT CLAIM TO ANY PARTICULAR  
FONT, STYLE, SIZE, OR COLOR.

FOR: AUTOMOBILE DEALERSHIPS, IN CLASS 35  
(U.S. CLS. 100, 101 AND 102).

SER. NO. 77-227,104, FILED 7-11-2007.

FIRST USE 1-19-1989; IN COMMERCE 1-19-1989.

DAWN FELDMAN, EXAMINING ATTORNEY

**Int. Cl.: 19**

**Prior U.S. Cls.: 1, 12, 33 and 50**

**United States Patent and Trademark Office**

**Reg. No. 3,394,618**

**Registered Mar. 11, 2008**

---

**TRADEMARK  
PRINCIPAL REGISTER**

**Sinu**

OCEANSIDE GLASSTILE COMPANY DBA MAN-  
DALA (CALIFORNIA CORPORATION)  
ATTN: ROBIN  
2293 COSMOS COURT  
CARLSBAD, CA 92011

THE MARK CONSISTS OF STANDARD CHAR-  
ACTERS WITHOUT CLAIM TO ANY PARTICULAR  
FONT, STYLE, SIZE, OR COLOR.

FOR: CERAMIC TILE FOR COMMERCIAL AND  
RESIDENTIAL USE ON WALLS AND COUNTER-  
TOPS, IN CLASS 19 (U.S. CLS. 1, 12, 33 AND 50).

SER. NO. 77-227,113, FILED 7-11-2007.

FIRST USE 4-17-2007; IN COMMERCE 5-14-2007.

CAROLINE WOOD, EXAMINING ATTORNEY

**Int. Cl.: 19**

**Prior U.S. Cls.: 1, 12, 33 and 50**

**United States Patent and Trademark Office**

**Reg. No. 3,394,619**

**Registered Mar. 11, 2008**

**TRADEMARK  
PRINCIPAL REGISTER**

**Etrusco**

OCEANSIDE GLASSTILE COMPANY (CALIFORNIA CORPORATION), DBA MANDALA  
ATTN: ROBIN KUNDERT  
2293 COSMOS COURT  
CARLSBAD, CA 92011

FOR: STONE TILES FOR COMMERCIAL AND RESIDENTIAL USE ON WALLS, FLOORS AND COUNTERTOPS, IN CLASS 19 (U.S. CLS. 1, 12, 33 AND 50).

FIRST USE 4-17-2007; IN COMMERCE 5-14-2007.

THE MARK CONSISTS OF STANDARD CHARACTERS WITHOUT CLAIM TO ANY PARTICULAR FONT, STYLE, SIZE, OR COLOR.

THE ENGLISH TRANSLATION OF THE WORD ETRUSCO IN THE MARK IS ETRUSCAN.

SER. NO. 77-227,116, FILED 7-11-2007.

CAROLINE WOOD, EXAMINING ATTORNEY



**Int. Cl.: 42**

**Prior U.S. Cls.: 100 and 101**

**United States Patent and Trademark Office**

**Reg. No. 3,394,620**

**Registered Mar. 11, 2008**

**SERVICE MARK  
PRINCIPAL REGISTER**

**ELEVATE**

GINGERBREAD SHED CORPORATION (DELA-  
WARE CORPORATION)  
930 S MILL AVENUE  
TEMPE, AZ 85281

FOR: APPLICATION SERVICE PROVIDER (ASP)  
FEATURING SOFTWARE FOR USE CONSISTING  
OF WEB BASED EVENT TICKETING AND REGIS-  
TRATION SERVICES, IN CLASS 42 (U.S. CLS. 100  
AND 101).

FIRST USE 6-13-1996; IN COMMERCE 8-25-2006.

THE MARK CONSISTS OF STANDARD CHAR-  
ACTERS WITHOUT CLAIM TO ANY PARTICULAR  
FONT, STYLE, SIZE, OR COLOR.

SER. NO. 77-227,126, FILED 7-11-2007.

CAROLINE WOOD, EXAMINING ATTORNEY

**Int. Cl.: 41**

**Prior U.S. Cls.: 100, 101 and 107**

**United States Patent and Trademark Office**

**Reg. No. 3,394,621**

**Registered Mar. 11, 2008**

**SERVICE MARK  
PRINCIPAL REGISTER**



DEPARTMENT OF DEFENSE (UNITED STATES  
AGENCY OF THE UNITED STATES GOVERN-  
MENT)

TRICARE MGT ACTIVITY, 5111 LEESBURG PIKE  
FALLS CHURCH, VA 22041

FOR: EDUCATION SERVICES, NAMELY, PRO-  
VIDING PRINTED AND ON-LINE INFORMATION,  
PUBLIC SERVICE VIDEOS AND EDUCATIONAL  
MATERIALS IN THE FIELD OF THE EFFECTS OF  
ALCOHOL CONSUMPTION, IN CLASS 41 (U.S. CLS.  
100, 101 AND 107).

FIRST USE 12-1-2006; IN COMMERCE 12-1-2006.

THE MARK CONSISTS OF THE UNIVERSAL "DO  
NOT ENTER" SYMBOL FORMED FROM A CIRCLE  
WITH A STRAIGHT LINE DRAWN AT AN ANGLE  
FROM OF TOP OF THE CIRCLE TO THE BOTTOM.  
THE STACKED WORDS THAT GUY ARE PRINTED  
IN BLOCK CAPITAL LETTER IN FRONT OF THE  
CIRCLE COVERING THE RIGHT AND LEFT SIDES  
OF THE CIRCLE, BUT BEHIND THE LINE GOING  
THROUGH THE CIRCLE. THE CIRCLE AND LINE  
ALL CONTAIN SMALL ROUND LIGHT COLORED  
CIRCLES SIMULATING LIGHTS.

SER. NO. 77-227,138, FILED 7-11-2007.

JANET LEE, EXAMINING ATTORNEY

**Int. Cl.: 44**

**Prior U.S. Cls.: 100 and 101**

**United States Patent and Trademark Office**

**Reg. No. 3,394,622**

**Registered Mar. 11, 2008**

**SERVICE MARK  
PRINCIPAL REGISTER**

**PREMIER ALLERGY & ASTHMA**

PREMIER ALLERGY & ASTHMA (COLORADO  
CORPORATION)  
SUITE C  
18525 E. SMOKY HILL ROAD  
AURORA, CO 80015

FOR: MEDICAL SERVICES, NAMELY, TREAT-  
MENT OF ALLERGIES AND ASTHMA, IN CLASS 44  
(U.S. CLS. 100 AND 101).

FIRST USE 8-1-2004; IN COMMERCE 8-1-2004.

THE MARK CONSISTS OF STANDARD CHAR-  
ACTERS WITHOUT CLAIM TO ANY PARTICULAR  
FONT, STYLE, SIZE, OR COLOR.

NO CLAIM IS MADE TO THE EXCLUSIVE  
RIGHT TO USE "ALLERGY & ASTHMA", APART  
FROM THE MARK AS SHOWN.

SER. NO. 77-227,195, FILED 7-11-2007.

DAVID COLLIER, EXAMINING ATTORNEY

**Int. Cl.: 43**

**Prior U.S. Cls.: 100 and 101**

**United States Patent and Trademark Office**

**Reg. No. 3,394,623**

**Registered Mar. 11, 2008**

**SERVICE MARK  
PRINCIPAL REGISTER**

**OLE FEED HOUSE**

THE OLE FEED HOUSE OF TEXARKANA, INC.  
(ARKANSAS CORPORATION)  
1514 ARKANSAS BLVD.  
TEXARKANA, AR 71854

THE MARK CONSISTS OF STANDARD CHAR-  
ACTERS WITHOUT CLAIM TO ANY PARTICULAR  
FONT, STYLE, SIZE, OR COLOR.

FOR: CAFE-RESTAURANTS, IN CLASS 43 (U.S.  
CLS. 100 AND 101).

SER. NO. 77-227,201, FILED 7-11-2007.

FIRST USE 12-7-1986; IN COMMERCE 12-7-1986.

DAVID COLLIER, EXAMINING ATTORNEY

**Int. Cl.: 35**

**Prior U.S. Cls.: 100, 101 and 102**

**United States Patent and Trademark Office**

**Reg. No. 3,394,624**

**Registered Mar. 11, 2008**

**SERVICE MARK  
PRINCIPAL REGISTER**

**Pleasure of the Month Club**

PLEASURE OF THE MONTH CLUB, LLC (ILLI-  
NOIS LTD LIAB CO)  
8700 W. BRYN MAWR AVE. SUITE 800 S  
CHICAGO, IL 60622

FOR: ONLINE RETAIL STORE SERVICES IN THE  
FIELD OF ADULT SEXUAL AIDS PROVIDED TO  
CONSUMERS, IN CLASS 35 (U.S. CLS. 100, 101 AND  
102).

FIRST USE 4-20-2007; IN COMMERCE 5-16-2007.

THE MARK CONSISTS OF STANDARD CHAR-  
ACTERS WITHOUT CLAIM TO ANY PARTICULAR  
FONT, STYLE, SIZE, OR COLOR.

NO CLAIM IS MADE TO THE EXCLUSIVE  
RIGHT TO USE "CLUB", APART FROM THE MARK  
AS SHOWN.

SER. NO. 77-227,206, FILED 7-11-2007.

DAVID COLLIER, EXAMINING ATTORNEY

**Int. Cls.: 9 and 16**

**Prior U.S. Cls.: 2, 5, 21, 22, 23, 26, 29, 36, 37, 38 and 50**

**United States Patent and Trademark Office**

**Reg. No. 3,394,625**

**Registered Mar. 11, 2008**

**TRADEMARK  
PRINCIPAL REGISTER**

**TAI-CHI-ONE**

MAYOPIA PRODUCTIONS, LLC (MARYLAND  
LTD LIAB CO)  
12 SOUTH DURHAM STREET  
BALTIMORE, MD 212311805

FOR: AUDIO AND VIDEO RECORDINGS FEATURING TAI CHI CHUAN INSTRUCTION, IN CLASS 9 (U.S. CLS. 21, 23, 26, 36 AND 38).

FIRST USE 11-25-1993; IN COMMERCE 11-25-1993.

FOR: PRINTED INSTRUCTIONAL, EDUCATIONAL, AND TEACHING MATERIALS IN THE FIELD OF TAI CHI CHUAN, IN CLASS 16 (U.S. CLS. 2, 5, 22, 23, 29, 37, 38 AND 50).

FIRST USE 11-25-1993; IN COMMERCE 11-25-1993.

THE MARK CONSISTS OF STANDARD CHARACTERS WITHOUT CLAIM TO ANY PARTICULAR FONT, STYLE, SIZE, OR COLOR.

SEC. 2(F).

SER. NO. 77-227,245, FILED 7-11-2007.

LAURA KOVALSKY, EXAMINING ATTORNEY

**Int. Cls.: 35 and 42**

**Prior U.S. Cls.: 100, 101 and 102**

**United States Patent and Trademark Office**

**Reg. No. 3,394,626**

**Registered Mar. 11, 2008**

**SERVICE MARK  
PRINCIPAL REGISTER**

**IDIZ**

IDIZ, INCORPORATED (INDIANA CORPORATION)  
8021 CASTLETON ROAD  
INDIANAPOLIS, IN 46250

FOR: ADVERTISING AND MARKETING, IN CLASS 35 (U.S. CLS. 100, 101 AND 102).

FIRST USE 3-2-2007; IN COMMERCE 3-2-2007.

FOR: GRAPHIC DESIGN SERVICES, IN CLASS 42 (U.S. CLS. 100 AND 101).

FIRST USE 3-2-2007; IN COMMERCE 3-2-2007.

THE MARK CONSISTS OF STANDARD CHARACTERS WITHOUT CLAIM TO ANY PARTICULAR FONT, STYLE, SIZE, OR COLOR.

SER. NO. 77-227,249, FILED 7-11-2007.

MATTHEW EINSTEIN, EXAMINING ATTORNEY

**Int. Cl.: 16**

**Prior U.S. Cls.: 2, 5, 22, 23, 29, 37, 38 and 50**

**United States Patent and Trademark Office**

**Reg. No. 3,394,627**

**Registered Mar. 11, 2008**

**TRADEMARK  
PRINCIPAL REGISTER**

**MACHINEPLUS**

PACKAGING MACHINERY MANUFACTURERS  
INSTITUTE (VIRGINIA CORPORATION)  
SUITE 600  
4350 NORTH FAIRFAX DRIVE  
ARLINGTON, VA 22203

FOR: PRINTED PUBLICATIONS, NAMELY,  
PAMPHLETS, BROCHURES, REPORTS, BOOK-  
LETS, BOOKS, BULLETINS, MANUALS, INFORMA-  
TIONAL FLYERS, INFORMATIONAL SHEETS,  
LEAFLETS, MONOGRAPHS, GUIDES, INFORMA-  
TIONAL CARDS, PRINTED TEACHING MATERI-  
ALS, QUESTIONNAIRES AND WORKBOOKS IN  
THE FIELD OF PACKAGING MACHINERY BUSI-

NESS STRATEGY AND PRACTICES, IN CLASS 16  
(U.S. CLS. 2, 5, 22, 23, 29, 37, 38 AND 50).

FIRST USE 4-0-2007; IN COMMERCE 4-0-2007.

THE MARK CONSISTS OF STANDARD CHAR-  
ACTERS WITHOUT CLAIM TO ANY PARTICULAR  
FONT, STYLE, SIZE, OR COLOR.

SER. NO. 77-227,289, FILED 7-11-2007.

JANICE L. MCMORROW, EXAMINING ATTOR-  
NEY



**Int. Cl.: 45**

**Prior U.S. Cls.: 100 and 101**

**United States Patent and Trademark Office**

**Reg. No. 3,394,628**

**Registered Mar. 11, 2008**

**SERVICE MARK  
PRINCIPAL REGISTER**



DALES, JEFFREY M. (UNITED STATES INDIVIDUAL), DBA SWEETONGEEKS.COM  
85 LAKEVIEW DR.  
NOTTINGHAM, NH 03290

FOR: INTERNET BASED SOCIAL NETWORKING, INTRODUCTION, AND DATING SERVICES, IN CLASS 45 (U.S. CLS. 100 AND 101).

FIRST USE 5-1-2006; IN COMMERCE 5-1-2006.

THE COLOR(S) WHITE, BLACK AND RED IS/ARE CLAIMED AS A FEATURE OF THE MARK.

THE MARK CONSISTS OF A WHITE BACKGROUND WITH A BLACK LOGO DEPICTING A HAIRLINE AND PAIR OF GLASSES TO THE LEFT OF THE MARK'S TEXT. THE TEXT CONSISTS OF THE WORDS "SWEET ON GEEKS" IN RED ABOVE THE TEXT "A DATING SPACE WHERE GRAY MATTERS" IN BLACK.

SER. NO. 77-227,342, FILED 7-11-2007.

TASNEEM HUSSAIN, EXAMINING ATTORNEY

**Int. Cls.: 36 and 37**

**Prior U.S. Cls.: 100, 101, 102, 103 and 106**

**United States Patent and Trademark Office**

**Reg. No. 3,394,629**

**Registered Mar. 11, 2008**

**SERVICE MARK  
PRINCIPAL REGISTER**



RUBLOFF INC. (DELAWARE CORPORATION)  
SUITE 500  
130 S. JEFFERSON  
CHICAGO, IL 60661

FOR: APPRAISAL OF REAL ESTATE; ASSESSMENT AND MANAGEMENT OF REAL ESTATE; EVALUATION OF REAL PROPERTY; FINANCIAL VALUATION OF PERSONAL PROPERTY AND REAL ESTATE; HOUSING SERVICES, NAMELY, REAL PROPERTY ACQUISITION AND CONSUMER FINANCING TO FACILITATE HOME OWNERSHIP; LAND ACQUISITION, NAMELY, REAL ESTATE BROKERAGE; LEASING OF REAL ESTATE; LEASING OF REAL PROPERTY; PROVIDING INFORMATION IN THE FIELD OF REAL ESTATE BY MEANS OF LINKING THE WEB SITE TO OTHER WEB SITES FEATURING REAL ESTATE INFORMATION; PROVIDING INFORMATION IN THE FIELD OF REAL ESTATE VIA THE INTERNET; PROVIDING REAL ESTATE LISTINGS AND REAL ESTATE INFORMATION VIA THE INTERNET; REAL ESTATE ACQUISITION SERVICES; REAL ESTATE AGENCIES; REAL ESTATE APPRAISAL; REAL ESTATE BROKERAGE; REAL ESTATE CONSULTANCY; REAL ESTATE CONSULTATION; REAL ESTATE INVESTMENT; REAL ESTATE INVESTMENT SERVICES IN THE NATURE OF PURCHASING AND SELLING OF REAL ESTATE FOR

OTHERS; REAL ESTATE LISTING; REAL ESTATE MANAGEMENT; REAL ESTATE MANAGEMENT CONSULTATION; REAL ESTATE PROCUREMENT FOR OTHERS; REAL ESTATE VALUATION SERVICES; REAL ESTATE VALUATIONS, IN CLASS 36 (U.S. CLS. 100, 101 AND 102).

FIRST USE 11-1-1983; IN COMMERCE 11-1-1983.

FOR: REAL ESTATE DEVELOPMENT; REAL ESTATE SITE SELECTION; HOUSING SERVICES, NAMELY, DEVELOPMENT OF REAL PROPERTY, NAMELY, REPAIR, IMPROVEMENT, AND NEW CONSTRUCTION; HOUSING SERVICES, NAMELY, REPAIR, IMPROVEMENT, AND CONSTRUCTION OF RESIDENTIAL REAL PROPERTY; CONSTRUCTION, MAINTENANCE AND RENOVATION OF PROPERTY, IN CLASS 37 (U.S. CLS. 100, 103 AND 106).

FIRST USE 11-1-1983; IN COMMERCE 11-1-1983.

THE MARK CONSISTS OF OCTOGONAL POLYGON SITTING ON TOP OF ANOTHER POLYGON NEXT TO THE WORD RUBLOFF.

SER. NO. 77-227,408, FILED 7-11-2007.

EDWARD NELSON, EXAMINING ATTORNEY

**Int. Cl.: 41**

**Prior U.S. Cls.: 100, 101 and 107**

**United States Patent and Trademark Office**

**Reg. No. 3,394,630**

**Registered Mar. 11, 2008**

**SERVICE MARK  
PRINCIPAL REGISTER**

**PMTO**

IMPLEMENTATION SCIENCES INTERNATIONAL, INC. (OREGON CORPORATION)  
10 SHELTON MCMURPHEY BLVD.  
EUGENE, OR 97401

FOR: EDUCATIONAL SERVICES, NAMELY, CONDUCTING PROGRAMS, COURSES, CLASSES AND WORKSHOPS FOR THERAPISTS AND OTHER MENTAL HEALTH PROFESSIONALS IN THE FIELD OF PARENTING SKILLS AND BEHAVIOR MANAGEMENT OF CHILDREN, IN CLASS 41 (U.S. CLS. 100, 101 AND 107).

FIRST USE 6-1-2004; IN COMMERCE 6-1-2004.

THE MARK CONSISTS OF STANDARD CHARACTERS WITHOUT CLAIM TO ANY PARTICULAR FONT, STYLE, SIZE, OR COLOR.

SER. NO. 77-227,426, FILED 7-11-2007.

KAPIL BHANOT, EXAMINING ATTORNEY

**Int. Cl.: 43**

**Prior U.S. Cls.: 100 and 101**

**United States Patent and Trademark Office**

**Reg. No. 3,394,631**

**Registered Mar. 11, 2008**

**SERVICE MARK  
PRINCIPAL REGISTER**

**POINT. CLICK. CHILL...**

STATION CASINOS, INC. (NEVADA CORPORATION)  
10973 WEST SUMMERLIN CENTRE DRIVE  
LAS VEGAS, NV 89135

FOR: RESORT HOTELS; RESORT LODGING SERVICES; TRAVEL AGENCY SERVICES, NAME-  
LY, MAKING RESERVATIONS AND BOOKINGS  
FOR RESTAURANTS AND MEALS, IN CLASS 43  
(U.S. CLS. 100 AND 101).

FIRST USE 6-0-2007; IN COMMERCE 6-0-2007.

THE MARK CONSISTS OF STANDARD CHAR-  
ACTERS WITHOUT CLAIM TO ANY PARTICULAR  
FONT, STYLE, SIZE, OR COLOR.

SER. NO. 77-227,486, FILED 7-11-2007.

KELLY CHOE, EXAMINING ATTORNEY

**Int. Cl.: 30**

**Prior U.S. Cl.: 46**

**United States Patent and Trademark Office**

**Reg. No. 3,394,632**

**Registered Mar. 11, 2008**

**TRADEMARK  
PRINCIPAL REGISTER**

# Aunt Cake's Cookies

AUNT CAKES COOKIES LLC (NEW JERSEY LTD  
LIAB CO)  
25 LOUIS DRIVE  
MONTVILLE, NJ 07045

NO CLAIM IS MADE TO THE EXCLUSIVE  
RIGHT TO USE "COOKIES", APART FROM THE  
MARK AS SHOWN.

FOR: COOKIES, IN CLASS 30 (U.S. CL. 46).

FIRST USE 5-1-2007; IN COMMERCE 5-1-2007.

SER. NO. 77-227,520, FILED 7-11-2007.

THE MARK CONSISTS OF STANDARD CHAR-  
ACTERS WITHOUT CLAIM TO ANY PARTICULAR  
FONT, STYLE, SIZE, OR COLOR.

SALLY SHIH, EXAMINING ATTORNEY

**Int. Cl.: 25**

**Prior U.S. Cls.: 22 and 39**

**United States Patent and Trademark Office**

**Reg. No. 3,394,633**

**Registered Mar. 11, 2008**

**TRADEMARK  
PRINCIPAL REGISTER**

LYNDIA BY LYNDIA PROCANIK

LYNDIA PROCANIK, LLC (CALIFORNIA LTD  
LIAB CO)  
450 NORTH BRAND BLVD., SUITE 600  
GLENDALE, CA 91203

OWNER OF U.S. REG. NOS. 2,987,385 AND  
3,157,689.

FOR: SHIRTS; KNIT SHIRTS; SWEATERS; BLOU-  
SES; SKIRTS; DRESSES; COATS; PANTS; EVENING  
GOWNS; SCARVES; SHAWLS; EVENING DRESSES,  
IN CLASS 25 (U.S. CLS. 22 AND 39).

THE NAME LYNDIA PROCANIK IDENTIFIES A  
LIVING INDIVIDUAL WHOSE CONSENT IS OF  
RECORD.

FIRST USE 11-30-2006; IN COMMERCE 11-30-2006.

SER. NO. 77-227,566, FILED 7-11-2007.

THE MARK CONSISTS OF STANDARD CHAR-  
ACTERS WITHOUT CLAIM TO ANY PARTICULAR  
FONT, STYLE, SIZE, OR COLOR.

KATINA MISTER, EXAMINING ATTORNEY

**Int. Cl.: 9**

**Prior U.S. Cls.: 21, 23, 26, 36 and 38**

**United States Patent and Trademark Office**

**Reg. No. 3,394,634**

**Registered Mar. 11, 2008**

**TRADEMARK  
PRINCIPAL REGISTER**

The logo for Mossburg features the word "Mossburg" in a serif font. The letter "M" is significantly larger than the other letters and is enclosed within a square frame that extends to the right and then down to form a partial border around the "M".

MOSSBURG MUSIC, LLC (NEVADA LTD LIAB  
CO)  
PO BOX 777231  
HENDERSON, NV 89077

FIRST USE 12-1-1993; IN COMMERCE 12-1-1993.

SER. NO. 77-227,585, FILED 7-11-2007.

FOR: DIGITAL MEDIA, NAMELY, CDS, DOWN-  
LOADABLE AUDIO FILES FEATURING MUSIC;  
AUDIO RECORDINGS FEATURING MUSIC, IN  
CLASS 9 (U.S. CLS. 21, 23, 26, 36 AND 38).

KELLEY WELLS, EXAMINING ATTORNEY

Int. Cl.: 30

Prior U.S. Cl.: 46

United States Patent and Trademark Office

Reg. No. 3,394,635

Registered Mar. 11, 2008

TRADEMARK  
PRINCIPAL REGISTER



LOTTE CHILSUNG BEVERAGE CO., LTD. (RE-  
PUBLIC OF KOREA CORPORATION)  
5TH FL. LOTTE WELFARE CENTER  
50-2 JAMWON-DONG, SEOCHO-GU  
SEOUL, REPUBLIC OF KOREA

FOR: COFFEE-BASED BEVERAGE CONTAIN-  
ING MILK; PREPARED COFFEE AND COFFEE-  
BASED BEVERAGES, IN CLASS 30 (U.S. CL. 46).

FIRST USE 9-6-1990; IN COMMERCE 11-1-2000.

THE MARK CONSISTS OF STYLIZED "LET'S BE"  
WORDING.

SER. NO. 77-227,615, FILED 7-12-2007.

VIVIAN MICZNIK FIRST, EXAMINING ATTOR-  
NEY



Int. Cl.: 41

Prior U.S. Cls.: 100, 101 and 107

United States Patent and Trademark Office

Reg. No. 3,394,636

Registered Mar. 11, 2008

**SERVICE MARK  
PRINCIPAL REGISTER**



DEGRAFF, ADAM J. (UNITED STATES INDIVIDUAL)  
174-A DAVIS STUART RD.  
LEWISBURG, WV 24901

FOR: ENTERTAINMENT, NAMELY, LIVE PERFORMANCES BY A MUSICAL BAND, IN CLASS 41 (U.S. CLS. 100, 101 AND 107).

FIRST USE 2-26-2005; IN COMMERCE 2-26-2005.

THE COLOR(S) BLACK AND IVORY IS/ARE CLAIMED AS A FEATURE OF THE MARK.

THE MARK CONSISTS OF THE OUTLINES OF A HORIZONTAL VIOLIN OR FIDDLE, A SET OF IVORY AND BLACK PIANO KEYS AND THE WORD PIANAFIDDLE IN BLACK.

SER. NO. 77-227,747, FILED 7-12-2007.

CYNTHIA SLOAN, EXAMINING ATTORNEY

**Int. Cl.: 9**

**Prior U.S. Cls.: 21, 23, 26, 36 and 38**

**United States Patent and Trademark Office**

**Reg. No. 3,394,637**

**Registered Mar. 11, 2008**

**TRADEMARK  
PRINCIPAL REGISTER**

**VANWARE**

AIRCRAFT BRAKING SYSTEMS CORPORATION (DELAWARE CORPORATION)  
1204 MASSILLON ROAD  
AKRON, OH 44306

THE MARK CONSISTS OF STANDARD CHARACTERS WITHOUT CLAIM TO ANY PARTICULAR FONT, STYLE, SIZE, OR COLOR.

FOR: SOFTWARE THAT FACILITATES ENGINEERING MODELING AND DESIGN, IN CLASS 9 (U.S. CLS. 21, 23, 26, 36 AND 38).

SER. NO. 77-227,922, FILED 7-12-2007.

FIRST USE 1-1-1994; IN COMMERCE 6-27-2007.

JILL C. ALT, EXAMINING ATTORNEY

**Int. Cl.: 25**

**Prior U.S. Cls.: 22 and 39**

**United States Patent and Trademark Office**

**Reg. No. 3,394,638**

**Registered Mar. 11, 2008**

**TRADEMARK  
PRINCIPAL REGISTER**

**STAR CLIPPERS**

STAR CLIPPERS, LTD. (BAHAMAS CORPORATION)  
4101 SALZEDO STREET  
CORAL GABLES, FL 33146

FOR: CLOTHING, NAMELY, JEANS, JACKETS, WIND-RESISTANT JACKETS, WOVEN SHIRTS, T-SHIRTS, POLO SHIRTS, KNIT SHIRTS, OVERALLS, SCARVES, PANTS, SHORTS, COATS, FOOTWEAR, SOCKS, HOSIERY, HATS, SWIMWEAR, SLEEPWEAR, GLOVES, SWEATSHIRTS, SWEATPANTS, SWEATSHORTS, SUITS, SLACKS, TIES, BELTS,

BLOUSES, SKIRTS AND DRESSES, IN CLASS 25 (U.S. CLS. 22 AND 39).

FIRST USE 6-0-1991; IN COMMERCE 6-0-1991.

THE MARK CONSISTS OF STANDARD CHARACTERS WITHOUT CLAIM TO ANY PARTICULAR FONT, STYLE, SIZE, OR COLOR.

SER. NO. 77-227,996, FILED 7-12-2007.

KAREN BRACEY, EXAMINING ATTORNEY

**Int. Cl.: 30**

**Prior U.S. Cl.: 46**

**United States Patent and Trademark Office**

**Reg. No. 3,394,639**

**Registered Mar. 11, 2008**

**TRADEMARK  
PRINCIPAL REGISTER**

**La Terza**

ARTISAN COFFEE ROASTERIE LLC (OHIO LTD  
LIAB CO)

24 W 70TH STREET

CINCINNATI, OH 45216

FOR: COFFEE, IN CLASS 30 (U.S. CL. 46).

FIRST USE 5-1-2007; IN COMMERCE 5-1-2007.

THE MARK CONSISTS OF STANDARD CHAR-  
ACTERS WITHOUT CLAIM TO ANY PARTICULAR  
FONT, STYLE, SIZE, OR COLOR.

THE FOREIGN WORDING IN THE MARK  
TRANSLATES INTO ENGLISH AS THE THIRD.

SER. NO. 77-228,056, FILED 7-12-2007.

JEFF DEFORD, EXAMINING ATTORNEY

**Int. Cl.: 35**

**Prior U.S. Cls.: 100, 101 and 102**

**United States Patent and Trademark Office**

**Reg. No. 3,394,640**

**Registered Mar. 11, 2008**

**SERVICE MARK  
PRINCIPAL REGISTER**

**TRAFFICMOVERS.NET**

DBA HOLDINGS LLC (DELAWARE LTD LIAB  
CO)  
501 SILVERSIDE RD., SUITE 105  
WILMINGTON, DE 19809

FOR: DISSEMINATION OF ADVERTISING FOR  
OTHERS VIA THE INTERNET; ON-LINE ADVER-  
TISING AND MARKETING SERVICES; PROMOT-  
ING, ADVERTISING AND MARKETING OF THE  
ON-LINE WEBSITES OF OTHERS, IN CLASS 35 (U.S.  
CLS. 100, 101 AND 102).

FIRST USE 6-30-2007; IN COMMERCE 6-30-2007.

THE MARK CONSISTS OF STANDARD CHAR-  
ACTERS WITHOUT CLAIM TO ANY PARTICULAR  
FONT, STYLE, SIZE, OR COLOR.

SER. NO. 77-228,133, FILED 7-12-2007.

LYDIA BELZER, EXAMINING ATTORNEY

**Int. Cl.: 25**

**Prior U.S. Cls.: 22 and 39**

**United States Patent and Trademark Office**

**Reg. No. 3,394,641**

**Registered Mar. 11, 2008**

**TRADEMARK  
PRINCIPAL REGISTER**

**SILVER STATE HELICOPTERS**

SILVER STATE HELICOPTERS, LLC (NEVADA  
LTD LIAB CO)  
500 EAST CHEYENNE AVENUE  
NORTH LAS VEGAS, NV 89030

FOR: CLOTHING AND CLOTHING ACCESSOR-  
IES, NAMELY, SHIRTS, T-SHIRTS, POLO SHIRTS,  
TANK TOPS, COATS, JACKETS, VESTS, SWEATERS,  
SWEATSHIRTS, BLOUSES AND HEADWEAR, IN  
CLASS 25 (U.S. CLS. 22 AND 39).

FIRST USE 1-1-2004; IN COMMERCE 1-1-2004.

THE MARK CONSISTS OF STANDARD CHAR-  
ACTERS WITHOUT CLAIM TO ANY PARTICULAR  
FONT, STYLE, SIZE, OR COLOR.

NO CLAIM IS MADE TO THE EXCLUSIVE  
RIGHT TO USE "SILVER STATE", APART FROM  
THE MARK AS SHOWN.

SER. NO. 77-228,148, FILED 7-12-2007.

LOURDES AYALA, EXAMINING ATTORNEY

**Int. Cl.: 43**

**Prior U.S. Cls.: 100 and 101**

**United States Patent and Trademark Office**

**Reg. No. 3,394,642**

**Registered Mar. 11, 2008**

**SERVICE MARK  
PRINCIPAL REGISTER**

# Hot Spots

CELEBREE HOLDINGS, INC. (MARYLAND  
CORPORATION)  
2111B LAUREL BUSH ROAD  
BEL AIR, MD 21015

THE MARK CONSISTS OF STANDARD CHAR-  
ACTERS WITHOUT CLAIM TO ANY PARTICULAR  
FONT, STYLE, SIZE, OR COLOR.

FOR: CHILD CARE CENTERS, IN CLASS 43 (U.S.  
CLS. 100 AND 101).

SER. NO. 77-228,149, FILED 7-12-2007.

FIRST USE 7-1-2006; IN COMMERCE 7-1-2006.

LINDSEY RUBIN, EXAMINING ATTORNEY

**Int. Cl.: 9**

**Prior U.S. Cls.: 21, 23, 26, 36 and 38**

**Reg. No. 3,394,643**

**United States Patent and Trademark Office**

**Registered Mar. 11, 2008**

**TRADEMARK  
PRINCIPAL REGISTER**

**MICROIR**

BAE SYSTEMS INFORMATION AND ELECTRO-  
NIC SYSTEMS INTEGRATION INC. (DELA-  
WARE CORPORATION)

PO BOX 868

65 SPITBROOK ROAD

NASHUA, NH 03061

FOR: MICROBOLOMETER MODULES, CAMERA  
CORES AND CAMERAS; IMAGING COMPONENTS  
FOR USE IN INFRARED CAMERAS, NAMELY  
CAMERA CORE, OPTIC LENSES, COMPUTER OP-  
ERATING PROGRAMS FOR PROCESSING IMAGES  
AND CONTROLLING THE CAMERA, AND INTER-  
FACE ELEMENTS, NAMELY, CAMERA FILTERS,  
OPTICS SHUTTERS, THERMOELECTRIC CORE  
COOLER, AND INPUT/OUTPUT CONNECTORS;  
THERMAL IMAGING SYSTEMS COMPRISING,  
THERMAL IMAGING CAMERA, INFRARED DE-  
TECTOR AND DISPLAY FOR SURVEILLANCE,

SECURITY, AND INTRUSION DETECTION; ELEC-  
TRONIC VISION SYSTEMS COMPRISING, IMAGE  
PROCESSING AND THERMAL SENSING ELEC-  
TRONICS, NAMELY, IMAGE PROCESSORS AND  
CAMERAS, IN CLASS 9 (U.S. CLS. 21, 23, 26, 36 AND  
38).

FIRST USE 1-31-2000; IN COMMERCE 7-26-2001.

THE MARK CONSISTS OF STANDARD CHAR-  
ACTERS WITHOUT CLAIM TO ANY PARTICULAR  
FONT, STYLE, SIZE, OR COLOR.

SEC. 2(F).

SER. NO. 77-228,167, FILED 7-12-2007.

JOHN DWYER, EXAMINING ATTORNEY



**Int. Cl.: 43**

**Prior U.S. Cls.: 100 and 101**

**United States Patent and Trademark Office**

**Reg. No. 3,394,644**

**Registered Mar. 11, 2008**

**SERVICE MARK  
PRINCIPAL REGISTER**

**Protect Educate Nurture**

CELEBREE HOLDINGS, INC. (MARYLAND  
CORPORATION)  
2111B LAUREL BUSH ROAD  
BEL AIR, MD 21015

THE MARK CONSISTS OF STANDARD CHAR-  
ACTERS WITHOUT CLAIM TO ANY PARTICULAR  
FONT, STYLE, SIZE, OR COLOR.

FOR: CHILD CARE CENTERS, IN CLASS 43 (U.S.  
CLS. 100 AND 101).

SER. NO. 77-228,220, FILED 7-12-2007.

FIRST USE 8-1-2006; IN COMMERCE 8-1-2006.

LINDSEY RUBIN, EXAMINING ATTORNEY

**Int. Cl.: 25**

**Prior U.S. Cls.: 22 and 39**

**United States Patent and Trademark Office**

**Reg. No. 3,394,645**

**Registered Mar. 11, 2008**

**TRADEMARK  
PRINCIPAL REGISTER**

**ESMERALDA FASHIONS**

SMILES FASHION CORP. (NEW YORK CORPORATION)  
555 SECAUCUS ROAD  
SECAUCUS, NJ 07094

FOR: WOMEN'S APPAREL, NAMELY, DRESSES, SHIRTS, SKIRTS AND PANT SETS, IN CLASS 25 (U.S. CLS. 22 AND 39).

FIRST USE 10-22-2000; IN COMMERCE 10-22-2000.

THE MARK CONSISTS OF STANDARD CHARACTERS WITHOUT CLAIM TO ANY PARTICULAR FONT, STYLE, SIZE, OR COLOR.

NO CLAIM IS MADE TO THE EXCLUSIVE RIGHT TO USE "FASHIONS", APART FROM THE MARK AS SHOWN.

THE ENGLISH TRANSLATION OF THE WORD ESMERALDA IN THE MARK IS EMERALD.

SER. NO. 77-228,274, FILED 7-12-2007.

RICHARD WHITE, EXAMINING ATTORNEY

**Int. Cl.: 35**

**Prior U.S. Cls.: 100, 101 and 102**

**United States Patent and Trademark Office**

**Reg. No. 3,394,646**

**Registered Mar. 11, 2008**

**SERVICE MARK  
PRINCIPAL REGISTER**

**MCergo.com**

MEDIA CONTROL CO. INC. (CONNECTICUT CORPORATION)  
176 BOLTON ROAD  
VERNON, CT 06066

FOR: ON-LINE RETAIL STORE SERVICES FEATURING SEATING PRODUCTS, KEYBOARD TRAYS, KEYBOARD PLATFORMS, KEYBOARD ARMS, MONITOR ARMS, ADJUSTABLE WORKSTATIONS, LIGHTING, PHONE HEADSETS, COMPUTER KEYBOARDS, COMPUTER MICE, ERGONOMIC ACCESORIES, IN CLASS 35 (U.S. CLS. 100, 101 AND 102).

FIRST USE 4-1-2001; IN COMMERCE 4-1-2001.

THE MARK CONSISTS OF STANDARD CHARACTERS WITHOUT CLAIM TO ANY PARTICULAR FONT, STYLE, SIZE, OR COLOR.

SER. NO. 77-228,276, FILED 7-12-2007.

MICHAEL TANNER, EXAMINING ATTORNEY

**Int. Cl.: 15**

**Prior U.S. Cls.: 2, 21 and 36**

**United States Patent and Trademark Office**

**Reg. No. 3,394,647**

**Registered Mar. 11, 2008**

**TRADEMARK  
PRINCIPAL REGISTER**

# OVERTURE

SHAR PRODUCTS COMPANY (MICHIGAN CORPORATION)  
2465 S INDUSTRIAL  
ANN ARBOR, MI 48104

THE MARK CONSISTS OF STANDARD CHARACTERS WITHOUT CLAIM TO ANY PARTICULAR FONT, STYLE, SIZE, OR COLOR.

FOR: STRINGS FOR MUSICAL INSTRUMENTS,  
IN CLASS 15 (U.S. CLS. 2, 21 AND 36).

SER. NO. 77-228,291, FILED 7-12-2007.

FIRST USE 8-21-2006; IN COMMERCE 8-23-2006.

STEVEN R. FOSTER, EXAMINING ATTORNEY

**Int. Cl.: 15**

**Prior U.S. Cls.: 2, 21 and 36**

**United States Patent and Trademark Office**

**Reg. No. 3,394,648**

**Registered Mar. 11, 2008**

**TRADEMARK  
PRINCIPAL REGISTER**

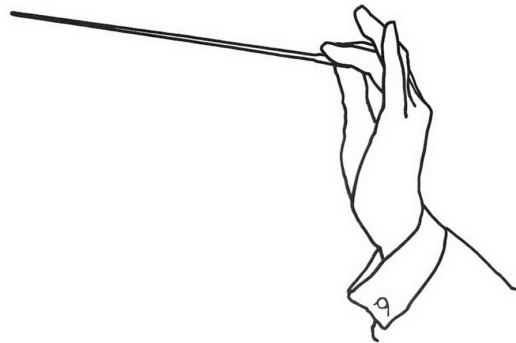

SHAR PRODUCTS COMPANY (MICHIGAN CORPORATION)  
2465 S. INDUSTRIAL  
ANN ARBOR, MI 48104

FIRST USE 8-21-2006; IN COMMERCE 8-23-2006.

SER. NO. 77-228,293, FILED 7-12-2007.

FOR: STRINGS FOR MUSICAL INSTRUMENTS,  
IN CLASS 15 (U.S. CLS. 2, 21 AND 36).

STEVEN R. FOSTER, EXAMINING ATTORNEY

**Int. Cls.: 9, 16 and 35**

**Prior U.S. Cls.: 2, 5, 21, 22, 23, 26, 29, 36, 37, 38, 50,  
100, 101 and 102**

**Reg. No. 3,394,649**

**United States Patent and Trademark Office**

**Registered Mar. 11, 2008**

**TRADEMARK  
SERVICE MARK  
PRINCIPAL REGISTER**



INVESTMENT COMPANY INSTITUTE (DELA-  
WARE CORPORATION)  
1401 H STREET, N.W.  
WASHINGTON, DC 20005

FOR: VIDEO TAPES, AUDIO TAPES, AND CDS  
CONTAINING INFORMATION REGARDING THE  
MUTUAL FUND AND INVESTMENT COMPANY  
INDUSTRY AND FINANCIAL INVESTING, IN  
CLASS 9 (U.S. CLS. 21, 23, 26, 36 AND 38).

FIRST USE 5-0-2006; IN COMMERCE 5-0-2006.

FOR: PUBLICATIONS, NAMELY, BOOKS, MA-  
GAZINES, BOOKLETS, NEWSLETTERS, PAMPH-  
LETS, AND BROCHURES REGARDING THE  
INVESTMENT COMPANY INDUSTRY AND FI-  
NANCIAL INVESTING, IN CLASS 16 (U.S. CLS. 2, 5,  
22, 23, 29, 37, 38 AND 50).

FIRST USE 12-16-2005; IN COMMERCE 12-16-2005.

FOR: TRADE ASSOCIATION SERVICES, NAME-  
LY, PROMOTING THE INTERESTS OF THE IN-  
VESTMENT COMPANY INDUSTRY, IN CLASS 35  
(U.S. CLS. 100, 101 AND 102).

FIRST USE 12-16-2005; IN COMMERCE 12-16-2005.

OWNER OF U.S. REG. NOS. 2,083,269, 2,090,612  
AND OTHERS.

SER. NO. 77-228,360, FILED 7-12-2007.

CHRISTINA SOBRAL, EXAMINING ATTORNEY

**Int. Cl.: 36**

**Prior U.S. Cls.: 100, 101 and 102**

**United States Patent and Trademark Office**

**Reg. No. 3,394,650**

**Registered Mar. 11, 2008**

**SERVICE MARK  
PRINCIPAL REGISTER**



GLOBAL STRATEGIES FOR HIV PREVENTION  
(CALIFORNIA CHARITABLE, NON-PROFIT  
CORPORATION)  
104 DOMINICAN DRIVE  
SAN RAFAEL, CA 94901

THE MARK CONSISTS OF HOPEWALKS AS A  
SINGLE WORD IN PLURAL WITH HOPE IN BLUE  
AND WALKS IN ORANGE AND A SYMBOLIC  
BARE FOOT IN THE CENTER OF THE O OF HOPE,  
IN WHITE. THE BACKGROUND IS WHITE.

FOR: CHARITABLE FUNDRAISING SERVICES,  
IN CLASS 36 (U.S. CLS. 100, 101 AND 102).

SER. NO. 77-228,372, FILED 7-12-2007.

FIRST USE 9-5-2006; IN COMMERCE 10-4-2006.

THE COLOR(S) WHITE, BLUE AND ORANGE IS/  
ARE CLAIMED AS A FEATURE OF THE MARK.

JOHN WILKE, EXAMINING ATTORNEY

**Int. Cls.: 37 and 40**

**Prior U.S. Cls.: 100, 103 and 106**

**United States Patent and Trademark Office**

**Reg. No. 3,394,651**

**Registered Mar. 11, 2008**

**SERVICE MARK  
PRINCIPAL REGISTER**



UNIVERSAL COMPRESSION, INC. (TEXAS CORPORATION)  
4444 BRITTMOORE ROAD  
HOUSTON, TX 77041

FOR: REPAIR AND MAINTENANCE OF NATURAL GAS COMPRESSION UNITS, IN CLASS 37 (U.S. CLS. 100, 103 AND 106).

FIRST USE 2-20-1998; IN COMMERCE 2-20-1998.

FOR: NATURAL GAS COMPRESSION SERVICES; CUSTOM MANUFACTURE OF NATURAL GAS COMPRESSION UNITS, IN CLASS 40 (U.S. CLS. 100, 103 AND 106).

FIRST USE 2-20-1998; IN COMMERCE 2-20-1998.

OWNER OF U.S. REG. NO. 2,434,606.

NO CLAIM IS MADE TO THE EXCLUSIVE RIGHT TO USE "COMPRESSION", APART FROM THE MARK AS SHOWN.

SER. NO. 77-228,373, FILED 7-12-2007.

JOHN WILKE, EXAMINING ATTORNEY



**Int. Cl.: 45**

**Prior U.S. Cls.: 100 and 101**

**United States Patent and Trademark Office**

**Reg. No. 3,394,652**

**Registered Mar. 11, 2008**

**SERVICE MARK  
PRINCIPAL REGISTER**

What they see ... is what  
you get

AILOR, SHERRY W. (UNITED STATES INDIVIDUAL)  
7312 CRESTHILL DRIVE  
KNOXVILLE, TN 37919

FOR: (BASED ON USE IN COMMERCE) PERSONAL IMAGE CONSULTING SERVICES; PERSONAL IMAGE DEVELOPMENT CONSULTATION, IN CLASS 45 (U.S. CLS. 100 AND 101).

FIRST USE 1-1-1997; IN COMMERCE 1-1-1997.

THE MARK CONSISTS OF STANDARD CHARACTERS WITHOUT CLAIM TO ANY PARTICULAR FONT, STYLE, SIZE, OR COLOR.

SER. NO. 77-228,399, FILED 7-12-2007.

SUSAN LESLIE DUBOIS, EXAMINING ATTORNEY

**Int. Cl.: 39**

**Prior U.S. Cls.: 100 and 105**

**United States Patent and Trademark Office**

**Reg. No. 3,394,653**

**Registered Mar. 11, 2008**

**SERVICE MARK  
PRINCIPAL REGISTER**

**SECURCARE**

SECURCARE SELF STORAGE, INC. (COLORADO CORPORATION)  
ROOSEVELT BUILDING  
9226 TEDDY BEAR LANE  
LONE TREE, CO 80124

FOR: PROVIDING SELF-STORAGE FACILITIES  
FOR OTHERS, IN CLASS 39 (U.S. CLS. 100 AND 105).

FIRST USE 1-0-1990; IN COMMERCE 1-0-1997.

THE MARK CONSISTS OF STANDARD CHARACTERS WITHOUT CLAIM TO ANY PARTICULAR FONT, STYLE, SIZE, OR COLOR.

SER. NO. 77-228,402, FILED 7-12-2007.

LINDA M. KING, EXAMINING ATTORNEY

**Int. Cl.: 45**

**Prior U.S. Cls.: 100 and 101**

**United States Patent and Trademark Office**

**Reg. No. 3,394,654**

**Registered Mar. 11, 2008**

**SERVICE MARK  
PRINCIPAL REGISTER**

**Focus  
What they see ...  
is what you get**

AILOR, SHERRY W. (UNITED STATES INDIVIDUAL)  
7312 CRESTHILL DRIVE  
KNOXVILLE, TN 37919

THE MARK CONSISTS OF STANDARD CHARACTERS WITHOUT CLAIM TO ANY PARTICULAR FONT, STYLE, SIZE, OR COLOR.

FOR: (BASED ON USE IN COMMERCE) PERSONAL IMAGE CONSULTING SERVICES; PERSONAL IMAGE DEVELOPMENT CONSULTATION, IN CLASS 45 (U.S. CLS. 100 AND 101).

SER. NO. 77-228,410, FILED 7-12-2007.

FIRST USE 1-1-1997; IN COMMERCE 1-1-1997.

SUSAN LESLIE DUBOIS, EXAMINING ATTORNEY

**Int. Cl.: 16**

**Prior U.S. Cls.: 2, 5, 22, 23, 29, 37, 38 and 50**

**United States Patent and Trademark Office**

**Reg. No. 3,394,655**

**Registered Mar. 11, 2008**

**TRADEMARK  
PRINCIPAL REGISTER**

wag more bark less

MELTON-JOHNSON, BRENNAN W. (UNITED STATES INDIVIDUAL)  
P.O. BOX 14437  
SAN LUIS OBISPO, CA 93455 AND  
MELTON-JOHNSON, JEFFIFER M. (UNITED STATES INDIVIDUAL)  
P.O. BOX 14437  
SAN LUIS OBISPO, CA 93455

THE MARK CONSISTS OF STANDARD CHARACTERS WITHOUT CLAIM TO ANY PARTICULAR FONT, STYLE, SIZE, OR COLOR.

OWNER OF U.S. REG. NOS. 3,108,531 AND 3,250,278.

FOR: BUMPER STICKERS; STICKERS, IN CLASS 16 (U.S. CLS. 2, 5, 22, 23, 29, 37, 38 AND 50).

SER. NO. 77-228,418, FILED 7-12-2007.

FIRST USE 9-1-2004; IN COMMERCE 11-18-2005.

ELLEN B. AWRICH, EXAMINING ATTORNEY

**Int. Cl.: 9**

**Prior U.S. Cls.: 21, 23, 26, 36 and 38**

**Reg. No. 3,394,656**

**United States Patent and Trademark Office**

**Registered Mar. 11, 2008**

---

**TRADEMARK  
PRINCIPAL REGISTER**

**ICI**

INVESTMENT COMPANY INSTITUTE (DELA-  
WARE CORPORATION)  
1401 H STREET, N.W.  
WASHINGTON, DC 20005

FOR: VIDEO TAPES, AUDIO TAPES, AND CDS  
CONTAINING INFORMATION REGARDING THE  
MUTUAL FUND AND INVESTMENT COMPANY  
INDUSTRY AND FINANCIAL INVESTING, IN  
CLASS 9 (U.S. CLS. 21, 23, 26, 36 AND 38).

FIRST USE 0-0-1970; IN COMMERCE 0-0-1970.

THE MARK CONSISTS OF STANDARD CHAR-  
ACTERS WITHOUT CLAIM TO ANY PARTICULAR  
FONT, STYLE, SIZE, OR COLOR.

OWNER OF U.S. REG. NOS. 2,083,269, 2,090,612  
AND OTHERS.

SER. NO. 77-228,432, FILED 7-12-2007.

CHRISTINA SOBRAL, EXAMINING ATTORNEY

**Int. Cl.: 36**

**Prior U.S. Cls.: 100, 101 and 102**

**United States Patent and Trademark Office**

**Reg. No. 3,394,657**

**Registered Mar. 11, 2008**

**SERVICE MARK  
PRINCIPAL REGISTER**

**HOPLITE**

HOPLITE CAPITAL MANAGEMENT, LLC (DE-  
LAWARE LTD LIAB CO)  
39TH FLOOR  
810 SEVENTH AVENUE  
NEW YORK, NY 10019

THE MARK CONSISTS OF STANDARD CHAR-  
ACTERS WITHOUT CLAIM TO ANY PARTICULAR  
FONT, STYLE, SIZE, OR COLOR.

FOR: FINANCIAL SERVICES, NAMELY, INVEST-  
MENT MANAGEMENT AND ADVISORY SERVI-  
CES, IN CLASS 36 (U.S. CLS. 100, 101 AND 102).

SER. NO. 77-228,439, FILED 7-12-2007.

FIRST USE 7-1-2003; IN COMMERCE 7-1-2003.

SUSAN LESLIE DUBOIS, EXAMINING ATTORNEY

**Int. Cl.: 41**

**Prior U.S. Cls.: 100, 101 and 107**

**United States Patent and Trademark Office**

**Reg. No. 3,394,658**

**Registered Mar. 11, 2008**

**SERVICE MARK  
PRINCIPAL REGISTER**

**Awry**

SETH FLEISHMAN (UNITED STATES INDIVIDUAL)  
20 WHITE PINE TRAIL  
SUSSEX, NJ 07461

FOR: (BASED ON USE IN COMMERCE) ENTERTAINMENT IN THE NATURE OF LIVE PERFORMANCES BY AWRY; ENTERTAINMENT IN THE NATURE OF VISUAL AND AUDIO PERFORMANCES, AND MUSICAL, VARIETY, NEWS AND COMEDY SHOWS; ENTERTAINMENT IN THE NATURE OF VISUAL AND AUDIO PERFORMANCES, NAMELY, MUSICAL BAND, ROCK GROUP, GYMNASTIC, DANCE, AND BALLET PERFOR-

MANCES; ENTERTAINMENT, NAMELY, LIVE PERFORMANCES BY A MUSICAL GROUP, IN CLASS 41 (U.S. CLS. 100, 101 AND 107).

FIRST USE 9-10-2006; IN COMMERCE 9-10-2006.

THE MARK CONSISTS OF STANDARD CHARACTERS WITHOUT CLAIM TO ANY PARTICULAR FONT, STYLE, SIZE, OR COLOR.

SER. NO. 77-228,444, FILED 7-12-2007.

AMY GEARIN, EXAMINING ATTORNEY

**Int. Cl.: 1**

**Prior U.S. Cls.: 1, 5, 6, 10, 26 and 46**

**United States Patent and Trademark Office**

**Reg. No. 3,394,659**

**Registered Mar. 11, 2008**

**TRADEMARK  
PRINCIPAL REGISTER**

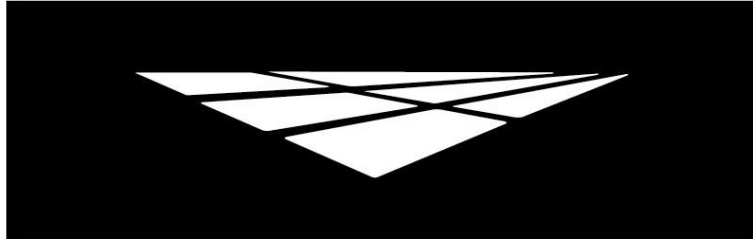

PACIFIC PEBBLES CORPORATION (CALIFORNIA CORPORATION)  
770 GATEWAY CENTER DRIVE  
SAN DIEGO, CA 92102

FOR: CONCRETE ADDITIVES AND ADMIXTURES FOR CONCRETE FLOORING RENOVATION, RESURFACING AND DECORATING; CHEMICAL COMPOUNDS FOR CURING CONCRETE; WATERPROOFING CHEMICAL COMPOSITIONS FOR ARTICLES OF MASONRY, WOOD, CONCRETE AND OTHER FLOORING SUB-

STRATES, IN CLASS 1 (U.S. CLS. 1, 5, 6, 10, 26 AND 46).

FIRST USE 2-5-2007; IN COMMERCE 2-5-2007.

THE MARK CONSISTS OF AN ABSTRACT TILE PATTERN.

SER. NO. 77-228,488, FILED 7-12-2007.

JULIE WATSON, EXAMINING ATTORNEY



**Int. Cl.: 36**

**Prior U.S. Cls.: 100, 101 and 102**

**United States Patent and Trademark Office**

**Reg. No. 3,394,660**

**Registered Mar. 11, 2008**

**SERVICE MARK  
PRINCIPAL REGISTER**

**ADVISOR CHARITABLE GIFT  
FUND**

THE TRUSTEES OF FIDELITY INVESTMENTS  
CHARITABLE GIFT FUND (MASSACHU-  
SETTS TRUST)

200 SEAPORT BOULEVARD, ZE7

BOSTON, MA 02109

FOR: DONOR-ADVISED INVESTMENT OF  
FUNDS FOR CHARITABLE PURPOSES; CHARITA-  
BLE FUND RAISING SERVICES; FINANCIAL MAN-  
AGEMENT SERVICES; PROVIDING FINANCIAL  
INFORMATION BY ELECTRONIC MEANS, IN  
CLASS 36 (U.S. CLS. 100, 101 AND 102).

FIRST USE 9-22-1999; IN COMMERCE 9-22-1999.

THE MARK CONSISTS OF STANDARD CHAR-  
ACTERS WITHOUT CLAIM TO ANY PARTICULAR  
FONT, STYLE, SIZE, OR COLOR.

OWNER OF U.S. REG. NOS. 2,516,390, 2,636,131,  
AND 3,069,020.

NO CLAIM IS MADE TO THE EXCLUSIVE  
RIGHT TO USE "CHARITABLE GIFT FUND",  
APART FROM THE MARK AS SHOWN.

SEC. 2(F).

SER. NO. 77-228,523, FILED 7-12-2007.

KAPIL BHANOT, EXAMINING ATTORNEY

**Int. Cl.: 2**

**Prior U.S. Cls.: 6, 11 and 16**

**United States Patent and Trademark Office**

**Reg. No. 3,394,661**

**Registered Mar. 11, 2008**

**TRADEMARK  
PRINCIPAL REGISTER**

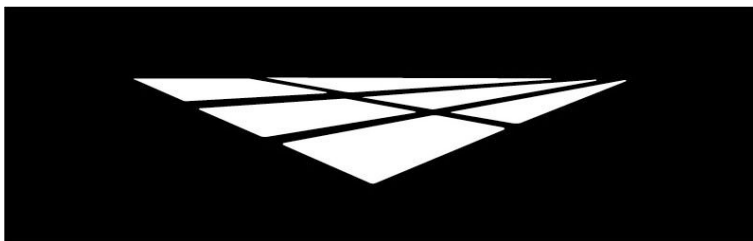

PACIFIC PEBBLES CORPORATION (CALIFORNIA CORPORATION)  
770 GATEWAY CENTER DRIVE  
SAN DIEGO, CA 92102

FOR: WOOD AND CONCRETE FLOORING RENOVATION, RESURFACING, AND DECORATING COATINGS AND AGENTS, NAMELY, CONCRETE SEALER COATINGS, SURFACE COATINGS, COLOR STAINS, PRIMERS, SEALERS, PAINTS, COLOR WASH, TEXTURE COATINGS, AND CURING AGENTS; WATERPROOF DECK FLOORING MATERIALS, NAMELY, ACRYLIC COATINGS, URETHANE COATINGS, ACRYLIC POLYMER SEALER AND EPOXY COATINGS; WOOD AND CONCRETE FLOORING MOISTURE BARRIER COATINGS; AC-

RYLIC POLYMER FLOOR COATINGS; URETHANE FLOOR COATINGS; EPOXY FLOOR COATINGS, AND COLORED PAINT CHIPS FOR USE WITH EPOXY FLOOR COATINGS, IN CLASS 2 (U.S. CLS. 6, 11 AND 16).

FIRST USE 2-5-2007; IN COMMERCE 2-5-2007.

THE MARK CONSISTS OF AN ABSTRACT TILE PATTERN.

SER. NO. 77-228,525, FILED 7-12-2007.

JULIE WATSON, EXAMINING ATTORNEY

**Int. Cl.: 40**

**Prior U.S. Cls.: 100, 103 and 106**

**United States Patent and Trademark Office**

**Reg. No. 3,394,662**

**Registered Mar. 11, 2008**

**SERVICE MARK  
PRINCIPAL REGISTER**

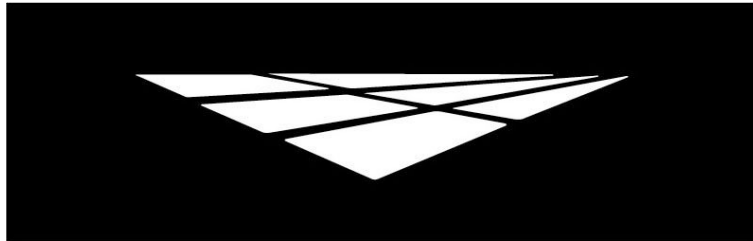

PACIFIC PEBBLES CORPORATION (CALIFORNIA CORPORATION)  
770 GATEWAY CENTER DRIVE  
SAN DIEGO, CA 92102

FOR: APPLICATION OF PROTECTIVE COATINGS TO COMMERCIAL, INDUSTRIAL AND RESIDENTIAL FLOORING SURFACES, NAMELY WATERPROOFING OF DECKING, DECK COATINGS, CONCRETE RESURFACING, CONCRETE RESTORATION AND EPOXY FLOOR COATINGS, ACRYLIC POLYMER FLOOR COATINGS AND

URETHANE FLOOR COATINGS, IN CLASS 40 (U.S. CLS. 100, 103 AND 106).

FIRST USE 2-5-2007; IN COMMERCE 2-5-2007.

THE MARK CONSISTS OF AN ABSTRACT TILE PATTERN.

SER. NO. 77-228,552, FILED 7-12-2007.

JULIE WATSON, EXAMINING ATTORNEY

**Int. Cl.: 18**

**Prior U.S. Cls.: 1, 2, 3, 22 and 41**

**United States Patent and Trademark Office**

**Reg. No. 3,394,663**

**Registered Mar. 11, 2008**

**TRADEMARK  
PRINCIPAL REGISTER**

**BOONE AND CROCKETT CLUB**

BOONE AND CROCKETT CLUB (D.C. CORPORATION)  
250 STATION DRIVE  
MISSOULA, MT 598012753

FOR: LUGGAGE, NAMELY, BACKPACKS, FANNY PACKS AND CARRYING POUCHES, IN CLASS 18 (U.S. CLS. 1, 2, 3, 22 AND 41).

FIRST USE 1-1-1998; IN COMMERCE 1-1-1998.

THE MARK CONSISTS OF STANDARD CHARACTERS WITHOUT CLAIM TO ANY PARTICULAR FONT, STYLE, SIZE, OR COLOR.

OWNER OF U.S. REG. NO. 3,203,249.

SER. NO. 77-228,563, FILED 7-12-2007.

CARRIE GENOVESE, EXAMINING ATTORNEY

**Int. Cl.: 35**

**Prior U.S. Cls.: 100, 101 and 102**

**United States Patent and Trademark Office**

**Reg. No. 3,394,664**

**Registered Mar. 11, 2008**

**SERVICE MARK  
PRINCIPAL REGISTER**

# Bowzers and Meowzers

CARMAN, DEBORAH DAY (UNITED STATES  
INDIVIDUAL)  
715 CLIFF DRIVE  
LAGUNA BEACH, CA 92651

THE MARK CONSISTS OF STANDARD CHAR-  
ACTERS WITHOUT CLAIM TO ANY PARTICULAR  
FONT, STYLE, SIZE, OR COLOR.

FOR: RETAIL VARIETY STORES SPECIALIZING  
IN DOG AND CAT THEMED PRODUCTS, IN CLASS  
35 (U.S. CLS. 100, 101 AND 102).

SER. NO. 77-228,577, FILED 7-12-2007.

FIRST USE 8-1-2005; IN COMMERCE 8-1-2005.

PATRICIA EVANKO, EXAMINING ATTORNEY

**Int. Cl.: 33**

**Prior U.S. Cls.: 47 and 49**

**United States Patent and Trademark Office**

**Reg. No. 3,394,665**

**Registered Mar. 11, 2008**

**TRADEMARK  
PRINCIPAL REGISTER**

**AU BON CLIMAT**

AU BON CLIMAT LLC (CALIFORNIA LTD LIAB  
CO)  
P.O. BOX 113  
LOS OLIVOS, CA 93441

THE FOREIGN WORDING IN THE MARK  
TRANSLATES INTO ENGLISH AS TO, OR AT, THE  
GOOD CLIMATE.

FOR: WINE, IN CLASS 33 (U.S. CLS. 47 AND 49).

FIRST USE 2-0-1983; IN COMMERCE 2-0-1983.

SER. NO. 77-228,644, FILED 7-12-2007.

THE MARK CONSISTS OF STANDARD CHAR-  
ACTERS WITHOUT CLAIM TO ANY PARTICULAR  
FONT, STYLE, SIZE, OR COLOR.

ESTHER A. BORSUK, EXAMINING ATTORNEY

**Int. Cl.: 42**

**Prior U.S. Cls.: 100 and 101**

**United States Patent and Trademark Office**

**Reg. No. 3,394,666**

**Registered Mar. 11, 2008**

**SERVICE MARK  
PRINCIPAL REGISTER**

## See the Possibilities

PHACIL (DELAWARE CORPORATION)  
SUITE 1710  
601 CALIFORNIA STREET  
SAN FRANCISCO, CA 94108

FOR: CONSULTING SERVICES IN THE FIELD OF DESIGN, SELECTION, IMPLEMENTATION AND USE OF COMPUTER HARDWARE AND SOFTWARE SYSTEMS FOR OTHERS; DESIGN AND DEVELOPMENT OF ON-LINE COMPUTER SOFTWARE SYSTEMS; INFORMATION TECHNOLOGY CONSULTATION; INTEGRATION OF COMPUTER SYSTEMS AND NETWORKS; RESEARCH IN THE FIELD OF INTELLIGENCE AND SECURITY; COMPUTER SERVICE, ACTING AS AN APPLICATION SERVICE PROVIDER IN THE FIELD OF KNOWLEDGE MANAGEMENT TO HOST COMPUTER APPLICATION SOFTWARE FOR CREATING SEARCHABLE DATABASES OF INFORMATION AND DATA TO ALLOW USERS TO PERFORM, ON-LINE, THE COLLECTING AND ANALYZING

OF DIFFERENT TYPES OF OPINION SURVEYS; COMPUTER SOFTWARE DESIGN, COMPUTER PROGRAMMING, OR MAINTENANCE OF COMPUTER SOFTWARE; INSTALLATION OF COMPUTER SOFTWARE; PROVIDING A WEBSITE THAT FEATURES INFORMATION ON COMPUTER TECHNOLOGY AND PROGRAMMING; TECHNICAL SUPPORT, NAMELY, PROVIDING BACK-UP COMPUTER PROGRAMS AND FACILITIES, IN CLASS 42 (U.S. CLS. 100 AND 101).

FIRST USE 1-1-2005; IN COMMERCE 1-1-2005.

THE MARK CONSISTS OF STANDARD CHARACTERS WITHOUT CLAIM TO ANY PARTICULAR FONT, STYLE, SIZE, OR COLOR.

SER. NO. 77-228,647, FILED 7-12-2007.

ESTHER A. BORSUK, EXAMINING ATTORNEY

**Int. Cl.: 16**

**Prior U.S. Cls.: 2, 5, 22, 23, 29, 37, 38 and 50**

**United States Patent and Trademark Office**

**Reg. No. 3,394,667**

**Registered Mar. 11, 2008**

**TRADEMARK  
PRINCIPAL REGISTER**

# Mosaically

MOSAICALLY (NEW YORK PARTNERSHIP)  
206 DAVIES AVE  
WEST HENRIETTA, NY 14586

FIRST USE 12-6-2006; IN COMMERCE 4-14-2007.

FOR: PHOTOGRAPHIC MOSAIC ART PRINTS IN WHICH MULTIPLE PHOTOGRAPHS ARE ORGANIZED AND ASSEMBLED WITH COMPUTERS TO CREATE THE LIKENESS OF A SINGLE PHOTOGRAPH, SIMULATING THE LOOK OF MOSAIC TILES, IN CLASS 16 (U.S. CLS. 2, 5, 22, 23, 29, 37, 38 AND 50).

THE MARK CONSISTS OF STANDARD CHARACTERS WITHOUT CLAIM TO ANY PARTICULAR FONT, STYLE, SIZE, OR COLOR.

SER. NO. 77-228,662, FILED 7-12-2007.

JOHN WILKE, EXAMINING ATTORNEY



**Int. Cl.: 33**

**Prior U.S. Cls.: 47 and 49**

**United States Patent and Trademark Office**

**Reg. No. 3,394,668**

**Registered Mar. 11, 2008**

**TRADEMARK  
PRINCIPAL REGISTER**

**MXB**

FREDERICK L. MAYTAG III (UNITED STATES  
INDIVIDUAL), DBA YORK CREEK VINE-  
YARDS  
3601 LAUGTRY ROAD  
ST. HELENA, CA 94574

THE MARK CONSISTS OF STANDARD CHAR-  
ACTERS WITHOUT CLAIM TO ANY PARTICULAR  
FONT, STYLE, SIZE, OR COLOR.

FOR: WINE, IN CLASS 33 (U.S. CLS. 47 AND 49).

SER. NO. 77-228,706, FILED 7-12-2007.

FIRST USE 3-5-2003; IN COMMERCE 3-5-2003.

GIANCARLO CASTRO, EXAMINING ATTORNEY

**Int. Cl.: 35**

**Prior U.S. Cls.: 100, 101 and 102**

**United States Patent and Trademark Office**

**Reg. No. 3,394,669**

**Registered Mar. 11, 2008**

**SERVICE MARK  
PRINCIPAL REGISTER**



EUROSTAR BRANDS, INC. (CALIFORNIA CORPORATION)  
13425 SOUTH FIGUEROA ST.  
LOS ANGELES, CA 90061

FOR: ONLINE WHOLESALE STORE SERVICES FEATURING FOOTWEAR AND FOOTWEAR ACCESSORIES, IN CLASS 35 (U.S. CLS. 100, 101 AND 102).

FIRST USE 11-30-2006; IN COMMERCE 11-30-2006.

THE MARK CONSISTS OF PROFILES OF A MAN'S LOAFER TO THE LEFT OF A WOMAN'S HIGH HEEL WHICH ARE BOTH ABOVE THE LITERAL ELEMENT, HOME OF SHOES, IN STYLIZED FORM.

SER. NO. 77-228,715, FILED 7-12-2007.

LOURDES AYALA, EXAMINING ATTORNEY

**Int. Cl.: 25**

**Prior U.S. Cls.: 22 and 39**

**United States Patent and Trademark Office**

**Reg. No. 3,394,670**

**Registered Mar. 11, 2008**

**TRADEMARK  
PRINCIPAL REGISTER**

**pink bench**

WRIGHT, ADRIENNE (UNITED STATES INDIVIDUAL)  
515 SHEFFIELD DRIVE  
PROVO, UT 84604

THE MARK CONSISTS OF STANDARD CHARACTERS WITHOUT CLAIM TO ANY PARTICULAR FONT, STYLE, SIZE, OR COLOR.

FOR: HEADBANDS, IN CLASS 25 (U.S. CLS. 22 AND 39).

SER. NO. 77-228,717, FILED 7-12-2007.

FIRST USE 6-1-2007; IN COMMERCE 6-5-2007.

SHAUNIA CARLYLE, EXAMINING ATTORNEY

Int. Cl.: 39

Prior U.S. Cls.: 100 and 105

United States Patent and Trademark Office

Reg. No. 3,394,671

Registered Mar. 11, 2008

**SERVICE MARK  
PRINCIPAL REGISTER**



JAMES, ALLESTER (UNITED STATES INDIVIDUAL)  
65 STONE RIDGE DRIVE  
COVINGTON, GA 30016

FOR: MOTORCYCLE RIDING CLUB SERVICES, NAMELY, ORGANIZING, ARRANGING AND CONDUCTING MOTORCYCLE RIDING EXCURSIONS, IN CLASS 39 (U.S. CLS. 100 AND 105).

FIRST USE 12-30-1993; IN COMMERCE 12-30-1993.

NO CLAIM IS MADE TO THE EXCLUSIVE RIGHT TO USE "ATLANTA, GA" AND "MOTORCYCLE CLUB", APART FROM THE MARK AS SHOWN.

THE COLOR(S) WHITE, BLACK AND BLUE IS/ARE CLAIMED AS A FEATURE OF THE MARK.

THE MARK CONSISTS OF AN IMAGE OF A PERSON RIDING A MOTORCYCLE CENTERED INTO A CIRCULAR IMAGE RESEMBLING A GEAR WITH COGS. THE FENDER, AND WINDSHIELD OF THE MOTORCYCLE ARE COLORED IN WHITE. THE LOWER PORTION OF THE MOTORCYCLE, THE NUMBER "5," AND THE FRONT TIRE IS COLORED IN BLACK. THE MOTORCYCLIST IS WEARING WHITE CLOTHING WITH A BLACK FACE SHIELD AND WHITE TOP OF HIS HELMET. THE COGS ON THE GEAR IMAGE AND THE WORDING FIFTH GEAR MOTORCYCLE CLUB ATLANTA, GA ARE COLORED IN BLUE.

SER. NO. 77-228,722, FILED 7-12-2007.

SHAUNIA CARLYLE, EXAMINING ATTORNEY

**Int. Cl.: 40**

**Prior U.S. Cls.: 100, 103 and 106**

**United States Patent and Trademark Office**

**Reg. No. 3,394,672**

**Registered Mar. 11, 2008**

**SERVICE MARK  
PRINCIPAL REGISTER**

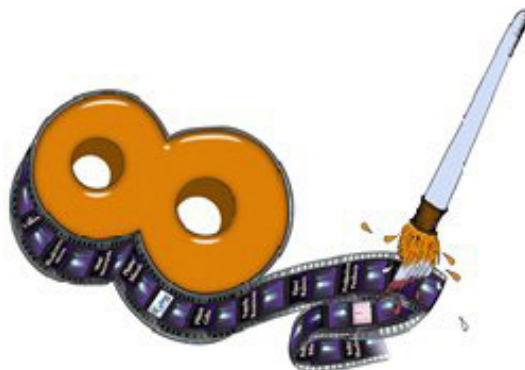

NUCRE8ION, INC. (NORTH CAROLINA CORPORATION)  
1421 EAST BROAD STREET, SUITE 338  
FUQUAY VARINA, NC 275260000

FOR: CREATION OF CUSTOM PORTRAITS AND PAINTINGS BASED ON PHOTOGRAPHS, SNAPSHOTS OR IMAGES PROVIDED BY THE CUSTOMER; CUSTOM IMPRINTING OF SHIRTS, CUPS, MUGS, CLOCKS, PLATES, PUZZLES, COASTERS, ID TAGS, BABY CLOTHING, BABY BLANKETS, PILLOW CASES, CANVAS BAGS, TOWELS, SERVING TRAYS, CUTTING BOARDS, PAPER WEIGHTS, TILE, PORCELAIN ORNAMENTS, SPOONS, CROSSES, PAPER, FLIERS, WOOD ITEMS WITH DECORATIVE DESIGNS; CUSTOMIZED PRINTING OF COMPANY NAMES AND LOGOS FOR PROMOTIONAL AND ADVERTISING PURPOSES ON THE GOODS OF OTHERS, IN CLASS 40 (U.S. CLS. 100, 103 AND 106).

FIRST USE 4-15-2007; IN COMMERCE 4-15-2007.

THE COLOR(S) ORANGE, BURNT ORANGE, GREY, SKY BLUE, BURGUNDY, PURPLE, WHITE, BLACK AND AQUA IS/ARE CLAIMED AS A FEATURE OF THE MARK.

THE COLOR(S) GREY APPEARS AS AN OUTLINE AROUND THE 8 AND ON THE FILM STRIP, ORANGE IS ON THE 8 AND ON THE PAINT BRUSH TIP, BURNT ORANGE IS INSIDE OF THE 8, SKY BLUE IS ON THE PAINT BRUSH HANDLE AND THE PAINT BRUSH TIP, BURGUNDY IS ON THE PAINT BRUSH TIP, PURPLE IS ON THE INDIVIDUAL FILM STRIP PANELS, WHITE IS ON THE FILM STRIP PANELS, BLACK IS AROUND THE FILM STRIP, BLACK AND AQUA ARE ON THE OUTLINE OF THE FILM STRIP.

SER. NO. 77-228,725, FILED 7-12-2007.

SHAUNIA CARLYLE, EXAMINING ATTORNEY

**Int. Cl.: 43**

**Prior U.S. Cls.: 100 and 101**

**United States Patent and Trademark Office**

**Reg. No. 3,394,673**

**Registered Mar. 11, 2008**

**SERVICE MARK  
PRINCIPAL REGISTER**

The logo for DRX Taco features the words "DRX" and "Taco" in a stylized, bold, black font with a white outline. The "R" in "DRX" has a unique shape with a small 'x' inside. The "Taco" is written in a similar bold, sans-serif style.

VALIANT GROUP, INC. (CALIFORNIA CORPORATION)  
133 E. DE LA GUERRA, #G  
SANTA BARBARA, CA 93101

THE MARK CONSISTS OF THE STYLIZED WORDS DRX TACO.

FOR: RESTAURANT SERVICES AND CARRY OUT FOOD SERVICES, IN CLASS 43 (U.S. CLS. 100 AND 101).

SER. NO. 77-228,727, FILED 7-12-2007.

FIRST USE 2-14-2007; IN COMMERCE 2-14-2007.

LINDA M. KING, EXAMINING ATTORNEY

**Int. Cl.: 43**

**Prior U.S. Cls.: 100 and 101**

**United States Patent and Trademark Office**

**Reg. No. 3,394,674**

**Registered Mar. 11, 2008**

**SERVICE MARK  
PRINCIPAL REGISTER**

**¡EL DOCTOR AHORA LE  
ALIMENTARÁ!**

VALIANT GROUP, INC. (CALIFORNIA CORPORATION)  
133 E. DE LA GUERRA, #G  
SANTA BARBARA, CA 93101

FOR: RESTAURANT SERVICES AND CARRY OUT FOOD SERVICES, IN CLASS 43 (U.S. CLS. 100 AND 101).

FIRST USE 12-31-2006; IN COMMERCE 12-31-2006.

THE MARK CONSISTS OF STANDARD CHARACTERS WITHOUT CLAIM TO ANY PARTICULAR FONT, STYLE, SIZE, OR COLOR.

THE FOREIGN WORDING IN THE MARK TRANSLATES INTO ENGLISH AS THE DOCTOR WILL NOW FEED YOU!.

SER. NO. 77-228,736, FILED 7-12-2007.

LINDA M. KING, EXAMINING ATTORNEY

**Int. Cl.: 41**

**Prior U.S. Cls.: 100, 101 and 107**

**United States Patent and Trademark Office**

**Reg. No. 3,394,675**

**Registered Mar. 11, 2008**

**SERVICE MARK  
PRINCIPAL REGISTER**

**Turning Your Dream Event  
Into a Reality Until "It's  
Simply Beautiful!"**

SIMPLY BEAUTIFUL WEDDING AND PARTY  
PLANNERS INC (NEW YORK CORPORATION)  
192 ROCK CUT ROAD  
WALDEN, NY 12586

FOR: SPECIAL EVENT PLANNING, IN CLASS 41  
(U.S. CLS. 100, 101 AND 107).

FIRST USE 3-8-2007; IN COMMERCE 3-8-2007.

THE MARK CONSISTS OF STANDARD CHARACTERS WITHOUT CLAIM TO ANY PARTICULAR FONT, STYLE, SIZE, OR COLOR.

SER. NO. 77-228,852, FILED 7-13-2007.

VIVIAN MICZNIK FIRST, EXAMINING ATTORNEY



**Int. Cl.: 16**

**Prior U.S. Cls.: 2, 5, 22, 23, 29, 37, 38 and 50**

**United States Patent and Trademark Office**

**Reg. No. 3,394,676**

**Registered Mar. 11, 2008**

**TRADEMARK  
PRINCIPAL REGISTER**



SILVER STATE HELICOPTERS, LLC (NEVADA  
LTD LIAB CO)  
500 EAST CHEYENNE AVENUE  
NORTH LAS VEGAS, NV 89030

FOR: PRINTED INSTRUCTIONAL, EDUCATIONAL, AND TEACHING MATERIALS IN THE FIELDS OF AIRCRAFTS, AIRCRAFT EQUIPMENT, AVIATION AND AIR TRAFFIC CONTROL; DECALS; STICKERS, IN CLASS 16 (U.S. CLS. 2, 5, 22, 23, 29, 37, 38 AND 50).

FIRST USE 2-1-2004; IN COMMERCE 2-1-2004.

NO CLAIM IS MADE TO THE EXCLUSIVE RIGHT TO USE "SILVER STATE HELICOPTERS", APART FROM THE MARK AS SHOWN.

THE MARK CONSISTS OF THE TEXT SILVER STATE HELICOPTERS CIRCUMSCRIBING A FIGURE RESEMBLING A HELICOPTER WITH A SPINNING PROPELLER.

SER. NO. 77-229,053, FILED 7-13-2007.

PAUL F. GAST, EXAMINING ATTORNEY

Int. Cl.: 25

Prior U.S. Cls.: 22 and 39

United States Patent and Trademark Office

Reg. No. 3,394,677

Registered Mar. 11, 2008

TRADEMARK  
PRINCIPAL REGISTER



SILVER STATE HELICOPTERS, LLC (NEVADA  
LTD LIAB CO)  
500 EAST CHEYENNE AVENUE  
NORTH LAS VEGAS, NV 89030

FOR: CLOTHING AND CLOTHING ACCESSORIES, NAMELY, SHIRTS, T-SHIRTS, POLO SHIRTS, TANK TOPS, COATS, JACKETS, VESTS, SWEATERS, SWEATSHIRTS, BLOUSES AND HEADWEAR, IN CLASS 25 (U.S. CLS. 22 AND 39).

FIRST USE 6-1-2004; IN COMMERCE 6-1-2004.

NO CLAIM IS MADE TO THE EXCLUSIVE RIGHT TO USE "SILVER STATE", APART FROM THE MARK AS SHOWN.

THE MARK CONSISTS OF THE TEXT SILVER STATE HELICOPTERS CIRCUMSCRIBING A FIGURE RESEMBLING A HELICOPTER WITH A SPINNING PROPELLER.

SER. NO. 77-229,066, FILED 7-13-2007.

PAUL F. GAST, EXAMINING ATTORNEY

**Int. Cl.: 10**

**Prior U.S. Cls.: 26, 39 and 44**

**United States Patent and Trademark Office**

**Reg. No. 3,394,678**

**Registered Mar. 11, 2008**

**TRADEMARK  
PRINCIPAL REGISTER**

**DENPEN**

CAO GROUP, INC. (UTAH CORPORATION)  
4628 W SKYHAWK DRIVE  
WEST JORDAN, UT 84084

THE MARK CONSISTS OF STANDARD CHAR-  
ACTERS WITHOUT CLAIM TO ANY PARTICULAR  
FONT, STYLE, SIZE, OR COLOR.

FOR: MEDICAL DEVICES, NAMELY, SURGICAL  
DEVICES THAT FACILITATE THE IDENTIFICA-  
TION, SEPARATION OR ABLATION OF BIOLOGIC  
TISSUES, IN CLASS 10 (U.S. CLS. 26, 39 AND 44).

SER. NO. 77-229,070, FILED 7-13-2007.

FIRST USE 2-1-2007; IN COMMERCE 2-2-2007.

ESTHER A. BORSUK, EXAMINING ATTORNEY

**Int. Cl.: 10**

**Prior U.S. Cls.: 26, 39 and 44**

**United States Patent and Trademark Office**

**Reg. No. 3,394,679**

**Registered Mar. 11, 2008**

**TRADEMARK  
PRINCIPAL REGISTER**

**DENLASER**

CAO GROUP, INC. (UTAH CORPORATION)  
4628 W SKYHAWK DRIVE  
WEST JORDAN, UT 84084

THE MARK CONSISTS OF STANDARD CHAR-  
ACTERS WITHOUT CLAIM TO ANY PARTICULAR  
FONT, STYLE, SIZE, OR COLOR.

FOR: LASERS FOR SURGICAL AND MEDICAL  
USE, IN CLASS 10 (U.S. CLS. 26, 39 AND 44).

SER. NO. 77-229,086, FILED 7-13-2007.

FIRST USE 7-4-2006; IN COMMERCE 7-4-2006.

ESTHER A. BORSUK, EXAMINING ATTORNEY

**Int. Cl.: 44**

**Prior U.S. Cls.: 100 and 101**

**United States Patent and Trademark Office**

**Reg. No. 3,394,680**

**Registered Mar. 11, 2008**

**SERVICE MARK  
PRINCIPAL REGISTER**

**STROKERS INK**

R.L. FAIRLESS, INC (TEXAS CORPORATION)  
9304 HARRY HINES BOULEVARD  
DALLAS, TX 75235

OWNER OF U.S. REG. NOS. 2,866,413, 2,934,355  
AND OTHERS.

FOR: BODY PIERCING AND TATTOOING SERVICES, IN CLASS 44 (U.S. CLS. 100 AND 101).

NO CLAIM IS MADE TO THE EXCLUSIVE RIGHT TO USE "INK", APART FROM THE MARK AS SHOWN.

FIRST USE 5-1-2007; IN COMMERCE 5-1-2007.

SER. NO. 77-229,164, FILED 7-13-2007.

THE MARK CONSISTS OF STANDARD CHARACTERS WITHOUT CLAIM TO ANY PARTICULAR FONT, STYLE, SIZE, OR COLOR.

MICHAEL ENGEL, EXAMINING ATTORNEY

**Int. Cl.: 41**

**Prior U.S. Cls.: 100, 101 and 107**

**United States Patent and Trademark Office**

**Reg. No. 3,394,681**

**Registered Mar. 11, 2008**

**SERVICE MARK  
PRINCIPAL REGISTER**

**You Silly Dog**

YOU SILLY DOG, LLC (MARYLAND LTD LIAB  
CO)  
18 CARRIAGE WALK COURT  
PARKVILLE, MD 21234

THE MARK CONSISTS OF STANDARD CHAR-  
ACTERS WITHOUT CLAIM TO ANY PARTICULAR  
FONT, STYLE, SIZE, OR COLOR.

FOR: DOG TRAINING, IN CLASS 41 (U.S. CLS.  
100, 101 AND 107).

SER. NO. 77-229,166, FILED 7-13-2007.

FIRST USE 8-10-2005; IN COMMERCE 8-10-2005.

MICHAEL ENGEL, EXAMINING ATTORNEY

Int. Cl.: 45

Prior U.S. Cls.: 100 and 101

United States Patent and Trademark Office

Reg. No. 3,394,682

Registered Mar. 11, 2008

SERVICE MARK  
PRINCIPAL REGISTER



FREEDOM WALK MINISTRIES, THROUGH ITS  
BOUND FOR GLORY MOTORCYCLE MINIS-  
TRY OPERATING DIVISION (TEXAS COR-  
PORATION)

SUITE C  
1036 E. FIRST STREET  
HUMBLE, TX 77338

FOR: MINISTERIAL SERVICES, IN CLASS 45 (U.S.  
CLS. 100 AND 101).

FIRST USE 6-30-2007; IN COMMERCE 6-30-2007.

NO CLAIM IS MADE TO THE EXCLUSIVE  
RIGHT TO USE "JESUS IS LORD", THE SYMBOL  
OF THE CROSS AND "MOTORCYCLE MINIS-  
TRY", APART FROM THE MARK AS SHOWN.

THE MARK CONSISTS OF THE WORDS BOUND  
FOR GLORY JESUS IS LORD MOTORCYCLE MIN-  
ISTRY IN A STYLIZED TEXT WITH A CROSS.

SER. NO. 77-229,211, FILED 7-13-2007.

DAVID H. STINE, EXAMINING ATTORNEY

Int. Cl.: 11

Prior U.S. Cls.: 13, 21, 23, 31 and 34

United States Patent and Trademark Office

Reg. No. 3,394,683

Registered Mar. 11, 2008

TRADEMARK  
PRINCIPAL REGISTER



CHIEN LUEN INDUSTRIES CO., LTD. INC.  
(FLORIDA CORPORATION)  
1951 N.W. 22ND STREET  
FT. LAUDERDALE, FL 33311

FOR: ENVIRONMENTAL CONTROL APPARATUS, NAMELY, ELECTRIC FLOOR FANS AND REPLACEMENT PARTS THEREFOR; ELECTRIC CIRCULATING FANS FOR DOMESTIC AND COMMERCIAL USE; INDOOR AND OUTDOOR CEILING AND WALL SURFACE MOUNTED FANS AND LIGHTS, FIXTURES AND PARTS THEREFOR; PORTABLE ELECTRIC FANS, FIXTURES AND PARTS THEREFOR; FREESTANDING ELECTRIC FANS, FIXTURES AND PARTS THEREFOR; AND ELECTRIC DESK FANS, FIXTURES AND PARTS THEREFOR, IN CLASS 11 (U.S. CLS. 13, 21, 23, 31 AND 34).

FIRST USE 3-19-2007; IN COMMERCE 3-19-2007.

THE COLOR(S) BLACK YELLOW AND WHITE IS/ARE CLAIMED AS A FEATURE OF THE MARK.

THE MARK CONSISTS OF THE WORD "BRIGHTWATTS" IN BLACK LETTERS WITH A YELLOW CIRCLE AROUND THE LETTERS "BRIGHT" WITH A WHITE CIRCLE INSIDE THE YELLOW ONE.

SER. NO. 77-229,219, FILED 7-13-2007.

TEJBIR SINGH, EXAMINING ATTORNEY



**Int. Cl.: 41**

**Prior U.S. Cls.: 100, 101 and 107**

**United States Patent and Trademark Office**

**Reg. No. 3,394,684**

**Registered Mar. 11, 2008**

**SERVICE MARK  
PRINCIPAL REGISTER**

**SHIFT THINKING**

ANDERSON, CHARLES (UNITED STATES INDIVIDUAL)  
500 MOUNTAIN AVENUE  
REVERE, MA 02151

FOR: EDUCATIONAL SERVICES, NAMELY, CONDUCTING WORKSHOPS AND SEMINARS IN THE FIELD OF SALES TRAINING AND DISTRIBUTION OF COURSE MATERIAL IN CONNECTION THEREWITH, IN CLASS 41 (U.S. CLS. 100, 101 AND 107).

FIRST USE 11-30-2004; IN COMMERCE 1-31-2005.

THE MARK CONSISTS OF STANDARD CHARACTERS WITHOUT CLAIM TO ANY PARTICULAR FONT, STYLE, SIZE, OR COLOR.

SER. NO. 77-229,229, FILED 7-13-2007.

CHARLES L. JENKINS, EXAMINING ATTORNEY

Int. Cls.: 25 and 28

Prior U.S. Cls.: 22, 23, 38, 39 and 50

United States Patent and Trademark Office

Reg. No. 3,394,685

Registered Mar. 11, 2008

TRADEMARK  
PRINCIPAL REGISTER

legacy players

GLEN DELL HAWKINS (UNITED STATES INDIVIDUAL)  
2457 RAMBLEWOOD DRIVE  
KALAMAZOO, MI 49009

FOR: WRIST BANDS; BELTS; CAPS; INFANT AND TODDLER ONE PIECE CLOTHING; JERSEYS; A-SHIRTS; CAMP SHIRTS; DRESS SHIRTS; GOLF SHIRTS; KNIT SHIRTS; NIGHT SHIRTS; OPEN-NECKED SHIRTS; PIQUE SHIRTS; POLO SHIRTS; SHIRTS; SHIRTS FOR SUITS; SHORT-SLEEVED OR LONG-SLEEVED T-SHIRTS; SHORT-SLEEVED SHIRTS; SLEEP SHIRTS; SPORT SHIRTS; T-SHIRTS; BALLOON PANTS; CAPRI PANTS; CARGO PANTS; DENIMS; LEATHER PANTS; LOUNGE PANTS; PANTS; SNOW PANTS; SNOWBOARD PANTS; SWEAT PANTS; TRACK PANTS; BASEBALL SHOES; BEACH SHOES; BOWLING SHOES; BOXING SHOES; CANVAS SHOES; CYCLING SHOES; DECK-SHOES; FOOTBALL SHOES; GOLF SHOES; GYMNASIIC SHOES; HANDBALL SHOES; WOMEN'S SHOES, IN CLASS 25 (U.S. CLS. 22 AND 39).

FIRST USE 7-9-2007; IN COMMERCE 7-9-2007.

FOR: CARD GAMES; ACTION SKILL GAMES; ARCADE GAMES; BACKGAMMON GAME SETS;

BADMINTON GAME PLAYING EQUIPMENT; BOARD GAMES; DICE GAMES; ELECTRONIC EDUCATIONAL GAME MACHINES FOR CHILDREN; EQUIPMENT SOLD AS A UNIT FOR PLAYING BOARD GAMES; EQUIPMENT SOLD AS A UNIT FOR PLAYING CARD GAMES; MANIPULATIVE GAMES; MEMORY GAMES; PARLOR GAMES; PARTY GAMES; POSITIONABLE PRINTED TOY FIGURES FOR USE IN GAMES; POSITIONABLE THREE DIMENSIONAL TOYS FOR USE IN GAMES; PRINTED POSITIONABLE TOYS FOR USE IN CHILDREN'S BOARD GAMES; PROMOTIONAL GAME CARDS; PROMOTIONAL GAME MATERIALS; ROLE PLAYING GAMES, IN CLASS 28 (U.S. CLS. 22, 23, 38 AND 50).

FIRST USE 7-9-2007; IN COMMERCE 7-9-2007.

THE MARK CONSISTS OF STANDARD CHARACTERS WITHOUT CLAIM TO ANY PARTICULAR FONT, STYLE, SIZE, OR COLOR.

SER. NO. 77-229,264, FILED 7-13-2007.

DAVID H. STINE, EXAMINING ATTORNEY

**Int. Cl.: 16**

**Prior U.S. Cls.: 2, 5, 22, 23, 29, 37, 38 and 50**

**United States Patent and Trademark Office**

**Reg. No. 3,394,686**

**Registered Mar. 11, 2008**

**TRADEMARK  
PRINCIPAL REGISTER**

**GO**

GO PUBLISHING, LLC (SOUTH CAROLINA LTD  
LIAB CO)  
210 GROVE ROAD  
GREENVILLE, SC 29605

THE MARK CONSISTS OF STANDARD CHAR-  
ACTERS WITHOUT CLAIM TO ANY PARTICULAR  
FONT, STYLE, SIZE, OR COLOR.

FOR: MAGAZINES FEATURING ENDURANCE  
SPORTS AND FITNESS, IN CLASS 16 (U.S. CLS. 2, 5,  
22, 23, 29, 37, 38 AND 50).

SER. NO. 77-229,272, FILED 7-13-2007.

FIRST USE 4-1-2006; IN COMMERCE 4-1-2006.

TEJBIR SINGH, EXAMINING ATTORNEY

**Int. Cl.: 6**

**Prior U.S. Cls.: 2, 12, 13, 14, 23, 25 and 50**

**Reg. No. 3,394,687**

**United States Patent and Trademark Office**

**Registered Mar. 11, 2008**

---

**TRADEMARK  
PRINCIPAL REGISTER**

**FasTrack**

AMERICAN STAIR CORPORATION, INC. (ILLINOIS CORPORATION)  
642 FORESTVILLE DRIVE  
ROMEOVILLE, IL 604461354

THE MARK CONSISTS OF STANDARD CHARACTERS WITHOUT CLAIM TO ANY PARTICULAR FONT, STYLE, SIZE, OR COLOR.

FOR: STAIR TREADS OF METAL, IN CLASS 6 (U.S. CLS. 2, 12, 13, 14, 23, 25 AND 50).

SER. NO. 77-229,420, FILED 7-13-2007.

FIRST USE 1-1-1993; IN COMMERCE 1-1-1993.

MICHAEL SOUDERS, EXAMINING ATTORNEY

**Int. Cl.: 25**

**Prior U.S. Cls.: 22 and 39**

**United States Patent and Trademark Office**

**Reg. No. 3,394,688**

**Registered Mar. 11, 2008**

**TRADEMARK  
PRINCIPAL REGISTER**

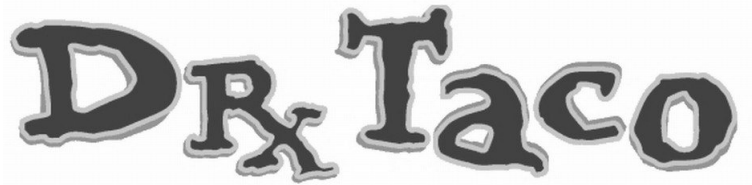
The logo features the words "DRX TACO" in a bold, stylized, hand-drawn font. The letters are thick with a slight shadow effect, giving them a three-dimensional appearance. The "X" is particularly stylized with a crossbar that has a small gap. The "T" is also thick and blocky. The "A" and "C" are rounded and simple in design. The "O" is a simple circle with a thick outline.

VALIANT GROUP, INC. (CALIFORNIA CORPORATION)  
133 E. DE LA GUERRA, #G  
SANTA BARBARA, CA 93101

FOR: CLOTHING, NAMELY, SHIRTS, TANK-TOPS, T-SHIRTS, NAMELY, LONG SLEEVE AND SHORT SLEEVE T-SHIRTS, POLO SHIRTS; HEADWEAR, NAMELY, CAPS, HATS, AND VISORS, IN CLASS 25 (U.S. CLS. 22 AND 39).

FIRST USE 3-21-2007; IN COMMERCE 3-21-2007.

THE MARK CONSISTS OF THE STYLIZED WORDS DRX TACO.

SER. NO. 77-229,495, FILED 7-13-2007.

LINDA M. KING, EXAMINING ATTORNEY

**Int. Cl.: 10**

**Prior U.S. Cls.: 26, 39 and 44**

**United States Patent and Trademark Office**

**Reg. No. 3,394,689**

**Registered Mar. 11, 2008**

**TRADEMARK  
PRINCIPAL REGISTER**



ADORN DESIGNS INC. (CALIFORNIA CORPORATION)  
25 JUDAH ST.  
SAN FRANCISCO, CA 94122

FOR: MEDICAL BAGS DESIGNED TO HOLD MEDICAL SUPPLIES, IN CLASS 10 (U.S. CLS. 26, 39 AND 44).

FIRST USE 10-1-2002; IN COMMERCE 11-1-2002.

THE MARK CONSISTS OF GRAPHIC LOGO OF "ADORN", STYLIZED WITH THE "D" BELOW THE LINE IN BETWEEN THE "A" AND THE "O" WHEN WRITTEN IN TEXT IT IS ADORN.

SER. NO. 77-229,512, FILED 7-13-2007.

CHRISTOPHER BUONGIORNO, EXAMINING ATTORNEY

**Int. Cl.: 5**

**Prior U.S. Cls.: 6, 18, 44, 46, 51 and 52**

**United States Patent and Trademark Office**

**Reg. No. 3,394,690**

**Registered Mar. 11, 2008**

**TRADEMARK  
PRINCIPAL REGISTER**

**RIVER'S EDGE**

RIVER'S EDGE PHARMACEUTICALS, LLC  
(GEORGIA LTD LIAB CO)  
5400 LAUREL SPRINGS PARKWAY  
SUWANEE, GA 30024

FOR: DERMATOLOGICAL PHARMACEUTICAL  
PRODUCTS; PHARMACEUTICAL ANTI-ALLER-  
GIC PREPARATIONS AND SUBSTANCES; PHAR-  
MACEUTICAL PREPARATIONS FOR THE  
TREATMENT OF ALLERGIES; COUGH AND COLD  
PREPARATIONS, IN CLASS 5 (U.S. CLS. 6, 18, 44, 46,  
51 AND 52).

FIRST USE 8-0-2003; IN COMMERCE 8-0-2003.

THE MARK CONSISTS OF STANDARD CHAR-  
ACTERS WITHOUT CLAIM TO ANY PARTICULAR  
FONT, STYLE, SIZE, OR COLOR.

SER. NO. 77-229,544, FILED 7-13-2007.

ANDREA BUTLER, EXAMINING ATTORNEY

Int. Cl.: 25

Prior U.S. Cls.: 22 and 39

United States Patent and Trademark Office

Reg. No. 3,394,691

Registered Mar. 11, 2008

TRADEMARK  
PRINCIPAL REGISTER

*Yvette Barreto*

YVETTE BARRETO (UNITED STATES INDIVIDUAL)  
NO. 500  
8306 WILSHIRE BOULEVARD  
BEVERLY HILLS, CA 90211

THE NAME YVETTE BARRETO IDENTIFIES A LIVING INDIVIDUAL WHOSE CONSENT IS OF RECORD.

FOR: SHOES, IN CLASS 25 (U.S. CLS. 22 AND 39).

SER. NO. 77-229,546, FILED 7-13-2007.

FIRST USE 7-4-2007; IN COMMERCE 7-4-2007.

MARY BOAGNI, EXAMINING ATTORNEY



**Int. Cl.: 5**

**Prior U.S. Cls.: 6, 18, 44, 46, 51 and 52**

**United States Patent and Trademark Office**

**Reg. No. 3,394,692**

**Registered Mar. 11, 2008**

**TRADEMARK  
PRINCIPAL REGISTER**



RIVER'S EDGE PHARMACEUTICALS, LLC  
(GEORGIA LTD LIAB CO)  
5400 LAUREL SPRINGS PARKWAY  
SUWANEE, GA 30024

PREPARATIONS, IN CLASS 5 (U.S. CLS. 6, 18, 44, 46,  
51 AND 52).

FIRST USE 8-0-2003; IN COMMERCE 8-0-2003.

FOR: DERMATOLOGICAL PHARMACEUTICAL  
PRODUCTS; PHARMACEUTICAL ANTI-ALLER-  
GIC PREPARATIONS AND SUBSTANCES; PHAR-  
MACEUTICAL PREPARATIONS FOR THE  
TREATMENT OF ALLERGIES; COUGH AND COLD

SER. NO. 77-229,551, FILED 7-13-2007.

ANDREA BUTLER, EXAMINING ATTORNEY

**Int. Cls.: 28 and 41**

**Prior U.S. Cls.: 22, 23, 38, 50, 100, 101 and 107**

**United States Patent and Trademark Office**

**Reg. No. 3,394,693**

**Registered Mar. 11, 2008**

**TRADEMARK  
SERVICE MARK  
PRINCIPAL REGISTER**

# HOOPRAMA

BECKS, SUNNY (UNITED STATES INDIVIDUAL)  
1515 FORREST AVENUE  
NASHVILLE, TN 37206

FOR: PLASTIC TOY HOOPS; PLASTIC HOOPS FOR EXERCISE AND FITNESS, IN CLASS 28 (U.S. CLS. 22, 23, 38 AND 50).

FIRST USE 5-8-2007; IN COMMERCE 5-8-2007.

FOR: DANCE INSTRUCTION USING HOOPS; ENTERTAINMENT IN THE NATURE OF DANCE PERFORMANCES USING HOOPS; TRAINING INSTRUCTORS IN THE FIELD OF USING HOOPS; CONDUCTING CLASSES IN THE FIELD OF DANCE

USING HOOPS; EDUCATION SERVICES, NAMELY, CONDUCTING CLASSES IN THE FIELD OF DANCE USING HOOPS; PHYSICAL FITNESS INSTRUCTION UTILIZING HOOPS, IN CLASS 41 (U.S. CLS. 100, 101 AND 107).

FIRST USE 5-8-2007; IN COMMERCE 5-8-2007.

THE MARK CONSISTS OF STANDARD CHARACTERS WITHOUT CLAIM TO ANY PARTICULAR FONT, STYLE, SIZE, OR COLOR.

SER. NO. 77-229,552, FILED 7-13-2007.

ANDREA BUTLER, EXAMINING ATTORNEY

**Int. Cl.: 25**

**Prior U.S. Cls.: 22 and 39**

**United States Patent and Trademark Office**

**Reg. No. 3,394,694**

**Registered Mar. 11, 2008**

**TRADEMARK  
PRINCIPAL REGISTER**

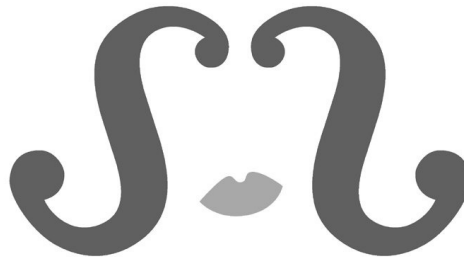

TASSI, LLC (ARIZONA LTD LIAB CO)  
4041 E. GROVE CIRCLE  
MESA, AZ 85206

THE MARK CONSISTS OF HAIR AND LIPS.

FOR: HEADWEAR, IN CLASS 25 (U.S. CLS. 22  
AND 39).

SER. NO. 77-229,699, FILED 7-13-2007.

FIRST USE 3-26-2007; IN COMMERCE 5-31-2007.

SALLY SHIH, EXAMINING ATTORNEY

**Int. Cl.: 9**

**Prior U.S. Cls.: 21, 23, 26, 36 and 38**

**United States Patent and Trademark Office**

**Reg. No. 3,394,695**

**Registered Mar. 11, 2008**

**TRADEMARK  
PRINCIPAL REGISTER**

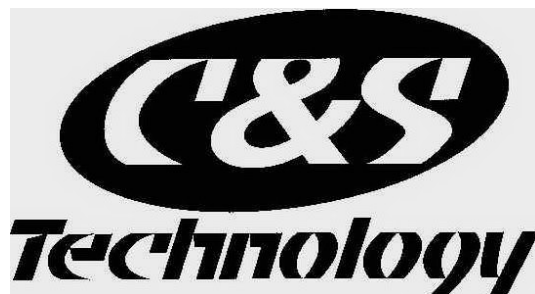

C&S TECHNOLOGY CO., LTD. (REPUBLIC OF  
KOREA CORPORATION)  
C&S BLDG.  
MUNJUNGI-DONG, 54-7 SONGPA-KU  
SEOUL, REPUBLIC OF KOREA

FOR: TELEPHONE SETS; VIDEO-TELEPHONES;  
INTERCOMS; APPARATUS FOR TRANSMITTING  
AND REPRODUCING SOUND OR IMAGES; MOD-  
EMS; SEMICONDUCTORS; INTEGRATED CIR-  
CUITS; MICROPROCESSORS; TRANSFORMERS;  
AUDIO-VIDEO RECEIVERS; NAVIGATION APPA-  
RATUS FOR VEHICLES; WIRELESS TELEPHONY  
APPARATUS, IN CLASS 9 (U.S. CLS. 21, 23, 26, 36  
AND 38).

OWNER OF REPUBLIC OF KOREA REG. NO. 40-  
0473817, DATED 7-20-2000, EXPIRES 7-20-2010.

NO CLAIM IS MADE TO THE EXCLUSIVE  
RIGHT TO USE "TECHNOLOGY", APART FROM  
THE MARK AS SHOWN.

THE MARK CONSISTS OF LETTERS "C&S" IN-  
SIDE AN OVAL IMAGE AND STYLIZED WORD  
"TECHNOLOGY" BELOW THE OVAL.

SER. NO. 77-229,741, FILED 7-13-2007.

TARAH HARDY, EXAMINING ATTORNEY

**Int. Cl.: 44**

**Prior U.S. Cls.: 100 and 101**

**United States Patent and Trademark Office**

**Reg. No. 3,394,696**

**Registered Mar. 11, 2008**

**SERVICE MARK  
PRINCIPAL REGISTER**

**DrBicuspid.com**

AUNTMINNIE.COM, INC. (DELAWARE CORPORATION)  
1350 N. KOLB RD. #215  
TUSCON, AZ 85715

THE MARK CONSISTS OF STANDARD CHARACTERS WITHOUT CLAIM TO ANY PARTICULAR FONT, STYLE, SIZE, OR COLOR.

FOR: PROVIDING NEWS AND INFORMATION IN THE FIELD OF DENTISTRY, IN CLASS 44 (U.S. CLS. 100 AND 101).

SER. NO. 77-229,770, FILED 7-13-2007.

FIRST USE 9-17-2007; IN COMMERCE 9-17-2007.

DEIRDRE ROBERTSON, EXAMINING ATTORNEY

Int. Cl.: 44

Prior U.S. Cls.: 100 and 101

**United States Patent and Trademark Office**

**Reg. No. 3,394,697**

Registered Mar. 11, 2008

**SERVICE MARK  
PRINCIPAL REGISTER**



AUNTMINNIE.COM, INC. (DELAWARE CORPORATION)  
1350 N. KOLB RD. #215  
TUSCON, AZ 85715

THE MARK CONSISTS OF A DRAWING OF A DENTIST WEARING A DENTAL MASK, GLASSES AND ENCIRCLED IN A ROUND SHADED CIRCLE.

FOR: PROVIDING NEWS AND INFORMATION IN THE FIELD OF DENTISTRY, IN CLASS 44 (U.S. CLS. 100 AND 101).

SER. NO. 77-229,772, FILED 7-13-2007.

FIRST USE 9-17-2007; IN COMMERCE 9-17-2007.

DEIRDRE ROBERTSON, EXAMINING ATTORNEY

**Int. Cl.: 28**

**Prior U.S. Cls.: 22, 23, 38 and 50**

**United States Patent and Trademark Office**

**Reg. No. 3,394,698**

**Registered Mar. 11, 2008**

**TRADEMARK  
PRINCIPAL REGISTER**

**POLY PONG**

POLY PONG, INC. (UTAH CORPORATION)  
412 SOUTH 100 EAST  
SALEM, UT 84653

FIRST USE 10-1-2006; IN COMMERCE 1-1-2007.

FOR: ACTION SKILL GAMES; BALLS FOR GAMES; GAME TABLES; TABLE TENNIS BALLS; TABLE TENNIS BATS; TABLE TENNIS PADDLE CASES; TABLE TENNIS PADDLES; TABLE TENNIS RACKETS; TABLE TENNIS TABLES; TABLE-TENNIS BALLS, IN CLASS 28 (U.S. CLS. 22, 23, 38 AND 50).

THE MARK CONSISTS OF STANDARD CHARACTERS WITHOUT CLAIM TO ANY PARTICULAR FONT, STYLE, SIZE, OR COLOR.

SER. NO. 77-229,775, FILED 7-13-2007.

DEIRDRE ROBERTSON, EXAMINING ATTORNEY

**Int. Cl.: 9**

**Prior U.S. Cls.: 21, 23, 26, 36 and 38**

**United States Patent and Trademark Office**

**Reg. No. 3,394,699**

**Registered Mar. 11, 2008**

**TRADEMARK  
PRINCIPAL REGISTER**

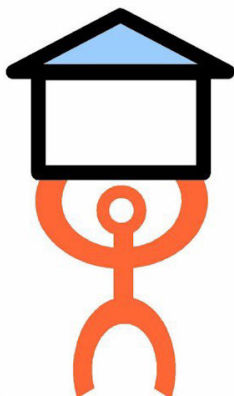

INTERACT SYSTEMS DEVELOPMENT, INC. (IS-  
RAEL CORPORATION)  
2401 GREEN VALLEY ROAD  
DARIEN, IL 60561

FOR: COMPUTER SOFTWARE FOR REAL ES-  
TATE INVESTMENT ANALYSIS; COMPUTER  
SOFTWARE FOR REAL ESTATE INVESTMENT  
ANALYSIS THAT MAY BE DOWNLOADED FROM  
A GLOBAL COMPUTER NETWORK; DOWNLOAD-  
ABLE SOFTWARE FOR REAL ESTATE INVEST-  
MENT ANALYSIS; FLOPPY DISCS FOR  
COMPUTERS FEATURING REAL ESTATE INVEST-  
MENT ANALYSIS, IN CLASS 9 (U.S. CLS. 21, 23, 26, 36  
AND 38).

FIRST USE 7-15-2007; IN COMMERCE 7-15-2007.

THE COLOR(S) ORANGE, WHITE, BLACK,  
LIGHT-BLUE IS/ARE CLAIMED AS A FEATURE  
OF THE MARK.

THE MARK CONSISTS OF A STICK FIGURE OF  
A PERSON HOLDING A HOUSE OVERHEAD. THE  
PERSON IS ORANGE WITH A WHITE FILLED  
HEAD. THE HOUSE IS OUTLINED WITH BLACK  
WITH WHITE FILLED WALLS AND LIGHT-BLUE  
FILLED ROOF.

SER. NO. 77-230,024, FILED 7-15-2007.

RAUL CORDOVA, EXAMINING ATTORNEY



**Int. Cl.: 36**

**Prior U.S. Cls.: 100, 101 and 102**

**United States Patent and Trademark Office**

**Reg. No. 3,394,700**

**Registered Mar. 11, 2008**

**SERVICE MARK  
PRINCIPAL REGISTER**

WHAT ARE YOU GONNA GET?

AMERICAN EXPRESS MARKETING & DEVELOPMENT CORP. (NEW YORK CORPORATION)  
200 VESEY STREET  
NEW YORK, NY 10285

THE MARK CONSISTS OF STANDARD CHARACTERS WITHOUT CLAIM TO ANY PARTICULAR FONT, STYLE, SIZE, OR COLOR.

FOR: CREDIT CARD SERVICES, IN CLASS 36 (U.S. CLS. 100, 101 AND 102).

SER. NO. 77-230,125, FILED 7-16-2007.

FIRST USE 11-1-2006; IN COMMERCE 11-1-2006.

RICHARD A. STRASER, EXAMINING ATTORNEY

**Int. Cl.: 9**

**Prior U.S. Cls.: 21, 23, 26, 36 and 38**

**Reg. No. 3,394,701**

**United States Patent and Trademark Office**

**Registered Mar. 11, 2008**

**TRADEMARK  
PRINCIPAL REGISTER**

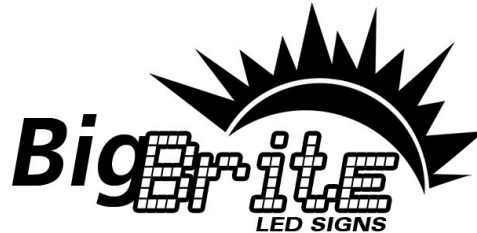

ICIM CORPORATION (KENTUCKY CORPORATION), DBA PLANET TELECOM  
432 STATE STREET  
NEW ALBANY, IN 47150

FOR: (BASED ON USE IN COMMERCE) LIGHT EMITTING DIODE (LED) DISPLAYS, IN CLASS 9 (U.S. CLS. 21, 23, 26, 36 AND 38).

FIRST USE 11-0-2006; IN COMMERCE 11-0-2006.

NO CLAIM IS MADE TO THE EXCLUSIVE RIGHT TO USE "LED SIGNS", APART FROM THE MARK AS SHOWN.

THE MARK CONSISTS OF A STYLIZED SUN AND THE TERM BIGBRITE UNDERSCORED BY THE WORDS LED SIGNS.

SER. NO. 77-230,168, FILED 7-16-2007.

SUSAN STIGLITZ, EXAMINING ATTORNEY

**Int. Cl.: 39**

**Prior U.S. Cls.: 100 and 105**

**United States Patent and Trademark Office**

**Reg. No. 3,394,702**

**Registered Mar. 11, 2008**

**SERVICE MARK  
PRINCIPAL REGISTER**

**Where Honeymoons Begin**

LIBERTY TRAVEL, INC. (NEW YORK COR-  
PORATION)  
69 SPRING STREET  
RAMSEY, NJ 07446

THE MARK CONSISTS OF STANDARD CHAR-  
ACTERS WITHOUT CLAIM TO ANY PARTICULAR  
FONT, STYLE, SIZE, OR COLOR.

FOR: TRAVEL BOOKING AGENCIES, IN CLASS  
39 (U.S. CLS. 100 AND 105).

SER. NO. 77-231,612, FILED 7-17-2007.

FIRST USE 6-1-2007; IN COMMERCE 6-1-2007.

DAVID TAYLOR, EXAMINING ATTORNEY

**Int. Cl.: 39**

**Prior U.S. Cls.: 100 and 105**

**United States Patent and Trademark Office**

**Reg. No. 3,394,703**

**Registered Mar. 11, 2008**

**SERVICE MARK  
PRINCIPAL REGISTER**

**Where Family Vacations  
Begin**

LIBERTY TRAVEL, INC. (NEW YORK COR-  
PORATION)  
69 SPRING STREET  
RAMSEY, NJ 07446

THE MARK CONSISTS OF STANDARD CHAR-  
ACTERS WITHOUT CLAIM TO ANY PARTICULAR  
FONT, STYLE, SIZE, OR COLOR.

FOR: TRAVEL BOOKING AGENCIES, IN CLASS  
39 (U.S. CLS. 100 AND 105).

SER. NO. 77-231,663, FILED 7-17-2007.

FIRST USE 6-1-2007; IN COMMERCE 6-1-2007.

DAVID TAYLOR, EXAMINING ATTORNEY

**Int. Cl.: 9**

**Prior U.S. Cls.: 21, 23, 26, 36 and 38**

**United States Patent and Trademark Office**

**Reg. No. 3,394,704**

**Registered Mar. 11, 2008**

**TRADEMARK  
PRINCIPAL REGISTER**

**ZOHO**

ADVENTNET, INC. (CALIFORNIA CORPORATION)  
5200 FRANKLIN DRIVE, SUITE 115  
PLEASANTON, CA 94588

FOR: COMPUTER SOFTWARE THAT MAY BE DOWNLOADED FROM A GLOBAL COMPUTER NETWORK FOR WORD PROCESSING, SPREADSHEETS, CALENDAR, E-MAILING, INSTANT MESSAGING, GROUP WARE FOR CALENDAR SHARING, COLLECTIVE WRITING, E-MAIL HANDLING AND SHARED DATABASE ACCESS, DOCUMENT SHARING, PERSONAL ORGANIZER FUNCTIONS, MANAGING DATA, CUSTOMER RELATIONSHIP MANAGEMENT, ONLINE POLLING, AND TO EDIT, CREATE, PUBLISH AND DESIGN PRESENTATIONS, IN CLASS 9 (U.S. CLS. 21, 23, 26, 36 AND 38).

FIRST USE 1-26-2005; IN COMMERCE 8-15-2005.

THE MARK CONSISTS OF STANDARD CHARACTERS WITHOUT CLAIM TO ANY PARTICULAR FONT, STYLE, SIZE, OR COLOR.

OWNER OF U.S. REG. NO. 3,260,807.

ZOHO HAS NO MEANING IN ENGLISH.

SER. NO. 77-232,249, FILED 7-18-2007.

KATHLEEN M. VANSTON, EXAMINING ATTORNEY

**Int. Cl.: 11**

**Prior U.S. Cls.: 13, 21, 23, 31 and 34**

**United States Patent and Trademark Office**

**Reg. No. 3,394,705**

**Registered Mar. 11, 2008**

**TRADEMARK  
PRINCIPAL REGISTER**



PANZERI CARLO S.R.L. (ITALY LTD LIAB CO)  
VIA PADANIA, 8  
BIASSONO (MILANO), ITALY

FOR: APPARATUS FOR LIGHTING, NAMELY,  
LAMPS, FLOOR LAMPS, TABLE LAMPS, CEILING  
LAMPS, WALL LAMPS, ARC LAMPS, DISCHARGE  
LAMPS, FITTINGS FOR DISCHARGE LAMPS,  
ELECTRIC LAMPS, FILAMENTS FOR ELECTRIC  
LAMPS, FLUORESCENT LAMPS, GAS LAMPS, IN-  
CANDESCENT LAMPS, INFRARED LAMPS,  
LAMPS WHOSE LIGHT CAN BE TURNED IN ALL  
DIRECTIONS, LAMP BASES, LAMP REFLECTORS;  
LIGHTING FIXTURES, ELECTRIC LIGHTING FIX-  
TURES, INFRARED LIGHTING FIXTURES, LAND-

SCAPE LIGHTING INSTALLATIONS, LIGHTING  
DEVICES FOR SHOW CASES, LIGHTING TRACKS,  
LIGHTING TUBES, IN CLASS 11 (U.S. CLS. 13, 21, 23,  
31 AND 34).

FIRST USE 10-0-2004; IN COMMERCE 10-0-2004.

PRIORITY CLAIMED UNDER SEC. 44(D) ON  
ERPNTY CMNTY TM OFC APPLICATION NO.  
6,041,016, FILED 6-26-2007.

SER. NO. 77-232,263, FILED 7-18-2007.

KEVON CHISOLM, EXAMINING ATTORNEY

Int. Cl.: 41

Prior U.S. Cls.: 100, 101 and 107

United States Patent and Trademark Office

Reg. No. 3,394,706

Registered Mar. 11, 2008

SERVICE MARK  
PRINCIPAL REGISTER



**PDA**  
*Professional Dental Assisting*

PENNWELL CORPORATION (OKLAHOMA CORPORATION)  
1421 SOUTH SHERIDAN ROAD  
TULSA, OK 74112

FOR: ARRANGING AND CONDUCTING EDUCATIONAL CONFERENCES IN THE FIELD OF DENTAL ASSISTING, IN CLASS 41 (U.S. CLS. 100, 101 AND 107).

FIRST USE 12-15-2005; IN COMMERCE 12-15-2005.

NO CLAIM IS MADE TO THE EXCLUSIVE RIGHT TO USE "PROFESSIONAL DENTAL ASSISTING", APART FROM THE MARK AS SHOWN.

THE MARK CONSISTS OF THE TERM "PDA" WITH A CURVED LINE OVERLAYING THE ENTIRE TERM AND THE END OF THE CURVED LINE ENSCONCED INTO THE MIDDLE OF THE LETTER "A". BENEATH THIS ELEMENT APPEARS THE WORDING "PROFESSIONAL DENTAL ASSISTING".

SER. NO. 77-233,273, FILED 7-19-2007.

MICHAEL WIENER, EXAMINING ATTORNEY

**Int. Cl.: 36**

**Prior U.S. Cls.: 100, 101 and 102**

**United States Patent and Trademark Office**

**Reg. No. 3,394,707**

**Registered Mar. 11, 2008**

**SERVICE MARK  
PRINCIPAL REGISTER**



POPULAR, INC. (PUERTO RICO CORPORATION)  
SUITE 913  
209 MUÑOZ RIVERA AVENUE  
SAN JUAN, PUERTO RICO 00918

THE MARK CONSISTS OF THE WORD "WE" FOLLOWED BY A HEART DESIGN FOLLOWED BY THE WORD "DREAMS" IN THE FOREGROUND WITH A CIRCLE DESIGN IN THE BACKGROUND.

FOR: BANKING, IN CLASS 36 (U.S. CLS. 100, 101 AND 102).

SER. NO. 77-233,381, FILED 7-19-2007.

FIRST USE 6-1-2007; IN COMMERCE 6-1-2007.

NELSON SNYDER, EXAMINING ATTORNEY



**Int. Cl.: 41**

**Prior U.S. Cls.: 100, 101 and 107**

**United States Patent and Trademark Office**

**Reg. No. 3,394,708**

**Registered Mar. 11, 2008**

**SERVICE MARK  
PRINCIPAL REGISTER**

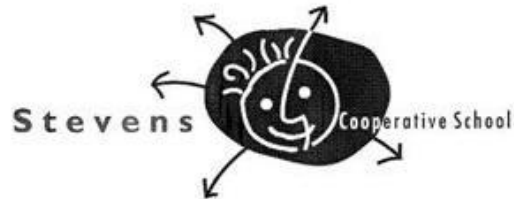

STEVENS COOPERATIVE SCHOOL (NEW JERSEY CORPORATION)  
301 GARDEN STREET  
HOBOKEN, NJ 07030

NO CLAIM IS MADE TO THE EXCLUSIVE RIGHT TO USE "COOPERATIVE SCHOOL", APART FROM THE MARK AS SHOWN.

FOR: EDUCATIONAL SCHOOL SERVICES, NAMELY, EDUCATING STUDENTS FROM TWO YEARS OLD THROUGH THE 8TH GRADE, IN CLASS 41 (U.S. CLS. 100, 101 AND 107).

SER. NO. 77-233,739, FILED 7-19-2007.

FIRST USE 1-1-1996; IN COMMERCE 1-1-1996.

JASON LOTT, EXAMINING ATTORNEY

**Int. Cl.: 35**

**Prior U.S. Cls.: 100, 101 and 102**

**United States Patent and Trademark Office**

**Reg. No. 3,394,709**

**Registered Mar. 11, 2008**

**SERVICE MARK  
PRINCIPAL REGISTER**

YOUR BUYING GROUP OF CHOICE

C & E VISION SERVICES, INC. (CALIFORNIA  
CORPORATION)  
1015 CALLE AMANECER  
SAN CLEMENTE, CA 92673

THE MARK CONSISTS OF STANDARD CHAR-  
ACTERS WITHOUT CLAIM TO ANY PARTICULAR  
FONT, STYLE, SIZE, OR COLOR.

FOR: BILLING SERVICE, IN CLASS 35 (U.S. CLS.  
100, 101 AND 102).

SER. NO. 77-233,779, FILED 7-19-2007.

FIRST USE 11-12-2006; IN COMMERCE 11-12-2006.

LINDSEY RUBIN, EXAMINING ATTORNEY

**Int. Cl.: 35**

**Prior U.S. Cls.: 100, 101 and 102**

**United States Patent and Trademark Office**

**Reg. No. 3,394,710**

**Registered Mar. 11, 2008**

**SERVICE MARK  
PRINCIPAL REGISTER**

**YOUR STYLE, YOUR SIZE**

REDCATS USA, L.P. (DELAWARE LIMITED  
PARTNERSHIP)  
2300 SOUTHEASTERN AVE.  
INDIANAPOLIS, IN 46201

FOR: (BASED ON USE IN COMMERCE) ON-LINE  
RETAIL STORE SERVICES FEATURING CLOTH-  
ING, SHOES AND ACCESSORIES, IN CLASS 35 (U.S.  
CLS. 100, 101 AND 102).

FIRST USE 7-10-2001; IN COMMERCE 7-10-2007.

THE MARK CONSISTS OF STANDARD CHAR-  
ACTERS WITHOUT CLAIM TO ANY PARTICULAR  
FONT, STYLE, SIZE, OR COLOR.

OWNER OF U.S. REG. NO. 2,604,539.

SER. NO. 77-233,866, FILED 7-19-2007.

LINDA E. BLOHM, EXAMINING ATTORNEY

**Int. Cl.: 33**

**Prior U.S. Cls.: 47 and 49**

**United States Patent and Trademark Office**

**Reg. No. 3,394,711**

**Registered Mar. 11, 2008**

**TRADEMARK  
PRINCIPAL REGISTER**

**DUE SOUTH**

THE WINE ANGEL, INC. (NEW YORK COR-  
PORATION)  
115 W 30TH ST, SUITE 505  
NEW YORK, NY 10001

THE MARK CONSISTS OF STANDARD CHAR-  
ACTERS WITHOUT CLAIM TO ANY PARTICULAR  
FONT, STYLE, SIZE, OR COLOR.

FOR: WINE; WINES, IN CLASS 33 (U.S. CLS. 47  
AND 49).

SER. NO. 77-235,194, FILED 7-20-2007.

FIRST USE 7-1-2007; IN COMMERCE 7-19-2007.

REBECCA EISINGER, EXAMINING ATTORNEY

**Int. Cl.: 12**

**Prior U.S. Cls.: 19, 21, 23, 31, 35 and 44**

**United States Patent and Trademark Office**

**Reg. No. 3,394,712**

**Registered Mar. 11, 2008**

**TRADEMARK  
PRINCIPAL REGISTER**



SPORTSTRONICS, INC (GEORGIA CORPORATION)  
1891 MCFARLAND PARKWAY  
ALPHARETTA, GA 30005

FIRST USE 4-0-2007; IN COMMERCE 4-0-2007.

SER. NO. 77-235,508, FILED 7-22-2007.

FOR: LARGE POOL AND LAKE INFLATABLE  
MOTORIZED WATERCRAFT, IN CLASS 12 (U.S.  
CLS. 19, 21, 23, 31, 35 AND 44).

SIMON TENG, EXAMINING ATTORNEY

**Int. Cl.: 36**

**Prior U.S. Cls.: 100, 101 and 102**

**United States Patent and Trademark Office**

**Reg. No. 3,394,713**

**Registered Mar. 11, 2008**

**SERVICE MARK  
PRINCIPAL REGISTER**

**HARTFORD**  
**INVESTMENT MANAGEMENT**

HARTFORD FIRE INSURANCE COMPANY  
(CONNECTICUT CORPORATION)  
CORP. LAW DEPT.-TECH/IP-TRADEMARK UNIT  
ONE HARTFORD PLAZA  
HARTFORD, CT 06155

FOR: INVESTMENT MANAGEMENT SERVICES,  
IN CLASS 36 (U.S. CLS. 100, 101 AND 102).

FIRST USE 5-0-2007; IN COMMERCE 5-0-2007.

OWNER OF U.S. REG. NOS. 2,153,863 AND  
2,164,076.

NO CLAIM IS MADE TO THE EXCLUSIVE  
RIGHT TO USE "INVESTMENT MANAGEMENT",  
APART FROM THE MARK AS SHOWN.

THE MARK CONSISTS OF TWO SQUARES AND  
THE WORDS HARTFORD INVESTMENT MAN-  
AGEMENT.

SEC. 2(F) AS TO "HARTFORD INVESTMENT  
MANAGEMENT COMPANY".

SER. NO. 77-236,175, FILED 7-23-2007.

TOBY BULLOFF, EXAMINING ATTORNEY

**Int. Cl.: 16**

**Prior U.S. Cls.: 2, 5, 22, 23, 29, 37, 38 and 50**

**United States Patent and Trademark Office**

**Reg. No. 3,394,714**

**Registered Mar. 11, 2008**

**TRADEMARK  
PRINCIPAL REGISTER**

 **LIBRITOS MÍOS**

THE OHIO STATE UNIVERSITY (OHIO EDUCATIONAL INSTITUTION)  
190 NORTH OVAL MALL  
COLUMBUS, OH 43210

FOR: CHILDREN'S BOOKS, IN CLASS 16 (U.S. CLS. 2, 5, 22, 23, 29, 37, 38 AND 50).

FIRST USE 4-0-1996; IN COMMERCE 4-0-1996.

OWNER OF U.S. REG. NO. 2,060,982.

NO CLAIM IS MADE TO THE EXCLUSIVE RIGHT TO USE LIBRITOS, APART FROM THE MARK AS SHOWN.

THE MARK CONSISTS OF LITERAL ELEMENT LIBRITOS MIOS WITH A POCKET-SHAPED SQUARE SURROUNDING THE L. ALONG THREE OF THE FOUR EDGES OF THE POCKET ARE DASHES. THE FOURTH EDGE OVERLAPS TWO OTHER SQUARE SHAPES.

THE FOREIGN WORDING IN THE MARK TRANSLATES INTO ENGLISH AS MY LITTLE BOOKS.

SER. NO. 77-237,207, FILED 7-24-2007.

ANGELA M. MICHELI, EXAMINING ATTORNEY

**Int. Cl.: 16**

**Prior U.S. Cls.: 2, 5, 22, 23, 29, 37, 38 and 50**

**United States Patent and Trademark Office**

**Reg. No. 3,394,715**

**Registered Mar. 11, 2008**

**TRADEMARK  
PRINCIPAL REGISTER**

**Shenandoah Living**

ROUTE 11 PUBLICATIONS LLC (VIRGINIA LTD  
LIAB CO)  
P.O. BOX 313  
LACEY SPRING, VA 22833

FOR: MAGAZINES FEATURING THE SHENAN-  
DOAH VALLEY OF VIRGINIA, IN CLASS 16 (U.S.  
CLS. 2, 5, 22, 23, 29, 37, 38 AND 50).

FIRST USE 1-1-2007; IN COMMERCE 1-1-2007.

THE MARK CONSISTS OF STANDARD CHAR-  
ACTERS WITHOUT CLAIM TO ANY PARTICULAR  
FONT, STYLE, SIZE, OR COLOR.

NO CLAIM IS MADE TO THE EXCLUSIVE  
RIGHT TO USE "SHENANDOAH", APART FROM  
THE MARK AS SHOWN.

SER. NO. 77-237,931, FILED 7-25-2007.

EDWARD NELSON, EXAMINING ATTORNEY



**Int. Cl.: 29**

**Prior U.S. Cl.: 46**

**United States Patent and Trademark Office**

**Reg. No. 3,394,716**

**Registered Mar. 11, 2008**

**TRADEMARK  
PRINCIPAL REGISTER**



PET INCORPORATED (DELAWARE CORPORATION)  
NUMBER ONE GENERAL MILLS BOULEVARD  
MINNEAPOLIS, MN 55426

FOR: CANNED TOMATOES AND TOMATO  
PUREE, IN CLASS 29 (U.S. CL. 46).

FIRST USE 12-0-2006; IN COMMERCE 12-0-2006.

OWNER OF U.S. REG. NOS. 398,874, 708,478, AND  
1,430,438.

NO CLAIM IS MADE TO THE EXCLUSIVE  
RIGHT TO USE "AWARD WINNING QUALITY",  
APART FROM THE MARK AS SHOWN.

THE MARK CONSISTS OF A ROUND SEAL WITH  
A SCALLOPED EDGE CONTAINING 4 STARS, 2  
SEMI-CIRCLE DESIGNS AND THE WORDING  
"PROGRESSO AWARD WINNING QUALITY".

THE ENGLISH TRANSLATION OF "PROGRES-  
SO" IN THE MARK IS "PROGRESS".

SER. NO. 77-238,084, FILED 7-25-2007.

INGA ERVIN, EXAMINING ATTORNEY

**Int. Cl.: 25**

**Prior U.S. Cls.: 22 and 39**

**United States Patent and Trademark Office**

**Reg. No. 3,394,717**

**Registered Mar. 11, 2008**

**TRADEMARK  
PRINCIPAL REGISTER**

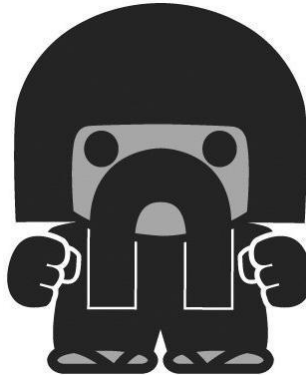

RAGEVOL LLC (CALIFORNIA LTD LIAB CO)  
PO BOX 3553  
TORRANCE, CA 90510

THE MARK CONSISTS OF A BOY WEARING A  
HELMET, A DISGUISED MUSTACHE, GLOVES,  
AND SLIPPERS.

FOR: POLO SHIRTS; SHIRTS; SHORT-SLEEVED  
OR LONG-SLEEVED T-SHIRTS; SWEAT SHIRTS; T-  
SHIRTS; TEE SHIRTS, IN CLASS 25 (U.S. CLS. 22  
AND 39).

SER. NO. 77-238,984, FILED 7-26-2007.

FIRST USE 6-12-2007; IN COMMERCE 6-12-2007.

EMILY CHUO, EXAMINING ATTORNEY

**Int. Cl.: 25**

**Prior U.S. Cls.: 22 and 39**

**United States Patent and Trademark Office**

**Reg. No. 3,394,718**

**Registered Mar. 11, 2008**

**TRADEMARK  
PRINCIPAL REGISTER**



RAGEVOL LLC (CALIFORNIA LTD LIAB CO)  
PO BOX 3553  
TORRANCE, CA 90510

THE MARK CONSISTS OF A HEART MADE UP  
OF 2 SECTIONS WITH THE LEFT SIDE BEING A  
STYLIZED LETTER "R".

FOR: POLO SHIRTS; SHIRTS; SHORT-SLEEVED  
OR LONG-SLEEVED T-SHIRTS; SWEAT SHIRTS; T-  
SHIRTS; TEE SHIRTS, IN CLASS 25 (U.S. CLS. 22  
AND 39).

SER. NO. 77-238,987, FILED 7-26-2007.

FIRST USE 6-17-2007; IN COMMERCE 6-17-2007.

EMILY CHUO, EXAMINING ATTORNEY

**Int. Cl.: 25**

**Prior U.S. Cls.: 22 and 39**

**United States Patent and Trademark Office**

**Reg. No. 3,394,719**

**Registered Mar. 11, 2008**

**TRADEMARK  
PRINCIPAL REGISTER**

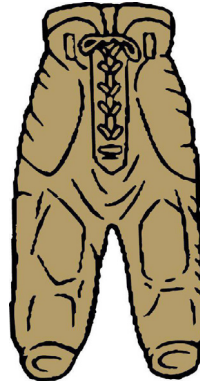

THE OHIO STATE UNIVERSITY (OHIO EDUCATIONAL INSTITUTION)  
190 NORTH OVAL MALL  
COLUMBUS, OH 432153484

FOR: CLOTHING, NAMELY, HATS, CAPS, SHIRTS, T-SHIRTS, JACKETS, JERSEYS, WIND RESISTANT JACKETS AND SWEATSHIRTS, IN CLASS 25 (U.S. CLS. 22 AND 39).

FIRST USE 11-22-1998; IN COMMERCE 11-22-1998.

OWNER OF U.S. REG. NO. 3,221,645.

"THE COLOR(S) GOLD AND BLACK IS/ARE CLAIMED AS A FEATURE OF THE MARK."

"THE MARK CONSISTS OF A PAIR OF GOLD FOOTBALL PANTS WITH THE COLOR BLACK IN THE OUTLINE OF THE PANTS, THE CREASES OF THE PANTS AND THE LACES OF THE PANTS."

SER. NO. 77-239,232, FILED 7-26-2007.

ANGELA M. MICHELI, EXAMINING ATTORNEY

**Int. Cl.: 25**

**Prior U.S. Cls.: 22 and 39**

**United States Patent and Trademark Office**

**Reg. No. 3,394,720**

**Registered Mar. 11, 2008**

**TRADEMARK  
PRINCIPAL REGISTER**

# GOLD PANTS

THE OHIO STATE UNIVERSITY (OHIO EDUCATIONAL INSTITUTION)  
190 NORTH OVAL MALL  
COLUMBUS, OH 43210

FOR: CLOTHING, NAMELY, HATS, CAPS, SHIRTS, T-SHIRTS, JACKETS, JERSEYS, WIND RESISTANT JACKETS AND SWEATSHIRTS, IN CLASS 25 (U.S. CLS. 22 AND 39).

FIRST USE 11-22-1998; IN COMMERCE 11-22-1998.

THE MARK CONSISTS OF STANDARD CHARACTERS WITHOUT CLAIM TO ANY PARTICULAR FONT, STYLE, SIZE, OR COLOR.

OWNER OF U.S. REG. NO. 3,221,645.

SER. NO. 77-239,233, FILED 7-26-2007.

ANGELA M. MICHELI, EXAMINING ATTORNEY

**Int. Cl.: 5**

**Prior U.S. Cls.: 6, 18, 44, 46, 51 and 52**

**United States Patent and Trademark Office**

**Reg. No. 3,394,721**

**Registered Mar. 11, 2008**

**TRADEMARK  
PRINCIPAL REGISTER**

**VISINE TEARS LASTING RELIEF**

JOHNSON & JOHNSON (NEW JERSEY CORPORATION)  
ONE JOHNSON & JOHNSON PLAZA  
NEW BRUNSWICK, NJ 089337001

OWNER OF U.S. REG. NOS. 1,121,279, 2,830,751  
AND OTHERS.

FOR: OPHTHALMIC PREPARATIONS, IN CLASS  
5 (U.S. CLS. 6, 18, 44, 46, 51 AND 52).

NO CLAIM IS MADE TO THE EXCLUSIVE  
RIGHT TO USE "TEARS" AND "RELIEF", APART  
FROM THE MARK AS SHOWN.

FIRST USE 4-15-2007; IN COMMERCE 4-15-2007.

SER. NO. 77-239,309, FILED 7-26-2007.

THE MARK CONSISTS OF STANDARD CHARACTERS  
WITHOUT CLAIM TO ANY PARTICULAR  
FONT, STYLE, SIZE, OR COLOR.

JULIE WATSON, EXAMINING ATTORNEY

**Int. Cl.: 9**

**Prior U.S. Cls.: 21, 23, 26, 36 and 38**

**Reg. No. 3,394,722**

**United States Patent and Trademark Office**

**Registered Mar. 11, 2008**

---

**TRADEMARK  
PRINCIPAL REGISTER**

**SIMPULL**

SOUTHWIRE COMPANY (DELAWARE CORPORATION)  
ONE SOUTHWIRE DRIVE  
CARROLLTON, GA 30119

FOR: (BASED ON USE IN COMMERCE) ELECTRICAL WIRES; ELECTRICAL CABLES, IN CLASS 9 (U.S. CLS. 21, 23, 26, 36 AND 38).

FIRST USE 1-3-2005; IN COMMERCE 1-3-2005.

THE MARK CONSISTS OF STANDARD CHARACTERS WITHOUT CLAIM TO ANY PARTICULAR FONT, STYLE, SIZE, OR COLOR.

OWNER OF U.S. REG. NO. 3,242,883.

SER. NO. 77-239,605, FILED 7-26-2007.

ANN E. SAPPENFIELD, EXAMINING ATTORNEY

**Int. Cl.: 35**

**Prior U.S. Cls.: 100, 101 and 102**

**United States Patent and Trademark Office**

**Reg. No. 3,394,723**

**Registered Mar. 11, 2008**

**SERVICE MARK  
PRINCIPAL REGISTER**

**Dog 30**

SALYER, MELISSA (UNITED STATES INDIVIDUAL), DBA DOG 30

1025 WHITE ST

KEY WEST, FL 33040

FOR: RETAIL PET STORES, IN CLASS 35 (U.S. CLS. 100, 101 AND 102).

FIRST USE 3-1-2007; IN COMMERCE 4-18-2007.

THE MARK CONSISTS OF STANDARD CHARACTERS WITHOUT CLAIM TO ANY PARTICULAR FONT, STYLE, SIZE, OR COLOR.

NO CLAIM IS MADE TO THE EXCLUSIVE RIGHT TO USE "DOG", APART FROM THE MARK AS SHOWN.

SER. NO. 77-239,748, FILED 7-26-2007.

INGRID C. EULIN, EXAMINING ATTORNEY



**Int. Cl.: 43**

**Prior U.S. Cls.: 100 and 101**

**United States Patent and Trademark Office**

**Reg. No. 3,394,724**

**Registered Mar. 11, 2008**

**SERVICE MARK  
PRINCIPAL REGISTER**

**Bella Vista**

CASA LARGA VINEYARDS, INC. (NEW YORK  
CORPORATION)  
2287 TURK HILL ROAD  
FAIRPORT, NY 14450

FOR: PROVIDING BANQUET AND SOCIAL  
FUNCTION FACILITIES FOR SPECIAL OCCA-  
SIONS, IN CLASS 43 (U.S. CLS. 100 AND 101).

FIRST USE 7-24-2007; IN COMMERCE 7-24-2007.

THE MARK CONSISTS OF STANDARD CHAR-  
ACTERS WITHOUT CLAIM TO ANY PARTICULAR  
FONT, STYLE, SIZE, OR COLOR.

THE ENGLISH TRANSLATION OF THE WORD  
BELLA VISTA IN THE MARK IS BEAUTIFUL VIEW.

SER. NO. 77-240,849, FILED 7-27-2007.

ALYSSA PALADINO, EXAMINING ATTORNEY

**Int. Cl.: 10**

**Prior U.S. Cls.: 26, 39 and 44**

**United States Patent and Trademark Office**

**Reg. No. 3,394,725**

**Registered Mar. 11, 2008**

**TRADEMARK  
PRINCIPAL REGISTER**

**VIBRENT**

PARI GMBH SPEZIALISTEN FUER EFFEKTIVE  
INHALATION (FED REP GERMANY COR-  
PORATION)  
MOOSSTRASSE #3  
STARNBERG, FED REP GERMANY 82319

FOR: MEDICAL AND HEALTH APPARATUS,  
EQUIPMENT AND INSTRUMENTS; NAMELY, IN-  
HALERS FOR MEDICAL PURPOSES, ELECTRIC  
VIBRATING NEBULIZERS FOR RESPIRATION  
THERAPY, ELECTRIC VAPORIZERS FOR RE-  
SPIRATION THERAPY, AIR-SPRAYING AND  
GAS-SPRAYING APPARATUS AND INSTRU-  
MENTS, MASSAGE APPARATUS, MUCUS SUC-  
TION PUMPS FOR THE RESPIRATORY TRACT,  
VACUUM FILTRATION APPARATUS AND IN-

STRUMENTS, AND COMPONENT PARTS FOR  
ALL THE AFORESAID GOODS, IN CLASS 10 (U.S.  
CLS. 26, 39 AND 44).

FIRST USE 10-1-2005; IN COMMERCE 10-1-2005.

THE MARK CONSISTS OF STANDARD CHAR-  
ACTERS WITHOUT CLAIM TO ANY PARTICULAR  
FONT, STYLE, SIZE, OR COLOR.

SER. NO. 77-241,968, FILED 7-30-2007.

KATHERINE CONNOLLY, EXAMINING ATTOR-  
NEY

**Int. Cls.: 5 and 10**

**Prior U.S. Cls.: 6, 18, 26, 39, 44, 46, 51 and 52**

**United States Patent and Trademark Office**

**Reg. No. 3,394,726**

**Registered Mar. 11, 2008**

**TRADEMARK  
PRINCIPAL REGISTER**

**PATIENT'S CHOICE**

CROSSTEX INTERNATIONAL, INC. (MINNESOTA CORPORATION)  
10 RANICK ROAD  
HAUPPAUGE, NY 11788

FOR: DENTAL FLUORIDE FOAM AND GEL SOLUTIONS FOR TREATING TEETH, NAMELY, ACIDULATED PHOSPHATE FLUORIDE SOLUTION FOR PROFESSIONAL USE ONLY; DENTAL PASTE FOR CLEANING TEETH SOLD EXCLUSIVELY TO DENTAL PROFESSIONALS; TOPICAL ANESTHETICS FOR MEDICAL AND DENTAL USE, IN CLASS 5 (U.S. CLS. 6, 18, 44, 46, 51 AND 52).

FIRST USE 9-25-2006; IN COMMERCE 9-25-2006.

FOR: OSCILLATING PROPHY ANGLE FOR DENTAL AND VETERINARY USE, IN CLASS 10 (U.S. CLS. 26, 39 AND 44).

FIRST USE 10-1-1999; IN COMMERCE 10-1-1999.

THE MARK CONSISTS OF STANDARD CHARACTERS WITHOUT CLAIM TO ANY PARTICULAR FONT, STYLE, SIZE, OR COLOR.

OWNER OF U.S. REG. NOS. 1,844,283 AND 3,277,409.

SER. NO. 77-242,723, FILED 7-31-2007.

TASHIA BUNCH, EXAMINING ATTORNEY

**Int. Cl.: 9**

**Prior U.S. Cls.: 21, 23, 26, 36 and 38**

**United States Patent and Trademark Office**

**Reg. No. 3,394,727**

**Registered Mar. 11, 2008**

**TRADEMARK  
PRINCIPAL REGISTER**

**RATATOUILLE**

PIXAR (CALIFORNIA CORPORATION)  
1200 PARK AVENUE  
EMERYVILLE, CA 94608

FOR: PRERECORDED CDS FEATURING MUSIC  
AND SONGS; AND COMPUTER GAME SOFT-  
WARE, IN CLASS 9 (U.S. CLS. 21, 23, 26, 36 AND 38).

FIRST USE 6-25-2007; IN COMMERCE 6-25-2007.

THE MARK CONSISTS OF STANDARD CHAR-  
ACTERS WITHOUT CLAIM TO ANY PARTICULAR  
FONT, STYLE, SIZE, OR COLOR.

SER. NO. 77-243,699, FILED 7-31-2007.

JACQUELINE A. LAVINE, EXAMINING ATTOR-  
NEY

**Int. Cl.: 9**

**Prior U.S. Cls.: 21, 23, 26, 36 and 38**

**United States Patent and Trademark Office**

**Reg. No. 3,394,728**

**Registered Mar. 11, 2008**

**TRADEMARK  
PRINCIPAL REGISTER**

# DBAppraise

DBAPPRAISE LLC (NEW HAMPSHIRE LTD LIAB  
CO)  
9 APPLETREE GREEN  
NASHUA, NH 03062

THE MARK CONSISTS OF STANDARD CHAR-  
ACTERS WITHOUT CLAIM TO ANY PARTICULAR  
FONT, STYLE, SIZE, OR COLOR.

FOR: COMPUTER SOFTWARE FOR DATABASE  
MONITORING, IN CLASS 9 (U.S. CLS. 21, 23, 26, 36  
AND 38).

SER. NO. 77-244,470, FILED 8-1-2007.

FIRST USE 6-13-2006; IN COMMERCE 6-13-2006.

CURTIS FRENCH, EXAMINING ATTORNEY

Int. Cl.: 45

Prior U.S. Cls.: 100 and 101

United States Patent and Trademark Office

Reg. No. 3,394,729

Registered Mar. 11, 2008

SERVICE MARK  
PRINCIPAL REGISTER



COLORADO STATE PATROL (COLORADO STATE AGENCY)  
700 KIPLING STREET, SUITE 3000  
DENVER, CO 80215

FOR: POLICE AND CIVIL PROTECTION SERVICES, IN CLASS 45 (U.S. CLS. 100 AND 101).

FIRST USE 10-20-1935; IN COMMERCE 10-20-1935.

NO CLAIM IS MADE TO THE EXCLUSIVE RIGHT TO USE "STATE PATROL TROOPER", APART FROM THE MARK AS SHOWN.

THE MARK CONSISTS OF A SEVEN-POINT STAR WITH A STYLIZED FLOWER ON EACH POINT, A

DOUBLE CIRCLE INSIDE THE STAR WITH THE WORDS "COLORADO STATE PATROL TROOPER" IN BETWEEN THE CIRCLES, AND MISCELLANEOUS DESIGN ELEMENTS AND THE WORDS "NIL SINE NUMINE" IN THE CENTER.

THE ENGLISH TRANSLATION OF "NIL SINE NUMINE" IS "NOTHING WITHOUT DEITY".

SEC. 2(F) AS TO "COLORADO".

SER. NO. 77-244,526, FILED 8-1-2007.

TRICIA SONNEBORN, EXAMINING ATTORNEY

Int. Cl.: 45

Prior U.S. Cls.: 100 and 101

United States Patent and Trademark Office

Reg. No. 3,394,730

Registered Mar. 11, 2008

SERVICE MARK  
PRINCIPAL REGISTER



COLORADO STATE PATROL (COLORADO STATE AGENCY)  
700 KIPLING STREET, SUITE 3000  
DENVER, CO 80215

FOR: POLICE AND CIVIL PROTECTION SERVICES, IN CLASS 45 (U.S. CLS. 100 AND 101).

FIRST USE 10-20-1935; IN COMMERCE 10-20-1935.

NO CLAIM IS MADE TO THE EXCLUSIVE RIGHT TO USE "STATE PATROL", APART FROM THE MARK AS SHOWN.

THE MARK CONSISTS OF WINGS, A SPOKED MOTORCYCLE WHEEL WITH TREAD DETAIL, TOP AND BOTTOM BANNERS, SIDE STARS AND THE WORDS "STATE PATROL" ON THE TOP BANNER, AND THE WORD "COLORADO" ON THE BOTTOM BANNER.

SEC. 2(F) AS TO "COLORADO".

SER. NO. 77-244,575, FILED 8-1-2007.

TRICIA SONNEBORN, EXAMINING ATTORNEY

**Int. Cl.: 41**

**Prior U.S. Cls.: 100, 101 and 107**

**United States Patent and Trademark Office**

**Reg. No. 3,394,731**

**Registered Mar. 11, 2008**

**SERVICE MARK  
PRINCIPAL REGISTER**

**PAYMENT MATTERS**

OBER, KALER, GRIMES & SHRIVER (MARY-  
LAND CORPORATION)  
120 E. BALTIMORE STREET  
BALTIMORE, MD 21202

FOR: PROVIDING NEWSLETTERS IN THE  
FIELD OF HEALTH LAW VIA E-MAIL, IN CLASS  
41 (U.S. CLS. 100, 101 AND 107).

FIRST USE 7-31-2007; IN COMMERCE 7-31-2007.

THE MARK CONSISTS OF STANDARD CHAR-  
ACTERS WITHOUT CLAIM TO ANY PARTICULAR  
FONT, STYLE, SIZE, OR COLOR.

NO CLAIM IS MADE TO THE EXCLUSIVE  
RIGHT TO USE "PAYMENT", APART FROM THE  
MARK AS SHOWN.

SER. NO. 77-244,639, FILED 8-1-2007.

MARK SPARACINO, EXAMINING ATTORNEY



**Int. Cls.: 1, 40 and 42**

**Prior U.S. Cls.: 1, 5, 6, 10, 26, 46, 100, 101, 103 and 106**

**United States Patent and Trademark Office**

**Reg. No. 3,394,732**

**Registered Mar. 11, 2008**

**TRADEMARK  
SERVICE MARK  
PRINCIPAL REGISTER**

**THE CONSTRUCTIVE BIOLOGY  
COMPANY**

CODON DEVICES, INC. (DELAWARE CORPORATION)  
ONE KENDALL SQUARE  
CAMBRIDGE, MA 02139

FOR: NUCLEIC ACIDS, CELLS, REAGENTS, AMINO ACIDS, AMINO ACID ANALOGS, NUCLEIC ACID ANALOGS, PROTEIN SEQUENCES, NUCLEIC ACID SEQUENCES FOR SCIENTIFIC, LABORATORY, AND INDUSTRIAL USE, OR MEDICAL RESEARCH, IN CLASS 1 (U.S. CLS. 1, 5, 6, 10, 26 AND 46).

FIRST USE 7-0-2007; IN COMMERCE 7-0-2007.

FOR: CUSTOM MANUFACTURING OF NUCLEIC ACIDS, CELLS, AMINO ACIDS, AMINO ACID ANALOGS, NUCLEIC ACID ANALOGS, PROTEIN SEQUENCES, NUCLEIC ACID SEQUENCES, IN CLASS 40 (U.S. CLS. 100, 103 AND 106).

FIRST USE 7-0-2007; IN COMMERCE 7-0-2007.

FOR: RESEARCH AND DEVELOPMENT OF NUCLEIC ACIDS, CELLS, AMINO ACIDS, AMINO ACID ANALOGS, NUCLEIC ACID ANALOGS, PROTEIN SEQUENCES, NUCLEIC ACID SEQUENCES, IN CLASS 42 (U.S. CLS. 100 AND 101).

FIRST USE 7-0-2007; IN COMMERCE 7-0-2007.

THE MARK CONSISTS OF STANDARD CHARACTERS WITHOUT CLAIM TO ANY PARTICULAR FONT, STYLE, SIZE, OR COLOR.

NO CLAIM IS MADE TO THE EXCLUSIVE RIGHT TO USE "BIOLOGY COMPANY", APART FROM THE MARK AS SHOWN.

SER. NO. 77-245,575, FILED 8-2-2007.

KATHERINE CONNOLLY, EXAMINING ATTORNEY

Int. Cl.: 30

Prior U.S. Cl.: 46

United States Patent and Trademark Office

Reg. No. 3,394,733

Registered Mar. 11, 2008

TRADEMARK  
PRINCIPAL REGISTER

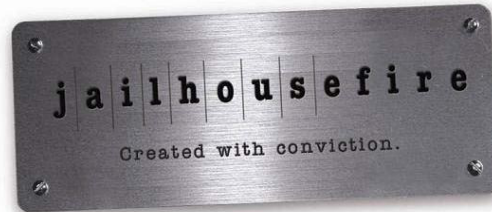

HILLSBOROUGH COUNTY SHERIFF'S OFFICE  
(FLORIDA A CONSTITUTIONAL OFFICE  
CREATED BY THE FLORIDA CONSTITUTION  
AND FLORIDA STATUTES)  
C/O JAIL INMATE CANTEEN FUND  
POST OFFICE BOX 3371  
TAMPA, FL 33601

FOR: CONDIMENTS, NAMELY, HOT SAUCES,  
IN CLASS 30 (U.S. CL. 46).

FIRST USE 1-1-2007; IN COMMERCE 6-14-2007.

THE MARK CONSISTS OF THE WORD JAILHOUSEFIRE WITH VERTICAL LINES IN BETWEEN THE LETTERS OF "JAILHOUSE" AND THE WORDS "CREATED WITH CONVICTION." UNDERNEATH, ALL IN A DESIGN OF A METAL NAMEPLATE WITH FOUR SCREWS IN EACH CORNER OF THE NAMEPLATE.

SER. NO. 77-246,399, FILED 8-3-2007.

JENNIFER MARTIN, EXAMINING ATTORNEY

**Int. Cl.: 35**

**Prior U.S. Cls.: 100, 101 and 102**

**United States Patent and Trademark Office**

**Reg. No. 3,394,734**

**Registered Mar. 11, 2008**

**SERVICE MARK  
PRINCIPAL REGISTER**

# Bank of Athletes

1 SPORT LLC (FLORIDA LTD LIAB CO)  
1670 BAY RD. N 6-B  
MIAMI BEACH, FL 33139

FOR: ONLINE ADVERTISING ON A COMPUTER NETWORK; MANAGEMENT OF COMPUTERIZED FILE; RENTAL OF ADVERTISING SPACE, IN CLASS 35 (U.S. CLS. 100, 101 AND 102).

FIRST USE 7-24-2006; IN COMMERCE 7-24-2006.

THE MARK CONSISTS OF STANDARD CHARACTERS WITHOUT CLAIM TO ANY PARTICULAR FONT, STYLE, SIZE, OR COLOR.

NO CLAIM IS MADE TO THE EXCLUSIVE RIGHT TO USE "ATHLETES", APART FROM THE MARK AS SHOWN.

SER. NO. 77-246,426, FILED 8-3-2007.

TASNEEM HUSSAIN, EXAMINING ATTORNEY

**Int. Cls.: 18 and 28**

**Prior U.S. Cls.: 1, 2, 3, 22, 23, 38, 41 and 50**

**United States Patent and Trademark Office**

**Reg. No. 3,394,735**

**Registered Mar. 11, 2008**

**TRADEMARK  
PRINCIPAL REGISTER**

**We've got the ball. You  
bring the game!**

TACHIKARA U.S.A., INC. (NEVADA CORPORATION)  
100 IRELAND DR.  
MCCARRAN, NV 89434

FOR: ALL PURPOSE SPORT BAGS; SPORTS BAGS, IN CLASS 18 (U.S. CLS. 1, 2, 3, 22 AND 41).

FIRST USE 1-10-2007; IN COMMERCE 1-10-2007.

FOR: STORAGE RACKS FOR SKI AND SPORTS EQUIPMENT, IN CLASS 28 (U.S. CLS. 22, 23, 38 AND 50).

FIRST USE 1-10-2007; IN COMMERCE 1-10-2007.

THE MARK CONSISTS OF STANDARD CHARACTERS WITHOUT CLAIM TO ANY PARTICULAR FONT, STYLE, SIZE, OR COLOR.

SER. NO. 77-247,119, FILED 8-3-2007.

WON TEAK OH, EXAMINING ATTORNEY

**Int. Cl.: 43**

**Prior U.S. Cls.: 100 and 101**

**United States Patent and Trademark Office**

**Reg. No. 3,394,736**

**Registered Mar. 11, 2008**

**SERVICE MARK  
PRINCIPAL REGISTER**

**TERRA VERDE**

STATION CASINOS, INC. (NEVADA CORPORATION)  
10973 WEST SUMMERLIN CENTRE DRIVE  
LAS VEGAS, NV 89135

FOR: RESTAURANT AND BAR SERVICES;  
COCKTAIL LOUNGES, IN CLASS 43 (U.S. CLS. 100  
AND 101).

FIRST USE 7-25-2007; IN COMMERCE 7-25-2007.

THE MARK CONSISTS OF STANDARD CHARACTERS WITHOUT CLAIM TO ANY PARTICULAR FONT, STYLE, SIZE, OR COLOR.

THE FOREIGN WORDING IN THE MARK TRANSLATES INTO ENGLISH AS GREEN EARTH.

SER. NO. 77-247,128, FILED 8-3-2007.

KELLY CHOE, EXAMINING ATTORNEY

**Int. Cls.: 35, 41 and 43**

**Prior U.S. Cls.: 100, 101, 102 and 107**

**United States Patent and Trademark Office**

**Reg. No. 3,394,737**

**Registered Mar. 11, 2008**

**SERVICE MARK  
PRINCIPAL REGISTER**

**SUCCESSFUL EVENTS AND  
TRANSPORTATION WITH ONE  
PHONE CALL**

CAPITOL SERVICES INC. (D.C. CORPORATION)  
108 N VIRGINIA AVENUE  
FALLS CHURCH, VA 22046

FOR: TRANSPORTATION MANAGEMENT SERVICES, NAMELY, PLANNING AND COORDINATING TRANSPORTATION OF PEOPLE FOR OTHERS, IN CLASS 35 (U.S. CLS. 100, 101 AND 102).

FIRST USE 1-1-1994; IN COMMERCE 1-1-1994.

FOR: SPECIAL EVENT PLANNING AND PRODUCTION SERVICES, IN CLASS 41 (U.S. CLS. 100, 101 AND 107).

FIRST USE 1-1-1994; IN COMMERCE 1-1-1994.

FOR: CATERING, IN CLASS 43 (U.S. CLS. 100 AND 101).

FIRST USE 1-1-1994; IN COMMERCE 1-1-1994.

THE MARK CONSISTS OF STANDARD CHARACTERS WITHOUT CLAIM TO ANY PARTICULAR FONT, STYLE, SIZE, OR COLOR.

SER. NO. 77-248,078, FILED 8-6-2007.

SUSAN RICHARDS, EXAMINING ATTORNEY

**Int. Cls.: 36 and 41**

**Prior U.S. Cls.: 100, 101, 102 and 107**

**United States Patent and Trademark Office**

**Reg. No. 3,394,738**

**Registered Mar. 11, 2008**

**SERVICE MARK  
PRINCIPAL REGISTER**



PROMUTUAL GROUP, INC. (MASSACHUSETTS CORPORATION)  
101 ARCH STREET  
BOSTON, MA 02110

FOR: UNDERWRITING PROFESSIONAL LIABILITY INSURANCE, IN CLASS 36 (U.S. CLS. 100, 101 AND 102).

FIRST USE 0-0-1998; IN COMMERCE 0-0-1998.

FOR: EDUCATIONAL SERVICES, NAMELY, LECTURES AND CONFERENCES IN THE FIELD OF HEALTH CARE; PROVIDING CONTINUING MEDICAL EDUCATION PROGRAMS FOR

HEALTH CARE PROVIDERS, IN CLASS 41 (U.S. CLS. 100, 101 AND 107).

FIRST USE 0-0-1998; IN COMMERCE 0-0-1998.

OWNER OF U.S. REG. NO. 2,347,720.

THE MARK CONSISTS OF THE DESIGN OF A CURVED ARCH HAVING A SOLID FACE FROM WHICH FOUR TRIANGULAR SHAPES ARE EXCISED.

SER. NO. 77-248,281, FILED 8-6-2007.

LA TONIA FISHER, EXAMINING ATTORNEY

**Int. Cl.: 35**

**Prior U.S. Cls.: 100, 101 and 102**

**United States Patent and Trademark Office**

**Reg. No. 3,394,739**

**Registered Mar. 11, 2008**

**SERVICE MARK  
PRINCIPAL REGISTER**

**SEE WHAT YOU'VE BEEN  
MISSING**

SOUTHWEST FIREARMS, INC. (TEXAS CORPORATION)  
420 CENTURY WAY, #100  
RED OAK, TX 75154

FOR: (BASED ON USE IN COMMERCE) ON-LINE RETAIL STORE SERVICES FEATURING RIFLE SCOPES AND PISTOL SCOPES; MAIL ORDER CATALOG SERVICES FEATURING RIFLE SCOPES AND PISTOL SCOPES , IN CLASS 35 (U.S. CLS. 100, 101 AND 102).

FIRST USE 1-1-1999; IN COMMERCE 1-1-1999.

THE MARK CONSISTS OF STANDARD CHARACTERS WITHOUT CLAIM TO ANY PARTICULAR FONT, STYLE, SIZE, OR COLOR.

SER. NO. 77-248,285, FILED 8-6-2007.

LA TONIA FISHER, EXAMINING ATTORNEY



**Int. Cl.: 10**

**Prior U.S. Cls.: 26, 39 and 44**

**United States Patent and Trademark Office**

**Reg. No. 3,394,740**

**Registered Mar. 11, 2008**

**TRADEMARK  
PRINCIPAL REGISTER**

**CU-SIL**

PRESENT INVESTMENT CORP. (FLORIDA CORPORATION)  
700 W. HILLSBORO BLVD., BLDG. 2-206  
DEERFIELD BEACH, FL 33441

FOR: ARTIFICIAL TEETH AND DENTURES, IN CLASS 10 (U.S. CLS. 26, 39 AND 44).

FIRST USE 9-0-1974; IN COMMERCE 9-0-1974.

THE MARK CONSISTS OF STANDARD CHARACTERS WITHOUT CLAIM TO ANY PARTICULAR FONT, STYLE, SIZE, OR COLOR.

OWNER OF U.S. REG. NO. 1,868,156.

SER. NO. 77-248,868, FILED 8-7-2007.

RENEE SERVANCE, EXAMINING ATTORNEY

**Int. Cl.: 43**

**Prior U.S. Cls.: 100 and 101**

**United States Patent and Trademark Office**

**Reg. No. 3,394,741**

**Registered Mar. 11, 2008**

**SERVICE MARK  
PRINCIPAL REGISTER**



EVOS FOOD CREATIONS, INC. (FLORIDA CORPORATION)  
609 S. HOWARD AVENUE  
TAMPA, FL 33606

FOR: RESTAURANT SERVICES, IN CLASS 43  
(U.S. CLS. 100 AND 101).

FIRST USE 2-21-2007; IN COMMERCE 2-21-2007.

NO CLAIM IS MADE TO THE EXCLUSIVE RIGHT TO USE "GREAT FAST FOOD" , APART FROM THE MARK AS SHOWN.

THE COLOR(S) GREEN, BLACK AND WHITE IS/ ARE CLAIMED AS A FEATURE OF THE MARK.

THE MARK CONSISTS OF THE WORD "EVOS" IN BLACK WITH WHITE BORDER, ACCENTS ABOVE THE "E" AND "O" IN BLACK WITH WHITE BORDER, THE WORDS "FEEL GREAT FAST FOOD" IN WHITE, ALL AGAINST A GREEN COLORED SQUARE-LIKE BACKGROUND WITH A GREEN AND WHITE COLORED TRIM.

SER. NO. 77-248,890, FILED 8-7-2007.

NAKIA HENRY, EXAMINING ATTORNEY

**Int. Cl.: 34**

**Prior U.S. Cls.: 2, 8, 9 and 17**

**United States Patent and Trademark Office**

**Reg. No. 3,394,742**

**Registered Mar. 11, 2008**

**TRADEMARK  
PRINCIPAL REGISTER**



K. HANSOTIA & CO., INC. (FLORIDA CORPORATION)

3705 N.W. 115 AVENUE, BAY #5

MIAMI, FL 33178

FOR: CIGARS, IN CLASS 34 (U.S. CLS. 2, 8, 9 AND 17).

FIRST USE 0-0-1992; IN COMMERCE 2-14-1997.

"THE NAME(S), PORTRAIT(S), AND/OR SIGNATURE(S) SHOWN IN THE MARK DOES NOT IDENTIFY A PARTICULAR LIVING INDIVIDUAL."

"THE MARK CONSISTS OF A DESIGN OF A MALE SOLDIER IN UNIFORM HOLDING A SWORD."

SER. NO. 77-248,939, FILED 8-7-2007.

RICHARD A. STRASER, EXAMINING ATTORNEY

**Int. Cl.: 28**

**Prior U.S. Cls.: 22, 23, 38 and 50**

**United States Patent and Trademark Office**

**Reg. No. 3,394,743**

**Registered Mar. 11, 2008**

**TRADEMARK  
PRINCIPAL REGISTER**

**Tour Beach**

TAKAIKI YOSHIDA (JAPAN INDIVIDUAL)  
7-14-10, HIGASHIKASAI, EDOGAWA-KU  
TOKYO, JAPAN 134-0084

FOR: GOLF EQUIPMENT, NAMELY, GOLF  
BALLS, GOLF CLUBS, GOLF CLUB SHAFTS, GOLF  
BAGS, GOLF TEES, GOLF CLUB HEAD COVERS,  
GOLF BALL CASES, GOLF CLUB CASES AND  
GOLF GLOVES, IN CLASS 28 (U.S. CLS. 22, 23, 38  
AND 50).

OWNER OF JAPAN REG. NO. 4263323, DATED 4-  
16-1999, EXPIRES 4-16-2009.

THE MARK CONSISTS OF THE WORDS TOUR  
BEACH IN STYLIZED LETTERING (CAPITAL T  
AND B, ALL OTHER LETTERS LOWER CASE).

SER. NO. 77-250,248, FILED 8-8-2007.

ANDREA BUTLER, EXAMINING ATTORNEY

**Int. Cl.: 37**

**Prior U.S. Cls.: 100, 103 and 106**

**United States Patent and Trademark Office**

**Reg. No. 3,394,744**

**Registered Mar. 11, 2008**

**SERVICE MARK  
PRINCIPAL REGISTER**

**HEBREW CONSTRUCTION**

BAGBY PROMOTIONS, INC. (MARYLAND CORPORATION), DBA HEBREW CONSTRUCTION  
5 PUTTING WAY  
REISTERSTOWN, MD 21136

FOR: CONSTRUCTION, RENOVATION, AND REPAIR OF BUILDINGS AND HOUSES; CONSTRUCTION SERVICES, NAMELY, PLANNING, LAYING OUT AND CUSTOM CONSTRUCTION OF RESIDENTIAL PROPERTIES, IN CLASS 37 (U.S. CLS. 100, 103 AND 106).

FIRST USE 11-0-1994; IN COMMERCE 11-0-1994.

THE MARK CONSISTS OF STANDARD CHARACTERS WITHOUT CLAIM TO ANY PARTICULAR FONT, STYLE, SIZE, OR COLOR.

NO CLAIM IS MADE TO THE EXCLUSIVE RIGHT TO USE "CONSTRUCTION", APART FROM THE MARK AS SHOWN.

SER. NO. 77-250,350, FILED 8-8-2007.

SUE LAWRENCE, EXAMINING ATTORNEY

**Int. Cl.: 36**

**Prior U.S. Cls.: 100, 101 and 102**

**United States Patent and Trademark Office**

**Reg. No. 3,394,745**

**Registered Mar. 11, 2008**

**SERVICE MARK  
PRINCIPAL REGISTER**

**INTERNETCRUSADE**

REAL ESTATE ELECTRONIC PUBLISHING CO.  
(HAWAII CORPORATION)  
7183 NAVAJO RD., SUITE F  
SAN DIEGO, CA 92119

FOR: PROVIDING INFORMATION IN THE  
FIELD OF REAL ESTATE VIA THE INTERNET;  
PROVIDING INFORMATION IN THE FIELD OF  
REAL ESTATE BY MEANS OF LINKING THE WEB  
SITE TO OTHER WEB SITES FEATURING REAL  
ESTATE INFORMATION, IN CLASS 36 (U.S. CLS.  
100, 101 AND 102).

FIRST USE 3-0-1997; IN COMMERCE 5-0-1997.

THE MARK CONSISTS OF STANDARD CHAR-  
ACTERS WITHOUT CLAIM TO ANY PARTICULAR  
FONT, STYLE, SIZE, OR COLOR.

SER. NO. 77-251,715, FILED 8-9-2007.

JACLYN KIDWELL, EXAMINING ATTORNEY

**Int. Cl.: 42**

**Prior U.S. Cls.: 100 and 101**

**United States Patent and Trademark Office**

**Reg. No. 3,394,746**

**Registered Mar. 11, 2008**

**SERVICE MARK  
PRINCIPAL REGISTER**

# TrueOutcomes

THOMSON LEARNING INC. (DELAWARE CORPORATION)  
200 FIRST STAMFORD PLACE  
STAMFORD, CT 06902

FOR: PROVIDING ONLINE NON-DOWNLOADABLE SOFTWARE FOR PROVIDING A SYSTEM LINKING ADMINISTRATORS, FACULTY, STUDENTS, ALUMNI AND EXTERNAL SHAREHOLDERS IN THE EDUCATION FIELD, WHICH ALLOWS FOR THE ASSESSMENT OF LEARNING AND THE DISPLAY OF RELATED CONTENT, IN CLASS 42 (U.S. CLS. 100 AND 101).

FIRST USE 5-7-2001; IN COMMERCE 5-7-2001.

THE MARK CONSISTS OF STANDARD CHARACTERS WITHOUT CLAIM TO ANY PARTICULAR FONT, STYLE, SIZE, OR COLOR.

SER. NO. 77-252,199, FILED 8-10-2007.

CHRISTINA SOBRAL, EXAMINING ATTORNEY

Int. Cl.: 36

Prior U.S. Cls.: 100, 101 and 102

United States Patent and Trademark Office

Reg. No. 3,394,747

Registered Mar. 11, 2008

SERVICE MARK  
PRINCIPAL REGISTER



PANKEY VENTURES (CALIFORNIA CORPORATION), DBA KEY LAND COMPANY  
POST OFFICE BOX 2800  
PASO ROBLES, CA 93447

FOR: (BASED ON USE IN COMMERCE) REAL ESTATE BROKERAGE, IN CLASS 36 (U.S. CLS. 100, 101 AND 102).

FIRST USE 3-31-2007; IN COMMERCE 3-31-2007.

NO CLAIM IS MADE TO THE EXCLUSIVE RIGHT TO USE "LAND COMPANY", APART FROM THE MARK AS SHOWN.

THE COLOR(S) LIGHT BLUE, MEDIUM BLUE, LIGHT GREEN, MEDIUM GREEN AND BLACK IS/ARE CLAIMED AS A FEATURE OF THE MARK.

THE COLOR LIGHT BLUE APPEARS INSIDE THE KEYHOLE ON TOP; THE COLOR BELOW AND INSIDE KEYHOLE IS LIGHT GREEN. THE COLOR MEDIUM BLUE APPEARS IN THE TOP PORTION OF THE CIRCULAR DESIGN SURROUNDING THE KEYHOLE; THE WORDS KEY LAND ALSO APPEAR IN DARK BLUE. THE COLOR DARK GREEN APPEARS IN THE LOWER PORTION OF THE CIRCULAR DESIGN SURROUNDING THE KEYHOLE; THE WORD COMPANY ALSO APPEARS IN DARK GREEN. THE COLOR BLACK APPEARS AS A PARTIAL OUTLINE OF THE DESIGN OF THE HILLS TO THE LEFT AND RIGHT OF THE KEYHOLE DESIGN.

SER. NO. 77-253,117, FILED 8-12-2007.

BARBARA A. LOUGHRAN, EXAMINING ATTORNEY



**Int. Cl.: 35**

**Prior U.S. Cls.: 100, 101 and 102**

**United States Patent and Trademark Office**

**Reg. No. 3,394,748**

**Registered Mar. 11, 2008**

**SERVICE MARK  
PRINCIPAL REGISTER**

**ACOMMERCE.COM**

VISTAEDGE INC (DELAWARE CORPORATION)  
421 WILLINGHAM ROAD  
MORRISVILLE, NC 27560

THE MARK CONSISTS OF STANDARD CHAR-  
ACTERS WITHOUT CLAIM TO ANY PARTICULAR  
FONT, STYLE, SIZE, OR COLOR.

FOR: PROVIDING AN ON-LINE COMMERCIAL  
INFORMATION DIRECTORY ON THE INTERNET,  
IN CLASS 35 (U.S. CLS. 100, 101 AND 102).

SER. NO. 77-253,278, FILED 8-13-2007.

FIRST USE 3-14-2005; IN COMMERCE 8-20-2005.

MIDGE BUTLER, EXAMINING ATTORNEY

**Int. Cl.: 42**

**Prior U.S. Cls.: 100 and 101**

**United States Patent and Trademark Office**

**Reg. No. 3,394,749**

**Registered Mar. 11, 2008**

**SERVICE MARK  
PRINCIPAL REGISTER**

**EZONE**

EASTMAN CHEMICAL COMPANY (DELAWARE  
CORPORATION)  
200 SOUTH WILCOX DRIVE  
KINGSPORT, TN 37660

THE MARK CONSISTS OF STANDARD CHAR-  
ACTERS WITHOUT CLAIM TO ANY PARTICULAR  
FONT, STYLE, SIZE, OR COLOR.

FOR: PROVIDING INFORMATION CONCERN-  
ING INTERIOR DESIGN OF RETAIL BUSINESS  
ESTABLISHMENTS FOR DESIGNERS VIA A WEB-  
SITE, IN CLASS 42 (U.S. CLS. 100 AND 101).

SER. NO. 77-255,065, FILED 8-14-2007.

FIRST USE 3-25-2007; IN COMMERCE 3-25-2007.

LAURA KOVALSKY, EXAMINING ATTORNEY

**Int. Cl.: 42**

**Prior U.S. Cls.: 100 and 101**

**United States Patent and Trademark Office**

**Reg. No. 3,394,750**

**Registered Mar. 11, 2008**

**SERVICE MARK  
PRINCIPAL REGISTER**

**MIDNIGHT TRANSFER**

MIDNIGHT TRANSFER, LLC (DELAWARE LTD  
LIAB CO)  
SUITE 101  
1937 EUCLID STREET  
SANTA MONICA, CA 90404

FOR: DIGITAL TRANSFER SERVICES FOR  
TRANSFERRING VIDEO AND AUDIO MEDIA TO  
DIGITAL FORMATS, IN CLASS 42 (U.S. CLS. 100  
AND 101).

FIRST USE 1-0-2007; IN COMMERCE 1-0-2007.

THE MARK CONSISTS OF STANDARD CHAR-  
ACTERS WITHOUT CLAIM TO ANY PARTICULAR  
FONT, STYLE, SIZE, OR COLOR.

NO CLAIM IS MADE TO THE EXCLUSIVE  
RIGHT TO USE "TRANSFER", APART FROM THE  
MARK AS SHOWN.

SER. NO. 77-258,521, FILED 8-17-2007.

AHSEN KHAN, EXAMINING ATTORNEY

**Int. Cl.: 26**

**Prior U.S. Cls.: 37, 39, 40, 42 and 50**

**United States Patent and Trademark Office**

**Reg. No. 3,394,751**

**Registered Mar. 11, 2008**

**TRADEMARK  
PRINCIPAL REGISTER**



LAS VEGAS SANDS CORP. (NEVADA CORPORATION)  
3355 LAS VEGAS BOULEVARD SOUTH  
LAS VEGAS, NV 89109

FOR: SEWING KITS COMPRISED OF BUTTONS, NEEDLES, PINS AND THREAD, IN CLASS 26 (U.S. CLS. 37, 39, 40, 42 AND 50).

FIRST USE 7-16-2007; IN COMMERCE 7-16-2007.

OWNER OF U.S. REG. NOS. 2,411,034, 2,542,999 AND OTHERS.

THE MARK CONSISTS OF WINGED LION WITH A CREST CONTAINING THE LETTER "V".

SER. NO. 77-259,072, FILED 8-20-2007.

LINDA LAVACHE, EXAMINING ATTORNEY

**Int. Cl.: 38**

**Prior U.S. Cls.: 100, 101 and 104**

**United States Patent and Trademark Office**

**Reg. No. 3,394,752**

**Registered Mar. 11, 2008**

**SERVICE MARK  
PRINCIPAL REGISTER**



LAS VEGAS SANDS CORP. (NEVADA CORPORATION)  
3355 LAS VEGAS BOULEVARD SOUTH  
LAS VEGAS, NV 89109

FOR: LOCAL AND LONG DISTANCE TELEPHONE SERVICES; PROVIDING TELEPHONE CONFERENCING SERVICES; TELEPHONE VOICE MESSAGING SERVICES; FACSIMILE TRANSMISSION AND RETRIEVAL SERVICES; WIRELESS BROADBAND COMMUNICATION SERVICES, IN CLASS 38 (U.S. CLS. 100, 101 AND 104).

FIRST USE 7-16-2007; IN COMMERCE 7-16-2007.

OWNER OF U.S. REG. NOS. 2,411,034, 2,542,999 AND OTHERS.

THE MARK CONSISTS OF WINGED LION WITH A CREST CONTAINING THE LETTER "V".

SER. NO. 77-259,338, FILED 8-20-2007.

LINDA LAVACHE, EXAMINING ATTORNEY

**Int. Cl.: 3**

**Prior U.S. Cls.: 1, 4, 6, 50, 51 and 52**

**United States Patent and Trademark Office**

**Reg. No. 3,394,753**

**Registered Mar. 11, 2008**

**TRADEMARK  
PRINCIPAL REGISTER**



LAS VEGAS SANDS CORP. (NEVADA CORPORATION)  
3355 LAS VEGAS BOULEVARD SOUTH  
LAS VEGAS, NV 89109

FOR: BAR SOAP; BATH GELS; HAIR CONDITIONERS; BODY LOTIONS; HAIR SHAMPOO, IN CLASS 3 (U.S. CLS. 1, 4, 6, 50, 51 AND 52).

FIRST USE 7-16-2007; IN COMMERCE 7-16-2007.

OWNER OF U.S. REG. NOS. 2,411,034, 2,542,999 AND OTHERS.

THE MARK CONSISTS OF WINGED LION WITH A CREST CONTAINING THE LETTER "V".

SER. NO. 77-259,372, FILED 8-20-2007.

LINDA LAVACHE, EXAMINING ATTORNEY

**Int. Cl.: 18**

**Prior U.S. Cls.: 1, 2, 3, 22 and 41**

**United States Patent and Trademark Office**

**Reg. No. 3,394,754**

**Registered Mar. 11, 2008**

**TRADEMARK  
PRINCIPAL REGISTER**



LAS VEGAS SANDS CORP. (NEVADA CORPORATION)  
3355 LAS VEGAS BOULEVARD SOUTH  
LAS VEGAS, NV 89109

FOR: ROLL BAG; PURSES; SMALL PURSES;  
CLUTCH BAGS, IN CLASS 18 (U.S. CLS. 1, 2, 3, 22  
AND 41).

FIRST USE 7-16-2007; IN COMMERCE 7-16-2007.

OWNER OF U.S. REG. NOS. 2,411,034, 2,542,999  
AND OTHERS.

THE MARK CONSISTS OF WINGED LION WITH  
A CREST CONTAINING THE LETTER "V".

SER. NO. 77-259,376, FILED 8-20-2007.

LINDA LAVACHE, EXAMINING ATTORNEY

**Int. Cl.: 25**

**Prior U.S. Cls.: 22 and 39**

**United States Patent and Trademark Office**

**Reg. No. 3,394,755**

**Registered Mar. 11, 2008**

**TRADEMARK  
PRINCIPAL REGISTER**

**FLOWLUCKYFREE**

WHITLOCK, MARK (UNITED STATES INDIVIDUAL)  
8683 ROGERS PARK AVE  
CORDOVA, TN 38016

THE MARK CONSISTS OF STANDARD CHARACTERS WITHOUT CLAIM TO ANY PARTICULAR FONT, STYLE, SIZE, OR COLOR.

FOR: HATS; JACKETS; PANTS; PULLOVERS; SHIRTS; SHORTS; SKIRTS, IN CLASS 25 (U.S. CLS. 22 AND 39).

SER. NO. 77-261,158, FILED 8-21-2007.

FIRST USE 6-30-2007; IN COMMERCE 7-15-2007.

JASON LOTT, EXAMINING ATTORNEY



**Int. Cl.: 17**

**Prior U.S. Cls.: 1, 5, 12, 13, 35 and 50**

**United States Patent and Trademark Office**

**Reg. No. 3,394,756**

**Registered Mar. 11, 2008**

**TRADEMARK  
PRINCIPAL REGISTER**

**PEACEMAKER**

ONE WISH, L.L.C. (OHIO LTD LIAB CO)  
34565 SEMINOLE WAY  
OLON, OH 44139

THE MARK CONSISTS OF STANDARD CHAR-  
ACTERS WITHOUT CLAIM TO ANY PARTICULAR  
FONT, STYLE, SIZE, OR COLOR.

FOR: ARCHITECTURAL ACOUSTIC PRODUCTS,  
NAMELY, SOUND ABSORBERS AND DIFFUSERS,  
IN CLASS 17 (U.S. CLS. 1, 5, 12, 13, 35 AND 50).

SER. NO. 77-261,312, FILED 8-22-2007.

FIRST USE 8-0-2006; IN COMMERCE 8-0-2006.

CARRIE GENOVESE, EXAMINING ATTORNEY

**Int. Cl.: 43**

**Prior U.S. Cls.: 100 and 101**

**United States Patent and Trademark Office**

**Reg. No. 3,394,757**

**Registered Mar. 11, 2008**

**SERVICE MARK  
PRINCIPAL REGISTER**



DD IP HOLDER LLC (DELAWARE LTD LIAB  
CO)  
130 ROYALL STREET  
CANTON, MA 02021

FOR: RESTAURANT SERVICES, CAFE SERVIC-  
ES, SNACK BAR SERVICES, CARRY-OUT FOOD  
SERVICES, IN CLASS 43 (U.S. CLS. 100 AND 101).

FIRST USE 6-6-2007; IN COMMERCE 6-6-2007.

THE COLOR(S) ORANGE AND PINK IS/ARE  
CLAIMED AS A FEATURE OF THE MARK.

THE MARK CONSISTS OF THE LETTERS DD IN  
A ROUNDED LETTER STYLE. THE FIRST LETTER  
D IS IN ORANGE AND THE SECOND LETTER D IS  
IN PINK.

SER. NO. 77-261,983, FILED 8-22-2007.

MELVIN AXILBUND, EXAMINING ATTORNEY

**Int. Cl.: 36**

**Prior U.S. Cls.: 100, 101 and 102**

**United States Patent and Trademark Office**

**Reg. No. 3,394,758**

**Registered Mar. 11, 2008**

**SERVICE MARK  
PRINCIPAL REGISTER**

**YOUR NEIGHBORHOOD  
FINANCIAL CONVENIENCE  
CENTER**

CHECK INTO CASH, INC. (DELAWARE COR-  
PORATION)  
SUITE 80  
201 KEITH STREET  
CLEVELAND, TN 37311

FOR: CONSUMER LOAN FINANCING AND  
CHECK CASHING SERVICES FEATURING DEFER-  
RED PRESENTMENT AND DELAYED DEPOSIT, IN  
CLASS 36 (U.S. CLS. 100, 101 AND 102).

FIRST USE 8-22-2007; IN COMMERCE 8-22-2007.

THE MARK CONSISTS OF STANDARD CHAR-  
ACTERS WITHOUT CLAIM TO ANY PARTICULAR  
FONT, STYLE, SIZE, OR COLOR.

NO CLAIM IS MADE TO THE EXCLUSIVE  
RIGHT TO USE "FINANCIAL CONVENIENCE CEN-  
TER", APART FROM THE MARK AS SHOWN.

SER. NO. 77-262,531, FILED 8-23-2007.

ANNE E. GUSTASON, EXAMINING ATTORNEY

**Int. Cl.: 16**

**Prior U.S. Cls.: 2, 5, 22, 23, 29, 37, 38 and 50**

**United States Patent and Trademark Office**

**Reg. No. 3,394,759**

**Registered Mar. 11, 2008**

**TRADEMARK  
PRINCIPAL REGISTER**

**WINEWS**

OLIN CORPORATION (VIRGINIA CORPORATION)  
190 CARONDELET PLAZA, SUITE 1530  
ST. LOUIS, MO 63105

THE MARK CONSISTS OF STANDARD CHARACTERS WITHOUT CLAIM TO ANY PARTICULAR FONT, STYLE, SIZE, OR COLOR.

FOR: NEWSLETTERS IN THE FIELD OF AMMUNITION AND FIREARMS, IN CLASS 16 (U.S. CLS. 2, 5, 22, 23, 29, 37, 38 AND 50).

SER. NO. 77-263,542, FILED 8-24-2007.

FIRST USE 12-31-2006; IN COMMERCE 12-31-2006.

TEJBIR SINGH, EXAMINING ATTORNEY

**Int. Cl.: 39**

**Prior U.S. Cls.: 100 and 105**

**United States Patent and Trademark Office**

**Reg. No. 3,394,760**

**Registered Mar. 11, 2008**

**SERVICE MARK  
PRINCIPAL REGISTER**

**WISE**

AIRSAGE, INC. (GEORGIA CORPORATION)  
400 EMBASSY ROW, SUITE 100  
ATLANTA, GA 30328

THE MARK CONSISTS OF STANDARD CHAR-  
ACTERS WITHOUT CLAIM TO ANY PARTICULAR  
FONT, STYLE, SIZE, OR COLOR.

FOR: TRAFFIC INFORMATION SERVICES, IN  
CLASS 39 (U.S. CLS. 100 AND 105).

SER. NO. 77-266,418, FILED 8-28-2007.

FIRST USE 6-4-2007; IN COMMERCE 6-4-2007.

DANIEL CAPSHAW, EXAMINING ATTORNEY

**Int. Cl.: 11**

**Prior U.S. Cls.: 13, 21, 23, 31 and 34**

**United States Patent and Trademark Office**

**Reg. No. 3,394,761**

**Registered Mar. 11, 2008**

**TRADEMARK  
PRINCIPAL REGISTER**

**TRUMAN CELL**

ORECK HOLDINGS, LLC (DELAWARE LTD  
LIAB CO)  
C/O CT CORPORATION SYST  
1720 CAREY AVENUE  
CHEYENNE, WY 82001

FOR: ELECTROSTATIC FILTRATION DEVICE,  
NAMELY, A CELL CONSISTING OF ELECTRO-  
STATIC PLATES FOR CAPTURING AIRBORNE  
PARTICLES SOLD AS A COMPONENT OF THE  
AIR FILTER; AIR FILTERS FOR DOMESTIC AND  
COMMERCIAL USE, CONSISTING OF AN ELEC-  
TROSTATIC FILTRATION DEVICE, IN CLASS 11  
(U.S. CLS. 13, 21, 23, 31 AND 34).

FIRST USE 8-30-2006; IN COMMERCE 8-30-2006.

THE MARK CONSISTS OF STANDARD CHAR-  
ACTERS WITHOUT CLAIM TO ANY PARTICULAR  
FONT, STYLE, SIZE, OR COLOR.

NO CLAIM IS MADE TO THE EXCLUSIVE  
RIGHT TO USE "CELL", APART FROM THE MARK  
AS SHOWN.

SER. NO. 77-268,256, FILED 8-30-2007.

DAVID COLLIER, EXAMINING ATTORNEY

Int. Cl.: 35

Prior U.S. Cls.: 100, 101 and 102

United States Patent and Trademark Office

Reg. No. 3,394,762

Registered Mar. 11, 2008

SERVICE MARK  
PRINCIPAL REGISTER



TABLE COMPLIMENTS LLC (ILLINOIS LTD  
LIAB CO)  
1725 MOUNTAIN COURT  
DEERFIELD, IL 60015

FOR: (BASED ON USE IN COMMERCE) RETAIL  
STORE SERVICES FEATURING A WIDE VARIETY  
OF CONSUMER GOODS OF OTHERS, IN CLASS 35  
(U.S. CLS. 100, 101 AND 102).

FIRST USE 6-29-2007; IN COMMERCE 6-29-2007.

NO CLAIM IS MADE TO THE EXCLUSIVE  
RIGHT TO USE "TABLE", APART FROM THE  
MARK AS SHOWN.

THE MARK CONSISTS OF THE WORDS TABLE  
COMPLIMENTS SHOWN IN STYLIZED LETTER-  
ING PICTURED IN THE CENTER OF A DOILY  
ABOVE A TABLE SETTING.

SER. NO. 77-268,698, FILED 8-30-2007.

JESSICA A. POWERS, EXAMINING ATTORNEY

**Int. Cl.: 33**

**Prior U.S. Cls.: 47 and 49**

**United States Patent and Trademark Office**

**Reg. No. 3,394,763**

**Registered Mar. 11, 2008**

**TRADEMARK  
PRINCIPAL REGISTER**

**LE BON CLIMAT**

AU BON CLIMAT LLC (CALIFORNIA LTD LIAB  
CO)  
P.O. BOX 113  
LOS OLIVOS, CA 93441

THE FOREIGN WORDING IN THE MARK  
TRANSLATES INTO ENGLISH AS THE GOOD  
CLIMATE.

FOR: WINE, IN CLASS 33 (U.S. CLS. 47 AND 49).

FIRST USE 0-0-2002; IN COMMERCE 0-0-2002.

SER. NO. 77-269,907, FILED 8-31-2007.

THE MARK CONSISTS OF STANDARD CHAR-  
ACTERS WITHOUT CLAIM TO ANY PARTICULAR  
FONT, STYLE, SIZE, OR COLOR.

ESTHER A. BORSUK, EXAMINING ATTORNEY



Int. Cl.: 33

Prior U.S. Cls.: 47 and 49

United States Patent and Trademark Office

Reg. No. 3,394,764

Registered Mar. 11, 2008

TRADEMARK  
PRINCIPAL REGISTER

# HONEYMOON

GAUGHEN HOLDINGS LLC (CALIFORNIA LTD  
LIAB CO)  
4954 NAUTILUS ST.  
OXNARD, CA 93035

FOR: ABSINTHE, ALCOHOLIC BEVERAGES PRODUCED FROM A BREWED MALT BASE WITH NATURAL FLAVORS, ALCOHOLIC BEVERAGES OF FRUIT, ALCOHOLIC BITTERS, ALCOHOLIC COCKTAIL MIXES, ALCOHOLIC COCKTAILS CONTAINING MILK, ALCOHOLIC COFFEE-BASED BEVERAGES, ALCOHOLIC EGG NOG, ALCOHOLIC ESSENCES, ALCOHOLIC EXTRACTS, ALCOHOLIC FRUIT EXTRACTS, ALCOHOLIC MALT COOLERS, ALCOHOLIC PUNCH, ALCOHOLIC TEA-BASED BEVERAGES, AMONTILLADO, ANISETTE; APERITIFS, NAMELY, ALCOHOLIC APERITIF BITTERS, APERITIFS WITH A WINE BASE, APERITIFS WITH A DISTILLED ALCOHOLIC LIQUOR BASE; ARMAGNAC, ARRACK, BLACK-CURRANT LIQUEUR, BRANDY, BRANDY SPIRITS, CACHACA, CALVADOS, CHAMPAGNE, CHERRY BRANDY; CHINESE LIQUORS, NAMELY, BREWED LIQUOR, MIXED LIQUOR, SPIRITS OF SORGHUM, WHITE LIQUOR; COFFEE-BASED LIQUORS, COGNAC, COOKING BRANDY, CORDIALS, CREAM LIQUEURS, CURACAO, DISTILLED SPIRITS, DISTILLED SPIRITS OF RICE, EXTRACTS OF SPIRITUOUS LIQUORS, FLAVORED BREWED MALT BEVERAGES, FRENCH BRANDY, GIN, GRAPPA, HARD CIDER, HERB LIQUEURS, HYDROMEL, MEAD, SPARKLING MEAD; JAPANESE LIQUORS, NAMELY, REGENERATED LIQUORS, SHOCHUH-BASED MIXED LI-

QUOR, SWEET RICE-BASED MIXED LIQUOR, WHITE LIQUOR; KIRSCH, KITS FOR MAKING WINE, LIQUEURS, DISTILLED LIQUOR, MEZCAL, OUZO, PORT WINES, POTABLE SPIRITS, PREPARED ALCOHOLIC COCKTAILS, PREPARED WINE COCKTAILS, RUM, SAKE, SAMBUCA, SANGRIA, SCHNAPPS, SHERRY, TEQUILA, TONIC LIQUEURS CONTAINING HERB EXTRACTS, TONIC LIQUEURS FLAVORED WITH JAPANESE PLUM EXTRACTS, TONIC SWEET GRAPE WINE CONTAINING EXTRACTS FROM GINSENG AND CINCHONA BARK, VERMOUTH, VODKA, WHISKEY; WINES, NAMELY, APERITIF WINE, COOKING WINE, WHITE WINE, RED WINE, FRUIT WINE, GRAPE WINE, HONEY WINE, STRAWBERRY WINE, SWEET WINE, SPARKLING FRUIT WINE, SPARKLING GRAPE WINE, NATURAL SPARKLING WINE, TABLE WINE; WINE PUNCHES, IN CLASS 33 (U.S. CLS. 47 AND 49).

FIRST USE 9-7-2007; IN COMMERCE 9-10-2007.

THE MARK CONSISTS OF STANDARD CHARACTERS WITHOUT CLAIM TO ANY PARTICULAR FONT, STYLE, SIZE, OR COLOR.

OWNER OF U.S. REG. NOS. 3,128,176, 3,257,007 AND OTHERS.

SER. NO. 77-275,767, FILED 9-10-2007.

ANDREA K. NADELMAN, EXAMINING ATTORNEY

**Int. Cl.: 33**

**Prior U.S. Cls.: 47 and 49**

**United States Patent and Trademark Office**

**Reg. No. 3,394,765**

**Registered Mar. 11, 2008**

**TRADEMARK  
PRINCIPAL REGISTER**

**CAB-MERLOT**

CASA LARGA VINEYARDS, INC. (NEW YORK  
CORPORATION)  
2287 TURK HILL ROAD  
FAIRPORT, NY 14450

THE MARK CONSISTS OF STANDARD CHAR-  
ACTERS WITHOUT CLAIM TO ANY PARTICULAR  
FONT, STYLE, SIZE, OR COLOR.

FOR: WINE, IN CLASS 33 (U.S. CLS. 47 AND 49).

SER. NO. 77-278,907, FILED 9-13-2007.

FIRST USE 10-0-2002; IN COMMERCE 10-0-2002.

ALYSSA PALADINO, EXAMINING ATTORNEY

**Int. Cl.: 33**

**Prior U.S. Cls.: 47 and 49**

**United States Patent and Trademark Office**

**Reg. No. 3,394,766**

**Registered Mar. 11, 2008**

**TRADEMARK  
PRINCIPAL REGISTER**

**CLV**

CASA LARGA VINEYARDS, INC. (NEW YORK  
CORPORATION)  
2287 TURK HILL ROAD  
FAIRPORT, NY 14450

FOR: WINE, IN CLASS 33 (U.S. CLS. 47 AND 49).

FIRST USE 3-0-2000; IN COMMERCE 3-0-2000.

THE MARK CONSISTS OF STANDARD CHAR-  
ACTERS WITHOUT CLAIM TO ANY PARTICULAR  
FONT, STYLE, SIZE, OR COLOR.

OWNER OF U.S. REG. NO. 3,215,102.

SER. NO. 77-278,947, FILED 9-13-2007.

ALYSSA PALADINO, EXAMINING ATTORNEY

**Int. Cls.: 35, 42 and 44**

**Prior U.S. Cls.: 100, 101 and 102**

**United States Patent and Trademark Office**

**Reg. No. 3,394,767**

**Registered Mar. 11, 2008**

**SERVICE MARK  
PRINCIPAL REGISTER**

**LIFE OVER CANCER**

CANCER THERAPY AND RESEARCH CENTER  
(TEXAS CORPORATION)  
7979 WURZBACH ROAD  
URSCHEL TOWER  
SAN ANTONIO, TX 78229

FOR: PROMOTING PUBLIC AWARENESS OF  
THE NEED FOR CANCER EDUCATION AND PRE-  
VENTION PRACTICES, IN CLASS 35 (U.S. CLS. 100,  
101 AND 102).

FIRST USE 9-12-2007; IN COMMERCE 9-12-2007.

FOR: MEDICAL AND SCIENTIFIC RESEARCH  
TO FACILITATE THE DISCOVERY OF THE CAU-  
SES, PREVENTION, TREATMENT AND CURE OF  
CANCER, IN CLASS 42 (U.S. CLS. 100 AND 101).

FIRST USE 9-12-2007; IN COMMERCE 9-12-2007.

FOR: MEDICAL SERVICES, NAMELY, MULTI-  
DISCIPLINARY TREATMENT OF PATIENTS, IN  
CLASS 44 (U.S. CLS. 100 AND 101).

FIRST USE 9-12-2007; IN COMMERCE 9-12-2007.

THE MARK CONSISTS OF STANDARD CHAR-  
ACTERS WITHOUT CLAIM TO ANY PARTICULAR  
FONT, STYLE, SIZE, OR COLOR.

NO CLAIM IS MADE TO THE EXCLUSIVE  
RIGHT TO USE "CANCER", APART FROM THE  
MARK AS SHOWN.

SER. NO. 77-279,667, FILED 9-14-2007.

TASNEEM HUSSAIN, EXAMINING ATTORNEY

**Int. Cl.: 36**

**Prior U.S. Cls.: 100, 101 and 102**

**United States Patent and Trademark Office**

**Reg. No. 3,394,768**

**Registered Mar. 11, 2008**

**SERVICE MARK  
PRINCIPAL REGISTER**

# ProPay Commission Payments

PROPAY USA, INC. (UTAH CORPORATION)  
500 TIMPANOGOS CIRCLE  
OREM, UT 84097

FOR: FINANCIAL SERVICES, NAMELY EN-  
ABLING ONLINE OR HOME BASED BUSINESSES  
TO MAKE AND RECEIVE PAYMENTS VIA TELE-  
PHONE, FACSIMILE, ONLINE AND WIRELESS  
APPLICATIONS, IN CLASS 36 (U.S. CLS. 100, 101  
AND 102).

FIRST USE 5-15-2007; IN COMMERCE 5-15-2007.

THE MARK CONSISTS OF STANDARD CHAR-  
ACTERS WITHOUT CLAIM TO ANY PARTICULAR  
FONT, STYLE, SIZE, OR COLOR.

OWNER OF U.S. REG. NO. 3,061,051.

NO CLAIM IS MADE TO THE EXCLUSIVE  
RIGHT TO USE "COMMISSION PAYMENTS",  
APART FROM THE MARK AS SHOWN.

SER. NO. 77-281,139, FILED 9-17-2007.

HEATHER BIDDULPH, EXAMINING ATTORNEY

**Int. Cl.: 36**

**Prior U.S. Cls.: 100, 101 and 102**

**United States Patent and Trademark Office**

**Reg. No. 3,394,769**

**Registered Mar. 11, 2008**

**SERVICE MARK  
PRINCIPAL REGISTER**

**POLARIS LIFE SERIES**

AMERICAN INTERNATIONAL GROUP, INC.  
(DELAWARE CORPORATION)  
70 PINE STREET  
NEW YORK, NY 10270

OWNER OF U.S. REG. NOS. 1,806,410, 3,226,308  
AND OTHERS.

FOR: INSURANCE UNDERWRITING IN THE  
FIELD OF UNIVERSAL LIFE INSURANCE, IN  
CLASS 36 (U.S. CLS. 100, 101 AND 102).

NO CLAIM IS MADE TO THE EXCLUSIVE  
RIGHT TO USE "LIFE SERIES", APART FROM  
THE MARK AS SHOWN.

FIRST USE 1-1-2000; IN COMMERCE 1-1-2000.

SER. NO. 77-287,996, FILED 9-25-2007.

THE MARK CONSISTS OF STANDARD CHAR-  
ACTERS WITHOUT CLAIM TO ANY PARTICULAR  
FONT, STYLE, SIZE, OR COLOR.

BRIDGETT SMITH, EXAMINING ATTORNEY

**Int. Cl.: 36**

**Prior U.S. Cls.: 100, 101 and 102**

**United States Patent and Trademark Office**

**Reg. No. 3,394,770**

**Registered Mar. 11, 2008**

**SERVICE MARK  
PRINCIPAL REGISTER**

**AIG CORPORATE INVESTOR**

AMERICAN INTERNATIONAL GROUP, INC.  
(DELAWARE CORPORATION)  
70 PINE STREET  
NEW YORK, NY 10270

OWNER OF U.S. REG. NOS. 1,151,229, 1,273,845  
AND OTHERS.

FOR: INSURANCE UNDERWRITING IN THE  
FIELD OF UNIVERSAL LIFE INSURANCE, IN  
CLASS 36 (U.S. CLS. 100, 101 AND 102).

NO CLAIM IS MADE TO THE EXCLUSIVE  
RIGHT TO USE "CORPORATE INVESTOR", APART  
FROM THE MARK AS SHOWN.

FIRST USE 9-4-2007; IN COMMERCE 9-4-2007.

SER. NO. 77-288,089, FILED 9-25-2007.

THE MARK CONSISTS OF STANDARD CHAR-  
ACTERS WITHOUT CLAIM TO ANY PARTICULAR  
FONT, STYLE, SIZE, OR COLOR.

BRIDGETT SMITH, EXAMINING ATTORNEY

**Int. Cl.: 35**

**Prior U.S. Cls.: 100, 101 and 102**

**United States Patent and Trademark Office**

**Reg. No. 3,394,771**

**Registered Mar. 11, 2008**

**SERVICE MARK  
PRINCIPAL REGISTER**



ER MARKS, INC. (DELAWARE CORPORATION)  
SUITE 205B, 2ND FLOOR BANCROFT BUILDING  
3411 SILVERSIDE ROAD, CONCORD PLAZA  
WILMINGTON, DE 19810

FOR: PROVIDING HOME SHOPPING SERVICES  
IN THE FIELD OF GENERAL MERCHANDISE BY  
MEANS OF TELEVISION; RETAIL STORE SERVI-  
CES AVAILABLE THROUGH INTERACTIVE TELE-  
VISION FEATURING GENERAL MERCHANDISE;  
AND RETAIL SHOPPING SERVICES IN THE FIELD  
OF GENERAL MERCHANDISE BY MEANS OF THE

INTERNET, IN CLASS 35 (U.S. CLS. 100, 101 AND  
102).

FIRST USE 9-24-2007; IN COMMERCE 9-24-2007.

OWNER OF U.S. REG. NOS. 1,455,889, 1,930,782  
AND OTHERS.

SER. NO. 77-299,729, FILED 10-9-2007.

CAROLINE WOOD, EXAMINING ATTORNEY



**Int. Cl.: 25**

**Prior U.S. Cls.: 22 and 39**

**United States Patent and Trademark Office**

**Reg. No. 3,394,772**

**Registered Mar. 11, 2008**

**TRADEMARK  
PRINCIPAL REGISTER**

**PASTRY**

RUN ATHLETICS INTERNATIONAL, LLC (NEW  
YORK LTD LIAB CO)  
29 WEST 56TH STREET  
NEW YORK, NY 10019

THE MARK CONSISTS OF STANDARD CHAR-  
ACTERS WITHOUT CLAIM TO ANY PARTICULAR  
FONT, STYLE, SIZE, OR COLOR.

FOR: FOOTWEAR, IN CLASS 25 (U.S. CLS. 22 AND  
39).

SER. NO. 77-975,030, FILED 3-2-2007.

FIRST USE 3-0-2007; IN COMMERCE 3-0-2007.

BERYL GARDNER, EXAMINING ATTORNEY

**Int. Cl.: 24**

**Prior U.S. Cls.: 42 and 50**

**United States Patent and Trademark Office**

**Reg. No. 3,394,773**

**Registered Mar. 11, 2008**

**TRADEMARK  
PRINCIPAL REGISTER**

**MÜ kitchen**

MEI, LLC (MINNESOTA LTD LIAB CO)  
5940 NEWTON AVENUE SOUTH  
MINNEAPOLIS, MN 55419

FOR: KITCHEN TOWELS, IN CLASS 24 (U.S. CLS.  
42 AND 50).

FIRST USE 9-1-2007; IN COMMERCE 9-1-2007.

THE MARK CONSISTS OF STANDARD CHAR-  
ACTERS WITHOUT CLAIM TO ANY PARTICULAR  
FONT, STYLE, SIZE, OR COLOR.

NO CLAIM IS MADE TO THE EXCLUSIVE  
RIGHT TO USE "KITCHEN", APART FROM THE  
MARK AS SHOWN.

SER. NO. 77-975,095, FILED 5-4-2007.

STEVEN JACKSON, EXAMINING ATTORNEY

**Int. Cls.: 7, 9 and 42**

**Prior U.S. Cls.: 13, 19, 21, 23, 26, 31, 34, 35, 36, 38, 100  
and 101**

**United States Patent and Trademark Office**

**Reg. No. 3,394,774**

**Registered Mar. 11, 2008**

**TRADEMARK  
SERVICE MARK  
PRINCIPAL REGISTER**



PROTON MOTOR FUEL CELL GMBH. (FED REP  
GERMANY CORPORATION)  
GAUTINGER STRASSE 6  
82319 STARNBERG, FED REP GERMANY

FOR: ELECTRIC DRIVES, NAMELY POWER  
UNITS FOR VEHICLES AND MACHINERY, IN  
CLASS 7 (U.S. CLS. 13, 19, 21, 23, 31, 34 AND 35).

FOR: FUEL CELLS FOR ENERGY CONVERSION  
USING PROTON EXCHANGE MEMBRANES, IN  
CLASS 9 (U.S. CLS. 21, 23, 26, 36 AND 38).

FOR: PRODUCT RESEARCH AND DEVELOP-  
MENT, IN CLASS 42 (U.S. CLS. 100 AND 101).

OWNER OF FED REP GERMANY REG. NO.  
312191, DATED 4-19-2001, EXPIRES 1-31-2011.

NO CLAIM IS MADE TO THE EXCLUSIVE  
RIGHT TO USE "PROTON MOTOR", APART FROM  
THE MARK AS SHOWN.

THE LINING IS A FEATURE OF THE MARK  
AND DOES NOT INDICATE COLOR.

SER. NO. 78-073,392, FILED 7-11-2001.

JILL C. ALT, EXAMINING ATTORNEY

**Int. Cl.: 5**

**Prior U.S. Cls.: 6, 18, 44, 46, 51 and 52**

**United States Patent and Trademark Office**

**Reg. No. 3,394,775**

**Registered Mar. 11, 2008**

**TRADEMARK  
PRINCIPAL REGISTER**

**AZAZA**

NYCOMED GMBH (FED REP GERMANY COR-  
PORATION)  
BYK-GULDEN-STRASSE, 2  
KONSTANZ, FED REP GERMANY 78467

FOR: PHARMACEUTICAL PREPARATIONS FOR  
THE TREATMENT OF RESPIRATORY DISEASES  
AND CONDITIONS, PHARMACEUTICAL PRE-  
PARATIONS FOR THE TREATMENT OF GASTRO-

INTESTINAL DISEASES AND CONDITIONS, IN  
CLASS 5 (U.S. CLS. 6, 18, 44, 46, 51 AND 52).

OWNER OF FED REP GERMANY REG. NO.  
30208425, DATED 3-22-2002, EXPIRES 2-28-2012.

SER. NO. 78-109,776, FILED 2-19-2002.

ROBIN CHOSID, EXAMINING ATTORNEY

**Int. Cl.: 5**

**Prior U.S. Cls.: 6, 18, 44, 46, 51 and 52**

**United States Patent and Trademark Office**

**Reg. No. 3,394,776**

**Registered Mar. 11, 2008**

**TRADEMARK  
PRINCIPAL REGISTER**

**NINOTALEM**

CIRCA DIA BV (NETHERLANDS CORPORATION)  
KNEUTERDIJK 2, 2514 EN  
DEN HAAG, NETHERLANDS

FOR: PHARMACEUTICAL PREPARATIONS, NAMELY, A HORMONE SUPPLEMENT; AN ANTI-OXIDANT PHARMACEUTICAL PREPARATION FOR THE TREATMENT OF CROHN'S DISEASE AND ULCERATIVE COLITIS; A PHARMACEUTICAL PREPARATION FOR INFLUENCING AND/OR CONTROLLING CIRCADIAN RHYTHMS; A PHARMACEUTICAL PREPARATION THAT ACTS ON THE CENTRAL NERVOUS SYSTEM FOR THE TREATMENT OF DISRUPTED SLEEP PATTERNS;

A PHARMACEUTICAL PREPARATION CONTAINING MELATONIN FOR THE TREATMENT OF CIRCADIAN RHYTHM DISORDERS, DISRUPTED SLEEP PATTERNS, DELAYED SLEEP PHASE SYNDROME AND INSOMNIA IN CHILDREN WITH ATTENTION DEFICIT HYPERACTIVITY DISORDER, IN CLASS 5 (U.S. CLS. 6, 18, 44, 46, 51 AND 52).

OWNER OF NETHERLANDS REG. NO. 002821551, DATED 10-14-2003, EXPIRES 8-7-2012.

SER. NO. 78-165,370, FILED 9-18-2002.

ALICE BENMAMAN, EXAMINING ATTORNEY

**Int. Cls.: 37 and 39**

**Prior U.S. Cls.: 100, 103, 105 and 106**

**United States Patent and Trademark Office**

**Reg. No. 3,394,777**

**Registered Mar. 11, 2008**

**SERVICE MARK  
PRINCIPAL REGISTER**

**PATRIOT PROPANE**

RICHLAND PARTNERS, LLC (PENNSYLVANIA  
LTD LIAB CO)  
225 EAST MAIN STREET  
RICHLAND, PA 17087

FOR: SERVICING OF EQUIPMENT THAT UTILI-  
ZES PROPANE, IN CLASS 37 (U.S. CLS. 100, 103 AND  
106).

FIRST USE 7-1-2001; IN COMMERCE 7-1-2001.

FOR: DELIVERY OF PROPANE BY TRUCK, IN  
CLASS 39 (U.S. CLS. 100 AND 105).

FIRST USE 7-1-2001; IN COMMERCE 7-1-2001.

NO CLAIM IS MADE TO THE EXCLUSIVE  
RIGHT TO USE "PROPANE", APART FROM THE  
MARK AS SHOWN.

SER. NO. 78-165,902, FILED 9-19-2002.

HEATHER BIDDULPH, EXAMINING ATTORNEY

**Int. Cl.: 42**

**Prior U.S. Cls.: 100 and 101**

**United States Patent and Trademark Office**

**Reg. No. 3,394,778**

**Registered Mar. 11, 2008**

**SERVICE MARK  
PRINCIPAL REGISTER**

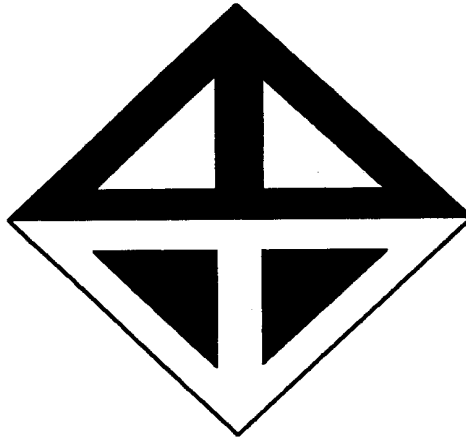

HOUSEY PHARMACEUTICALS, INC. (DELA-  
WARE CORPORATION)  
16800 WEST TWELVE MILE ROAD, SUITE 201  
SOUTHFIELD, MI 48076

FOR: INTELLECTUAL PROPERTY LICENSING  
IN THE FIELD OF PHARMACEUTICALS, IN CLASS  
42 (U.S. CLS. 100 AND 101).

FIRST USE 7-0-1991; IN COMMERCE 7-0-1991.

SER. NO. 78-195,269, FILED 12-17-2002.

AMY HELLA, EXAMINING ATTORNEY

**Int. Cl.: 3**

**Prior U.S. Cls.: 1, 4, 6, 50, 51 and 52**

**United States Patent and Trademark Office**

**Reg. No. 3,394,779**

**Registered Mar. 11, 2008**

**TRADEMARK  
PRINCIPAL REGISTER**

**J. FERNANDO BELMONT**

JAFER LIMITED (BERMUDA CORPORATION)  
CLARENDON HOUSE, 2 CHURCH STREET  
HAMILTON, HM12, BERMUDA

FOR: COLOGNE, PERFUME, EAU DE TOILETTE, EAU DE PERFUME, AFTERSHAVE LOTION; FACE POWDER, TALCUM POWDER; SHAVING BALM, SHAVING CREAM, SHAVING GEL, SHAVING LOTION; SHOWER GEL, SKIN CLARIFIERS, SKIN EMOLLIENTS, SKIN LIGHTENERS, SKIN LOTIONS, SKIN MOISTURIZERS, SKIN SOAPS, SKIN TONER; TOILET SOAP, LIQUID SOAP FOR FACE, HANDS AND BODY; SUNBLOCK PREPARATIONS, SUNSCREEN PREPARATIONS, SUN TANNING PREPARATIONS; MAKE-UP; FACIAL MAKEUP, FOUNDATION MAKEUP, LIP GLOSS; COSMETIC PENCILS; LIPSTICK, LIP PENCIL, EYELINER PENCIL, FACIAL CLEANERS, EYE MAKEUP REMOVERS; BLUSHER, EYE SHADOWS, EYE LINERS, EYE PENCILS, MASCARA, LIPSTICKS, LIP PENCILS, NAIL ENAMEL, SKIN CLEANSING LOTIONS,

COLD CREAMS, SKIN MOISTURIZER, NAIL CARE PREPARATIONS, NAIL GROOMING PRODUCTS, NAMELY, TIPS, GLUE, LACQUER AND GLITTER, NAIL POLISH, NAIL POLISH BASE COAT, NAIL POLISH TOP COAT; BODY CREAMS, GELS AND BODY LOTIONS; DEODORANT SOAP, IN CLASS 3 (U.S. CLS. 1, 4, 6, 50, 51 AND 52).

OWNER OF BERMUDA REG. NO. 00100866, DATED 9-15-2004, EXPIRES 9-15-2014.

THE NAME(S), PORTRAIT(S), AND/OR SIGNATURE(S) SHOWN IN THE MARK IDENTIFIES "MR. JUAN FERNANDO BELMONT ANDERSON", WHOSE CONSENT(S) TO REGISTER IS SUBMITTED.

SER. NO. 78-210,906, FILED 2-4-2003.

MICHAEL WEBSTER, EXAMINING ATTORNEY



**Int. Cl.: 29**

**Prior U.S. Cl.: 46**

**United States Patent and Trademark Office**

**Reg. No. 3,394,780**

**Registered Mar. 11, 2008**

**TRADEMARK  
PRINCIPAL REGISTER**

**FRINGS**

RUBY'S DINER, INC. (CALIFORNIA CORPORATION)  
660 NEWPORT CENTER DRIVESUITE 850  
NEWPORT BEACH, CA 92660

FIRST USE 1-1-1992; IN COMMERCE 1-1-1992.

SER. NO. 78-230,704, FILED 3-27-2003.

FOR: ONION RINGS AND FRENCH FRIES FOR  
CONSUMPTION ON OR OFF THE PREMISES, IN  
CLASS 29 (U.S. CL. 46).

LAURA KOVALSKY, EXAMINING ATTORNEY

**Int. Cl.: 43**

**Prior U.S. Cls.: 100 and 101**

**United States Patent and Trademark Office**

**Reg. No. 3,394,781**

**Registered Mar. 11, 2008**

**SERVICE MARK  
PRINCIPAL REGISTER**

**BUDGET INN**

JSK, LLC (CONNECTICUT LTD LIAB JT ST CO)  
593 PROVIDENCE - NEW LONDON TURNPIKE  
NORTH STONINGTON, CT 06359

FOR: HOTEL AND MOTEL SERVICES, IN CLASS  
43 (U.S. CLS. 100 AND 101).

FIRST USE 8-27-1997; IN COMMERCE 8-27-1997.

NO CLAIM IS MADE TO THE EXCLUSIVE  
RIGHT TO USE "INN", APART FROM THE MARK  
AS SHOWN.

SEC. 2(F).

SER. NO. 78-239,205, FILED 4-17-2003.

JOHN SCHUYLER YARD, EXAMINING ATTOR-  
NEY

**Int. Cl.: 25**

**Prior U.S. Cls.: 22 and 39**

**United States Patent and Trademark Office**

**Reg. No. 3,394,782**

**Registered Mar. 11, 2008**

**TRADEMARK  
PRINCIPAL REGISTER**

**BODYLOVE**

PIAT-NISKI, INGRID (AUSTRALIA INDIVIDUAL)  
APPARTMENT #1G/119 BANK STREET, GREENWIC  
NYC, NY 10015

FOR: T-SHIRTS, YOGA WEAR, SLEEP/BED WEAR CAPS, EXERCISE WEAR, TRACK SUITS, NAMELY, GYM SUITS, JOGGING SUITS, SWEAT SUITS; CASUAL DAYWEAR, NAMELY, SHORTS, LEGGINGS, SKIRTS, PANTS, TOPS, CARDIGANS,

TWIN SETS, LINGERIE, JEANS AND JACKETS, IN CLASS 25 (U.S. CLS. 22 AND 39).

PRIORITY CLAIMED UNDER SEC. 44(D) ON AUSTRALIA APPLICATION NO. 31046, FILED 2-20-2003, REG. NO. 971072, DATED 9-20-2003, EXPIRES 9-20-2013.

SER. NO. 78-241,635, FILED 4-24-2003.

GEOFFREY FOSDICK, EXAMINING ATTORNEY

**Int. Cl.: 12**

**Prior U.S. Cls.: 19, 21, 23, 31, 35 and 44**

**Reg. No. 3,394,783**

**United States Patent and Trademark Office**

**Registered Mar. 11, 2008**

**TRADEMARK  
PRINCIPAL REGISTER**



DIBYDI 3, S.L. (SPAIN CORPORATION)  
AVENIDA DE EUROPA, 24-2A PLANTA  
ALCOBENDAS (MADRID), SPAIN 28108

PRIORITY CLAIMED UNDER SEC. 44(D) ON  
ERPN CMNTY TM OFC APPLICATION NO.  
003061819, FILED 2-19-2003, REG. NO. 3061819, DA-  
TED 2-6-2005, EXPIRES 2-19-2013.

FOR: VEHICLES FOR LOCOMOTION BY WA-  
TER, NAMELY BOATS, YACHTS, AND SHIPS, IN  
CLASS 12 (U.S. CLS. 19, 21, 23, 31, 35 AND 44).

SER. NO. 78-256,480, FILED 5-30-2003.

EDWARD NELSON, EXAMINING ATTORNEY

**Int. Cl.: 30**

**Prior U.S. Cl.: 46**

**United States Patent and Trademark Office**

**Reg. No. 3,394,784**

**Registered Mar. 11, 2008**

**TRADEMARK  
PRINCIPAL REGISTER**

**LICK'EM LIGHTS**

POPPIN' GLOWS, INC. (OKLAHOMA CORPORATION)  
431 S. 122ND E. AVE  
TULSA, OK 74128

FIRST USE 10-31-2001; IN COMMERCE 10-31-2001.

SER. NO. 78-272,180, FILED 7-9-2003.

FOR: ICE POPS, FROZEN DESERT NOVELTY, IN  
CLASS 30 (U.S. CL. 46).

JEFF DEFORD, EXAMINING ATTORNEY

**Int. Cls.: 9 and 37**

**Prior U.S. Cls.: 21, 23, 26, 36, 38, 100, 103 and 106**

**Reg. No. 3,394,785**

**United States Patent and Trademark Office**

**Registered Mar. 11, 2008**

**TRADEMARK  
SERVICE MARK  
PRINCIPAL REGISTER**

**VICTORIA**

TREND COMMUNICATIONS LIMITED (UNITED KINGDOM CORPORATION)  
KNAVES BEECH ESTATE, LOUDWATER  
HIGH WYCOMBE, UNITED KINGDOM HP10 9QZ

FOR: TESTERS FOR TELECOMMUNICATION LINES; COMPUTER SOFTWARE FOR TESTING AND MAINTAINING TELECOMMUNICATION AND COMPUTER SYSTEMS; ELECTRONIC TEST INSTRUMENTS FOR THE COMMUNICATIONS AND COMPUTER INDUSTRY, NAMELY FOR TESTING THE CHARACTERISTICS OF COMMUNICATION MEDIA AS WELL AS THE SIGNAL TRANSPORTED BY SUCH MEDIA INCLUDING SIGNAL BANDWIDTH, SIGNAL POWER, SIGNAL STRENGTH, SIGNAL ATTENUATION, SIGNAL LOSS, INSERTION LOSS, RETURN LOSS, ENVIRONMENTAL NOISE, CROSS TALK, DATA RATE, VOLTAGE, IMPEDANCE, FREQUENCY, AMPLITUDE, WATTAGE, POWER SPECTRAL DENSITY, APPLIED LONGITUDINAL VOLTAGE, LONGITUDINAL BALANCE, MEASURED VOLTAGE, MODULATION AND MULTIPLEXING, LINE LENGTH, LINE SUITABILITY, THERMO/MECHANICAL EFFECTS ON SIGNAL, THROUGHPUT, INSULATION, TAPS, SPLITS, SIGNAL BOOST STRENGTH, BREAKS, SHORTS AND RESISTANCE OF SIGNAL TRANSPORT MEDIA AND FOR USE IN TESTING

COMMUNICATIONS AND COMPUTER SYSTEMS, DATA TRANSMITTING DEVICES AND DATA RECEIVING DEVICES; ELECTRONIC DEVICES FOR TESTING INPUT DATA WAVEFORM SYSTEMS AND SYNCHRONOUS DATA DISTORTION IN TELEPHONE INSTALLATIONS AND PARTS FOR ALL THE AFORESAID GOODS, IN CLASS 9 (U.S. CLS. 21, 23, 26, 36 AND 38).

FOR: MAINTENANCE OF TELEPHONE INSTALLATIONS, COMMUNICATION EQUIPMENT, TELECOMMUNICATION AND COMPUTER SYSTEM TESTING EQUIPMENT, TELECOMMUNICATIONS AND COMPUTER SYSTEMS, FEATURING THE USE OF ELECTRONIC CIRCUITS AND ASSOCIATED SOFTWARE, IN CLASS 37 (U.S. CLS. 100, 103 AND 106).

PRIORITY CLAIMED UNDER SEC. 44(D) ON UNITED KINGDOM APPLICATION NO. 2323936, FILED 2-15-2003, REG. NO. 2323936, DATED 3-9-2005, EXPIRES 3-9-2015.

SER. NO. 78-285,817, FILED 8-11-2003.

KATHLEEN M. VANSTON, EXAMINING ATTORNEY

**Int. Cl.: 37**

**Prior U.S. Cls.: 100, 103 and 106**

**United States Patent and Trademark Office**

**Reg. No. 3,394,786**

**Registered Mar. 11, 2008**

**SERVICE MARK  
PRINCIPAL REGISTER**

**NATIONAL BARN COMPANY**

KEANE CONSTRUCTION, INC. (OKLAHOMA CORPORATION)  
1739 EAST HIGHWAY 62  
FORT GIBSON, OK 74434

CAROLINA, SOUTH CAROLINA, GEORGIA, OHIO, PENNSYLVANIA, NEW YORK, WEST VIRGINIA, RHODE ISLAND, DELAWARE, MARYLAND AND FLORIDA.

FOR: COMMERCIAL, RESIDENTIAL AND AGRICULTURAL BUILDING CONSTRUCTION, IN CLASS 37 (U.S. CLS. 100, 103 AND 106).

NO CLAIM IS MADE TO THE EXCLUSIVE RIGHT TO USE "COMPANY", APART FROM THE MARK AS SHOWN.

FIRST USE 3-0-1992; IN COMMERCE 3-0-1992.

SEC. 2(F).

KEANE CONSTRUCTION INC., IS ENTITLED TO REGISTRATION FOR THE AREA COMPRISING THE ENTIRE UNITED STATES AND ITS TERRITORIES EXCEPT FOR THE STATES OF TENNESSEE, ALABAMA, KENTUCKY, VIRGINIA, NORTH

SER. NO. 78-287,913, FILED 8-15-2003.

KEVON CHISOLM, EXAMINING ATTORNEY

**Int. Cl.: 37**

**Prior U.S. Cls.: 100, 103 and 106**

**United States Patent and Trademark Office**

**Reg. No. 3,394,787**

**Registered Mar. 11, 2008**

**SERVICE MARK  
PRINCIPAL REGISTER**

**NATIONAL BARN COMPANY**

THREE BOYS ENTERPRISES, LLC (TENNESSEE  
LTD LIAB CO)  
1869 HIGHWAY 52 EAST  
PORTLAND, TN 37148

FOR: COMMERCIAL, RESIDENTIAL AND AGRICULTURAL BUILDING CONSTRUCTION, IN CLASS 37 (U.S. CLS. 100, 103 AND 106).

FIRST USE 1-0-1998; IN COMMERCE 1-0-1998.

THREE BOYS ENTERPRISE, LLC, IS ENTITLED TO REGISTRATION FOR AREA COMPRISING THE STATES OF TENNESSEE, ALABAMA, KENTUCKY, VIRGINIA, NORTH CAROLINA, SOUTH CAROLI-

NA, GEORGIA, OHIO, PENNSYLVANIA, NEW YORK, WEST VIRGINIA, RHODE ISLAND, DELAWARE, MARYLAND AND FLORIDA.

NO CLAIM IS MADE TO THE EXCLUSIVE RIGHT TO USE "COMPANY", APART FROM THE MARK AS SHOWN.

SEC. 2(F).

SER. NO. 78-287,919, FILED 8-15-2003.

AMY ALFIERI, EXAMINING ATTORNEY



Int. Cl.: 42

Prior U.S. Cls.: 100 and 101

United States Patent and Trademark Office

Reg. No. 3,394,788

Registered Mar. 11, 2008

SERVICE MARK  
PRINCIPAL REGISTER

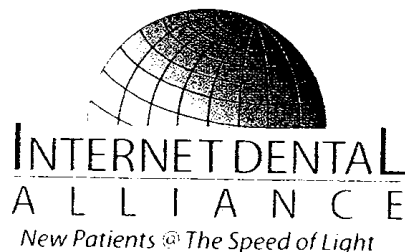

INTERNET DENTAL ALLIANCE, INC. (CALIFORNIA CORPORATION)  
2200 MAR EAST STREET  
TIBURON, CA 94920

FOR: COMPUTER SERVICES, NAMELY, DESIGNING AND IMPLEMENTING WEB SITES AND WEB PAGES FOR OTHERS, IN CLASS 42 (U.S. CLS. 100 AND 101).

FIRST USE 4-12-1999; IN COMMERCE 4-12-1999.

OWNER OF U.S. REG. NOS. 2,444,352 AND 2,633,952.

NO CLAIM IS MADE TO THE EXCLUSIVE RIGHT TO USE "INTERNET DENTAL" AND "NEW PATIENTS @ THE SPEED OF LIGHT", APART FROM THE MARK AS SHOWN.

THE STIPPLING IS FOR SHADING PURPOSES.

THE MARK CONSISTS OF A FANCIFUL GLOBE DESIGN

SEC. 2(F).

SER. NO. 78-300,522, FILED 9-15-2003.

INGRID C. EULIN, EXAMINING ATTORNEY

Int. Cl.: 16

Prior U.S. Cls.: 2, 5, 22, 23, 29, 37, 38 and 50

United States Patent and Trademark Office

Reg. No. 3,394,789

Registered Mar. 11, 2008

TRADEMARK  
PRINCIPAL REGISTER



MONTGOMERY, DEVIDA (UNITED STATES IN-  
DIVIDUAL)  
1708 EMERALD  
ODESSA, TX 79761

FOR: ART PRODUCTS SPECIFICALLY PAINT  
CADDIES, IN CLASS 16 (U.S. CLS. 2, 5, 22, 23, 29, 37, 38  
AND 50).

FIRST USE 3-20-2007; IN COMMERCE 5-29-2007.

NO CLAIM IS MADE TO THE EXCLUSIVE  
RIGHT TO USE "ART", APART FROM THE MARK  
AS SHOWN.

THE MARK CONSISTS OF HAND-HELD PAINT  
PALETTE WITH THE LETTERS A AND I FORMING  
AN EASEL ON THE PALETTE.

SER. NO. 78-338,965, FILED 12-10-2003.

DARRYL SPRUILL, EXAMINING ATTORNEY

**Int. Cl.: 9**

**Prior U.S. Cls.: 21, 23, 26, 36 and 38**

**Reg. No. 3,394,790**

**United States Patent and Trademark Office**

**Registered Mar. 11, 2008**

**TRADEMARK  
PRINCIPAL REGISTER**



**BILGI ELEKTRONIK TELEKOMUNIKASYON  
SISTEMLERI SANAYI VE TICARET ANONIM  
SIRKETI (TURKEY INCORPORATED COM-  
PANY)**

**HASANPASA, UZUNCAYIR CAD. NO: 19 KAT: 2  
KADIKOY - ISTANBUL, TURKEY**

**FOR: SCIENTIFIC, NAUTICAL, SURVEYING,  
PHOTOGRAPHIC, CINEMATOGRAPHIC, OPTI-  
CAL, WEIGHING, MEASURING, SIGNALING,  
CHECKING/SUPERVISION, LIFE-SAVING AND  
TEACHING APPARATUS AND INSTRUMENTS,  
NAMELY, BAROMETERS, CURRENT RECTIFIERS,  
GAS TESTING INSTRUMENTS, THERMOMETERS  
NOT FOR MEDICAL PURPOSES, VOLTMETERS,  
MICROSCOPES, TELESCOPES, PERISCOPES;  
LABORATORY TEST TUBES, OVENS FOR LABORA-  
TORY USE, FURNITURE ESPECIALLY MADE FOR  
LABORATORIES, LABORATORY TRAYS; APPA-  
RATUS FOR RECORDING, TRANSMISSION OR  
REPRODUCTION OF SOUND OR IMAGES, NAME-  
LY, DIGITAL AUDIO RECORDERS, DIGITAL  
AUDIO RECORDERS FOR DVD, DIGITAL AUDIO  
RECORDERS FOR DIVX, DIGITAL AUDIO REC-  
ORDERS FOR MP3; VIDEO SERVERS, INTERNET  
PROTOCOL (IP) CAMERAS, CLOSED CIRCUIT  
TELEVISION (CCTV) CAMERAS, INDUSTRIAL  
CAMERAS, OPTIC LENSES FOR CCTV CAMERAS,  
VIDEO SWITCHING AND PROCESSING UNITS,  
CAMERA MOTION AND CONTROL UNITS, LI-  
QUID CRYSTAL DISPLAY (LCD) AND CATHODE  
RAY TUBE (CRT) MONITORS, VIDEO CONFER-  
ENCE SYSTEMS; RADIOS, TELEVISION SETS, VI-  
DEO CASSETTE RECORDERS, DIGITAL VIDEO  
RECORDERS, NETWORK VIDEO AND AUDIO  
RECORDERS, PHOTOGRAPHIC CAMERAS, CINE-  
MATOGRAPHIC CAMERAS; AUDIOVISUAL**

**TEACHING APPARATUS, NAMELY, VIDEO PRO-  
JECTORS, LCD PROJECTORS; AMUSEMENT AP-  
PARATUS ADAPTED FOR USE WITH TELEVISION  
RECEIVERS ONLY, NAMELY, TELEVISION AND  
COMPUTER GAME CONSOLES; LOUDSPEAKERS,  
MEGAPHONES, MICROPHONES, PROJECTION AP-  
PARATUS, NAMELY, PROJECTION SCREENS;  
COMPUTERS; RECORDED COMPUTER SOFT-  
WARE FOR DATA ACQUISITION, DATA PROCES-  
SING, MONITORING, CONTROLLING AND  
ESTABLISHING OFF-SITE COMMUNICATIONS  
FOR SECURITY AND SAFETY SYSTEMS; DOWN-  
LOADABLE COMPUTER SOFTWARE FOR DATA  
ACQUISITION, DATA PROCESSING, MONITOR-  
ING, CONTROLLING AND ESTABLISHING OFF-  
SITE COMMUNICATIONS FOR SECURITY AND  
SAFETY SYSTEMS; PRINTERS FOR USE WITH  
COMPUTERS, DATA PROCESSING SCANNERS,  
CASH REGISTERS, CALCULATING MACHINES;  
BAR CODE READERS; DIGITAL VIDEO REC-  
ORDERS; CASSETTE PLAYERS; BLANK OPTICAL  
DISCS; BLANK COMPACT DISCS; PHOTOGRAPH-  
IC ENLARGING DEVICE TO PRODUCE EN-  
LARGED PHOTOGRAPHIC REPRODUCTIONS;  
LIGHT EXPOSURE METERS FOR PHOTOGRAPHIC  
DEVICES; EXPOSED X-RAY FILMS; ANTENNAS;  
ELEVATOR OPERATING APPARATUS AND CON-  
TROLS, NAMELY, EMBEDDED SOFTWARE IN  
CONTROLLERS FOR MONITORING ELEVATOR  
FUNCTIONS; AUTOMATED MONEY COUNTING  
AND SORTING MACHINES; BALANCING APPA-  
RATUS, NAMELY, TIRE BALANCING MACHINES  
FOR LAND VEHICLES; AUTOMATED TICKET  
DISPENSERS; ELECTRONIC PARTS OF MACHINES  
AND EQUIPMENT, NAMELY, ELECTRIC MOTOR  
DRIVER UNITS, ELECTRIC MOTOR CONTROL**

UNITS, AND AUTOMATION UNITS FOR MONITORING AND CONTROLLING SECURITY AND SAFETY SYSTEMS; SEMICONDUCTORS; ELECTRONIC CIRCUITS FOR THE MANUFACTURE OF INTEGRATED CIRCUITS AND ELECTRONIC BOARDS AND EQUIPMENT; INTEGRATED CIRCUITS; CHIPS, NAMELY, COMPUTER CHIPS, DNA CHIPS, ELECTRONIC CHIPS FOR THE MANUFACTURER OF INTEGRATED CIRCUITS, SEMI-CONDUCTOR CHIPS, AND CHARGE COUPLED DEVICES (CCD) AND COMPLEMENTARY METAL OXIDE SEMICONDUCTOR (CMOS) SENSORS; TRANSISTORS; ELECTRONIC CIRCUIT CARDS; CONDENSERS, NAMELY, CAPACITORS, MICROSCOPE CONDENSERS, INDUCTORS, DIODES, AND RESISTORS; WATER LEVEL INDICATORS; HEAT REGULATING APPARATUS, NAMELY, THERMOSTATS, HEAT SENSORS, AUTOMATION SENSORS, ELECTRIC CONVERTERS; COMMUNICATION EQUIPMENT, NAMELY, TELEPHONES, FACSIMILE MACHINES, TELEFAXES, TELEX, TELEGRAPHS, MOBILE PHONES, WIRELESS PHONES; TELEPRINTERS; PHOTOGRAPHIC, ELECTROSTATIC AND THERMIC PHOTOCOPIERS; GAS METERS; GASOMETERS; METERED GASOLINE PUMPS FOR SERVICE STATIONS; PARKING METERS; MAGNETIC ENCODED CARDS FOR ACCESS CONTROL SYSTEMS; WEIGHING APPARATUS AND INSTRUMENTS, NAMELY, INDUSTRIAL AND COMMERCIAL SCALES; SCALES; STEELYARD BALANCES; DETECTORS, NAMELY, RADON DETECTORS, SMOKE DETECTORS, CARBON MONOXIDE DETECTORS, PASSIVE INFRARED (PIR) AND MOTION DETECTORS, PHOTOELECTRIC BEAM SENSORS, HEAT DETECTORS; X-RAY PRODUCING APPARATUS AND INSTALLATIONS NOT FOR MEDICAL PURPOSES; RADIOLOGICAL APPARATUS FOR INDUSTRIAL PURPOSES; LIFE SAVING APPARATUS AND EQUIPMENT, NAMELY, PROTECTIVE CLOTHING MADE FROM INFLAMMABLE AND REFLECTIVE FABRIC, FIRE EXTINGUISHERS, FIRE SPRINKLERS, GAS MASKS; FIRE ALARMS; INTRUDER ALARMS; RESPIRATORY MASKS OTHER THAN FOR ARTIFICIAL RESPIRATION, RESPIRATORS FOR FILTERING AIR, LIFE BELTS, LIFE NETS;

CLOTHING FOR PROTECTION AGAINST ACCIDENTS, IRRADIATION AND FIRE; GLOVES FOR DIVERS; GLOVES FOR PROTECTION AGAINST ACCIDENTS; SPECTACLE GLASSES; SIGNALING WHISTLES; SIGNAL LANTERNS; SIGNALING BUOYS; EYEGLASSES; SUN GLASSES; CONTACT LENSES; CONTACT LENS CASES; ELECTRIC PLUGS; ELECTRIC SOCKETS AND OTHER ELECTRIC CONNECTIONS, NAMELY, ELECTRIC SWITCHES, CIRCUITS BREAKERS AND CLOSERS, FUSES, ELECTRIC RESISTANCE WIRES; ELECTRIC DOOR BELLS; ELECTRIC ALARM BELLS; ELECTRIC CABLES; FIBER OPTIC CABLES; ELECTRICAL POWER SUPPLIES; ELECTRIC BATTERIES; BATTERIES; ELECTRICAL ADAPTERS AND CHARGERS FOR ELECTRIC BATTERIES; ELECTRIC FLAT IRONS; SPEED INDICATORS FOR VEHICLES; VEHICLE BREAKDOWN WARNING TRIANGLES; LUMINOUS OR MECHANICAL ROAD SIGNS; FLASHING SAFETY LIGHTS; FIRE-EXTINGUISHING SYSTEMS; ELECTRIC WELDING APPARATUS; RADAR DETECTORS; SONARS; SIGHTING TELESCOPES; LEVELING RODS FOR SURVEYING; PLUMB LINES; TAPE MEASURES; DOSAGE DISPENSERS THAT COUNT OR MEASURE OUTPUT FOR USE WITH AUTOMATION EQUIPMENT; ELECTRICALLY HEATED HAIR CURLERS; ELECTRIC DEVICES FOR ATTRACTING AND KILLING INSECTS; ELECTRIC DOOR CLOSERS; ELECTRIC DOOR OPENERS; AUTOMATIC TURNSTILES; SATELLITES FOR SCIENTIFIC PURPOSES; ELECTROLYSERS; GALVANOMETERS; ANODES; CATHODE RAY TUBES; SCREEN FILTERS FOR COMPUTERS AND TELEVISIONS., IN CLASS 9 (U.S. CLS. 21, 23, 26, 36 AND 38).

PRIORITY CLAIMED UNDER SEC. 44(D) ON TURKEY APPLICATION NO. 2003/17362, FILED 7-3-2003, REG. NO. 2003/17362, DATED 7-3-2003, EXPIRES 7-3-2013.

SER. NO. 78-344,009, FILED 12-21-2003.

ALICIA COLLINS, EXAMINING ATTORNEY

**Int. Cl.: 41**

**Prior U.S. Cls.: 100, 101 and 107**

**United States Patent and Trademark Office**

**Reg. No. 3,394,791**

**Registered Mar. 11, 2008**

**SERVICE MARK  
PRINCIPAL REGISTER**

**HYPERFITNESS**

BURCH, SEAN T. (UNITED STATES INDIVIDUAL)  
8102 SUMMERFIELD HILLS DR.  
WARRENTON, VA 20186

FOR: EDUCATIONAL SERVICES, NAMELY, PROVIDING INSTRUCTION IN THE FIELD OF PHYSICAL AND MENTAL WELL BEING AND EXERCISING THROUGH CLASSES IN THE AREAS OF FITNESS, MARTIAL ARTS AND WELLNESS, AND CONSULTING SERVICES RELATING TO THE AREAS OF FITNESS, MARTIAL ARTS AND WELLNESS, IN CLASS 41 (U.S. CLS. 100, 101 AND 107).

FIRST USE 1-3-2004; IN COMMERCE 1-9-2004.

THE MARK CONSISTS OF STANDARD CHARACTERS WITHOUT CLAIM TO ANY PARTICULAR FONT, STYLE, SIZE, OR COLOR.

SER. NO. 78-350,657, FILED 1-12-2004.

HENRY S. ZAK, EXAMINING ATTORNEY

**Int. Cls.: 9, 16 and 41**

**Prior U.S. Cls.: 2, 5, 21, 22, 23, 26, 29, 36, 37, 38, 50,  
100, 101 and 107**

**Reg. No. 3,394,792**

**United States Patent and Trademark Office**

**Registered Mar. 11, 2008**

---

**TRADEMARK  
SERVICE MARK  
PRINCIPAL REGISTER**

**VINYL CAFE**

MCLEAN, STUART (CANADA INDIVIDUAL)  
588 PALMERSTON AVENUE  
TORONTO, ONTARIO, CANADA M6G 2P7

FOR: PRE-RECORDED CD'S FEATURING SOCIAL COMMENTARY, DRAMATIC WORKS FOR RECITATION, COMEDY, SATIRE, POETRY, IN CLASS 9 (U.S. CLS. 21, 23, 26, 36 AND 38).

FIRST USE 12-5-1999; IN COMMERCE 12-5-1999.

FOR: BOOKS FEATURING SOCIAL COMMENTARY, DRAMATIC WORKS FOR RECITATION, COMEDY, SATIRE, POETRY, IN CLASS 16 (U.S. CLS. 2, 5, 22, 23, 29, 37, 38 AND 50).

FIRST USE 12-5-1999; IN COMMERCE 12-5-1999.

FOR: ENTERTAINMENT IN THE NATURE OF LIVE VARIETY PERFORMANCES, IN CLASS 41 (U.S. CLS. 100, 101 AND 107).

FIRST USE 12-5-1999; IN COMMERCE 12-5-1999.

THE MARK CONSISTS OF STANDARD CHARACTERS WITHOUT CLAIM TO ANY PARTICULAR FONT, STYLE, SIZE, OR COLOR.

SER. NO. 78-352,659, FILED 1-15-2004.

JOHN DALIER, EXAMINING ATTORNEY

**Int. Cl.: 36**

**Prior U.S. Cls.: 100, 101 and 102**

**United States Patent and Trademark Office**

**Reg. No. 3,394,793**

**Registered Mar. 11, 2008**

**SERVICE MARK  
PRINCIPAL REGISTER**



**STEADY HAND, RELIABLE PARTNER**

VERITY INSURANCE SERVICES INC. (CALI-  
FORNIA CORPORATION)  
20955 PATHFINDER ROAD, #160  
DIAMOND BAR, CA 91765

NO CLAIM IS MADE TO THE EXCLUSIVE  
RIGHT TO USE "INSURANCE", APART FROM  
THE MARK AS SHOWN.

FOR: INSURANCE AGENCY AND BROKERAGE  
SERVICES, IN CLASS 36 (U.S. CLS. 100, 101 AND 102).

SER. NO. 78-356,799, FILED 1-23-2004.

FIRST USE 10-1-2003; IN COMMERCE 10-1-2003.

B. PARADEWELAI, EXAMINING ATTORNEY

**Int. Cls.: 9 and 28**

**Prior U.S. Cls.: 21, 22, 23, 26, 36, 38 and 50**

**Reg. No. 3,394,794**

**United States Patent and Trademark Office**

**Registered Mar. 11, 2008**

**TRADEMARK  
PRINCIPAL REGISTER**

**PENNY PIPER**

ATRONIC INTERNATIONAL GMBH (FED REP  
GERMANY CORPORATION)  
BORSIGSTRASSE 26  
32312 LUBBECKE, FED REP GERMANY 32312

FOR: ELECTRIC AND ELECTRONIC APPARATUS, INSTRUMENTS, DEVICES AND MACHINES NAMELY, AUTOMATED COIN DISPENSING MACHINES, COIN AND MONEY BILL OPERATED MACHINES, NAMELY SLOT MACHINES, GAMING MACHINES OPERABLE WITH BILLS, MAGNETIC CARDS; COMPUTER CHIPS, MICRO-PROCESSORS AND COMPUTER CHIPS FOR COIN OPERATED GAMING MACHINES, MECHANISMS FOR COIN-OPERATED MACHINES NAMELY, COIN, CURRENCY AND CHIP-CONTROLLED GAMING MACHINES, APPARATUS FOR BILLING OPERATIONS OF COIN-OPERATED MACHINES, NAMELY COMPUTER SOFTWARE USED TO GENERATE BILLS IN CONNECTION WITH COIN OPERATED GAMING MACHINES, COMPUTERS AND COMPUTER HARDWARE, COMPUTER PRINTERS, ELECTRONIC INDICATORS FOR DISPLAYING TOTAL WINNINGS IN FRONT OF GAMING MACHINES, MONEY CHANGE MACHINES, VENDING MACHINES PROVIDING CHIPS, COUPONS AND GAME CARDS; GAMING EQUIPMENT, NAMELY GAMING MACHINES, VIDEO SLOT MACHINES, ENTERTAINMENT AND CASINO GAMING EQUIPMENT, NAMELY SLOT MACHINES AND PARTS THEREFORE, GAME SYMBOL CYLINDERS FOR SLOT MACHINES; DROP-DOWN CAROUSELS FOR SLOT MACHINES AND GAMING MACHINES; TV MONITORS, LCD-DISPLAY MONITORS, ALL FOR GAMBLING MACHINES; ELECTRONIC CASINO GAME MACHINES; ELECTRIC AND ELECTRONIC

GAMING AND GAMBLING MACHINES; BETTING MACHINES; COMPUTER GAME CASSETTES AND CARTRIDGES FOR ELECTRONIC POCKET GAMES VIDEO GAME MACHINES FOR USE WITH TELEVISION; PRERECORDED DATA CARRIERS PROGRAMMED FOR ELECTRONIC VIDEO AND AUDIO DISPLAY FOR PLAYING ELECTRONIC GAMES GAME, IN CLASS 9 (U.S. CLS. 21, 23, 26, 36 AND 38).

FOR: ELECTRIC AND ELECTRONIC STAND ALONE VIDEO MACHINES FEATURING GAMES-, AMUSEMENT AND SPORTS-AND ENTERTAINMENT ALL FOR USE INDIVIDUALLY OR AS A NETWORK, COIN-OPERATED STAND ALONE COMPACT VIDEO GAME SPORTS MACHINES; HANDHELD UNIT FOR PLAYING ELECTRONIC GAMES NAMELY COMPACT SPORTS MACHINES FOR PLAYING IN SMALL AREAS, NAMELY, DARTS, TABLE SOCCER, POOL-BILLIARD, SNOOKER, SHOOTING GALLERIES, PINBALL GAMES; HAND HELD CONSOLES FOR ELECTRONIC GAMES, ELECTRONIC PARLOR GAMES, VIDEO GAMES AND INSTRUMENTS, NAMELY HANDHELD UNIT FOR PLAYING VIDEO GAMES, STAND ALONE VIDEO GAME MACHINES, IN CLASS 28 (U.S. CLS. 22, 23, 38 AND 50).

THE MARK CONSISTS OF STANDARD CHARACTERS WITHOUT CLAIM TO ANY PARTICULAR FONT, STYLE, SIZE, OR COLOR.

PRIORITY CLAIMED UNDER SEC. 44(D) ON ERPN CMNTY TM OFC APPLICATION NO. 003574001, FILED 12-5-2003, REG. NO. 003574001, DATED 6-10-2005, EXPIRES 12-5-2013.



SER. NO. 78-364,660, FILED 2-9-2004.

DAWN HAN, EXAMINING ATTORNEY

**Int. Cl.: 9**

**Prior U.S. Cls.: 21, 23, 26, 36 and 38**

**United States Patent and Trademark Office**

**Reg. No. 3,394,795**

**Registered Mar. 11, 2008**

**TRADEMARK  
PRINCIPAL REGISTER**



METRO-GOLDWYN-MAYER STUDIOS INC. (DE-  
LAWARE CORPORATION)  
SUITE 7018  
10250 CONSTELLATION BLVD.  
LOS ANGELES, CA 900676241

FOR: MOTION PICTURE FILMS FEATURING  
ENTERTAINMENT, NAMELY, COMEDY, DRAMA,  
ANIMATION, ROMANCE AND/OR ACTION/AD-  
VENTURE; PRE-RECORDED AUDIO AND VIDEO  
TAPES, VIDEO DISCS AND DVDS FEATURING  
ENTERTAINMENT, NAMELY, COMEDY, DRAMA,  
ANIMATION, ROMANCE, AND/OR ACTION/AD-

VENTURE; AND MUSICAL SOUND RECORDINGS,  
IN CLASS 9 (U.S. CLS. 21, 23, 26, 36 AND 38).

FIRST USE 4-24-2001; IN COMMERCE 4-24-2001.

OWNER OF U.S. REG. NOS. 1,647,246 AND  
2,773,761.

SER. NO. 78-378,729, FILED 3-4-2004.

BENJAMIN OKEKE, EXAMINING ATTORNEY

**Int. Cls.: 2, 16, 20, 35, 36, 39 and 41**

**Prior U.S. Cls.: 2, 5, 6, 11, 13, 16, 22, 23, 25, 29, 32, 37, 38, 50, 100, 101, 102, 105 and 107**

**Reg. No. 3,394,796**

**United States Patent and Trademark Office**

**Registered Mar. 11, 2008**

**TRADEMARK  
SERVICE MARK  
PRINCIPAL REGISTER**

# NATIONAL TRUST

NATIONAL TRUST FOR HISTORIC PRESERVATION IN THE UNITED STATES (UNITED STATES FEDERALLY CHARTERED CORPORATION)

1785 MASSACHUSETTS AVENUE, N.W.  
WASHINGTON, DC 20036

FOR: PAINTS, NAMELY, HOUSE PAINT, EXTERIOR PAINT, AND INTERIOR PAINT, IN CLASS 2 (U.S. CLS. 6, 11 AND 16).

FIRST USE 4-30-2001; IN COMMERCE 4-30-2001.

FOR: PRINTED PUBLICATIONS, NAMELY, NEWSLETTERS, BOOKS AND PAMPHLETS IN THE FIELD OF HISTORIC PRESERVATION, ARCHITECTURE, ECONOMIC DEVELOPMENT AND DESIGN; GUIDE BOOKS IN THE AREAS OF TRAVEL, ARCHITECTURE, HISTORICAL PRESERVATION, AND POINTS OF CULTURAL AND HISTORICAL INTEREST; COOKBOOKS; DIRECTORIES OF HISTORIC BUILDINGS, IN CLASS 16 (U.S. CLS. 2, 5, 22, 23, 29, 37, 38 AND 50).

FIRST USE 12-31-1949; IN COMMERCE 12-31-1949.

FOR: FURNITURE, IN CLASS 20 (U.S. CLS. 2, 13, 22, 25, 32 AND 50).

FIRST USE 5-31-1998; IN COMMERCE 5-31-1998.

FOR: BUSINESS MANAGEMENT SERVICES, NAMELY, CONSULTING WITH COMMUNITY REVITALIZATION ORGANIZATIONS TO HELP THEM WORK MORE EFFECTIVELY AND EFFICIENTLY AND TO HELP COMMUNITIES ACHIEVE ECONOMIC AND SOCIAL CHANGE; ASSOCIATION SERVICES, NAMELY, PROMOTING THE INTERESTS OF ENVIRONMENTAL ORGANIZATIONS, LAND USE PLANNING ORGANIZATIONS, HEALTH AND SAFETY ORGANIZATIONS, HISTORIC AND CULTURAL PRESERVATION ORGA-

NIZATIONS, AND THOSE ORGANIZATIONS THAT ASSIST COMMUNITIES IN ACHIEVING ECONOMIC AND SOCIAL CHANGE, IN CLASS 35 (U.S. CLS. 100, 101 AND 102).

FIRST USE 12-31-1980; IN COMMERCE 12-31-1980.

FOR: INSURANCE BROKERAGE IN THE FIELD OF HOME REPLACEMENT COST COVERAGE INSURANCE, IN CLASS 36 (U.S. CLS. 100, 101 AND 102).

FIRST USE 1-31-2001; IN COMMERCE 1-31-2001.

FOR: TRAVEL SERVICES, NAMELY, TRAVEL INFORMATION SERVICES; AND TRAVEL GUIDE SERVICES, IN CLASS 39 (U.S. CLS. 100 AND 105).

FIRST USE 12-31-1970; IN COMMERCE 12-31-1970.

FOR: RECOGNIZING OVERALL ACHIEVEMENT IN COMMERCIAL DISTRICT REVITALIZATION THROUGH PROVISION OF AWARDS AND PUBLIC RECOGNITION; EDUCATIONAL SERVICES, NAMELY, CONDUCTING SEMINARS TO ASSIST LOCAL COMMUNITIES IN THE ECONOMIC DEVELOPMENT, REVITALIZATION AND HISTORIC PRESERVATION OF DOWNTOWN COMMERCIAL AREAS; DEVELOPMENT AND DISSEMINATION OF EDUCATIONAL MATERIALS RELATING TO HISTORIC BUILDINGS; PROVIDING INCENTIVES TO PEOPLE AND ORGANIZATIONS TO DEMONSTRATE EXCELLENCE IN THE FIELD OF PRESERVATION OF HISTORIC HOMES THROUGH THE ISSUANCE OF AWARDS, IN CLASS 41 (U.S. CLS. 100, 101 AND 107).

FIRST USE 12-31-1949; IN COMMERCE 12-31-1949.

THE MARK CONSISTS OF STANDARD CHARACTERS WITHOUT CLAIM TO ANY PARTICULAR FONT, STYLE, SIZE, OR COLOR.

OWNER OF U.S. REG. NOS. 2,631,873 AND  
2,659,539.

SER. NO. 78-392,209, FILED 3-29-2004.

SEC. 2(F).

TINA L. SNAPP, EXAMINING ATTORNEY

**Int. Cl.: 42**

**Prior U.S. Cls.: 100 and 101**

**United States Patent and Trademark Office**

**Reg. No. 3,394,797**

**Registered Mar. 11, 2008**

**SERVICE MARK  
PRINCIPAL REGISTER**

**SPAMINATOR**

NETWAVE TECHNOLOGIES, INC. (NEW YORK  
CORPORATION)  
5TH FLOOR  
25 BROADWAY  
NEW YORK, NY 10004

FOR: COMPUTER SERVICES, NAMELY, PROVIDING MONITORING AND FILTERING SERVICES TO DISTINGUISH BETWEEN SOLICITED AND UNSOLICITED ELECTRONIC MAIL MESSAGES ON A GLOBAL INTERACTIVE COMPUTER NETWORK, IN CLASS 42 (U.S. CLS. 100 AND 101).

FIRST USE 4-15-2004; IN COMMERCE 5-19-2004.

THE MARK CONSISTS OF STANDARD CHARACTERS WITHOUT CLAIM TO ANY PARTICULAR FONT, STYLE, SIZE, OR COLOR.

SER. NO. 78-427,410, FILED 5-29-2004.

KEVON CHISOLM, EXAMINING ATTORNEY

**Int. Cl.: 35**

**Prior U.S. Cls.: 100, 101 and 102**

**United States Patent and Trademark Office**

**Reg. No. 3,394,798**

**Registered Mar. 11, 2008**

---

**SERVICE MARK  
PRINCIPAL REGISTER**

**SHOP IN THE NAME  
OF LOVE**

MACY'S, INC. (DELAWARE CORPORATION)  
7 WEST SEVENTH STREET  
CINCINNATI, OH 45202

THE MARK CONSISTS OF STANDARD CHAR-  
ACTERS WITHOUT CLAIM TO ANY PARTICULAR  
FONT, STYLE, SIZE, OR COLOR.

FOR: RETAIL DEPARTMENT STORE SERVICES,  
IN CLASS 35 (U.S. CLS. 100, 101 AND 102).

SER. NO. 78-481,489, FILED 9-10-2004.

FIRST USE 1-1-2004; IN COMMERCE 1-1-2004.

DANIEL BRODY, EXAMINING ATTORNEY

Int. Cls.: 3 and 24

Prior U.S. Cls.: 1, 4, 6, 42, 50, 51 and 52

United States Patent and Trademark Office

Reg. No. 3,394,799

Registered Mar. 11, 2008

TRADEMARK  
PRINCIPAL REGISTER



ETABLISSEMENTS MARIUS FABRE JEUNE  
(FRANCE CORPORATION)  
148 AVENUE PAUL BOURRET  
SALON DE PROVENCE, FRANCE 13116

FOR: BLEACHING PREPARATIONS FOR COSMETIC PURPOSES, BLEACHING PREPARATIONS FOR CLOTHES, WASHING POWDER, SOAPS FOR PERSONAL USE, HOUSEHOLD SOAP, TOILET SOAP, SHAMPOO, SHOWER GEL, SHOWER CREAM, BATH CREAM, BATH SALTS, SHAVING CREAM, SHAVING SOAP, POLISHING PREPARATIONS, LIQUID SCOURING, PERFUMES, ESSENTIAL OILS FOR COSMETIC PURPOSE, ESSENTIAL OILS FOR PERSONAL USE, PERFUMED WATER FOR IRONING, COSMETICS, HAIR CARE CONDITIONERS, TOOTH PASTES, DEPILATORIES, MAKE-UP REMOVERS, LIPSTICKS, BEAUTY MASKS, IN CLASS 3 (U.S. CLS. 1, 4, 6, 50, 51 AND 52).

FOR: TOWELS AND WASH CLOTHS, BED SHEETS, TEXTILE NAPKINS, BED LINENS, AND BATH LINENS, IN CLASS 24 (U.S. CLS. 42 AND 50).

OWNER OF FRANCE REG. NO. 033212221, DATED 2-27-2003, EXPIRES 2-27-2013.

NO CLAIM IS MADE TO THE EXCLUSIVE RIGHT TO USE "DEPUIS 1900", APART FROM THE MARK AS SHOWN.

THE NAME SHOWN IN THE MARK DOES NOT IDENTIFY A PARTICULAR LIVING INDIVIDUAL.

THE COLORS LIGHT BLUE, DARK BLUE, GOLD AND WHITE ARE CLAIMED AS FEATURES OF THE MARK.

THE MARK CONSISTS OF THE GOLD WORDING "LES MILLE ET UN BAINS" AND A PATTERNED DESIGN IN GOLD AGAINST A DARK BLUE BACKGROUND, BENEATH THE WORDING "LES MILLE ET UN BAINS" IS "MARIUS FABRE" AND "DEPUIS 1900" IN THE COLOR WHITE; ALL WORDING IS LOCATED INSIDE OF A DESIGN IN LIGHT BLUE WITH A WHITE OUTLINE ON THE EDGE OF THE DESIGN AND FOUR DOTS IN WHITE; OUTSIDE OF THE LIGHT BLUE DESIGN ARE FOUR CRESCENTS ADJACENT TO THE DOTS IN THE COLOR WHITE.

THE FOREIGN WORDING IN THE MARK TRANSLATES INTO ENGLISH AS A THOUSAND AND ONE BATHS; SINCE 1900.

SER. NO. 78-483,401, FILED 9-14-2004.

CHRISTOPHER BUONGIORNO, EXAMINING ATTORNEY

**Int. Cl.: 32**

**Prior U.S. Cls.: 45, 46 and 48**

**United States Patent and Trademark Office**

**Reg. No. 3,394,800**

**Registered Mar. 11, 2008**

**TRADEMARK  
PRINCIPAL REGISTER**

**THE EDGE OF THE  
WORLD**

MH WATERS PTY LTD (AUSTRALIA CORPORATION)  
8 TUNKS STREET  
WAVERTON, NSW 2060, AUSTRALIA

FOR: CARBONATED AND NON-CARBONATED  
WATER; BOTTLED WATER; FLAVORED WATER,  
IN CLASS 32 (U.S. CLS. 45, 46 AND 48).

FIRST USE 8-22-2006; IN COMMERCE 8-22-2006.

THE MARK CONSISTS OF STANDARD CHARACTERS WITHOUT CLAIM TO ANY PARTICULAR FONT, STYLE, SIZE, OR COLOR.

OWNER OF AUSTRALIA REG. NO. 1007020,  
DATED 6-18-2004, EXPIRES 6-18-2014.

SER. NO. 78-489,335, FILED 9-24-2004.

KIMBERLY FRYE, EXAMINING ATTORNEY



Int. Cl.: 9

Prior U.S. Cls.: 21, 23, 26, 36 and 38

United States Patent and Trademark Office

Reg. No. 3,394,801

Registered Mar. 11, 2008

TRADEMARK  
PRINCIPAL REGISTER

SpaRing

SUNPLUS TECHNOLOGY CO., LTD. (TAIWAN CORPORATION)  
1, SCIENCE-BASED INDUSTRIAL PARK  
19, INNOVATION ROAD  
HSIN-CHU, TAIWAN

FOR: AUDIO PROCESSOR FOR ELECTRONIC SOUND; SOUND EFFECTS GENERATOR; MIDI RECORDER; COMPUTER SOFTWARE FOR THE MOBILE, MULTIMEDIA AND BROADCAST INDUSTRIES USED FOR THE PURPOSE OF PROCESSING AND ENCODING DIGITAL MEDIA, NAMELY, MIDI, AUDIO, VIDEO AND DATA, FROM ONE ANALOG OR DIGITAL FORMAT TO OTHER DIGITAL FORMATS AND STREAMS; DOWNLOADABLE COMPUTER SOFTWARE FOR THE MOBILE, MULTIMEDIA AND BROADCAST INDUSTRIES USED FOR THE PURPOSE OF PROCESSING AND ENCODING DIGITAL MEDIA, NAMELY, MIDI, AUDIO, VIDEO AND DATA,

FROM ONE ANALOG OR DIGITAL FORMAT TO OTHER DIGITAL FORMATS AND STREAMS; LARGE SCALE INTEGRATION CHIPS; SOFTWARE FOR DOWNLOADABLE COMPUTER MELODIES FOR SIGNALING AN INCOMING CALL OF CELLULAR PHONES; SOFTWARE FOR DOWNLOADABLE AUTOMATICALLY INSPECTING DIGITAL CONTENTS SUCH AS VIDEO AND SOUND INFORMATION, SOUND, MUSIC, IMAGES, CHARACTER INFORMATION AND WORDS FILES, IN CLASS 9 (U.S. CLS. 21, 23, 26, 36 AND 38).

OWNER OF TAIWAN REG. NO. 01153791, DATED 5-16-2005, EXPIRES 5-15-2015.

SER. NO. 78-493,291, FILED 10-1-2004.

KAPIL BHANOT, EXAMINING ATTORNEY

**Int. Cls.: 11, 35 and 37**

**Prior U.S. Cls.: 13, 21, 23, 31, 34, 100, 101, 102, 103  
and 106**

**Reg. No. 3,394,802**

**United States Patent and Trademark Office**

**Registered Mar. 11, 2008**

**TRADEMARK  
SERVICE MARK  
PRINCIPAL REGISTER**



VENMAR VENTILATION INC. (CANADA CORPORATION)  
550, BOUL. LEMIRE  
DRUMMONDVILLE, QUEBEC, CANADA J2C 7W9

FOR: TURBO VENTILATION UNITS FOR DOMESTIC AND COMMERCIAL USE; AIR EXCHANGERS FOR CLEANING AND PURIFICATION OF AIR; HEAT EXCHANGERS, HEAT RECOVERY VENTILATORS, APARTMENT VENTILATORS, STOVE VENTILATION HOODS, BATHROOM HEATERS, WALL-MOUNTED HEATERS AND TURBINE DRIVEN VENTILATION FANS; AND INTEGRATED HEATING SYSTEMS COMPRISED OF HEAT EXCHANGERS, HEAT RECOVERY VENTILATORS, STOVE VENTILATION HOODS, BATHROOM HEATERS, WALL-MOUNTED HEATERS, AND TURBINE DRIVEN VENTILATION FANS, IN CLASS 11 (U.S. CLS. 13, 21, 23, 31 AND 34).

FOR: DISTRIBUTORSHIP SERVICES AND RETAIL STORE SERVICES FEATURING AIR EXCHANGERS, HEAT EXCHANGERS, HEAT RECOVERY VENTILATORS, APARTMENT VENTILATORS, STOVE VENTILATION HOODS, BATHROOM HEATERS, WALL-MOUNTED HEATERS,

TURBINES, AND INTEGRATED HEATING SYSTEMS, IN CLASS 35 (U.S. CLS. 100, 101 AND 102).

FOR: INSTALLATION OF AIR EXCHANGERS, HEAT EXCHANGERS, HEAT RECOVERY VENTILATORS, APARTMENT VENTILATORS, STOVE VENTILATION HOODS, BATHROOM HEATERS, WALL-MOUNTED HEATERS, TURBINES, AND INTEGRATED HEATING SYSTEMS, IN CLASS 37 (U.S. CLS. 100, 103 AND 106).

PRIORITY CLAIMED UNDER SEC. 44(D) ON CANADA APPLICATION NO. 1231322, FILED 9-23-2004, REG. NO. TMA663,973, DATED 5-10-2006, EXPIRES 9-23-2014.

NO CLAIM IS MADE TO THE EXCLUSIVE RIGHT TO USE "INDOOR" AND "NETWORK", APART FROM THE MARK AS SHOWN.

THE MARK CONSISTS OF THE WORDS INDOOR AIR NETWORK WITH AN ARBITRARY DESIGN.

SER. NO. 78-493,741, FILED 10-4-2004.

KEVIN DINALLO, EXAMINING ATTORNEY

**Int. Cls.: 18, 25, 26 and 28**

**Prior U.S. Cls.: 1, 2, 3, 22, 23, 37, 38, 39, 40, 41, 42 and 50**

**Reg. No. 3,394,803**

**United States Patent and Trademark Office**

**Registered Mar. 11, 2008**

**TRADEMARK  
PRINCIPAL REGISTER**



JAFER LIMITED (BERMUDA CORPORATION)  
CLARENDON HOUSE, 2 CHURCH STREET  
HAMILTON, HM12, BERMUDA

FOR: (BASED PERU REGISTRATION 161799)HOUSE MARK FOR USE IN CONNECTION WITH ALL OF THE FOLLOWING GOODS- ATHLETIC BAGS, ATTACHÉ CASES, BABY BACKPACKS, SPORTS BAGS, BEACH BAGS, CARRY-ON BAGS, CLUTCH BAGS, DIAPER BAGS, GYM BAGS, LEATHER BAGS, SCHOOL BAGS, TRAVEL BAGS, BAGS, SHOULDER BAGS, BRIEFCASES, COSMETIC CASES SOLD EMPTY, HANDBAGS, HUNTING BAGS, LEATHER SOLD IN BULK, IMITATION LEATHER SOLD IN BULK, LUGGAGE, STRAPS FOR LUGGAGE, LUGGAGE CARTS, LUGGAGE TAGS, OVERNIGHT BAGS, SHOPPING BAGS, SHOULDER BAGS, SUITCASES, WAIST BAGS, WALLETS, TOTE BAGS, EVENING BAGS, LEATHER KEY CHAINS, COIN PURSES, AND BUSINESS CARD CASES, IN CLASS 18 (U.S. CLS. 1, 2, 3, 22 AND 41).

FOR: (BASED PERU REGISTRATION 161800) HOUSE MARK FOR USE IN CONNECTION WITH ALL OF THE FOLLOWING GOODS- PANTIES, PANTS, BALLOON PANTS, SKI PANTS, SNOW PANTS, SWEATPANTS, TAP PANTS, PANTSUITS, PANTYHOSE, POLO SHIRTS, PONCHOS, PULL-OVERS, RAINWEAR, SHIRTS, SHOES, SHORTS, UNDERSHIRTS, NIGHT SHIRTS, GOLF SHIRTS, KNIT SHIRTS, SHOULDER PADS FOR CLOTHING, SHOWER CAPS, SKIRTS, SLEEPWEAR, SOCKS, STOCKINGS, STOLEs, SUITS, SWEATSHIRTS, SWEATERS, SWEAT SOCKS, BATHING SUITS, SWIMSUITS, T-SHIRTS, TANGAS, BOW TIES, TIES, SWIM TRUNKS, BATHING TRUNKS, UNDERPANTS, UNDERWEAR, V-NECK SWEATERS, VESTED SUITS, VESTS, WET SUITS, WARM-UP SUITS, GYM SUITS, JOGGING SUITS, PLAY SUITS, BEACH COVER-UPS, BEACHWEAR, BED JACKETS, BELTS, BIKINIS, BLAZERS, BLOOMERS, BLOUSES, BODY

SHAPERS, BODY SUITS, BOXER SHORTS, BRAS, BRASSIERES, CAMISOLES, CAPS, CHEMISES, COATS, FUR COATS, LAB COATS, LEATHER COATS, OVERCOATS, RAINCOATS, SPORT COATS, SUIT COATS, TOPCOATS, GLOVES, GYM SHORTS, HATS, TENNIS WEAR, TROUSERS, INFANT WEAR, JACKETs, FUR JACKETs, LEATHER JACKETs, WIND-RESISTANT JACKETs, JEANS, JERSEYS, JUMPERS, MONEY BELTS, NEGLIGEEs AND PAJAMAS, IN CLASS 25 (U.S. CLS. 22 AND 39).

FOR: (BASED PERU REGISTRATION 161801) HOUSE MARK FOR USE IN CONNECTION WITH ALL OF THE FOLLOWING GOODS- LACE AND EMBROIDERY, RIBBONS AND BRAID; BUTTONS FOR CLOTHING, HOOKS AND EYES, SAFETY PINS AND BOBBY PINS, AND NEEDLES; ARTIFICIAL FLOWERS, IN CLASS 26 (U.S. CLS. 37, 39, 40, 42 AND 50).

FOR: (BASED PERU REGISTRATION 161802) HOUSE MARK FOR USE IN CONNECTION WITH THE FOLLOWING GOODS- TOYS, NAMELY, WOODEN TRUCKS, WOODEN BLOCKS, WOODEN DOLLS; WOODEN CARS; WOODEN BALLS, PLUSH TOYS, SPORT BALLS, PLASTIC PLAYGROUND BALLS, PLASTIC DOLLS, PLASTIC TOY TRUCKS, PLASTIC BLOCKS, PLASTIC CARS, PLASTIC CHARACTER TOYS; BOARD GAMES; DECORATIONS FOR CHRISTMAS TREES, IN CLASS 28 (U.S. CLS. 22, 23, 38 AND 50).

OWNER OF PERU REG. NO. 161802, DATED 12-2-2002, EXPIRES 12-2-2012.

OWNER OF PERU REG. NO. 161801, DATED 12-2-2002, EXPIRES 12-2-2012.

OWNER OF PERU REG. NO. 161800, DATED 12-2-2002, EXPIRES 12-2-2012.

OWNER OF PERU REG. NO. 161799, DATED 12-2-2002, EXPIRES 12-2-2012.

OWNER OF U.S. REG. NO. 1,241,758.

THE COLOR(S) ORANGE, RED AND WHITE IS/ARE CLAIMED AS A FEATURE OF THE MARK.

THE MARK CONSISTS OF AN ORANGE RECTANGLE WITH A RED SLASH WITH THE WORD YANBAL IN WHITE LETTERING.

SER. NO. 78-496,489, FILED 10-7-2004.

BRIDGETT SMITH, EXAMINING ATTORNEY

**Int. Cls.: 9 and 28**

**Prior U.S. Cls.: 21, 22, 23, 26, 36, 38 and 50**

**United States Patent and Trademark Office**

**Reg. No. 3,394,804**

**Registered Mar. 11, 2008**

**TRADEMARK  
PRINCIPAL REGISTER**

**MONEY MAGNET**

ATRONIC INTERNATIONAL GMBH (FED REP  
GERMANY CORPORATION)  
BORSIGSTR. 26  
32312 LÜBBECKE, FED REP GERMANY

FOR: ELECTRIC AND ELECTRONIC APPARATUS, INSTRUMENTS, DEVICES AND MACHINES NAMELY, COIN OPERATED MACHINES AND MACHINES OPERABLE WITH BILLS, MAGNETIC CARDS, COMPUTER CHIPS, MICRO-PROCESSOR DEVICES AND TOKENS NAMELY GAMING AND GAMBLING MACHINES; MECHANISMS FOR COIN OPERATED AND COIN CONTROLLED MACHINES, NAMELY MECHANICAL UNITS FOR DISPENSING COINS; COIN, CURRENCY AND TOKEN-CONTROLLED GAMING AND GAMBLING MACHINES; COMPUTERS FOR BILLING OPERATIONS OF COIN-OPERATED MACHINES AND COMPUTER HARDWARE AND SOFTWARE THEREFOR; COMPUTER DATA PRINTER FOR DISPLAYING TOTAL WINNINGS ON THE FRONT OF GAMING MACHINES; ELECTRONIC CIRCUIT BOARDS; MONEY CHANGE MACHINES; VENDING MACHINES THAT PROVIDE TOKENS, COUPONS AND GAME CARDS; SLOT MACHINES WITH OR WITHOUT VIDEO OUTPUT; REPLACEMENT PARTS FOR SLOT MACHINES AND GAMING MACHINES; DROP-DOWN CAROUSELS FOR SLOT MACHINES AND GAMING MACHINES, NAMELY HOPPERS; TV MONITORS AND LCD-DISPLAY MONITORS FOR GAMING AND GAMBLING MACHINES; COMPUTER GAME CASSETTES AND CARTRIDGES FOR ELECTRONIC POCKET GAMES VIDEO GAME MACHINES FOR USE WITH TELEVISION; PRERECORDED MAGNETIC DATA CARRIERS PROGRAMMED FOR ELECTRONIC VIDEO

AND AUDIO DISPLAY FOR PLAYING ELECTRONIC GAMES, IN CLASS 9 (U.S. CLS. 21, 23, 26, 36 AND 38).

FOR: ELECTRIC AND ELECTRONIC STAND ALONE VIDEO MACHINES FEATURING GAMES-, AMUSEMENT AND SPORTS-AND ENTERTAINMENT ALL FOR USE INDIVIDUALLY OR AS A NETWORK, COIN-OPERATED STAND ALONE COMPACT VIDEO GAME SPORTS MACHINES; HANDHELD UNIT FOR PLAYING ELECTRONIC GAMES NAMELY COMPACT SPORTS MACHINES FOR PLAYING IN SMALL AREAS, NAMELY, DARTS, TABLE SOCCER, POOL-BILLIARD, SNOOKER, SHOOTING GALLERIES, PINBALL GAMES; HAND HELD CONSOLES FOR ELECTRONIC GAMES, ELECTRONIC PARLOR GAMES, VIDEO GAMES AND INSTRUMENTS, NAMELY HANDHELD UNIT FOR PLAYING VIDEO GAMES, STAND ALONE VIDEO GAME MACHINES, IN CLASS 28 (U.S. CLS. 22, 23, 38 AND 50).

THE MARK CONSISTS OF STANDARD CHARACTERS WITHOUT CLAIM TO ANY PARTICULAR FONT, STYLE, SIZE, OR COLOR.

PRIORITY CLAIMED UNDER SEC. 44(D) ON ERPN CMNTY TM OFC APPLICATION NO. 004125399, FILED 11-19-2004, REG. NO. 004125399, DATED 1-25-2006, EXPIRES 11-19-2014.

SER. NO. 78-522,558, FILED 11-24-2004.

DAWN FELDMAN, EXAMINING ATTORNEY

**Int. Cl.: 16**

**Prior U.S. Cls.: 2, 5, 22, 23, 29, 37, 38 and 50**

**United States Patent and Trademark Office**

**Reg. No. 3,394,805**

**Registered Mar. 11, 2008**

**TRADEMARK  
PRINCIPAL REGISTER**

**SOFT STUFF**

EARLY LEARNING CENTRE LIMITED (UNITED  
KINGDOM LTD LIAB CO)  
SOUTH MARSTON INDUSTRIAL PARK  
SWINDON, UNITED KINGDOM SN3 4TJ

FOR: MODELING CLAY; PAINT BRUSHES;  
DRAWING BOARDS AND EASELS; STENCILS, IN  
CLASS 16 (U.S. CLS. 2, 5, 22, 23, 29, 37, 38 AND 50).

THE MARK CONSISTS OF STANDARD CHAR-  
ACTERS WITHOUT CLAIM TO ANY PARTICULAR  
FONT, STYLE, SIZE, OR COLOR.

OWNER OF UNITED KINGDOM REG. NO.  
2111922, DATED 5-16-1997, RENEWED AS REG. NO.  
2111922, DATED 5-16-2006, EXPIRES 10-5-2016.

OWNER OF U.S. REG. NO. 2,885,250.

NO CLAIM IS MADE TO THE EXCLUSIVE  
RIGHT TO USE "SOFT", APART FROM THE MARK  
AS SHOWN.

SER. NO. 78-536,520, FILED 12-21-2004.

JASON LOTT, EXAMINING ATTORNEY

**Int. Cl.: 9**

**Prior U.S. Cls.: 21, 23, 26, 36 and 38**

**United States Patent and Trademark Office**

**Reg. No. 3,394,806**

**Registered Mar. 11, 2008**

**TRADEMARK  
PRINCIPAL REGISTER**

**MAGELLAN**

PERFORMANCE MOTION DEVICES, INC. (MAS-  
SACHUSETTS CORPORATION)  
55 OLD BEDFORD ROAD  
LINCOLN, MA 01773

FOR: INTEGRATED CIRCUITS FOR MOTION  
CONTROL; COMPUTER SOFTWARE PROGRAM  
FOR USE IN ELECTRONIC MOTION CONTROL  
PROGRAMMING; APPLICATION PROGRAM IN-  
TERFACE SOFTWARE FOR DEVELOPING APPLI-  
CATIONS FOR MOTION CONTROL INTEGRATED  
CIRCUITS; ALL FOR USE IN THE MOTION CON-  
TROL INDUSTRY FOR USE IN THE FIELDS OF  
MEDICAL, SCIENTIFIC, ROBOTICS, AND INDUS-

TRIAL AUTOMATION, IN CLASS 9 (U.S. CLS. 21, 23,  
26, 36 AND 38).

FIRST USE 11-10-2003; IN COMMERCE 11-10-2003.

THE MARK CONSISTS OF STANDARD CHAR-  
ACTERS WITHOUT CLAIM TO ANY PARTICULAR  
FONT, STYLE, SIZE, OR COLOR.

SER. NO. 78-544,989, FILED 1-10-2005.

ANDREA K. NADELMAN, EXAMINING ATTOR-  
NEY

**Int. Cl.: 34**

**Prior U.S. Cls.: 2, 8, 9 and 17**

**United States Patent and Trademark Office**

**Reg. No. 3,394,807**

**Registered Mar. 11, 2008**

**TRADEMARK  
PRINCIPAL REGISTER**



DAILY, DAVID R. (UNITED STATES INDIVIDUAL)  
2306 JOEL WHEATON  
HOUSTON, TX 77077

THE MARK IS A BLACK AND BLUE OUTLINED OVAL CONTAINING THE WORD "GRAVITRON", WITH THE LETTERS "GRVTON" IN BLACK AND THE LETTERS "AIR" IN BLUE.

FOR: PIPES USED FOR SMOKING TOBACCO, IN CLASS 34 (U.S. CLS. 2, 8, 9 AND 17).

FIRST USE 5-15-2004; IN COMMERCE 5-31-2004.

SER. NO. 78-557,965, FILED 2-1-2005.

THE COLOR(S) BLUE AND BLACK IS/ARE CLAIMED AS A FEATURE OF THE MARK.

TARAH HARDY, EXAMINING ATTORNEY



**Int. Cls.: 3, 14, 16, 18, 19, 20, 21, 24, 25, 27, 42 and 44**

**Prior U.S. Cls.: 1, 2, 3, 4, 5, 6, 12, 13, 19, 20, 22, 23, 25, 27, 28, 29, 30, 32, 33, 37, 38, 39, 40, 41, 42, 50, 51, 52, 100 and 101**

**Reg. No. 3,394,808**

**United States Patent and Trademark Office**

**Registered Mar. 11, 2008**

**TRADEMARK  
SERVICE MARK  
PRINCIPAL REGISTER**

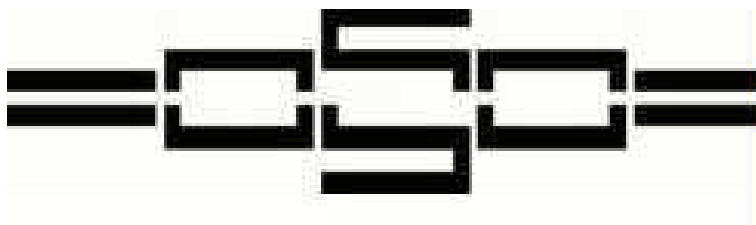

LEVENE, HARRY (UNITED KINGDOM INDIVIDUAL)  
ASC STUDIOS  
1-5 VYNER STREET  
LONDON, UNITED KINGDOM E2 9DG

FOR: PERFUMES, COLOGNES AND FRAGRANCES FOR PERSONAL USE, COSMETICS AND HAIR LOTIONS, IN CLASS 3 (U.S. CLS. 1, 4, 6, 50, 51 AND 52).

FOR: PRECIOUS METALS AND THEIR ALLOYS; JEWELRY; PRECIOUS STONES; HOROLOGICAL AND CHRONOMETRIC INSTRUMENTS, IN CLASS 14 (U.S. CLS. 2, 27, 28 AND 50).

FOR: PAPER, CARDBOARD AND GOODS MADE FROM THESE MATERIALS, NAMELY, GREETINGS CARDS, POSTCARDS, POSTERS, FLYERS, WRAPPING PAPER, PRINTS OF ARTWORK AND INVITATIONS; PRINTED MATTER, NAMELY, BOOKS, MAGAZINES, NEWSLETTERS, JOURNALS, PAMPHLETS, CATALOGUES, BROCHURES AND ADVERTISING MATERIALS IN THE FIELD OF ART, ART HISTORY, DESIGN, DESIGN HISTORY AND ARTWORK; BOOKBINDINGS; PHOTOGRAPHS; STATIONERY; ADHESIVES FOR STATIONERY OR HOUSEHOLD PURPOSES; PAINT BRUSHES; TYPEWRITERS; OFFICE REQUISITES, NAMELY, PENS, PENCILS, ERASERS, NOTEPAPER, DESK ORGANIZERS AND PEN-HOLDERS; INSTRUCTIONAL AND TEACHING MATERIAL, NAMELY, TEXTBOOKS IN THE FIELD OF ART, ART HISTORY, DESIGN, DESIGN HISTORY AND ARTWORK; PLASTIC BAGS FOR PACKAGING; PRINTER'S TYPE AND PRINTING BLOCKS; LEATHER BOOKBINDING, IN CLASS 16 (U.S. CLS. 2, 5, 22, 23, 29, 37, 38 AND 50).

FOR: SEMI-WORKED LEATHER; IMITATIONS OF LEATHER SOLD IN BULK; GOODS MADE OF LEATHER OR IMITATION LEATHER, NAMELY, LEATHER CASES, LEATHER BAGS, LEATHER PURSES AND LEATHER KEY CHAINS; ANIMAL SKINS; ANIMAL HIDES; LUGGAGE TRUNKS; TRAVELLING BAGS; UMBRELLAS; PARASOLS; WALKING STICKS; WHIPS; HARNESSES AND SADDLERY, IN CLASS 18 (U.S. CLS. 1, 2, 3, 22 AND 41).

FOR: CERAMIC TILES, EARTHENWARE TILES, GLASS TILES, TILES OF MARBLE, TILES OF PORCELAIN, TILES OF SLATE, IN CLASS 19 (U.S. CLS. 1, 12, 33 AND 50).

FOR: FURNITURE, MIRRORS, PICTURE FRAMES NOT OF PRECIOUS METAL, IN CLASS 20 (U.S. CLS. 2, 13, 22, 25, 32 AND 50).

FOR: KITCHEN AND HOUSEHOLD UTENSILS, NAMELY, SERVING FORKS, SERVING SPOONS AND CHOPSTICKS NOT MADE OF PRECIOUS METALS, WHISKS SPATULAS, ROLLING PINS, CUTTING BOARDS, SIEVES, COLANDERS; CONTAINERS FOR HOUSEHOLD OR KITCHEN USE NOT OF PRECIOUS METAL; COMBS; SPONGES FOR HOUSEHOLD PURPOSES; BRUSHES, NAMELY, HAIR BRUSHES, CLOTHES BRUSHES, SHOE BRUSHES, DISHWASHING BRUSHES AND TOOTH BRUSHES; STEEL WOOL FOR CLEANING; UNWORKED OR SEMIWORKED GLASS NOT FOR BUILDING; BEVERAGE GLASSWARE, IN CLASS 21 (U.S. CLS. 2, 13, 23, 29, 30, 33, 40 AND 50).

FOR: TEXTILES AND TEXTILE GOODS, NAMELY PAPER BED COVERS; TABLECLOTHS NOT OF PAPER; PRINTED FABRIC SIGNAGE PANELS; WO-

VEN LINEN FABRICS, SPUN SILK FABRICS AND KNITTED FABRICS , IN CLASS 24 (U.S. CLS. 42 AND 50).

FOR: CLOTHING AND HEADGEAR, NAMELY, T-SHIRTS, SHIRTS, WAISTCOATS, HATS, CAPS, SCARVES, TIES, GLOVES, SHORTS, TROUSERS, SWEATERS, JACKETS, RAINCOATS, UNDERWEAR, SOCKS AND FOOTWEAR; LEATHER BELTS, LEATHER SHOES, LEATHER JACKETS, LEATHER TROUSERS, LEATHER HATS, IN CLASS 25 (U.S. CLS. 22 AND 39).

FOR: CARPETS, RUGS, MATS AND MATTING, LINOLEUM FOR COVERING EXISTING FLOORS; NON-TEXTILE WALL HANGINGS AND WALLPAPER, IN CLASS 27 (U.S. CLS. 19, 20, 37, 42 AND 50).

FOR: ARCHITECTURAL DESIGN, IN CLASS 42 (U.S. CLS. 100 AND 101).

FOR: LANDSCAPE GARDENING DESIGN FOR OTHERS, IN CLASS 44 (U.S. CLS. 100 AND 101).

PRIORITY CLAIMED UNDER SEC. 44(D) ON ERPN CMNTY TM OFC APPLICATION NO. 004284485, FILED 2-11-2005, REG. NO. 004284485, DATED 3-8-2006, EXPIRES 2-11-2015.

SER. NO. 78-579,688, FILED 3-3-2005.

GIANCARLO CASTRO, EXAMINING ATTORNEY

**Int. Cls.: 35, 37, 40 and 42**

**Prior U.S. Cls.: 100, 101, 102, 103 and 106**

**United States Patent and Trademark Office**

**Reg. No. 3,394,809**

**Registered Mar. 11, 2008**

**SERVICE MARK  
PRINCIPAL REGISTER**

**ENSIL INNOVATION  
BEYOND  
IMAGINATION**

ENSILVER CORP. (CANADA CORPORATION)  
15 SABRINA COURT  
RICHMOND HILL, ONTARIO, CANADA

FOR: WHOLESALE DISTRIBUTORSHIP FEATURING CIRCUIT BOARDS AND ASSEMBLIES, ELECTRONIC EQUIPMENT AND COMPUTER SOFTWARE, IN CLASS 35 (U.S. CLS. 100, 101 AND 102).

FOR: MACHINERY MAINTENANCE AND REPAIR, NAMELY, REPAIR, REFURBISHING AND MODIFICATION OF ELECTRONIC EQUIPMENT, IN CLASS 37 (U.S. CLS. 100, 103 AND 106).

FOR: CUSTOM MANUFACTURING OF CIRCUIT BOARD AND ASSEMBLIES, IN CLASS 40 (U.S. CLS. 100, 103 AND 106).

FOR: DESIGN SERVICES FOR OTHERS, NAMELY, DESIGN OF CIRCUIT BOARDS AND ASSEMBLIES FOR OTHERS; CALIBRATION, INSPECTION,

TESTING, REPAIR, REFURBISHING AND MODIFICATION OF COMPUTER SOFTWARE; CALIBRATION, INSPECTION, AND TESTING OF ELECTRONIC EQUIPMENT, IN CLASS 42 (U.S. CLS. 100 AND 101).

THE MARK CONSISTS OF STANDARD CHARACTERS WITHOUT CLAIM TO ANY PARTICULAR FONT, STYLE, SIZE, OR COLOR.

PRIORITY CLAIMED UNDER SEC. 44(D) ON CANADA APPLICATION NO. 1247518, FILED 2-16-2005, REG. NO. TMA662531, DATED 4-11-2006, EXPIRES 4-11-2021.

OWNER OF U.S. REG. NOS. 2,728,522 AND 2,790,066.

SER. NO. 78-582,594, FILED 3-8-2005.

INGRID C. EULIN, EXAMINING ATTORNEY

**Int. Cl.: 8**

**Prior U.S. Cls.: 23, 28 and 44**

**United States Patent and Trademark Office**

**Reg. No. 3,394,810**

**Registered Mar. 11, 2008**

**TRADEMARK  
PRINCIPAL REGISTER**

**MANICURE-TO-GO**

REVLON CONSUMER PRODUCTS CORPORATION  
(DELAWARE CORPORATION)  
237 PARK AVENUE  
NEW YORK, NY 10017

THE MARK CONSISTS OF STANDARD CHARACTERS WITHOUT CLAIM TO ANY PARTICULAR FONT, STYLE, SIZE, OR COLOR.

FOR: MANICURE KITS CONSISTING PRIMARILY OF NAIL FILES, NAIL CLIPPERS, NON-ELECTRIC NAIL BUFFERS AND CUTICLE TRIMMERS, IN CLASS 8 (U.S. CLS. 23, 28 AND 44).

SER. NO. 78-583,539, FILED 3-9-2005.

FIRST USE 9-30-2003; IN COMMERCE 9-30-2003.

LINDA ESTRADA, EXAMINING ATTORNEY

**Int. Cl.: 5**

**Prior U.S. Cls.: 6, 18, 44, 46, 51 and 52**

**United States Patent and Trademark Office**

**Reg. No. 3,394,811**

**Registered Mar. 11, 2008**

**TRADEMARK  
PRINCIPAL REGISTER**

**ANCYRIX**

GLAXOSMITHKLINE BIOLOGICALS S.A. (BEL-  
GIUM CORPORATION)  
RUE DE L'INSTITUT  
RIXENSART, BELGIUM B-1330

PRIORITY CLAIMED UNDER SEC. 44(D) ON  
UNITED KINGDOM APPLICATION NO. 2383922,  
FILED 2-9-2005, REG. NO. 0776693, DATED 11-15-  
2005, EXPIRES 6-2-2015.

FOR: VACCINES FOR HUMAN USE, IN CLASS 5  
(U.S. CLS. 6, 18, 44, 46, 51 AND 52).

SER. NO. 78-587,407, FILED 3-15-2005.

THE MARK CONSISTS OF STANDARD CHAR-  
ACTERS WITHOUT CLAIM TO ANY PARTICULAR  
FONT, STYLE, SIZE, OR COLOR.

TASNEEM HUSSAIN, EXAMINING ATTORNEY

**Int. Cl.: 5**

**Prior U.S. Cls.: 6, 18, 44, 46, 51 and 52**

**United States Patent and Trademark Office**

**Reg. No. 3,394,812**

**Registered Mar. 11, 2008**

**TRADEMARK  
PRINCIPAL REGISTER**

**AMCYRIX**

GLAXOSMITHKLINE BIOLOGICALS S.A. (BEL-  
GIUM CORPORATION)  
RUE DE L'INSTITUT 89  
RIXENSART, BELGIUM B-1330

FOR: VACCINES FOR HUMAN USE, IN CLASS 5  
(U.S. CLS. 6, 18, 44, 46, 51 AND 52).

THE MARK CONSISTS OF STANDARD CHAR-  
ACTERS WITHOUT CLAIM TO ANY PARTICULAR  
FONT, STYLE, SIZE, OR COLOR.

PRIORITY CLAIMED UNDER SEC. 44(D) ON  
UNITED KINGDOM APPLICATION NO. 2383921,  
FILED 2-9-2005, REG. NO. 00776694, DATED 11-15-  
2006, EXPIRES 6-2-2015.

SER. NO. 78-587,502, FILED 3-15-2005.

TASNEEM HUSSAIN, EXAMINING ATTORNEY

**Int. Cl.: 35**

**Prior U.S. Cls.: 100, 101 and 102**

**United States Patent and Trademark Office**

**Reg. No. 3,394,813**

**Registered Mar. 11, 2008**

**SERVICE MARK  
PRINCIPAL REGISTER**

**INNOVA FINANCIAL**

IBARRA, RAFAEL, U (CALIFORNIA SOLE PROPRIETORSHIP)

2498 ROLL DR. #138 SAN DIEGO, CA 92154

SAN DIEGO, CA 92154

FOR: INCOME TAX PREPARATION AND CONSULTING, IN CLASS 35 (U.S. CLS. 100, 101 AND 102).

FIRST USE 3-1-2005; IN COMMERCE 3-1-2005.

THE MARK CONSISTS OF STANDARD CHARACTERS WITHOUT CLAIM TO ANY PARTICULAR FONT, STYLE, SIZE, OR COLOR.

NO CLAIM IS MADE TO THE EXCLUSIVE RIGHT TO USE "FINANCIAL", APART FROM THE MARK AS SHOWN.

SER. NO. 78-589,729, FILED 3-17-2005.

ESTHER A. BORSUK, EXAMINING ATTORNEY

**Int. Cl.: 9**

**Prior U.S. Cls.: 21, 23, 26, 36 and 38**

**United States Patent and Trademark Office**

**Reg. No. 3,394,814**

**Registered Mar. 11, 2008**

**TRADEMARK  
PRINCIPAL REGISTER**

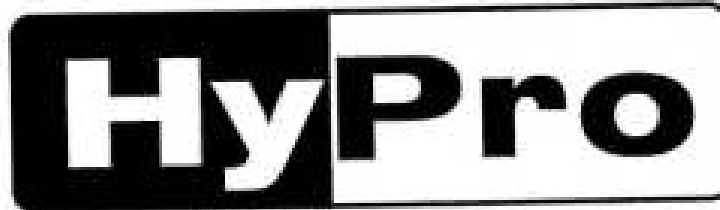

NBB CONTROLS + COMPONENTS AG (FED  
REP GERMANY CORPORATION)  
1-3, OTTO-HAHN-STRASSE  
OELBRONN-DUERRN, FED REP GERMANY D-  
75248

FOR: ELECTRIC AND ELECTRONIC APPARA-  
TUS NAMELY TRANSMITTERS AND RECEIVERS  
FOR REMOTE CONTROL OF INDUSTRIAL EQUIP-  
MENT CONFINED EXCLUSIVELY TO PROPOR-  
TIONAL CONTROLS FOR USE IN CONNECTION

WITH THE TRUCK CRANE INDUSTRY; COMPU-  
TER SYSTEM SOFTWARE FOR OPERATING SUCH  
TRANSMITTERS AND RECEIVERS, IN CLASS 9  
(U.S. CLS. 21, 23, 26, 36 AND 38).

FIRST USE 1-1-2006; IN COMMERCE 1-1-2006.

SER. NO. 78-594,547, FILED 3-24-2005.

KEVON CHISOLM, EXAMINING ATTORNEY



**Int. Cls.: 9 and 38**

**Prior U.S. Cls.: 21, 23, 26, 36, 38, 100, 101 and 104**

**United States Patent and Trademark Office**

**Reg. No. 3,394,815**

**Registered Mar. 11, 2008**

**TRADEMARK  
SERVICE MARK  
PRINCIPAL REGISTER**

**BEOLINE**

BANG & OLUFSEN A/S (DENMARK PRIVATE LIMITED COMPANY)  
PETER BANGS VEJ 15  
STRUER, DENMARK 7600

FOR: TELEPHONES; TELEPHONES WITH BUILT-IN ANSWERING MACHINES; TELEPHONE ANSWERING MACHINES; TELEPHONES WITH BUILT IN CAMERAS AND MONITORS; TELEPHONES FOR TRANSMISSION OF DATA THROUGH THE INTERNET AND OTHER NETWORKS; TELEPHONE APPARATUS UNITS TO BE USED AS A BASE FOR THE PROCESSING AND DISTRIBUTION OF ANALOGUE OR DIGITAL TELEPHONE CALLS; TELECOMMUNICATION EQUIPMENT, NAMELY, TELECOMMUNICATIONS AND DATA NETWORKING HARDWARE FOR LOCAL AND LONG DISTANCE TRANSMISSION OF INFORMATION, VOICE, DATA, AND GRAPHICS; SOFTWARE FOR ELECTRIC AND ELECTRONIC APPARATUS AND APPLIANCES, NAMELY, TELECOMMUNICATIONS AND DATA NETWORK OPERATING SOFTWARE FOR TELEPHONES, TELEPHONIC UNITS AND TELECOMMUNICATION EQUIPMENT; SPARE PARTS, PARTS AND FITTINGS FOR ALL THE AFOREMENTIONED GOODS, IN CLASS 9 (U.S. CLS. 21, 23, 26, 36 AND 38).

FOR: TELECOMMUNICATION SERVICES, NAMELY, LOCAL AND LONG DISTANCE TRANSMISSION OF VOICE, DATA, GRAPHICS BY MEANS OF TELEPHONE, TELEGRAPHIC, CABLE, AND SATELLITE TRANSMISSIONS; RENTAL OF TELECOMMUNICATIONS EQUIPMENT, NAMELY, TELEPHONES AND TELEPHONE SYSTEMS; VOICE MAIL SERVICES, IN CLASS 38 (U.S. CLS. 100, 101 AND 104).

THE MARK CONSISTS OF STANDARD CHARACTERS WITHOUT CLAIM TO ANY PARTICULAR FONT, STYLE, SIZE, OR COLOR.

PRIORITY CLAIMED UNDER SEC. 44(D) ON DENMARK APPLICATION NO. VA200500871, FILED 3-2-2005, REG. NO. VR20050096, DATED 3-16-2005, EXPIRES 3-16-2015.

OWNER OF U.S. REG. NOS. 992,401 AND 1,539,045.

SER. NO. 78-596,823, FILED 3-29-2005.

MICHAEL GAAFAR, EXAMINING ATTORNEY

**Int. Cls.: 9 and 28**

**Prior U.S. Cls.: 21, 22, 23, 26, 36, 38 and 50**

**Reg. No. 3,394,816**

**United States Patent and Trademark Office**

**Registered Mar. 11, 2008**

**TRADEMARK  
PRINCIPAL REGISTER**

**FANTASY FOREST**

ATRONIC INTERNATIONAL GMBH (FED REP GERMANY CORPORATION)  
BORSIGSTRABE 26  
32312 LÜBBECKE, FED REP GERMANY

FOR: ELECTRIC AND ELECTRONIC APPARATUS, INSTRUMENTS, DEVICES AND MACHINES, NAMELY, AUTOMATED COIN DISPENSING MACHINES FOR GAMING AND GAMBLING; MECHANISMS FOR COIN, BILL AND CHIP OPERATED GAMING MACHINES IN THE NATURE OF ELECTRIC AND ELECTRONIC CIRCUITS FOR OPERATION OF SAID MACHINES; APPARATUS FOR BILLING OPERATIONS OF COIN-OPERATED MACHINES, NAMELY, COMPUTER SOFTWARE USED TO GENERATE BILLS IN CONNECTION WITH COIN OPERATED GAMING MACHINES, COMPUTERS AND COMPUTER HARDWARE; COMPUTER PRINTERS FOR USE IN CONNECTION WITH GAMING AND GAMBLING MACHINES; PRINTED ELECTRONIC CIRCUITS FOR APPARATUS AND CARDS BEARING INTEGRATED CIRCUITS; COIN AND BILL MONEY CHANGE MACHINES; VENDING MACHINES PROVIDING CHIPS, COUPONS AND GAME CARDS; ENTERTAINMENT AND CASINO GAMING AND GAMBLING EQUIPMENT, NAMELY, SLOT MACHINES; GAMING EQUIPMENT, NAMELY, GAMING MACHINES, SLOT MACHINES WITH VIDEO OUT PUT AND STRUCTURAL PARTS THEREFOR; DROP-DOWN CAROUSELS FOR GAMING AND SLOT MACHINES BEING STRUCTURAL PARTS THEREOF, NAMELY HOPPERS; TV MONITORS AND LCD- MONITORS BOTH FOR GAMBLING MACHINES; ELECTRONIC CASINO GAME AND GAMBLING MACHINES; PRERECORDED DATA CARRIERS WITH COMPUTER OPERATING PROGRAMS FOR USE IN ELECTRONIC OPERATION OF ELECTRIC AND ELECTRONIC AMUSEMENT,

ENTERTAINMENT, GAMING AND GAMBLING MACHINES; DATA CARRIERS FEATURING COMPUTER PROGRAMS FOR ELECTRONIC VIDEO AND AUDIO DISPLAY AND OPERATION OF AMUSEMENT, AND ENTERTAINMENT GAMING AND GAMBLING MACHINES, IN CLASS 9 (U.S. CLS. 21, 23, 26, 36 AND 38).

FOR: COIN AND MONEY BILL OPERATED AMUSEMENT MACHINES OPERABLE WITH MAGNETIC CARDS, MICRO PROCESSORS AND COMPUTER CHIPS; ELECTRIC AND ELECTRONIC STAND ALONE VIDEO MACHINES FEATURING GAMES, AMUSEMENT AND SPORTS AND ENTERTAINMENT ALL FOR USE INDIVIDUALLY OR AS A NETWORK, NAMELY COIN-OPERATED ARCADE-TYPE ELECTRONIC GAMES; COMPACT SPORTS GAME MACHINES FOR PLAYING IN SMALL AREAS, NAMELY, DARTS, TABLE SOCCER, POOL-BILLIARD, SNOOKER, SHOOTING GALLERIES, PINBALL GAMES; HAND OPERATED CONSOLES FOR ELECTRONIC GAMES; ELECTRONIC PARLOR GAMES, IN CLASS 28 (U.S. CLS. 22, 23, 38 AND 50).

THE MARK CONSISTS OF STANDARD CHARACTERS WITHOUT CLAIM TO ANY PARTICULAR FONT, STYLE, SIZE, OR COLOR.

PRIORITY CLAIMED UNDER SEC. 44(D) ON ERPN CMNTY TM OFC APPLICATION NO. 004307013, FILED 3-23-2005, REG. NO. 004307013, DATED 4-13-2006, EXPIRES 3-23-2015.

SER. NO. 78-598,883, FILED 3-31-2005.

ZHALEH DELANEY, EXAMINING ATTORNEY

**Int. Cl.: 45**

**Prior U.S. Cls.: 100 and 101**

**United States Patent and Trademark Office**

**Reg. No. 3,394,817**

**Registered Mar. 11, 2008**

**SERVICE MARK  
PRINCIPAL REGISTER**

**LOOKING OUT FOR  
YOU**

CANTAMOUNT, KENNETH C. (UNITED STATES  
INDIVIDUAL)  
P.O. BOX 620944  
WOODSIDE, CA 94062

THE MARK CONSISTS OF STANDARD CHAR-  
ACTERS WITHOUT CLAIM TO ANY PARTICULAR  
FONT, STYLE, SIZE, OR COLOR.

FOR: LICENSED CIVIL AND CRIMINAL PRI-  
VATE INVESTIGATIVE SERVICES, IN CLASS 45  
(U.S. CLS. 100 AND 101).

SER. NO. 78-600,781, FILED 4-3-2005.

FIRST USE 11-1-1995; IN COMMERCE 11-1-1995.

WENDY GOODMAN, EXAMINING ATTORNEY

**Int. Cls.: 35, 36 and 45**

**Prior U.S. Cls.: 100, 101 and 102**

**United States Patent and Trademark Office**

**Reg. No. 3,394,818**

**Registered Mar. 11, 2008**

**SERVICE MARK  
PRINCIPAL REGISTER**

**HMB Inc**

HMB INC. (TEXAS CORPORATION)  
C/O HMBI  
2000 EAST LAMAR BLVD., SUITE 710  
ARLINGTON, TX 76011

FOR: MARKETING SERVICES IN RELATION TO GOVERNMENT OWNED REAL ESTATE AND HOUSES AND FORECLOSED FEDERAL HOUSING ADMINISTRATION HOUSES; CONSULTING SERVICES RELATED TO REAL ESTATE SALES MANAGEMENT, IN CLASS 35 (U.S. CLS. 100, 101 AND 102).

FIRST USE 7-1-2004; IN COMMERCE 7-1-2004.

FOR: REAL ESTATE MANAGEMENT OF GOVERNMENT OWNED REAL ESTATE AND HOUSES; REAL ESTATE MANAGEMENT OF FORECLOSED FEDERAL HOUSING ADMINISTRATION HOUSES; CONSULTING SERVICES RELATED TO THE GENERAL MANAGEMENT OF MULTIFAMILY AND SINGLE FAMILY HOUSING PROPERTIES; FINANCING SERVICES; CONSULTING SERVICES RELATED TO THE FISCAL ASPECTS OF MULTIFAMILY

AND SINGLE FAMILY HOUSING PROPERTIES, IN CLASS 36 (U.S. CLS. 100, 101 AND 102).

FIRST USE 7-1-2004; IN COMMERCE 7-1-2004.

FOR: CONSULTING SERVICES RELATED TO THE REGULATORY ASPECTS OF MULTIFAMILY AND SINGLE FAMILY HOUSING PROPERTIES, IN CLASS 45 (U.S. CLS. 100 AND 101).

FIRST USE 7-1-2004; IN COMMERCE 7-1-2004.

THE MARK CONSISTS OF STANDARD CHARACTERS WITHOUT CLAIM TO ANY PARTICULAR FONT, STYLE, SIZE, OR COLOR.

NO CLAIM IS MADE TO THE EXCLUSIVE RIGHT TO USE "INC", APART FROM THE MARK AS SHOWN.

SER. NO. 78-603,397, FILED 4-6-2005.

PAUL E. FAHRENKOPF, EXAMINING ATTORNEY

**Int. Cls.: 24 and 25**

**Prior U.S. Cls.: 22, 39, 42 and 50**

**United States Patent and Trademark Office**

**Reg. No. 3,394,819**

**Registered Mar. 11, 2008**

**TRADEMARK  
PRINCIPAL REGISTER**

**LA CHATELAINE**

SOCIETE NOUVELLE LA CHATELAINE  
(FRANCE CORPORATION)  
170 AVENUE VICTOR HUGO  
75016 PARIS, FRANCE

FOR: TEXTILES AND TEXTILE GOODS NOT INCLUDED IN OTHER CLASSES, NAMELY, BATH LINEN, BED BLANKETS, BED LINEN, BED SHEETS, BEDSPREADS, PILLOW CASES, PILLOW COVERS, HOUSEHOLD LINEN, TABLE LINEN, IN CLASS 24 (U.S. CLS. 42 AND 50).

FOR: BABY AND CHILDREN'S CLOTHING, NAMELY, LAYETTES, SHIRTS, PANTS, JACKETS, HATS, SHOES AND LINGERIE, IN CLASS 25 (U.S. CLS. 22 AND 39).

THE MARK CONSISTS OF STANDARD CHARACTERS WITHOUT CLAIM TO ANY PARTICULAR FONT, STYLE, SIZE, OR COLOR.

OWNER OF FRANCE REG. NO. 1252852, DATED 11-30-1983, RENEWED AS REG. NO. 2021586, DATED 7-21-1993, EXPIRES 7-21-2013.

THE ENGLISH TRANSLATION OF LA CHATELAINE IS LADY OF THE MANOR.

SER. NO. 78-603,439, FILED 4-6-2005.

LINDA E. BLOHM, EXAMINING ATTORNEY

**Int. Cl.: 36**

**Prior U.S. Cls.: 100, 101 and 102**

**United States Patent and Trademark Office**

**Reg. No. 3,394,820**

**Registered Mar. 11, 2008**

**SERVICE MARK  
PRINCIPAL REGISTER**

**FIDUCIARY OPPORTUNITY FUND**

FIDUCIARY ASSET MANAGEMENT, LLC (MISSOURI LIMITED LIABILITY CORPORATION)  
8112 MARYLAND AVENUE, SUITE 200  
ST. LOUIS, MO 63105

FOR: (BASED ON USE IN COMMERCE) FINANCIAL INVESTMENT SERVICES, NAMELY, FINANCIAL MANAGEMENT OF INVESTMENTS; FUND INVESTMENT CONSULTATION, INVESTMENT CONSULTATION, INVESTMENT ADVICE, FUNDS INVESTMENT, FINANCIAL ANALYSIS AND CONSULTATION; PROVIDING INFORMATION ON THE TOPICS OF FUND INVESTMENT CONSULTATION, INVESTMENT CONSULTATION, INVESTMENT ADVICE, FUNDS INVESTMENT, FINANCIAL ANALYSIS AND CONSULTATION VIA A GLOBAL COMPUTER NETWORK; INVESTMENT PORTFOLIO CONSTRUCTION; FINANCIAL RISK MANAGEMENT; MUTUAL FUND INVESTMENT; MUTUAL FUND BROKERAGE; MUTUAL FUND DISTRIBUTION; AND PROVIDING INFORMATION IN THE FIELD OF MUTUAL FUNDS AND MUTUAL FUND INVESTMENT; MUTUAL FUND

INVESTMENT CONSULTATION, ADVICE AND ANALYSIS, IN CLASS 36 (U.S. CLS. 100, 101 AND 102).

FIRST USE 11-12-2004; IN COMMERCE 12-22-2004.

THE MARK CONSISTS OF STANDARD CHARACTERS WITHOUT CLAIM TO ANY PARTICULAR FONT, STYLE, SIZE, OR COLOR.

OWNER OF U.S. REG. NOS. 2,893,100, 2,923,301, AND 2,966,315.

NO CLAIM IS MADE TO THE EXCLUSIVE RIGHT TO USE "OPPORTUNITY FUND", APART FROM THE MARK AS SHOWN.

SEC. 2(F).

SER. NO. 78-606,331, FILED 4-11-2005.

JAY BESCH, EXAMINING ATTORNEY

**Int. Cls.: 3, 9, 14, 16, 18, 25, 28, 35, 36, 38 and 41**

**Prior U.S. Cls.: 1, 2, 3, 4, 5, 6, 21, 22, 23, 26, 27, 28, 29, 36, 37, 38, 39, 41, 50, 51, 52, 100, 101, 102, 104 and 107**

**Reg. No. 3,394,821**

**United States Patent and Trademark Office**

**Registered Mar. 11, 2008**

**TRADEMARK  
SERVICE MARK  
PRINCIPAL REGISTER**

# Global Angels

GLOBAL ANGELS LTD (UNITED KINGDOM CORPORATION)  
1 CONDUIT STREET  
LONDON, UNITED KINGDOM W1S 2XA

FOR: PERFUMES; NON-MEDICATED TOILET AND COSMETIC PREPARATIONS, NAMELY LOTIONS, POWDERS AND CREAMS FOR USE ON THE SKIN, DENTIFRICES, COSMETIC DEPILATORY CREAMS, PERSONAL DEODORANTS, NON-MEDICATED BATH PREPARATIONS, PREPARATIONS FOR CARE OF THE HAIR, SHAMPOOS, SOAPS AND ESSENTIAL OILS FOR PERSONAL USE, IN CLASS 3 (U.S. CLS. 1, 4, 6, 50, 51 AND 52).

FOR: SOUND AND VIDEO RECORDINGS FEATURING MUSIC, LIVE CONCERTS AND MUSICAL CONCERTS; SOFTWARE FOR USE IN PLAYING MUSIC; SOUND AND VIDEO RECORDINGS DOWNLOADABLE FROM THE INTERNET FEATURING MUSIC, LIVE CONCERTS AND MUSICAL CONCERTS; SOFTWARE DOWNLOADABLE FROM THE INTERNET FOR USE IN PLAYING MUSIC; SOFTWARE DOWNLOADABLE FROM THE INTERNET FOR USE ON MOBILE TELEPHONES AND FOR USE IN PLAYING MUSIC AND VIDEO ON MOBILE TELEPHONES, AND FOR USE WITH MOBILE PHONE AND INTERNET DOWNLOADS AND RING TONES; SOFTWARE FOR REPRODUCING RING TONES ON MOBILE TELEPHONES; SOFTWARE FOR PRODUCING BACKGROUNDS AND SCREEN SAVERS FOR SCREENS OF MOBILE PHONES; RECORDING MEDIA, NAMELY, BLANK AUDIO TAPES, BLANK AUDIO CASSETTES, BLANK VIDEO TAPES, BLANK VIDEO CASSETTES, BLANK CD ROMS FOR SOUND OR VIDEO RECORDING, BLANK COMPUTER DISCS, BLANK RECORDABLE DVDS, BLANK COMPACT DISCS; ELECTRONIC PUBLICATIONS CONTAINING SOUND IMAGES AND DATA, NAMELY, MAGAZINES RELATING TO MUSIC, LIVE CONCERTS

AND MUSICAL CONCERTS; GAME CONSOLES, NAMELY, VIDEO GAME MACHINES FOR USE WITH TELEVISIONS; CONSOLE GAMES, NAMELY, COMPUTER GAME CARTRIDGES; COMPUTER GAMES, NAMELY, COMPUTER GAME SOFTWARE, IN CLASS 9 (U.S. CLS. 21, 23, 26, 36 AND 38).

FOR: JEWELRY; CLOCKS AND WATCHES; COSTUME JEWELRY, IN CLASS 14 (U.S. CLS. 2, 27, 28 AND 50).

FOR: PRINTED MATTERS AND PRINTED PUBLICATIONS NAMELY CHILDREN'S BOOKS, PRINTED CARTOONS, CARTOON PRINTS, PHOTOGRAPHY BOOKS, COFFEE TABLE BOOKS FEATURING TRAVEL DESTINATIONS AND FEATURING PHOTOGRAPHS OF PEOPLE IN DIFFERENT COUNTRIES AND LOCATIONS; BOOKS, MAGAZINES, PRINTED PERIODICALS AND MAGAZINE SUPPLEMENTS TO NEWSPAPERS, BROCHURES AND CATALOGUES, FACT SHEETS, PAMPHLETS AND LEAFLETS ALL RELATING TO CHARITABLE ISSUES OR TO CHARITABLE FUND RAISING OR RELATING TO MUSIC OR RELATING TO LIVE CONCERTS OR TO MUSICAL CONCERTS; STATIONERY, DECALCOMANIAS; PENS, PENCILS, CRAYONS, PENCIL CASES, ERASERS, RULERS BEING ARTICLES OF STATIONERY OR FOR USE IN DRAWING, PRINTED TICKETS AND EVENT PROGRAMMES RELATING TO MUSICAL ARTISTS, OR TO MUSICAL CONCERTS; ART PRINTS, POSTERS FOR DECORATIVE PURPOSES, POSTERS IN THE NATURE OF ART PRINTS, PICTURES, STICKERS, PAPERWEIGHTS, DIARIES AND CALENDARS; PAINT BRUSHES, CARDBOARD BOXES AND PAPER BOXES CONTAINING PAINTS, PAINT BRUSHES, PENCILS, AND CRAYONS; PRINTED MUSICAL SCORES AND LIBRETTO, SHEET MUSIC; GREETINGS CARDS, POSTAL CARDS, PAPER FOR USE AS GIFT WRAP, NOTEBOOKS AND ADDRESS BOOKS, IN CLASS 16 (U.S. CLS. 2, 5, 22, 23, 29, 37, 38 AND 50).

FOR: BAGS, NAMELY, TRAVEL BAGS; LUGGAGE; BELTS AND STRAPS FOR LUGGAGE; HANDBAGS; GARMENT BAGS FOR TRAVEL; BACKPACKS; TRUNKS FOR TRAVEL; SUITCASES; BRIEFCASES; SATCHELS; RUCKSACKS; HAVERSACKS; VANITY CASES SOLD EMPTY; DUFFEL BAGS; SHOULDER BAGS; PORTFOLIOS OF THE BRIEFCASE TYPE; WALLETS; PURSES; CREDIT CARD, BUSINESS CARD AND CALLING CARD CASES; DRAWSTRING POUCHES; KEY CASES; UMBRELLAS AND UMBRELLA COVERS, IN CLASS 18 (U.S. CLS. 1, 2, 3, 22 AND 41).

FOR: ARTICLES OF CLOTHING, NAMELY SHIRTS, JUMPERS, SKIRTS, BLOUSES, COATS, JACKETS, WIND RESISTANT JACKETS, TRACK SUITS, SLACKS, TROUSERS, SHORTS, OVERALLS, DUNGAREES, SWEATERS, T-SHIRTS, SWEATSHIRTS, BLOUSONS, JEANS, BELTS, SUSPENDERS, TIES, SCARVES AND GLOVES, HATS, CAPS, BEREETS, HEADBANDS, HOODS; SHOES, BOOTS, SANDALS, SLIPPERS, SNEAKERS, SPORTS SHOES, HOSIERY, TIGHTS, SOCKS AND STOCKINGS, IN CLASS 25 (U.S. CLS. 22 AND 39).

FOR: GAMES, TOYS AND PLAYTHINGS, NAMELY BOARD GAMES, ACTION FIGURES, TOY STUFFED ANIMALS, PUPPETS AND DOLLS, HAND HELD ELECTRONIC GAME UNITS FEATURING ANIMATION, MUSIC AND SOUND; TOY MUSIC BOXES, AND MUSIC BOX TOYS, IN CLASS 28 (U.S. CLS. 22, 23, 38 AND 50).

FOR: BUSINESS CONSULTANCY SERVICES RELATING TO BUSINESS MANAGEMENT; MARKETING AND PROMOTION; ADVERTISING AND PUBLICITY CONSULTATION; BUSINESS CONSULTATION SERVICES TO ASSIST NON-PROFITABLE ORGANIZATIONS IN PLANNING, MANAGING AND CONDUCTING FUND RAISING ACTIVITIES, BUSINESS CONSULTATION SERVICES TO ASSIST NON-PROFITABLE ORGANIZATIONS IN PLANNING, MANAGING AND CONDUCTING FUND RAISING ACTIVITIES VIA A GLOBAL COMPUTER NETWORK; ON-LINE SHOPPING SERVICES, NAMELY PROMOTING THE GOODS AND SERVICES OF OTHERS BY MEANS OF OPERATING AN ON-LINE SHOPPING MALL WITH LINKS TO THE RETAIL WEB-SITES OF OTHERS; ON-LINE SHOPPING PORTALS, NAMELY, ON-LINE RETAIL STORE SERVICES ENABLING CONSUMERS TO PURCHASE GOODS OVER THE INTERNET, FEATURING MUSICAL AND VIDEO RECORDINGS AND TICKETS FOR MUSICAL CONCERTS; MAIL ORDER SERVICES, ON-LINE MAIL ORDER SERVICES, MAIL ORDER CATALOGUE SERVICES AND ON-LINE MAIL ORDER CATALOGUE SERVICES FEATURING MUSIC AND VIDEO RECORDINGS AND TICKETS FOR MUSICAL CONCERTS, IN CLASS 35 (U.S. CLS. 100, 101 AND 102).

FOR: FINANCIAL SERVICES, NAMELY, CHARITABLE FUNDRAISING. FACILITATING AND ARRANGING FOR THE FINANCING OF SETTING UP BUSINESSES IN UNDER-DEVELOPED COUNTRIES; FINANCIAL SPONSORSHIP OF CHILDREN IN UNDER-DEVELOPED COUNTRIES AND OF

CHILDREN HAVING SPECIAL NEEDS, FINANCIAL SPONSORSHIP OF CHILDREN REQUIRING SPECIALIZED SCHOOLING, FINANCIAL SPONSORSHIP FOR TALENTED CHILDREN FOR SPECIALIZED SCHOOLING AND SPECIALIST FEES, AND FINANCIAL SPONSORSHIP TO ASSIST THE ADOPTION OF ORPHANS; FINANCIAL MANAGEMENT; INVESTMENT SERVICES, NAMELY, HEDGE FUND INVESTMENT SERVICES, FUNDS INVESTMENT; CREDIT CARD SERVICES; CONSULTANCY AND ADVISORY SERVICES RELATING TO FINANCIAL MANAGEMENT AND INVESTMENTS, IN CLASS 36 (U.S. CLS. 100, 101 AND 102).

FOR: COMMUNICATIONS SERVICES, NAMELY, ELECTRONIC TRANSMISSION OF DATA, IMAGES AND DOCUMENTS; PROVIDING ACCESS TO THE INTERNET; TV, RADIO, CABLE TELEVISION BROADCASTING SERVICES; SATELLITE COMMUNICATIONS; ELECTRONIC TRANSMISSION OF MESSAGES, DATA AND IMAGES; COMMUNICATION BY ELECTRONIC MAIL AND BY COMPUTER TERMINALS; TRANSMISSION OF INFORMATION VIA NATIONAL AND INTERNATIONAL NETWORKS; BROADCASTING SERVICES, NAMELY RADIO, TV AND CABLE TV BROADCASTING, BROADBAND TELEVISION BROADCASTING; THE PROVISION OF MOBILE TELEPHONE SERVICES; TRANSMISSION OF SOUND, VIDEO AND INFORMATION IN THE FORM OF MUSIC, FILM AND CARTOONS; AND PROVIDING BROADBAND AND CABLE TELEVISION BROADCASTING SERVICES; TRANSMISSION OF SOUND, VIDEO AND INFORMATION IN THE FORM OF MUSIC, FILM AND CARTOONS, IN CLASS 38 (U.S. CLS. 100, 101 AND 104).

FOR: PUBLISHING SERVICES, NAMELY PUBLICATION OF CHILDREN'S BOOKS, PRINTED CARTOONS, PHOTOGRAPHY BOOKS, COFFEE TABLE BOOKS FEATURING TRAVEL DESTINATIONS AND FEATURING PHOTOGRAPHS OF PEOPLE IN DIFFERENT COUNTRIES AND LOCATIONS; BOOKS, MAGAZINES, LEAFLET AND PAMPHLET PUBLISHING; MUSIC PUBLISHING SERVICES REGARDING SOUND AND VIDEO RECORDINGS; ELECTRONIC PUBLISHING SERVICES, NAMELY, PUBLICATION OF TEXT AND GRAPHIC WORKS OF OTHERS ON CD, DVD AND ON-LINE FEATURING MUSIC, CONCERTS AND MUSICAL CONCERTS, AND PUBLICATION OF VIDEO ON CD, DVD AND ONLINE FEATURING MUSIC AND CONCERTS, MUSICAL CONCERTS; EDUCATIONAL SERVICES, NAMELY PROVIDING CLASSES AND WORKSHOPS IN THE FIELD OF MUSIC RELATING TO CHARITABLE FUND RAISING; ENTERTAINMENT SERVICES IN THE FORM OF LIVE MUSICAL CONCERTS; PROVIDING ON-LINE COMPUTER GAMES, IN CLASS 41 (U.S. CLS. 100, 101 AND 107).

THE MARK CONSISTS OF STANDARD CHARACTERS WITHOUT CLAIM TO ANY PARTICULAR FONT, STYLE, SIZE, OR COLOR.



PRIORITY CLAIMED UNDER SEC. 44(D) ON  
UNITED KINGDOM APPLICATION NO. 2376195,  
FILED 10-20-2004, REG. NO. 2376195, DATED 10-20-  
2004, EXPIRES 10-20-2014.

NO CLAIM IS MADE TO THE EXCLUSIVE  
RIGHT TO USE "GLOBAL", APART FROM THE  
MARK AS SHOWN.

SER. NO. 78-610,250, FILED 4-15-2005.

SALLY SHIH, EXAMINING ATTORNEY

**Int. Cls.: 41 and 42**

**Prior U.S. Cls.: 100, 101 and 107**

**United States Patent and Trademark Office**

**Reg. No. 3,394,822**

**Registered Mar. 11, 2008**

**SERVICE MARK  
PRINCIPAL REGISTER**

**DIGITAL COMMONS**

TEACHERS4SCHOOLS, LLC (ALASKA LTD LIAB  
CO)  
PO BOX 579  
BONNER, MT 59823

FOR: EDUCATIONAL SERVICES, NAMELY, CONDUCTING DISTANCE LEARNING INSTRUCTION AT THE K-12, POST-SECONDARY AND GRADUATE LEVELS FEATURING COURSE MANAGEMENT DESIGN, DISTANCE LEARNING CONTENT, AND COURSE DEVELOPMENT; TRAINING SERVICES IN THE FIELD OF DISTANCE LEARNING; TRAINING IN THE USE AND OPERATION OF DISTANCE LEARNING TECHNOLOGY, NAMELY, DATABASE-DRIVEN COURSE MANAGEMENT SYSTEMS; COMPUTER EDUCATION TRAINING SERVICES, NAMELY, TRAINING IN THE USE OF PERSONAL COMPUTERS AND OPERATING SYSTEMS, DIGITAL VIDEO AND SOUND EDITING, PODCASTING, VODCASTING, RSS FEEDS AND VIDEO CONFERENCING EQUIPMENT; EDUCATION SERVICES, NAMELY, PROVIDING COURSES AND TRAINING IN THE FIELD OF DATA MANAGEMENT, IN CLASS 41 (U.S. CLS. 100, 101 AND 107).

FIRST USE 2-9-2006; IN COMMERCE 2-9-2006.

FOR: DESIGN, CREATION, HOSTING AND MAINTENANCE OF WEBSITES FOR EDUCATION-

AL ORGANIZATIONS; CONSULTING SERVICES IN THE FIELD OF DESIGN, SELECTION, IMPLEMENTATION AND USE OF COMPUTER HARDWARE AND SOFTWARE SYSTEMS FOR EDUCATIONAL ORGANIZATIONS; COMPUTER SERVICES, NAMELY, PROVIDING DATA MANAGEMENT FOR EDUCATIONAL ORGANIZATIONS, NAMELY, HOSTING OF DATA, NAMELY, HOSTING OF DIGITAL CONTENT ON THE INTERNET, AND PROVIDING INFORMATION IN THE FIELD OF DATA MANAGEMENT VIA THE INTERNET, AND IMPLEMENTATION OF DATA HOSTING, NAMELY, HOSTING OF DIGITAL CONTENT ON THE INTERNET, IN CLASS 42 (U.S. CLS. 100 AND 101).

FIRST USE 2-9-2006; IN COMMERCE 2-9-2006.

THE MARK CONSISTS OF STANDARD CHARACTERS WITHOUT CLAIM TO ANY PARTICULAR FONT, STYLE, SIZE, OR COLOR.

NO CLAIM IS MADE TO THE EXCLUSIVE RIGHT TO USE "DIGITAL", APART FROM THE MARK AS SHOWN.

SER. NO. 78-620,698, FILED 5-2-2005.

SCOTT SISUN, EXAMINING ATTORNEY

**Int. Cls.: 36, 37 and 42**

**Prior U.S. Cls.: 100, 101, 102, 103 and 106**

**United States Patent and Trademark Office**

**Reg. No. 3,394,823**

**Registered Mar. 11, 2008**

**SERVICE MARK  
PRINCIPAL REGISTER**

**WOODBURY**

WOODBURY CORPORATION (UTAH CORPORATION)  
2733 PARLEYS WAY SUITE 300  
SALT LAKE CITY, UT 841091662

FOR: COMMERCIAL REAL ESTATE SERVICES, NAMELY, COMMERCIAL REAL ESTATE AGENCIES AND COMMERCIAL REAL ESTATE CONSULTATION; REAL ESTATE INVESTMENT SERVICES; REAL ESTATE MANAGEMENT SERVICES; BROKERAGE SERVICES, NAMELY, REAL ESTATE BROKERAGE AND MUTUAL FUND BROKERAGE, IN CLASS 36 (U.S. CLS. 100, 101 AND 102).

FIRST USE 12-31-1919; IN COMMERCE 12-31-1945.

FOR: REAL ESTATE DEVELOPMENT SERVICES, IN CLASS 37 (U.S. CLS. 100, 103 AND 106).

FIRST USE 12-31-1919; IN COMMERCE 12-31-1945.

FOR: ARCHITECTURAL DESIGN SERVICES, IN CLASS 42 (U.S. CLS. 100 AND 101).

FIRST USE 12-31-1919; IN COMMERCE 12-31-1945.

THE MARK CONSISTS OF STANDARD CHARACTERS WITHOUT CLAIM TO ANY PARTICULAR FONT, STYLE, SIZE, OR COLOR.

SEC. 2(F).

SER. NO. 78-628,204, FILED 5-11-2005.

JASON LOTT, EXAMINING ATTORNEY

**Int. Cl.: 44**

**Prior U.S. Cls.: 100 and 101**

**United States Patent and Trademark Office**

**Reg. No. 3,394,824**

**Registered Mar. 11, 2008**

**SERVICE MARK  
PRINCIPAL REGISTER**

**LOOKER**

RUSSO, PAUL (UNITED STATES INDIVIDUAL)  
#107  
11687 MONTANA AVE.  
LOS ANGELES, CA 90049

THE MARK CONSISTS OF STANDARD CHAR-  
ACTERS WITHOUT CLAIM TO ANY PARTICULAR  
FONT, STYLE, SIZE, OR COLOR.

FOR: BEAUTY SALON SERVICES, IN CLASS 44  
(U.S. CLS. 100 AND 101).

SER. NO. 78-628,848, FILED 5-12-2005.

FIRST USE 1-1-1983; IN COMMERCE 9-0-2001.

SUE LAWRENCE, EXAMINING ATTORNEY

**Int. Cl.: 1**

**Prior U.S. Cls.: 1, 5, 6, 10, 26 and 46**

**Reg. No. 3,394,825**

**United States Patent and Trademark Office**

**Registered Mar. 11, 2008**

**TRADEMARK  
PRINCIPAL REGISTER**

# RiKAFAST

RIKA INTERNATIONAL LIMITED (ENGLAND CORPORATION)  
C3 BROOKSIDE BUSINESS PARK GREENGATE C  
HADDERTON  
OLDHAM, ENGLAND

FOR: CHEMICAL AND CHEMICAL PRODUCTS FOR INDUSTRIAL USE; CHEMICALS USED IN INDUSTRY, SCIENCE AND PHOTOGRAPHS, AS WELL AS IN AGRICULTURE, HORTICULTURE AND FORESTRY; CHEMICALS AND CHEMICAL PRODUCTS FOR USE IN MANUFACTURING PLASTICS; CHEMICAL PRODUCTS FOR USE IN THE PLASTICS INDUSTRY; UNPROCESSED ARTIFICIAL RESINS FOR POLYPROPYLENE; UNPROCESSED PLASTICS; MANURES; FIRE EXTINGUISHING COMPOSITIONS; TEMPERING CHEMICALS FOR USE IN METALWORKING

AND SOLDERING; TANNING AGENTS FOR USE IN MANUFACTURING OF LEATHER; ADHESIVES USED IN INDUSTRY, IN CLASS 1 (U.S. CLS. 1, 5, 6, 10, 26 AND 46).

THE MARK CONSISTS OF STANDARD CHARACTERS WITHOUT CLAIM TO ANY PARTICULAR FONT, STYLE, SIZE, OR COLOR.

PRIORITY CLAIMED UNDER SEC. 44(D) ON ERPN CMNTY TM OFC APPLICATION NO. 004362463, FILED 3-30-2005, REG. NO. 004362463, DATED 4-18-2006, EXPIRES 3-30-2015.

SER. NO. 78-629,038, FILED 5-12-2005.

JENNY PARK, EXAMINING ATTORNEY

**Int. Cls.: 7 and 9**

**Prior U.S. Cls.: 13, 19, 21, 23, 26, 31, 34, 35, 36 and 38**

**United States Patent and Trademark Office**

**Reg. No. 3,394,826**

**Registered Mar. 11, 2008**

**TRADEMARK  
PRINCIPAL REGISTER**

# NANOLENS

NANOMOTION LTD. (ISRAEL CORPORATION)  
INDUSTRIAL ZONE YOQNEAM  
HAYEZIRA 3 ST., ISRAEL 20692

FOR: ELECTRIC MOTORS FOR USE IN CAMERAS, NAMELY, FOR USE IN POSITIONING LENSES IN CAMERAS, VIDEO CAMERAS AND FOR USE IN THE LENS MODULE, IN PARTICULAR, CAMERA MODULES IN PORTABLE PHONES, COMPUTERS AND OTHER ELECTRONIC TERMINAL DEVICES; PIEZOELECTRIC MOTORS FOR USE IN POSITIONING LENSES IN CAMERAS, VIDEO CAMERAS AND FOR USE IN THE LENS MODULE FOR SUCH PARTS, IN PARTICULAR, CAMERA MODULES IN PORTABLE PHONES, COMPUTERS AND OTHER ELECTRONIC TERMINAL DEVICES; GEARS FOR ELECTRIC MOTORS, OTHER THAN FOR LAND VEHICLES; GEARBOX ASSEMBLIES FOR PIEZOELECTRIC MOTORS; GEARBOX ASSEMBLIES FOR ELECTRIC MOTORS, NAMELY, FOR USE IN POSITIONING LENSES IN CAMERAS, VIDEO CAMERAS AND FOR USE IN THE LENS MODULE, IN PARTICULAR, CAMERA MODULES IN PORTABLE PHONES, COMPUTERS AND OTHER ELECTRONIC TERMINAL DEVICES; PIEZOELECTRIC MOTOR AND GEARBOX ASSEMBLIES FOR POSITIONING A LENS IN A CAMERA

OR VIDEO CAMERA, IN CLASS 7 (U.S. CLS. 13, 19, 21, 23, 31, 34 AND 35).

FOR: CAMERA LENS MODULES FOR SUPPORTING A LENS FOR A CAMERA FUNCTION; CAMERAS; DIGITAL CAMERAS; CAMERA LENSES; CAMCORDERS; VIDEO TELEPHONES; VIDEO CAMERAS; PORTABLE TELEPHONES WITH CAMERA FUNCTION; PORTABLE TELEPHONES WITH VIDEO FUNCTION; INTERCHANGEABLE LENSES FOR CAMERAS; CAMERA ACCESSORIES NAMELY CASES, BAGS AND STRAPS; CAMERAS FOR COMPUTERS, NAMELY, WEBCAMS, IN CLASS 9 (U.S. CLS. 21, 23, 26, 36 AND 38).

THE MARK CONSISTS OF STANDARD CHARACTERS WITHOUT CLAIM TO ANY PARTICULAR FONT, STYLE, SIZE, OR COLOR.

OWNER OF ISRAEL REG. NO. 101029, DATED 2-5-2007, EXPIRES 6-1-2015.

OWNER OF ISRAEL REG. NO. 181028, DATED 2-5-2007, EXPIRES 6-1-2015.

SER. NO. 78-629,310, FILED 5-13-2005.

PAM WILLIS, EXAMINING ATTORNEY

**Int. Cl.: 27**

**Prior U.S. Cls.: 19, 20, 37, 42 and 50**

**United States Patent and Trademark Office**

**Reg. No. 3,394,827**

**Registered Mar. 11, 2008**

**TRADEMARK  
PRINCIPAL REGISTER**

**DOLMA**

DOLMA, INC. (NEW YORK CORPORATION)  
417 LAFAYETTE STREET #2  
NEW YORK, NY 10003

FOR: CARPETS AND RUGS, IN CLASS 27 (U.S.  
CLS. 19, 20, 37, 42 AND 50).

FIRST USE 10-1-1998; IN COMMERCE 10-1-1998.

THE MARK CONSISTS OF STANDARD CHAR-  
ACTERS WITHOUT CLAIM TO ANY PARTICULAR  
FONT, STYLE, SIZE, OR COLOR.

SER. NO. 78-631,547, FILED 5-17-2005.

TRACY WHITTAKER-BROWN, EXAMINING AT-  
TORNEY

Int. Cl.: 30

Prior U.S. Cl.: 46

**United States Patent and Trademark Office**

**Reg. No. 3,394,828**

Registered Mar. 11, 2008

**TRADEMARK  
PRINCIPAL REGISTER**

*Che Pottle*

EASTMAN OUTDOORS, INC. (MICHIGAN CORPORATION)  
3475 EASTMAN DR.  
FLUSHING, MI 48433

FIRST USE 3-1-2004; IN COMMERCE 3-1-2004.

SER. NO. 78-634,026, FILED 5-20-2005.

FOR: BASED ON USE STAPLE FOODS, NAMELY, DRY SPICES AND SEASONINGS, IN CLASS 30 (U.S. CL. 46).

LAURA HAMMEL, EXAMINING ATTORNEY



**Int. Cl.: 9**

**Prior U.S. Cls.: 21, 23, 26, 36 and 38**

**United States Patent and Trademark Office**

**Reg. No. 3,394,829**

**Registered Mar. 11, 2008**

**TRADEMARK  
PRINCIPAL REGISTER**

**BANANA KING**

ARISTOCRAT TECHNOLOGIES AUSTRALIA  
PTY LTD (AUSTRALIA LTD LIAB CO)  
71 LONGUEVILLE ROAD  
LANE COVE, NEW SOUTH WALES, AUSTRALIA  
2066

FOR: GAMING DEVICES, NAMELY, GAMING  
MACHINES AND COMPUTER SOFTWARE USED  
THEREWITH TO ENABLE THE GAMING MA-  
CHINE TO RUN, IN CLASS 9 (U.S. CLS. 21, 23, 26,  
36 AND 38).

THE MARK CONSISTS OF STANDARD CHAR-  
ACTERS WITHOUT CLAIM TO ANY PARTICULAR  
FONT, STYLE, SIZE, OR COLOR.

PRIORITY CLAIMED UNDER SEC. 44(D) ON  
AUSTRALIA APPLICATION NO. 1054073, FILED 5-  
6-2005, REG. NO. 1054073, DATED 12-19-2005, EX-  
PIRES 12-19-2015.

SER. NO. 78-634,295, FILED 5-20-2005.

MICHELLE DUBOIS, EXAMINING ATTORNEY

Int. Cl.: 30

Prior U.S. Cl.: 46

United States Patent and Trademark Office

Reg. No. 3,394,830

Registered Mar. 11, 2008

TRADEMARK  
PRINCIPAL REGISTER



TROPICALE FOODS, INC. (CALIFORNIA CORPORATION)  
12290 COLONY AVENUE  
CHINO, CA 91710

FOR: ICE CREAM AND FROZEN CONFECTIONS; ICE CREAM BARS; ICE CREAM FILLED CUPS; FROZEN CUSTARDS; AND FROZEN YOGURTS, IN CLASS 30 (U.S. CL. 46).

FIRST USE 12-1-2004; IN COMMERCE 12-1-2004.

OWNER OF U.S. REG. NO. 2,958,976.

NO CLAIM IS MADE TO THE EXCLUSIVE RIGHT TO USE "MEXICO" AND "HELADOS" AND "PALETAS", APART FROM THE MARK AS SHOWN.

THE COLOR(S) BLUE, YELLOW, RED, WHITE AND BLACK IS/ARE CLAIMED AS A FEATURE OF THE MARK.

THE MARK CONSISTS OF THE TERM "MEXICO" APPEARING IN THE COLORS BLUE, YELLOW AND WHITE; THE TERM "HELADOS" APPEARS IN THE COLOR BLUE; THE CART DESIGN APPEARS IN SHADES OF THE COLOR BLUE WITH THREE BELLS IN BLUE AND YELLOW AGAINST A WHITE BACKGROUND ON THE HANDLE PORTION OF THE CART; THE BEAR DESIGN ON THE FRONT OF THE CART APPEARS IN SHADES OF BLUE, WITH BLACK AND WHITE EYES, AND A RED TONGUE; THE TERM "PALETAS" APPEARS IN THE COLOR BLUE WITH A YELLOW BACKGROUND SURROUNDING THE LETTERS.

THE FOREIGN WORDING IN THE MARK TRANSLATES INTO ENGLISH AS HELADOS IS ENGLISH FOR ICE CREAMS. THE ENGLISH TRANSLATION OF "PALETAS" IS "NOVELTY FOOD ON A STICK".

SER. NO. 78-637,083, FILED 5-25-2005.

PAULA MAHONEY, EXAMINING ATTORNEY

**Int. Cls.: 41, 43 and 44**

**Prior U.S. Cls.: 100, 101 and 107**

**United States Patent and Trademark Office**

**Reg. No. 3,394,831**

**Registered Mar. 11, 2008**

**SERVICE MARK  
PRINCIPAL REGISTER**

**EVIAN**

SOCIETE ANONYME DES EAUX MINERALES  
D'EVIAN (FRANCE JOINT STOCK COMPAN-  
NY)  
22, AVENUE DES SOURCES  
EVIAN, FRANCE 74500

FOR: EDUCATIONAL SERVICES, NAMELY PRO-  
VIDING TRAINING COURSES IN THE FIELD OF  
NUTRITION AND HEALTH; PROVIDING ENTER-  
TAINMENT IN THE FORM OF ORGANIZING  
EDUCATIONAL CHALLENGES FOR STUDENTS;  
ORGANIZING MUSIC FESTIVALS; PROVIDING  
CULTURAL AND SPORTS CLUBS, NAMELY GOLF  
CLUB SERVICES; ORGANIZING AND CONDUCT-  
ING EDUCATIONAL SYMPOSIUMS IN THE FIELD  
OF NUTRITION, HEALTH AND FOOD, IN CLASS 41  
(U.S. CLS. 100, 101 AND 107).

FOR: HOTEL AND RESTAURANT SERVICES;  
RENTAL OF MEETING ROOMS, IN CLASS 43 (U.S.  
CLS. 100 AND 101).

FOR: HEALTH SPA SERVICES, NAMELY, COS-  
METIC BODY CARE SERVICES; BEAUTY SALON  
SERVICES; TANNING SALONS; SKIN CARE SAL-  
ONS, IN CLASS 44 (U.S. CLS. 100 AND 101).

THE MARK CONSISTS OF STANDARD CHAR-  
ACTERS WITHOUT CLAIM TO ANY PARTICULAR  
FONT, STYLE, SIZE, OR COLOR.

PRIORITY CLAIMED UNDER SEC. 44(D) ON  
FRANCE APPLICATION NO. 043329034, FILED 12-  
10-2004, REG. NO. 043329034, DATED 12-10-2004,  
EXPIRES 12-10-2014.

OWNER OF U.S. REG. NOS. 848,243, 1,778,995 AND  
OTHERS.

SER. NO. 78-643,044, FILED 6-3-2005.

WILLIAM BRECKENFELD, EXAMINING ATTOR-  
NEY

**Int. Cls.: 40 and 42**

**Prior U.S. Cls.: 100, 101, 103 and 106**

**United States Patent and Trademark Office**

**Reg. No. 3,394,832**

**Registered Mar. 11, 2008**

**SERVICE MARK  
PRINCIPAL REGISTER**

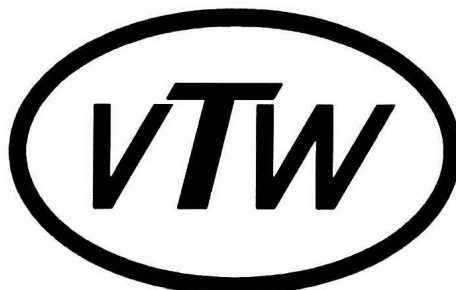

VERSATILITY TOOL WORKS AND MANUFACTURING, INC. (ILLINOIS CORPORATION)  
11532 SOUTH MAYFIELD AVENUE  
ALSIP, IL 60803

FOR: (BASED ON USE IN COMMERCE) TOOL FABRICATION; SHEET METAL ASSEMBLY; MACHINING, LONG AND SHORT RUN STAMPING, HIGH SPEED STAMPING, TURRET PUNCHING, PRECISION SHEET METAL FABRICATION AND ROBOTIC PRODUCTION WELDING TO THE ORDER AND SPECIFICATION OF OTHERS, IN CLASS 40 (U.S. CLS. 100, 103 AND 106).

FIRST USE 0-0-1984; IN COMMERCE 0-0-1984.

FOR: (BASED ON USE IN COMMERCE) TOOL DESIGN, IN CLASS 42 (U.S. CLS. 100 AND 101).

FIRST USE 0-0-1984; IN COMMERCE 0-0-1984.

SER. NO. 78-650,531, FILED 6-14-2005.

LINDA POWELL, EXAMINING ATTORNEY

**Int. Cls.: 5, 10 and 35**

**Prior U.S. Cls.: 6, 18, 26, 39, 44, 46, 51, 52, 100, 101  
and 102**

**Reg. No. 3,394,833**

**United States Patent and Trademark Office**

**Registered Mar. 11, 2008**

**TRADEMARK  
SERVICE MARK  
PRINCIPAL REGISTER**

**WOLF-PAK**

WOLF MEDICAL SUPPLY, INC. (FLORIDA CORPORATION)  
591 SAWGRASS CORPORATE PARKWAY  
SUNRISE, FL 33325

FOR: PRE-MOISTENED MEDICATED TOWELTRES, IN CLASS 5 (U.S. CLS. 6, 18, 44, 46, 51 AND 52).

FIRST USE 5-24-2005; IN COMMERCE 5-27-2005.

FOR: MEDICAL PROCEDURE KITS FOR CENTRAL VENOUS CATHETERS AND CENTRAL VENOUS LINES, NAMELY, DRESSING CHANGE KITS COMPRISING PLASTIC TRAYS, SURGICAL MASK, EXAMINATION GLOVES, SURGICAL DRAPE, PAPER TAPE MEASURE, SWAB STICKS, SURGICAL SPONGES, NON-ADHERENT PADS, TAPE, DRESSING, ANTISEPTIC CLEANSER, AND CHANGE LABEL TO INDICATE DATE OF LAST SITE CLEANING, INTRAVENOUS START KITS COMPRISING PLASTIC TRAYS EXAMINATION GLOVES, ALCOHOL PREP PADS, TOURNIQUETS, SURGICAL SPONGE, TAPE, DRESSING, POVIDINE-IODINE PAD, ANTISEPTIC CLEANSER, AND CHANGE LABEL TO INDICATE DATE OF LAST SITE CLEANING; MEDICAL DEVICES, NAMELY, SYRINGES, INFUSION SETS, INTRAVENOUS FLOW VALVES, INTRAVENOUS EXTENSION TUBING, TOTAL

PARENTERAL NUTRITION BAGS, MEDICAL BAGS DESIGNED TO HOLD MEDICAL EQUIPMENT, MEDICAL FLOW CONTROL DEVICES, NAMELY, INTRAVENOUS FLOW REGULATOR, MEDICAL TUBING FOR ADMINISTERING FLUIDS NEEDLE-FREE VALVE TO CONNECT WITH AND/OR ADAPT TO INTRAVENOUS TUBES AND TO INTRAVENOUS ACCESS DEVICE, PLASTIC CONTAINERS FOR PARENTERAL FLUIDS, IN CLASS 10 (U.S. CLS. 26, 39 AND 44).

FIRST USE 6-1-1999; IN COMMERCE 6-1-1999.

FOR: DISTRIBUTORSHIP SERVICES IN THE FIELD OF MEDICAL SUPPLIES; WHOLESALE ONLINE STORE FEATURING MEDICAL SUPPLIES, IN CLASS 35 (U.S. CLS. 100, 101 AND 102).

FIRST USE 1-0-1997; IN COMMERCE 1-0-1997.

THE MARK CONSISTS OF STANDARD CHARACTERS WITHOUT CLAIM TO ANY PARTICULAR FONT, STYLE, SIZE, OR COLOR.

SER. NO. 78-659,819, FILED 6-28-2005.

ALICE BENMAMAN, EXAMINING ATTORNEY

Int. Cl.: 36

Prior U.S. Cls.: 100, 101 and 102

United States Patent and Trademark Office

Reg. No. 3,394,834

Registered Mar. 11, 2008

SERVICE MARK  
PRINCIPAL REGISTER

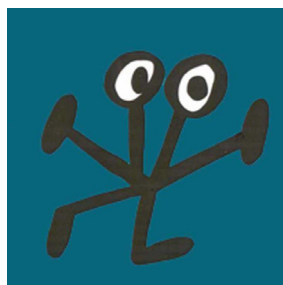

Bancaja

CAJA DE AHORROS DE VALENCIA, CASTEL-  
LON Y ALICANTE, BANCAJA (SPAIN COR-  
PORATION)  
PINTOR SOROLLA, 8  
VALENCIA, SPAIN 46002

FOR: INSURANCE AGENCY SERVICES; FINAN-  
CIAL SERVICES, NAMELY, CURRENCY EX-  
CHANGE AND ADVICE SERVICES; FINANCIAL  
CLEARINGHOUSE SERVICES; COOPERATIVE  
CREDIT ORGANIZATION SERVICES; INVEST-  
MENT MANAGEMENT TRUST SERVICES FOR  
HOLDING COMPANIES; BROKERAGE SERVICES  
RELATING TO STOCKS, BONDS AND REAL ES-  
TATE; REAL ESTATE TRUSTEE SERVICES AND  
TRUSTEESHIP REPRESENTATIVES; ISSUING TRAVELERS CHECKS, CREDIT CARDS AND LETTERS OF CREDIT; FINANCIAL ANALYSIS AND CONSULTATION; INVESTMENT BROKERAGE SERVICES FOR OTHERS; COLLECTION AND CREDIT AGENCIES, FIDUCIARY REPRESENTATIVE, LEASE-PURCHASE AND LOAN FINANCING SERVICES; SAFETY DEPOSIT BOX SERVICES; AND REAL ESTATE APPRAISAL AND MANAGEMENT, IN CLASS 36 (U.S. CLS. 100, 101 AND 102).

PRIORITY CLAIMED UNDER SEC. 44(D) ON  
ERPNTY TM OFC APPLICATION NO.  
004414918, FILED 4-29-2005, REG. NO. 004414918,  
DATED 5-18-2006, EXPIRES 4-29-2015.

OWNER OF U.S. REG. NO. 2,676,628.

THE COLORS BLUE, BLACK AND WHITE ARE  
CLAIMED AS A FEATURE OF THE MARK.

THE COLOR BLACK APPEARS IN THE APPEN-  
DAGES AND THE WORDING BANCAJA; THE  
COLOR WHITE APPEARS IN THE EYES AND  
RECTANGULAR BACKGROUND AND THE COL-  
OR BLUE APPEARS IN THE BACKGROUND OF  
THE APPENDAGES DESIGN.

THE MARK CONSISTS OF A FIGURE HAVING  
SIX APPENDAGES, THE TOP TWO OF WHICH ARE  
EYES, THE BOTTOM TWO OF WHICH ARE LEGS  
WITH FEET, AND TWO SIDE APPENDAGES ARE  
ARMS WITH HANDS, ALL OF WHICH ARE JOINED  
IN THE MIDDLE AND CENTERED IN A RECTAN-  
GLE. THE TERM BANCAJA IN STYLIZED LET-  
TERS APPEARS BELOW THE RECTANGLE.

SER. NO. 78-662,246, FILED 6-30-2005.

LESLEY LAMOTHE, EXAMINING ATTORNEY

**Int. Cl.: 35**

**Prior U.S. Cls.: 100, 101 and 102**

**United States Patent and Trademark Office**

**Reg. No. 3,394,835**

**Registered Mar. 11, 2008**

**SERVICE MARK  
PRINCIPAL REGISTER**

**SHIPVIA**

SHIPVIA INC. (CANADA CORPORATION)  
325 ST. LAWRENCE STREET  
WHITBY, ONTARIO, CANADA L1N 1H2

FOR: PROVIDING LOGISTICS MANAGEMENT SERVICES VIA AN E-COMMERCE WEBSITE, NAMELY COMPARING, ARRANGING, MANAGING, PLANNING, TRACKING AND TRACING SHIPMENTS IN TRANSIT FOR OTHERS, IN CLASS 35 (U.S. CLS. 100, 101 AND 102).

THE MARK CONSISTS OF STANDARD CHARACTERS WITHOUT CLAIM TO ANY PARTICULAR FONT, STYLE, SIZE, OR COLOR.

PRIORITY CLAIMED UNDER SEC. 44(D) ON CANADA APPLICATION NO. 1264219, FILED 7-8-2005, REG. NO. TMA684953, DATED 3-29-2007, EXPIRES 3-29-2022.

SER. NO. 78-668,824, FILED 7-12-2005.

ALICIA COLLINS, EXAMINING ATTORNEY

**Int. Cl.: 9**

**Prior U.S. Cls.: 21, 23, 26, 36 and 38**

**Reg. No. 3,394,836**

**United States Patent and Trademark Office**

**Registered Mar. 11, 2008**

---

**TRADEMARK  
PRINCIPAL REGISTER**

**TAXON**

KEYTONE TECHNOLOGIES INC. (CALIFORNIA  
CORPORATION)  
SUITE 200  
3140 DE LA CRUZ BLVD  
SANTA CLARA, CA 95054

FOR: COMPUTER SOFTWARE TO DESIGN, DE-  
VELOP, TEST, INTEGRATE AND MANAGE RFID  
ENABLED APPLICATIONS, IN CLASS 9 (U.S. CLS.  
21, 23, 26, 36 AND 38).

FIRST USE 7-1-2005; IN COMMERCE 7-1-2005.

THE MARK CONSISTS OF STANDARD CHAR-  
ACTERS WITHOUT CLAIM TO ANY PARTICULAR  
FONT, STYLE, SIZE, OR COLOR.

SER. NO. 78-669,199, FILED 7-13-2005.

NELSON SNYDER, EXAMINING ATTORNEY



**Int. Cl.: 16**

**Prior U.S. Cls.: 2, 5, 22, 23, 29, 37, 38 and 50**

**United States Patent and Trademark Office**

**Reg. No. 3,394,837**

**Registered Mar. 11, 2008**

**TRADEMARK  
PRINCIPAL REGISTER**

**TVB** | TELEVISION  
BROADCAST

NEWBAY MEDIA, LLC (DELAWARE LTD LIAB  
CO)  
810 7TH AVENUE  
NEW YORK, NY 10019

FOR: PRINT PUBLICATIONS, NAMELY, TECHNOLOGY, NEWS AND INFORMATION MAGAZINE IN THE FIELDS OF BROADCAST MANAGEMENT, ENGINEERING OPERATIONS, PRODUCTION MEDIA AND ENTERTAINMENT , IN CLASS 16 (U.S. CLS. 2, 5, 22, 23, 29, 37, 38 AND 50).

FIRST USE 6-17-2005; IN COMMERCE 6-17-2005.

NO CLAIM IS MADE TO THE EXCLUSIVE RIGHT TO USE "TELEVISION BROADCAST", APART FROM THE MARK AS SHOWN.

SEC. 2(F).

SER. NO. 78-669,569, FILED 7-13-2005.

JAMES STEIN, EXAMINING ATTORNEY

**Int. Cl.: 43**

**Prior U.S. Cls.: 100 and 101**

**United States Patent and Trademark Office**

**Reg. No. 3,394,838**

**Registered Mar. 11, 2008**

**SERVICE MARK  
PRINCIPAL REGISTER**



WESTIN HOTEL MANAGEMENT, L.P. (DELA-  
WARE LIMITED PARTNERSHIP)  
1111 WESTCHESTER AVENUE  
WHITE PLAINS, NY 10604

FIRST USE 8-0-2005; IN COMMERCE 8-0-2005.

OWNER OF U.S. REG. NO. 1,899,388.

FOR: HEALTH RESORT SERVICES, NAMELY,  
PROVIDING FOOD AND LODGING THAT SPECIA-  
LIZE IN PROMOTING PATRONS' GENERAL  
HEALTH AND WELL-BEING; HOTEL SERVICES  
FOR PREFERRED CUSTOMERS; HOTEL, BAR  
AND RESTAURANT SERVICES; HOTELS; MOTELS;  
RESORT HOTELS; RESORT LODGING SERVICES,  
IN CLASS 43 (U.S. CLS. 100 AND 101).

NO CLAIM IS MADE TO THE EXCLUSIVE  
RIGHT TO USE "KIDS CLUB", APART FROM THE  
MARK AS SHOWN.

SER. NO. 78-673,067, FILED 7-19-2005.

GRETTA YAO, EXAMINING ATTORNEY

**Int. Cl.: 35**

**Prior U.S. Cls.: 100, 101 and 102**

**United States Patent and Trademark Office**

**Reg. No. 3,394,839**

**Registered Mar. 11, 2008**

**SERVICE MARK  
PRINCIPAL REGISTER**



FARMACIA GUADALAJARA, S.A. DE C.V.  
(MEXICO CORPORATION)  
7573 CAMINO DE QUERABI  
TUCSON, AZ 85715

FOR: BUSINESS MARKETING SERVICES OF PHARMACEUTICAL PRODUCTS, GROCERIES, PERFUMERY, CONFECTIONERY, MAGAZINES, PERISHABLE FOOD ITEMS, CLEANING PRODUCTS, TOBACCO, ALCOHOLIC DRINKS, PHOTOGRAPHY ARTICLES, CARDS, DECORATION FIGURES, GAMES, TOYS, JEWELRY AND STATIONERY STORE ARTICLES NAMELY PAPER, ENVELOPES AND PENS; RETAIL STORE SERVICES FEATURING PHARMACEUTICAL PRODUCTS, GROCERIES, PERFUMERY, CONFECTIONERY, MAGAZINES, PERISHABLE FOOD ITEMS, CLEANING PRODUCTS, TOBACCO, ALCOHOLIC DRINKS, PHOTOGRAPHY ARTICLES, CARDS, DECORATION FIGURES, GAMES, TOYS, JEWELRY AND STATIONERY STORE ARTICLES NAMELY PAPER, ENVELOPES AND PENS, IN CLASS 35 (U.S. CLS. 100, 101 AND 102).

OWNER OF MEXICO REG. NO. 862446, DATED 11-30-2004, EXPIRES 9-27-2014.

NO CLAIM IS MADE TO THE EXCLUSIVE RIGHT TO USE "FARMACIAS GUADALAJARA", APART FROM THE MARK AS SHOWN.

THE COLOR(S) BLUE AND WHITE IS/ARE CLAIMED AS A FEATURE OF THE MARK.

THE MARK CONSISTS OF AN OVAL DESIGN IN BLUE AND THE LINING DESIGNS AND WORDING WITHIN THE OVAL DESIGN ARE WHITE.

THE FOREIGN WORDING IN THE MARK TRANSLATES INTO ENGLISH AS PHARMACIES GUADALAJARA.

SER. NO. 78-673,390, FILED 7-19-2005.

DANIEL CAPSHAW, EXAMINING ATTORNEY

**Int. Cl.: 41**

**Prior U.S. Cls.: 100, 101 and 107**

**United States Patent and Trademark Office**

**Reg. No. 3,394,840**

**Registered Mar. 11, 2008**

**SERVICE MARK  
PRINCIPAL REGISTER**

# PROFORMA

AMSAN, LLC (DELAWARE LIMITED LIABILITY  
COMPANY)  
3 PARKWAY NORTH SUITE 120  
DEERFIELD, IL 60015

THE MARK CONSISTS OF STANDARD CHAR-  
ACTERS WITHOUT CLAIM TO ANY PARTICULAR  
FONT, STYLE, SIZE, OR COLOR.

FOR: EDUCATION AND TRAINING PROGRAMS  
IN THE FIELDS OF JANITORIAL AND SANITARY  
MAINTENANCE AND COST MANAGEMENT, IN  
CLASS 41 (U.S. CLS. 100, 101 AND 107).

SER. NO. 78-674,193, FILED 7-20-2005.

FIRST USE 1-30-2004; IN COMMERCE 1-30-2004.

STEVEN PEREZ, EXAMINING ATTORNEY

**Int. Cls.: 9 and 25**

**Prior U.S. Cls.: 21, 22, 23, 26, 36, 38 and 39**

**United States Patent and Trademark Office**

**Reg. No. 3,394,841**

**Registered Mar. 11, 2008**

**TRADEMARK  
PRINCIPAL REGISTER**



WALL, CONRAD (UNITED KINGDOM INDIVIDUAL)  
14 CHANDLERS HOUSE, 38 OLD LONDON ROAD  
KINGSTON-UPON-THAMES  
SURREY, UNITED KINGDOM KT2 6QF

FOR: SOUND, VIDEO AND DATA RECORDING AND REPRODUCING APPARATUS; VIDEO GAME MACHINES FOR USE WITH TELEVISION SCREENS AND VIDEO MONITORS; COMPUTER, ELECTRONIC AND VIDEO GAME PROGRAMS, SOFTWARE AND CARTRIDGES; ELECTRONIC GAMES SOFTWARE FOR CELLULAR TELEPHONES; COMPACT DISCS, TAPES, CARTRIDGES AND ELECTRONIC CARDS FEATURING SOUND RECORDINGS, VIDEO RECORDINGS, DATA, IMAGES, GAMES, GRAPHICS, TEXT AND COMPUTER PROGRAMS; BLANK COMPACT DISCS, TAPES, CARTRIDGES AND ELECTRONIC CARDS FOR USE IN RECORDING SOUND RECORDINGS, VIDEO RECORDINGS, DATA, IMAGES, GAMES, GRAPHICS, TEXT AND COMPUTER PROGRAMS; MEMORY CARRIERS IN THE NATURE OF BOARDS AND CARDS; PARTS AND FITTINGS

FOR ALL THE AFORESAID GOODS, IN CLASS 9 (U.S. CLS. 21, 23, 26, 36 AND 38).

FOR: ARTICLES OF CLOTHING, FOOTWEAR AND HEADGEAR, NAMELY, T-SHIRTS, SPORTS SHOES, TRAINERS, BOOTS, WALKING BOOTS, FOOTBALL BOOTS, SHOES, CYCLING SHOES, COATS; JACKETS, ANORAKS, PULLOVERS, TROUSERS, JEANS, SHIRTS, CAGOULES, SMOCK AND SALOPETTES; GLOVES, HATS, CAPS, BALACLAVAS, SOCKS, UNDERWEAR AND GAITERS; WET SUITS; GLOVES, FISHING SMOCKS; FISHING JACKETS, BOOTS AND VESTS, IN CLASS 25 (U.S. CLS. 22 AND 39).

OWNER OF UNITED KINGDOM REG. NO. 2377537, DATED 9-2-2005, EXPIRES 11-6-2014.

THE MARK CONSISTS OF THE TEXT CANNONBALL 8000 INSIDE AN OVAL.

SER. NO. 78-678,168, FILED 7-26-2005.

LAURA KOVALSKY, EXAMINING ATTORNEY

Int. Cl.: 42

Prior U.S. Cls.: 100 and 101

United States Patent and Trademark Office

Reg. No. 3,394,842

Registered Mar. 11, 2008

SERVICE MARK  
PRINCIPAL REGISTER



ARENA SOLUTIONS, INC. (CALIFORNIA CORPORATION)  
4100 E. THIRD AVENUE, SUITE 300  
FOSTER CITY, CA 94404

FOR: PROVIDING NON-DOWNLOADABLE SOFTWARE VIA COMPUTER AND COMMUNICATION NETWORKS FOR PRODUCT LIFECYCLE MANAGEMENT AND PRODUCT DATA MANAGEMENT; PROVIDING NON-DOWNLOADABLE SOFTWARE VIA COMPUTER AND COMMUNICATION NETWORKS FOR MANAGING, ORGANIZING, AND COMMUNICATING MANUFACTURING PRODUCT DATA, PROCESSES, AND LIFECYCLE FOR PROVIDERS OF GOODS, ORIGINAL EQUIPMENT MANUFACTURERS, SUPPLIERS AND OUTSOURCE PARTNERS; PROVIDING NON-DOWNLOADABLE SOFTWARE VIA COMPUTER AND COMMUNICATION NETWORKS FOR BILL OF MATERIALS MANAGEMENT; PROVIDING NON-DOWNLOADABLE SOFTWARE VIA COMPUTER AND COMMUNICATION NETWORKS FOR COLLABORATING WITH CUSTOMERS, VENDORS, AND PARTNERS ON PRODUCT MANUFACTURING; PROVIDING NON-DOWNLOADABLE SOFTWARE VIA COMPUTER AND COMMUNICATION NETWORKS FOR MANAGING THE SUBMISSION AND APPROVAL OF ENGINEERING AND MANUFACTURING CHANGE REQUESTS AND CHANGE ORDERS; PROVIDING NON-DOWNLOADABLE SOFTWARE VIA COMPUTER AND COMMUNICATION NETWORKS FOR CONFORMING BUSINESS, ENGINEERING, PRODUCT PLANNING, AND MANUFACTURING PROCESSES TO REGULATORY REQUIREMENTS; PROVIDING NON-DOWNLOADABLE SOFTWARE VIA COMPUTER AND COMMUNICATION NETWORKS ENABLING

USERS TO CREATE REPOSITORIES OF PRODUCT DATA, PRODUCT AND COMPONENT SPECIFICATIONS, ENGINEERING DRAWINGS, PROJECT PLANS, PART NAMES AND NUMBERS, AND GEOMETRY FILES; APPLICATION SERVICE PROVIDER SERVICES, NAMELY HOSTING OF COMPUTER SOFTWARE APPLICATIONS FOR USE BY OTHERS; TECHNICAL SUPPORT SERVICES, NAMELY, TROUBLESHOOTING OF COMPUTER SOFTWARE PROBLEMS; PROFESSIONAL SERVICES FOR THE IMPLEMENTATION AND CUSTOMIZATION OF HOSTED COMPUTER SOFTWARE SOLUTIONS EXCLUDING FOR USE IN CONNECTION WITH FINANCIAL SERVICES, PAYMENT CARD, BANK CARD, DEBIT CARD, CREDIT CARD, CHARGE CARD, MAGNETIC ENCODED CARD, STORED VALUE AND/OR PREPAID CARD SERVICES, OR ATM SERVICES, IN CLASS 42 (U.S. CLS. 100 AND 101).

FIRST USE 1-0-2003; IN COMMERCE 1-0-2003.

"THE COLOR(S) PEACH, ORANGE, BLACK, AND WHITE IS/ARE CLAIMED AS A FEATURE OF THE MARK."

THE MARK CONSISTS OF A PEACH-COLORED CIRCLE ON THE LEFT, PARTIALLY OVERLAPPING WITH AN ORANGE CIRCLE ON THE RIGHT, WITH THE AREA OF OVERLAP IN WHITE, ALL POSITIONED SEPARATELY FROM THE WORD "ARENA" IN BLACK.

SER. NO. 78-688,473, FILED 8-9-2005.

JENNIFER MARTIN, EXAMINING ATTORNEY

**Int. Cls.: 16 and 41**

**Prior U.S. Cls.: 2, 5, 22, 23, 29, 37, 38, 50, 100, 101 and 107**

**Reg. No. 3,394,843**

**United States Patent and Trademark Office**

**Registered Mar. 11, 2008**

**TRADEMARK  
SERVICE MARK  
PRINCIPAL REGISTER**

# Centro

MEDIA GENERAL COMMUNICATIONS HOLDINGS, LLC (DELAWARE LTD LIAB CO)  
33 EAST FRANKLIN STREET  
RICHMOND, VA 23219

FOR: SPANISH LANGUAGE NEWSPAPER COVERING CURRENT EVENTS AND MATTERS OF GENERAL INTEREST NOT FOCUSED ON RELIGION, IN CLASS 16 (U.S. CLS. 2, 5, 22, 23, 29, 37, 38 AND 50).

FIRST USE 10-1-2005; IN COMMERCE 10-1-2005.

FOR: PUBLICATION OF ELECTRONIC SPANISH LANGUAGE NEWSPAPER COVERING CURRENT EVENTS AND MATTERS OF GENERAL INTEREST NOT FOCUSED ON RELIGION ACCESSIBLE VIA A

GLOBAL COMPUTER NETWORK, IN CLASS 41 (U.S. CLS. 100, 101 AND 107).

FIRST USE 9-15-2005; IN COMMERCE 9-15-2005.

THE MARK CONSISTS OF STANDARD CHARACTERS WITHOUT CLAIM TO ANY PARTICULAR FONT, STYLE, SIZE, OR COLOR.

THE FOREIGN WORDING IN THE MARK TRANSLATES INTO ENGLISH AS CENTER OR MIDDLE.

SER. NO. 78-697,191, FILED 8-22-2005.

CAROLINE WOOD, EXAMINING ATTORNEY

**Int. Cl.: 18**

**Prior U.S. Cls.: 1, 2, 3, 22 and 41**

**United States Patent and Trademark Office**

**Reg. No. 3,394,844**

**Registered Mar. 11, 2008**

**TRADEMARK  
PRINCIPAL REGISTER**

# Siege Gear

REED, SCOTT (UNITED STATES INDIVIDUAL)  
1134 EAST HARRISON AVENUE  
SALT LAKE CITY, UT 84105

FOR: OUTDOOR GEAR, NAMELY, BACKPACKS,  
IN CLASS 18 (U.S. CLS. 1, 2, 3, 22 AND 41).

FIRST USE 5-1-2005; IN COMMERCE 5-1-2005.

THE MARK CONSISTS OF STANDARD CHAR-  
ACTERS WITHOUT CLAIM TO ANY PARTICULAR  
FONT, STYLE, SIZE, OR COLOR.

NO CLAIM IS MADE TO THE EXCLUSIVE  
RIGHT TO USE "GEAR", APART FROM THE  
MARK AS SHOWN.

SER. NO. 78-705,093, FILED 9-1-2005.

ALICIA COLLINS, EXAMINING ATTORNEY



**Int. Cl.: 25**

**Prior U.S. Cls.: 22 and 39**

**United States Patent and Trademark Office**

**Reg. No. 3,394,845**

**Registered Mar. 11, 2008**

**TRADEMARK  
PRINCIPAL REGISTER**

**OUTER RIDGE**

LEISUREWEAR CANADA LTD. (CANADA CORPORATION)  
2345 WHITTINGTON DRIVE  
PETERBOROUGH, CANADA K9J 7H6

FOR: CLOTHING, NAMELY, COATS, JACKETS, WINDSHIRTS, GOLF SHIRTS, SWEATERS, VESTS, PANTS, SHORTS, SWEATSHIRTS, RUNNING SUITS, SHIRTS, MOCKNECK SHIRTS, TURTLENECK SHIRTS, HENLEY SHIRTS, TRACKSUITS, AND T-SHIRTS, IN CLASS 25 (U.S. CLS. 22 AND 39).

THE MARK CONSISTS OF STANDARD CHARACTERS WITHOUT CLAIM TO ANY PARTICULAR FONT, STYLE, SIZE, OR COLOR.

PRIORITY CLAIMED UNDER SEC. 44(D) ON CANADA APPLICATION NO. 1265817, FILED 7-22-2005, REG. NO. TMA699,326, DATED 10-23-2007, EXPIRES 10-23-2022.

SER. NO. 78-707,774, FILED 9-7-2005.

ESTHER A. BORSUK, EXAMINING ATTORNEY

**Int. Cls.: 17 and 40**

**Prior U.S. Cls.: 1, 5, 12, 13, 35, 50, 100, 103 and 106**

**United States Patent and Trademark Office**

**Reg. No. 3,394,846**

**Registered Mar. 11, 2008**

**TRADEMARK  
SERVICE MARK  
PRINCIPAL REGISTER**

**PUTNAM PLASTICS**

PUTNAM PLASTICS COMPANY LLC (CONNECTICUT LIMITED LIABILITY COMPANY)  
C/O MEMRY CORPORATION  
3 BERKSHIRE BOULEVARD;  
BETHEL, CT 06801

FOR: EXTRUDED POLYMER TUBING, FILM, AND SOLID PELLETS WHICH ARE MELTED AND EXTRUDED ON RODS OR WIRES IN THE NATURE OF COATINGS, SOLD AS SEMI-FINISHED PRODUCTS FOR USE IN THE FURTHER MANUFACTURE OF INDUSTRIAL AND MEDICAL DEVICES, IN CLASS 17 (U.S. CLS. 1, 5, 12, 13, 35 AND 50).

FIRST USE 0-0-1984; IN COMMERCE 0-0-1986.

FOR: CUSTOM MANUFACTURING OF PRODUCTS MADE OF PLASTICS MOLDED BY INJECTION OR EXTRUSION PROCEDURES FOR DIVERSE INDUSTRIES; MANUFACTURE OF PRODUCTS MADE OF PLASTICS MOLDED BY INJECTION OR EXTRUSION PROCEDURES FOR DIVERSE INDUSTRIES TO THE ORDER AND

SPECIFICATION OF OTHERS; CUSTOM TOOLING, FIXTURING, AND COATING TO THE ORDER AND SPECIFICATIONS OF OTHERS FOR MANUFACTURE OF PLASTIC MATERIALS, IN CLASS 40 (U.S. CLS. 100, 103 AND 106).

FIRST USE 0-0-1984; IN COMMERCE 0-0-1986.

THE MARK CONSISTS OF STANDARD CHARACTERS WITHOUT CLAIM TO ANY PARTICULAR FONT, STYLE, SIZE, OR COLOR.

NO CLAIM IS MADE TO THE EXCLUSIVE RIGHT TO USE "PLASTICS", APART FROM THE MARK AS SHOWN.

SEC. 2(F).

SER. NO. 78-708,231, FILED 9-7-2005.

MICHAEL ENGEL, EXAMINING ATTORNEY

**Int. Cl.: 36**

**Prior U.S. Cls.: 100, 101 and 102**

**United States Patent and Trademark Office**

**Reg. No. 3,394,847**

**Registered Mar. 11, 2008**

**SERVICE MARK  
PRINCIPAL REGISTER**

**HIGH-TOUCH SERVICE**

WARNER PACIFIC INSURANCE SERVICES (CALIFORNIA CORPORATION)  
32110 AGOURA ROAD  
WESTLAKE VILLAGE, CA 913614026

FOR: INSURANCE BROKERAGE IN THE FIELD OF MEDICAL, DENTAL, VISION, WORKER'S COMPENSATION, AND LIFE INSURANCE, IN CLASS 36 (U.S. CLS. 100, 101 AND 102).

FIRST USE 3-1-1998; IN COMMERCE 3-1-1998.

THE MARK CONSISTS OF STANDARD CHARACTERS WITHOUT CLAIM TO ANY PARTICULAR FONT, STYLE, SIZE, OR COLOR.

OWNER OF U.S. REG. NO. 2,284,277.

NO CLAIM IS MADE TO THE EXCLUSIVE RIGHT TO USE "SERVICE", APART FROM THE MARK AS SHOWN.

SEC. 2(F).

SER. NO. 78-709,366, FILED 9-8-2005.

HOWARD B. LEVINE, EXAMINING ATTORNEY

**Int. Cl.: 41**

**Prior U.S. Cls.: 100, 101 and 107**

**United States Patent and Trademark Office**

**Reg. No. 3,394,848**

**Registered Mar. 11, 2008**

**SERVICE MARK  
PRINCIPAL REGISTER**

**The Freeman Institute**

FREEMAN, JOEL, A. (UNITED STATES INDIVIDUAL)  
1103 BURKHARDT LANE  
SEVERN, MD 21144

FOR: CONDUCTING WORKSHOPS AND SEMINARS IN TEAM BUILDING, DIVERSITY, FAMILY BUSINESS ISSUES, BLACK HISTORY, LEADERSHIP, ANGER MANAGEMENT, SALES, CORPORATE CULTURE CHANGE, STRESS MANAGEMENT, AND CUSTOMER SERVICE, IN CLASS 41 (U.S. CLS. 100, 101 AND 107).

FIRST USE 1-1-1993; IN COMMERCE 5-11-1993.

THE MARK CONSISTS OF STANDARD CHARACTERS WITHOUT CLAIM TO ANY PARTICULAR FONT, STYLE, SIZE, OR COLOR.

NO CLAIM IS MADE TO THE EXCLUSIVE RIGHT TO USE "INSTITUTE", APART FROM THE MARK AS SHOWN.

SER. NO. 78-712,549, FILED 9-14-2005.

INGRID C. EULIN, EXAMINING ATTORNEY

**Int. Cls.: 9 and 35**

**Prior U.S. Cls.: 21, 23, 26, 36, 38, 100, 101 and 102**

**United States Patent and Trademark Office**

**Reg. No. 3,394,849**

**Registered Mar. 11, 2008**

**TRADEMARK  
SERVICE MARK  
PRINCIPAL REGISTER**

**qu $\alpha$ ntcast**

QUANTCAST CORPORATION (DELAWARE CORPORATION)  
400 SECOND ST., SUITE 350  
SAN FRANCISCO, CA 94107

FOR: COMPUTER SOFTWARE FOR THE MEASUREMENT, ANALYSIS AND EXCHANGE OF ONLINE ADVERTISING, IN CLASS 9 (U.S. CLS. 21, 23, 26, 36 AND 38).

FIRST USE 9-19-2006; IN COMMERCE 9-19-2006.

FOR: ADVERTISING AND ADVERTISEMENT SERVICES; ADVERTISING BY TRANSMISSION OF ONLINE PUBLICITY FOR THIRD PARTIES THROUGH ELECTRONIC COMMUNICATIONS NETWORKS; ADVERTISING VIA ELECTRONIC MEDIA AND SPECIFICALLY THE INTERNET; DISSEMINATION OF ADVERTISING FOR OTHERS VIA THE INTERNET; MEDIATION OF ADVERTISING; SERVICES TO DETERMINE THE AUDIENCE AFFECTED BY ADVERTISEMENTS, IN CLASS 35 (U.S. CLS. 100, 101 AND 102).

FIRST USE 9-19-2006; IN COMMERCE 9-19-2006.

THE COLOR(S) BLACK AND PURPLE IS/ARE CLAIMED AS A FEATURE OF THE MARK.

THE COLOR BLACK IS IN LETTERING OF THE MARK WITH PURPLE ALPHA SYMBOL.

THE MARK CONSISTS OF THE WORD "QUANTCAST" IN LOWER CASE WITH THE FIRST "A" REPLACED BY A LOWER CASE GREEK 'ALPHA' SYMBOL. THE SYMBOL IS SHOWN IN A CONTRASTING COLOR TO THE SURROUNDING TEXT.

SER. NO. 78-714,513, FILED 9-16-2005.

DOMINIC J. FERRAIUOLO, EXAMINING ATTORNEY

**Int. Cl.: 12**

**Prior U.S. Cls.: 19, 21, 23, 31, 35 and 44**

**Reg. No. 3,394,850**

**United States Patent and Trademark Office**

**Registered Mar. 11, 2008**

**TRADEMARK  
PRINCIPAL REGISTER**

**MICRALITE**

MICRALITE LIMITED (UNITED KINGDOM  
CORPORATION)  
76 CALVERLEY ROAD, TUNBRIDGE WELLS  
KENT, UNITED KINGDOM TN1 2UJ

FOR: CARRIAGES FOR BABIES AND TOD-  
DLERS, STROLLERS FOR BABIES AND TOD-  
DLERS, PRAMS FOR BABIES AND TODDLERS,  
AND PARTS AND FITTINGS FOR ALL THE  
AFORESAID GOODS, IN CLASS 12 (U.S. CLS. 19,  
21, 23, 31, 35 AND 44).

THE MARK CONSISTS OF STANDARD CHAR-  
ACTERS WITHOUT CLAIM TO ANY PARTICULAR  
FONT, STYLE, SIZE, OR COLOR.

OWNER OF ERPN CMNTY TM OFC REG. NO.  
3898343, DATED 9-2-2005, EXPIRES 6-16-2014.

SER. NO. 78-717,092, FILED 9-20-2005.

TASNEEM HUSSAIN, EXAMINING ATTORNEY

**Int. Cls.: 35, 37, 40, 41 and 42**

**Prior U.S. Cls.: 100, 101, 102, 103, 106 and 107**

**United States Patent and Trademark Office**

**Reg. No. 3,394,851**

**Registered Mar. 11, 2008**

**SERVICE MARK  
PRINCIPAL REGISTER**

**INNOVATIVE SOLUTIONS FOR  
SPACE EXPLORATION**

UNITED SPACE ALLIANCE, LLC (DELAWARE  
LTD LIAB CO)  
8550 ASTRONAUT BOULEVARD  
CAPE CANAVERAL, FL 329204304

FOR: FACILITIES MANAGEMENT OF TECHNICAL OPERATIONS; INVENTORY PLANNING IN THE NATURE OF INVENTORY MANAGEMENT AND INVENTORY CONTROL, BOTH FOR SPACE FLIGHT AND SPACE EXPLORATION MISSIONS; BUSINESS MANAGEMENT SERVICES, NAMELY, LOGISTICS AND SUPPLY CHAIN MANAGEMENT; TESTING, ANALYSIS AND EVALUATION OF THE PROFESSIONAL PROFICIENCY OF OTHERS FOR PURPOSES OF CERTIFICATION; AND LOGISTICS MANAGEMENT IN THE FIELDS OF SPACE FLIGHT AND SPACE EXPLORATION MISSIONS, SPACE FACILITIES OPERATIONS, SPACE HARDWARE PROCESSING, VEHICLE PROCESSING RELATED TO SPACE HARDWARE, RISK ASSESSMENT TASKS RELATED TO SPACE FLIGHTS, SPACE MISSION PLANNING AND CONTROL, AND IN THE FIELDS OF SPACE MISSION CONFIGURATION VERIFICATION, CONFIGURATION MANAGEMENT, PAYLOAD MANAGEMENT, PAYLOAD PLANNING AND PAYLOAD INTEGRATION, IN CLASS 35 (U.S. CLS. 100, 101 AND 102).

FIRST USE 1-31-2005; IN COMMERCE 1-31-2005.

FOR: MAINTENANCE OF SPACE FLIGHT AND SPACE EXPLORATION FACILITIES; REPAIR AND MAINTENANCE OF VEHICLES AND PLATFORMS FOR USE IN SPACE FLIGHT AND SPACE EXPLORATION; REPAIR, SERVICING AND MAINTENANCE OF VEHICLES AND APPARATUS FOR LOCOMOTION BY AIR, IN SPACE AND ON EXTRATERRESTRIAL SURFACES, IN CLASS 37 (U.S. CLS. 100, 103 AND 106).

FIRST USE 1-31-2005; IN COMMERCE 1-31-2005.

FOR: ASSEMBLY OF SPACECRAFT AND VEHICLES TO THE ORDER AND SPECIFICATION OF OTHERS, IN CLASS 40 (U.S. CLS. 100, 103 AND 106).

FIRST USE 1-31-2005; IN COMMERCE 1-31-2005.

FOR: SPACE FLIGHT AND SPACE EXPLORATION SYSTEMS TRAINING; SPACE LAUNCH AND FLIGHT CONTROLLER TRAINING; COMPUTER HARDWARE PROCESSING TRAINING, IN CLASS 41 (U.S. CLS. 100, 101 AND 107).

FIRST USE 1-31-2005; IN COMMERCE 1-31-2005.

FOR: ENGINEERING PROJECT MANAGEMENT IN THE FIELDS OF SPACE SHUTTLE AND OTHER SPACE FLIGHT MISSIONS, SPACE EXPLORATION MISSIONS, SPACE FLIGHT LAUNCHES, SPACE FLIGHT OPERATIONS, AND GROUND OPERATIONS RELATED TO SPACE FLIGHT MISSIONS; SPACE EXPLORATION OPERATIONS, NAMELY, AEROSPACE ENGINEERING TECHNICAL CONSULTATION, ENGINEERING, AEROSPACE ENGINEERING, AND SYSTEMS ENGINEERING SERVICES, ALL FOR THE SPACE EXPLORATION AND SPACE FLIGHT INDUSTRIES IN THE AREAS OF MISSION CONTROL SYSTEMS OPERATION AND MANAGEMENT, FLIGHT DESIGN AND INTEGRATED MISSION PLANNING, SIMULATION AND EXECUTION, SPACE FLIGHT MISSION CONTINGENCY PLANNING AND EXECUTION, AND OPERATIONAL TECHNICAL SUPPORT AND ANALYSIS OF MISSION-RELATED COMPUTER HARDWARE AND SOFTWARE; ENGINEERING CONTINGENCY PLANNING AND EXECUTION IN THE NATURE OF ENGINEERING SERVICES INVOLVING THE DESIGN OF EQUIPMENT FOR SPACE FLIGHT AND SPACE EXPLORATION MISSIONS; ORBITAL SYSTEMS CONTROL AND MANAGEMENT IN THE FIELD OF SPACE FLIGHT AND SPACE EXPLORATION, NAMELY, TECHNICAL SUPPORT IN THE NATURE OF TROUBLESHOOT-

ING COMPUTER HARDWARE AND SOFTWARE PROBLEMS FOR ORBITAL ELECTRONIC COMMUNICATIONS EQUIPMENT AND MONITORING OF COMPUTER AND ELECTRONIC NETWORK SYSTEMS USED BOTH ON THE GROUND AND ON SPACE CRAFT IN THE FIELD OF SPACE FLIGHT AND SPACE EXPLORATION; REAL-TIME SYSTEMS AND CONTROL SYSTEMS CENTER OPERATIONS IN THE NATURE OF TECHNICAL SUPPORT IN THE NATURE OF TROUBLESHOOTING COMPUTER HARDWARE AND SOFTWARE PROBLEMS FOR THE ELECTRONIC COMMUNICATION NETWORKS AND EQUIPMENT THAT ARE USED FOR SPACE FLIGHT AND SPACE EXPLORATION; REVIEWING STANDARDS AND PRACTICES TO ENSURE COMPLIANCE WITH LAWS, REGULATIONS AND INDUSTRY STANDARDS PERTAINING TO SPACE FLIGHT AND SPACE EXPLORATION PROGRAMS; SOFTWARE DEVELOPMENT AND INTEGRATION IN THE

FIELD OF SPACE FLIGHT AND SPACE EXPLORATION; AND PROVIDING QUALITY ASSURANCE SERVICES IN THE FIELD OF SPACE EXPLORATION AND SPACE FLIGHT PROGRAMS, IN CLASS 42 (U.S. CLS. 100 AND 101).

FIRST USE 1-31-2005; IN COMMERCE 1-31-2005.

THE MARK CONSISTS OF STANDARD CHARACTERS WITHOUT CLAIM TO ANY PARTICULAR FONT, STYLE, SIZE, OR COLOR.

NO CLAIM IS MADE TO THE EXCLUSIVE RIGHT TO USE "SPACE EXPLORATION", APART FROM THE MARK AS SHOWN.

SER. NO. 78-717,816, FILED 9-21-2005.

CAROLYN GRAY, EXAMINING ATTORNEY



**Int. Cl.: 35**

**Prior U.S. Cls.: 100, 101 and 102**

**United States Patent and Trademark Office**

**Reg. No. 3,394,852**

**Registered Mar. 11, 2008**

**SERVICE MARK  
PRINCIPAL REGISTER**

**BUILD YOUR OWN EARRINGS**

BLUE NILE, INC. (DELAWARE CORPORATION)  
705 FIFTH AVENUE SOUTH, SUITE 900  
SEATTLE, WA 98104

FOR: ONLINE RETAIL STORE SERVICES IN THE  
FIELD OF JEWELRY, IN CLASS 35 (U.S. CLS. 100, 101  
AND 102).

FIRST USE 4-18-2002; IN COMMERCE 4-18-2002.

THE MARK CONSISTS OF STANDARD CHAR-  
ACTERS WITHOUT CLAIM TO ANY PARTICULAR  
FONT, STYLE, SIZE, OR COLOR.

NO CLAIM IS MADE TO THE EXCLUSIVE  
RIGHT TO USE "EARRINGS", APART FROM THE  
MARK AS SHOWN.

SEC. 2(F).

SER. NO. 78-724,606, FILED 9-30-2005.

LINDA POWELL, EXAMINING ATTORNEY

**Int. Cl.: 35**

**Prior U.S. Cls.: 100, 101 and 102**

**United States Patent and Trademark Office**

**Reg. No. 3,394,853**

**Registered Mar. 11, 2008**

**SERVICE MARK  
PRINCIPAL REGISTER**

**BUILD YOUR OWN  
THREE-STONE RING**

BLUE NILE, INC. (DELAWARE CORPORATION)  
705 FIFTH AVENUE SOUTH, SUITE 900  
SEATTLE, WA 98104

FOR: ONLINE RETAIL STORE SERVICES IN THE  
FIELD OF JEWELRY, IN CLASS 35 (U.S. CLS. 100, 101  
AND 102).

FIRST USE 7-29-2003; IN COMMERCE 7-29-2003.

THE MARK CONSISTS OF STANDARD CHAR-  
ACTERS WITHOUT CLAIM TO ANY PARTICULAR  
FONT, STYLE, SIZE, OR COLOR.

NO CLAIM IS MADE TO THE EXCLUSIVE  
RIGHT TO USE "THREE-STONE RING", APART  
FROM THE MARK AS SHOWN.

SEC. 2(F).

SER. NO. 78-724,608, FILED 9-30-2005.

LINDA POWELL, EXAMINING ATTORNEY

**Int. Cl.: 14**

**Prior U.S. Cls.: 2, 27, 28 and 50**

**United States Patent and Trademark Office**

**Reg. No. 3,394,854**

**Registered Mar. 11, 2008**

**TRADEMARK  
PRINCIPAL REGISTER**

**ANA EUGENIA**

HINKES, ANNA (UNITED STATES INDIVIDUAL)  
3243 CALLE DE DEBORAH, NW  
ALBUQUERQUE, NM 871043001

FOR: JEWELRY, IN CLASS 14 (U.S. CLS. 2, 27, 28 AND 50).

FIRST USE 2-20-2004; IN COMMERCE 6-26-2004.

THE MARK CONSISTS OF STANDARD CHARACTERS WITHOUT CLAIM TO ANY PARTICULAR FONT, STYLE, SIZE, OR COLOR.

THE NAME "ANA EUGENIA" DOES NOT IDENTIFY A LIVING INDIVIDUAL.

THE ENGLISH TRANSLATION OF THE WORD "EUGENIA" IN THE MARK IS "TROPICAL TREE".

SER. NO. 78-725,346, FILED 10-3-2005.

REBECCA EISINGER, EXAMINING ATTORNEY

Int. Cl.: 41

Prior U.S. Cls.: 100, 101 and 107

United States Patent and Trademark Office

Reg. No. 3,394,855

Registered Mar. 11, 2008

**SERVICE MARK  
PRINCIPAL REGISTER**

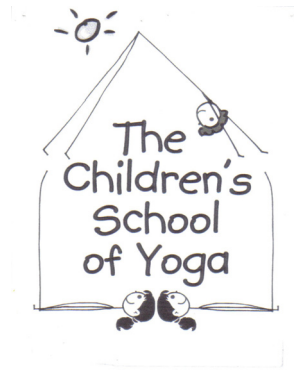

FOXWELL, DOREEN B. (NEW YORK SOLE  
PROPRIETORSHIP)  
32 BUCKINGHAM CIRCLE  
ROCK HILL, NY 12775

FOR: YOGA INSTRUCTION, IN CLASS 41 (U.S.  
CLS. 100, 101 AND 107).

FIRST USE 4-1-2004; IN COMMERCE 4-1-2004.

NO CLAIM IS MADE TO THE EXCLUSIVE  
RIGHT TO USE "THE CHILDREN'S SCHOOL OF  
YOGA", APART FROM THE MARK AS SHOWN.

THE MARK CONSISTS OF THE COMPANY  
NAME WITHIN THE COMPANY LOGO.

SER. NO. 78-732,305, FILED 10-13-2005.

CHRIS WELLS, EXAMINING ATTORNEY

**Int. Cl.: 41**

**Prior U.S. Cls.: 100, 101 and 107**

**United States Patent and Trademark Office**

**Reg. No. 3,394,856**

**Registered Mar. 11, 2008**

**SERVICE MARK  
PRINCIPAL REGISTER**

**ORANGE SHOE GYM**

ORANGE SHOE GYM HOLDINGS INCORPORATED (WISCONSIN CORPORATION)  
6220 NESBITT ROAD  
FITCBURG, WI 53719

FOR: HEALTH CLUB SERVICES, NAMELY, PROVIDING INSTRUCTION AND EQUIPMENT IN THE FIELD OF PHYSICAL EXERCISE, IN CLASS 41 (U.S. CLS. 100, 101 AND 107).

FIRST USE 10-1-2004; IN COMMERCE 10-1-2004.

THE MARK CONSISTS OF STANDARD CHARACTERS WITHOUT CLAIM TO ANY PARTICULAR FONT, STYLE, SIZE, OR COLOR.

NO CLAIM IS MADE TO THE EXCLUSIVE RIGHT TO USE "GYM", APART FROM THE MARK AS SHOWN.

SER. NO. 78-741,047, FILED 10-26-2005.

BARNEY CHARLON, EXAMINING ATTORNEY

**Int. Cl.: 2**

**Prior U.S. Cls.: 6, 11 and 16**

**United States Patent and Trademark Office**

**Reg. No. 3,394,857**

**Registered Mar. 11, 2008**

**TRADEMARK  
PRINCIPAL REGISTER**

**X-100 NATURAL SEAL**

AMERICAN BUILDING RESTORATION PRO-  
DUCTS, INC. (WISCONSIN CORPORATION)  
9720 S 60TH STREET  
FRANKLIN, WI 53132

FOR: WOOD PRESERVATIVES; COATINGS,  
NAMELY, STAINS, PROTECTIVE GLOSSES, PRE-  
FINISHES, FINISHES AND PAINTS FOR EXTERIOR  
AND INTERIOR USE ON A VARIETY OF SURFA-  
CES; SEALER COATINGS FOR USE ON EXTERIOR  
AND INTERIOR WOOD SURFACES; WATER-  
PROOF COATINGS FOR WOOD, IN CLASS 2 (U.S.  
CLS. 6, 11 AND 16).

FIRST USE 12-5-1986; IN COMMERCE 12-5-1986.

THE MARK CONSISTS OF STANDARD CHAR-  
ACTERS WITHOUT CLAIM TO ANY PARTICULAR  
FONT, STYLE, SIZE, OR COLOR.

OWNER OF U.S. REG. NOS. 1,552,423 AND  
2,277,792.

NO CLAIM IS MADE TO THE EXCLUSIVE  
RIGHT TO USE "NATURAL SEAL", APART FROM  
THE MARK AS SHOWN.

SER. NO. 78-751,526, FILED 11-10-2005.

LINDA MICKLEBURGH, EXAMINING ATTORNEY

**Int. Cl.: 41**

**Prior U.S. Cls.: 100, 101 and 107**

**United States Patent and Trademark Office**

**Reg. No. 3,394,858**

**Registered Mar. 11, 2008**

**SERVICE MARK  
PRINCIPAL REGISTER**

**WALL 2 WALL**

WTF PROMOTIONS, INC. (MICHIGAN CORPORATION)  
SUITE 300  
190 MONROE AVE., N.W.  
GRAND RAPIDS, MI 49503

FOR: SPECIAL EVENT PLANNING, NAMELY, PLANNING AND CONDUCTING SPECIAL EVENTS AND PARTIES AT BARS, NIGHTCLUBS, AND RESTAURANTS, EXCLUDING EVENTS INVOLVING SOCCER , IN CLASS 41 (U.S. CLS. 100, 101 AND 107).

FIRST USE 6-12-2004; IN COMMERCE 6-12-2004.

THE MARK CONSISTS OF STANDARD CHARACTERS WITHOUT CLAIM TO ANY PARTICULAR FONT, STYLE, SIZE, OR COLOR.

SER. NO. 78-753,138, FILED 11-14-2005.

RICHARD A. STRASER, EXAMINING ATTORNEY

**Int. Cl.: 35**

**Prior U.S. Cls.: 100, 101 and 102**

**United States Patent and Trademark Office**

**Reg. No. 3,394,859**

**Registered Mar. 11, 2008**

**SERVICE MARK  
PRINCIPAL REGISTER**

**CHEMICAL INFORMATION  
TECHNOLOGY CENTER (CHEMITC)**

AMERICAN CHEMISTRY COUNCIL, INC. (NEW  
YORK CORPORATION)  
1300 WILSON BOULEVARD  
ARLINGTON, VA 22209

FOR: FULL RANGE OF TRADE ASSOCIATION  
SERVICES, NAMELY, PROMOTING THE INTER-  
ESTS OF THE CHEMICAL INDUSTRY, IN CLASS 35  
(U.S. CLS. 100, 101 AND 102).

FIRST USE 4-18-2006; IN COMMERCE 4-18-2006.

THE MARK CONSISTS OF STANDARD CHAR-  
ACTERS WITHOUT CLAIM TO ANY PARTICULAR  
FONT, STYLE, SIZE, OR COLOR.

SEC. 2(F) AS TO "CHEMICAL INFORMATION  
TECHNOLOGY CENTER".

SER. NO. 78-753,493, FILED 11-14-2005.

MARK T. MULLEN, EXAMINING ATTORNEY



**Int. Cl.: 41**

**Prior U.S. Cls.: 100, 101 and 107**

**United States Patent and Trademark Office**

**Reg. No. 3,394,860**

**Registered Mar. 11, 2008**

**SERVICE MARK  
PRINCIPAL REGISTER**

**Frank Sinatra**

SHEFFIELD ENTERPRISES, INC. (TENNESSEE CORPORATION)

200

9350 WILSHIRE BOULEVARD

BEVERLY HILLS, CA 90212

FOR: ENTERTAINMENT SERVICES, NAMELY, PRESENTATION OF MUSICAL PERFORMANCES RENDERED BY A SINGER, IN CLASS 41 (U.S. CLS. 100, 101 AND 107).

FIRST USE 9-0-1935; IN COMMERCE 9-0-1935.

THE MARK CONSISTS OF STANDARD CHARACTERS WITHOUT CLAIM TO ANY PARTICULAR FONT, STYLE, SIZE, OR COLOR.

THE NAME FRANK SINATRA DOES NOT IDENTIFY A LIVING INDIVIDUAL.

SER. NO. 78-758,315, FILED 11-21-2005.

JENNIFER VASQUEZ, EXAMINING ATTORNEY

**Int. Cls.: 5 and 32**

**Prior U.S. Cls.: 6, 18, 44, 45, 46, 48, 51 and 52**

**United States Patent and Trademark Office**

**Reg. No. 3,394,861**

**Registered Mar. 11, 2008**

**TRADEMARK  
PRINCIPAL REGISTER**

**ENGINE COOLANT FOR YOUR  
BODY**

MEDION CORPORATION (CANADA CORPORATION)  
4779 YONGE STREET  
TORONTO, CANADA M2N 5M5

FOR: ELECTROLYTE CAPSULES AND NUTRITIONAL SPORTS GELS FOR USE AS AN ENERGY SUPPLEMENT, IN CLASS 5 (U.S. CLS. 6, 18, 44, 46, 51 AND 52).

FOR: SPORTS DRINKS , IN CLASS 32 (U.S. CLS. 45, 46 AND 48).

THE MARK CONSISTS OF STANDARD CHARACTERS WITHOUT CLAIM TO ANY PARTICULAR FONT, STYLE, SIZE, OR COLOR.

PRIORITY CLAIMED UNDER SEC. 44(D) ON CANADA APPLICATION NO. 1,280,377, FILED 11-22-2005, REG. NO. TMA689034, DATED 6-5-2007, EXPIRES 6-5-2022.

SER. NO. 78-759,158, FILED 11-22-2005.

FLORENTINA BLANDU, EXAMINING ATTORNEY

**Int. Cl.: 35**

**Prior U.S. Cls.: 100, 101 and 102**

**United States Patent and Trademark Office**

**Reg. No. 3,394,862**

**Registered Mar. 11, 2008**

**SERVICE MARK  
PRINCIPAL REGISTER**



AMERICAN CHEMISTRY COUNCIL, INC. (NEW YORK CORPORATION)  
1300 WILSON BOULEVARD  
ARLINGTON, VA 22209

FOR: A FULL RANGE OF TRADE ASSOCIATION SERVICES, NAMELY, PROMOTING THE INTERESTS OF THE CHEMICAL INDUSTRY, IN CLASS 35 (U.S. CLS. 100, 101 AND 102).

FIRST USE 4-18-2006; IN COMMERCE 4-18-2006.

THE MARK CONSISTS OF A STYLIZED DEPICTION OF A HUMAN FIGURE, TOGETHER WITH THE WORDING CHEMITC CHEMICAL INFORMATION TECHNOLOGY CENTER.

SEC. 2(F) AS TO "CHEMICAL INFORMATION TECHNOLOGY CENTER".

SER. NO. 78-763,955, FILED 11-30-2005.

MARK T. MULLEN, EXAMINING ATTORNEY

**Int. Cl.: 41**

**Prior U.S. Cls.: 100, 101 and 107**

**United States Patent and Trademark Office**

**Reg. No. 3,394,863**

**Registered Mar. 11, 2008**

**SERVICE MARK  
PRINCIPAL REGISTER**

**SYSTEM BUILDER SUMMIT**

GARTNER, INC. (DELAWARE CORPORATION)  
56 TOP GALLANT ROAD  
STAMFORD, CT 06904

FOR: EDUCATIONAL SERVICES PROVIDED TO  
COMPUTER AND SOFTWARE SYSTEM FABRICA-  
TORS AND INTEGRATORS, NAMELY, CONDUCT-  
ING CONFERENCES, SEMINARS AND VENDOR  
FORUMS IN THE FIELD OF COMPUTER HARD-  
WARE AND SOFTWARE, IN CLASS 41 (U.S. CLS.  
100, 101 AND 107).

FIRST USE 7-31-1998; IN COMMERCE 7-31-1998.

THE MARK CONSISTS OF STANDARD CHAR-  
ACTERS WITHOUT CLAIM TO ANY PARTICULAR  
FONT, STYLE, SIZE, OR COLOR.

OWNER OF U.S. REG. NO. 2,336,856.

SEC. 2(F).

SER. NO. 78-768,586, FILED 12-7-2005.

RICHARD WHITE, EXAMINING ATTORNEY

**Int. Cl.: 33**

**Prior U.S. Cls.: 47 and 49**

**United States Patent and Trademark Office**

**Reg. No. 3,394,864**

**Registered Mar. 11, 2008**

**TRADEMARK  
PRINCIPAL REGISTER**



**LAS LILAS**  
**A r g e n t i n a**

SURCO, LLC (NEW HAMPSHIRE LTD LIAB CO)  
529 CENTRAL PARK AVENUE, SUITE 205  
SCARSDALE, NY 10583

FOR: WINE, IN CLASS 33 (U.S. CLS. 47 AND 49).

FIRST USE 3-15-2005; IN COMMERCE 3-15-2005.

NO CLAIM IS MADE TO THE EXCLUSIVE  
RIGHT TO USE "ARGENTINA" , APART FROM  
THE MARK AS SHOWN.

THE MARK CONSISTS OF A FLORAL DESIGN  
WITH WORDING LAS LILAS ARGENTINA.

THE ENGLISH TRANSLATION OF THE WORD  
"LAS LILAS" IN THE MARK IS "THE LILY".

SER. NO. 78-774,082, FILED 12-15-2005.

JANICE L. MCMORROW, EXAMINING ATTOR-  
NEY

**Int. Cl.: 36**

**Prior U.S. Cls.: 100, 101 and 102**

**United States Patent and Trademark Office**

**Reg. No. 3,394,865**

**Registered Mar. 11, 2008**

**SERVICE MARK  
PRINCIPAL REGISTER**



CHICAGO CLIMATE EXCHANGE, INC. (DELA-  
WARE CORPORATION)  
190 A. LASALLE STREET 8TH FLOOR  
CHICAGO, IL 60603

FOR: COMMODITY AND FUTURES EXCHANGE  
SERVICES, NAMELY, DIOXIDE AND OTHER  
GREENHOUSE GAS EMISSIONS EXCHANGE SER-  
VICES THAT FACILITATE THE TRADING OR  
SALE OF CARBON DIOXIDE AND OTHER GREEN-  
HOUSE GAS EMISSIONS ALLOWANCES AND OFF-

SETS, AS WELL AS FUTURES, BETWEEN  
BUSINESS AND OTHER MARKET PARTICIPANTS,  
IN CLASS 36 (U.S. CLS. 100, 101 AND 102).

FIRST USE 11-30-2004; IN COMMERCE 11-30-2004.

SER. NO. 78-777,267, FILED 12-20-2005.

REBECCA EISINGER, EXAMINING ATTORNEY

**Int. Cl.: 20**

**Prior U.S. Cls.: 2, 13, 22, 25, 32 and 50**

**United States Patent and Trademark Office**

**Reg. No. 3,394,866**

**Registered Mar. 11, 2008**

**TRADEMARK  
PRINCIPAL REGISTER**

**TILTON**

LES PLASTIQUES TILTON INC. (CANADA CORPORATION)  
175, RUE DES GRANDS LACS  
ST-AUGUSTIN-DE-DESMARES, CANADA G3A  
2K8

FOR: PLASTIC CONTAINERS FOR FOOD-STUFFS FOR COMMERCIAL AND INDUSTRIAL USE, IN CLASS 20 (U.S. CLS. 2, 13, 22, 25, 32 AND 50).

FIRST USE 1-1-1985; IN COMMERCE 1-1-1990.

THE MARK CONSISTS OF STANDARD CHARACTERS WITHOUT CLAIM TO ANY PARTICULAR FONT, STYLE, SIZE, OR COLOR.

PRIORITY CLAIMED UNDER SEC. 44(D) ON CANADA APPLICATION NO. 1282923, FILED 11-29-2005.

SER. NO. 78-779,137, FILED 12-22-2005.

SHANNON TWOHIG, EXAMINING ATTORNEY

**Int. Cl.: 36**

**Prior U.S. Cls.: 100, 101 and 102**

**United States Patent and Trademark Office**

**Reg. No. 3,394,867**

**Registered Mar. 11, 2008**

**SERVICE MARK  
PRINCIPAL REGISTER**

**CCFE**

CHICAGO CLIMATE EXCHANGE, INC. (DELA-  
WARE CORPORATION)  
190 S. LASALLE STREET, 8TH FLOOR  
CHICAGO, IL 60603

FOR: COMMODITY AND FUTURES EXCHANGE  
SERVICES, NAMELY, DIOXIDE AND OTHER  
GREENHOUSE GAS EMISSIONS EXCHANGE SER-  
VICES THAT FACILITATE THE TRADING OR  
SALE OF CARBON DIOXIDE AND OTHER GREEN-  
HOUSE GAS EMISSIONS ALLOWANCES AND OFF-  
SETS, AS WELL AS FUTURES, BETWEEN

BUSINESS AND OTHER MARKET PARTICIPANTS,  
IN CLASS 36 (U.S. CLS. 100, 101 AND 102).

FIRST USE 8-31-2004; IN COMMERCE 8-31-2004.

THE MARK CONSISTS OF STANDARD CHAR-  
ACTERS WITHOUT CLAIM TO ANY PARTICULAR  
FONT, STYLE, SIZE, OR COLOR.

SER. NO. 78-782,512, FILED 12-29-2005.

JORDAN BAKER, EXAMINING ATTORNEY



**Int. Cls.: 1, 2 and 3**

**Prior U.S. Cls.: 1, 4, 5, 6, 10, 11, 16, 26, 46, 50, 51 and 52**

**Reg. No. 3,394,868**

**United States Patent and Trademark Office**

**Registered Mar. 11, 2008**

**TRADEMARK  
PRINCIPAL REGISTER**

The logo for "First Contact" features the words "First Contact" in a bold, black, sans-serif font. The word "First" is positioned to the left of "Contact". Behind the letter "o" in "Contact", there is a solid green circle. To the left of this circle, a light green crescent shape is partially visible, appearing to wrap around the left side of the green circle.

PHOTONIC CLEANING TECHNOLOGIES, LLC  
(WISCONSIN LTD LIAB CO)  
180 BAYLEY AVE  
PLATTEVILLE, WI 53818

FOR: CHEMICAL PREPARATIONS FOR SCIENTIFIC PURPOSES; COATINGS USED IN THE MANUFACTURE OF PRINTED CIRCUIT BOARDS; DEGREASING PREPARATIONS USED IN MANUFACTURING PROCESSES FOR REMOVING SURFACE CONTAMINANTS AND DUST, IN CLASS 1 (U.S. CLS. 1, 5, 6, 10, 26 AND 46).

FIRST USE 1-24-2005; IN COMMERCE 1-24-2005.

FOR: CLEAR COATING PROTECTANT FOR VEHICLES; COATING COMPOSITION IN THE NATURE OF PAINT FOR INDUSTRIAL APPLICATIONS; COATINGS FOR USE AS PROTECTANTS AND CLEANERS FOR USE ON OPTIC, PHOTONIC, SEMICONDUCTOR DEVICES AND ELECTRONIC DISPLAYING DEVICES; CORROSION INHIBITANTS IN THE NATURE OF A COATING; OPTICAL COATINGS; PRINTING INKS, COATINGS, PIGMENTS AND DISPERSIONS FOR USE IN THE GRAPHIC ARTS INDUSTRY; RUST PRESERVATIVES IN THE NATURE OF A COATING, IN CLASS 2 (U.S. CLS. 6, 11 AND 16).

FIRST USE 1-24-2005; IN COMMERCE 1-24-2005.

FOR: ALL-PURPOSE CLEANERS; AUTOMOTIVE CLEANING PREPARATIONS; GLASS CLEANERS; GLASS CLEANING PREPARATIONS; GUN-CLEAN-

ING PREPARATIONS; PAINT AND VARNISH STRIPPING OR REMOVING PREPARATIONS; POLYMER SEALANT FOR CLEANING, SHINING AND PROTECTING AUTOMOBILE EXTERIOR SURFACES; PREPARATIONS FOR CLEANING, PROTECTING AND PRESERVING VEHICLE SURFACES; STRIPPING PREPARATIONS FOR PHOTO-RESIST AND REMOVAL OF OTHER TEMPORARY COATINGS IN SEMICONDUCTOR AND CIRCUIT BOARD MANUFACTURE; TREATMENT PREPARATIONS FOR USE ON VEHICLE WHEELS AND WHEEL COVERS, IN CLASS 3 (U.S. CLS. 1, 4, 6, 50, 51 AND 52).

FIRST USE 1-24-2005; IN COMMERCE 1-24-2005.

THE COLOR(S) LIGHT GREEN, DARK GREEN AND BLACK IS/ARE CLAIMED AS A FEATURE OF THE MARK.

THE COLOR BLACK APPEARS IN THE WORDING "FIRST CONTACT", THE COLOR LIGHT GREEN APPEARS IN THE DESIGN OF A CRESCENT ON THE LEFT SIDE OF THE MARK AND AS A CRESCENT ATTACHED ON THE LEFT SIDE OF THE OVAL, AND THE COLOR DARK GREEN APPEARS IN THE OVAL.

SER. NO. 78-783,935, FILED 1-3-2006.

ELIZABETH BEYER, EXAMINING ATTORNEY

**Int. Cl.: 3**

**Prior U.S. Cls.: 1, 4, 6, 50, 51 and 52**

**United States Patent and Trademark Office**

**Reg. No. 3,394,869**

**Registered Mar. 11, 2008**

**TRADEMARK  
PRINCIPAL REGISTER**

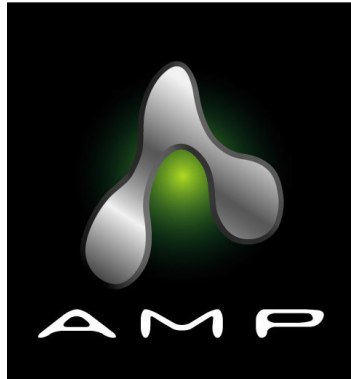

PEPSICO, INC. (NORTH CAROLINA CORPORATION)  
700 ANDERSON HILL ROAD  
PURCHASE, NY 10577

FOR: LIP BALM; LIP GLOSS, IN CLASS 3 (U.S. CLS. 1, 4, 6, 50, 51 AND 52).

FIRST USE 2-0-2006; IN COMMERCE 2-0-2006.

OWNER OF U.S. REG. NOS. 2,735,615 AND 3,014,963.

THE COLOR(S) SILVER, BLACK, GRAY, GREEN AND WHITE IS/ARE CLAIMED AS A FEATURE OF THE MARK.

THE MARK CONSISTS OF A STYLIZED A IN SILVER WITH A GRAY OUTLINE SUPERIMPOSED OVER A GREEN ORB ON A BLACK BACKGROUND; THE WORD AMP IS IN WHITE LETTERING ON A BLACK BACKGROUND.

SER. NO. 78-785,422, FILED 1-5-2006.

JOHN KELLY, EXAMINING ATTORNEY

**Int. Cl.: 41**

**Prior U.S. Cls.: 100, 101 and 107**

**United States Patent and Trademark Office**

**Reg. No. 3,394,870**

**Registered Mar. 11, 2008**

**SERVICE MARK  
PRINCIPAL REGISTER**

# The Bittersweets

THE BITTERSWEETS (CALIFORNIA PARTNER-  
SHIP)  
2601 ADELIN ST. SUITE 160A  
OAKLAND, CA 94607

FOR: ENTERTAINMENT, NAMELY, LIVE PER-  
FORMANCES BY A MUSICAL BAND, IN CLASS 41  
(U.S. CLS. 100, 101 AND 107).

FIRST USE 8-26-2003; IN COMMERCE 10-15-2004.

THE MARK CONSISTS OF STANDARD CHAR-  
ACTERS WITHOUT CLAIM TO ANY PARTICULAR  
FONT, STYLE, SIZE, OR COLOR.

SER. NO. 78-789,276, FILED 1-11-2006.

CHRISTINA SOBRAL, EXAMINING ATTORNEY

**Int. Cls.: 16, 21, 30 and 35**

**Prior U.S. Cls.: 2, 5, 13, 22, 23, 29, 30, 33, 37, 38, 40,  
46, 50, 100, 101 and 102**

**Reg. No. 3,394,871**

**United States Patent and Trademark Office**

**Registered Mar. 11, 2008**

**TRADEMARK  
SERVICE MARK  
PRINCIPAL REGISTER**

**GOCAKEGO**

GOCAKEGO, LLC (DELAWARE LTD LIAB CO)  
#335 E. MAPLEWOOD AVE  
GREENWOOD VILLAGE, CO 80111

FOR: PARTY SUPPLIES, NAMELY, PAPER NAP-  
KINS, IN CLASS 16 (U.S. CLS. 2, 5, 22, 23, 29, 37, 38  
AND 50).

FIRST USE 1-18-2006; IN COMMERCE 1-18-2006.

FOR: PARTY SUPPLIES, NAMELY, PLATES AND  
CAKE SERVER, IN CLASS 21 (U.S. CLS. 2, 13, 23, 29,  
30, 33, 40 AND 50).

FIRST USE 1-18-2006; IN COMMERCE 1-18-2006.

FOR: CAKES, IN CLASS 30 (U.S. CL. 46).

FIRST USE 1-18-2006; IN COMMERCE 1-18-2006.

FOR: COMPUTERIZED ON-LINE ORDERING  
SERVICES IN THE FIELD OF PARTY CAKES AND  
RELATED PARTY SUPPLIES, IN CLASS 35 (U.S.  
CLS. 100, 101 AND 102).

FIRST USE 1-18-2006; IN COMMERCE 1-18-2006.

THE MARK CONSISTS OF STANDARD CHAR-  
ACTERS WITHOUT CLAIM TO ANY PARTICULAR  
FONT, STYLE, SIZE, OR COLOR.

SER. NO. 78-794,017, FILED 1-18-2006.

RON FAIRBANKS, EXAMINING ATTORNEY

**Int. Cl.: 16**

**Prior U.S. Cls.: 2, 5, 22, 23, 29, 37, 38 and 50**

**Reg. No. 3,394,872**

**United States Patent and Trademark Office**

**Registered Mar. 11, 2008**

**TRADEMARK  
PRINCIPAL REGISTER**

**SUPPORT★OUR★TROOPS**

SUPPORT OUR TROOPS FOUNDATION, INC  
(FLORIDA CORPORATION)  
P. O. BOX 30  
DAYTONA BEACH, FL 32174

FOR: PAPER GOODS, NAMELY, POSTERS, NOTEPADS, BUMPER STICKERS, PENCILS, PENS AND PAPER MILK CAPS FOR TRADING, PHOTOGRAPHIC ALBUMS, APPOINTMENT BOOKS, ART PHOTOGRAPHS, AUTOGRAPH BOOKS, BALL-POINT PENS, PAPER BANNERS, LOOSE LEAF BINDERS, BULLETIN BOARDS, CLIP BOARDS, MAGNETIC BOARDS, PICTURE FRAMING MAT BOARDS, BOOK COVERS, BOOKMARKS, CHILDREN'S ACTIVITY BOOKS, COLORING BOOKS, COMPOSITION BOOKS, PICTURE BOOKS, GIFT WRAPPING PAPER, CALENDARS, BLANK CARDS, GIFT CARDS, GREETING CARDS, PENCIL CASES, PEN CASES, DRAWING RULERS, ERASERS,

FLASH CARDS, CROSSWORD PUZZLES, MARKERS, PAPER PARTY DECORATIONS, PAPER PARTY HATS, PENCIL HOLDERS, POSTCARDS, CALENDARS AND SCRAPBOOKS, IN CLASS 16 (U.S. CLS. 2, 5, 22, 23, 29, 37, 38 AND 50).

FIRST USE 10-16-2001; IN COMMERCE 10-16-2001.

OWNER OF U.S. REG. NOS. 3,075,463 AND 3,110,681.

THE MARK CONSISTS OF WORDS COMBINED WITH A DESIGN ELEMENT OF STARS.

SER. NO. 78-801,752, FILED 1-29-2006.

MARY ROSSMAN, EXAMINING ATTORNEY

**Int. Cl.: 7**

**Prior U.S. Cls.: 13, 19, 21, 23, 31, 34 and 35**

**United States Patent and Trademark Office**

**Reg. No. 3,394,873**

**Registered Mar. 11, 2008**

**TRADEMARK  
PRINCIPAL REGISTER**

**DMX**

DURAMAX MARINE, LLC (OHIO LTD LIAB CO)  
17990 GREAT LAKES PARKWAY  
HIRAM, OH 44234

THE MARK CONSISTS OF STANDARD CHAR-  
ACTERS WITHOUT CLAIM TO ANY PARTICULAR  
FONT, STYLE, SIZE, OR COLOR.

FOR: MACHINE PARTS NAMELY, BEARINGS  
FOR USE IN ROTATING SHAFTING PUMPS AND  
DOWN-HOLE DRILLING TOOLS, IN CLASS 7 (U.S.  
CLS. 13, 19, 21, 23, 31, 34 AND 35).

OWNER OF U.S. REG. NO. 2,995,467.

SER. NO. 78-803,589, FILED 1-31-2006.

FIRST USE 7-31-2004; IN COMMERCE 7-31-2004.

ROSELLE HERRERA, EXAMINING ATTORNEY

**Int. Cl.: 35**

**Prior U.S. Cls.: 100, 101 and 102**

**United States Patent and Trademark Office**

**Reg. No. 3,394,874**

**Registered Mar. 11, 2008**

**SERVICE MARK  
PRINCIPAL REGISTER**



GALLAGHER, CHARLES GERARD (UNITED STATES INDIVIDUAL)  
307 STYER ROAD  
GLENMOORE, PA 19343

FOR: BUSINESS MANAGEMENT CONSULTANCY SERVICES AS WELL AS DEVELOPMENT OF PROCESSES FOR THE ANALYSIS AND THE IMPLEMENTATION OF STRATEGY PLANS AND THE

MANAGEMENT OF PROJECTS , IN CLASS 35 (U.S. CLS. 100, 101 AND 102).

FIRST USE 7-5-2007; IN COMMERCE 7-5-2007.

SER. NO. 78-807,225, FILED 2-4-2006.

BILL DAWE, EXAMINING ATTORNEY

**Int. Cl.: 25**

**Prior U.S. Cls.: 22 and 39**

**United States Patent and Trademark Office**

**Reg. No. 3,394,875**

**Registered Mar. 11, 2008**

**TRADEMARK  
PRINCIPAL REGISTER**

**THANK GOD YOU'RE HERE**

WORKING DOG PTY LTD (AUSTRALIA CORPORATION)  
2 HAZELDON PLACE  
SOUTH YARRA, 3141, VIC, AUSTRALIA

FOR: CLOTHING, FOOTWEAR AND HEADGEAR, NAMELY, MEN'S WOMEN'S AND CHILDREN'S SWIMWEAR, ITEMS OF UNDERWEAR, TRACKSUITS, SHIRTS, T-SHIRTS, PANTS, TROUSERS, DRESSES, SKIRTS, SHOES, BOOTS, SLIPPERS, CAPS, BASEBALL CAPS, HATS AND SCARVES, IN CLASS 25 (U.S. CLS. 22 AND 39).

THE MARK CONSISTS OF STANDARD CHARACTERS WITHOUT CLAIM TO ANY PARTICULAR FONT, STYLE, SIZE, OR COLOR.

PRIORITY CLAIMED UNDER SEC. 44(D) ON AUSTRALIA APPLICATION NO. 1072035, FILED 8-25-2005, REG. NO. 1072035, DATED 8-25-2005, EXPIRES 8-25-2015.

SER. NO. 78-809,491, FILED 2-7-2006.

KEVIN DINALLO, EXAMINING ATTORNEY



**Int. Cl.: 36**

**Prior U.S. Cls.: 100, 101 and 102**

**United States Patent and Trademark Office**

**Reg. No. 3,394,876**

**Registered Mar. 11, 2008**

**SERVICE MARK  
PRINCIPAL REGISTER**

**MANAGING EXPECTATIONS**

THE COMMONWEALTH GROUP, INC. (FLORIDA CORPORATION)  
551 NW 77TH STREET, SUITE 101  
BOCA RATON, FL 33487

THE MARK CONSISTS OF STANDARD CHARACTERS WITHOUT CLAIM TO ANY PARTICULAR FONT, STYLE, SIZE, OR COLOR.

FOR: INVESTMENT CONSULTING SERVICES,  
IN CLASS 36 (U.S. CLS. 100, 101 AND 102).

SER. NO. 78-810,016, FILED 2-8-2006.

FIRST USE 3-1-2004; IN COMMERCE 3-1-2004.

PRISCILLA MILTON, EXAMINING ATTORNEY

**Int. Cl.: 9**

**Prior U.S. Cls.: 21, 23, 26, 36 and 38**

**Reg. No. 3,394,877**

**United States Patent and Trademark Office**

**Registered Mar. 11, 2008**

**TRADEMARK  
PRINCIPAL REGISTER**

**V-JET**

ATLANTIS SYSTEMS INTERNATIONAL INC.  
(CANADA CORPORATION)  
1 KENVIEW BOULEVARD  
BRAMPTON, ONTARIO, CANADA L6T 5E6

PRIORITY CLAIMED UNDER SEC. 44(D) ON  
CANADA APPLICATION NO. 1269271, FILED 8-19-  
2005, REG. NO. TMA677463, DATED 11-22-2006, EX-  
PIRES 11-22-2021.

FOR: JET ENGINE SIMULATORS, IN CLASS 9  
(U.S. CLS. 21, 23, 26, 36 AND 38).

SER. NO. 78-810,812, FILED 2-9-2006.

THE MARK CONSISTS OF STANDARD CHAR-  
ACTERS WITHOUT CLAIM TO ANY PARTICULAR  
FONT, STYLE, SIZE, OR COLOR.

FLORENTINA BLANDU, EXAMINING ATTORNEY

Int. Cl.: 32

Prior U.S. Cls.: 45, 46 and 48

United States Patent and Trademark Office

Reg. No. 3,394,878

Registered Mar. 11, 2008

TRADEMARK  
PRINCIPAL REGISTER



MEZGO INVERSIONES, S.L. (SPAIN CORPORATION)  
PRINCESA 17  
MADRID, SPAIN

FOR: FRUIT FLAVORED SOFT DRINKS, IN CLASS 32 (U.S. CLS. 45, 46 AND 48).

FIRST USE 7-24-1973; IN COMMERCE 10-0-1986.

NO CLAIM IS MADE TO THE EXCLUSIVE RIGHT TO USE "NON-ALCOHOLIC SANGRIA" AND "NATURAL AND ARTIFICIAL FLAVOR SANGRIA FLAVORED CARBONATED BEVERAGE", APART FROM THE MARK AS SHOWN.

THE MARK CONSISTS OF A THREE-DIMENSIONAL CONFIGURATION OF A BOTTLE THAT IS

USED TO CONTAIN THE GOODS, AS WELL AS A LABEL DESIGN. THE LABEL DESIGN IS CLAIMED AS A FEATURE OF THE MARK. THE ELONGATED BOTTLE NECK AND SHORTENED BOTTLE BODY ARE ALSO CLAIMED AS FEATURES OF THE MARK.

THE FOREIGN WORDING IN THE MARK TRANSLATES INTO ENGLISH AS MANORIAL.

SEC. 2(F).

SER. NO. 78-811,379, FILED 2-9-2006.

JULIE WATSON, EXAMINING ATTORNEY

**Int. Cl.: 33**

**Prior U.S. Cls.: 47 and 49**

**United States Patent and Trademark Office**

**Reg. No. 3,394,879**

**Registered Mar. 11, 2008**

**TRADEMARK  
PRINCIPAL REGISTER**

**BEN NEVIS**

BEN NEVIS DISTILLERY (FORT WILLIAM) LIMITED (UNITED KINGDOM CORPORATION)  
LOCHY BRIDGE FORT WILLIAM  
INVERNESS-SHIRE, SCOTLAND PH33 6TJ

FOR: SCOTCH WHISKY, IN CLASS 33 (U.S. CLS. 47 AND 49).

THE MARK CONSISTS OF STANDARD CHARACTERS WITHOUT CLAIM TO ANY PARTICULAR FONT, STYLE, SIZE, OR COLOR.

OWNER OF UNITED KINGDOM REG. NO. 1247304, DATED 7-31-1992, EXPIRES 7-31-2016.

OWNER OF U.S. REG. NO. 1,912,711.

THE NAME BEN NEVIS DOES NOT IDENTIFY ANY PARTICULAR LIVING INDIVIDUAL.

SER. NO. 78-811,389, FILED 2-9-2006.

CARYN GLASSER, EXAMINING ATTORNEY

**Int. Cl.: 14**

**Prior U.S. Cls.: 2, 27, 28 and 50**

**United States Patent and Trademark Office**

**Reg. No. 3,394,880**

**Registered Mar. 11, 2008**

**TRADEMARK  
PRINCIPAL REGISTER**

**OFFICIAL SUPPORT OUR  
TROOPS PRODUCT**

SUPPORT OUR TROOPS FOUNDATION, INC  
(FLORIDA CORPORATION)

P. O. BOX 30

DAYTONA BEACH, FL 321150030

FOR: JEWELRY; COSTUME JEWELRY; JEWELRY BRACELETS; JEWELRY CHAINS; JEWELRY IDENTIFICATION BRACELETS; JEWELRY LAPEL PINS; PINS BEING JEWELRY; RINGS BEING JEWELRY, IN CLASS 14 (U.S. CLS. 2, 27, 28 AND 50).

FIRST USE 10-21-2001; IN COMMERCE 10-23-2001.

THE MARK CONSISTS OF STANDARD CHARACTERS WITHOUT CLAIM TO ANY PARTICULAR FONT, STYLE, SIZE, OR COLOR.

OWNER OF U.S. REG. NOS. 3,075,463 AND 3,110,681.

NO CLAIM IS MADE TO THE EXCLUSIVE RIGHT TO USE "OFFICIAL" AND "PRODUCT", APART FROM THE MARK AS SHOWN.

SER. NO. 78-812,910, FILED 2-12-2006.

MARY ROSSMAN, EXAMINING ATTORNEY

**Int. Cl.: 16**

**Prior U.S. Cls.: 2, 5, 22, 23, 29, 37, 38 and 50**

**Reg. No. 3,394,881**

**United States Patent and Trademark Office**

**Registered Mar. 11, 2008**

**TRADEMARK  
PRINCIPAL REGISTER**

**SUPPORT OUR TROOPS BRAND**

SUPPORT OUR TROOPS FOUNDATION, INC  
(FLORIDA CORPORATION)  
P. O. BOX 30  
DAYTONA BEACH, FL 321150030

FOR: PAPER GOODS, NAMELY, POSTERS, NOTEPADS, BUMPER STICKERS, PENCILS, PENS AND PAPER MILK CAPS FOR TRADING, PHOTOGRAPHIC ALBUMS, APPOINTMENT BOOKS, ART PHOTOGRAPHS, AUTOGRAPH BOOKS, BALLPOINT PENS, PAPER BANNERS, LOOSE LEAF BINDERS, BULLETIN BOARDS, CLIP BOARDS, MAGNETIC BOARDS, PICTURE FRAMING MAT BOARDS, BOOK COVERS, BOOKMARKS, CHILDREN'S ACTIVITY BOOKS, COLORING BOOKS, COMPOSITION BOOKS, PICTURE BOOKS, GIFT WRAPPING PAPER, CALENDARS, BLANK CARDS, GIFT CARDS, GREETING CARDS, PENCIL CASES, PEN CASES, DRAWING RULERS, ERASERS, FLASH CARDS, CROSSWORD PUZZLES, MARKERS, PAPER PARTY DECORATIONS, PAPER

PARTY HATS, PENCIL HOLDERS, POSTCARDS, CALENDARS AND SCRAPBOOKS, IN CLASS 16 (U.S. CLS. 2, 5, 22, 23, 29, 37, 38 AND 50).

FIRST USE 10-21-2001; IN COMMERCE 10-21-2001.

THE MARK CONSISTS OF STANDARD CHARACTERS WITHOUT CLAIM TO ANY PARTICULAR FONT, STYLE, SIZE, OR COLOR.

OWNER OF U.S. REG. NOS. 3,075,463 AND 3,110,681.

NO CLAIM IS MADE TO THE EXCLUSIVE RIGHT TO USE "BRAND", APART FROM THE MARK AS SHOWN.

SER. NO. 78-812,913, FILED 2-12-2006.

MARY ROSSMAN, EXAMINING ATTORNEY

**Int. Cl.: 25**

**Prior U.S. Cls.: 22 and 39**

**United States Patent and Trademark Office**

**Reg. No. 3,394,882**

**Registered Mar. 11, 2008**

**TRADEMARK  
PRINCIPAL REGISTER**

**SUPPORT OUR TROOPS GENUINE  
BRAND**

SUPPORT OUR TROOPS FOUNDATION, INC  
(FLORIDA CORPORATION)

P. O. BOX 30

DAYTONA BEACH, FL 321150030

FOR: CLOTHING, NAMELY, TEE SHIRTS, GOLF SHIRTS, JACKETS, HATS, SHORTS, SWEAT SHIRTS, APRONS, CLOTH BIBS, GLOVES, AND UNDERCLOTHES, IN CLASS 25 (U.S. CLS. 22 AND 39).

FIRST USE 10-21-2001; IN COMMERCE 10-23-2001.

THE MARK CONSISTS OF STANDARD CHARACTERS WITHOUT CLAIM TO ANY PARTICULAR FONT, STYLE, SIZE, OR COLOR.

OWNER OF U.S. REG. NOS. 3,075,463 AND 3,110,681.

NO CLAIM IS MADE TO THE EXCLUSIVE RIGHT TO USE "GENUINE BRAND", APART FROM THE MARK AS SHOWN.

SER. NO. 78-812,914, FILED 2-12-2006.

MARY ROSSMAN, EXAMINING ATTORNEY

**Int. Cl.: 14**

**Prior U.S. Cls.: 2, 27, 28 and 50**

**United States Patent and Trademark Office**

**Reg. No. 3,394,883**

**Registered Mar. 11, 2008**

**TRADEMARK  
PRINCIPAL REGISTER**

**SUPPORT OUR TROOPS  
OFFICIAL PRODUCT**

SUPPORT OUR TROOPS FOUNDATION, INC  
(FLORIDA CORPORATION)

P. O. BOX 30

DAYTONA BEACH, FL 321150030

FOR: JEWELRY; COSTUME JEWELRY; JEWELRY BRACELETS; JEWELRY CHAINS; JEWELRY IDENTIFICATION BRACELETS; JEWELRY LAPEL PINS; PINS BEING JEWELRY; RINGS BEING JEWELRY, IN CLASS 14 (U.S. CLS. 2, 27, 28 AND 50).

FIRST USE 10-21-2001; IN COMMERCE 10-23-2001.

THE MARK CONSISTS OF STANDARD CHARACTERS WITHOUT CLAIM TO ANY PARTICULAR FONT, STYLE, SIZE, OR COLOR.

OWNER OF U.S. REG. NOS. 3,075,463 AND 3,110,681.

NO CLAIM IS MADE TO THE EXCLUSIVE RIGHT TO USE "OFFICIAL PRODUCT", APART FROM THE MARK AS SHOWN.

SER. NO. 78-812,915, FILED 2-12-2006.

MARY ROSSMAN, EXAMINING ATTORNEY



**Int. Cl.: 25**

**Prior U.S. Cls.: 22 and 39**

**United States Patent and Trademark Office**

**Reg. No. 3,394,884**

**Registered Mar. 11, 2008**

**TRADEMARK  
PRINCIPAL REGISTER**

**GENUINE BRAND SUPPORT OUR  
TROOPS APPAREL**

SUPPORT OUR TROOPS FOUNDATION, INC  
(FLORIDA CORPORATION)  
P. O. BOX 30  
DAYTONA BEACH, FL 321150030

FOR: CLOTHING, NAMELY, TEE SHIRTS, GOLF SHIRTS, JACKETS, HATS, SHORTS, SWEAT SHIRTS, APRONS, CLOTH BIBS, GLOVES, AND UNDERCLOTHES, IN CLASS 25 (U.S. CLS. 22 AND 39).

FIRST USE 10-21-2001; IN COMMERCE 10-23-2001.

THE MARK CONSISTS OF STANDARD CHARACTERS WITHOUT CLAIM TO ANY PARTICULAR FONT, STYLE, SIZE, OR COLOR.

NO CLAIM IS MADE TO THE EXCLUSIVE RIGHT TO USE "GENUINE BRAND" AND "APPAREL", APART FROM THE MARK AS SHOWN.

SER. NO. 78-812,917, FILED 2-12-2006.

MARY ROSSMAN, EXAMINING ATTORNEY

**Int. Cl.: 28**

**Prior U.S. Cls.: 22, 23, 38 and 50**

**United States Patent and Trademark Office**

**Reg. No. 3,394,885**

**Registered Mar. 11, 2008**

**TRADEMARK  
PRINCIPAL REGISTER**

**SUPPORT OUR TROOPS  
OFFICIAL BRAND**

SUPPORT OUR TROOPS FOUNDATION, INC  
(FLORIDA CORPORATION)  
P. O. BOX 30  
DAYTONA BEACH, FL 321150030

OWNER OF U.S. REG. NOS. 3,075,463 AND  
3,110,681.

FOR: PLAYING CARDS, IN CLASS 28 (U.S. CLS.  
22, 23, 38 AND 50).

NO CLAIM IS MADE TO THE EXCLUSIVE  
RIGHT TO USE "OFFICIAL BRAND", APART  
FROM THE MARK AS SHOWN.

FIRST USE 10-21-2001; IN COMMERCE 10-23-2001.

SER. NO. 78-812,919, FILED 2-12-2006.

THE MARK CONSISTS OF STANDARD CHAR-  
ACTERS WITHOUT CLAIM TO ANY PARTICULAR  
FONT, STYLE, SIZE, OR COLOR.

MARY ROSSMAN, EXAMINING ATTORNEY

**Int. Cl.: 9**

**Prior U.S. Cls.: 21, 23, 26, 36 and 38**

**United States Patent and Trademark Office**

**Reg. No. 3,394,886**

**Registered Mar. 11, 2008**

**TRADEMARK  
PRINCIPAL REGISTER**

# TrueMobile

ON2 TECHNOLOGIES, INC. (DELAWARE CORPORATION)  
560 WHITE PLAINS ROAD  
TARRYTOWN, NY 10591

FOR: COMPUTER APPLICATION SOFTWARE FOR MOBILE PHONES; COMPUTER SOFTWARE DEVELOPMENT TOOLS; COMPUTER SOFTWARE FOR DIGITAL COMPRESSION AND DECOMPRESSION AND DISSEMINATION OF VIDEO AND AUDIO INFORMATION; DECODER SOFTWARE, IN CLASS 9 (U.S. CLS. 21, 23, 26, 36 AND 38).

FIRST USE 2-1-2005; IN COMMERCE 2-1-2005.

THE MARK CONSISTS OF STANDARD CHARACTERS WITHOUT CLAIM TO ANY PARTICULAR FONT, STYLE, SIZE, OR COLOR.

OWNER OF U.S. REG. NOS. 1,845,078 AND 2,047,131.

SER. NO. 78-813,654, FILED 2-13-2006.

BARBARA BROWN, EXAMINING ATTORNEY

**Int. Cl.: 9**

**Prior U.S. Cls.: 21, 23, 26, 36 and 38**

**United States Patent and Trademark Office**

**Reg. No. 3,394,887**

**Registered Mar. 11, 2008**

**TRADEMARK  
PRINCIPAL REGISTER**

INFORMATION IS OPPORTUNITY

OVERTONE SOFTWARE, INC. (MARYLAND CORPORATION)  
3 BETHESDA METRO SUITE 700  
BETHESDA, MD 20814

FOR: COMPUTER SOFTWARE PROGRAMS FOR MIGRATING OR MOVING DATA FILES AND DATA, IN CLASS 9 (U.S. CLS. 21, 23, 26, 36 AND 38).

FIRST USE 2-0-2006; IN COMMERCE 2-0-2006.

THE MARK CONSISTS OF STANDARD CHARACTERS WITHOUT CLAIM TO ANY PARTICULAR FONT, STYLE, SIZE, OR COLOR.

SER. NO. 78-813,943, FILED 2-14-2006.

HEATHER SAPP, EXAMINING ATTORNEY

**Int. Cl.: 1**

**Prior U.S. Cls.: 1, 5, 6, 10, 26 and 46**

**United States Patent and Trademark Office**

**Reg. No. 3,394,888**

**Registered Mar. 11, 2008**

**TRADEMARK  
PRINCIPAL REGISTER**

**CBMax**

Q'MAX SOLUTIONS INC. (CANADA CORPORATION)  
SUITE 1700  
407 2ND STREET S.W.  
CALGARY, CANADA T2P 2Y3

PRIORITY CLAIMED UNDER SEC. 44(D) ON  
CANADA APPLICATION NO. 1268966, FILED 8-17-  
2005, REG. NO. TMA668514, DATED 7-24-2006, EX-  
PIRES 7-24-2021.

FOR: POLYMERS USED AS A DRILLING FLUID  
FOR COAL BED METHANE DRILLING, IN CLASS 1  
(U.S. CLS. 1, 5, 6, 10, 26 AND 46).

SER. NO. 78-815,906, FILED 2-15-2006.

THE MARK CONSISTS OF STANDARD CHAR-  
ACTERS WITHOUT CLAIM TO ANY PARTICULAR  
FONT, STYLE, SIZE, OR COLOR.

LINDA ESTRADA, EXAMINING ATTORNEY

**Int. Cl.: 9**

**Prior U.S. Cls.: 21, 23, 26, 36 and 38**

**Reg. No. 3,394,889**

**United States Patent and Trademark Office**

**Registered Mar. 11, 2008**

---

**TRADEMARK  
PRINCIPAL REGISTER**

**ForecastX SDK**

JOHN GALT DEVELOPMENT, INC. (ILLINOIS  
CORPORATION)  
125 SOUTH CLARK STREET, SUITE 1950  
CHICAGO, IL 60603

FOR: COMPUTER SOFTWARE FOR ENTER-  
PRISE PLANNING FOR BUSINESSES, IN CLASS 9  
(U.S. CLS. 21, 23, 26, 36 AND 38).

FIRST USE 2-1-1998; IN COMMERCE 2-1-1998.

THE MARK CONSISTS OF STANDARD CHAR-  
ACTERS WITHOUT CLAIM TO ANY PARTICULAR  
FONT, STYLE, SIZE, OR COLOR.

NO CLAIM IS MADE TO THE EXCLUSIVE  
RIGHT TO USE "SDK", APART FROM THE MARK  
AS SHOWN.

SER. NO. 78-820,800, FILED 2-22-2006.

DOMINIC FATHY, EXAMINING ATTORNEY

**Int. Cls.: 7, 11 and 37**

**Prior U.S. Cls.: 13, 19, 21, 23, 31, 34, 35, 100, 103 and 106**

**Reg. No. 3,394,890**

**United States Patent and Trademark Office**

**Registered Mar. 11, 2008**

**TRADEMARK  
SERVICE MARK  
PRINCIPAL REGISTER**



CANDY S.P.A. (ITALY CORPORATION)  
VIA MISSORI, 8  
MONZA (MILANO), ITALY 20052

FOR: ELECTRICALLY OPERATED COMMERCIAL, DOMESTIC AND HOUSEHOLD APPARATUS, INSTRUMENTS AND MACHINES, NAMELY VACUUM CLEANERS; CARPET CLEANING MACHINES; CLOTHES WASHING MACHINES; DISHWASHERS; STEAM CLEANERS; REPLACEMENT AND/OR COMPONENT PARTS AND FITTINGS FOR THE AFORESAID GOODS, NAMELY BRUSHES, PUMPS, AND FILTERS, IN CLASS 7 (U.S. CLS. 13, 19, 21, 23, 31, 34 AND 35).

FOR: ELECTRIC CLOTHES DRYING MACHINES AND REPLACEMENT AND/OR COMPONENT PARTS THEREFORE, NAMELY FILTERS; REFRIGERATORS, FREEZERS, ELECTRIC COOKING OVENS, GAS COOKING OVENS, MICROWAVE OVENS, ELECTRIC COOKING STOVES, GAS COOKERS, IN CLASS 11 (U.S. CLS. 13, 21, 23, 31 AND 34).

FOR: REPAIR AND MAINTENANCE OF ELECTRICAL HOUSEHOLD APPLIANCES NAMELY, VACUUM CLEANERS CARPET CLEANING MACHINES, WASHING MACHINES, DISHWASHERS, STEAM CLEANERS, PUMPS, ELECTRIC CLOTHES DRYING MACHINES, REFRIGERATORS, FREEZERS, ELECTRIC COOKING OVENS, GAS COOKING OVENS, MICROWAVE OVENS, ELECTRIC COOKING STOVES, GAS COOKERS, IN CLASS 37 (U.S. CLS. 100, 103 AND 106).

OWNER OF ERPN CMNTY TM OFC REG. NO. 1707116, DATED 9-11-2001, EXPIRES 6-14-2010.

OWNER OF U.S. REG. NO. 803,803.

SER. NO. 78-822,734, FILED 2-24-2006.

NAKIA HENRY, EXAMINING ATTORNEY

**Int. Cl.: 3**

**Prior U.S. Cls.: 1, 4, 6, 50, 51 and 52**

**United States Patent and Trademark Office**

**Reg. No. 3,394,891**

**Registered Mar. 11, 2008**

**TRADEMARK  
PRINCIPAL REGISTER**



**swissdent**

SWISSDENT COSMETICS AG (SWITZERLAND  
CORPORATION)  
KREUZSTRASSE 54  
8008 ZURICH, SWITZERLAND

10-10-2005, REG. NO. 540.332, DATED 11-29-2005,  
EXPIRES 10-10-2015.

FOR: PREPARATIONS FOR DENTAL CARE AND  
DENTAL TREATMENT, NAMELY, DENTAL  
BLEACHING GEL, DENTIFRICES, DENTIFRICES  
IN FORM OF CHEWING GUMS SOLD THROUGH  
RETAIL OUTLETS, IN CLASS 3 (U.S. CLS. 1, 4, 6, 50,  
51 AND 52).

THE MARK CONSISTS OF THE WORD "SWISS-  
DENT" IN STYLIZED FONT, WITH THE DOT OF  
THE "I" REPRESENTED BY A STYLIZED DRAW-  
ING OF A TOOTHPASTE SQUIGGLE.

SER. NO. 78-825,285, FILED 2-28-2006.

PRIORITY CLAIMED UNDER SEC. 44(D) ON  
SWITZERLAND APPLICATION NO. 540.332, FILED

SUSAN LESLIE DUBOIS, EXAMINING ATTORNEY



**Int. Cl.: 8**

**Prior U.S. Cls.: 23, 28 and 44**

**United States Patent and Trademark Office**

**Reg. No. 3,394,892**

**Registered Mar. 11, 2008**

**TRADEMARK  
PRINCIPAL REGISTER**

**SURGRIP**

ELMER'S PRODUCTS, INC. (DELAWARE COR-  
PORATION)  
ONE EASTON OVAL  
COLUMBUS, OH 43219

THE MARK CONSISTS OF STANDARD CHAR-  
ACTERS WITHOUT CLAIM TO ANY PARTICULAR  
FONT, STYLE, SIZE, OR COLOR.

FOR: UTILITY KNIVES WITH REPLACEMENT  
BLADES, IN CLASS 8 (U.S. CLS. 23, 28 AND 44).

SER. NO. 78-826,658, FILED 3-1-2006.

FIRST USE 8-0-1979; IN COMMERCE 8-0-1979.

AMY MCMENAMIN, EXAMINING ATTORNEY

**Int. Cl.: 5**

**Prior U.S. Cls.: 6, 18, 44, 46, 51 and 52**

**United States Patent and Trademark Office**

**Reg. No. 3,394,893**

**Registered Mar. 11, 2008**

**TRADEMARK  
PRINCIPAL REGISTER**

**BIONOX**

NALCO COMPANY (DELAWARE CORPORATION)  
PATENT & LICENSING DEPT  
1601 W. DIEHL RD  
NAPERVILLE, IL 605631198

THE MARK CONSISTS OF STANDARD CHARACTERS WITHOUT CLAIM TO ANY PARTICULAR FONT, STYLE, SIZE, OR COLOR.

FOR: COOLING WATER TOWER BIOCIDES, IN CLASS 5 (U.S. CLS. 6, 18, 44, 46, 51 AND 52).

SER. NO. 78-827,532, FILED 3-2-2006.

FIRST USE 2-27-2006; IN COMMERCE 2-27-2006.

DAYNA BROWNE, EXAMINING ATTORNEY

**Int. Cls.: 12, 16 and 24**

**Prior U.S. Cls.: 2, 5, 19, 21, 22, 23, 29, 31, 35, 37, 38,  
42, 44 and 50**

**United States Patent and Trademark Office**

**Reg. No. 3,394,894**

**Registered Mar. 11, 2008**

**TRADEMARK  
PRINCIPAL REGISTER**



CLASSY KID, INC. (NEVADA CORPORATION)  
P.O. BOX 31927  
LAS VEGAS, NV 89173

THE COLOR(S) GREEN, YELLOW, WHITE, RED,  
GRAY, AND BLACK IS/ARE CLAIMED AS A FEAT-  
URE OF THE MARK.

FOR: VEHICLE SEAT BACK COVERS; FITTED  
OR SEMI-FITTED SHOPPING CART SEAT COVERS,  
IN CLASS 12 (U.S. CLS. 19, 21, 23, 31, 35 AND 44).

FIRST USE 3-9-2005; IN COMMERCE 3-9-2005.

FOR: PAPER BABY BIBS; DISPOSABLE PLASTIC  
COATED PAPER TOILET SEAT COVERS, IN CLASS  
16 (U.S. CLS. 2, 5, 22, 23, 29, 37, 38 AND 50).

FIRST USE 3-9-2005; IN COMMERCE 3-9-2005.

FOR: PLASTIC PLACE MATS, IN CLASS 24 (U.S.  
CLS. 42 AND 50).

FIRST USE 3-9-2005; IN COMMERCE 3-9-2005.

THE MARK CONSISTS OF A WHITE CARTOON  
CHILD IN A GRAY HELMET AND ARMOR IM-  
POSED OVER A GREEN MICROBE WITHIN A  
CIRCLE AND DIAGONAL SLASH IN RED. THE  
FEATURES OF THE HELMET, SUIT OF ARMOR  
AND CHILD ARE OUTLINED IN BLACK. A SEC-  
TION OF YELLOW HAIR PEEKS OUT FROM  
BENEATH THE CHILD'S HELMET.

SER. NO. 78-828,368, FILED 3-3-2006.

MARK RADEMACHER, EXAMINING ATTORNEY

**Int. Cl.: 31**

**Prior U.S. Cls.: 1 and 46**

**United States Patent and Trademark Office**

**Reg. No. 3,394,895**

**Registered Mar. 11, 2008**

**TRADEMARK  
PRINCIPAL REGISTER**

**SUPER WRAPPED**

PATTEN SEED COMPANY (GEORGIA CORPORATION)

P.O. BOX 217

LAKELAND, GA 31635

FOR: GRASS SEED, IN CLASS 31 (U.S. CLS. 1 AND 46).

FIRST USE 1-1-2005; IN COMMERCE 1-1-2005.

THE MARK CONSISTS OF STANDARD CHARACTERS WITHOUT CLAIM TO ANY PARTICULAR FONT, STYLE, SIZE, OR COLOR.

NO CLAIM IS MADE TO THE EXCLUSIVE RIGHT TO USE "WRAPPED", APART FROM THE MARK AS SHOWN.

SER. NO. 78-828,687, FILED 3-3-2006.

DAVID YONTEF, EXAMINING ATTORNEY

**Int. Cls.: 10 and 28**

**Prior U.S. Cls.: 22, 23, 26, 38, 39, 44 and 50**

**United States Patent and Trademark Office**

**Reg. No. 3,394,896**

**Registered Mar. 11, 2008**

**TRADEMARK  
PRINCIPAL REGISTER**

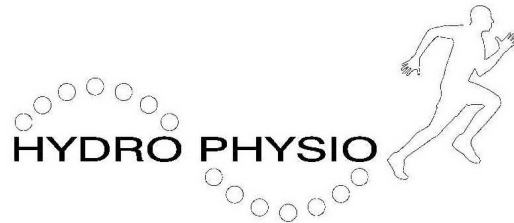

SYPAL HOLDINGS LIMITED (UNITED KING-  
DOM LIMITED COMPANY)  
COCKSHUTT LANE  
BROSELEY, SHROPSHIRE, UNITED KINGDOM  
TF12 5JA

FOR: HYDROTHERAPY AND PHYSIOTHERAPY  
EQUIPMENT, NAMELY, HYDROTHERAPY POOLS  
AND TREADMILLS FOR THE REHABILITATION  
OF HUMANS AND ANIMALS., IN CLASS 10 (U.S.  
CLS. 26, 39 AND 44).

FOR: AQUATIC TREADMILLS FOR PHYSICAL  
EXERCISE OF HUMANS AND ANIMALS AND

PARTS AND ACCESSORIES SOLD THEREWITH.,  
IN CLASS 28 (U.S. CLS. 22, 23, 38 AND 50).

PRIORITY CLAIMED UNDER SEC. 44(D) ON  
ERPNTY CMNTY TM OFC APPLICATION NO.  
004943891, FILED 3-2-2006, REG. NO. 004943891,  
DATED 6-8-2007, EXPIRES 3-2-2016.

SER. NO. 78-830,280, FILED 3-6-2006.

LINDA POWELL, EXAMINING ATTORNEY

**Int. Cl.: 36**

**Prior U.S. Cls.: 100, 101 and 102**

**United States Patent and Trademark Office**

**Reg. No. 3,394,897**

**Registered Mar. 11, 2008**

**SERVICE MARK  
PRINCIPAL REGISTER**



NORTH SHORE BANK, FSB (WISCONSIN CHARTERED BANK)  
15700 WEST BLUEMOUND ROAD  
BROOKFIELD, WI 53005

FOR: BANKING SERVICES, IN CLASS 36 (U.S. CLS. 100, 101 AND 102).

FIRST USE 1-1-1996; IN COMMERCE 1-1-1996.

NO CLAIM IS MADE TO THE EXCLUSIVE RIGHT TO USE "STATE BANK", APART FROM THE MARK AS SHOWN.

THE COLOR(S) GREEN AND WHITE IS/ARE CLAIMED AS A FEATURE OF THE MARK.

THE MARK CONSISTS OF A DISTINCTIVE LOGO COMPRISING THE DESIGN OF AN ARC IN THE COLOR GREEN WITH THE WORDS "ILLINOIS STATE BANK" IN THE COLOR WHITE.

SEC. 2(F).

SER. NO. 78-831,927, FILED 3-8-2006.

JAMES STEIN, EXAMINING ATTORNEY

**Int. Cl.: 2**

**Prior U.S. Cls.: 6, 11 and 16**

**United States Patent and Trademark Office**

**Reg. No. 3,394,898**

**Registered Mar. 11, 2008**

**TRADEMARK  
PRINCIPAL REGISTER**



LI ZE LAN (CHINA INDIVIDUAL)  
RM 401, UNIT 4, SUITE 15  
ZHUDAO GARDEN, QIAOZHONG, GUANGZHOU  
CITY  
GUANGDONG PROV., CHINA 510163

FOR: DYES FOR USE IN THE MANUFACTURE OF WOOD; DIRECT DYES; MORDANT DYES; PIGMENTS; WATERCOLOR PAINTS; PRINTERS' INK; PRINTING INK FOR USE IN THE GRAPHIC ARTS INDUSTRY; TATTOO INKS; PAINTS; VARNISHES; ANILINE DYES; DYES FOR USE IN THE MANUFACTURE OF LEATHER; MORDANTS FOR USE IN THE MANUFACTURE OF WOOD; BACTERICIDAL PAINTS; METALS IN POWDER FORM FOR PAINTERS, DECORATORS, PRINTERS AND ARTISTS;

COLORANTS FOR USE IN THE MANUFACTURE OF BEVERAGES; FOOD DYES; COLORANTS FOR USE IN THE MANUFACTURE OF LIQUEURS; FIREPROOF PAINTS; ANTI-CORROSIVE PAINTS; RAW MATERIAL RESINS FOR USE IN THE MANUFACTURE OF RESINS AND FOR GENERAL INDUSTRIAL USE; DYESTUFFS FOR USE IN THE MANUFACTURE OF WOOD, IN CLASS 2 (U.S. CLS. 6, 11 AND 16).

FIRST USE 9-3-2003; IN COMMERCE 5-22-2005.

SER. NO. 78-833,438, FILED 3-9-2006.

MARK SPARACINO, EXAMINING ATTORNEY

**Int. Cls.: 35 and 44**

**Prior U.S. Cls.: 100, 101 and 102**

**United States Patent and Trademark Office**

**Reg. No. 3,394,899**

**Registered Mar. 11, 2008**

**SERVICE MARK  
PRINCIPAL REGISTER**



**A p o l l o M D**

APOLLOMD BUSINESS SERVICES, LLC (GEORGIA LTD LIAB CO)  
SUITE 320  
5565 NEW NORTHSIDE DRIVE  
ATLANTA, GA 30328

FOR: ADMINISTRATION, BILLING AND RECONCILIATION OF ACCOUNTS ON BEHALF OF OTHERS; BILLING, IN CLASS 35 (U.S. CLS. 100, 101 AND 102).

FIRST USE 3-1-2001; IN COMMERCE 7-1-2001.

FOR: EMERGENCY MEDICAL SERVICES, NAMELY, PROVIDING EMERGENCY MEDICAL ASSISTANCE, EMERGENCY MEDICAL RESPONSE AND PHYSICIAN SERVICES PRIMARILY FOR HOSPITAL EMERGENCY ROOMS AND EMERGENCY DEPARTMENTS AND EXCLUDING MED-

ICAL SERVICES PROVIDED ON A CHARITABLE BASIS, IN CLASS 44 (U.S. CLS. 100 AND 101).

FIRST USE 3-1-2001; IN COMMERCE 7-1-2001.

NO CLAIM IS MADE TO THE EXCLUSIVE RIGHT TO USE "MD", APART FROM THE MARK AS SHOWN.

"THE MARK CONSISTS OF LARGE WAXING CRESCENT, SMALLER WANING CRESCENT, A FIGURE OF A MAN BETWEEN THE TWO CRESCENTS AND THE TERM 'APOLLO MD'."

SER. NO. 78-834,309, FILED 3-10-2006.

KATHLEEN M. VANSTON, EXAMINING ATTORNEY



**Int. Cl.: 9**

**Prior U.S. Cls.: 21, 23, 26, 36 and 38**

**Reg. No. 3,394,900**

**United States Patent and Trademark Office**

**Registered Mar. 11, 2008**

**TRADEMARK  
PRINCIPAL REGISTER**

**IRONPORT ANTI-SPAM**

IRONPORT SYSTEMS, INC. (DELAWARE CORPORATION)  
950 ELM STREET  
SAN BRUNO, CA 94066

FOR: COMPUTER SOFTWARE FOR USE IN PREVENTING ELECTRONIC MAIL MESSAGES THAT ARE UNWANTED, OR SPAM, OR CONTAIN VIRUSES, OR CONTAIN PHISHING ATTACKS, OR OTHER THREATS, IN CLASS 9 (U.S. CLS. 21, 23, 26, 36 AND 38).

FIRST USE 1-26-2006; IN COMMERCE 1-26-2006.

THE MARK CONSISTS OF STANDARD CHARACTERS WITHOUT CLAIM TO ANY PARTICULAR FONT, STYLE, SIZE, OR COLOR.

OWNER OF U.S. REG. NO. 3,017,184.

NO CLAIM IS MADE TO THE EXCLUSIVE RIGHT TO USE "ANTI-SPAM", APART FROM THE MARK AS SHOWN.

SER. NO. 78-834,723, FILED 3-10-2006.

JASON TURNER, EXAMINING ATTORNEY

**Int. Cl.: 35**

**Prior U.S. Cls.: 100, 101 and 102**

**United States Patent and Trademark Office**

**Reg. No. 3,394,901**

**Registered Mar. 11, 2008**

**SERVICE MARK  
PRINCIPAL REGISTER**

**HOMESTEAD REALTY**

HOMESTEAD REALTY INC. (WISCONSIN CORPORATION)  
8405 W. LISBON AVE.  
MILWAUKEE, WI 532223726

FOR: PROVIDING BUSINESS CONSULTATION IN THE REAL ESTATE INDUSTRY, NAMELY, BY PROVIDING OFFICE SUPPORT, STAFF SERVICES, AND SECRETARIAL SERVICES, BY PROVIDING FACILITIES FOR USE OF OFFICE EQUIPMENT, AND BY ASSISTING REAL ESTATE AGENTS AND ASSOCIATES TO ADVERTISE AND MARKET THEIR REAL ESTATE SERVICES BY PROVIDING FOR BULK MAILINGS, SIGNAGE TEMPLATES, AND ADVERTISING IN LOCAL PAPERS, JOURNALS AND HOME-RELATED MAGAZINES, IN CLASS 35 (U.S. CLS. 100, 101 AND 102).

FIRST USE 10-24-1985; IN COMMERCE 10-24-1985.

THE MARK CONSISTS OF STANDARD CHARACTERS WITHOUT CLAIM TO ANY PARTICULAR FONT, STYLE, SIZE, OR COLOR.

NO CLAIM IS MADE TO THE EXCLUSIVE RIGHT TO USE "REALTY", APART FROM THE MARK AS SHOWN.

SER. NO. 78-834,777, FILED 3-10-2006.

COLLEEN KEARNEY, EXAMINING ATTORNEY

Int. Cl.: 41

Prior U.S. Cls.: 100, 101 and 107

United States Patent and Trademark Office

Reg. No. 3,394,902

Registered Mar. 11, 2008

SERVICE MARK  
PRINCIPAL REGISTER



MARTENS, ELIZABETH L. (UNITED STATES  
INDIVIDUAL)  
272 EAST DEERPATH, SUITE 318  
LAKE FOREST, IL 60045

FOR: CONDUCTING ENTERTAINMENT EXHIBITIONS IN THE NATURE OF CRAFT DEMONSTRATIONS, GAMES, STORYTELLING, AND NATURE WALKS WITH A HALLOWEEN THEME, IN CLASS 41 (U.S. CLS. 100, 101 AND 107).

FIRST USE 10-1-1995; IN COMMERCE 10-1-1995.

NO CLAIM IS MADE TO THE EXCLUSIVE RIGHT TO USE "LAKE FOREST OPEN LANDS" AND "WALK", APART FROM THE MARK AS SHOWN.

THE MARK CONSISTS OF A PICTURE OF A WITCH WALKING NEXT TO THE WORDS.

SER. NO. 78-835,596, FILED 3-13-2006.

MARK RADEMACHER, EXAMINING ATTORNEY

**Int. Cl.: 41**

**Prior U.S. Cls.: 100, 101 and 107**

**United States Patent and Trademark Office**

**Reg. No. 3,394,903**

**Registered Mar. 11, 2008**

**SERVICE MARK  
PRINCIPAL REGISTER**



MARTENS, ELIZABETH L. (UNITED STATES  
INDIVIDUAL)  
272 EAST DEERPATH, SUITE 318  
LAKE FOREST, IL 60045

FOR: CONDUCTING ENTERTAINMENT EXHIBITIONS IN THE NATURE OF A HARVEST SEASON CELEBRATION, FEATURING BAGPIPES PERFORMANCES, GAMES, A PICNIC AND A BONFIRE , IN CLASS 41 (U.S. CLS. 100, 101 AND 107).

FIRST USE 9-1-1995; IN COMMERCE 9-1-1995.

NO CLAIM IS MADE TO THE EXCLUSIVE RIGHT TO USE "LAKE FOREST OPEN LANDS BAGPIPES & BONFIRE", APART FROM THE MARK AS SHOWN.

THE MARK CONSISTS OF A PICTURE OF A MAN PLAYING BAGPIPES NEXT TO THE WORDS.

SER. NO. 78-835,612, FILED 3-13-2006.

MARK RADEMACHER, EXAMINING ATTORNEY

**Int. Cls.: 1 and 17**

**Prior U.S. Cls.: 1, 5, 6, 10, 12, 13, 26, 35, 46 and 50**

**United States Patent and Trademark Office**

**Reg. No. 3,394,904**

**Registered Mar. 11, 2008**

**TRADEMARK  
PRINCIPAL REGISTER**

**MINTECH**

MOMAR, INC. (GEORGIA CORPORATION)  
1830 ELLSWORTH INDUSTRIAL DRIVE, NW  
ATLANTA, GA 30318

FOR: CHEMICALS AND CHEMICAL ADDITIVES FOR USE IN MINERAL HANDLING AND TRANSPORTATION; DE-ICERS FOR RAILROAD SWITCHES AND CONVEYOR BELTS; WET COAL FLOW ADDITIVES USED TO IMPROVE THE FLOW OF WET COAL; FREEZE CONDITIONING ADDITIVES USED TO INHIBIT FREEZING; RELEASE AGENT FOR RAILCARS; DUST SUPPRESSANT CHEMICALS FOR USE WITH MINERAL HANDLING SYSTEMS, IN CLASS 1 (U.S. CLS. 1, 5, 6, 10, 26 AND 46).

FIRST USE 0-0-1999; IN COMMERCE 0-0-1999.

FOR: ACRYLIC BASED POLYMER SEALANTS FOR USE IN THE HANDLING, TRANSPORTATION AND STORAGE OF COAL, IN CLASS 17 (U.S. CLS. 1, 5, 12, 13, 35 AND 50).

FIRST USE 0-0-1999; IN COMMERCE 0-0-1999.

THE MARK CONSISTS OF STANDARD CHARACTERS WITHOUT CLAIM TO ANY PARTICULAR FONT, STYLE, SIZE, OR COLOR.

SER. NO. 78-837,626, FILED 3-15-2006.

THEODORE MCBRIDE, EXAMINING ATTORNEY

**Int. Cl.: 43**

**Prior U.S. Cls.: 100 and 101**

**United States Patent and Trademark Office**

**Reg. No. 3,394,905**

**Registered Mar. 11, 2008**

**SERVICE MARK  
PRINCIPAL REGISTER**

NOT YOUR ORDINARY DINER

EAST BROAD ENTERPRISES, LLC (PENNSYLVANIA LTD LIAB CO)  
10 EAST BROAD STREET  
BETHLEHEM, PA 18018

THE MARK CONSISTS OF STANDARD CHARACTERS WITHOUT CLAIM TO ANY PARTICULAR FONT, STYLE, SIZE, OR COLOR.

FOR: RESTAURANT SERVICES, IN CLASS 43 (U.S. CLS. 100 AND 101).

SER. NO. 78-837,799, FILED 3-15-2006.

FIRST USE 10-5-2002; IN COMMERCE 12-5-2002.

TINA BROWN, EXAMINING ATTORNEY

**Int. Cls.: 39 and 41**

**Prior U.S. Cls.: 100, 101, 105 and 107**

**United States Patent and Trademark Office**

**Reg. No. 3,394,906**

**Registered Mar. 11, 2008**

**SERVICE MARK  
PRINCIPAL REGISTER**

**JOHNNY JET**

JOHNNY JET, INC. (DELAWARE CORPORATION)  
PO BOX 3213  
MANHATTAN BEACH, CA 90266

THE MARK CONSISTS OF STANDARD CHARACTERS WITHOUT CLAIM TO ANY PARTICULAR FONT, STYLE, SIZE, OR COLOR.

FOR: TRAVEL AND TOUR INFORMATION SERVICE, IN CLASS 39 (U.S. CLS. 100 AND 105).

OWNER OF U.S. REG. NO. 2,516,868.

FIRST USE 7-2-1999; IN COMMERCE 7-2-1999.

THE NAME(S), PORTRAIT(S), AND/OR SIGNATURE(S) SHOWN IN THE MARK DOES NOT IDENTIFY A PARTICULAR LIVING INDIVIDUAL.

FOR: PROVIDING NON-DOWNLOADABLE NEWSLETTERS IN THE FIELD OF TRAVEL VIA E-MAIL AND THE INTERNET, IN CLASS 41 (U.S. CLS. 100, 101 AND 107).

SER. NO. 78-838,794, FILED 3-16-2006.

FIRST USE 7-2-1999; IN COMMERCE 7-2-1999.

ALYSSA PALADINO, EXAMINING ATTORNEY

**Int. Cls.: 16, 20, 35 and 40**

**Prior U.S. Cls.: 2, 5, 13, 22, 23, 25, 29, 32, 37, 38, 50,  
100, 101, 102, 103 and 106**

**Reg. No. 3,394,907**

**United States Patent and Trademark Office**

**Registered Mar. 11, 2008**

**TRADEMARK  
SERVICE MARK  
PRINCIPAL REGISTER**



**BorderTrends**

BORDER TRENDS INC. (CANADA CORPORATION)  
5496 GORVAN DRIVE  
MISSISSAUGA, ONTARIO, CANADA L4W 3E8

FOR: FRAMED ART REPRODUCTIONS, FRAMED ART PICTURES, FRAMED ART ETCHINGS, FRAMED ART PRINTS AND FRAMED GRAPHIC ART REPRODUCTIONS, IN CLASS 16 (U.S. CLS. 2, 5, 22, 23, 29, 37, 38 AND 50).

FOR: PICTURE FRAMES, FRAMED MIRRORS, IN CLASS 20 (U.S. CLS. 2, 13, 22, 25, 32 AND 50).

FOR: WHOLESALE ORDERING SERVICES, WHOLESALE STORES AND WHOLESALE DISTRIBUTORSHIPS, ALL OF THE FOREGOING IN THE FIELD OF FRAMED ART, PICTURE FRAMES AND FRAMED MIRRORS, IN CLASS 35 (U.S. CLS. 100, 101 AND 102).

FOR: CUSTOM PLAQUE MOUNTING AND FRAMING, IN CLASS 40 (U.S. CLS. 100, 103 AND 106).

PRIORITY CLAIMED UNDER SEC. 44(D) ON CANADA APPLICATION NO. 1272561, FILED 9-19-2005, REG. NO. TMA698873, DATED 10-18-2007, EXPIRES 10-18-2017.

THE MARK CONSISTS OF THE STYLIZED LETTERS BT IN A SQUARE WITH ROUNDED CORNERS, AND THE WORD BORDERTRENDS IN STYLIZED TYPE BENEATH THE DESIGN.

SER. NO. 78-840,349, FILED 3-17-2006.

WON TEAK OH, EXAMINING ATTORNEY



**Int. Cls.: 35, 37, 38, 39, 40 and 45**

**Prior U.S. Cls.: 100, 101, 102, 103, 104, 105 and 106**

**United States Patent and Trademark Office**

**Reg. No. 3,394,908**

**Registered Mar. 11, 2008**

**SERVICE MARK  
PRINCIPAL REGISTER**

# ENOGEX

OGE ENERGY CORP. (OKLAHOMA CORPORATION)  
P.O. BOX 321  
OKLAHOMA CITY, OK 731010321

FOR: BUSINESS MARKETING SERVICES FOR NATURAL GAS AND RELATED SERVICES; PROVIDING BUSINESS INFORMATION TO CONSUMERS ABOUT THE REAL-TIME AND LONGER-TERM PRICING OF NATURAL GAS; PROMOTING PUBLIC AWARENESS OF THE EFFICIENT USE OF GAS; PROVIDING INFORMATION ON EFFECTIVE USE OF ELECTRICITY AND NATURAL GAS; ASSOCIATION SERVICES, NAMELY, PROMOTING ENVIRONMENTAL CONCERNS IN CONNECTION WITH GAS EXPLORATION, PRODUCTION AND USE, IN CLASS 35 (U.S. CLS. 100, 101 AND 102).

FIRST USE 10-1-1986; IN COMMERCE 10-1-1986.

FOR: INSTALLATION AND MAINTENANCE OF PIPELINES, GATHERING NATURAL GAS FOR OTHERS, IN CLASS 37 (U.S. CLS. 100, 103 AND 106).

FIRST USE 10-1-1986; IN COMMERCE 10-1-1986.

FOR: SATELLITE AND FIBER-OPTIC TRANSMISSION SERVICES; BROADCAST, CABLE AUDIO AND VIDEO CONFERENCE TRANSMISSION SERVICES; VIDEO BROADCASTING SERVICES; BROADCASTING PROGRAMS AND INFORMATION VIA A GLOBAL COMPUTER NETWORK; PROGRAMS PROVIDING TELECOMMUNICATIONS LINKS FOR DIAL-UP AND DEDICATED ACCESS TO MULTI-USER GLOBAL COMPUTER INFORMATION NETWORKS; TELEPHONE VOICE MESSAGE SERVICES; TELECOMMUNICATIONS

AND TELECOMMUNICATIONS SERVICES, NAMELY, PERSONAL COMMUNICATIONS, LONG DISTANCE TELEPHONE AND ISDN, IN CLASS 38 (U.S. CLS. 100, 101 AND 104).

FIRST USE 10-1-1986; IN COMMERCE 10-1-1986.

FOR: DISTRIBUTION OF ENERGY AND NATURAL GAS; STORAGE OF NATURAL GAS; TRANSMISSION OF NATURAL GAS THROUGH PIPELINES, IN CLASS 39 (U.S. CLS. 100 AND 105).

FIRST USE 10-1-1986; IN COMMERCE 10-1-1986.

FOR: PRODUCTION AND PROCESSING OF NATURAL GAS; REMOVAL OF NATURAL GAS LIQUIDS FROM NATURAL GAS, IN CLASS 40 (U.S. CLS. 100, 103 AND 106).

FIRST USE 10-1-1986; IN COMMERCE 10-1-1986.

FOR: PROVIDING INFORMATION IN THE NATURE OF SAFETY GUIDELINES AND TIPS FOR THE USE OF ELECTRICITY AND GAS, IN CLASS 45 (U.S. CLS. 100 AND 101).

FIRST USE 10-1-1986; IN COMMERCE 10-1-1986.

THE MARK CONSISTS OF STANDARD CHARACTERS WITHOUT CLAIM TO ANY PARTICULAR FONT, STYLE, SIZE, OR COLOR.

SER. NO. 78-844,608, FILED 3-23-2006.

MICHAEL LEWIS, EXAMINING ATTORNEY

**Int. Cls.: 35, 36, 37, 40 and 42**

**Prior U.S. Cls.: 100, 101, 102, 103 and 106**

**United States Patent and Trademark Office**

**Reg. No. 3,394,909**

**Registered Mar. 11, 2008**

**SERVICE MARK  
PRINCIPAL REGISTER**



OG E ENERGY CORP. (OKLAHOMA CORPORATION)

P.O. BOX 321

OKLAHOMA CITY, OK 731010321

FOR: CUSTOMER SERVICE FOR UTILITIES, NAMELY, STARTING, STOPPING, AND TRANSFERRING SERVICE VIA THE INTERNET, PROVIDING ON-LINE ORDERING SERVICES FOR AN ANTI-SURGE SYSTEM; MARKETING OF ELECTRICAL UTILITY SERVICES; PROVIDING INFORMATION ON EFFECTIVE USE OF ELECTRICITY AND NATURAL GAS; PROMOTING PUBLIC AWARENESS OF THE EFFICIENT USE OF ELECTRICITY AND GAS AND SAFETY GUIDELINES AND TIPS FOR THE USE OF ELECTRICITY AND GAS; ASSOCIATION SERVICES, NAMELY, PROMOTING ENVIRONMENTAL CONCERNS IN CONNECTION WITH POWER PRODUCTION, IN CLASS 35 (U.S. CLS. 100, 101 AND 102).

FIRST USE 1-1-2005; IN COMMERCE 1-1-2005.

FOR: PROVIDING EXTENDED WARRANTIES AGAINST ELECTRICAL SURGE OF CUSTOMERS ELECTRIC, ELECTRONIC OR ELECTRO-MECHANICAL EQUIPMENT OF OTHERS; PROVIDING EXTENDED WARRANTIES FOR CONVECTION OVENS WHEREBY CUSTOMERS WHO ARE DISSATISFIED WITH THE PERFORMANCE OF CONVECTION OVENS PURCHASED THROUGH OTHER FOODSERVICE DEALERS MAY RECEIVE REFUNDS PROVIDED WARRANTY CONDITIONS ARE COMPLIED WITH; CREDIT CARD SERVICES; BILL PAYMENT SERVICES AND CREDIT RECOVERY AND COLLECTION SERVICES IN THE NATURE OF ESTABLISHING SYSTEMS AND PROCEDURES FOR AND OPERATION OF A SERVICE WHICH PROVIDES FOR UTILITY

CUSTOMERS TO PAY UTILITY BILLS AND CHARGES FOR OFFERED CONSUMER SERVICES THROUGH FLEXIBLE PAYMENT PLANS MADE AVAILABLE BY OR THROUGH UTILITY COMPANIES AND PROVIDING HEAT PUMP LOANS VIA THE INTERNET, IN CLASS 36 (U.S. CLS. 100, 101 AND 102).

FIRST USE 8-1-1995; IN COMMERCE 8-1-1995.

FOR: INSTALLATION OF SURGE PROTECTORS TO CUSTOMERS EQUIPMENT SUCH AS ELECTRICAL APPLIANCES, ELECTRONIC EQUIPMENT, ELECTRO-MECHANICAL DEVICES, COAXIAL CABLE, TELEPHONES AND TELEPHONE LINES, MODEMS, AND FAX MACHINES; DRILLING OF NATURAL GAS; DRILLING WELLS FOR GAS, INSTALLATION AND MAINTENANCE OF PIPELINES, GATHERING NATURAL GAS; CONSTRUCTION SERVICES, NAMELY, PLANNING AND BUILDING PIPELINES FOR THE TRANSPORT OF CRUDE AND REFINED PETROLEUM PRODUCTS AND NATURAL GAS, POWER PLANTS, ROADS, AND OTHER MAJOR INFRASTRUCTURE PROJECTS, DRILLING FOR NATURAL GAS; CUSTOMER PREMISE VOICE AND DATA EQUIPMENT INSTALLATION AND MAINTENANCE, IN CLASS 37 (U.S. CLS. 100, 103 AND 106).

FIRST USE 8-1-1995; IN COMMERCE 8-1-1995.

FOR: PRODUCTION AND PROCESSING OF NATURAL GAS; REMOVAL OF NATURAL GAS LIQUIDS FROM NATURAL GAS, IN CLASS 40 (U.S. CLS. 100, 103 AND 106).

FIRST USE 9-1-1986; IN COMMERCE 9-1-1986.

FOR: GEOTHERMAL HEATING AND COOLING  
DESIGN FOR OTHERS; TECHNICAL DESIGN OF  
ENERGY EFFICIENT HOMES OF OTHERS, IN  
CLASS 42 (U.S. CLS. 100 AND 101).

FIRST USE 8-1-1995; IN COMMERCE 8-1-1995.

OWNER OF U.S. REG. NOS. 1,932,910, 1,932,911  
AND OTHERS.

SER. NO. 78-844,851, FILED 3-23-2006.

MICHAEL LEWIS, EXAMINING ATTORNEY

**Int. Cl.: 29**

**Prior U.S. Cl.: 46**

**United States Patent and Trademark Office**

**Reg. No. 3,394,910**

**Registered Mar. 11, 2008**

**TRADEMARK  
PRINCIPAL REGISTER**

**SOUL SOUP**

SOUL SOUP INC. (CANADA CORPORATION)  
102 - 10171 SASKATCHEWAN DRIVE  
EDMONTON, ALBERTA, CANADA T6E 4R5

2005, REG. NO. TMA690,508, DATED 6-21-2007, EX-  
PIRES 6-21-2022.

FOR: SOUPS, IN CLASS 29 (U.S. CL. 46).

NO CLAIM IS MADE TO THE EXCLUSIVE  
RIGHT TO USE "SOUP", APART FROM THE MARK  
AS SHOWN.

THE MARK CONSISTS OF STANDARD CHAR-  
ACTERS WITHOUT CLAIM TO ANY PARTICULAR  
FONT, STYLE, SIZE, OR COLOR.

SER. NO. 78-845,920, FILED 3-24-2006.

PRIORITY CLAIMED UNDER SEC. 44(D) ON  
CANADA APPLICATION NO. 1273480, FILED 9-26-

SKYE YOUNG, EXAMINING ATTORNEY

**Int. Cl.: 28**

**Prior U.S. Cls.: 22, 23, 38 and 50**

**United States Patent and Trademark Office**

**Reg. No. 3,394,911**

**Registered Mar. 11, 2008**

**TRADEMARK  
PRINCIPAL REGISTER**

**VENTURE**

ERMICO, INC. (CALIFORNIA CORPORATION)  
BUILDING 439  
HUNTER'S POINT NAVAL ANNEX  
SAN FRANCISCO, CA 94124

THE MARK CONSISTS OF STANDARD CHAR-  
ACTERS WITHOUT CLAIM TO ANY PARTICULAR  
FONT, STYLE, SIZE, OR COLOR.

FOR: SKATEBOARD TRUCKS AND DECKS, IN  
CLASS 28 (U.S. CLS. 22, 23, 38 AND 50).

SER. NO. 78-846,062, FILED 3-24-2006.

FIRST USE 12-31-1984; IN COMMERCE 12-31-1984.

PAUL E. FAHRENKOPF, EXAMINING ATTORNEY

**Int. Cls.: 9 and 35**

**Prior U.S. Cls.: 21, 23, 26, 36, 38, 100, 101 and 102**

**Reg. No. 3,394,912**

**United States Patent and Trademark Office**

**Registered Mar. 11, 2008**

**TRADEMARK  
SERVICE MARK  
PRINCIPAL REGISTER**

**CEP**

VALUE CREATION COMPANY LIMITED (UNITED KINGDOM COMPANY)  
9 CAMBRIDGE TERRACE  
BATH, UNITED KINGDOM BA2 6BE

FOR: COMPUTER SOFTWARE FOR THE ANALYSIS AND EVALUATION OF ADVERTISING AND MARKETING MATERIAL, IN CLASS 9 (U.S. CLS. 21, 23, 26, 36 AND 38).

FOR: ADVERTISING ANALYSIS AND CONSULTANCY; MARKETING RESEARCH; BUSINESS ANALYSIS AND EVALUATION OF ADVERTISING AND OTHER MARKETING MATERIAL BEFORE, DURING AND AFTER THEY ARE USED IN A

COMMERCIAL ENVIRONMENT, IN CLASS 35 (U.S. CLS. 100, 101 AND 102).

THE MARK CONSISTS OF STANDARD CHARACTERS WITHOUT CLAIM TO ANY PARTICULAR FONT, STYLE, SIZE, OR COLOR.

PRIORITY CLAIMED UNDER SEC. 44(D) ON ERPN CMNTY TM OFC APPLICATION NO. 004846101, FILED 1-19-2006, REG. NO. 004846101, DATED 1-19-2006, EXPIRES 1-19-2016.

SER. NO. 78-847,845, FILED 3-28-2006.

KELLY BOULTON, EXAMINING ATTORNEY

Int. Cl.: 44

Prior U.S. Cls.: 100 and 101

United States Patent and Trademark Office

Reg. No. 3,394,913

Registered Mar. 11, 2008

SERVICE MARK  
PRINCIPAL REGISTER



(APPLICANT) LKD, INC. (WISCONSIN CORPORATION)  
N2347 HARVEY COURT  
WALWORTH, WI 53184

FOR: ANIMAL GROOMING, IN CLASS 44 (U.S. CLS. 100 AND 101).

FIRST USE 11-1-2005; IN COMMERCE 12-1-2005.

NO CLAIM IS MADE TO THE EXCLUSIVE RIGHT TO USE "MOBILE SPA" AND "PUP", APART FROM THE MARK AS SHOWN.

THE COLOR(S) WHITE, BLACK, RED, BROWN, GOLD AND BLUE IS/ARE CLAIMED AS A FEATURE OF THE MARK.

THE MARK CONSISTS OF THE WORDS PAMPERED PUP IS IN GOLD AND FORMS AN ARCH WITH THE WORD PUP ON A SECOND LINE. ABOVE THE ARCH IS A DRAWING OF A PEERING PUPPY THAT IS HOLDING ON TO THE TOP OF THE WORDS PAMPERED. THE PUPPY IS WHITE WITH BROWN FLOPPY EARS AND A BROWN SPOT AROUND ONE EYE. THE PUPPY WEARS A RED AND GOLD COLLAR AND IS SURROUNDED BY BLUE BUBBLES, SYMBOLIZING A BATH. THE WORDS MOBILE SPA, IN RED, IS LOCATED TO THE LEFT OF THE DRAWING AND ABOVE THE BUBBLES AND WORDS PAMPERED PUP.

SER. NO. 78-852,014, FILED 4-1-2006.

SALLY SHIH, EXAMINING ATTORNEY

Int. Cl.: 38

Prior U.S. Cls.: 100, 101 and 104

United States Patent and Trademark Office

Reg. No. 3,394,914

Registered Mar. 11, 2008

SERVICE MARK  
PRINCIPAL REGISTER



BERRY, JOCELYN, M. (UNITED STATES INDIVIDUAL)  
25736 PLAYER DRIVE, R-14  
VALENCIA, CA 91355 AND  
GUERRA, BENJAMIN, V. (UNITED STATES INDIVIDUAL)  
25736 PLAYER DRIVE, R-14  
VALENCIA, CA 91355

FOR: MOBILE MEDIA AND ENTERTAINMENT SERVICES IN THE NATURE OF ELECTRONIC TRANSMISSION OF ENTERTAINMENT MEDIA CONTENT, IN CLASS 38 (U.S. CLS. 100, 101 AND 104).

FIRST USE 2-27-2006; IN COMMERCE 2-27-2006.

NO CLAIM IS MADE TO THE EXCLUSIVE RIGHT TO USE MOBILE, APART FROM THE MARK AS SHOWN.

THE MARK CONSISTS OF THE STYLIZED WORDS "SPIRITUAL," "LIFT" AND THE STYLIZED PHRASE "MOBILE INSPIRATIONS" AND A DESIGN OF A HALF SUN UNDER THE WORD "LIFT."

SER. NO. 78-852,049, FILED 4-2-2006.

CHRISTOPHER BUONGIORNO, EXAMINING ATTORNEY



Int. Cl.: 35

Prior U.S. Cls.: 100, 101 and 102

United States Patent and Trademark Office

Reg. No. 3,394,915

Registered Mar. 11, 2008

SERVICE MARK  
PRINCIPAL REGISTER



ASSOCIATION *of*  
FISH & WILDLIFE  
AGENCIES

ASSOCIATION OF FISH AND WILDLIFE AGEN-  
CIES (D.C. CORPORATION)  
SUITE 725  
444 NORTH CAPITOL STREET, NW  
WASHINGTON, DC 20001

FOR: NATURAL RESOURCE MANAGEMENT,  
IN CLASS 35 (U.S. CLS. 100, 101 AND 102).

FIRST USE 3-24-2006; IN COMMERCE 3-27-2006.

NO CLAIM IS MADE TO THE EXCLUSIVE  
RIGHT TO USE "ASSOCIATION OF FISH AND

WILDLIFE AGENCIES", APART FROM THE MARK  
AS SHOWN.

THE MARK CONSISTS OF THE SILHOUETTES  
OF AN EAGLE, MOUNTAIN, FISH AND BUCK  
AGAINST A SOLID BACKGROUND. BENEATH  
ARE THE WORDS, ASSOCIATION OF FISH &  
WILDLIFE AGENCIES.

SER. NO. 78-852,622, FILED 4-3-2006.

KENNETH E. SHARPERSON, EXAMINING ATTOR-  
NEY

**Int. Cl.: 12**

**Prior U.S. Cls.: 19, 21, 23, 31, 35 and 44**

**Reg. No. 3,394,916**

**United States Patent and Trademark Office**

**Registered Mar. 11, 2008**

**TRADEMARK  
PRINCIPAL REGISTER**

**KING OFF-ROAD RACING SHOCKS**

KING SHOCK TECHNOLOGY, INC. (CALIFORNIA CORPORATION)

12842 JOY STREET

GARDEN GROVE, CA 92840

FOR: VEHICLE PARTS, NAMELY, SHOCK ABSORBERS, IN CLASS 12 (U.S. CLS. 19, 21, 23, 31, 35 AND 44).

FIRST USE 2-0-1996; IN COMMERCE 2-0-1996.

THE MARK CONSISTS OF STANDARD CHARACTERS WITHOUT CLAIM TO ANY PARTICULAR FONT, STYLE, SIZE, OR COLOR.

NO CLAIM IS MADE TO THE EXCLUSIVE RIGHT TO USE "OFF-ROAD RACING SHOCKS", APART FROM THE MARK AS SHOWN.

SER. NO. 78-855,173, FILED 4-5-2006.

TRACY WHITTAKER-BROWN, EXAMINING ATTORNEY

**Int. Cl.: 6**

**Prior U.S. Cls.: 2, 12, 13, 14, 23, 25 and 50**

**Reg. No. 3,394,917**

**United States Patent and Trademark Office**

**Registered Mar. 11, 2008**

---

**TRADEMARK  
PRINCIPAL REGISTER**

**BLUE OX**

BLACCO SPLICING & RIGGING LOFT, INC.  
(OHIO CORPORATION)  
1976 ALUM CREEK DRIVE  
COLUMBUS, OH 43207

THE MARK CONSISTS OF STANDARD CHAR-  
ACTERS WITHOUT CLAIM TO ANY PARTICULAR  
FONT, STYLE, SIZE, OR COLOR.

FOR: WIRE ROPE SLING; WIRE ROPES, IN  
CLASS 6 (U.S. CLS. 2, 12, 13, 14, 23, 25 AND 50).

SER. NO. 78-856,699, FILED 4-7-2006.

FIRST USE 10-31-1982; IN COMMERCE 3-25-1983.

KATHY DE JONGE, EXAMINING ATTORNEY

**Int. Cls.: 35, 36, 41, 42, 44 and 45**

**Prior U.S. Cls.: 100, 101, 102 and 107**

**United States Patent and Trademark Office**

**Reg. No. 3,394,918**

**Registered Mar. 11, 2008**

**SERVICE MARK  
PRINCIPAL REGISTER**

**PARTNERS IN HEALTH**

PARTNERS IN HEALTH, A NONPROFIT CORPORATION (MASSACHUSETTS CORPORATION)  
641 HUNTINGTON AVENUE  
BOSTON, MA 02110

FOR: PROVIDING TECHNICAL ASSISTANCE TO COMMUNITY-BASED ORGANIZATIONS IN THE ESTABLISHMENT AND OPERATION OF HEALTH SERVICES ORGANIZATIONS; PROMOTING PUBLIC AWARENESS OF THE MEDICAL NEEDS OF IMPOVERISHED COMMUNITIES; PHILANTHROPIC SERVICES IN THE NATURE OF COORDINATION OF THE PROCUREMENT AND DISTRIBUTION OF FOOD DONATIONS, MEDICAL SUPPLIES, MEDICAL EQUIPMENT AND DRUGS FROM MANUFACTURERS, WHOLESALERS, RETAILERS, AND GOVERNMENT AGENCIES TO COMMUNITY-BASED ORGANIZATIONS PROVIDING THE AFOREMENTIONED FREE GOODS TO NEEDY PEOPLE; CHARITABLE SERVICES, NAMELY, PROVIDING TECHNICAL ASSISTANCE TO THE COMMUNITY-BASED ORGANIZATIONS IN ORGANIZING AND COORDINATING VOLUNTEER AND FUNDRAISING PROGRAMS RELATED TO THE IMPROVEMENT OF ECONOMIC-BASED HEALTHCARE ISSUES, IN CLASS 35 (U.S. CLS. 100, 101 AND 102).

FIRST USE 6-15-1987; IN COMMERCE 6-15-1987.

FOR: CHARITABLE FUNDRAISING; PHILANTHROPIC SERVICES, NAMELY, CHARITABLE DONATION OF FUNDS, IN CLASS 36 (U.S. CLS. 100, 101 AND 102).

FIRST USE 6-15-1987; IN COMMERCE 6-15-1987.

FOR: MEDICAL TRAINING SERVICES, IN CLASS 41 (U.S. CLS. 100, 101 AND 107).

FIRST USE 6-15-1987; IN COMMERCE 6-15-1987.

FOR: MEDICAL AND SCIENTIFIC RESEARCH SERVICES, IN CLASS 42 (U.S. CLS. 100 AND 101).

FIRST USE 6-15-1987; IN COMMERCE 6-15-1987.

FOR: CHARITABLE SERVICES, NAMELY, ASSISTING COMMUNITY-BASED ORGANIZATIONS IN IMPROVING ECONOMIC-BASED HEALTHCARE ISSUES THROUGH THE INTERNATIONAL PROVISION OF MEDICAL SUPPLIES, IN CLASS 44 (U.S. CLS. 100 AND 101).

FIRST USE 10-31-1996; IN COMMERCE 10-31-1996.

FOR: PROVIDING PATIENT ADVOCACY SERVICES, NAMELY, RAISING AWARENESS OF THE MEDICAL NEEDS OF IMPOVERISHED PATIENTS, IN CLASS 45 (U.S. CLS. 100 AND 101).

FIRST USE 6-15-1987; IN COMMERCE 6-15-1987.

THE MARK CONSISTS OF STANDARD CHARACTERS WITHOUT CLAIM TO ANY PARTICULAR FONT, STYLE, SIZE, OR COLOR.

NO CLAIM IS MADE TO THE EXCLUSIVE RIGHT TO USE "HEALTH", APART FROM THE MARK AS SHOWN.

SER. NO. 78-857,792, FILED 4-10-2006.

CHRISTINE COOPER, EXAMINING ATTORNEY

**Int. Cl.: 31**

**Prior U.S. Cls.: 1 and 46**

**United States Patent and Trademark Office**

**Reg. No. 3,394,919**

**Registered Mar. 11, 2008**

**TRADEMARK  
PRINCIPAL REGISTER**

**ENHANCE**

ARKAT NUTRITION, INC. (ARKANSAS COR-  
PORATION)  
P.O. BOX 720  
DUMAS, AR 71639

FOR: ANIMAL FEED, IN CLASS 31 (U.S. CLS. 1  
AND 46).

FIRST USE 6-24-1996; IN COMMERCE 6-24-1996.

THE MARK CONSISTS OF STANDARD CHAR-  
ACTERS WITHOUT CLAIM TO ANY PARTICULAR  
FONT, STYLE, SIZE, OR COLOR.

OWNER OF U.S. REG. NO. 2,100,299.

SER. NO. 78-857,796, FILED 4-10-2006.

WENDY GOODMAN, EXAMINING ATTORNEY

**Int. Cl.: 41**

**Prior U.S. Cls.: 100, 101 and 107**

**United States Patent and Trademark Office**

**Reg. No. 3,394,920**

**Registered Mar. 11, 2008**

**SERVICE MARK  
PRINCIPAL REGISTER**

**EPIC**

EPIC MEDIA GROUP LLC (NEVADA LTD LIAB  
CO)  
605 S. DOUGLAS STREET  
EL SEGUNDO, CA 90245

FOR: SPECIAL EVENT PLANNING, IN CLASS 41  
(U.S. CLS. 100, 101 AND 107).

FIRST USE 12-31-2005; IN COMMERCE 12-31-2005.

THE MARK CONSISTS OF STANDARD CHAR-  
ACTERS WITHOUT CLAIM TO ANY PARTICULAR  
FONT, STYLE, SIZE, OR COLOR.

OWNER OF U.S. REG. NO. 3,023,944.

SER. NO. 78-858,202, FILED 4-10-2006.

CARYN GLASSER, EXAMINING ATTORNEY

**Int. Cl.: 9**

**Prior U.S. Cls.: 21, 23, 26, 36 and 38**

**Reg. No. 3,394,921**

**United States Patent and Trademark Office**

**Registered Mar. 11, 2008**

**TRADEMARK  
PRINCIPAL REGISTER**

**THERMOTECH**

COWIE TECHNOLOGY GROUP LTD (UNITED  
KINGDOM CORPORATION)  
RIDGWAY, COULBY NEWHAM  
MIDDLESBROUGH, UNITED KINGDOM TS8 0TQ

PRIORITY CLAIMED UNDER SEC. 44(D) ON  
ERPNTM OFC APPLICATION NO.  
005008751, FILED 4-10-2006, REG. NO. 005008751,  
DATED 2-13-2007, EXPIRES 4-10-2016.

FOR: LABORATORY AND SCIENTIFIC INSTRU-  
MENTS, NAMELY, GLASSWARE, FLASKS AND  
BEAKERS FOR SCIENTIFIC AND LABORATORY  
USE, IN CLASS 9 (U.S. CLS. 21, 23, 26, 36 AND 38).

SER. NO. 78-859,891, FILED 4-12-2006.

THE MARK CONSISTS OF STANDARD CHAR-  
ACTERS WITHOUT CLAIM TO ANY PARTICULAR  
FONT, STYLE, SIZE, OR COLOR.

LINDA M. KING, EXAMINING ATTORNEY

**Int. Cl.: 12**

**Prior U.S. Cls.: 19, 21, 23, 31, 35 and 44**

**Reg. No. 3,394,922**

**United States Patent and Trademark Office**

**Registered Mar. 11, 2008**

**TRADEMARK  
PRINCIPAL REGISTER**



MACDON INDUSTRIES LTD. (CANADA CORPORATION)  
680 MORAY STREET  
WINNIPEG, MANITOBA, CANADA R3J 3S3

FOR: AGRICULTURAL EQUIPMENT, NAMELY,  
WINDROWER TRACTORS, IN CLASS 12 (U.S. CLS.  
19, 21, 23, 31, 35 AND 44).

OWNER OF CANADA REG. NO. 694484, DATED  
8-21-2007, EXPIRES 8-21-2022.

NO CLAIM IS MADE TO THE EXCLUSIVE  
RIGHT TO USE "DUAL DIRECTION", APART  
FROM THE MARK AS SHOWN.

SER. NO. 78-860,634, FILED 4-13-2006.

LANA PHAM, EXAMINING ATTORNEY



Int. Cl.: 30

Prior U.S. Cl.: 46

United States Patent and Trademark Office

Reg. No. 3,394,923

Registered Mar. 11, 2008

TRADEMARK  
PRINCIPAL REGISTER



CHOCOLATERIE GUYLIAN N.V. (BELGIUM  
JOINT STOCK COMPANY)  
EUROPARK OOST 1  
9100 SINT-NIKLAAS, BELGIUM

FOR: CHOCOLATE, CHOCOLATES AND PRA-  
LINES, IN CLASS 30 (U.S. CL. 46).

FIRST USE 12-31-1988; IN COMMERCE 12-31-1988.

OWNER OF U.S. REG. NO. 3,041,886.

THE MARK CONSISTS OF A THREE-DIMENSION-  
AL CONFIGURATION OF A CHOCOLATE SEA-  
HORSE WITH THE TAIL CURLING TO THE BACK.

SEC. 2(F).

SER. NO. 78-860,771, FILED 4-13-2006.

ELLEN B. AWRICH, EXAMINING ATTORNEY

**Int. Cl.: 41**

**Prior U.S. Cls.: 100, 101 and 107**

**United States Patent and Trademark Office**

**Reg. No. 3,394,924**

**Registered Mar. 11, 2008**

**SERVICE MARK  
PRINCIPAL REGISTER**

# SwimFarr

SWIMFARR SWIM SAFE, INC. (CALIFORNIA  
CORPORATION)  
3450 LINDBERGH STREET  
SAN DIEGO, CA 92154

FOR: EDUCATION AND TRAINING, NAMELY,  
PROVIDING COURSES OF INSTRUCTION AND  
TRAINING IN THE FIELD OF SWIMMING, CPR  
AND FIRST AID; ENTERTAINMENT IN THE NAT-  
URE OF SWIMMING POOL RELATED SPORTS  
AND CULTURAL ACTIVITIES, NAMELY, AQUA-  
TIC EXERCISE AND WATER POLO, IN CLASS 41  
(U.S. CLS. 100, 101 AND 107).

FIRST USE 2-0-2006; IN COMMERCE 2-0-2006.

THE MARK CONSISTS OF STANDARD CHAR-  
ACTERS WITHOUT CLAIM TO ANY PARTICULAR  
FONT, STYLE, SIZE, OR COLOR.

SER. NO. 78-860,993, FILED 4-13-2006.

GEORGIA CARTY, EXAMINING ATTORNEY

**Int. Cls.: 9 and 42**

**Prior U.S. Cls.: 21, 23, 26, 36, 38, 100 and 101**

**United States Patent and Trademark Office**

**Reg. No. 3,394,925**

**Registered Mar. 11, 2008**

**TRADEMARK  
SERVICE MARK  
PRINCIPAL REGISTER**

# Cartasite

CARTASITE, INC. (COLORADO CORPORATION)  
SUITE 500  
1860 LINCOLN ST.  
DENVER, CO 80295

FOR: GLOBAL POSITIONING SYSTEMS AND COMPONENT PARTS THEREOF FOR IDENTIFYING THE LOCATION OF AND TELEMETRY INFORMATION ABOUT ASSETS CONSISTING OF COMPUTERS, INCLUDING SERVERS, COMPUTER SOFTWARE, TRANSMITTERS, RECEIVERS, AND NETWORK INTERFACE DEVICES; COMPUTER SOFTWARE FOR USE IN DATABASE MANAGEMENT; COMPUTER SOFTWARE FOR USE IN BUSINESS MANAGEMENT, NAMELY, FOR PROVIDING REAL-TIME ANALYTICS TO ALLOW BUSINESS EXECUTIVES TO MAKE INFORMED DECISIONS ABOUT THE ALLOCATION OF RESOURCES, ASSETS, AND MANPOWER; COMPUTER SOFTWARE, NAMELY, AN APPLICATION ALLOWING SALES AND FIELD SERVICE EMPLOYEES TO UPDATE AND RECEIVE DATA STORED IN AN ENTERPRISE'S COMPUTER DATABASES IN REAL TIME, USING A MOBILE DEVICE, AND/OR SOFTWARE FEATURES OF THE MOBILE DEVICE; ENTERPRISE SOFTWARE IN THE NATURE OF A DATABASE FOR NON-TRANSACTIONAL DATA AND A SEARCH ENGINE FOR DATABASE CONTENT; AND GRAPHICAL USER INTERFACE SOFTWARE, IN CLASS 9 (U.S. CLS. 21, 23, 26, 36 AND 38).

FIRST USE 1-1-2004; IN COMMERCE 6-1-2004.

FOR: APPLICATION SERVICE PROVIDER (ASP) FEATURING SOFTWARE IN THE FIELD OF TRANSPORTATION FOR USE IN DATABASE MANAGEMENT; APPLICATION SERVICE PROVIDER (ASP) FEATURING SOFTWARE IN THE FIELD OF TRANSPORTATION FOR USE IN BUSINESS MANAGEMENT, NAMELY, FOR PROVIDING REAL-TIME ANALYTICS TO ALLOW BUSINESS EXECUTIVES TO MAKE INFORMED DECISIONS ABOUT THE ALLOCATION OF RESOURCES, ASSETS, AND MANPOWER; COMPUTER SERVICE, NAMELY, ACTING AS AN APPLICATION SERVICE PROVIDER IN THE FIELD OF KNOWLEDGE MANAGEMENT TO HOST COMPUTER APPLICATION SOFTWARE FOR SEARCHING AND RETRIEVING INFORMATION FROM DATABASES AND COMPUTER NETWORKS; MAINTENANCE OF COMPUTER SOFTWARE; SOFTWARE AUTHORIZING; TECHNICAL SUPPORT SERVICES, NAMELY, TROUBLESHOOTING OF COMPUTER HARDWARE AND SOFTWARE PROBLEMS; AND UPDATING OF COMPUTER SOFTWARE FOR OTHERS, IN CLASS 42 (U.S. CLS. 100 AND 101).

FIRST USE 1-1-2004; IN COMMERCE 6-1-2004.

THE MARK CONSISTS OF STANDARD CHARACTERS WITHOUT CLAIM TO ANY PARTICULAR FONT, STYLE, SIZE, OR COLOR.

SER. NO. 78-861,412, FILED 4-13-2006.

ATTIYA MALIK, EXAMINING ATTORNEY

**Int. Cls.: 41 and 44**

**Prior U.S. Cls.: 100, 101 and 107**

**United States Patent and Trademark Office**

**Reg. No. 3,394,926**

**Registered Mar. 11, 2008**

**SERVICE MARK  
PRINCIPAL REGISTER**

**INTERNATIONAL UMBILICAL  
CORD BLOOD TRANSPLANTATION  
SYMPOSIUM**

STEMCYTE, INC. (DELAWARE CORPORATION)  
400 ROLYN PLACE  
ARCADIA, CA 91007

FOR: EDUCATIONAL SERVICES, NAMELY,  
PROVIDING SEMINARS, CLASSES, FORUMS,  
MEETINGS AND EDUCATIONAL EVENTS IN  
THE FIELD OF UMBILICAL CORD BLOOD AND  
STEM CELLS, IN CLASS 41 (U.S. CLS. 100, 101 AND  
107).

FIRST USE 4-1-2002; IN COMMERCE 5-1-2002.

FOR: PROVIDING ON-LINE INFORMATION  
FOR OTHERS IN THE FIELD OF UMBILICAL  
CORD BLOOD AND STEM CELLS, IN CLASS 44  
(U.S. CLS. 100 AND 101).

FIRST USE 4-1-2002; IN COMMERCE 5-1-2002.

THE MARK CONSISTS OF STANDARD CHAR-  
ACTERS WITHOUT CLAIM TO ANY PARTICULAR  
FONT, STYLE, SIZE, OR COLOR.

NO CLAIM IS MADE TO THE EXCLUSIVE  
RIGHT TO USE "UMBILICAL CORD BLOOD  
TRANSPLANTATION SYMPOSIUM", APART  
FROM THE MARK AS SHOWN.

SEC. 2(F).

SER. NO. 78-862,071, FILED 4-14-2006.

PAUL E. FAHRENKOPF, EXAMINING ATTORNEY

**Int. Cl.: 41**

**Prior U.S. Cls.: 100, 101 and 107**

**United States Patent and Trademark Office**

**Reg. No. 3,394,927**

**Registered Mar. 11, 2008**

**SERVICE MARK  
PRINCIPAL REGISTER**

**PRACTICE MADE PERFECT**

CLIENTWHYS, INC. (CALIFORNIA CORPORATION)  
5310 DERRY AVENUE, SUITE J  
AGOURA HILLS, CA 91301

FOR: EDUCATIONAL SERVICES, NAMELY, CONDUCTING CONTINUING EDUCATION CLASSES, COURSES, AND SEMINARS IN THE FIELD OF TAXES AND ACCOUNTING OFFERED TO ENROLLED AGENTS, CERTIFIED PUBLIC ACCOUNTANTS, CERTIFIED FINANCIAL PLANNERS, TAX PREPARERS AND ATTORNEYS AND THEIR CLIENTS; PROVIDING ON-LINE PUBLICATIONS, NAMELY, BROCHURES, BOOKLETS, PHAMPLETS AND NEWSLETTERS IN THE FIELD OF TAXES AND ACCOUNTING TO ENROLLED AGENTS,

CERTIFIED PUBLIC ACCOUNTANTS, CERTIFIED FINANCIAL PLANNERS, TAX PREPARERS AND ATTORNEYS AND THEIR CLIENTS, IN CLASS 41 (U.S. CLS. 100, 101 AND 107).

FIRST USE 5-9-1990; IN COMMERCE 5-9-1990.

THE MARK CONSISTS OF STANDARD CHARACTERS WITHOUT CLAIM TO ANY PARTICULAR FONT, STYLE, SIZE, OR COLOR.

SER. NO. 78-862,174, FILED 4-14-2006.

MICHELE SWAIN, EXAMINING ATTORNEY

**Int. Cl.: 9**

**Prior U.S. Cls.: 21, 23, 26, 36 and 38**

**Reg. No. 3,394,928**

**United States Patent and Trademark Office**

**Registered Mar. 11, 2008**

**TRADEMARK  
PRINCIPAL REGISTER**



FREEWAVE TECHNOLOGIES, INC. (COLORADO CORPORATION)  
SUITE F  
1880 S FLATIRON CT  
BOULDER, CO 80301

OWNER OF U.S. REG. NO. 2,004,263.

FOR: WIRELESS RADIO TRANSCEIVERS AND COMPUTER SOFTWARE FOR USE IN WIRELESS RADIO TRANSCEIVERS FOR TRANSMITTING DATA BETWEEN TWO OR MORE DEVICES , IN CLASS 9 (U.S. CLS. 21, 23, 26, 36 AND 38).

THE MARK CONSISTS OF THE WORD FREEWAVE AND CURVED LINES REPRESENTING SOUND WAVES EMANATING FROM THE RIGHT SIDE OF THE MARK.

SER. NO. 78-864,047, FILED 4-18-2006.

FIRST USE 2-24-2002; IN COMMERCE 11-24-2003.

KRISTINA MORRIS, EXAMINING ATTORNEY

Int. Cl.: 39

Prior U.S. Cls.: 100 and 105

United States Patent and Trademark Office

Reg. No. 3,394,929

Registered Mar. 11, 2008

SERVICE MARK  
PRINCIPAL REGISTER



JONES, BRENT, M (ARIZONA INDIVIDUAL)  
STE #103  
16410 N. 91ST ST SUITE #103  
SCOTTSDALE, AZ 85260

FOR: COURIER SERVICES; MESSENGER SERVICES; PROVIDING OCEAN TRANSPORTATION, STORAGE AND DELIVERY SERVICES; TRANSPORTATION AND DELIVERY SERVICES, NAMELY, SAME DAY SHIPMENT SERVICES, IN CLASS 39 (U.S. CLS. 100 AND 105).

FIRST USE 3-31-2006; IN COMMERCE 3-31-2006.

THE COLOR(S) BROWN, ORANGE, YELLOW, GREEN, AND BLACK IS/ARE CLAIMED AS A FEATURE OF THE MARK.

THE MARK CONSISTS OF THE STYLIZED WORD ALOHA WITH THE O OF THE WORD IN THE SHAPE AND COLORS OF A PINEAPPLE. A PINEAPPLE WITH BROWN, ORANGE, YELLOW, AND BLACK BODY AND A GREEN AND BLACK STEM.

SER. NO. 78-864,110, FILED 4-18-2006.

HEATHER SAPP, EXAMINING ATTORNEY

**Int. Cls.: 35 and 41**

**Prior U.S. Cls.: 100, 101, 102 and 107**

**United States Patent and Trademark Office**

**Reg. No. 3,394,930**

**Registered Mar. 11, 2008**

**SERVICE MARK  
PRINCIPAL REGISTER**

**GENUINEVIDEO**

COLDSTREAM GROUP (WASHINGTON PART-  
NERSHIP)  
7717 E. PRINCETON AVE  
SPOKANE, WA 99212

FOR: DISTRIBUTION OF ADVERTISEMENT  
PRESENTATIONS, IN CLASS 35 (U.S. CLS. 100, 101  
AND 102).

FIRST USE 3-27-2006; IN COMMERCE 3-27-2006.

FOR: AUDIO PRODUCTION; PRODUCTION OF  
VIDEO MEDIA IN THE NATURE OF VIDEO DISKS,  
AND COMPUTER READABLE MEMORY; AUDIO

AND VIDEO EDITING; DISTRIBUTION OF FILMS,  
TELEVISION PROGRAMS, AND PODCASTS, IN  
CLASS 41 (U.S. CLS. 100, 101 AND 107).

FIRST USE 3-27-2006; IN COMMERCE 3-27-2006.

THE MARK CONSISTS OF STANDARD CHAR-  
ACTERS WITHOUT CLAIM TO ANY PARTICULAR  
FONT, STYLE, SIZE, OR COLOR.

SER. NO. 78-867,282, FILED 4-21-2006.

MARK SPARACINO, EXAMINING ATTORNEY



**Int. Cl.: 25**

**Prior U.S. Cls.: 22 and 39**

**United States Patent and Trademark Office**

**Reg. No. 3,394,931**

**Registered Mar. 11, 2008**

**TRADEMARK  
PRINCIPAL REGISTER**

keep reaching for the  
stars...the sky's the limit

JOHANNES LEE (UNITED STATES INDIVIDUAL)  
1484 S. ROBERTSON BLVD  
LOS ANGELES, CA 90035

FIRST USE 2-1-2006; IN COMMERCE 2-1-2006.

FOR: BELTS MADE OF LEATHER; DENIMS; HATS; HEADWEAR, NAMELY, BEANIES, SWEAT BANDS; PANTS; SHIRT FRONTS; SHIRTS; SHORT-SLEEVED OR LONG-SLEEVED T-SHIRTS; SHORT-SLEEVED SHIRTS; SLEEP SHIRTS; SPORT SHIRTS; SPORTS SHIRTS WITH SHORT SLEEVES; SWEAT PANTS; SWEAT SHIRTS; T-SHIRTS; WAIST BELTS, IN CLASS 25 (U.S. CLS. 22 AND 39).

THE MARK CONSISTS OF STANDARD CHARACTERS WITHOUT CLAIM TO ANY PARTICULAR FONT, STYLE, SIZE, OR COLOR.

SER. NO. 78-870,410, FILED 4-26-2006.

ZACHARY BELLO, EXAMINING ATTORNEY

**Int. Cl.: 5**

**Prior U.S. Cls.: 6, 18, 44, 46, 51 and 52**

**United States Patent and Trademark Office**

**Reg. No. 3,394,932**

**Registered Mar. 11, 2008**

**TRADEMARK  
PRINCIPAL REGISTER**

**ORAL DEFENSE**

ORAL DEFENSE LLC (WASHINGTON LTD LIAB  
CO)  
SUITE 101  
4610 NORTH ASH STREET  
SPOKANE, WA 99205

FOR: MEDICATED ORAL HYGIENE PRODUCTS,  
NAMELY, MEDICATED MOUTHWASH, MEDICA-  
TED MOUTH RINSE, MEDICATED TOOTHGEL,  
AND MEDICATED DENTAL PROPHYLAXIS PRE-  
PARATIONS INCLUDING MOUTHWASH, IN  
CLASS 5 (U.S. CLS. 6, 18, 44, 46, 51 AND 52).

FIRST USE 11-0-1999; IN COMMERCE 11-0-1999.

THE MARK CONSISTS OF STANDARD CHAR-  
ACTERS WITHOUT CLAIM TO ANY PARTICULAR  
FONT, STYLE, SIZE, OR COLOR.

NO CLAIM IS MADE TO THE EXCLUSIVE  
RIGHT TO USE "ORAL", APART FROM THE MARK  
AS SHOWN.

SER. NO. 78-870,773, FILED 4-27-2006.

GINA FINK, EXAMINING ATTORNEY

**Int. Cl.: 20**

**Prior U.S. Cls.: 2, 13, 22, 25, 32 and 50**

**United States Patent and Trademark Office**

**Reg. No. 3,394,933**

**Registered Mar. 11, 2008**

**TRADEMARK  
PRINCIPAL REGISTER**

**SleepJoy**

ROTHBARD, MICHAEL (UNITED STATES INDIVIDUAL)  
3215 FOOTHILL ROAD  
CARPINTERIA, CA 93013

THE MARK CONSISTS OF STANDARD CHARACTERS WITHOUT CLAIM TO ANY PARTICULAR FONT, STYLE, SIZE, OR COLOR.

FOR: SLEEP RELATED PRODUCTS, NAMELY, MATTRESSES, MATTRESS TOPPERS AND PILLOWS, IN CLASS 20 (U.S. CLS. 2, 13, 22, 25, 32 AND 50).

SER. NO. 78-874,494, FILED 5-2-2006.

FIRST USE 3-26-2006; IN COMMERCE 4-1-2006.

PAUL CROWLEY, EXAMINING ATTORNEY

Int. Cls.: 43 and 44

Prior U.S. Cls.: 100 and 101

United States Patent and Trademark Office

Reg. No. 3,394,934

Registered Mar. 11, 2008

SERVICE MARK  
PRINCIPAL REGISTER



VETS HOLDINGS INC. (JAPAN CORPORATION)  
7-21, MINAMISEMBA 4-CHOME, CHUOKU  
OSAKA, JAPAN

FOR: PREPARING AND SERVING OF FOOD AND BEVERAGES AT DRINKING AND EATING ESTABLISHMENTS WHERE BOTH HUMAN AND PETS CAN DRINK AND EAT TOGETHER; PROVIDING PET BOARDING SERVICES AND PROVIDING INFORMATION CONCERNING THE AFORESAID SERVICES, PROVIDING TEMPORARY ACCOMMODATION, TRAVEL AGENCY SERVICES, NAMELY, MAKING RESERVATIONS FOR TEMPORARY LODGING, IN CLASS 43 (U.S. CLS. 100 AND 101).

FOR: VETERINARY SERVICES AND PROVIDING INFORMATION CONCERNING THE AFORESAID SERVICES, VACCINATION OF ANIMALS, PREPARATION AND DISPENSING OF MEDICATIONS FOR ANIMALS, PHYSICAL EXAMINATION

OF ANIMALS, VETERINARY SERVICES FEATURING THE MEDICAL CARE AND NURSING OF PETS, ANIMAL BREEDING, DIETARY AND NUTRITIONAL GUIDANCE FOR PETS, PET GROOMING, BEAUTY SALONS OR HAIRDRESSING SALONS FOR PETS, PROVIDING BATH HOUSES FOR PETS, PROVIDING MASSAGE FOR PETS, PROVIDING AROMATHERAPY FOR PETS, PROVIDING PHYSICAL REHABILITATION SERVICES FOR PETS, IN CLASS 44 (U.S. CLS. 100 AND 101).

PRIORITY CLAIMED UNDER SEC. 44(D) ON JAPAN APPLICATION NO. 2005105547, FILED 11-10-2005, REG. NO. 4969230, DATED 7-14-2006, EXPIRES 7-14-2016.

SER. NO. 78-874,584, FILED 5-2-2006.

KATHERINE CHANG, EXAMINING ATTORNEY

**Int. Cl.: 35**

**Prior U.S. Cls.: 100, 101 and 102**

**United States Patent and Trademark Office**

**Reg. No. 3,394,935**

**Registered Mar. 11, 2008**

**SERVICE MARK  
PRINCIPAL REGISTER**

**ENLIVEN INTERNATIONAL**

ENLIVEN INTERNATIONAL, INC. (NEVADA CORPORATION)  
SUITE 208  
20 NORTH MAIN  
ST. GEORGE, UT 84770

FOR: MULTI-LEVEL MARKETING BUSINESS SERVICES, SUCH SERVICES PROVIDED THROUGH HOME-BASED BUSINESS OPPORTUNITIES., IN CLASS 35 (U.S. CLS. 100, 101 AND 102).

FIRST USE 8-31-2003; IN COMMERCE 8-31-2003.

THE MARK CONSISTS OF STANDARD CHARACTERS WITHOUT CLAIM TO ANY PARTICULAR FONT, STYLE, SIZE, OR COLOR.

NO CLAIM IS MADE TO THE EXCLUSIVE RIGHT TO USE "INTERNATIONAL", APART FROM THE MARK AS SHOWN.

SER. NO. 78-874,892, FILED 5-2-2006.

CARYN GLASSER, EXAMINING ATTORNEY

Int. Cls.: 35, 38 and 41

Prior U.S. Cls.: 100, 101, 102, 104 and 107

United States Patent and Trademark Office

Reg. No. 3,394,936

Registered Mar. 11, 2008

SERVICE MARK  
PRINCIPAL REGISTER



BRANDON MARLING (UNITED STATES INDIVIDUAL)  
30 S. TRANQUIL PATH  
THE WOODLANDS, TX 77380

FOR: ON-LINE SERVICES, NAMELY, ON-LINE ORDERING SERVICES, ON-LINE RETAIL STORE SERVICES, ELECTRONIC RETAILING SERVICES VIA COMPUTER, ON-LINE ORDERING AND INVENTORY MONITORING SERVICES, ALL FEATURING RECREATIONAL UTILITY VEHICLES, PARTS, ACCESSORIES, NOVELTIES, CLOTHING AND AFTER-MARKET ITEMS RELATED TO SMALL OPEN MOTORIZED BUGGIES AND TRICYCLES DESIGNED FOR OFF-ROAD USE, IN CLASS 35 (U.S. CLS. 100, 101 AND 102).

FIRST USE 9-30-2001; IN COMMERCE 9-30-2001.

FOR: PROVIDING ON-LINE FORUMS, NAMELY, PROVIDING ON-LINE CHAT ROOMS, ELECTRONIC BULLETIN BOARDS, DISCUSSION FORUMS, TRADING FORUMS AND LISTSERVICES FOR TRANSMISSION OF MESSAGES AMONG COMPUTER USERS CONCERNING SMALL OPEN MOTORIZED BUGGIES AND TRICYCLES DESIGNED FOR OFF-ROAD USE AND PARTS, ACCESSORIES, NOVELTY ITEMS, CLOTHING AND AFTERMARKET ITEMS FOR SMALL OPEN MOTORIZED BUGGIES AND TRICYCLES DESIGNED FOR OFF-ROAD USE, IN CLASS 38 (U.S. CLS. 100, 101 AND 104).

FIRST USE 9-30-2001; IN COMMERCE 9-30-2001.

FOR: ENTERTAINMENT SERVICES, NAMELY, PROVIDING ONLINE COMPUTER GAMES; ONLINE PUBLICATION OF PHOTOGRAPHS CONCERNING SMALL OPEN MOTORIZED BUGGIES AND TRICYCLES DESIGNED FOR OFF-ROAD USE AND PARTS, ACCESSORIES, NOVELTY ITEMS, CLOTHING AND AFTERMARKET ITEMS FOR SMALL OPEN MOTORIZED BUGGIES AND TRICYCLES DESIGNED FOR OFF-ROAD USE, IN CLASS 41 (U.S. CLS. 100, 101 AND 107).

FIRST USE 9-30-2001; IN COMMERCE 9-30-2001.

NO CLAIM IS MADE TO THE EXCLUSIVE RIGHT TO USE THE OUTLINE OF THE STATE OF TEXAS AND "ATVS", APART FROM THE MARK AS SHOWN.

THE MARK CONSISTS OF A DRAWING OF THE STATE OF TEXAS WITH THE WORDS "TEXAS ATVS."

SEC. 2(F) AS TO "TEXAS ATVS"..

SER. NO. 78-875,675, FILED 5-3-2006.

COLLEEN DOMBROW, EXAMINING ATTORNEY

**Int. Cl.: 35**

**Prior U.S. Cls.: 100, 101 and 102**

**United States Patent and Trademark Office**

**Reg. No. 3,394,937**

**Registered Mar. 11, 2008**

**SERVICE MARK  
PRINCIPAL REGISTER**

**VISTA MEDIA**

ENTRAVISION COMMUNICATIONS CORPORATION (CALIFORNIA CORPORATION)  
6000 WEST  
2425 OLYMPIC BLVD.  
SANTA MONICA, CA 90404

FOR: DISPLAYING OF OUTDOOR ADVERTISING FOR OTHERS ON BILLBOARDS AND ON SIGNS ON BUILDINGS, VEHICLES, AND OTHER PUBLIC LOCATIONS , IN CLASS 35 (U.S. CLS. 100, 101 AND 102).

FIRST USE 5-31-1998; IN COMMERCE 5-31-1998.

THE MARK CONSISTS OF STANDARD CHARACTERS WITHOUT CLAIM TO ANY PARTICULAR FONT, STYLE, SIZE, OR COLOR.

NO CLAIM IS MADE TO THE EXCLUSIVE RIGHT TO USE "MEDIA", APART FROM THE MARK AS SHOWN.

SER. NO. 78-876,797, FILED 5-4-2006.

SARA THOMAS, EXAMINING ATTORNEY

**Int. Cls.: 9 and 42**

**Prior U.S. Cls.: 21, 23, 26, 36, 38, 100 and 101**

**United States Patent and Trademark Office**

**Reg. No. 3,394,938**

**Registered Mar. 11, 2008**

**TRADEMARK  
SERVICE MARK  
PRINCIPAL REGISTER**



MIPS TECHNOLOGIES, INC. (DELAWARE CORPORATION)  
1225 CHARLESTON ROAD  
MOUNTAIN VIEW, CA 94043

FOR: COMPUTER HARDWARE AND SOFTWARE USED IN, AND FOR USE IN THE DESIGN, DEVELOPMENT AND TESTING OF COMPUTING DEVICES, INTEGRATED CIRCUITS, COMPUTER HARDWARE AND CODE, NAMELY, SOFTWARE FOR DESCRIBING, DESIGNING, MODELING, SIMULATING, DEBUGGING, DEVELOPING, VERIFYING, INTERFACING, AND CONSTRUCTING COMPUTING DEVICES, COMPUTER HARDWARE AND CODE, NAMELY, SEMICONDUCTOR INTELLECTUAL PROPERTY (SIP) ARCHITECTURES AND CORES, MICROPROCESSOR CORES; COMPUTING DEVICES, NAMELY, PRINTED CIRCUIT BOARDS, SEMICONDUCTORS, SEMICONDUCTOR DEVICES, AND COMPONENT PARTS THEREFORE, NAMELY, INTEGRATED CIRCUITS, CIRCUIT CHIPS, MICROPROCESSORS, MICROPROCESSOR CORES, MICRO CONTROLLERS, AND MICRO CONTROLLER CORES; INSTRUCTION SET ARCHITECTURES AND PROGRAMMABLE LOGIC DEVICE PROGRAMMERS AND CHIPS; ELECTRONIC PUBLICATIONS

IN THE NATURE OF MANUALS, SPECIFICATIONS, GUIDES, AND DATA SHEETS, ALL IN THE FIELD OF COMPUTER TECHNOLOGY IN DOWNLOADABLE FORM OR RECORDED ON COMPUTER MEDIA, IN CLASS 9 (U.S. CLS. 21, 23, 26, 36 AND 38).

FIRST USE 11-1-1999; IN COMMERCE 1-1-2000.

FOR: DESIGN SERVICES FOR OTHERS IN THE FIELD OF PROGRAMMING, TESTING, AND DEBUGGING EMBEDDED MICROPROCESSOR SYSTEMS, IN CLASS 42 (U.S. CLS. 100 AND 101).

FIRST USE 11-1-1999; IN COMMERCE 1-1-2000.

OWNER OF U.S. REG. NOS. 2,675,182 AND 2,693,442.

NO CLAIM IS MADE TO THE EXCLUSIVE RIGHT TO USE "SILICON" OR "SOLUTIONS", APART FROM THE MARK AS SHOWN.

SER. NO. 78-878,150, FILED 5-5-2006.

KAPIL BHANOT, EXAMINING ATTORNEY



Int. Cl.: 25

Prior U.S. Cls.: 22 and 39

**United States Patent and Trademark Office**

**Reg. No. 3,394,939**

Registered Mar. 11, 2008

**TRADEMARK  
PRINCIPAL REGISTER**



MCCULLOUGH, ROBERT/JR. (UNITED STATES  
INDIVIDUAL)  
SUITE 8GG  
2311 5TH AVENUE  
NEW YORK, NY 10037

THE MARK CONSISTS OF MEN PLAYING BASKETBALL ON A PLAYGROUND BASKETBALL COURT WITH SPECTATORS SURROUNDING THE BASKETBALL COURT.

FOR: CLOTHING NAMELY, PANTS, SHORTS, T-SHIRTS, CAPS, SWEATSHIRTS, JACKETS AND BELTS, IN CLASS 25 (U.S. CLS. 22 AND 39).

SER. NO. 78-878,384, FILED 5-7-2006.

FIRST USE 8-1-2002; IN COMMERCE 8-22-2004.

WILLIAM ROSSMAN, EXAMINING ATTORNEY

**Int. Cl.: 33**

**Prior U.S. Cls.: 47 and 49**

**United States Patent and Trademark Office**

**Reg. No. 3,394,940**

**Registered Mar. 11, 2008**

**TRADEMARK  
PRINCIPAL REGISTER**

**LANGE**

LANGE, WENDY (UNITED STATES INDIVIDUAL)  
18380 NE BUENA VISTA DRIVE  
DUNDEE, OR 97115 AND  
LANGE, DON (UNITED STATES INDIVIDUAL)  
18380 NE BUENA VISTA DRIVE  
DUNDEE, OR 97115

THE MARK CONSISTS OF STANDARD CHARACTERS WITHOUT CLAIM TO ANY PARTICULAR FONT, STYLE, SIZE, OR COLOR.

SEC. 2(F).

FOR: WINES, IN CLASS 33 (U.S. CLS. 47 AND 49).

SER. NO. 78-878,632, FILED 5-8-2006.

FIRST USE 6-30-1984; IN COMMERCE 7-1-1987.

ALEX KEAM, EXAMINING ATTORNEY

Int. Cl.: 42

Prior U.S. Cls.: 100 and 101

United States Patent and Trademark Office

Reg. No. 3,394,941

Registered Mar. 11, 2008

SERVICE MARK  
PRINCIPAL REGISTER



TANDY ENGINEERING & ASSOCIATES, INC.  
(TEXAS CORPORATION)  
SUITE F100  
25003 PITKIN  
THE WOODLANDS, TX 77386

FOR: ENGINEERING, IN CLASS 42 (U.S. CLS. 100 AND 101).

FIRST USE 1-2-2002; IN COMMERCE 5-10-2006.

NO CLAIM IS MADE TO THE EXCLUSIVE RIGHT TO USE "ENGINEERING & ASSOCIATES, INC.", APART FROM THE MARK AS SHOWN.

THE COLOR(S) BLUE, GRAY, BROWN, BLACK AND WHITE IS/ARE CLAIMED AS A FEATURE OF THE MARK.

THE MARK CONSISTS OF THE PHRASE "TANDY ENGINEERING" IN BLACK WITH WHITE BACKGROUND, AND BELOW IT IS THE PHRASE "& ASSOCIATES, INC." IN WHITE WITH A BLUE BACKGROUND. TO THE LEFT OF THE TEXT IS A BROWN AND BLACK STEERING WHEEL, AND TO THE LEFT OF THAT IS WITH GRAY ROAD THAT IS OUTLINED IN A DARKER GRAY.

SER. NO. 78-880,194, FILED 5-10-2006.

ALYSSA PALADINO, EXAMINING ATTORNEY

**Int. Cls.: 18 and 25**

**Prior U.S. Cls.: 1, 2, 3, 22, 39 and 41**

**United States Patent and Trademark Office**

**Reg. No. 3,394,942**

**Registered Mar. 11, 2008**

**TRADEMARK  
PRINCIPAL REGISTER**

**TEACHERS CLOZE**

LEPLER, MICHELLE (UNITED STATES INDIVIDUAL)  
6 BRYCEWOOD DRIVE  
DIX HILLS, NY 11746

FOR: BACKPACKS; BRIEFCASES; TOTE BAGS; UMBRELLAS, IN CLASS 18 (U.S. CLS. 1, 2, 3, 22 AND 41).

FIRST USE 11-1-2005; IN COMMERCE 3-1-2006.

FOR: APRONS; HATS; JACKETS; SHIRTS; SWEAT SHIRTS; TOPS, IN CLASS 25 (U.S. CLS. 22 AND 39).

FIRST USE 11-1-2005; IN COMMERCE 3-1-2006.

THE MARK CONSISTS OF STANDARD CHARACTERS WITHOUT CLAIM TO ANY PARTICULAR FONT, STYLE, SIZE, OR COLOR.

SER. NO. 78-881,074, FILED 5-11-2006.

NAAKWAMA ANKRAH, EXAMINING ATTORNEY

**Int. Cl.: 1**

**Prior U.S. Cls.: 1, 5, 6, 10, 26 and 46**

**United States Patent and Trademark Office**

**Reg. No. 3,394,943**

**Registered Mar. 11, 2008**

**TRADEMARK  
PRINCIPAL REGISTER**

**E.Z.N.A.**

OMEGA BIO-TEK, INC. (GEORGIA CORPORATION)  
P.O. BOX 47310  
DORAVILLE, GA 30362

FOR: REAGENTS FOR SCIENTIFIC OR MEDICAL RESEARCH USE; KITS COMPRISED OF CHEMICAL SOLUTIONS FOR THE IDENTIFICATION OF NUCLEIC ACIDS, CELLS, PROTEINS, AND GENERAL MOLECULES FOR SCIENTIFIC RESEARCH, IN CLASS 1 (U.S. CLS. 1, 5, 6, 10, 26 AND 46).

FIRST USE 9-30-1998; IN COMMERCE 9-30-1998.

THE MARK CONSISTS OF STANDARD CHARACTERS WITHOUT CLAIM TO ANY PARTICULAR FONT, STYLE, SIZE, OR COLOR.

SER. NO. 78-881,318, FILED 5-11-2006.

AMY GEARIN, EXAMINING ATTORNEY

**Int. Cl.: 33**

**Prior U.S. Cls.: 47 and 49**

**United States Patent and Trademark Office**

**Reg. No. 3,394,944**

**Registered Mar. 11, 2008**

**TRADEMARK  
PRINCIPAL REGISTER**

**RUNNING TIGERS**

BRYANT, DANIEL J. (UNITED STATES INDIVIDUAL)  
SUITE B  
1805 TRIBUTE ROAD  
SACRAMENTO, CA 95815

THE MARK CONSISTS OF STANDARD CHARACTERS WITHOUT CLAIM TO ANY PARTICULAR FONT, STYLE, SIZE, OR COLOR.

FOR: PORT WINES; RED WINE; TABLE WINES; WHITE WINE; WINE; WINES, IN CLASS 33 (U.S. CLS. 47 AND 49).

SER. NO. 78-882,567, FILED 5-12-2006.

FIRST USE 6-1-2005; IN COMMERCE 6-1-2005.

GISELLE AGOSTO, EXAMINING ATTORNEY

**Int. Cl.: 9**

**Prior U.S. Cls.: 21, 23, 26, 36 and 38**

**Reg. No. 3,394,945**

**United States Patent and Trademark Office**

**Registered Mar. 11, 2008**

**TRADEMARK  
PRINCIPAL REGISTER**

# Empower

TELETECH HOLDINGS, INC. (DELAWARE CORPORATION)  
9197 SOUTH PEORIA STREET  
ENGLEWOOD, CO 801125833

FOR: COMPUTER SOFTWARE, NAMELY, WORKFORCE PERFORMANCE EVALUATION SOFTWARE WHICH TRACKS INDIVIDUAL EMPLOYEES' PROGRESS AGAINST A SPECIFIED SET OF METRICS AND MEASUREMENTS, PROVIDES FOR CORRECTIVE ACTION BASED UPON THOSE MEASUREMENTS, GENERATES STATISTICS AS TO HOW THE PERSONNEL BASE OR SEGMENT IS PERFORMING AS A UNIT, AND PROVIDES

REAL-TIME SUPERVISOR AND MANAGEMENT VIEWS OF AN EMPLOYEE'S PERFORMANCE, IN CLASS 9 (U.S. CLS. 21, 23, 26, 36 AND 38).

FIRST USE 9-15-2005; IN COMMERCE 10-1-2005.

THE MARK CONSISTS OF STANDARD CHARACTERS WITHOUT CLAIM TO ANY PARTICULAR FONT, STYLE, SIZE, OR COLOR.

SER. NO. 78-882,735, FILED 5-12-2006.

ELI HELLMAN, EXAMINING ATTORNEY

**Int. Cl.: 35**

**Prior U.S. Cls.: 100, 101 and 102**

**United States Patent and Trademark Office**

**Reg. No. 3,394,946**

**Registered Mar. 11, 2008**

**SERVICE MARK  
PRINCIPAL REGISTER**

**ARCHITECTURAL ELEGANCE**

ARCHITECTURAL ELEGANCE, INC. (FLORIDA CORPORATION)  
704 WEST STATE ROAD 436, SUITE 116  
ALTAMONTE SPRINGS, FL 32714

FOR: RETAIL AND WHOLESALE STORE SERVICES FEATURING LUXURY BUILDING SUPPLIES, MATERIALS AND ACCENTS; HOME FURNISHINGS; FURNITURE; ANTIQUES; LIGHTING; LAMPS; MANTELS; STAIRCASE NEWELS AND BALUSTERS; BATHROOM VANITIES; SINKS; FINE ART; PAINTINGS; MIRRORS; DOORS; FINIALS AND DORMERS; COLUMNS AND MOULDINGS; LIBRARY LADDERS; IRON URNS; WINDOWS; SHUTTERS; DOOR AND CABINET HARDWARE; KITCHEN AND BATH FIXTURES; GAZEBOS; AR-

BORS; AND HOME DECORATING ACCESSORIES, IN CLASS 35 (U.S. CLS. 100, 101 AND 102).

FIRST USE 11-1-2003; IN COMMERCE 11-1-2003.

THE MARK CONSISTS OF STANDARD CHARACTERS WITHOUT CLAIM TO ANY PARTICULAR FONT, STYLE, SIZE, OR COLOR.

NO CLAIM IS MADE TO THE EXCLUSIVE RIGHT TO USE ARCHITECTURAL, APART FROM THE MARK AS SHOWN.

SER. NO. 78-883,005, FILED 5-13-2006.

SHARON MEIER, EXAMINING ATTORNEY



**Int. Cls.: 11 and 42**

**Prior U.S. Cls.: 13, 21, 23, 31, 34, 100 and 101**

**United States Patent and Trademark Office**

**Reg. No. 3,394,947**

**Registered Mar. 11, 2008**

**TRADEMARK  
SERVICE MARK  
PRINCIPAL REGISTER**

**MTR**

UHDE INVENTA-FISCHER GMBH (FED REP  
GERMANY CORPORATION)  
HOLZHAUSER STR. 157-159  
BERLIN, FED REP GERMANY D-13509

FOR: POLYMERIZATION PLANTS, NAMELY,  
PLANTS FOR THE PRODUCT OF POLYESTER  
AND POLYAMIDE POLYMERS , IN CLASS 11 (U.S.  
CLS. 13, 21, 23, 31 AND 34).

FOR: ENGINEERING, NAMELY, PLANNING,  
DESIGN AND INSTALLATION OF POLYMERIZA-  
TION PLANTS; TECHNICAL RESEARCH IN THE  
FIELD OF PROCESS ENGINEERING, NAMELY,  
ENGINEERING IN THE FIELD OF POLYMERIZA-  
TION, IN CLASS 42 (U.S. CLS. 100 AND 101).

THE MARK CONSISTS OF STANDARD CHAR-  
ACTERS WITHOUT CLAIM TO ANY PARTICULAR  
FONT, STYLE, SIZE, OR COLOR.

PRIORITY CLAIMED UNDER SEC. 44(D) ON  
ERPNTY CMNTY TM OFC APPLICATION NO.  
004969201, FILED 3-20-2006, REG. NO. 004969201,  
DATED 3-20-2006, EXPIRES 3-20-2016.

SER. NO. 78-883,412, FILED 5-15-2006.

SUNG IN, EXAMINING ATTORNEY

**Int. Cl.: 35**

**Prior U.S. Cls.: 100, 101 and 102**

**United States Patent and Trademark Office**

**Reg. No. 3,394,948**

**Registered Mar. 11, 2008**

**SERVICE MARK  
PRINCIPAL REGISTER**

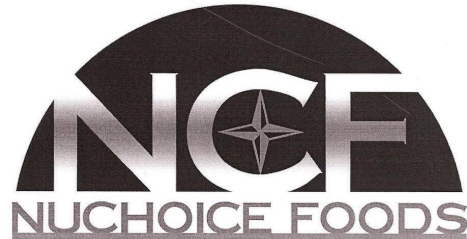

NUCHOICE FOODS, INC. (TEXAS CORPORATION)  
4553A S. WESTMORELAND ROAD  
DALLAS, TX 752371015

FOR: DISTRIBUTORSHIPS IN THE FIELD OF BROAD LINE WHOLESALE FOOD, NAMELY, DRY, REFRIGERATED, AND FROZEN FOOD PRODUCTS, PAPER PRODUCTS, CONDIMENTS, AND CHEMICALS, IN CLASS 35 (U.S. CLS. 100, 101 AND 102).

FIRST USE 8-7-2002; IN COMMERCE 10-7-2002.

NO CLAIM IS MADE TO THE EXCLUSIVE RIGHT TO USE "FOODS", APART FROM THE MARK AS SHOWN.

THE MARK CONSISTS OF A HALF CIRCLE WITH NCF ON IT AND NUCHOICE FOODS BELOW IT.

SER. NO. 78-884,035, FILED 5-15-2006.

ALLISON HOLTZ, EXAMINING ATTORNEY

**Prior U.S. Cl.: B**

**United States Patent and Trademark Office**

**Reg. No. 3,394,949**

**Registered Mar. 11, 2008**

**CERTIFICATION MARK  
PRINCIPAL REGISTER**

**CERTIFIED WILDLIFE  
BIOLOGIST**

THE WILDLIFE SOCIETY (D.C. CORPORATION)  
5410 GROSVENOR LANE, SUITE 200  
BETHESDA, MD 208142144

FOR: WILDLIFE MANAGEMENT AND CONSER-  
VATION SERVICES, IN CLASS B (U.S. CL. B).

FIRST USE 3-1-1977; IN COMMERCE 3-1-1977.

THE MARK CONSISTS OF STANDARD CHAR-  
ACTERS WITHOUT CLAIM TO ANY PARTICULAR  
FONT, STYLE, SIZE, OR COLOR.

THE CERTIFICATION MARK, AS USED BY  
PERSONS AUTHORIZED BY THE CERTIFIER,  
CERTIFIES THAT AN INDIVIDUAL HAS MET  
THE EDUCATIONAL, EXPERIENCE AND ETHI-  
CAL STANDARDS ADOPTED BY THE WILDLIFE  
SOCIETY.

SEC. 2(F).

SER. NO. 78-885,342, FILED 5-17-2006.

MARGERY A. TIERNEY, EXAMINING ATTORNEY

**Prior U.S. Cl.: B**

**United States Patent and Trademark Office**

**Reg. No. 3,394,950**

**Registered Mar. 11, 2008**

**CERTIFICATION MARK  
PRINCIPAL REGISTER**

**ASSOCIATE WILDLIFE  
BIOLOGIST**

THE WILDLIFE SOCIETY (D.C. CORPORATION)  
5410 GROSVENOR LANE, SUITE 200  
BETHESDA, MD 208142144

FOR: WILDLIFE MANAGEMENT AND CONSER-  
VATION SERVICES, IN CLASS B (U.S. CL. B).

FIRST USE 3-1-1977; IN COMMERCE 3-1-1977.

THE MARK CONSISTS OF STANDARD CHAR-  
ACTERS WITHOUT CLAIM TO ANY PARTICULAR  
FONT, STYLE, SIZE, OR COLOR.

THE CERTIFICATION MARK, AS USED BY  
PERSONS AUTHORIZED BY THE CERTIFIER,  
CERTIFIES THAT AN INDIVIDUAL HAS MET  
THE EDUCATIONAL, EXPERIENCE AND ETHI-  
CAL STANDARDS ADOPTED BY THE WILDLIFE  
SOCIETY.

SEC. 2(F).

SER. NO. 78-885,362, FILED 5-17-2006.

MARGERY A. TIERNEY, EXAMINING ATTORNEY

**Int. Cl.: 9**

**Prior U.S. Cls.: 21, 23, 26, 36 and 38**

**Reg. No. 3,394,951**

**United States Patent and Trademark Office**

**Registered Mar. 11, 2008**

**TRADEMARK  
PRINCIPAL REGISTER**

# CRIWARE

CRI MIDDLEWARE CO., LTD. (JAPAN CORPORATION)  
3-13-18 MINAMI AOYAMA, MINATO-KU  
313 MINAMI AOYAMA BLDG. 7F  
TOKYO, JAPAN 107-0062

FOR: COMPUTER APPLICATION SOFTWARE FOR MOBILE PHONES; COMPUTER GAME SOFTWARE; COMPUTER GRAPHIC SOFTWARE; COMPUTER SCREEN SAVER SOFTWARE; COMPUTER SOFTWARE DEVELOPMENT TOOLS; COMPUTER SOFTWARE FOR COMMUNICATING WITH USERS OF HAND-HELD COMPUTERS; COMPUTER SOFTWARE FOR PROCESSING DIGITAL MUSIC FILES; COMPUTER SOFTWARE FOR CONTROLLING AND MANAGING ACCESS SERVER APPLICATIONS; COMPUTER SOFTWARE FOR ORGANIZING AND VIEWING DIGITAL IMAGES AND PHOTOGRAPHS; COMPUTER SOFTWARE FOR USE IN DIGITAL ANIMATION AND SPECIAL EFFECTS OF IMAGES; COMPUTER SOFTWARE THAT ASSISTS COMPUTERS IN DEPLOYING PARALLEL APPLICATIONS AND PERFORMING PARALLEL COMPUTATIONS; COMPUTER SOFTWARE TO CONTROL AND IMPROVE COMPUTER EQUIPMENT SOUND QUALITY; COMPUTER SOFTWARE TO ENHANCE THE AUDIO-VISUAL CAPABILITIES OF MULTIMEDIA APPLICATIONS, NAMELY, FOR THE INTEGRATION OF TEXT, AUDIO, GRAPHICS, STILL IMAGES, AND MOVING IMAGES IN MULTIMEDIA APPLICATIONS; COMPUTER SOFTWARE TO TRANSMIT PHOTOGRAPHS TO MOBILE TELEPHONES; DATA COMPRESSION SOFTWARE; SOFTWARE FOR DECODING ENCODED INFORMATION AND DATA; DOWNLOADABLE SOFTWARE FOR USE IN COMPUTER APPLICATION SOFTWARE FOR MOBILE PHONES, COMPUTER GAMES, COMPUTER GRAPHICS, COMPUTER SCREEN SAVERS, COMPUTER SOFTWARE DEVELOPMENT TOOLS, COMMUNICATING WITH USERS OF HAND-HELD COMPUTERS, PROCESSING DIGITAL MUSIC, FILES, CONTROLLING

AND MANAGING ACCESS SERVER APPLICATIONS, ORGANIZING AND VIEWING DIGITAL IMAGES AND PHOTOGRAPHS, DIGITAL ANIMATION AND SPECIAL EFFECTS OF IMAGES, ASSISTING COMPUTERS IN DEPLOYING PARALLEL APPLICATIONS AND PERFORMING PARALLEL COMPUTATIONS, CONTROLLING AND IMPROVING COMPUTER AND AUDIO EQUIPMENT SOUND QUALITY, ENHANCE THE AUDIO-VISUAL CAPABILITIES OF MULTIMEDIA APPLICATIONS, NAMELY, FOR THE INTEGRATION OF TEXT, AUDIO, GRAPHICS, STILL IMAGES AND MOVING, TRANSMISSION OF PHOTOGRAPHS TO MOBILE TELEPHONES, GRAPHICAL USER INTERFACE SOFTWARE; "VIRTUAL REALITY" INTERACTIVE VIDEO GAMES COMPRISED OF COMPUTER HARDWARE AND SOFTWARE; MULTIMEDIA SOFTWARE RECORDED ON CD-ROM IN THE FIELD OF COMPUTER GAMES AND ENTERTAINMENT; MUSIC-COMPOSITION SOFTWARE; NETWORK ACCESS SERVER OPERATING SOFTWARE; SOFTWARE FOR PROCESSING IMAGES, GRAPHICS AND TEXT; SOFTWARE PROGRAMMABLE MICROPROCESSORS; VIDEO GAME SOFTWARE; "VIRTUAL REALITY" GAME SOFTWARE; EDUCATIONAL SOFTWARE FEATURING INSTRUCTION IN COMPUTER DEVELOPMENT, IN CLASS 9 (U.S. CLS. 21, 23, 26, 36 AND 38).

THE MARK CONSISTS OF STANDARD CHARACTERS WITHOUT CLAIM TO ANY PARTICULAR FONT, STYLE, SIZE, OR COLOR.

PRIORITY CLAIMED UNDER SEC. 44(D) ON JAPAN APPLICATION NO. 2006-8029, FILED 2-2-2006, REG. NO. 4977929, DATED 8-11-2006, EXPIRES 8-11-2016.

SER. NO. 78-885,685, FILED 5-17-2006.

ROBERT STRUCK, EXAMINING ATTORNEY

**Int. Cls.: 9, 35 and 41**

**Prior U.S. Cls.: 21, 23, 26, 36, 38, 100, 101, 102 and 107**

**United States Patent and Trademark Office**

**Reg. No. 3,394,952**

**Registered Mar. 11, 2008**

**TRADEMARK  
SERVICE MARK  
PRINCIPAL REGISTER**



DISC MARKETING, LLC (CALIFORNIA LTD  
LIAB CO)  
THE OLD FIREHOUSE, 35 WEST DAYTON STREET  
PASADENA, CA 91105

FOR: PRE-RECORDED CDS, DVDS, CD-ROMS,  
ECDS FEATURING AUDIO-VISUAL ENTERTAIN-  
MENT IN THE NATURE OF MUSIC, MOVIES,  
VIDEOS, INTERACTIVE GAMES, AND INFORMA-  
TION ABOUT WEB LINKS PROMOTIONS AND  
SWEEPSTAKES, IN CLASS 9 (U.S. CLS. 21, 23, 26, 36  
AND 38).

FIRST USE 4-30-2006; IN COMMERCE 4-30-2006.

FOR: ADVERTISING SERVICES, NAMELY, PRO-  
MOTING THE GOODS ANDS SERVICES OF OTH-  
ERS THROUGH THE CREATION AND  
DISSEMINATION OF DIGITAL MEDIA ADVERTIS-  
ING MATTER FEATURING ENTERTAINMENT, IN  
CLASS 35 (U.S. CLS. 100, 101 AND 102).

FIRST USE 12-31-2005; IN COMMERCE 12-31-2005.

FOR: ENTERTAINMENT SERVICES, NAMELY,  
PRODUCTION OF MOTION PICTURE FILMS AND  
VIDEODISCS AND TAPES; PROVIDING ONLINE  
INTERACTIVE GAMES; ENTERTAINMENT SERVI-  
CES IN THE NATURE OF ARRANGEMENT OF  
MUSICAL COMPOSITIONS FOR OTHERS, IN  
CLASS 41 (U.S. CLS. 100, 101 AND 107).

FIRST USE 12-31-2005; IN COMMERCE 12-31-2005.

OWNER OF U.S. REG. NOS. 2,819,355, 2,878,873,  
AND 2,881,085.

THE MARK CONSISTS OF THE STYLIZED LET-  
TER "D" INSIDE A CIRCLE WITH WING-LIKE  
PROJECTIONS EMANATING FROM THE TOP  
AND BOTTOM OF THE CIRCLE. THE LETTERS  
"DMI" ARE IN STYLIZED LETTERING ON THE  
LEFT OUTSIDE THE CIRCLE.

SER. NO. 78-886,135, FILED 5-17-2006.

KAREN BRACEY, EXAMINING ATTORNEY

**Int. Cls.: 35 and 45**

**Prior U.S. Cls.: 100, 101 and 102**

**United States Patent and Trademark Office**

**Reg. No. 3,394,953**

**Registered Mar. 11, 2008**

**SERVICE MARK  
PRINCIPAL REGISTER**

# MY THINGS

SWIFT-FIND LIMITED (UNITED KINGDOM CORPORATION)  
162-164 FINCHLEY ROAD  
LONDON, UNITED KINGDOM NW3 5HE

FOR: MAINTAINING AN ONLINE REGISTRY OF VALUABLE GOODS; PROVIDING ONLINE LINKS TO THE WEB SITES OF OTHERS IN THE FIELD OF VALUABLE GOODS, NAMELY, PRICING, REGISTRATION WITH MANUFACTURERS, AUCTIONS, PRODUCT MANUALS AND PRODUCT REVIEWS, IN CLASS 35 (U.S. CLS. 100, 101 AND 102).

FIRST USE 12-12-2006; IN COMMERCE 12-12-2006.

FOR: PROVIDING AN ONLINE DATABASE OF VALUABLE GOODS FOR THE PURPOSE OF IDEN-

TIFICATION, AUTHENTICATION OR TRACKING AND TRACING OF OWNERSHIP OF THE AFORESAID VALUABLE GOODS, IN CLASS 45 (U.S. CLS. 100 AND 101).

FIRST USE 12-12-2006; IN COMMERCE 12-12-2006.

THE MARK CONSISTS OF STANDARD CHARACTERS WITHOUT CLAIM TO ANY PARTICULAR FONT, STYLE, SIZE, OR COLOR.

SER. NO. 78-889,294, FILED 5-22-2006.

JANICE L. MCMORROW, EXAMINING ATTORNEY

**Int. Cl.: 30**

**Prior U.S. Cl.: 46**

**United States Patent and Trademark Office**

**Reg. No. 3,394,954**

**Registered Mar. 11, 2008**

**TRADEMARK  
PRINCIPAL REGISTER**

**ALMOND AL**

CELESTIAL SWEETIES, INC. (MINNESOTA CORPORATION)  
2506 UNIVERSITY AVENUE W  
SAINT PAUL, MN 55114

NO CLAIM IS MADE TO THE EXCLUSIVE RIGHT TO USE "ALMOND", APART FROM THE MARK AS SHOWN.

FOR: CANDY, IN CLASS 30 (U.S. CL. 46).

FIRST USE 5-5-2006; IN COMMERCE 5-5-2006.

SER. NO. 78-889,407, FILED 5-22-2006.

THE MARK CONSISTS OF STANDARD CHARACTERS WITHOUT CLAIM TO ANY PARTICULAR FONT, STYLE, SIZE, OR COLOR.

DAVID YONTEF, EXAMINING ATTORNEY



**Int. Cl.: 41**

**Prior U.S. Cls.: 100, 101 and 107**

**United States Patent and Trademark Office**

**Reg. No. 3,394,955**

**Registered Mar. 11, 2008**

**SERVICE MARK  
PRINCIPAL REGISTER**

**Your World Outdoors**

B.H. PUBLISHING LLC (MINNESOTA LTD LIAB  
CO)  
513 EAST 98TH STREET  
BLOOMINGTON, MN 55420

THE MARK CONSISTS OF STANDARD CHAR-  
ACTERS WITHOUT CLAIM TO ANY PARTICULAR  
FONT, STYLE, SIZE, OR COLOR.

FOR: PROVIDING ON-LINE PUBLICATIONS IN  
THE NATURE OF MAGAZINES FEATURING TO-  
PICS OF INTEREST TO OUTDOOR ENTHUSIASTS,  
IN CLASS 41 (U.S. CLS. 100, 101 AND 107).

SER. NO. 78-890,831, FILED 5-23-2006.

FIRST USE 12-19-2005; IN COMMERCE 4-30-2006.

HANNO RITTNER, EXAMINING ATTORNEY

**Int. Cls.: 38 and 41**

**Prior U.S. Cls.: 100, 101, 104 and 107**

**United States Patent and Trademark Office**

**Reg. No. 3,394,956**

**Registered Mar. 11, 2008**

**SERVICE MARK  
PRINCIPAL REGISTER**

TV FOR WHATEVER TURNS YOU  
ON

LIFESKOOL COMPANY LLC (DELAWARE LTD  
LIAB CO)  
11 PENN PLAZA  
NEW YORK, NY 10001

FOR: TELECOMMUNICATIONS SERVICES,  
NAMELY, BROADCASTING TARGETED NICHE  
PROGRAMMING GEARED TOWARD PROFES-  
SIONAL, CULTURAL AND AVOCATIONAL  
GROUPS VIA BROADCAST, CABLE, TELEPHONE  
AND SATELLITE DELIVERY, IN CLASS 38 (U.S.  
CLS. 100, 101 AND 104).

FIRST USE 10-0-2004; IN COMMERCE 10-0-2004.

FOR: PROVIDING ENTERTAINMENT AND IN-  
STRUCTION IN THE NATURE OF ONGOING TAR-  
GETED NICHE PROGRAMMING GEARED

TOWARD PROFESSIONAL, CULTURAL AND AVO-  
CATIONAL GROUPS VIA BROADCAST, CABLE  
AND SATELLITE TELEVISION, AUDIO AND VI-  
DEO MEDIA, A GLOBAL COMPUTER NETWORK,  
AND IN-TRANSIT DELIVERY ON TRANSPORTA-  
TION VEHICLES, IN CLASS 41 (U.S. CLS. 100, 101  
AND 107).

FIRST USE 10-0-2004; IN COMMERCE 10-0-2004.

THE MARK CONSISTS OF STANDARD CHAR-  
ACTERS WITHOUT CLAIM TO ANY PARTICULAR  
FONT, STYLE, SIZE, OR COLOR.

SER. NO. 78-891,254, FILED 5-24-2006.

JILL PRATER, EXAMINING ATTORNEY

**Int. Cls.: 20 and 40**

**Prior U.S. Cls.: 2, 13, 22, 25, 32, 50, 100, 103 and 106**

**United States Patent and Trademark Office**

**Reg. No. 3,394,957**

**Registered Mar. 11, 2008**

**TRADEMARK  
SERVICE MARK  
PRINCIPAL REGISTER**

# TITLE STORY

2579023 MANITOBA LTD. (CANADA CORPORATION)  
#6 - 851 LAGIMODIERE BLVD.  
WINNIPEG, CANADA R2J 3K4

FOR: PICTURE FRAMES; CUSTOM PICTURE FRAMES, IN CLASS 20 (U.S. CLS. 2, 13, 22, 25, 32 AND 50).

FOR: PICTURE FRAMING SERVICES; CUSTOM MANUFACTURE OF PICTURE MAT BOARDS AND PICTURE FRAMES FOR OTHERS, IN CLASS 40 (U.S. CLS. 100, 103 AND 106).

THE MARK CONSISTS OF STANDARD CHARACTERS WITHOUT CLAIM TO ANY PARTICULAR FONT, STYLE, SIZE, OR COLOR.

PRIORITY CLAIMED UNDER SEC. 44(D) ON CANADA APPLICATION NO. 1281325, FILED 11-30-2005, REG. NO. 677747, DATED 11-28-2006, EXPIRES 11-28-2021.

SER. NO. 78-891,959, FILED 5-24-2006.

RICHARD WHITE, EXAMINING ATTORNEY

**Int. Cl.: 5**

**Prior U.S. Cls.: 6, 18, 44, 46, 51 and 52**

**United States Patent and Trademark Office**

**Reg. No. 3,394,958**

**Registered Mar. 11, 2008**

**TRADEMARK  
PRINCIPAL REGISTER**



ROTAM LTD. (HONG KONG CORPORATION)  
7/F., CHEUNG TAT CENTRE  
18 CHEUNG LEE STREET  
CHAI WAN, HONG KONG

FIRST USE 6-0-2006; IN COMMERCE 6-0-2006.

SER. NO. 78-893,358, FILED 5-25-2006.

FOR: AGRICULTURAL HERBICIDES, INSECTI-  
CIDES AND FUNGICIDES, IN CLASS 5 (U.S. CLS. 6,  
18, 44, 46, 51 AND 52).

CAROL SPILS, EXAMINING ATTORNEY

**Int. Cls.: 5, 16, 35, 36 and 44**

**Prior U.S. Cls.: 2, 5, 6, 18, 22, 23, 29, 37, 38, 44, 46, 50,  
51, 52, 100, 101 and 102**

**Reg. No. 3,394,959**

**United States Patent and Trademark Office**

**Registered Mar. 11, 2008**

**TRADEMARK  
SERVICE MARK  
PRINCIPAL REGISTER**

**LIFE EXTENSION**

LIFE EXTENSION FOUNDATION, INC. (FLORIDA CORPORATION)  
1100 W. COMMERCIAL BOULEVARD  
FT. LAUDERDALE, FL 33309

FOR: HOMEOPATHIC DIETARY SUPPLEMENTS, IN CLASS 5 (U.S. CLS. 6, 18, 44, 46, 51 AND 52).

FIRST USE 10-17-1980; IN COMMERCE 10-17-1980.

FOR: MAGAZINES, BOOKS, BROCHURES AND LEAFLETS RELATED TO HEALTH AND NUTRITION, IN CLASS 16 (U.S. CLS. 2, 5, 22, 23, 29, 37, 38 AND 50).

FIRST USE 10-17-1980; IN COMMERCE 10-17-1980.

FOR: RETAIL STORE SERVICES FEATURING NUTRITIONAL AND DIETARY SUPPLEMENTS AND BOOKS AND MAGAZINES RELATED TO HEALTH AND NUTRITION; MAIL ORDER CATALOG SERVICES FEATURING NUTRITIONAL AND DIETARY SUPPLEMENTS AND BOOKS AND MAGAZINES RELATED TO HEALTH AND NUTRITION; ONLINE RETAIL STORE SERVICES

FEATURING NUTRITIONAL AND DIETARY SUPPLEMENTS AND BOOKS AND MAGAZINES RELATED TO HEALTH AND NUTRITION, IN CLASS 35 (U.S. CLS. 100, 101 AND 102).

FIRST USE 1-31-1982; IN COMMERCE 1-31-1982.

FOR: PROVIDING GRANTS TO CONDUCT RESEARCH IN THE FIELD OF ANTI-AGING, IN CLASS 36 (U.S. CLS. 100, 101 AND 102).

FIRST USE 3-31-1985; IN COMMERCE 3-31-1985.

FOR: COUNSELING IN THE FIELD OF NUTRITION, IN CLASS 44 (U.S. CLS. 100 AND 101).

FIRST USE 10-17-1980; IN COMMERCE 10-17-1980.

THE MARK CONSISTS OF STANDARD CHARACTERS WITHOUT CLAIM TO ANY PARTICULAR FONT, STYLE, SIZE, OR COLOR.

SER. NO. 78-893,563, FILED 5-25-2006.

ELLEN PERKINS, EXAMINING ATTORNEY

**Int. Cl.: 5**

**Prior U.S. Cls.: 6, 18, 44, 46, 51 and 52**

**United States Patent and Trademark Office**

**Reg. No. 3,394,960**

**Registered Mar. 11, 2008**

**TRADEMARK  
PRINCIPAL REGISTER**



ROTAM LTD. (HONG KONG CORPORATION)  
7/F., CHEUNG TAT CENTRE  
18 CHEUNG LEE STREET  
CHAI WAN, HONG KONG

FIRST USE 4-0-2006; IN COMMERCE 4-0-2006.

SER. NO. 78-893,722, FILED 5-26-2006.

FOR: AGRICULTURAL HERBICIDES, INSECTI-  
CIDES AND FUNGICIDES, IN CLASS 5 (U.S. CLS. 6,  
18, 44, 46, 51 AND 52).

CAROL SPILS, EXAMINING ATTORNEY

**Int. Cl.: 35**

**Prior U.S. Cls.: 100, 101 and 102**

**United States Patent and Trademark Office**

**Reg. No. 3,394,961**

**Registered Mar. 11, 2008**

**SERVICE MARK  
PRINCIPAL REGISTER**

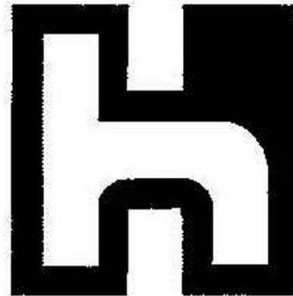

HON HAI PRECISION INDUSTRY CO., LTD.  
(TAIWAN CORPORATION)  
NO. 2, TZU YU STREET, TU-CHENG CITY  
TAIPEI HSIEN, TAIWAN

OWNER OF TAIWAN REG. NO. 13446, DATED 9-1-1984, EXPIRES 3-15-2014.

FOR: IMPORT AND EXPORT AGENCIES;  
GOODS OR SERVICES PRICE QUOTATIONS; AND  
RETAIL STORE AND WHOLESALE DISTRIBUTOR-  
SHIPS OF COMPUTERS, COMMUNICATION PRO-  
DUCTS, CONSUMABLE ELECTRONIC PRODUCTS,  
AND THEIR PARTS AND ACCESSORIES, IN CLASS  
35 (U.S. CLS. 100, 101 AND 102).

THE MARK CONSISTS OF THE STYLIZED LET-  
TERS H AND H.

SER. NO. 78-894,311, FILED 5-26-2006.

WILLIAM VERHOSEK, EXAMINING ATTORNEY

**Int. Cl.: 25**

**Prior U.S. Cls.: 22 and 39**

**United States Patent and Trademark Office**

**Reg. No. 3,394,962**

**Registered Mar. 11, 2008**

**TRADEMARK  
PRINCIPAL REGISTER**

# Powered By Garri

ORIJ, NDIDI A. (UNITED STATES INDIVIDUAL)  
10213 SOUTH FIRST AVENUE  
ENGLEWOOD, CA 90303

FOR: BANDANAS, BASEBALL CAPS, CAPS WITH VISORS, DRESS SHIRTS, EARBANDS, FABRIC BELTS, FOOTWEAR, HEAD SCARVES, HEAD SWEATBANDS, HEADBANDS, SHOES, SKULLIES, SWEAT BANDS, SWEAT PANTS, SWEAT SHIRTS, SWEAT SHORTS, FOLK COSTUME CLOTHING, TANK TOPS, TANKINIS, T-SHIRTS, WIND RESIS-

TANT JACKETS, WRISTBANDS, IN CLASS 25 (U.S. CLS. 22 AND 39).

FIRST USE 9-3-2005; IN COMMERCE 9-3-2005.

THE MARK CONSISTS OF STANDARD CHARACTERS WITHOUT CLAIM TO ANY PARTICULAR FONT, STYLE, SIZE, OR COLOR.

SER. NO. 78-895,685, FILED 5-30-2006.

SANI KHOURI, EXAMINING ATTORNEY



**Int. Cl.: 9**

**Prior U.S. Cls.: 21, 23, 26, 36 and 38**

**United States Patent and Trademark Office**

**Reg. No. 3,394,963**

**Registered Mar. 11, 2008**

---

**TRADEMARK  
PRINCIPAL REGISTER**

# MapCore

ELBIT SYSTEMS LTD. (ISRAEL CORPORATION)  
P.O. BOX 539  
ADVANCED TECHNOLOGY CENTER  
HAIFA, ISRAEL 31053

PRIORITY CLAIMED UNDER SEC. 44(D) ON  
ISRAEL APPLICATION NO. 186312, FILED 12-26-  
2005, REG. NO. 186312, DATED 8-6-2007, EXPIRES 12-  
26-2015.

FOR: COMPUTER SOFTWARE FOR GENERAT-  
ING MAPS USING DIGITAL DATA, IN CLASS 9  
(U.S. CLS. 21, 23, 26, 36 AND 38).

SER. NO. 78-896,746, FILED 5-31-2006.

THE MARK CONSISTS OF STANDARD CHAR-  
ACTERS WITHOUT CLAIM TO ANY PARTICULAR  
FONT, STYLE, SIZE, OR COLOR.

MICHAEL WEBSTER, EXAMINING ATTORNEY

**Int. Cl.: 36**

**Prior U.S. Cls.: 100, 101 and 102**

**United States Patent and Trademark Office**

**Reg. No. 3,394,964**

**Registered Mar. 11, 2008**

**SERVICE MARK  
PRINCIPAL REGISTER**



ISLAMIC RELIEF WORLDWIDE (ENGLAND  
NONPROFIT CORPORATION)  
19 REA STREET SOUTH  
BIRMINGHAM, UNITED KINGDOM B5 6LB65

FOR: CHARITABLE FUNDRAISING SERVICES;  
LOAN FINANCING, NAMELY, PROVIDING FI-  
NANCIAL ASSISTANCE TO FAMILIES TO ESTAB-  
LISH AND DEVELOP SMALL BUSINESSES AND TO  
FOSTER HOMELESS AND ORPHANED CHIL-  
DREN; CHARITABLE FUNDRAISING SERVICES  
FOR LOAN FINANCING AND GRANTS TO INDI-  
VIDUALS IN DEVELOPING COUNTRIES FOR MI-  
CRO-ECONOMIC DEVELOPMENT; FINANCING  
SERVICES, NAMELY, PROVIDING LOANS AND  
GRANTS TO INDIVIDUALS IN DEVELOPING  
COUNTRIES FOR MICRO-ECONOMIC DEVELOP-  
MENT; ADMINISTRATION OF PROGRAMS PRO-

VIDING LOAN FINANCING AND GRANTS TO  
INDIVIDUALS IN DEVELOPING COUNTRIES  
FOR MICRO-ECONOMIC DEVELOPMENT; AND  
ACCEPTING AND ADMINISTERING MONETARY  
CHARITABLE CONTRIBUTIONS, IN CLASS 36 (U.S.  
CLS. 100, 101 AND 102).

FIRST USE 0-0-1994; IN COMMERCE 0-0-1994.

OWNER OF ERPN CMNTY TM OFC REG. NO.  
004214334, DATED 1-19-2007, EXPIRES 12-17-2014.

SEC. 2(F) AS TO "ISLAMIC RELIEF".

SER. NO. 78-897,108, FILED 5-31-2006.

ALEX KEAM, EXAMINING ATTORNEY

**Int. Cl.: 38**

**Prior U.S. Cls.: 100, 101 and 104**

**United States Patent and Trademark Office**

**Reg. No. 3,394,965**

**Registered Mar. 11, 2008**

**SERVICE MARK  
PRINCIPAL REGISTER**



ISLAMIC RELIEF WORLDWIDE (ENGLAND  
NONPROFIT CORPORATION)  
19 REA STREET SOUTH  
BIRMINGHAM, UNITED KINGDOM B56LB 645

FOR: ELECTRONIC TRANSMISSION OF MESSAGES AND DATA VIA A GLOBAL COMMUNICATIONS NETWORK; PROVIDING ELECTRONIC BULLETIN BOARDS AND ON-LINE CHAT ROOMS FEATURING GENERAL NEWS AND INFORMATION OF INTEREST IN THE FIELDS OF ISLAM, HUMANITARIAN AID AND DEVELOPMENT SERVICES, EMERGENCY AID, AND FINANCIAL SERVICES, AND ABOUT PROVISION OF FOOD, HEALTH CARE, HOUSING, EDUCATION, JOBS,

CLEAN WATER AND MEDICAL ASSISTANCE TO REFUGEES AND NEEDY PERSONS, IN CLASS 38 (U.S. CLS. 100, 101 AND 104).

OWNER OF ERPN CMNTY TM OFC REG. NO. 004214334, DATED 1-19-2007, EXPIRES 12-17-2014.

NO CLAIM IS MADE TO THE EXCLUSIVE RIGHT TO USE "ISLAMIC RELIEF", APART FROM THE MARK AS SHOWN.

SER. NO. 78-897,119, FILED 5-31-2006.

ALEX KEAM, EXAMINING ATTORNEY

**Int. Cl.: 41**

**Prior U.S. Cls.: 100, 101 and 107**

**United States Patent and Trademark Office**

**Reg. No. 3,394,966**

**Registered Mar. 11, 2008**

**SERVICE MARK  
PRINCIPAL REGISTER**



ISLAMIC RELIEF WORLDWIDE (ENGLAND  
NONPROFIT CORPORATION)  
19 REA STREET SOUTH  
BIRMINGHAM, UNITED KINGDOM B56LB 645

FOR: EDUCATION SERVICES, NAMELY, ARRANGING AND ORGANIZING CONFERENCES, SEMINARS, WORKSHOPS, FORUMS, COURSES, TRAINING, LECTURES, SYMPOSIA, AND COMMUNITY EVENTS FOR ADHERENTS OF ISLAM AND THE GENERAL PUBLIC, ALL IN THE FIELDS OF ISLAM, HUMANITARIAN AID AND DEVELOPMENT SERVICES, EMERGENCY AID, FINANCIAL SERVICES, AND PROVISION OF FOOD, HEALTH CARE, HOUSING, EDUCATION, JOBS, CLEAN WATER AND MEDICAL ASSISTANCE TO REFUGEES AND NEEDY PERSONS, AND DISTRIBUTION OF EDUCATIONAL MATERIALS IN CONNECTION THEREWITH; PROVIDING ONLINE WORKBOOKS, TEXTBOOKS, MAGAZINES, NEWSPAPERS, NEWSLETTERS, BROCHURES, BOOKS, BOOKLETS, PAMPHLETS, REPORTS, INSTRUCTIONAL AND TEACHING MANUALS, STUDY GUIDES, ARTICLES, JOURNALS, ALL IN THE FIELDS OF ISLAM, HUMANITARIAN AID AND DEVELOPMENT SERVICES, EMERGENCY AID, FINANCIAL SERVICES, AND PROVISION OF FOOD, HEALTH CARE, HOUSING, EDUCATION, JOBS, CLEAN WATER

AND MEDICAL ASSISTANCE TO REFUGEES AND NEEDY PERSONS; EDUCATIONAL SERVICES, NAMELY, PROVIDING A WEBSITE FEATURING NON-DOWNLOADABLE AUDIO AND VIDEO RECORDINGS, ALL IN THE FIELDS OF ISLAM, HUMANITARIAN AID AND DEVELOPMENT SERVICES, EMERGENCY AID, FINANCIAL SERVICES, FOOD, HEALTH CARE, HOUSING, EDUCATION, JOBS, CLEAN WATER AND MEDICAL ASSISTANCE TO REFUGEES AND NEEDY PERSONS; PROVIDING VOCATIONAL EDUCATION TO NEEDY PERSONS IN THE FIELDS OF AGRICULTURE, TAILORING, COMPUTER SKILLS, CRAFT-MAKING, AND MICROENTERPRISES, IN CLASS 41 (U.S. CLS. 100, 101 AND 107).

FIRST USE 0-0-1994; IN COMMERCE 0-0-1994.

OWNER OF ERPN CMNTY TM OFC REG. NO. 004214334, DATED 1-19-2007, EXPIRES 12-17-2014.

SEC. 2(F) AS TO "ISLAMIC RELIEF".

SER. NO. 78-897,127, FILED 5-31-2006.

ALEX KEAM, EXAMINING ATTORNEY

**Int. Cl.: 43**

**Prior U.S. Cls.: 100 and 101**

**United States Patent and Trademark Office**

**Reg. No. 3,394,967**

**Registered Mar. 11, 2008**

**SERVICE MARK  
PRINCIPAL REGISTER**



ISLAMIC RELIEF WORLDWIDE (ENGLAND  
NONPROFIT CORPORATION)  
19 REA STREET SOUTH  
BIRMINGHAM, UNITED KINGDOM B56LB645

FOR: CHARITABLE SERVICES, NAMELY, PRO-  
VIDING FOOD TO NEEDY PERSONS; EMERGEN-  
CY SHELTER SERVICES, NAMELY, PROVIDING  
TEMPORARY HOUSING TO NEEDY PERSONS;  
PROVIDING INFORMATION VIA A GLOBAL COM-  
MUNICATIONS NETWORK ON PROVIDING  
FOOD, TEMPORARY HOUSING ACCOMMODA-  
TIONS, AND TEMPORARY EMERGENCY HOUS-

ING TO NEEDY PERSONS, IN CLASS 43 (U.S. CLS.  
100 AND 101).

FIRST USE 0-0-1994; IN COMMERCE 0-0-1994.

OWNER OF ERPN CMNTY TM OFC REG. NO.  
004214334, DATED 1-19-2007, EXPIRES 12-17-2014.

SEC. 2(F) AS TO "ISLAMIC RELIEF".

SER. NO. 78-897,133, FILED 5-31-2006.

ALEX KEAM, EXAMINING ATTORNEY

**Int. Cl.: 44**

**Prior U.S. Cls.: 100 and 101**

**United States Patent and Trademark Office**

**Reg. No. 3,394,968**

**Registered Mar. 11, 2008**

**SERVICE MARK  
PRINCIPAL REGISTER**



ISLAMIC RELIEF WORLDWIDE (ENGLAND  
NONPROFIT CORPORATION)  
19 REA STREET SOUTH  
BIRMINGHAM, UNITED KINGDOM B56LB645

FOR: CHARITABLE SERVICES, NAMELY, PRO-  
VIDING MEDICAL SERVICES, HEALTH CARE,  
AND EMERGENCY MEDICAL ASSISTANCE TO  
NEEDY PERSONS; PROVIDING AGRICULTURAL  
ADVICE; CHARITABLE SERVICES, NAMELY, PRO-  
VIDING AGRICULTURAL TOOLS AND SEEDS TO  
NEEDY PERSONS; PROVIDING INFORMATION  
VIA A GLOBAL COMMUNICATIONS NETWORK  
ON PROVIDING MEDICAL SERVICES, HEALTH  
CARE, AND EMERGENCY MEDICAL ASSISTANCE

TO NEEDY PERSONS, IN CLASS 44 (U.S. CLS. 100  
AND 101).

FIRST USE 0-0-1994; IN COMMERCE 0-0-1994.

OWNER OF ERPN CMNTY TM OFC REG. NO.  
004214334, DATED 1-19-2007, EXPIRES 12-17-2014.

SEC. 2(F) AS TO "ISLAMIC RELIEF".

SER. NO. 78-897,143, FILED 5-31-2006.

ALEX KEAM, EXAMINING ATTORNEY

**Int. Cls.: 16 and 41**

**Prior U.S. Cls.: 2, 5, 22, 23, 29, 37, 38, 50, 100, 101 and 107**

**Reg. No. 3,394,969**

**United States Patent and Trademark Office**

**Registered Mar. 11, 2008**

**TRADEMARK  
SERVICE MARK  
PRINCIPAL REGISTER**



LYNN, JOANNA (UNITED STATES INDIVIDUAL)  
6200 MONTGOMERY ROAD  
CINCINNATI, OH 45213

FOR: EDUCATIONAL BOOKS FEATURING EXERCISE, FITNESS AND MENTAL, SPIRITUAL, AND PHYSICAL HEALTH; EDUCATIONAL PUBLICATIONS, NAMELY, TRAINING MANUALS IN THE FIELD OF EXERCISE, FITNESS AND MENTAL, SPIRITUAL, AND PHYSICAL HEALTH; EXERCISE BOOKS; PRINTED INSTRUCTIONAL, EDUCATIONAL, AND TEACHING MATERIALS IN THE FIELD OF EXERCISE, FITNESS AND MENTAL, SPIRITUAL, AND PHYSICAL HEALTH; PRINTED SEMINAR NOTES; WORKBOOKS DIRECTED TO EXERCISE, FITNESS AND MENTAL, SPIRITUAL, AND PHYSICAL HEALTH, IN CLASS 16 (U.S. CLS. 2, 5, 22, 23, 29, 37, 38 AND 50).

FIRST USE 3-1-2006; IN COMMERCE 3-1-2006.

FOR: ARRANGING AND CONDUCTING EDUCATIONAL EXHIBITIONS AND SEMINARS DEMONSTRATING THE INTEGRATION OF CHRISTIAN BELIEFS WITH A SYSTEM OF SPIRITUAL, MENTAL AND PHYSICAL FITNESS AND DISTRIBUTING COURSE WORKBOOKS AND NOTEBOOKS IN CONNECTION THEREWITH; PROVIDING EDUCATIONAL SERVICES, NAMELY, SEMINARS AND EXHIBITIONS IN THE FIELD OF EXERCISE, FITNESS AND MENTAL, SPIRITUAL, AND PHYSICAL HEALTH AND DISTRIBUTING COURSE WORKBOOKS AND NOTEBOOKS IN CONNECTION THEREWITH; PROVIDING EDUCATIONAL SERVICES, NAMELY, PROVIDING SEMINARS IN THE FIELD OF EXERCISE, FITNESS AND MENTAL, SPIRITUAL, AND PHYSICAL HEALTH

AND DISTRIBUTING COURSE WORKBOOKS AND NOTEBOOKS IN CONNECTION THEREWITH; CONDUCTING ON-LINE EXHIBITIONS WITH INTERACTIVE EXHIBITS IN THE FIELD OF THE INTEGRATION OF PHYSICAL EXERCISE WITH MENTAL, SPIRITUAL, AND PHYSICAL HEALTH; PROVIDING A WEBSITE FEATURING, PHOTOGRAPHIC, AUDIO, VIDEO AND PROSE PRESENTATIONS ON THE SUBJECT OF THE INTEGRATION OF SPIRITUAL BELIEFS WITH PHYSICAL AND MENTAL FITNESS; PERSONAL TRAINING SERVICES, NAMELY, STRENGTH AND CONDITIONING TRAINING AND PHYSICAL FITNESS EDUCATION SERVICES, INCLUDING INSTRUCTION IN THE INTEGRATION OF SPIRITUAL, PHYSICAL AND MENTAL HEALTH; PHYSICAL FITNESS CONSULTATION; PHYSICAL FITNESS INSTRUCTION; PROVIDING AN ON-LINE COMPUTER DATABASE CONTAINING INFORMATION ABOUT EXERCISE AND FITNESS BEFORE AND AFTER PREGNANCY; PROVIDING FITNESS AND EXERCISE FACILITIES; PROVIDING INFORMATION IN THE FIELD OF EXERCISE TRAINING; PROVIDING NON-DOWNLOADABLE ON-LINE NEWSLETTERS IN THE FIELD OF EXERCISE, FITNESS AND MENTAL, SPIRITUAL AND PHYSICAL HEALTH VIA EMAIL; ARRANGING TRAINING COURSES AND EDUCATIONAL CONFERENCES TO TEACH THE INTEGRATION OF CHRISTIAN SPIRITUAL BELIEFS WITH PHYSICAL AND MENTAL HEALTH AND THE DISTRIBUTION WORKBOOKS AND NOTEBOOKS IN CONNECTION THEREWITH, IN CLASS 41 (U.S. CLS. 100, 101 AND 107).

FIRST USE 3-1-2006; IN COMMERCE 3-1-2006.

THE MARK CONSISTS OF THE WORD CHRISTIAN-CISE WITH THE WORDS EXERCISING FOR GOD UNDERNEATH, CHRISTIAN-CISE STARTS WITH LARGE C WHICH SWOOPS FROM TOP TO BOTTOM TO ENCOMPASS THE WORD HRISTIAN WITH THE TOP OF THE C STARTING AT I IN HISTRIAN AND EXTENDING AROUND UNDER THE WORD HRISTIAN AND THE WORD EXERCIS-

ING TO JOIN UP WITH THE C IN CISE, THE I IN CISE IS DOTTED BY A STAR-SHAPED DOT WITH 10 RADIATING ARMS OR LINES OF VARYING LENGTHS.

SER. NO. 78-903,607, FILED 6-8-2006.

SUSAN RICHARDS, EXAMINING ATTORNEY



**Int. Cl.: 17**

**Prior U.S. Cls.: 1, 5, 12, 13, 35 and 50**

**United States Patent and Trademark Office**

**Reg. No. 3,394,970**

**Registered Mar. 11, 2008**

**TRADEMARK  
PRINCIPAL REGISTER**

**KOBRA**

J/B INDUSTRIES, INC. (ILLINOIS CORPORATION)  
P.O. BOX 1180  
AURORA, IL 605071180

THE MARK CONSISTS OF STANDARD CHARACTERS WITHOUT CLAIM TO ANY PARTICULAR FONT, STYLE, SIZE, OR COLOR.

FOR: INDUSTRIAL HOSES MADE OF NITRILE AND ARAMID FIBER FOR USE IN THE AIR CONDITIONING, AND REFRIGERATION INDUSTRIES, IN CLASS 17 (U.S. CLS. 1, 5, 12, 13, 35 AND 50).

SER. NO. 78-906,703, FILED 6-13-2006.

FIRST USE 1-3-2006; IN COMMERCE 1-3-2006.

STEVEN R. FINE, EXAMINING ATTORNEY

**Int. Cl.: 35**

**Prior U.S. Cls.: 100, 101 and 102**

**United States Patent and Trademark Office**

**Reg. No. 3,394,971**

**Registered Mar. 11, 2008**

**SERVICE MARK  
PRINCIPAL REGISTER**

**WORLD TALENT**

WORLD TALENT INC. (HAWAII CORPORATION)  
1347 KAPIOLANI BOULEVARD, #403  
HONOLULU, HI 96814

FOR: TALENT AGENCY SERVICES; MANAGEMENT OF PROFESSIONAL MODELS, ACTORS, ENTERTAINERS, SINGERS, DANCERS AND FILMMAKERS; BUSINESS DEVELOPMENT SERVICES IN THE NATURE OF PROVIDING START-UP SUPPORT FOR BUSINESSES OF MODELS, ACTORS AND ENTERTAINERS, IN CLASS 35 (U.S. CLS. 100, 101 AND 102).

FIRST USE 0-0-2001; IN COMMERCE 0-0-2001.

THE MARK CONSISTS OF STANDARD CHARACTERS WITHOUT CLAIM TO ANY PARTICULAR FONT, STYLE, SIZE, OR COLOR.

NO CLAIM IS MADE TO THE EXCLUSIVE RIGHT TO USE "TALENT", APART FROM THE MARK AS SHOWN.

SEC. 2(F).

SER. NO. 78-908,094, FILED 6-14-2006.

KELLY CHOE, EXAMINING ATTORNEY

**Int. Cl.: 35**

**Prior U.S. Cls.: 100, 101 and 102**

**United States Patent and Trademark Office**

**Reg. No. 3,394,972**

**Registered Mar. 11, 2008**

**SERVICE MARK  
PRINCIPAL REGISTER**

**LIFE MIRACLE**

SMULOWITZ, MARC (UNITED STATES INDIVIDUAL)  
P.O. BOX 285  
HARVEYS LAKE, PA 18618

THE MARK CONSISTS OF STANDARD CHARACTERS WITHOUT CLAIM TO ANY PARTICULAR FONT, STYLE, SIZE, OR COLOR.

FOR: PRODUCT MERCHANDISING, IN CLASS 35 (U.S. CLS. 100, 101 AND 102).

SER. NO. 78-908,559, FILED 6-14-2006.

FIRST USE 11-12-1997; IN COMMERCE 11-12-1997.

JASON TURNER, EXAMINING ATTORNEY

**Int. Cl.: 1**

**Prior U.S. Cls.: 1, 5, 6, 10, 26 and 46**

**Reg. No. 3,394,973**

**United States Patent and Trademark Office**

**Registered Mar. 11, 2008**

---

**TRADEMARK  
PRINCIPAL REGISTER**

**MINNO**

ALZO INTERNATIONAL, INC. (NEW JERSEY CORPORATION), DBA BERNEL CHEMICAL COMPANY, INC.  
650 JERNEE MILL RD.  
SAYREVILLE, NJ 08872

FOR: EMOLLIENTS USED IN THE MANUFACTURE OF COSMETICS, IN CLASS 1 (U.S. CLS. 1, 5, 6, 10, 26 AND 46).

FIRST USE 7-6-1993; IN COMMERCE 7-6-1993.

THE MARK CONSISTS OF STANDARD CHARACTERS WITHOUT CLAIM TO ANY PARTICULAR FONT, STYLE, SIZE, OR COLOR.

OWNER OF U.S. REG. NO. 2,360,365.

SEC. 2(F).

SER. NO. 78-910,166, FILED 6-16-2006.

KEVON CHISOLM, EXAMINING ATTORNEY

**Int. Cls.: 35 and 42**

**Prior U.S. Cls.: 100, 101 and 102**

**United States Patent and Trademark Office**

**Reg. No. 3,394,974**

**Registered Mar. 11, 2008**

**SERVICE MARK  
PRINCIPAL REGISTER**

**FRESHCONCENTRATE**

GIL, RAMON S. (UNITED STATES INDIVIDUAL)  
235 EAST 49TH STREET, SUITE 5A  
NEW YORK, NY 10017

FOR: ADVERTISING AGENCIES, NAMELY, PROMOTING THE GOODS AND SERVICES OF OTHERS; ADVERTISING AND ADVERTISEMENT SERVICES; ADVERTISING AND BUSINESS ADVICE RELATING TO TELEMATICS SERVICES; ADVERTISING AND BUSINESS SERVICES, NAMELY, SECURING AIRTIME ON ALL FORMS OF MEDIA COMMUNICATIONS STATIONS, SYSTEMS, NETWORKS, AND SERVICES FOR THE PURPOSE OF PROMOTING THE GOODS AND SERVICES OF OTHERS; ADVERTISING AND COMMERCIAL INFORMATION SERVICES, VIA THE INTERNET; ADVERTISING AND MARKETING; ADVERTISING AND PROMOTION SERVICES AND RELATED CONSULTING; ADVERTISING AND PUBLICITY SERVICES; CREATION OF MARKETING TOOLS DESIGNED TO INCREASE A CLIENT COMPANY'S KNOWLEDGE OF CUSTOMER NEEDS, AND ITS COMPETITORS' PRODUCTS AND SERVICES, PRICING, ADVERTISING STRATEGY AND SALES

STRATEGY; PUBLIC RELATIONS; PUBLICITY AND SALES PROMOTION RELATING TO GOODS AND SERVICES, OFFERED AND ORDERED BY TELECOMMUNICATION OR THE ELECTRONIC WAY, IN CLASS 35 (U.S. CLS. 100, 101 AND 102).

FIRST USE 1-1-2006; IN COMMERCE 1-1-2006.

FOR: COMMERCIAL ART DESIGN; COMPUTER GRAPHICS SERVICES; DESIGN, CREATION, HOSTING AND MAINTENANCE OF INTERNET SITES FOR THIRD PARTIES , IN CLASS 42 (U.S. CLS. 100 AND 101).

FIRST USE 1-1-2006; IN COMMERCE 1-1-2006.

THE MARK CONSISTS OF STANDARD CHARACTERS WITHOUT CLAIM TO ANY PARTICULAR FONT, STYLE, SIZE, OR COLOR.

SER. NO. 78-912,383, FILED 6-20-2006.

JEAN IM, EXAMINING ATTORNEY

Prior U.S. Cl.: A

United States Patent and Trademark Office

Reg. No. 3,394,975

Registered Mar. 11, 2008

CERTIFICATION MARK  
PRINCIPAL REGISTER



MASTER CHEFS, LLC (NEW YORK LTD LIAB  
CO)  
5 SLOCUM ROAD  
BEACON, NY 12508

FOR: FOODS, BEVERAGES AND COOKWARE,  
IN CLASS A (U.S. CL. A).

FIRST USE 1-19-2006; IN COMMERCE 1-19-2006.

NO CLAIM IS MADE TO THE EXCLUSIVE  
RIGHT TO USE "MASTER CHEFS' INSTITUTE",  
APART FROM THE MARK AS SHOWN.

THE COLOR(S) RED, WHITE AND BLACK IS/  
ARE CLAIMED AS A FEATURE OF THE MARK.

THE MARK CONSISTS OF A SEAL FEATURING  
A CENTRAL RED CIRCLE WITH A DEPICTION OF  
FIVE TOQUES (OR CHEFS HATS) IN BLACK AND  
WHITE OVER FIVE WHITE STARS ALL, SUR-

ROUNDED BY A THIN WHITE CIRCLE, WHICH  
IS SURROUNDED BY A CIRCULAR BLACK BAND  
IN WHICH THE WORDS MASTER CHEFS' INSTI-  
TUTE SEAL OF EXCELLENCE APPEAR IN WHITE,  
ALL OF WHICH IS SURROUNDED BY A THIN RED  
CIRCLE.

THE CERTIFICATION MARK, AS USED AU-  
THORIZED PERSONS, CERTIFIES THAT FOODS,  
BEVERAGES AND COOKWARE COMPLY AND/OR  
ARE CONSISTENT WITH CERTIFIER'S STAN-  
DARDS AND GUIDELINES FOR EXCELLENCE,  
NAMELY THAT THEY PERFORM WELL IN A  
REAL KITCHEN, EXHIBIT CONSISTENT PRO-  
DUCT ATTRIBUTES FROM SAMPLE TO SAMPLE,  
AND OUTPERFORMS THE VAST MAJORITY OF  
ITS COMPETITION.

SER. NO. 78-912,902, FILED 6-21-2006.

MIDGE BUTLER, EXAMINING ATTORNEY

**Int. Cls.: 35, 36 and 42**

**Prior U.S. Cls.: 100, 101 and 102**

**United States Patent and Trademark Office**

**Reg. No. 3,394,976**

**Registered Mar. 11, 2008**

**SERVICE MARK  
PRINCIPAL REGISTER**

# COVER-ALL

COVER-ALL TECHNOLOGIES INC. (DELAWARE CORPORATION)  
SUITE 300  
55 LANE ROAD  
FAIRFIELD, NJ 07004

FOR: BUSINESS CONSULTING SERVICES FOR THE PROPERTY AND CASUALTY INSURANCE INDUSTRY, IN CLASS 35 (U.S. CLS. 100, 101 AND 102).

FIRST USE 11-30-1984; IN COMMERCE 11-30-1984.

FOR: INSURANCE CONSULTATION, NAMELY, ANALYZING THE CHANGES, DEVELOPMENT, QUALITY, INSURANCE DOCUMENTATION AND DISTRIBUTION OF INSURANCE POLICIES FOR THE PROPERTY AND CASUALTY INSURANCE INDUSTRY, IN CLASS 36 (U.S. CLS. 100, 101 AND 102).

FIRST USE 11-30-1984; IN COMMERCE 11-30-1984.

FOR: DESIGN AND DEVELOPMENT OF COMPUTER NETWORKS AND SOFTWARE FOR OTHERS FOR MANAGING INFORMATION FOR INSURANCE AND FINANCIAL SERVICES COMPANIES, IN CLASS 42 (U.S. CLS. 100 AND 101).

FIRST USE 11-30-1984; IN COMMERCE 11-30-1984.

THE MARK CONSISTS OF STANDARD CHARACTERS WITHOUT CLAIM TO ANY PARTICULAR FONT, STYLE, SIZE, OR COLOR.

OWNER OF U.S. REG. NO. 1,860,730.

SER. NO. 78-913,338, FILED 6-21-2006.

JUSTINE D. PARKER, EXAMINING ATTORNEY

**Int. Cls.: 9 and 41**

**Prior U.S. Cls.: 21, 23, 26, 36, 38, 100, 101 and 107**

**Reg. No. 3,394,977**

**United States Patent and Trademark Office**

**Registered Mar. 11, 2008**

**TRADEMARK  
SERVICE MARK  
PRINCIPAL REGISTER**

# DESERT DREAMS

DESERT DREAMS PRODUCTIONS, LLC (ARIZONA LTD LIAB CO)

10645 N TATUM BLVD

SUITE 200 - 463

PHOENIX, AZ 85028

FOR: PRODUCTS AND MULTIMEDIA ARTICLES PRODUCED, MANUFACTURED, DISTRIBUTED AND SOLD IN CONNECTION WITH A RECORD LABEL, MUSICAL GROUP AND SOLO RECORDING ARTISTS, NAMELY, MUSICAL SOUND RECORDINGS, MUSICAL VIDEO RECORDINGS; PRE-RECORDED CDS, CD-RS, DVDS, DVD-RS, DIGITAL AUDIO TAPES, DIGITAL AUDIO CASSETTES, MINI-DISCS IN THE NATURE OF MAGNETO-OPTICAL DISCS, PHONOGRAPH RECORDS, AUDIO AND VIDEO TAPES, AUDIO AND VIDEO CASSETTES AND AUDIO AND VIDEO DISCS, ALL FEATURING MUSIC; MOUSE PADS; DOWNLOADABLE ELECTRONIC PUBLICATIONS NAMELY NEWSLETTERS IN THE FIELD OF MUSIC; DOWNLOADABLE DIGITAL MUSIC VIA THE INTERNET; DOWNLOADABLE DIGITAL MUSIC PROVIDED VIA MP3 WEB SITES ON THE INTERNET; COMPUTER SCREEN SAVER SOFTWARE, DOWNLOADABLE PICTURE MESSAGES AND LOGOS FOR COMPUTERS AND TELEPHONES, NAMELY, DOWNLOADABLE GRAPHICS VIA A GLOBAL COMPUTER NETWORK AND WIRELESS DEVICES; DOWNLOADABLE MOBILE PHONE RING TONES VIA A GLOBAL COMPUTER NETWORK AND WIRELESS DEVICES; CELL PHONE COVERS, NAMELY, COVERS AND REPLACEABLE HOUSINGS FOR TELEPHONES AND MOBILE TELEPHONES; AND STRUCTURAL PARTS FOR ALL OF THE FOREGOING GOODS, IN CLASS 9 (U.S. CLS. 21, 23, 26, 36 AND 38).

FIRST USE 8-0-2005; IN COMMERCE 8-0-2005.

FOR: ENTERTAINMENT AND ENTERTAINER SERVICES, NAMELY, PRODUCTION OF MUSICAL SOUND AND AUDIOVISUAL RECORDINGS, IN THE NATURE OF CDS, CD-RS, DVDS, DVD-RS, DIGITAL AUDIO TAPES, DIGITAL AUDIO CASSETTES, MINI-DISCS IN THE NATURE OF MAGNETO-OPTICAL DISCS, PHONOGRAPH RECORDS, AUDIO AND VIDEO TAPES, AUDIO AND VIDEO CASSETTES AND AUDIO AND VIDEO DISCS, CD-ROMS, AUDIO COMPACT DISCS, VIDEOTAPES AND AUDIO CASSETTE TAPES FEATURING MUSIC; MUSIC PUBLISHING SERVICES; RECORDING STUDIO SERVICES, NAMELY, AUDIO, MUSIC AND VIDEO PRODUCTION, MIXING, RE-MIXING, EDITING AND RECORDING SERVICES; PUBLISHING OF MUSIC; PUBLICATION OF BOOKS AND SHEET MUSIC FEATURING LYRICS OF SONGS; PUBLICATION OF MUSIC AND MUSIC BOOKS; ARRANGEMENT OF CONCERTS AND MUSIC FESTIVALS FOR ENTERTAINMENT PURPOSES; ARRANGEMENT AND PRESENTATION OF MUSIC PERFORMANCES, MUSIC SHOWS AND MUSICAL ENTERTAINMENT IN THE NATURE OF LIVE PERFORMANCES BY AN ENTERTAINER OR MUSICAL GROUP; PRESENTATION OF LIVE SHOW PERFORMANCES, NAMELY, DANCE, MUSIC AND DRAMA PERFORMANCES; PRODUCTION OF SOUND AND MUSIC VIDEO RECORDINGS; ENTERTAINMENT, NAMELY, PRODUCTION OF CONCERTS, AND LIVE ENTERTAINMENT SHOWS; DISCOTHEQUE SERVICES; ENTERTAINMENT IN THE NATURE OF LIVE MUSICAL CONCERTS AND ONGOING TELEVISION AND RADIO PROGRAMS IN THE FIELD OF MUSIC; NIGHT CLUBS AND NIGHT CLUB SERVICES; PRODUCTION OF MUSICAL VIDEO RECORDINGS, MOTION PICTURE FILMS, AND RADIO AND TELEVISION PROGRAMS, NAMELY, PROGRAMS TRANSMITTED VIA THE INTERNET, WIRELESS APPLICATION PROTOCOL, INTERACTIVE DIGITAL TELEVISION, AND CABLE, SATELLITE, IN-



TERNET BROADCAST NETWORKS; LIVE MUSIC TICKET AGENCY SERVICES; PROVISION OF ON-LINE INFORMATION IN THE FIELD OF MUSIC AND MUSICAL ENTERTAINMENT; ORGANIZATION OF MUSICAL BAND COMPETITIONS; DANCE HALL SERVICES; ENTERTAINMENT IN THE NATURE OF CONDUCTING RECORD FAIRS NOT FOR COMMERCIAL PURPOSES; ON-LINE LIBRARY SERVICES, NAMELY, PROVIDING ELECTRONIC LIBRARY SERVICES WHICH FEATURE NEWSPAPERS, MAGAZINES, PHOTOGRAPHS AND PICTURES VIA AN ON-LINE COMPUTER NETWORK; PROVIDING NON-DOWNLOADABLE DIGITAL MUSIC FROM THE INTERNET; PROVIDING NON-DOWNLOADABLE DIGITAL MUSIC FROM MP3 INTERNET WEBSITES; INFORMATION, ADVISORY AND CONSULTANCY SERVICES IN RELATION TO MUSIC PERFORMANCES; ARTIST DEVELOPMENT, NAMELY, TRAINING IN THE FIELD OF VOCAL PERFORMANCE OR INSTRUMENTAL PERFORMANCE; FAN CLUB SERVICES; PARTY PLANNING SERVICES; PROVIDING TRAINING

SERVICES IN THE FIELD OF VOCAL COACHING, DANCE AND MOVEMENT COACHING; TRAINING IN THE FIELD OF PUBLIC APPEARANCE ETIQUETTE, VOCAL AND INSTRUMENTAL PRESENTATIONS; RECORDING STUDIOS; ENTERTAINMENT IN THE NATURE OF LIVE PERFORMANCES OF A MUSICAL BAND AND LIVE PERFORMANCES FEATURING PRERECORDED VOCAL AND INSTRUMENTAL PERFORMANCES BY A MUSICAL BAND VIEWED ON A BIG SCREEN, IN CLASS 41 (U.S. CLS. 100, 101 AND 107).

FIRST USE 8-0-2005; IN COMMERCE 8-0-2005.

THE MARK CONSISTS OF STANDARD CHARACTERS WITHOUT CLAIM TO ANY PARTICULAR FONT, STYLE, SIZE, OR COLOR.

SER. NO. 78-913,455, FILED 6-21-2006.

CARRIE GENOVESE, EXAMINING ATTORNEY

**Int. Cls.: 7 and 9**

**Prior U.S. Cls.: 13, 19, 21, 23, 26, 31, 34, 35, 36 and 38**

**United States Patent and Trademark Office**

**Reg. No. 3,394,978**

**Registered Mar. 11, 2008**

**TRADEMARK  
PRINCIPAL REGISTER**

**TRUEPRESS**

DAINIPPON SCREEN MFG. CO., LTD. (JAPAN CORPORATION)  
TENJINKITA-CHO 1-1 TERANOUCHE-AGARU  
4-CHOME, HORIKAWA-DORI  
KAMIGYO-KU, KYOTO, JAPAN

FOR: PRINTING PRESSES, IN CLASS 7 (U.S. CLS. 13, 19, 21, 23, 31, 34 AND 35).

FIRST USE 3-0-2005; IN COMMERCE 6-0-2006.

FOR: ELECTRONIC CONTROL SYSTEMS FOR PRINTING PRESSES, INKJET PRINTERS AND RASTER IMAGE PROCESSORS, IN CLASS 9 (U.S. CLS. 21, 23, 26, 36 AND 38).

FIRST USE 10-0-2006; IN COMMERCE 10-0-2006.

THE MARK CONSISTS OF STANDARD CHARACTERS WITHOUT CLAIM TO ANY PARTICULAR FONT, STYLE, SIZE, OR COLOR.

OWNER OF JAPAN REG. NO. 4334645, DATED 11-12-1999, EXPIRES 11-12-2009.

OWNER OF JAPAN REG. NO. 4300593, DATED 7-30-1999, EXPIRES 7-30-2009.

SER. NO. 78-916,537, FILED 6-26-2006.

EDWARD NELSON, EXAMINING ATTORNEY

**Int. Cls.: 9 and 38**

**Prior U.S. Cls.: 21, 23, 26, 36, 38, 100, 101 and 104**

**United States Patent and Trademark Office**

**Reg. No. 3,394,979**

**Registered Mar. 11, 2008**

**TRADEMARK  
SERVICE MARK  
PRINCIPAL REGISTER**



ADMINISTRADORA DE MARCAS RD, S. DE  
R.L. DE C.V. (MEXICO CORPORATION)

INDUSTRIESTRASSE 7

ZUG, SWITZERLAND CH-6301

FOR: TELECOMMUNICATION PRODUCTS, NAMELY, TELEPHONES, CELLULAR TELEPHONES AND TELEPHONE ANSWERING MACHINES; APPARATUS FOR RECORDING, TRANSMISSION, REPRODUCTION OF SOUND OR IMAGES, NAMELY, PHONOGRAPH RECORD, CD AND DVD PLAYERS, AUDIO AND VIDEO TAPE RECORDERS; BLANK AUDIO AND VIDEO TAPES AND CDS; STEREO RECEIVERS, AMPLIFIERS, AND TUNERS; BLANK MAGNETIC DATA CARRIERS, DATA PROCESSORS AND COMPUTERS; COMPUTER HARDWARE, NAMELY, MEMORY CARDS, MODEMS, COMPUTER INTERFACE BOARDS, BLANK MAGNETIC COMPUTER TAPES, FAX MACHINES, FIBER OPTIC CABLES, COMPUTER AND ELECTRIC CABLES, OPTICAL CHARACTER RECOGNITION APPARATUS, BLANK OPTICAL DISCS, OPTICAL SCANNERS, MAGNETIC CODED CARDS FOR PREPAID TELECOMMUNICATIONS SERVICES; SATELLITES, BLANK DIGITAL OPTICAL DISKS, COMPUTER KEYBOARDS, COMPUTERS FOR DATA AND WORD PROCESSING, COMPUTER TERMINALS, COMPUTER PRINTERS, COMPUTER MONITORS, INTEGRATED CIRCUITS AND COMPONENTS, NAMELY, COMPUTER CHIPS; ELECTRONIC CIRCUIT BOARDS, ELECTRONIC NOTICE BOARDS, AND BLANK INTEGRATED CIRCUIT CARDS, IN CLASS 9 (U.S. CLS. 21, 23, 26, 36 AND 38).

FOR: TELECOMMUNICATION SERVICES, NAMELY, PERSONAL COMMUNICATION SERVICES; MOBILE TELECOMMUNICATIONS SERVICES, NAMELY, ELECTRONIC TRANSMISSION OF VOICE SIGNALS AND DATA ACCESSIBLE BY ACCESS CODE OR TERMINALS, TELEPHONE, TELEVISION, RADIO AND TELEPRINTER; ELECTRONIC TRANSMISSION OF MESSAGES AND CODED IMAGES; ELECTRONIC TRANSMISSION OF MESSAGES AND DATA; WIRELESS DIGITAL MESSAGING SERVICES, ELECTRONIC STORE-AND-FORWARD MESSAGING, ELECTRONIC TRANSMISSION OF DATA AND DOCUMENTS VIA COMPUTER TERMINALS, COMPUTER TELECOMMUNICATIONS, NAMELY, PROVIDING MULTIPLE USER ACCESS TO THE INTERNET, FACSIMILE TRANSMISSION, ELECTRONIC MAIL SERVICES, TELEPHONE COMMUNICATION SERVICES, IN CLASS 38 (U.S. CLS. 100, 101 AND 104).

PRIORITY CLAIMED UNDER SEC. 44(D) ON MEXICO APPLICATION NO. 784858, FILED 5-26-2006, REG. NO. 942395, DATED 6-30-2006, EXPIRES 5-26-2016.

PRIORITY CLAIMED UNDER SEC. 44(D) ON MEXICO APPLICATION NO. 784859, FILED 5-26-2006, REG. NO. 942396, DATED 6-30-2006, EXPIRES 5-26-2016.

NO CLAIM IS MADE TO THE EXCLUSIVE RIGHT TO USE "ROCKAMPEONATO", APART FROM THE MARK AS SHOWN.

THE COLOR(S) RED, WHITE, BLACK, BROWN AND BLUE IS/ARE CLAIMED AS A FEATURE OF THE MARK.

THE MARK CONSISTS OF ROCKAMPEONATO WITH THE TERM ROC IN RED AND THE TERM KAMPEONATO IN WHITE AGAINST A BACKGROUND OF BLACK EXPLODING LIQUID WITH

REPRESENTATIONS OF LOUDSPEAKERS IN THE COLORS BROWN, BLUE AND BLACK EMITTING FROM THE EXPLOSION IN THE FOUR CORNERS OF THE MARK.

SER. NO. 78-918,224, FILED 6-27-2006.

ZHALEH DELANEY, EXAMINING ATTORNEY

**Int. Cl.: 41**

**Prior U.S. Cls.: 100, 101 and 107**

**United States Patent and Trademark Office**

**Reg. No. 3,394,980**

**Registered Mar. 11, 2008**

**SERVICE MARK  
PRINCIPAL REGISTER**

**SoCal Wicked**

SOCAL WICKED (CALIFORNIA NON-PROFIT  
501(C)(3) ORGANIZATION)  
11723 SANTA GERTRUDES AVE.  
WHITTIER, CA 90604

FOR: ENTERTAINMENT SERVICES IN THE  
NATURE OF GIRLS FAST PITCH SOFTBALL  
GAMES, IN CLASS 41 (U.S. CLS. 100, 101 AND 107).

FIRST USE 9-13-2003; IN COMMERCE 9-13-2003.

THE MARK CONSISTS OF STANDARD CHAR-  
ACTERS WITHOUT CLAIM TO ANY PARTICULAR  
FONT, STYLE, SIZE, OR COLOR.

NO CLAIM IS MADE TO THE EXCLUSIVE  
RIGHT TO USE "SOCAL", APART FROM THE  
MARK AS SHOWN.

SER. NO. 78-918,394, FILED 6-28-2006.

WILLIAM VERHOSEK, EXAMINING ATTORNEY

**Int. Cl.: 28**

**Prior U.S. Cls.: 22, 23, 38 and 50**

**United States Patent and Trademark Office**

**Reg. No. 3,394,981**

**Registered Mar. 11, 2008**

**TRADEMARK  
PRINCIPAL REGISTER**



OMGYM LLC (MARYLAND LIMITED LIABILITY CORPORATION)  
6355 TAMAR DRIVE  
COLUMBIA, MD 21045

FIRST USE 12-12-2005; IN COMMERCE 3-1-2006.

SER. NO. 78-919,653, FILED 6-29-2006.

FOR: NON-MEDICAL PORTABLE INVERSION THERAPY AND AERIAL YOGA SLINGS, IN CLASS 28 (U.S. CLS. 22, 23, 38 AND 50).

LINDA E. BLOHM, EXAMINING ATTORNEY

**Int. Cls.: 18, 25 and 28**

**Prior U.S. Cls.: 1, 2, 3, 22, 23, 38, 39, 41 and 50**

**United States Patent and Trademark Office**

**Reg. No. 3,394,982**

**Registered Mar. 11, 2008**

**TRADEMARK  
PRINCIPAL REGISTER**

**ONE MILLION BUCKS**

KEMNER, THOMAS (FED REP GERMANY INDIVIDUAL)  
HELLIGENBREITE 19  
ANGERSTEIN, FED REP GERMANY 37176

FOR: CARRY-ALL BAGS, BACKPACKS, AND RUCKSACKS, IN CLASS 18 (U.S. CLS. 1, 2, 3, 22 AND 41).

FOR: CLOTHING, NAMELY, SUITS, COATS, JACKETS, JEANS, PANTS, SHORTS, SHIRTS, DRESSES, GOWNS, SKIRTS, VESTS, SWEATERS, BLOUSES, UNDER GARMENTS, INFANTWEAR, SOCKS, NECKWEAR, SLEEPWEAR, BELTS FOR CLOTHING; ATHLETIC WEAR, NAMELY, PANTS, SHORTS, SHIRTS, T-SHIRTS, PULLOVERS, SWEATSHIRTS, SWEAT PANTS, UNDERWEAR, SPORTS BRAS, DRESSES, SKIRTS, SWEATERS, JACKETS, SOCKS, HEADWEAR AND SWEAT BANDS; FOOTWEAR FOR MEN, WOMEN AND CHILDREN; AND

HEADGEAR, NAMELY, HATS AND CAPS, IN CLASS 25 (U.S. CLS. 22 AND 39).

FOR: SPORTING ARTICLES, NAMELY SKI BAGS, SNOWBOARD BAGS, AND BAGS FOR ATHLETIC EQUIPMENT, IN CLASS 28 (U.S. CLS. 22, 23, 38 AND 50).

THE MARK CONSISTS OF STANDARD CHARACTERS WITHOUT CLAIM TO ANY PARTICULAR FONT, STYLE, SIZE, OR COLOR.

OWNER OF ERPN CMNTY TM OFC REG. NO. 004482972, DATED 5-10-2006, EXPIRES 6-10-2015.

SER. NO. 78-923,479, FILED 7-6-2006.

ALEXANDER L. POWERS, EXAMINING ATTORNEY

**Int. Cl.: 11**

**Prior U.S. Cls.: 13, 21, 23, 31 and 34**

**Reg. No. 3,394,983**

**United States Patent and Trademark Office**

**Registered Mar. 11, 2008**

---

**TRADEMARK  
PRINCIPAL REGISTER**

**IMEK**

GREEN-LIGHTS INC. (CANADA CORPORATION)  
15 EMERSON PLACE  
ST. ALBERT, CANADA T8N 5X3

PRIORITY CLAIMED UNDER SEC. 44(D) ON  
CANADA APPLICATION NO. 1307102, FILED 6-27-  
2006, REG. NO. TMA690,520, DATED 6-21-2007, EX-  
PIRES 6-21-2022.

FOR: LIGHT FIXTURES, IN CLASS 11 (U.S. CLS.  
13, 21, 23, 31 AND 34).

SER. NO. 78-923,665, FILED 7-6-2006.

THE MARK CONSISTS OF STANDARD CHAR-  
ACTERS WITHOUT CLAIM TO ANY PARTICULAR  
FONT, STYLE, SIZE, OR COLOR.

NATALIE POLZER, EXAMINING ATTORNEY



**Int. Cls.: 9, 16, 25, 35, 36, 38, 39 and 41**

**Prior U.S. Cls.: 2, 5, 21, 22, 23, 26, 29, 36, 37, 38, 39,  
50, 100, 101, 102, 104, 105 and 107**

**Reg. No. 3,394,984**

**United States Patent and Trademark Office**

**Registered Mar. 11, 2008**

**TRADEMARK  
SERVICE MARK  
PRINCIPAL REGISTER**

**MilCoz**

THETA FILMS LIMITED (UNITED KINGDOM  
LTD LIAB CO)  
6 BROAD COURT COVENT GARDEN  
LONDON, UNITED KINGDOM WC2B 5QZ

FOR: AUDIO VISUAL RECORDINGS AND  
DOWNLOADABLE AUDIO VISUAL RECORDINGS  
FEATURING MOTION PICTURES AND TELEVI-  
SION PROGRAMS; SOUND RECORDINGS FEAT-  
URING SOUNDTRACKS FROM MOTION  
PICTURES AND TELEVISION PROGRAMS, IN  
CLASS 9 (U.S. CLS. 21, 23, 26, 36 AND 38).

FOR: POSTERS; STICKERS; BOOKS IN THE  
FIELD OF MOTION PICTURES AND TELEVISION  
PROGRAMS; FICTION BOOKS AND NOVELS; AND  
BOOKS FEATURING INFORMATION ON THE  
MAKING OF MOTION PICTURES AND TELEVI-  
SION PROGRAMS, IN CLASS 16 (U.S. CLS. 2, 5, 22, 23,  
29, 37, 38 AND 50).

FOR: CLOTHING, NAMELY, T-SHIRTS, JACK-  
ETS, COATS, SWEATSHIRTS AND SHORTS;  
CLOTHING ACCESSORIES, NAMELY, SCARVES,  
IN CLASS 25 (U.S. CLS. 22 AND 39).

FOR: SUBSCRIPTION SERVICES TO A TELEVI-  
SION CHANNEL PROVIDING MOTION PICTURES,  
TELEVISION PROGRAMS AND OTHER CONTENT  
VIA THE INTERNET, IN CLASS 35 (U.S. CLS. 100, 101  
AND 102).

FOR: LOAN FINANCING FOR THE FILMS, MO-  
TION PICTURES AND TELEVISION PROGRAMS,  
ALL OF OTHERS, IN CLASS 36 (U.S. CLS. 100, 101  
AND 102).

FOR: PROVIDING CONSUMERS ACCESS TO  
MOTION PICTURES, TELEVISION PROGRAMS

AND OTHER CONTENT VIA THE INTERNET, IN  
CLASS 38 (U.S. CLS. 100, 101 AND 104).

FOR: DISTRIBUTION OF ENERGY, IN CLASS 39  
(U.S. CLS. 100 AND 105).

FOR: ENTERTAINMENT SERVICES, NAMELY,  
PRODUCTION OF MOTION PICTURES AND TELE-  
VISION PROGRAMS; DISTRIBUTION OF MOTION  
PICTURES AND TELEVISION PROGRAMS; EXHI-  
BITION OF FILMS, NAMELY, MOVIE THEATRE  
SERVICES; FILM STUDIO SERVICES, NAMELY,  
PROVIDING FACILITIES FOR THE PRODUCTION  
OF FILMS; FILM EDITING; FILM RENTAL; REN-  
TAL OF VIDEO TAPES AND DIGITAL VIDEO  
DISCS FEATURING TELEVISION PROGRAMS; IN-  
TERNET SERVICES, NAMELY, PROVIDING A  
WEBSITE FEATURING ENTERTAINMENT INFOR-  
MATION REGARDING A MOTION PICTURE, TEL-  
EVISION AND ENTERTAINMENT PRODUCTION  
STUDIO; PROVIDING INFORMATION AND CON-  
SULTATION IN THE AFORESAID EDUCATION  
AND ENTERTAINMENT FIELDS, IN CLASS 41  
(U.S. CLS. 100, 101 AND 107).

THE MARK CONSISTS OF STANDARD CHAR-  
ACTERS WITHOUT CLAIM TO ANY PARTICULAR  
FONT, STYLE, SIZE, OR COLOR.

PRIORITY CLAIMED UNDER SEC. 44(D) ON  
ERPNTY CMNTY TM OFC APPLICATION NO.  
005145016, FILED 6-19-2006, REG. NO. 005145016,  
DATED 7-9-2007, EXPIRES 6-19-2016.

SER. NO. 78-923,878, FILED 7-6-2006.

TRACY WHITTAKER-BROWN, EXAMINING AT-  
TORNEY

Int. Cl.: 9

Prior U.S. Cls.: 21, 23, 26, 36 and 38

**United States Patent and Trademark Office**

**Reg. No. 3,394,985**

Registered Mar. 11, 2008

---

**TRADEMARK  
PRINCIPAL REGISTER**



EEDUTECH, LLC (TEXAS LTD LIAB CO), DBA  
GRAYBEARD CONSULTING  
#102  
2437 BAY AREA BLVD.  
HOUSTON, TX 77058

NO CLAIM IS MADE TO THE EXCLUSIVE  
RIGHT TO USE "PROJECTS PM", APART FROM  
THE MARK AS SHOWN.

FOR: DOWNLOADABLE COMPUTER SOFT-  
WARE FOR MANAGING PROJECT PORTFOLIOS,  
IN CLASS 9 (U.S. CLS. 21, 23, 26, 36 AND 38).

SER. NO. 78-924,367, FILED 7-7-2006.

FIRST USE 1-1-2002; IN COMMERCE 1-1-2002.

LINDA ORNDORFF, EXAMINING ATTORNEY

**Int. Cl.: 25**

**Prior U.S. Cls.: 22 and 39**

**United States Patent and Trademark Office**

**Reg. No. 3,394,986**

**Registered Mar. 11, 2008**

**TRADEMARK  
PRINCIPAL REGISTER**

**LATUNIDO**

4DH, LLC (TEXAS LTD LIAB CO)  
3300 MAIN ST. SUITE # 103  
DALLAS, TX 75226

WRAPS; SWADDLING CLOTHES; TIES; TOPS;  
WRAPS, IN CLASS 25 (U.S. CLS. 22 AND 39).

FIRST USE 5-15-2006; IN COMMERCE 5-15-2006.

FOR: BELTS; CAPS; CLOTHING, NAMELY, ARM  
WARMERS; CLOTHING, NAMELY, WRAP-  
AROUNDS; CORSETS; FOULARDS; HOODS; IN-  
FANT AND TODDLER ONE PIECE CLOTHING;  
JERSEYS; LEATHER BELTS; MANTLES; MUF-  
FLERS; PERSPIRATION ABSORBENT UNDER-  
WEAR CLOTHING; SHORT SETS; SHOULDER

THE MARK CONSISTS OF STANDARD CHAR-  
ACTERS WITHOUT CLAIM TO ANY PARTICULAR  
FONT, STYLE, SIZE, OR COLOR.

SER. NO. 78-926,357, FILED 7-11-2006.

LINDA ESTRADA, EXAMINING ATTORNEY

**Int. Cl.: 35**

**Prior U.S. Cls.: 100, 101 and 102**

**United States Patent and Trademark Office**

**Reg. No. 3,394,987**

**Registered Mar. 11, 2008**

**SERVICE MARK  
PRINCIPAL REGISTER**

**TREO SOLUTIONS**

TREO SOLUTIONS INC. (NEW YORK CORPORATION)  
2 TIVOLI STREET  
ALBANY, NY 12207

FOR: PROVIDING AN ONLINE COMPUTER DATABASE FEATURING INFORMATION, TABLES AND DATA SUMMARIES IN THE FIELD OF HEALTH CARE COST CONTAINMENT; LICENSING OF COMPUTER SOFTWARE; MARKET RESEARCH SERVICES TO MEASURE MARKETS IN THE HEALTH CARE INDUSTRY; BUSINESS CONSULTATION CONCERNING THE HEALTH CARE INDUSTRY; PROVIDING CUSTOMIZED STATISTICAL REPORTS CONCERNING THE HEALTH CARE INDUSTRY, NAMELY, PREPARING BUSINESS REPORTS, IN CLASS 35 (U.S. CLS. 100, 101 AND 102).

FIRST USE 0-0-2002; IN COMMERCE 0-0-2002.

THE MARK CONSISTS OF STANDARD CHARACTERS WITHOUT CLAIM TO ANY PARTICULAR FONT, STYLE, SIZE, OR COLOR.

NO CLAIM IS MADE TO THE EXCLUSIVE RIGHT TO USE "SOLUTIONS" , APART FROM THE MARK AS SHOWN.

SER. NO. 78-928,149, FILED 7-12-2006.

JOHN DWYER, EXAMINING ATTORNEY

**Int. Cl.: 35**

**Prior U.S. Cls.: 100, 101 and 102**

**United States Patent and Trademark Office**

**Reg. No. 3,394,988**

**Registered Mar. 11, 2008**

**SERVICE MARK  
PRINCIPAL REGISTER**

# TREO STAT

TREO SOLUTIONS INC. (NEW YORK CORPORATION)  
2 TIVOLI STREET  
ALBANY, NY 12207

FOR: PROVIDING AN ONLINE COMPUTER DATABASE FEATURING INFORMATION, TABLES AND DATA SUMMARIES IN THE FIELD OF HEALTH CARE COST CONTAINMENT; LICENSING OF COMPUTER SOFTWARE FOR USE IN ACCESSING COMPUTER DATABASE FEATURING INFORMATION, TABLES AND DATA SUMMARIES IN THE FIELD OF HEALTH CARE COST CONTAINMENT, NOT INCLUDING SOFTWARE FOR USE IN CONNECTION WITH HANDHELD OR MOBILE COMPUTER OR COMMUNICATIONS PRODUCTS, OR SOFTWARE FOR THE PROVISION OF INFORMATION, TABLES, DATA SUMMARIES, BUSINESS REPORTS OR STATISTICAL REPORTS VIA HANDHELD OR MOBILE COMPUTER OR COMMUNICATIONS DEVICES; MARKET RESEARCH SERVICES TO MEASURE MARKETS IN THE HEALTH CARE

INDUSTRY; BUSINESS CONSULTATION CONCERNING THE HEALTH CARE INDUSTRY; PROVIDING CUSTOMIZED STATISTICAL REPORTS CONCERNING THE HEALTH CARE INDUSTRY, NAMELY, PREPARING BUSINESS REPORTS, IN CLASS 35 (U.S. CLS. 100, 101 AND 102).

FIRST USE 1-0-2006; IN COMMERCE 1-0-2006.

THE MARK CONSISTS OF STANDARD CHARACTERS WITHOUT CLAIM TO ANY PARTICULAR FONT, STYLE, SIZE, OR COLOR.

NO CLAIM IS MADE TO THE EXCLUSIVE RIGHT TO USE "STAT", APART FROM THE MARK AS SHOWN.

SER. NO. 78-928,170, FILED 7-12-2006.

JOHN DWYER, EXAMINING ATTORNEY

**Int. Cl.: 36**

**Prior U.S. Cls.: 100, 101 and 102**

**United States Patent and Trademark Office**

**Reg. No. 3,394,989**

**Registered Mar. 11, 2008**

**SERVICE MARK  
PRINCIPAL REGISTER**

**FAMILY ADVANTAGE ACCIDENT  
INSURANCE**

AMERICAN INTERNATIONAL GROUP, INC.  
(DELAWARE CORPORATION)  
70 PINE STREET  
NEW YORK, NY 10270

OWNER OF U.S. REG. NOS. 2,132,378, 3,154,916  
AND OTHERS.

FOR: INSURANCE UNDERWRITING IN THE  
FIELD OF PERSONAL AUTOMOBILE INSURANCE,  
IN CLASS 36 (U.S. CLS. 100, 101 AND 102).

NO CLAIM IS MADE TO THE EXCLUSIVE  
RIGHT TO USE "FAMILY" AND "ACCIDENT IN-  
SURANCE", APART FROM THE MARK AS  
SHOWN.

FIRST USE 6-13-2006; IN COMMERCE 6-13-2006.

SER. NO. 78-929,066, FILED 7-13-2006.

THE MARK CONSISTS OF STANDARD CHAR-  
ACTERS WITHOUT CLAIM TO ANY PARTICULAR  
FONT, STYLE, SIZE, OR COLOR.

ESTHER BELENKER, EXAMINING ATTORNEY

**Int. Cl.: 12**

**Prior U.S. Cls.: 19, 21, 23, 31, 35 and 44**

**Reg. No. 3,394,990**

**United States Patent and Trademark Office**

**Registered Mar. 11, 2008**

---

**TRADEMARK  
PRINCIPAL REGISTER**

**KRUZ**

KRUZ, INC. (INDIANA CORPORATION)  
P.O. BOX 129  
1201 WEST CULVER ROAD  
KNOX, IN 46534

FIRST USE 2-17-2003; IN COMMERCE 2-17-2003.

THE MARK CONSISTS OF STANDARD CHARACTERS WITHOUT CLAIM TO ANY PARTICULAR FONT, STYLE, SIZE, OR COLOR.

FOR: TRUCK TRAILERS, SEMI-TRAILERS, DISCHARGE TRAILERS, CARGO TRAILERS AND STRUCTURAL PARTS THEREOF, IN CLASS 12 (U.S. CLS. 19, 21, 23, 31, 35 AND 44).

SER. NO. 78-930,919, FILED 7-17-2006.

SHANNON TWOHIG, EXAMINING ATTORNEY

**Int. Cls.: 3 and 30**

**Prior U.S. Cls.: 1, 4, 6, 46, 50, 51 and 52**

**United States Patent and Trademark Office**

**Reg. No. 3,394,991**

**Registered Mar. 11, 2008**

**TRADEMARK  
PRINCIPAL REGISTER**

**SUPERNATURAL**

KERRY GROUP SERVICES INTERNATIONAL,  
LTD. (IRELAND CORPORATION)  
ATTN: BRIAN DURRAN, COMPANY SECRETARY  
PRINCE'S STREET  
TRALEE, COUNTY KERRY, IRELAND

FOR: FOOD FLAVORINGS, BEING ESSENTIAL  
OILS FOR USE IN THE FURTHER MANUFACTURE  
OF FOODS BY OTHERS , IN CLASS 3 (U.S.  
CLS. 1, 4, 6, 50, 51 AND 52).

FIRST USE 7-12-2006; IN COMMERCE 7-12-2006.

FOR: FLAVORS AND FLAVOR EMULSIONS,  
NAMELY, FOOD FLAVORINGS, IN CLASS 30 (U.S.  
CL. 46).

FIRST USE 5-17-2006; IN COMMERCE 5-31-2006.

THE MARK CONSISTS OF STANDARD CHAR-  
ACTERS WITHOUT CLAIM TO ANY PARTICULAR  
FONT, STYLE, SIZE, OR COLOR.

SER. NO. 78-933,529, FILED 7-20-2006.

LINDA ESTRADA, EXAMINING ATTORNEY



Int. Cl.: 35

Prior U.S. Cls.: 100, 101 and 102

**United States Patent and Trademark Office**

**Reg. No. 3,394,992**

Registered Mar. 11, 2008

**SERVICE MARK  
PRINCIPAL REGISTER**

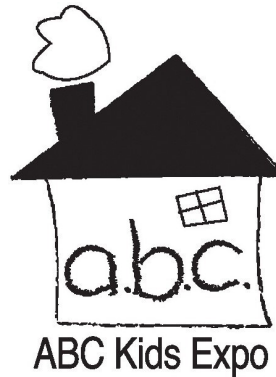

ALL BABY & CHILD, INC. (INDIANA CORPORATION)  
12302 HART RANCH  
SAN ANTONIO, TX 78249

FOR: ARRANGING AND CONDUCTING TRADESHOWS IN THE FIELD OF INFANT, JUVENILE AND MATERNITY PRODUCTS, IN CLASS 35 (U.S. CLS. 100, 101 AND 102).

FIRST USE 9-10-2004; IN COMMERCE 9-10-2004.

NO CLAIM IS MADE TO THE EXCLUSIVE RIGHT TO USE "KIDS EXPO", APART FROM THE MARK AS SHOWN.

THE MARK CONSISTS OF A DESIGN OF A HOUSE.

SER. NO. 78-934,919, FILED 7-21-2006.

ALLISON HOLTZ, EXAMINING ATTORNEY

**Int. Cl.: 35**

**Prior U.S. Cls.: 100, 101 and 102**

**United States Patent and Trademark Office**

**Reg. No. 3,394,993**

**Registered Mar. 11, 2008**

**SERVICE MARK  
PRINCIPAL REGISTER**

# DiversiTech

DIVERSITECH CORP. (GEORGIA CORPORATION)  
6650 SUGARLOAF PARKWAY  
SUITE 100  
DULUTH, GA 30035

FOR: RETAIL STORE SERVICES AND DISTRIBUTORSHIP SERVICES RELATED TO THE HVAC/R INDUSTRY, NAMELY, RETAIL STORE SERVICES AND DISTRIBUTORSHIP SERVICES FEATURING GRILL PADS AND PROTECTIVE EXTERIOR FLOOR COVERINGS IN THE NATURE OF FIBER CEMENT PROTECTIVE BLANKETS FOR USE ON DECKS, DOCKS AND PATIOS AND IN ASSOCIATION WITH GRILLS, FIREPLACES, FRYERS, FIREPITS, CHIMENEA, FRYERS AND HEATERS, ELECTRIC MOTORS FOR MACHINES, NAMELY, FRACTIONAL HORSE POWER ELECTRIC MOTORS FOR HVAC/R INDUSTRY, HVAC PARTS AND COMPONENTS, NAMELY, POWER-OPERATED PIPE CLEANING GUNS, CHEMICALS USED IN HVAC UNITS, NAMELY, PAN TABLETS, CHEMICAL LEAK DETECTORS AND REFRIGERATION CHEMICALS; FIN STRAIGHTENING TOOLS, HVAC PARTS AND COMPONENTS, NAME-

LY, TIME DELAYS, VOLTAGE MONITORS AND HARD START CAPACITOR KITS COMPRISED OF CAPACITOR, POSITIVE TEMPERATURE COEFFICIENT RESISTOR, HOOKUP WARE AND PLASTIC HOUSING, HVAC PARTS AND COMPONENTS, NAMELY, LINE TAP VALVES, ACCESS VALVES AND COPPER SPUN DRIERS; DEVICES TO DETECT THE PRESENCE OF CONDENSATE OVERFLOW WHICH WILL INTERRUPT THE CONTROL CIRCUIT OF AN AIR CONDITIONER, REFRIGERATION UNIT OR WATER COOLING SYSTEM, LIQUID AIR CONDITIONER COIL CLEANER, CONCRETE COATED POLYSTYRENE FOAM BLOCKS, IN CLASS 35 (U.S. CLS. 100, 101 AND 102).

FIRST USE 0-0-1971; IN COMMERCE 0-0-1971.

THE MARK CONSISTS OF STANDARD CHARACTERS WITHOUT CLAIM TO ANY PARTICULAR FONT, STYLE, SIZE, OR COLOR.

SER. NO. 78-935,734, FILED 7-24-2006.

AMY GEARIN, EXAMINING ATTORNEY

Int. Cl.: 32

Prior U.S. Cls.: 45, 46 and 48

United States Patent and Trademark Office

Reg. No. 3,394,994

Registered Mar. 11, 2008

TRADEMARK  
PRINCIPAL REGISTER



COORS GLOBAL PROPERTIES, INC. (COLOR-  
ADO CORPORATION)  
CE 235  
17735 W. 32ND AVENUE  
GOLDEN, CO 80401

FOR: BEER, IN CLASS 32 (U.S. CLS. 45, 46 AND 48).

FIRST USE 9-30-2005; IN COMMERCE 9-30-2005.

OWNER OF U.S. REG. NOS. 2,406,363 AND  
2,970,387.

NO CLAIM IS MADE TO THE EXCLUSIVE  
RIGHT TO USE "HUNT RESPONSIBLY" AND  
"PRACTICE FAIR CHASE. HARVEST SELECTIVE-  
LY. CONSERVE THE HABITAT. NEVER DRINK  
AND HUNT.", APART FROM THE MARK AS  
SHOWN.

THE MARK CONSISTS OF A MOUNTAIN DE-  
SIGN AND ANTLERS WITHIN A CIRCLE. THE  
WORDING "HUNT RESPONSIBLY" APPEARS  
HORIZONTALLY ACROSS THE BOTTOM OF THE  
CIRCLE BETWEEN TWO HORIZONTAL LINES.  
THE WORDING "PRACTICE FAIR CHASE. HAR-  
VEST SELECTIVELY. CONSERVE THE HABITAT.  
NEVER DRINK AND HUNT." AND "WHATEVER  
YOUR GAME." SURROUNDS THE TOP OF THE  
CIRCLE. THE WORDING "IT'S OUR SPORT. PRO-  
TECT IT." SURROUNDS THE BOTTOM OF THE  
CIRCLE.

SER. NO. 78-936,638, FILED 7-25-2006.

COLLEEN DOMBROW, EXAMINING ATTORNEY

**Int. Cl.: 13**

**Prior U.S. Cls.: 2 and 9**

**United States Patent and Trademark Office**

**Reg. No. 3,394,995**

**Registered Mar. 11, 2008**

**TRADEMARK  
PRINCIPAL REGISTER**

**DUO**

DUO, S.R.O. (CZECH REPUBLIC CORPORATION)  
NA OLIVE 467  
OPOCNO, CZECH REPUBLIC

FOR: HAND OPERATED FIRE ARMS AND AMMUNITION, IN CLASS 13 (U.S. CLS. 2 AND 9).

THE MARK CONSISTS OF STANDARD CHARACTERS WITHOUT CLAIM TO ANY PARTICULAR FONT, STYLE, SIZE, OR COLOR.

OWNER OF CZECH REPUBLIC REG. NO. 214712, DATED 12-28-1998, RENEWED AS REG. NO. 214712, DATED 3-12-2007, EXPIRES 12-19-2017.

OWNER OF U.S. REG. NOS. 2,338,210 AND 2,338,328.

SER. NO. 78-937,383, FILED 7-25-2006.

CHARLES L. JENKINS, EXAMINING ATTORNEY

**Int. Cl.: 3**

**Prior U.S. Cls.: 1, 4, 6, 50, 51 and 52**

**United States Patent and Trademark Office**

**Reg. No. 3,394,996**

**Registered Mar. 11, 2008**

**TRADEMARK  
PRINCIPAL REGISTER**

**SPAMOXIE**

THE CREATIVE CONCEPT (INDIANA CORPORATION)  
PO BOX 8326  
FORT WAYNE, IN 46898

FOR: BATH FOAMS; BATH GEL; BATH LOTION; BATH MILKS; BATH OIL; BATH POWDER; BATH SALTS; BATH SALTS; BATH SOAPS IN LIQUID, SOLID OR GEL FORM; BEAUTY CREAMS FOR BODY CARE; BODY AND BEAUTY CARE PREPARATIONS; BODY SCRUB; EXFOLIANT CREAMS; FACE AND BODY BEAUTY CREAMS; FACE AND BODY CREAMS; FACE AND BODY

LOTIONS; FACIAL SCRUBS; LIP BALM; LIP BALM, IN CLASS 3 (U.S. CLS. 1, 4, 6, 50, 51 AND 52).

FIRST USE 11-1-2005; IN COMMERCE 11-1-2005.

THE MARK CONSISTS OF STANDARD CHARACTERS WITHOUT CLAIM TO ANY PARTICULAR FONT, STYLE, SIZE, OR COLOR.

SER. NO. 78-942,783, FILED 8-2-2006.

JILL C. ALT, EXAMINING ATTORNEY

**Int. Cl.: 16**

**Prior U.S. Cls.: 2, 5, 22, 23, 29, 37, 38 and 50**

**United States Patent and Trademark Office**

**Reg. No. 3,394,997**

**Registered Mar. 11, 2008**

**TRADEMARK  
PRINCIPAL REGISTER**

**CRECER FELIZ**

HACHETTE FILIPACCHI, S.A. (SPAIN CORPORATION)  
SANTA ENGRACIA, 23  
MADRID, SPAIN 28010

FOR: PUBLICATIONS, NAMELY NEWSPAPERS, MAGAZINES AND BOOKS IN THE FIELD OF ARTS AND CRAFT, HOME, DECORATION, COOKING, FAMILY AND CHILD-REARING, IN CLASS 16 (U.S. CLS. 2, 5, 22, 23, 29, 37, 38 AND 50).

THE MARK CONSISTS OF STANDARD CHARACTERS WITHOUT CLAIM TO ANY PARTICULAR FONT, STYLE, SIZE, OR COLOR.

PRIORITY CLAIMED UNDER SEC. 44(D) ON ERPN CMNTY TM OFC APPLICATION NO. 5188032, FILED 7-10-2006, REG. NO. 005188032, DATED 6-15-2007, EXPIRES 10-7-2016.

THE FOREIGN WORDING IN THE MARK TRANSLATES INTO ENGLISH AS HAPPY GROW.

SER. NO. 78-944,214, FILED 8-3-2006.

JILL C. ALT, EXAMINING ATTORNEY

**Int. Cls.: 35, 37 and 42**

**Prior U.S. Cls.: 100, 101, 102, 103 and 106**

**United States Patent and Trademark Office**

**Reg. No. 3,394,998**

**Registered Mar. 11, 2008**

**SERVICE MARK  
PRINCIPAL REGISTER**

**REPUBLIC ELECTRIC**

REPUBLIC INTELLIGENT TRANSPORTATION SERVICES, INC. (CALIFORNIA CORPORATION)  
371 BEL MARIN KEYS BLVD., SUITE 200  
NOVATO, CA 94949

FOR: DISTRIBUTORSHIPS FEATURING EQUIPMENT RELATED TO TRAFFIC SIGNALS, STREETLIGHTS, OUTDOOR LIGHTING, AND ELECTRICAL SYSTEMS, IN CLASS 35 (U.S. CLS. 100, 101 AND 102).

FIRST USE 3-31-2004; IN COMMERCE 3-31-2004.

FOR: REPAIR, INSTALLATION AND MAINTENANCE OF EQUIPMENT RELATED TO TRAFFIC SIGNALS, STREETLIGHTS, OUTDOOR LIGHTING, AND ELECTRICAL SYSTEMS, IN CLASS 37 (U.S. CLS. 100, 103 AND 106).

FIRST USE 12-31-1991; IN COMMERCE 7-31-1999.

FOR: DESIGN OF EQUIPMENT FOR OTHERS RELATED TO TRAFFIC SIGNALS, STREETLIGHTS, OUTDOOR LIGHTING, AND ELECTRICAL SYSTEMS, IN CLASS 42 (U.S. CLS. 100 AND 101).

FIRST USE 5-31-2002; IN COMMERCE 5-31-2002.

THE MARK CONSISTS OF STANDARD CHARACTERS WITHOUT CLAIM TO ANY PARTICULAR FONT, STYLE, SIZE, OR COLOR.

NO CLAIM IS MADE TO THE EXCLUSIVE RIGHT TO USE "ELECTRIC", APART FROM THE MARK AS SHOWN.

SER. NO. 78-944,240, FILED 8-3-2006.

CAROLYN CATALDO, EXAMINING ATTORNEY

**Int. Cls.: 35, 37 and 42**

**Prior U.S. Cls.: 100, 101, 102, 103 and 106**

**United States Patent and Trademark Office**

**Reg. No. 3,394,999**

**Registered Mar. 11, 2008**

**SERVICE MARK  
PRINCIPAL REGISTER**

# REPUBLIC ITS

REPUBLIC INTELLIGENT TRANSPORTATION SERVICES, INC. (CALIFORNIA CORPORATION)  
371 BEL MARIN KEYS BLVD., SUITE 200  
NOVATO, CA 94949

FOR: DISTRIBUTORSHIPS FEATURING EQUIPMENT RELATED TO TRAFFIC SIGNALS, STREETLIGHTS, OUTDOOR LIGHTING, AND ELECTRICAL SYSTEMS, IN CLASS 35 (U.S. CLS. 100, 101 AND 102).

FIRST USE 9-1-2006; IN COMMERCE 9-1-2006.

FOR: REPAIR, INSTALLATION AND MAINTENANCE OF EQUIPMENT RELATED TO TRAFFIC SIGNALS, STREETLIGHTS, OUTDOOR LIGHTING, AND ELECTRICAL SYSTEMS, IN CLASS 37 (U.S. CLS. 100, 103 AND 106).

FIRST USE 9-1-2006; IN COMMERCE 9-1-2006.

FOR: DESIGN OF EQUIPMENT FOR OTHERS RELATED TO TRAFFIC SIGNALS, STREETLIGHTS, OUTDOOR LIGHTING, AND ELECTRICAL SYSTEMS, IN CLASS 42 (U.S. CLS. 100 AND 101).

FIRST USE 9-1-2006; IN COMMERCE 9-1-2006.

THE MARK CONSISTS OF STANDARD CHARACTERS WITHOUT CLAIM TO ANY PARTICULAR FONT, STYLE, SIZE, OR COLOR.

NO CLAIM IS MADE TO THE EXCLUSIVE RIGHT TO USE "ITS", APART FROM THE MARK AS SHOWN.

SER. NO. 78-944,255, FILED 8-3-2006.

CAROLYN CATALDO, EXAMINING ATTORNEY



**Int. Cls.: 35, 37 and 42**

**Prior U.S. Cls.: 100, 101, 102, 103 and 106**

**United States Patent and Trademark Office**

**Reg. No. 3,395,000**

**Registered Mar. 11, 2008**

**SERVICE MARK  
PRINCIPAL REGISTER**

REPUBLIC INTELLIGENT  
TRANSPORTATION SERVICES,  
INC.

REPUBLIC INTELLIGENT TRANSPORTATION  
SERVICES, INC. (CALIFORNIA CORPORATION)  
371 BEL MARIN KEYS BLVD., SUITE 200  
NOVATA, CA 94949

FOR: DISTRIBUTORSHIPS FEATURING EQUIP-  
MENT RELATED TO TRAFFIC SIGNALS, STREET-  
LIGHTS, OUTDOOR LIGHTING, AND  
ELECTRICAL SYSTEMS, IN CLASS 35 (U.S. CLS.  
100, 101 AND 102).

FIRST USE 9-1-2006; IN COMMERCE 9-1-2006.

FOR: REPAIR, INSTALLATION AND MAINTENANCE  
OF EQUIPMENT RELATED TO TRAFFIC  
SIGNALS, STREETLIGHTS, OUTDOOR LIGHTING,  
AND ELECTRICAL SYSTEMS, IN CLASS 37 (U.S.  
CLS. 100, 103 AND 106).

FIRST USE 9-1-2006; IN COMMERCE 9-1-2006.

FOR: DESIGN OF EQUIPMENT FOR OTHERS  
RELATED TO TRAFFIC SIGNALS, STREET-  
LIGHTS, OUTDOOR LIGHTING, AND ELECTRI-  
CAL SYSTEMS, IN CLASS 42 (U.S. CLS. 100 AND 101).

FIRST USE 9-1-2006; IN COMMERCE 9-1-2006.

THE MARK CONSISTS OF STANDARD CHAR-  
ACTERS WITHOUT CLAIM TO ANY PARTICULAR  
FONT, STYLE, SIZE, OR COLOR.

NO CLAIM IS MADE TO THE EXCLUSIVE  
RIGHT TO USE "INTELLIGENT TRANSPORTA-  
TION SERVICES, INC.", APART FROM THE MARK  
AS SHOWN.

SER. NO. 78-944,276, FILED 8-3-2006.

CAROLYN CATALDO, EXAMINING ATTORNEY

Int. Cl.: 25

Prior U.S. Cls.: 22 and 39

United States Patent and Trademark Office

Reg. No. 3,395,001

Registered Mar. 11, 2008

TRADEMARK  
PRINCIPAL REGISTER

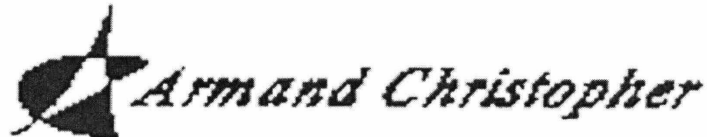

ARMAND CHRISTOPHER, LLC (TEXAS LTD  
LIAB CO)  
3800 PERRIN CENTRAL BLVD #437  
SAN ANTONIO, TX 78217

THE MARK CONSISTS OF THE GEOMETRICAL-  
LY STYLIZED LETTERING AC AND THE STY-  
LIZED WORDING ARMAND CHRISTOPHER.

FOR: TIES, IN CLASS 25 (U.S. CLS. 22 AND 39).

SER. NO. 78-948,760, FILED 8-9-2006.

FIRST USE 1-16-2006; IN COMMERCE 1-16-2006.

THE NAME ARMAND CHRISTOPHER DOES  
NOT IDENTIFY A LIVING INDIVIDUAL.

DAVID TOOLEY, EXAMINING ATTORNEY

Int. Cl.: 3

Prior U.S. Cls.: 1, 4, 6, 50, 51 and 52

United States Patent and Trademark Office

Reg. No. 3,395,002

Registered Mar. 11, 2008

TRADEMARK  
PRINCIPAL REGISTER



BEAUTY & BIO INC. (CALIFORNIA CORPORATION)  
1130 MONTEREY PASS ROAD  
MONTEREY PARK, CA 91754

FOR: CLEANSING MILK, SLIMMING CREAM IN THE NATURE OF CELLULITE REDUCTION CREAM, FACIAL PURIFYING MASK, TONER LOTION, EYE CREAM AND GELS, NIGHT CREAM, DAY SKIN CREAM, SKIN CLEANSING GEL, SKIN EXFOLIATING GEL, IN CLASS 3 (U.S. CLS. 1, 4, 6, 50, 51 AND 52).

FIRST USE 8-12-2006; IN COMMERCE 8-14-2006.

THE COLOR(S) GREEN AND WHITE IS/ARE CLAIMED AS A FEATURE OF THE MARK.

THE COLOR GREEN APPEARS IN THE WORDING BEAUTY & BIO AND IN THE DESIGN OF A LEAF. THE COLOR WHITE APPEARS IN THE DESIGN OF A LEAF.

SER. NO. 78-950,933, FILED 8-12-2006.

SOPHIA S. KIM, EXAMINING ATTORNEY

**Int. Cl.: 43**

**Prior U.S. Cls.: 100 and 101**

**United States Patent and Trademark Office**

**Reg. No. 3,395,003**

**Registered Mar. 11, 2008**

**SERVICE MARK  
PRINCIPAL REGISTER**

# 1 Plus 1 Cafe

1 PLUS 1 CAFE, LLC (HAWAII LTD LIAB CO)  
315 MAKAALA ST.  
STE#110  
HILO, HI 96720

FOR: RESTAURANTS, IN CLASS 43 (U.S. CLS. 100  
AND 101).

FIRST USE 11-4-2004; IN COMMERCE 11-4-2004.

THE MARK CONSISTS OF STANDARD CHAR-  
ACTERS WITHOUT CLAIM TO ANY PARTICULAR  
FONT, STYLE, SIZE, OR COLOR.

NO CLAIM IS MADE TO THE EXCLUSIVE  
RIGHT TO USE "CAFE", APART FROM THE MARK  
AS SHOWN.

SER. NO. 78-950,958, FILED 8-13-2006.

EDWARD NELSON, EXAMINING ATTORNEY

**Int. Cls.: 38, 41 and 42**

**Prior U.S. Cls.: 100, 101, 104 and 107**

**United States Patent and Trademark Office**

**Reg. No. 3,395,004**

**Registered Mar. 11, 2008**

**SERVICE MARK  
PRINCIPAL REGISTER**

**ZYLOM**

ZYLOM MEDIA GROUP B.V. (NETHERLANDS CORPORATION)  
DE ZAALE 11  
EINDHOVEN, NETHERLANDS 5612 AJ

FOR: TRANSFER OF DATA BY TELECOMMUNICATIONS, IN CLASS 38 (U.S. CLS. 100, 101 AND 104).

FOR: ENTERTAINMENT SERVICES, NAMELY, PROVIDING ON-LINE COMPUTER GAMES, IN CLASS 41 (U.S. CLS. 100, 101 AND 107).

FOR: DESIGN AND DEVELOPMENT OF COMPUTER SOFTWARE, IN PARTICULAR IN CON-

NECTION WITH INTERACTIVE GAMES, IN CLASS 42 (U.S. CLS. 100 AND 101).

THE MARK CONSISTS OF STANDARD CHARACTERS WITHOUT CLAIM TO ANY PARTICULAR FONT, STYLE, SIZE, OR COLOR.

OWNER OF ERPN CMNTY TM OFC REG. NO. 003164613, DATED 12-2-2004, EXPIRES 4-9-2013.

SER. NO. 78-951,858, FILED 8-14-2006.

G. MAYERSCHOFF, EXAMINING ATTORNEY

**Int. Cl.: 35**

**Prior U.S. Cls.: 100, 101 and 102**

**United States Patent and Trademark Office**

**Reg. No. 3,395,005**

**Registered Mar. 11, 2008**

**SERVICE MARK  
PRINCIPAL REGISTER**

**TREO**

TREO SOLUTIONS INC. (NEW YORK CORPORATION)  
2 TIVOLI STREET  
ALBANY, NY 12207

FOR: PROVIDING AN ONLINE COMPUTER DATABASE FEATURING INFORMATION, TABLES AND DATA SUMMARIES IN THE FIELD OF HEALTH CARE COST CONTAINMENT; LICENSING OF COMPUTER SOFTWARE; MARKET RESEARCH SERVICES TO MEASURE MARKETS IN THE HEALTH CARE INDUSTRY; BUSINESS CONSULTATION CONCERNING THE HEALTH CARE INDUSTRY; PROVIDING CUSTOMIZED STATISTI-

CAL REPORTS CONCERNING THE HEALTH CARE INDUSTRY, NAMELY, PREPARING BUSINESS REPORTS, IN CLASS 35 (U.S. CLS. 100, 101 AND 102).

FIRST USE 0-0-2002; IN COMMERCE 0-0-2002.

THE MARK CONSISTS OF STANDARD CHARACTERS WITHOUT CLAIM TO ANY PARTICULAR FONT, STYLE, SIZE, OR COLOR.

SER. NO. 78-951,994, FILED 8-15-2006.

JOHN DWYER, EXAMINING ATTORNEY

**Int. Cl.: 35**

**Prior U.S. Cls.: 100, 101 and 102**

**United States Patent and Trademark Office**

**Reg. No. 3,395,006**

**Registered Mar. 11, 2008**

**SERVICE MARK  
PRINCIPAL REGISTER**

**DOREMUS**

DOREMUS & COMPANY (DELAWARE CORPORATION)  
200 VARICK STREET  
NEW YORK, NY 10014

FOR: ADVERTISING SERVICES; ADVERTISING AGENCY SERVICES IN THE BUSINESS, CORPORATE AND FINANCIAL FIELDS; MARKETING SERVICES; DIRECT MARKETING; PRODUCTION AND DISSEMINATION OF ADVERTISING; BUSINESS MARKETING CONSULTING; MARKET RESEARCH AND ANALYSIS; EVENT MARKETING; BRAND CONSULTING, NAMELY, CONSULTING FOR OTHERS ON BRAND DEVELOPMENT, BRAND CREATION AND BRAND MARKETING; PUBLICITY SERVICES; PROMOTIONAL SERVICES, NAMELY, PROMOTING THE GOODS AND SERVICES OF OTHERS THROUGH THE DISSEMINA-

TION OF SALES PROMOTION MATERIALS; PUBLIC RELATIONS SERVICES; PLANNING, BUYING AND NEGOTIATING ADVERTISING AND MEDIA SPACE AND TIME, IN CLASS 35 (U.S. CLS. 100, 101 AND 102).

FIRST USE 0-0-1903; IN COMMERCE 0-0-1903.

THE MARK CONSISTS OF STANDARD CHARACTERS WITHOUT CLAIM TO ANY PARTICULAR FONT, STYLE, SIZE, OR COLOR.

SEC. 2(F).

SER. NO. 78-952,171, FILED 8-15-2006.

LAURIE MAYES, EXAMINING ATTORNEY

**Int. Cl.: 29**

**Prior U.S. Cl.: 46**

**United States Patent and Trademark Office**

**Reg. No. 3,395,007**

**Registered Mar. 11, 2008**

**TRADEMARK  
PRINCIPAL REGISTER**

**IT IS SO GOOD!**

YOPLAIT MARQUES INTERNATIONALES  
(FRANCE CORPORATION)  
170 BIS, BOULEVARD DU MONTPARNASSE  
75014 PARIS, FRANCE

THE MARK CONSISTS OF STANDARD CHAR-  
ACTERS WITHOUT CLAIM TO ANY PARTICULAR  
FONT, STYLE, SIZE, OR COLOR.

FOR: DAIRY PRODUCTS EXCLUDING ICE  
CREAM, ICE MILK, AND FROZEN YOGURT, IN  
CLASS 29 (U.S. CL. 46).

SER. NO. 78-956,826, FILED 8-21-2006.

FIRST USE 3-31-2005; IN COMMERCE 3-31-2005.

SHANNON TWOHIG, EXAMINING ATTORNEY



**Int. Cls.: 35, 40 and 42**

**Prior U.S. Cls.: 100, 101, 102, 103 and 106**

**United States Patent and Trademark Office**

**Reg. No. 3,395,008**

**Registered Mar. 11, 2008**

**SERVICE MARK  
PRINCIPAL REGISTER**

**POG**

THE PRINT OPERATIONS GROUP INC. (CANADA CORPORATION)  
70 HAMILTON DRIVE  
CALGARY, ALBERTA, CANADA T3R 1A2

FOR: BUSINESS CONSULTATION SERVICES, NAMELY, ASSESSING BUSINESS DOCUMENT MANAGEMENT REQUIREMENTS, RECOMMENDING SOLUTIONS FOR PRODUCTIVITY IMPROVEMENTS AND COST REDUCTIONS, ASSISTING WITH THE IMPLEMENTATION OF ANY DOCUMENT MANAGEMENT SOLUTIONS THAT ARE ACQUIRED BY THE BUSINESS, AND CONDUCTING VALIDATION AND INDUSTRY BENCHMARKING STUDIES FOR THE DEPLOYED SOLUTIONS; PROCURING OF CONTRACTS FOR THE PURCHASE OF GOODS, IN CLASS 35 (U.S. CLS. 100, 101 AND 102).

FOR: PRINTING CONSULTATION SERVICES, NAMELY, ASSESSING THIRD PARTY ELECTRONIC AND PHYSICAL PRINT REQUIREMENTS AND ASSISTING WITH THE IMPLEMENTATION

OF ANY PRINT SOLUTIONS THAT ARE REQUIRED, IN CLASS 40 (U.S. CLS. 100, 103 AND 106).

FOR: COMPUTER SOFTWARE AND HARDWARE CONSULTATION SERVICES, NAMELY, PROVIDING RECOMMENDATIONS WITH RESPECT TO HARDWARE AND SOFTWARE NEEDS; INSTALLING AND TESTING COMPUTER SOFTWARE; COMPUTER PROJECT MANAGEMENT SERVICES, IN CLASS 42 (U.S. CLS. 100 AND 101).

THE MARK CONSISTS OF STANDARD CHARACTERS WITHOUT CLAIM TO ANY PARTICULAR FONT, STYLE, SIZE, OR COLOR.

PRIORITY CLAIMED UNDER SEC. 44(D) ON CANADA APPLICATION NO. 1296447, FILED 4-3-2006, REG. NO. TMA692110, DATED 7-16-2007, EXPIRES 7-16-2022.

SER. NO. 78-958,276, FILED 8-23-2006.

CARRIE GENOVESE, EXAMINING ATTORNEY

**Int. Cls.: 35, 36 and 37**

**Prior U.S. Cls.: 100, 101, 102, 103 and 106**

**United States Patent and Trademark Office**

**Reg. No. 3,395,009**

**Registered Mar. 11, 2008**

**SERVICE MARK  
PRINCIPAL REGISTER**

**SP S&P DESTINATION  
PROPERTIES**

S&P REAL ESTATE PARTNERS INC. (CANADA CORPORATION)  
1750-1500 WEST GEORGIA STREET  
VANCOUVER, CANADA V6G 2Z6

FOR: REAL ESTATE SERVICES, NAMELY, REAL ESTATE MARKETING SERVICES AND REAL ESTATE SALES MANAGEMENT, IN CLASS 35 (U.S. CLS. 100, 101 AND 102).

FIRST USE 5-1-2005; IN COMMERCE 5-1-2005.

FOR: REAL ESTATE SERVICES, NAMELY, REAL ESTATE BROKERAGE SERVICES, IN CLASS 36 (U.S. CLS. 100, 101 AND 102).

FIRST USE 5-1-2005; IN COMMERCE 5-1-2005.

FOR: LAND DEVELOPMENT SERVICES, NAMELY, MASTER PLANNING AND LAYING OUT OF RESIDENTIAL AND/OR COMMERCIAL COMMUNITIES, IN CLASS 37 (U.S. CLS. 100, 103 AND 106).

FIRST USE 5-1-2005; IN COMMERCE 5-1-2005.

THE MARK CONSISTS OF STANDARD CHARACTERS WITHOUT CLAIM TO ANY PARTICULAR FONT, STYLE, SIZE, OR COLOR.

PRIORITY CLAIMED UNDER SEC. 44(D) ON CANADA APPLICATION NO. 1313864, FILED 8-22-2006, REG. NO. TMA692,595, DATED 7-23-2007, EXPIRES 7-23-2022.

NO CLAIM IS MADE TO THE EXCLUSIVE RIGHT TO USE "DESTINATION PROPERTIES", APART FROM THE MARK AS SHOWN.

SER. NO. 78-960,930, FILED 8-25-2006.

ELLEN BURNS, EXAMINING ATTORNEY

**Int. Cl.: 41**

**Prior U.S. Cls.: 100, 101 and 107**

**United States Patent and Trademark Office**

**Reg. No. 3,395,010**

**Registered Mar. 11, 2008**

**SERVICE MARK  
PRINCIPAL REGISTER**

# Tabitha's Secret

STANLEY , JOHN JOSEPH (FLORIDA COR-  
PORATION)  
2249 TWISTED PINE RD  
OCOEE, FL 34761

FOR: ENTERTAINMENT IN THE NATURE OF  
VISUAL AND AUDIO PERFORMANCES, NAMELY,  
MUSICAL BAND, ROCK GROUP, GYMNASTIC,  
DANCE, AND BALLET PERFORMANCES, IN  
CLASS 41 (U.S. CLS. 100, 101 AND 107).

FIRST USE 9-1-1993; IN COMMERCE 12-1-1993.

THE MARK CONSISTS OF STANDARD CHAR-  
ACTERS WITHOUT CLAIM TO ANY PARTICULAR  
FONT, STYLE, SIZE, OR COLOR.

SER. NO. 78-961,478, FILED 8-28-2006.

JOHN SCHUYLER YARD, EXAMINING ATTOR-  
NEY

**Int. Cls.: 36 and 37**

**Prior U.S. Cls.: 100, 101, 102, 103 and 106**

**United States Patent and Trademark Office**

**Reg. No. 3,395,011**

**Registered Mar. 11, 2008**

**SERVICE MARK  
PRINCIPAL REGISTER**

**UNICORP**

UNICORP NATIONAL DEVELOPMENTS, INC.  
(FLORIDA CORPORATION)  
7505 W. SAND LAKE ROAD  
ORLANDO, FL 32819

FOR: LEASING AND MANAGEMENT OF REAL  
PROPERTY, IN CLASS 36 (U.S. CLS. 100, 101 AND  
102).

FIRST USE 6-0-1995; IN COMMERCE 6-0-1995.

FOR: LAND DEVELOPMENT SERVICES, NAME-  
LY, PLANNING AND LAYING OUT OF COMMER-  
CIAL, RESIDENTIAL AND RESORT

COMMUNITIES, IN CLASS 37 (U.S. CLS. 100, 103  
AND 106).

FIRST USE 6-0-1995; IN COMMERCE 6-0-1995.

THE MARK CONSISTS OF STANDARD CHAR-  
ACTERS WITHOUT CLAIM TO ANY PARTICULAR  
FONT, STYLE, SIZE, OR COLOR.

SER. NO. 78-962,844, FILED 8-29-2006.

ELIZABETH BEYER, EXAMINING ATTORNEY

**Int. Cls.: 36 and 37**

**Prior U.S. Cls.: 100, 101, 102, 103 and 106**

**United States Patent and Trademark Office**

**Reg. No. 3,395,012**

**Registered Mar. 11, 2008**

**SERVICE MARK  
PRINCIPAL REGISTER**



**U N I C O R P**  
NATIONAL DEVELOPMENTS, INC.

UNICORP NATIONAL DEVELOPMENTS, INC.  
(FLORIDA CORPORATION)  
7505 W. SAND LAKE ROAD  
ORLANDO, FL 32819

FOR: LEASING AND MANAGEMENT OF REAL  
PROPERTY, IN CLASS 36 (U.S. CLS. 100, 101 AND  
102).

FIRST USE 1-0-2004; IN COMMERCE 1-0-2004.

FOR: LAND DEVELOPMENT SERVICES, NAME-  
LY, PLANNING AND LAYING OUT OF COMMER-  
CIAL, RESIDENTIAL AND RESORT

COMMUNITIES, IN CLASS 37 (U.S. CLS. 100, 103  
AND 106).

FIRST USE 1-0-2004; IN COMMERCE 1-0-2004.

NO CLAIM IS MADE TO THE EXCLUSIVE  
RIGHT TO USE "NATIONAL DEVELOPMENTS,  
INC.", APART FROM THE MARK AS SHOWN.

SER. NO. 78-962,952, FILED 8-29-2006.

ELIZABETH BEYER, EXAMINING ATTORNEY

**Int. Cl.: 36**

**Prior U.S. Cls.: 100, 101 and 102**

**United States Patent and Trademark Office**

**Reg. No. 3,395,013**

**Registered Mar. 11, 2008**

**SERVICE MARK  
PRINCIPAL REGISTER**

**AARP FINANCIAL**

AARP (D.C. NON-PROFIT CORPORATION)  
601 E STREET, N.W.  
WASHINGTON, DC 20049

FOR: FINANCIAL AND INVESTMENT SERVICES, NAMELY, PROVIDING INFORMATION, ADVICE AND CONSULTATION IN THE FIELDS OF LOANS, REAL ESTATE, MORTGAGES, BANKING, INSURANCE, MONEY MANAGEMENT, INVESTMENT, FINANCE, AND PREDATORY LENDING; TELEPHONE HOT LINE COUNSELING AND TELEPHONE INFORMATION SERVICES IN THE FIELDS OF LOANS, REAL ESTATE, MORTGAGES, BANKING, INSURANCE, MONEY MANAGEMENT, INVESTMENTS, FINANCE, AND PREDATORY LENDING; MONEY MANAGEMENT AND INVESTMENT ADVISORY SERVICES; FINANCIAL MANAGEMENT, INVESTMENT MANAGEMENT AND ASSET MANAGEMENT SERVICES; INVESTMENT AND ADMINISTRATION OF FUNDS AND INVESTMENT ASSETS FOR OTHERS; MUTUAL FUND INVESTMENT SERVICES; ADMINISTERING AUTOMOBILE, LIFE, GROUP HEALTH AND HOMEOWNER'S INSURANCE PROGRAMS; PROVIDING INFORMATION AND ADMINISTRATION SERVICES IN THE FIELD OF GROUP HEALTH INSUR-

ANCE, ANNUITIES AND RETIREMENT PLANS; CREDIT CARD SERVICES; ISSUE OF TRAVELER'S CHEQUES; AND PROVIDING ONLINE ELECTRONIC DATABASES IN THE FIELDS OF FINANCE, BANKING, INSURANCE, ASSET MANAGEMENT AND INVESTMENT; AND CONSULTATION SERVICES IN CONNECTION WITH THE FOREGOING, IN CLASS 36 (U.S. CLS. 100, 101 AND 102).

FIRST USE 4-0-2006; IN COMMERCE 4-0-2006.

THE MARK CONSISTS OF STANDARD CHARACTERS WITHOUT CLAIM TO ANY PARTICULAR FONT, STYLE, SIZE, OR COLOR.

OWNER OF U.S. REG. NOS. 1,335,496, 2,957,554 AND OTHERS.

NO CLAIM IS MADE TO THE EXCLUSIVE RIGHT TO USE "FINANCIAL", APART FROM THE MARK AS SHOWN.

SER. NO. 78-963,801, FILED 8-30-2006.

LAURIE KAUFMAN, EXAMINING ATTORNEY

**Int. Cl.: 20**

**Prior U.S. Cls.: 2, 13, 22, 25, 32 and 50**

**United States Patent and Trademark Office**

**Reg. No. 3,395,014**

**Registered Mar. 11, 2008**

**TRADEMARK  
PRINCIPAL REGISTER**

**POTCHA**

THE JOHN HENRY COMPANY (MICHIGAN  
CORPORATION)  
5800 W. GRAND RIVER AVENUE  
LANSING, MI 48901

THE MARK CONSISTS OF STANDARD CHAR-  
ACTERS WITHOUT CLAIM TO ANY PARTICULAR  
FONT, STYLE, SIZE, OR COLOR.

FOR: PLASTIC PLANT TAGS, IN CLASS 20 (U.S.  
CLS. 2, 13, 22, 25, 32 AND 50).

SER. NO. 78-964,056, FILED 8-30-2006.

FIRST USE 6-1-2006; IN COMMERCE 6-1-2006.

JOHN GARTNER, EXAMINING ATTORNEY

**Int. Cl.: 36**

**Prior U.S. Cls.: 100, 101 and 102**

**United States Patent and Trademark Office**

**Reg. No. 3,395,015**

**Registered Mar. 11, 2008**

**SERVICE MARK  
PRINCIPAL REGISTER**



WAGREICH, JERRY (NEW YORK SOLE PROPRIETORSHIP)  
P.O BOX 536  
MILLWOOD, NY 10546

FOR: PRE-PAID PURCHASE CARD SERVICES, NAMELY, PROCESSING ELECTRONIC PAYMENTS MADE THROUGH PREPAID CARDS; PRE-PAID PURCHASE CARD SERVICES, NAMELY, PROCESSING ELECTRONIC PAYMENTS THROUGH PRE-PAID CARDS, IN CLASS 36 (U.S. CLS. 100, 101 AND 102).

FIRST USE 1-20-2002; IN COMMERCE 7-31-2002.

THE COLOR(S) WHITE, BLUE, GREEN IS/ARE CLAIMED AS A FEATURE OF THE MARK.

THE WORD IPAYED APPEARS IN WHITE LETTERS ON A BLUE BACKGROUND, WITH A BLUE AND GREEN DOT FORMING A GLOBE ABOVE THE LETTER I.

SER. NO. 78-964,566, FILED 8-31-2006.

PATRICIA EVANKO, EXAMINING ATTORNEY



**Int. Cls.: 35 and 42**

**Prior U.S. Cls.: 100, 101 and 102**

**United States Patent and Trademark Office**

**Reg. No. 3,395,016**

**Registered Mar. 11, 2008**

**SERVICE MARK  
PRINCIPAL REGISTER**

**THOMASNET**

THOMAS PUBLISHING COMPANY (NEW YORK CORPORATION)  
FIVE PENN PLAZA  
NEW YORK, NY 10001

FOR: PROVIDING ONLINE COMPUTER DATABASES IN THE NATURE OF A DIRECTORY OF INDUSTRIAL PRODUCTS, SERVICES, COMPANIES AND EXECUTIVES; ELECTRONIC COMMERCE SERVICES, NAMELY, PROVIDING ON-LINE ORDERING OF INDUSTRIAL PRODUCTS AND SERVICES VIA A GLOBAL COMPUTER INFORMATION NETWORK; ADVERTISING SERVICES, NAMELY, PROVIDING LISTINGS, VIDEO CATALOG, LINE CARD, BROCHURE AND FAX INFORMATION FOR MANUFACTURERS IN ON-LINE COMPUTER DATABASE IN THE NATURE OF A DIRECTORY OF INDUSTRIAL PRODUCTS AND SERVICES; COMPILATION OF DIRECTORIES FOR PUBLISHING ON THE INTERNET; PROVISION OF SPACE ON WEBSITES FOR ADVERTISING GOODS AND SERVICES; BUSINESS MARKETING AND CONSULTANCY SERVICES IN THE FIELD OF WEBSITE MARKETING; CONDUCTING BUSINESS AND MARKET RESEARCH SURVEYS; PROVIDING AN ON-LINE COMPUTER DATABASE FEATURING TRADE INFORMATION IN THE FIELD

OF COMPUTER ASSISTED DESIGN (CAD) PRODUCT AND SERVICE SUPPLIERS, AND DRAWINGS THEMSELVES; PROVIDING ONLINE INDUSTRIAL PRODUCT INFORMATION TO FACILITATE PURCHASING DECISIONS, IN CLASS 35 (U.S. CLS. 100, 101 AND 102).

FIRST USE 3-0-1997; IN COMMERCE 3-0-1997.

FOR: PROVIDING SEARCH ENGINES FOR OBTAINING DATA ON INDUSTRIAL PRODUCTS; AND CONSULTANCY SERVICES IN THE FIELD OF SEARCH ENGINE OPTIMIZATION, IN CLASS 42 (U.S. CLS. 100 AND 101).

FIRST USE 3-0-1997; IN COMMERCE 3-0-1997.

THE MARK CONSISTS OF STANDARD CHARACTERS WITHOUT CLAIM TO ANY PARTICULAR FONT, STYLE, SIZE, OR COLOR.

OWNER OF U.S. REG. NO. 2,232,798.

SER. NO. 78-966,990, FILED 9-5-2006.

MELVIN AXILBUND, EXAMINING ATTORNEY

**Int. Cl.: 6**

**Prior U.S. Cls.: 2, 12, 13, 14, 23, 25 and 50**

**United States Patent and Trademark Office**

**Reg. No. 3,395,017**

**Registered Mar. 11, 2008**

**TRADEMARK  
PRINCIPAL REGISTER**

**TANTALINE**

DANFOSS A/S (DENMARK CORPORATION)  
NORDBORGVEJ 81  
NORDBORG, DENMARK DK-6430

FOR: COMMON METALS AND THEIR ALLOYS, NAMELY, TANTALUM; GOODS OF COMMON METAL AND THEIR ALLOYS NOT INCLUDED IN OTHER CLASSES, NAMELY, HOSE FITTINGS, JOINERY FITTINGS, FASTENERS, NAMELY, BOLTS, NUTS, NAILS, RIVETS AND SCREWS, MANUALLY-OPERATED VALVES OF METAL OTHER THAN PARTS OF MACHINERY, AND TUBES OF METAL, IN CLASS 6 (U.S. CLS. 2, 12, 13, 14, 23, 25 AND 50).

THE MARK CONSISTS OF STANDARD CHARACTERS WITHOUT CLAIM TO ANY PARTICULAR FONT, STYLE, SIZE, OR COLOR.

PRIORITY CLAIMED UNDER SEC. 44(D) ON ERPN CMNTY TM OFC APPLICATION NO. 004946067, FILED 3-8-2006, REG. NO. 004946067, DATED 5-31-2007, EXPIRES 3-8-2016.

SER. NO. 78-968,834, FILED 9-7-2006.

AMY HELLA, EXAMINING ATTORNEY

**Int. Cl.: 17**

**Prior U.S. Cls.: 1, 5, 12, 13, 35 and 50**

**United States Patent and Trademark Office**

**Reg. No. 3,395,018**

**Registered Mar. 11, 2008**

**TRADEMARK  
PRINCIPAL REGISTER**

**ALTAFLUOR**

ALTAFLUO LLC (NEW JERSEY LTD LIAB CO)  
UNIT 9  
10 MILLPOND DRIVE  
LAFAYETTE, NJ 07848

FOR: PLASTIC FLUOROPOLYMER TUBING  
AND PIPES FOR INDUSTRIAL AND COMMERCIAL  
USES, IN CLASS 17 (U.S. CLS. 1, 5, 12, 13, 35  
AND 50).

FIRST USE 6-1-2006; IN COMMERCE 8-1-2006.

THE MARK CONSISTS OF STANDARD CHARACTERS  
WITHOUT CLAIM TO ANY PARTICULAR FONT,  
STYLE, SIZE, OR COLOR.

SER. NO. 78-968,917, FILED 9-7-2006.

RICHARD A. STRASER, EXAMINING ATTORNEY

**Int. Cl.: 29**

**Prior U.S. Cl.: 46**

**United States Patent and Trademark Office**

**Reg. No. 3,395,019**

**Registered Mar. 11, 2008**

**TRADEMARK  
PRINCIPAL REGISTER**



CARIBBEAN PRODUCE INC. (NEW YORK CORPORATION)  
26 BRONX TERMINAL MARKET  
BRONX, NY 10451

NO CLAIM IS MADE TO THE EXCLUSIVE RIGHT TO USE "FAMOUS BRAND", APART FROM THE MARK AS SHOWN.

FOR: CONDENSED MILK AND EVAPORATED MILK, IN CLASS 29 (U.S. CL. 46).

SER. NO. 78-969,009, FILED 9-7-2006.

FIRST USE 2-1-1989; IN COMMERCE 2-1-1989.

PATRICIA EVANKO, EXAMINING ATTORNEY

**Int. Cl.: 35**

**Prior U.S. Cls.: 100, 101 and 102**

**United States Patent and Trademark Office**

**Reg. No. 3,395,020**

**Registered Mar. 11, 2008**

**SERVICE MARK  
PRINCIPAL REGISTER**

**TEACH CHINA**

BUNAC TRAVEL SERVICES LIMITED (UNITED KINGDOM CORPORATION)  
16 BOWLING GREEN LANE  
LONDON, UNITED KINGDOM EC1R 0QH

FOR: ADMINISTRATION OF TEMPORARY EMPLOYMENT PROGRAMMES; RECRUITMENT SERVICES, NAMELY, EMPLOYMENT RECRUITMENT; PROVIDING WORK EXPERIENCE IN ENVIRONMENTAL, TOURISM, EDUCATION AND SOCIAL WELFARE PROJECTS, ALL IN CHINA; PROVIDING WORK EXPERIENCE IN DEVELOPMENT PROJECTS, IN INDUSTRY OR IN EDUCATIONAL ESTABLISHMENTS, ALL IN CHINA; INFORMATION AND ADVISORY SERVICES RELATING TO ALL THE AFORESAID SERVICES INCLUDING BUT NOT LIMITED TO SUCH SERVICES BEING PRO-

VIDED ON-LINE OR VIA THE INTERNET, IN CLASS 35 (U.S. CLS. 100, 101 AND 102).

THE MARK CONSISTS OF STANDARD CHARACTERS WITHOUT CLAIM TO ANY PARTICULAR FONT, STYLE, SIZE, OR COLOR.

PRIORITY CLAIMED UNDER SEC. 44(D) ON UNITED KINGDOM APPLICATION NO. 2422090, FILED 5-15-2006, REG. NO. 2422090, DATED 11-10-2006, EXPIRES 5-15-2016.

SER. NO. 78-969,238, FILED 9-7-2006.

MATTHEW EINSTEIN, EXAMINING ATTORNEY

**Int. Cl.: 9**

**Prior U.S. Cls.: 21, 23, 26, 36 and 38**

**United States Patent and Trademark Office**

**Reg. No. 3,395,021**

**Registered Mar. 11, 2008**

**TRADEMARK  
PRINCIPAL REGISTER**

# Jimmybox

JAMES O'DONNELL (UNITED STATES INDIVIDUAL)  
2ND FL  
144 OLD POST ROAD  
FAIRFIELD, CT 06824

FOR: CARRIER ATTACHMENT THAT ATTACHES TO VIDEO CAMERAS FOR CARRYING WIRELESS AUDIO RECEIVERS, DIRECT TO EDIT UNITS, OUTBOARD HARD DRIVE UNITS AND VIDEO TRANSMITTER UNITS, IN CLASS 9 (U.S. CLS. 21, 23, 26, 36 AND 38).

FIRST USE 3-25-2004; IN COMMERCE 3-25-2004.

THE MARK CONSISTS OF STANDARD CHARACTERS WITHOUT CLAIM TO ANY PARTICULAR FONT, STYLE, SIZE, OR COLOR.

SER. NO. 78-971,244, FILED 9-11-2006.

EDWARD NELSON, EXAMINING ATTORNEY

**Int. Cls.: 9, 16, 20, 28 and 41**

**Prior U.S. Cls.: 2, 5, 13, 21, 22, 23, 25, 26, 29, 32, 36, 37, 38, 50, 100, 101 and 107**

**Reg. No. 3,395,022**

**United States Patent and Trademark Office**

**Registered Mar. 11, 2008**

**TRADEMARK  
SERVICE MARK  
PRINCIPAL REGISTER**

**CHILDREN OF HURIN**

THE J.R.R. TOLKIEN ESTATE LIMITED (UNITED KINGDOM LIMITED COMPANY)  
OXFORD BUSINESS PARK C/O MANCHES LLP  
9400 GARSINGTON ROAD  
OXFORD, UNITED KINGDOM OX4 2HN

FOR: COMPUTER GAME, ELECTRONIC GAME AND VIDEO GAME SOFTWARE, PROGRAMS, CARTRIDGES, DISCS AND TAPES; PRE-RECORDED AUDIO AND VIDEO TAPES, COMPACT DISCS, VINYL RECORDS, CD-ROMS, DVDS, LASER DISCS, MINI DISCS AND CASSETTE TAPES, ALL FEATURING MUSIC, THEATRICAL PERFORMANCES, DRAMATIC PERFORMANCES, MUSICAL SOUND RECORDINGS, SPOKEN WORD SOUND RECORDINGS, IMAGES IN THE FIELD OF LITERATURE AND ACCOMPANYING TEXT; DOWNLOADABLE MUSICAL AND SPOKEN WORD SOUND RECORDINGS; DOWNLOADABLE VIDEO RECORDINGS FEATURING MUSIC, THEATRICAL PERFORMANCES, DRAMATIC PERFORMANCES, IMAGES IN THE FIELD OF LITERATURE AND ACCOMPANYING TEXT; COMPUTER SOFTWARE FOR ENTERTAINMENT, EDUCATION AND PUBLISHING, NAMELY, FOR ORGANIZING AND VIEWING IMAGES, CREATING A SEARCHABLE DATABASE, AND INTEGRATING IMAGES AND TEXT IN A MULTIMEDIA FORMAT; MAGNETS; REFRIGERATOR MAGNETS; MOUSE PADS; ELECTRONIC PUBLICATIONS, NAMELY, BOOKS, MAGAZINES, NEWSPAPERS AND NEWSLETTERS IN THE FIELD OF LITERATURE RECORDED ON ELECTRONIC MEDIA; DOWNLOADABLE ELECTRONIC PUBLICATIONS, NAMELY, BOOKS, MAGAZINES, NEWSPAPERS AND NEWSLETTERS IN THE FIELD OF LITERATURE, IN CLASS 9 (U.S. CLS. 21, 23, 26, 36 AND 38).

FOR: PRINTED PUBLICATIONS, NAMELY, BOOKS, MAGAZINES, NEWSPAPERS AND NEWS-

LETTERS IN THE FIELD OF LITERATURE; SOUVENIR PROGRAMS CONCERNING DRAMATIC PERFORMANCES, MUSICAL PERFORMANCES, LITERATURE AND THEATRICAL PRODUCTIONS; BOOKMARKS; BOOKPLATES; ADVERTISING SIGNS OF PAPER AND CARDBOARD; PHOTOGRAPHS, ART PRINTS, ART ILLUSTRATIONS, POSTERS AND MAPS; POSTCARDS; GREETING CARDS; CHRISTMAS CARDS; STATIONERY, NAMELY, NOTE PAPER AND ENVELOPES; PAPER WEIGHTS; DESK ACCESSORIES, NAMELY, DESK PADS, PENCIL HOLDERS, PEN SETS COMPRISING PENS AND PEN INK REFILLS, LETTER OPENERS, LETTER RACKS, BOOKENDS AND STATIONERY FILE AND LETTER TRAYS; DIARIES; ALMANACS; ARTISTS' MATERIAL, NAMELY, CANVAS FOR PAINTING, PAINT BRUSHES, PENS, PENCILS, DRAWING PADS AND PAINTING SETS; EDUCATIONAL, INSTRUCTIONAL AND TEACHING MATERIALS, NAMELY, BOOKS AND PRINTED INSTRUCTIONAL MATERIALS IN THE FIELD OF LITERATURE, IN CLASS 16 (U.S. CLS. 2, 5, 22, 23, 29, 37, 38 AND 50).

FOR: PLASTIC AND PLASTER FIGURINES, IN CLASS 20 (U.S. CLS. 2, 13, 22, 25, 32 AND 50).

FOR: TOYS, GAMES AND PLAYTHINGS, NAMELY, BOARD GAMES, PLAYING CARDS, CHESS SETS, CHESS BOARDS, PLUSH TOYS AND ACCESSORIES THEREFOR, PUPPETS, TOY ACTION FIGURES AND ACCESSORIES THEREFOR, PUZZLES; DOLLS AND DOLL ACCESSORIES; ELECTRONIC TOYS, NAMELY, HAND HELD UNITS FOR PLAYING ELECTRONIC GAMES; COMPUTER GAMES NOT INCLUDED IN ANY OTHER CLASSES, NAMELY, BATTERY-POWERED COMPUTER GAMES WITH LCD SCREENS FEATURING ANIMATION AND SOUND EFFECTS; CHRISTMAS TREE DEC-

ORATIONS; CHRISTMAS-RELATED TOYS, GAMES, PLAYTHINGS, DECORATIONS AND NOVELTY ITEMS, NAMELY, ARTIFICIAL CHRISTMAS GARLANDS, ARTIFICIAL CHRISTMAS TREES, CHRISTMAS STOCKINGS, CHRISTMAS TREE ORNAMENTS, CHRISTMAS TREE SKIRTS, CHRISTMAS TREE STANDS, CHRISTMAS TREE STAND COVERS, TINSEL FOR DECORATING CHRISTMAS TREES AND TOY CHRISTMAS TREES, IN CLASS 28 (U.S. CLS. 22, 23, 38 AND 50).

FOR: PRODUCTION, PRESENTATION AND DISTRIBUTION OF TELEVISION PROGRAMS, RADIO PROGRAMS AND MOTION PICTURES; PRODUCTION AND RECORDING OF AUDIO RECORDINGS, VIDEOTAPES AND VIDEODISCS; ENTERTAINMENT IN THE NATURE OF THEATER PRODUCTIONS; LIVE MUSICAL PERFORMANCES IN THE NATURE OF MUSICAL CONCERTS; PUBLICATION OF BOOKS, MAGAZINES, NEWSLETTERS AND JOURNALS IN THE FIELD OF LITERATURE; PROVIDING ENTERTAINMENT INFORMATION IN THE FIELDS OF MUSIC AND

LITERATURE BY MEANS OF A GLOBAL COMPUTER NETWORK; ENTERTAINMENT SERVICES, NAMELY, PROVIDING A WEB SITE FEATURING ONLINE NON-DOWNLOADABLE PRERECORDED VIDEO RECORDINGS AND MUSICAL AND SPOKEN WORD SOUND RECORDINGS; PROVIDING ONLINE COMPUTER GAMES; PROVIDING THEME PARK, AMUSEMENT PARK AND RECREATION PARK SERVICES, IN CLASS 41 (U.S. CLS. 100, 101 AND 107).

THE MARK CONSISTS OF STANDARD CHARACTERS WITHOUT CLAIM TO ANY PARTICULAR FONT, STYLE, SIZE, OR COLOR.

PRIORITY CLAIMED UNDER SEC. 44(D) ON ERPN CMNTY TM OFC APPLICATION NO. 005313861, FILED 9-14-2006, REG. NO. 005313861, DATED 7-4-2007, EXPIRES 9-14-2016.

SER. NO. 78-974,160, FILED 9-14-2006.

JAMES MACFARLANE, EXAMINING ATTORNEY



**Int. Cls.: 9 and 42**

**Prior U.S. Cls.: 21, 23, 26, 36, 38, 100 and 101**

**United States Patent and Trademark Office**

**Reg. No. 3,395,023**

**Registered Mar. 11, 2008**

**TRADEMARK  
SERVICE MARK  
PRINCIPAL REGISTER**

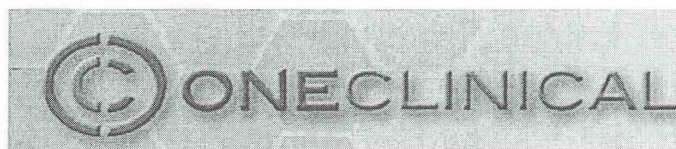

TAKE SOLUTIONS, INC. (NEW JERSEY CORPORATION)  
SUITE 3500  
600 COLLEGE ROAD EAST  
PRINCETON, NJ 08540

FOR: SOFTWARE TO BE USED IN THE FIELDS OF DRUG DEVELOPMENT AND DRUG TESTING, IN CLASS 9 (U.S. CLS. 21, 23, 26, 36 AND 38).

FIRST USE 7-31-2005; IN COMMERCE 7-31-2005.

FOR: CONSULTING SERVICES IN THE FIELD OF DESIGN, SELECTION, IMPLEMENTATION AND USE OF COMPUTER HARDWARE AND SOFTWARE FOR DRUG DEVELOPMENT AND TESTING, IN CLASS 42 (U.S. CLS. 100 AND 101).

FIRST USE 7-31-2005; IN COMMERCE 7-31-2005.

THE COLOR(S) GREEN AND BLUE IS/ARE CLAIMED AS A FEATURE OF THE MARK.

THE MARK CONSISTS OF A BROKEN CIRCLE OF BLUE WITH A GREEN BROKEN "C" AND THE WORDS "ONE" IN BLUE JOINED WITH THE WORD "CLINICAL" IN GREEN.

SER. NO. 78-974,596, FILED 9-14-2006.

INGA ERVIN, EXAMINING ATTORNEY

**Int. Cl.: 9**

**Prior U.S. Cls.: 21, 23, 26, 36 and 38**

**Reg. No. 3,395,024**

**United States Patent and Trademark Office**

**Registered Mar. 11, 2008**

**TRADEMARK  
PRINCIPAL REGISTER**



NETGUARD CORPORATION (NORTH CAROLINA CORPORATION)  
401 ROUTE 202N  
RARITAN, NJ 08869

FIRST USE 9-14-2006; IN COMMERCE 9-14-2006.

FOR: COMPUTER HARDWARE, NAMELY, A REPLACEMENT ETHERNET CABLE THAT IS REMOTELY CONTROLLED TO CONNECT AND DISCONNECT AN INTERNET CONNECTION TO THE COMPUTER TO WHICH IT IS ATTACHED, IN CLASS 9 (U.S. CLS. 21, 23, 26, 36 AND 38).

NO CLAIM IS MADE TO THE EXCLUSIVE RIGHT TO USE "NETGUARD", APART FROM THE MARK AS SHOWN.

SER. NO. 78-974,759, FILED 9-14-2006.

SUSAN LESLIE DUBOIS, EXAMINING ATTORNEY

**Int. Cl.: 9**

**Prior U.S. Cls.: 21, 23, 26, 36 and 38**

**Reg. No. 3,395,025**

**United States Patent and Trademark Office**

**Registered Mar. 11, 2008**

**TRADEMARK  
PRINCIPAL REGISTER**

**ZANGO**

ZANGO TECHNOLOGIES LLC (NEVADA LTD  
LIAB CO)  
3600 136TH PLACE SE  
BELLEVUE, WA 98006

FOR: COMPUTER SOFTWARE FOR PROVIDING ACCESS TO AND DOWNLOADS OF DATA, VIDEOS, GAMES, PICTURES, SCREENSAVERS, THIRD-PARTY WEB SITES, AND ONLINE INFORMATION IN THE FIELD OF GENERAL INTEREST OVER A COMPUTER NETWORK; COMPUTER SOFTWARE TO IDENTIFY AND EXECUTE KEYWORD, BANNER, OPTIMIZATION, AND OTHER INTERNET SEARCH ADVERTISING PLACEMENT AND EXECUTION; COMPUTER SOFTWARE TO TRACK, LOG AND ANALYZE INTERNET USAGE HABITS, INTERNET SEARCHING HABITS, AND CUSTOMER LOYALTY; COMPUTER SOFTWARE FOR COMPILING, ANALYZING, STORING, SORTING, ORGANIZING AND DISTRIBUTING DEMOGRAPHIC, LIFESTYLE AND BEHAVIORAL DATA AND INFORMATION; COMPUTER SOFTWARE FOR GENERATING MARKET RESEARCH DATA, REPORTS AND ANALYSES, AND OTHER INFORMATION FOR MARKETING AND ADVERTISING PURPOSES; COMPUTER SOFTWARE TO FACILITATE COMPARISON SHOPPING VIA THE INTERNET; COMPUTER SOFTWARE FOR SEARCHING, COMPILING, INDEXING AND ORGANIZING INFORMATION ON THE INTERNET; COMPUTER SOFTWARE FOR CREATING INDEXES OF INFORMATION, INDEXES OF WEB SITES AND INDEXES OF OTHER INFORMATION RESOURCES; COMPUTER SOFTWARE FOR CREATING SEARCHABLE DATABASES OF INFORMATION AND DATA; COMPUTER SOFTWARE, NAMELY, ONLINE

DOWNLOADABLE COMPUTER GAMES; ONLINE DOWNLOADABLE COMPUTER VIDEO GAMES SOFTWARE; DOWNLOADABLE RING TONES, GRAPHICS AND MUSIC VIA A GLOBAL COMPUTER NETWORK AND WIRELESS DEVICES; DOWNLOADABLE COMPUTER SCREEN SAVERS; DOWNLOADABLE FILMS AND VIDEO PROGRAMS VIA THE INTERNET; DOWNLOADABLE AUDIO AND VIDEO RECORDINGS FEATURING MUSIC AND ENTERTAINMENT, NAMELY, MUSICAL PERFORMANCES, MUSICAL VIDEOS, FILM CLIPS, PHOTOGRAPHS AND OTHER MULTIMEDIA MATERIALS; DOWNLOADABLE SOFTWARE FOR INSTANT MESSAGING AND ELECTRONIC MAIL SERVICES; DOWNLOADABLE SOFTWARE FOR INSTANT MESSAGING AND ELECTRONIC MAIL SERVICES; DOWNLOADABLE COMPUTER SOFTWARE FOR MASTERING AND RECORDING CDS AND DVDS; DOWNLOADABLE COMPUTER SOFTWARE FOR WEATHER UPDATES AND ASTROLOGY READINGS, IN CLASS 9 (U.S. CLS. 21, 23, 26, 36 AND 38).

FIRST USE 3-30-2004; IN COMMERCE 3-30-2004.

THE MARK CONSISTS OF STANDARD CHARACTERS WITHOUT CLAIM TO ANY PARTICULAR FONT, STYLE, SIZE, OR COLOR.

OWNER OF U.S. REG. NO. 3,069,080.

SER. NO. 78-974,940, FILED 9-14-2006.

AISHA SALEM, EXAMINING ATTORNEY

**Int. Cl.: 41**

**Prior U.S. Cls.: 100, 101 and 107**

**United States Patent and Trademark Office**

**Reg. No. 3,395,026**

**Registered Mar. 11, 2008**

**SERVICE MARK  
PRINCIPAL REGISTER**

**ZANGO**

ZANGO TECHNOLOGIES LLC (NEVADA LTD  
LIAB CO)  
3600 136TH PLACE SE  
BELLEVUE, WA 98006

FOR: ENTERTAINMENT SERVICES, NAMELY, PROVIDING ON-LINE COMPUTER GAMES, PRE-RECORDED VIDEOS, PICTURES, AND PRE-RECORDED ONLINE MUSIC; ENTERTAINMENT SERVICES, NAMELY, A WEB SITE WHERE USERS CREATE AND DOWNLOAD MUSIC VIDEOS AND ONLINE CONTENT, NAMELY, MUSICAL VIDEOS, FILM CLIPS, PHOTOGRAPHS AND OTHER MULTIMEDIA MATERIALS, AND ACCESS AND VIEW A WIDE RANGE OF ONLINE TELEVISION, NEWS, VIDEO, AND MUSIC PROGRAMMING; ENTERTAINMENT SERVICES, NAMELY, PROVIDING ON-LINE REVIEWS OF MOVIES, BOOKS, MUSIC, AND COMPUTER GAMES; ONLINE PUBLISHING AND PUBLISHING INFORMATION SERVICES; ON-

LINE JOURNALS, NAMELY, BLOGS FEATURING NEWS, EDITORIALS, AND OPINIONS CONCERNING CURRENT EVENTS, INTERNET POLICY, AND ENTERTAINMENT; PROVIDING INFORMATION IN THE FIELD OF GENERAL INTEREST FROM SEARCHABLE INDEXES AND DATABASES OF INFORMATION, NAMELY GAMES, VIDEOS, MUSIC AND PICTURES, BY MEANS OF THE INTERNET, IN CLASS 41 (U.S. CLS. 100, 101 AND 107).

FIRST USE 3-30-2004; IN COMMERCE 3-30-2004.

THE MARK CONSISTS OF STANDARD CHARACTERS WITHOUT CLAIM TO ANY PARTICULAR FONT, STYLE, SIZE, OR COLOR.

SER. NO. 78-974,941, FILED 9-14-2006.

AISHA SALEM, EXAMINING ATTORNEY

**Int. Cl.: 3**

**Prior U.S. Cls.: 1, 4, 6, 50, 51 and 52**

**United States Patent and Trademark Office**

**Reg. No. 3,395,027**

**Registered Mar. 11, 2008**

**TRADEMARK  
PRINCIPAL REGISTER**

**BUDDHA-BAR**

GEORGE V RESTAURATION (FRANCE SOCI-  
ETE ANONYME)  
4 AVENUE DE L'OPERA  
PARIS, FRANCE 75001

PRIORITY CLAIMED UNDER SEC. 44(D) ON  
FRANCE APPLICATION NO. 023145430, FILED 2-4-  
2002.

FOR: PERFUMERY, COSMETICS, SOAPS, ESSEN-  
TIAL OILS, HAIR LOTIONS, DENTRIFICES, IN  
CLASS 3 (U.S. CLS. 1, 4, 6, 50, 51 AND 52).

OWNER OF U.S. REG. NOS. 2,439,577, 2,496,729,  
AND 2,552,052.

FIRST USE 6-15-2007; IN COMMERCE 6-15-2007.

SER. NO. 78-975,046, FILED 7-16-2002.

PRIORITY CLAIMED UNDER SEC. 44(D) ON  
FRANCE APPLICATION NO. 023153923, FILED 3-  
15-2002.

CIMMERIAN COLEMAN, EXAMINING ATTOR-  
NEY

**Int. Cl.: 41**

**Prior U.S. Cls.: 100, 101 and 107**

**United States Patent and Trademark Office**

**Reg. No. 3,395,028**

**Registered Mar. 11, 2008**

**SERVICE MARK  
PRINCIPAL REGISTER**



BUMBLE AND BUMBLE LLC (NEW YORK LTD  
LIAB CO)  
146 EAST 56TH STREET  
NEW YORK, NY 10022

OWNER OF U.S. REG. NOS. 2,613,019 AND  
2,786,551.

FOR: EDUCATIONAL SERVICES, NAMELY,  
SEMINARS, CLASSES AND WORKSHOPS FOR  
TEACHING HAIR COLORING AND HAIR STY-  
LING TECHNIQUES TO OTHERS, IN CLASS 41 (U.S.  
CLS. 100, 101 AND 107).

THE MARK CONSISTS OF THE LETTERS BB  
WITH A PERIOD IN A STYLIZED FORM.

SER. NO. 78-979,360, FILED 9-30-2005.

FIRST USE 1-31-1992; IN COMMERCE 1-31-1992.

ADA HAN, EXAMINING ATTORNEY

Int. Cls.: 25, 41 and 43

Prior U.S. Cls.: 22, 39, 100, 101 and 107

United States Patent and Trademark Office

Reg. No. 3,395,029

Registered Mar. 11, 2008

TRADEMARK  
SERVICE MARK  
PRINCIPAL REGISTER



ROADBLOCK BAR, INC. (NEW YORK CORPORATION)  
3232 RAILROAD AVENUE  
WANTAGH, NY 11793

FOR: T-SHIRTS, SWEATSHIRTS, POLO SHIRTS, SPORT SHIRTS, JACKETS, JERSEYS, SWEATERS, HATS, CAPS, BELTS, SUN VISORS, TANK TOPS, BATHROBES, DRESSES, SOCKS, SHORTS, PANTS, NIGHTSHIRTS, BANDANNAS, BOXER SHORTS, BATHING SUITS, FOOTWEAR, PULLOVERS, IN CLASS 25 (U.S. CLS. 22 AND 39).

FIRST USE 6-1-2001; IN COMMERCE 6-1-2001.

FOR: ENTERTAINMENT SERVICES, NAMELY SERVICES IN THE NATURE OF A NIGHT CLUB AND DANCE CLUB, LIVE PERFORMANCES BY MUSICAL BANDS, SINGERS AND MUSICIANS, LIVE MUSIC CONCERTS, LIVE APPEARANCES BY PROFESSIONAL ENTERTAINERS, AND LIVE

SPORTING EVENTS, IN CLASS 41 (U.S. CLS. 100, 101 AND 107).

FIRST USE 6-1-2001; IN COMMERCE 6-1-2001.

FOR: BAR, PUB, LOUNGE, CAFE AND RESTAURANT SERVICES, IN CLASS 43 (U.S. CLS. 100 AND 101).

FIRST USE 6-1-2001; IN COMMERCE 6-1-2001.

NO CLAIM IS MADE TO THE EXCLUSIVE RIGHT TO USE "PUB & MUSIC HALL" AND "WANTAGH, NY", APART FROM THE MARK AS SHOWN.

SER. NO. 78-979,697, FILED 7-10-2006.

JENNIFER VASQUEZ, EXAMINING ATTORNEY

**Int. Cl.: 3**

**Prior U.S. Cls.: 1, 4, 6, 50, 51 and 52**

**United States Patent and Trademark Office**

**Reg. No. 3,395,030**

**Registered Mar. 11, 2008**

**TRADEMARK  
PRINCIPAL REGISTER**

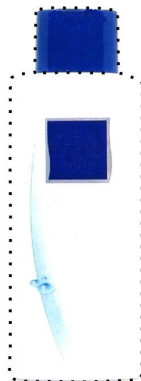

BEIERSDORF AG (FED REP GERMANY JOINT  
STOCK COMPANY)

UNNASTRASSE 48

20253 HAMBURG, FED REP GERMANY

FOR: BODY AND BEAUTY CARE PREPARA-  
TIONS, IN CLASS 3 (U.S. CLS. 1, 4, 6, 50, 51 AND 52).

PRIORITY DATE OF 1-28-2005 IS CLAIMED.

OWNER OF INTERNATIONAL REGISTRATION  
0848676 DATED 4-8-2005, EXPIRES 4-8-2015.

THE COLOR(S) WHITE, BLUE, LIGHT BLUE,  
SILVER IS/ARE CLAIMED AS A FEATURE OF  
THE MARK.

THE MARK CONSISTS OF THE COLOR BLUE  
APPLIED TO THE CAP OF THE CONTAINER OF  
THE GOODS, A WHITE BACKGROUND APPLIED  
TO THE REST OF THE CONTAINER, A BLUE  
RECTANGLE WITH A SILVER BORDER DIS-  
PLAYED AGAINST THE WHITE BACKGROUND,  
A LIGHT BLUE CURVING BAND, BROADENING  
FROM TOP TO BOTTOM, EXTENDING FROM THE  
TOP LEFT CORNER OF THE BLUE RECTANGLE  
TO THE BOTTOM PORTION OF THE WHITE BACK-  
GROUND, AND THREE LIGHT BLUE DROPLETS  
ON THE LEFT SIDE OF THE WHITE BACK-  
GROUND. THE DOTTED LINES OUTLINING THE  
CONTAINER AND ITS LID ARE NOT CLAIMED AS  
PART OF THE MARK, BUT RATHER SERVE ONLY  
TO SHOW THE POSITION OF THE MARK.

SER. NO. 79-010,587, FILED 4-8-2005.

LA TONIA FISHER, EXAMINING ATTORNEY



**Int. Cl.: 14**

**Prior U.S. Cls.: 2, 27, 28 and 50**

**United States Patent and Trademark Office**

**Reg. No. 3,395,031**

**Registered Mar. 11, 2008**

**TRADEMARK  
PRINCIPAL REGISTER**

**TCF**

SWAROVSKI AKTIENGESELLSCHAFT (LIECH-  
TENSTEIN JOINT STOCK COMPANY)  
DRÖSCHSTRASSE 15  
FL-9495 TRIESEN  
LIECHTENSTEIN

FOR: NATURAL AND SYNTHETIC PRECIOUS  
STONES OF ALL TYPES AND FOR EVERY PUR-  
POSE; GEM STONES, JEWELRY, JEWELRY ORNA-  
MENTS OF PRECIOUS METAL; SMALL JEWELRY  
OBJECTS OF GLASS, PLASTIC OR NON-PRECIOUS  
METALS FOR PERSONAL USE, NAMELY UN-  
WROUGHT AND SEMI-WROUGHT PRECIOUS  
STONES AND THEIR IMITATIONS; ALL EXCLU-  
SIVE OF USE IN THE BANKING FIELD AND THE  
SPORTS STADIUM FIELD, IN CLASS 14 (U.S. CLS. 2,  
27, 28 AND 50).

THE MARK CONSISTS OF STANDARD CHAR-  
ACTERS WITHOUT CLAIM TO ANY PARTICULAR  
FONT, STYLE, SIZE, OR COLOR.

PRIORITY DATE OF 1-17-2005 IS CLAIMED.

OWNER OF INTERNATIONAL REGISTRATION  
0857569 DATED 5-24-2005, EXPIRES 5-24-2015.

SER. NO. 79-013,697, FILED 5-24-2005.

KRISTIN DAHLING, EXAMINING ATTORNEY

**Int. Cl.: 42**

**Prior U.S. Cls.: 100 and 101**

**United States Patent and Trademark Office**

**Reg. No. 3,395,032**

**Registered Mar. 11, 2008**

**SERVICE MARK  
PRINCIPAL REGISTER**

**GOBOOKINGS**

GOBOOKINGS INTERNATIONAL PTY LTD ACN  
093 758 242 (AUSTRALIA COMPANY)  
LEVEL 1  
135A QUEEN STREET  
CLEVELAND, AUSTRALIA QLD 4163

FOR: PROVIDING TEMPORARY USE OF ON-  
LINE INTERACTIVE, NON-DOWNLOADABLE  
SOFTWARE, FOR USE IN AUTOMATED SCHE-  
DULING AND BOOKINGS OF APPOINTMENTS  
AND RESOURCES FOR USE BY INDIVIDUALS  
OR BUSINESSES, IN CLASS 42 (U.S. CLS. 100 AND  
101).

THE MARK CONSISTS OF STANDARD CHAR-  
ACTERS WITHOUT CLAIM TO ANY PARTICULAR  
FONT, STYLE, SIZE, OR COLOR.

OWNER OF INTERNATIONAL REGISTRATION  
0858465 DATED 6-14-2005, EXPIRES 6-14-2015.

SER. NO. 79-014,075, FILED 6-14-2005.

DAVID HOFFMAN, EXAMINING ATTORNEY

**Int. Cl.: 36**

**Prior U.S. Cls.: 100, 101 and 102**

**United States Patent and Trademark Office**

**Reg. No. 3,395,033**

**Registered Mar. 11, 2008**

**SERVICE MARK  
PRINCIPAL REGISTER**

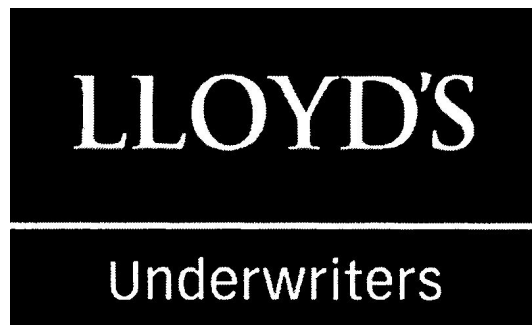

LLOYD'S, A BODY INCORPORATED BY THE LLOYD'S ACT 1871 (UNITED KINGDOM A BODY INCORPORATED BY THE LLOYD'S ACT 1871, UNITED KINGDOM)  
ONE LIME STREET  
LONDON, UNITED KINGDOM EC3M 7HA

FOR: INSURANCE SERVICES, NAMELY, INSURANCE ADMINISTRATION; INSURANCE UNDERWRITING SERVICES FOR ALL TYPES OF INSURANCE; LIFE, CASUALTY, ACCIDENT, HEALTH, PROPERTY AND MARINE INSURANCE UNDERWRITING SERVICES AND REINSURANCE UNDERWRITING SERVICES, LIFE GUARANTEE ASSURANCE UNDERWRITING SERVICES, ASSESSING AND PROCESSING INSURANCE CLAIMS; INSURANCE BROKERAGE SERVICES; ELECTRONIC TRANSFER OF FUNDS; ADVISORY AND INFORMATION SERVICES, NAMELY, PROVIDING ADVICE AND INFORMATION TO OTHERS CONCERNING INSURANCE MARKETS, INSURANCE

BROKERAGE, AND ASSURANCE AND INSURANCE BROKERAGE INVESTMENT; ALL THE AFORESAID SERVICES ALSO PROVIDED ON-LINE FROM A COMPUTER DATABASE OR THE INTERNET, IN CLASS 36 (U.S. CLS. 100, 101 AND 102).

OWNER OF INTERNATIONAL REGISTRATION 0860684 DATED 7-5-2005, EXPIRES 7-5-2015.

OWNER OF U.S. REG. NOS. 1,116,464, 2,921,863 AND OTHERS.

NO CLAIM IS MADE TO THE EXCLUSIVE RIGHT TO USE "UNDERWRITERS", APART FROM THE MARK AS SHOWN.

SER. NO. 79-014,827, FILED 7-5-2005.

WILLIAM VERHOSEK, EXAMINING ATTORNEY

Int. Cls.: 9, 10, 12, 24 and 25

Prior U.S. Cls.: 19, 21, 22, 23, 26, 31, 35, 36, 38, 39, 42,  
44 and 50

Reg. No. 3,395,034

United States Patent and Trademark Office

Registered Mar. 11, 2008

TRADEMARK  
PRINCIPAL REGISTER

DESIGN BLUE LTD. (UNITED KINGDOM LTD  
LIAB CO)  
1ST FLOOR, MICROScape HOUSE  
HOVE PARK VILLA HOVE  
EAST SUSSEX, UNITED KINGDOM BN3 6HX

FOR: PROTECTIVE CLOTHING AGAINST ACCIDENTS; CLOTHING, NAMELY, PROTECTIVE CLOTHING FOR PROTECTION AGAINST INJURY OR ACCIDENT; FOOTWEAR FOR PROTECTION AGAINST INJURY OR ACCIDENT; SAFETY AND PROTECTIVE HEADGEAR FOR PROTECTION AGAINST INJURY OR ACCIDENT IN SPORTS, WINTER AND SNOW SPORTS, WATERSPORTS AND SUBAQUA SPORTS, MOTORSPORTS AND MOTOCROSS, MOTORCYCLE RIDING, BICYCLE RIDING, MOUNTAINEERING, HOCKEY, SKATING, SKATEBOARDING, AND GOLFING, NAMELY, BUMPCAPS, HELMETS, HATS AND CAPS; PROTECTIVE EQUESTRIAN HATS, PROTECTIVE MILITARY AND NAVAL HEADGEAR, NAMELY, HELMETS, HATS AND CAPS; ATHLETIC AND SPORTS PROTECTIVE PADS FOR BODY, LIMB AND HEAD, NAMELY FACE, SHOULDER, ELBOW, WRIST, CHEST, KNEE, SHIN; PROTECTIVE PADS FOR BODY, LIMB AND HEAD, NAMELY, FACE, SHOULDER, ELBOW, WRIST, CHEST, KNEE, SHIN FOR USE BY MILITARY, NAVAL AND POLICE AND SECURITY SERVICES, IN CLASS 9 (U.S. CLS. 21, 23, 26, 36 AND 38).

FOR: MEDICAL ARTICLES, NAMELY, MEDICAL BRACES FOR KNEE, ANKLE, ELBOW, NECK, BACK WRIST AND HANDS, PROSTHETIC LIMB

SOCKETS AND SOCKS FOR AMPUTEES, PROSTHETIC SOCKETS FOR FASTENING PROSTHETIC LIMBS TO THE BODY; MOUTH GUARDS, CHIN GUARDS AND ELBOW GUARDS FOR MEDICAL PURPOSES; SUPPORTIVE APPLIANCES, NAMELY, ABDOMINAL PADS, ARCH SUPPORTS FOR BOOTS AND SHOES, AND SUPPORTS FOR KNEE, ANKLE, ELBOW, NECK, BACK, WRIST, HANDS, AND FOR GENERAL MEDICAL USE, BANDAGES, NAMELY, BANDAGES FOR ANATOMICAL JOINTS, ELASTIC BANDAGES AND ORTHOPEDIC SUPPORT BANDAGES, CLOTHING FOR MEDICAL USE, NAMELY, ELASTIC STOCKINGS, ELASTIC HOSE SUPPORTERS, KNEE HIGH HOSE AND THIGH HIGH HOSE; ORTHOPAEDIC ARTICLES, NAMELY, ORTHOPEDIC SUPPORTS, BRACES, FOOTWEAR AND SOLES AND ORTHOTIC INSERTS FOR FOOTWEAR AND ORTHOTICS FOR THE FOOT AND HAND, IN CLASS 10 (U.S. CLS. 26, 39 AND 44).

FOR: SEATS, HEADRESTS, UPHOLSTERY, SAFETY SEATS FOR CHILDREN, ALL FOR LAND VEHICLES, VESSELS, AIRCRAFT OR SPACECRAFT; CHILD RESTRAINTS, NAMELY, CHILD RESTRAINTS FOR VEHICLE SEATS, SAFETY BELTS, NAMELY, SEAT BELTS AND SEAT SAFETY HARNESSES FOR VEHICLES, IN CLASS 12 (U.S. CLS. 19, 21, 23, 31, 35 AND 44).

FOR: TEXTILE, NAMELY, TEXTILE AND TEXTILE LAMINATE FABRIC OR SYNTHETIC LINING FABRIC FOR CLOTHING, TEXTILE GOODS, NAMELY, PRINTED TEXTILE LABELS, CLOTH,

NAMELY, LABELS OF CLOTH, FABRIC, NAMELY, BALLISTIC RESISTANT FABRICS FOR USE IN THE PRODUCTION OF BULLET PROOF AND BLAST PROOF CLOTHING, SHOES AND BULLET AND BLAST PROOF SHIELDS, FABRIC USED FOR ANTI-TRAUMA PURPOSES IN BALLISTIC RESISTANT PACK AND CLOTHING, FABRIC FOR BOOTS AND SHOES, AND WATER PROOF FABRIC FOR MANUFACTURING CLOTHING, FURNITURE, AUTOMOBILE UPHOLSTERY AND LUGGAGE; MATERIALS FOR USE IN THE MANUFACTURE OF PROTECTIVE CLOTHING, FOOTWEAR, HEADGEAR AND ARTICLES FOR WEAR, NAMELY, WOVEN ARAMID FABRICS, IMPACT-ABSORBING MATERIALS, NAMELY, TEXTILE SUBSTITUTE MADE FROM SYNTHETIC MATERIALS THAT ARE USED AS PART OF A HELMET, GLOVE, BUMP CAP, INSOLE OR SHOCK ABSORBING FOOTWEAR COMPONENTS, IN CLASS 24 (U.S. CLS. 42 AND 50).

FOR: CLOTHING, NAMELY, ANORAKS, GLOVES, FOUNDATION GARMENTS, UNDERWEAR, BRASSIERES, PANTS, SHORTS, JEANS, ARM WARMERS, KNEE WARMERS, JACKETS, COATS, RAINCOATS, JERSEYS, PULLOVERS, VESTS, SHIRTS, T-SHIRTS, TROUSERS, FOOTWEAR, NAMELY, BOOTS, SHOES, SLIPPERS,

PUMPS, SOCKS AND SANDALS, HEADGEAR, NAMELY, HATS, CAPS, BASEBALL CAPS, BATHING CAPS, BERETS, BALACLAVAS, BEANIES, ARTICLES FOR WEAR, NAMELY, FOOTBALL STUDS, GOLF CLEATS, SHOULDER PADS FOR CLOTHING, SOLES AND HEELS FOR BOOTS AND SHOES, SPORTS CLOTHING, NAMELY, GLOVES, FOUNDATION GARMENTS, UNDERWEAR, SPORTS BRASSIERES, PANTS, SHORTS, ARM WARMERS, KNEE WARMERS, JACKETS, COATS, SHIRTS, T-SHIRTS, TROUSERS, JODHPURS, JUDO, KENDO AND KARATE SUITS, MARTIAL ARTS UNIFORMS, FLIGHT SUITS, SKATING OUTFITS, SKI WEAR, SNOW BOARDING SUITS, SURF WEAR, AND RUGBY TOPS, IN CLASS 25 (U.S. CLS. 22 AND 39).

PRIORITY DATE OF 4-20-2005 IS CLAIMED.

OWNER OF INTERNATIONAL REGISTRATION 0868389 DATED 5-16-2005, EXPIRES 5-16-2015.

SER. NO. 79-017,706, FILED 5-16-2005.

MICHAEL ENGEL, EXAMINING ATTORNEY

**Int. Cls.: 1, 6, 7 and 42**

**Prior U.S. Cls.: 1, 2, 5, 6, 10, 12, 13, 14, 19, 21, 23, 25,  
26, 31, 34, 35, 46, 50, 100 and 101**

**Reg. No. 3,395,035**

**United States Patent and Trademark Office**

**Registered Mar. 11, 2008**

**TRADEMARK  
SERVICE MARK  
PRINCIPAL REGISTER**

**INTERNATIONAL MINERAL RESOURCES IMR**

IMR INTERNATIONAL MINERAL RESOURCES  
B.V. (NETHERLANDS CORPORATION)  
JAN LUIJKENSTRAAT 8 BG  
NL-1071 CM CM  
AMSTERDAM, NETHERLANDS

FOR: CHEMICALS FOR USE IN INDUSTRY;  
MINERALS FOR USE IN CHEMICAL PRODUCTS  
USED IN INDUSTRY, IN CLASS 1 (U.S. CLS. 1, 5, 6,  
10, 26 AND 46).

FOR: COMMON METALS AND THEIR ALLOYS,  
UNWROUGHT AND SEMI-WORKED, FOR FUR-  
THER MANUFACTURE, FOR USE IN STEEL, AL-  
LOYS, MAGNET, CHEMICAL AND OTHER  
GENERAL INDUSTRY; METAL ORES FOR USE  
IN INDUSTRY, NAMELY, CHROME IRON ORES,  
NICKEL ORES, COPPER ORES, COBALT ORES,  
AND IRON ORES, IN CLASS 6 (U.S. CLS. 2, 12, 13,  
14, 23, 25 AND 50).

FOR: MACHINES FOR USE IN MINING OPERA-  
TIONS, IN PARTICULAR FOR THE EXTRACTION  
AND PROCESSING OF UNDERGROUND  
WEALTH, NAMELY SHAFT SINKERS, IN CLASS 7  
(U.S. CLS. 13, 19, 21, 23, 31, 34 AND 35).

FOR: TECHNICAL CONSULTING IN THE FIELD  
OF RAW MATERIALS MINING OPERATIONS EX-  
PLORATION, IN CLASS 42 (U.S. CLS. 100 AND 101).

THE MARK CONSISTS OF STANDARD CHAR-  
ACTERS WITHOUT CLAIM TO ANY PARTICULAR  
FONT, STYLE, SIZE, OR COLOR.

PRIORITY DATE OF 9-15-2005 IS CLAIMED.

OWNER OF INTERNATIONAL REGISTRATION  
0869129 DATED 10-25-2005, EXPIRES 10-25-2015.

NO CLAIM IS MADE TO THE EXCLUSIVE  
RIGHT TO USE "INTERNATIONAL MINERAL RE-  
SOURCES", APART FROM THE MARK AS SHOWN.

SER. NO. 79-018,014, FILED 10-25-2005.

TRICIA SONNEBORN, EXAMINING ATTORNEY

Int. Cl.: 30

Prior U.S. Cl.: 46

United States Patent and Trademark Office

Reg. No. 3,395,036

Registered Mar. 11, 2008

TRADEMARK  
PRINCIPAL REGISTER

SOARO

LEE KYU II (REPUBLIC OF KOREA INDIVIDUAL)  
SANG-A APT 3 DONG 802 HO SAMSUNG-DONG  
19-4 GANGNAM-GU; SEOUL, REPUBLIC OF KOREA

FOR: FRESH GROUND RICE MEAL CONTAINING SOYA AND PERILLA FLOUR; DRIED POWDER OF RICE FLOUR, SOYA FLOUR, AND PERILLA FLOUR; RICE FLOUR CONTAINING SOYA AND PERILLA, IN CLASS 30 (U.S. CL. 46).

THE MARK CONSISTS OF STANDARD CHARACTERS WITHOUT CLAIM TO ANY PARTICULAR FONT, STYLE, SIZE, OR COLOR.

PRIORITY DATE OF 5-24-2004 IS CLAIMED.

OWNER OF INTERNATIONAL REGISTRATION  
0871438 DATED 11-20-2004, EXPIRES 11-20-2014.

SER. NO. 79-018,926, FILED 11-20-2004.

JIM RINGLE, EXAMINING ATTORNEY

**Int. Cls.: 36 and 38**

**Prior U.S. Cls.: 100, 101, 102 and 104**

**United States Patent and Trademark Office**

**Reg. No. 3,395,037**

**Registered Mar. 11, 2008**

**SERVICE MARK  
PRINCIPAL REGISTER**

# Key2Roam

TOGEWA HOLDING AG (SWITZERLAND CORPORATION)  
NUSSBAUMSTRASSE 25  
CH-3000 BERN 22  
SWITZERLAND

FOR: FINANCIAL CLEARING HOUSE SERVICES EXCLUSIVELY IN THE FIELD OF BILLING TRANSACTIONS FOR MOBILE TELECOMMUNICATIONS; DEBIT CARD BILLING SERVICES EXCLUSIVELY IN THE FIELD OF MOBILE TELECOMMUNICATIONS; CREDIT CARD BILLING SERVICES EXCLUSIVELY IN THE FIELD OF MOBILE TELECOMMUNICATIONS, IN CLASS 36 (U.S. CLS. 100, 101 AND 102).

FOR: PROVIDING INFORMATION IN THE FIELD OF MOBILE TELECOMMUNICATIONS, IN CLASS 38 (U.S. CLS. 100, 101 AND 104).

THE MARK CONSISTS OF STANDARD CHARACTERS WITHOUT CLAIM TO ANY PARTICULAR FONT, STYLE, SIZE, OR COLOR.

PRIORITY DATE OF 8-26-2005 IS CLAIMED.

OWNER OF INTERNATIONAL REGISTRATION 0874626 DATED 12-23-2005, EXPIRES 12-23-2015.

SER. NO. 79-020,081, FILED 12-23-2005.

CHRISTOPHER BUONGIORNO, EXAMINING ATTORNEY



**Int. Cls.: 9, 38, 41 and 42**

**Prior U.S. Cls.: 21, 23, 26, 36, 38, 100, 101, 104 and 107**

**Reg. No. 3,395,038**

**United States Patent and Trademark Office**

**Registered Mar. 11, 2008**

**TRADEMARK  
SERVICE MARK  
PRINCIPAL REGISTER**

**SULAKE**

SULAKE CORPORATION OY (FINLAND LTD  
LIAB CO)  
UNIONINKATU 13  
FI-00130 HELSINKI  
FINLAND

FOR: COMPUTER AND VIDEO GAME SOFTWARE; VIRTUAL REALITY GAME SOFTWARE; COMPUTER GAME SOFTWARE ENABLING USERS TO PLAY GAMES WITH MOBILE PHONES; COMPUTER GAME SOFTWARE FOR COMMUNICATION DEVICES; ELECTRONIC GAME SOFTWARE FOR HANDHELD AND WIRELESS ELECTRONIC DEVICES; INTERACTIVE VIDEO GAMES OF VIRTUAL REALITY COMPRISED OF COMPUTER HARDWARE AND SOFTWARE, IN CLASS 9 (U.S. CLS. 21, 23, 26, 36 AND 38).

FOR: PROVIDING ON-LINE CHAT ROOMS, ELECTRONIC BULLETIN BOARDS AND DISCUSSION FORUMS FOR TRANSMISSION OF MESSAGES AMONG USERS IN THE FIELD OF GENERAL INTEREST; MOBILE MEDIA AND ENTERTAINMENT SERVICES IN THE NATURE OF ELECTRONIC TRANSMISSION OF ENTERTAINMENT MEDIA CONTENT; NOT INCLUDING BROADCASTING SERVICES, IN CLASS 38 (U.S. CLS. 100, 101 AND 104).

FOR: ENTERTAINMENT SERVICES, NAMELY, PROVIDING ON-LINE COMPUTER GAMES, PROVIDING A WEBSITE SITE FEATURING MUSICAL

VIDEOS, FILM CLIPS, PHOTOGRAPHS AND OTHER ENTERTAINMENT-BASED MULTIMEDIA MATERIALS AND INFORMATION; ENTERTAINMENT SOFTWARE PRODUCTION SERVICES, IN CLASS 41 (U.S. CLS. 100, 101 AND 107).

FOR: DESIGN AND DEVELOPMENT OF COMPUTER HARDWARE AND SOFTWARE FOR OTHERS; LICENSING OF INDUSTRIAL PROPERTY, NAMELY LICENSING OF INTELLECTUAL PROPERTY; PROVISION OF TECHNICAL ADVICE, CONSULTANCY AND INFORMATION REGARDING ALL OF THE AFORESAID SERVICES, IN CLASS 42 (U.S. CLS. 100 AND 101).

PRIORITY DATE OF 11-12-2004 IS CLAIMED.

OWNER OF INTERNATIONAL REGISTRATION 0876718 DATED 11-16-2004, EXPIRES 11-16-2014.

THE ENGLISH TRANSLATION OF THE FOREIGN WORD(S) IN THE MARK IS: ELECTRICAL FUSE.

SER. NO. 79-020,809, FILED 11-16-2004.

KATHERINE CONNOLLY, EXAMINING ATTORNEY

**Int. Cls.: 9, 16 and 42**

**Prior U.S. Cls.: 2, 5, 21, 22, 23, 26, 29, 36, 37, 38, 50,  
100 and 101**

**Reg. No. 3,395,039**

**United States Patent and Trademark Office**

**Registered Mar. 11, 2008**

**TRADEMARK  
SERVICE MARK  
PRINCIPAL REGISTER**

# PHACET

FARMACO-LOGICA BV (NETHERLANDS LIMITED LIABILITY CORPORATION)  
WOLKENDEK 17  
NL-3454 TG DE MEERN  
NETHERLANDS

FOR: CENTRAL PROCESSING UNITS AND DATA PROCESSORS FOR THE REPRODUCTION, STORAGE AND ARCHIVING OF DATA IN THE HEALTH CARE FIELD; COMPUTERS, COMPUTER PERIPHERALS, AND COMPUTER SOFTWARE FOR RECORDING PATIENT HEALTH DATA, IN THE HEALTH CARE FIELD, IN CLASS 9 (U.S. CLS. 21, 23, 26, 36 AND 38).

FOR: PRINTED MATTER, NAMELY, INSTRUCTION MANUALS, TRAINING BROCHURES, SOLD AS A UNIT WITH COMPUTER SOFTWARE, ON THE USE OF COMPUTER SOFTWARE AND COMPUTER DEVICES IN THE HEALTH CARE FIELD, IN CLASS 16 (U.S. CLS. 2, 5, 22, 23, 29, 37, 38 AND 50).

FOR: COMPUTER PROGRAMMING IN THE HEALTH CARE FIELD, AND DESIGN AND DEVELOPMENT OF COMPUTER SYSTEMS AND SOFTWARE INTENDED FOR USE IN THE HEALTH CARE FIELD, IN CLASS 42 (U.S. CLS. 100 AND 101).

THE MARK CONSISTS OF STANDARD CHARACTERS WITHOUT CLAIM TO ANY PARTICULAR FONT, STYLE, SIZE, OR COLOR.

PRIORITY DATE OF 10-13-2005 IS CLAIMED.

OWNER OF INTERNATIONAL REGISTRATION 0877813 DATED 11-8-2005, EXPIRES 11-8-2015.

SER. NO. 79-021,243, FILED 11-8-2005.

JOHN E. MICHOS, EXAMINING ATTORNEY

**Int. Cls.: 8, 9, 16, 21, 25, 29, 30, 41 and 43**

**Prior U.S. Cls.: 2, 5, 13, 21, 22, 23, 26, 28, 29, 30, 33, 36, 37, 38, 39, 40, 44, 46, 50, 100, 101 and 107**

**Reg. No. 3,395,040**

**United States Patent and Trademark Office**

**Registered Mar. 11, 2008**

**TRADEMARK  
SERVICE MARK  
PRINCIPAL REGISTER**



LE CORDON BLEU INTERNATIONAL B.V.  
(NETHERLANDS CORPORATION)  
HERENGRACHT 28  
AMSTERDAM, NETHERLANDS NL1015 BL

FOR: HAND OPERATED HAND TOOLS AND IMPLEMENTS, NAMELY, CUTLERY, KNIVES, FORKS, SPOONS, HUNTING KNIVES, KITCHEN KNIVES; NON-ELECTRIC RAZORS; NON-ELECTRIC FRUIT PEELERS; NON-ELECTRIC TIN AND CAN OPENERS; HAND-HELD FOOD PROCESSORS, IN CLASS 8 (U.S. CLS. 23, 28 AND 44).

FOR: APPARATUS FOR RECORDING, TRANSMISSION OR REPRODUCTION OF SOUND AND IMAGES, PRERECORDED MAGNETIC DATA CARRIERS, PRERECORDED COMPACT DISCS, CD'S CD ROMS, VIDEOTAPES, VIDEOCASSETTES, DVD'S AND DOWNLOADABLE ELECTRONIC PUBLICATIONS IN THE NATURE OF MAGAZINES, ALL FEATURING EDUCATIONAL MATERIAL IN THE FIELDS OF GASTRONOMY, OENOLOGY, HOSPITALITY AND COOKING, IN CLASS 9 (U.S. CLS. 21, 23, 26, 36 AND 38).

FOR: PRINTED MATTER, NAMELY, BOOKS IN THE FIELD OF CULINARY ARTS AND OENOLOGY, MAGAZINES AND REVIEWS IN THE FIELD OF COOKING AND OENOLOGY, STATIONERY; PRINTED MENUS; CALLING CARDS, NOT MAGNETICALLY ENCODED; BUSINESS CARDS; GUEST SEATING CARDS; ADHESIVES FOR STATIONERY AND HOUSEHOLD PURPOSES; PLASTIC BAGS AND FILM FOR WRAPPING AND PACKAGING; COASTERS MADE OF PAPER; PRINTING BLOCKS, IN CLASS 16 (U.S. CLS. 2, 5, 22, 23, 29, 37, 38 AND 50).

FOR: HOUSEHOLD, KITCHEN AND COOKING UTENSILS AND CONTAINERS NOT OF PRECIOUS

METAL OR COATED THEREWITH, NAMELY, SAUCE PANS, SKILLETS, DUTCH OVENS, CASSEROLES, COOKING RACKS AND CUPS TO FIT THE RACKS, STRAINERS, AND COVERS; HAND-OPERATED COFFEE GRINDERS AND PEPPER MILLS, AND FOOD GRATERS; GLASSWARE, PORCELAIN AND EARTHENWARE, NAMELY, CUPS AND MUGS, COFFEE MUGS, DRINKING GLASSES, BOWELS, PANS, DISHES, SAUCERS, SOUP TUREENS, SERVING DISHES, FIGURES, FIGURINES, SCULPTURES, TEA KETTLES, TEA POTS, TEA SETS; COMBS AND CLEANING AND SCOURING BRUSHES; BRUSHES, EXCLUDING PAINTBRUSHES, FOR BASTING, APPLYING SAUCES AND COATING; MATERIAL FOR BRUSH MAKING; CLEANING EQUIPMENT, NAMELY, CLEANING MITTS OF FABRIC, CLEANING PADS, DUSTING OR CLEANING CLOTHS, METAL WOOL FOR CLEANING, POT CLEANING BRUSHES, STEEL WOOL FOR CLEANING; UNWORKED OR SEMI-WORKED GLASS, EXCLUDING BUILDING GLASS, IN CLASS 21 (U.S. CLS. 2, 13, 23, 29, 30, 33, 40 AND 50).

FOR: FOOTWEAR AND ARTICLES OF CLOTHING, NAMELY, PULLOVERS, DRESSES SKIRTS, SHIRTS, JACKETS, COATS, SOCKS AND TIGHTS, UNDERWEAR, APRONS, OVERALLS, COVERALLS FOR USE WHILE COOKING, IN CLASS 25 (U.S. CLS. 22 AND 39).

FOR: MEAT, FISH, POULTRY AND GAME; MEAT EXTRACTS; PRESERVED, DRIED AND COOKED FRUITS AND VEGETABLES; JELLIES, JAMS, EGGS, MILK, BUTTER, CHEESES, CREAMS AND MILK PRODUCTS, EXCLUDING ICE CREAM, ICE MILK AND FROZEN YOGURT; EDIBLE OILS AND FATS, IN CLASS 29 (U.S. CL. 46).

FOR: COFFEE, TEA, COCOA, SUGAR, RICE, TAPIOCA, SAGO, ARTIFICIAL COFFEE; FLOUR

AND CEREAL PREPARATIONS NAMELY, CEREAL BASED SNACK FOODS AND READY TO EAT MUESLI, CORN FLAKES, CORN CHIPS, POPCORN, COUSCOUS, OATMEAL AND OAT FLAKES; READY TO EAT CEREAL DERIVED FOOD BARS; BREAD, PASTRIES, BISCUITS AND CONFECTIONERY, NAMELY, COOKIES, CAKES, NAMELY PETIT FOURS; CANDY; PRALINES; PUDDINGS; CAKES; EDIBLE ICES, NAMELY SHERBET, ICE MILK; HONEY, TREACLE SYRUP; YEAST, BAKING POWDER; SALT, MUSTARD; VINEGAR, SAUCES; DRESSINGS FOR SALADS; SPICES; ICE, IN CLASS 30 (U.S. CL. 46).

FOR: EDUCATIONAL SERVICES, NAMELY CONDUCTING COURSES AND CONFERENCES IN THE FIELD OF GASTRONOMY, OENOLOGY, HOSPITALITY AND COOKING; EDUCATIONAL SERVICES IN THE NATURE OF SCHOOLS PROVIDING INSTRUCTION IN THE FIELD OF GASTRONOMY, OENOLOGY, HOSPITALITY AND COOKING; PUBLISHING OF ELECTRONIC BOOKS AND REVIEWS; BOOK LENDING SERVICES; ENTERTAINMENT SHOWS, NAMELY ENTERTAINMENT IN THE NATURE OF COOKING SHOWS, AND SHOWS ABOUT FOOD, WINE AND HOSPITALITY; ENTERTAINMENT SERVICES, NAMELY, PROVIDING AND PRODUCING RADIO AND TELEVISION SHOWS IN THE FIELD OF GASTRONOMY, OENOLOGY, HOSPITALITY AND COOKING; FILM PRODUCTION AND RENTAL OF FILMS, PHONOGRAPHIC RECORDINGS AND THEATRE SCENERY RELATED TO GASTRONOMY, OENOLOGY, HOSPITALITY AND COOKING; ARRANGING OF EDUCATION AND ENTERTAINMENT

COMPETITIONS IN THE FIELDS OF GASTRONOMY, COOKING AND HOSPITALITY; EDUCATIONAL SERVICES, NAMELY, PROVIDING INCENTIVES TO CHEFS, COOKS AND PERSONS INTERESTED IN COOKING, FOOD AND WINE THROUGH THE ISSUANCE OF AWARDS FOR EXCELLENCE IN THE CULINARY FIELD, IN CLASS 41 (U.S. CLS. 100, 101 AND 107).

FOR: RESTAURANT, BAR AND BISTRO SERVICES; CATERING SERVICES; CATERING SERVICES, NAMELY, PREPARATION OF GALA DINNERS AND COCKTAIL PARTIES, IN CLASS 43 (U.S. CLS. 100 AND 101).

PRIORITY DATE OF 4-25-2005 IS CLAIMED.

OWNER OF INTERNATIONAL REGISTRATION 0879066 DATED 5-18-2005, EXPIRES 5-18-2015.

OWNER OF U.S. REG. NOS. 1,641,838, 2,837,534 AND OTHERS.

NO CLAIM IS MADE TO THE EXCLUSIVE RIGHT TO USE "PARIS" AND "1895", APART FROM THE MARK AS SHOWN.

THE ENGLISH TRANSLATION OF THE TERM "LE CORDON BLEU" IS "THE BLUE RIBBON."

SER. NO. 79-021,688, FILED 5-18-2005.

MARY CRAWFORD, EXAMINING ATTORNEY

**Int. Cls.: 9, 16 and 42**

**Prior U.S. Cls.: 2, 5, 21, 22, 23, 26, 29, 36, 37, 38, 50,  
100 and 101**

**Reg. No. 3,395,041**

**United States Patent and Trademark Office**

**Registered Mar. 11, 2008**

**TRADEMARK  
SERVICE MARK  
PRINCIPAL REGISTER**



PLANIT INTERNATIONAL LIMITED (UNITED KINGDOM LIMITED LIABILITY COMPANY INCORPORATED IN ENGLAND)  
INCA HOUSE  
EUREKA SCIENCE & BUSINESS PARK; ASHFORD, KENT TN25 4AB  
UNITED KINGDOM

FOR: COMPUTER AIDED DRAWING AND COMPUTER AIDED MANUFACTURING COMPUTER SOFTWARE PROGRAMS FOR ENGINEERING AND MANUFACTURING APPLICATIONS; COMPUTER PROGRAMS AND COMPUTER SOFTWARE FOR ENGINEERING AND MANUFACTURING, INCLUDING PRODUCTION CONTROL FOR ENGINEERING AND MANUFACTURING APPLICATIONS; COMPUTER SOFTWARE DEVELOPMENT TOOLS FOR ENGINEERING AND MANUFACTURING APPLICATIONS, INCLUDING PRODUCTION CONTROL FOR ENGINEERING AND MANUFACTURING APPLICATIONS; COMPUTER SOFTWARE FOR COMPUTER AIDED SOFTWARE ENGINEERING APPLICATIONS, INCLUDING PRODUCTION CONTROL FOR ENGINEERING AND MANUFACTURING APPLICATIONS; COMPUTER HARDWARE FOR ENGINEERING AND MANUFACTURING APPLICATIONS, INCLUDING COMPUTER PERIPHERAL DEVICES, INCLUDING PRODUCTION CONTROL FOR ENGINEERING AND MANUFACTURING APPLICATIONS; INTERACTIVE TUTORIAL CDS FOR ENGINEERING AND MANUFACTURING APPLICATIONS, INCLUDING PRODUCTION CONTROL FOR ENGINEERING AND MANUFACTURING APPLICATIONS; THREE DIMENSIONAL DIGITIZING UNITS FOR ENGI-

NEERING AND MANUFACTURING APPLICATIONS, INCLUDING PRODUCTION CONTROL FOR ENGINEERING AND MANUFACTURING APPLICATIONS; COMPUTER AIDED DESIGN SOFTWARE FOR ENGINEERING AND MANUFACTURING APPLICATIONS; COMPUTER AIDED MANUFACTURING SOFTWARE FOR ENGINEERING AND MANUFACTURING APPLICATIONS, INCLUDING PRODUCTION CONTROL FOR ENGINEERING AND MANUFACTURING APPLICATIONS; COMPUTER PROGRAMS AND COMPUTER SOFTWARE FOR COMPUTER AIDED DESIGN, MANUFACTURE AND DRAWING OF CABINETS, UNITS, FURNITURE, KITCHENS, BATHROOMS, BEDROOMS AND ROOM INTERIORS; COMPUTER PROGRAMS FOR USE IN GRAPHICS, DRAWING, MULTIMEDIA PRESENTATIONS, VIDEO FOR ENGINEERING AND MANUFACTURING APPLICATIONS, INCLUDING PRODUCTION CONTROL FOR ENGINEERING AND MANUFACTURING APPLICATIONS; USER MANUALS AND MULTIMEDIA SOFTWARE RECORDED ON CD ROM FOR USE AS INTERACTIVE TUTORIALS IN THE FIELD OF COMPUTER AIDED DESIGN, MANUFACTURE AND DRAWINGS OF CABINETS, UNITS, FURNITURE, KITCHENS, BATHROOMS, BEDROOMS AND ROOM INTERIORS, IN CLASS 9 (U.S. CLS. 21, 23, 26, 36 AND 38).

FOR: USER AND INSTRUCTION MANUALS FOR USE WITH COMPUTER SOFTWARE PROGRAMS FOR ENGINEERING AND MANUFACTURING APPLICATIONS; USER AND INSTRUCTION MANUALS FOR USE AS A GUIDE

AND INTERACTIVE TUTORIAL WITH COMPUTER SOFTWARE PROGRAMS IN THE FIELD OF COMPUTER AIDED DESIGN AND MANUFACTURING, IN CLASS 16 (U.S. CLS. 2, 5, 22, 23, 29, 37, 38 AND 50).

FOR: DESIGN AND DEVELOPMENT OF COMPUTER HARDWARE AND SOFTWARE FOR OTHERS FOR ENGINEERING AND MANUFACTURING APPLICATIONS, INCLUDING PRODUCTION CONTROL FOR ENGINEERING AND MANUFACTURING APPLICATIONS; COMPUTER AIDED DESIGN AND DRAWING SERVICES FOR OTHERS FOR ENGINEERING AND MANUFACTURING APPLICATIONS; COMPUTER PROGRAMMING FOR ENGINEERING AND MANUFACTURING APPLICATIONS, INCLUDING PRODUCTION CONTROL FOR ENGINEERING AND MANUFACTURING APPLICATIONS; COMPUTER AIDED DESIGN AND DRAWING SERVICES FOR OTHERS AND COMPUTER PROGRAMMING IN RELATION TO THE DESIGN, DRAWING, MANUFACTURE AND INSTALLATION OF CABINETS, UNITS, FURNITURE, KITCHENS, BATHROOMS, BEDROOMS AND ROOM INTERIORS, IN CLASS 42 (U.S. CLS. 100 AND 101).

PRIORITY DATE OF 11-28-2005 IS CLAIMED.

OWNER OF INTERNATIONAL REGISTRATION 0879447 DATED 1-12-2006, EXPIRES 1-12-2016.

OWNER OF U.S. REG. NOS. 2,478,852, 2,801,992 AND OTHERS.

THE COLOR(S) GRAY AND BLACK IS/ARE CLAIMED AS A FEATURE OF THE MARK.

THE COLOR GRAY APPEARS IN THE DEVICE ELEMENT OF THE MARK APPEARING ABOVE THE WORD "PLANIT", AND THE COLOR BLACK APPEARS IN THE WORD "PLANIT".

SER. NO. 79-021,807, FILED 1-12-2006.

CAROLYN CATALDO, EXAMINING ATTORNEY

Int. Cls.: 21 and 33

Prior U.S. Cls.: 2, 13, 23, 29, 30, 33, 40, 47, 49 and 50

Reg. No. 3,395,042

United States Patent and Trademark Office

Registered Mar. 11, 2008

TRADEMARK  
PRINCIPAL REGISTER

# Kwarx

J.G. DURAND INDUSTRIES (FRANCE SOCIETE ANONYME A DIRECTOIRE ET CONSEIL DE SURVEILLANCE)  
38, RUE ADRIEN DANVERS  
F-62510 ARQUES  
FRANCE

FOR: HOUSEHOLD AND KITCHEN UTENSILS NOT OF PRECIOUS METAL OR COATED THEREWITH, NAMELY, POTS, PANS, SKILLETS, CASSEROLES AND NON-ELECTRIC KETTLES, TEA KETTLES, TEA POTS, SERVING PLATTERS, PLATES, BOWLS, CREAMER PITCHERS, CUPS AND SAUCERS, MUGS, BAKING DISHES, COFFEE SERVERS, GRAVY BOAT DISHES, COVERED BUTTER DISHES, GRATERS, SIEVES, SPATULAS, STRAINERS, TURNERS, ROLLING PINS, CAKE SERVERS, PIE SERVERS, SERVING AND MIXING SPOONS, SERVING LADLES, CUTTING BOARDS, NAPKIN HOLDERS, AND SPICE RACKS; HOUSEHOLD AND KITCHEN CONTAINERS NOT OF PRECIOUS METAL OR COATED THEREWITH, NAMELY, ALL PURPOSE PORTABLE HOUSEHOLD CONTAINERS, CONTAINERS FOR HOUSEHOLD OR KITCHEN USE, HOUSEHOLD CONTAINERS FOR FOODS, TEA CANISTERS, GLASS STORAGE JARS, THERMAL INSULATED BEVERAGE CONTAINERS, CARAFES, PITCHERS, SALT AND PEPPER SHAKERS, BREAD BOXES, VASES, PLANTERS FOR FLOWERS AND PLANTS, AND DECANTERS; COMBS AND BATH SPONGES, CLEANING SPONGES, SCOURING SPONGES, AND SCRUB TOILET SPONGES; BRUSHES EXCLUDING PAINTBRUSHES, NAMELY, BRUSHES FOR BASTING MEAT, COSMETIC BRUSHES, DISHWASHING BRUSHES, BRUSHES FOR FOOTWEAR, AND CLOTHES BRUSHES; BRUSH MAKING MATERIALS; ARTICLES FOR CLEANING PURPOSES, NAMELY, CLEANING CLOTHS, CLEANING PADS, CLEANING RAGS, SCOURING PADS, SCOURING BRUSHES, AND STEEL WOOL FOR CLEANING;

UNWORKED OR SEMI WORKED GLASS NOT FOR BUILDING; GLASSWARE, PORCELAIN AND EARTHENWARE NOT INCLUDED IN OTHER CLASSES, NAMELY GLASS BOXES, CANDLESTICKS NOT OF PRECIOUS METAL, FIGURINES OF PORCELAIN OR GLASS, MOSAICS OF GLASS NOT FOR BUILDINGS, OPALINE GLASS, VASES NOT OF PRECIOUS METAL, TABLEWARE NOT OF PRECIOUS METAL IN THE NATURE OF DRINKING GLASSES, DECANTERS, PLATES, BOWLS, CUPS, GOBLETS, SERVING PLATTERS, MUGS, SALAD BOWLS, GLASS JARS, SUGAR BOWLS, CREAMER PITCHERS, RAMEKINS, JUGS, SERVING TRAYS, EGG CUPS, PEPPER SHAKERS, SALT SHAKERS, OIL SHAKERS IN THE NATURE OF CRUETS, AND GLASS CANDY BOXES; FLASKS NOT OF PRECIOUS METAL, PERFUME SPRAYERS, PERFUME VAPORIZERS SOLD EMPTY; GLASS BEVERAGeware, BARWARE AND STEMWARE, NAMELY, GLASS AND CRYSTAL STEMWARE, DRINKING GLASSES, SHOT GLASSES, GOBLETS, PILSNER DRINKING GLASSES AND SELTZER BOTTLES, IN CLASS 21 (U.S. CLS. 2, 13, 23, 29, 30, 33, 40 AND 50).

FOR: ALCOHOLIC BEVERAGES EXCEPT BEERS, NAMELY, RUM, WHISKEY, VODKA, GIN, WINE; HARD CIDERS; DIGESTERS, NAMELY LIQUEURS; DIGESTERS, NAMELY BRANDY, DISTILLED, AND POTABLE SPIRITS; WINES; ALCOHOLIC EXTRACTS AND ESSENCES, IN CLASS 33 (U.S. CLS. 47 AND 49).

THE MARK CONSISTS OF STANDARD CHARACTERS WITHOUT CLAIM TO ANY PARTICULAR FONT, STYLE, SIZE, OR COLOR.

PRIORITY DATE OF 8-31-2005 IS CLAIMED.

OWNER OF INTERNATIONAL REGISTRATION  
0879602 DATED 2-24-2006, EXPIRES 2-24-2016.

SER. NO. 79-021,851, FILED 2-24-2006.  
COLLEEN DOMBROW, EXAMINING ATTORNEY



**Int. Cl.: 25**

**Prior U.S. Cls.: 22 and 39**

**United States Patent and Trademark Office**

**Reg. No. 3,395,043**

**Registered Mar. 11, 2008**

**TRADEMARK  
PRINCIPAL REGISTER**

# GronkWear

NICHOLAS DELAVERIS (AUSTRALIA INDIVIDUAL)  
15 CLELAND STREET  
MASCOT NSW 2020  
AUSTRALIA

FOR: SPORTSWEAR NAMELY, POLO SHIRTS, T-SHIRTS, SINGLET, SHORTS, PANTS, JACKETS, RAINWEAR, SWIM WEAR, JERSEYS, TRACK SUITS, SWEATERS, IN CLASS 25 (U.S. CLS. 22 AND 39).

THE MARK CONSISTS OF STANDARD CHARACTERS WITHOUT CLAIM TO ANY PARTICULAR FONT, STYLE, SIZE, OR COLOR.

OWNER OF INTERNATIONAL REGISTRATION  
0880770 DATED 10-21-2005, EXPIRES 10-21-2015.

SER. NO. 79-022,316, FILED 10-21-2005.

KATHERINE M. DUBRAY, EXAMINING ATTORNEY

**Int. Cl.: 12**

**Prior U.S. Cls.: 19, 21, 23, 31, 35 and 44**

**United States Patent and Trademark Office**

**Reg. No. 3,395,044**

**Registered Mar. 11, 2008**

**TRADEMARK  
PRINCIPAL REGISTER**

**NOKIAN HEAVY TYRES**

NOKIAN TYRES PLC (FINLAND PUBLIC LIMITED COMPANY)  
PIRKKALAISTIE 7  
FI-37100 NOKIA  
FINLAND

FOR: VEHICLE WHEEL INNER TUBES AND TIRES; RETREADED TIRES; TREADS USED TO RETREAD TIRES; REPAIR OUTFITS FOR INNER TUBES AND TIRES, NAMELY, TIRE PATCHING KITS COMPRISING TIRE PATCHES, TIRE PUMPS, VALVE STEMS FOR VEHICLE TIRES, VEHICLE TIRE VALVE STEM CAPS, TIRE LINERS, TIRE RETREADING CAPS, TIRE VALVES, ADHESIVE RUBBER PATCHES FOR REPAIRING TUBES OR TIRES, INNER TUBES FOR VEHICLE TIRES; INNER TUBE AND TIRE PATCHING EQUIPMENT, NAMELY, TIRE PATCHES, TIRE PUMPS, VALVE STEMS FOR VEHICLE TIRES, VEHICLE TIRE VALVE STEM CAPS, TIRE LINERS, TIRE RETREADING CAPS, TIRE VALVES, ADHESIVE RUBBER PATCHES FOR REPAIRING TUBES OR TIRES, IN CLASS 12 (U.S. CLS. 19, 21, 23, 31, 35 AND 44).

THE MARK CONSISTS OF STANDARD CHARACTERS WITHOUT CLAIM TO ANY PARTICULAR FONT, STYLE, SIZE, OR COLOR.

PRIORITY DATE OF 2-14-2006 IS CLAIMED.

OWNER OF INTERNATIONAL REGISTRATION 0884227 DATED 3-2-2006, EXPIRES 3-2-2016.

OWNER OF U.S. REG. NOS. 2,962,873, 3,086,419 AND OTHERS.

NO CLAIM IS MADE TO THE EXCLUSIVE RIGHT TO USE "HEAVY TYRES", APART FROM THE MARK AS SHOWN.

SER. NO. 79-023,458, FILED 3-2-2006.

DANIEL BRODY, EXAMINING ATTORNEY

**Int. Cls.: 3, 7 and 8**

**Prior U.S. Cls.: 1, 4, 6, 13, 19, 21, 23, 28, 31, 34, 35, 44,  
50, 51 and 52**

**Reg. No. 3,395,045**

**United States Patent and Trademark Office**

**Registered Mar. 11, 2008**

**TRADEMARK  
PRINCIPAL REGISTER**

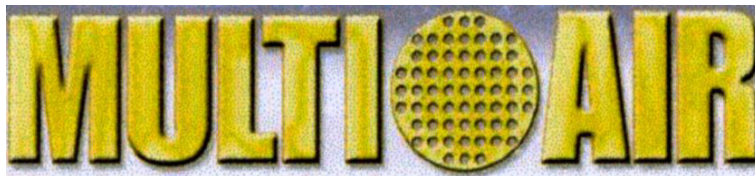

SAINT-GOBAIN ABRASIFS, SOCIÉTÉ ANON-  
YME (FRANCE CORPORATION)  
RUE DE L'AMBASSADEUR  
F-78700 CONFLANS-SAINTE-HONORINE  
FRANCE

FOR: GENERAL PURPOSE CLEANING, POLISH-  
ING AND ABRASIVE LIQUIDS AND POWDERS;  
EMERY PAPER; EMERY CLOTH; INDUSTRIAL  
ABRASIVES FOR USE IN DISCS, FLAP WHEELS,  
RECTANGULAR SHEETS, AND ROLLS, NAMELY,  
ABRASIVES MADE WITH CORRUNDUM; GENER-  
AL PURPOSE ABRASIVE LIQUIDS AND POWDERS  
FOR GLASS; GENERAL PURPOSE ABRASIVE PA-  
PERS; COATED ABRASIVE SANDPAPER IN THE  
FORM OF DISCS, SHEETS, BELTS AND ROLLS, IN  
CLASS 3 (U.S. CLS. 1, 4, 6, 50, 51 AND 52).

FOR: MACHINES FOR POLISHING, ABRADING,  
TRIMMING, SAND PAPERING, GRINDING AND  
SURFACING, NAMELY, TABLE SAWS USED FOR  
MASONRY, CIRCULAR SAWS USED FOR MASON-  
RY, AND POWER-OPERATED SAWS USED FOR  
MASONRY; TABLE SAWS; POWER-OPERATED  
FLOOR SAWS; POWER DRILLS, POWER DRILL  
RIGS AND POWER-OPERATED WALL SAWS; MA-  
CHINE TOOLS, NAMELY, POWER DRILLS; ABR-  
ASIVE DISCS, ABRASIVE SHEETS, ABRASIVE BELTS,  
ABRASIVE WHEELS AND ABRASIVE ROLLS, ALL  
FOR USE WITH POWER OPERATED MACHINES  
FOR ABRADING, GRINDING, SHARPENING,  
TRIMMING, SURFACING AND POLISHING; EN-  
GINES NOT FOR LAND VEHICLES, USED FOR  
POLISHING, ABRADING, TRIMMING, SANDING,  
GRINDING AND SURFACING; COUPLINGS AND  
POWER TRANSMISSIONS FOR MACHINES USED  
FOR POLISHING, ABRADING, TRIMMING, SAND-

ING, GRINDING AND SURFACING, IN CLASS 7  
(U.S. CLS. 13, 19, 21, 23, 31, 34 AND 35).

FOR: HAND-OPERATED HAND TOOLS AND  
IMPLEMENTS, NAMELY, DRILLS; ABRADING  
TOOLS, NAMELY, ABRASIVE DISCS, ABRASIVE  
SHEETS, ABRASIVE BELTS, ABRASIVE FLAP  
WHEELS AND ABRASIVE ROLLS ALL IN BONDED  
FORM FOR USE WITH MANUALLY OPERATED  
HAND TOOLS; HAND TOOLS, NAMELY, MANU-  
ALLY-OPERATED GRINDSTONES; SHARPENING  
STONES, IN CLASS 8 (U.S. CLS. 23, 28 AND 44).

OWNER OF INTERNATIONAL REGISTRATION  
0813216 DATED 5-23-2003, EXPIRES 5-23-2013.

THE COLOR(S) YELLOW, BLACK, WHITE, AND  
GRAY IS/ARE CLAIMED AS A FEATURE OF THE  
MARK.

THE MARK CONSISTS OF THE COLOR YELLOW  
APPEARS IN THE WORDING MULTI AND AIR,  
AND IN THE CIRCLE SHAPED DESIGN; THE  
COLOR BLACK APPEARS IN THE SHADOWING  
BEHIND THE LETTERS AND DESIGN; THE COLOR  
WHITE APPEARS IN THE LOWER HALF OF THE  
BACKGROUND; AND THE COLOR GRAY AP-  
PEARS IN THE UPPER HALF OF THE BACK-  
GROUND.

SER. NO. 79-023,709, FILED 3-1-2006.

KATHERINE E. HALMEN, EXAMINING ATTOR-  
NEY

**Int. Cls.: 9, 10 and 21**

**Prior U.S. Cls.: 2, 13, 21, 23, 26, 29, 30, 33, 36, 38, 39,  
40, 44 and 50**

**Reg. No. 3,395,046**

**United States Patent and Trademark Office**

**Registered Mar. 11, 2008**

**TRADEMARK  
PRINCIPAL REGISTER**

**CHARMEUR**

ING. ERICH PFEIFFER GMBH (FED REP GER-  
MANY LTD LIAB CO)  
ÖSCHLESTRABE 54-56  
78315 RADOLFSZELL  
FED REP GERMANY

FOR: DOSING DEVICES, NAMELY, DISPENSERS  
IN THE NATURE THAT COUNT OR MEASURE  
DOSAGE OUTPUT FOR USE WITH COSMETIC  
AND PHARMACEUTICAL PRODUCTS, IN CLASS  
9 (U.S. CLS. 21, 23, 26, 36 AND 38).

FOR: ATOMIZERS, AEROSOL DISPENSERS FOR  
MEDICAL PURPOSES, GEL DISPENSERS FOR  
MEDICAL PURPOSES, SPRAY DISPENSERS FOR  
MEDICAL PURPOSES, LOTION DISPENSERS FOR  
MEDICAL PURPOSES AND DISPENSER PUMPS  
FOR DISPENSING MEDICINES AND PHARMA-  
CEUTICAL OR VETERINARY SUBSTANCES AS  
PARTS OF CONTAINERS FOR MEDICATION,  
SOLD EMPTY, IN CLASS 10 (U.S. CLS. 26, 39 AND  
44).

FOR: ATOMIZERS, AEROSOL DISPENSERS FOR  
NON-MEDICAL PURPOSES, LIQUID SOAP DISPEN-  
SERS, PERFUME DISPENSERS, LOTION DISPEN-  
SERS FOR NON-MEDICAL PURPOSES, GEL

DISPENSERS FOR NON-MEDICAL PURPOSES  
AND DISPENSER PUMPS FOR USAGE WITH  
SOAPS, WITH NON-MEDICAL LOTIONS, WITH  
NON-MEDICAL GELS OR WITH PERFUME AS  
PARTS OF COSMETIC DEVICES, SOLD EMPTY, IN  
CLASS 21 (U.S. CLS. 2, 13, 23, 29, 30, 33, 40 AND 50).

THE MARK CONSISTS OF STANDARD CHAR-  
ACTERS WITHOUT CLAIM TO ANY PARTICULAR  
FONT, STYLE, SIZE, OR COLOR.

PRIORITY DATE OF 5-11-2005 IS CLAIMED.

OWNER OF INTERNATIONAL REGISTRATION  
0884815 DATED 11-7-2005, EXPIRES 11-7-2015.

THE ENGLISH TRANSLATION OF THE WORD  
"CHARMEUR" IN THE MARK IS "CHARMING  
PERSON".

SER. NO. 79-023,812, FILED 11-7-2005.

LEIGH LOWRY, EXAMINING ATTORNEY

**Int. Cls.: 6 and 20**

**Prior U.S. Cls.: 2, 12, 13, 14, 22, 23, 25, 32 and 50**

**United States Patent and Trademark Office**

**Reg. No. 3,395,047**

**Registered Mar. 11, 2008**

**TRADEMARK  
PRINCIPAL REGISTER**

 **lightway**

LIGHTWAY S.R.O. (CZECH REPUBLIC CORPORATION)  
LEDVINOVA 1714/12  
CZ-149 00 PRAHA 4 - CHODOV, CZECH REPUBLIC

OWNER OF INTERNATIONAL REGISTRATION  
0797020 DATED 11-12-2002, EXPIRES 11-12-2012.

FOR: METAL SKYLIGHTS FOR BUILDING, IN  
CLASS 6 (U.S. CLS. 2, 12, 13, 14, 23, 25 AND 50).

SER. NO. 79-023,916, FILED 2-7-2006.

FOR: MIRRORS FOR SKYLIGHTS WITH TUBES  
FOR TRANSPORTING DAYLIGHT, IN CLASS 20  
(U.S. CLS. 2, 13, 22, 25, 32 AND 50).

LEIGH CAROLINE CASE, EXAMINING ATTORNEY

**Int. Cl.: 42**

**Prior U.S. Cls.: 100 and 101**

**United States Patent and Trademark Office**

**Reg. No. 3,395,048**

**Registered Mar. 11, 2008**

**SERVICE MARK  
PRINCIPAL REGISTER**

**ONESQUARED**

ONESQUARED LIMITED (NEW ZEALAND REGISTERED COMPANY)  
LEVEL 4, ANVIL HOUSE,  
138-140 WAKEFIELD STREET; WELLINGTON  
NEW ZEALAND

FOR: COMPUTER SOFTWARE DESIGN FOR OTHERS AND PROGRAMMING FOR OTHERS, DESIGN AND DEVELOPMENT OF COMPUTER HARDWARE AND SOFTWARE FOR OTHERS; WEB SITE HOSTING SERVICES; CREATING AND MAINTAINING WEB SITES AND WEB PAGES FOR OTHERS; WEB SITE MANAGEMENT SERVICES FOR OTHERS; DATA ENCRYPTION SERVICES; COMPUTER SECURITY SERVICES, NAMELY, RESTRICTING ACCESS TO AND BY COMPUTER NETWORKS TO AND AT WEB SITES, MEDIA AND INDIVIDUALS AND FACILITIES; COMPUTER CONSULTATION NAMELY ANALYSIS OF SOFTWARE, COMPUTERS, COMPUTER SYSTEMS AND/OR COMPUTER NETWORKS; TECHNICAL

SUPPORT SERVICES, NAMELY, TROUBLESHOOTING OF PROBLEMS IN COMPUTER SOFTWARE, COMPUTERS, COMPUTER SYSTEMS AND/OR COMPUTER NETWORKS; ADVISORY AND CONSULTANCY SERVICES IN RELATION TO THE AFORESAID SERVICES, IN CLASS 42 (U.S. CLS. 100 AND 101).

THE MARK CONSISTS OF STANDARD CHARACTERS WITHOUT CLAIM TO ANY PARTICULAR FONT, STYLE, SIZE, OR COLOR.

OWNER OF INTERNATIONAL REGISTRATION  
0885808 DATED 3-13-2006, EXPIRES 3-13-2016.

SER. NO. 79-024,189, FILED 3-13-2006.

DORITT L. CARROLL, EXAMINING ATTORNEY

**Int. Cls.: 16 and 30**

**Prior U.S. Cls.: 2, 5, 22, 23, 29, 37, 38, 46 and 50**

**Reg. No. 3,395,049**

**United States Patent and Trademark Office**

**Registered Mar. 11, 2008**

**TRADEMARK  
PRINCIPAL REGISTER**

**HAPPY & SMART**

AGENTUR DONNA MOBILE GMBH (SWITZERLAND GMBH, LIMITED LIABILITY COMPANY)  
ROTZBERGSTRASSE 17  
CH-6362 STANSSTAD AM SEE  
SWITZERLAND

FOR: PRINTED MATTER, NAMELY, PRINTED MAGAZINES IN THE FIELD OF GENERAL POPULAR INTEREST GENERAL FEATURE MAGAZINES, IN CLASS 16 (U.S. CLS. 2, 5, 22, 23, 29, 37, 38 AND 50).

FOR: COCOA, CHOCOLATE, CHOCOLATE PRODUCTS, NAMELY, CHOCOLATE BARS, CHOCOLATE CANDIES, CHOCOLATE CHIPS, IN CLASS 30 (U.S. CL. 46).

THE MARK CONSISTS OF STANDARD CHARACTERS WITHOUT CLAIM TO ANY PARTICULAR FONT, STYLE, SIZE, OR COLOR.

PRIORITY DATE OF 2-20-2006 IS CLAIMED.

OWNER OF INTERNATIONAL REGISTRATION 0886612 DATED 5-9-2006, EXPIRES 5-9-2016.

SER. NO. 79-024,518, FILED 5-9-2006.

ERNEST SHOSHO, EXAMINING ATTORNEY

**Int. Cls.: 35, 37, 41 and 42**

**Prior U.S. Cls.: 100, 101, 102, 103, 106 and 107**

**United States Patent and Trademark Office**

**Reg. No. 3,395,050**

**Registered Mar. 11, 2008**

**SERVICE MARK  
PRINCIPAL REGISTER**

**IPM**

ALSTOM TECHNOLOGY LTD (SWITZERLAND  
AG)  
BROWN BOVERI STRASSE 7  
CH-5400 BADEN, SWITZERLAND

FOR: BUSINESS ORGANISATION AND MANAGEMENT CONSULTING; BUSINESS ADMINISTRATION; CONSULTING IN BUSINESS MANAGEMENT; BUSINESS MANAGEMENT FOR THIRD PARTIES; PROFESSIONAL BUSINESS MANAGEMENT CONSULTING; RECRUITMENT SERVICES, NAMELY, HIRING OF HIGHLY QUALIFIED STAFF, IN CLASS 35 (U.S. CLS. 100, 101 AND 102).

FOR: REPAIR AND MAINTENANCE OF POWER STATIONS OR COMPONENTS OF POWER STATIONS; CONSULTING IN REPAIR AND MAINTENANCE FOR POWER STATIONS OR COMPONENTS OF POWER STATIONS; INSTALLATION, REPAIR AND MAINTENANCE OF POWER STATIONS OR COMPONENTS OF POWER STATIONS, CONSULTING IN THIS FIELD, IN CLASS 37 (U.S. CLS. 100, 103 AND 106).

FOR: TUITION, NAMELY, EDUCATIONAL SERVICES PROVIDED VIA CONFERENCES, CLASSES AND WORKSHOPS IN THE FIELD OF POWER STATIONS; ONGOING TRAINING OF HIGHLY QUALIFIED STAFF IN THE FIELD OF POWER

STATION MAINTENANCE, IN CLASS 41 (U.S. CLS. 100, 101 AND 107).

FOR: TECHNICAL CONSULTING IN THE ENERGY SCIENTIFIC RESEARCH SECTOR; SCIENTIFIC RESEARCH AND DEVELOPMENT SERVICES IN THE ENERGY SCIENTIFIC RESEARCH SECTOR, RESEARCH AND DEVELOPMENT OF COMPUTER HARDWARE AND SOFTWARE FOR OPERATING OF POWER STATIONS OR COMPONENTS OF POWER STATIONS; LEGAL SERVICES, IN CLASS 42 (U.S. CLS. 100 AND 101).

THE MARK CONSISTS OF STANDARD CHARACTERS WITHOUT CLAIM TO ANY PARTICULAR FONT, STYLE, SIZE, OR COLOR.

PRIORITY DATE OF 7-5-2005 IS CLAIMED.

OWNER OF INTERNATIONAL REGISTRATION 0886668 DATED 1-4-2006, EXPIRES 1-4-2016.

SER. NO. 79-024,535, FILED 1-4-2006.

DAVID HOFFMAN, EXAMINING ATTORNEY



**Int. Cls.: 35 and 41**

**Prior U.S. Cls.: 100, 101, 102 and 107**

**United States Patent and Trademark Office**

**Reg. No. 3,395,051**

**Registered Mar. 11, 2008**

**SERVICE MARK  
PRINCIPAL REGISTER**



ENGINEERING PEOPLE GMBH (FED REP GER-  
MANY PRIVATE LIMITED COMPANY)  
RIEDWIESENWEG 8  
89081 ULM, FED REP GERMANY

OWNER OF INTERNATIONAL REGISTRATION  
0889706 DATED 5-3-2006, EXPIRES 5-3-2016.

FOR: BUSINESS CONSULTING, ESPECIALLY  
CONSULTING WITH REGARD TO PERSONNEL  
MANAGEMENT IN THE FIELD OF MEDICINE;  
TEMPORARY EMPLOYMENT BUSINESS, NAME-  
LY, TEMPORARY EMPLOYMENT AGENCY, IN  
CLASS 35 (U.S. CLS. 100, 101 AND 102).

NO CLAIM IS MADE TO THE EXCLUSIVE  
RIGHT TO USE "MEDICALPEOPLE", APART  
FROM THE MARK AS SHOWN.

THE COLOR(S) RED, GREY AND WHITE IS/ARE  
CLAIMED AS A FEATURE OF THE MARK.

FOR: ORGANIZATION AND RUNNING OF  
TRAINING COURSES FOR MEDICAL DOCTORS,  
NAMELY, TRAINING COURSES CONCERNING  
TECHNICAL INNOVATIONS AND IMPROVE-  
MENTS IN THE FIELD OF ANESTHETICS AND  
TRAINING COURSES IN THE FIELD OF HAND-  
LING OF DEVICES AND EQUIPMENT FOR MED-  
ICAL PURPOSES, IN CLASS 41 (U.S. CLS. 100, 101  
AND 107).

THE COLOR RED APPEARS IN THE WORD  
MEDICAL AND THE RIGHT PART OF THE RING;  
THE COLOR GREY APPEARS IN THE WORD  
PEOPLE AND THE LEFT PART OF THE RING  
AND THE COLOR WHITE APPEARS AS THE BACK-  
GROUND.

SER. NO. 79-025,623, FILED 5-3-2006.

PRIORITY DATE OF 11-4-2005 IS CLAIMED.

CARYN GLASSER, EXAMINING ATTORNEY

**Int. Cls.: 5, 20, 21 and 22**

**Prior U.S. Cls.: 1, 2, 6, 7, 13, 18, 19, 22, 23, 25, 29, 30, 32, 33, 40, 42, 44, 46, 50, 51 and 52**

**Reg. No. 3,395,052**

**United States Patent and Trademark Office**

**Registered Mar. 11, 2008**

**TRADEMARK  
PRINCIPAL REGISTER**

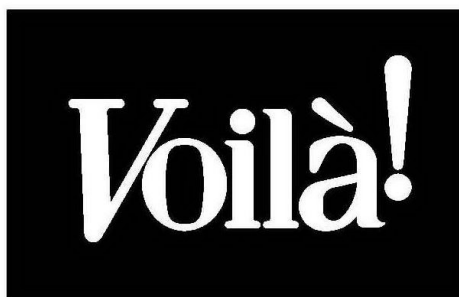

COSATTO SPA (ITALY JOINT STOCK COMPANY)  
VIA SPILIMBERGO, 156  
I-33035 MARTIGNACCO (UD)  
ITALY

FOR: AIR DEODORANT OR DEODORIZER; AIR FRESHENERS; CAR DEODORANT OR DEODORIZER; CARPET DEODORIZERS; CEDAR WOOD FOR USE AS A CLOTHING PROTECTOR AND/OR DEODORIZER; CEDAR WOOD FOR USE AS AN INSECT REPELLENT; HOUSEHOLD DEODORANT OR DEODORIZER; ROOM DEODORANT OR DEODORIZER; SHOE DEODORIZERS; INSECT REPELLENTS; ODOUR NEUTRALIZING PREPARATIONS FOR USE AT HOME IN WARDROBES, ON CARPETS, ON TEXTILE, OR IN CARS; SANITIZERS FOR HOUSEHOLD USE, IN CLASS 5 (U.S. CLS. 6, 18, 44, 46, 51 AND 52).

FOR: BAG CLOSURES NOT OF METAL; BEDROOM FURNITURE; PLASTIC BOXES; WOOD BOXES; FURNITURE TOY BOXES; NON-METAL BROOM HANDLES; PLASTIC HANDLES FOR BOXES AND CONTAINERS; PLASTIC CAKE DECORATIONS; PLASTIC CAPS; NON-METAL CAPS FOR BOTTLES; NON-METAL CLOSURES FOR BOTTLES, BAGS AND CONTAINERS; CLOTHES HANGERS; DRESS HANGERS; NON-METAL CLOTHES HOOKS; COAT HANGERS; CONTAINERS, NOT OF METAL, FOR COMMERCIAL USE; PLASTIC STORAGE DRUMS; NON-METAL HOOKS; PLASTIC LUGGAGE LINING MATERIAL; NON-METAL TENT PEGS; NON-METAL PEGS; NON-METAL PIPE CLIPS; FITTED PLASTIC INSERTS FOR USE AS CONTAINER LINERS; STORAGE RACKS; TOY

CHESTS; WARDROBES, IN CLASS 20 (U.S. CLS. 2, 13, 22, 25, 32 AND 50).

FOR: NON-METAL BASKETS OF PLASTIC, CLOTH FOR PEGS, FOOD, LIQUID, CLOTH; PORTABLE BEVERAGE DISPENSERS; WASHING BOARDS; BOTTLE OPENERS; BREAD BOXES; CAT LITTER BOXES; BOXES FOR DISPENSING PAPER TOWELS; FEATHER BROOMS; HARD BROOMS; ROUGH BROOMS; CLOTHES BRUSHES; COSMETIC BRUSHES; FLOOR BRUSHES; HAIR BRUSHES; SHOE BRUSHES; TOILET BRUSHES; LAMP GLASS BRUSHES; BRUSHES FOR FOOTWEAR; BRUSHES FOR PARQUET FLOORS; BRUSHES FOR PETS; NON-ELECTRIC CARPET CLEANERS; POT CLEANING BRUSHES; CLEANING CLOTHS; IMPREGNATED CLEANING CLOTHS; CLEANING PADS; CLEANING RAGS; CLOTH FOR WIPING OR DUSTING; CLOTHES DRYING RACKS; CLOTHING STRETCHERS; IMPREGNATED CLEANING, DUSTING OR POLISHING CLOTHS; WASHING CLOTHS; CONTAINERS FOR HOUSEHOLD OR KITCHEN USE NOT OF PRECIOUS METAL; CLEANING COTTON; DISHES; DISHWASHING BRUSHES; DISPENSERS FOR LIQUID SOAP FOR HOUSEHOLD USE; DRINKING GLASSES; DUST PANS; WINDOW DUSTERS; DUSTING BRUSHES; DUSTING GLOVES; FLOOR BRUSHES; FLOWER BASKETS; FLOWER POTS; GARDENING GLOVES; PLASTIC HOUSEHOLD GLOVES; POLISHING GLOVES; HOUSEHOLD GLOVES FOR GENERAL USE; PORTABLE ICE CHESTS FOR FOOD AND BEVERAGES; ICE CUBE MOLDS FOR REFRIGERATORS; SHAPED IRONING BOARD COVERS; IRONING BOARDS; PLASTIC JARS FOR JAMS AND JELLIES; KITCHEN

LADLES; POLISHING LEATHER; LUNCH BOXES; COOKERY MOLDS; MOPS; NAPKIN HOLDERS; IMPREGNATED PAPER TISSUES FOR CLEANING DISHWARE; PERFUME BURNERS; PERFUME SPRAYERS SOLD EMPTY; PIE SERVERS; PLASTIC CUPS; PRE-MOISTENED TOWELETTES FOR CLEANING; SHOE HORNS; SHOE STRETCHERS OF WOOD; SHOE TREES; CANDLE SNUFFERS; SOAP BOXES; SOAP DISPENSERS; SPONGES FOR HOUSEHOLD PURPOSE; SUGAR BASINS; TEA KETTLES; TOOTHPICK HOLDERS; TOILET BRUSHES; TOILET PAPER HOLDER; TOILET TISSUE HOLDERS; TOWEL HOLDERS; NON-ELECTRIC TROUSER PRESSES; VACUUM BOTTLES; WASHING CLOTHS; HOUSEHOLD UTENSILS NAMELY NON-ELECTRIC CITRUS FRUIT SQUEEZERS, NON-ELECTRIC WHISKS FOR HOUSEHOLD PURPOSES, TRAYS FOR DOMESTIC PURPOSES; CLOTHES PINS, IN CLASS 21 (U.S. CLS. 2, 13, 23, 29, 30, 33, 40 AND 50).

FOR: LAUNDRY BAGS; CANVAS BAGS FOR LAUNDRY; CLOTH BAGS FOR LAUNDRY; GARMENT BAGS FOR STORAGE; MESH BAGS FOR STORAGE; SHOE BAGS FOR STORAGE; CANVAS BAGS FOR STORAGE OF CLOTHES; CLOTH BAGS FOR STORAGE; SACKS OR BAGS FOR THE TRANSPORTATION OR STORAGE OF MATERIAL

IN BULK; STORAGE BAGS MADE OF NYLON OR CANVAS FOR VACUUM CLEANER ACCESSORIES; NON-METAL BELTS FOR HANDLING LOADS; BUNGIE CORDS; CANVAS BAGS FOR STORING CLOTHES INSIDE THE WARDROBE; CANVAS CANOPIES; MULTIPURPOSE CLOTH BAGS; CLOTHESLINE; DROP CLOTHS; UNFITTED VEHICLE COVERS; DISPOSABLE BULK CONTAINER LINERS; ELASTIC NETTING FOR MEAT PRODUCTS; FABRIC AND POLYESTER MESH NET USED FOR STORING TOYS AND OTHER HOUSEHOLD ITEMS; PLASTIC TIES FOR HOME OR GARDEN USE; ALL PURPOSE STRAPS, IN CLASS 22 (U.S. CLS. 1, 2, 7, 19, 22, 42 AND 50).

PRIORITY DATE OF 2-7-2005 IS CLAIMED.

OWNER OF INTERNATIONAL REGISTRATION 0889935 DATED 7-22-2005, EXPIRES 7-22-2015.

THE FOREIGN WORDING IN THE MARK TRANSLATES INTO ENGLISH AS "THERE, WELL."

SER. NO. 79-025,731, FILED 7-22-2005.

EDWARD FENNESSY, EXAMINING ATTORNEY

**Int. Cl.: 32**

**Prior U.S. Cls.: 45, 46 and 48**

**United States Patent and Trademark Office**

**Reg. No. 3,395,053**

**Registered Mar. 11, 2008**

**TRADEMARK  
PRINCIPAL REGISTER**

# BLACK STAR

SOL PARTICIPATIONS SARL (LUXEMBOURG SARL)  
48, RUE HENRI DUNANT  
L-1426 LUXEMBOURG  
LUXEMBOURG

FOR: MINERAL AND AERATED WATERS; FRUIT BEVERAGES AND FRUIT JUICES; SYRUPS AND OTHER PREPARATIONS FOR MAKING WATERS, FRUIT DRINKS, AND ENERGY DRINKS; AERATED NON-ALCOHOLIC BEVERAGES, NAMELY WATERS, FRUIT DRINKS, AND ENERGY DRINKS; PASTILLES FOR EFFERVESCENT NON-ALCOHOLIC BEVERAGES, NAMELY WATERS, FRUIT DRINKS, AND ENERGY DRINKS; POWDERS FOR EFFERVESCENT NON-ALCOHOLIC BEVERAGES, NAMELY WATERS, FRUIT DRINKS, AND ENERGY DRINKS; PREPARATIONS FOR MAKING WATERS, FRUIT DRINKS, AND ENERGY DRINKS; AND CARBONATED BEVERA-

GES WITH STIMULATING PROPERTIES, NAMELY, ENERGY DRINKS, IN CLASS 32 (U.S. CLS. 45, 46 AND 48).

THE MARK CONSISTS OF STANDARD CHARACTERS WITHOUT CLAIM TO ANY PARTICULAR FONT, STYLE, SIZE, OR COLOR.

PRIORITY DATE OF 10-27-2005 IS CLAIMED.

OWNER OF INTERNATIONAL REGISTRATION 0890101 DATED 4-11-2006, EXPIRES 4-11-2016.

SER. NO. 79-025,789, FILED 4-11-2006.

KAREN K. BUSH, EXAMINING ATTORNEY

Int. Cls.: 7, 9 and 37

Prior U.S. Cls.: 13, 19, 21, 23, 26, 31, 34, 35, 36, 38,  
100, 103 and 106

Reg. No. 3,395,054

United States Patent and Trademark Office

Registered Mar. 11, 2008

TRADEMARK  
SERVICE MARK  
PRINCIPAL REGISTER

GEIGER

BILFINGER BERGER UMWELTECHNIK  
GMBH (FED REP GERMANY GMBH)  
PASSAVANT-ROEDIGER-STRASSE 1  
65326 AARBERGEN  
FED REP GERMANY

FOR: MACHINES AND PARTS OF MACHINES USED FOR STORING, TREATING, TRANSPORTING AND DRAINING-OFF OF LIQUIDS, WASTES OF ALL KIND, SCREENINGS, SLUDGE AND FILTER CAKE; MACHINES FOR SOLID AND/OR LIQUID SEPARATION IN THE NATURE OF SCREENING MACHINES; MACHINES AND PARTS FOR SOLID AND/OR LIQUID SEPARATION, NAMELY SCREENING RAKES, STEP RAKES, SIEVES, CLIMBER SCREENS, REVOLVING CHAIN SCREENS, BAR SCREENS, TRAVERSING BAR SCREENS, TRAVERSING TRASH RAKING MACHINES, TRAVELLING BAND SCREENS, MULTI DISC SCREENS, DRUM SCREENS, MESH SCREENS, THICKENERS, ROTARY SCREENS AND SCREENING WASHERS, SCRAPING MACHINES, SPIRAL CONVEYORS; MACHINES FOR TREATING LIQUIDS, NAMELY, AERATION MACHINES, PARTS FOR ISOLATING MACHINES, NAMELY, SLIDE GATES, STOP LOGS AND SHUT-OFF UNITS; DEWATERING DEVICES IN THE NATURE OF SLUDGE DEWATERING MACHINES, NAMELY, CHAMBER FILTER PRESSES AND BELT FILTER PRESSES; SLUDGE DRYING MACHINES, SLUDGE THICKENING MACHINES, NAMELY, DRUM THICKENERS, GRAVITY THICKENERS AND DRAIN BELT THICKENERS; SPIRAL PRESSING MACHINES; MACHINES FOR TREATMENT OF SAND, NAMELY, SAND CLASSIFIER MACHINES, SAND WASHER MACHINES AND SAND SEPARATOR MACHINES; MACHINE OPERATED SPIRAL CONVEYORS AND CONVEYOR SPIRALS AS PARTS OF MACHINES FOR DRY, MOIST, WET, PASTY, ADHESIVE, DUSTY, BULKY OR ABRASIVE MATERIAL; DRY OR WET POSITIONED MACHINE PUMPS FOR WASTEWATER AND SLUDGE,

NAMELY, VORTEX VACUUM PUMPS, BILGE PUMPS, CUTTER HEAD PUMPS AND TURBOTEX PUMPS; GAS AND LIQUID FILTERS AS PARTS OF THE AFOREMENTIONED MACHINES FOR SOLID AND/OR LIQUID SEPARATION; NONE OF THE AFOREMENTIONED GOODS BEING OR INCLUDING INDUSTRIAL ROBOTS, IN CLASS 7 (U.S. CLS. 13, 19, 21, 23, 31, 34 AND 35).

FOR: APPARATUS AND INSTRUMENTS FOR WEIGHING, MEASURING, NAMELY, SCALES; APPARATUS AND INSTRUMENTS FOR SIGNALLING AND CHECKING SUPERVISORY PURPOSES, NAMELY, SENSORS; ELECTRIC AND ELECTRONIC DEVICES FOR RECORDING, PROCESSING, TRANSMISSION, STORAGE AND OUTPUT OF DATA AND MULTI-FUNCTIONAL CALCULATORS; CENTRAL PROCESSING UNITS, COMPUTER MEMORIES, PRINTERS AND ELECTRIC AND ELECTRONIC CONTROL DEVICES FOR MACHINES USED FOR STORING, TREATING, TRANSPORTING AND DRAINING-OFF OF LIQUIDS, WASTES OF ALL KIND, SCREENINGS, SLUDGE AND FILTER CAKE; INTERFACE DEVICES, NAMELY, INTERFACES FOR DETECTORS AND COMPUTER INTERFACE BOARDS; INPUT AND OUTPUT DEVICES, NAMELY, KEYBOARDS AND DISPLAYS USED TO INDICATE INFORMATION; CONTROL EQUIPMENT, NAMELY, ELECTRIC CONTROL PANELS AND COMPUTER CURSOR CONTROL DEVICES IN THE NATURE OF A MOUSE, A TRACKBALL OR A JOYSTICK; CAMERA; SECURITY INSTALLATIONS, NAMELY, VIDEO SURVEILLANCE INSTALLATIONS; WARNING AND PROTECTION DEVICES AGAINST WATER AND FIRE DAMAGE, NAMELY, SENSORS; LEAK DETECTING APPARATUS FOR MACHINES USED FOR STORING, TREATING, TRANSPORTING AND DRAINING-OFF OF LIQUIDS, WASTES OF ALL KIND, SCREENINGS, SLUDGE AND FILTER CAKE; ELECTRIC APPARATUS IN THE NATURE OF A SENSOR FOR REGISTERING AND

MEASURING OF POLLUTANTS IN AIR, WATER AND SOIL; ELECTRIC APPARATUS FOR SENSING AND DETECTING NOISE IN THE NATURE OF A SENSOR OR A NOISEMETER; APPARATUS FOR PROCESS ENGINEERING, NAMELY, FLOW METERS; PRESSURE MEASURING APPARATUS IN THE NATURE OF A PRESSURE SENSOR; REGULATOR DEVICES IN THE NATURE OF PRESSURE, VELOCITY AND VOLUME REGULATORS FOR LIQUID AND GAS IN MACHINES USED FOR STORING, TREATING, TRANSPORTING AND DRAINING-OFF OF LIQUIDS, WASTES OF ALL KIND, SCREENINGS, SLUDGE AND FILTER CAKE EXCEPT FOR REGULATORS FOR SANITARY INSTALLATIONS; ELECTRIC ACTUATORS; ELECTRIC AND ELECTRONIC APPARATUS FOR USE IN ANALYSIS OF LIQUIDS AND GAS; APPARATUS AND INSTRUMENTS FOR CONDUCTING, SWITCHING, TRANSFORMING, ACCUMULATING, REGULATING OR CONTROLLING ELECTRICITY, NAMELY, SWITCHES, DIMMERS, PLUGS, SWITCH PLUGS, DISTRIBUTION BOXES, EMERGENCY POWER SUPPLY APPARATUS, ELECTRIC BATTERIES AND ACCUMULATORS, CONNECTOR ASSEMBLIES, AND FUSES, IN CLASS 9 (U.S. CLS. 21, 23, 26, 36 AND 38).

FOR: CONSTRUCTION OF BUILDINGS; INSTALLATION OF MACHINES USED FOR STORING, TREATING, TRANSPORTING AND DRAINING-OFF OF LIQUIDS, WASTES OF ALL KIND, SCREENINGS, SLUDGE AND FILTER CAKE; INSTALLATION OF MACHINES FOR WASTE TREATMENT AND MANAGEMENT, IN CLASS 37 (U.S. CLS. 100, 103 AND 106).

THE MARK CONSISTS OF STANDARD CHARACTERS WITHOUT CLAIM TO ANY PARTICULAR FONT, STYLE, SIZE, OR COLOR.

PRIORITY DATE OF 5-11-2005 IS CLAIMED.

OWNER OF INTERNATIONAL REGISTRATION 0893068 DATED 11-2-2005, EXPIRES 11-2-2015.

THE ENGLISH TRANSLATION OF GEIGER IS MALE VIOLINIST.

SER. NO. 79-026,779, FILED 11-2-2005.

AISHA CLARKE, EXAMINING ATTORNEY

**Int. Cl.: 7**

**Prior U.S. Cls.: 13, 19, 21, 23, 31, 34 and 35**

**United States Patent and Trademark Office**

**Reg. No. 3,395,055**

**Registered Mar. 11, 2008**

**TRADEMARK  
PRINCIPAL REGISTER**

***SMARTLASER*** 

COMAU SPA (ITALY CORPORATION)  
VIA RIVALTA, 30  
I-10095 GRUGLIASCO, TORINO  
ITALY

FOR: ROBOTS FOR INDUSTRIAL USE; LASER  
WELDING SYSTEMS AND INSTALLATIONS,  
NAMELY, LASER WELDING MACHINES, IN  
CLASS 7 (U.S. CLS. 13, 19, 21, 23, 31, 34 AND 35).

PRIORITY DATE OF 11-8-2005 IS CLAIMED.

OWNER OF INTERNATIONAL REGISTRATION  
0893416 DATED 4-14-2006, EXPIRES 4-14-2016.

OWNER OF U.S. REG. NO. 2,837,854.

THE MARK CONSISTS OF THE WORDING  
SMARTLASER AND BELOW, A HORIZONTAL  
BROKEN LINE WITH THE REPRESENTATION OF  
AN ASTERISK AT THE END.

SER. NO. 79-026,928, FILED 4-14-2006.

CARRIE GENOVESE, EXAMINING ATTORNEY

**Int. Cls.: 1, 5 and 42**

**Prior U.S. Cls.: 1, 5, 6, 10, 18, 26, 44, 46, 51, 52, 100  
and 101**

**Reg. No. 3,395,056**

**United States Patent and Trademark Office**

**Registered Mar. 11, 2008**

**TRADEMARK  
SERVICE MARK  
PRINCIPAL REGISTER**

# DOTTISOL

DOTTIKON ES HOLDING AG (SWITZERLAND  
SOCIÉTÉ ANONYME)  
HEMBRUNNSTRASSE 17  
CH-5605 DOTTIKON, SWITZERLAND

FOR: INDUSTRIAL CHEMICALS, NAMELY, AL-  
DEHYDES, ETHYL ALCOHOL, ANHYDRIDES,  
ETHERS, ACETATES, INACTIVE BASES FOR USE  
IN THE COMPOUNDING OF CHEMICAL PRO-  
DUCTS; BENZENE DERIVATIVES FOR USE AS  
PRESERVATIVES IN PHARMACEUTICAL AND  
MEDICAL PREPARATIONS; CHEMICAL PRE-  
PARATIONS FOR USE IN PHOTOGRAPHY; CHE-  
MICALS FOR USE IN INDUSTRY AND SCIENCE;  
CHEMICAL PREPARATIONS FOR SCIENTIFIC  
PURPOSES NOT FOR MEDICAL OR VETERINARY  
USE; COMBUSTING PREPARATIONS, NAMELY,  
CHEMICAL ADDITIVES FOR FUELS; CHEMICAL  
PREPARATIONS FOR THE MANUFACTURE OF  
PAINTS; CHEMICAL REAGENTS NOT FOR MED-  
ICINAL OR VETERINARY USE; THIONYL- AND  
SULFURIL CHLORIDES; DETERGENTS USED  
DURING MANUFACTURING OPERATIONS; DI-  
AGNOSTIC PREPARATIONS, OTHER THAN FOR  
MEDICAL OR VETERINARY PURPOSES; NITRATE  
ESTERS; CARBONIC HYDRATES; CHEMICAL  
CATALYSTS FOR USE IN THE MANUFACTURE  
OF A WIDE VARIETY OF GOODS IN THE CHEMI-  
CAL AND PHARMACEUTICAL INDUSTRIES;  
PLANT GROWTH REGULATING PREPARATIONS,  
PICRIC ACID, REAGENTS FOR SCIENTIFIC AP-  
PLICATIONS; CHEMICALS, NAMELY, ORGANIC  
AND INORGANIC ACIDS FOR USE IN FERTILI-  
ZERS AND OTHER AGRICULTURAL PRODUCTS;  
BENZENE-BASED ACIDS, IN CLASS 1 (U.S. CLS. 1,  
5, 6, 10, 26 AND 46).

FOR: AMINO ACIDS FOR MEDICAL PURPOSES;  
AMINO ACIDS FOR VETERINARY PURPOSES;  
MEDICINES FOR HUMAN PURPOSES FOR THE  
TREATMENT OF HIGH BLOOD PRESSURE, CAN-  
CER, GASTROINTESTINAL DISEASE AND IRRI-

TABLE BOWEL SYNDROME; MEDICINES FOR  
VETERINARY PURPOSES, NAMELY, ANTIBIO-  
TICS, VACCINES AND ANTISEPTIC SOLUTIONS;  
ANTISEPTIC ETHERS FOR PHARMACEUTICAL  
PURPOSES; CHEMICAL-PHARMACEUTICALS  
PREPARATIONS FOR COMBATING INFECTIOUS  
DISEASES; CHEMICAL REAGENTS FOR MEDICAL  
OR VETERINARY PURPOSES; HERBICIDES;  
PHARMACEUTICAL PRODUCTS FOR TREAT-  
MENT OF VIRAL AND INFECTIOUS DISEASE  
AND FOR THE TREATMENT OF CANCER; VETER-  
INARY PRODUCTS FOR THE COMBAT OF INFEC-  
TIOUS DISEASE; RADIOLOGICAL CONTRAST  
SUBSTANCES FOR MEDICAL PURPOSES; AMINO  
ACIDS FOR PHARMACEUTICAL PURPOSES;  
WEEDKILLERS; VERMIN DESTROYING PRE-  
PARATIONS; DIETETIC SUGAR FOR MEDICAL  
PURPOSES, IN CLASS 5 (U.S. CLS. 6, 18, 44, 46, 51  
AND 52).

FOR: CHEMISTRY RESEARCH SERVICES; CHE-  
MICAL ANALYSIS; RESEARCH AND DEVELOP-  
MENT OF NEW PRODUCTS FOR THIRD PARTIES;  
CHEMICAL RESEARCH, IN CLASS 42 (U.S. CLS. 100  
AND 101).

THE MARK CONSISTS OF STANDARD CHAR-  
ACTERS WITHOUT CLAIM TO ANY PARTICULAR  
FONT, STYLE, SIZE, OR COLOR.

PRIORITY DATE OF 3-24-2006 IS CLAIMED.

OWNER OF INTERNATIONAL REGISTRATION  
0893448 DATED 6-22-2006, EXPIRES 6-22-2016.

SER. NO. 79-026,936, FILED 6-22-2006.

BENJAMIN OKEKE, EXAMINING ATTORNEY



**Int. Cls.: 9 and 11**

**Prior U.S. Cls.: 13, 21, 23, 26, 31, 34, 36 and 38**

**United States Patent and Trademark Office**

**Reg. No. 3,395,057**

**Registered Mar. 11, 2008**

**TRADEMARK  
PRINCIPAL REGISTER**

**XENIUS**

HELLA KGAA HUECK & CO. (FED REP GER-  
MANY KOMMANDITGESELLSCHAFT AUF  
AKTIEN (KGAA))  
RIXBECKER STRAÙE 75  
59552 LIPPSTADT  
FED REP GERMANY

FOR: ELECTRIC AND ELECTRONIC CONTROL  
DEVICES, NAMELY, ELECTRIC BALLASTS; ELEC-  
TRIC SWITCHING DEVICES FOR LIGHTING  
EQUIPMENT FOR MOTOR VEHICLES, NAMELY,  
FOR HEADLAMPS AND LAMPS, IN CLASS 9 (U.S.  
CLS. 21, 23, 26, 36 AND 38).

FOR: LIGHTING EQUIPMENT FOR MOTOR  
VEHICLES, NAMELY, HEADLAMPS AND LAMPS,  
IN CLASS 11 (U.S. CLS. 13, 21, 23, 31 AND 34).

THE MARK CONSISTS OF STANDARD CHAR-  
ACTERS WITHOUT CLAIM TO ANY PARTICULAR  
FONT, STYLE, SIZE, OR COLOR.

PRIORITY DATE OF 9-9-2005 IS CLAIMED.

OWNER OF INTERNATIONAL REGISTRATION  
0893738 DATED 2-24-2006, EXPIRES 2-24-2016.

SER. NO. 79-027,052, FILED 2-24-2006.

SHARON MEIER, EXAMINING ATTORNEY

**Int. Cls.: 9 and 38**

**Prior U.S. Cls.: 21, 23, 26, 36, 38, 100, 101 and 104**

**United States Patent and Trademark Office**

**Reg. No. 3,395,058**

**Registered Mar. 11, 2008**

**TRADEMARK  
SERVICE MARK  
PRINCIPAL REGISTER**

# LIVEPHONE

FRANCE TELECOM (FRANCE SOCIÉTÉ ANONYME)  
6, PLACE D'ALLERAY  
F-75015 PARIS  
FRANCE

FOR: TELEPHONE APPARATUS, NAMELY, WIRELESS TELEPHONE APPARATUS FOR SENDING AND RECEIVING TELEPHONE CALLS, ELECTRONIC DATA, TEXT MESSAGES, DIGITAL IMAGES, AND SOUND RECORDINGS USING A CHIP COMPOSED OF TRANSISTORS FOR EXCHANGING DATA BETWEEN DIFFERENT PERIPHERAL DEVICES BY MEANS OF A LOW-FREQUENCY RADIO LINK; TELEPHONE APPARATUS FOR SENDING AND RECEIVING TELEPHONE CALLS, ELECTRONIC DATA, TEXT MESSAGES, DIGITAL IMAGES, AND SOUND RECORDINGS USING A TELECOMMUNICATION NETWORK NOT EXCLUSIVELY RESTRICTED TO TWO INTERLOCUTORS BY CAUSING TO CIRCULATE ON THE INTERNET DATA PACKETS CORRESPONDING TO DIGITIZED VOICE SAMPLES, IN CLASS 9 (U.S. CLS. 21, 23, 26, 36 AND 38).

FOR: TELECOMMUNICATIONS SERVICES, NAMELY, COMMUNICATIONS SERVICES BY TELEPHONE, BY MOBILE TELEPHONE, OPTICAL FIBER AND CABLE NETWORKS AND BY ALL

REMOTE DATA PROCESSING MEANS; COMMUNICATIONS BY COMPUTER TERMINALS; PROVIDING MOBILE TELECOMMUNICATION SERVICES BY USING A SYSTEM OF PRE-PAID CARDS; MOBILE RADIOTELEPHONY SERVICES; TRANSMISSION OF DATA, SOUNDS AND IMAGE SIGNALS, ELECTRONIC TRANSMISSION OF INFORMATION BY MEANS OF DATA COMMUNICATIONS ACCESSIBLE VIA ACCESS CODES OR TERMINALS; INFORMATION AND DATA TRANSMISSION SERVICES BY MEANS OF COMPUTER; DATA TRANSMISSION SERVICES USING DATA COMMUNICATION SYSTEMS, NAMELY, THE INTERNET, EXTRANET AND INTRANET NETWORKS; ELECTRONIC TRANSMISSION OF INFORMATION BY SECURED MESSAGING SYSTEMS; PROVIDING ACCESS TO TELEPHONE, MOBILE TELEPHONE, COMPUTING AND TELEMATIC NETWORKS, IN CLASS 38 (U.S. CLS. 100, 101 AND 104).

OWNER OF INTERNATIONAL REGISTRATION  
0893943 DATED 5-12-2006, EXPIRES 5-12-2016.

SER. NO. 79-027,120, FILED 5-12-2006.

JEFF DEFORD, EXAMINING ATTORNEY

**Int. Cl.: 43**

**Prior U.S. Cls.: 100 and 101**

**United States Patent and Trademark Office**

**Reg. No. 3,395,059**

**Registered Mar. 11, 2008**

**SERVICE MARK  
PRINCIPAL REGISTER**

**LA PICARDE**

HOLDER (FRANCE SOCIÉTÉ PAR ACTIONS  
SIMPLIFIÉE)  
2, PLACE DE LA GARE  
F-59110 LA MADELEINE  
FRANCE

OWNER OF INTERNATIONAL REGISTRATION  
0894106 DATED 5-16-2006, EXPIRES 5-16-2016.

FOR: PROVIDING FOOD AND DRINKS IN RESTAURANTS; BAR SERVICES; CATERING SERVICES, IN CLASS 43 (U.S. CLS. 100 AND 101).

THE FOREIGN WORDING IN THE MARK TRANSLATES INTO ENGLISH AS THE WOMAN FROM PICARDY.

THE MARK CONSISTS OF STANDARD CHARACTERS WITHOUT CLAIM TO ANY PARTICULAR FONT, STYLE, SIZE, OR COLOR.

SER. NO. 79-027,187, FILED 5-16-2006.

PRIORITY DATE OF 11-16-2005 IS CLAIMED.

LINDA POWELL, EXAMINING ATTORNEY

**Int. Cls.: 5 and 9**

**Prior U.S. Cls.: 6, 18, 21, 23, 26, 36, 38, 44, 46, 51 and 52**

**Reg. No. 3,395,060**

**United States Patent and Trademark Office**

**Registered Mar. 11, 2008**

---

**TRADEMARK  
PRINCIPAL REGISTER**



DAYSOF LIMITED  
151 ST VINCENT STREET  
GLASGOW G2 5NJ  
UNITED KINGDOM

FOR: SOLUTIONS AND CLEANING PREPARATIONS FOR CONTACT LENSES, IN CLASS 5 (U.S. CLS. 6, 18, 44, 46, 51 AND 52).

FOR: CONTACT LENSES; CASES AND HOLDERS FOR CONTACT LENSES; OPTICAL AND OPH-

THALMIC LENSES; EYEGASSES, IN CLASS 9 (U.S. CLS. 21, 23, 26, 36 AND 38).

OWNER OF INTERNATIONAL REGISTRATION 0896296 DATED 5-5-2006, EXPIRES 5-5-2016.

SER. NO. 79-028,035, FILED 5-5-2006.

RAMONA ORTIGA, EXAMINING ATTORNEY

**Int. Cl.: 18**

**Prior U.S. Cls.: 1, 2, 3, 22 and 41**

**Reg. No. 3,395,061**

**United States Patent and Trademark Office**

**Registered Mar. 11, 2008**

**TRADEMARK  
PRINCIPAL REGISTER**



PUNCH INTERNATIONAL PTY LTD (AUSTRALIA COMPANY INCORPORATED IN NEW SOUTH WALES AUSTRALIA)

UNIT 6  
2 BISHOP STREET; ST PETERS NSW 2044  
AUSTRALIA

NO CLAIM IS MADE TO THE EXCLUSIVE RIGHT TO USE "SUPERIOR DURABILITY", APART FROM THE MARK AS SHOWN.

FOR: LEATHER AND IMITATION LEATHER, IN CLASS 18 (U.S. CLS. 1, 2, 3, 22 AND 41).

SER. NO. 79-028,582, FILED 4-18-2006.

OWNER OF INTERNATIONAL REGISTRATION 0897794 DATED 4-18-2006, EXPIRES 4-18-2016.

JOHN DWYER, EXAMINING ATTORNEY

**Int. Cl.: 9**

**Prior U.S. Cls.: 21, 23, 26, 36 and 38**

**United States Patent and Trademark Office**

**Reg. No. 3,395,062**

**Registered Mar. 11, 2008**

**TRADEMARK  
PRINCIPAL REGISTER**

**ENDURA ELITE**

IDX COMPANY, LTD. (JAPAN CORPORATION)  
28-11, SHUKUGAWARA 6-CHOME  
TAMA-KU, KAWASAKI-SHI  
KANAGAWA-KEN 214-0021, JAPAN

FOR: ELECTRIC BATTERIES FOR VIDEO CAMERAS FOR THE BROADCAST AND VIDEO INDUSTRY, CHARGERS WITH ELECTRIC DISCHARGE FUNCTION FOR BATTERIES OF A VIDEO CAMERA, CHARGERS FOR BATTERIES OF OTHER TYPES, METERS OF STATE OF CHARGE OF ELECTRIC BATTERIES, METERS OF STATE OF RESIDUAL-CAPACITY OF ELECTRIC BATTERIES, STORAGE CONTAINERS FOR BATTERIES OF A VIDEO CAMERA, POWER SUPPLY ADAPTERS FOR CHARGERS, CINEMATOGRAPHIC MACHINES, ELECTRIC OR MAGNETIC METERS AND TESTERS, RECEIVERS OF ELECTRONIC AUDIO SIGNALS, RECEIVERS OF ELECTRONIC VIDEO SIGNALS, TRANSMITTERS OF ELECTRONIC AUDIO SIGNALS, TRANSMITTERS OF ELECTRONIC VIDEO SIGNALS, IN CLASS 9 (U.S. CLS. 21, 23, 26, 36 AND 38).

THE MARK CONSISTS OF STANDARD CHARACTERS WITHOUT CLAIM TO ANY PARTICULAR FONT, STYLE, SIZE, OR COLOR.

PRIORITY DATE OF 5-19-2006 IS CLAIMED.

OWNER OF INTERNATIONAL REGISTRATION 0898457 DATED 5-29-2006, EXPIRES 5-29-2016.

OWNER OF U.S. REG. NOS. 2,671,020 AND 3,133,274.

NO CLAIM IS MADE TO THE EXCLUSIVE RIGHT TO USE "ELITE", APART FROM THE MARK AS SHOWN.

SER. NO. 79-028,885, FILED 5-29-2006.

MICHAEL ENGEL, EXAMINING ATTORNEY

**Int. Cls.: 7, 37 and 40**

**Prior U.S. Cls.: 13, 19, 21, 23, 31, 34, 35, 100, 103 and 106**

**United States Patent and Trademark Office**

**Reg. No. 3,395,063**

**Registered Mar. 11, 2008**

**TRADEMARK  
SERVICE MARK  
PRINCIPAL REGISTER**



ATLANTIS RESOURCES CORPORATION; PTE  
LIMITED (SINGAPORE PRIVATE LIMITED  
COMPANY)  
C/O 5 SHENTON WAY,  
#02-02, UIC BUILDING; SINGAPORE 068808  
SINGAPORE

FOR: GENERATORS, NAMELY, UNDERWATER  
ELECTRICITY GENERATORS; PUBLIC OR PRI-  
VATE UTILITY INSTALLATIONS FOR GENERAT-  
ING POWER FROM NATURAL SOURCES, MOBILE  
ELECTRICAL POWER GENERATORS, TURBINES  
FOR POWER GENERATION, TURBINE BLADES  
FOR POWER GENERATION; DYNAMOS; ELEC-  
TRIC MOTORS FOR MACHINES; ELECTRIC  
PUMPS; PUMPS FOR COOLING ENGINES; AND  
METALWORKING MACHINE TOOLS, IN CLASS 7  
(U.S. CLS. 13, 19, 21, 23, 31, 34 AND 35).

FOR: ADVISORY AND CONSULTATION SERVI-  
CES RELATING TO THE INSTALLATION OF GEN-  
ERATORS; INSTALLATION OF ELECTRICITY  
GENERATORS; MAINTENANCE AND REPAIR OF  
ELECTRIC POWER GENERATING INSTALLA-  
TIONS, IN CLASS 37 (U.S. CLS. 100, 103 AND 106).

FOR: RENTAL OF ELECTRICITY GENERATORS;  
GENERATING OF ELECTRICITY; TREATMENT  
OF WASTE MATERIAL FROM GENERATING OP-  
ERATIONS, IN CLASS 40 (U.S. CLS. 100, 103 AND  
106).

PRIORITY DATE OF 5-8-2006 IS CLAIMED.

OWNER OF INTERNATIONAL REGISTRATION  
0899174 DATED 7-14-2006, EXPIRES 7-14-2016.

"THE MARK CONSISTS OF THE WORDS AQUA-  
NATOR WITHIN A RECTANGLE WITH A WAVE  
BELOW THE WORDING AND A SHADED SQUARE  
TO THE LEFT OF THE WORDING WHICH CON-  
TAINS WATER DROPS."

SER. NO. 79-029,203, FILED 7-14-2006.

MARY BOAGNI, EXAMINING ATTORNEY

**Int. Cls.: 32, 35 and 43**

**Prior U.S. Cls.: 45, 46, 48, 100, 101 and 102**

**United States Patent and Trademark Office**

**Reg. No. 3,395,064**

**Registered Mar. 11, 2008**

**TRADEMARK  
SERVICE MARK  
PRINCIPAL REGISTER**



HUBERTUS ANTONIUS FRANCISCUS; MARIA  
VAN OSTADEN (BELGIUM INDIVIDUAL)  
KROMMEKEERSTRAAT 21 B-8755  
RUISELEDE, BELGIUM AND  
HILDEGARD ODETTE ANGÈLE OVERMEIRE  
(BELGIUM INDIVIDUAL)  
KROMMEKEERSTRAAT 21 B-8755  
RUISELEDE, BELGIUM

FOR: BEERS INCLUDING NON-ALCOHOLIC  
BEERS AND BEERS WITH LOW PERCENTAGE,  
NON-ALCOHOLIC DRINKS, NAMELY, NON-AL-  
COHOLIC FRUIT JUICE BEVERAGES AND NON-  
ALCOHOLIC MALT COOLERS, IN CLASS 32 (U.S.  
CLS. 45, 46 AND 48).

FOR: ADVERTISING; BUSINESS MANAGE-  
MENT; BUSINESS ADMINISTRATION; OFFICE  
FUNCTIONS, IN CLASS 35 (U.S. CLS. 100, 101 AND  
102).

FOR: SERVICES FOR PROVIDING FOOD AND  
DRINKS; TEMPORARY ACCOMMODATION, IN  
CLASS 43 (U.S. CLS. 100 AND 101).

PRIORITY DATE OF 4-20-2006 IS CLAIMED.

OWNER OF INTERNATIONAL REGISTRATION  
0899358 DATED 7-19-2006, EXPIRES 7-19-2016.

THE MARK CONSISTS OF THE WORD URTHEL  
BENEATH A STYLIZED IMAGE OF A BUST OF A  
MAN, THE MAN IS HOLDING A BEER WITH A  
WHITE HEAD.

SER. NO. 79-029,265, FILED 7-19-2006.

ALICE BENMAMAN, EXAMINING ATTORNEY



**Int. Cls.: 6, 9, 19, 20 and 37**

**Prior U.S. Cls.: 1, 2, 12, 13, 14, 21, 22, 23, 25, 26, 32, 33, 36, 38, 50, 100, 103 and 106**

**Reg. No. 3,395,065**

**United States Patent and Trademark Office**

**Registered Mar. 11, 2008**

**TRADEMARK  
SERVICE MARK  
PRINCIPAL REGISTER**



KONE CORPORATION (FINLAND PUBLIC LIMITED LIABILITY COMPANY)  
KARTANONTIE 1  
FI-00330 HELSINKI  
FINLAND

FOR: DOORS OF METAL OR PREDOMINANTLY OF METAL, INCLUDING SLIDING DOORS, REVOLVING DOORS, NON-AUTOMATIC TURNSTILES, ROLLER DOORS, FOLDING DOORS, AND SWING-UP DOORS; BUILDING FITTINGS AND DOOR AND WINDOW HARDWARE, NAMELY, FITTINGS FOR WINDOWS AND DOORS OF METAL, METAL DOOR HINGES, METAL DOOR HANDLES, METAL DOOR BOLTS, METAL DOOR KNOBS, AND METAL DOOR FRAMES, IN CLASS 6 (U.S. CLS. 2, 12, 13, 14, 23, 25 AND 50).

FOR: ACCESS CONTROL MONITORING SYSTEMS FOR ENABLING ACCESS OR ENTRANCE CONTROL; AUTOMATIC SLIDING DOORS; AND ELECTRIC AND ELECTRONIC OPERATING MECHANISMS FOR AUTOMATIC BARRIERS AND GATES, IN CLASS 9 (U.S. CLS. 21, 23, 26, 36 AND 38).

FOR: NON-METALLIC SLIDING DOORS, NON-METALLIC REVOLVING DOORS, NON-METALLIC AND NON-AUTOMATIC TURNSTILES, NON-METALLIC ROLLER DOORS, NON-METALLIC FOLDING DOORS AND SWING-UP DOORS, NON-METALLIC FLEXIBLE HANGING AND STRIP DOORS; AND NON-METALLIC DOOR FRAMES, IN CLASS 19 (U.S. CLS. 1, 12, 33 AND 50).

FOR: NON-METALLIC BUILDING FITTINGS AND DOOR AND WINDOW FURNITURE, NAMELY, DOOR HINGES, DOOR HANDLES, DOOR BOLTS, AND DOOR KNOBS; FITTINGS FOR WINDOWS AND DOORS NOT OF METAL, NAMELY, NON-METAL DOOR LATCHES, NON-METAL DOOR TRIMS, NON-METAL DOOR VIEWERS, AND NON-METAL WINDOW TRIMS, IN CLASS 20 (U.S. CLS. 2, 13, 22, 25, 32 AND 50).

FOR: MAINTENANCE, REPAIR, AND INSTALLATION OF DOORS, GATES, AND BARRIERS, ESPECIALLY AUTOMATIC DOORS, INDUSTRIAL DOORS, AND AUTOMATIC GATES AND BARRIERS AND ASSOCIATED COMPONENTS AND SPARE PARTS FOR SUCH EQUIPMENT, IN CLASS 37 (U.S. CLS. 100, 103 AND 106).

PRIORITY DATE OF 9-28-2005 IS CLAIMED.

OWNER OF INTERNATIONAL REGISTRATION 0899464 DATED 10-13-2005, EXPIRES 10-13-2015.

OWNER OF U.S. REG. NOS. 1,105,492, 2,984,683 AND OTHERS.

THE ENGLISH TRANSLATION OF THE WORD KONE IN THE MARK IS ENGINE OR MACHINE.

SER. NO. 79-029,302, FILED 10-13-2005.

DANIEL CAPSHAW, EXAMINING ATTORNEY

**Int. Cls.: 10 and 44**

**Prior U.S. Cls.: 26, 39, 44, 100 and 101**

**United States Patent and Trademark Office**

**Reg. No. 3,395,066**

**Registered Mar. 11, 2008**

**TRADEMARK  
SERVICE MARK  
PRINCIPAL REGISTER**



MICROLIFE INTELLECTUAL PROPERTY  
GMBH (SWITZERLAND GMBH)  
MAX SCHMIDHEINY-STRASSE 201  
CH-9435 HEERBRUGG  
SWITZERLAND

FOR: MEDICAL APPARATUS AND INSTRUMENTS, NAMELY, ALARMS AND SENSORS TO BE WORN ON A PERSON WHILE EXERCISING FOR THE PURPOSE OF MONITORING HEART RATE, APPARATUS FOR BLOOD ANALYSIS, APPARATUS FOR CLINICAL DIAGNOSIS, APPARATUS FOR TAKING BLOOD SAMPLES, BLOOD GLUCOSE METER, BLOOD PRESSURE MEASURING APPARATUS, BLOOD PRESSURE MONITORS, BODY FAT MONITORS, CARRYING CASE SPECIFICALLY ADAPTED FOR CARRYING DIABETIC SUPPLIES, NAMELY, BLOOD GLUCOSE METER, TESTING STRIPS AND ALSO INCLUDING INSULIN AND OTHER RELATED APPARATUS, CASES FITTED FOR MEDICAL INSTRUMENTS AND/OR FOR USE BY DOCTORS, CLINICAL THERMOMETERS, DEVICES FOR MEASURING BLOOD SUGAR, EKG MACHINES, ELECTROCARDIOGRAPHS, FEVER THERMOMETERS, HEALTH MONITORS COMPRISING SENSORS THAT MONITOR THE HEALTH OF THE ELDERLY OR HANDICAPPED IN THEIR OWN HOMES, HEART MONITORS, HEART MONITORS TO BE WORN DURING EXERCISE, HEARTBEAT MEASURING APPARATUS, MEDICAL APPARATUS FOR DIAGNOSING OR TREATING RESPIRA-

TORY CONDITIONS, MEDICAL DIAGNOSTIC APPARATUS, ANALYTICAL APPARATUS FOR MEDICAL PURPOSES AND BLOOD PRESSURE MEASURING APPARATUS, MEDICAL INSTRUMENT FOR CARDIOVASCULAR DIAGNOSTICS, MEDICAL TEST KITS FOR DIABETES MONITORING FOR HOME USE, PULSE MEASURING DEVICES, PULSE RATE MONITORS, RESPIRATION MONITORS, IN CLASS 10 (U.S. CLS. 26, 39 AND 44).

FOR: HEALTH CARE, MEDICAL SERVICES AND MEDICAL ASSISTANCE, HOSPITALS, NURSING, PHARMACEUTICAL ADVICE, PHYSIOTHERAPY, SERVICES OF A PSYCHOLOGIST, NAMELY, PSYCHOLOGICAL CONSULTATION AND PSYCHOLOGICAL COUNSELING, IN CLASS 44 (U.S. CLS. 100 AND 101).

PRIORITY DATE OF 3-27-2006 IS CLAIMED.

OWNER OF INTERNATIONAL REGISTRATION  
0899598 DATED 9-25-2006, EXPIRES 9-25-2016.

OWNER OF U.S. REG. NO. 3,124,639.

SER. NO. 79-029,358, FILED 9-25-2006.

LINDA M. KING, EXAMINING ATTORNEY

Int. Cls.: 9, 38 and 42

Prior U.S. Cls.: 21, 23, 26, 36, 38, 100, 101 and 104

Reg. No. 3,395,067

United States Patent and Trademark Office

Registered Mar. 11, 2008

TRADEMARK  
SERVICE MARK  
PRINCIPAL REGISTER



DYLOGIC S.R.L. (ITALY CORPORATION)  
VIA SAN VITTORE, 40  
I-20123 MILANO, ITALY

FOR: COMPUTER HARDWARE AND SOFTWARE FOR TELECONFERENCING AND VIDEOCONFERENCING; COMPUTER SOFTWARE FOR TRANSMITTING, DISTRIBUTING, ROUTING, INTEGRATING, SHARING, CONTROLLING, ENHANCING, SECURING AND MANAGING AUDIO, VIDEO AND DATA COMMUNICATIONS TO AND FROM MULTIPLE USERS AND LOCATIONS; COMPUTERS; COMPUTER HARDWARE TO ENABLE VIDEOCONFERENCING, VIDEO TELEPHONY, VIDEO AND VOICE COMMUNICATION; COMPUTER SOFTWARE FOR USE IN VIDEOCONFERENCING, VIDEO TELEPHONY, VIDEO AND VOICE COMMUNICATION AND FOR USE IN THE DEVELOPMENT OF CONVERGED VOICE, VIDEO AND DATA OVER INTERNET PROTOCOL AND THIRD GENERATION NETWORKS; COMPUTER HARDWARE; COMPUTER SOFTWARE FOR USE IN CONTROLLING AND DIAGNOSING PROBLEMS WITH HARDWARE IN THE FIELD OF TELECOMMUNICATIONS; TELECOMMUNICATIONS HARDWARE, NAMELY, TELECOMMUNICATIONS EXCHANGERS, TELECOMMUNICATIONS TOWERS, TELECOMMUNICATIONS CABLES, TELECOMMUNICATIONS TRANSMITTERS, COMPUTER HARDWARE FOR TELECOMMUNICATIONS, AUTOMATIC SWITCHING APPARATUS; TELECOMMUNICATIONS SWITCHES; SEMICONDUCTORS; ELECTRONIC AND ELECTROMECHANICAL APPARATUS FOR USE WITH COMPUTERS AND/OR COMPUTER NETWORKS, NAMELY, COMPUTER PERIPHERALS; VIDEO EQUIPMENT, NAMELY, VIDEO CAMERAS, DIGITAL VIDEO RECORDERS, DISTRIBUTION AMPLIFIERS FOR VIDEO SIGNALS, VIDEO CIRCUIT BOARDS, VIDEO DISPLAY CARDS; DATA RECORDED IN ELECTRONIC, OPTICAL OR MAGNETIC FORM, NAMELY, PRERECORDED MAGNETIC DATA

CARRIERS FEATURING TELECOMMUNICATIONS INFORMATION; MICROPROCESSORS; COMPUTER MEDIA SERVERS; GATEWAY ROUTERS IN THE NATURE OF COMPUTER CONTROL HARDWARE; INTEGRATED CIRCUITS; APPARATUS AND INSTRUMENTS FOR RECORDING, PROCESSING, RECEIVING, REPRODUCING, TRANSMITTING, MODIFYING, COMPRESSING, DECOMPRESSING, BROADCASTING, MERGING OR ENHANCING OF DATA, VIDEO, SOUND AND OTHER MEDIA OR MULTI-MEDIA, NAMELY, DIGITAL VIDEO AND AUDIO RECORDERS, APPARATUS FOR RECORDING, TRANSMISSION OR REPRODUCTION OF SOUND AND IMAGES, TRANSCEIVERS, TELECOMMUNICATIONS TRANSMITTERS, DATA COMPRESSION SOFTWARE, TRANSMITTING AND RECEIVING APPARATUS FOR RADIO AND TELEVISION BROADCASTING AND FOR LONG-DISTANCE TRANSMISSION; INTERFACE SWITCHES, NAMELY, TELECOMMUNICATION SWITCHES, MULTIPLEXERS; COMPUTER SERVERS, NAMELY, BROADBAND VIDEO STORAGE AND BROADCAST SERVERS; TELEPHONE APPARATUS, NAMELY, TELECONFERENCING BRIDGES; LAN HARDWARE, NAMELY, NETWORK INTERFACE CARDS; SWITCHING DEVICES FOR USE WITH LOCAL AND/OR WIDE AREA NETWORKS, NAMELY, TELECOMMUNICATION SWITCHES, MULTIPLEXERS; COMPUTER NETWORK ANALYZERS, NAMELY, COMPUTER SOFTWARE FOR USE IN ANALYZING COMPUTER NETWORKS, IN CLASS 9 (U.S. CLS. 21, 23, 26, 36 AND 38).

FOR: TELECOMMUNICATIONS CONSULTATION, NAMELY, CONSULTATION RELATING TO VIDEO TELEPHONY, VIDEO CONFERENCING, TELECONFERENCING AND TELECOMMUNICATING; TRANSMISSION OF IMAGES, DATA, MESSAGES, AUDIO AND VIDEO VIA LANS, WANS, BROADBAND ACCESS AND A GLOBAL COMMUNICATIONS NETWORK; ELECTRONIC EX-

CHANGE OF IMAGES, DATA, MESSAGES, AUDIO AND VIDEO VIA TELECOMMUNICATION NETWORKS; WIRELESS DATA COMMUNICATIONS SERVICES, NAMELY, WIRELESS ELECTRONIC TRANSMISSION OF VOICE SIGNALS, DATA, FACSIMILES, IMAGES AND INFORMATION; TELECOMMUNICATIONS SERVICES, NAMELY, LOCAL AND LONG DISTANCE TRANSMISSION OF VOICE, DATA, GRAPHICS BY MEANS OF TELEPHONE, TELEGRAPHIC, CABLE, FIBER OPTIC AND SATELLITE TRANSMISSIONS; COMMUNICATIONS SERVICES VIA ELECTRONIC PLATFORMS, NAMELY, INFORMATION TRANSMISSION VIAL ELECTRONIC COMMUNICATIONS NETWORKS; ELECTRONIC DATA INTERCHANGE SERVICES; TELECOMMUNICATIONS SERVICES FOR DOCUMENT AND INFORMATION EXCHANGE, NAMELY, TRANSMISSION OF DATA AND DOCUMENTS AMONG USERS OF COMPUTERS; AUDIO AND VIDEO TELECONFERENCING; STREAMING OF VIDEO MATERIAL ON THE INTERNET; PROVISION OF MULTIPLE USER ACCESS TO A GLOBAL COMPUTER INFORMATION NETWORK; PROVISION OF CENTRAL SWITCHING SERVICES FOR ELECTRONIC COMMUNICATIONS NETWORKS, NAMELY, WORLDWIDE SWITCHED TEXT AND MESSAGE TRANSMISSION SERVICES; PROVIDING ACCESS TO ELECTRONIC TELECOMMUNICATIONS NETWORKS, FOR TRANSMISSION OR RECEPTION OF DATA, AUDIO, VIDEO OR MULTIMEDIA CONTENT; PROVISION OF ACCESS TO TELECOMMUNICATIONS NETWORKS FOR ACCESSING AND UPDATING INFORMATION ACROSS MULTIPLE COMMUNICATIONS AND COMPUTING DEVICES; ELECTRONIC MAIL SERVICES; INTERNET SERVICE PROVIDER SERVICES, IN CLASS 38 (U.S. CLS. 100, 101 AND 104).

FOR: COMPUTER SERVICES, NAMELY, COMPUTER DIAGNOSTIC SERVICES, DATA RECOVERY SERVICES, DESIGNING AND IMPLEMENTING NETWORK WEBPAGES FOR OTHERS, PROVIDING SEARCH ENGINES FOR OBTAINING DATA ON A GLOBAL COMPUTER NETWORK, FILTERING OF UNWANTED E-MAILS; COMPUTER CONSULTATION SERVICES; CONSULTATION IN THE FIELD OF COMPUTER HARDWARE, COMPUTER SOFTWARE, COMPUTER NETWORKING AND INFORMATION TECHNOLOGY; DESIGN, NAMELY, COMPUTER SOFTWARE DESIGN FOR OTHERS, COMPUTER NETWORK DESIGN FOR OTHERS, COMPUTER SITE DESIGN, WEBSITE DESIGN FOR OTHERS;

TESTING, RESEARCH, AND ANALYSIS OF COMPUTERS, COMPUTER NETWORKS, COMPUTER SOFTWARE; TECHNICAL SUPPORT SERVICES, NAMELY, TROUBLE SHOOTING OF COMPUTER HARDWARE AND SOFTWARE PROBLEMS, MONITORING OF NETWORK SYSTEMS, AND PROVIDING BACK-UP COMPUTER PROGRAMS AND FACILITIES; RESEARCH AND DEVELOPMENT OF COMPUTER AND COMMUNICATIONS SOFTWARE; DESIGN AND UPGRADING OF COMPUTER SOFTWARE AND COMMUNICATIONS SOFTWARE; PROVIDING INFORMATION AT THE SPECIFIC REQUEST OF END-USERS BY MEANS OF GLOBAL COMPUTER NETWORKS; PROVIDING SEARCH ENGINES FOR OBTAINING DATA ON A GLOBAL COMPUTER NETWORK; COMPUTER SERVICES, NAMELY, ACTING AS AN APPLICATION SERVICE PROVIDER IN THE FIELD OF KNOWLEDGE MANAGEMENT TO HOST COMPUTER APPLICATION SOFTWARE FOR CREATING SEARCHABLE DATABASES OF INFORMATION AND DATA; DESIGN, CREATION, MAINTENANCE AND HOSTING OF COMPUTER SOFTWARE APPLICATIONS AND WEBSITES ENABLING TELECONFERENCING, VIDEO CONFERENCING, VIDEO CALLS, VIDEO PORTAL, VIDEO MAIL, CONFERENCE OVERFLOW AND VIDEO EVENTS, IN CLASS 42 (U.S. CLS. 100 AND 101).

PRIORITY DATE OF 6-27-2006 IS CLAIMED.

OWNER OF INTERNATIONAL REGISTRATION 0901024 DATED 10-2-2006, EXPIRES 10-2-2016.

NO CLAIM IS MADE TO THE EXCLUSIVE RIGHT TO USE "MEDIA STATION", APART FROM THE MARK AS SHOWN.

THE MARK CONSISTS OF THE STYLIZED WORDING "MIRIAL" ABOVE THE STYLIZED WORDING AND CHARACTERS "[:"; "MEDIA STATION", "]:"; WITH THE DESIGN OF SEMI-CIRCULAR OBJECT WITH THE SILHOUETTE OF TWO SHADED TRIANGLES BEHIND IT. THE MARK ALSO CONSISTS OF EACH LETTER OF THE WORDING "MIRIAL" SURROUNDED BY A GENERALLY SQUARE, SHADED OBJECT.

SER. NO. 79-029,766, FILED 10-2-2006.

JAY BESCH, EXAMINING ATTORNEY

**Int. Cls.: 35, 36 and 41**

**Prior U.S. Cls.: 100, 101, 102 and 107**

**United States Patent and Trademark Office**

**Reg. No. 3,395,068**

**Registered Mar. 11, 2008**

**SERVICE MARK  
PRINCIPAL REGISTER**

**4 F**

OIKOCREDIT, ECUMENICAL DEVELOPMENT  
CO-OPERATIVE; SOCIETY U.A. (BELGIUM  
ECUMENICAL DEVELOPMENT CO-OPERATIVE;  
SOCIETY U.A)  
TESSELSCHADELAAN 4  
NL-3818 WD AMERSFOORT, NETHERLANDS

FOR: BUSINESS MANAGEMENT AND CONSULTATION RELATED THERETO; ECONOMICAL BUSINESS ADVICE IN THE FIELD OF ETHICAL INVESTMENTS, IN CLASS 35 (U.S. CLS. 100, 101 AND 102).

FOR: FINANCIAL SERVICES, NAMELY, INVESTMENT SERVICES RELATED TO ETHICAL PRINCIPLES AND DEVELOPMENT AID, NAMELY, INVESTMENT ADVICE, INVESTMENT CONSULTATION, INVESTMENT MANAGEMENT AND INVESTMENT FINANCING SERVICES; FINANCIAL MANAGEMENT OF FUNDS TO FINANCE AID AND DEVELOPMENT PROJECTS; FINANCIAL ANALYSES FOR THE EVALUATION OF DEVELOPMENT PROJECTS AND AID PROGRAMS, FINANCIAL ADVICE IN THE FIELD OF FINANCING; MUTUAL FUNDS DISTRIBUTION AND INVESTMENT RELATED TO DEVELOPMENT AID; INTERMEDIARY SERVICES IN THE FIELD OF STOCKS AND BONDS BROKERAGE, NAMELY, THE BUYING AND SELLING OF STOCKS AND BONDS; LOAN FINANCING; FINANCIAL INVESTMENT

IN COMMERCIAL, INDUSTRIAL AND FINANCIAL BUSINESSES OF OTHERS WITH AN ETHICAL CONTENT, IN CLASS 36 (U.S. CLS. 100, 101 AND 102).

FOR: EDUCATION, NAMELY, PROVIDING CLASSES, SEMINARS, WORKSHOPS IN THE FIELD OF DEVELOPMENT AID; PROVIDING TRAINING IN THE FIELD OF DEVELOPMENT AID; ORGANIZING EDUCATIONAL EXHIBITIONS, CONFERENCES AND CULTURAL ACTIVITIES IN THE FIELD OF DEVELOPMENT AID, IN CLASS 41 (U.S. CLS. 100, 101 AND 107).

THE MARK CONSISTS OF STANDARD CHARACTERS WITHOUT CLAIM TO ANY PARTICULAR FONT, STYLE, SIZE, OR COLOR.

PRIORITY DATE OF 12-23-2005 IS CLAIMED.

OWNER OF INTERNATIONAL REGISTRATION  
0901038 DATED 6-12-2006, EXPIRES 6-12-2016.

SER. NO. 79-029,914, FILED 6-12-2006.

WARREN L. OLANDRIA, EXAMINING ATTORNEY

**Int. Cls.: 9, 25, 35, 38, 41 and 42**

**Prior U.S. Cls.: 21, 22, 23, 26, 36, 38, 39, 100, 101, 102, 104 and 107**

**Reg. No. 3,395,069**

**United States Patent and Trademark Office**

**Registered Mar. 11, 2008**

**TRADEMARK  
SERVICE MARK  
PRINCIPAL REGISTER**



TAATU S.A. (BELGIUM SOCIÉTÉ ANONYME)  
CHAUSSÉE DE LOUVAIN 490  
B-1380 LASNE  
BELGIUM

FOR: ELECTRICAL CONDUCTORS; ELECTRICAL SWITCHES; ELECTRICAL TRANSFORMERS; ELECTRICAL ACCUMULATORS; VOLTAGE REGULATORS FOR ELECTRICAL POWER; ELECTRICAL CONTROLLERS; APPARATUS FOR RECORDING, TRANSMISSION OR REPRODUCTION OF SOUND AND IMAGES; PRERECORDED MAGNETIC DATA CARRIERS FEATURING SINGLE AND MULTI-PLAYER GAME PROGRAMS AND INFORMATION REGARDING VIRTUAL COMMUNITIES ON THE INTERNET; PRERECORDED SOUND RECORDING DISCS FEATURING MUSIC; AUTOMATIC VENDING MACHINES AND MECHANISMS FOR COIN-OPERATED APPARATUS IN THE NATURE OF COIN ACCEPTORS FOR SEPARATING GOOD COINS FROM COUNTERFEITS; CASH REGISTERS, CALCULATORS, DATA PROCESSORS AND COMPUTERS; FIRE EXTINGUISHERS, IN CLASS 9 (U.S. CLS. 21, 23, 26, 36 AND 38).

FOR: CLOTHING, NAMELY, SHIRTS, PANTS, AND JACKETS; FOOTWEAR; HEADGEAR, NAMELY, HATS AND CAPS, IN CLASS 25 (U.S. CLS. 22 AND 39).

FOR: COMPILATION OF TRADE AND BUSINESS DATA AND STATISTICAL DATA ON THE INTERNET, IN CLASS 35 (U.S. CLS. 100, 101 AND 102).

FOR: TELECOMMUNICATIONS, NAMELY, ELECTRONIC MAIL AND ELECTRONIC MESSAGE TRANSMISSION SERVICES; PROVIDING ONLINE FORUMS FOR TRANSMISSION OF MESSAGES AMONG COMPUTER USERS IN THE FIELD OF GENERAL INTEREST; ELECTRONIC TRANSMISSION OF DOCUMENTS AND MESSAGES ON INTERNET; PROVIDING ONLINE ELECTRONIC BULLETIN BOARDS FOR TRANSMISSION OF MESSAGES AMONG COMPUTER USERS IN THE FIELD OF GENERAL INTEREST, IN CLASS 38 (U.S. CLS. 100, 101 AND 104).

FOR: ORGANIZING COMMUNITY SPORTING AND CULTURAL EVENTS; ON-LINE SERVICES PROVIDING SINGLE AND MULTI-PLAYER COMPUTER GAMES THAT MAKE USE OF EDUCATIONAL CONTENT AND CULTURAL INFORMATION; ON-LINE EDUCATIONAL SERVICES, NAMELY, WORKSHOPS, TRAINING AND DEMONSTRATIONS IN THE FIELD OF SINGLE AND MULTI-PLAYER GAME PROGRAMS AND CULTURAL INFORMATION REGARDING VIRTUAL COMMUNITIES ON THE INTERNET, IN CLASS 41 (U.S. CLS. 100, 101 AND 107).

FOR: SCIENTIFIC RESEARCH AND TECHNOLOGICAL CONSULTATION SERVICES REGARDING COMPUTER AND SCIENTIFIC TECHNOLOGY IN THE FIELD OF ENTERTAINMENT SERVICES, NAMELY, VIRTUAL COMMUNITY ON INTERNET AND SCIENTIFIC RESEARCH AND DEVELOPMENT RELATING THERETO; DESIGN AND DEVELOPMENT OF COMPUTERS AND SOFTWARE; LEGAL SERVICES, IN CLASS 42 (U.S. CLS. 100 AND 101).

PRIORITY DATE OF 12-9-2005 IS CLAIMED.

OWNER OF INTERNATIONAL REGISTRATION  
0902392 DATED 6-8-2006, EXPIRES 6-8-2016.

THE COLOR(S) PINK, BLACK, WHITE IS/ARE  
CLAIMED AS A FEATURE OF THE MARK.

THE TERM "TAATU" APPEARS IN THE COLOR  
WHITE AGAINST A RECTANGULAR PINK BACK-  
GROUND, AND THE TERMS "CREATE THE  
WORLD" APPEAR IN THE COLOR BLACK  
AGAINST A WHITE BACKGROUND.

SER. NO. 79-030,471, FILED 6-8-2006.

PAULA MAHONEY, EXAMINING ATTORNEY

**Int. Cl.: 7**

**Prior U.S. Cls.: 13, 19, 21, 23, 31, 34 and 35**

**Reg. No. 3,395,070**

**United States Patent and Trademark Office**

**Registered Mar. 11, 2008**

**TRADEMARK  
PRINCIPAL REGISTER**

# MicroKom

KOMET GROUP HOLDING GMBH (FED REP  
GERMANY PUBLIC LIMITED COMPANY)  
ZEPPELINSTRASSE 3  
74354 BESIGHEIM, FED REP GERMANY

FOR: MACHINE-DRIVEN TOOLS, NAMELY, TOOLS FOR MACHINE TOOLS, NAMELY, CUTTING MACHINE TOOLS WITH FIXED OR EXCHANGEABLE CUTTERS MADE OF HARD CUTTING MATERIALS, NAMELY, DRILLING TOOLS, BORING, REBORING AND BORING-OUT TOOLS, SUPER-FINISH LATHE TOOLS, COUNTER-SINKING AND DEBURRING TOOLS, LANCING TOOLS; CUTTING MACHINE TOOLS WITH EXCHANGEABLE BORING-OUT RODS AND BORING-OUT STEELS, NAMELY, CHISELS FOR INSIDE AND OUTSIDE WORK AND LANCING; SUPPORT, GUIDE, ADJUSTING AND CLAMPING ELEMENTS FOR USE WITH MACHINE TOOLS; MANUALLY ADJUSTABLE AND MACHINE-ADJUSTABLE MACHINE-DRIVEN TOOLS; MACHINE-DRIVEN SPECIAL TOOLS AND THEIR COMPONENTS, NAMELY, MACHINE-DRIVEN SAWS, SAW BLADES AND SAW INSERTS MADE OF HARD CUTTING MATERIALS FOR THE AFOREMENTIONED SAWS, POWER-OPERATED METAL CUTTERS, POWER-OPERATED DRILLS, POWER-OPERATED PILOT, CENTER AND LEAD DRILL BITS FOR DRILLS, REBORERS AND OUT-BORERS, SUPER-FINISH LATHE TOOLS, REAMERS, COUNTERSINKERS AND DEBURRERS, LANCES, THREADERS; TOOL-HOLDING FIXTURES OR ADAPTERS, NAMELY, TAPER SHANKS, CLAMPING CHUCKS, EXTENSION AND REDUCING PIE-

CES FOR MACHINE TOOLS; MACHINE-DRIVEN MODULAR ADD-ON TOOLS WITH COUPLINGS AS INTERFACE AND SEPARATION POINTS FOR A MANUAL OR MACHINE-OPERATED COUPLING OF TOOLS TO MACHINE TOOL SPINDLES AND TOOLS; CUTTING INSERTS, REVERSIBLE CUTTING PLATES AND LATHE CHISELS MADE OF HARD CUTTING MATERIALS FOR USE IN MACHINE TOOLS; TOOL HOLDERS WITH FIRMLY FIXED OR EXCHANGEABLE CUTTERS FOR USE IN MACHINE TOOLS, NAMELY, REVERSIBLE CUTTING PLATE INSERTS, LATHE CHISELS, CLAMPING AND MOUNTING INSERTS AND HOLDERS, SUPER-FINISH LATHE INSERTS AND PARTS THEREOF, NAMELY, BOLTS, CLAMPS AND SCREWS, IN CLASS 7 (U.S. CLS. 13, 19, 21, 23, 31, 34 AND 35).

THE MARK CONSISTS OF STANDARD CHARACTERS WITHOUT CLAIM TO ANY PARTICULAR FONT, STYLE, SIZE, OR COLOR.

PRIORITY DATE OF 2-21-2006 IS CLAIMED.

OWNER OF INTERNATIONAL REGISTRATION  
0902424 DATED 8-17-2006, EXPIRES 8-17-2016.

SER. NO. 79-030,485, FILED 8-17-2006.

PRISCILLA MILTON, EXAMINING ATTORNEY



Int. Cl.: 7

Prior U.S. Cls.: 13, 19, 21, 23, 31, 34 and 35

Reg. No. 3,395,071

United States Patent and Trademark Office

Registered Mar. 11, 2008

TRADEMARK  
PRINCIPAL REGISTER

# TwinKom

KOMET GROUP HOLDING GMBH (FED REP  
GERMANY PUBLIC LIMITED COMPANY)  
ZEPPELINSTRASSE 3  
74354 BESIGHEIM, FED REP GERMANY

FOR: MACHINE-DRIVEN TOOLS, NAMELY, TOOLS FOR MACHINE TOOLS, NAMELY, CUTTING MACHINE TOOLS WITH FIXED OR EXCHANGEABLE CUTTERS MADE OF HARD CUTTING MATERIALS, NAMELY, DRILLING TOOLS, BORING, REBORING AND BORING-OUT TOOLS, SUPER-FINISH LATHE TOOLS, COUNTER-SINKING AND DEBURRING TOOLS, LANCING TOOLS; CUTTING MACHINE TOOLS WITH EXCHANGEABLE BORING-OUT RODS AND BORING-OUT STEELS, NAMELY, CHISELS FOR INSIDE AND OUTSIDE WORK AND LANCING; SUPPORT, GUIDE, ADJUSTING AND CLAMPING ELEMENTS FOR USE WITH MACHINE TOOLS; MANUALLY ADJUSTABLE AND MACHINE-ADJUSTABLE MACHINE-DRIVEN TOOLS; MACHINE-DRIVEN SPECIAL TOOLS AND THEIR COMPONENTS, NAMELY, MACHINE-DRIVEN SAWS, SAW BLADES AND SAW INSERTS MADE OF HARD CUTTING MATERIALS FOR THE AFOREMENTIONED SAWS, POWER-OPERATED METAL CUTTERS, POWER-OPERATED DRILLS, POWER-OPERATED PILOT, CENTER AND LEAD DRILL BITS FOR DRILLS, REBORERS AND OUT-BORERS, SUPER-FINISH LATHE TOOLS, REAMERS, COUNTER-SINKERS AND DEBURRERS, LANCES, THREADERS; TOOL-HOLDING FIXTURES OR ADAPTERS, NAMELY, TAPER SHANKS, CLAMPING CHUCKS, EXTENSION AND REDUCING PIE-

CES FOR MACHINE TOOLS; MACHINE-DRIVEN MODULAR ADD-ON TOOLS WITH COUPLINGS AS INTERFACE AND SEPARATION POINTS FOR A MANUAL OR MACHINE-OPERATED COUPLING OF TOOLS TO MACHINE TOOL SPINDLES AND TOOLS; CUTTING INSERTS, REVERSIBLE CUTTING PLATES AND LATHE CHISELS MADE OF HARD CUTTING MATERIALS FOR USE IN MACHINE TOOLS; TOOL HOLDERS WITH FIRMLY FIXED OR EXCHANGEABLE CUTTERS FOR USE IN MACHINE TOOLS, NAMELY, REVERSIBLE CUTTING PLATE INSERTS, LATHE CHISELS, CLAMPING AND MOUNTING INSERTS AND HOLDERS, SUPER-FINISH LATHE INSERTS AND PARTS THEREOF, NAMELY, BOLTS, CLAMPS AND SCREWS, IN CLASS 7 (U.S. CLS. 13, 19, 21, 23, 31, 34 AND 35).

THE MARK CONSISTS OF STANDARD CHARACTERS WITHOUT CLAIM TO ANY PARTICULAR FONT, STYLE, SIZE, OR COLOR.

PRIORITY DATE OF 2-21-2006 IS CLAIMED.

OWNER OF INTERNATIONAL REGISTRATION  
0902425 DATED 8-17-2006, EXPIRES 8-17-2016.

SER. NO. 79-030,486, FILED 8-17-2006.

PRISCILLA MILTON, EXAMINING ATTORNEY

**Int. Cls.: 9, 14, 16, 18, 25 and 34**

**Prior U.S. Cls.: 1, 2, 3, 5, 8, 9, 17, 21, 22, 23, 26, 27, 28, 29, 36, 37, 38, 39, 41 and 50**

**Reg. No. 3,395,072**

**United States Patent and Trademark Office**

**Registered Mar. 11, 2008**

**TRADEMARK  
PRINCIPAL REGISTER**

The logo for Dunhill, featuring the word "dunhill" in a lowercase, bold, sans-serif font. Above the letters "u", "n", and "h" are three vertical bars of varying heights, corresponding to the letters they are positioned above.

ALFRED DUNHILL LIMITED (UNITED KINGDOM LIMITED COMPANY)  
30 DUKE STREET,  
ST. JAMES'S; LONDON SW1Y 6DL  
UNITED KINGDOM

FOR: OPTICAL APPARATUS AND INSTRUMENTS, NAMELY, SPECTACLES, SUNGLASSES; CASES, FRAMES, CLOTHS, CORDS AND CHAINS FOR SPECTACLES AND SUNGLASSES; MAGNIFYING GLASSES; BINOCULARS; COMPASSES; GOGGLES FOR SPORTS; MOUSE PADS, COMPUTER CARRYING CASES; SPECIALTY HOLSTER FOR CARRYING CELLULAR PHONES; CASES FOR TELEPHONES, TELEPHONE ACCESSORIES, NAMELY, MOBILE PHONE TAGS, IN CLASS 9 (U.S. CLS. 21, 23, 26, 36 AND 38).

FOR: PRECIOUS METAL AND THEIR ALLOYS; LETTER OPENERS, BUTTONS, MONEY CLIPS ALL THE FOREGOING OF PRECIOUS METALS; KEY RINGS AND KEY CHAINS OF PRECIOUS METALS; JEWELRY, CUFFLINKS; TIE BARS; TIE CLIPS; TIE PINS; LAPEL PINS; COLLAR AND SHIRT STUDS; PRECIOUS STONES; HOROLOGICAL OR CHRONOMETRIC INSTRUMENTS, WATCHES, CLOCKS, WATCH STRAPS, WATCH BRACELETS, IN CLASS 14 (U.S. CLS. 2, 27, 28 AND 50).

FOR: PRINTED MATTER, NAMELY, PRINTED TICKETS AND PAPER LABELS, WRITING INSTRUMENTS; POUCHES FOR WRITING INSTRUMENTS;

WRITING INK, PEN INK REFILLS, STATIONERY, ORGANIZERS FOR STATIONERY USE, PERSONAL ORGANIZERS, DESK SETS, FOUNTAIN PENS, BALL-POINT PENS, PENCILS; PEN AND PENCIL HOLDERS; PAPER WEIGHTS, DIARIES; INKWELLS AND INK STANDS; PASSPORT HOLDERS, CHECKBOOK HOLDERS; CHECKBOOK COVERS; PEN AND PENCIL CASES; ALBUM OF PHOTOGRAPHS; BOOKENDS, PEN NIBS; DOCUMENT HOLDERS, IN CLASS 16 (U.S. CLS. 2, 5, 22, 23, 29, 37, 38 AND 50).

FOR: GOODS MADE OF LEATHER AND IMITATIONS OF LEATHER, NAMELY, POCKET WALLETS, COIN PURSES, LUGGAGE TAGS; TRUNKS AND TRAVELING BAGS, UMBRELLAS, PARASOLS AND WALKING STICKS; SHOOTING STICKS, NAMELY, A COMBINED WALKING STICK AND SEAT; CANES; LEADS FOR PETS, NAMELY, LEASHES FOR ANIMALS; COLLARS FOR PETS; LUGGAGE, BAGS, NAMELY, TOTE BAGS, DUFFLE BAGS, CARRY ON BAGS, ALL PURPOSE SPORTS BAGS, FLIGHT BAGS, TRAVEL BAGS, TIE BAGS FOR TRAVEL, BARREL BAGS, SHAVING BAGS SOLD EMPTY, OVERNIGHT BAGS AND CASES, NAMELY, KEY CASES, BUSINESS CARD CASES, AND TOTE BAGS, BEACH BAGS, SATCHELS, TOILETRY BAGS SOLD EMPTY, SUITCASES; BRIEFCASES, ATTACHÉ CASES, AFTERSHAVE CASES SOLD EMPTY, DOCUMENT CASES, HOLD ALLS, NAMELY, POUCHETTES, HAND-HELD CARRYING CASES FOR DOCUMENTS AND PERSONAL

ITEMS; GARMENT BAGS FOR TRAVEL, KNAPSACKS, BACKPACKS, CREDIT CARD CASES, SUITCASES, KEY CASES, WALLETS, COIN PURSES, HANDBAGS, IN CLASS 18 (U.S. CLS. 1, 2, 3, 22 AND 41).

FOR: CLOTHING, NAMELY, SHIRTS, PANTS, TROUSERS, SLACKS, JACKETS, EVENING JACKETS, TUXEDOS, BLAZERS, WIND JACKETS, BLOUSES, FLEECE PULLOVERS, QUILTED VESTS, SUITS, RAINCOATS, COATS, SHORTS, CARDIGANS, SWEATERS, TANK TOPS, WAIST COATS, T-SHIRTS, POLO SHIRTS, CASUAL SHIRTS, BUSINESS SHIRTS, BATHROBES, DRESSING GOWNS, SOCKS, GOLF SHIRTS, GOLF SWEATERS, GOLF TROUSERS, GOLF SHOES, SWIMWEAR, SLEEPWEAR, UNDERWEAR, RAINWEAR, WATER-PROOF JACKETS, SWEATSHIRTS, SWEATPANTS, SWEATBANDS, CUMMERBUNDS, GLOVES, FOOTWEAR AND HEADWEAR, NAMELY, HATS, CAPS, SUNVISORS, SUSPENDERS, SCARVES, BELTS, TIES, GLOVES, CRAVATS, BANDANAS, WRIST BANDS, MOTORISTS CLOTHING, NAMELY, LEATHER COATS, IN CLASS 25 (U.S. CLS. 22 AND 39).

FOR: SMOKER'S ARTICLES, NAMELY, SMOKING PIPES, CIGAR AND CIGARETTE LIGHTERS, CIGAR CUTTERS, CIGAR AND CIGARETTE CASES, HUMIDORS, CIGAR AND CIGARETTE HOLDERS AND MATCHES, IN CLASS 34 (U.S. CLS. 2, 8, 9 AND 17).

THE MARK CONSISTS OF STANDARD CHARACTERS WITHOUT CLAIM TO ANY PARTICULAR FONT, STYLE, SIZE, OR COLOR.

PRIORITY DATE OF 6-14-2006 IS CLAIMED.

OWNER OF INTERNATIONAL REGISTRATION 0902887 DATED 8-18-2006, EXPIRES 8-18-2016.

OWNER OF U.S. REG. NOS. 1,799,883, 3,085,590 AND OTHERS.

SER. NO. 79-030,680, FILED 8-18-2006.

BERYL GARDNER, EXAMINING ATTORNEY

**Int. Cl.: 24**

**Prior U.S. Cls.: 42 and 50**

**United States Patent and Trademark Office**

**Reg. No. 3,395,073**

**Registered Mar. 11, 2008**

**TRADEMARK  
PRINCIPAL REGISTER**

**MOD**

LINEN HOUSE PTY LTD (AUSTRALIA CORPORATION)  
60 CORPORATE DRIVE  
MOORABBIN, AUSTRALIA VIC 3189

FOR: LINEN AND TEXTILE GOODS, NAMELY, BED SHEETS, PILLOW CASES, SHAMS, PILLOW SHAMS, QUILT COVERS, DUVETS, DUVET COVERS, COMFORTERS, BED SPREADS, BED SKIRTS, FABRIC VALENCES AND DRAPERY, TEXTILE BED COVERS; UNFITTED FABRIC COUCH COVERS; COVERS FOR CUSHIONS; BED BLANKETS; BATH LINEN, NAMELY, TOWELS, BEACH TOWELS, FACE TOWELS, HAND TOWELS; NAPERY, NAMELY, TEXTILE TABLE CLOTHS AND COVERS, TEXTILE NAPKINS, TEXTILE PLACE MATS; TEXTILE OVEN MITTS AND POT HOLDERS, DISH TOWELS, TEA TOWELS; FABRIC WINDOW COV-

ERINGS AND TREATMENTS, NAMELY, CURTAINS AND DRAPES; AND SHOWER CURTAINS, IN CLASS 24 (U.S. CLS. 42 AND 50).

THE MARK CONSISTS OF STANDARD CHARACTERS WITHOUT CLAIM TO ANY PARTICULAR FONT, STYLE, SIZE, OR COLOR.

OWNER OF INTERNATIONAL REGISTRATION 0903347 DATED 1-31-2006, EXPIRES 1-31-2016.

SER. NO. 79-030,877, FILED 1-31-2006.

CHRISTOPHER BUONGIORNO, EXAMINING ATTORNEY

**Int. Cls.: 7, 37 and 40**

**Prior U.S. Cls.: 13, 19, 21, 23, 31, 34, 35, 100, 103 and 106**

**Reg. No. 3,395,074**

**United States Patent and Trademark Office**

**Registered Mar. 11, 2008**

**TRADEMARK  
SERVICE MARK  
PRINCIPAL REGISTER**

# AQUANATOR

ATLANTIS RESOURCES CORPORATION; PTE LIMITED (SINGAPORE PRIVATE LIMITED COMPANY)  
C/O 5 SHENTON WAY,  
#02-02, UIC BUILDING; SINGAPORE 068808  
SINGAPORE

FOR: GENERATORS, NAMELY, UNDERWATER ELECTRICITY GENERATORS; PUBLIC OR PRIVATE UTILITY INSTALLATIONS FOR GENERATING POWER FROM NATURAL SOURCES, MOBILE ELECTRICAL POWER GENERATORS, TURBINES FOR POWER GENERATION, TURBINE BLADES FOR POWER GENERATION, DYNAMOS; ELECTRIC MOTORS FOR MACHINES; ELECTRIC PUMPS; PUMPS FOR COOLING ENGINES; AND METALWORKING MACHINE TOOLS, IN CLASS 7 (U.S. CLS. 13, 19, 21, 23, 31, 34 AND 35).

FOR: ADVISORY AND CONSULTATION SERVICES RELATING TO THE INSTALLATION OF GENERATORS; INSTALLATION OF ELECTRICITY

GENERATORS; MAINTENANCE AND REPAIR OF ELECTRIC POWER GENERATING INSTALLATIONS, IN CLASS 37 (U.S. CLS. 100, 103 AND 106).

FOR: RENTAL OF ELECTRICITY GENERATORS; GENERATING OF ELECTRICITY; TREATMENT OF WASTE MATERIAL FROM GENERATING OPERATIONS, IN CLASS 40 (U.S. CLS. 100, 103 AND 106).

PRIORITY DATE OF 5-8-2006 IS CLAIMED.

OWNER OF INTERNATIONAL REGISTRATION 0903979 DATED 7-14-2006, EXPIRES 7-14-2016.

SER. NO. 79-031,113, FILED 7-14-2006.

MARY BOAGNI, EXAMINING ATTORNEY

Int. Cl.: 9

Prior U.S. Cls.: 21, 23, 26, 36 and 38

United States Patent and Trademark Office

Reg. No. 3,395,075

Registered Mar. 11, 2008

TRADEMARK  
PRINCIPAL REGISTER

# MOVOTEC

MOVOTEC GMBH & CO. KG (FED REP GER-  
MANY LIMITED PARTNERSHIP)  
LEEBERGSTRASSE 46 83684 TEGERNSEE  
TEGERNSEE, FED REP GERMANY

FOR: APPARATUS FOR RECORDING, TRANSMISSION AND REPRODUCTION OF SOUND AND IMAGES; BLANK MAGNETIC DATA CARRIERS; BLANK RECORDABLE OPTICAL DISCS; COMPUTERS; BLANK MAGNETO-OPTICAL DISCS; BATTERIES AND BATTERY CHARGING DEVICES; CAMERAS; FILM CAMERAS; CINE CAMERAS; AUTOCOLLIMATORS; ROTARY ENCODERS; LCD PROJECTORS AND REPLACEMENT OPTICAL PARTS AND REPLACEMENT COMPONENTS FOR LCD PROJECTORS; DIGITAL VIDEO CAMERAS; DIGITAL FIXED IMAGE CAMERAS; OBJECTIVES FOR DIGITAL CAMERAS; INFRARED CAMERAS; TV CAMERAS; OBJECTIVES FOR TV CAMERAS; SINGLE AND MULTIPLE LIGHT METERS; LIGHT METER SYSTEMS COMPRISED PRIMARILY OF SINGLE AND MULTIPLE LIGHT METERS; LIGHT METERS FOR LIQUID CRYSTAL DISPLAY SUBSTRATES AND LIGHT METER SYSTEMS COMPRISED PRIMARILY OF LIGHT METERS FOR LIQUID CRYSTAL DISPLAY SUBSTRATES; SINGLE AND MULTIPLE LIGHT METERS FOR LIQUID CRYSTAL DISPLAY SUBSTRATES; SINGLE AND MULTIPLE LIGHT METERS FOR MAGNETIC HEADS AND LIGHT METER SYSTEMS COM-

PRISED PRIMARILY OF LIGHT METERS FOR MAGNETIC HEADS; COMPUTER PROGRAMS FOR IMAGE ANALYSIS AND PROCESSING, OTHER THAN COMPUTER PROGRAMS FOR CREATING OF GRAPHICS AND SPECIAL EFFECTS; FILM SCANNERS; BLANK OPTICAL DISCS; BLANK OPTICAL MAGNETIC DISCS; BLANK MAGNETIC TAPES; MEMORY CARDS AND ADAPTERS FOR MEMORY CARDS; TRIPODS FOR PHOTOGRAPHIC APPARATUS AND INSTRUMENTS; REPLACEMENT PARTS AND REPLACEMENT COMPONENTS FOR ALL AFOREMENTIONED GOODS, IN CLASS 9 (U.S. CLS. 21, 23, 26, 36 AND 38).

THE MARK CONSISTS OF STANDARD CHARACTERS WITHOUT CLAIM TO ANY PARTICULAR FONT, STYLE, SIZE, OR COLOR.

PRIORITY DATE OF 12-15-2005 IS CLAIMED.

OWNER OF INTERNATIONAL REGISTRATION  
0904687 DATED 5-26-2006, EXPIRES 5-26-2016.

SER. NO. 79-031,374, FILED 5-26-2006.

DEBRA LEE, EXAMINING ATTORNEY

Int. Cl.: 30

Prior U.S. Cl.: 46

United States Patent and Trademark Office

Reg. No. 3,395,076

Registered Mar. 11, 2008

TRADEMARK  
PRINCIPAL REGISTER



RAFFINAGE TEREOS (FRANCE SOCIÉTÉ PAR  
ACTIONS SIMPLIFIÉE)  
45, BOULEVARD BÉNONI GOULLIN  
F-44000 NANTES  
FRANCE

FOR: SUGAR AND NATURAL SWEETENERS, IN  
CLASS 30 (U.S. CL. 46).

OWNER OF INTERNATIONAL REGISTRATION  
0892905 DATED 6-15-2006, EXPIRES 6-15-2016.

OWNER OF U.S. REG. NOS. 1,830,466 AND  
1,837,722.

THE COLOR(S) YELLOW, ORANGE, PURPLE,  
LIGHT GREEN, DARK GREEN, BLACK, BROWN,  
WHITE AND RED IS/ARE CLAIMED AS A FEAT-  
URE OF THE MARK.

THE COLOR ORANGE APPEARS IN THE WORD-  
ING "LA PERRUCHE" AND IN THE CURVED  
LINES ABOVE AND BELOW THE WORDING,  
AND IN THE BEAK, WING, FEET AND THE

CURVED LINE UNDER THE EYE OF THE PARA-  
KEET; YELLOW APPEARS IN THE HEAD, NECK,  
WING, AND FRONT OF THE PARAKEET, AND IN  
THE BACKGROUND BEHIND THE WORDING;  
LIGHT GREEN APPEARS IN THE PALM TREE  
AND OTHER LEAVES, AND THE HEAD, CHEST,  
BACK AND BOTTOM OF THE PARAKEET; DARK  
GREEN APPEARS IN THE OTHER LEAVES,  
BROWN APPEARS IN THE PALM TREE TRUNK;  
BLACK APPEARS IN THE EYE OF THE PARAKEET,  
SHADING IN THE CENTER OF THE PALM  
LEAVES, AND LINING OF THE OTHER LEAVES;  
PURPLE APPEARS IN THE PARAKEET WING AND  
THE MOUNTAINS OF THE ISLAND; WHITE AP-  
PEARS IN THE SEA AND THE SHADING BEHIND  
THE WORDING; RED APPEARS IN THE WATER  
WAVES.

THE ENGLISH TRANSLATION OF THE WORD  
"PERRUCHE" IN THE MARK IS "PARAKEET."

SER. NO. 79-031,554, FILED 9-21-2006.

REBECCA POVARCHUK, EXAMINING ATTOR-  
NEY

**Int. Cls.: 30 and 43**

**Prior U.S. Cls.: 46, 100 and 101**

**United States Patent and Trademark Office**

**Reg. No. 3,395,077**

**Registered Mar. 11, 2008**

**TRADEMARK  
SERVICE MARK  
PRINCIPAL REGISTER**

**PANOPOLIS**

SELECT SERVICE PARTNER UK LTD (UNITED  
KINGDOM LIMITED COMPANY)  
169 EUSTON ROAD  
LONDON, UNITED KINGDOM NW1 2AE

FOR: COFFEE; TEA, COCOA, SUGAR, RICE,  
TAPIOCA, SAGO, ARTIFICIAL COFFEE; FLOUR,  
BREAD, AND PASTRY; SANDWICHES; PASTRIES;  
PIES; PIZZAS; QUICHES; CAKES; HONEY, TREA-  
CLE; YEAST, BAKING POWDER; SALT, MUSTARD;  
VINEGAR; SPICES; ICE; SALAD DRESSINGS; PAS-  
TA AND RICE, IN CLASS 30 (U.S. CL. 46).

FOR: SERVICES FOR PROVIDING FOOD AND  
DRINK; RESTAURANTS; CAFES; CAFETERIAS;  
CANTEENS; SELF-SERVICE RESTAURANTS;  
SNACK BARS; CATERING SERVICES, IN CLASS  
43 (U.S. CLS. 100 AND 101).

THE MARK CONSISTS OF STANDARD CHAR-  
ACTERS WITHOUT CLAIM TO ANY PARTICULAR  
FONT, STYLE, SIZE, OR COLOR.

PRIORITY DATE OF 5-19-2006 IS CLAIMED.

OWNER OF INTERNATIONAL REGISTRATION  
0905927 DATED 11-7-2006, EXPIRES 11-7-2016.

SER. NO. 79-031,794, FILED 11-7-2006.

JENNY PARK, EXAMINING ATTORNEY



**Int. Cls.: 1, 5, 41, 42 and 44**

**Prior U.S. Cls.: 1, 5, 6, 10, 18, 26, 44, 46, 51, 52, 100,  
101 and 107**

**Reg. No. 3,395,078**

**United States Patent and Trademark Office**

**Registered Mar. 11, 2008**

**TRADEMARK  
SERVICE MARK  
PRINCIPAL REGISTER**

**AICURIS**

AICURIS GMBH & CO. KG (FED REP GERMA-  
NY LTD LIAB CO)  
APRATHER WEG 18A  
42117 WUPPERTAL, FED REP GERMANY

FOR: CHEMICAL, BIOLOGICAL, AND BIOTECH-  
NICAL PREPARATIONS FOR SCIENTIFIC PURPO-  
SES; CHEMICAL, BIOLOGICAL, AND  
BIOTECHNICAL PREPARATIONS FOR USE IN  
AGRICULTURE AND FORESTRY, NAMELY, CHE-  
MICAL PREPARATIONS FOR THE TREATMENT  
OF SEEDS AND PLANTS, IN CLASS 1 (U.S. CLS. 1, 5,  
6, 10, 26 AND 46).

FOR: PHARMACEUTICAL AND VETERINARY  
PRODUCTS, NAMELY, ANTIBIOTICS; PHARMA-  
CEUTICAL AND VETERINARY PREPARATIONS,  
NAMELY, ANTI-INFECTIVES FOR THE TREAT-  
MENT OR PROPHYLAXIS OF INFECTIOUS DIS-  
EASES; PHARMACEUTICAL AND VETERINARY  
PREPARATIONS, NAMELY, ANTIMYCOTICS FOR  
THE TREATMENT OR PROPHYLAXIS OF FUN-  
GAL INFECTIONS; PHARMACEUTICAL AND VE-  
TERINARY PREPARATIONS, NAMELY,  
ANTIVIRAL PRODUCTS FOR THE TREATMENT  
OR PROPHYLAXIS OF VIRAL INFECTIONS; PHAR-  
MACEUTICAL AND VETERINARY PREPARA-  
TIONS, NAMELY, ONCOLOGICAL THERAPEUTIC  
AGENTS FOR THE TREATMENT OR PROPHY-  
LAXIS OF CANCER; PHARMACEUTICAL AND  
VETERINARY PREPARATIONS, NAMELY, IM-  
MUNE SYSTEM MODULATING PRODUCTS FOR  
THE TREATMENT OR PROPHYLAXIS OF IM-  
MUNE DEFICIENCY SYNDROMES; DIETETIC  
FOODS ADAPTED FOR MEDICAL USE; DIETETIC  
SUGAR FOR MEDICAL USE; BIOLOGICAL AND  
BIOTECHNOLOGICAL PREPARATIONS FOR MED-  
ICAL PURPOSES, IN CLASS 5 (U.S. CLS. 6, 18, 44, 46,  
51 AND 52).

FOR: TRAINING IN THE FIELD OF BIOLOGY,  
CHEMISTRY, PHARMACOLOGY, PHARMACEU-

TICS AND MEDICINE; EDUCATIONAL SERVICES,  
NAMELY, PROVIDING EDUCATIONAL ACTIVITY  
IN THE FORM OF CLASSES, SEMINARS AND  
WORKSHOPS IN THE FIELD OF BIOLOGY, CHEM-  
ISTRY, PHARMACOLOGY, PHARMACEUTICS  
AND MEDICINE; ARRANGING AND CONDUCT-  
ING SEMINARS IN THE FIELD OF BIOLOGY,  
CHEMISTRY, PHARMACOLOGY, PHARMACEU-  
TICS AND MEDICINE, IN CLASS 41 (U.S. CLS. 100,  
101 AND 107).

FOR: SCIENTIFIC AND TECHNOLOGICAL RE-  
SEARCH IN THE FIELD OF BIOLOGY, CHEMIS-  
TRY, PHARMACOLOGY, PHARMACEUTICS AND  
MEDICINE; SCIENTIFIC AND TECHNICAL CON-  
SULTING IN THE FIELD OF BIOLOGY, CHEMIS-  
TRY, PHARMACOLOGY, PHARMACEUTICS AND  
MEDICINE, IN CLASS 42 (U.S. CLS. 100 AND 101).

FOR: MEDICAL AND VETERINARY SERVICES  
IN THE FIELD OF BIOLOGY, CHEMISTRY, PHAR-  
MACOLOGY, PHARMACEUTICS, MEDICINE, HY-  
GIENE AND BEAUTY CARE FOR HUMAN BEINGS  
OR ANIMALS, IN CLASS 44 (U.S. CLS. 100 AND 101).

THE MARK CONSISTS OF STANDARD CHAR-  
ACTERS WITHOUT CLAIM TO ANY PARTICULAR  
FONT, STYLE, SIZE, OR COLOR.

PRIORITY DATE OF 7-11-2006 IS CLAIMED.

OWNER OF INTERNATIONAL REGISTRATION  
0905926 DATED 7-18-2006, EXPIRES 7-18-2016.

SER. NO. 79-031,874, FILED 7-18-2006.

MONIQUE MILLER, EXAMINING ATTORNEY

**Int. Cls.: 35 and 42**

**Prior U.S. Cls.: 100, 101 and 102**

**United States Patent and Trademark Office**

**Reg. No. 3,395,079**

**Registered Mar. 11, 2008**

**SERVICE MARK  
PRINCIPAL REGISTER**

**CYD**

CYD RESEARCH GMBH (SWITZERLAND SOCI-  
ÉTÉ À RESPONSABILITÉ LIMITÉE)  
HAUS ZUM MAULBEERBAUM, BÄUMLEINGASSE  
10  
CH-4051 BASEL  
SWITZERLAND

FOR: ADVERTISING; BUSINESS MANAGE-  
MENT; BUSINESS ADMINISTRATION, IN CLASS  
35 (U.S. CLS. 100, 101 AND 102).

FOR: DESIGN AND DEVELOPMENT OF COM-  
PUTERS AND SOFTWARE; LEGAL SERVICES, IN  
CLASS 42 (U.S. CLS. 100 AND 101).

THE MARK CONSISTS OF STANDARD CHAR-  
ACTERS WITHOUT CLAIM TO ANY PARTICULAR  
FONT, STYLE, SIZE, OR COLOR.

PRIORITY DATE OF 7-7-2006 IS CLAIMED.

OWNER OF INTERNATIONAL REGISTRATION  
0906580 DATED 11-2-2006, EXPIRES 11-2-2016.

SER. NO. 79-032,132, FILED 11-2-2006.

PETER B. BROMAGHIM, EXAMINING ATTORNEY

Int. Cls.: 29 and 30

Prior U.S. Cl.: 46

United States Patent and Trademark Office

Reg. No. 3,395,080

Registered Mar. 11, 2008

TRADEMARK  
PRINCIPAL REGISTER



MATSUKURA INC. (JAPAN CORPORATION)  
2-4-17, HOUNAN  
SUGIMI-KU  
TOKYO 168-0062, JAPAN

FOR: EDIBLE OILS AND FATS; MILK PRODUCTS EXCLUDING ICE CREAM, ICE MILK AND FROZEN YOGURT; CHARCUTERIE; PACKAGED ENTREES CONSISTING PRIMARILY OF MEAT; FROZEN ENTREES CONSISTING PRIMARILY OF MEAT; PREPARED ENTREES CONSISTING PRIMARILY OF MEAT; PACKAGED ENTREES CONSISTING PRIMARILY OF SEAFOOD; FROZEN ENTREES CONSISTING PRIMARILY OF SEAFOOD; PREPARED ENTREES CONSISTING PRIMARILY OF SEAFOOD; PACKAGED ENTREES CONSISTING PRIMARILY OF VEGETABLES; FROZEN ENTREES CONSISTING PRIMARILY OF VEGETABLES; PREPARED ENTREES CONSISTING PRIMARILY OF VEGETABLES; KONJAC (JELLY MADE FROM DEVIL'S TONGUE ROOT); DAIRY PRODUCTS EXCLUDING ICE CREAM, ICE MILK AND FROZEN YOGURT; INSTANT OR PRE-COOKED CURRY, STEW AND SOUP, IN CLASS 29 (U.S. CL. 46).

FOR: SEASONINGS; CONDIMENTS, NAMELY, STEAK SAUCE, BARBECUE SAUCE, MARINADES, PEPPER, SAUCES, KETCHUP, MUSTARD, MAYONNAISE; SANDWICHES; HAMBURGER SANDWI-

CHES; FROZEN PREPARED COOKED MEALS CONSISTING PRIMARILY OF PASTA OR RICE, PACKED IN A LUNCH BOX; PREPARED COOKED MEALS CONSISTING PRIMARILY OF PASTA OR RICE, PACKED IN A LUNCH BOX; HOT DOG SANDWICHES; MEAT PIES; SPAGHETTI SAUCES; DRY SEASONING MIX FOR SPAGHETTI; CURRY PASTES; CURRY POWDER, IN CLASS 30 (U.S. CL. 46).

PRIORITY DATE OF 4-14-2006 IS CLAIMED.

OWNER OF INTERNATIONAL REGISTRATION  
0906836 DATED 8-15-2006, EXPIRES 8-15-2016.

THE ENGLISH TRANSLATION OF THE NON-LATIN ELEMENTS IN THE MARK IS FRANCE AND ARBOR. THE COMPOSITE TERM HAS NO PARTICULAR MEANING AS A WHOLE.

THE TRANSLITERATION OF THE NON-LATIN CHARACTERS IN THE MARK IS FU-RA-N-SU-TEI.

SER. NO. 79-032,239, FILED 8-15-2006.

KATHERINE CONNOLLY, EXAMINING ATTORNEY

**Int. Cls.: 7 and 9**

**Prior U.S. Cls.: 13, 19, 21, 23, 26, 31, 34, 35, 36 and 38**

**Reg. No. 3,395,081**

**United States Patent and Trademark Office**

**Registered Mar. 11, 2008**

**TRADEMARK  
PRINCIPAL REGISTER**

**NETLINE**

SCM GROUP S.P.A. (ITALY JOINT STOCK COMPANY)  
VIA EMILIA 77  
I-47900 RIMINI RN  
ITALY

FOR: POWER OPERATED WOODWORKING MACHINES, NAMELY, PANEL SAWS AND EDGE BANDERS AND A PROGRAMMABLE CONTROL CENTER FOR THE INTEGRATED AND COMBINED OPERATION OF PANEL SAWS AND EDGE BANDERS, IN CLASS 7 (U.S. CLS. 13, 19, 21, 23, 31, 34 AND 35).

FOR: SOFTWARE FOR WOODWORKING, NAMELY, SOFTWARE FOR FURNITURE-MAKING THAT GENERATES FURNITURE DESIGNS, DRAWINGS OF GOODS, CALCULATES PRODUCTION COSTS, PRODUCES PRODUCTION LISTS

AND DRAWINGS AND INSTRUCTIONS FOR ASSEMBLING THE GOODS, IN CLASS 9 (U.S. CLS. 21, 23, 26, 36 AND 38).

THE MARK CONSISTS OF STANDARD CHARACTERS WITHOUT CLAIM TO ANY PARTICULAR FONT, STYLE, SIZE, OR COLOR.

PRIORITY DATE OF 9-1-2006 IS CLAIMED.

OWNER OF INTERNATIONAL REGISTRATION 0908143 DATED 11-21-2006, EXPIRES 11-21-2016.

SER. NO. 79-032,739, FILED 11-21-2006.

TASNEEM HUSSAIN, EXAMINING ATTORNEY

**Int. Cl.: 6**

**Prior U.S. Cls.: 2, 12, 13, 14, 23, 25 and 50**

**Reg. No. 3,395,082**

**United States Patent and Trademark Office**

**Registered Mar. 11, 2008**

**TRADEMARK  
PRINCIPAL REGISTER**

**YUGUANG**

**HENAN YUGUANG GOLD & LEAD; GROUP  
CO., LTD. (CHINA CORPORATION)**

**NO. 1 SOUTH JINGLIANG STREET**

**JIYUAN CITY**

**HENAN PROVINCE, CHINA**

**FOR: LEAD INGOTS THAT ARE PROCESSED  
ELECTROLYTICALLY, IN CLASS 6 (U.S. CLS. 2, 12,  
13, 14, 23, 25 AND 50).**

**OWNER OF INTERNATIONAL REGISTRATION  
0908184 DATED 12-7-2006, EXPIRES 12-7-2016.**

**THE NAME YUGUANG DOES NOT IDENTIFY A  
LIVING INDIVIDUAL.**

**SER. NO. 79-032,755, FILED 12-7-2006.**

**LAURA HAMMEL, EXAMINING ATTORNEY**

**Int. Cl.: 9**

**Prior U.S. Cls.: 21, 23, 26, 36 and 38**

**United States Patent and Trademark Office**

**Reg. No. 3,395,083**

**Registered Mar. 11, 2008**

**TRADEMARK  
PRINCIPAL REGISTER**

**SIMATIC PX**

SIEMENS AKTIENGESELLSCHAFT (FED REP  
GERMANY JOINT STOCK COMPANY)

WITTELSBACHERPLATZ 2

80333 MÜNCHEN, FED REP GERMANY

FOR: ELECTRICAL DEVICES, NAMELY, PROXIMITY SWITCHES; PROXIMITY SENSORS FOR USE IN INDUSTRIAL AUTOMATION PROCESSES TO RECORD, COUNT, MEASURE AND POSITION MATERIALS; COMPUTER SOFTWARE FOR PROGRAMMING PROXIMITY SWITCHES AND SENSORS USED IN INDUSTRIAL AUTOMATION PROCESSES AND TO INTEGRATE PROXIMITY SWITCHES AND SENSORS INTO INDUSTRIAL AUTOMATION CONTROL SYSTEMS, IN CLASS 9 (U.S. CLS. 21, 23, 26, 36 AND 38).

THE MARK CONSISTS OF STANDARD CHARACTERS WITHOUT CLAIM TO ANY PARTICULAR FONT, STYLE, SIZE, OR COLOR.

PRIORITY DATE OF 8-17-2006 IS CLAIMED.

OWNER OF INTERNATIONAL REGISTRATION  
0908526 DATED 11-21-2006, EXPIRES 11-21-2016.

OWNER OF U.S. REG. NOS. 1,026,594, 2,751,899  
AND OTHERS.

SER. NO. 79-032,898, FILED 11-21-2006.

RON FAIRBANKS, EXAMINING ATTORNEY

**Int. Cl.: 20**

**Prior U.S. Cls.: 2, 13, 22, 25, 32 and 50**

**United States Patent and Trademark Office**

**Reg. No. 3,395,084**

**Registered Mar. 11, 2008**

**TRADEMARK  
PRINCIPAL REGISTER**

**RIETVELD BY RIETVELD**

RIETVELD BY RIETVELD BV (NETHERLANDS  
LTD LIAB CO)  
SLEEDOORN 16  
NL-6581 VX MALDEN  
NETHERLANDS

FOR: FURNITURE, IN CLASS 20 (U.S. CLS. 2, 13,  
22, 25, 32 AND 50).

PRIORITY DATE OF 10-19-2006 IS CLAIMED.

OWNER OF INTERNATIONAL REGISTRATION  
0908562 DATED 11-1-2006, EXPIRES 11-1-2016.

THE ENGLISH TRANSLATION OF THE FOR-  
EIGN WORD(S) IN THE MARK IS RIETVELD BY  
RIETVELD.

SER. NO. 79-032,919, FILED 11-1-2006.

ANTHONY RINKER, EXAMINING ATTORNEY

**Int. Cl.: 29**

**Prior U.S. Cl.: 46**

**United States Patent and Trademark Office**

**Reg. No. 3,395,085**

**Registered Mar. 11, 2008**

**TRADEMARK  
PRINCIPAL REGISTER**



SALICA, INDUSTRIA ALIMENTARIA, S.A.  
(SPAIN S.A.)  
POLIGONO LANDABASO, S/N  
E-48370 BERMEO (VIZCAYA)  
SPAIN

FOR: FISH, NOT LIVE; SEAWEED EXTRACTS FOR FOOD; CLAMS, NOT LIVE; PROCESSED ANCHOVIES, ANCHOVY PASTE; HERRINGS, NOT LIVE; TUNA FISH; BROTH; CRABS, NOT LIVE; CAVIAR; SEA CUCUMBERS, NOT LIVE; PRE-SERVED FISH; FISH CROQUETTES; FILLETS OF FISH; PRAWNS, NOT LIVE; FAT-CONTAINING MIXTURES FOR BREAD SLICES; SPINY LOBSTERS, NOT LIVE; SHELLFISH, NOT LIVE; MUSSELS, NOT LIVE; EDIBLE MOLLUSCS, NOT LIVE; OYSTERS, NOT LIVE; SALTED FISH; FOOD PRE-

PARED FROM FISH, NAMELY, FROZEN, PREPARED OR PACKAGED MEALS CONSISTING PRIMARILY OF FISH; SARDINES; SOUPS, IN CLASS 29 (U.S. CL. 46).

OWNER OF INTERNATIONAL REGISTRATION  
0908734 DATED 7-27-2006, EXPIRES 7-27-2016.

"BACHI" HAS NO MEANING IN ANY FOREIGN LANGUAGE.

SER. NO. 79-032,980, FILED 7-27-2006.

LAURIE MAYES, EXAMINING ATTORNEY



**Int. Cl.: 9**

**Prior U.S. Cls.: 21, 23, 26, 36 and 38**

**Reg. No. 3,395,086**

**United States Patent and Trademark Office**

**Registered Mar. 11, 2008**

**TRADEMARK  
PRINCIPAL REGISTER**

**NETCLAW**

ANRITSU A/S (DENMARK LTD LIAB CO)  
KIRKEBJERG ALLÉ 90  
DK-2605 BRØNDBY, DENMARK

THE MARK CONSISTS OF STANDARD CHARACTERS WITHOUT CLAIM TO ANY PARTICULAR FONT, STYLE, SIZE, OR COLOR.

FOR: PRECISION MEASURING EQUIPMENT AND INSTRUMENTS FOR USE IN TESTING, MONITORING AND OPTIMIZING TELECOMMUNICATIONS NETWORKS AND TELECOMMUNICATIONS EQUIPMENT IN THE FIELD OF WIRELESS, NEXT GENERATION AND OPTICAL NETWORKS, NAMELY, SIGNAL ANALYZERS, SIGNALING PROTOCOL TESTERS; AND COMPUTER SOFTWARE FOR THE ANALYSIS AND DISPLAY OF TEST DATA RELATING TO TELECOMMUNICATIONS NETWORKS AND TELECOMMUNICATIONS EQUIPMENT, IN CLASS 9 (U.S. CLS. 21, 23, 26, 36 AND 38).

PRIORITY DATE OF 5-8-2006 IS CLAIMED.

OWNER OF INTERNATIONAL REGISTRATION 0908842 DATED 11-7-2006, EXPIRES 11-7-2016.

SER. NO. 79-033,023, FILED 11-7-2006.

DAVID COLLIER, EXAMINING ATTORNEY

**Int. Cl.: 9**

**Prior U.S. Cls.: 21, 23, 26, 36 and 38**

**United States Patent and Trademark Office**

**Reg. No. 3,395,087**

**Registered Mar. 11, 2008**

**TRADEMARK  
PRINCIPAL REGISTER**

**MASTERCLAW**

ANRITSU A/S (DENMARK LTD LIAB CO)  
KIRKEBJERG ALLÉ 90  
DK-2605 BRØNDBY  
DENMARK

FOR: PRECISION MEASURING EQUIPMENT AND INSTRUMENTS FOR USE IN TESTING, MONITORING AND OPTIMIZING TELECOMMUNICATIONS NETWORKS AND TELECOMMUNICATIONS EQUIPMENT IN THE FIELD OF WIRELESS, NEXT GENERATION AND OPTICAL NETWORKS, NAMELY, SIGNAL ANALYZERS, SIGNALING PROTOCOL TESTERS; AND COMPUTER SOFTWARE FOR THE ANALYSIS AND DISPLAY OF TEST DATA RELATING TO TELECOMMUNICATIONS NETWORKS AND TEL-

ECOMMUNICATIONS EQUIPMENT, IN CLASS 9 (U.S. CLS. 21, 23, 26, 36 AND 38).

THE MARK CONSISTS OF STANDARD CHARACTERS WITHOUT CLAIM TO ANY PARTICULAR FONT, STYLE, SIZE, OR COLOR.

PRIORITY DATE OF 5-8-2006 IS CLAIMED.

OWNER OF INTERNATIONAL REGISTRATION 0908854 DATED 11-7-2006, EXPIRES 11-7-2016.

SER. NO. 79-033,027, FILED 11-7-2006.

LINDA ESTRADA, EXAMINING ATTORNEY

Int. Cl.: 25

Prior U.S. Cls.: 22 and 39

United States Patent and Trademark Office

Reg. No. 3,395,088

Registered Mar. 11, 2008

TRADEMARK  
PRINCIPAL REGISTER

*Nezir*

NEYIR TEKSTIL SANAYI TICARET ANONIM  
SIRKETI (TURKEY JOINT STOCK COMPANY)  
MESRZUTİYET MAHALLESİ SAİR NIGAR  
SOKAK YARCINKAYA İS MERKEZİ NO: 90 K.2/3.,  
OSMANBEY, SİSLİ, İSTANBUL  
TURKEY

FOR: CLOTHING, NAMELY, SWEATERS,  
SHIRTS, JACKETS, BLOUSES, DRESSES, SKIRTS,  
TROUSERS, SHORTS, PULLOVERS, SCARVES, TU-  
NICS, TAILLEURS, SWIM WEAR FOR GENTLE-  
MEN AND LADIES, KNITWEAR, NAMELY,  
BLOUSES, PULLOVERS, UNDER GARMENTS,  
STOCKINGS, IN CLASS 25 (U.S. CLS. 22 AND 39).

OWNER OF INTERNATIONAL REGISTRATION  
0908978 DATED 10-31-2006, EXPIRES 10-31-2016.

THE NAME "NEYIR" DOES NOT IDENTIFY A  
LIVING INDIVIDUAL.

SER. NO. 79-033,081, FILED 10-31-2006.

FRED CARL, EXAMINING ATTORNEY

**Int. Cl.: 32**

**Prior U.S. Cls.: 45, 46 and 48**

**United States Patent and Trademark Office**

**Reg. No. 3,395,089**

**Registered Mar. 11, 2008**

**TRADEMARK  
PRINCIPAL REGISTER**

**C E V I T A N A**

PI "VITAMINKA" A.D. PRILEP (MACEDONIA  
AKTZIONERO DRUZHESTVO (AD))  
UL. "LECE KOTESKI" BR. 23  
7500 PRILEP  
MACEDONIA

OWNER OF INTERNATIONAL REGISTRATION  
0909567 DATED 11-17-2006, EXPIRES 11-17-2016.

FOR: NON-ALCOHOLIC BEVERAGES, NAMELY,  
FRUIT JUICE; PREPARATIONS FOR MAKING  
FRUIT DRINKS; ESSENCES FOR USE IN MAKING  
SOFT DRINKS, NOT IN THE NATURE OF ESSEN-  
TIAL OILS; NON-ALCOHOLIC FRUIT EXTRACTS  
USED IN THE PREPARATION OF BEVERAGES;  
NON-ALCOHOLIC FRUIT BEVERAGES; FRUIT  
JUICES, IN CLASS 32 (U.S. CLS. 45, 46 AND 48).

THE WORD CEVITANA HAS NO MEANING IN  
ENGLISH.

SER. NO. 79-033,278, FILED 11-17-2006.

ALLISON HOLTZ, EXAMINING ATTORNEY

**Int. Cls.: 1, 2 and 17**

**Prior U.S. Cls.: 1, 5, 6, 10, 11, 12, 13, 16, 26, 35, 46 and 50**

**Reg. No. 3,395,090**

**United States Patent and Trademark Office**

**Registered Mar. 11, 2008**

**TRADEMARK  
PRINCIPAL REGISTER**

**SEALCAP**

LE JOINT FRANCAIS SNC (FRANCE PARTNER-  
SHIP)  
SERVICE JURIDIQUE  
2, RUE BALZAC,; F-75008 PARIS  
FRANCE

FOR: ADHESIVES FOR USE IN SEALING AND  
ASSEMBLING AIRCRAFT AND AUTOMOBILES, IN  
CLASS 1 (U.S. CLS. 1, 5, 6, 10, 26 AND 46).

FOR: GLASS SEALERS USED FOR GLUING  
FIXED AUTOMOBILE WINDOWS, IN CLASS 2  
(U.S. CLS. 6, 11 AND 16).

FOR: RUBBER SEALANT USED FOR ACOUSTIC  
SOUNDPROOFING OF CARS AND FOR INSULAT-  
ING WINDOWS, IN CLASS 17 (U.S. CLS. 1, 5, 12, 13, 35  
AND 50).

THE MARK CONSISTS OF STANDARD CHAR-  
ACTERS WITHOUT CLAIM TO ANY PARTICULAR  
FONT, STYLE, SIZE, OR COLOR.

PRIORITY DATE OF 3-21-2006 IS CLAIMED.

OWNER OF INTERNATIONAL REGISTRATION  
0909410 DATED 8-25-2006, EXPIRES 8-25-2016.

SER. NO. 79-033,305, FILED 8-25-2006.

NANCY CLARKE, EXAMINING ATTORNEY

Int. Cl.: 30

Prior U.S. Cl.: 46

Reg. No. 3,395,091

United States Patent and Trademark Office

Registered Mar. 11, 2008

TRADEMARK  
PRINCIPAL REGISTER

DONGGUAN QIBAOYIDING; FOOD CO., LTD.  
(CHINA CORPORATION)  
LIUYONGWEI VILLAGE  
WANJIANG DISTRICT,; DONGGUAN CITY;  
GUANGDONG PROVINCE  
CHINA

FOR: SUGAR; CONFECTIONERY CHIPS FOR  
BAKING; HONEY; MOLASSES SYRUP; BREAD;  
PASTRIES; WHEAT FLOUR; INSTANT NOODLES;  
SEASONINGS; CEREAL PRODUCTS, NAMELY,  
BREAKFAST CEREALS, PROCESSED CEREALS;  
TAPIOCA FLOUR FOR FOOD, IN CLASS 30 (U.S.  
CL. 46).

OWNER OF INTERNATIONAL REGISTRATION  
0909659 DATED 12-11-2006, EXPIRES 12-11-2016.

THE FIRST CHINESE CHARACTER MEANS  
"EIGHT", THE SECOND CHINESE CHARACTER  
MEANS "TREASURE", THE THIRD CHINESE  
CHARACTER MEANS "ONE", THE LAST CHINESE  
CHARACTER MEANS "THE FOURTH"; THE FOUR  
CHINESE CHARACTERS HAVE NO MEANING IN  
COMBINATION.

THE NON-LATIN CHARACTERS IN THE MARK  
IS: "BA", "BAO", "YI", "DING".

SER. NO. 79-033,388, FILED 12-11-2006.

COLLEEN DOMBROW, EXAMINING ATTORNEY

Int. Cl.: 30

Prior U.S. Cl.: 46

United States Patent and Trademark Office

Reg. No. 3,395,092

Registered Mar. 11, 2008

TRADEMARK  
PRINCIPAL REGISTER



FITNESS CAFFE'

GVM I.E. DI MICIONI GIULIO VALTER (ITALY  
SOLE PROPRIETORSHIP)  
VIA VINCENZO PILOTTI, 15  
I-64100 TERAMO (TE)  
ITALY AND  
TANINA IRINA (RUSSIAN FED. INDIVIDUAL)  
VIA VINCENZO PILOTTI, 15  
I-64100 TERAMO (TE)  
ITALY

FOR: COFFEE; COFFEE, NAMELY, ROASTED  
COFFEE, POWDERED COFFEE, GRANULATED  
COFFEE; PREPARED COFFEE AND COFFEE-  
BASED BEVERAGES; COFFEE SUBSTITUTES,  
NAMELY, VEGETABLE PREPARATIONS FOR  
USE AS COFFEE; CAFFEINE-FREE COFFEE; COF-  
FEE PODS; BEVERAGES MADE OF COFFEE, IN  
CLASS 30 (U.S. CL. 46).

PRIORITY DATE OF 10-24-2005 IS CLAIMED.

OWNER OF INTERNATIONAL REGISTRATION  
0910401 DATED 4-4-2006, EXPIRES 4-4-2016.

NO CLAIM IS MADE TO THE EXCLUSIVE  
RIGHT TO USE "CAFFÉ", APART FROM THE  
MARK AS SHOWN.

THE MARK CONSISTS OF A STYLIZED FIGURE  
OF A PERSON WHO HOLDS AN OLYMPIC TORCH  
IN ONE HAND AND A COFFEE-CUP IN THE  
OTHER HAND; THE WORDING "FITNESS CAFFE"  
IS PLACED INSIDE AND UNDER THIS FIGURE.

"THE FOREIGN WORDING IN THE MARK  
TRANSLATES INTO ENGLISH AS COFFEE."

SER. NO. 79-033,590, FILED 4-4-2006.

ROBERT STRUCK, EXAMINING ATTORNEY

**Int. Cl.: 28**

**Prior U.S. Cls.: 22, 23, 38 and 50**

**United States Patent and Trademark Office**

**Reg. No. 3,395,093**

**Registered Mar. 11, 2008**

**TRADEMARK  
PRINCIPAL REGISTER**

**TRI ROCKET**

EVOLUTION WATERSPORT (HK) LIMITED  
(HONG KONG HONG KONG LIMITED COM-  
PANY)  
SUCCESSCOM BUILDING,  
6F FLAT B.; 251 HENNESSY ROAD  
HONG KONG

FOR: WATERSKI TUBES IN THE NATURE OF  
INFLATABLE TUBES FOR AQUATIC RECREA-  
TIONAL USE, IN CLASS 28 (U.S. CLS. 22, 23, 38  
AND 50).

THE MARK CONSISTS OF STANDARD CHAR-  
ACTERS WITHOUT CLAIM TO ANY PARTICULAR  
FONT, STYLE, SIZE, OR COLOR.

PRIORITY DATE OF 9-4-2006 IS CLAIMED.

OWNER OF INTERNATIONAL REGISTRATION  
0910908 DATED 12-18-2006, EXPIRES 12-18-2016.

SER. NO. 79-033,657, FILED 12-18-2006.

PAUL CROWLEY, EXAMINING ATTORNEY



**Int. Cls.: 8 and 21**

**Prior U.S. Cls.: 2, 13, 23, 28, 29, 30, 33, 40, 44 and 50**

**Reg. No. 3,395,094**

**United States Patent and Trademark Office**

**Registered Mar. 11, 2008**

**TRADEMARK  
PRINCIPAL REGISTER**



CELEC KABUSHIKIKAISHA (JAPAN CORPORATION)  
341 OYABU-CHO  
TAJIMI-SHI; GIFU-KEN, JAPAN 5078568

FOR: HAND-HELD ELECTRIC BRAIDERS, HAND-HELD HOES, DIGGING FORKS IN THE NATURE OF SPADING FORKS, HAND-HELD LAWN RAKES, HAND-HELD LASTS FOR SHOE-MAKING, NON-ELECTRIC PLANES FOR FLAKING DRIED BONITO BLOCKS IN THE NATURE OF KATSUO-BUSHI PLANES, SUGAR TONGS, NON-ELECTRIC CAN OPENERS, NUTCRACKERS NOT OF PRECIOUS METAL, CUTLERY, NAMELY, SPOONS AND FORKS, NON-ELECTRIC FLAT IRONS, NEEDLE-THREADERS, DRESSMAKERS' CHALK SHARPENERS, POT STANDS, JAPANESE CHARCOAL EXTINGUISHERS, FIRE TONGS, HAND-HELD INSECTICIDE SPRAYERS AND PALLETTE KNIVES, IN CLASS 8 (U.S. CLS. 23, 28 AND 44).

FOR: UNWORKED OR SEMI-WORKED GLASS NOT FOR BUILDING, MANGERS FOR ANIMALS AND TROUGHS FOR LIVESTOCK, POULTRY RINGS, COOKING SKEWERS, TUB BRUSHES, BRUSHES FOR PIPES, SHIP-SCRUBBING BRUSHES, NON-ELECTRIC COOKING POTS AND PANS, NON-ELECTRIC COFFEE-POTS NOT OF PRECIOUS METAL, TABLEWARE NOT OF PRECIOUS METAL, NAMELY, KNIVES, FORKS, SPOONS, DISHES AND PLATES, JAPANESE STYLE TEA-SERVING POTS, DRINKING CUPS NOT OF PRECIOUS METAL, TEACUPS, NON-ELECTRIC PORTABLE COLD-BOXES, RICE CHESTS, FOOD PRESERVING JARS OF GLASS, DRINKING FLASKS FOR TRAVELERS, VACUUM BOTTLES IN THE NATURE OF INSULATED FLASKS, ICE PAILS, NON-ELECTRIC WHISKS, COOKING STRAINERS, PEPPER POTS, SUGAR BOWLS AND SALT SHAKERS NOT OF PRECIOUS METAL, EGG CUPS NOT OF PRECIOUS METAL, TRAYS NOT OF PRECIOUS METAL, TOOTHPICK

HOLDERS NOT OF PRECIOUS METAL, COLANDERS, SHAKERS, NAMELY, COCKTAIL SHAKERS, JAPANESE STYLE COOKED RICE SCOOPS, HAND-OPERATED COFFEE GRINDERS AND PEPPER MILLS, COOKING FUNNELS, JAPANESE STYLE WOODEN PESTLES, JAPANESE STYLE EARTHENWARE MORTARS, JAPANESE STYLE PERSONAL DINING TRAYS OR STANDS, BOTTLE OPENERS, COOKING GRATERS, TART SCOOPS, CHOPSTICKS, CHOPSTICK CASES, KITCHEN UTENSILS, NAMELY, LADLES AND DIPPERS, COOKING SIEVES AND SITTERS, CHOPPING BOARDS FOR KITCHEN USE, ROLLING PINS FOR COOKING PURPOSES, COOKING UTENSILS, NAMELY, GRILLS, TOOTHPICKS, LEMON SQUEEZERS, NON-ELECTRIC WAFFLE IRONS, IRONING BOARDS, BATHROOM STOOLS, BATHROOM PAILS, CANDLE EXTINGUISHERS AND CANDLESTICKS NOT OF PRECIOUS METAL, CINDER SIFTERS FOR HOUSEHOLD PURPOSES, COAL SCUTTLES, FLY SWATTERS, MOUSE TRAPS, FLOWER POTS, WATERING CANS, FEEDING VESSELS FOR PETS, BRUSHES FOR PETS, BIRD CAGES FOR DOMESTIC BIRDS, BIRD BATHS, CLOTHES BRUSHES, CHAMBER POTS, TOILET PAPER HOLDERS, PIGGY BANKS NOT OF METAL, BOXES OF METAL FOR DISPENSING PAPER TOWELS, BOOTJACKS, SOAP DISPENSERS, FLOWER VASES AND BOWLS NOT OF PRECIOUS METAL, WIND CHIMES, UPRIGHT SIGNBOARDS OF GLASS OR CERAMICS, PERFUME BURNERS, PIG BRISTLES AND HOG BRISTLES FOR BRUSHES, TEA-STRAINERS, TEAPOTS, HOUSEHOLD CONTAINERS FOR FOOD, AND AROMA LAMPS, IN CLASS 21 (U.S. CLS. 2, 13, 23, 29, 30, 33, 40 AND 50).

PRIORITY DATE OF 4-10-2006 IS CLAIMED.

OWNER OF INTERNATIONAL REGISTRATION  
0910637 DATED 4-21-2006, EXPIRES 4-21-2016.

SER. NO. 79-033,678, FILED 4-21-2006.

MICHAEL WIENER, EXAMINING ATTORNEY

**Int. Cls.: 6, 12 and 17**

**Prior U.S. Cls.: 1, 2, 5, 12, 13, 14, 19, 21, 23, 25, 31, 35,  
44 and 50**

**United States Patent and Trademark Office**

**Reg. No. 3,395,095**

**Registered Mar. 11, 2008**

**TRADEMARK  
PRINCIPAL REGISTER**

**One4**

VOITH TURBO SCHARFENBERG; GMBH & CO.  
KG (FED REP GERMANY LIMITED PART-  
NERSHIP)  
GOTTFRIED-LINKE-STRASSE 205  
38239 SALZGITTER  
FED REP GERMANY

FOR: BUFFERS OF METAL, NAMELY, SHOCK  
ABSORBING METAL BUFFERS FOR INDUSTRIAL  
MACHINERY, IN CLASS 6 (U.S. CLS. 2, 12, 13, 14, 23,  
25 AND 50).

FOR: METAL COUPLINGS FOR AIR, STEAM,  
WATER AND POWER SUPPLY LINES BETWEEN  
RAIL-MOUNTED VEHICLES; COIL AND LEAF  
SPRINGS OTHER THAN AS ENGINE PARTS FOR  
BUFFERS, COUPLINGS AND STABILIZERS; AND  
COUPLINGS, NAMELY, AUTOMATIC CENTER  
BUFFER COUPLINGS FOR RAIL-MOUNTED VE-  
HICLES, IN CLASS 12 (U.S. CLS. 19, 21, 23, 31, 35 AND  
44).

FOR: SHOCK ABSORBING RUBBER BUFFERS  
FOR INDUSTRIAL MACHINERY, IN CLASS 17 (U.S.  
CLS. 1, 5, 12, 13, 35 AND 50).

THE MARK CONSISTS OF STANDARD CHAR-  
ACTERS WITHOUT CLAIM TO ANY PARTICULAR  
FONT, STYLE, SIZE, OR COLOR.

PRIORITY DATE OF 12-1-2005 IS CLAIMED.

OWNER OF INTERNATIONAL REGISTRATION  
0910494 DATED 5-10-2006, EXPIRES 5-10-2016.

SER. NO. 79-033,687, FILED 5-10-2006.

MICHAEL WIENER, EXAMINING ATTORNEY

**Int. Cls.: 18, 25 and 35**

**Prior U.S. Cls.: 1, 2, 3, 22, 39, 41, 100, 101 and 102**

**United States Patent and Trademark Office**

**Reg. No. 3,395,096**

**Registered Mar. 11, 2008**

**TRADEMARK  
SERVICE MARK  
PRINCIPAL REGISTER**



STEPHANIE PETERS-DIJKSTRA (NETHERLANDS INDIVIDUAL)  
VERLENGDE TALMALAAN 43  
NL-3762 AB SOEST  
NETHERLANDS

FOR: LEATHER UNWORKED OR SEMI-WORKED AND IMITATION OF LEATHER; LEATHER AND IMITATION LEATHER GOODS, NAMELY, BAGS, CASES, ATHLETIC BAGS, ALL PURPOSED SPORTS BAGS, BEACH BAGS, BOOK BAGS, CARRY-ON BAGS, DUFFEL BAGS, GYM BAGS, OVERNIGHT BAGS, SCHOOL BAGS, SHOULDER BAGS, TEXTILE SHOPPING BAGS, TEXTILE BACKPACKS, TOTE BAGS, GARMENT BAGS FOR TRAVEL, SHOE BAGS FOR TRAVEL AND SUIT BAGS, SUITCASES AND WALLETS, HANDBAGS; UMBRELLAS AND PARASOLS; TRUNKS AND TRAVELING BAGS; BAGS, NAMELY, SPORT BAGS, BABY CARRYING BAGS, BARREL BAGS, CARRY-ALL BAGS, BACKPACKS, IN CLASS 18 (U.S. CLS. 1, 2, 3, 22 AND 41).

FOR: CLOTHING, NAMELY, SHIRTS, T-SHIRTS, PANTS, JEANS, SKIRTS, DRESSES, SWEATSHIRTS, POLO SHIRTS, RUGBY SHIRTS, HOODED SWEATERS, SINGLETs, PAJAMAS, BOXER SHORTS, UNDERWEAR; BABY CLOTHES, NAMELY, LONG SLEEVE AND SHORT SLEEVE CREEPERS, BABY PLAYSUITS; FOOTWEAR, NAMELY, BOOTS, SHOES, SANDALS, SLIPPERS, ATHLETIC FOOTWEAR, CASUAL FOOTWEAR, INFANT FOOTWEAR AND BEACH FOOTWEAR, SOCKS AND TIGHTS; HEADGEAR, NAMELY, HATS AND CAPS, IN CLASS 25 (U.S. CLS. 22 AND 39).

FOR: COMMERCIAL INTERMEDIARY SERVICES IN THE FIELD OF PURCHASING AND SELLING OF GOODS, NAMELY, LEATHER AND IMITATION LEATHER GOODS, CLOTHING, FOOTWEAR AND HEADGEAR VIA GLOBAL COMPUTER NETWORKS; RETAIL STORE SERVICES AND ONLINE RETAIL STORE SERVICES IN THE FIELD OF CLOTHING AND FASHION, IN CLASS 35 (U.S. CLS. 100, 101 AND 102).

OWNER OF INTERNATIONAL REGISTRATION  
0900552 DATED 7-28-2006, EXPIRES 7-28-2016.

NO CLAIM IS MADE TO THE EXCLUSIVE RIGHT TO USE "COLORS" FOR CLASSES 18 AND 25, APART FROM THE MARK AS SHOWN.

THE COLOR(S) RED, GREEN, BLUE AND WHITE IS/ARE CLAIMED AS A FEATURE OF THE MARK.

THE COLOR WHITE APPEARS IN THE WORDING SIMPLY COLORS; THE COLOR RED APPEARS ON THE LEFT-HAND SIDE OF THE RECTANGLE, THE COLOR GREEN APPEARS DIRECTLY NEXT TO THE RED AND THE COLOR BLUE APPEARS DIRECTLY NEXT TO THE GREEN.

SER. NO. 79-033,795, FILED 12-8-2006.

MICHAEL LEWIS, EXAMINING ATTORNEY

**Int. Cl.: 25**

**Prior U.S. Cls.: 22 and 39**

**United States Patent and Trademark Office**

**Reg. No. 3,395,097**

**Registered Mar. 11, 2008**

**TRADEMARK  
PRINCIPAL REGISTER**

**LUHTA**

L-FASHION GROUP OY (FINLAND JOINT  
STOCK COMPANY)  
LINJAKATU 5  
FI-15100 LAHTI, FINLAND

OWNER OF U.S. REG. NO. 2,481,259.

FOR: CLOTHING, NAMELY, COATS, JACKETS,  
TROUSERS, PANTS, LEGGINGS, OVERALLS, JOG-  
GING SUITS, DUNGAREES, SHIRTS, SHORTS,  
DRESSES, SKIRTS, UNDERWEAR, SOCKS, STOCK-  
INGS, GLOVES; FOOTWEAR; AND HEADWEAR, IN  
CLASS 25 (U.S. CLS. 22 AND 39).

"THE FOREIGN WORDING IN THE MARK  
TRANSLATES INTO ENGLISH AS MARSH FOR  
HARVESTING FODDER."

SER. NO. 79-033,874, FILED 12-15-2006.

OWNER OF INTERNATIONAL REGISTRATION  
0911318 DATED 12-15-2006, EXPIRES 12-15-2016.

SUSAN RICHARDS, EXAMINING ATTORNEY

Int. Cls.: 1, 6, 9 and 17

Prior U.S. Cls.: 1, 2, 5, 6, 10, 12, 13, 14, 21, 23, 25, 26, 35, 36, 38, 46 and 50

Reg. No. 3,395,098

United States Patent and Trademark Office

Registered Mar. 11, 2008

TRADEMARK  
PRINCIPAL REGISTER

***muRata***

MURATA MANUFACTURING CO., LTD. (JAPAN CORPORATION)  
10-1, HIGASHIKOTARI 1 CHOME  
NAGAOKAKYO-SHI, KYOTO 617-8555  
JAPAN

FOR: CHEMICALS USED IN INDUSTRY AND SCIENCE AND NOT FOR MEDICAL AND VETERINARY USE; UNPROCESSED ARTIFICIAL RESINS, UNPROCESSED PLASTICS; CERAMIC MATERIALS IN PASTE AND/OR POWDER FORMS FOR USE IN INDUSTRY, NAMELY, CERAMIC POWDERS AND PASTE USED FOR MANUFACTURING; METALLIC OXIDES; MAGNETIC IRON OXIDE; FERRITE COMPOUNDS IN PASTE AND POWDER FORMS FOR USE IN MANUFACTURING MAGNETS; TRANSPARENT CERAMICS IN PASTE AND POWDER FORM USED FOR MANUFACTURING OTHER PRODUCTS; ALUMINUM OXIDE IN THE NATURE OF ALUMINA CERAMICS USED IN MANUFACTURING ELECTRONIC COMPONENTS, IN CLASS 1 (U.S. CLS. 1, 5, 6, 10, 26 AND 46).

FOR: METALLIC POWDERS OF COMMON METALS FOR USE IN MANUFACTURING AND NOT FOR PAINTERS, ARTISTS, DECORATORS OR PRINTERS; COMMON METAL PASTES, NAMELY, SOLDER PASTE, IN CLASS 6 (U.S. CLS. 2, 12, 13, 14, 23, 25 AND 50).

FOR: CAPACITORS; CERAMIC CAPACITORS; MONOLITHIC CERAMIC CAPACITORS; LAMINATED CERAMIC CAPACITORS; SEMI CONDUCTIVE CERAMIC CAPACITORS; HIGH VOLTAGE CAPACITORS; HIGH FREQUENCY POWER CAPACITORS; HIGH FREQUENCY MICROCHIP CAPACITORS; TRIMMER CAPACITORS; CAPACITANCE NETWORKS, NAMELY CAPACITORS; ELECTRIC RESISTORS; TRIMMER POTENTIOMETERS; HIGH VOLTAGE ELECTRIC RESISTORS; NETWORK RESISTORS, NAMELY, CAPACITORS; THERMISTORS; POSITIVE TEMPERATURE RESIS-

TANCE COEFFICIENT THERMISTORS; NEGATIVE TEMPERATURE RESISTANCE COEFFICIENT THERMISTORS; NOISE SUPPRESSION PRODUCTS, NAMELY, ELECTROMAGNETIC INTERFERENCE SUPPRESSION FILTERS, FERRITE BEADS INDUCTORS, FERRITE MAGNET CORES, COMMON MODE CHOKE ELECTRIC CHOKE COILS, VARISTORS; ELECTROMAGNETIC INTERFERENCE SUPPRESSION FILTERS; FERRITE BEADS INDUCTORS; FERRITE MAGNET CORES; COMMON MODE ELECTRIC CHOKE COILS; VARISTORS; MICROWAVE ABSORBING SHEETS FOR NOISE SUPPRESSION AS PARTS OF TELECOMMUNICATION EQUIPMENT, COMPUTERS AND ITS PERIPHERAL DEVICES, AUDIO/VISUAL EQUIPMENT, TELEVISION SETS, DIGITAL STILL CAMERAS AND DIGITAL CAMCORDERS; RESISTANCE CAPACITANCE MODULES AND CAPACITANCE MODULES, NAMELY, CAPACITORS; ELECTRIC COILS; ELECTRIC CHIP COILS; PIEZOELECTRIC TRANSFORMERS; RESONATORS; CERAMIC RESONATORS; SURFACE ACOUSTIC WAVE RESONATORS; BGS WAVE RESONATORS; PIEZOELECTRIC SOUND COMPONENTS, NAMELY, PIEZOELECTRIC DIAPHRAGMS, PIEZOELECTRIC BUZZERS, PIEZOELECTRIC SOUNDERS, PIEZOELECTRIC RECEIVERS, PIEZOELECTRIC SPEAKERS, PIEZOELECTRIC RINGERS; PIEZOELECTRIC DIAPHRAGMS; PIEZOELECTRIC BUZZERS; PIEZOELECTRIC SOUND COMPONENTS; PIEZOELECTRIC RECEIVERS, NAMELY, RECEIVERS FOR TELEPHONES; PIEZOELECTRIC AUDIO SPEAKERS; PIEZOELECTRIC RINGERS FOR USE WITH TELEPHONES; FILTERS FOR AUDIOVISUAL EQUIPMENT AND COMMUNICATION EQUIPMENT, NAMELY, CERAMIC FILTERS, CERAMIC DISCRIMINATORS, CERAMIC TRAP CIRCUITS, BGS WAVE TRAPS, SURFACE ACOUSTIC WAVE FILTERS, BGS WAVE FILTERS, MICROWAVE FILTERS, INDUCTANCE AND CAPACITANCE FILTERS, DUPLEXERS, DIPLEXERS; CERAMIC FILTERS, CERAMIC DISCRIMINA-

TORS; ELECTRONIC CIRCUITS CONTAINING CERAMIC TRAPS; ELECTRONIC CIRCUITS WHICH BLOCK OR ATTENUATE BGS WAVES; SURFACE ACOUSTIC WAVE FILTERS; BGS SOUND WAVE FILTERS; MICROWAVE FILTERS; INDUCTANCE AND CAPACITANCE FILTERS; DUPLEXERS; DIPLEXERS; MICROWAVE COMPONENTS, NAMELY, COAXIAL CONNECTORS, ISOLATORS, CIRCULATORS, DIELECTRIC RESONATORS, DIELECTRIC ANTENNAS, MULTILAYER COUPLERS FOR HIGH-FREQUENCY SIGNAL PROCESSING, MULTILAYER BALUNS, DELAY LINES, CHIP DELAY LINES; COAXIAL ELECTRICAL CONNECTORS; ISOLATORS; CIRCULATORS; DIELECTRIC RESONATORS; DIELECTRIC ANTENNAS; MULTILAYER ANTENNAS; MULTILAYER COUPLERS FOR HIGH-FREQUENCY SIGNAL PROCESSING; ELECTRICAL TRANSFORMERS, NAMELY, MULTILAYER BALUNS; DELAY LINES; CHIP DELAY LINES; MICROWAVE MODULES, NAMELY RADIO FREQUENCY DIODE SWITCHES, VOLTAGE CONTROL OSCILLATORS, TEMPERATURE COMPENSATED CRYSTAL OSCILLATORS, PHASE-LOCKED LOOP MODULES, RADIO FREQUENCY SUB MODULES, ACTIVE FILTERS; RADIO FREQUENCY DIODE SWITCHES; VOLTAGE CONTROL OSCILLATORS; TEMPERATURE COMPENSATED CRYSTAL OSCILLATORS; PHASE-LOCKED LOOP MODULES; RADIO FREQUENCY SUB MODULES FOR USE IN RADIO FREQUENCY TRANSMISSION; ACTIVE FILTERS FOR USE WITH AUDIO VISUAL APPARATUS; HYBRID INTEGRATED CIRCUITS; RADIO FREQUENCY MODULES; WIRED MODEMS; PERSONAL COMPUTER MEMORY CARD MODULATION AND DEMODULATION; PARTS FOR VIDEO EQUIPMENT, NAMELY, RADIO SIGNAL TUNERS, FLY BACK TRANSFORMERS, HIGH VOLTAGE CAPACITANCE AND RESISTANCE BLOCKS, HIGH VOLTAGE RECTIFIED BLOCKS, HIGH VOLTAGE STABILIZATION CIRCUIT MODULES, FOCUS ADJUSTING RESISTORS; RADIO SIGNAL TUNERS; FLY BACK TRANSFORMERS; HIGH VOLTAGE CAPACITANCE AND RESISTANCE BLOCKS, NAMELY, POWER DISTRIBUTION BLOCKS; HIGH VOLTAGE RECTIFIED BLOCKS, NAMELY, POWER DISTRIBUTION BLOCKS; HIGH VOLTAGE STABILIZATION CIRCUIT MODULES, NAMELY, POWER DISTRIBUTION BLOCKS; FOCUS ADJUSTING ELECTRIC RESISTORS; ELECTRIC POWER SUPPLY; HIGH VOLTAGE POWER SUPPLY; HIGH VOLTAGE TRANSFORMERS; SWITCHING POWER SUPPLY; CONVERTERS; INVERTERS; SENSORS; INFRARED SENSORS; MAGNETIC PATTERN RECOGNITION SENSORS; SHOCK SENSORS; ELECTRIC POTENTIAL SENSORS; TEMPERATURE

SENSORS; ROTARY POSITION SENSORS; POTENTIOMETERS; ROTARY SENSORS; AIRBAG SENSORS; ULTRASONIC SENSORS; PIEZOELECTRIC GYROSCOPES; ELECTRIC ACTUATORS; INTEGRATED CIRCUITS; MICROWAVE MONOLITHIC INTEGRATED CIRCUITS; GALLIUM ARSENIDE (GAAS) FIELD EFFECT TRANSISTORS; TESTING DUMMIES FOR THE MEASUREMENT AND ANALYSIS OF EFFECT OF ANTENNA PROPAGATION CHARACTERISTICS OF MOBILE COMMUNICATION EQUIPMENT; PRINT CIRCUIT BOARDS; DIELECTRIC BOARDS FOR PRINTED CIRCUITS; ELECTRICALLY INSULATED BOARD FOR PRINTED CIRCUITS; MULTILAYER FUNCTIONAL SUBSTRATES, NAMELY, MULTILAYER PRINTER CIRCUIT BOARDS, MULTILAYER PRINTED WIRING BOARDS; AUDIO SPEAKER SYSTEMS COMPRISED PRIMARILY OF AUDIO SPEAKERS; SPHERICAL AUDIO SPEAKER SYSTEMS COMPRISED PRIMARILY OF AUDIO SPEAKERS; AUDIO TWEETER SYSTEMS COMPRISED PRIMARILY OF AUDIO SPEAKERS; SPHERICAL AUDIO TWEETER SYSTEMS COMPRISED PRIMARILY OF AUDIO SPEAKERS; ANTENNA COILS; AC LINE FILTERS; TRIPLEXERS WITH INTEGRATED SURFACE ACOUSTIC WAVE (SAW) FILTERS; AC-DC CONVERTER MODULES; FRESNEL LENSES; OPTICAL TRANSCEIVERS; CONDUCTIVE ELECTRODE PASTES AND RESINS CONTAINING CONDUCTIVE METAL, IN CLASS 9 (U.S. CLS. 21, 23, 26, 36 AND 38).

FOR: PLASTICS IN EXTRUDED FORM FOR USE IN MANUFACTURE; ELECTRICAL INSULATING MATERIALS, ELECTRICAL INSULATING SUBSTANCES IN THE NATURE OF DIELECTRIC INSULATORS; ELECTRICAL INSULATING MATERIALS IN THE NATURE OF PAINTS, COATINGS, VARNISH, RESINS AND FOILS; DIELECTRIC COMPOUND MATERIALS CONSISTING OF CERAMICS AND RESIN, IN CLASS 17 (U.S. CLS. 1, 5, 12, 13, 35 AND 50).

PRIORITY DATE OF 11-16-2005 IS CLAIMED.

OWNER OF INTERNATIONAL REGISTRATION 0911332 DATED 1-27-2006, EXPIRES 1-27-2016.

OWNER OF U.S. REG. NOS. 841,564 AND 1,264,578.

SER. NO. 79-033,883, FILED 1-27-2006.

SEAN CROWLEY, EXAMINING ATTORNEY

Int. Cls.: 9, 35, 36, 38, 39 and 41

Prior U.S. Cls.: 21, 23, 26, 36, 38, 100, 101, 102, 104,  
105 and 107

Reg. No. 3,395,099

United States Patent and Trademark Office

Registered Mar. 11, 2008

TRADEMARK  
SERVICE MARK  
PRINCIPAL REGISTER

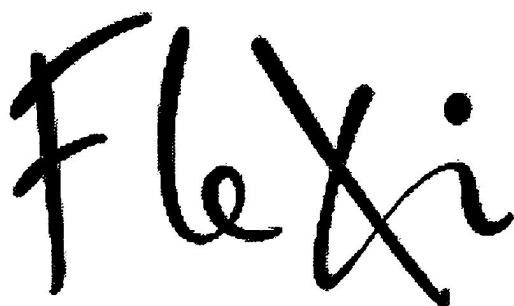

TÜRKİYE GARANTI BANKASI; ANONİM SİR-  
KETİ (TURKEY JOINT STOCK COMPANY)  
LEVENT NİSPETİYE MAHALLESİ  
AYTAR CADDESİ NO. 2; BEŞİKTAS, İSTANBUL  
TURKEY

FOR: APPARATUS AND INSTRUMENTS USED FOR MEASURING, WEIGHING AND EVALUATION IN THE FIELD OF SCIENCE, NAUTICAL, TOPOGRAPHY, METEOROLOGY, ELECTRIC, PHOTOGRAPHY, CINEMATOGRAPHY, AND FOR EQUIPMENT TESTING, NAMELY, BAROMETERS, AMMETERS, GAS TESTING INSTRUMENTS, SLIDE CALIPERS, HYGROMETERS, THERMOMETERS, VOLTMETERS, MICROSCOPES, OPTICAL MAGNIFYING GLASS, TELESCOPES AND PERISCOPIES; EQUIPMENTS USED IN LABORATORY, NAMELY, TEST TUBES, MEASURING TUBES; FURNACES FOR LABORATORY EXPERIMENTS, FURNITURE ESPECIALLY MADE FOR LABORATORIES; ELECTRONIC SIGNS IN THE NATURE OF ILLUMINATED ADVERTISEMENT BOARDS, SCOREBOARDS AND NOTICE BOARDS; APPARATUS FOR RECORDING, TRANSMISSION OR REPRODUCTION OF SOUND OR IMAGE; RADIOS, TELEVISIONS, VIDEO DISK PLAYERS, PHOTOGRAPHIC CAMERAS, AUDIO RECORDING APPARATUS; AMUSEMENT APPARATUS ADAPTED FOR USE WITH TELEVISION RECEIVERS ONLY, NAMELY, VIDEO GAME MACHINES FOR USE WITH TELEVISIONS; CINEMATOGRAPHIC CAMERAS, REMOTE CONTROLS FOR TELEVISIONS, RADIOS AND COMPACT DISC PLAYERS; HEADPHONES, LOUDSPEAKERS, MEGAPHONES, INTERCOMS, PICTURE AND SLIDE PROJECTORS; DATA PROCESSORS; COMPUTERS, COMPUTER

GAME SOFTWARE; COMPUTER HARDWARE, PRINTERS FOR USE WITH COMPUTERS, LASER PRINTERS FOR USE WITH COMPUTERS, SCANNERS, CASH REGISTERS, CALCULATING MACHINES, BAR CODE READERS; REPLACEMENT PARTS FOR COMPUTER PRINTERS; ON-BOARD NAVIGATION COMPUTERS FOR VEHICLES; BLANK MAGNETIC AND OPTIC DATA CARRIERS; BLANK OPTICAL DISCS, AUDIO CASSETTES, COMPUTER DISKS, FLOPPY DISKS AND COMPACT AUDIO DISCS; EXPOSED CAMERA FILM; PHOTOGRAPHY CAMERAS, REPLACEMENT PARTS FOR CAMERAS; DIGITAL COLOR COPIERS FOR ENLARGING PHOTOGRAPHS; UNEXPOSED CINEMATOGRAPHY FILMS; EXPOSED X-RAY FILMS; ANTENNAS, SATELLITE ANTENNAS, AMPLIFIERS AND REPLACEMENT PARTS THEREOF; ELECTRONIC APPARATUS, NAMELY, A RADIO TRANSMITTER FOR REMOTE IGNITION OF VEHICLE ENGINES; COIN-ACCEPTING MECHANISMS FOR COIN, CARD AND TOKEN OPERATED APPARATUS; AUTOMATIC VENDING MACHINES, COIN OPERATED ELECTRONIC PHOTOGRAPH PORTRAIT MACHINES, AUTOMATED TICKET DISPENSING MACHINES FOR GAMING, AUTOMATED WEIGHING MACHINES, AUTOMATIC TELLER MACHINES; ELECTRONIC COMPONENTS FOR MACHINES AND INSTRUMENTS, NAMELY, ELECTRICAL CONDUCTORS, ELECTRONIC INTEGRATED CIRCUITS, INTEGRATED CIRCUIT MODULES, COMPUTER CHIPS, PHOTOCELL PRODUCTS, NAMELY PLUG-IN SOCKETS, DIODES, TRANSISTORS, CIRCUIT CARDS, CRYSTAL OSCILLATORS, CONDENSERS, INTERFACE CIRCUITS FOR VIDEO CAMERAS, RELAYS, LI-



QUID CRYSTAL DISPLAYS, HYBRID PRINTED CIRCUITS, THERMOSTATS, CONVERTERS, COMPONENTS FOR CARD READERS, NAMELY, MAGNETIC HEADS, MAGNETIC DEVIATORS; COMMUNICATION MACHINES, NAMELY, TELEPHONES, FACSIMILE MACHINES, TELEX MACHINE, TELEGRAPH MACHINES, WIRELESS TELEPHONES, AUTOMATIC SWITCHBOARDS; ELECTRIC MACHINES FOR PHOTOCOPYING AND REPRODUCTION OF IMAGES; PHOTOCOPIERS, BLUEPRINT PRINTING MACHINES; GEIGER COUNTERS; WATER AND ELECTRICITY METERS, GASOMETERS, PARKING METERS, TIMERS, MECHANICAL EGG TIMERS; BLANK ELECTRONIC CHIP AND MAGNETICALLY ENCODED DEBIT CARDS; MAGNETICALLY ENCODED PRE-PAID TELEPHONE; MAGNETIC CARDS FOR AUTOMATIC CARDS FOR OPENING AND CLOSING DOORS, ENCODED SMART CARDS CONTAINING PROGRAMMING USED TO COUNT INVENTORY; MAGNETIC CARDS FOR USE AS ELECTRONIC TICKETS; WEIGHING MACHINES, NAMELY, PRECISION BALANCES, SCALES, BALANCES; GAMMA RADIATION DETECTOR FOR ELECTRONIC DETECTION OF HIDDEN CONTRABAND; ROENTGEN APPARATUS NOT FOR MEDICAL PURPOSES, X-RAY MACHINES NOT FOR MEDICAL PURPOSES, RADIOLOGICAL APPARATUS FOR INDUSTRIAL PURPOSES; LIFE SAVING AND PROTECTING INSTRUMENTS, NAMELY, LIFE JACKETS, LIFE BUOYS, SWIMMING JACKETS; RESPIRATORY MASKS NOT FOR MEDICAL USE, DIVING SUITS, SCUBA DIVERS' MASKS, SAFETY RESTRAINTS OTHER THAN FOR VEHICLE SEATS AND SPORT EQUIPMENT, COMMERCIAL SAFETY NETS; PROTECTIVE CLOTHES, WORK GLOVES, GLASSES AND HELMETS; SIGNALING WHISTLES AND LANTERNS, SIGNALING BUOYS; EYEGLASSES; SUNGLASSES, OPTICAL LENSES, EYEGLASS AND CONTACT LENS CASES, AND REPLACEMENT PARTS AND FITTINGS OF THESE GOODS; INSTRUMENTS AND APPARATUS FOR CONDUCTING, SWITCHING, TRANSFORMING, ACCUMULATING, REGULATING OR CONTROLLING ELECTRICITY, NAMELY, PLUGS, SOCKETS, JUNCTION BOXES, ELECTRIC SWITCHES, CIRCUIT BREAKERS, CIRCUIT CLOSERS, FUSES, BALLASTS, FLUORESCENT STARTERS, ELECTRIC CIRCUIT BOARDS, ELECTRONIC CONTROLLER TO MANAGE THE POWER, MOVEMENT AND FUNCTIONS OF AN ELEVATOR, CONDUITS, RESISTORS, ELECTRIC CONNECTORS, ADAPTERS, BATTERY CHARGERS; ELECTRIC DOORBELLS, BURGLAR ALARMS; SIRENS; COMPUTER CABLES AND RESISTANCE WIRES; ELECTRICAL CABLES AND WIRES AND MAGNETIC TELEPHONE WIRES, OPTICAL FIBER CABLE; ELECTRIC ACCUMULATORS, SOLAR BATTERIES, BATTERIES, ELECTRIC FLAT IRONS, ELECTRIC IRONS, STEAM IRON, ELECTRIC PRESS IRON; INDICATORS FOR VEHICLES, NAMELY, GAUGES FOR SPEED, OIL, FUEL AND HEAT LEVELS, TACHOMETERS, TAXIMETERS; TIRE BALANCING MACHINES FOR LAND VEHICLES; VEHICLE BREAKDOWN WARNING TRIANGLES, LUMINOUS OR MECHANICAL ROAD SIGNS, MECHANICAL OR ELECTRICAL EQUIPMENT FOR

TRAFFIC SIGNALIZATION, CONTROLLING EQUIPMENTS FOR ROAD JUNCTIONS, NAMELY, REFLECTORS FOR TRAFFIC SIGNALS AND FLASHING TRAFFIC LIGHTS; FIRE EXTINGUISHER INSTRUMENTS, FIRE-EXTINGUISHING APPARATUS; ELECTRIC WELDING APPARATUS, NAMELY, SOLDERING IRONS, WELDING ELECTRODES FOR ELECTRIC SPOT WELDING MACHINES AND ELECTRIC SOLDERING MACHINES; RADAR APPARATUS, SONAR, NIGHT VISION GOGGLES; ELECTRICAL LIGHTING CONDUCTORS; LIQUID LEVEL SENSORS, METERS, MEASURES, PLUMB BOBS; MACHINES FOR DISPENSING PRE-DETERMINED DOSAGES OF MEDICATION; ELECTRICALLY HEATED HAIR-CURLERS; ELECTRIC DEVICES FOR ATTRACTING AND KILLING INSECTS; AUTOMATIC CONTROLLERS FOR DOORS FOR BUILDING, AUTOMATIC TURNSTILES, ELECTRIC DOOR OPENERS AND CLOSERS; SATELLITES FOR SCIENTIFIC PURPOSES; ELECTROLYSERS, GALVANIZING APPARATUS; ANODES, CATHODES RAY TUBES; FILTERS FOR COMPUTER AND TELEVISION SCREENS; REMOTE CONTROL MECHANISMS FOR VEHICLE DOORS; MAGNETS, DECORATIVE MAGNETS; EAR PLUGS NOT FOR MEDICAL PURPOSES, IN CLASS 9 (U.S. CLS. 21, 23, 26, 36 AND 38).

FOR: ADVERTISING SERVICES, ADVERTISING AGENCIES, PRODUCTION AND DISTRIBUTION OF RADIO AND TELEVISION COMMERCIALS, DISSEMINATION OF ADVERTISING MATTERS, ORGANIZATION OF EXHIBITIONS FOR COMMERCIAL OR ADVERTISING PURPOSES, MODELING FOR ADVERTISING OR SALES PROMOTION, CONDUCTING MARKETING STUDIES, SALES PROMOTION SERVICES, SHOP WINDOW DRESSING, CONDUCTING CONSUMER RESEARCH THROUGH QUESTIONNAIRES, PUBLIC RELATIONS; OFFICE FUNCTIONS; SECRETARIAL SERVICES, DOCUMENT REPRODUCTION, PHOTOCOPYING, TYPING SERVICES, WORD PROCESSING, COMPILATION OF INFORMATION INTO COMPUTER DATABASES, SYSTEMIZATION OF INFORMATION INTO COMPUTER DATABASES, TELEPHONE ANSWERING SERVICES, ARRANGING NEWSPAPER SUBSCRIPTIONS, RENTAL OF OFFICE MACHINES AND EQUIPMENTS, RENTAL OF VENDING MACHINES; BUSINESS ADMINISTRATION SERVICES; COMMERCIAL OR INDUSTRIAL MANAGEMENT ASSISTANCE, CONSULTANCY OF BUSINESS MANAGEMENT AND ORGANIZATION, BUSINESS MANAGEMENT OF HOTELS, BUSINESS INVESTIGATION, PROVIDING STATISTICAL INFORMATION, PERSONNEL MANAGEMENT CONSULTANCY, PERSONNEL RECRUITMENT, ACCOUNTING, DRAWING UP OF STATEMENTS OF ACCOUNTS, ACCOUNT AUDITING, COST/PRICE ANALYSIS, ECONOMIC FORECASTING, PAYROLL PREPARATION, TAX PREPARATION; IMPORT AND EXPORT AGENCIES; BUSINESS MANAGEMENT OF PERFORMING ARTISTS; PROVIDING BUSINESS EXPERT ADVICE REGARDING THE PRODUCTION OF INDUSTRIAL AND COMMERCIAL GOODS, AUCTIONEERING; AND RE-

TAIL STORE SERVICES FEATURING A WIDE VARIETY OF CONSUMER GOODS OF OTHERS, IN CLASS 35 (U.S. CLS. 100, 101 AND 102).

FOR: INSURANCE SERVICES, NAMELY, ACCIDENT, LIFE, FIRE, HEALTH AND MARINE INSURANCE UNDERWRITING, INSURANCE INVESTIGATION RELATED TO CLAIMS, ACTUARIAL SERVICES, INSURANCE CONSULTANCY; FINANCIAL AND MONETARY AFFAIRS, NAMELY, BANKING, FINANCIAL MANAGEMENT, FINANCIAL ANALYSIS, FINANCIAL INFORMATION PROCESSING; FACTORING AGENCIES; LEASING OF REAL PROPERTY; ISSUANCE OF CREDIT CARDS FOR SHOPPING BY INSTALLMENT; EXCHANGING CURRENCY; REAL ESTATE AFFAIRS, NAMELY, REAL ESTATE BROKERAGE, APARTMENT HOUSE MANAGEMENT SERVICES; REAL ESTATE APPRAISAL SERVICES; ANTIQUE MONEY APPRAISAL, ANTIQUE APPRAISAL, JEWELRY APPRAISAL, STAMP APPRAISAL, ART APPRAISAL; CUSTOMS BROKERAGE, IN CLASS 36 (U.S. CLS. 100, 101 AND 102).

FOR: RADIO AND TELEVISION BROADCASTING SERVICES; CONSULTING CONCERNING THE ARRANGEMENT OF THE BROADCASTING FLOW OF RADIO, TELEVISION AND OTHER COMMUNICATION DEVICES; COMMUNICATION SERVICES, NAMELY, PERSONAL TELECOMMUNICATIONS SERVICES; COMMUNICATION SERVICES BY CELLULAR TELEPHONES, COMMUNICATION SERVICES BY SATELLITE, COMMUNICATION SERVICES BETWEEN COMPUTER TERMINALS, COMMUNICATION SERVICES BY TELEGRAPH, COMMUNICATION SERVICES BY TELEPHONE, ELECTRONIC TRANSMISSION OF IMAGES AND MESSAGES VIA COMPUTER, E-MAIL SERVICES, FACSIMILE TRANSMISSION SERVICES, TELEGRAPH SERVICES, TELEPHONE COMMUNICATION SERVICES, COMMUNICATION VIA TELETYPEWRITERS THAT COMMUNICATE VIA TELEPHONE LINES, PROVIDING INFORMATION RELATED TO COMMUNICATION, CONSULTANCY SERVICES RELATED TO COMMUNICATION, PROVIDING MULTIPLE USER ACCESS TO GLOBAL COMPUTER NETWORKS; RENTAL OF COMMUNICATION INSTRUMENTS AND DEVICES; NEWS AGENCY SERVICES, NAMELY, THE TRANSMISSION OF NEWS ITEMS TO NEWS REPORTING ORGANIZATIONS, IN CLASS 38 (U.S. CLS. 100, 101 AND 104).

FOR: LAND, AIR AND SEA TRANSPORT SERVICES BY MEANS OF TRUCKS, AIRPLANES AND SHIPS; TRANSPORT COMMISSION AGENCY SERVICES, NAMELY, ARRANGING FOR THE TRANSPORTATION OF FREIGHT BY SHIP; AMBULANCE TRANSPORT SERVICES; PRIVATE CHAUFFEUR SERVICES, AIRPLANE PILOT SERVICES; TOURIST AGENCY SERVICES; TRAVEL AGENCY SERVICES, NAMELY, MAKING RESERVATIONS AND BOOKINGS FOR TRAVEL TRANSPORTATION AND TRAVEL TOURS; COURIER SERVICES FOR THE DELIVERY OF MESSAGES AND GOODS; DELIV-

ERY OF GOODS BY TRUCK; DELIVERY OF NEWSPAPERS; PACKAGE DELIVERY SERVICES BY VARIOUS MODES OF TRANSPORTATION; RENTAL OF LAND, AIR AND SEA VEHICLES; PARKING LOT SERVICES, GARAGE RENTAL SERVICES, BOAT SHELTERING SERVICES; TRANSMISSION OF OIL OR GAS THROUGH PIPELINES; ELECTRICITY DISTRIBUTION SERVICES, WATER SUPPLY SERVICES; VEHICLE AND GOODS RESCUE SERVICES; STORAGE, PACKAGING AND CRATING OF GOODS; AND GARBAGE STORAGE, COLLECTION AND TRUCK TRANSPORT SERVICES, IN CLASS 39 (U.S. CLS. 100 AND 105).

FOR: EDUCATION AND INSTRUCTION SERVICES, NAMELY, ORGANIZATION AND CONDUCTING SYMPOSIA, CONFERENCES, CONGRESSES AND SEMINARS IN THE FIELD OF TRAVEL AND TOURISM; ANIMAL TRAINING SERVICES; MUSEUM SERVICES; ENTERTAINMENT SERVICES, NAMELY, ORGANIZATION AND ADMINISTRATION OF BEAUTY CONTESTS, ORGANIZATION OF DANCE SHOWS, ORGANIZATION OF DANCE CONTESTS; LIBRARY SERVICES; PUBLICATION OF MAGAZINES AND BOOKS; NEWSPAPERS PUBLISHING SERVICES; SPORTS SERVICES, NAMELY, PROVIDING SPORTS FACILITIES AND ORGANIZATION OF SPORTS EVENTS IN THE FIELDS OF FOOTBALL, BASKETBALL AND BASEBALL; CASINO SERVICES, PRODUCTION SERVICES FOR MOTION PICTURE FILM, VIDEOTAPES AND VIDEO DISCS, AND TELEVISION AND RADIO PROGRAMS; RECORDING STUDIO SERVICES, FILM DUBBING SERVICES, RENTAL OF RADIO AND TELEVISION RECEIVERS, RENTAL OF CINEFILMS AND VIDEO FILMS, RENTAL OF CINEFILM PROJECTORS AND ACCESSORIES THEREOF, RENTAL OF SOUND RECORDING DEVICES, RENTAL OF VIDEO TAPES, RENTAL OF VIDEO TAPE RECORDERS; SERVICES RELATED TO THE ARTISTIC ACTIVITIES, NAMELY, PROVIDING MOVIE THEATERS; ENTERTAINMENT IN THE NATURE OF ORCHESTRA PERFORMANCES; ARRANGING AND CONDUCTING OF CONCERTS AND LIVE SHOW PERFORMANCES; ARRANGING FOR TICKET RESERVATIONS FOR SHOWS AND OTHER ENTERTAINMENT EVENTS; MODELING SERVICES FOR ARTISTS; RENTAL OF STAGE AND SHOW DECORATIONS; NEWS REPORTING CORRESPONDENT SERVICES, NEWSPAPER PHOTOGRAPHY SERVICES; PHOTOGRAPHER SERVICES; MICROFILMING FOR OTHERS; TRANSLATION SERVICES; AND SIGN LANGUAGE TRANSLATION SERVICES, IN CLASS 41 (U.S. CLS. 100, 101 AND 107).

OWNER OF INTERNATIONAL REGISTRATION 0911443 DATED 5-3-2006, EXPIRES 5-3-2016.

SER. NO. 79-033,920, FILED 5-3-2006.

VERNA BETH RIRIE, EXAMINING ATTORNEY

**Int. Cl.: 25**

**Prior U.S. Cls.: 22 and 39**

**United States Patent and Trademark Office**

**Reg. No. 3,395,100**

**Registered Mar. 11, 2008**

**TRADEMARK  
PRINCIPAL REGISTER**

**CHE BY CHEVIGNON**

NAF NAF DISTRIBUTION B.V. (NETHERLANDS  
LTD LIAB CO)  
KONINGIN WILHELMINAPLEIN 13  
NL-1062 HH AMSTERDAM, NETHERLANDS

FOR: CLOTHING, NAMELY, JEANS, SHORTS,  
BERMUDA SHORTS, TROUSERS, DUNGAREES,  
COVERALLS, APRONS, SHIRTS, JACKETS, WIND-  
RESISTANT JACKETS, PULLOVERS, TEE-SHIRTS,  
SWEAT-SHIRTS, BUSINESS SUITS, JACKETS, AN-  
ORAKS, COATS, RAINCOATS, PETTICOATS, DRES-  
SES, UNDERWEAR, SWIM WEAR, STOCKINGS,  
TIGHTS, SOCKS, PEIGNOIRS, BEACH DRESSES,  
LINGERIE, LAYETTES, BELTS, TIES, GLOVES,  
STOLES, SASHES FOR WEAR, BELTS OF CLOTH,  
SHAWLS; SHOES, BOOTS, SLIPPERS; HEADGEAR,  
NAMELY, HATS, CAPS, BERETS, BONNETS, IN  
CLASS 25 (U.S. CLS. 22 AND 39).

THE MARK CONSISTS OF STANDARD CHAR-  
ACTERS WITHOUT CLAIM TO ANY PARTICULAR  
FONT, STYLE, SIZE, OR COLOR.

PRIORITY DATE OF 7-10-2006 IS CLAIMED.

OWNER OF INTERNATIONAL REGISTRATION  
0912132 DATED 12-7-2006, EXPIRES 12-7-2016.

OWNER OF U.S. REG. NO. 3,029,250.

SER. NO. 79-034,130, FILED 12-7-2006.

LAURA HAMMEL, EXAMINING ATTORNEY

Int. Cl.: 30

Prior U.S. Cl.: 46

United States Patent and Trademark Office

Reg. No. 3,395,101

Registered Mar. 11, 2008

TRADEMARK  
PRINCIPAL REGISTER



YANGZHOU FUCHUN YINFU JITUAN; YOUXIAN GONGSI FUCHUN CHASHE (CHINA CORPORATION)  
NO. 35, DESHENGQIAO  
YANGZHOU CITY; JIANGSU  
CHINA

FOR: FRIED RICE; GLUTINOUS RICE CAKE; EIGHT-TREASURE RICE PUDDINGS; SWEETENED BEAN PASTE; STEAMED BREAD; STEAMED TWISTED ROLL; GOURMET POWDER, NAMELY, BAKING, CHILI, CHOCOLATE, CINNAMON, CLOVE, CURRY, HOT PEPPER, JAPANESE ARROWROOT, WASABI, AND MUSTARD POWDERS; FLAVORING SAUCE; STEAMED STUFFED BUNS; SPRING ROLLS; RICE GLUE BALL; ZONGZI (A PYRAMID-SHAPED DUMPLING MADE OF GLUTINOUS RICE WRAPPED IN BAMBOO OR REED LEAVES, EATEN DURING THE DRAGON BOAT FESTIVAL); NOODLES; THIN PANCAKE; PASTRIES; DUMPLING; FRIED CAKES; CRISP CAKE; SWEET CAKE; DUMPLINGS MADE BY LOTUS ROOT FLOUR; WHEAT FLOUR; GROATS FOR HUMAN FOOD; GLUTINOUS RICE FLOUR; PROCESSED CEREAL PREPARATIONS; CAKE POWDER; CRUSHED BARLEY; HUSKED BARLEY; CAKE POWDER; FLOUR PREPARATIONS FOR FOOD; SEASONINGS; CAKE PASTE; LARGE FLAT

BREAD; LEAVEN FOR COOKING; ESSENCES FOR FOODSTUFFS, EXCEPT ETHERIC ESSENCES AND ESSENTIAL OILS, NAMELY, CORN FLOUR, CORN STARCH AND EXTRACTS USED AS FOOD FLAVORING; STEAMED DUMPLING WITH THE DOUGH GATHERED AT THE TOP, IN CLASS 30 (U.S. CL. 46).

OWNER OF INTERNATIONAL REGISTRATION  
0912532 DATED 8-22-2006, EXPIRES 8-22-2016.

THE TERM "FU" MEANS RICH AND THE TERM "CHUN" MEANS SPRING BUT THE COMBINATION OF THE TWO WORDS HAS NO MEANING. THE MARK HAS NO MEANING IN A FOREIGN LANGUAGE.

THE NON-LATIN CHARACTERS IN THE MARK TRANSLITERATE TO "FU" AND "CHUN" AND THIS MEANS "RICH" AND "SPRING" IN ENGLISH.

SER. NO. 79-034,256, FILED 8-22-2006.

TAMARA FRAZIER, EXAMINING ATTORNEY

**Int. Cls.: 3, 9, 18 and 25**

**Prior U.S. Cls.: 1, 2, 3, 4, 6, 21, 22, 23, 26, 36, 38, 39,  
41, 50, 51 and 52**

**Reg. No. 3,395,102**

**United States Patent and Trademark Office**

**Registered Mar. 11, 2008**

**TRADEMARK  
PRINCIPAL REGISTER**

# WHO\* S WHO

MAX - COMPANY S.R.L. (ITALY LTD LIAB CO)  
VIA OZANAM FEDERICO, 6  
I-20129 MILANO  
ITALY

FOR: PERFUMES, TOILET WATER, PERSONAL DEODORANTS, ESSENTIAL OILS FOR PERSONAL USE, BODY LOTIONS, SHOWER GEL, BUBBLE BATH, BATH OILS, BATH PEARLS, SKIN SOAPS, SHAVING BALMS, SHAVING CREAM, AFTER-SHAVE LOTIONS, COSMETIC PENCILS, FOUNDATION MAKE-UP, FACE POWDERS, TALCUM POWDERS, ROUGES, LIPSTICKS, MASCARAS, SKIN CLEANSING CREAMS, SKIN CLEANSING LOTIONS, SUN SCREEN PREPARATIONS, NAIL POLISHES, BEAUTY MASKS, FACIAL SCRUBS, FACE CREAMS, BODY CREAMS, COSMETIC CREAMS, LOTIONS AND GELS ALL FOR SLIMMING PURPOSES AND FOR THE REDUCTION OF CELLULITE; HAIR SHAMPOOS, HAIR SPRAYS, HAIR LOTIONS, HAIR DYES, HAIR RINSES, HAIR CONDITIONERS, HAIR LIGHTENERS, HAIR STYLING FOAMS AND GELS, DENTIFRICES, IN CLASS 3 (U.S. CLS. 1, 4, 6, 50, 51 AND 52).

FOR: EYEGLASSES, SUNGLASSES, CASES FOR GLASSES, SPORT GLASSES, CHAINS FOR GLASSES, FRAMES FOR GLASSES, LENSES FOR EYEGLASSES; LENSES FOR SUNGLASSES, PINCE-NEZ, PROTECTIVE HELMETS, PROTECTIVE CARRYING CASES FOR CD PLAYERS; CASES FOR MOBILE PHONES, IN CLASS 9 (U.S. CLS. 21, 23, 26, 36 AND 38).

FOR: UNWORKED AND SEMI-WORKED LEATHER, MOLESKIN BEING IMITATION OF LEA-

THER, HANDBAGS, LUGGAGE, SHOULDER BAGS, BEACH BAGS, CLUTCH BAGS, ALL PURPOSE SPORTS BAGS, ATTACHE CASES, SCHOOL BAGS, TOTE BAGS, TRAVELING BAGS, DOCUMENT CASES, COSMETIC CASES SOLD EMPTY, KEYCASES, KNAPSACKS, RUCKSACKS, BRIEFCASES, PURSES, WALLETS, TRAVELING TRUNKS, SUITCASES, UMBRELLAS, PARASOLS, WALKING STICKS; DOG COLLARS; WHIPS, IN CLASS 18 (U.S. CLS. 1, 2, 3, 22 AND 41).

FOR: BRASSIERES, CORSETS, SINGLET, PETTICOATS, NIGHTGOWNS, PAJAMAS, DRESSING GOWNS, PULLOVERS, BATH ROBES, BATHING SUITS, GLOVES BEING CLOTHING, CARDIGANS, JERSEYS, NECKTIES, NECKERCHIEFS, SCARVES, SWEATERS, SOCKS, STOCKINGS, TIGHTS, TROUSERS, LEGGINGS, SKIRTS, JACKETS, JERKINS, SHIRTS, VESTS, WAISTCOATS, JUMPERS, TRACK SUITS, BLOUSES, JEANS, PANTIES, PANTS, BERMUDA SHORTS, T-SHIRTS, SWEAT-SHIRTS, SUITS AND DRESSES, OVERCOATS, COATS, ANORAKS, RAINCOATS, BELTS, SUSPENDERS, SHOES, BOOTS, SLIPPERS, HATS, CAPS, IN CLASS 25 (U.S. CLS. 22 AND 39).

OWNER OF INTERNATIONAL REGISTRATION  
0912563 DATED 1-17-2006, EXPIRES 1-17-2016.

OWNER OF U.S. REG. NO. 2,969,085.

SER. NO. 79-034,264, FILED 1-17-2006.

Laura Hammel, Examining Attorney

**Int. Cl.: 5**

**Prior U.S. Cls.: 6, 18, 44, 46, 51 and 52**

**United States Patent and Trademark Office**

**Reg. No. 3,395,103**

**Registered Mar. 11, 2008**

**TRADEMARK  
PRINCIPAL REGISTER**

**STENVAX**

BIOMIRA B.V. (NETHERLANDS B.V.)  
DE BOELELAAN 575 A  
NL-1082 RM AMSTERDAM  
NETHERLANDS

THE MARK CONSISTS OF STANDARD CHARACTERS WITHOUT CLAIM TO ANY PARTICULAR FONT, STYLE, SIZE, OR COLOR.

OWNER OF INTERNATIONAL REGISTRATION  
0863163 DATED 9-6-2005, EXPIRES 9-6-2015.

FOR: IMMUNOLOGICAL PHARMACEUTICAL PREPARATIONS USED FOR THE PREVENTION AND TREATMENT OF CANCER, IN CLASS 5 (U.S. CLS. 6, 18, 44, 46, 51 AND 52).

SER. NO. 79-034,455, FILED 2-8-2007.

DOMINIC FATHY, EXAMINING ATTORNEY

**Int. Cls.: 3, 18, 25 and 35**

**Prior U.S. Cls.: 1, 2, 3, 4, 6, 22, 39, 41, 50, 51, 52, 100,  
101 and 102**

**Reg. No. 3,395,104**

**United States Patent and Trademark Office**

**Registered Mar. 11, 2008**

**TRADEMARK  
SERVICE MARK  
PRINCIPAL REGISTER**

# **HARVEY NICHOLS**

HARVEY NICHOLS AND COMPANY LIMITED  
(ENGLAND CORPORATION)  
109-125 KNIGHTSBRIDGE  
LONDON SW1X 7RJ  
UNITED KINGDOM

FOR: NON-MEDICATED BATH PREPARATIONS FOR THE APPLICATION TO, CONDITIONING AND CARE OF HAIR, SCALP, SKIN AND NAILS; SOAPS; PERFUMES; PERFUMERY; EAU DE COLOGNE; TOILET WATERS; ESSENTIAL OILS, NAMELY, HERBAL OILS; COSMETICS; MAKE-UP PREPARATIONS; NON-MEDICATED TOILET PREPARATIONS, NAMELY, FACE POWDERS; HAIR SPRAYS AND HAIR GELS; NON-MEDICATED BATH PREPARATIONS FOR USE IN THE BATH OR SHOWER; NON-MEDICATED BATH PREPARATIONS, NAMELY, BATH AND SHOWER OILS, GELS, CREAMS AND FOAMS; FACE AND BODY MASKS; FACE AND BODY SCRUBS; FACIAL WASHES; SKIN CLEANSERS AND HYDRATORS; SKIN TONERS; SKIN MOISTURIZERS; NON-MEDICATED BLEMISH CREAMS AND BLEMISH GELS; DEODORANTS FOR PERSONAL USE; PREPARATIONS FOR USE BEFORE SHAVING AND AFTER SHAVING; SHAVING SOAPS; SHAVING CREAMS; SHAVING GELS; AFTER-SHAVE PREPARATIONS; PRE-SHAVE PREPARATIONS; TALCUM POWDERS; NON-MEDICATED TOILETRIES; DENTIFRICES; TOOTHPASTES, IN CLASS 3 (U.S. CLS. 1, 4, 6, 50, 51 AND 52).

FOR: ARTICLES OF LEATHER, NAMELY, BRIEFCASES, HANDBAGS, HOLDALLS, PURSES, SUITCASES AND WALLETS, IN CLASS 18 (U.S. CLS. 1, 2, 3, 22 AND 41).

FOR: ARTICLES OF CLOTHING, NAMELY, FOOTWEAR; BOOTS, SHOES, SLIPPERS, SANDALS, TRAINERS, SOCKS AND HOSIERY; HEADGEAR IN THE NATURE OF HATS, HEADBANDS, CAPS, BERETS, AND SCARVES; GLOVES; MITTENS; BELTS BEING ARTICLES OF CLOTHING; SHIRTS, T-SHIRTS, POLO SHIRTS, SPORTS SHIRTS, FOOTBALL AND RUGBY SHIRTS; TROUSERS, JEANS,

SHORTS, SPORTS SHORTS; SWIMWEAR; UNDERWEAR; LINGERIE; TRACKSUITS; FOOTBALL BOOTS, RUGBY BOOTS; ARTICLES OF OUTERWEAR IN THE NATURE OF COATS, JACKETS, SKI JACKETS, CASUAL JACKETS, WATERPROOF AND WEATHERPROOF JACKETS AND COATS, PARKAS, SKI WEAR; SUITS; SWEATERS; LEGGINGS; NECKTIES; PAJAMAS; WAISTCOATS; HEADBANDS AND WRISTBANDS; WOMEN'S WEAR, NAMELY, PANTS, TOPS, DRESSES, SKIRTS, SHOES, HATS, SWEATERS, COATS AND JACKETS; CHILDREN'S WEAR, NAMELY, PANTS, TOPS, DRESSES, SKIRTS, SHOES, HATS, CAPS, SWEATERS, COATS AND JACKETS, IN CLASS 25 (U.S. CLS. 22 AND 39).

FOR: THE BRINGING TOGETHER, FOR THE BENEFIT OF OTHERS, OF A VARIETY OF GOODS, ENABLING CUSTOMERS TO CONVENIENTLY VIEW AND PURCHASE THESE GOODS IN A RETAIL DEPARTMENT STORE; THE BRINGING TOGETHER, FOR THE BENEFIT OF OTHERS, OF A VARIETY OF GOODS, ENABLING CUSTOMER TO CONVENIENTLY VIEW AND PURCHASE THOSE GOODS VIA MAIL ORDER CATALOGUES, TELEPHONE OR OTHER MEANS OF TELECOMMUNICATIONS; COMMERCIAL INFORMATION AND ADVICE FOR CONSUMERS FOR GOODS SOLD IN A RETAIL DEPARTMENT STORE, VIA MAIL ORDER CATALOGUES AND VIA TELEPHONE OR OTHER MEANS OF TELECOMMUNICATIONS; PERSONNEL PLACEMENT FOR IN-STORE RETAILERS, IN CLASS 35 (U.S. CLS. 100, 101 AND 102).

OWNER OF INTERNATIONAL REGISTRATION  
0913106 DATED 9-28-2006, EXPIRES 9-28-2016.

THE NAME(S), PORTRAIT(S), AND/OR SIGNATURE(S) SHOWN IN THE MARK DOES NOT IDENTIFY A PARTICULAR LIVING INDIVIDUAL.

SER. NO. 79-034,476, FILED 9-28-2006.

KAELIE KUNG, EXAMINING ATTORNEY

**Int. Cls.: 3 and 44**

**Prior U.S. Cls.: 1, 4, 6, 50, 51, 52, 100 and 101**

**United States Patent and Trademark Office**

**Reg. No. 3,395,105**

**Registered Mar. 11, 2008**

**TRADEMARK  
SERVICE MARK  
PRINCIPAL REGISTER**

# **BEYOND BEAUTY**

HARVEY NICHOLS AND COMPANY LIMITED  
(ENGLAND CORPORATION)  
109-125 KNIGHTSBRIDGE  
LONDON SW1X 7RJ  
UNITED KINGDOM

FOR: BLEACHING PREPARATIONS FOR HOUSEHOLDS USE AND OTHER SUBSTANCES FOR LAUNDRY USE, NAMELY, LAUNDRY DETERGENT AND LAUNDRY SIZING; GENERAL PURPOSE CLEANING, POLISHING, SCOURING AND ABRASIVE PREPARATIONS IN THE NATURE OF LIQUIDS AND POWDERS; SOAPS; PERFUMERY, ESSENTIAL OILS, COSMETICS, HAIR LOTIONS; DENTIFRICES, IN CLASS 3 (U.S. CLS. 1, 4, 6, 50, 51 AND 52).

FOR: ADVICE AND CONSULTANCY SERVICES RELATING TO THE APPLICATION AND USE OF COSMETICS; SERVICES OF A MAKE-UP ARTISTS, NAMELY, APPLICATION OF COSMETIC PRODUCTS TO THE BODY AND FACE; COSMETIC ELECTROLYSIS; COSMETIC MAKE-UP SERVICES, IN THE NATURE OF SERVICES OF A MAKEUP ARTIST; COSMETIC TREATMENT, IN THE NATURE OF FACIAL TREATMENTS; COSMETIC SURGERY; ADVISORY SERVICES RELATING TO A WIDE VARIETY OF BEAUTY TREATMENTS;

BEAUTY CONSULTANCY, NAMELY, PROVIDING CONSULTATIONS ABOUT COSMETICS AND BEAUTY TREATMENTS; BEAUTY COUNSELING, NAMELY, COUNSELING ABOUT COSMETICS AND BEAUTY TREATMENTS; BEAUTY SALON SERVICES; BEAUTY SALONS; BEAUTY THERAPY SERVICES, IN THE NATURE OF COSMETIC ANALYSIS; CONSULTATION SERVICES RELATING TO BEAUTY TREATMENTS AND COSMETICS; DENTAL HYGIENIST SERVICES; DENTISTRY IN THE NATURE OF TOOTH POLISHING AND TOOTH WHITENING SERVICES; HAIRDRESSING SERVICES; TANNING SALON SERVICES; SOLARIUM SERVICES; FAKE TANNING SALON SERVICES, IN CLASS 44 (U.S. CLS. 100 AND 101).

OWNER OF INTERNATIONAL REGISTRATION  
0913107 DATED 9-28-2006, EXPIRES 9-28-2016.

NO CLAIM IS MADE TO THE EXCLUSIVE RIGHT TO USE "BEAUTY", APART FROM THE MARK AS SHOWN.

SER. NO. 79-034,477, FILED 9-28-2006.

KAELIE KUNG, EXAMINING ATTORNEY



Int. Cl.: 36

Prior U.S. Cls.: 100, 101 and 102

United States Patent and Trademark Office

Reg. No. 3,395,106

Registered Mar. 11, 2008

SERVICE MARK  
PRINCIPAL REGISTER



STANDARD LIFE EMPLOYEE; SERVICES LIMITED (UNITED KINGDOM LIMITED COMPANY)

STANDARD LIFE HOUSE,  
30 LOTHIAN ROAD; EDINBURGH EH1 2DH  
UNITED KINGDOM

FOR: BANKING; TRUST MANAGEMENT ACCOUNTS; ESTATE TRUST MANAGEMENT; UNIT TRUST SERVICES, NAMELY, INVESTMENT AND TRUST COMPANY SERVICES; TRUSTEESHIP REPRESENTATIVE; FUND INVESTMENT MANAGEMENT; INSURANCE MANAGEMENT SERVICES, NAMELY, INSURANCE ADMINISTRATION IN THE FIELD OF LIFE, HEALTHCARE AND CRITICAL ILLNESS INSURANCE; FINANCIAL INVESTMENT AND FINANCIAL MANAGEMENT; PENSION MANAGEMENT, NAMELY, ADMINISTRATION OF EMPLOYEE PENSION PLANS; PERSONAL LOAN FINANCING AND MORTGAGING, NAMELY, MORTGAGE BROKERAGE AND MORT-

GAGE LENDING AND MORTGAGE BANKING; REAL ESTATE AGENCY; REAL ESTATE MANAGEMENT AND REAL ESTATE LEASING SERVICES; PROVISION OF FINANCE OR OF CREDIT, NAMELY, FINANCING SERVICES FOR REAL ESTATE DEVELOPMENT, IN CLASS 36 (U.S. CLS. 100, 101 AND 102).

OWNER OF INTERNATIONAL REGISTRATION  
0913297 DATED 12-14-2006, EXPIRES 12-14-2016.

NO CLAIM IS MADE TO THE EXCLUSIVE RIGHT TO USE "LIFE", APART FROM THE MARK AS SHOWN.

SER. NO. 79-034,516, FILED 12-14-2006.

BRENDAN MCCAULEY, EXAMINING ATTORNEY

Int. Cls.: 19 and 21

Prior U.S. Cls.: 1, 2, 12, 13, 23, 29, 30, 33, 40 and 50

United States Patent and Trademark Office

Reg. No. 3,395,107

Registered Mar. 11, 2008

TRADEMARK  
PRINCIPAL REGISTER

The logo for "Pro Natura" is written in a cursive, handwritten-style font. The word "Pro" is in a smaller, simpler font, and "Natura" is larger and more flowing. A small, detailed illustration of a ladybug is positioned between the two words, appearing to be crawling on the letter "o" in "Natura".

DEROMA S.P.A. (ITALY JOINT STOCK COMPANY)  
VIA PASUBIO, 17  
I-36034 MALO (VICENZA), ITALY

FOR: NON-METALLIC BUILDING MATERIALS, NAMELY, PARTITION WALLS FOR USE AS DIVIDERS IN GARDENING, NON-METALLIC RETAINING WALL TIES FOR GARDEN USE, BRICKS, MADE OF TERRA-COTTA, MARBLE SAWDUST IN THE NATURE OF PARTICLES OF MARBLE FORMED BY CUTTING MARBLE WITH A MASONRY SAW, TERRA-COTTA INCLUDING MAGNESIUM AND JUTE FIBER COMPONENTS; NON-METALLIC BUILDING MATERIALS, NAMELY, STONE; NON-METALLIC RIGID PIPES FOR BUILDING; ASPHALT, PITCH AND BITUMEN ASPHALT; NON-METALLIC TRANSPORTABLE BUILDINGS; MONUMENTS, NOT OF METAL, NAMELY, MONUMENTS OF STONE, CONCRETE OR MARBLE; BAKED CLAY, NAMELY, STATUES, STATUETTES, AND DECORATIVE ELEMENTS FOR EXTERNAL USE IN THE NATURE OF FIGURINES OR SCULPTURES; TERRA-COTTA AS RAW MATERIAL FOR EXTERNAL AND INTERNAL FURNITURE, FOR STATUES, FOR FOUNTAINS, FOR CONTAINERS FOR GARDEN USE, FOR POTS, FOR SLABS USED AS DIVIDERS IN GARDENING, FOR TIES, FOR NON-METALLIC RETAINING WALL TIES FOR GARDEN USE, BRICKS FOR INTERNAL AND EXTERNAL USE, IN CLASS 19 (U.S. CLS. 1, 12, 33 AND 50).

FOR: HOUSEHOLD OR KITCHEN UTENSILS AND CONTAINERS NOT OF PRECIOUS METAL OR COATED THEREWITH, NAMELY, POTS AND

CONTAINERS FOR GARDEN USE COMPOSED OF CLAY, CERAMIC GLAZE GLASSY COATINGS, FIBER GLASS, PLASTIC, TERRA-COTTA INCLUDING MAGNESIUM AND JUTE FIBER COMPONENTS, MARBLE SAWDUST IN THE NATURE OF PARTICLES OF MARBLE FORMED BY CUTTING MARBLE WITH A MASONRY SAW; UNWORKED OR SEMI-WORKED GLASS NOT FOR BUILDING; GLASSWARE, PORCELAIN AND EARTHENWARE NOT INCLUDED IN OTHER CLASSES, NAMELY, POTS, CONTAINERS FOR GARDEN USE, DECORATIVE ELEMENTS IN SAID MATERIALS FOR INTERNAL AND EXTERNAL USE, NAMELY, FIGURINES AND GARDEN ORNAMENTS; EARTHENWARE, NAMELY, EARTHENWARE POTS, CONTAINERS FOR GARDEN USE, DECORATIVE ELEMENTS IN SAID MATERIALS FOR INTERNAL AND EXTERNAL USE, NAMELY, FIGURINES AND GARDEN ORNAMENTS; FLOWER POTS, IN CLASS 21 (U.S. CLS. 2, 13, 23, 29, 30, 33, 40 AND 50).

PRIORITY DATE OF 3-9-2006 IS CLAIMED.

OWNER OF INTERNATIONAL REGISTRATION  
0913357 DATED 9-4-2006, EXPIRES 9-4-2016.

THE ENGLISH TRANSLATION OF THE WORD  
NATURA IN THE MARK IS NATURE.

SER. NO. 79-034,533, FILED 9-4-2006.

KAELIE KUNG, EXAMINING ATTORNEY

**Int. Cls.: 9, 16 and 42**

**Prior U.S. Cls.: 2, 5, 21, 22, 23, 26, 29, 36, 37, 38, 50,  
100 and 101**

**Reg. No. 3,395,108**

**United States Patent and Trademark Office**

**Registered Mar. 11, 2008**

**TRADEMARK  
SERVICE MARK  
PRINCIPAL REGISTER**



SIEMENS AKTIENGESELLSCHAFT (FED REP  
GERMANY CORPORATION)

WITTELSBACHERPLATZ 2

80333 MÜNCHEN, FED REP GERMANY

FOR: ELECTROTECHNICAL AND ELECTRONIC APPLIANCES, DEVICES AND INSTRUMENTS, NAMELY, ELECTRONIC SENSORS, ELECTRONIC ACTUATORS, ELECTRONIC CONTROLLERS AND MICROCONTROLLERS, HUMAN MACHINE INTERFACE DEVICES, CONNECTORS, COMPUTER HARDWARE AND COMPUTER SOFTWARE FOR USE IN MANUFACTURING AND PROCESS CONTROL AND FOR COMMUNICATING BETWEEN INTELLIGENT DEVICES USED IN MANUFACTURING OPERATIONS; ELECTRICAL SIGNALING, MEASURING, COUNTING, RECORDING, MONITORING, TESTING, OPEN AND CLOSED-LOOP CONTROL AND SWITCHING DEVICES; ELECTRICAL DEVICES FOR INPUT, PROCESSING, TRANSMISSION, STORAGE AND OUTPUT OF DATA; AND PARTS OF THE ABOVE-MENTIONED APPLIANCES, DEVICES AND INSTRUMENTS; DATA PROCESSING COMPUTER PROGRAMS, IN CLASS 9 (U.S. CLS. 21, 23, 26, 36 AND 38).

FOR: PRINTED MATERIALS, NAMELY, JOURNALS, MAGAZINES, BOOKLETS, BOOKS, AND BROCHURES PERTAINING TO INFORMATION

AND DATA SYSTEMS TECHNOLOGY, IN CLASS 16 (U.S. CLS. 2, 5, 22, 23, 29, 37, 38 AND 50).

FOR: DEVELOPING, GENERATING AND LEASING OF DATA PROCESSING PROGRAMS; TECHNICAL SERVICES, NAMELY, ENGINEERING SERVICES IN THE FIELD OF MANUFACTURING AND PROCESS CONTROL, IN CLASS 42 (U.S. CLS. 100 AND 101).

OWNER OF INTERNATIONAL REGISTRATION 0913501 DATED 12-19-2006, EXPIRES 12-19-2016.

THE COLOR(S) YELLOW, RED, BLACK, GREEN AND BLUE IS/ARE CLAIMED AS A FEATURE OF THE MARK.

THE MARK CONSISTS OF A RED CIRCLE IN THE CENTER OF A YELLOW CIRCLE, WITH THE WORDING I AM PROFISAFE APPEARING IN BLACK LETTERS AROUND THE EDGE OF THE YELLOW CIRCLE AND A MISCELLANEOUS DESIGN IS IN THE CENTER OF THE RED CIRCLE WHICH CONSISTS OF A HORIZONTAL BLUE LINE WITH FIVE SMALL BLUE CIRCLES IN A HORIZONTAL LINE DIRECTLY BENEATH THE BLUE LINE AND 5 SMALL GREEN CIRCLES IN A HOR-

IZONTAL LINE DIRECTLY ABOVE THE BLUE  
LINE.

SER. NO. 79-034,577, FILED 12-19-2006.

ZACHARY BELLO, EXAMINING ATTORNEY

**Int. Cls.: 5, 29 and 32**

**Prior U.S. Cls.: 6, 18, 44, 45, 46, 48, 51 and 52**

**United States Patent and Trademark Office**

**Reg. No. 3,395,109**

**Registered Mar. 11, 2008**

**TRADEMARK  
PRINCIPAL REGISTER**

**CEPALEC**

NATURAL ASA (NORWAY CORPORATION)  
POSTBOKS 165  
N-1325 LYSAKER  
OSLOW, NORWAY

FOR: FOOD SUPPLEMENTS; DIETARY FOOD  
SUPPLEMENTS; DIETETIC FOODS ADAPTED FOR  
MEDICAL USE, AND BABY FOOD, IN CLASS 5 (U.S.  
CLS. 6, 18, 44, 46, 51 AND 52).

FOR: MEAT, FISH, POULTRY AND GAME;  
MEAT EXTRACTS; JELLIES, JAMS, APPLESAUCE;  
EGGS, MILK AND MILK PRODUCTS EXCLUDING  
ICE CREAM, ICE MILK AND FROZEN YOGURT;  
DAIRY BASED BEVERAGES; EDIBLE OILS AND  
FATS, IN CLASS 29 (U.S. CL. 46).

FOR: MINERAL AND AERATED WATERS, NON-  
ALCOHOLIC DRINKS, NAMELY, SPORTS DRINKS;

FRUIT DRINKS AND FRUIT JUICES; SYRUPS FOR  
BEVERAGES; PREPARATIONS FOR MAKING BEV-  
ERAGES, NAMELY, SPORTS DRINKS AND MILK  
BASED DRINKS, IN CLASS 32 (U.S. CLS. 45, 46 AND  
48).

PRIORITY DATE OF 10-24-2006 IS CLAIMED.

OWNER OF INTERNATIONAL REGISTRATION  
0913611 DATED 11-24-2006, EXPIRES 11-24-2016.

CEPALAC HAS NO MEANING IN A FOREIGN  
LANGUAGE.

SER. NO. 79-034,607, FILED 11-24-2006.

JASON TURNER, EXAMINING ATTORNEY

Int. Cl.: 5

Prior U.S. Cls.: 6, 18, 44, 46, 51 and 52

United States Patent and Trademark Office

Reg. No. 3,395,110

Registered Mar. 11, 2008

TRADEMARK  
PRINCIPAL REGISTER

OSALEUKIN

TMRC CO., LTD. (JAPAN CORPORATION)  
4-3, AKASAKA 3-CHOME  
MINATO-KU; TOKYO 107-0052  
JAPAN

LOSIS, WRINKLES, AND SEVERE ACNE, IN CLASS  
5 (U.S. CLS. 6, 18, 44, 46, 51 AND 52).

PRIORITY DATE OF 11-7-2006 IS CLAIMED.

FOR: ANTICANCER DRUGS; ANTITUMOR  
DRUGS; ANTINEOPLASTIC DRUGS; DRUGS FOR  
MEDICAL PURPOSES, NAMELY, RETINOIC ACID  
RECEPTOR AGONIST FOR THE TREATMENT OF  
AUTOIMMUNE/INFLAMMATORY DISEASES,  
VASCULAR DISEASES, NEURODEGENERATIVE  
DISEASES, PSORIASIS, PALMOPLANTAR PUSTU-

OWNER OF INTERNATIONAL REGISTRATION  
0913653 DATED 12-15-2006, EXPIRES 12-15-2016.

SER. NO. 79-034,631, FILED 12-15-2006.

ZACHARY BELLO, EXAMINING ATTORNEY

**Int. Cls.: 9, 12 and 25**

**Prior U.S. Cls.: 19, 21, 22, 23, 26, 31, 35, 36, 38, 39 and 44**

**Reg. No. 3,395,111**

**United States Patent and Trademark Office**

**Registered Mar. 11, 2008**

**TRADEMARK  
PRINCIPAL REGISTER**

**SPIUK**

JOSÉ MANUEL FERNÁNDEZ ARZA (SPAIN INDIVIDUAL)  
C/ PINTOR JOSÉ ARRUE, 6-2º D  
LLODIO (ALAVA), SPAIN E01400

FOR: CLOTHING, NAMELY, SHIRTS, T-SHIRTS, PANTS, SHORT PANTS, SHORTS AND SOCKS, FOOTWEAR AND HEADGEAR, NAMELY, HATS AND CAPS , IN CLASS 25 (U.S. CLS. 22 AND 39).

FOR: PROTECTIVE GLASSES, PROTECTIVE HELMETS FOR SPORTS; ELECTRONIC DEVICES, NAMELY, TIRE PRESSURE GAUGES, SPOKE TENSION GAUGES, COMPUTERS FOR MONITORING, PEDALING CADENCE, BICYCLE NAVIGATION AND SPEED, ALL FOR USE WITH BICYCLING, IN CLASS 9 (U.S. CLS. 21, 23, 26, 36 AND 38).

PRIORITY DATE OF 9-18-2006 IS CLAIMED.

OWNER OF INTERNATIONAL REGISTRATION 0913748 DATED 1-4-2007, EXPIRES 1-4-2017.

FOR: BICYCLES, BICYCLE FRAMES, BICYCLE PUMPS, RIMS FOR BICYCLE WHEELS, TUBELESS BICYCLE TIRES, BICYCLE TIRES, BICYCLE BRAKES, BICYCLE PEDALS AND BICYCLE SADDLES, IN CLASS 12 (U.S. CLS. 19, 21, 23, 31, 35 AND 44).

OWNER OF U.S. REG. NO. 3,177,196.

SER. NO. 79-034,652, FILED 1-4-2007.

EDWARD NELSON, EXAMINING ATTORNEY

**Int. Cl.: 38**

**Prior U.S. Cls.: 100, 101 and 104**

**United States Patent and Trademark Office**

**Reg. No. 3,395,112**

**Registered Mar. 11, 2008**

**SERVICE MARK  
PRINCIPAL REGISTER**

**FuturLink**

WILICO WIRELESS NETWORKING SOLUTIONS  
S.A. (SPAIN SOCIEDAD ANONIMA)  
CALLE PUJADES, 74, 1<sup>o</sup> 8A  
E-08005 BARCELONA  
SPAIN

FOR: TELEPHONE AND WIRELESS COMMUNICATIONS SERVICES, NAMELY, INTERNATIONAL TELEPHONE SERVICE AND WIRELESS TELEPHONE TELECOMMUNICATIONS SERVICES, NAMELY, WIRELESS MOBILE TELEPHONE CALLING PLANS; ELECTRONIC TRANSMISSION OF INFORMATION VIA THE INTERNET AND MOBILE TELEPHONE; ELECTRONIC TRANSMISSION OF DATA VIA GLOBAL AND TELEPHONE COMPUTER NETWORK; COMPUTER-ASSISTED MESSAGE AND IMAGE TRANSMISSION; ELECTRONIC MAIL SERVICES; WEB BROADCASTING SERVICES; ELECTRONIC TRANSMISSION OF MESSAGES BETWEEN USERS ON MUSIC, NEWS, ENTERTAINMENT, TRAVEL, TOURISM, ART AND LEISURE; ELECTRONIC AND WIRELESS TRANSMISSION OF DATA, IMAGES, AUDIO, VIDEO AND GENERAL INFORMATION; SERVICES OF DELIVERY OF ELECTRONIC MESSAGES; PROVISION OF SERVICES OF CONNECTIVITY AND ACCESS TO ELECTRONIC COMMUNICATIONS SITES FOR TRANSMISSION OR RECEPTION OF DATA, AUDIO, VIDEO OR MULTIMEDIA CON-

TENT, PROVIDING TELECOMMUNICATIONS CONNECTIONS TO A GLOBAL COMPUTER NETWORK; PROVIDING ON-LINE COMMUNICATIONS LINKS WHICH TRANSFER THE WEBSITE USER TO OTHER LOCAL AND GLOBAL WEB PAGES; MOBILE RADIOTELEPHONY, NAMELY, MOBILE RADIO TELEPHONE SERVICE, IN CLASS 38 (U.S. CLS. 100, 101 AND 104).

OWNER OF INTERNATIONAL REGISTRATION  
0913752 DATED 12-21-2006, EXPIRES 12-21-2016.

THE COLOR(S) ORANGE AND BLACK IS/ARE  
CLAIMED AS A FEATURE OF THE MARK.

THE MARK COMPRISES LITERAL ELEMENT  
FUTURLINK AND A DESIGN ELEMENT OF  
THREE SOUND WAVES, APPEARING OVER THE  
LETTER "K". THE COLOR BLACK APPEARS IN  
THE MARK'S LITERAL ELEMENT. THE COLOR  
ORANGE APPEARS IN THE MARK'S DESIGN  
ELEMENT.

SER. NO. 79-034,653, FILED 12-21-2006.

LAURIE KAUFMAN, EXAMINING ATTORNEY



**Int. Cl.: 25**

**Prior U.S. Cls.: 22 and 39**

**United States Patent and Trademark Office**

**Reg. No. 3,395,113**

**Registered Mar. 11, 2008**

**TRADEMARK  
PRINCIPAL REGISTER**



FUJIAN POWERLAND LEATHER CASE & PRODUCTS CO., LTD (CHINA LIMITED COMPANY)

HUSHI INDUSTRIAL ZONE,  
XIUYU DISTRICT, PUTIAN CITY351100 FUJIAN  
PROVINCE  
CHINA

FOR: SWIMSUITS; FOOTBALL SHOES; SHOES;  
HATS; HOSIERY; CLOTHING, NAMELY, GLOVES;

NECKTIES; GIRDLES , IN CLASS 25 (U.S. CLS. 22 AND 39).

OWNER OF INTERNATIONAL REGISTRATION  
0914571 DATED 2-5-2007, EXPIRES 2-5-2017.

SER. NO. 79-034,905, FILED 2-5-2007.

LESLIE RICHARDS, EXAMINING ATTORNEY

**Int. Cls.: 25, 30 and 43**

**Prior U.S. Cls.: 22, 39, 46, 100 and 101**

**United States Patent and Trademark Office**

**Reg. No. 3,395,114**

**Registered Mar. 11, 2008**

**TRADEMARK  
SERVICE MARK  
PRINCIPAL REGISTER**



FRANCESCHELLI GROUP S.P.A. (ITALY JOINT  
STOCK COMPANY)  
VIA MACERI SUPERIORE, 16/A  
I-40061 MINERBIO (BO), ITALY

FOR: CLOTHING, NAMELY, T-SHIRTS, SWEAT-  
SHIRTS, POLO SHIRTS, SPORT SHIRTS, SWEA-  
TERS, JACKETS, AND COATS; FOOTWEAR;  
HEADGEAR, NAMELY, HATS AND CAPS, IN  
CLASS 25 (U.S. CLS. 22 AND 39).

FOR: ICE CREAMS, TEA, COFFEE, COCOA,  
SUGAR, PASTRIES; CONFECTIONARY, NAMELY,  
CANDY AND FRUIT JELLIES; HONEY, IN CLASS  
30 (U.S. CL. 46).

FOR: SERVING FOOD AND DRINKS, BAR SER-  
VICES, CAFETERIAS, PROVIDING TEMPORARY  
ACCOMMODATIONS, IN CLASS 43 (U.S. CLS. 100  
AND 101).

PRIORITY DATE OF 11-14-2006 IS CLAIMED.

OWNER OF INTERNATIONAL REGISTRATION  
0914577 DATED 12-19-2006, EXPIRES 12-19-2016.

NO CLAIM IS MADE TO THE EXCLUSIVE  
RIGHT TO USE "ITALIA", APART FROM THE  
MARK AS SHOWN.

THE ENGLISH TRANSLATION OF THE WORD  
TIAMO ITALIA IN THE MARK IS "I LOVE YOU  
ITALY".

SER. NO. 79-034,906, FILED 12-19-2006.

WILLIAM VERHOSEK, EXAMINING ATTORNEY

**Int. Cl.: 3**

**Prior U.S. Cls.: 1, 4, 6, 50, 51 and 52**

**United States Patent and Trademark Office**

**Reg. No. 3,395,115**

**Registered Mar. 11, 2008**

**TRADEMARK  
PRINCIPAL REGISTER**

**PARFUM DE BEAUTE**

NOMS DE CODE (FRANCE SOCIÉTÉ PAR AC-  
TIONS SIMPLIFIÉE)  
28-32, AVENUE VICTOR HUGO  
F-75116 PARIS  
FRANCE

FOR: PERFUMES, IN CLASS 3 (U.S. CLS. 1, 4, 6, 50,  
51 AND 52).

OWNER OF INTERNATIONAL REGISTRATION  
0914698 DATED 1-4-2007, EXPIRES 1-4-2017.

NO CLAIM IS MADE TO THE EXCLUSIVE  
RIGHT TO USE PARFUM, APART FROM THE  
MARK AS SHOWN.

THE FOREIGN WORDING IN THE MARK  
TRANSLATES INTO ENGLISH AS PERFUME OF  
BEAUTY.

SER. NO. 79-034,949, FILED 1-4-2007.

EDWARD NELSON, EXAMINING ATTORNEY

**Int. Cl.: 10**

**Prior U.S. Cls.: 26, 39 and 44**

**United States Patent and Trademark Office**

**Reg. No. 3,395,116**

**Registered Mar. 11, 2008**

**TRADEMARK  
PRINCIPAL REGISTER**

The logo for OPTIKON features the word "OPTIKON" in a bold, blue, sans-serif font. The letter "O" is stylized, with a blue arc above it and a white arc below it, creating a circular shape that resembles a lens or a stylized eye.

OPTIKON 2000 S.P.A. (ITALY JOINT STOCK  
COMPANY)  
VIA DEL CASALE DI SETTEBAGNI, 13  
I-00138 ROMA  
ITALY

FOR: SURGICAL APPARATUS AND INSTRU-  
MENTS FOR OPHTHALMOLOGY, IN CLASS 10  
(U.S. CLS. 26, 39 AND 44).

OWNER OF INTERNATIONAL REGISTRATION  
0914843 DATED 1-30-2007, EXPIRES 1-30-2017.

THE COLOR(S) BLUE, AZURE AND WHITE IS/  
ARE CLAIMED AS A FEATURE OF THE MARK.

THE COLOR BLUE APPEARS IN THE WORDING  
OPTIKON. THE COLORS AZURE, BLUE AND  
WHITE APPEAR IN THE DESIGN ELEMENT COM-  
PRISING THE SECOND LETTER 'O' IN OPTIKON.

SER. NO. 79-034,991, FILED 1-30-2007.

MATTHEW EINSTEIN, EXAMINING ATTORNEY

**Int. Cl.: 9**

**Prior U.S. Cls.: 21, 23, 26, 36 and 38**

**United States Patent and Trademark Office**

**Reg. No. 3,395,117**

**Registered Mar. 11, 2008**

**TRADEMARK  
PRINCIPAL REGISTER**

**OpenStage**

SIEMENS ENTERPRISE COMMUNICATIONS;  
GMBH & CO. KG (FED REP GERMANY  
LIMITED PARTNERSHIP)  
HOFMANNSTR. 51  
81379 MÜNCHEN, FED REP GERMANY

FOR: TELEPHONES, IN CLASS 9 (U.S. CLS. 21, 23,  
26, 36 AND 38).

THE MARK CONSISTS OF STANDARD CHAR-  
ACTERS WITHOUT CLAIM TO ANY PARTICULAR  
FONT, STYLE, SIZE, OR COLOR.

PRIORITY DATE OF 7-14-2006 IS CLAIMED.

OWNER OF INTERNATIONAL REGISTRATION  
0915032 DATED 12-11-2006, EXPIRES 12-11-2016.

SER. NO. 79-035,061, FILED 12-11-2006.

RAUL CORDOVA, EXAMINING ATTORNEY

**Int. Cl.: 9**

**Prior U.S. Cls.: 21, 23, 26, 36 and 38**

**United States Patent and Trademark Office**

**Reg. No. 3,395,118**

**Registered Mar. 11, 2008**

**TRADEMARK  
PRINCIPAL REGISTER**

**OPTIMA by TIMELOX**

VINGCARD ELSAFE AS (NORWAY LTD LIAB  
CO)  
SOPHUS LIES VEI  
N-1523 MOSS  
NORWAY

FOR: ELECTRONIC LOCK SYSTEMS COMPRIS-  
ING ELECTRONIC LOCKS, MICRO PROCESSORS  
FOR OPERATING LOCKING MECHANISMS, ME-  
TAL KEYS AND KEYCARDS, ENCODERS, ACCESS  
CONTROL DEVICES FOR HOTELS, HOMES AND  
BUSINESSES, AND SOFTWARE FOR USE THERE-  
FOR, IN CLASS 9 (U.S. CLS. 21, 23, 26, 36 AND 38).

THE MARK CONSISTS OF STANDARD CHAR-  
ACTERS WITHOUT CLAIM TO ANY PARTICULAR  
FONT, STYLE, SIZE, OR COLOR.

PRIORITY DATE OF 10-31-2006 IS CLAIMED.

OWNER OF INTERNATIONAL REGISTRATION  
0915057 DATED 12-5-2006, EXPIRES 12-5-2016.

OWNER OF U.S. REG. NO. 1,824,213.

SER. NO. 79-035,071, FILED 12-5-2006.

GILBERT SWIFT, EXAMINING ATTORNEY

Int. Cl.: 25

Prior U.S. Cls.: 22 and 39

United States Patent and Trademark Office

Reg. No. 3,395,119

Registered Mar. 11, 2008

TRADEMARK  
PRINCIPAL REGISTER

KHRIÖ  
INSIDE

ALFIERE SPA (ITALY CORPORATION)  
VIA TANGENZIALE, 14  
I-62010 MONTECOSARO (MC), ITALY

FOR: HEADGEAR, NAMELY, CAPS AND HATS;  
HEADWEAR; FOOTWEAR FOR MEN AND WO-  
MEN NAMELY BOOTS, BOOTIES, SANDALS,  
SNEAKERS AND SHOES; CLOTHING, NAMELY,  
BELTS, BLOUSES, GYM SUITS, JACKETS AND  
SPORT JACKETS, JEANS, OVERCOATS, PANTS,  
PULLOVERS, RAINCOATS, SHIRTS, SPORT  
SHIRTS, POLO SHIRTS, SKIRTS, SHORTS, SOCKS,  
SUITS, DRESSES, SWEAT PANTS, SWEATERS,

SWEAT-SHIRTS, TRACKSUITS, TROUSERS, T-  
SHIRTS, IN CLASS 25 (U.S. CLS. 22 AND 39).

PRIORITY DATE OF 10-23-2006 IS CLAIMED.

OWNER OF INTERNATIONAL REGISTRATION  
0915159 DATED 11-23-2006, EXPIRES 11-23-2016.

SER. NO. 79-035,104, FILED 11-23-2006.

ELLEN B. AWRICH, EXAMINING ATTORNEY

**Int. Cls.: 9 and 13**

**Prior U.S. Cls.: 2, 9, 21, 23, 26, 36 and 38**

**United States Patent and Trademark Office**

**Reg. No. 3,395,120**

**Registered Mar. 11, 2008**

**TRADEMARK  
PRINCIPAL REGISTER**

# Ahead

OERLIKON CONTRAVES AG (SWITZERLAND  
SOCIÉTÉ ANONYME)  
BIRCHSTRASSE 155  
CH-8050 ZÜRICH, SWITZERLAND

FOR: ELECTRONIC FIRING APPARATUS FOR  
ARMAMENTS, IN CLASS 9 (U.S. CLS. 21, 23, 26, 36  
AND 38).

FOR: CANNONS; PROGRAMMABLE AMMUNI-  
TION CONTAINING SMALL PROJECTILES, IN  
CLASS 13 (U.S. CLS. 2 AND 9).

THE MARK CONSISTS OF STANDARD CHAR-  
ACTERS WITHOUT CLAIM TO ANY PARTICULAR  
FONT, STYLE, SIZE, OR COLOR.

PRIORITY DATE OF 7-24-2006 IS CLAIMED.

OWNER OF INTERNATIONAL REGISTRATION  
0915255 DATED 12-11-2006, EXPIRES 12-11-2016.

OWNER OF U.S. REG. NO. 3,071,818.

SER. NO. 79-035,150, FILED 12-11-2006.

RAUL CORDOVA, EXAMINING ATTORNEY



**Int. Cl.: 9**

**Prior U.S. Cls.: 21, 23, 26, 36 and 38**

**United States Patent and Trademark Office**

**Reg. No. 3,395,121**

**Registered Mar. 11, 2008**

**TRADEMARK  
PRINCIPAL REGISTER**

**XENOTECH**

INFICON GMBH (SWITZERLAND GMBH)  
HINTERGASSE 15B  
CH-7310 BAD RAGAZ  
SWITZERLAND

THE MARK CONSISTS OF STANDARD CHARACTERS WITHOUT CLAIM TO ANY PARTICULAR FONT, STYLE, SIZE, OR COLOR.

FOR: GAS LEAK DETECTORS; LEAK DETECTORS FOR USE IN VACUUM PROCESSES; INSTRUMENTS FOR CHECKING THE TIGHTNESS, NAMELY, TIGHTNESS OF A WALL FOR A HOLLOW BODY; MASS SPECTROMETERS; GAS DETECTORS FOR DETECTING THE PRESENCE OF GAS; INSTRUMENTS FOR GAS CALIBRATION, IN CLASS 9 (U.S. CLS. 21, 23, 26, 36 AND 38).

OWNER OF INTERNATIONAL REGISTRATION  
0915387 DATED 12-19-2006, EXPIRES 12-19-2016.

SER. NO. 79-035,187, FILED 12-19-2006.

WILLIAM VERHOSEK, EXAMINING ATTORNEY

**Int. Cls.: 25 and 35**

**Prior U.S. Cls.: 22, 39, 100, 101 and 102**

**United States Patent and Trademark Office**

**Reg. No. 3,395,122**

**Registered Mar. 11, 2008**

**TRADEMARK  
SERVICE MARK  
PRINCIPAL REGISTER**



B STORE LIMITED (UNITED KINGDOM PRIVATE LIMITED COMPANY)  
26 GROSVENOR STREET  
MAYFAIR; LONDON, UNITED KINGDOM  
W1K4QW

FOR: CLOTHING, NAMELY, FOOTWEAR, SHOES, BOOTS, SNEAKERS, SOCKS, UNDERWEAR, LINGERIE, T-SHIRTS, PANTS, SKIRTS, DRESSES, BLOUSES, TOPS, BOTTOMS, JEANS, JACKETS, COATS, VESTS, SWEATERS, SHIRTS, SUITS, SWEAT SHIRTS AND SWEAT PANTS, BELTS, TIES, NECKWEAR, NAMELY, SCARVES AND KERCHIEFS, HEADWEAR, NAMELY, HATS, CAPS, BANDANNAS; AND SWIMWEAR, IN CLASS 25 (U.S. CLS. 22 AND 39).

FOR: RETAIL STORE SERVICES IN THE FIELD OF CLOTHING, FOOTWEAR AND HEADWEAR; RETAIL STORE SERVICES CONNECTED WITH THE SALE OF CLOTHING, FOOTWEAR AND HEADWEAR, BAGS, RUCKSACKS AND BACKPACKS, JEWELRY, IMITATION JEWELRY, PERFUMES, COSMETICS AND TOILET ARTICLES; ON-LINE RETAIL STORE, MAIL ORDER, AND CATALOGUE SERVICES FEATURING CLOTHING,

FOOTWEAR AND HEADWEAR, AND CHRONOMETRIC AND HOROLOGICAL INSTRUMENTS; AND PROVIDING CONSULTING AND CUSTOMER ASSISTANCE FOR THE AFOREMENTIONED SERVICES IN THE NATURE OF PROVISION OF COMMERCIAL INFORMATION TO CUSTOMERS AND ADVICE TO CUSTOMERS FOR THE SELECTION OF ALL THE AFOREMENTIONED GOODS AVAILABLE ON-LINE OR IN A RETAIL STORE ENVIRONMENT, ALSO KNOWN AS A CLICKS OR MORTAR ENVIRONMENT, IN CLASS 35 (U.S. CLS. 100, 101 AND 102).

OWNER OF INTERNATIONAL REGISTRATION  
0915388 DATED 7-26-2006, EXPIRES 7-26-2016.

NO CLAIM IS MADE TO THE EXCLUSIVE RIGHT TO USE "STORE", APART FROM THE MARK AS SHOWN.

SER. NO. 79-035,188, FILED 7-26-2006.

MARCIE MILONE, EXAMINING ATTORNEY

Int. Cls.: 29 and 30

Prior U.S. Cl.: 46

United States Patent and Trademark Office

Reg. No. 3,395,123

Registered Mar. 11, 2008

TRADEMARK  
PRINCIPAL REGISTER



LIPPOLIS S.R.L. (ITALY LTD LIAB JT ST CO)  
VIA MICHELE MUMMOLO (ZONA INDUSTRIALE)  
I-70017 PUTIGNANO (BARI), ITALY

FOR: DAIRY PRODUCTS, NAMELY, DAIRY-BASED BEVERAGES, DAIRY-BASED CHOCOLATE FOOD BEVERAGES, DAIRY-BASED DIPS, DAIRY-BASED FOOD BEVERAGES, NON-DAIRY CREAMER, DAIRY OR NON DAIRY-BASED WHIPPED TOPPING; EDIBLE OILS AND FATS; TINNED FOODSTUFFS, NAMELY, TINNED AMARENA CHERRIES, APRICOTS, BANANAS, BILBERRIES, BLACKCURRANTS, CHERRIES, CITRONS, EXOTIC FRUIT MIXES, WILD BERRIES, GRAPES, GREEN APPLES, KIWI, MANDARINS, LEMONS, MANGOES, ORANGES, PAPAYA, PASSION FRUIT, PEACHES, PEARS, PINEAPPLES, PEACH-MANGO WITH ADDED VITAMINS, PINK GRAPEFRUITS, RASPBERRIES, WILD STRAWBERRIES, RENNET APPLES, ALMONDS, HAZELNUTS, PISTACHIOS, COCONUTS, MINT, WALNUTS, WATERMELONS, PUMPKINS, PLUMS, LIMES, CRANBERRY, INDIAN FIGS, MULBERRY; FRUIT FILLINGS AND COATINGS FOR CAKES AND TARTS; UNFLAVORED GELATINE, IN CLASS 29 (U.S. CL. 46).

FOR: FLAVORED ICES, CONSISTING OF FRUIT, HONEY, TREACLE SYRUP, COFFEE, TEA, COCOA; FROZEN CONFECTIONS, FROZEN CUSTARDS, FROZEN YOGURT, ICE MILK, SHERBET AND SORBET; EMULSIFIER PREPARATIONS IN THE NATURE OF BASES FOR ICE-CREAM CONSISTING OF MILK POWDER, COCOA, COFFEE, VEGE-

TABLE FAT, FRUITS, DEXTROSE, STABILIZERS, EMULSIFIER, FLAVOUR, MILK OR VEGETABLE PROTEIN AND COLOUR FOR MAKING OR MARBLE ICING ICE-CREAMS; FLAVOURED TOPPING SYRUPS FOR ICE-CREAMS, IN CLASS 30 (U.S. CL. 46).

PRIORITY DATE OF 6-23-2006 IS CLAIMED.

OWNER OF INTERNATIONAL REGISTRATION  
0915581 DATED 9-28-2006, EXPIRES 9-28-2016.

NO CLAIM IS MADE TO THE EXCLUSIVE RIGHT TO USE "PREPARA IL GELATO IN", APART FROM THE MARK AS SHOWN.

THE COLOR(S) BROWN, ORANGE, WHITE IS/ ARE CLAIMED AS A FEATURE OF THE MARK.

THE DRAWING CONSISTS OF A BROWN CIRCLE WITH THE LITERAL ELEMENT "QUATTRO QUATTROTTO" APPEARING IN WHITE WITHIN THE CIRCLE, WITH THE LAST "O" IN THE WORD "QUATTROTTO" APPEARING AS AN ORANGE CIRCLE WITH A WHITE OUTLINE AND THE ORANGE LIGHTENING TO A SHEEN ON THE TOP AND BOTTOM OF THE CIRCLE. THE LITERAL ELEMENT "PREPARA IL GELATO TN" APPEARS IN ORANGE AND APPEARS CURVED AROUND THE UPPER PART OF THE BROWN

CIRCLE. THERE IS AN ORANGE CIRCLE THAT IS SUPERIMPOSED ON THE RIGHT SIDE OF THE BROWN CIRCLE AND IT LIGHTENS TO A SHEEN IN THE UPPER LEFT CORNER. THE LITERAL ELEMENTS "&" AND "LIPPOLIS" APPEAR IN WHITE WITHIN THE ORANGE CIRCLE. THERE IS ANOTHER SMALLER ORANGE CIRCLE THAT IS SUPERIMPOSED ON THE LOWER RIGHT OF THE BIGGER ORANGE CIRCLE.

THE ENGLISH TRANSLATION OF THE WORDING "PREPARA IL GELATO IN QUATTRO QUATTRO" IN THE MARK IS "MAKE ICE CREAM IN AN INSTANT".

SER. NO. 79-035,252, FILED 9-28-2006.

LINDSEY RUBIN, EXAMINING ATTORNEY

**Int. Cl.: 27**

**Prior U.S. Cls.: 19, 20, 37, 42 and 50**

**United States Patent and Trademark Office**

**Reg. No. 3,395,124**

**Registered Mar. 11, 2008**

**TRADEMARK  
PRINCIPAL REGISTER**

**ALTRO TIMBERSAFE**

ALTRO LIMITED (UNITED KINGDOM LIMITED  
COMPANY)  
WORKS ROAD  
LETCHWORTH GARDEN CITY; HERTFORDSHIRE  
SG6 1NW  
UNITED KINGDOM

FOR: MATERIALS FOR COVERING WALLS,  
FLOORS, AND STAIRS, NAMELY, VINYL, RUBBER  
AND RESILIENT HARD SURFACE COVERING, IN  
CLASS 27 (U.S. CLS. 19, 20, 37, 42 AND 50).

THE MARK CONSISTS OF STANDARD CHAR-  
ACTERS WITHOUT CLAIM TO ANY PARTICULAR  
FONT, STYLE, SIZE, OR COLOR.

PRIORITY DATE OF 7-6-2006 IS CLAIMED.

OWNER OF INTERNATIONAL REGISTRATION  
0915848 DATED 1-4-2007, EXPIRES 1-4-2017.

OWNER OF U.S. REG. NOS. 867,034 AND 867,088.

SER. NO. 79-035,367, FILED 1-4-2007.

SCOTT BIBB, EXAMINING ATTORNEY

**Int. Cls.: 1 and 9**

**Prior U.S. Cls.: 1, 5, 6, 10, 21, 23, 26, 36, 38 and 46**

**United States Patent and Trademark Office**

**Reg. No. 3,395,125**

**Registered Mar. 11, 2008**

**TRADEMARK  
PRINCIPAL REGISTER**

**DSPA**

FLAME GUARD SALES B.V. (NETHERLANDS  
BESLOTEN VENNOOTSCHAP)  
HULZENWEG 10-20  
NL-6534 AN NIJMEGEN  
NETHERLANDS

FOR: FIRE RESISTANT, FIRE EXTINGUISHING,  
FIRE RETARDANT AND FIREPROOFING PRE-  
PARATIONS, IN CLASS 1 (U.S. CLS. 1, 5, 6, 10, 26  
AND 46).

FOR: FIRE-EXTINGUISHERS AND SPRINKLER  
SYSTEMS FOR FIRE PROTECTION, IN CLASS 9  
(U.S. CLS. 21, 23, 26, 36 AND 38).

THE MARK CONSISTS OF STANDARD CHAR-  
ACTERS WITHOUT CLAIM TO ANY PARTICULAR  
FONT, STYLE, SIZE, OR COLOR.

PRIORITY DATE OF 7-24-2006 IS CLAIMED.

OWNER OF INTERNATIONAL REGISTRATION  
0916005 DATED 11-28-2006, EXPIRES 11-28-2016.

SER. NO. 79-035,406, FILED 11-28-2006.

AMY HELLA, EXAMINING ATTORNEY

**Int. Cls.: 9, 35, 38 and 41**

**Prior U.S. Cls.: 21, 23, 26, 36, 38, 100, 101, 102, 104  
and 107**

**Reg. No. 3,395,126**

**United States Patent and Trademark Office**

**Registered Mar. 11, 2008**

**TRADEMARK  
SERVICE MARK  
PRINCIPAL REGISTER**

# SCROBBLER

AUDIOSCROBBLER LIMITED (UNITED KING-  
DOM LTD LIAB CO)  
86C GREENFIELD ROAD  
LONDON, UNITED KINGDOM E1 1EJ

FOR: DIGITAL MUSIC, DOWNLOADABLE FROM THE INTERNET AND VIA OTHER COMMUNICATIONS NETWORKS; DOWNLOADABLE TELEPHONE RING TONES VIA THE INTERNET AND WIRELESS DEVICE; MUSICAL SOUND RECORDINGS; ELECTRONIC PUBLICATIONS IN THE NATURE OF MAGAZINES, MANUALS AND BOOKS IN THE FIELD OF MUSIC AND ART, DOWNLOADABLE FROM THE INTERNET, IN CLASS 9 (U.S. CLS. 21, 23, 26, 36 AND 38).

FOR: PROVISION OF ADVERTISING SPACE ON INTERNET WEBSITES; RADIO ADVERTISING; THE BRINGING TOGETHER, FOR THE BENEFIT OF OTHERS, OF A VARIETY OF MUSIC RELATED GOODS, INCLUDING MUSICAL RECORDINGS, ENABLING CUSTOMERS TO CONVENIENTLY VIEW AND PURCHASE THOSE GOODS FROM A GENERAL MERCHANDISE CATALOG BY MAIL ORDER, BY MEANS OF TELECOMMUNICATIONS SYSTEMS, FROM AN INTERNET WEBSITE, FROM A GENERAL MERCHANDISE RETAIL STORE, AND FROM A RETAIL OUTLET SPECIALIZING IN MUSIC, IN CLASS 35 (U.S. CLS. 100, 101 AND 102).

FOR: PROVIDING ACCESS TO ELECTRONIC SITES FEATURING DIGITAL MUSIC, AND ELECTRONIC DELIVERY OF DIGITAL MUSIC VIA THE INTERNET; ELECTRONIC DELIVERY OF DIGITAL MUSIC BY TELECOMMUNICATION NETWORKS AND WIRELESS RADIO COMMUNICATIONS SYS-

TEMS; AUDIO BROADCASTING FEATURING MUSIC; DIGITAL RADIO BROADCASTING, IN CLASS 38 (U.S. CLS. 100, 101 AND 104).

FOR: PROVISION OF NON-DOWNLOADABLE DIGITAL MUSIC VIA THE INTERNET AND OTHER COMMUNICATIONS NETWORKS; PRODUCTION AND DISTRIBUTION OF RADIO PROGRAMS; ENTERTAINMENT BY MEANS OF RADIO, NAMELY, RADIO ENTERTAINMENT PRODUCTION, RADIO PROGRAM SYNDICATION, RADIO PROGRAMMING; PROVISION OF MUSICAL ENTERTAINMENT, NAMELY, PROVIDING PRERECORDED MUSIC, INFORMATION IN THE FIELD OF MUSIC, AND COMMENTARY AND ARTICLES ABOUT MUSIC AND LIVE MUSICAL PERFORMANCES BY MUSICAL BANDS, DISC JOCKEYS AND INDIVIDUALS, ALL ON-LINE VIA A GLOBAL COMPUTER NETWORK; PROVISION OF MUSICAL ENTERTAINMENT, NAMELY, LIVE MUSICAL PERFORMANCES BY MUSICAL BANDS, DISC JOCKEYS AND INDIVIDUALS; MUSIC LIBRARY SERVICES, IN CLASS 41 (U.S. CLS. 100, 101 AND 107).

THE MARK CONSISTS OF STANDARD CHARACTERS WITHOUT CLAIM TO ANY PARTICULAR FONT, STYLE, SIZE, OR COLOR.

OWNER OF INTERNATIONAL REGISTRATION 0916238 DATED 12-18-2006, EXPIRES 12-18-2016.

SER. NO. 79-035,477, FILED 12-18-2006.

JAY BESCH, EXAMINING ATTORNEY

**Int. Cl.: 7**

**Prior U.S. Cls.: 13, 19, 21, 23, 31, 34 and 35**

**United States Patent and Trademark Office**

**Reg. No. 3,395,127**

**Registered Mar. 11, 2008**

**TRADEMARK  
PRINCIPAL REGISTER**

**PLATEMAT**

BSH HOLICE, A.S. (CZECH REPUBLIC CORPORATION)  
PARDUBICKÁ 332  
CZ-534 13 HOLICE  
CZECH REPUBLIC

FOR: MACHINE TOOLS, NAMELY, GRINDING MACHINES AND THEIR COMPONENTS, IN CLASS 7 (U.S. CLS. 13, 19, 21, 23, 31, 34 AND 35).

THE MARK CONSISTS OF STANDARD CHARACTERS WITHOUT CLAIM TO ANY PARTICULAR FONT, STYLE, SIZE, OR COLOR.

PRIORITY DATE OF 6-21-2006 IS CLAIMED.

OWNER OF INTERNATIONAL REGISTRATION 0916546 DATED 12-21-2006, EXPIRES 12-21-2016.

SER. NO. 79-035,595, FILED 12-21-2006.

KIMBERLY PERRY, EXAMINING ATTORNEY



**Int. Cl.: 5**

**Prior U.S. Cls.: 6, 18, 44, 46, 51 and 52**

**United States Patent and Trademark Office**

**Reg. No. 3,395,128**

**Registered Mar. 11, 2008**

**TRADEMARK  
PRINCIPAL REGISTER**

# STIMRIS

BIOMIRA B.V. (NETHERLANDS B.V.)  
DE BOELELAAN 575 A  
NL-1082 RM AMSTERDAM  
NETHERLANDS

FOR: IMMUNOLOGICAL PHARMACEUTICAL  
PREPARATIONS USED FOR THE PREVENTION  
AND TREATMENT OF CANCER, IN CLASS 5 (U.S.  
CLS. 6, 18, 44, 46, 51 AND 52).

THE MARK CONSISTS OF STANDARD CHAR-  
ACTERS WITHOUT CLAIM TO ANY PARTICULAR  
FONT, STYLE, SIZE, OR COLOR.

OWNER OF INTERNATIONAL REGISTRATION  
0863224 DATED 8-12-2005, EXPIRES 8-12-2015.

SER. NO. 79-035,623, FILED 2-26-2007.

DOMINIC FATHY, EXAMINING ATTORNEY

**Int. Cl.: 7**

**Prior U.S. Cls.: 13, 19, 21, 23, 31, 34 and 35**

**United States Patent and Trademark Office**

**Reg. No. 3,395,129**

**Registered Mar. 11, 2008**

**TRADEMARK  
PRINCIPAL REGISTER**

**Cobra**

J. WAGNER GMBH (FED REP GERMANY LTD  
LIAB CO)  
OTTO-LILIENTHAL-STRASSE 18  
88677 MARKDORF  
FED REP GERMANY

FOR: MACHINES, NAMELY, PNEUMATICALLY  
OPERATED PUMPS FOR CONVEYING COATING  
LIQUIDS TO SPRAY GUNS, IN CLASS 7 (U.S. CLS.  
13, 19, 21, 23, 31, 34 AND 35).

THE MARK CONSISTS OF STANDARD CHAR-  
ACTERS WITHOUT CLAIM TO ANY PARTICULAR  
FONT, STYLE, SIZE, OR COLOR.

PRIORITY DATE OF 7-4-2006 IS CLAIMED.

OWNER OF INTERNATIONAL REGISTRATION  
0916659 DATED 12-27-2006, EXPIRES 12-27-2016.

SER. NO. 79-035,646, FILED 12-27-2006.

COLLEEN KEARNEY, EXAMINING ATTORNEY

**Int. Cls.: 9, 18 and 25**

**Prior U.S. Cls.: 1, 2, 3, 21, 22, 23, 26, 36, 38, 39 and 41**

**Reg. No. 3,395,130**

**United States Patent and Trademark Office**

**Registered Mar. 11, 2008**

**TRADEMARK  
PRINCIPAL REGISTER**



SANDA' S.R.L. (ITALY LTD LIAB CO)  
VIA SCARLATTI, 10  
I-41019 SOLIERA (MODENA), ITALY

FOR: CORRECTIVE GLASSES AND SUN GLASSES; SPECTACLE FRAMES; SPECTACLE GLASSES; SPECTACLE CHAINS NOT OF PRECIOUS METAL; SPECTACLE CORDS; SPECTACLE CASES, IN CLASS 9 (U.S. CLS. 21, 23, 26, 36 AND 38).

FOR: BAGS, NAMELY, HANDBAGS AND SHOULDER BAGS; TRAVELING BAGS; TRAVELING CASES OF LEATHER AND OF IMITATION LEATHER; GARMENT BAGS FOR TRAVEL; BOXES OF LEATHER FOR HATS, HANDBAGS FOR MEN, TRUNKS, TRAVELING TRUNKS, COSMETIC AND TOILETRY BAGS AND CASES SOLD EMPTY, MULTI PURPOSE PURSES, PURSES, COIN PURSES NOT OF PRECIOUS METAL, WALLETS, DOCUMENT CASES, BRIEFCASES, BRIEF BAGS, SACHELS, DRAWSTRING POUCHES, WAIST BAGS, LEATHER CASES FOR KEYS, IMITATION LEATHER CASES FOR KEYS, BAGS FOR KEYS, SHOPPING BAGS, LUGGAGE, SUITCASES, ATTACHÉ CASES, BACK PACKS, UMBRELLAS AND PARASOLS, BEACH UMBRELLAS AND BEACH PARASOLS, WALKING

STICKS, WALKING CANES, IN CLASS 18 (U.S. CLS. 1, 2, 3, 22 AND 41).

FOR: COATS, OVERCOATS, RAINCOATS, WIND-CHEATERS, ANORAKS, JACKETS, TROUSERS, SHORTS, SUITS, SHIRTS, DRESSES, SKIRTS, BLOUSES, T-SHIRTS, SINGLETs, JERSEYS, JUMPERS, SWEATERS, SWEATSHIRTS, WAISTCOATS, VESTS, FUR COATS, FUR STOLEs, TRACKSUITS, SPORT JACKETS, BATHING SUITS, SWIMSUITS, BEACHWEAR, UNDERSHIRTS, BRASSIERES, UNDERPANTS, BRIEFS, SOCKS, STOCKINGS, PYJAMAS, NIGHTGOWNS, DRESSING GOWNS, BATHROBES, SHOES, BOOTS, SLIPPERS, CAPS, HATS, GLOVES, SCARFS, SHAWLS, BELTS, SUSPENDERS, TIES, IN CLASS 25 (U.S. CLS. 22 AND 39).

PRIORITY DATE OF 6-30-2006 IS CLAIMED.

OWNER OF INTERNATIONAL REGISTRATION  
0917061 DATED 12-27-2006, EXPIRES 12-27-2016.

SER. NO. 79-035,811, FILED 12-27-2006.

COLLEEN KEARNEY, EXAMINING ATTORNEY

**Int. Cls.: 35, 42 and 44**

**Prior U.S. Cls.: 100, 101 and 102**

**United States Patent and Trademark Office**

**Reg. No. 3,395,131**

**Registered Mar. 11, 2008**

**SERVICE MARK  
PRINCIPAL REGISTER**

# ALCIMED

ALCIMED (FRANCE SOCIÉTÉ PAR ACTIONS  
SIMPLIFIÉE)  
57, BOULEVARD DE MONTMORENCY  
F-75016 PARIS  
FRANCE

FOR: COMMERCIAL BUSINESS ORGANIZATION AND MANAGEMENT CONSULTING; MANAGEMENT OF COMMERCIAL OR INDUSTRIAL COMPANIES; MARKET STUDY; MARKET RESEARCH; BUSINESS MANAGEMENT; SALES PROMOTION; PERSONNEL RECRUITMENT; COMPUTERIZED FILE MANAGEMENT; DATA INPUT AND PROCESSING SERVICES; COMPUTER MANAGEMENT CONSULTING, NAMELY, CONSULTING IN THE FIELD OF MANAGEMENT OF COMPUTERIZED FILES, IN CLASS 35 (U.S. CLS. 100, 101 AND 102).

FOR: CHEMICAL ANALYSIS; ANALYSIS FOR OIL-FIELD EXPLORATION; RESEARCH AND DEVELOPMENT AND CONSULTANCY RELATED THERETO IN THE FIELD OF SCIENCE AND TECHNOLOGY; INTELLECTUAL PROPERTY CONSULTANCY; COMPUTER CONSULTING; PROFESSIONAL CONSULTING SERVICES IN THE FIELDS OF SCIENCE AND TECHNOLOGY AND IN CONNECTION WITH INNOVATION; TECHNICAL

PROJECT STUDIES IN THE FIELD OF SCIENCE AND TECHNOLOGY; SOFTWARE DESIGN AND DEVELOPMENT; MATERIAL TESTING; SURVEYING; PATENT EXPLOITATION, NAMELY, PATENT LICENSING; COMPUTER PROGRAMMING; RESEARCH AND DEVELOPMENT OF NEW PRODUCTS; BIOLOGICAL RESEARCH; BACTERIOLOGICAL RESEARCH; CHEMICAL RESEARCH; COSMETIC SCIENCE RESEARCH; PHYSICS RESEARCH; TECHNICAL RESEARCH IN THE FIELD OF SCIENCE AND TECHNOLOGY , IN CLASS 42 (U.S. CLS. 100 AND 101).

FOR: PHARMACEUTICAL ADVICE, IN CLASS 44 (U.S. CLS. 100 AND 101).

THE MARK CONSISTS OF STANDARD CHARACTERS WITHOUT CLAIM TO ANY PARTICULAR FONT, STYLE, SIZE, OR COLOR.

OWNER OF INTERNATIONAL REGISTRATION  
0917271 DATED 9-29-2006, EXPIRES 9-29-2016.

SER. NO. 79-035,884, FILED 9-29-2006.

EMILY CHUO, EXAMINING ATTORNEY

**Int. Cl.: 9**

**Prior U.S. Cls.: 21, 23, 26, 36 and 38**

**United States Patent and Trademark Office**

**Reg. No. 3,395,132**

**Registered Mar. 11, 2008**

**TRADEMARK  
PRINCIPAL REGISTER**

# Greenchrome

INDUSTRIE DE NORA S.P.A. (ITALY JOINT  
STOCK COMPANY)  
VIA LEONARDO BISTOLFI, 35  
I-20134 MILANO  
ITALY

PRIORITY DATE OF 6-27-2006 IS CLAIMED.

FOR: APPARATUS, NAMELY, ANODES FOR  
GALVANIC DEPOSITING, IN CLASS 9 (U.S. CLS.  
21, 23, 26, 36 AND 38).

OWNER OF INTERNATIONAL REGISTRATION  
0917407 DATED 12-21-2006, EXPIRES 12-21-2016.

THE MARK CONSISTS OF STANDARD CHAR-  
ACTERS WITHOUT CLAIM TO ANY PARTICULAR  
FONT, STYLE, SIZE, OR COLOR.

SER. NO. 79-035,958, FILED 12-21-2006.

MICHAEL LITZAU, EXAMINING ATTORNEY

**Int. Cls.: 1 and 19**

**Prior U.S. Cls.: 1, 5, 6, 10, 12, 26, 33, 46 and 50**

**United States Patent and Trademark Office**

**Reg. No. 3,395,133**

**Registered Mar. 11, 2008**

**TRADEMARK  
PRINCIPAL REGISTER**

# KERNEOS

KERNEOS (FRANCE SOCIETE ANONYME)  
8 RUE DES GRAVIERS  
F-92200 NEUILLY-SUR-SEINE  
FRANCE

FOR: CALCIUM ALUMINATES, NAMELY, CALCIUM ALUMINATE CHEMICAL PRODUCTS FOR USE IN THE BUILDING INDUSTRY, CALCIUM ALUMINATE CHEMICAL PRODUCTS FOR USE IN THE REFRACTORY INDUSTRY, AND CALCIUM ALUMINATE CHEMICAL PRODUCTS FOR STEEL TREATMENT; MINERAL AND ORGANIC ADDITIVES AND ADMIXTURES FOR BUILDING MATERIALS, NAMELY, CONCRETE ADDITIVES, CONCRETE ADMIXTURES, CEMENT ADDITIVES, CEMENT ADMIXTURES, MORTAR ADDITIVES, AND MORTAR ADMIXTURES; HYDRAULIC FLUIDS, NAMELY, HYDRAULIC BINDERS; CARBONATES, NAMELY, LIME CARBONATE; CALCIUM ALUMINATES; MINERAL CHEMICAL REAGENTS FOR NON-MEDICAL PURPOSES; CHEMICAL PRODUCTS MADE OF CALCIUM ALUMINATES, OF MINERAL REAGENTS AND OF ORGANIC COMPOUNDS OR ADDITIVES FOR CONCRETE, MORTAR AND CEMENT, IN CLASS 1 (U.S. CLS. 1, 5, 6, 10, 26 AND 46).

FOR: CEMENTS, NAMELY, CEMENT MIXES; CEMENT MIXES MADE OF CALCIUM ALUMINATES; REFRACTORY CEMENT MIXES; REFRACTORY MATERIALS NOT OF METAL, NAMELY, REFRACTORY BLOCKS, REFRACTORY BRICKS, REFRACTORY CONCRETE, REFRACTORY MORTAR, REFRACTORY CEMENT MIXES, AND REFRACTORY CONSTRUCTION MATERIALS; HYDRAULIC BINDERS, NAMELY, HYDRAULIC CEMENTS; AGGREGATE BINDING MATERIAL,

NAMELY, CEMENT MIXES COMPOSED OF CALCIUM ALUMINATES, MINERAL REAGENTS, AND ORGANIC COMPOUNDS AND ADDITIVES NOT OF METAL; ALL OF THE ABOVE MATERIALS FOR USE IN THE BUILDING INDUSTRY, THE REFRACTORY INDUSTRY AND IN THE SIDING, LINING AND COATING OF HIGH-TEMPERATURE OVENS AND FURNACES AND SIMILAR INSTALLATIONS; CONCRETES; MORTARS; MORTARS MADE OF CALCIUM ALUMINATES; HARD AGGREGATE MATERIAL COMPOSED OF CEMENT AND MORTAR, FOR HIGH PERFORMANCE CONCRETE; NON-METALLIC HIGH-ALUMINA BUILDING MATERIALS, NAMELY, CEMENTS, CONCRETES, AND MORTARS; ALL THE AFORESAID GOODS EXCLUDING FLAGS, PAVING STONES, TILES, AND TILING FOR FLOORS AND WALLS, MADE OF CONCRETE, OF CERAMIC, OR OF ALL OTHER MATERIALS, IN CLASS 19 (U.S. CLS. 1, 12, 33 AND 50).

THE MARK CONSISTS OF STANDARD CHARACTERS WITHOUT CLAIM TO ANY PARTICULAR FONT, STYLE, SIZE, OR COLOR.

PRIORITY DATE OF 5-24-2006 IS CLAIMED.

OWNER OF INTERNATIONAL REGISTRATION 0917415 DATED 11-21-2006, EXPIRES 11-21-2016.

SER. NO. 79-035,962, FILED 11-21-2006.

KATHERINE CONNOLLY, EXAMINING ATTORNEY

**Int. Cl.: 5**

**Prior U.S. Cls.: 6, 18, 44, 46, 51 and 52**

**United States Patent and Trademark Office**

**Reg. No. 3,395,134**

**Registered Mar. 11, 2008**

**TRADEMARK  
PRINCIPAL REGISTER**

**EPCAMTRIN**

FRESENIUS BIOTECH GMBH (FED REP GER-  
MANY GMBH (LIMITED COMPANY))  
AM HAAG 6-7  
82166 GRÄFELFING, FED REP GERMANY

FOR: PHARMACEUTICAL COMPOUNDS CON-  
TAINING ANTIBODIES, NAMELY, PHARMACEU-  
TICAL COMPOUNDS FOR USE IN ONCOLOGY, IN  
CLASS 5 (U.S. CLS. 6, 18, 44, 46, 51 AND 52).

THE MARK CONSISTS OF STANDARD CHAR-  
ACTERS WITHOUT CLAIM TO ANY PARTICULAR  
FONT, STYLE, SIZE, OR COLOR.

PRIORITY DATE OF 7-21-2006 IS CLAIMED.

OWNER OF INTERNATIONAL REGISTRATION  
0917541 DATED 1-18-2007, EXPIRES 1-18-2017.

SER. NO. 79-036,031, FILED 1-18-2007.

ALLISON SCHRODY, EXAMINING ATTORNEY

**Int. Cl.: 5**

**Prior U.S. Cls.: 6, 18, 44, 46, 51 and 52**

**United States Patent and Trademark Office**

**Reg. No. 3,395,135**

**Registered Mar. 11, 2008**

**TRADEMARK  
PRINCIPAL REGISTER**

**ECAMTRIN**

FRESENIUS BIOTECH GMBH (FED REP GER-  
MANY GMBH (LIMITED COMPANY))  
AM HAAG 6-7  
82166 GRÄFELFING, FED REP GERMANY

FOR: PHARMACEUTICAL COMPOUNDS CON-  
TAINING ANTIBODIES, NAMELY, PHARMACEU-  
TICAL COMPOUNDS FOR USE IN ONCOLOGY, IN  
CLASS 5 (U.S. CLS. 6, 18, 44, 46, 51 AND 52).

THE MARK CONSISTS OF STANDARD CHAR-  
ACTERS WITHOUT CLAIM TO ANY PARTICULAR  
FONT, STYLE, SIZE, OR COLOR.

PRIORITY DATE OF 7-21-2006 IS CLAIMED.

OWNER OF INTERNATIONAL REGISTRATION  
0917544 DATED 1-18-2007, EXPIRES 1-18-2017.

SER. NO. 79-036,032, FILED 1-18-2007.

ALLISON SCHRODY, EXAMINING ATTORNEY



**Int. Cl.: 35**

**Prior U.S. Cls.: 100, 101 and 102**

**United States Patent and Trademark Office**

**Reg. No. 3,395,136**

**Registered Mar. 11, 2008**

**SERVICE MARK  
PRINCIPAL REGISTER**

**Swedstar**

EUROSALESMAN SWEDEN AB (SWEDEN PRIVATE LIMITED COMPANY)  
REIMERSHOLMSGATAN 79  
SE-117 40 STOCKHOLM, SWEDEN

FOR: ADVERTISING; BUSINESS MANAGEMENT; BUSINESS ADMINISTRATION CONSULTANCY; OFFICE FUNCTIONS, IN CLASS 35 (U.S. CLS. 100, 101 AND 102).

THE MARK CONSISTS OF STANDARD CHARACTERS WITHOUT CLAIM TO ANY PARTICULAR FONT, STYLE, SIZE, OR COLOR.

PRIORITY DATE OF 12-27-2006 IS CLAIMED.

OWNER OF INTERNATIONAL REGISTRATION 0917548 DATED 2-27-2007, EXPIRES 2-27-2017.

SER. NO. 79-036,033, FILED 2-27-2007.

VERNA BETH RIRIE, EXAMINING ATTORNEY

**Int. Cl.: 6**

**Prior U.S. Cls.: 2, 12, 13, 14, 23, 25 and 50**

**Reg. No. 3,395,137**

**United States Patent and Trademark Office**

**Registered Mar. 11, 2008**

**TRADEMARK  
PRINCIPAL REGISTER**



CAPRAL ALUMINIUM LIMITED (AUSTRALIA  
CORPORATION)  
71 ASHBURN ROAD  
BUNDAMBA QLD 4304  
AUSTRALIA

PANELS, IN CLASS 6 (U.S. CLS. 2, 12, 13, 14, 23, 25  
AND 50).

OWNER OF INTERNATIONAL REGISTRATION  
0917605 DATED 1-19-2007, EXPIRES 1-19-2017.

FOR: METAL DOOR AND WINDOWS SCREENS;  
METAL SECURITY WINDOW SCREENS; METAL  
PATIO SCREENS; METAL SECURITY DOORS; ME-  
TAL SCREEN DOORS; METAL WINDOW SECUR-  
ITY GRILLS; AND METAL SECURITY DOOR

SER. NO. 79-036,064, FILED 1-19-2007.

TINA L. SNAPP, EXAMINING ATTORNEY

**Int. Cls.: 1 and 31**

**Prior U.S. Cls.: 1, 5, 6, 10, 26 and 46**

**United States Patent and Trademark Office**

**Reg. No. 3,395,138**

**Registered Mar. 11, 2008**

**TRADEMARK  
PRINCIPAL REGISTER**

**PHOTOTOPO**

AXXAM S.P.A. (ITALY JOINT STOCK COMPAN-  
NY)  
VIA OLGETTINA, 58  
I-20132 MILANO (MI)  
ITALY

FOR: RECOMBINANT CELLS AND PROTEINS  
FOR SCIENTIFIC, LABORATORY OR MEDICAL  
RESEARCH DERIVED FROM MOUSE STEM CELLS  
AND TRANSGENIC MICE , IN CLASS 1 (U.S. CLS. 1,  
5, 6, 10, 26 AND 46).

FOR: LIVE MICE, IN CLASS 31 (U.S. CLS. 1 AND  
46).

THE MARK CONSISTS OF STANDARD CHAR-  
ACTERS WITHOUT CLAIM TO ANY PARTICULAR  
FONT, STYLE, SIZE, OR COLOR.

PRIORITY DATE OF 6-16-2006 IS CLAIMED.

OWNER OF INTERNATIONAL REGISTRATION  
0917629 DATED 11-21-2006, EXPIRES 11-21-2016.

SER. NO. 79-036,071, FILED 11-21-2006.

TASNEEM HUSSAIN, EXAMINING ATTORNEY

**Int. Cls.: 9, 18 and 25**

**Prior U.S. Cls.: 1, 2, 3, 21, 22, 23, 26, 36, 38, 39 and 41**

**Reg. No. 3,395,139**

**United States Patent and Trademark Office**

**Registered Mar. 11, 2008**

**TRADEMARK  
PRINCIPAL REGISTER**

FLASH & PARTNERS S.P.A. (ITALY JOINT  
STOCK COMPANY)  
VIA TIEPOLO, 6  
I-35019 TOMBOLO (PADOVA)  
ITALY

FOR: GLASSES, NAMELY, OPTICAL GLASSES,  
SPECTACLES GLASSES AND READING GLASSES,  
AND SUNGLASSES AND THEIR PARTS AND AC-  
CESSORIES, NAMELY, FRAMES, CHAINS AND  
CASES; CONTACT LENSES, IN CLASS 9 (U.S. CLS.  
21, 23, 26, 36 AND 38).

FOR: LEATHER AND IMITATIONS OF LEA-  
THER AND GOODS MADE OF THESE MATERI-  
ALS, NAMELY BAGS, HANDBAGS, WALLETS AND  
BRIEFCASES, IN CLASS 18 (U.S. CLS. 1, 2, 3, 22 AND  
41).

FOR: DRESSES, COATS, OVERCOATS, RAIN-  
COATS, JACKETS, SPORTS JACKETS, TROUSERS,  
JEANS, SHORTS, SKIRTS, TRACK SUITS, SWEA-

TERS, SHIRTS, T-SHIRTS, CARDIGANS, DRESSING  
GOWNS, NIGHTGOWNS, PAJAMAS, PETTICOATS,  
SOCKS, STOCKINGS, TIGHTS, GLOVES, SCARVES,  
FOULARDS AND NECKERCHIEFS, BELTS, WAIST-  
COATS, BATHING SUITS, HATS, CAPS, SHOES,  
BOOTS, SANDALS, SLIPPERS, IN CLASS 25 (U.S.  
CLS. 22 AND 39).

PRIORITY DATE OF 9-29-2005 IS CLAIMED.

OWNER OF INTERNATIONAL REGISTRATION  
0917928 DATED 11-7-2005, EXPIRES 11-7-2015.

OWNER OF U.S. REG. NOS. 2,820,720, 2,951,878,  
AND 2,981,226.

SER. NO. 79-036,166, FILED 11-7-2005.

JESSICA FATHY, EXAMINING ATTORNEY

**Int. Cl.: 5**

**Prior U.S. Cls.: 6, 18, 44, 46, 51 and 52**

**Reg. No. 3,395,140**

**United States Patent and Trademark Office**

**Registered Mar. 11, 2008**

**TRADEMARK  
PRINCIPAL REGISTER**



MEFRONT; AGRICULTURAL CHEMICALS CO.,  
LTD (CHINA CORPORATION)  
NO. 2 JIUFENGSAN ROAD,  
ECONOMIC AND TECHNOLOGICAL; DEVELOP-  
MENTZONE, WENZHO; ZHEJIANG  
CHINA

FOR: AGRICULTURAL PESTICIDES, IN CLASS 5  
(U.S. CLS. 6, 18, 44, 46, 51 AND 52).

OWNER OF INTERNATIONAL REGISTRATION  
0918011 DATED 3-13-2007, EXPIRES 3-13-2017.

THE ENGLISH TRANSLATION OF THE NON-  
LATIN CHARACTERS IN THE MARK IS BEAUTI-  
FUL AND FERTILITY; THE COMBINATION OF  
THE CHARACTERS IS MEANINGLESS.

THE NON-LATIN CHARACTERS IN THE MARK  
TRANSLITERATE TO "MEI FENG."

SER. NO. 79-036,197, FILED 3-13-2007.

BRIAN PINO, EXAMINING ATTORNEY

**Int. Cls.: 35, 36, 37 and 43**

**Prior U.S. Cls.: 100, 101, 102, 103 and 106**

**United States Patent and Trademark Office**

**Reg. No. 3,395,141**

**Registered Mar. 11, 2008**

**SERVICE MARK  
PRINCIPAL REGISTER**



MIRVAC PROJECTS PTY LIMITED (AUSTRALIA  
PROPRIETARY COMPANY)

40 MILLER STREET

NORTH SYDNEY NSW 2060, AUSTRALIA

FOR: ADVERTISING, BUSINESS MANAGEMENT, BUSINESS ADMINISTRATION, OFFICE FUNCTIONS; RETAIL STORE SERVICES IN THE FIELDS OF CLOTHING AND FOOD AND BEVERAGES, IN CLASS 35 (U.S. CLS. 100, 101 AND 102).

FOR: REAL ESTATE AFFAIRS, NAMELY, LEASING, MANAGEMENT AND ADMINISTRATION OF REAL ESTATE, NAMELY, RESIDENTIAL, RETAIL, COMMERCIAL AND INDUSTRIAL PROPERTY, CAR PARKS; FINANCING OF PROPERTY DEVELOPMENT AND REAL ESTATE AGENCY SERVICES RELATING TO THE SALE OF LAND PACKAGES, CONTRACT HOMES, HOME AND LAND PACKAGES, RESIDENTIAL PROPERTY, RETIREMENT VILLAGES, RETAIL, COMMERCIAL AND INDUSTRIAL PROPERTY, CAR PARKS; INVESTMENT ADVICE IN RELATION TO THE FOREGOING AND FUNDS MANAGEMENT, NAMELY, MANAGEMENT OF PRIVATE EQUITY FUNDS; INSURANCE SERVICES, NAMELY, INSURANCE CARRIER SERVICES; FINANCIAL AFFAIRS, NAMELY, CREDIT AND FINANCIAL CONSULTATION, IN CLASS 36 (U.S. CLS. 100, 101 AND 102).

FOR: BUILDING CONSTRUCTION SERVICES, IN CLASS 37 (U.S. CLS. 100, 103 AND 106).

FOR: SERVICES FOR THE PROVISION OF FOOD AND DRINK, NAMELY, SERVING OF FOOD AND DRINK; RENTAL OF MEETING ROOMS; PROVISION OF TEMPORARY ACCOMMODATION; HOTELS, IN CLASS 43 (U.S. CLS. 100 AND 101).

PRIORITY DATE OF 9-5-2006 IS CLAIMED.

OWNER OF INTERNATIONAL REGISTRATION 0918029 DATED 10-19-2006, EXPIRES 10-19-2016.

THE COLOR(S) BLUE AND GREEN IS/ARE CLAIMED AS A FEATURE OF THE MARK.

THE COLOUR BLUE APPEARS IN THE WORDING MIRVAC AND IN THE DESIGN OF THE THREE STRAIGHT DIAMOND-SHAPED FOLDS ABOVE THE LETTERS VAC; THE COLOUR GREEN APPEARS IN THE CURVED DIAMOND-SHAPED FOLD ABOVE THE LETTERS IR.

SER. NO. 79-036,209, FILED 10-19-2006.

TASNEEM HUSSAIN, EXAMINING ATTORNEY

**Int. Cl.: 25**

**Prior U.S. Cls.: 22 and 39**

**United States Patent and Trademark Office**

**Reg. No. 3,395,142**

**Registered Mar. 11, 2008**

**TRADEMARK  
PRINCIPAL REGISTER**

**BURQINI**

AHIIDA PTY LTD (AUSTRALIA COMPANY)  
5 THE BOULEVARDE  
YAGOONA, AUSTRALIA NSW 2199

PRIORITY DATE OF 8-22-2006 IS CLAIMED.

FOR: SWIMWEAR, HOODED SWIMWEAR, FOR  
WOMEN, IN CLASS 25 (U.S. CLS. 22 AND 39).

OWNER OF INTERNATIONAL REGISTRATION  
0918090 DATED 2-20-2007, EXPIRES 2-20-2017.

THE MARK CONSISTS OF STANDARD CHAR-  
ACTERS WITHOUT CLAIM TO ANY PARTICULAR  
FONT, STYLE, SIZE, OR COLOR.

SER. NO. 79-036,238, FILED 2-20-2007.

SARA THOMAS, EXAMINING ATTORNEY

**Int. Cl.: 5**

**Prior U.S. Cls.: 6, 18, 44, 46, 51 and 52**

**Reg. No. 3,395,143**

**United States Patent and Trademark Office**

**Registered Mar. 11, 2008**

**TRADEMARK  
PRINCIPAL REGISTER**

**PRO-IONIC**

FIRST WATER LIMITED (UNITED KINGDOM  
LIMITED COMPANY)  
HILLDROP LANE, RAMSBURY  
MARLBOROUGH, WILTSHIRE SN8 2RB, UNITED  
KINGDOM

OWNER OF INTERNATIONAL REGISTRATION  
0918965 DATED 2-19-2007, EXPIRES 2-19-2017.

FOR: WOUND DRESSINGS; SKIN ADHESIVES,  
NAMELY, ADHESIVES FOR BANDAGES FOR SKIN  
WOUNDS, IN CLASS 5 (U.S. CLS. 6, 18, 44, 46, 51 AND  
52).

SER. NO. 79-036,543, FILED 2-19-2007.

PRIORITY DATE OF 9-8-2006 IS CLAIMED.

MYRIAH HABEEB, EXAMINING ATTORNEY



**Int. Cls.: 30, 31 and 33**

**Prior U.S. Cls.: 1, 46, 47 and 49**

**United States Patent and Trademark Office**

**Reg. No. 3,395,144**

**Registered Mar. 11, 2008**

**TRADEMARK  
PRINCIPAL REGISTER**



HEFEI HUATAI FOOD CO., LTD. (CHINA CORPORATION)  
SOUTH OF GENGYUN ROAD  
EAST OF LIANHUA ROAD; ECONOMIC & TECHNOLOGICAL; DEVELOPMENT ZONE; HEFEI, ANHUI  
CHINA

FOR: TEA SUBSTITUTES; FRUIT JELLIES; BISCUITS; CORN FLAKES; SHERBETS; SORBETS; CEREAL BASED SNACK FOODS, NAMELY, CHIPS WITH SHRIMP FLAVORS; RICE CRACKERS, IN CLASS 30 (U.S. CL. 46).

FOR: UNPROCESSED GRAINS; UNPROCESSED AND RAW BEANS; SEEDLINGS; SPINY LOBSTERS; FRESH NUTS; FRESH PEANUTS; FRESH MUSHROOM SPAWN; PLANT SEEDS; PET FOOD; MALT FOR BREWING AND DISTILLING, IN CLASS 31 (U.S. CLS. 1 AND 46).

FOR: PEPPERMINT LIQUEURS; APERITIFS; ARRACK; PREPARED ALCOHOLIC COCKTAILS; WINE; BRANDY; SAKE; ALCOHOLIC EXTRACTS; ALCOHOLIC BEVERAGE CONTAINING FRUIT;

DISTILLED SPIRITS , IN CLASS 33 (U.S. CLS. 47 AND 49).

OWNER OF INTERNATIONAL REGISTRATION 0919497 DATED 9-26-2006, EXPIRES 9-26-2016.

OWNER OF U.S. REG. NOS. 2,664,129, 2,961,966, AND 3,057,118.

THE MARK CONSISTS OF TWO CHINESE CHARACTERS.

THE FIRST CHINESE CHARACTER IN THE MARK MEANS "IN HARMONY", THE SECOND CHARACTER MEANS THE SAME.

THE TRANSLITERATION OF THE MARK IS QIA QIA.

SER. NO. 79-036,703, FILED 9-26-2006.

DAVID HOFFMAN, EXAMINING ATTORNEY

**Int. Cl.: 11**

**Prior U.S. Cls.: 13, 21, 23, 31 and 34**

**United States Patent and Trademark Office**

**Reg. No. 3,395,145**

**Registered Mar. 11, 2008**

**TRADEMARK  
PRINCIPAL REGISTER**

**OM**

HERAEUS QUARZGLAS GMBH & CO. KG (FED  
REP GERMANY A LIMITED COMMERCIAL  
PARTNERSHIP)  
QUARZSTRASSE 8  
63450 HANAU, FED REP GERMANY

FOR: LIGHTING DEVICES, NAMELY, LAMP  
GLASSES AND REFLECTORS FOR LAMPS MADE  
OF QUARTZ GLASS, IN CLASS 11 (U.S. CLS. 13, 21,  
23, 31 AND 34).

THE MARK CONSISTS OF STANDARD CHAR-  
ACTERS WITHOUT CLAIM TO ANY PARTICULAR  
FONT, STYLE, SIZE, OR COLOR.

PRIORITY DATE OF 7-14-2006 IS CLAIMED.

OWNER OF INTERNATIONAL REGISTRATION  
0919562 DATED 12-21-2006, EXPIRES 12-21-2016.

SER. NO. 79-036,722, FILED 12-21-2006.

BENJAMIN OKEKE, EXAMINING ATTORNEY

**Int. Cl.: 20**

**Prior U.S. Cls.: 2, 13, 22, 25, 32 and 50**

**United States Patent and Trademark Office**

**Reg. No. 3,395,146**

**Registered Mar. 11, 2008**

**TRADEMARK  
PRINCIPAL REGISTER**

**MADE BY YOU**

RDS MONTANA GRUPPEN INVEST APS (DEN-  
MARK LTD LIAB CO)  
ENGHAVEN 9  
DK-3450 ALLERØD, DENMARK

FOR: FURNITURE; FURNITURE FOR STO-  
RAGE; CHAIRS; TABLES; SOFAS; STORAGE  
RACKS AND RACK SYSTEMS COMPRISED OF  
SHELVES AND CONNECTORS FOR STORAGE;  
BED HEADBOARDS WITH ATTACHED NIGHT  
STANDS; BENCHES; FOOTSTOOLS; CHESTS OF  
DRAWERS; DESKS; WRITING DESKS; STOOLS;  
DISPLAY STANDS; DISPLAY CASES; FURNITURE,  
NAMELY, SALE, DISPLAY AND RECEPTION  
COUNTERS; BEDS; SHELVES; MIRRORS, IN CLASS  
20 (U.S. CLS. 2, 13, 22, 25, 32 AND 50).

THE MARK CONSISTS OF STANDARD CHAR-  
ACTERS WITHOUT CLAIM TO ANY PARTICULAR  
FONT, STYLE, SIZE, OR COLOR.

PRIORITY DATE OF 10-13-2006 IS CLAIMED.

OWNER OF INTERNATIONAL REGISTRATION  
0920468 DATED 2-28-2007, EXPIRES 2-28-2017.

SER. NO. 79-037,106, FILED 2-28-2007.

ELI HELLMAN, EXAMINING ATTORNEY

**Int. Cls.: 19 and 37**

**Prior U.S. Cls.: 1, 12, 33, 50, 100, 103 and 106**

**United States Patent and Trademark Office**

**Reg. No. 3,395,147**

**Registered Mar. 11, 2008**

**TRADEMARK  
SERVICE MARK  
PRINCIPAL REGISTER**



KALTUN MADENCILIK; SANAYI VE TICARET ANONIM SIRKETI (TURKEY CORPORATION)

AYDIN-MUGLA KARAYOLU  
35.KM MEVKII; ÇINE AYDIN  
KADIKOY; ISTANBUL, TURKEY

FOR: FLOOR TILES NOT OF METAL; BUILDING GLASS FOR WINDOWS; QUARTZ, NAMELY, SILICA STONE AND SILICA QUARTZ; TERRA COTTA, NAMELY, CERAMIC, TILES AND TERRA COTTA BUILDING MATERIALS, SPECIFICALLY, TERRA COTTA TILES, ROOFING AND FLOORING; TILE FLOORINGS NOT OF METAL; TILES NOT OF METAL; TILES NOT OF METAL FOR BUILDING; WALL TILES NOT OF METAL FOR BUILDING; WINDOW GLASS EXCEPT GLASS FOR VEHICLE WINDOWS; WINDOW GLASS FOR BUILDING; WINDOWS NOT OF METAL; STAINED-GLASS FOR WINDOWS; ROCK CRYSTAL USED IN THE MANUFACTURE OF FLOORING, ROOFING, COUNTERTOPS, WALLS, CLADDING AND FIREPLACES, IN CLASS 19 (U.S. CLS. 1, 12, 33 AND 50).

FOR: MINING EXTRACTION, IN CLASS 37 (U.S. CLS. 100, 103 AND 106).

OWNER OF INTERNATIONAL REGISTRATION 0920520 DATED 2-22-2007, EXPIRES 2-22-2017.

NO CLAIM IS MADE TO THE EXCLUSIVE RIGHT TO USE "MINING COMPANY", APART FROM THE MARK AS SHOWN.

THE COLOR(S) GREEN, YELLOW AND BLACK IS/ARE CLAIMED AS A FEATURE OF THE MARK.

THE MARK CONSISTS OF THE WORDING KALTUN MINING COMPANY IN STYLIZED FORM. THE COLOR GREEN APPEARS IN THE LETTERS KAL AND THE OUTLINE OF THE LETTERS TUN. THE COLOR YELLOW APPEARS IN THE LETTERS TUN. THE COLOR BLACK APPEARS IN THE WORDING MINING COMPANY.

THE WORDING KALTUN HAS NO MEANING IN A FOREIGN LANGUAGE.

SER. NO. 79-037,125, FILED 2-22-2007.

TINA BROWN, EXAMINING ATTORNEY

**Int. Cl.: 25**

**Prior U.S. Cls.: 22 and 39**

**United States Patent and Trademark Office**

**Reg. No. 3,395,148**

**Registered Mar. 11, 2008**

**TRADEMARK  
PRINCIPAL REGISTER**

**JULIE GUERLANDE**

JULIE GUERLANDE (SOCIÉTÉ ANONYME)  
(FRANCE SOCIÉTÉ ANONYME)  
21 RUE DE L'INDUSTRIE  
ZONE INDUSTRIELLE  
F-67720 HOERDT, FRANCE

FOR: CLOTHING, NAMELY, SKIRTS, BLOUSES, SHIRTS, T-SHIRTS, PANTS, DRESSES, COATS, RAINCOATS, BLAZERS, ROBES, JUMPERS, SWEATERS, JACKETS, PANTS-SKIRTS, COMBINATIONS, VESTS, BLOUSONS, WIND-RESISTANT JACKETS, SCARVES, BOMBER JACKETS, BELTS, HATS, PARKAS, SHORTS, LEGGINGS, SKIWEAR AND SWIMWEAR; HAND KNITS, NAMELY, KNIT SHIRTS AND KNIT PANTS, IN CLASS 25 (U.S. CLS. 22 AND 39).

THE MARK CONSISTS OF STANDARD CHARACTERS WITHOUT CLAIM TO ANY PARTICULAR FONT, STYLE, SIZE, OR COLOR.

OWNER OF INTERNATIONAL REGISTRATION  
0920942 DATED 3-19-2007, EXPIRES 3-19-2017.

THE NAME JULIE GUERLANDE DOES NOT IDENTIFY A LIVING INDIVIDUAL.

SER. NO. 79-037,266, FILED 3-19-2007.

ALLISON HOLTZ, EXAMINING ATTORNEY

**Int. Cl.: 10**

**Prior U.S. Cls.: 26, 39 and 44**

**United States Patent and Trademark Office**

**Reg. No. 3,395,149**

**Registered Mar. 11, 2008**

**TRADEMARK  
PRINCIPAL REGISTER**

**YOUR PARTNER OF CHOICE**

VENTRASSIST PTY LTD (AUSTRALIA CORPORATION)

126 GREVILLE STREET

CHATSWOOD, NSW 2067

AUSTRALIA

FOR: MEDICAL DEVICES, NAMELY, BLOOD PUMPS, ROTARY BLOOD PUMPS, PULSATILE PUMPS, LEFT VENTRICLE ASSIST DEVICES, CANNULAE AND SURGICAL TOOLS, NAMELY, TROCARS, SCALPELS AND KNIVES FOR SURGICAL PURPOSES, IN CLASS 10 (U.S. CLS. 26, 39 AND 44).

THE MARK CONSISTS OF STANDARD CHARACTERS WITHOUT CLAIM TO ANY PARTICULAR FONT, STYLE, SIZE, OR COLOR.

PRIORITY DATE OF 2-27-2007 IS CLAIMED.

OWNER OF INTERNATIONAL REGISTRATION 0921419 DATED 3-22-2007, EXPIRES 3-22-2017.

SER. NO. 79-037,470, FILED 3-22-2007.

LAURIE KAUFMAN, EXAMINING ATTORNEY

**Int. Cl.: 30**

**Prior U.S. Cl.: 46**

**United States Patent and Trademark Office**

**Reg. No. 3,395,150**

**Registered Mar. 11, 2008**

**TRADEMARK  
PRINCIPAL REGISTER**

# Tekrum

GRIESSON - DE BEUKELAER GMBH & CO. KG  
(FED REP GERMANY GMBH & CO. KG)  
AUGUST-HORCH-STRASSE 23  
56751 POLCH, FED REP GERMANY

OWNER OF INTERNATIONAL REGISTRATION  
0921483 DATED 4-5-2007, EXPIRES 4-5-2017.

FOR: PASTRY AND CONFECTIONERY, NAME-  
LY, PASTRIES AND CANDIES, IN CLASS 30 (U.S.  
CL. 46).

SER. NO. 79-037,501, FILED 4-5-2007.

THE MARK CONSISTS OF STANDARD CHAR-  
ACTERS WITHOUT CLAIM TO ANY PARTICULAR  
FONT, STYLE, SIZE, OR COLOR.

COLLEEN KEARNEY, EXAMINING ATTORNEY

**Int. Cl.: 3**

**Prior U.S. Cls.: 1, 4, 6, 50, 51 and 52**

**United States Patent and Trademark Office**

**Reg. No. 3,395,151**

**Registered Mar. 11, 2008**

**TRADEMARK  
PRINCIPAL REGISTER**

**COLLECTION CROISIERE**

PARFUMS CHRISTIAN DIOR (FRANCE SOCI-  
ETE ANONYME)  
33 AVENUE HOCHÉ  
F-75008 PARIS  
FRANCE

FOR: TOILETS SOAPS, PERFUMES, EAU-DE-CO-  
LOGNE, EAUX DE TOILETTE, COSMETICS, ESSEN-  
TIAL OILS FOR PERSONAL USE, CLEANSING  
MILKS, BODY AND BATH LOTIONS, BODY AND  
FACIAL CREAMS, BODY AND FACIAL EMUL-  
SIONS, SCENTED GELS FOR THE FACE AND  
BODY, DEODORANTS FOR PERSONAL USE, HAIR  
LOTIONS, IN CLASS 3 (U.S. CLS. 1, 4, 6, 50, 51 AND  
52).

OWNER OF INTERNATIONAL REGISTRATION  
0921656 DATED 1-15-2007, EXPIRES 1-15-2017.

NO CLAIM IS MADE TO THE EXCLUSIVE  
RIGHT TO USE "COLLECTION", APART FROM  
THE MARK AS SHOWN.

THE ENGLISH TRANSLATION OF THE WORD  
COLLECTION CROISIERE IN THE MARK IS  
CRUISE COLLECTION.

SER. NO. 79-037,572, FILED 1-15-2007.

LAURIE KAUFMAN, EXAMINING ATTORNEY



**Int. Cl.: 7**

**Prior U.S. Cls.: 13, 19, 21, 23, 31, 34 and 35**

**United States Patent and Trademark Office**

**Reg. No. 3,395,152**

**Registered Mar. 11, 2008**

**TRADEMARK  
PRINCIPAL REGISTER**

# **QUILT EXPRESSION**

VSM GROUP AB (SWEDEN A COMPANY  
(JOINT-STOCK COMPANY))  
SE-561 84 HUSKVARNA  
SWEDEN

FOR: SEWING MACHINES, PARTS AND ACCESSORIES TO SEWING MACHINES, NAMELY, MACHINE CONTROLS, PRESSER FEET AND PERIPHERAL UNITS ATTACHABLE TO SEWING MACHINES, IN CLASS 7 (U.S. CLS. 13, 19, 21, 23, 31, 34 AND 35).

OWNER OF INTERNATIONAL REGISTRATION  
0922078 DATED 3-23-2007, EXPIRES 3-23-2017.

NO CLAIM IS MADE TO THE EXCLUSIVE RIGHT TO USE "QUILT", APART FROM THE MARK AS SHOWN.

SER. NO. 79-037,729, FILED 3-23-2007.

JESSICA FATHY, EXAMINING ATTORNEY

**Int. Cl.: 7**

**Prior U.S. Cls.: 13, 19, 21, 23, 31, 34 and 35**

**United States Patent and Trademark Office**

**Reg. No. 3,395,153**

**Registered Mar. 11, 2008**

**TRADEMARK  
PRINCIPAL REGISTER**

**EXPRESSION**

VSM GROUP AB (SWEDEN JOINT STOCK COMPANY)  
SE-561 84  
HUSKVARNA, SWEDEN

OWNER OF INTERNATIONAL REGISTRATION  
0922079 DATED 3-23-2007, EXPIRES 3-23-2017.

FOR: SEWING MACHINES, PARTS AND ACCESSORIES TO SEWING MACHINES, NAMELY, MACHINE CONTROLS, PRESSER FEET AND PERIPHERAL UNITS ATTACHABLE TO SEWING MACHINES, IN CLASS 7 (U.S. CLS. 13, 19, 21, 23, 31, 34 AND 35).

SER. NO. 79-037,730, FILED 3-23-2007.

JESSICA FATHY, EXAMINING ATTORNEY

**Int. Cl.: 32**

**Prior U.S. Cls.: 45, 46 and 48**

**United States Patent and Trademark Office**

**Reg. No. 3,395,154**

**Registered Mar. 11, 2008**

**TRADEMARK  
PRINCIPAL REGISTER**

**COFFEINN**  
ENERGY DRINK

ARTHUR MÜLLER (FED REP GERMANY INDIVIDUAL)  
DAIMLERSTRAS. 14  
75173 PFORZHEIM  
FED REP GERMANY

FOR: BEERS, MINERAL AND AERATED WATERS, SOFT DRINKS, FRUIT DRINKS, FRUIT JUICES AND NON-ALCOHOLIC DRINKS, NAMELY, COFFEE-FLAVORED ENERGY DRINKS; PREPARATIONS FOR MAKING COFFEE-FLAVORED ENERGY DRINKS IN LIQUID AND POWDER FORM; SYRUPS BEING FLAVOURINGS FOR MAKING BEVERAGES; FLAVOURED AND NON-FLAVOURED DRINKING WATER, AERATED WATERS, MINERAL WATERS, FRUIT JUICES, AERATED FRUIT DRINKS AND JUICES, AND SODA POPS, IN CLASS 32 (U.S. CLS. 45, 46 AND 48).

PRIORITY DATE OF 11-17-2006 IS CLAIMED.

OWNER OF INTERNATIONAL REGISTRATION  
0922136 DATED 3-19-2007, EXPIRES 3-19-2017.

NO CLAIM IS MADE TO THE EXCLUSIVE RIGHT TO USE "ENERGY DRINK", APART FROM THE MARK AS SHOWN.

SER. NO. 79-037,753, FILED 3-19-2007.

FRED MANDIR, EXAMINING ATTORNEY

**Int. Cls.: 38 and 42**

**Prior U.S. Cls.: 100, 101 and 104**

**United States Patent and Trademark Office**

**Reg. No. 3,395,155**

**Registered Mar. 11, 2008**

**SERVICE MARK  
PRINCIPAL REGISTER**



OUR PAGES LTD (UNITED KINGDOM COMPANY)  
43 BOTLEY RD  
OXFORD OX2 0BN  
UNITED KINGDOM

FOR: ELECTRONIC MAIL SERVICES, IN CLASS 38 (U.S. CLS. 100, 101 AND 104).

FOR: CREATING OF COMPUTER WEBSITES FOR OTHERS; WEBSITE HOSTING SERVICES; COMPUTER SERVICES, NAMELY, PROVISION OF COMPUTER NETWORK FIREWALLS FOR OTHERS, IN CLASS 42 (U.S. CLS. 100 AND 101).

PRIORITY DATE OF 10-21-2006 IS CLAIMED.

OWNER OF INTERNATIONAL REGISTRATION 0922214 DATED 4-16-2007, EXPIRES 4-16-2017.

NO CLAIM IS MADE TO THE EXCLUSIVE RIGHT TO USE "INSTANT EDITABLE WEBSITES", APART FROM THE MARK AS SHOWN.

THE COLOR(S) BROWN, RED, BLUE AND GRAY IS/ARE CLAIMED AS A FEATURE OF THE MARK.

THE COLOR GRAY APPEARS IN THE CONJOINED WORDS "OURPAGES" AND THE COLOR BLUE APPEARS IN THE WORDING "INSTANT EDITABLE WEBSITES" AND BOTH COLORS APPEAR ALSO IN THE DESIGN OF THE FOUR INTERLOCKING GROTESQUE MEN THAT FORM THE OVERALL DIAMOND SHAPE AND WHICH ARE INDIVIDUALLY COLORED AS FOLLOWS: TOP ONE IS BROWN, BOTTOM ONE IS BLUE, LEFT ONE IS GRAY AND THE RIGHT ONE IS RED.

SER. NO. 79-037,785, FILED 4-16-2007.

DAVID H. STINE, EXAMINING ATTORNEY

**Int. Cls.: 6, 19, 37 and 42**

**Prior U.S. Cls.: 1, 2, 12, 13, 14, 23, 25, 33, 50, 100, 101,  
103 and 106**

**Reg. No. 3,395,156**

**United States Patent and Trademark Office**

**Registered Mar. 11, 2008**

**TRADEMARK  
SERVICE MARK  
PRINCIPAL REGISTER**

# **CABRIO-HOUSE**

WAKONIG, MARTIN (AUSTRIA INDIVIDUAL)  
JUDENGASSE 11/13  
A-1010 WIEN, AUSTRIA

FOR: TRANSPORTABLE AND NON-TRANSPORTABLE PREFABRICATED BUILDINGS OF METAL, IN CLASS 6 (U.S. CLS. 2, 12, 13, 14, 23, 25 AND 50).

FOR: TRANSPORTABLE AND NON-TRANSPORTABLE PREFABRICATED NON-METAL BUILDINGS, IN CLASS 19 (U.S. CLS. 1, 12, 33 AND 50).

FOR: BUILDING CONSTRUCTION SERVICES; BUILDING CONSTRUCTION MANAGEMENT, IN CLASS 37 (U.S. CLS. 100, 103 AND 106).

FOR: ARCHITECTURE DESIGN AND CONSULTATION SERVICES IN THE FIELD OF ARCHITECTURAL DESIGN, IN CLASS 42 (U.S. CLS. 100 AND 101).

OWNER OF INTERNATIONAL REGISTRATION  
0922437 DATED 4-5-2007, EXPIRES 4-5-2017.

SER. NO. 79-037,857, FILED 4-5-2007.

ELI HELLMAN, EXAMINING ATTORNEY

**Int. Cls.: 6, 7 and 9**

**Prior U.S. Cls.: 2, 12, 13, 14, 19, 21, 23, 25, 26, 31, 34,  
35, 36, 38 and 50**

**Reg. No. 3,395,157**

**United States Patent and Trademark Office**

**Registered Mar. 11, 2008**

**TRADEMARK  
PRINCIPAL REGISTER**

**SHEATHEX**

BWE LIMITED (UNITED KINGDOM PLC)  
BEAVER INDUSTRIAL ESTATE  
ASHFORD, KENT TN23 7SH  
UNITED KINGDOM

FOR: ELONGATE METAL EXTRUSIONS, NAME-  
LY, EXTRUDED METAL TUBES AND CASINGS  
FOR USE IN CONSTRUCTION AND GENERAL  
MANUFACTURE, METAL TUBES, METAL CABLES  
AND WIRES, IN CLASS 6 (U.S. CLS. 2, 12, 13, 14, 23, 25  
AND 50).

FOR: EXTRUSION MACHINERY, NAMELY, EX-  
TRUSION MOULDING MACHINES, METAL EX-  
TRUSION PRESSES, AND WIRE EXTRUDING  
MACHINES FOR PRODUCING ELONGATE ME-  
TALLIC EXTRUSIONS, METAL TUBES, METAL  
CABLES AND WIRES AND PARTS THEREOF, IN  
CLASS 7 (U.S. CLS. 13, 19, 21, 23, 31, 34 AND 35).

FOR: CONTROL EQUIPMENT, NAMELY, ELEC-  
TRICAL CONTROLLERS AND ELECTRIC CON-  
TROL PANELS FOR CONTROLLING EXTRUSION  
MACHINERY USED TO PRODUCE ELONGATE  
METALLIC EXTRUSIONS, METAL TUBES, METAL  
CABLES AND WIRES AND PARTS THEREOF, IN  
CLASS 9 (U.S. CLS. 21, 23, 26, 36 AND 38).

OWNER OF INTERNATIONAL REGISTRATION  
0922498 DATED 3-16-2007, EXPIRES 3-16-2017.

SHEATHEX HAS NO MEANING IN A FOREIGN  
LANGUAGE.

SER. NO. 79-037,883, FILED 3-16-2007.

JOHN KELLY, EXAMINING ATTORNEY

**Int. Cls.: 16, 39, 41 and 43**

**Prior U.S. Cls.: 2, 5, 22, 23, 29, 37, 38, 50, 100, 101, 105  
and 107**

**Reg. No. 3,395,158**

**United States Patent and Trademark Office**

**Registered Mar. 11, 2008**

**TRADEMARK  
SERVICE MARK  
PRINCIPAL REGISTER**



TUI AG (FED REP GERMANY JOINT STOCK  
COMPANY)  
KARL-WIECHERT-ALLEE 4  
30625 HANNOVER  
FED REP GERMANY

MACHINES, CLOTH FOR BOOKBINDING; ADHESIVES FOR STATIONERY PURPOSES; ALL AFOREMENTIONED GOODS ONLY IN CONNECTION WITH CRUISES, IN CLASS 16 (U.S. CLS. 2, 5, 22, 23, 29, 37, 38 AND 50).

FOR: PAPER, CARDBOARD AND GOODS MADE FROM THESE MATERIALS INCLUDED IN THIS CLASS, NAMELY, STICKERS, CONTAINERS FOR STATIONERY, BEER MATS, PAPER AND PLASTIC PACKING BAGS, PAPER BAGS, PADS OF PAPER, WRITING PAPER AND TRANSFERS, NAMELY, IRON-ONS, TEMPORARY TATTOOS; PRINTED MATTER, NAMELY, BOOKS, LEAFLETS, BROCHURES, NEWSPAPERS AND MAGAZINES ALL IN THE FIELD OF BUSINESS MANAGEMENT, TRAVEL AND ENTERTAINMENT MANAGEMENT, NEWSPAPERS, PHOTOGRAPHS, POSTCARDS; PRINTED TICKETS, ENTRY TICKETS, CALENDARS, CARDS, NAMELY, NOTE CARDS, GREETING CARDS, BUSINESS CARDS AND BLANK CARDS, CATALOGUES IN THE FIELD OF TRAVEL MANAGEMENT; WRITING INSTRUMENTS, NAMELY, PENS, PENCILS AND FOUNTAIN PENS; ARTISTS' MATERIALS, NAMELY PAINTING SETS AND PAINT BRUSHES; OFFICE REQUISITES OTHER THAN FURNITURE, NAMELY, ADHESIVE TAPE DISPENSERS, CORRECTING FLUID FOR TYPE, STAPLERS, FRANKING MACHINES; PRINTED INSTRUCTIONAL AND TEACHING MATERIAL EXCEPT APPARATUS, NAMELY, WORKBOOKS AND WORKSHEETS DIRECTED TO THE FIELDS OF BUSINESS MANAGEMENT, BUSINESS OUTSOURCING, TRAVEL AND ENTERTAINMENT; CARDBOARD, PAPER AND PLASTIC MATERIALS FOR PACKAGING INCLUDED IN THIS CLASS, NAMELY, BAGS, BUBBLE PACKS; PRINTERS' TYPE; PAPER FLAGS AND PENNANTS; BOOKBINDING MATERIAL, NAMELY, TAPE, WIRE, BOOKBINDS, BOOKBINDING

FOR: TRANSPORT AND STORAGE OF GOODS, NAMELY, DOCUMENTS, LUGGAGE, RAW MATERIALS, FURNITURE AND OTHER FREIGHT; TRANSPORT OF PERSONS AND GOODS, NAMELY, BY ROAD, RAIL, SEA AND AIR; PORTER SERVICES; GUARDED TRANSPORTATION OF MONEY AND VALUABLES BY TRUCK; TRAVEL ORGANIZATION, BOOKING AND ARRANGEMENT OF TRAVEL, EXCURSIONS AND CRUISES; ARRANGEMENT OF TRANSPORT SERVICES; RENTAL OF DEEP SEA DIVING SUITS; ORGANIZATION, BOOKING AND ARRANGEMENT OF EXCURSIONS, DAY TRIPS AND SIGHTSEEING TOURS; TRAVEL CONSULTANCY AND TOUR ESCORTING OF TRAVELLERS; RENTAL, BOOKING AND PROVIDING OF AIRCRAFT; RENTAL, BOOKING AND PROVIDING OF SHIPS, NAMELY, ROWING AND MOTOR BOATS, SAILING VESSELS AND CANOES, RENTAL, BOOKING AND PROVIDING OF MOTOR VEHICLES AND BICYCLES, HORSES; PACKAGING AND STORAGE OF GOODS; PARCEL DELIVERY; ORGANIZATION OF TRIPS, HOLIDAYS AND SIGHTSEEING TOURS; TRAVEL AGENCY SERVICES, IN PARTICULAR CONSULTANCY AND BOOKING SERVICES FOR TRAVEL; PROVIDING INFORMATION ABOUT TRAVEL, ARRANGEMENT OF TRANSPORT SERVICES AND TRAVEL; RESERVATION SERVICES FOR TRAVEL INCLUDED IN THIS CLASS; ONLINE TRAVEL AGENCIES, NAMELY, PROVIDING INFORMATION ABOUT TRAVEL ON THE INTERNET, NAMELY, ABOUT RESERVATION AND BOOKING IN THE TOURISM AND BUSINESS TRAVEL SECTOR (ONLINE TRAVEL AGENCIES); ALL THE

ABOVE SERVICES NAMELY, IN THE TRAVEL AND RECREATIONAL SECTOR; DELIVERY, DISPATCHING AND DISTRIBUTION OF NEWSPAPERS AND MAGAZINES; CONSULTATION PROVIDED BY TELEPHONE CALL CENTRES AND HOTLINES IN THE FIELD OF TOURISM, TRANSPORT AND STORAGE OF GOODS AND PASSENGERS; LOCATION OF PASSENGER VEHICLES BY COMPUTER; ALL AFOREMENTIONED SERVICES ONLY IN CONNECTION WITH CRUISES, IN CLASS 39 (U.S. CLS. 100 AND 105).

FOR: EDUCATION AND CONTINUOUS TRAINING IN THE FIELD OF MUSIC, ART AND CULTURE RENDERED THROUGH WORKSHOPS, SEMINARS AND CLASSES; EDUCATIONAL CONSULTANCY IN THE FIELD OF HIGHER EDUCATION ADMINISTRATION; TEACHING IN THE FIELD OF CORRESPONDENCE AND LANGUAGE COURSES; ENTERTAINMENT SERVICES, NAMELY, ENTERTAINMENT IN THE NATURE OF LIVE PERFORMANCES BY THEATER GROUPS, ETHNIC FESTIVALS, TOURIST AND CULTURE SHOWS, LIVE THEATRICAL PERFORMANCES, BASEBALL, FOOTBALL AND BASKETBALL GAMES; MOTION PICTURE FILM AND VIDEO FILM PRODUCTION, FILM AND VIDEO RENTAL, FILM AND VIDEO PERFORMANCES; ARTIST AGENCY SERVICES, NAMELY, BOOKING OF SEATS FOR SHOWS AND BOOKING OF THEATRE TICKETS; ENTERTAINMENT, NAMELY, MODELLING FOR ARTISTS; PRESENTATION OF MUSICAL PERFORMANCES; CIRCUS PERFORMANCES; PUBLIC ENTERTAINMENT IN THE NATURE OF TOURIST AND CULTURAL SHOWS; THEATRICAL PERFORMANCES; ORGANIZATION AND PROVIDING OF AN AFTER SCHOOL CHILDREN'S ENTERTAINMENT CENTRE FEATURING EDUCATIONAL ENTERTAINMENT; ENTERTAINMENT SERVICES, NAMELY HOLIDAY CAMP SERVICES; ARRANGING AND ADMINISTRATION OF TEACHING IN THE FIELD OF SPORTS, LANGUAGES, FILM AND MUSICAL PERFORMANCES; HEALTH CLUB SERVICES, NAMELY, PROVIDING EQUIPMENT AND INSTRUCTION IN THE FIELD OF PHYSICAL FITNESS INCLUDED IN THIS CLASS, PROVIDING TRAINING CLUBS AND FITNESS CLUBS, GOLF COURSES, TENNIS COURTS, RIDING FACILITIES, CINEMA THEATRE FACILITIES, DISCOTHEQUES, MUSEUM FACILITIES, AMUSEMENT ARCADES, SPORTS CAMPS AND SPORTS FACILITIES, AMUSEMENT PARKS; EDUCATIONAL SERVICES, NAMELY, PROVIDING COURSES OF INSTRUCTION AT THE KINDERGARTEN LEVEL; RENTAL OF SKIN DIVING EQUIPMENT; ORGANIZATION OF SPORTS COMPETITIONS; ORGANIZATION AND ARRANGEMENT OF CULTURAL AND SPORTING EVENTS; RESERVATION SERVICES INCLUDED IN THIS CLASS, NAMELY, ARRANGING FOR TICKET RESERVATIONS FOR SPORTING, SCIENTIFIC AND CULTURAL EVENTS; ENTERTAINMENT SERVICES, NAMELY, PROVIDING ONLINE COMPUTER GAMES; RENTAL OF RECORDED DATA CARRIERS FEATURING FILMS, MUSIC, AND GAMES, PROJECTOR APPARATUS AND THE ACCESSORIES THEREOF INCLUDED IN THIS CLASS; RENTAL OF NEWSPAPERS AND MAGA-

ZINES TO THE PUBLIC, PUBLICATION OF BOOKS, NEWSPAPERS, MAGAZINES AND OTHER PRINTED MATERIALS NAMELY, JOURNALS AND LEAFLETS; PUBLISHING AND ISSUING OF PRINTED MATTER, NAMELY, OF BOOKS, MAGAZINES, CATALOGUES AND NEWSPAPERS INCLUDING MULTIMEDIA PUBLISHING OF BOOKS, MAGAZINES, JOURNALS, SOFTWARE, GAMES, MUSIC, AND ELECTRONIC PUBLICATIONS; MULTIMEDIA ENTERTAINMENT SERVICES IN THE NATURE OF RECORDING OF DVDS AND CD-ROMS, VIDEO TAPING MOTION PICTURE AND MUSIC; ORGANIZATION OF EXHIBITIONS FOR CULTURAL AND TEACHING PURPOSES; SERVICES OF A RECREATION AND AMUSEMENT PARK IN THE EDUCATION AND ENTERTAINMENT SECTOR; SERVICES OF A LANGUAGE INTERPRETER AND OF A TRANSLATOR; PHOTOGRAPHY SERVICES; RADIO ENTERTAINMENT PRODUCTION, TELEVISION ENTERTAINMENT, NAMELY, PRODUCTION OF TELEVISION PROGRAMS; CONSULTATION SERVICES PROVIDED BY TELEPHONE CALL CENTRES AND HOTLINES IN THE FIELD OF EDUCATION AND ENTERTAINMENT; CONSULTATION PROVIDED BY TELEPHONE CALL CENTRES AND HOTLINES IN THE FIELD OF RESERVATION SERVICE FOR SPORTING, SCIENTIFIC AND CULTURAL EVENTS; PROVIDING INFORMATION ABOUT ENTERTAINMENT AND ENTERTAINMENT EVENTS VIA ONLINE NETWORK AND INTERNET; ALL AFOREMENTIONED SERVICES ONLY IN CONNECTION WITH CRUISES; RENTAL OF DIVING EQUIPMENT INCLUDED IN THIS CLASS, IN CLASS 41 (U.S. CLS. 100, 101 AND 107).

FOR: PROVIDING TEMPORARY ACCOMMODATION, PROVIDING OF FOOD AND DRINKS FOR GUESTS; ACCOMMODATION BUREAU SERVICES, NAMELY, RESERVATION SERVICES FOR TRAVELERS ROOM ACCOMMODATION VIA TRAVEL AGENCIES AND BROKERS; PROVIDING AND RENTAL OF HOLIDAY HOMES, HOLIDAY FLATS AND APARTMENTS; PROVIDING ROOM RESERVATION AND HOTEL RESERVATION SERVICES, PROVIDING HOTEL, BOARDING HOUSE AND MOTEL SERVICES; CATERING; SERVICES OF BOARDING HOUSES, HOTELS AND MOTELS; RENTAL OF MEETING ROOMS; PROVIDING OF FOOD AND DRINKS IN RESTAURANTS AND BARS; PROVIDING FOOD AND DRINKS IN INTERNET CAFES; CONSULTATION PROVIDED BY TELEPHONE CALL CENTRES AND HOTLINES IN THE FIELD OF TEMPORARY ROOM, BOARDING ACCOMMODATION AND ACCOMMODATION BUREAU SERVICES, PROVIDING AND RENTAL OF HOLIDAY HOMES, ACCOMMODATION SERVICE AND HOTEL RESERVATION AS WELL AS ACCOMMODATION AND CATERING FOR GUESTS; ALL AFOREMENTIONED SERVICES ONLY IN CONNECTION WITH CRUISES, IN CLASS 43 (U.S. CLS. 100 AND 101).

PRIORITY DATE OF 10-26-2006 IS CLAIMED.



OWNER OF INTERNATIONAL REGISTRATION  
0922767 DATED 2-2-2007, EXPIRES 2-2-2017.

THE COLOR(S) RED, BLUE IS/ARE CLAIMED AS  
A FEATURE OF THE MARK.

OWNER OF U.S. REG. NOS. 2,928,468, 2,975,052,  
AND 3,237,678.

THE COLOR RED APPEARS IN THE SMILING  
FACE DESIGN AND IN THE WORDING TUI,  
WHEREAS THE COLOR BLUE APPEARS IN THE  
WORDING CRUISES.

NO CLAIM IS MADE TO THE EXCLUSIVE  
RIGHT TO USE "CRUISES", APART FROM THE  
MARK AS SHOWN.

SER. NO. 79-037,988, FILED 2-2-2007.

DARRYL SPRUILL, EXAMINING ATTORNEY

**Int. Cls.: 3, 9 and 14**

**Prior U.S. Cls.: 1, 2, 4, 6, 21, 23, 26, 27, 28, 36, 38, 50,  
51 and 52**

**Reg. No. 3,395,159**

**United States Patent and Trademark Office**

**Registered Mar. 11, 2008**

**TRADEMARK  
PRINCIPAL REGISTER**

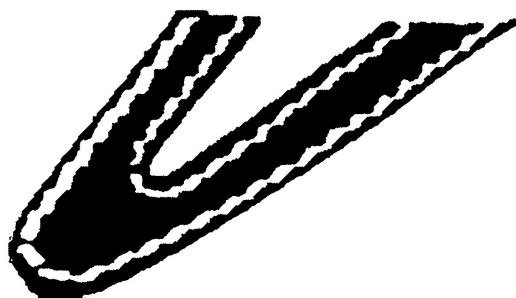

TRETORN AKTIEBOLAG (SWEDEN JOINT  
STOCK COMPANY)  
P.O. BOX 931  
SE-251 09 HELSINGBORG  
SWEDEN

FOR: BLEACHING PREPARATIONS FOR  
HOUSEHOLD USE AND LAUNDRY DETERGENTS;  
CLEANING, POLISHING, SCOURING AND ABRA-  
SIVE PREPARATIONS FOR HOUSEHOLD USE;  
SOAPS; PERFUMERY, ESSENTIAL OILS, COSMET-  
ICS, HAIR LOTIONS; DENTIFRICES, IN CLASS 3  
(U.S. CLS. 1, 4, 6, 50, 51 AND 52).

FOR: APPARATUS FOR RECORDING, TRANS-  
MISSION OR REPRODUCTION OF SOUND OR  
IMAGES; BLANK RECORD DISCS; AUTOMATIC  
VENDING MACHINES; CASH REGISTERS, CAL-  
CULATORS, COMPUTERS; FIRE-EXTINGUISH-  
ERS; EYEGLOSS CASES; EYEGLOSSSES; CONTACT  
LENSES; CONTAINERS FOR CONTACT LENSES;  
SUNGLASSES, AUTOMOBILE WINDSHIELD SUN-  
SHADES, CASES AND BAGS SUITED THEREFORE;

CLOTHING FOR PROTECTION AGAINST ACCI-  
DENTS, IRRADIATION AND FIRE; SHOES FOR  
PROTECTION AGAINST ACCIDENTS, IRRADIA-  
TION AND FIRE; FOOTWEAR FOR PROTECTION  
AGAINST ACCIDENTS, IRRADIATION AND FIRE,  
IN CLASS 9 (U.S. CLS. 21, 23, 26, 36 AND 38).

FOR: JEWELRY, PRECIOUS STONES; HOROLO-  
GICAL AND CHRONOMETRIC INSTRUMENTS, IN  
CLASS 14 (U.S. CLS. 2, 27, 28 AND 50).

PRIORITY DATE OF 8-18-2006 IS CLAIMED.

OWNER OF INTERNATIONAL REGISTRATION  
0923047 DATED 2-15-2007, EXPIRES 2-15-2017.

SER. NO. 79-038,097, FILED 2-15-2007.

ASMAT KHAN, EXAMINING ATTORNEY

**Int. Cls.: 3, 9 and 14**

**Prior U.S. Cls.: 1, 2, 4, 6, 21, 23, 26, 27, 28, 36, 38, 50,  
51 and 52**

**Reg. No. 3,395,160**

**United States Patent and Trademark Office**

**Registered Mar. 11, 2008**

**TRADEMARK  
PRINCIPAL REGISTER**

# TRETORN

TRETORN AKTIEBOLAG (SWEDEN JOINT  
STOCK COMPANY)  
P.O. BOX 931  
SE-251 09 HELSINGBORG  
SWEDEN

FOR: BLEACHING PREPARATIONS FOR  
HOUSEHOLD USE AND LAUNDRY DETERGENTS;  
CLEANING, POLISHING, SCOURING AND ABRA-  
SIVE PREPARATIONS FOR HOUSEHOLD USE;  
SOAPS; PERFUMERY, ESSENTIAL OILS, COSMET-  
ICS, HAIR LOTIONS; DENTIFRICES, IN CLASS 3  
(U.S. CLS. 1, 4, 6, 50, 51 AND 52).

FOR: APPARATUS FOR RECORDING, TRANS-  
MISSION OR REPRODUCTION OF SOUND OR  
IMAGES; BLANK RECORD DISCS; AUTOMATIC  
VENDING MACHINES; CASH REGISTERS, CAL-  
CULATORS, COMPUTERS; FIRE-EXTINGUISH-  
ERS; EYEGLOSS CASES; EYEGLOSSSES; CONTACT  
LENSES; CONTAINERS FOR CONTACT LENSES;  
SUNGLASSES, AUTOMOBILE WINDSHIELD SUN-  
SHADES, CASES AND BAGS SUITED THEREFOR;  
CLOTHING FOR PROTECTION AGAINST ACCI-  
DENTS, IRRADIATION AND FIRE; SHOES FOR

PROTECTION AGAINST ACCIDENTS, IRRADIA-  
TION AND FIRE; FOOTWEAR FOR PROTECTION  
AGAINST ACCIDENTS, IRRADIATION AND FIRE,  
IN CLASS 9 (U.S. CLS. 21, 23, 26, 36 AND 38).

FOR: JEWELRY, PRECIOUS STONES; HOROLO-  
GICAL AND CHRONOMETRIC INSTRUMENTS, IN  
CLASS 14 (U.S. CLS. 2, 27, 28 AND 50).

THE MARK CONSISTS OF STANDARD CHAR-  
ACTERS WITHOUT CLAIM TO ANY PARTICULAR  
FONT, STYLE, SIZE, OR COLOR.

PRIORITY DATE OF 8-18-2006 IS CLAIMED.

OWNER OF INTERNATIONAL REGISTRATION  
0923053 DATED 2-15-2007, EXPIRES 2-15-2017.

SER. NO. 79-038,099, FILED 2-15-2007.

ASMAT KHAN, EXAMINING ATTORNEY

**Int. Cl.: 10**

**Prior U.S. Cls.: 26, 39 and 44**

**United States Patent and Trademark Office**

**Reg. No. 3,395,161**

**Registered Mar. 11, 2008**

**TRADEMARK  
PRINCIPAL REGISTER**

**ORCELLEX**

ROVERS MEDICAL DEVICES B.V. (NETHERLANDS BESLOTEN VENNOOTSCHAP)

10, LEKSTRAAT

NL-5347 KV OSS

NETHERLANDS

FOR: SURGICAL, MEDICAL, DENTAL AND VETERINARY APPARATUS AND INSTRUMENTS, NAMELY, SAMPLING DEVICES WHICH ARE USED IN RELATION TO CYTOLOGICAL ANALYSIS, VIRAL, BACTERIOLOGICAL AND DNA TESTING, IN CLASS 10 (U.S. CLS. 26, 39 AND 44).

THE MARK CONSISTS OF STANDARD CHARACTERS WITHOUT CLAIM TO ANY PARTICULAR FONT, STYLE, SIZE, OR COLOR.

PRIORITY DATE OF 10-6-2006 IS CLAIMED.

OWNER OF INTERNATIONAL REGISTRATION 0923382 DATED 3-20-2007, EXPIRES 3-20-2017.

SER. NO. 79-038,208, FILED 3-20-2007.

KELLY MCCOY, EXAMINING ATTORNEY

**Int. Cls.: 7 and 12**

**Prior U.S. Cls.: 13, 19, 21, 23, 31, 34, 35 and 44**

**United States Patent and Trademark Office**

**Reg. No. 3,395,162**

**Registered Mar. 11, 2008**

**TRADEMARK  
PRINCIPAL REGISTER**

# WATER SNAKE

JARVIS WALKER PTY LTD; ACN 004 479 056  
(AUSTRALIA CORPORATION)  
297-305 SOUTH GIPPSLAND HIGHWAY  
DANDENONG SOUTH VIC 3175  
AUSTRALIA

FOR: MOTORS AND ENGINES FOR BOATS;  
INBOARD AND OUTBOARD ENGINES AND MO-  
TORS FOR BOATS; PARTS FOR MOTORS AND  
ENGINES FOR BOATS, NAMELY, PISTON RINGS,  
ENGINE CAMSHAFTS, AND CONNECTING RODS  
FOR MACHINES, MOTORS, AND ENGINES; BILGE  
PUMPS; WINCHES FOR BOATS; MOTORS AND  
ENGINES FOR BOATS, CANOES, DINGHIES, AND  
INFLATABLE WATER CRAFT, IN CLASS 7 (U.S.  
CLS. 13, 19, 21, 23, 31, 34 AND 35).

FOR: BOATS, YACHTS, CANOES, AND DINGH-  
IES; PERSONAL INFLATABLE AND COLLAPSIBLE  
WATERCRAFT, NAMELY, RAFTS; BOAT, CANOE,  
DINGHY, AND RAFT ACCESSORIES, NAMELY,  
CANVAS COVERS, ENCLOSURES AND WINDOWS  
SOLD AS A UNIT AND AFFIXED TO THE BOAT

FOR RECREATIONAL MARINE USE; SCREW-PRO-  
PELLERS; BOAT PARTS, NAMELY, STEERING  
GEARS AND SPARS; PROPULSION SYSTEMS FOR  
BOATS, CANOES, DINGHIES, AND RAFTS, NAME-  
LY, PROPELLERS, IN CLASS 12 (U.S. CLS. 19, 21, 23,  
31, 35 AND 44).

THE MARK CONSISTS OF STANDARD CHAR-  
ACTERS WITHOUT CLAIM TO ANY PARTICULAR  
FONT, STYLE, SIZE, OR COLOR.

PRIORITY DATE OF 2-15-2007 IS CLAIMED.

OWNER OF INTERNATIONAL REGISTRATION  
0923714 DATED 2-19-2007, EXPIRES 2-19-2017.

SER. NO. 79-038,326, FILED 2-19-2007.

JASON BLAIR, EXAMINING ATTORNEY

**Int. Cls.: 6 and 9**

**Prior U.S. Cls.: 2, 12, 13, 14, 21, 23, 25, 26, 36, 38 and 50**

**Reg. No. 3,395,163**

**United States Patent and Trademark Office**

**Registered Mar. 11, 2008**

**TRADEMARK  
PRINCIPAL REGISTER**

# **REVO.torch**

DINSE GMBH (FED REP GERMANY COMPANY  
WITH LIMITED LIABILITY)  
TARPEN 36  
22419 HAMBURG, FED REP GERMANY

FOR: METAL TOOL HOLDERS, NAMELY, METAL MAGAZINES FOR HOLDING AND CHANGING ROBOT WELDING TOOLS, IN CLASS 6 (U.S. CLS. 2, 12, 13, 14, 23, 25 AND 50).

FOR: WELDING APPARATUS, NAMELY, ELECTRIC ARC WELDERS AND WELDING TORCHES, AND STRUCTURAL PARTS THEREFORE; CUTTING APPARATUS, NAMELY, ELECTRIC WELDING TORCHES AND STRUCTURAL PARTS THEREFORE; WELDING AND CUTTING TOOLS, NAMELY, ELECTRIC BRAZING APPARATUS, ELECTRIC WELDING TORCHES, WELDING TONGS, NAMELY, ELECTRIC IGNITERS FOR WELDING TORCHES, WELDING CABLE COUPLINGS THAT ARE STRUCTURAL PARTS OF WELDING TORCHES, HAND SCREW CRAMPS THAT ARE STRUCTURAL PARTS OF ELECTRIC WELDING TORCHES, POLE MAGNETS, INERT GAS SHIELDED LASER WELDING GUNS, COMPACT BUSHINGS THAT ARE STRUCTURAL

PARTS OF WELDING TORCHES, PLASMA WELDING GUNS, SAFETY CUT-OUT SWITCHES, WELDING TORCH HOLDERS, HOLDERS FOR WELDING TORCH SUPPLY LINES AND WIRE DRIVES; ELECTRONIC TESTING APPARATUS FOR AUTOMATIC WELDING GUNS FOR TESTING PRESSURE TIGHTNESS OR GAS FLOW RATES; WIRE FEEDING APPARATUS BEING STRUCTURAL PARTS FOR THE AFORESAID WELDING DEVICES, NAMELY, ELECTRICALLY OPERATED MACHINES FOR FEEDING METAL WELDING OR BRAZING WIRE OR WELDING OR BRAZING ROD INTO A WELDING TORCH WHICH ARE STRUCTURAL PARTS OF ELECTRIC ARC WELDERS AND ELECTRIC WELDING TORCHES, IN CLASS 9 (U.S. CLS. 21, 23, 26, 36 AND 38).

OWNER OF INTERNATIONAL REGISTRATION  
0923877 DATED 2-28-2007, EXPIRES 2-28-2017.

SER. NO. 79-038,381, FILED 2-28-2007.

MICHAEL TANNER, EXAMINING ATTORNEY

**Int. Cl.: 29**

**Prior U.S. Cl.: 46**

**United States Patent and Trademark Office**

**Reg. No. 3,395,164**

**Registered Mar. 11, 2008**

**TRADEMARK  
PRINCIPAL REGISTER**

**AKADIA**

NORDEX HOLDING A/S (DENMARK LIMITED  
LIABILITY COMPANY)  
BLYTÆKKERVEJ 6  
DK-9330 DRONNINGLUND, DENMARK

OWNER OF INTERNATIONAL REGISTRATION  
0661459 DATED 9-17-1996, EXPIRES 9-17-2016.

FOR: FOOD CONSISTING OF MIXED VEGETA-  
BLE SALADS; MILK AND DAIRY PRODUCTS,  
NAMELY, CHEESE, IN CLASS 29 (U.S. CL. 46).

SER. NO. 79-038,562, FILED 5-7-2007.

THE MARK CONSISTS OF STANDARD CHAR-  
ACTERS WITHOUT CLAIM TO ANY PARTICULAR  
FONT, STYLE, SIZE, OR COLOR.

DOMINIC FATHY, EXAMINING ATTORNEY

**Int. Cls.: 9 and 39**

**Prior U.S. Cls.: 21, 23, 26, 36, 38, 100 and 105**

**United States Patent and Trademark Office**

**Reg. No. 3,395,165**

**Registered Mar. 11, 2008**

**TRADEMARK  
SERVICE MARK  
PRINCIPAL REGISTER**



CORPORACIÓN EUROPEA; DE MOBILIARIO  
URBANO, S.A. (SPAIN SOCIEDAD ANÓNIMA)  
FRANCISCO SANCHA, 24  
E-28034 MADRID, SPAIN

FOR: AUTOMATIC VENDING MACHINES AND  
MECHANISMS FOR COIN OPERATED APPARA-  
TUS, IN CLASS 9 (U.S. CLS. 21, 23, 26, 36 AND 38).

FOR: SERVICES OF RENTAL OF VEHICLES AND  
PARKING SPACES, IN PARTICULAR FOR BI-  
CYCLES, IN CLASS 39 (U.S. CLS. 100 AND 105).

PRIORITY DATE OF 1-15-2007 IS CLAIMED.

OWNER OF INTERNATIONAL REGISTRATION  
0924788 DATED 3-28-2007, EXPIRES 3-28-2017.

NO CLAIM IS MADE TO THE EXCLUSIVE  
RIGHT TO USE CYCLES, APART FROM THE  
MARK AS SHOWN.

THE COLOR(S) GRAY AND RED IS/ARE  
CLAIMED AS A FEATURE OF THE MARK.

THE MARK CONSISTS OF THE WORDING C  
AND CYCLES IN GRAY. THE C SHAPE HAS A RED  
HORIZONTAL LINE IN THE MIDDLE.

SER. NO. 79-038,708, FILED 3-28-2007.

TARAH HARDY, EXAMINING ATTORNEY



**Int. Cls.: 9 and 39**

**Prior U.S. Cls.: 21, 23, 26, 36, 38, 100 and 105**

**United States Patent and Trademark Office**

**Reg. No. 3,395,166**

**Registered Mar. 11, 2008**

**TRADEMARK  
SERVICE MARK  
PRINCIPAL REGISTER**



CORPORACIÓN EUROPEA; DE MOBILIARIO  
URBANO, S.A. (SPAIN SOCIEDAD ANONIMA)  
FRANCISCO SANCHA, 24  
E-28034 MADRID  
SPAIN

FOR: AUTOMATIC VENDING MACHINES AND  
MECHANISMS FOR COIN OPERATED APPARA-  
TUS, IN CLASS 9 (U.S. CLS. 21, 23, 26, 36 AND 38).

FOR: RENTAL SERVICES FOR VEHICLES AND  
PARKING SPACES, IN PARTICULAR FOR BI-  
CYCLES, IN CLASS 39 (U.S. CLS. 100 AND 105).

PRIORITY DATE OF 1-15-2007 IS CLAIMED.

OWNER OF INTERNATIONAL REGISTRATION  
0924789 DATED 3-28-2007, EXPIRES 3-28-2017.

THE COLOR(S) GRAY AND RED IS/ARE  
CLAIMED AS A FEATURE OF THE MARK.

THE MARK CONSISTS OF A RED BICYCLE  
WITH A GREY SEMI-CIRCLE CONTAINING A  
RED HORIZONTAL LINE.

SER. NO. 79-038,709, FILED 3-28-2007.

TARAH HARDY, EXAMINING ATTORNEY

**Int. Cl.: 34**

**Prior U.S. Cls.: 2, 8, 9 and 17**

**United States Patent and Trademark Office**

**Reg. No. 3,395,167**

**Registered Mar. 11, 2008**

**TRADEMARK  
PRINCIPAL REGISTER**

# Liga Centro Americana

CHARLES FAIRMORN INTERNATIONAL  
GMBH (FED REP GERMANY LTD LIAB CO)  
DRECHSLERSTR. 1-3  
23556 LÜBECK, FED REP GERMANY

FOR: TOBACCO; CIGARETTES, CIGARS, CIGAR-  
ILLOS, SMOKING-TOBACCO, IN CLASS 34 (U.S.  
CLS. 2, 8, 9 AND 17).

THE MARK CONSISTS OF STANDARD CHAR-  
ACTERS WITHOUT CLAIM TO ANY PARTICULAR  
FONT, STYLE, SIZE, OR COLOR.

OWNER OF INTERNATIONAL REGISTRATION  
0924834 DATED 4-18-2007, EXPIRES 4-18-2017.

NO CLAIM IS MADE TO THE EXCLUSIVE  
RIGHT TO USE "CENTRO AMERICANA", APART  
FROM THE MARK AS SHOWN.

THE ENGLISH TRANSLATION OF THE FOR-  
EIGN WORD(S) IN THE MARK IS CENTRAL  
AMERICAN LEAGUE.

SER. NO. 79-038,734, FILED 4-18-2007.

DAYNA BROWNE, EXAMINING ATTORNEY

**Int. Cl.: 15**

**Prior U.S. Cls.: 2, 21 and 36**

**United States Patent and Trademark Office**

**Reg. No. 3,395,168**

**Registered Mar. 11, 2008**

**TRADEMARK  
PRINCIPAL REGISTER**

**CONDE HERMANOS**

CONDE CAVIA, FELIPE (SPAIN INDIVIDUAL)  
CALLE FELIPE V, Nº 2  
E-28013 MADRID, SPAIN AND  
CONDE CAVIA, MARIANO FÉLIX (SPAIN INDIVIDUAL)  
CALLE FELIPE V, Nº 2  
E-28013 MADRID, SPAIN

FOR STRINGED MUSICAL INSTRUMENTS, IN  
CLASS 15 (U.S. CLS. 2, 21 AND 36).

OWNER OF INTERNATIONAL REGISTRATION  
0925060 DATED 12-14-2006, EXPIRES 12-14-2016.

THE ENGLISH TRANSLATION OF CONDE HERMANOS IS CONDE BROTHERS.

SER. NO. 79-038,823, FILED 12-14-2006.

DEBRA LEE, EXAMINING ATTORNEY

FOR: MUSICAL INSTRUMENTS, SUCH AS GUITARS; STRINGS FOR WESTERN MUSICAL INSTRUMENTS, ACCESSORIES FOR MUSICAL INSTRUMENTS, NAMELY, TUNERS, APPARATUS FOR TUNING MUSICAL INSTRUMENTS, PICKS

**Int. Cls.: 11 and 21**

**Prior U.S. Cls.: 2, 13, 21, 23, 29, 30, 31, 33, 34, 40 and 50**

**United States Patent and Trademark Office**

**Reg. No. 3,395,169**

**Registered Mar. 11, 2008**

**TRADEMARK  
PRINCIPAL REGISTER**



PUNTOSHOP S.P.A. (SAN MARINO LTD LIAB  
CO)  
STRADA BORRANA 32/A  
SERRAVALLE  
SAN MARINO

FOR: BROOMS AND BRUSHES FOR DOMESTIC  
WASHING, CLEANING AND HYGIENIZING USE,  
IN CLASS 21 (U.S. CLS. 2, 13, 23, 29, 30, 33, 40 AND 50).

OWNER OF INTERNATIONAL REGISTRATION  
0925061 DATED 3-14-2007, EXPIRES 3-14-2017.

FOR: STEAM GENERATORS FOR DOMESTIC  
CLEANING USE, IN CLASS 11 (U.S. CLS. 13, 21, 23, 31  
AND 34).

SER. NO. 79-038,824, FILED 3-14-2007.

JOHN E. MICHOS, EXAMINING ATTORNEY

**Int. Cl.: 36**

**Prior U.S. Cls.: 100, 101 and 102**

**United States Patent and Trademark Office**

**Reg. No. 3,395,170**

**Registered Mar. 11, 2008**

**SERVICE MARK  
PRINCIPAL REGISTER**

**TAI KANG**

TAIKANG LIFE INSURANCE CO., LTD.  
8TH FLOOR, BUILDING B,  
NO. 156 FU XING MEN NEI STREET100031 XI-  
CHENG DISTRICT, BEIJING  
CHINA

FOR: ACTUARIAL SERVICES; INSURANCE  
BROKERAGE; FUND INVESTMENTS; LIFE INSUR-  
ANCE UNDERWRITING; INSURANCE CONSUL-  
TANCY; INSURANCE INFORMATION;  
TRUSTEESHIP SERVICES; FACTORING SERVICES;  
INSTALLMENT LOANS; MARINE INSURANCE  
UNDERWRITING; LOAN FINANCING; FINAN-  
CIAL MANAGEMENT; FINANCIAL CONSULTAN-

CY; RENTING OF APARTMENTS; LEASING OF  
REAL ESTATE; SECURITIES BROKERAGE, IN  
CLASS 36 (U.S. CLS. 100, 101 AND 102).

OWNER OF INTERNATIONAL REGISTRATION  
0925491 DATED 5-8-2007, EXPIRES 5-8-2017.

THE ENGLISH TRANSLATION OF THE WORD-  
ING TAI KANG IN THE MARK IS PEACE HEALTH.

SER. NO. 79-039,012, FILED 5-8-2007.

DANIEL CAPSHAW, EXAMINING ATTORNEY

**Int. Cl.: 36**

**Prior U.S. Cls.: 100, 101 and 102**

**United States Patent and Trademark Office**

**Reg. No. 3,395,171**

**Registered Mar. 11, 2008**

**SERVICE MARK  
PRINCIPAL REGISTER**



TAIKANG LIFE INSURANCE CO., LTD.  
8TH FLOOR, BUILDING B,  
NO. 156 FU XING MEN NEI STREET100031 XI-  
CHENG DISTRICT, BEIJING  
CHINA

FOR: ACTUARIAL SERVICES; INSURANCE  
BROKERAGE; FUND INVESTMENTS; LIFE INSUR-  
ANCE UNDERWRITING; INSURANCE CONSUL-  
TANCY; INSURANCE INFORMATION;  
TRUSTEESHIP SERVICES; FACTORING SERVICES;  
INSTALLMENT LOANS; MARINE INSURANCE  
UNDERWRITING; LOAN FINANCING; FINAN-  
CIAL MANAGEMENT; FINANCIAL CONSULTAN-  
CY; RENTING OF APARTMENTS; LEASING OF

REAL ESTATE; SECURITIES BROKERAGE, IN  
CLASS 36 (U.S. CLS. 100, 101 AND 102).

OWNER OF INTERNATIONAL REGISTRATION  
0926958 DATED 5-8-2007, EXPIRES 5-8-2017.

THE NON-LATIN CHARACTER(S) IN THE  
MARK TRANSLITERATES INTO TAI KANG, AND  
THIS MEANS PEACE AND HEALTH IN ENGLISH.

SER. NO. 79-039,618, FILED 5-8-2007.

DANIEL CAPSHAW, EXAMINING ATTORNEY

**Int. Cls.: 7, 9 and 42**

**Prior U.S. Cls.: 13, 19, 21, 23, 26, 31, 34, 35, 36, 38, 100  
and 101**

**Reg. No. 3,395,172**

**United States Patent and Trademark Office**

**Registered Mar. 11, 2008**

**TRADEMARK  
SERVICE MARK  
PRINCIPAL REGISTER**



FRONIUS INTERNATIONAL GMBH (AUSTRIA  
PRIVATE LIMITED COMPANY)  
VORCHDORFER STRASSE 40  
A-4643 PETTENBACH  
AUSTRIA

FOR: NON-ELECTRIC WELDING AND CUTTING APPARATUS, NAMELY, GAS-WELDING MACHINES, LASER WELDING MACHINES, IN CLASS 7 (U.S. CLS. 13, 19, 21, 23, 31, 34 AND 35).

FOR: CHARGING APPARATUS FOR ACCUMULATORS, NAMELY, CHARGING APPLIANCES FOR RECHARGEABLE EQUIPMENT; ARC AND LASER-WELDING APPARATUS FOR NON-MEDICAL USE, NAMELY, LASER-WELDING DEVICES; ELECTRICAL WELDING APPLIANCES, ELECTRIC CUTTING TORCHES AND ARC-WELDING APPARATUS, NAMELY, ELECTRICALLY POWERED WELDING TORCHES; WELDING ELECTRODES; ELECTRICAL POWER SUPPLIES AND VOLTAGE STABILIZING POWER SUPPLIES, NAMELY, CURRENT SOURCES, REVERSE CURRENT SOURCES, FREQUENCY CHANGERS AND CURRENT SOURCES FOR PLASMA-ARC-WELDING; TRANSFORMERS; PHOTOVOLTAIC INSTALLATIONS, NAMELY, PHOTOVOLTAIC CELLS AND INVERTERS OR CONVERTERS FOR PHOTOVOLTAIC SYSTEMS; COMPUTER SOFTWARE ON DATA MEDIA FOR CONTROLLING, REGULATING, SU-

PERVISING AND ANALYZING OF DATA ON WELDING AND CUTTING PROCESSES AND CHARGING PROCESSES IN THIS FIELD, IN CLASS 9 (U.S. CLS. 21, 23, 26, 36 AND 38).

FOR: PROFESSIONAL SCIENTIFIC AND TECHNICAL CONSULTING AND RESEARCH AND DEVELOPMENT REGARDING AVAILABLE TECHNOLOGICAL ADVANCES IN THE FIELDS OF ELECTRICAL CURRENT SOURCES, WELDING APPARATUS, APPLIANCES AND CONTROLS AND ELECTRONIC SYSTEMS FOR CURRENT SOURCES AND WELDING APPARATUS; DEVELOPMENT OF COMPUTER SOFTWARE, NAMELY, FOR CONTROLLING WELDING APPARATUS QUALITY ASSURANCE AND FOR ADMINISTRATION OF ORDERS; RESEARCH AND DEVELOPMENT IN THE FIELDS OF NEW WELDING PROCEDURES AND NEW ADDITIVE MATERIALS FOR SUCH PROCEDURES, IN CLASS 42 (U.S. CLS. 100 AND 101).

OWNER OF INTERNATIONAL REGISTRATION  
0926991 DATED 2-9-2007, EXPIRES 2-9-2017.

SER. NO. 79-039,629, FILED 2-9-2007.

KRISTIN DAHLING, EXAMINING ATTORNEY

Int. Cl.: 21

Prior U.S. Cls.: 2, 13, 23, 29, 30, 33, 40 and 50

United States Patent and Trademark Office

Reg. No. 3,395,173

Registered Mar. 11, 2008

TRADEMARK  
PRINCIPAL REGISTER



SÄCHSISCHE PORZELLAN-MANUFAKTUR;  
DRESDEN GMBH & CO KG (FED REP GER-  
MANY GMBH)  
16, BACHSTRASSE  
01705 FREITAL, FED REP GERMANY

OWNER OF INTERNATIONAL REGISTRATION  
0927600 DATED 5-3-2007, EXPIRES 5-3-2017.

FOR: WHITE AND DECORATED PORCELAIN,  
NAMELY, BOXES OF PORCELAIN, BASKETS OF  
PORCELAIN, CANDLESTICKS, DINNERWARE,  
BOWLS, VASES, FIGURES OF PORCELAIN, FIG-  
URINES OF PORCELAIN, ORNAMENTS OF POR-  
CELAIN NOT BEING CHRISTMAS TREE  
ORNAMENTS, WALL PLAQUES OF PORCELAIN,  
AND FLOWER POTS, IN CLASS 21 (U.S. CLS. 2, 13,  
23, 29, 30, 33, 40 AND 50).

NO CLAIM IS MADE TO THE EXCLUSIVE  
RIGHT TO USE "DRESDEN", APART FROM THE  
MARK AS SHOWN.

SER. NO. 79-039,840, FILED 5-3-2007.

ZHALEH DELANEY, EXAMINING ATTORNEY



**Int. Cls.: 9 and 42**

**Prior U.S. Cls.: 21, 23, 26, 36, 38, 100 and 101**

**United States Patent and Trademark Office**

**Reg. No. 3,395,174**

**Registered Mar. 11, 2008**

**TRADEMARK  
SERVICE MARK  
PRINCIPAL REGISTER**

**TAIVAL**

BALLERINI MARIO (ITALY INDIVIDUAL)  
VIA NAVIGA, 7  
I-21102 CASCIAGO (VA), ITALY

FOR: DATA PROCESSING COMPUTER PROGRAMS FOR ADMINISTRATION AND MANAGEMENT OF COMPUTER DATA, IN CLASS 9 (U.S. CLS. 21, 23, 26, 36 AND 38).

FOR: DESIGN, DEVELOPMENT AND IMPLEMENTATION OF COMPUTER SOFTWARE PROGRAMS FOR DATA MANAGEMENT; COMPUTER SOFTWARE CONSULTANCY; MAINTENANCE OF COMPUTER SOFTWARE; TECHNICAL SUPPORT SERVICES, NAMELY, TROUBLESHOOTING OF COMPUTER SOFTWARE PROBLEMS, IN CLASS 42 (U.S. CLS. 100 AND 101).

THE MARK CONSISTS OF STANDARD CHARACTERS WITHOUT CLAIM TO ANY PARTICULAR FONT, STYLE, SIZE, OR COLOR.

PRIORITY DATE OF 11-14-2006 IS CLAIMED.

OWNER OF INTERNATIONAL REGISTRATION 0929286 DATED 5-14-2007, EXPIRES 5-14-2017.

SER. NO. 79-040,454, FILED 5-14-2007.

EVELYN BRADLEY, EXAMINING ATTORNEY

**Int. Cl.: 20**

**Prior U.S. Cls.: 2, 13, 22, 25, 32 and 50**

**United States Patent and Trademark Office**

**Reg. No. 3,395,175**

**Registered Mar. 11, 2008**

**TRADEMARK  
PRINCIPAL REGISTER**



SEGIS - SPA; SOCIETÀ UNIPERSONALE (ITALY  
JOINT STOCK COMPANY)  
VIA UMBRIA 14  
LOC. FOSCI; I-53036 POGGIBONSI (SI), ITALY

FOR: ARMCHAIRS; BEDS; FURNITURE  
BENCHES; FURNITURE BOOK RESTS; FURNI-  
TURE INDEX CABINETS; FURNITURE CARTS  
FOR COMPUTERS; CHAIRS; FURNITURE PARTS,  
NAMESLY, COUNTERS AND COUNTER TOPS;  
DECK CHAIRS; DESKS; EASY CHAIRS; FURNI-  
TURE FLOWER STANDS; FURNITURE; FURNI-  
TURE OF METAL; OFFICE FURNITURE;  
FURNITURE SHELVES; SCHOOL FURNITURE;  
FURNITURE SCREENS; SEATS; SEATS OF METAL;  
FURNITURE SHELVES FOR FILING CABINETS;  
SHELVES FOR STORAGE; SOFAS; STOOLS; FUR-  
NITURE PARTS, NAMESLY, TABLE TOPS; TABLES;

TABLES OF METAL; FURNITURE TROLLEYS FOR  
COMPUTERS; FURNITURE TROLLEYS, NAMESLY,  
FOOD TROLLEYS; UMBRELLA STANDS, IN CLASS  
20 (U.S. CLS. 2, 13, 22, 25, 32 AND 50).

PRIORITY DATE OF 12-21-2006 IS CLAIMED.

OWNER OF INTERNATIONAL REGISTRATION  
0929310 DATED 5-15-2007, EXPIRES 5-15-2017.

OWNER OF U.S. REG. NO. 3,194,451.

SER. NO. 79-040,462, FILED 5-15-2007.

KIM SAITO, EXAMINING ATTORNEY

**Int. Cl.: 6**

**Prior U.S. Cls.: 2, 12, 13, 14, 23, 25 and 50**

**United States Patent and Trademark Office**

**Reg. No. 3,395,176**

**Registered Mar. 11, 2008**

**TRADEMARK  
PRINCIPAL REGISTER**



NORTHEAST LIGHT ALLOY CO., LTD. (CHINA CORPORATION)  
NO. 11, XINJIANG THIRD STREET  
PINGFANG DISTRICT; HARBIN  
HEILONGJIANG, CHINA

FOR: ALUMINUM AND ALUMINUM ALLOY WROUGHT MATERIALS, NAMELY, ALUMINUM ALLOY PLATES, SHEETS AND STRIPS; ALUMINUM ALLOY BARS, RODS AND PROFILES; ALUMINUM ALLOY TUBES AND PIPES; ALUMINUM ALLOY WIRES; ALUMINUM POWDERS AND FLAKES; ALUMINUM FOIL; ALUMINUM COIL SHEETS; ALUMINUM STRUCTURES, NAMELY, ALUMINUM SHELTER STRUCTURES, IN CLASS 6 (U.S. CLS. 2, 12, 13, 14, 23, 25 AND 50).

OWNER OF INTERNATIONAL REGISTRATION  
0929564 DATED 4-28-2007, EXPIRES 4-28-2017.

THE TRADEMARK CONSISTS OF TWO CHINESE CHARACTERS, LATIN CHARACTERS DONGBEIQINGHEJIN AND A DEVICE.

THE ENGLISH TRANSLATION OF THE FOREIGN WORDS IN THE MARK IS SWAN.

THE TRANSLITERATION OF THE NON-LATIN CHARACTERS IN THE MARK IS TIAN E AND THIS MEANS SWAN IN ENGLISH.

SER. NO. 79-040,551, FILED 4-28-2007.

MARGERY A. TIERNEY, EXAMINING ATTORNEY

**Int. Cl.: 20**

**Prior U.S. Cls.: 2, 13, 22, 25, 32 and 50**

**United States Patent and Trademark Office**

**Reg. No. 3,395,177**

**Registered Mar. 11, 2008**

**TRADEMARK  
PRINCIPAL REGISTER**



SEGIS - SPA; SOCIETÀ UNIPERSONALE (ITALY  
JOINT STOCK COMPANY)  
VIA UMBRIA 14  
LOC. FOSCI; I-53036 POGGIBONSI (SI), ITALY

FOR: ARMCHAIRS; BEDS; FURNITURE  
BENCHES; FURNITURE BOOK RESTS; FURNI-  
TURE INDEX CABINETS; FURNITURE CARTS  
FOR COMPUTERS; CHAIRS; FURNITURE PARTS,  
NAMELY, COUNTERS AND COUNTER TOPS;  
DECK CHAIRS; DESKS; EASY CHAIRS; FURNI-  
TURE FLOWER STANDS; FURNITURE; FURNI-  
TURE OF METAL; OFFICE FURNITURE;  
FURNITURE SHELVES; SCHOOL FURNITURE;  
FURNITURE SCREENS; SEATS; SEATS OF METAL;  
FURNITURE SHELVES FOR FILING CABINETS;  
SHELVES FOR STORAGE; SOFAS; STOOLS; FUR-  
NITURE PARTS, NAMELY, TABLE TOPS; TABLES;  
TABLES OF METAL; FURNITURE TROLLEYS FOR  
COMPUTERS; FURNITURE TROLLEYS, NAMELY,  
FOOD TROLLEYS; UMBRELLA STANDS, IN CLASS  
20 (U.S. CLS. 2, 13, 22, 25, 32 AND 50).

PRIORITY DATE OF 12-21-2006 IS CLAIMED.

OWNER OF INTERNATIONAL REGISTRATION  
0930026 DATED 5-15-2007, EXPIRES 5-15-2017.

THE COLOR(S) RED, BLUE AND GREEN IS/ARE  
CLAIMED AS A FEATURE OF THE MARK.

THE CIRCLE ON THE LEFT IS RED, THE CIRCLE  
IN THE MIDDLE IS BLUE AND THE CIRCLE ON  
THE RIGHT IS GREEN.

SER. NO. 79-040,758, FILED 5-15-2007.

KIM SAITO, EXAMINING ATTORNEY

**Int. Cl.: 20**

**Prior U.S. Cls.: 2, 13, 22, 25, 32 and 50**

**United States Patent and Trademark Office**

**Reg. No. 3,395,178**

**Registered Mar. 11, 2008**

**TRADEMARK  
PRINCIPAL REGISTER**



SEGIS - SPA; SOCIETÀ UNIPERSONALE (ITALY  
JOINT STOCK COMPANY)  
VIA UMBRIA 14  
LOC. FOSCI; I-53036 POGGIBONSI (SI), ITALY

FOR: ARMCHAIRS; BEDS; FURNITURE  
BENCHES; FURNITURE BOOK RESTS; FURNI-  
TURE INDEX CABINETS; FURNITURE CARTS  
FOR COMPUTERS; CHAIRS; FURNITURE PARTS,  
NAMELY, COUNTERS AND COUNTER TOPS;  
DECK CHAIRS; DESKS; EASY CHAIRS; FURNI-  
TURE FLOWER STANDS; FURNITURE; FURNI-  
TURE OF METAL; OFFICE FURNITURE;  
FURNITURE SHELVES; SCHOOL FURNITURE;  
FURNITURE SCREENS; SEATS; SEATS OF METAL;  
FURNITURE SHELVES FOR FILING-CABINETS;  
SHELVES FOR STORAGE; SOFAS; STOOLS; FUR-  
NITURE PARTS, NAMELY, TABLE TOPS; TABLES;  
TABLES OF METAL; FURNITURE TROLLEYS FOR  
COMPUTERS; FURNITURE TROLLEYS, NAMELY,  
FOOD TROLLEYS; UMBRELLA STANDS, IN CLASS  
20 (U.S. CLS. 2, 13, 22, 25, 32 AND 50).

PRIORITY DATE OF 12-20-2006 IS CLAIMED.

OWNER OF INTERNATIONAL REGISTRATION  
0930027 DATED 5-15-2007, EXPIRES 5-15-2017.

OWNER OF U.S. REG. NO. 3,194,451.

THE COLOR(S) RED, BLUE, GREEN AND WHITE  
IS/ARE CLAIMED AS A FEATURE OF THE MARK.

THE CIRCLE ON THE LEFT IS RED, THE CIRCLE  
IN THE MIDDLE IS BLUE AND THE CIRCLE ON  
THE RIGHT IS GREEN. ALL THE WRITING IS  
WHITE.

SER. NO. 79-040,759, FILED 5-15-2007.

KIM SAITO, EXAMINING ATTORNEY

**Int. Cl.: 37**

**Prior U.S. Cls.: 100, 103 and 106**

**United States Patent and Trademark Office**

**Reg. No. 3,395,179**

**Registered Mar. 11, 2008**

**SERVICE MARK  
PRINCIPAL REGISTER**

# HEINEN & HOPMAN

HEINEN & HOPMAN ENGINEERING B.V.  
(NETHERLANDS B.V.)  
ZUIDWENK 45  
NL-3751 CB BUNSCHOTEN SPAKENBURG  
NETHERLANDS

PRIORITY DATE OF 4-3-2007 IS CLAIMED.

FOR: CONSTRUCTION, MAINTENANCE, INSTALLATION AND REPAIR OF HEATING, VENTILATING, COOLING, SANITARY AND FIRE PROTECTION INSTALLATIONS , IN CLASS 37 (U.S. CLS. 100, 103 AND 106).

OWNER OF INTERNATIONAL REGISTRATION  
0930294 DATED 7-4-2007, EXPIRES 7-4-2017.

SER. NO. 79-040,852, FILED 7-4-2007.

THE MARK CONSISTS OF STANDARD CHARACTERS WITHOUT CLAIM TO ANY PARTICULAR FONT, STYLE, SIZE, OR COLOR.

CARYN GLASSER, EXAMINING ATTORNEY

**Int. Cls.: 9 and 42**

**Prior U.S. Cls.: 21, 23, 26, 36, 38, 100 and 101**

**United States Patent and Trademark Office**

**Reg. No. 3,395,180**

**Registered Mar. 11, 2008**

**TRADEMARK  
SERVICE MARK  
PRINCIPAL REGISTER**



GMC SOFTWARE AG (SWITZERLAND CORPORATION)  
HIRSCHENGASSE 12  
CH-9050 APPENZELL, SWITZERLAND

FOR: SOFTWARE FOR PERSONALIZING ELECTRONIC COMMUNICATION SYSTEMS AND DIGITAL PRINTING SYSTEMS, IN CLASS 9 (U.S. CLS. 21, 23, 26, 36 AND 38).

FOR: DEVELOPMENT, DESIGN AND MAINTENANCE OF SOFTWARE FOR PERSONALIZED COMMUNICATION SYSTEMS AND DIGITAL PRINTING SYSTEMS, AND CONSULTING ON SOFTWARE MIGRATION, SOFTWARE INTEGRATION AND SOFTWARE INSTALLATION, IN CLASS 42 (U.S. CLS. 100 AND 101).

PRIORITY DATE OF 1-23-2007 IS CLAIMED.

OWNER OF INTERNATIONAL REGISTRATION 0930426 DATED 4-17-2007, EXPIRES 4-17-2017.

NO CLAIM IS MADE TO THE EXCLUSIVE RIGHT TO USE "SOFTWARE TECHNOLOGY", APART FROM THE MARK AS SHOWN.

SER. NO. 79-040,976, FILED 4-17-2007.

DEBRA LEE, EXAMINING ATTORNEY

**Int. Cls.: 2, 7, 9 and 16**

**Prior U.S. Cls.: 2, 5, 6, 11, 13, 16, 19, 21, 22, 23, 26, 29,  
31, 34, 35, 36, 37, 38 and 50**

**Reg. No. 3,395,181**

**United States Patent and Trademark Office**

**Registered Mar. 11, 2008**

**TRADEMARK  
PRINCIPAL REGISTER**

# HIPRINT

MAN ROLAND DRUCKMASCHINEN AG (FED  
REP GERMANY CORPORATION)  
MÜHLHEIMER STR. 341  
63075 OFFENBACH/MAIN, FED REP GERMANY

FOR: RAW NATURAL RESINS AND LACQUERS  
FOR INDUSTRIAL PURPOSES , IN CLASS 2 (U.S.  
CLS. 6, 11 AND 16).

FOR: INDUSTRIAL PRINTING MACHINES AND  
HOUSINGS THEREFOR; CYLINDERS AND ROLLS  
AS PARTS OF INDUSTRIAL PRINTING MA-  
CHINES; PLATE BENDING MACHINES; FOLDING  
MACHINES; INDUSTRIAL MACHINES FOR PRO-  
CESSING PLASTIC AND FILMS; INDUSTRIAL MA-  
CHINES FOR LACQUERING AND EMBOSSING;  
ELECTRIC MOTORS FOR THE ABOVE-MEN-  
TIONED MACHINES, IN CLASS 7 (U.S. CLS. 13, 19,  
21, 23, 31, 34 AND 35).

FOR: SOFTWARE FOR CONTROLLING, REGU-  
LATING, AND MAINTAINING INDUSTRIAL  
PRINTING MACHINES, PLATE BENDING MA-  
CHINES, FOLDING MACHINES, INDUSTRIAL MA-  
CHINES FOR PROCESSING PLASTIC AND FILMS,  
AND INDUSTRIAL MACHINES FOR LACQUER-  
ING AND EMBOSSING; ELECTRICAL AND ELEC-  
TRONIC MOTOR CONTROL UNITS AND  
REGULATING UNITS FOR INDUSTRIAL PRINT-  
ING MACHINES, PLATE BENDING MACHINES,  
FOLDING MACHINES, INDUSTRIAL MACHINES

FOR PROCESSING PLASTIC AND FILMS, AND  
INDUSTRIAL MACHINES FOR LACQUERING  
AND EMBOSSING, IN CLASS 9 (U.S. CLS. 21, 23, 26,  
36 AND 38).

FOR: PACKAGING MATERIAL MADE OF PLAS-  
TIC, NAMELY, FILMS MADE OF PLASTIC OR  
REGENERATED CELLULOSE FOR PACKAGING  
PURPOSES NOT FOR COMMERCIAL OR INDUS-  
TRIAL PURPOSES, AS WELL AS PACKAGING  
SACKS, ENVELOPES, AND BAGS MADE OF PLAS-  
TIC; ADHESIVE TAPE AND ADHESIVE FILMS FOR  
STATIONERY USE, IN CLASS 16 (U.S. CLS. 2, 5, 22,  
23, 29, 37, 38 AND 50).

THE MARK CONSISTS OF STANDARD CHAR-  
ACTERS WITHOUT CLAIM TO ANY PARTICULAR  
FONT, STYLE, SIZE, OR COLOR.

PRIORITY DATE OF 12-9-2006 IS CLAIMED.

OWNER OF INTERNATIONAL REGISTRATION  
0931256 DATED 4-27-2007, EXPIRES 4-27-2017.

SER. NO. 79-041,229, FILED 4-27-2007.

DOMINIC FATHY, EXAMINING ATTORNEY



**Int. Cl.: 5**

**Prior U.S. Cls.: 6, 18, 44, 46, 51 and 52**

**United States Patent and Trademark Office**

**Reg. No. 3,395,182**

**Registered Mar. 11, 2008**

**TRADEMARK  
PRINCIPAL REGISTER**



TAIHO PHARMACEUTICAL CO., LTD. (JAPAN  
CORPORATION)  
1-27 KANDANISHIKI-CHO CHIYODA-KU  
TOKYO, JAPAN 1018444

THE ENGLISH TRANSLATION OF TAIHO IS BIG  
BIRD.

FOR: PHARMACEUTICAL PREPARATIONS FOR  
THE TREATMENT OF CANCER, IN CLASS 5 (U.S.  
CLS. 6, 18, 44, 46, 51 AND 52).

SER. NO. 79-041,231, FILED 5-25-2007.

OWNER OF INTERNATIONAL REGISTRATION  
0931266 DATED 5-25-2007, EXPIRES 5-25-2017.

DAWN FELDMAN, EXAMINING ATTORNEY

**Int. Cls.: 35 and 36**

**Prior U.S. Cls.: 100, 101 and 102**

**United States Patent and Trademark Office**

**Reg. No. 3,395,183**

**Registered Mar. 11, 2008**

**SERVICE MARK  
PRINCIPAL REGISTER**

# RepRisk

ECOFACT AG (SWITZERLAND SOCIÉTÉ ANON-  
YME)  
STAMPFENBACHSTRASSE 42  
CH-8006 ZÜRICH, SWITZERLAND

FOR: ADVERTISING; BUSINESS RISK MANAGE-  
MENT CONSULTATION; BUSINESS ADMINISTRA-  
TION; PROVIDING OFFICE FUNCTIONS, IN CLASS  
35 (U.S. CLS. 100, 101 AND 102).

FOR: INSURANCE CONSULTATION; FINAN-  
CIAL RISK MANAGEMENT CONSULTATION;  
MONETARY EXCHANGE; REAL ESTATE CON-  
SULTANCY, IN CLASS 36 (U.S. CLS. 100, 101 AND  
102).

THE MARK CONSISTS OF STANDARD CHAR-  
ACTERS WITHOUT CLAIM TO ANY PARTICULAR  
FONT, STYLE, SIZE, OR COLOR.

PRIORITY DATE OF 3-30-2007 IS CLAIMED.

OWNER OF INTERNATIONAL REGISTRATION  
0932282 DATED 6-29-2007, EXPIRES 6-29-2017.

SER. NO. 79-041,718, FILED 6-29-2007.

MONIQUE MILLER, EXAMINING ATTORNEY

**Int. Cl.: 25**

**Prior U.S. Cls.: 22 and 39**

**United States Patent and Trademark Office**

**Reg. No. 3,395,184**

**Registered Mar. 11, 2008**

**TRADEMARK  
PRINCIPAL REGISTER**

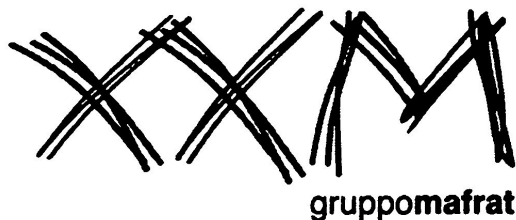

F.LLI TOTARO MAGLIFICIO MAFRAT S.P.A.  
(ITALY JOINT STOCK COMPANY)  
VIA BENGASI, 19  
I-70017 PUTIGNANO (BA)  
ITALY

OWNER OF INTERNATIONAL REGISTRATION  
0933044 DATED 6-27-2007, EXPIRES 6-27-2017.

FOR: CLOTHING ARTICLES FOR MEN, WOMEN AND CHILDREN, NAMELY, SHIRTS, T-SHIRTS, BLOUSES, SKIRTS, COATS, TROUSERS, PANTS, VESTS, JERSEYS, PAJAMAS, SOCKS AND STOCKINGS, SINGLETS, CORSETS, GARTERS, UNDERPANTS, PETTICOATS, HATS, HEADSCARVES, NECKTIES, RAINCOATS, OVERCOATS, GREATCOATS, BATHING SUITS, SWEATERS, SPORTS OVERALLS, JACKETS, BELTS, FUR COATS, SCARVES, GLOVES, GOWNS; FOOTWEAR, NAMELY SHOES, SLIPPERS AND BOOTS, IN CLASS 25 (U.S. CLS. 22 AND 39).

THE MARK CONSISTS OF THE WORDINGS XXM AND GRUPPOMAFRAT PLACED ON TWO LINES AND RESPECTIVELY IN FANCY CAPITAL AND SMALL LETTERS; IN PARTICULAR THE WORDING XXM IS BIGGER THAN THE REST AND THE PART GRUPPOMAFRAT IS PLACED UNDER THE FINAL LETTER M.

SER. NO. 79-042,002, FILED 6-27-2007.

PRIORITY DATE OF 4-27-2007 IS CLAIMED.

JOHN SCHUYLER YARD, EXAMINING ATTORNEY

**Int. Cl.: 1**

**Prior U.S. Cls.: 1, 5, 6, 10, 26 and 46**

**United States Patent and Trademark Office**

**Reg. No. 3,395,185**

**Registered Mar. 11, 2008**

**TRADEMARK  
PRINCIPAL REGISTER**



JAPAN VAM & POVAL CO., LTD. (JAPAN JOINT  
STOCK COMPANY)  
3-11-1, CHIKKO-SHINMACHI  
NISHI-KU.; SAKAI-SHI; OSAKA 592-8331  
JAPAN

OWNER OF INTERNATIONAL REGISTRATION  
0933245 DATED 6-26-2007, EXPIRES 6-26-2017.

SER. NO. 79-042,078, FILED 6-26-2007.

FOR: POLYVINYL ALCOHOL RESINS, IN CLASS  
1 (U.S. CLS. 1, 5, 6, 10, 26 AND 46).

JOHN KELLY, EXAMINING ATTORNEY

**Int. Cl.: 14**

**Prior U.S. Cls.: 2, 27, 28 and 50**

**United States Patent and Trademark Office**

**Reg. No. 3,395,186**

**Registered Mar. 11, 2008**

**TRADEMARK  
PRINCIPAL REGISTER**

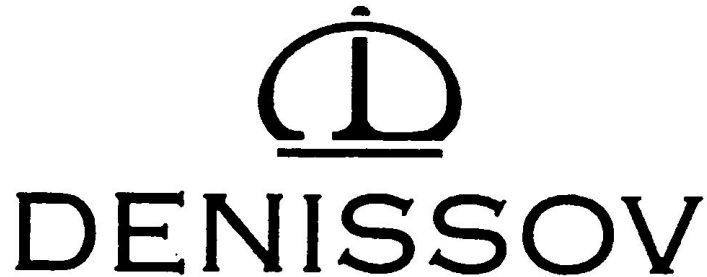

OBSHCHESTVO S OGRANICHENNOY; OT-  
VETSTVENNOSTYU "CHASOVAYA; KOMPA-  
NIYA "DENISOV" (RUSSIAN FED. LTD LIAB  
CO)

KORPUS 8, 34, ULITSA MARKSISTSKAYA  
RU-109147 MOSCOVA, RUSSIAN FED.

FOR: CLOCKS; WATCHES, IN CLASS 14 (U.S. CLS.  
2, 27, 28 AND 50).

OWNER OF INTERNATIONAL REGISTRATION  
0934268 DATED 7-10-2007, EXPIRES 7-10-2017.

SER. NO. 79-042,531, FILED 7-10-2007.

WENDY JUN, EXAMINING ATTORNEY

**Int. Cl.: 42**

**Prior U.S. Cls.: 100 and 101**

**United States Patent and Trademark Office**

**Reg. No. 3,395,187**

**Registered Mar. 11, 2008**

**SERVICE MARK  
PRINCIPAL REGISTER**

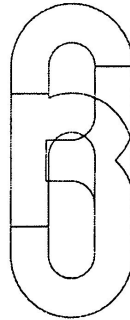

**STUDIO63**

STUDIO 63 S.R.L. (ITALY LTD LIAB CO)  
VIA S. SPIRITO, 6  
I-50125 FIRENZE, ITALY

FOR: ARCHITECTURE SERVICES, IN CLASS 42  
(U.S. CLS. 100 AND 101).

PRIORITY DATE OF 6-19-2007 IS CLAIMED.

OWNER OF INTERNATIONAL REGISTRATION  
0934669 DATED 7-10-2007, EXPIRES 7-10-2017.

THE ENGLISH TRANSLATION OF THE FOR-  
EIGN WORD(S) IN THE MARK IS STUDY 63.

SER. NO. 79-042,662, FILED 7-10-2007.

WENDY JUN, EXAMINING ATTORNEY

**Int. Cl.: 9**

**Prior U.S. Cls.: 21, 23, 26, 36 and 38**

**United States Patent and Trademark Office**

**Reg. No. 3,395,188**

**Registered Mar. 11, 2008**

**TRADEMARK  
PRINCIPAL REGISTER**

**D-TILE**

KONINKLIJKE PHILIPS ELECTRONICS N.V.  
(NETHERLANDS LTD LIAB CO)  
GROENEWOUDSEWEG 1  
NL-5621 BA EINDHOVEN  
NETHERLANDS

FOR: APPARATUS AND INSTRUMENTS FOR  
RECORDING, TRANSMITTING, REPRODUCING  
AND AMPLIFYING SOUND AND IMAGES, NAME-  
LY, VIDEO DISPLAY SCREENS, VIDEO PROJEC-  
TION SCREEN, LCD AND LED VIDEO DISPLAY  
SCREENS; OPERATING SOFTWARE FOR THE  
AFORESAID GOODS, IN CLASS 9 (U.S. CLS. 21, 23,  
26, 36 AND 38).

THE MARK CONSISTS OF STANDARD CHAR-  
ACTERS WITHOUT CLAIM TO ANY PARTICULAR  
FONT, STYLE, SIZE, OR COLOR.

PRIORITY DATE OF 11-15-2006 IS CLAIMED.

OWNER OF INTERNATIONAL REGISTRATION  
0935468 DATED 5-4-2007, EXPIRES 5-4-2017.

SER. NO. 79-043,005, FILED 5-4-2007.

MICHELE SWAIN, EXAMINING ATTORNEY

**Int. Cl.: 11**

**Prior U.S. Cls.: 13, 21, 23, 31 and 34**

**United States Patent and Trademark Office**

**Reg. No. 3,395,189**

**Registered Mar. 11, 2008**

**TRADEMARK  
PRINCIPAL REGISTER**

**Y U M E**

TAKARA BELMONT CORPORATION (JAPAN  
CORPORATION)  
2-1-1, HIGASHI-SHINSAIBASHI  
CHUO-KU., OSAKA-SHI, OSAKA 542-0083  
JAPAN

FOR: MACHINES AND APPARATUS USED IN  
BEAUTY SALONS OR BARBER SHOPS, NAMELY,  
ELECTRIC HAIR DRYERS, HAIR STEAMERS FOR  
HAIRDRESSING, TOWEL STEAMERS AND HAIR  
WASH BASINS, IN CLASS 11 (U.S. CLS. 13, 21, 23, 31  
AND 34).

OWNER OF INTERNATIONAL REGISTRATION  
0935646 DATED 6-14-2007, EXPIRES 6-14-2017.

THE ENGLISH TRANSLATION OF THE FOR-  
EIGN WORD(S) IN THE MARK IS: "ASPIRATION"  
OR "LONGING WHICH IS CHERISHED IN HOPES  
OF HAVING IT REALIZED IN THE FUTURE."

SER. NO. 79-043,078, FILED 6-14-2007.

RUSS HERMAN, EXAMINING ATTORNEY



**Int. Cl.: 6**

**Prior U.S. Cls.: 2, 12, 13, 14, 23, 25 and 50**

**United States Patent and Trademark Office**

**Reg. No. 3,395,190**

**Registered Mar. 11, 2008**

**TRADEMARK  
PRINCIPAL REGISTER**

**NIMAX**

UDDEHOLM TOOLING AKTIEBOLAG (SWEDEN LIMITED COMPANY)

SE-683 85 HAGFORS

SWEDEN

FOR: COMMON METALS AND THEIR ALLOYS, NAMELY, ALLOYED AND UNALLOYED TOOL STEEL AND STAINLESS STEEL IN THE FORM OF BARS, BLOCKS, PLATES, RINGS, WIRES, STRIPS AND TUBES, IN CLASS 6 (U.S. CLS. 2, 12, 13, 14, 23, 25 AND 50).

THE MARK CONSISTS OF STANDARD CHARACTERS WITHOUT CLAIM TO ANY PARTICULAR FONT, STYLE, SIZE, OR COLOR.

OWNER OF INTERNATIONAL REGISTRATION 0935679 DATED 7-11-2007, EXPIRES 7-11-2017.

SER. NO. 79-043,088, FILED 7-11-2007.

JACQUELINE A. LAVINE, EXAMINING ATTORNEY

**Int. Cl.: 30**

**Prior U.S. Cl.: 46**

**United States Patent and Trademark Office**

**Reg. No. 3,395,191**

**Registered Mar. 11, 2008**

**TRADEMARK  
PRINCIPAL REGISTER**



YUNNAN XIAGUAN TUOCHA; (GROUP) CO.,  
LTD. (CHINA CORPORATION)  
NO. 141, JIANSHE ROAD  
XIAGUAN, DALI; YUNNAN  
CHINA

OWNER OF INTERNATIONAL REGISTRATION  
0936259 DATED 7-4-2007, EXPIRES 7-4-2017.

SER. NO. 79-043,335, FILED 7-4-2007.

FOR: TEA, IN CLASS 30 (U.S. CL. 46).

KATINA MISTER, EXAMINING ATTORNEY

**Int. Cls.: 24 and 25**

**Prior U.S. Cls.: 22, 39, 42 and 50**

**United States Patent and Trademark Office**

**Reg. No. 3,395,192**

**Registered Mar. 11, 2008**

**TRADEMARK  
PRINCIPAL REGISTER**

# REVOLUTIONAL

CARVICO S.P.A. (ITALY JOINT STOCK COMPANY)

VIA DON A. PEDRINELLI, 96

I-24030 CARVICO (BG)

ITALY

FOR: FABRICS AND TEXTILES NOT INCLUDED IN OTHER CLASSES, FOR USE IN THE MANUFACTURE OF CLOTHING, NAMELY, CHENILLE, COTTON, DAMASK, CREPE, FLANNEL, FUSTIAN, GAUZE, JERSEY, LINEN, RAYON, SILK, TAFFETA, VELVET, WOOLLEN FABRICS, IN CLASS 24 (U.S. CLS. 42 AND 50).

FOR: CLOTHING FOR MEN, WOMEN AND CHILDREN, NAMELY, SHIRTS, JUMPERS, SKIRTS, JACKETS, TROUSERS, SHORTS, SPORT JERSEYS, SUITS, PAJAMAS, SOCKS, UNDERSHIRTS, CORSETS, SOCK SUSPENDERS, UNDERWEAR, PETTICOAT, HATS, SCARVES, NECKTIES, TIES, OUTERWEAR, RAINCOATS, TRENCH COATS, OVERCOATS, BATHING SUITS, SPORTS TRACK SUITS, ANORAKS, SKI PANTS, BELTS, FURS, SA-

SHES, GLOVES, DRESSING GOWNS; LEATHER SHIRTS, LEATHER SKIRTS, LEATHER JACKETS, LEATHER PANTS, LEATHER SHORTS, LEATHER SUITS, LEATHER OVERCOATS, LEATHER TRENCH COATS, LEATHER GLOVES; FOOTWEAR NAMELY, SLIPPERS, SHOES, ATHLETIC FOOTWEAR, BOOTS, IN CLASS 25 (U.S. CLS. 22 AND 39).

THE MARK CONSISTS OF STANDARD CHARACTERS WITHOUT CLAIM TO ANY PARTICULAR FONT, STYLE, SIZE, OR COLOR.

PRIORITY DATE OF 1-15-2007 IS CLAIMED.

OWNER OF INTERNATIONAL REGISTRATION 0936661 DATED 5-4-2007, EXPIRES 5-4-2017.

SER. NO. 79-043,520, FILED 5-4-2007.

SANDRA MANIOS, EXAMINING ATTORNEY

**Int. Cls.: 21 and 24**

**Prior U.S. Cls.: 2, 13, 23, 29, 30, 33, 40, 42 and 50**

**United States Patent and Trademark Office**

**Reg. No. 3,395,193**

**Registered Mar. 11, 2008**

**TRADEMARK  
PRINCIPAL REGISTER**

# **MULTICONFORM**

SAINT-GOBAIN VETROTEX FRANCE S.A.  
(FRANCE SOCIÉTÉ ANONYME)  
130, RUE DES FOLLAZ  
F-73000 CHAMBERY, FRANCE

PRIORITY DATE OF 1-11-2007 IS CLAIMED.

FOR: GLASS FIBRES AND GLASS FIBRE MATS  
FOR REINFORCING PLASTIC, RUBBER, PAPER,  
METAL, BITUMEN, PLASTER, CEMENT, COMPO-  
SITE MATERIALS OTHER THAN FOR INSULA-  
TION OR TEXTILE USE, IN CLASS 21 (U.S. CLS. 2, 13,  
23, 29, 30, 33, 40 AND 50).

OWNER OF INTERNATIONAL REGISTRATION  
0936699 DATED 7-5-2007, EXPIRES 7-5-2017.

SER. NO. 79-043,538, FILED 7-5-2007.

FOR: FELTS AND FABRICS MADE WITH GLASS  
FIBRES FOR TEXTILE APPLICATIONS, IN CLASS  
24 (U.S. CLS. 42 AND 50).

KATINA MISTER, EXAMINING ATTORNEY

Int. Cl.: 33

Prior U.S. Cls.: 47 and 49

United States Patent and Trademark Office

Reg. No. 3,395,194

Registered Mar. 11, 2008

TRADEMARK  
PRINCIPAL REGISTER



*Villa  
Rinaldi*

VILLA RINALDI S.A.S.; DI RINALDI RINALDO  
E C. (ITALY LIMITED PARTNERSHIP)  
LOCALITA' SAN LORENZO, 74  
I-37038 SOAVE (VR)  
ITALY

FOR: WINES, SPARKLING WINES, IN CLASS 33  
(U.S. CLS. 47 AND 49).

OWNER OF INTERNATIONAL REGISTRATION  
0802637 DATED 4-7-2003, EXPIRES 4-7-2013.

THE TRADE MARK CONSISTS IN A STYLISED  
REPRESENTATION OF A CROWN; BELOW IS THE  
WORD "VILLA" AND FURTHER BELOW "RINAL-  
DI"; THESE WORDS ARE WRITTEN IN LOWER-  
CASE CURSIVE SCRIPT; THE LETTERS "V" AND  
"R" ARE UPPER-CASE AND ARE JOINED.

SER. NO. 79-043,801, FILED 1-15-2007.

KAELIE KUNG, EXAMINING ATTORNEY

**Int. Cls.: 6, 9, 12, 14, 16, 24, 25, 28, 35, 37, 39, 41, 42 and 43**

**Prior U.S. Cls.: 2, 5, 12, 13, 14, 19, 21, 22, 23, 25, 26, 27, 28, 29, 31, 35, 36, 37, 38, 39, 42, 44, 50, 100, 101, 102, 103, 105, 106 and 107**

**Reg. No. 3,395,195**

**United States Patent and Trademark Office**

**Registered Mar. 11, 2008**

**TRADEMARK  
SERVICE MARK  
PRINCIPAL REGISTER**

# **FERNANDO ALONSO**

ALONSO DIAZ, FERNANDO (SPAIN INDIVIDUAL)

37 COX'S GROUND

WATERSAYS, OXFORD OX2 6PX

UNITED KINGDOM

FOR: METAL SIGNBOARDS, AND METAL RINGS FOR KEYS, IN CLASS 6 (U.S. CLS. 2, 12, 13, 14, 23, 25 AND 50).

FOR: SUITS AND GLOVES FOR PROTECTION AGAINST ACCIDENTS, RADIATION AND FIRE; PROTECTIVE HELMETS; SPECTACLES; AND VIDEO GAMES, NAMELY, VIDEO GAME CONSOLES, VIDEO GAME CARTRIDGES, DISCS AND CD-ROMS; APPARATUS FOR PLAYING AUDIO AND VISUAL GAMES, NAMELY, HAND HELD JOY STICK UNITS FOR PLAYING VIDEO GAMES; VIDEO AND AUDIO-VISUAL GAMES, NAMELY, VIDEO GAME MACHINES FOR USE WITH TELEVISIONS; COMPUTER GAME PROGRAMS, IN CLASS 9 (U.S. CLS. 21, 23, 26, 36 AND 38).

FOR: VEHICLES, NAMELY, BOATS, MOTOR BOATS, ROWBOATS, SAILBOATS, YACHTS, RAFTS, PERSONAL JET-BOATS, GLIDERS, AIRPLANES, SPACE VEHICLES, HELICOPTERS, TRAVEL TRAILERS, MOTORCYCLES, BICYCLES, MOTOR BICYCLES, TRICYCLES WITH MOTOR ENGINES, BABY CARRIAGES, AUTOMOBILES, CARS, VEHICLE PASSENGER CARS, LAND VEHICLES AND STRUCTURAL PARTS THEREFOR; LAND VEHICLE PARTS, NAMELY, DRIVE GEAR, SHOCK ABSORBERS, MIRRORS, NAMELY, SIDE MIRRORS, REAR VIEW MIRRORS OF AUTOMOBILES, SEAT BELTS FOR VEHICLES, HUBCAPS, FITTED AND SEMI-FITTED SEAT COVERS, ANTI-THEFT ALARMS FOR VEHICLES, WHEELS AND TIRES; GASOLINE AND DIESEL ENGINES FOR LAND VEHICLES, IN CLASS 12 (U.S. CLS. 19, 21, 23, 31, 35 AND 44).

FOR: PRECIOUS METALS AND THEIR ALLOYS; JEWELRY, BIJOUTERIE, PRECIOUS STONES AND PRECIOUS GEMSTONES; HOROLOGICAL AND CHRONOMETRIC INSTRUMENTS, NAMELY, WATCHES AND CHRONOMETERS AND PARTS THEREOF; JEWELRY PINS AND CUFFLINKS, IN CLASS 14 (U.S. CLS. 2, 27, 28 AND 50).

FOR: STATIONERY; BOOKS, MAGAZINES, CATALOGS, CHARTS AND PLATS, NEWSPAPERS, MAGAZINES, MANUALS, ANNUAL MAGAZINES, ALMANACS, BUSINESS PAPER, STICKER ALBUMS AND COMPUTER INSTRUCTION MANUALS, ALL RELATING TO AUTOMOBILE RACING, AUTOMOTIVE PRODUCTS AND SERVICES AND SPORTS PERSONALITIES; PRINTED PAPER SIGNS; CALENDARS; PHOTOGRAPHS; PORTRAITS; POSTERS; ADHESIVES FOR STATIONERY OR HOUSEHOLD PURPOSES; STICKERS AND STICKER ALBUMS; TRANSFERS; BUMPER STICKERS; TRADING CARDS; ADDRESS BOOKS; DESKTOP ORGANIZERS; WRITING PADS; ROUTE MAPS; PRINTING, PAINTING AND DRAWING SETS, NAMELY, CRAYONS, MARKERS AND DRAWING PENCILS, ERASERS, PENCIL SHARPENERS, CHARCOAL PENCILS, PASTEL PENCILS, ARTISTS' PENCILS, PENCIL LEADS, DRAFTING AND DRAWING COMPASSES, FOUNTAIN PENS, PENCIL CASES, PEN RESTS; PAINTBRUSHES; DRAWING OR UNCALIBRATED RULERS; PENS; PENCILS; ELECTRONIC TYPEWRITERS; PLASTIC BAGS FOR PACKAGING; PLASTIC BAGS FOR MERCHANDISE PACKAGING; WRAPPING PAPER; GIFT WRAPPING PAPER; PRINTERS' TYPE; PRINTING BLOCKS, IN CLASS 16 (U.S. CLS. 2, 5, 22, 23, 29, 37, 38 AND 50).

FOR: LABELS, PATCHES AND BADGES MADE OF TEXTILE MATERIAL; CLOTH BANNERS; BATH TOWELS; BED BLANKETS, BED LINEN, BED SHEETS, QUILTS AND BEDSPREADS; TABLE CLOTHS NOT OF PAPER, TABLE LINEN, TABLE

MATS NOT OF PAPER, TEXTILE TABLE NAPKINS, FABRIC TABLE RUNNERS AND TEA TOWELS, IN CLASS 24 (U.S. CLS. 42 AND 50).

FOR: BUSINESS SUITS, TROUSERS, JACKETS, JEANS, SWEATERS, SPORT SHIRTS, POLO SHIRTS, BATHROBES, BATHING SUITS, BELTS, BOOTS, BRASSIERES, COATS, UNDERWEAR, SANDALS, FUR COATS AND JACKETS, FUR CLOAKS, FUR STOLES, FUR HATS, FUR MUFFS, GLOVES, GOWNS, GYMNASTIC SHOES, HATS, HEADWEAR, CUFFS, CLOTHING HOODS, BODICES, HOSIERY, LEGGINGS, NECKTIES, OVERALLS, PANTS, PAJAMAS, SCARVES, ATHLETIC UNIFORMS, T-SHIRTS, SWIMMING SUITS, SHOES, RUNNING SHOES, TENNIS SHOES, ATHLETIC SHOES, SKIRTS, SUITS, PROFESSIONAL UNIFORMS, CAPS, WIND RESISTANT JACKETS, IN CLASS 25 (U.S. CLS. 22 AND 39).

FOR: BOARD GAMES; MOBILE TOYS AND GAMES FOR CHILDREN, NAMELY, BATHTUB TOYS, MINIATURE TOY HELMETS OF RACING DRIVERS, BALLS FOR SPORTS AND PLAY, TOY BUILDING BLOCKS, BALLOONS, HAND HELD UNITS FOR PLAYING ELECTRONIC AND VIDEO GAMES, DOLLS, STUFFED TOYS, PUZZLES, TOY CARS AND MODEL CARS; GYMNASTIC APPARATUS; SPORTS EQUIPMENT, NAMELY, BASEBALL BATS; NON-ELECTRIC CHRISTMAS TREE DECORATIONS, NOT COMPRISING CONFECTIONERY GOODS, IN CLASS 28 (U.S. CLS. 22, 23, 38 AND 50).

FOR: SERVICES OF ADVERTISING AND ASSISTANCE FOR THE OPERATION AND MANAGEMENT OF COMMERCIAL OR INDUSTRIAL COMPANIES OF OTHERS; EXPORT AND IMPORT SERVICES; TALENT AGENT SERVICES, IN CLASS 35 (U.S. CLS. 100, 101 AND 102).

FOR: REPAIR AND MAINTENANCE OF AUTOMOBILES, IN CLASS 37 (U.S. CLS. 100, 103 AND 106).

FOR: TRANSPORT OF GOODS AND PERSONS BY CAR, TAXI, TRUCK, BUS, FERRY, BOAT, RAIL AND AIR; POSTAL SERVICES NAMELY, PACKAGING ARTICLES FOR TRANSPORTATION; COURIER SERVICES AND MESSENGER SERVICES; NEWSPAPER DELIVERY SERVICES; TRANSPORTATION AND STORAGE FOR OTHERS OF LETTERS, DOCUMENTS, MESSAGES, PRINTED MATTER, PARCELS AND OTHER GOODS BY LAND SEA OR AIR; RENTING AND LEASING OF VEHICLES; RENTAL OF PARKING SPACES; STORAGE OF GOODS IN GENERAL; WAREHOUSING SERVICES, NAMELY, PACKAGING AND STORAGE OF GOODS FOR SHIPMENT FOR OTHERS; STORAGE OF ELECTRONICALLY STORED DATA, IN CLASS 39 (U.S. CLS. 100 AND 105).

FOR: ARRANGING, ORGANIZING AND STAGING OF SPORTS EVENTS, TOURNAMENTS AND COMPETITIONS IN THE FIELD OF MOTOR SPORTS; PRODUCTION OF SPORTS EVENTS, TOURNAMENTS AND COMPETITIONS FOR RADIO, FILM AND TELEVISION IN THE FIELD OF MOTOR SPORT; PROVISION OF RECREATION FACILITIES FOR EVENTS, TOURNAMENTS AND COMPETITIONS IN THE FIELD OF MOTOR SPORT; PROVIDING AN INTERACTIVE COMPUTER DATABASE IN THE FIELD OF SPORTS; ORGANIZING EXHIBITIONS RELATING TO MOTOR VEHICLES AND MOTOR SPORTS; ENTERTAINMENT SERVICES IN THE NATURE OF AUTOMOBILE RACES; ENTERTAINMENT SERVICES, NAMELY, PERFORMING AND COMPETING IN MOTOR SPORTS EVENTS; ORGANIZING SPORTING EVENTS, NAMELY, MOTOR SPORTS EVENTS; AND TEACHING OF SPORTS, NAMELY, IN THE FIELD OF MOTOR SPORTS, IN CLASS 41 (U.S. CLS. 100, 101 AND 107).

FOR: SCIENTIFIC AND TECHNOLOGICAL SERVICES, NAMELY, SCIENTIFIC RESEARCH AND DEVELOPMENT FOR OTHERS IN THE FIELD OF AUTO RACING, RECOVERY OF COMPUTER DATA, COMPUTER RENTAL, INSTALLATION AND MAINTENANCE OF COMPUTER SOFTWARE, COMPILATION OF DATABASES, NAMELY, DATABASE DEVELOPMENT SERVICES, COMPUTER PROGRAMMING FOR COMPUTERS, COMPUTER SYSTEMS ANALYSIS, ENGINEERING, DESIGN AND MAINTENANCE OF COMPUTING SITES FOR THIRD PARTIES, CREATION AND DESIGN OF WEB SITES; INDUSTRIAL ANALYSIS AND RESEARCH SERVICES, NAMELY, ADVISORY AND CONSULTANCY SERVICES IN THE FIELD OF COMPUTER HARDWARE AND SOFTWARE SOLUTIONS; COMPUTER AND SOFTWARE DESIGN AND DEVELOPMENT; LEGAL SERVICES, IN CLASS 42 (U.S. CLS. 100 AND 101).

FOR: HOTEL, RESTAURANT, BAR AND CATERING SERVICES; TEMPORARY ACCOMMODATION, IN CLASS 43 (U.S. CLS. 100 AND 101).

PRIORITY DATE OF 7-28-2004 IS CLAIMED.

OWNER OF INTERNATIONAL REGISTRATION 0869570 DATED 10-1-2004, EXPIRES 10-1-2014.

THE NAME "FERNANDO ALONSO" IDENTIFIES A LIVING INDIVIDUAL WHOSE CONSENT IS OF RECORD.

SER. NO. 79-975,010, FILED 10-1-2004.

MONIQUE MILLER, EXAMINING ATTORNEY

**Int. Cl.: 3**

**Prior U.S. Cls.: 1, 4, 6, 50, 51 and 52**

**United States Patent and Trademark Office**

**Reg. No. 3,395,196**

**Registered Mar. 11, 2008**

**TRADEMARK  
PRINCIPAL REGISTER**



**NATURALIA  
SINTESI**

NATURALIA SINTESI S.R.L. (ITALY S.R.L.)  
VIA SAN GIOVANNI VALDARNO, 8  
I-00138 ROMA  
ITALY

FOR: FACE AND BODY SOAPS; PERFUMERY,  
ESSENTIAL OILS FOR PERSONAL USE; COSMET-  
ICS; HAIR LOTIONS; DENTIFRICES; NATURAL  
AND SYNTHETIC COSMETICS, IN CLASS 3 (U.S.  
CLS. 1, 4, 6, 50, 51 AND 52).

PRIORITY DATE OF 12-16-2004 IS CLAIMED.

OWNER OF INTERNATIONAL REGISTRATION  
0848887 DATED 2-18-2005, EXPIRES 2-18-2015.

OWNER OF U.S. REG. NO. 3,237,520.

NO CLAIM IS MADE TO THE EXCLUSIVE  
RIGHT TO USE "SINTESI", APART FROM THE  
MARK AS SHOWN.

THE MARK CONSISTS OF THE WORDS "NAT-  
URALIA SINTESI" IN TWO LINES, BELOW AN  
ARC, PART OF A CIRCLE.

THE ENGLISH TRANSLATION OF THE WORD-  
ING IN THE MARK IS "NATURAL SYNTHESIS."

SER. NO. 79-975,013, FILED 2-18-2005.

KALIE KUNG, EXAMINING ATTORNEY



**Int. Cl.: 9**

**Prior U.S. Cls.: 21, 23, 26, 36, and 38**

**United States Patent and Trademark Office**

**Reg. No. 3,395,197**

**Registered Mar. 11, 2008**

**TRADEMARK  
PRINCIPAL REGISTER**

**PICTAL**

JONES, LAWRENCE R. (UNITED STATES INDIVIDUAL)  
13585 GLENCLIFF WAY  
SAN DIEGO, CA 92130

FIRST USE 4-18-1998; IN COMMERCE 9-8-2007.

SN 75-409,758, FILED 12-23-1997.

FOR: COMPUTER SOFTWARE AND HARDWARE FOR THE PROCESSING, TRANSMISSION, TRANSPORT, AND RECEPTION OF DIGITIZED STILL IMAGES BY MEANS OF WIRELESS MEDIA, IN CLASS 9 (U.S. CLS. 21, 23, 26, 36 AND 38).

DOMINIC J. FERRAIUOLO, EXAMINING ATTORNEY

**Int. Cl.: 36**

**Prior U.S. Cls.: 100, 101, and 102**

**United States Patent and Trademark Office**

**Reg. No. 3,395,198**

**Registered Mar. 11, 2008**

**SERVICE MARK  
PRINCIPAL REGISTER**

**MIBANK**

MARSHALL & ILSLEY CORPORATION (WIS-  
CONSIN CORPORATION)  
770 NORTH WATER STREET  
MILWAUKEE, WI 53202

FIRST USE 10-29-2007; IN COMMERCE 10-29-2007.

FOR: BANKING SERVICES PROVIDED OVER A  
GLOBAL COMPUTER NETWORK; FINANCIAL  
SERVICES PROVIDED OVER A GLOBAL COMPU-  
TER NETWORK, NAMELY, FINANCIAL PLAN-  
NING, INVESTMENT CONSULTING, TRUST  
MANAGEMENT AND MORTGAGE LENDING SER-  
VICES, IN CLASS 36 (U.S. CLS. 100, 101 AND 102).

OWNER OF U.S. REG. NOS. 1,439,491 AND  
2,266,077.

SN 75-787,845, FILED 8-30-1999.

BENJAMIN OKEKE, EXAMINING ATTORNEY

**Int. Cl.: 36**

**Prior U.S. Cls.: 100, 101, and 102**

**United States Patent and Trademark Office**

**Reg. No. 3,395,199**

**Registered Mar. 11, 2008**

**SERVICE MARK  
PRINCIPAL REGISTER**

**MITRUST**

MARSHALL & ILSLEY CORPORATION (WIS-  
CONSIN CORPORATION)  
770 NORTH WATER STREET  
MILWAUKEE, WI 53202

FOR: ON-LINE TRUST MANAGEMENT AND  
TRUST CONSULTING SERVICES PROVIDED OVER  
A GLOBAL COMPUTER NETWORK, IN CLASS 36  
(U.S. CLS. 100, 101 AND 102).

FIRST USE 10-26-2007; IN COMMERCE 10-26-2007.

OWNER OF U.S. REG. NOS. 1,439,491 AND  
2,266,077.

SN 75-787,846, FILED 8-30-1999.

BENJAMIN OKEKE, EXAMINING ATTORNEY

**Int. Cl.: 12**

**Prior U.S. Cls.: 19, 21, 23, 31, 35, and 44**

**United States Patent and Trademark Office**

**Reg. No. 3,395,200**

**Registered Mar. 11, 2008**

**TRADEMARK  
PRINCIPAL REGISTER**

**LEGEND**

BOMBARDIER RECREATIONAL PRODUCTS  
INC. (CANADA CORPORATION)  
726 ST-JOSEPH STREET  
VALCOURT, QUEBEC, CANADA J0E 2L0

FIRST USE 3-31-2001; IN COMMERCE 3-31-2001.

SN 76-045,396, FILED 5-10-2000.

FOR: SNOWMOBILES, IN CLASS 12 (U.S. CLS. 19,  
21, 23, 31, 35 AND 44).

CHRISIE B. KING, EXAMINING ATTORNEY

**Int. Cl.: 40**

**Prior U.S. Cls.: 100, 103, and 106**

**United States Patent and Trademark Office**

**Reg. No. 3,395,201**

**Registered Mar. 11, 2008**

---

**SERVICE MARK  
PRINCIPAL REGISTER**

**INKCHASER.COM**

ECORPORATEPRINTERS INC (DELAWARE  
CORPORATION)  
P.O. BOX 9843  
SEATTLE, WA 98109

FIRST USE 8-0-2002; IN COMMERCE 8-0-2002.

SN 76-049,216, FILED 5-17-2000.

FOR: DIGITAL IMAGING SERVICES, BOOK-  
BINDING, IN CLASS 40 (U.S. CLS. 100, 103 AND 106).

MARK SPARACINO, EXAMINING ATTORNEY

**Int. Cl.: 9**

**Prior U.S. Cls.: 21, 23, 26, 36, and 38**

**United States Patent and Trademark Office**

**Reg. No. 3,395,202**

**Registered Mar. 11, 2008**

**TRADEMARK  
PRINCIPAL REGISTER**

**THREE WISHES**

HARRAH'S LICENSE COMPANY, LLC (NEVADA  
LTD LIAB CO)  
ONE HARRAH'S COURT  
LAS VEGAS, NV 89119

FOR: GAMING MACHINES; GAMING MA-  
CHINES FEATURING SLOT MACHINE TYPE  
GAMES VIA VIDEO DISPLAYS; ELECTRONIC  
SLOT MACHINES INCORPORATING OPERATING

SOFTWARE , IN CLASS 9 (U.S. CLS. 21, 23, 26, 36  
AND 38).

FIRST USE 12-11-2000; IN COMMERCE 12-11-2000.

SN 76-072,652, FILED 5-31-2000.

AMY ALFIERI, EXAMINING ATTORNEY

**Int. Cls.: 1, 5, 31, and 42**

**Prior U.S. Cls.: 1, 5, 6, 10, 18, 26, 44, 46, 51, 52, 100,  
and 101**

**Reg. No. 3,395,203**

**United States Patent and Trademark Office**

**Registered Mar. 11, 2008**

**TRADEMARK  
SERVICE MARK  
PRINCIPAL REGISTER**

**PRO SELECT**

OMS INVESTMENTS, INC. (DELAWARE COR-  
PORATION)  
10250 CONSTELLATION BLVD, SUITE 2800  
LOS ANGELES, CA 900676228

FOR: LAWN AND GARDEN FERTILIZER,  
PLANT FOOD, ALL FOR DOMESTIC USE, IN  
CLASS 1 (U.S. CLS. 1, 5, 6, 10, 26 AND 46).

FIRST USE 2-1-2007; IN COMMERCE 2-1-2007.

FOR: HERBICIDES FOR DOMESTIC USE, IN  
CLASS 5 (U.S. CLS. 6, 18, 44, 46, 51 AND 52).

FIRST USE 2-1-2007; IN COMMERCE 2-1-2007.

FOR: FLOWER, VEGETABLE, PLANT AND  
GRASS SEED FOR DOMESTIC USE; LIVE PLANTS  
FOR DOMESTIC USE, IN CLASS 31 (U.S. CLS. 1 AND  
46).

FIRST USE 2-2-2007; IN COMMERCE 2-2-2007.

FOR: PROVIDING INFORMATION VIA THE IN-  
TERNET ON LAWN CARE AND LANDSCAPE  
GARDENING, INCLUDING HOW TO USE AND  
APPLY FERTILIZERS, HERBICIDES, INSECTI-  
CIDES, GRASS SEED, PLANT FOOD, , ALL INFOR-  
MATION FOR THE ABOVE SERVICES RELATED  
TO DOMESTIC USE, IN CLASS 42 (U.S. CLS. 100  
AND 101).

FIRST USE 4-30-2007; IN COMMERCE 4-30-2007.

SN 76-291,958, FILED 7-26-2001.

MICHAEL SOUDERS, EXAMINING ATTORNEY

**Int. Cl.: 16**

**Prior U.S. Cls.: 2, 5, 22, 23, 29, 37, 38, and 50**

**Reg. No. 3,395,204**

**United States Patent and Trademark Office**

**Registered Mar. 11, 2008**

---

**TRADEMARK  
PRINCIPAL REGISTER**

**ARTISTIC ANIMALS**

STUDIO EL NINO, INC. (NEW YORK CORPORATION)  
C/O E. BOLAN CO.  
116 CHAMBERS ST. 4TH FLOOR  
NEW YORK, NY 10007

FOR: MAGAZINES FEATURING ENTERTAINMENT FOR CHILDREN, NAMELY, FICTION, COMICS AND DRAWINGS; A SERIES OF FICTIONAL BOOKS, IN CLASS 16 (U.S. CLS. 2, 5, 22, 23, 29, 37, 38 AND 50).

FIRST USE 3-18-2006; IN COMMERCE 3-18-2006.

NO CLAIM IS MADE TO THE EXCLUSIVE RIGHT TO USE "ANIMALS", APART FROM THE MARK AS SHOWN.

SN 76-314,171, FILED 9-17-2001.

MARGERY A. TIERNEY, EXAMINING ATTORNEY



**Int. Cls.: 9 and 18**

**Prior U.S. Cls.: 1, 2, 3, 21, 22, 23, 26, 36, 38, and 41**

**United States Patent and Trademark Office**

**Reg. No. 3,395,205**

**Registered Mar. 11, 2008**

**TRADEMARK  
PRINCIPAL REGISTER**

**TARGUS**

TARGUS GROUP INTERNATIONAL, INC. (DELAWARE CORPORATION)  
1211 N. MILLER STREET  
ANAHEIM, CA 92806

FOR: COMPUTER PERIPHERALS; KEYBOARDS; KEYPADS; DISK DRIVES; MICE; MODEM PROTECTORS; MONITOR STANDS FOR USE BY KEYBOARD OPERATORS; MOBILE COMPUTING ACCESSORIES, NAMELY, AC AND DC ADAPTERS FOR PROVIDING POWER TO PORTABLE COMPUTERS, CELLULAR TELEPHONES AND MOBILE ELECTRONIC DEVICES, ADAPTER CABLES, WIRELESS CONNECTORS; CONNECTORS AND PLUGS; HUBS; ELECTRICAL AND TELEPHONE CABLES AND CORDS, TELEPHONE CONNECTING CORDS; CABLE MANAGEMENT APPARATUS, NAMELY, CABLE GUIDES; ELECTRICAL POWER SUPPLY APPARATUS, NAMELY, BATTERIES; SECURITY APPARATUS, NAMELY, SECURITY ALARMS, THEFT PREVENTION CABLES AND LOCKS, AND ANTI-THEFT WARNING ALARMS; CASES, COVERS AND CONTAINERS FOR PORTABLE COMPUTERS, PRINTERS, COMPUTER DISCS, COMPACT DISCS, VIDEO CAMERAS, DIGITAL

CAMERAS, CELLULAR TELEPHONES, AND MOBILE ELECTRONIC DEVICES; NOTEBOOK COMPUTER CARRYING CASES, PROTECTIVE BAGS FOR COMPUTERS, PRINTERS, VIDEO CAMERAS, DIGITAL CAMERAS, AND CELLULAR TELEPHONES, IN CLASS 9 (U.S. CLS. 21, 23, 26, 36 AND 38).

FIRST USE 0-0-1988; IN COMMERCE 0-0-1988.

FOR: HANDBAGS, SHOULDER BAGS, HANDBAGS, SHOULDER BAGS, BRIEFCASES, VALISES, HOLDALLS, TRAVELLING BAGS, SUITCASES, TRUNKS, NAMELY, LUGGAGE, BACKPACKS AND WALLETS, IN CLASS 18 (U.S. CLS. 1, 2, 3, 22 AND 41).

FIRST USE 0-0-1988; IN COMMERCE 0-0-1988.

OWNER OF U.S. REG. NOS. 1,519,635, 2,316,437, AND OTHERS.

SN 76-321,840, FILED 10-5-2001.

CURTIS FRENCH, EXAMINING ATTORNEY

**Int. Cl.: 36**

**Prior U.S. Cls.: 100, 101, and 102**

**United States Patent and Trademark Office**

**Reg. No. 3,395,206**

**Registered Mar. 11, 2008**

**SERVICE MARK  
PRINCIPAL REGISTER**

**AEGIS ENERGY SYNDICATE 1225**

ASSOCIATED ELECTRIC & GAS INSURANCE  
SERVICES LIMITED (BERMUDA CORPORATION)

1 CHURCH STREET, 4TH FLOOR  
THE MAXWELL ROBERTS BUILDING  
HAMILTON, BERMUDA HM11

FOR: INSURANCE SERVICES, NAMELY, INSURANCE UNDERWRITING, INSURANCE CLAIMS ADMINISTRATION AND LOSS CONTROL SERVICES IN THE FIELD OF PROPERTY AND CASUALTY INSURANCE AND RISK MANAGEMENT SERVICES IN THE FIELD OF PROPERTY AND CASUALTY INSURANCE, IN CLASS 36 (U.S. CLS. 100, 101 AND 102).

FIRST USE 12-31-1998; IN COMMERCE 12-31-1998.

OWNER OF U.S. REG. NOS. 1,896,440 AND 1,925,826.

NO CLAIM IS MADE TO THE EXCLUSIVE RIGHT TO USE "ENERGY SYNDICATE 1225", APART FROM THE MARK AS SHOWN.

SN 76-374,708, FILED 2-22-2002.

INGA ERVIN, EXAMINING ATTORNEY

**Int. Cl.: 25**

**Prior U.S. Cls.: 22 and 39**

**United States Patent and Trademark Office**

**Reg. No. 3,395,207**

**Registered Mar. 11, 2008**

**TRADEMARK  
PRINCIPAL REGISTER**



BACARDI & COMPANY LIMITED (LIECHTEN-  
STEIN CORPORATION)  
1000 BACARDI ROAD  
NASSAU, BAHAMAS

FOR: CLOTHING, NAMELY, DRESS SHIRTS,  
SWEATSHIRTS, SPORT SHIRTS, T-SHIRTS, POLO  
SHIRTS, BLOUSES, SHORTS, PANTS, TROUSERS,  
SWEATPANTS, JUMPERS, SKIRTS, SHIRTS, JACK-  
ETS, COATS, WIND RESISTANT JACKETS, RAIN  
JACKETS, OVERALLS, TURTLENECKS, SWEA-  
TERS, VESTS, TIES, BELTS, SUSPENDERS, HEAD-  
BANDS, SWEATBANDS, SCARVES, GLOVES,  
HEADWEAR, FOOTWEAR, SPORTSWEAR, NAME-  
LY, SPORT COATS, CREW NECK SWEATERS AND

CREW NECK T-SHIRTS, ATHLETIC WEAR, NAME-  
LY, GYM SHORTS, SWEAT SHORTS, GYM SUITS,  
GYM SOCKS, JOGGING SUITS, IN CLASS 25 (U.S.  
CLS. 22 AND 39).

FIRST USE 12-30-2003; IN COMMERCE 12-30-2003.

OWNER OF U.S. REG. NOS. 302,916, 1,869,854,  
AND OTHERS.

SN 76-388,136, FILED 3-28-2002.

SAMUEL E. SHARPER JR., EXAMINING ATTOR-  
NEY

**Int. Cl.: 35**

**Prior U.S. Cls.: 100, 101, and 102**

**United States Patent and Trademark Office**

**Reg. No. 3,395,208**

**Registered Mar. 11, 2008**

---

**SERVICE MARK  
PRINCIPAL REGISTER**

**FLOORING ONE**

CCA GLOBAL PARTNERS, INC. (DELAWARE  
CORPORATION)  
4301 EARTH CITY EXPRESSWAY  
EARTH CITY, MO 63045

FOR: WHOLESALE DISTRIBUTORSHIP, RETAIL  
STORE, MAIL ORDER CATALOG, AND ON-LINE  
RETAIL STORE SERVICES FEATURING FLOOR  
COVERINGS AND ACCESSORIES , IN CLASS 35  
(U.S. CLS. 100, 101 AND 102).

FIRST USE 6-30-2004; IN COMMERCE 6-30-2004.

NO CLAIM IS MADE TO THE EXCLUSIVE  
RIGHT TO USE "FLOORING", APART FROM THE  
MARK AS SHOWN.

SN 76-402,630, FILED 4-29-2002.

SIMON TENG, EXAMINING ATTORNEY

**Int. Cls.: 20 and 28**

**Prior U.S. Cls.: 2, 13, 22, 23, 25, 32, 38, and 50**

**United States Patent and Trademark Office**

**Reg. No. 3,395,209**

**Registered Mar. 11, 2008**

**TRADEMARK  
PRINCIPAL REGISTER**

**MR. BINGLE**

DILLARD'S INC. (DELAWARE CORPORATION)  
1600 CANTRELL ROAD  
P.O. BOX 486  
LITTLE ROCK, AR 72203

FIRST USE 0-0-1999; IN COMMERCE 0-0-1999.

OWNER OF U.S. REG. NOS. 535,774 AND 1,466,640.

FOR: HOLIDAY ORNAMENTS AND FIGURINES  
OF PLASTIC RESIN, IN CLASS 20 (U.S. CLS. 2, 13, 22,  
25, 32 AND 50).

THE NAME IN THE MARK DOES NOT IDENTIFY  
A LIVING INDIVIDUAL.

FIRST USE 0-0-1999; IN COMMERCE 0-0-1999.

SN 76-425,657, FILED 6-27-2002.

FOR: CHRISTMAS TREE ORNAMENTS MADE  
OF RESIN, MINIATURE TREE ORNAMENTS, IN  
CLASS 28 (U.S. CLS. 22, 23, 38 AND 50).

LINDA POWELL, EXAMINING ATTORNEY

**Int. Cl.: 31**

**Prior U.S. Cls.: 1 and 46**

**United States Patent and Trademark Office**

**Reg. No. 3,395,210**

**Registered Mar. 11, 2008**

---

**TRADEMARK  
PRINCIPAL REGISTER**

**LITTLE HEROES**

TEJAS INDUSTRIES, INC. (TEXAS CORPORATION)  
101 S.E. 11TH AVE.  
AMARILLO, TX 79101

FIRST USE 7-5-2007; IN COMMERCE 7-5-2007.

SN 76-434,180, FILED 7-25-2002.

FOR: PET FOOD AND EDIBLE PET TREATS, IN  
CLASS 31 (U.S. CLS. 1 AND 46).

DAVID ELTON, EXAMINING ATTORNEY

**Int. Cl.: 19**

**Prior U.S. Cls.: 1, 12, 33, and 50**

**United States Patent and Trademark Office**

**Reg. No. 3,395,211**

**Registered Mar. 11, 2008**

**TRADEMARK  
PRINCIPAL REGISTER**

**POLY WELD**

ROYAL MOULDINGS LIMITED (NEVADA CORPORATION)  
P.O. BOX 610  
MARION, VA 243540610

NO CLAIM IS MADE TO THE EXCLUSIVE RIGHT TO USE "WELD", APART FROM THE MARK AS SHOWN.

FOR: WELDABLE CELLULAR VINYL WINDOWS AND COMPONENTS THEREFOR, NAMELY, CASEMENTS, FRAMES, SCREENS, SHUTTERS, SILLS, AND PANES, IN CLASS 19 (U.S. CLS. 1, 12, 33 AND 50).

SN 76-460,780, FILED 10-16-2002.

FIRST USE 9-15-2005; IN COMMERCE 9-15-2005.

JANICE L. MCMORROW, EXAMINING ATTORNEY

**Int. Cls.: 9, 16, 25, and 41**

**Prior U.S. Cls.: 2, 5, 21, 22, 23, 26, 29, 36, 37, 38, 39,  
50, 100, 101, and 107**

**Reg. No. 3,395,212**

**United States Patent and Trademark Office**

**Registered Mar. 11, 2008**

**TRADEMARK  
SERVICE MARK  
PRINCIPAL REGISTER**



CURB, MIKE (UNITED STATES INDIVIDUAL)  
47 MUSIC SQUARE EAST  
NASHVILLE, TN 37203

FOR: PRERECORDED AUDIO DISCS, TAPES  
AND PHONOGRAPH RECORDS FEATURING MU-  
SIC, AND AUDIO RECORDINGS FEATURING MU-  
SIC DOWNLOADABLE VIA A GLOBAL  
COMPUTER NETWORK, IN CLASS 9 (U.S. CLS. 21,  
23, 26, 36 AND 38).

FIRST USE 8-21-2007; IN COMMERCE 8-21-2007.

FOR: POSTERS AND STICKERS, IN CLASS 16  
(U.S. CLS. 2, 5, 22, 23, 29, 37, 38 AND 50).

FIRST USE 8-22-2007; IN COMMERCE 8-22-2007.

FOR: CLOTHING; NAMELY, T-SHIRTS, SWEAT-  
SHIRTS, POLO SHIRTS, SPORT SHIRTS, JACKETS,

CAPS, AND JERSEYS, IN CLASS 25 (U.S. CLS. 22  
AND 39).

FIRST USE 8-22-2007; IN COMMERCE 8-22-2007.

FOR: ENTERTAINMENT SERVICES, NAMELY,  
PRODUCTION OF VIDEO AND AUDIO RECORD-  
INGS FEATURING MUSIC; AND PROVIDING PRE-  
RECORDED MUSIC AND VIDEO ONLINE VIA A  
GLOBAL COMPUTER NETWORK, IN CLASS 41  
(U.S. CLS. 100, 101 AND 107).

FIRST USE 8-20-2007; IN COMMERCE 8-20-2007.

NO CLAIM IS MADE TO THE EXCLUSIVE  
RIGHT TO USE "RECORDS", APART FROM THE  
MARK AS SHOWN.

SN 76-472,904, FILED 12-9-2002.

BRENDAN REGAN, EXAMINING ATTORNEY



**Int. Cl.: 25**

**Prior U.S. Cls.: 22 and 39**

**United States Patent and Trademark Office**

**Reg. No. 3,395,213**

**Registered Mar. 11, 2008**

**TRADEMARK  
PRINCIPAL REGISTER**

**"AND AS SHE BELIEVES, SO IT IS FOR HER"**

GIRL POWER, INC. (FLORIDA CORPORATION)  
P.O. BOX 237624  
COCOA, FL 32923

FOR: WOMENS AND CHILDREN'S CLOTHING,  
NAMELY, T-SHIRTS, TANK, TOPS, SWEATSHIRTS,  
BLOUSES, JACKETS, KNIT SHIRTS, SHORTS,  
SLACKS, JEANS, SWEATPANTS, SWIMWEAR, LIN-  
GERIE, BRAS, PANTIES ETC, SLEEPWEAR, LOUN-  
GEWEAR, SOCKS, GLOVES; FOOTWEAR,

NAMELY, WOMENS AND CHILDRENS SHOES,  
SANDALS; HEADWEAR, NAMELY HATS, CAPS,  
AND SUN VISORS, IN CLASS 25 (U.S. CLS. 22 AND  
39).

FIRST USE 11-23-2007; IN COMMERCE 11-23-2007.

SN 76-488,857, FILED 2-6-2003.

DOMINICK J. SALEMI, EXAMINING ATTORNEY

**Int. Cl.: 30**

**Prior U.S. Cl.: 46**

**United States Patent and Trademark Office**

**Reg. No. 3,395,214**

**Registered Mar. 11, 2008**

**TRADEMARK  
PRINCIPAL REGISTER**

**EATING RIGHT**

SAFEWAY INC. (DELAWARE CORPORATION)  
5918 STONERIDGE MALL ROAD  
PLEASANTON, CA 945882322

FIRST USE 3-28-2004; IN COMMERCE 3-28-2004.

FOR: PREPARED FOODS, FROZEN ENTREES,  
DELI, BAKERY AND SNACK GOODS, NAMELY,  
BISCUITS, COOKIES, FROZEN LASAGNA AND  
FROZEN CANNOLLI, IN CLASS 30 (U.S. CL. 46).

SN 76-492,812, FILED 2-26-2003.

SUE LAWRENCE, EXAMINING ATTORNEY

Prior U.S. Cl.: B

United States Patent and Trademark Office

Reg. No. 3,395,215

Registered Mar. 11, 2008

**CERTIFICATION MARK  
SERVICES  
PRINCIPAL REGISTER**

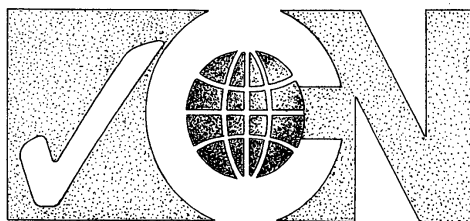

INTERNATIONAL CYANIDE MANAGEMENT  
INSTITUTE (CALIFORNIA NON-MEMBER,  
NON-PROFIT CORPORATION)  
1200 G STREET, NW  
SUITE 800  
WASHINGTON, DC 20005

FOR: PRODUCTION AND DISTRIBUTION OF  
CYANIDE; USE OF CYANIDE IN THE RECOVERY  
OF GOLD, IN CLASS B (U.S. CL. B).

FIRST USE 10-0-2007; IN COMMERCE 10-0-2007.

THE STIPPLING IN THE DRAWING IS FOR  
SHADING PURPOSES ONLY.

THE CERTIFICATION MARK, AS INTENDED TO  
BE USED BY AUTHORIZED PERSONS, CERTIFIES  
THAT THE PRODUCTION AND DISTRIBUTION OF  
CYANIDE, AND THE USE OF CYANIDE IN THE  
RECOVERY OF GOLD, WAS PROPERLY CARRIED  
OUT IN ACCORDANCE WITH THE INTERNA-  
TIONAL CYANIDE MANAGEMENT CODE.

SN 76-493,276, FILED 2-27-2003.

INGA ERVIN, EXAMINING ATTORNEY

**Int. Cl.: 9**

**Prior U.S. Cls.: 21, 23, 26, 36, and 38**

**United States Patent and Trademark Office**

**Reg. No. 3,395,216**

**Registered Mar. 11, 2008**

**TRADEMARK  
PRINCIPAL REGISTER**

**HOT EYE**

NIGHT VISION TECHNOLOGIES, INC. (TEXAS  
CORPORATION)  
SUITE 101  
1119 LUKE STREET  
IRVING, TX 750604003

FOR: INTEGRATED NIGHT VISION SYSTEMS,  
COMPRISING VIDEO CAMERA, VIDEO DISPLAYS

AND SPOT LIGHTS, IN CLASS 9 (U.S. CLS. 21, 23, 26,  
36 AND 38).

FIRST USE 9-19-2007; IN COMMERCE 9-19-2007.

SN 76-496,860, FILED 2-26-2003.

DAVID H. STINE, EXAMINING ATTORNEY

**Int. Cl.: 31**

**Prior U.S. Cls.: 1 and 46**

**United States Patent and Trademark Office**

**Reg. No. 3,395,217**

**Registered Mar. 11, 2008**

**TRADEMARK  
PRINCIPAL REGISTER**

**FETCH IT! STICKS**

THREE DOG BAKERY, INC. (DELAWARE COR-  
PORATION)  
1843 N. TOPPING AVE.  
KANSAS CITY, MO 64120

NO CLAIM IS MADE TO THE EXCLUSIVE  
RIGHT TO USE "STICKS" , APART FROM THE  
MARK AS SHOWN.

FOR: EDIBLE DOG TREATS, IN CLASS 31 (U.S.  
CLS. 1 AND 46).

SN 76-510,532, FILED 5-1-2003.

FIRST USE 6-0-2003; IN COMMERCE 6-0-2003.

AMY ALFIERI, EXAMINING ATTORNEY

**Int. Cl.: 9**

**Prior U.S. Cls.: 21, 23, 26, 36, and 38**

**United States Patent and Trademark Office**

**Reg. No. 3,395,218**

**Registered Mar. 11, 2008**

---

**TRADEMARK  
PRINCIPAL REGISTER**

**RIOT BOY**

REEVES, MICHAEL MORGAN (UNITED STATES  
INDIVIDUAL)  
2840 SHANANDALE DR.  
SILVER SPRING, MD 20904

FIRST USE 8-4-1993; IN COMMERCE 2-4-2007.

SN 76-511,015, FILED 4-16-2003.

FOR: PRERECORDED CD'S FEATURING MU-  
SIC, IN CLASS 9 (U.S. CLS. 21, 23, 26, 36 AND 38).

LINDA E. BLOHM, EXAMINING ATTORNEY

**Int. Cl.: 5**

**Prior U.S. Cls.: 6, 18, 44, 46, 51, and 52**

**United States Patent and Trademark Office**

**Reg. No. 3,395,219**

**Registered Mar. 11, 2008**

**TRADEMARK  
PRINCIPAL REGISTER**

**IF THE PROCEDURE IS MINIMALLY INVASIVE, BLEEDING  
CONTROL MUST BE NON-INVASIVE**

MARINE POLYMER TECHNOLOGIES, INC. (DE-  
LAWARE CORPORATION)  
107 WATER STREET  
DANVERS, MA 01923

FIRST USE 11-0-2006; IN COMMERCE 11-0-2006.

SN 76-520,394, FILED 6-5-2003.

FOR: PHARMACEUTICAL AGENT USED TO  
STOP BLEEDING, PROMOTE WOUND CLOSURE  
AND AID IN WOUND HEALING, IN CLASS 5 (U.S.  
CLS. 6, 18, 44, 46, 51 AND 52).

DAVID TOOLEY, EXAMINING ATTORNEY

**Int. Cl.: 5**

**Prior U.S. Cls.: 6, 18, 44, 46, 51, and 52**

**United States Patent and Trademark Office**

**Reg. No. 3,395,220**

**Registered Mar. 11, 2008**

**TRADEMARK  
PRINCIPAL REGISTER**

**WHEN PRESSED FOR TIME, ONLY HEMOSTASIS MATTERS**

MARINE POLYMER TECHNOLOGIES, INC. (DE-  
LAWARE CORPORATION)  
107 WATER STREET  
DANVERS, MA 01923

FIRST USE 11-0-2006; IN COMMERCE 11-0-2006.

SN 76-520,395, FILED 6-5-2003.

FOR: PHARMACEUTICAL AGENT USED TO  
STOP BLEEDING, PROMOTE WOUND CLOSURE  
AND AID IN WOUND HEALING, IN CLASS 5 (U.S.  
CLS. 6, 18, 44, 46, 51 AND 52).

ESTHER A. BORSUK, EXAMINING ATTORNEY



**Int. Cl.: 36**

**Prior U.S. Cls.: 100, 101, and 102**

**United States Patent and Trademark Office**

**Reg. No. 3,395,221**

**Registered Mar. 11, 2008**

**SERVICE MARK  
PRINCIPAL REGISTER**

**SELF COMPLETING PENSION PLAN**

TAX AWARENESS PLANNING, INC. (TEXAS  
CORPORATION)  
1600 HIGHWAY 6 SOUTH, SUITE 270  
SUGAR LAND, TX 77478

FOR: CONSULTING SERVICES IN THE FIELD  
OF SPECIALIZED RETIREMENT PLANS FOR OTH-  
ERS, IN CLASS 36 (U.S. CLS. 100, 101 AND 102).

FIRST USE 1-31-2004; IN COMMERCE 1-31-2004.

NO CLAIM IS MADE TO THE EXCLUSIVE  
RIGHT TO USE "PENSION PLAN", APART FROM  
THE MARK AS SHOWN.

SN 76-522,813, FILED 6-16-2003.

CHRISTOPHER BUONGIORNO, EXAMINING AT-  
TORNEY

**Int. Cl.: 16**

**Prior U.S. Cls.: 2, 5, 22, 23, 29, 37, 38, and 50**

**United States Patent and Trademark Office**

**Reg. No. 3,395,222**

**Registered Mar. 11, 2008**

**TRADEMARK  
PRINCIPAL REGISTER**

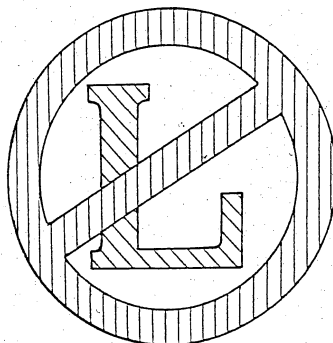

KENNING, D. SCOTT (UNITED STATES INDIVIDUAL)

P.O. BOX 6064

PITTSBURGH, PA 15211

FOR: PAPER PRODUCTS, NAMELY, PAPER NAPKINS, PAPER CUPS, PAPER PLATES, PAPER BOWLS, WRAPPING PAPER, PAPER BOXES, STATIONERY AND GREETING CARDS, IN CLASS 16 (U.S. CLS. 2, 5, 22, 23, 29, 37, 38 AND 50).

FIRST USE 11-19-2007; IN COMMERCE 11-19-2007.

NO CLAIM IS MADE TO THE EXCLUSIVE RIGHT TO USE THE INTERNATIONAL PROHIBITION SYMBOL, APART FROM THE MARK AS SHOWN.

THE MARK CONSISTS OF THE INTERNATIONAL PROHIBITION SYMBOL IN RED CENTERED OVER THE LETTER "L" IN GREEN. COLOR IS CLAIMED AS A FEATURE OF THE MARK.

SN 76-523,791, FILED 6-9-2003.

DOMINICK J. SALEMI, EXAMINING ATTORNEY

**Int. Cls.: 35 and 44**

**Prior U.S. Cls.: 100, 101, and 102**

**United States Patent and Trademark Office**

**Reg. No. 3,395,223**

**Registered Mar. 11, 2008**

**SERVICE MARK  
PRINCIPAL REGISTER**

**LYSODELIVERY**

ADVP MANAGEMENT, L.P. (DELAWARE LIMITED PARTNERSHIP)  
5215 N. O'CONNOR BOULEVARD, SUITE 1600  
IRVING, TX 75039

FOR: RETAIL PHARMACY SERVICES IN THE FIELD OF PHARMACEUTICAL AND BIOTECHNOLOGICAL PRODUCTS USED IN ENZYME REPLACEMENT THERAPY FOR HOSPITALS, PHARMACIES, PHYSICIANS, HOME CARE PROVIDERS AND PATIENTS; BUSINESS ADMINISTRATION AND MANAGEMENT, NAMELY, THE COORDINATION OF THE PROCUREMENT AND DISTRIBUTION OF PHARMACEUTICALS, BIOTECHNOLOGICAL PRODUCTS, AND HOME HEALTH CARE SERVICES ON BEHALF OF PA-

TIENTS UNDERGOING ENZYME REPLACEMENT THERAPY, IN CLASS 35 (U.S. CLS. 100, 101 AND 102).

FIRST USE 9-0-2003; IN COMMERCE 9-0-2003.

FOR: PROVIDING MEDICAL INFORMATION AND PHARMACY AND MEDICAL TREATMENT COUNSELING FOR PATIENTS UNDERGOING ENZYME REPLACEMENT THERAPY, IN CLASS 44 (U.S. CLS. 100 AND 101).

FIRST USE 9-0-2003; IN COMMERCE 9-0-2003.

SN 76-529,449, FILED 7-15-2003.

JOHN GARTNER, EXAMINING ATTORNEY

**Int. Cl.: 10**

**Prior U.S. Cls.: 26, 39, and 44**

**United States Patent and Trademark Office**

**Reg. No. 3,395,224**

**Registered Mar. 11, 2008**

---

**TRADEMARK  
PRINCIPAL REGISTER**

**5MP**

RAMVAC DENTAL PRODUCTS, INC. (SOUTH  
DAKOTA CORPORATION)  
3100 FIRST AVENUE  
SPEARFISH, SD 57783

FIRST USE 6-1-2005; IN COMMERCE 6-1-2005.

SN 76-531,441, FILED 7-22-2003.

FOR: DENTAL PRODUCTS, NAMELY, VACUUM  
PUMP FILTERS, IN CLASS 10 (U.S. CLS. 26, 39 AND  
44).

CAROLINE WOOD, EXAMINING ATTORNEY

**Int. Cl.: 25**

**Prior U.S. Cls.: 22 and 39**

**United States Patent and Trademark Office**

**Reg. No. 3,395,225**

**Registered Mar. 11, 2008**

**TRADEMARK  
PRINCIPAL REGISTER**

**Vēba**

2022283 ONTARIO, INC. (CANADA CORPORATION)  
150 SPINNAKER WAY, UNIT 3  
CONCORD, ONTARIO, CANADA L4K 4M1

PRIORITY CLAIMED UNDER SEC. 44(D) ON  
CANADA APPLICATION NO. 1,165,475, FILED 1-23-  
2003, REG. NO. TMA659628, DATED 2-22-2006, EX-  
PIRES 2-22-2021.

FOR: SOCKS, IN CLASS 25 (U.S. CLS. 22 AND 39).

SN 76-531,821, FILED 7-23-2003.

FIRST USE 5-10-2007; IN COMMERCE 5-10-2007.

DAWN FELDMAN, EXAMINING ATTORNEY

**Int. Cls.: 37, 41, and 42**

**Prior U.S. Cls.: 100, 101, 103, 106, and 107**

**United States Patent and Trademark Office**

**Reg. No. 3,395,226**

**Registered Mar. 11, 2008**

**SERVICE MARK  
PRINCIPAL REGISTER**

**BIOPHARM-ALLIANCE**

SARTORIUS STEDIM BIOTECH GMBH (FED REP GERMANY CORPORATION)  
AUGUST-SPINDLER-STRASSE 11  
GOTTINGEN, FED REP GERMANY 37079

FOR: INSTALLATION AND REPAIR OF MEMBRANE-BASED FILTRATION EQUIPMENT, MEMBRANE-BASED FERMENTATION EQUIPMENT IN THE FOOD AND BEVERAGE INDUSTRY AND MEMBRANE-BASED BIOREACTORS FOR CELL CULTIVATION, IN CLASS 37 (U.S. CLS. 100, 103 AND 106).

FIRST USE 10-15-2003; IN COMMERCE 10-15-2003.

FOR: ARRANGING AND CONDUCTING TECHNOLOGICAL SEMINARS IN THE FIELD OF CHEMICAL AND BIOCHEMICAL SEPARATIONS BY POROUS MEMBRANE FILTERS, IN CLASS 41 (U.S. CLS. 100, 101 AND 107).

FIRST USE 10-15-2003; IN COMMERCE 10-15-2003.

FOR: FERMENTATION RESEARCH FOR OTHERS; PHARMACEUTICAL DRUG DEVELOPMENT SERVICES; COMPUTER PROGRAMMING AND CONSULTING, COMPUTER SOFTWARE DESIGN AND CONSULTING, ALL FOR OTHERS; TECHNOLOGY SUPERVISION AND INSPECTION IN THE FIELD OF QUALITY CONTROL OPTIMIZATION FOR OTHERS IN THE FORM OF GUIDANCE IN CORRECTIVE ACTIONS, PROCESS OPTIMIZATION, DEVELOPMENT SUPPORT, DESIGN REVIEW, TECHNOLOGY TRANSFER, DOCUMENTATION OF OPTIMIZATION, AND REGULATORY COMPLIANCE; REVIEWING STANDARDS AND PRACTICES TO ASSURE COMPLIANCE WITH FOOD AND DRUG LAWS AND REGULATIONS RELATING TO COMPLIANCE AUDITS, READINESS FOR FDA INSPECTIONS,

PLANT/PROCESS SURVEYS, VALIDATION SURVEYS, QUALITY SYSTEM SURVEYS, TECHNICAL AUDITS, DESIGNING VALIDATION STUDIES, PRE-APPROVAL INSPECTION AND PREPARATION, POST-APPROVAL CHANGES, 21 CFR SECTION 11/GAMP COMPLIANCE, EQUIPMENT QUALIFICATION, FILTER/CLEANING/PROCESS VALIDATION, AND EXTRACTABLE/LEACHABLE TESTING; LEGAL SERVICES IN THE NATURE OF REGULATORY LIAISON SERVICES; CALIBRATION AND STANDARDIZATION OF MEMBRANE-BASED FILTRATION EQUIPMENT, MEMBRANE-BASED FERMENTATION EQUIPMENT IN THE FOOD AND BEVERAGE INDUSTRIES AND MEMBRANE-BASED BIOREACTORS FOR CELL CULTIVATION; TESTING OF MEMBRANE-BASED FILTRATION EQUIPMENT, MEMBRANE-BASED FERMENTATION EQUIPMENT IN THE FOOD AND BEVERAGE INDUSTRIES AND MEMBRANE-BASED BIOREACTORS FOR CELL CULTIVATION; TESTING OF MEMBRANE-BASED FILTRATION EQUIPMENT, MEMBRANE-BASED FERMENTATION EQUIPMENT IN THE FOOD AND BEVERAGE INDUSTRIES AND MEMBRANE-BASED BIOREACTORS FOR CELL CULTIVATION FOR OTHERS FOR THE PURPOSE OF CERTIFICATION, IN CLASS 42 (U.S. CLS. 100 AND 101).

FIRST USE 10-15-2003; IN COMMERCE 10-15-2003.

PRIORITY CLAIMED UNDER SEC. 44(D) ON FED REP GERMANY APPLICATION NO. DE30318610.0, FILED 4-9-2003.

SN 76-532,676, FILED 7-16-2003.

KRISTINA MORRIS, EXAMINING ATTORNEY

**Int. Cl.: 28**

**Prior U.S. Cls.: 22, 23, 38, and 50**

**United States Patent and Trademark Office**

**Reg. No. 3,395,227**

**Registered Mar. 11, 2008**

---

**TRADEMARK  
PRINCIPAL REGISTER**

**POWER LEGS**

ALL PRO EXERCISE PRODUCTS, INC. (FLORIDA CORPORATION)  
P.O. BOX 8268  
LONGBOAT KEY, FL 34228

NO CLAIM IS MADE TO THE EXCLUSIVE RIGHT TO USE "LEGS", APART FROM THE MARK AS SHOWN.

FOR: WEIGHT ADJUSTABLE LEG WEIGHTS, IN CLASS 28 (U.S. CLS. 22, 23, 38 AND 50).

SN 76-536,372, FILED 7-31-2003.

FIRST USE 7-6-2007; IN COMMERCE 7-6-2007.

ANGELA GAW, EXAMINING ATTORNEY

**Int. Cl.: 9**

**Prior U.S. Cls.: 21, 23, 26, 36, and 38**

**Reg. No. 3,395,228**

**United States Patent and Trademark Office**

**Registered Mar. 11, 2008**

---

**TRADEMARK  
PRINCIPAL REGISTER**

**EM1**

RAZAVI APPLICATION DEVELOPERS, INC.  
(VIRGINIA CORPORATION)  
14489 STORE HOUSE DRIVE  
CENTREVILLE, VA 20121

TERS, WEATHER, FLOODING, FIRE, RELEASE  
OF HAZARDOUS MATERIALS, DISRUPTION OF  
SERVICES AND CIVIL UNREST, IN CLASS 9 (U.S.  
CLS. 21, 23, 26, 36 AND 38).

FOR: COMPUTER SOFTWARE THAT ASSISTS  
GOVERNMENT AGENCIES PLAN AND PLAN FOR  
EVENTS, NAMELY DEMONSTRATIONS AND IN-  
FRASTRUCTURE CLOSINGS AND RESTRICTIONS  
AND STREET CLOSINGS AND RESTRICTIONS,  
AND TO RESPOND TO EVENTS, NAMELY EMER-  
GENCIES AND ACCIDENTS, NATURAL DISAS-

FIRST USE 10-19-2007; IN COMMERCE 10-19-2007.

SN 76-536,594, FILED 7-2-2003.

DEZMONA MIZELLE, EXAMINING ATTORNEY



**Int. Cl.: 41**

**Prior U.S. Cls.: 100, 101, and 107**

**United States Patent and Trademark Office**

**Reg. No. 3,395,229**

**Registered Mar. 11, 2008**

---

**SERVICE MARK  
PRINCIPAL REGISTER**

**WORLD SERIES OF PROFESSIONAL LADIES' GOLF**

WORLD SERIES OF GOLF INC. (NEVADA CORPORATION)  
1613 NIGHT WIND DRIVE  
LAS VEGAS, NV 89117

NO CLAIM IS MADE TO THE EXCLUSIVE RIGHT TO USE "PROFESSIONAL LADIES' GOLF", APART FROM THE MARK AS SHOWN.

FOR: ORGANIZING AND CONDUCTING A SERIES OF PROFESSIONAL LADIES' GOLF TOURNAMENTS, IN CLASS 41 (U.S. CLS. 100, 101 AND 107).

SN 76-536,845, FILED 8-12-2003.

FIRST USE 1-1-2007; IN COMMERCE 1-1-2007.

ESTHER A. BORSUK, EXAMINING ATTORNEY

**Int. Cl.: 41**

**Prior U.S. Cls.: 100, 101, and 107**

**United States Patent and Trademark Office**

**Reg. No. 3,395,230**

**Registered Mar. 11, 2008**

**SERVICE MARK  
PRINCIPAL REGISTER**

**WORLD SERIES OF PROFESSIONAL MEN'S GOLF**

WORLD SERIES OF GOLF INC. (NEVADA CORPORATION)  
1613 NIGHT WIND DRIVE  
LAS VEGAS, NV 89117

NO CLAIM IS MADE TO THE EXCLUSIVE RIGHT TO USE "PROFESSIONAL MEN'S GOLF", APART FROM THE MARK AS SHOWN.

FOR: ORGANIZING AND CONDUCTING A SERIES OF PROFESSIONAL MEN'S GOLF TOURNAMENTS, IN CLASS 41 (U.S. CLS. 100, 101 AND 107).

SN 76-536,846, FILED 8-12-2003.

FIRST USE 1-1-2007; IN COMMERCE 1-1-2007.

ESTHER A. BORSUK, EXAMINING ATTORNEY

**Int. Cl.: 1**

**Prior U.S. Cls.: 1, 5, 6, 10, 26, and 46**

**United States Patent and Trademark Office**

**Reg. No. 3,395,231**

**Registered Mar. 11, 2008**

**TRADEMARK  
PRINCIPAL REGISTER**

**EARTH HELPER**

PIKE NURSERY HOLDING LLC (GEORGIA LTD  
LIAB CO)  
C/O ROARK CAPITAL GROUP INC.  
1170 PEACHTREE ST. SUITE 1825M  
ATLANTA, GA 30309

OWNER OF U.S. REG. NO. 1,784,333.

SEC. 2(F) AS TO "EARTH".

FOR: SOIL CONDITIONERS FOR DOMESTIC  
AND HORTICULTURAL USE, IN CLASS 1 (U.S.  
CLS. 1, 5, 6, 10, 26 AND 46).

SN 76-541,603, FILED 8-25-2003.

FIRST USE 7-27-1993; IN COMMERCE 7-27-1993.

CURTIS FRENCH, EXAMINING ATTORNEY

**Int. Cl.: 31**

**Prior U.S. Cls.: 1 and 46**

**United States Patent and Trademark Office**

**Reg. No. 3,395,232**

**Registered Mar. 11, 2008**

**TRADEMARK  
PRINCIPAL REGISTER**

**FIT BITS**

NATURE'S ANIMALS, INC. (DELAWARE CORPORATION)  
628 WAVERLY AVENUE  
MAMARONECK, NY 10543

FOR: DOG BISCUITS, IN CLASS 31 (U.S. CLS. 1 AND 46).

FIRST USE 8-1-2007; IN COMMERCE 8-1-2007.

NO CLAIM IS MADE TO THE EXCLUSIVE RIGHT TO USE "BITS" , APART FROM THE MARK AS SHOWN.

SN 76-546,261, FILED 9-22-2003.

KARANENDRA S. CHHINA, EXAMINING ATTORNEY

**Int. Cl.: 1**

**Prior U.S. Cls.: 1, 5, 6, 10, 26, and 46**

**United States Patent and Trademark Office**

**Reg. No. 3,395,233**

**Registered Mar. 11, 2008**

**TRADEMARK  
PRINCIPAL REGISTER**

**SOFTSHELL**

BROWN, NICHOLAS (UNITED KINGDOM INDIVIDUAL)  
C/O NIKWAX LTD  
UNIT F, DURGATES INDUSTRIAL ESTATE  
WADHURST, EAST SUSSEX, UNITED KINGDOM  
TN5 6DF

FOR: WATERPROOFING COMPOSITIONS FOR FABRIC AND LEATHER; CHEMICAL COMPOSITIONS FOR WATERPROOFING FABRIC AND LEATHER; PREPARATIONS FOR WATERPROOFING LEATHER, FABRICS, CLOTHING, DOWN, FEATH-

ERS AND FIBROUS MATERIALS, IN CLASS 1 (U.S. CLS. 1, 5, 6, 10, 26 AND 46).

FIRST USE 8-0-2003; IN COMMERCE 8-0-2003.

PRIORITY CLAIMED UNDER SEC. 44(D) ON ERPN CMNTY TM OFC APPLICATION NO. 3152972, FILED 5-2-2003.

SN 76-546,687, FILED 9-22-2003.

CAROLYN CATALDO, EXAMINING ATTORNEY

**Int. Cl.: 9**

**Prior U.S. Cls.: 21, 23, 26, 36, and 38**

**Reg. No. 3,395,234**

**United States Patent and Trademark Office**

**Registered Mar. 11, 2008**

**TRADEMARK  
PRINCIPAL REGISTER**



**STREAMER**

THE BRIX GROUP, INC. (CALIFORNIA CORPORATION)  
541 DIVISION STREET  
CAMPBELL, CA 95008

FIRST USE 10-13-2003; IN COMMERCE 10-13-2003.

NO CLAIM IS MADE TO THE EXCLUSIVE RIGHT TO USE "STREAMER", APART FROM THE MARK AS SHOWN.

FOR: EQUIPMENT FOR RECEIVING BROADCAST RADIO TRANSMISSIONS, NAMELY, RADIOS, TUNERS, DECODERS, DEMODULATORS, RECEIVERS AND ANTENNAS, IN CLASS 9 (U.S. CLS. 21, 23, 26, 36 AND 38).

SN 76-546,709, FILED 8-29-2003.

JENNIFER VASQUEZ, EXAMINING ATTORNEY

**Int. Cl.: 41**

**Prior U.S. Cls.: 100, 101, and 107**

**United States Patent and Trademark Office**

**Reg. No. 3,395,235**

**Registered Mar. 11, 2008**

**SERVICE MARK  
PRINCIPAL REGISTER**

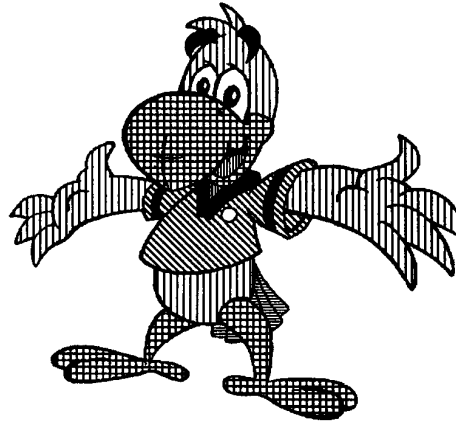

HETZEL ENTERTAINMENT, LLC (TENNESSEE  
LTD LIAB CO)  
1918 BLAIR BOULEVARD  
NASHVILLE, TN 37212

THE MARK CONSISTS OF A STYLIZED DEPICTION OF A RED BIRD, WITH A YELLOW BEAK AND LEGS, A BLUE TAIL, AND A GREEN SHIRT WITH YELLOW TRIM.

FOR: ENTERTAINMENT SERVICES, NAMELY, A TELEVISION PROGRAM SERIES FOR CHILDREN AND YOUNG ADULTS, IN CLASS 41 (U.S. CLS. 100, 101 AND 107).

SN 76-551,090, FILED 9-23-2003.

FIRST USE 8-30-2007; IN COMMERCE 8-30-2007.

LAURA KOVALSKY, EXAMINING ATTORNEY

**Int. Cl.: 5**

**Prior U.S. Cls.: 6, 18, 44, 46, 51, and 52**

**United States Patent and Trademark Office**

**Reg. No. 3,395,236**

**Registered Mar. 11, 2008**

**TRADEMARK  
PRINCIPAL REGISTER**

**CHRONOMETRIC SYSTEM**

DRUGTECH CORPORATION (DELAWARE CORPORATION)  
300 DELAWARE AVENUE, SUITE 1270  
WILMINGTON, DE 19801

FOR: NUTRITIONAL SUPPLEMENTS; VITAMINS AND PHARMACEUTICAL AND THERAPEUTIC SUBSTANCES FOR THE TREATMENT OF A WIDE VARIETY OF ILLNESSES, DISEASES AND MEDICAL CONDITIONS, NAMELY, HORMONES, ANALGESICS, ELECTROLYTES, ANTI-INFECTIVES, CARDIOVASCULAR AGENTS, FERTILITY AGENTS, BIRTH CONTROL AGENTS, NEONATAL AGENTS, OSTEOPORETIC, ANTI-AGING AGENT, ANTI-SENILITY AGENTS, AND ANTI-NAUSEA AGENTS, ALL FOR USE IN THE TREATMENT OF MORNING SICKNESS, HORMONE REPLACEMENT, INFLAMMATION, MUSCLE PAIN, ARTHRITIS, MIGRAINES, HYPOKALEMIA,

DEHYDRATION, FUNGAL AND MICROBIAL INFECTIONS, VIRALOGICAL INFECTIONS, HYPERTENSION, CIRCULATION DISEASES, INFERTILITY, CONCEPTION, OSTEOPOROSIS, ALZHEIMERS, AND DEMENTIA, SCHIZOPHRENIA, PANIC DISORDERS, CENTRAL NERVOUS SYSTEM DISEASES, AND TREMORS, IN CLASS 5 (U.S. CLS. 6, 18, 44, 46, 51 AND 52).

FIRST USE 9-20-2004; IN COMMERCE 9-20-2004.

NO CLAIM IS MADE TO THE EXCLUSIVE RIGHT TO USE "SYSTEM", APART FROM THE MARK AS SHOWN.

SN 76-555,249, FILED 10-30-2003.

SOPHIA S. KIM, EXAMINING ATTORNEY



**Int. Cl.: 35**

**Prior U.S. Cls.: 100, 101, and 102**

**United States Patent and Trademark Office**

**Reg. No. 3,395,237**

**Registered Mar. 11, 2008**

---

**SERVICE MARK  
PRINCIPAL REGISTER**

**GARNET HILL KIDS**

GARNET HILL, INC. (NEW HAMPSHIRE CORPORATION)  
1 HSN DRIVE  
ST. PETERSBURG, FL 33729

OWNER OF U.S. REG. NO. 1,829,433.

FOR: RETAIL MAIL ORDER CATALOG SERVICES AND ON-LINE RETAIL STORE SERVICES FEATURING CLOTHES, FURNITURE AND BED AND BATH PRODUCTS, IN CLASS 35 (U.S. CLS. 100, 101 AND 102).

NO CLAIM IS MADE TO THE EXCLUSIVE RIGHT TO USE "KIDS", APART FROM THE MARK AS SHOWN.

SN 76-555,308, FILED 10-10-2003.

FIRST USE 1-20-2006; IN COMMERCE 1-20-2006.

BILL DAWE, EXAMINING ATTORNEY

**Int. Cl.: 3**

**Prior U.S. Cls.: 1, 4, 6, 50, 51, and 52**

**United States Patent and Trademark Office**

**Reg. No. 3,395,238**

**Registered Mar. 11, 2008**

**TRADEMARK  
PRINCIPAL REGISTER**

**TATTOO-EZE**

HANSEN, DALE (UNITED STATES INDIVIDUAL)  
4630 N.E. 190TH LANE  
PORTLAND, OR 97230

FIRST USE 7-5-2007; IN COMMERCE 7-5-2007.

SN 76-555,519, FILED 10-31-2003.

FOR: LOTIONS AND GELS CONTAINING ALOE  
OR SKIN MOISTURIZERS, IN CLASS 3 (U.S. CLS. 1,  
4, 6, 50, 51 AND 52).

GIANCARLO CASTRO, EXAMINING ATTORNEY

**Int. Cl.: 9**

**Prior U.S. Cls.: 21, 23, 26, 36, and 38**

**United States Patent and Trademark Office**

**Reg. No. 3,395,239**

**Registered Mar. 11, 2008**

**TRADEMARK  
PRINCIPAL REGISTER**

**MULTIFORMAT ENGINE UNIT**

SONY KABUSHIKI KAISHA (JAPAN CORPORATION), TA SONY CORPORATION,  
1-7-1 KONAN, MINATO-KU  
TOKYO, JAPAN

FOR: VIDEO MONITORS, IN CLASS 9 (U.S. CLS. 21, 23, 26, 36 AND 38).

FIRST USE 9-30-2003; IN COMMERCE 9-30-2003.

THE MARK CONSISTS OF STANDARD CHARACTERS WITHOUT CLAIM TO ANY PARTICULAR FONT, STYLE, SIZE, OR COLOR.

PRIORITY CLAIMED UNDER SEC. 44(D) ON JAPAN APPLICATION NO. 2003037471, FILED 5-9-2003, REG. NO. 4724179, DATED 11-7-2003, EXPIRES 11-7-2013.

NO CLAIM IS MADE TO THE EXCLUSIVE RIGHT TO USE "MULTIFORMAT", APART FROM THE MARK AS SHOWN.

SN 76-559,819, FILED 10-30-2003.

WILLIAM P. SHANAHAN, EXAMINING ATTORNEY

**Int. Cl.: 41**

**Prior U.S. Cls.: 100, 101, and 107**

**United States Patent and Trademark Office**

**Reg. No. 3,395,240**

**Registered Mar. 11, 2008**

**SERVICE MARK  
PRINCIPAL REGISTER**

**DRA. ISABEL**

BASSOLS, ISABEL GOMEZ (UNITED STATES  
INDIVIDUAL)  
5851 N. BAYSHORE DRIVE  
MIAMI, FL 33137

FOR: ENTERTAINMENT SERVICES, NAMELY, A  
SYNDICATED RADIO TALK SHOW CONSISTING  
OF MEDICAL AND SOCIAL COMMENTARY, IN  
CLASS 41 (U.S. CLS. 100, 101 AND 107).

FIRST USE 1-3-1997; IN COMMERCE 1-3-1997.

THE MARK CONSISTS OF STANDARD CHAR-  
ACTERS WITHOUT CLAIM TO ANY PARTICULAR  
FONT, STYLE, SIZE, OR COLOR.

THE NAME "DRA. ISABEL" IDENTIFIES A LIV-  
ING INDIVIDUAL WHOSE CONSENT IS OF RE-  
CORD.

SN 76-560,640, FILED 11-18-2003.

SUSAN STIGLITZ, EXAMINING ATTORNEY

**Int. Cl.: 11**

**Prior U.S. Cls.: 13, 21, 23, 31, and 34**

**United States Patent and Trademark Office**

**Reg. No. 3,395,241**

**Registered Mar. 11, 2008**

**TRADEMARK  
PRINCIPAL REGISTER**

**VASTU**

EK2, LLC (DELAWARE LTD LIAB CO), DBA  
VASTU,  
1829 14TH STREET, N.W.  
WASHINGTON, DC 20009

FOR: LAMPS AND LAMP SHADES; ELECTRIC LANTERNS; FLUORESCENT LAMPS, GAS AND OIL LAMPS, INFRARED LAMPS, INFRARED LAMP AND LIGHTING FIXTURES, AND ARC LAMPS; ELECTRIC LIGHTING FIXTURES; SCONCE LIGHTING FIXTURES; ELECTRIC LUMINAIRES; ELECTRIC NIGHT LIGHTS; FIXTURES FOR INCANDESCENT LIGHT BULBS; CHEMICALLY-ACTIVATED LIGHT STICKS; WALL LIGHTS; ELECTRIC, HALOGEN AND INCANDESCENT LIGHT BULBS; FLUORESCENT LIGHTING TUBES; FLASHLIGHTS AND FLASHLIGHT POINTERS; PEN LIGHTS; HIGH INTENSITY SEARCH LIGHTS; BICYCLE LAMPS; ELECTRIC HOLIDAY LIGHTS; ELECTRIC CANDLES; ELECTRIC CANDELABRAS; ELECTRIC AIR DEODORIZERS; ELECTRIC FRAGRANCE DISPENSERS, ELECTRIC PLUG-IN DISPENSERS FOR AIR FRESHENERS AND DEODORIZERS; FRAGRANCE DISPENSING UNIT WHICH ALSO FEATURES A NIGHT LIGHT; ELECTRIC AND BATTERY OPERATED AROMATHERAPY UNITS; ELECTRICALLY-HEATED MUGS; HAND-HELD ELECTRIC HAIR DRYERS; ELECTRIC FANS; ELECTRIC HEATING FANS; PORTABLE ELECTRIC FANS AND HEATERS; ELECTRIC

BLANKETS NOT FOR MEDICAL PURPOSES; HEATING CUSHIONS AND HEATING PADS NOT FOR MEDICAL PURPOSES; ELECTRIC FOOT WARMERS; ELECTRIC TOWEL WARMERS; ELECTRIC HEATERS FOR BABY BOTTLES; DOMESTIC ELECTRIC APPLIANCES AND COOKWARE, NAMELY, FRY PANS, SKILLETS, WOKS, SLOW COOKERS, CASSEROLES, BREAD COOKERS, EGG COOKERS, RICE COOKERS, RICE STEAMERS, YOGURT MAKERS, FOOD STEAMERS AND FOOD WARMERS, HOT PLATES, WAFFLE IRONS AND WAFFLE MAKERS, GRIDDLES, GRILLS, PRESSURE COOKERS, KETTLES, COFFEE MAKERS, COFFEE POTS, COFFEE PERCOLATORS, ESPRESSO MACHINES, COOKING OVENS, TOASTER OVENS, DEEP FRYERS, BROILERS, ROASTERS, ROTISSERIES, RANGES AND STOVES, IN CLASS 11 (U.S. CLS. 13, 21, 23, 31 AND 34).

FIRST USE 4-19-2003; IN COMMERCE 4-19-2003.

THE MARK CONSISTS OF STANDARD CHARACTERS WITHOUT CLAIM TO ANY PARTICULAR FONT, STYLE, SIZE, OR COLOR.

SN 76-563,160, FILED 11-20-2003.

BARBARA A. GOLD, EXAMINING ATTORNEY

**Int. Cl.: 10**

**Prior U.S. Cls.: 26, 39, and 44**

**United States Patent and Trademark Office**

**Reg. No. 3,395,242**

**Registered Mar. 11, 2008**

---

**TRADEMARK  
PRINCIPAL REGISTER**

**NANOSHIELD**

NANOVIBRONIX, INC. (DELAWARE CORPORATION)  
601 CHESTNUT STREET  
CEDARHURST, NY 11516

FIRST USE 6-1-2007; IN COMMERCE 6-1-2007.

SN 76-565,998, FILED 12-18-2003.

FOR: MEDICAL CATHETERS AND CATHETER  
ACCESSORIES, IN CLASS 10 (U.S. CLS. 26, 39 AND  
44).

WON TEAK OH, EXAMINING ATTORNEY

**Int. Cl.: 10**

**Prior U.S. Cls.: 26, 39, and 44**

**United States Patent and Trademark Office**

**Reg. No. 3,395,243**

**Registered Mar. 11, 2008**

---

**TRADEMARK  
PRINCIPAL REGISTER**

**NANOVIBRONIX**

NANOVIBRONIX, INC. (DELAWARE CORPORATION)  
601 CHESTNUT STREET  
CEDARHURST, NY 11516

FIRST USE 6-1-2007; IN COMMERCE 6-1-2007.

SN 76-565,999, FILED 12-18-2003.

FOR: MEDICAL CATHETERS AND CATHETER ACCESSORIES, IN CLASS 10 (U.S. CLS. 26, 39 AND 44).

WON TEAK OH, EXAMINING ATTORNEY

**Int. Cls.: 1, 5, 9, and 10**

**Prior U.S. Cls.: 1, 5, 6, 10, 18, 21, 23, 26, 36, 38, 39, 44,  
46, 51, and 52**

**Reg. No. 3,395,244**

**United States Patent and Trademark Office**

**Registered Mar. 11, 2008**

**TRADEMARK  
PRINCIPAL REGISTER**

**LIGHTSCANNER**

IDAHO TECHNOLOGY, INC. (IDAHO CORPORATION)

390 WAKARA WAY

SALT LAKE CITY, UT 84108

FOR: CHEMICAL PRODUCTS, NAMELY, REAGENTS, BUFFERS AND DIAGNOSTIC PREPARATIONS FOR SCIENTIFIC, RESEARCH AND INDUSTRIAL PURPOSES; CONTROL SOLUTIONS AND CONTROL REAGENTS FOR USE WITH SCIENTIFIC AND RESEARCH APPARATUS, INSTRUMENTS AND DEVICES FOR QUALITY CONTROL AND CALIBRATION PURPOSES; AND KITS COMPRISED OF REAGENTS, BUFFERS AND DIAGNOSTIC PREPARATIONS FOR USE WITH SCIENTIFIC AND RESEARCH APPARATUS, INSTRUMENTS AND DEVICES FOR QUALITY CONTROL AND CALIBRATION PURPOSES, IN CLASS 1 (U.S. CLS. 1, 5, 6, 10, 26 AND 46).

FIRST USE 1-12-2005; IN COMMERCE 1-12-2005.

FOR: REAGENTS, BUFFERS AND IN VITRO DIAGNOSTIC AGENTS FOR MEDICAL, VETERINARY, BIOLOGICAL, PATHOLOGICAL, PHARMACEUTICAL, GENETIC AND ENVIRONMENTAL CLINICAL, DIAGNOSTIC AND LABORATORY USE; CONTROL SOLUTIONS AND CONTROL REAGENTS FOR USE WITH MEDICAL, VETERINARY, BIOLOGICAL, PATHOLOGICAL, PHARMACEUTICAL, GENETIC AND ENVIRONMENTAL CLINICAL, DIAGNOSTIC AND LABORATORY APPARATUS, INSTRUMENTS AND DEVICES FOR MONITORING THE ACCURACY AND PRECISION OF MEDICAL TESTS; AND KITS COMPRISED OF CONTROL SOLUTIONS AND CONTROL REAGENTS FOR MONITORING THE

ACCURACY AND PRECISION OF MEDICAL TESTS, IN CLASS 5 (U.S. CLS. 6, 18, 44, 46, 51 AND 52).

FIRST USE 1-12-2005; IN COMMERCE 1-12-2005.

FOR: LABORATORY APPARATUS, INSTRUMENTS AND DEVICES FOR ANALYZING NUCLEIC ACID, CELLS, GENES AND BIOLOGICAL SAMPLES, NAMELY, DIGITAL IMAGING DEVICES COMPRISING FLUORIMETERS USED TO RECORD FLUORESCENCE SIGNALS AND PRODUCE DIGITAL DATA, THERMAL CONTROL ELEMENTS FOR HEATING AND COOLING, LIGHT EMITTERS SUCH AS LASERS AND LIGHT BULBS, LENSES, MIRRORS, STATIONS FOR PLACEMENT OF MICROTITER PLATES, MICROTITER PLATE READERS, COMPUTERS, INSTRUMENT SOFTWARE, ANALYTICAL SOFTWARE, AND CASES TO HOLD THE FOREGOING, FOR SCIENTIFIC, RESEARCH AND LABORATORY PURPOSES; LABORATORY APPARATUS, MATERIALS, ARTICLES AND DISPOSABLE ITEMS, NAMELY, PIPETTES, PLASTIC AND METAL RECEIVER CARTRIDGES, AND MICROTITER PLATES, FOR SCIENTIFIC, RESEARCH AND LABORATORY USE, AND FOR USE WITH SCIENTIFIC, RESEARCH AND LABORATORY APPARATUS, INSTRUMENTS AND DEVICES; COMPUTER SOFTWARE AND COMPUTER PROGRAMS FOR USE IN STORING AND ANALYZING EXPERIMENTAL AND OTHER DATA FOR SCIENTIFIC, RESEARCH, LABORATORY, MEDICAL, VETERINARY, CLINICAL DIAGNOSTIC, INDUSTRIAL, BIOLOGICAL, PATHOLOGICAL, PHARMACEUTICAL, GENETIC, ENVIRONMENTAL, DIETARY AND AGRICULTURAL PURPOSES; AND LAPTOP COMPUTERS, HARD DRIVES FOR COMPUTERS, AND COMPUTER HARDWARE, IN CLASS 9 (U.S. CLS. 21, 23, 26, 36 AND 38).



FIRST USE 1-12-2005; IN COMMERCE 1-12-2005.

FOR: MEDICAL APPARATUS, INSTRUMENTS AND DEVICES, NAMELY, DIGITAL IMAGING DEVICES COMPRISING FLUORIMETERS USED TO RECORD FLUORESCENCE SIGNALS AND PRODUCE DIGITAL DATA, THERMAL CONTROL ELEMENTS FOR HEATING AND COOLING, LIGHT EMITTERS SUCH AS LASERS AND LIGHT BULBS, LENSES, MIRRORS, STATIONS FOR PLACEMENT OF MICROTITER PLATES, MICROTITER PLATE READERS, COMPUTERS, INSTRUMENT SOFTWARE, ANALYTICAL SOFTWARE, AND CASES TO HOLD THE FOREGOING, FOR ANALYZING NUCLEIC ACID, CELLS, GENES AND BIOLOGICAL SAMPLES FOR MEDICAL, SURGICAL, VETERINARY, CLINICAL AND DIAGNOSTIC PURPOSES; AND MEDICAL APPARATUS, MATE-

RIALS, ARTICLES AND DISPOSABLE ITEMS, NAMELY, PLASTIC AND METAL RECEIVER CARTRIDGES, AND MICROTITER PLATES, FOR MEDICAL, SURGICAL, VETERINARY, CLINICAL AND DIAGNOSTIC USE, AND FOR USE WITH MEDICAL, SURGICAL, VETERINARY, CLINICAL AND DIAGNOSTIC APPARATUS, INSTRUMENTS AND DEVICES, IN CLASS 10 (U.S. CLS. 26, 39 AND 44).

FIRST USE 1-12-2005; IN COMMERCE 1-12-2005.

THE MARK CONSISTS OF STANDARD CHARACTERS WITHOUT CLAIM TO ANY PARTICULAR FONT, STYLE, SIZE, OR COLOR.

SN 76-566,941, FILED 12-10-2003.

RENEE MCCRAY, EXAMINING ATTORNEY

**Int. Cls.: 35, 38, and 41**

**Prior U.S. Cls.: 100, 101, 102, 104, and 107**

**United States Patent and Trademark Office**

**Reg. No. 3,395,245**

**Registered Mar. 11, 2008**

**SERVICE MARK  
PRINCIPAL REGISTER**

**BELAMIONLINE**

JANOSOV, LANNING (CZECH REPUBLIC INDIVIDUAL)  
126 EL DORADO  
MONTEREY, CA 93940

FOR: ON-LINE RETAIL STORE FEATURING BOOKS, CALENDARS, CARDS, PRE-RECORDED VIDEOTAPES, AND PRE-RECORDED DVDS, IN CLASS 35 (U.S. CLS. 100, 101 AND 102).

FIRST USE 8-23-2006; IN COMMERCE 8-23-2006.

FOR: ON-LINE ENTERTAINMENT SERVICES, NAMELY STREAMING VIDEO AND PAY-PER VIEW VIDEO PROVIDED VIA WEBSITE, IN CLASS 38 (U.S. CLS. 100, 101 AND 104).

FIRST USE 8-23-2006; IN COMMERCE 8-23-2006.

FOR: ON-LINE ENTERTAINMENT SERVICES, NAMELY, PROVIDING A WEBSITE TO SUBSCRIPTION MEMBERS FOR THE PURPOSE OF VIEWING INFORMATION, PHOTOGRAPHS, AND VIDEO IMAGES OF MALE MODELS, IN CLASS 41 (U.S. CLS. 100, 101 AND 107).

FIRST USE 8-23-2006; IN COMMERCE 8-23-2006.

OWNER OF U.S. REG. NOS. 2,181,754, 2,502,332, AND OTHERS.

SN 76-568,225, FILED 12-22-2003.

COLLEEN KEARNEY, EXAMINING ATTORNEY

**Int. Cl.: 25**

**Prior U.S. Cls.: 22 and 39**

**United States Patent and Trademark Office**

**Reg. No. 3,395,246**

**Registered Mar. 11, 2008**

**TRADEMARK  
PRINCIPAL REGISTER**



CON'S CYCLE CENTER, INC. (FLORIDA CORPORATION), DBA THE HOUSE OF POWER, 4515 BABCOCK STREET, N.E. PALM BAY, FL 32905

FOR: CLOTHING, NAMELY, T-SHIRTS, SHIRTS, JACKETS, HATS, SWEAT PANTS, SWEATSHIRTS, CAPS AND BANDANAS, IN CLASS 25 (U.S. CLS. 22 AND 39).

FIRST USE 12-0-2004; IN COMMERCE 12-0-2004.

AS SHOWN IN THE ACCOMPANYING DRAWING, THE MARK SOUGHT TO BE REGISTERED IS COMPRISED OF A DESIGN OF A MASK.

SEC. 2(F).

SN 76-570,792, FILED 1-20-2004.

MICHAEL LEWIS, EXAMINING ATTORNEY

**Int. Cl.: 9**

**Prior U.S. Cls.: 21, 23, 26, 36, and 38**

**United States Patent and Trademark Office**

**Reg. No. 3,395,247**

**Registered Mar. 11, 2008**

**TRADEMARK  
PRINCIPAL REGISTER**

**PRACTICE MINDER**

PRACTICE MINDER, INC. (NEVADA CORPORATION)  
1523 NORTH MARKET STREET  
TROY, OH 45373

FOR: COMPUTER SOFTWARE FOR USE IN DENTAL PRACTICE MANAGEMENT, IN CLASS 9 (U.S. CLS. 21, 23, 26, 36 AND 38).

FIRST USE 1-2-2006; IN COMMERCE 1-2-2006.

THE MARK CONSISTS OF STANDARD CHARACTERS WITHOUT CLAIM TO ANY PARTICULAR FONT, STYLE, SIZE, OR COLOR.

NO CLAIM IS MADE TO THE EXCLUSIVE RIGHT TO USE "PRACTICE", APART FROM THE MARK AS SHOWN.

SN 76-573,443, FILED 1-30-2004.

JENNY PARK, EXAMINING ATTORNEY

Int. Cl.: 35

Prior U.S. Cls.: 100, 101, and 102

United States Patent and Trademark Office

Reg. No. 3,395,248

Registered Mar. 11, 2008

**SERVICE MARK  
PRINCIPAL REGISTER**

**Survivor Depot**

*The ALTERNATIVE to "Duct Tape & Plastic" !*

SURVIVOR DEPOT, INC. (FLORIDA CORPORATION)  
P.O. BOX 551957  
FORT LAUDERDALE, FL 33355

FOR: RETAIL STORES AND WHOLESALE DISTRIBUTORSHIPS FEATURING NUCLEAR, BIOLOGICAL AND CHEMICAL AIR FILTRATION CONTAMINATION PROTECTION UNITS, IN CLASS 35 (U.S. CLS. 100, 101 AND 102).

FIRST USE 6-0-2003; IN COMMERCE 6-0-2003.

NO CLAIM IS MADE TO THE EXCLUSIVE RIGHT TO USE "DEPOT", APART FROM THE MARK AS SHOWN.

SN 76-574,906, FILED 2-9-2004.

JANICE L. MCMORROW, EXAMINING ATTORNEY

**Int. Cl.: 1**

**Prior U.S. Cls.: 1, 5, 6, 10, 26, and 46**

**Reg. No. 3,395,249**

**United States Patent and Trademark Office**

**Registered Mar. 11, 2008**

**TRADEMARK  
PRINCIPAL REGISTER**

**T.I.O**

THE NISSHIN OILLIO GROUP, LTD. (JAPAN CORPORATION)  
23-1, SHINKAWA 1-CHOME  
CHUO-KU, TOKYO, 104-8285, JAPAN

FOR: EMULSIFIERS FOR USE IN THE MANUFACTURE OF COSMETICS; EMULSION-STABILIZING AGENTS FOR USE IN THE MANUFACTURE OF COSMETICS; SURFACE-ACTIVE CHEMICAL AGENTS FOR USE IN THE MANUFACTURE OF COSMETICS; ESTERS FOR USE IN THE MANUFACTURE OF COSMETICS; FATTY ACIDS FOR USE IN THE MANUFACTURE OF COSMETICS; SOLVENTS FOR USE IN THE MANUFACTURE OF COSMETICS; GUM RESINS FOR USE IN THE MANUFACTURE OF COSMETICS; HIGHER FATTY

ACIDS FOR USE IN THE MANUFACTURE OF COSMETICS; HIGHER FATTY ACIDS FOR INDUSTRIAL PURPOSES, IN CLASS 1 (U.S. CLS. 1, 5, 6, 10, 26 AND 46).

FIRST USE 8-20-1972; IN COMMERCE 2-25-2004.

THE MARK CONSISTS OF STANDARD CHARACTERS WITHOUT CLAIM TO ANY PARTICULAR FONT, STYLE, SIZE, OR COLOR.

SN 76-574,965, FILED 2-10-2004.

DAVID TAYLOR, EXAMINING ATTORNEY

**Int. Cl.: 19**

**Prior U.S. Cls.: 1, 12, 33, and 50**

**United States Patent and Trademark Office**

**Reg. No. 3,395,250**

**Registered Mar. 11, 2008**

**TRADEMARK  
PRINCIPAL REGISTER**

**SEAMOD**

SEAMENT SHORELINE SYSTEMS, INC. (VIRGINIA CORPORATION)  
8267 LIGHTHOUSE LANE  
KING GEORGE, VA 22485

FOR: PRECAST CONCRETE, WOOD AND POLYMERIC BUILDING MATERIALS, NAMELY, BOX-LIKE OR CYLINDRICAL BUILDING COMPONENTS HAVING POLYGONAL CROSS SECTIONS IN THE NATURE OF TRIANGULAR, PENTAGONAL, HEXAGONAL AND HALF-HEXAGONAL BLOCKS, POSTS, COLUMNS, SLABS, PANELS OR HOLLOW CELLS FOR ASSEMBLY INTO A VARIETY OF TERRESTRIAL, FLOATING

AND SHORELINE STRUCTURES, IN CLASS 19 (U.S. CLS. 1, 12, 33 AND 50).

FIRST USE 10-27-2006; IN COMMERCE 10-27-2006.

THE MARK CONSISTS OF STANDARD CHARACTERS WITHOUT CLAIM TO ANY PARTICULAR FONT, STYLE, SIZE, OR COLOR.

SN 76-576,127, FILED 2-18-2004.

CAROLINE WOOD, EXAMINING ATTORNEY

**Int. Cl.: 28**

**Prior U.S. Cls.: 22, 23, 38, and 50**

**United States Patent and Trademark Office**

**Reg. No. 3,395,251**

**Registered Mar. 11, 2008**

**TRADEMARK  
PRINCIPAL REGISTER**

**THRUST**

REEBOK FINLAND OY (FINLAND CORPORATION)

KAUKJARVENTIE 284 PL 28

FORSSA, FINLAND 30101

FOR: ICE HOCKEY SKATES AND BLADES, NAMELY, GOALIE SKATES AND BLADES, IN CLASS 28 (U.S. CLS. 22, 23, 38 AND 50).

FIRST USE 11-0-2005; IN COMMERCE 5-31-2006.

THE MARK CONSISTS OF STANDARD CHARACTERS WITHOUT CLAIM TO ANY PARTICULAR FONT, STYLE, SIZE, OR COLOR.

PRIORITY CLAIMED UNDER SEC. 44(D) ON CANADA APPLICATION NO. 1194048, FILED 10-20-2003, REG. NO. TMA625843, DATED 11-18-2004, EXPIRES 11-18-2019.

SN 76-576,390, FILED 2-17-2004.

JASON TURNER, EXAMINING ATTORNEY



**Int. Cl.: 29**

**Prior U.S. Cl.: 46**

**United States Patent and Trademark Office**

**Reg. No. 3,395,252**

**Registered Mar. 11, 2008**

**TRADEMARK  
PRINCIPAL REGISTER**

**FISHERMEN'S FAVORITE FOODS**

US TUNA CORPORATION (CALIFORNIA CORPORATION)  
3802 CANON STREET  
SAN DIEGO, CA 92106

THE MARK CONSISTS OF STANDARD CHARACTERS WITHOUT CLAIM TO ANY PARTICULAR FONT, STYLE, SIZE, OR COLOR.

FOR: FISH, SEAFOOD, FRESH AND FROZEN SEAFOOD AND FISH, TUNA, SHRIMP, SQUID, SARDINES, OYSTERS, MOLLUSCA, CRUSTACEA, SHELLFISH, SALTED FISH, CAVIAR, SHRIMP NUGGETS, FISH STICKS, FISH FILLETS, EDIBLE OILS AND FATS, DIPS, IN CLASS 29 (U.S. CL. 46).

NO CLAIM IS MADE TO THE EXCLUSIVE RIGHT TO USE "FOODS", APART FROM THE MARK AS SHOWN.

SN 76-578,129, FILED 2-27-2004.

FIRST USE 7-31-2007; IN COMMERCE 7-31-2007.

ALICE BENMAMAN, EXAMINING ATTORNEY

**Int. Cls.: 35 and 41**

**Prior U.S. Cls.: 100, 101, 102, and 107**

**United States Patent and Trademark Office**

**Reg. No. 3,395,253**

**Registered Mar. 11, 2008**

**SERVICE MARK  
PRINCIPAL REGISTER**



VULCAN PARK FOUNDATION (ALABAMA  
NOT-FOR-PROFIT CORPORATION)  
P.O. BOX 59754  
BIRMINGHAM, AL 35257

FOR: PROMOTING ECONOMIC DEVELOPMENT, BUSINESS, CHAMBER OF COMMERCE, SERVICES IN THE NATURE OF CONVENTION, AND TOURISM IN AND AROUND THE CITY OF BIRMINGHAM, ALABAMA; RETAIL GIFT SHOP SERVICES FEATURING ARTICLES RELATING TO THE VULCAN PARK STATUE THE "VULCAN" AND THE HISTORY OF BIRMINGHAM, ALABAMA; PROMOTING AND ENHANCING THE IMAGE OF THE CITY OF BIRMINGHAM BY ARRANGING FOR THE LICENSING OF THE VULCAN PARK STATUE, ITS LIKENESS, AND THE VULCAN NAME IN CONNECTION WITH GOODS SUCH AS WEARING APPAREL, FOODS, AND NOVELTIES, IN CLASS 35 (U.S. CLS. 100, 101 AND 102).

FIRST USE 12-31-1904; IN COMMERCE 12-31-1904.

FOR: SPONSORING AND ORGANIZING SPORTING EVENTS, CULTURAL EVENTS AND RECREATIONAL ACTIVITIES IN AND AROUND THE CITY OF BIRMINGHAM, ALABAMA; EDUCATION AND ENTERTAINMENT SERVICES, NAMELY, CONDUCTING SEMINARS, WORKSHOPS, CONFERENCES, AND EXHIBITS IN THE FIELD OF HISTORY OF BIRMINGHAM, ALABAMA, IN CLASS 41 (U.S. CLS. 100, 101 AND 107).

FIRST USE 12-31-1904; IN COMMERCE 12-31-1904.

SEC. 2(F).

SN 76-579,511, FILED 3-2-2004.

MARY I. SPARROW, EXAMINING ATTORNEY

**Int. Cl.: 3**

**Prior U.S. Cls.: 1, 4, 6, 50, 51, and 52**

**United States Patent and Trademark Office**

**Reg. No. 3,395,254**

**Registered Mar. 11, 2008**

**TRADEMARK  
PRINCIPAL REGISTER**

**MESOTHERAPIE & ESTETIK**

MESO MANAGEMENT LLC (NEVADA LTD  
LIAB CO)  
P.O. BOX 12578  
RENO, NV 89510

NO CLAIM IS MADE TO THE EXCLUSIVE  
RIGHT TO USE "MESOTHERAPIE", APART FROM  
THE MARK AS SHOWN.

FOR: EXFOLIATING BODY SCRUBS; BEAUTY  
GELS; HAND, SKIN AND BODY LOTIONS; HAND,  
SKIN AND BODY CREAMS; TONERS; BATH  
SALTS; BODY OILS, IN CLASS 3 (U.S. CLS. 1, 4, 6,  
50, 51 AND 52).

THE ENGLISH TRANSLATION OF THE FRENCH  
WORD "MESOTHERAPIE" IS "MESOTHERAPY".  
THE ENGLISH TRANSLATION OF THE SWEDISH  
WORD "ESTETIK" IS "AESTHETIC".

FIRST USE 11-29-2007; IN COMMERCE 11-29-2007.

SN 76-583,084, FILED 3-24-2004.

THE MARK CONSISTS OF STANDARD CHAR-  
ACTERS WITHOUT CLAIM TO ANY PARTICULAR  
FONT, STYLE, SIZE, OR COLOR.

IRA J. GOODSaid, EXAMINING ATTORNEY

**Int. Cls.: 38 and 41**

**Prior U.S. Cls.: 100, 101, 104, and 107**

**United States Patent and Trademark Office**

**Reg. No. 3,395,255**

**Registered Mar. 11, 2008**

**SERVICE MARK  
PRINCIPAL REGISTER**

**I - GUIDE**

TV GUIDE MAGAZINE GROUP, INC. (DELA-  
WARE CORPORATION)  
6922 HOLLYWOOD BOULEVARD  
LOS ANGELES, CA 90028

FOR: COMMUNICATIONS SERVICES, NAMELY,  
THE TRANSMISSION AND DELIVERY OF PROMO-  
TIONAL, INFORMATIONAL, AND INTERACTIVE  
TELEVISION PROGRAMMING SERVICES VIA  
BROADCAST, CABLE, SATELLITE AND ON-LINE  
ELECTRONIC COMMUNICATIONS NETWORKS,  
IN CLASS 38 (U.S. CLS. 100, 101 AND 104).

FIRST USE 3-8-2004; IN COMMERCE 3-8-2004.

FOR: ENTERTAINMENT SERVICES, NAMELY,  
THE PRODUCTION AND DISTRIBUTION OF PRO-  
MOTIONAL, INFORMATIONAL, AND INTERAC-

TIVE TELEVISION PROGRAMMING SERVICES  
VIA BROADCAST, CABLE, SATELLITE AND ON-  
LINE ELECTRONIC COMMUNICATIONS NET-  
WORKS, IN CLASS 41 (U.S. CLS. 100, 101 AND 107).

FIRST USE 3-8-2004; IN COMMERCE 3-8-2004.

THE MARK CONSISTS OF STANDARD CHAR-  
ACTERS WITHOUT CLAIM TO ANY PARTICULAR  
FONT, STYLE, SIZE, OR COLOR.

OWNER OF U.S. REG. NOS. 650,942, 2,833,591,  
AND OTHERS.

SN 76-584,072, FILED 3-30-2004.

MARGERY A. TIERNEY, EXAMINING ATTORNEY

**Int. Cl.: 12**

**Prior U.S. Cls.: 19, 21, 23, 31, 35, and 44**

**United States Patent and Trademark Office**

**Reg. No. 3,395,256**

**Registered Mar. 11, 2008**

---

**TRADEMARK  
PRINCIPAL REGISTER**

**S.drive**

THE YOKOHAMA RUBBER COMPANY LIM-  
ITED (JAPAN CORPORATION)  
36-11, SHIMBASHI 5-CHOME, MINATO-KU  
TOKYO 105-8685, JAPAN

FIRST USE 1-14-2005; IN COMMERCE 7-1-2007.

SN 76-585,547, FILED 4-7-2004.

FOR: AUTOMOBILE TIRES, IN CLASS 12 (U.S.  
CLS. 19, 21, 23, 31, 35 AND 44).

JULIE WATSON, EXAMINING ATTORNEY

**Int. Cl.: 10**

**Prior U.S. Cls.: 26, 39, and 44**

**United States Patent and Trademark Office**

**Reg. No. 3,395,257**

**Registered Mar. 11, 2008**

**TRADEMARK  
PRINCIPAL REGISTER**

**DRSS**

DEAN, JOETTA G. (UNITED STATES INDIVIDUAL)  
15 PARK AVE.  
FAIR HAVEN, VT 05743

THE MARK CONSISTS OF STANDARD CHARACTERS WITHOUT CLAIM TO ANY PARTICULAR FONT, STYLE, SIZE, OR COLOR.

FOR: SUPPORTS FOR SHOULDER FOR MEDICAL USE, IN CLASS 10 (U.S. CLS. 26, 39 AND 44).

SN 76-589,451, FILED 4-29-2004.

FIRST USE 7-21-2007; IN COMMERCE 7-21-2007.

TIMOTHY FINNEGAN, EXAMINING ATTORNEY

**Int. Cl.: 41**

**Prior U.S. Cls.: 100, 101, and 107**

**United States Patent and Trademark Office**

**Reg. No. 3,395,258**

**Registered Mar. 11, 2008**

**SERVICE MARK  
PRINCIPAL REGISTER**

**KEEPING DIABETES INLINE, ONLINE**

NIPRO DIABETES SYSTEMS, INC. (FLORIDA CORPORATION)  
3361 ENTERPRISE WAY  
MIRAMAR, FL 33025

FOR: EDUCATIONAL SERVICES, NAMELY, CONDUCTING SEMINARS AND CLASSES ON DIABETES AND TREATING DIABETES, IN CLASS 41 (U.S. CLS. 100, 101 AND 107).

FIRST USE 4-30-2006; IN COMMERCE 4-30-2006.

THE MARK CONSISTS OF STANDARD CHARACTERS WITHOUT CLAIM TO ANY PARTICULAR FONT, STYLE, SIZE, OR COLOR.

SN 76-590,387, FILED 5-4-2004.

CHRISTOPHER BUONGIORNO, EXAMINING ATTORNEY

**Int. Cl.: 11**

**Prior U.S. Cls.: 13, 21, 23, 31, and 34**

**United States Patent and Trademark Office**

**Reg. No. 3,395,259**

**Registered Mar. 11, 2008**

**TRADEMARK  
PRINCIPAL REGISTER**

**PLASMA CLUSTER**

SHARP KABUSHIKI KAISHA (JAPAN CORPORATION), TA SHARP CORPORATION,  
22-22, NAGAIKE-CHO, ABENO-KU  
OSAKA 545-8522, JAPAN

FOR: AIR CONDITIONERS FOR CAR USE, IN  
CLASS 11 (U.S. CLS. 13, 21, 23, 31 AND 34).

FIRST USE 5-1-2006; IN COMMERCE 5-1-2006.

THE MARK CONSISTS OF STANDARD CHARACTERS WITHOUT CLAIM TO ANY PARTICULAR FONT, STYLE, SIZE, OR COLOR.

OWNER OF U.S. REG. NO. 2,854,841.

SN 76-592,831, FILED 5-18-2004.

JEFF DEFORD, EXAMINING ATTORNEY



**Int. Cls.: 9 and 35**

**Prior U.S. Cls.: 21, 23, 26, 36, 38, 100, 101, and 102**

**United States Patent and Trademark Office**

**Reg. No. 3,395,260**

**Registered Mar. 11, 2008**

**TRADEMARK  
SERVICE MARK  
PRINCIPAL REGISTER**

**TV TRAFFIC**

TV TRAFFIC, INC. (CALIFORNIA CORPORATION)  
11755 WILSHIRE BOULEVARD  
SUITE 1150  
LOS ANGELES, CA 90025

FOR: COMPUTER SOFTWARE TO FACILITATE MANAGING THE OPERATIONS OF DIRECT RESPONSE ADVERTISING IN THE FIELD OF SPORTS EQUIPMENT AND HOUSEWARES, IN CLASS 9 (U.S. CLS. 21, 23, 26, 36 AND 38).

FIRST USE 10-7-2007; IN COMMERCE 10-7-2007.

FOR: BUSINESS MANAGEMENT SERVICES, NAMELY, MANAGING THE OPERATIONS OF DIRECT RESPONSE ADVERTISING IN THE FIELD OF

SPORTS EQUIPMENT AND HOUSEWARES; TELEPHONE CALL CENTERS FOR CUSTOMER SUPPORT; ORDER PROCESSING; AND ORDER FULFILLMENT SERVICES, IN CLASS 35 (U.S. CLS. 100, 101 AND 102).

FIRST USE 10-7-2007; IN COMMERCE 10-7-2007.

THE MARK CONSISTS OF STANDARD CHARACTERS WITHOUT CLAIM TO ANY PARTICULAR FONT, STYLE, SIZE, OR COLOR.

SN 76-594,311, FILED 5-24-2004.

MARGERY A. TIERNEY, EXAMINING ATTORNEY

Int. Cls.: 9 and 15

Prior U.S. Cls.: 2, 21, 23, 26, 36, and 38

Reg. No. 3,395,261

United States Patent and Trademark Office

Registered Mar. 11, 2008

TRADEMARK  
PRINCIPAL REGISTER



YAMAHA CORPORATION (JAPAN CORPORATION)  
10-1, NAKAZAWA-CHO  
HAMAMATSU-SHI, SHIZUOKA, JAPAN

FOR: RADIO-BROADCASTING RECEIVERS, TELEVISION SETS, VIDEO MONITORS, MICROPHONES, LOUDSPEAKERS, HEADPHONES, EARPHONES, MINI AUDIO SYSTEMS COMPRISING AMPLIFIERS, LOUDSPEAKERS AND OPTICAL DISK PLAYERS, AUDIO/VIDEO AMPLIFIERS, COMPACT DISC PLAYERS/RECORDERS, DIGITAL VIDEO VERSATILE DISC PLAYERS, HARD DISC RECORDERS, AUDIO MIXERS, AUDIO SIGNAL PROCESSORS, AUDIO/VIDEO RECEIVERS, GRAPHIC EQUALIZERS, ELECTRONIC SOUND EFFECTORS, AMPLIFIERS FOR MUSICAL INSTRUMENTS, EFFECTORS FOR MUSICAL INSTRUMENTS, SAMPLERS, SAMPLING UNITS, NAMELY, DIGITAL PHRASE SAMPLERS USED TO RECORD, REPLAY, AND EDIT DIGITALLY STORED MUSIC SAMPLERS; MUSIC SYNTHESIZERS, NAMELY, DESK TOP CONTROL UNITS USED TO SYNTHESIZE MUSIC THAT DO NOT FUNCTION INDEPENDENTLY AS MUSICAL INSTRUMENTS; ELECTRONIC TONE GENERATORS, ELECTRONIC CIRCUITS FOR TONE GENERATORS, RECORDERS AND PLAYERS OF MIDI DATA, ELECTRONIC MUSIC SEQUENCERS, RHYTHM PROGRAMMERS, KARAOKE MACHINES, PERSONAL COMPUTERS, PERSONAL DIGITAL ASSISTANTS, SOUND CARDS, CD-R/RW DRIVES, COMPUTER GAME MACHINES, TELEPHONE SETS, CELLULAR PHONES, INTERFACE BOXES AND INTERFACE CARDS FOR MUTUALLY CONNECTING AFOREMENTIONED GOODS; INTERFACE BOXES AND INTERFACE CARDS FOR CONNECTING AFOREMENTIONED GOODS WITH ELECTRONIC MUSICAL INSTRUMENTS, INTERFACE BOARDS AND INTERFACE CARDS TO BE INSTALLED IN AFOREMENTIONED

GOODS, INTERFACE BOARDS AND INTERFACE CARDS TO BE INSTALLED IN AFOREMENTIONED GOODS, INTERFACE BOARDS AND INTERFACE CARDS TO BE INSTALLED IN ELECTRONIC MUSICAL INSTRUMENTS, AUDIO AND MIDI (MUSICAL INSTRUMENTS DIGITAL INTERFACE) INTERFACE BOARDS, AUDIO AND MIDI INTERFACE CARDS, AUDIO AND MIDI INTERFACE BOXES, MIDI INTERFACES, DISKS PRE-RECORDED WITH MUSIC DATA IN MIDI FILE FORMAT, DISKS PRE-RECORDED WITH MUSIC DATA FOR USE IN THE OPERATION OF PLAYER PIANOS AND ELECTRONIC MUSICAL INSTRUMENTS, PRE-RECORDED DISCS FEATURING SOUND OR MUSIC, COMPUTER SOFTWARE FOR PRODUCING SOUND OR MUSIC, COMPUTER SOFTWARE FOR EFFECTING SOUND OR MUSIC, COMPUTER SOFTWARE FOR MIXING SOUND OR MUSIC, COMPUTER SOFTWARE FOR SYNTHESIZING SOUND OR MUSIC, COMPUTER SOFTWARE FOR SETTING OR MEMORIZING PARAMETERS OR VALUES OF EFFECTORS, MIXERS OR SYNTHESIZERS, COMPUTER SOFTWARE FOR SUPERVISING OTHER SOFTWARES SO AS TO PRODUCE MUSIC OR SOUND HARMONIOUSLY, COMPUTER SOFTWARE FOR GENERATING, REPRODUCING AND RECORDING SOUND, COMPUTER SOFTWARE FOR ARRANGING AND SEQUENCING MUSIC, COMPUTER SOFTWARE FOR ENCODING/PLAYING MP3 MUSIC, COMPUTER SOFTWARE FOR MIXING SOUND OR MUSIC, COMPUTER SOFTWARE FOR OPERATING AND CONTROLLING AUDIO AND PUBLIC ADDRESS APPARATUS, COMPUTER SOFTWARE FOR OPERATING AND CONTROLLING ELECTRONIC MUSICAL INSTRUMENTS, ELECTRONIC CIRCUITS, ELECTRONIC INTEGRATED CIRCUITS, LARGE SCALE INTEGRATION CHIPS, ELECTRONIC MICROASSEMBLIES, SEMI-CONDUCTOR DEVICES, ELECTRONIC PUBLICATIONS IN THE FIELD OF

MUSIC, DOWNLOADABLE ELECTRONIC MUSIC PROVIDED FROM A COMPUTER NETWORK DOWNLOADABLE, DOWNLOADABLE ELECTRONIC MUSIC FOR RING TONE, IN CLASS 9 (U.S. CLS. 21, 23, 26, 36 AND 38).

FIRST USE 8-27-2004; IN COMMERCE 8-27-2004.

FOR: ELECTRONIC MUSICAL INSTRUMENTS AND ACCESSORIES SOLD IN CONNECTION THEREWITH, NAMELY, ELECTRONIC PIANOS, ELECTRONIC ORGANS, ELECTRONIC DRUMS, ELECTRONIC PERCUSSION INSTRUMENTS AND ELECTRONIC STRINGED INSTRUMENTS, MUSIC SYNTHESIZERS, SAMPLERS, ELECTRONIC MUSICAL KEYBOARDS, INTERFACE BOXES AND INTERFACE CARDS FOR MUTUALLY

CONNECTING ELECTRONIC MUSICAL INSTRUMENTS, INTERFACE BOXES AND INTERFACE CARDS FOR CONNECTING ELECTRONIC MUSICAL INSTRUMENTS WITH AUDIO AND PUBLIC ADDRESS APPARATUS AND COMPUTERS, INTERFACE BOARDS AND INTERFACE CARDS TO BE INSTALLED IN ELECTRONIC MUSICAL INSTRUMENTS, IN CLASS 15 (U.S. CLS. 2, 21 AND 36).

FIRST USE 10-18-2006; IN COMMERCE 10-18-2006.

THE MARK CONSISTS OF TWO CONNECTED STYLIZED OVALS.

SN 76-594,789, FILED 5-28-2004.

DAVID HOFFMAN, EXAMINING ATTORNEY

**Int. Cl.: 16**

**Prior U.S. Cls.: 2, 5, 22, 23, 29, 37, 38, and 50**

**Reg. No. 3,395,262**

**United States Patent and Trademark Office**

**Registered Mar. 11, 2008**

**TRADEMARK  
PRINCIPAL REGISTER**

**SN'S WH WHOLE HEALTH**

PENTON BUSINESS MEDIA, INC. (DELAWARE  
CORPORATION)  
249 WEST 17TH STREET, 4TH FLOOR  
NEW YORK, NY 10011

OWNER OF U.S. REG. NO. 1,807,439.

FOR: PERIODIC MAGAZINE IN THE NATURE  
OF FOOD AND FOOD PRODUCTS, IN CLASS 16  
(U.S. CLS. 2, 5, 22, 23, 29, 37, 38 AND 50).

NO CLAIM IS MADE TO THE EXCLUSIVE  
RIGHT TO USE "WHOLE HEALTH", APART FROM  
THE MARK AS SHOWN.

FIRST USE 10-0-2004; IN COMMERCE 10-0-2004.

SN 76-595,173, FILED 6-1-2004.

THE MARK CONSISTS OF STANDARD CHAR-  
ACTERS WITHOUT CLAIM TO ANY PARTICULAR  
FONT, STYLE, SIZE, OR COLOR.

MATTHEW KLINE, EXAMINING ATTORNEY

**Int. Cl.: 35**

**Prior U.S. Cls.: 100, 101, and 102**

**United States Patent and Trademark Office**

**Reg. No. 3,395,263**

**Registered Mar. 11, 2008**

**SERVICE MARK  
PRINCIPAL REGISTER**

**AVUE ATLAS**

AVUE TECHNOLOGIES CORPORATION (DELA-  
WARE CORPORATION)  
1145 BROADWAY PLAZA, SUITE 800  
TACOMA, WA 98402

FOR: BUSINESS CONSULTING SERVICES IN  
THE FIELD OF WORKFORCE MANAGEMENT  
AND HUMAN RESOURCES, PROVIDED VIA TELE-  
PHONE, FACSIMILE, AND E-MAIL, INCLUDING  
TRANSACTION PROCESSING, DECISION SUP-  
PORT, AND WORKFLOW ENABLING, ALL IN  
THE AREAS OF PERSONNEL FORECASTING, PO-  
SITION DESIGN, STAFFING, RECRUITMENT, HIR-  
ING, TRAINING, EVALUATION, DEVELOPMENT,  
COMPENSATION, COMPLIANCE, ANALYSIS, OR-

GANIZATIONAL ARCHITECTURE ANALYSIS,  
MANAGEMENT AND SUCCESSION PLANNING,  
IN CLASS 35 (U.S. CLS. 100, 101 AND 102).

FIRST USE 10-5-2005; IN COMMERCE 10-5-2005.

THE MARK CONSISTS OF STANDARD CHAR-  
ACTERS WITHOUT CLAIM TO ANY PARTICULAR  
FONT, STYLE, SIZE, OR COLOR.

SN 76-602,616, FILED 7-16-2004.

KATHERINE STOIDES, EXAMINING ATTORNEY

**Int. Cl.: 33**

**Prior U.S. Cls.: 47 and 49**

**United States Patent and Trademark Office**

**Reg. No. 3,395,264**

**Registered Mar. 11, 2008**

**TRADEMARK  
PRINCIPAL REGISTER**



LOUIS ROYER (FRANCE S.A.S.)  
27-29 RUE DU CHAIL  
JARNAC, FRANCE 16200

NO CLAIM IS MADE TO THE EXCLUSIVE  
RIGHT TO USE "SUPREME", APART FROM THE  
MARK AS SHOWN.

FOR: POTABLE SPIRITS, IN CLASS 33 (U.S. CLS.  
47 AND 49).

SN 76-604,346, FILED 7-26-2004.

FIRST USE 8-25-2007; IN COMMERCE 8-25-2007.

CHRIS WELLS, EXAMINING ATTORNEY

**Int. Cls.: 29, 35, and 40**

**Prior U.S. Cls.: 46, 100, 101, 102, 103, and 106**

**United States Patent and Trademark Office**

**Reg. No. 3,395,265**

**Registered Mar. 11, 2008**

**TRADEMARK  
SERVICE MARK  
PRINCIPAL REGISTER**

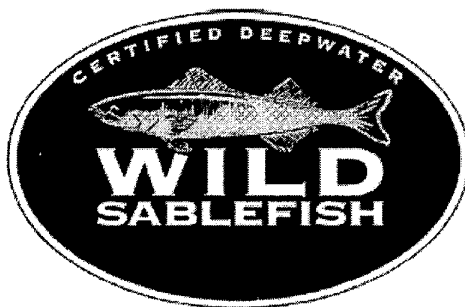

CANADIAN SABLEFISH ASSOCIATION (CANADA INC. ASSOCIATION)  
SUITE 406 - 535 HOWE STREET  
VANCOUVER, BRITISH COLUMBIA, CANADA V6C 2Z4

FOR: (BASED ON USE IN COMMERCE) (BASED ON 44(E)) FRESH, FROZEN AND SMOKED SABLEFISH, NAMELY, ANOPILOPOMA FIMBRIA, IN CLASS 29 (U.S. CL. 46).

FIRST USE 12-17-2004; IN COMMERCE 5-1-2005.

FOR: (BASED ON 44(E)) WHOLESALE DISTRIBUTORSHIPS AND RETAIL STORE SERVICES FEATURING SABLEFISH, IN CLASS 35 (U.S. CLS. 100, 101 AND 102).

FOR: (BASED ON 44(E)) HARVESTING AND PROCESSING OF SABLEFISH FOR OTHERS, IN CLASS 40 (U.S. CLS. 100, 103 AND 106).

PRIORITY CLAIMED UNDER SEC. 44(D) ON CANADA APPLICATION NO. 1225267, FILED 7-28-2004, REG. NO. TMA661603, DATED 3-28-2006, EXPIRES 3-28-2021.

NO CLAIM IS MADE TO THE EXCLUSIVE RIGHT TO USE "CERTIFIED DEEPWATER WILD SABLEFISH", APART FROM THE MARK AS SHOWN.

SN 76-606,657, FILED 8-12-2004.

PATRICIA EVANKO, EXAMINING ATTORNEY

**Int. Cl.: 35**

**Prior U.S. Cls.: 100, 101, and 102**

**United States Patent and Trademark Office**

**Reg. No. 3,395,266**

**Registered Mar. 11, 2008**

**SERVICE MARK  
PRINCIPAL REGISTER**

**MANAGEMENT BY RESPECT**

MUNCY, PATRICIA (UNITED STATES INDIVIDUAL)  
4127 FARM BROOK DRIVE  
CARY, NC 27518

FOR: BUSINESS ORGANIZATION AND MANAGEMENT CONSULTING SERVICES, IN CLASS 35 (U.S. CLS. 100, 101 AND 102).

FIRST USE 4-1-2007; IN COMMERCE 4-1-2007.

THE MARK CONSISTS OF STANDARD CHARACTERS WITHOUT CLAIM TO ANY PARTICULAR FONT, STYLE, SIZE, OR COLOR.

NO CLAIM IS MADE TO THE EXCLUSIVE RIGHT TO USE "MANAGEMENT", APART FROM THE MARK AS SHOWN.

SN 76-606,957, FILED 8-11-2004.

LINDA MICKLEBURGH, EXAMINING ATTORNEY



**Int. Cls.: 9 and 42**

**Prior U.S. Cls.: 21, 23, 26, 36, 38, 100, and 101**

**United States Patent and Trademark Office**

**Reg. No. 3,395,267**

**Registered Mar. 11, 2008**

**TRADEMARK  
SERVICE MARK  
PRINCIPAL REGISTER**

**TOTALCOVER**

BROWN BEAR COMMUNICATIONS, INC. (DE-  
LAWARE CORPORATION)  
115 EAST 86TH STREET APARTMENT 131  
NEW YORK, NY 10028

FOR: COMPUTER NETWORK SECURITY SOFT-  
WARE FOR SECURING INFORMATION ENTERED  
FROM LOCAL AND REMOTE LOCATIONS , IN  
CLASS 9 (U.S. CLS. 21, 23, 26, 36 AND 38).

FIRST USE 8-22-2007; IN COMMERCE 10-2-2007.

FOR: COMPUTER NETWORK SECURITY SER-  
VICES PROVIDING ENCRYPTION AND SECURED  
TRANSACTION SECURITY FOR USERS OF TELE-  
COMMUNICATIONS NETWORKS; COMPUTER SE-  
CURITY SERVICES, NAMELY PROVIDING  
SECURED TRANSACTION AND ONLINE SECUR-

ITY SERVICES TO REGISTERED USERS OF A  
GLOBAL COMPUTER NETWORK OR PRIVATE  
NETWORK TO ENSURE THE SECURITY AND  
AUTHENTICATION OF ONLINE TRANSACTIONS  
INCLUDING ANY TYPE OF FILE TRANSFERS , IN  
CLASS 42 (U.S. CLS. 100 AND 101).

FIRST USE 8-22-2007; IN COMMERCE 8-22-2007.

THE MARK CONSISTS OF STANDARD CHAR-  
ACTERS WITHOUT CLAIM TO ANY PARTICULAR  
FONT, STYLE, SIZE, OR COLOR.

SN 76-607,921, FILED 8-18-2004.

CHARLES L. JENKINS, EXAMINING ATTORNEY

**Int. Cl.: 42**

**Prior U.S. Cls.: 100 and 101**

**United States Patent and Trademark Office**

**Reg. No. 3,395,268**

**Registered Mar. 11, 2008**

**SERVICE MARK  
PRINCIPAL REGISTER**

**LAB IMPULSE**

MATHENY, JOHN ELVIN (UNITED STATES INDIVIDUAL)  
6507 WINTER STONE  
HOUSTON, TX 77084

FOR: DEVELOPMENT, DESIGN AND TESTING OF LABORATORY INSTRUMENTATION, NAMELY, GAS CHROMATOGRAPHS, MASS SPECTROMETERS, TOTAL HYDROCARBON ANALYZERS, COLUMN OVENS, ELECTROMETER AMPLIFIERS, INSTRUMENTATION SOFTWARE AND DEVICES USING FLAME IONIZATION, THERMIONIC IONIZATION, PHOTO IONIZATION, ELECTRON CAPTURE, FLAME PHOTOMETRIC INFRARED

CATALYTIC AND THERMAL DETECTION TECHNOLOGIES, IN CLASS 42 (U.S. CLS. 100 AND 101).

FIRST USE 11-27-2007; IN COMMERCE 11-27-2007.

THE MARK CONSISTS OF STANDARD CHARACTERS WITHOUT CLAIM TO ANY PARTICULAR FONT, STYLE, SIZE, OR COLOR.

SN 76-607,950, FILED 8-20-2004.

DAWN FELDMAN, EXAMINING ATTORNEY

**Int. Cl.: 41**

**Prior U.S. Cls.: 100, 101, and 107**

**United States Patent and Trademark Office**

**Reg. No. 3,395,269**

**Registered Mar. 11, 2008**

**SERVICE MARK  
PRINCIPAL REGISTER**

**TODDWORLD**

TAFFY PRODUCTIONS, LLC (CALIFORNIA LTD  
LIAB CO)  
SUITE 100  
21300 OXNARD STREET  
WOODLAND HILLS, CA 91367

FOR: ENTERTAINMENT SERVICES IN THE NATURE OF AN ON-GOING, ANIMATED TELEVISION SERIES; PRODUCTION AND DISTRIBUTION OF A SERIES OF CHILDREN'S PROGRAMS, ANIMATED SHORT FILMS, AND ANIMATED FULL LENGTH MOVIES; INTERACTIVE COMPUTER GAMES, NAMELY, PROVIDING A COMPUTER GAME THAT MAY BE ACCESSED BY INTERNET USERS; PRESENTATION OF SHOW PERFORMANCES, NAMELY, THEATRICAL, LIVE-ACTION SHOW AND PERSONAL APPEARANCES BY A COSTUMED CHARACTER; PROVIDING AN IN-

TERACTIVE WEBSITE ON COMPUTER NETWORKS FEATURING INFORMATION IN THE FIELD OF ENTERTAINMENT; PROVIDING ONLINE NEWSLETTERS IN THE FIELD OF ENTERTAINMENT, IN CLASS 41 (U.S. CLS. 100, 101 AND 107).

FIRST USE 11-8-2004; IN COMMERCE 11-8-2004.

THE MARK CONSISTS OF STANDARD CHARACTERS WITHOUT CLAIM TO ANY PARTICULAR FONT, STYLE, SIZE, OR COLOR.

SN 76-609,362, FILED 8-30-2004.

ANGELA GAW, EXAMINING ATTORNEY

**Int. Cl.: 12**

**Prior U.S. Cls.: 19, 21, 23, 31, 35, and 44**

**Reg. No. 3,395,270**

**United States Patent and Trademark Office**

**Registered Mar. 11, 2008**

---

**TRADEMARK  
PRINCIPAL REGISTER**

**LEADER**

CONTINENTAL AKTIENGESELLSCHAFT (FED  
REP GERMANY JOINT STOCK COMPANY)  
VAHRENWALDER STR. 9  
30165 HANNOVER, FED REP GERMANY

THE MARK CONSISTS OF STANDARD CHAR-  
ACTERS WITHOUT CLAIM TO ANY PARTICULAR  
FONT, STYLE, SIZE, OR COLOR.

FOR: BICYCLE TIRES, INNER TUBES FOR BI-  
CYCLE TIRES, IN CLASS 12 (U.S. CLS. 19, 21, 23, 31,  
35 AND 44).

SN 76-610,967, FILED 9-8-2004.

FIRST USE 10-0-1995; IN COMMERCE 9-0-2004.

BILL DAWE, EXAMINING ATTORNEY

**Int. Cl.: 31**

**Prior U.S. Cls.: 1 and 46**

**United States Patent and Trademark Office**

**Reg. No. 3,395,271**

**Registered Mar. 11, 2008**

**TRADEMARK  
PRINCIPAL REGISTER**

**SWEET AS CANDY**

BROWNING SEED, INC. (TEXAS CORPORATION)  
3101 S. IH 27-BOX 1  
PLAINVIEW, TX 79072

FOR: SORGHUM-SUDANGRASS HYBRID SEED,  
IN CLASS 31 (U.S. CLS. 1 AND 46).

FIRST USE 1-1-1969; IN COMMERCE 1-1-1969.

THE MARK CONSISTS OF STANDARD CHARACTERS WITHOUT CLAIM TO ANY PARTICULAR FONT, STYLE, SIZE, OR COLOR.

SN 76-611,112, FILED 9-13-2004.

CHRISTOPHER BUONGIORNO, EXAMINING ATTORNEY

**Int. Cl.: 9**

**Prior U.S. Cls.: 21, 23, 26, 36, and 38**

**Reg. No. 3,395,272**

**United States Patent and Trademark Office**

**Registered Mar. 11, 2008**

**TRADEMARK  
PRINCIPAL REGISTER**

**LANLink**

SIELOX, LLC (DELAWARE LTD LIAB CO)  
C/O LQ CORPORATION  
888 SEVENTH AVENUE, 17TH FLOOR  
NEW YORK, NY 10016

FIRST USE 5-0-2005; IN COMMERCE 7-0-2005.

THE MARK CONSISTS OF STANDARD CHARACTERS WITHOUT CLAIM TO ANY PARTICULAR FONT, STYLE, SIZE, OR COLOR.

FOR: ACCESS CONTROL AND EVENT MANAGEMENT CONTROLLERS, NAMELY, ELECTRICAL CONTROLLERS FOR DOORS AND OTHER ACCESS POINTS FOR BUILDING SECURITY , IN CLASS 9 (U.S. CLS. 21, 23, 26, 36 AND 38).

SN 76-613,781, FILED 9-28-2004.

ELLEN PERKINS, EXAMINING ATTORNEY

Int. Cls.: 3 and 5

Prior U.S. Cls.: 1, 4, 6, 18, 44, 46, 50, 51, and 52

United States Patent and Trademark Office

Reg. No. 3,395,273

Registered Mar. 11, 2008

TRADEMARK  
PRINCIPAL REGISTER



HWA, JULIE (GUAM INDIVIDUAL)  
P.O. BOX 5445  
HAGATNA, GUAM 69632

FOR: COSMETICS, SKIN CLEANSERS, AND NON-MEDICATED BATH PREPARATIONS, NAME-  
LY, BATH SALTS AND RENEWING CLEANSING  
PASTE, IN CLASS 3 (U.S. CLS. 1, 4, 6, 50, 51 AND 52).

FIRST USE 9-12-2005; IN COMMERCE 7-12-2007.

FOR: MEDICATED COMPOSITIONS FOR SKIN,  
NAME-  
LY, REJUVENATING SKIN PASTE; MEDI-  
CATED COMPOSITIONS FOR HAIR, NAME-  
LY, HAIR REVITALIZING TONER, REVITALIZING  
GEL AND PASTE TO HOLD AND STYLE THE  
HAIR; MEDICATED ORAL COMPOSITIONS,  
NAME-  
LY, MOUTHWASH AND GARGLE TONER

COMPLEX; AND MEDICATED VAGINAL TREAT-  
MENTS, NAME-  
LY, REVITALIZING CLEANSER  
AND TONER, IN CLASS 5 (U.S. CLS. 6, 18, 44, 46, 51  
AND 52).

FIRST USE 9-12-2005; IN COMMERCE 7-12-2007.

NO CLAIM IS MADE TO THE EXCLUSIVE  
RIGHT TO USE "HERBAL THERAPY", APART  
FROM THE MARK AS SHOWN.

THE NAME "MS. HWA" IDENTIFIES A LIVING  
INDIVIDUAL WHOSE CONSENT IS OF RECORD.

SN 76-619,823, FILED 11-10-2004.

DORITT L. CARROLL, EXAMINING ATTORNEY

**Int. Cls.: 9 and 16**

**Prior U.S. Cls.: 2, 5, 21, 22, 23, 26, 29, 36, 37, 38, and 50**

**Reg. No. 3,395,274**

**United States Patent and Trademark Office**

**Registered Mar. 11, 2008**

**TRADEMARK  
PRINCIPAL REGISTER**

**LUCINDA BASSETT**

MIDWEST CENTER FOR STRESS AND ANXIETY, INC. (OHIO CORPORATION)

P.O. BOX 205

OAK HARBOR, OH 43449

FOR: KITS CONSISTING PRIMARILY OF PRE-RECORDED AUDIO RECORDINGS BUT ALSO CONTAINING ANY COMBINATION OF WORKBOOKS, PRINTED EDUCATIONAL AND MOTIVATIONAL MATERIALS, MOTIVATIONAL CARDS, NEWSLETTERS, AND INFORMATION ON A NETWORK OF HEALTH CARE PROVIDERS, ALL IN FIELDS OF SELF-HELP AND SELF-AWARENESS FOR COPING WITH ANXIETY, DEPRESSION, STRESS, PANIC, OBESITY, SUBSTANCE ABUSE, AND INSOMNIA; AND PRERECORDED AUDIO RECORDINGS IN THE FIELDS OF SELF-HELP AND SELF-AWARENESS FOR COPING WITH ANXIETY, DEPRESSION, STRESS, OBESITY, SUBSTANCE ABUSE, AND INSOMNIA, IN CLASS 9 (U.S. CLS. 21, 23, 26, 36 AND 38).

FIRST USE 9-0-2007; IN COMMERCE 11-14-2007.

FOR: WORKBOOKS AND PRINTED EDUCATIONAL AND MOTIVATIONAL MATERIALS IN THE FIELDS OF SELF-HELP AND SELF-AWARENESS FOR COPING WITH ANXIETY, DEPRESSION, STRESS, PANIC, OBESITY, SUBSTANCE ABUSE, AND INSOMNIA, IN CLASS 16 (U.S. CLS. 2, 5, 22, 23, 29, 37, 38 AND 50).

FIRST USE 8-0-2007; IN COMMERCE 10-0-2007.

THE MARK CONSISTS OF STANDARD CHARACTERS WITHOUT CLAIM TO ANY PARTICULAR FONT, STYLE, SIZE, OR COLOR.

OWNER OF U.S. REG. NO. 2,248,847.

MS. LUCINDA BASSETT IS A LIVING INDIVIDUAL WHOSE CONSENT IS OF RECORD BY VIRTUE OF HER SIGNING BELOW.

SN 76-621,159, FILED 11-18-2004.

DOMINIC J. FERRAIUOLO, EXAMINING ATTORNEY



**Int. Cl.: 16**

**Prior U.S. Cls.: 2, 5, 22, 23, 29, 37, 38, and 50**

**United States Patent and Trademark Office**

**Reg. No. 3,395,275**

**Registered Mar. 11, 2008**

**TRADEMARK  
PRINCIPAL REGISTER**

**MIMI**

GRAPHIC PUBLICATIONS, INC. (OHIO CORPORATION)  
7368 COUNTY ROAD 623  
MILLERSBURG, OH 44654

FOR: PERIODIC PUBLICATION, NAMELY, A MAGAZINE CONCERNING MATTERS OF GENERAL INTEREST TO A PREDETERMINED REGION, IN CLASS 16 (U.S. CLS. 2, 5, 22, 23, 29, 37, 38 AND 50).

FIRST USE 6-11-2003; IN COMMERCE 12-20-2006.

THE MARK CONSISTS OF STANDARD CHARACTERS WITHOUT CLAIM TO ANY PARTICULAR FONT, STYLE, SIZE, OR COLOR.

THE NAME(S), PORTRAIT(S), AND/OR SIGNATURE(S) SHOWN IN THE MARK DOES NOT IDENTIFY A PARTICULAR LIVING INDIVIDUAL.

SN 76-621,653, FILED 11-22-2004.

KATHERINE STOIDES, EXAMINING ATTORNEY

**Int. Cl.: 11**

**Prior U.S. Cls.: 13, 21, 23, 31, and 34**

**United States Patent and Trademark Office**

**Reg. No. 3,395,276**

**Registered Mar. 11, 2008**

**TRADEMARK  
PRINCIPAL REGISTER**

# **DFI LIGHTING**

JIMWAY INC. (CALIFORNIA CORPORATION),  
DBA DFI LIGHTING,  
20101 S. SANTA FE AVENUE  
RANCHO DOMINGUEZ, CA 90221

FOR: LIGHTING FIXTURES, NAMELY, CEILING LIGHT FIXTURES, CHANDELIER LIGHT FIXTURES, WALL LIGHT FIXTURES, BATHROOM LIGHT FIXTURES, SPOT LIGHTING FIXTURES, RECESSED LIGHT FIXTURES, TRACK LIGHTING FIXTURES, SCONCE LIGHTING FIXTURES, HANGING LAMP FIXTURES; LAMPS, NAMELY, TABLE LAMPS, FLOOR LAMPS, STREET LAMPS, PARKING LOT LAMPS, KLIEG LAMPS, ELECTRIC LANTERNS, ELECTRIC NIGHT LIGHTS, OUTDOOR SECURITY LIGHTING FOR BUILDINGS, SHOP LIGHTS, NAMELY, INDOOR HANGING LIGHTING PANELS, WORK LIGHTS, NAMELY, FREE STANDING HIGH INTENSITY LIGHTS,

LAMP SHADES, LIGHT REFLECTORS, LIGHT DIFFUSERS, VEHICLE LIGHTING, NAMELY, HEADLIGHTS AND TAIL LIGHTS; AND CEILING FANS, IN CLASS 11 (U.S. CLS. 13, 21, 23, 31 AND 34).

FIRST USE 5-23-2005; IN COMMERCE 5-23-2005.

THE MARK CONSISTS OF STANDARD CHARACTERS WITHOUT CLAIM TO ANY PARTICULAR FONT, STYLE, SIZE, OR COLOR.

NO CLAIM IS MADE TO THE EXCLUSIVE RIGHT TO USE "LIGHTING", APART FROM THE MARK AS SHOWN.

SN 76-621,657, FILED 11-22-2004.

KATHERINE STOIDES, EXAMINING ATTORNEY

**Int. Cl.: 25**

**Prior U.S. Cls.: 22 and 39**

**United States Patent and Trademark Office**

**Reg. No. 3,395,277**

**Registered Mar. 11, 2008**

**TRADEMARK  
PRINCIPAL REGISTER**

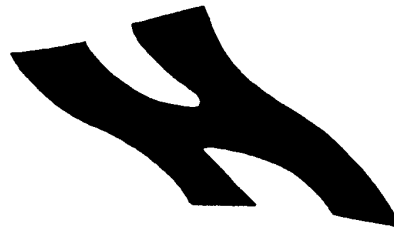

CUSTOMCRAFT MERCHANDISE CORP. (TAI-  
WAN CORPORATION)  
12FL., NO. 285, SEC. 4  
CHUNG HSIAO E. RD.  
TAIPEI, TAIWAN

FOR: SHOES, BOOTS, RAIN BOOTS, SANDALS,  
SLIPPERS, ATHLETIC SHOES, BASEBALL SHOES,  
FOOTBALL SHOES, GYMNASTIC SHOES, SPORT

SHOES, INSOLES FOR SHOES AND BOOTS, SHOE  
SOLES, IN CLASS 25 (U.S. CLS. 22 AND 39).

FIRST USE 4-21-2006; IN COMMERCE 4-21-2006.

SN 76-624,078, FILED 12-13-2004.

DAWN FELDMAN, EXAMINING ATTORNEY

**Int. Cl.: 30**

**Prior U.S. Cl.: 46**

**United States Patent and Trademark Office**

**Reg. No. 3,395,278**

**Registered Mar. 11, 2008**

**TRADEMARK  
PRINCIPAL REGISTER**

**MOUNTAIN GORILLA**

URTH CAFFE CORPORATION (CALIFORNIA  
CORPORATION)  
1307 W. PICO BOULEVARD  
LOS ANGELES, CA 90015

FOR: WHOLE BEAN AND GROUND COFFEE, IN  
CLASS 30 (U.S. CL. 46).

FIRST USE 12-0-2005; IN COMMERCE 12-0-2005.

THE MARK CONSISTS OF STANDARD CHAR-  
ACTERS WITHOUT CLAIM TO ANY PARTICULAR  
FONT, STYLE, SIZE, OR COLOR.

SN 76-624,175, FILED 12-10-2004.

KARANENDRA S. CHHINA, EXAMINING ATTOR-  
NEY

Int. Cl.: 32

Prior U.S. Cls.: 45, 46, and 48

United States Patent and Trademark Office

Reg. No. 3,395,279

Registered Mar. 11, 2008

TRADEMARK  
PRINCIPAL REGISTER



JAQUEZ, RAMON E. (UNITED STATES INDIVIDUAL)  
19 GRANT AVENUE  
BRENTWOOD, NY 11717

FOR: BOTTLED DRINKING WATER, IN CLASS 32 (U.S. CLS. 45, 46 AND 48).

FIRST USE 1-1-2006; IN COMMERCE 1-1-2006.

OWNER OF U.S. REG. NO. 2,968,864.

NO CLAIM IS MADE TO THE EXCLUSIVE RIGHT TO USE "MULTI-VITAMIN ENHANCED WATER", APART FROM THE MARK AS SHOWN.

THE MARK CONSISTS OF THE STYLIZED LETTER "V" BEHIND THE WORDING "MULTI-VITAMIN ENHANCED WATER" WITH A WATER DROP APPEARING AFTER THE TERM "MULTI".

SN 76-625,178, FILED 12-20-2004.

ASMAT KHAN, EXAMINING ATTORNEY

**Int. Cl.: 5**

**Prior U.S. Cls.: 6, 18, 44, 46, 51, and 52**

**Reg. No. 3,395,280**

**United States Patent and Trademark Office**

**Registered Mar. 11, 2008**

---

**TRADEMARK  
PRINCIPAL REGISTER**

**ITCHBUSTER**

RIOWELL, LLC (TEXAS LIMITED LIABILITY  
CORPORATION)  
7230 EMPIRE CENTRAL DRIVE  
HOUSTON, TX 77040

THE MARK CONSISTS OF STANDARD CHAR-  
ACTERS WITHOUT CLAIM TO ANY PARTICULAR  
FONT, STYLE, SIZE, OR COLOR.

FOR: TOPICAL PREPARATIONS FOR THE RE-  
LIEF OF ITCHING, IN CLASS 5 (U.S. CLS. 6, 18, 44, 46,  
51 AND 52).

SN 76-626,489, FILED 12-29-2004.

FIRST USE 8-1-1998; IN COMMERCE 8-1-1998.

KEVIN DINALLO, EXAMINING ATTORNEY

**Int. Cls.: 25 and 41**

**Prior U.S. Cls.: 22, 39, 100, 101, and 107**

**United States Patent and Trademark Office**

**Reg. No. 3,395,281**

**Registered Mar. 11, 2008**

**TRADEMARK  
SERVICE MARK  
PRINCIPAL REGISTER**



NAUTOR'S SWAN INTERNATIONAL S.P.A. (ITALY CORPORATION)  
VIA DE' TORNABUONI, 15  
FLORENCE, ITALY 50123

FOR: T-SHIRTS, IN CLASS 25 (U.S. CLS. 22 AND 39).

FIRST USE 0-0-1995; IN COMMERCE 0-0-1999.

FOR: ENTERTAINMENT SERVICES, NAMELY, ORGANIZING AMATEUR AND PROFESSIONAL SPORTING AND CULTURAL ACTIVITIES IN THE

FIELDS OF SAILING AND YACHTING, IN CLASS 41 (U.S. CLS. 100, 101 AND 107).

FIRST USE 0-0-1995; IN COMMERCE 0-0-1995.

NO CLAIM IS MADE TO THE EXCLUSIVE RIGHT TO USE "AMERICAN REGATTA", APART FROM THE MARK AS SHOWN.

SN 76-627,099, FILED 1-6-2005.

GIANCARLO CASTRO, EXAMINING ATTORNEY

**Int. Cls.: 14 and 25**

**Prior U.S. Cls.: 2, 22, 27, 28, 39, and 50**

**United States Patent and Trademark Office**

**Reg. No. 3,395,282**

**Registered Mar. 11, 2008**

**TRADEMARK  
PRINCIPAL REGISTER**



BEMENT, ROBIN M. (UNITED STATES INDIVIDUAL)

1811 WHITLEY AVENUE #600  
LOS ANGELES, CA 90028

FOR: JEWELRY, NAMELY, NECKLACES, BRACELETS, EAR RINGS, EAR STUDS AND CHARMS, IN CLASS 14 (U.S. CLS. 2, 27, 28 AND 50).

FIRST USE 1-1-2002; IN COMMERCE 1-1-2003.

FOR: CLOTHING, NAMELY, DRESSES, JACKETS, PANTS, SHIRTS AND TOPS, IN CLASS 25 (U.S. CLS. 22 AND 39).

FIRST USE 1-1-2002; IN COMMERCE 1-1-2003.

OWNER OF U.S. REG. NO. 2,873,854.

THE MARK CONSISTS OF THE DESIGN OF AN ARMY TANK.

SN 76-627,307, FILED 1-7-2005.

LEIGH CAROLINE CASE, EXAMINING ATTORNEY



**Int. Cl.: 7**

**Prior U.S. Cls.: 13, 19, 21, 23, 31, 34, and 35**

**Reg. No. 3,395,283**

**United States Patent and Trademark Office**

**Registered Mar. 11, 2008**

**TRADEMARK  
PRINCIPAL REGISTER**

**MAX FIRE**

MTD PRODUCTS INC (DELAWARE CORPORATION)  
5903 GRAFTON ROAD  
VALLEY CITY, OH 44280

FOR: IGNITIONS FOR HAND HELD PRODUCTS,  
NAMESLY, GAS STRING TRIMMERS, GAS LEAF  
BLOWERS, GAS CHAIN SAWS, GAS HEDGE TRIM-  
MERS, GAS BRUSH CUTTERS, AND GAS TILLER/  
CULTIVATORS, FOR USE WITH LAWN AND GAR-

DENS, IN CLASS 7 (U.S. CLS. 13, 19, 21, 23, 31, 34 AND  
35).

FIRST USE 1-0-2005; IN COMMERCE 1-0-2005.

SN 76-627,716, FILED 1-5-2005.

PAULA MAYS, EXAMINING ATTORNEY

**Int. Cls.: 9, 11, and 12**

**Prior U.S. Cls.: 13, 19, 21, 23, 26, 31, 34, 35, 36, 38, and 44**

**United States Patent and Trademark Office**

**Reg. No. 3,395,284**

**Registered Mar. 11, 2008**

**TRADEMARK  
PRINCIPAL REGISTER**

**GENTEX**

GENTEX CORPORATION (MICHIGAN CORPORATION)  
600 N. CENTENNIAL STREET  
ZEELAND, MI 49464

FOR: ELECTRONIC SYSTEM COMPRISED OF HARDWARE AND SOFTWARE FOR AUTOMATICALLY CONTROLLING VEHICLE HEADLAMPS; LIGHT SOURCES, NAMELY, LIGHT EMITTING DIODES; AND DEVICES INCORPORATING THE LIGHT SOURCES, NAMELY, LED DISPLAYS AND BACK-LIGHTING FOR DISPLAYS, NAMELY, LIQUID CRYSTAL DISPLAYS, IN CLASS 9 (U.S. CLS. 21, 23, 26, 36 AND 38).

FIRST USE 0-0-1998; IN COMMERCE 0-0-1998.

FOR: DEVICES INCORPORATING THE LIGHT SOURCES, NAMELY, ILLUMINATION DEVICES IN THE NATURE OF INTERIOR AND EXTERIOR VEHICLE LAMP MODULES; AND INDICATOR LIGHTS FOR VEHICLE CONSOLES AND INSTRU-

MENT PANELS, AND LIGHTED BUTTONS AND SWITCHES FOR VEHICLES, IN CLASS 11 (U.S. CLS. 13, 21, 23, 31 AND 34).

FIRST USE 0-0-1998; IN COMMERCE 0-0-1998.

FOR: VEHICLE TURN SIGNALS, IN CLASS 12 (U.S. CLS. 19, 21, 23, 31, 35 AND 44).

FIRST USE 12-0-2002; IN COMMERCE 12-0-2002.

THE MARK CONSISTS OF STANDARD CHARACTERS WITHOUT CLAIM TO ANY PARTICULAR FONT, STYLE, SIZE, OR COLOR.

OWNER OF U.S. REG. NO. 2,273,189.

SN 76-628,301, FILED 1-19-2005.

NAAKWAMA ANKRAH, EXAMINING ATTORNEY

Int. Cl.: 35

Prior U.S. Cls.: 100, 101, and 102

United States Patent and Trademark Office

Reg. No. 3,395,285

Registered Mar. 11, 2008

**SERVICE MARK  
PRINCIPAL REGISTER**



COOPER, STEVEN C. (UNITED STATES INDIVIDUAL), DBA ENTERTAINMENT USA MEMPHIS, INC.,

5100 POPLAR AVENUE, SUITE 2114

MEMPHIS, TN 38137

FOR: RETAIL DEPARTMENT STORES FEATURING ADULT GAMES, TOYS AND CLOTHING, IN CLASS 35 (U.S. CLS. 100, 101 AND 102).

FIRST USE 7-12-2005; IN COMMERCE 7-12-2005.

NO CLAIM IS MADE TO THE EXCLUSIVE RIGHT TO USE "ADULT MEGA BOUTIQUE", APART FROM THE MARK AS SHOWN.

THE MARK CONSISTS OF A STYLIZED VERSION OF THE WORDS "SIMPLY EXPLICIT ADULT MEGA BOUTIQUE" DISPOSED WITHIN A RECTANGLE CIRCUMSCRIBED BY A PARALLELOGRAM.

SN 76-630,937, FILED 2-10-2005.

KEVON CHISOLM, EXAMINING ATTORNEY

**Int. Cl.: 19**

**Prior U.S. Cls.: 1, 12, 33, and 50**

**United States Patent and Trademark Office**

**Reg. No. 3,395,286**

**Registered Mar. 11, 2008**

**TRADEMARK  
PRINCIPAL REGISTER**

**POP N GO**

DOSKOCIL MANUFACTURING COMPANY,  
INC. (TEXAS CORPORATION)  
4209 BARNETT  
ARLINGTON, TX 76017

THE MARK CONSISTS OF STANDARD CHAR-  
ACTERS WITHOUT CLAIM TO ANY PARTICULAR  
FONT, STYLE, SIZE, OR COLOR.

FOR: PET SHELTERS, NAMELY, PREFABRICA-  
TED DOGHOUSES, IN CLASS 19 (U.S. CLS. 1, 12, 33  
AND 50).

SN 76-632,951, FILED 3-10-2005.

FIRST USE 11-30-2005; IN COMMERCE 11-30-2005.

DAVID TAYLOR, EXAMINING ATTORNEY

**Int. Cl.: 35**

**Prior U.S. Cls.: 100, 101, and 102**

**United States Patent and Trademark Office**

**Reg. No. 3,395,287**

**Registered Mar. 11, 2008**

**SERVICE MARK  
PRINCIPAL REGISTER**

**TRAFFIXWORKS**

TALENT PARTNERS G.P. (NEW YORK LIMITED  
PARTNERSHIP)  
541 N. FAIRBANKS COURT  
CHICAGO, IL 60611

FOR: DISSEMINATION OF ADVERTISING MAT-  
TER; DISTRIBUTION OF ADVERTISEMENTS;  
COPYRIGHT AND PUBLICITY RIGHTS LICEN-  
SING INFORMATION CLEARING HOUSE AND  
MONITORING SERVICES; BUSINESS SERVICES,  
NAMELY, ISSUING INSTRUCTIONS FOR THE  
DUPLICATION AND BROADCAST OF ADVER-  
TISEMENTS; MONITORING USAGE AND BROAD-  
CAST OF ADVERTISEMENTS TO TRACK

PAYMENT OF RESIDUALS AND ROYALTIES  
FOR OTHERS, IN CLASS 35 (U.S. CLS. 100, 101  
AND 102).

FIRST USE 4-1-2005; IN COMMERCE 4-1-2005.

THE MARK CONSISTS OF STANDARD CHAR-  
ACTERS WITHOUT CLAIM TO ANY PARTICULAR  
FONT, STYLE, SIZE, OR COLOR.

SN 76-634,115, FILED 3-24-2005.

LINDA E. BLOHM, EXAMINING ATTORNEY

Int. Cl.: 25

Prior U.S. Cls.: 22 and 39

United States Patent and Trademark Office

Reg. No. 3,395,288

Registered Mar. 11, 2008

TRADEMARK  
PRINCIPAL REGISTER

**NRICHED**

LABELLA, HEATHER M. (UNITED STATES INDIVIDUAL)

NO. 205

3615 WATSEKA AVENUE

LOS ANGELES, CA 90034

FOR: MEN'S AND BOY'S WEARING APPAREL, NAMELY, T-SHIRTS, DRESS SHIRTS, SWEATSHIRTS, TANK TOPS, WOVEN SHIRTS, SWEATERS, CARDIGANS, VESTS, JACKETS, PANTS, SWEATPANTS, JEANS, SUITS, JERSEYS, SHORTS, HATS, CAPS, COATS, SCARVES, NECKERCHIEFS, NECK BANDS, WRIST BANDS, HEAD BANDS, GLOVES, BELTS, PAJAMAS, SHOES, SOCKS, UNDERWEAR, SWIM WEAR, AND TRUNKS; AND WOMEN'S AND GIRL'S WEARING APPAREL, NAMELY, T-SHIRTS, DRESS SHIRTS, SWEATSHIRTS, TANK TOPS, WOVEN SHIRTS, SWEATERS, CARDIGANS, VESTS, JACKETS, PANTS, SWEATPANTS, JEANS, SUITS,

JERSEYS, SHORTS, HATS, CAPS, COATS, BELTS, SCARVES, NECKERCHIEFS, NECK BANDS, WRIST BANDS, HEAD BANDS, GLOVES, PAJAMAS, SHOES, SOCKS, UNDERWEAR, FOUNDATION GARMENTS, PANTYHOSE, TEDDIES, BRAS, SKIRTS, DRESSES, BLOUSES, SWIM WEAR, AND BIKINIS, IN CLASS 25 (U.S. CLS. 22 AND 39).

FIRST USE 5-1-2005; IN COMMERCE 5-1-2005.

THE MARK CONSISTS OF STANDARD CHARACTERS WITHOUT CLAIM TO ANY PARTICULAR FONT, STYLE, SIZE, OR COLOR.

SN 76-635,010, FILED 4-4-2005.

BRETT J. GOLDEN, EXAMINING ATTORNEY

**Int. Cls.: 35 and 36**

**Prior U.S. Cls.: 100, 101, and 102**

**United States Patent and Trademark Office**

**Reg. No. 3,395,289**

**Registered Mar. 11, 2008**

**SERVICE MARK  
PRINCIPAL REGISTER**

**APO**

THE HALTER GROUP, INC. (TEXAS CORPORATION)  
12890 HILLTOP ROAD  
ARGYLE, TX 76226

FOR: BUSINESS ACQUISITION AND MERGER  
CONSULTATION SERVICES, IN CLASS 35 (U.S. CLS.  
100, 101 AND 102).

FIRST USE 5-5-2005; IN COMMERCE 5-5-2005.

FOR: CONSULTING SERVICES IN THE FIELD  
OF RAISING CAPITAL FOR BUSINESS EXPAN-  
SION, IN CLASS 36 (U.S. CLS. 100, 101 AND 102).

FIRST USE 5-5-2005; IN COMMERCE 5-5-2005.

THE MARK CONSISTS OF STANDARD CHAR-  
ACTERS WITHOUT CLAIM TO ANY PARTICULAR  
FONT, STYLE, SIZE, OR COLOR.

SN 76-637,680, FILED 5-3-2005.

LINDA MICKLEBURGH, EXAMINING ATTORNEY

**Int. Cl.: 18**

**Prior U.S. Cls.: 1, 2, 3, 22, and 41**

**United States Patent and Trademark Office**

**Reg. No. 3,395,290**

**Registered Mar. 11, 2008**

**TRADEMARK  
PRINCIPAL REGISTER**



LAING BAN INTERNATIONAL INC. (TAIWAN CORPORATION)  
RM. 204, NO.5 WU CHUAN 1 RD.  
HSIN CHUANG CITY, TAIPEI HSIEN, TAIWAN

FOR: BILLFOLDS, WALLETS, PURSES, BACKPACKS, SCHOOL BAGS, WAIST BAGS, SUITCASES, TRAVELING BAGS, HANDBAGS, LEATHER SHOPPING BAGS, TEXTILE SHOPPING BAGS, SHOPPING BAGS WITH WHEELS ATTACHED; TOILETRY CASES SOLD EMPTY, ATTACHE CASES, LUGGAGE, DUFFLE BAGS, ALL-PURPOSE

ATHLETIC BAGS, LEATHER AND IMITATIONS OF LEATHER, FUR, IN CLASS 18 (U.S. CLS. 1, 2, 3, 22 AND 41).

FIRST USE 2-1-1988; IN COMMERCE 9-1-2007.

OWNER OF U.S. REG. NO. 2,631,431.

SN 76-637,832, FILED 5-4-2005.

STEVEN PEREZ, EXAMINING ATTORNEY



**Int. Cl.: 16**

**Prior U.S. Cls.: 2, 5, 22, 23, 29, 37, 38, and 50**

**Reg. No. 3,395,291**

**United States Patent and Trademark Office**

**Registered Mar. 11, 2008**

**TRADEMARK  
PRINCIPAL REGISTER**

**YOU HAVE THE RIGHTS! THE  
FIRST AMENDMENT IN THE  
NEWS**

ADVANCE MAGAZINE PUBLISHERS INC. (NEW  
YORK CORPORATION)  
FOUR TIMES SQUARE  
NEW YORK, NY 10036

FIRST USE 5-1-2005; IN COMMERCE 5-1-2005.

FOR: PRINTED EDUCATIONAL PUBLICA-  
TIONS, NAMELY, PAMPHLETS, TEXT BOOKS,  
AND BROCHURES ON THE SUBJECT OF FIRST  
AMENDMENT RIGHTS PROVIDED BY SCHOOLS  
TO ITS STUDENTS, IN CLASS 16 (U.S. CLS. 2, 5, 22,  
23, 29, 37, 38 AND 50).

THE MARK CONSISTS OF STANDARD CHAR-  
ACTERS WITHOUT CLAIM TO ANY PARTICULAR  
FONT, STYLE, SIZE, OR COLOR.

SN 76-640,548, FILED 6-10-2005.

BARBARA GAYNOR, EXAMINING ATTORNEY

**Int. Cls.: 9, 35, 39, and 45**

**Prior U.S. Cls.: 21, 23, 26, 36, 38, 100, 101, 102, and 105**

**Reg. No. 3,395,292**

**United States Patent and Trademark Office**

**Registered Mar. 11, 2008**

**TRADEMARK  
SERVICE MARK  
PRINCIPAL REGISTER**



SENTRILOCK, INC. (OHIO CORPORATION)  
11988 TRAMWAY DRIVE  
CINCINNATI, OH 45241

FOR: ELECTRONICALLY-OPERATED LOCKING DEVICES THAT CONTAIN KEYS OR ACCESS CODES, WHICH LATCH ONTO STRUCTURES SUCH AS BUILDINGS OR FENCES, AND WHICH CANNOT BE REMOVED WITHOUT A SECURITY CODE; ELECTRONICALLY-OPERATED REAL ESTATE LOCK BOXES THAT CONTAIN KEYS OR ACCESS CODES, WHICH LATCH ONTO STRUCTURES SUCH AS BUILDINGS OR FENCES, AND WHICH CANNOT BE REMOVED WITHOUT A SECURITY CODE; ELECTRONIC MEMORY CARDS, IN CLASS 9 (U.S. CLS. 21, 23, 26, 36 AND 38).

FIRST USE 9-21-2007; IN COMMERCE 9-21-2007.

FOR: COMPUTERIZED DATABASE MANAGEMENT SERVICES, NAMELY, MAINTAINING A DATABASE OF AUTHORIZED COMPUTER USERS HAVING SECURITY ACCESS TO REMOTELY-LOCATED ELECTRONICALLY-OPERATED LOCKING DEVICES, IN CLASS 35 (U.S. CLS. 100, 101 AND 102).

FIRST USE 9-21-2007; IN COMMERCE 9-21-2007.

FOR: ELECTRONIC STORAGE OF SECURE ACCESS DATA AT A CENTRAL COMPUTER, IN CLASS 39 (U.S. CLS. 100 AND 105).

FIRST USE 9-21-2007; IN COMMERCE 9-21-2007.

FOR: MONITORING OF COMPUTER SYSTEMS FOR SECURITY PURPOSES, NAMELY, MONITORING AND RETRIEVING SECURE ACCESS DATA STORED AT A CENTRAL COMPUTER, MONITORING ACCESS TO COMPUTER-OPERATED SYSTEMS BY AUTHORIZED USERS AT REMOTE SITES, AND COMPILING AND DISSEMINATING A SECURE ACCESS DATA LOG RELATED THERETO, IN CLASS 45 (U.S. CLS. 100 AND 101).

FIRST USE 9-21-2007; IN COMMERCE 9-21-2007.

THE MARK CONSISTS OF THE LETTER "S" WITH THE UPPER PORTION FORMING THE SHACKLE OF A DETACHABLE LOCKING DEVICE.

SN 76-640,700, FILED 6-13-2005.

CURTIS FRENCH, EXAMINING ATTORNEY

**Int. Cl.: 44**

**Prior U.S. Cls.: 100 and 101**

**United States Patent and Trademark Office**

**Reg. No. 3,395,293**

**Registered Mar. 11, 2008**

**SERVICE MARK  
PRINCIPAL REGISTER**

**PEPS**

JOANGIL ENTERPRISES, LLC (NEW JERSEY  
LTD LIAB CO)  
7 MCCUE ROAD  
MORGANVILLE, NJ 07751

THE MARK CONSISTS OF STANDARD CHAR-  
ACTERS WITHOUT CLAIM TO ANY PARTICULAR  
FONT, STYLE, SIZE, OR COLOR.

FOR: NUTRITION COUNSELING, IN CLASS 44  
(U.S. CLS. 100 AND 101).

SN 76-640,979, FILED 6-16-2005.

FIRST USE 10-1-2005; IN COMMERCE 10-1-2005.

REBECCA EISINGER, EXAMINING ATTORNEY

Int. Cl.: 28

Prior U.S. Cls.: 22, 23, 38, and 50

**United States Patent and Trademark Office**

**Reg. No. 3,395,294**

Registered Mar. 11, 2008

**TRADEMARK  
PRINCIPAL REGISTER**



PBC INTERNATIONAL, INC. (CALIFORNIA  
CORPORATION)  
P.O. BOX 5767  
OXNARD, CA 93031

FIRST USE 7-6-2005; IN COMMERCE 7-6-2005.

SN 76-641,012, FILED 6-17-2005.

FOR: STUFFED PLUSH TOY CHARACTERS, IN  
CLASS 28 (U.S. CLS. 22, 23, 38 AND 50).

DOMINIC J. FERRAIUOLO, EXAMINING ATTOR-  
NEY

**Int. Cl.: 9**

**Prior U.S. Cls.: 21, 23, 26, 36, and 38**

**Reg. No. 3,395,295**

**United States Patent and Trademark Office**

**Registered Mar. 11, 2008**

**TRADEMARK  
PRINCIPAL REGISTER**

**LONGTAIL STUDIOS**

LONGTAIL STUDIOS, INC. (NEW YORK CORPORATION)  
180 VARICK STREET  
SUITE 1614  
NEW YORK, NY 10014

FOR: SOFTWARE AND ELECTRONIC GAMES, NAMELY, SOFTWARE GAMES RECORDED ON CD-ROM AND DIGITAL VIDEO DISCS FOR COMPUTERS; SOFTWARE GAMES RECORDED ON CD-ROMS, DIGITAL VIDEO DISCS, AND CARTRIDGES FOR CONSOLE AND INDIVIDUAL PORTABLE GAMING SYSTEMS; SOFTWARE GAMES THAT ARE DOWNLOADABLE FROM A REMOTE COMPUTER SITE; AND SOFTWARE GAMES FOR MOBILE PHONES, PERSONAL DIGITAL ASSISTANTS,

AND HANDHELD COMPUTERS, IN CLASS 9 (U.S. CLS. 21, 23, 26, 36 AND 38).

FIRST USE 8-1-2005; IN COMMERCE 8-1-2005.

THE MARK CONSISTS OF STANDARD CHARACTERS WITHOUT CLAIM TO ANY PARTICULAR FONT, STYLE, SIZE, OR COLOR.

NO CLAIM IS MADE TO THE EXCLUSIVE RIGHT TO USE "STUDIOS" , APART FROM THE MARK AS SHOWN.

SN 76-641,606, FILED 6-24-2005.

JUSTINE D. PARKER, EXAMINING ATTORNEY

**Int. Cls.: 25 and 41**

**Prior U.S. Cls.: 22, 39, 100, 101, and 107**

**Reg. No. 3,395,296**

**United States Patent and Trademark Office**

**Registered Mar. 11, 2008**

**TRADEMARK  
SERVICE MARK  
PRINCIPAL REGISTER**

# **SWINGN SINGLES**

RODRIGUES, NANCY SYMBULSKI (UNITED STATES INDIVIDUAL)  
3340 PETALUMA BLVD NORTH  
PETALUMA, CA 94952

FOR: CLOTHING AND HEADGEAR; NAMELY, T-SHIRTS, GOLF HATS AND JACKETS AND SWEATSHIRTS, IN CLASS 25 (U.S. CLS. 22 AND 39).

FIRST USE 10-15-2007; IN COMMERCE 10-15-2007.

FOR: ENTERTAINMENT, SPORTING AND CULTURAL ACTIVITIES, NAMELY, ORGANIZING LUNCHEONS, DINNERS, GOLF TOURNAMENTS,

GOLF CLINICS AND REGULAR MEMBERSHIP MEETINGS, IN CLASS 41 (U.S. CLS. 100, 101 AND 107).

FIRST USE 10-15-2007; IN COMMERCE 10-15-2007.

THE MARK CONSISTS OF STANDARD CHARACTERS WITHOUT CLAIM TO ANY PARTICULAR FONT, STYLE, SIZE, OR COLOR.

SN 76-642,630, FILED 7-11-2005.

INGA ERVIN, EXAMINING ATTORNEY

**Int. Cl.: 43**

**Prior U.S. Cls.: 100 and 101**

**United States Patent and Trademark Office**

**Reg. No. 3,395,297**

**Registered Mar. 11, 2008**

**SERVICE MARK  
PRINCIPAL REGISTER**



JAVA CUP CORPORATION (TEXAS CORPORATION)  
14302 HARVEST RIDGE  
HOUSTON, TX 77062

NO CLAIM IS MADE TO THE EXCLUSIVE  
RIGHT TO USE "JAVA", APART FROM THE MARK  
AS SHOWN.

FOR: RESTAURANT SERVICES, NAMELY, PROVIDING BEVERAGES, IN CLASS 43 (U.S. CLS. 100 AND 101).

SN 76-645,560, FILED 8-24-2005.

FIRST USE 9-0-2005; IN COMMERCE 4-0-2006.

MICHAEL LEWIS, EXAMINING ATTORNEY

**Int. Cl.: 21**

**Prior U.S. Cls.: 2, 13, 23, 29, 30, 33, 40, and 50**

**United States Patent and Trademark Office**

**Reg. No. 3,395,298**

**Registered Mar. 11, 2008**

**TRADEMARK  
PRINCIPAL REGISTER**

**MAGNET CLOTH**

CASABELLA HOLDINGS, L.L.C. (DELAWARE  
LTD LIAB CO)  
400 CORPORATE DRIVE  
BLAUVELT, NY 10913

FOR: CLEANING CLOTHS FOR AUTOS, BATH-  
ROOMS KITCHENS, BICYCLES, PDA'S, CELL  
PHONES, PLASMA TV SCREENS, COMPUTER  
SCREENS, FAUCETS, STAINLESS STEEL, GLASS,  
GRANITE, MARBLE, SOAPSTONE MUSICAL IN-  
STRUMENTS, COPPER, SILVER, AND EYEGLAS-  
SES, IN CLASS 21 (U.S. CLS. 2, 13, 23, 29, 30, 33, 40  
AND 50).

FIRST USE 1-0-2006; IN COMMERCE 2-0-2006.

THE MARK CONSISTS OF STANDARD CHAR-  
ACTERS WITHOUT CLAIM TO ANY PARTICULAR  
FONT, STYLE, SIZE, OR COLOR.

OWNER OF U.S. REG. NOS. 1,966,965 AND  
2,444,893.

NO CLAIM IS MADE TO THE EXCLUSIVE  
RIGHT TO USE "CLOTH", APART FROM THE  
MARK AS SHOWN.

SN 76-646,008, FILED 8-29-2005.

CIMMERIAN COLEMAN, EXAMINING ATTOR-  
NEY



**Int. Cl.: 36**

**Prior U.S. Cls.: 100, 101, and 102**

**United States Patent and Trademark Office**

**Reg. No. 3,395,299**

**Registered Mar. 11, 2008**

**SERVICE MARK  
PRINCIPAL REGISTER**

**LIVE LIKE A CHAMPION**

OKLAHOMA DEVELOPMENT GROUP, L.L.C.  
(OKLAHOMA LTD LIAB CO)  
2627 CLASSEN BOULEVARD  
NORMAN, OK 730714263

THE MARK CONSISTS OF STANDARD CHAR-  
ACTERS WITHOUT CLAIM TO ANY PARTICULAR  
FONT, STYLE, SIZE, OR COLOR.

FOR: APARTMENT LEASING, RENTAL AND  
MANAGEMENT SERVICES, IN CLASS 36 (U.S.  
CLS. 100, 101 AND 102).

SN 76-646,248, FILED 9-6-2005.

FIRST USE 5-0-2005; IN COMMERCE 5-0-2005.

KATHERINE STOIDES, EXAMINING ATTORNEY

**Int. Cl.: 21**

**Prior U.S. Cls.: 2, 13, 23, 29, 30, 33, 40, and 50**

**United States Patent and Trademark Office**

**Reg. No. 3,395,300**

**Registered Mar. 11, 2008**

**TRADEMARK  
PRINCIPAL REGISTER**

**BROW STIX**

ANASTASIA BEVERLY HILLS, INC. (CALIFORNIA CORPORATION)

438 NORTH BEDFORD DRIVE

BEVERLY HILLS, CA 90210

FOR: ADHESIVE EYEBROW STENCILS TO OVERLAY EYEBROWS FOR SHAPING, IN CLASS 21 (U.S. CLS. 2, 13, 23, 29, 30, 33, 40 AND 50).

FIRST USE 11-0-2006; IN COMMERCE 11-0-2006.

THE MARK CONSISTS OF STANDARD CHARACTERS WITHOUT CLAIM TO ANY PARTICULAR FONT, STYLE, SIZE, OR COLOR.

NO CLAIM IS MADE TO THE EXCLUSIVE RIGHT TO USE "BROW", APART FROM THE MARK AS SHOWN.

SN 76-648,592, FILED 10-17-2005.

WARREN L. OLANDRIA, EXAMINING ATTORNEY

**Int. Cl.: 9**

**Prior U.S. Cls.: 21, 23, 26, 36, and 38**

**United States Patent and Trademark Office**

**Reg. No. 3,395,301**

**Registered Mar. 11, 2008**

**TRADEMARK  
PRINCIPAL REGISTER**

**IMOBILE**

VECTOR PRODUCTS, INC. (FLORIDA CORPORATION)  
8100 S.W. 10TH STREET, SUITE 3000  
PLANTATION, FL 33324

FOR: VEHICLE POWER ACCESSORY ADAPTERS; AC/DC CONVERTERS; PORTABLE/RECHARGEABLE DOCKING STATIONS FEATURING COOLING FANS, GRASPS AND ENHANCED SPEAKERS FOR USE WITH PORTABLE ENTERTAINMENT SYSTEMS; POCKET SIZE DC TO AC INVERTERS, POWER INVERTER; POWER INVERTERS WITH LCD SCREEN, AND POWER

INVERTERS WITH LCD SCREEN AND DVD PLAYER, IN CLASS 9 (U.S. CLS. 21, 23, 26, 36 AND 38).

FIRST USE 8-31-2005; IN COMMERCE 8-31-2005.

THE MARK CONSISTS OF STANDARD CHARACTERS WITHOUT CLAIM TO ANY PARTICULAR FONT, STYLE, SIZE, OR COLOR.

SN 76-649,528, FILED 11-1-2005.

MATTHEW EINSTEIN, EXAMINING ATTORNEY

**Int. Cl.: 25**

**Prior U.S. Cls.: 22 and 39**

**United States Patent and Trademark Office**

**Reg. No. 3,395,302**

**Registered Mar. 11, 2008**

**TRADEMARK  
PRINCIPAL REGISTER**

**HIDE IN CHIC**

MCCOY, ELIZABETH T. (UNITED STATES IN-  
DIVIDUAL)  
880 TWISTED OAK LANE  
BUFFALO GROVE, IL 60089

THE MARK CONSISTS OF STANDARD CHAR-  
ACTERS WITHOUT CLAIM TO ANY PARTICULAR  
FONT, STYLE, SIZE, OR COLOR.

FOR: CLOTHING, NAMELY, NURSING SHIRTS  
AND NURSING SMOCKS, IN CLASS 25 (U.S. CLS. 22  
AND 39).

SN 76-649,643, FILED 11-2-2005.

FIRST USE 8-30-2007; IN COMMERCE 8-30-2007.

ROBERT STRUCK, EXAMINING ATTORNEY

**Int. Cl.: 35**

**Prior U.S. Cls.: 100, 101, and 102**

**United States Patent and Trademark Office**

**Reg. No. 3,395,303**

**Registered Mar. 11, 2008**

**SERVICE MARK  
PRINCIPAL REGISTER**

**GOVTOOLS**

W. S. SPOTSWOOD & SONS, INC. (VIRGINIA CORPORATION)  
5415-E BACKLICK ROAD  
SPRINGFIELD, VA 22154

FOR: INDEPENDENT SALES REPRESENTATIVES IN THE FIELD OF DESIGN, SELECTION, IMPLEMENTATION AND USE OF HARDWARE, CONSUMER GOODS AND CONSTRUCTION GOODS; RETAIL STORE SERVICES FEATURING A WIDE VARIETY OF CONSUMER GOODS AND CONSTRUCTION GOODS OF OTHERS; BUSINESS MARKETING SERVICES; ADVERTISING, INCLUDING PROMOTION RELATING TO THE SALE OF ARTICLES AND SERVICES FOR THIRD PARTIES BY THE TRANSMISSION OF ADVERTISING MATERIAL AND THE DISSEMINATION OF ADVERTISING MESSAGES ON COMPUTER NETWORKS; COOPERATIVE ADVERTISING AND MARKETING SERVICES BY WAY OF SOLICITATION, CUSTOMER SERVICE AND PROVIDING MARKETING INFORMATION VIA WEBSITES ON A GLOBAL COMPUTER NETWORK; COMPUTERIZED DATABASE MANAGEMENT; PROVIDING CONSUMER PRODUCT INFORMATION, NAMELY, ON-LINE REVIEWS OF A WIDE VARIETY OF CONSUMER

GOODS AND CONSTRUCTION GOODS OF OTHERS; ELECTRONIC RETAILING SERVICES VIA COMPUTER FEATURING A WIDE VARIETY OF CONSUMER GOODS AND CONSTRUCTION GOODS OF OTHERS; BUSINESS MANAGEMENT CONSULTING WITH RELATION TO STRATEGY, MARKETING PRODUCTION, PERSONNEL AND RETAIL AND WHOLESALE SALE MATTERS; BUSINESS CONSULTING SERVICES RELATING TO PRODUCT DISTRIBUTION, OPERATIONS MANAGEMENT SERVICES, LOGISTICS, REVERSE LOGISTICS, SUPPLY CHAIN AND PRODUCTION SYSTEMS AND DISTRIBUTION SOLUTIONS, IN CLASS 35 (U.S. CLS. 100, 101 AND 102).

FIRST USE 11-10-2005; IN COMMERCE 11-10-2005.

THE MARK CONSISTS OF STANDARD CHARACTERS WITHOUT CLAIM TO ANY PARTICULAR FONT, STYLE, SIZE, OR COLOR.

SN 76-650,078, FILED 11-9-2005.

PATRICIA EVANKO, EXAMINING ATTORNEY

**Int. Cl.: 39**

**Prior U.S. Cls.: 100 and 105**

**United States Patent and Trademark Office**

**Reg. No. 3,395,304**

**Registered Mar. 11, 2008**

**SERVICE MARK  
PRINCIPAL REGISTER**

**PRODUCTIVITY IN MOTION**

WEST BROTHERS TRANSPORTATION SERVICES, INC. (NORTH CAROLINA CORPORATION)

P.O. BOX 21019  
224 N. HOOVER ROAD  
DURHAM, NC 27703

FOR: SUPPLY CHAIN AND LOGISTICS, NAME-  
LY, TRANSPORTATION AND DELIVERY OF  
FREIGHT FOR OTHERS BY TRUCK ON A CON-  
TRACT BASIS, IN CLASS 39 (U.S. CLS. 100 AND 105).

FIRST USE 3-0-2006; IN COMMERCE 3-0-2006.

THE MARK CONSISTS OF STANDARD CHAR-  
ACTERS WITHOUT CLAIM TO ANY PARTICULAR  
FONT, STYLE, SIZE, OR COLOR.

SN 76-650,801, FILED 11-15-2005.

RENEE MCCRAY, EXAMINING ATTORNEY

**Int. Cl.: 9**

**Prior U.S. Cls.: 21, 23, 26, 36, and 38**

**United States Patent and Trademark Office**

**Reg. No. 3,395,305**

**Registered Mar. 11, 2008**

**TRADEMARK  
PRINCIPAL REGISTER**

**NEVER LEAN**

ADVANCED INJECTION TECHNOLOGIES, INC.  
(COLORADO CORPORATION)  
2016 LINCOLN AVENUE  
FORT COLLINS, CO 80524

FOR: CONTROLLER FOR MONITORING PERFORMANCE OF AND CONTROLLING FUEL DELIVERY TO INTERNAL COMBUSTION ENGINES OF MOTOR VEHICLES, IN CLASS 9 (U.S. CLS. 21, 23, 26, 36 AND 38).

FIRST USE 1-1-2006; IN COMMERCE 1-1-2006.

THE MARK CONSISTS OF STANDARD CHARACTERS WITHOUT CLAIM TO ANY PARTICULAR FONT, STYLE, SIZE, OR COLOR.

SN 76-650,893, FILED 11-23-2005.

SHAUNIA CARLYLE, EXAMINING ATTORNEY

**Int. Cl.: 9**

**Prior U.S. Cls.: 21, 23, 26, 36, and 38**

**United States Patent and Trademark Office**

**Reg. No. 3,395,306**

**Registered Mar. 11, 2008**

**TRADEMARK  
PRINCIPAL REGISTER**

**PROLOGGER**

ADVANCED INJECTION TECHNOLOGIES, INC.  
(COLORADO CORPORATION)  
2016 LINCOLN AVENUE  
FORT COLLINS, CO 80524

FOR: CONTROLLER FOR MONITORING PERFORMANCE OF AND CONTROLLING FUEL DELIVERY TO INTERNAL COMBUSTION ENGINES OF MOTOR VEHICLES, IN CLASS 9 (U.S. CLS. 21, 23, 26, 36 AND 38).

FIRST USE 1-1-2006; IN COMMERCE 1-1-2006.

THE MARK CONSISTS OF STANDARD CHARACTERS WITHOUT CLAIM TO ANY PARTICULAR FONT, STYLE, SIZE, OR COLOR.

SN 76-650,894, FILED 11-23-2005.

SHAUNIA CARLYLE, EXAMINING ATTORNEY



**Int. Cl.: 27**

**Prior U.S. Cls.: 19, 20, 37, 42, and 50**

**United States Patent and Trademark Office**

**Reg. No. 3,395,307**

**Registered Mar. 11, 2008**

**TRADEMARK  
PRINCIPAL REGISTER**

**ENVIROCEL**

UNIVERSAL TEXTILE TECHNOLOGIES (GEORGIA CORPORATION)  
204 WEST INDUSTRIAL BOULEVARD  
DALTON, GA 30720

THE MARK CONSISTS OF STANDARD CHARACTERS WITHOUT CLAIM TO ANY PARTICULAR FONT, STYLE, SIZE, OR COLOR.

FOR: CARPET, SYNTHETIC TURF AND ARTIFICIAL GRASS FOR SPORTS AND RECREATIONAL USE, IN CLASS 27 (U.S. CLS. 19, 20, 37, 42 AND 50).

SN 76-651,384, FILED 12-2-2005.

FIRST USE 11-1-2007; IN COMMERCE 11-1-2007.

REBECCA SMITH, EXAMINING ATTORNEY

**Int. Cl.: 41**

**Prior U.S. Cls.: 100, 101, and 107**

**United States Patent and Trademark Office**

**Reg. No. 3,395,308**

**Registered Mar. 11, 2008**

**SERVICE MARK  
PRINCIPAL REGISTER**

**CARE TO CHANGE THE WORLD.**

THE TRUSTEES OF THE UNIVERSITY OF  
PENNSYLVANIA (PENNSYLVANIA NON-  
PROFIT CORPORATION)  
OFFICE OF THE GENERAL COUNSEL  
133 S. 36TH STREET, SUITE 300  
PHILADELPHIA, PA 19104

FOR: EDUCATIONAL SERVICES, NAMELY, OF-  
FERING UNDERGRADUATE AND POST GRADU-  
ATE DEGREE PROGRAMS OF INSTRUCTION IN  
THE FIELDS OF HEALTH CARE AND NURSING;  
ARRANGING AND CONDUCTING EDUCATION-  
AL CONFERENCES AND SEMINARS; PROVIDING  
NON DEGREE INSTRUCTIONAL PROGRAMS FOR  
NURSES AND HEALTH CARE PROFESSIONALS;

PROVIDING ONLINE EDUCATIONAL INFORMA-  
TION IN THE FIELDS OF NURSING AND HEALTH  
CARE, IN CLASS 41 (U.S. CLS. 100, 101 AND 107).

FIRST USE 1-0-2007; IN COMMERCE 1-0-2007.

THE MARK CONSISTS OF STANDARD CHAR-  
ACTERS WITHOUT CLAIM TO ANY PARTICULAR  
FONT, STYLE, SIZE, OR COLOR.

SN 76-653,458, FILED 1-12-2006.

GIANCARLO CASTRO, EXAMINING ATTORNEY

**Int. Cl.: 9**

**Prior U.S. Cls.: 21, 23, 26, 36, and 38**

**Reg. No. 3,395,309**

**United States Patent and Trademark Office**

**Registered Mar. 11, 2008**

**TRADEMARK  
PRINCIPAL REGISTER**

**X-TREME**

SPERIAN HEARING PROTECTION, LLC (DELA-  
WARE LTD LIAB CO), DBA HOWARD  
LEIGHT HEARING PROTECTION,  
7828 WATERVILLE ROAD  
SAN DIEGO, CA 92154

THE MARK CONSISTS OF STANDARD CHAR-  
ACTERS WITHOUT CLAIM TO ANY PARTICULAR  
FONT, STYLE, SIZE, OR COLOR.

FOR: DISPOSABLE FOAM EARPLUGS FOR  
NONMEDICAL PURPOSES, IN CLASS 9 (U.S. CLS.  
21, 23, 26, 36 AND 38).

SN 76-654,548, FILED 2-3-2006.

FIRST USE 9-10-2007; IN COMMERCE 9-10-2007.

NAAKWAMA ANKRAH, EXAMINING ATTORNEY

**Int. Cl.: 28**

**Prior U.S. Cls.: 22, 23, 38, and 50**

**United States Patent and Trademark Office**

**Reg. No. 3,395,310**

**Registered Mar. 11, 2008**

**TRADEMARK  
PRINCIPAL REGISTER**

**KID MOTION**

HASBRO, INC. (RHODE ISLAND CORPORATION)  
1027 NEWPORT AVENUE  
PAWTUCKET, RI 02862

FOR: TOYS AND GAMES, NAMELY, CHILDREN'S RIDE TOYS; CHILDREN'S REVOLVING RIDE ON TOYS; PHYSICAL FITNESS BALANCING TOYS, NAMELY, FOOT ENGAGING, INVERTED CUP LIKE DEVICES WITH ATTACHED HAND CORD; TOY BALLS; TOY BASEBALLS; TOY BASEBALL BATS; TOY BASEBALL GLOVES; TOY SOCCER BALLS; TOY FOOTBALLS; TOY PINWHEELS TAG GAMES, IN CLASS 28 (U.S. CLS. 22, 23, 38 AND 50).

FIRST USE 3-6-2007; IN COMMERCE 3-6-2007.

THE MARK CONSISTS OF STANDARD CHARACTERS WITHOUT CLAIM TO ANY PARTICULAR FONT, STYLE, SIZE, OR COLOR.

NO CLAIM IS MADE TO THE EXCLUSIVE RIGHT TO USE "KID", APART FROM THE MARK AS SHOWN.

SN 76-655,109, FILED 2-14-2006.

SUSAN RICHARDS, EXAMINING ATTORNEY

**Int. Cl.: 35**

**Prior U.S. Cls.: 100, 101, and 102**

**United States Patent and Trademark Office**

**Reg. No. 3,395,311**

**Registered Mar. 11, 2008**

**SERVICE MARK  
PRINCIPAL REGISTER**

WHERE THE BUSINESS CALLS YOU

DAG INTERACTIVE, INC. (DELAWARE CORPORATION)  
125-10 QUEENS BLVD.  
KEW GARDENS, NY 11415

FOR: PROVIDING A WEB SITE WHEREBY BUYERS OF GOODS OR SERVICES SUBMIT THEIR REQUEST OR NEED AND THE SYSTEM AUTOMATICALLY MATCHES THE REQUEST WITH POTENTIALLY QUALIFYING PARTICIPATING BUSINESSES OR VENDORS WHO IN TURN PROVIDE THE CONSUMER WITH QUOTATIONS AND

ESSENTIALLY BID ON NEW SALES OPPORTUNITIES, IN CLASS 35 (U.S. CLS. 100, 101 AND 102).

FIRST USE 3-1-2006; IN COMMERCE 3-1-2006.

THE MARK CONSISTS OF STANDARD CHARACTERS WITHOUT CLAIM TO ANY PARTICULAR FONT, STYLE, SIZE, OR COLOR.

SN 76-655,450, FILED 2-22-2006.

STEVEN R. FOSTER, EXAMINING ATTORNEY

**Int. Cl.: 30**

**Prior U.S. Cl.: 46**

**United States Patent and Trademark Office**

**Reg. No. 3,395,312**

**Registered Mar. 11, 2008**

**TRADEMARK  
PRINCIPAL REGISTER**

**CANDY CHASERS**

HASBRO, INC. (RHODE ISLAND CORPORATION)  
1027 NEWPORT AVENUE  
PAWTUCKET, RI 02862

NO CLAIM IS MADE TO THE EXCLUSIVE  
RIGHT TO USE "CANDY", APART FROM THE  
MARK AS SHOWN.

FOR: CANDY, IN CLASS 30 (U.S. CL. 46).

FIRST USE 6-1-2006; IN COMMERCE 6-1-2006.

SN 76-655,880, FILED 3-1-2006.

THE MARK CONSISTS OF STANDARD CHARACTERS WITHOUT CLAIM TO ANY PARTICULAR FONT, STYLE, SIZE, OR COLOR.

KIMBERLY FRYE, EXAMINING ATTORNEY

**Int. Cl.: 9**

**Prior U.S. Cls.: 21, 23, 26, 36, and 38**

**United States Patent and Trademark Office**

**Reg. No. 3,395,313**

**Registered Mar. 11, 2008**

**TRADEMARK  
PRINCIPAL REGISTER**

**TROPICAL MADNESS**

GAMELOFT S.A. (FRANCE SOCIETE ANONYME  
(CORPORATION))  
14 RUE AUBER  
PARIS, FRANCE 75009

FOR: COMPUTER SOFTWARE FOR ELECTRONIC GAMES AND ENTERTAINMENT, NAMELY, COMPUTER GAME SOFTWARE USED AND PLAYED ON MOBILE CELLULAR TELEPHONES, HANDHELD COMPUTERS, PERSONAL COMPUTERS AND PERSONAL DIGITAL ASSISTANTS; DOWNLOADABLE ELECTRONIC GAME PROGRAMS; DOWNLOADABLE RING TONES; DOWNLOADABLE VOICE RINGERS FOR MOBILE TELECOMMUNICATIONS DEVICES; COMPUTER SOFTWARE FOR WALL PAPERS, NAMELY, STILL IMAGES FOR USE IN BACKGROUNDS ON MOBILE PHONE SCREENS; COMPUTER SCREEN SAVER SOFTWARE; COMPUTER SOFTWARE FOR PROCESSING ANIMATED IMAGES FOR USE ON MOBILE PHONE SCREENS; AND PROGRAMS FOR

DOWNLOADING IMAGES TO MOBILE TELECOMMUNICATION DEVICES, NAMELY, MOBILE AND CELLULAR TELEPHONES, HANDHELD COMPUTERS, PERSONAL COMPUTERS AND PERSONAL DIGITAL ASSISTANTS VIA THE GLOBAL COMPUTER NETWORK AND WIRELESS DEVICES; AND COMPUTER SOFTWARE FOR USE IN THE DESIGN, DEVELOPMENT AND EXECUTION OF WIRELESS COMPUTER GAMES, IN CLASS 9 (U.S. CLS. 21, 23, 26, 36 AND 38).

FIRST USE 8-1-2006; IN COMMERCE 8-1-2006.

THE MARK CONSISTS OF STANDARD CHARACTERS WITHOUT CLAIM TO ANY PARTICULAR FONT, STYLE, SIZE, OR COLOR.

SN 76-656,168, FILED 3-7-2006.

REBECCA EISINGER, EXAMINING ATTORNEY

**Int. Cl.: 35**

**Prior U.S. Cls.: 100, 101, and 102**

**United States Patent and Trademark Office**

**Reg. No. 3,395,314**

**Registered Mar. 11, 2008**

**SERVICE MARK  
PRINCIPAL REGISTER**

**BIGGEST. BOLDEST. BEST.**

AMC, INC. (GEORGIA CORPORATION)  
240 PEACHTREE STREET, N.W., SUITE 2200  
ATLANTA, GA 30303

FOR: ORGANIZING, ARRANGING, AND CONDUCTING TRADE SHOWS IN THE FIELDS OF GIFTS, APPAREL, HOME FURNISHINGS, AND RELATED MERCHANDISE, IN CLASS 35 (U.S. CLS. 100, 101 AND 102).

FIRST USE 7-0-2006; IN COMMERCE 7-0-2006.

THE MARK CONSISTS OF STANDARD CHARACTERS WITHOUT CLAIM TO ANY PARTICULAR FONT, STYLE, SIZE, OR COLOR.

SN 76-656,212, FILED 3-7-2006.

LINDA POWELL, EXAMINING ATTORNEY



**Int. Cl.: 29**

**Prior U.S. Cl.: 46**

**United States Patent and Trademark Office**

**Reg. No. 3,395,315**

**Registered Mar. 11, 2008**

**TRADEMARK  
PRINCIPAL REGISTER**

**NATURE'S FINEST**

BETTER BRANDS, INC. (NEW YORK CORPORATION)  
B-12 HUNTS POINT COOPERATIVE MARKET  
BRONX, NY 10474

FOR: SOY BEAN OIL, IN CLASS 29 (U.S. CL. 46).

FIRST USE 1-1-1999; IN COMMERCE 1-1-1999.

THE MARK CONSISTS OF STANDARD CHARACTERS WITHOUT CLAIM TO ANY PARTICULAR FONT, STYLE, SIZE, OR COLOR.

SN 76-656,735, FILED 3-16-2006.

MATTHEW EINSTEIN, EXAMINING ATTORNEY

**Int. Cl.: 19**

**Prior U.S. Cls.: 1, 12, 33, and 50**

**United States Patent and Trademark Office**

**Reg. No. 3,395,316**

**Registered Mar. 11, 2008**

**TRADEMARK  
PRINCIPAL REGISTER**

**LIFELINES**

MAR-FLEX SYSTEMS, INC. (OHIO CORPORATION)  
6866 CHRISMAN LANE  
MIDDLETOWN, OH 45042

THE MARK CONSISTS OF STANDARD CHARACTERS WITHOUT CLAIM TO ANY PARTICULAR FONT, STYLE, SIZE, OR COLOR.

FOR: NON-METAL WINDOW WELLS, IN CLASS 19 (U.S. CLS. 1, 12, 33 AND 50).

SN 76-657,394, FILED 3-28-2006.

FIRST USE 2-15-2006; IN COMMERCE 2-15-2006.

KEVON CHISOLM, EXAMINING ATTORNEY

**Int. Cl.: 31**

**Prior U.S. Cls.: 1 and 46**

**United States Patent and Trademark Office**

**Reg. No. 3,395,317**

**Registered Mar. 11, 2008**

**TRADEMARK  
PRINCIPAL REGISTER**

**CUTTING BOARD SELECT BITS**

DOSKOCIL MANUFACTURING COMPANY,  
INC. (TEXAS CORPORATION)

4300 BARNETT

ARLINGTON, TX 76017

FOR: EDIBLE DOG TREATS, IN CLASS 31 (U.S.  
CLS. 1 AND 46).

FIRST USE 9-30-2006; IN COMMERCE 9-30-2006.

THE MARK CONSISTS OF STANDARD CHAR-  
ACTERS WITHOUT CLAIM TO ANY PARTICULAR  
FONT, STYLE, SIZE, OR COLOR.

NO CLAIM IS MADE TO THE EXCLUSIVE  
RIGHT TO USE "SELECT BITS", APART FROM  
THE MARK AS SHOWN.

SN 76-660,648, FILED 5-25-2006.

AMY MCMENAMIN, EXAMINING ATTORNEY

**Int. Cl.: 31**

**Prior U.S. Cls.: 1 and 46**

**United States Patent and Trademark Office**

**Reg. No. 3,395,318**

**Registered Mar. 11, 2008**

**TRADEMARK  
PRINCIPAL REGISTER**

**CUTTING BOARD SELECTS**

DOSKOCIL MANUFACTURING COMPANY,  
INC. (TEXAS CORPORATION)

4300 BARNETT

ARLINGTON, TX 76017

FOR: EDIBLE DOG TREATS, IN CLASS 31 (U.S.  
CLS. 1 AND 46).

FIRST USE 9-30-2006; IN COMMERCE 9-30-2006.

THE MARK CONSISTS OF STANDARD CHAR-  
ACTERS WITHOUT CLAIM TO ANY PARTICULAR  
FONT, STYLE, SIZE, OR COLOR.

NO CLAIM IS MADE TO THE EXCLUSIVE  
RIGHT TO USE "SELECTS", APART FROM THE  
MARK AS SHOWN.

SN 76-660,649, FILED 5-25-2006.

DAVID MILLER, EXAMINING ATTORNEY

**Int. Cl.: 31**

**Prior U.S. Cls.: 1 and 46**

**United States Patent and Trademark Office**

**Reg. No. 3,395,319**

**Registered Mar. 11, 2008**

**TRADEMARK  
PRINCIPAL REGISTER**

**NUTTA BUTTA**

DOSKOCIL MANUFACTURING COMPANY,  
INC. (TEXAS CORPORATION)  
4300 BARNETT  
ARLINGTON, TX 76017

THE MARK CONSISTS OF STANDARD CHAR-  
ACTERS WITHOUT CLAIM TO ANY PARTICULAR  
FONT, STYLE, SIZE, OR COLOR.

FOR: EDIBLE DOG TREATS, IN CLASS 31 (U.S.  
CLS. 1 AND 46).

SN 76-660,650, FILED 5-25-2006.

FIRST USE 9-30-2006; IN COMMERCE 9-30-2006.

MELISSA VALLILLO, EXAMINING ATTORNEY

**Int. Cl.: 3**

**Prior U.S. Cls.: 1, 4, 6, 50, 51, and 52**

**United States Patent and Trademark Office**

**Reg. No. 3,395,320**

**Registered Mar. 11, 2008**

**TRADEMARK  
PRINCIPAL REGISTER**

**PEPTIDE VECTORS**

NEWFACE COSMETICS LLC (NEW YORK LTD  
LIAB CO)  
55 RAILROAD AVENUE  
RIDGEFIELD, NJ 07657

FOR: COSMETIC INGREDIENTS, NAMELY,  
ALOE VERA GEL FOR COSMETIC PURPOSES, IN  
CLASS 3 (U.S. CLS. 1, 4, 6, 50, 51 AND 52).

FIRST USE 2-6-2006; IN COMMERCE 2-6-2006.

THE MARK CONSISTS OF STANDARD CHAR-  
ACTERS WITHOUT CLAIM TO ANY PARTICULAR  
FONT, STYLE, SIZE, OR COLOR.

NO CLAIM IS MADE TO THE EXCLUSIVE  
RIGHT TO USE "PEPTIDE", APART FROM THE  
MARK AS SHOWN.

SN 76-660,875, FILED 6-1-2006.

SEAN CROWLEY, EXAMINING ATTORNEY

**Int. Cl.: 41**

**Prior U.S. Cls.: 100, 101, and 107**

**United States Patent and Trademark Office**

**Reg. No. 3,395,321**

**Registered Mar. 11, 2008**

**SERVICE MARK  
PRINCIPAL REGISTER**

**BECAUSE PALMER IS CHIROPRACTIC**

PALMER COLLEGE FOUNDATION (IOWA NON-PROFIT CORPORATION)  
1000 BRADY STREET  
DAVENPORT, IA 52803

FOR: EDUCATIONAL SERVICES, NAMELY, PROVIDING COURSES OF INSTRUCTION IN THE FIELD OF CHIROPRACTIC; PROVIDING CONTINUING EDUCATION COURSES FOR THOSE ALREADY IN CHIROPRACTIC PRACTICE, IN CLASS 41 (U.S. CLS. 100, 101 AND 107).

FIRST USE 3-0-2006; IN COMMERCE 3-0-2006.

THE MARK CONSISTS OF STANDARD CHARACTERS WITHOUT CLAIM TO ANY PARTICULAR FONT, STYLE, SIZE, OR COLOR.

OWNER OF U.S. REG. NOS. 1,238,925, 2,905,066, AND OTHERS.

SN 76-661,138, FILED 6-6-2006.

BENJAMIN OKEKE, EXAMINING ATTORNEY

**Int. Cls.: 3 and 5**

**Prior U.S. Cls.: 1, 4, 6, 18, 44, 46, 50, 51, and 52**

**United States Patent and Trademark Office**

**Reg. No. 3,395,322**

**Registered Mar. 11, 2008**

**TRADEMARK  
PRINCIPAL REGISTER**

**PROUVÉ**

ULMER, DOUGLAS K. (UNITED STATES INDIVIDUAL)  
1045 ATLANTIC AVE #819  
LONG BEACH, CA 90813

FOR: NON-MEDICATED SKIN CARE PREPARATIONS, IN CLASS 3 (U.S. CLS. 1, 4, 6, 50, 51 AND 52).

FIRST USE 8-0-2006; IN COMMERCE 9-0-2006.

FOR: COMPOUNDED MEDICAL PHARMACEUTICALS FOR DERMATOLOGICAL USE, IN CLASS 5 (U.S. CLS. 6, 18, 44, 46, 51 AND 52).

FIRST USE 8-0-2006; IN COMMERCE 9-0-2006.

THE MARK CONSISTS OF STANDARD CHARACTERS WITHOUT CLAIM TO ANY PARTICULAR FONT, STYLE, SIZE, OR COLOR.

THE ENGLISH TRANSLATION OF THE WORD "PROUVÉ" IN THE MARK IS "PROVEN."

SN 76-661,275, FILED 6-5-2006.

MELVIN AXILBUND, EXAMINING ATTORNEY



**Int. Cls.: 40 and 42**

**Prior U.S. Cls.: 100, 101, 103, and 106**

**United States Patent and Trademark Office**

**Reg. No. 3,395,323**

**Registered Mar. 11, 2008**

**SERVICE MARK  
PRINCIPAL REGISTER**



CELERITY AUTOMATION, INC. (KENTUCKY CORPORATION)

485 PONDEROSA DRIVE  
PAINTSVILLE, KY 41240

FOR: CUSTOM MANUFACTURE FOR OTHERS OF THE FOLLOWING GOODS, NAMELY, LINEAR TRANSFER VEHICLES, PICK AND PLACE PNEUMATIC ROBOTS, ROBOT END OF ARM TOOLING, ROBOT CONTROLLERS, STEP FEED CONVEYORS; OF CAR-ON-TRACK MATERIAL HANDLING EQUIPMENT, NAMELY, CONVEYORS, ACCUMULATORS, TRANSFER UNITS AND LINEAR DRIVE UNITS, AND PARTS THEREOF; OF PALLETIZERS, DE-PALLETIZERS, GANTRY ROBOTS, PICK AND PLACE ROBOTS; OF MATERIAL HANDLING SYSTEMS, NAMELY, STORAGE AND RETRIEVAL CAROUSELS AND CONVEYORS, AND PARTS THEREFOR; OF STORAGE AND RETRIEVAL ROBOTS, NAMELY, ROBOTS FOR SELECTIVELY INSERTING AND ERECTING STORED GOODS FROM AUTOMATED STORAGE SYSTEMS; OF AUTOMATION MACHINERY THAT IS CUSTOM DESIGNED AND BUILT FOR BOTH INDUSTRIAL AND CONSUMER PRODUCTS MANUFACTURERS, NAMELY, INDUSTRIAL ROBOTS, GANTRY ROBOTS, PALLETIZERS, DEPALLETIZERS, AUTOMATED STORAGE AND RETRIEVAL SYSTEMS, CONVEYORS, STACKERS, PILE STACKERS, HORIZONTAL STACKERS, UNSTACKERS, ORIENTERS, AND POSITIONERS; OF AUTOMATIC AND MOBILE PILOTLESS ROBOTS ON RAILS FOR SELECTIVELY INSERTING AND ERECTING STORED GOODS FROM AUTOMATED STORAGE SYSTEMS; OF PICK AND PLACE UNITS, AND WORK PIECE HANDLERS; OF PARTS FEEDING AND ORIENTING MACHINES, IN CLASS 40 (U.S. CLS. 100, 103 AND 106).

FIRST USE 11-1-2007; IN COMMERCE 11-1-2007.

FOR: SPATIAL ENGINEERING CONSULTING; DRAFTING SPECIFICATIONS FOR MANUFACTURE, ENGINEERING RESEARCH, DEVELOPMENT, TESTING, VERIFYING SPECIFICATIONS, AND CUSTOM DESIGN FOR OTHERS OF METAL AND PLASTIC MACHINE LINEAR TRANSFER VEHICLES, PICK AND PLACE PNEUMATIC ROBOTS, ROBOT END OF ARM TOOLING, ROBOT CONTROLLERS, STEP FEED CONVEYORS; OF CAR-ON-TRACK MATERIAL HANDLING EQUIPMENT, NAMELY, CONVEYORS, ACCUMULATORS, TRANSFER UNITS AND LINEAR DRIVE UNITS, AND PARTS THEREOF; OF PALLETIZERS, DE-PALLETIZERS, GANTRY ROBOTS, PICK AND PLACE ROBOTS; OF MATERIAL HANDLING SYSTEMS, NAMELY, STORAGE AND RETRIEVAL CAROUSELS AND CONVEYORS, AND PARTS THEREFOR; OF STORAGE AND RETRIEVAL ROBOTS, NAMELY, ROBOTS FOR SELECTIVELY INSERTING AND ERECTING STORED GOODS FROM AUTOMATED STORAGE SYSTEMS; OF AUTOMATION MACHINERY THAT IS CUSTOM DESIGNED AND BUILT FOR BOTH INDUSTRIAL AND CONSUMER PRODUCTS MANUFACTURERS, NAMELY, INDUSTRIAL ROBOTS, GANTRY ROBOTS, PALLETIZERS, DEPALLETIZERS, AUTOMATED STORAGE AND RETRIEVAL SYSTEMS, CONVEYORS, STACKERS, PILE STACKERS, HORIZONTAL STACKERS, UNSTACKERS, ORIENTERS, AND POSITIONERS; OF AUTOMATIC AND MOBILE PILOTLESS ROBOTS ON RAILS FOR SELECTIVELY INSERTING AND ERECTING STORED GOODS FROM AUTOMATED STORAGE SYSTEMS, PICK AND PLACE UNITS, AND WORK PIECE HANDLERS, PARTS FEEDING AND ORIENTING MACHINES, IN CLASS 42 (U.S. CLS. 100 AND 101).

FIRST USE 11-1-2007; IN COMMERCE 11-1-2007.

SN 76-662,188, FILED 6-27-2006.

NO CLAIM IS MADE TO THE EXCLUSIVE  
RIGHT TO USE "AUTOMATION", APART FROM  
THE MARK AS SHOWN.

PAUL F. GAST, EXAMINING ATTORNEY

**Int. Cl.: 9**

**Prior U.S. Cls.: 21, 23, 26, 36, and 38**

**Reg. No. 3,395,324**

**United States Patent and Trademark Office**

**Registered Mar. 11, 2008**

---

**TRADEMARK  
PRINCIPAL REGISTER**

**CHEMMAX**

LAKELAND INDUSTRIES, INC. (NEW YORK  
CORPORATION)  
701 KOEHLER AVENUE, SUITE 7  
RONKONKOMA, NY 117797410

THE MARK CONSISTS OF STANDARD CHAR-  
ACTERS WITHOUT CLAIM TO ANY PARTICULAR  
FONT, STYLE, SIZE, OR COLOR.

FOR: CHEMICAL PROTECTIVE CLOTHING,  
NAMELY, COVERALLS, PANTS, JACKETS,  
HOODS, GLOVES AND APRONS, IN CLASS 9 (U.S.  
CLS. 21, 23, 26, 36 AND 38).

SN 76-662,284, FILED 6-28-2006.

FIRST USE 12-1-2005; IN COMMERCE 12-1-2005.

FRANK LATTUCA, EXAMINING ATTORNEY

Int. Cls.: 16, 24, 25, and 26

Prior U.S. Cls.: 2, 5, 22, 23, 29, 37, 38, 39, 40, 42, and 50

Reg. No. 3,395,325

United States Patent and Trademark Office

Registered Mar. 11, 2008

TRADEMARK  
PRINCIPAL REGISTER

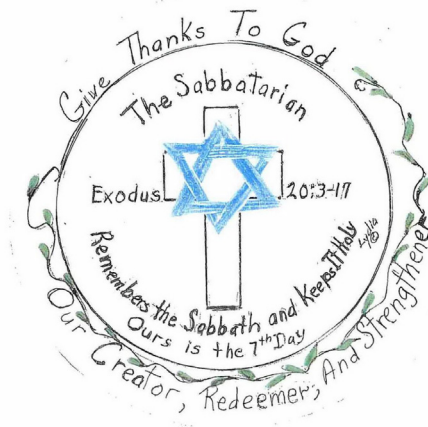

GRINAGE, LYDIA LOUISE (UNITED STATES INDIVIDUAL)  
7101 PLYMOUTH ROAD  
PIKESVILLE, MD 212086034

FOR: PAPER FLAGS, PAPER-GREETING CARDS, POST CARDS, STATIONERY, IN CLASS 16 (U.S. CLS. 2, 5, 22, 23, 29, 37, 38 AND 50).

FIRST USE 4-15-2000; IN COMMERCE 7-29-2007.

FOR: FABRIC FLAGS, IN CLASS 24 (U.S. CLS. 42 AND 50).

FIRST USE 4-15-2000; IN COMMERCE 7-29-2007.

FOR: CLOTHING, NAMELY, HATS, SHIRTS, JACKETS, SCARVES, IN CLASS 25 (U.S. CLS. 22 AND 39).

FIRST USE 4-15-2000; IN COMMERCE 7-29-2007.

FOR: ORNAMENTAL CAMPAIGN STYLE BUTTONS, IN CLASS 26 (U.S. CLS. 37, 39, 40, 42 AND 50).

FIRST USE 4-15-2000; IN COMMERCE 7-29-2007.

THE COLOR(S) BLACK, BLUE, GREEN IS/ARE CLAIMED AS A FEATURE OF THE MARK.

BLOCK WRITING ON WHITE BACKGROUND. DRAWING OUT LINED IN BLACK. STAR OF DAVID IS BLUE. VINE LEAVES ARE GREEN. BORDER - GREEN LEAVES WITH WRITING IN BLACK.

SN 76-662,656, FILED 7-7-2006.

CHERYL CLAYTON, EXAMINING ATTORNEY

**Int. Cl.: 16**

**Prior U.S. Cls.: 2, 5, 22, 23, 29, 37, 38, and 50**

**Reg. No. 3,395,326**

**United States Patent and Trademark Office**

**Registered Mar. 11, 2008**

**TRADEMARK  
PRINCIPAL REGISTER**

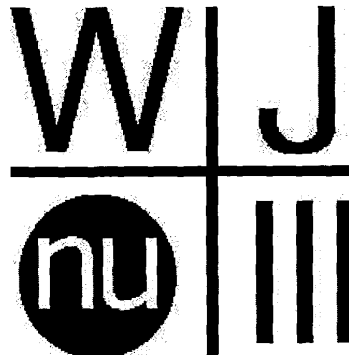

HOUGHTON MIFFLIN COMPANY (DELAWARE CORPORATION)  
222 BERKELEY STREET  
BOSTON, MA 02116

FIRST USE 12-0-2006; IN COMMERCE 12-0-2006.

OWNER OF U.S. REG. NOS. 2,456,103, 2,458,193, AND OTHERS.

FOR: PAPER GOODS AND PRINTED MATTER, NAMELY, MATERIALS USED IN THE STANDARDIZED TESTING OF COGNITIVE ABILITIES AND ACHIEVEMENT, IN CLASS 16 (U.S. CLS. 2, 5, 22, 23, 29, 37, 38 AND 50).

SN 76-663,575, FILED 7-24-2006.

KATHERINE STOIDES, EXAMINING ATTORNEY

**Int. Cl.: 9**

**Prior U.S. Cls.: 21, 23, 26, 36, and 38**

**Reg. No. 3,395,327**

**United States Patent and Trademark Office**

**Registered Mar. 11, 2008**

**TRADEMARK  
PRINCIPAL REGISTER**

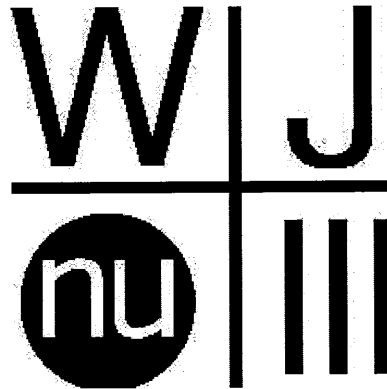

HOUGHTON MIFFLIN COMPANY (MASSACHU-  
SETTS CORPORATION)  
222 BERKELEY STREET  
BOSTON, MA 02116

FOR: PRE-RECORDED VIDEO TAPES AND CD-  
ROMS FEATURING TRAINING MATERIALS FOR  
ADMINISTERING AND SCORING STANDAR-  
DIZED TESTS OF COGNITIVE ABILITIES AND  
ACHIEVEMENT, AND COMPUTER SOFTWARE  
PROGRAMS USED FOR SCORING AND INTER-  
PRETATION OF STANDARDIZED TESTS OF COG-

NITIVE ABILITIES AND ACHIEVEMENT, IN CLASS  
9 (U.S. CLS. 21, 23, 26, 36 AND 38).

FIRST USE 12-0-2006; IN COMMERCE 12-0-2006.

OWNER OF U.S. REG. NOS. 2,456,103, 2,458,193,  
AND OTHERS.

SN 76-663,576, FILED 7-24-2006.

KATHERINE STOIDES, EXAMINING ATTORNEY

**Int. Cl.: 16**

**Prior U.S. Cls.: 2, 5, 22, 23, 29, 37, 38, and 50**

**United States Patent and Trademark Office**

**Reg. No. 3,395,328**

**Registered Mar. 11, 2008**

**TRADEMARK  
PRINCIPAL REGISTER**

**ATHLETIC BIRTH CERTIFICATE**

SLOAN, RUSS (UNITED STATES INDIVIDUAL)  
2301 QUEEN PALM COURT  
LEESBURG, FL 34748

FOR: PRINTED MARKETING MATERIALS FOR ATTRACTING FINANCIAL SUPPORT FROM ALUMNI, SUPPORTERS AND FANS OF COLLEGES AND UNIVERSITIES, NAMELY PRINTED CERTIFICATES BEING ISSUED TO ALUMNI, SUPPORTERS OR FANS OF COLLEGES AND UNIVERSITIES, IN ACKNOWLEDGEMENT OF THEIR FINANCIAL SUPPORT TO THE COLLEGE OR UNIVERSITY, IN CLASS 16 (U.S. CLS. 2, 5, 22, 23, 29, 37, 38 AND 50).

FIRST USE 9-5-2006; IN COMMERCE 9-5-2006.

THE MARK CONSISTS OF STANDARD CHARACTERS WITHOUT CLAIM TO ANY PARTICULAR FONT, STYLE, SIZE, OR COLOR.

NO CLAIM IS MADE TO THE EXCLUSIVE RIGHT TO USE "ATHLETIC" AND "CERTIFICATE", APART FROM THE MARK AS SHOWN.

SN 76-663,634, FILED 7-25-2006.

JANICE KIM, EXAMINING ATTORNEY

**Int. Cl.: 42**

**Prior U.S. Cls.: 100 and 101**

**United States Patent and Trademark Office**

**Reg. No. 3,395,329**

**Registered Mar. 11, 2008**

**SERVICE MARK  
PRINCIPAL REGISTER**



COSMIC POSITIVE INTERACTIONS (KEN-ETH)  
(NEW YORK CORPORATION)  
29 HIGHGATE CIRCLE  
ITHACA, NY 14850

NO CLAIM IS MADE TO THE EXCLUSIVE  
RIGHT TO USE "INSTITUTE", APART FROM THE  
MARK AS SHOWN.

FOR: SCIENTIFIC RESEARCH AND DEVELOP-  
MENT, IN CLASS 42 (U.S. CLS. 100 AND 101).

SN 76-663,883, FILED 7-27-2006.

FIRST USE 11-1-2007; IN COMMERCE 11-1-2007.

BERNICE MIDDLETON, EXAMINING ATTORNEY



Int. Cl.: 11

Prior U.S. Cls.: 13, 21, 23, 31, and 34

United States Patent and Trademark Office

Reg. No. 3,395,330

Registered Mar. 11, 2008

TRADEMARK  
PRINCIPAL REGISTER



*openbath*

DONGWON CERAMIC CO., LTD. (REPUBLIC OF  
KOREA CORPORATION)  
111-89, HWAGOK - 5 DONG  
KANGSEO-KU, SEOUL, REPUBLIC OF KOREA

FOR: TOILET BOWLS, TOILET SEATS, BIDETS,  
URINALS, SHOWERS, SHOWER ENCLOSURES,  
BATHROOM SINKS, BATHROOM SINK PEDES-  
TALS, PEDESTAL SINKS, WALL MOUNT SINKS,  
VESSEL SINKS, UNDER COUNTER LAVATORY;

BATHTUBS, TAP WATER FAUCETS, IN CLASS 11  
(U.S. CLS. 13, 21, 23, 31 AND 34).

FIRST USE 9-7-2007; IN COMMERCE 9-7-2007.

SN 76-664,562, FILED 8-14-2006.

JAMES STEIN, EXAMINING ATTORNEY

**Int. Cl.: 31**

**Prior U.S. Cls.: 1 and 46**

**United States Patent and Trademark Office**

**Reg. No. 3,395,331**

**Registered Mar. 11, 2008**

**TRADEMARK  
PRINCIPAL REGISTER**



DOG-EQUINE, LLC (CALIFORNIA LTD LIAB  
CO)  
P.O. BOX 3563  
SAN CLEMENTE, CA 92674

NO CLAIM IS MADE TO THE EXCLUSIVE  
RIGHT TO USE "THE DESIGN OF A DOG", APART  
FROM THE MARK AS SHOWN.

FOR: NUTRITIONAL ADDITIVES TO FOOD-  
STUFFS FOR ANIMALS, NOT FOR MEDICAL  
PURPOSES, IN CLASS 31 (U.S. CLS. 1 AND 46).

SN 76-664,772, FILED 8-18-2006.

FIRST USE 6-21-2007; IN COMMERCE 12-17-2007.

LAURIE MAYES, EXAMINING ATTORNEY

**Int. Cl.: 35**

**Prior U.S. Cls.: 100, 101, and 102**

**United States Patent and Trademark Office**

**Reg. No. 3,395,332**

**Registered Mar. 11, 2008**

**SERVICE MARK  
PRINCIPAL REGISTER**



AMP INFORMATION SERVICES, INC. (DELA-  
WARE CORPORATION)  
1515 S. JEFFERSON DAVIS HIGHWAY  
ARLINGTON, VA 22202

FOR: BUSINESS CONSULTING SERVICES IN  
THE FIELD OF DATA RESOURCE MANAGEMENT  
AND INFORMATION TECHNOLOGY, NAMELY,  
HELPING BUSINESSES OPTIMIZE THE EFFEC-  
TIVE AND EFFICIENT USE OF DATA RESOURCES  
THROUGH THE APPLICATION OF INFORMA-  
TION TECHNOLOGY, IN CLASS 35 (U.S. CLS. 100,  
101 AND 102).

FIRST USE 10-1-2007; IN COMMERCE 10-1-2007.

NO CLAIM IS MADE TO THE EXCLUSIVE  
RIGHT TO USE "AUTOMATION MANAGEMENT  
PROFESSIONALS", APART FROM THE MARK AS  
SHOWN.

THE COLOR(S) BLUE AND WHITE IS/ARE  
CLAIMED AS A FEATURE OF THE MARK.

THE WORDING AND DESIGN ARE DEPICTED  
IN THE COLOR BLUE. THE WORDING AMP AND  
THE DESIGN ELEMENT ARE DEPICTED IN THE  
COLOR WHITE AT THE BOTTOM OF THE LET-  
TERS GRADUALLY CHANGING UPWARD FROM  
A LIGHT BLUE TO A DARKER BLUE AND THE  
DESIGN ON THE LEFT IS WHITE GRADUALLY  
CHANGING FROM A LIGHT BLUE TO A DARKER  
BLUE COLOR. THE WORDING "AUTOMATION  
MANAGEMENT PROFESSIONALS" IS DEPICTED  
IN THE COLOR BLUE.

SN 76-664,876, FILED 8-21-2006.

MATTHEW EINSTEIN, EXAMINING ATTORNEY

**Int. Cl.: 43**

**Prior U.S. Cls.: 100 and 101**

**United States Patent and Trademark Office**

**Reg. No. 3,395,333**

**Registered Mar. 11, 2008**

**SERVICE MARK  
PRINCIPAL REGISTER**

**ROCKABILLY BBQ**

HRP CREATIVE SERVICES CO., LLC (FLORIDA  
LTD LIAB CO)

622 EAST WASHINGTON STREET, SUITE 500

ORLANDO, FL 32801

FOR: RESTAURANT SERVICES, IN CLASS 43  
(U.S. CLS. 100 AND 101).

FIRST USE 11-5-2007; IN COMMERCE 11-5-2007.

THE MARK CONSISTS OF STANDARD CHAR-  
ACTERS WITHOUT CLAIM TO ANY PARTICULAR  
FONT, STYLE, SIZE, OR COLOR.

NO CLAIM IS MADE TO THE EXCLUSIVE  
RIGHT TO USE "BBQ", APART FROM THE MARK  
AS SHOWN.

SN 76-664,922, FILED 8-22-2006.

DARRYL SPRUILL, EXAMINING ATTORNEY

**Int. Cl.: 43**

**Prior U.S. Cls.: 100 and 101**

**United States Patent and Trademark Office**

**Reg. No. 3,395,334**

**Registered Mar. 11, 2008**

**SERVICE MARK  
PRINCIPAL REGISTER**

**PIZZERIA ROSSO**

KEVIN CRONIN (UNITED STATES INDIVIDUAL)  
516 EDMONT LANE  
ANGWIN, CA 94508

FOR: RESTAURANT SERVICES, FOOD AND DRINK SERVICES, NAMELY, FOOD AND DRINK PREPARATION, SERVING FOOD AND DRINKS, AND CATERING SERVICES, IN CLASS 43 (U.S. CLS. 100 AND 101).

FIRST USE 9-11-2006; IN COMMERCE 8-13-2007.

THE MARK CONSISTS OF STANDARD CHARACTERS WITHOUT CLAIM TO ANY PARTICULAR FONT, STYLE, SIZE, OR COLOR.

NO CLAIM IS MADE TO THE EXCLUSIVE RIGHT TO USE "PIZZERIA", APART FROM THE MARK AS SHOWN.

SN 76-666,001, FILED 9-14-2006.

ALLISON SCHRODY, EXAMINING ATTORNEY

**Int. Cl.: 20**

**Prior U.S. Cls.: 2, 13, 22, 25, 32, and 50**

**United States Patent and Trademark Office**

**Reg. No. 3,395,335**

**Registered Mar. 11, 2008**

**TRADEMARK  
PRINCIPAL REGISTER**

**RACTEC**

ROTEN, RANDAL E. (UNITED STATES INDIVIDUAL)  
3304 BUCK RUN TRAIL  
WAKE FOREST, NC 27587

FOR: A PLASTIC RACK COMPRISED OF A SERIES OF INTEGRATED PLASTIC LOOPS FOR HOLDING CAPS, TOOLS, SPORTING EQUIPMENT SUCH AS FISHING RODS AND GOLF CLUBS, AND FOR HOLDING OTHER DOMESTIC UTENSILS, IN CLASS 20 (U.S. CLS. 2, 13, 22, 25, 32 AND 50).

FIRST USE 7-30-2005; IN COMMERCE 1-9-2007.

THE MARK CONSISTS OF STANDARD CHARACTERS WITHOUT CLAIM TO ANY PARTICULAR FONT, STYLE, SIZE, OR COLOR.

SN 76-666,198, FILED 9-18-2006.

LYDIA BELZER, EXAMINING ATTORNEY

**Int. Cls.: 35 and 39**

**Prior U.S. Cls.: 100, 101, 102, and 105**

**United States Patent and Trademark Office**

**Reg. No. 3,395,336**

**Registered Mar. 11, 2008**

**SERVICE MARK  
PRINCIPAL REGISTER**



**FREIGHTCO**  
LOGISTICS

CRUISE LOGISTICS LLC (FLORIDA LTD LIAB  
CO)  
11013 NW 30TH ST #100  
MIAMI, FL 33172

THE COLOR(S) ORANGE, GREY, WHITE AND  
BLUE IS/ARE CLAIMED AS A FEATURE OF THE  
MARK.

FOR: TRANSPORTATION LOGISTIC SERVICES,  
NAMELY, ARRANGING THE TRANSPORTATION  
OF GOODS FOR OTHERS AND TRANSPORTA-  
TION LOGISTICS SERVICES, NAMELY, PLAN-  
NING AND SCHEDULING SHIPMENTS FOR  
USERS OF TRANSPORTATION SERVICES, IN  
CLASS 35 (U.S. CLS. 100, 101 AND 102).

THE COLOR ORANGE APPEARS IN THE WORD-  
ING "FREIGHTCO" AND THE TOP PORTION OF  
THE THREE BOX DESIGN; THE COLOR GREY  
APPEARS IN THE WORDING "LOGISTICS" AND  
THE CENTER BOX DESIGN AND IN THE BORDER  
SURROUNDING THE BOX DESIGNS; THE COLOR  
BLUE APPEARS IN THE BOTTOM BOX DESIGN  
AND THE COLOR WHITE APPEARS IN THE OUT-  
ER EDGE OF THE BOX DESIGN AND BETWEEN  
THE THREE SECTIONS OF BOXES.

FIRST USE 1-1-2007; IN COMMERCE 1-1-2007.

FOR: FREIGHT FORWARDING, IN CLASS 39  
(U.S. CLS. 100 AND 105).

FIRST USE 1-1-2007; IN COMMERCE 1-1-2007.

SN 76-667,057, FILED 10-5-2006.

NO CLAIM IS MADE TO THE EXCLUSIVE  
RIGHT TO USE "LOGISTICS", APART FROM THE  
MARK AS SHOWN.

LESLEY LAMOTHE, EXAMINING ATTORNEY

**Int. Cl.: 9**

**Prior U.S. Cls.: 21, 23, 26, 36, and 38**

**United States Patent and Trademark Office**

**Reg. No. 3,395,337**

**Registered Mar. 11, 2008**

**TRADEMARK  
PRINCIPAL REGISTER**

**CHANALYZER**

METAGEEK, L.L.C. (IDAHO CORPORATION)  
5465 TERRA LINDA WAY SUITE 96  
NAMPA, ID 83687

THE MARK CONSISTS OF STANDARD CHAR-  
ACTERS WITHOUT CLAIM TO ANY PARTICULAR  
FONT, STYLE, SIZE, OR COLOR.

FOR: COMPUTER SOFTWARE FOR ADMINIS-  
TRATION OF COMPUTER LOCAL AREA NET-  
WORKS; WIRELESS COMPUTER PERIPHERALS,  
IN CLASS 9 (U.S. CLS. 21, 23, 26, 36 AND 38).

SN 76-667,386, FILED 10-13-2006.

FIRST USE 10-15-2006; IN COMMERCE 10-15-2006.

PRISCILLA MILTON, EXAMINING ATTORNEY



**Int. Cl.: 27**

**Prior U.S. Cls.: 19, 20, 37, 42, and 50**

**United States Patent and Trademark Office**

**Reg. No. 3,395,338**

**Registered Mar. 11, 2008**

**TRADEMARK  
PRINCIPAL REGISTER**

**BECAUSE THERE'S NEVER AN OFFSEASON**

TECHNOLOGY LICENSING CORP ("TLC")  
(OHIO CORPORATION)  
3607 CHURCH STREET, SUITE 300  
CINCINNATI, OH 45244

THE MARK CONSISTS OF STANDARD CHAR-  
ACTERS WITHOUT CLAIM TO ANY PARTICULAR  
FONT, STYLE, SIZE, OR COLOR.

FOR: ARTIFICIAL TURF, IN CLASS 27 (U.S. CLS.  
19, 20, 37, 42 AND 50).

SN 76-667,639, FILED 10-17-2006.

FIRST USE 10-1-2006; IN COMMERCE 10-1-2006.

PETER B. BROMAGHIM, EXAMINING ATTORNEY

**Int. Cl.: 14**

**Prior U.S. Cls.: 2, 27, 28, and 50**

**United States Patent and Trademark Office**

**Reg. No. 3,395,339**

**Registered Mar. 11, 2008**

**TRADEMARK  
PRINCIPAL REGISTER**



PRESTIGE JEWELRY INTERNATIONAL, INC.  
(NEW YORK CORPORATION)  
529 FIFTH AVENUE 17TH FL.  
NEW YORK, NY 10017

FIRST USE 11-1-2006; IN COMMERCE 11-1-2006.

SN 76-668,393, FILED 11-1-2006.

FOR: JEWELRY, NAMELY, RINGS, NECKLA-  
CES, PENDANTS AND PRECIOUS STONES, IN  
CLASS 14 (U.S. CLS. 2, 27, 28 AND 50).

TINA L. SNAPP, EXAMINING ATTORNEY

**Int. Cl.: 7**

**Prior U.S. Cls.: 13, 19, 21, 23, 31, 34, and 35**

**Reg. No. 3,395,340**

**United States Patent and Trademark Office**

**Registered Mar. 11, 2008**

**TRADEMARK  
PRINCIPAL REGISTER**



EXCETEK TECHNOLOGIES CO., LTD. (TAIWAN CORPORATION)  
1F, NO. 5, 36TH RD  
TAICHUNG INDUSTRIAL PARK, SITUN DISTRICT  
TAICHUNG CITY, R.O.C., TAIWAN 407

FOR: MILLING MACHINES; LATHES; CUTTING MACHINES FOR METALWORKING; MACHINES AND MACHINE TOOLS FOR THE CUTTING AND FORMING OF MATERIALS; ENGRAVING MA-

CHINES; GRINDING MACHINES FOR METALWORKING, IN CLASS 7 (U.S. CLS. 13, 19, 21, 23, 31, 34 AND 35).

FIRST USE 12-20-2006; IN COMMERCE 3-1-2007.

SN 76-668,446, FILED 11-2-2006.

EMILY CARLSEN, EXAMINING ATTORNEY

**Int. Cl.: 3**

**Prior U.S. Cls.: 1, 4, 6, 50, 51, and 52**

**Reg. No. 3,395,341**

**United States Patent and Trademark Office**

**Registered Mar. 11, 2008**

**TRADEMARK  
PRINCIPAL REGISTER**

**RITUALISTIX**

TUSSEY, JULIE A. (UNITED STATES INDIVIDUAL)  
77 SEVENTH AVENUE, APT 3S  
NEW YORK, NY 10011

THE MARK CONSISTS OF STANDARD CHARACTERS WITHOUT CLAIM TO ANY PARTICULAR FONT, STYLE, SIZE, OR COLOR.

FOR: COSMETIC MAKE-UP PENCILS, IN CLASS 3 (U.S. CLS. 1, 4, 6, 50, 51 AND 52).

SN 76-668,516, FILED 11-6-2006.

FIRST USE 12-28-2006; IN COMMERCE 12-28-2006.

DARRYL SPRUILL, EXAMINING ATTORNEY

**Int. Cl.: 16**

**Prior U.S. Cls.: 2, 5, 22, 23, 29, 37, 38, and 50**

**United States Patent and Trademark Office**

**Reg. No. 3,395,342**

**Registered Mar. 11, 2008**

**TRADEMARK  
PRINCIPAL REGISTER**

**STORGANIZER**

NOTTINGHAM SPIRK DESIGN ASSOCIATES  
(OHIO CORPORATION)  
2200 OVERLOOK ROAD  
CLEVELAND, OH 44106

FOR: MODULAR DESKTOP ORGANIZERS, IN  
CLASS 16 (U.S. CLS. 2, 5, 22, 23, 29, 37, 38 AND 50).

FIRST USE 3-31-2007; IN COMMERCE 10-31-2007.

THE MARK CONSISTS OF STANDARD CHAR-  
ACTERS WITHOUT CLAIM TO ANY PARTICULAR  
FONT, STYLE, SIZE, OR COLOR.

SN 76-669,153, FILED 11-17-2006.

ALEXANDER L. POWERS, EXAMINING ATTOR-  
NEY

**Int. Cl.: 26**

**Prior U.S. Cls.: 37, 39, 40, 42, and 50**

**United States Patent and Trademark Office**

**Reg. No. 3,395,343**

**Registered Mar. 11, 2008**

**TRADEMARK  
PRINCIPAL REGISTER**

**ZAKKERZ**

ZAKKERZ, INC. (NEW YORK CORPORATION)  
C/O JAMIE LAZAR  
72 MIDDLENECK ROAD  
GREAT NECK, NY 11021

FIRST USE 6-27-2007; IN COMMERCE 6-27-2007.

FOR: CLOTHING HEM FASTENERS, NAMELY,  
A DEVICE FOR TEMPORARILY MAINTAINING A  
PANT OR TROUSER TO THE WEARER'S DESIRED  
LENGTH, A FULL SET OF THE DEVICE CONSIST-  
ING OF FOUR IDENTICAL STRIPS OF FABRIC,  
EACH WITH ATTRACTING MAGNETS ON EITHER  
SIDE, IN CLASS 26 (U.S. CLS. 37, 39, 40, 42 AND 50).

THE MARK CONSISTS OF STANDARD CHAR-  
ACTERS WITHOUT CLAIM TO ANY PARTICULAR  
FONT, STYLE, SIZE, OR COLOR.

SN 76-670,454, FILED 12-18-2006.

LINDA ESTRADA, EXAMINING ATTORNEY

**Int. Cl.: 41**

**Prior U.S. Cls.: 100, 101, and 107**

**United States Patent and Trademark Office**

**Reg. No. 3,395,344**

**Registered Mar. 11, 2008**

**SERVICE MARK  
PRINCIPAL REGISTER**

**AIP ARTICLES ON DEMAND**

AMERICAN INSTITUTE OF PHYSICS (NEW  
YORK CORPORATION)

2 HUNTINGTON QUADRANGLE

SUITE 1N01

MELVILLE, NY 117474502

FOR: PROVIDING ON-LINE PUBLICATIONS IN  
THE NATURE OF ARTICLES ABOUT PHYSICS VIA  
A GLOBAL COMPUTER NETWORK, IN CLASS 41  
(U.S. CLS. 100, 101 AND 107).

FIRST USE 5-3-2007; IN COMMERCE 5-3-2007.

THE MARK CONSISTS OF STANDARD CHAR-  
ACTERS WITHOUT CLAIM TO ANY PARTICULAR  
FONT, STYLE, SIZE, OR COLOR.

OWNER OF U.S. REG. NOS. 1,761,628 AND  
1,866,361.

NO CLAIM IS MADE TO THE EXCLUSIVE  
RIGHT TO USE "ARTICLES ON DEMAND", APART  
FROM THE MARK AS SHOWN.

SN 76-670,616, FILED 12-20-2006.

STEVEN JACKSON, EXAMINING ATTORNEY

**Int. Cl.: 9**

**Prior U.S. Cls.: 21, 23, 26, 36, and 38**

**United States Patent and Trademark Office**

**Reg. No. 3,395,345**

**Registered Mar. 11, 2008**

**TRADEMARK  
PRINCIPAL REGISTER**

**GRAMMATICON**

KNOWLEDGE ATHLETES, INC. (NEW YORK CORPORATION)  
13 COUNTRYSIDE ROAD  
FAIRPORT, NY 14450

FOR: COMPUTER SOFTWARE THAT PROVIDES REAL-TIME, INTEGRATED BUSINESS MANAGEMENT INTELLIGENCE BY COMBINING INFORMATION FROM VARIOUS DATABASES AND PRESENTING IT IN AN EASY-TO-UNDERSTAND USER INTERFACE, IN CLASS 9 (U.S. CLS. 21, 23, 26, 36 AND 38).

FIRST USE 10-31-2007; IN COMMERCE 10-31-2007.

THE MARK CONSISTS OF STANDARD CHARACTERS WITHOUT CLAIM TO ANY PARTICULAR FONT, STYLE, SIZE, OR COLOR.

SN 76-670,895, FILED 12-28-2006.

EMILY CARLSEN, EXAMINING ATTORNEY



**Int. Cls.: 16 and 25**

**Prior U.S. Cls.: 2, 5, 22, 23, 29, 37, 38, 39, and 50**

**United States Patent and Trademark Office**

**Reg. No. 3,395,346**

**Registered Mar. 11, 2008**

**TRADEMARK  
PRINCIPAL REGISTER**

**HAPPY FATHER'S DAY MOM**

OKEEFE, JAMES (UNITED STATES INDIVIDUAL)  
183 SEA BREEZE WAY  
KEANSBURG, NJ 07734

FOR: GREETING CARDS, IN CLASS 16 (U.S. CLS. 2, 5, 22, 23, 29, 37, 38 AND 50).

FIRST USE 3-1-2007; IN COMMERCE 3-1-2007.

FOR: CLOTHING, NAMELY, SHIRTS, T-SHIRTS, AND HATS, IN CLASS 25 (U.S. CLS. 22 AND 39).

FIRST USE 3-1-2007; IN COMMERCE 3-1-2007.

THE MARK CONSISTS OF STANDARD CHARACTERS WITHOUT CLAIM TO ANY PARTICULAR FONT, STYLE, SIZE, OR COLOR.

SN 76-671,009, FILED 1-4-2007.

MELVIN AXILBUND, EXAMINING ATTORNEY

**Int. Cl.: 3**

**Prior U.S. Cls.: 1, 4, 6, 50, 51, and 52**

**United States Patent and Trademark Office**

**Reg. No. 3,395,347**

**Registered Mar. 11, 2008**

**TRADEMARK  
PRINCIPAL REGISTER**

**FRAGRANCE BROKER**

FRAGRANCE BROKER, LLC (GEORGIA LTD  
LIAB CO)

1415 HIGHWAY 85 N., SUITE #310-330

FAYETTEVILLE, GA 30214

FOR: COLOGNES, PERFUMES, AND FRAGRAN-  
CES, IN CLASS 3 (U.S. CLS. 1, 4, 6, 50, 51 AND 52).

FIRST USE 3-30-2007; IN COMMERCE 3-30-2007.

THE MARK CONSISTS OF STANDARD CHAR-  
ACTERS WITHOUT CLAIM TO ANY PARTICULAR  
FONT, STYLE, SIZE, OR COLOR.

NO CLAIM IS MADE TO THE EXCLUSIVE  
RIGHT TO USE "FRAGRANCE", APART FROM  
THE MARK AS SHOWN.

SN 76-672,332, FILED 2-7-2007.

RICHARD A. STRASER, EXAMINING ATTORNEY

Prior U.S. Cl.: B

United States Patent and Trademark Office

Reg. No. 3,395,348

Registered Mar. 11, 2008

**CERTIFICATION MARK  
SERVICES  
PRINCIPAL REGISTER**



AMERICAN PETROLEUM INSTITUTE (D.C. CORPORATION)  
1220 L STREET, N.W.  
WASHINGTON, DC 20005

FOR: MANAGEMENT SYSTEM, NAMELY, QUALITY ASSURANCE, PRODUCT DESIGN, PRODUCT DEVELOPMENT, PRODUCT INSTALLATION, AND PRODUCT SERVICING FOR USE IN THE FIELDS OF OIL AND GAS EXPLORATION, DRILLING, PRODUCTION, TRANSPORTATION; MANUFACTURING PROCESSES FOR PRODUCTS, MATERIALS, AND EQUIPMENT FOR USE IN THE FIELDS OF OIL AND GAS EXPLORATION, DRILLING, PRODUCTION, AND TRANSPORTATION, IN CLASS B (U.S. CL. B).

FIRST USE 10-4-2004; IN COMMERCE 10-4-2004.

NO CLAIM IS MADE TO THE EXCLUSIVE RIGHT TO USE "ISO/TS 29001 REGISTERED", APART FROM THE MARK AS SHOWN.

THE MARKS CONSISTS OF A DESIGN OF A GLOBE ENCLOSED IN A RECTANGLE WITH THE WORDING API ISO/TS 29001 REGISTERED UNDERNEATH OF THE GLOBE DESIGN.

THE CERTIFICATION MARK, AS INTENDED TO BE USED BY ORGANIZATIONS AUTHORIZED BY THE CERTIFIER, WILL CERTIFY THAT THE CERTIFIED PARTIES' QUALITY MANAGEMENT SYSTEMS DESCRIBED ABOVE HAVE MET THE TECHNICAL STANDARDS SET BY AMERICAN PETROLEUM INSTITUTE (API) AND THE INTERNATIONAL ORGANIZATION FOR STANDARDIZATION (ISO) FOR BUSINESSES IN THE PETROLEUM AND NATURAL GAS INDUSTRY

SN 76-978,721, FILED 6-27-2005.

CHARLES L. JENKINS, EXAMINING ATTORNEY

**Int. Cl.: 24**

**Prior U.S. Cls.: 42 and 50**

**United States Patent and Trademark Office**

**Reg. No. 3,395,349**

**Registered Mar. 11, 2008**

**TRADEMARK  
PRINCIPAL REGISTER**



WAL-MART STORES, INC. (DELAWARE COR-  
PORATION)  
702 SW 8TH STREET  
BENTONVILLE, AR 727168095

FIRST USE 6-30-2004; IN COMMERCE 6-30-2004.

SN 76-978,733, FILED 11-6-2003.

FOR: HOUSEHOLD LINENS FOR BED, IN CLASS  
24 (U.S. CLS. 42 AND 50).

ROBERT C. CLARK JR., EXAMINING ATTORNEY

**Int. Cls.: 9, 16, 35, 41, and 42**

**Prior U.S. Cls.: 2, 5, 21, 22, 23, 26, 29, 36, 37, 38, 50,  
100, 101, 102, and 107**

**Reg. No. 3,395,350**

**United States Patent and Trademark Office**

**Registered Mar. 11, 2008**

**TRADEMARK  
SERVICE MARK  
PRINCIPAL REGISTER**

**LANDIS + GYR**

LANDIS+GYR AG (SWITZERLAND CORPORATION)  
FELDSTRASSE 1  
ZUG, SWITZERLAND 6300

FOR: ENERGY SUPERVISORY APPARATUS, NAMELY, ENERGY ACCOUNTING, CONTROL AND MONITORING UNITS FOR USE IN UTILITY COMMODITY DISTRIBUTION; BLANK MAGNETIC DATA CARRIERS AND BLANK OPTICAL DISCS; VENDING MACHINES AND MECHANISMS FOR COIN OPERATED DEVICES, NAMELY, COIN IDENTIFYING MECHANISMS; CASH REGISTERS; FIRE EXTINGUISHERS; ENERGY MANAGEMENT SYSTEMS COMPOSED PRIMARILY OF ELECTRONIC HARDWARE AND SOFTWARE, MONITORS AND SENSING DEVICES FOR MEASURING, MONITORING, DISPLAYING, RECORDING AND PROCESSING THE OUTPUTS OF ELECTRICITY CONSUMPTION METERS, SUCH AS SUPPLY, TRANSFER, CONSUMPTION AND LOSS OF ELECTRICITY, TEMPERATURE, PRESSURE AND POWER MEASUREMENTS, FOR USE IN CONTROLLING THE OPERATION OF ENERGY CONSUMING EQUIPMENT; ELECTRICITY METERS, HEAT METERS, GAS METERS, WATER METERS, FLOW METERS, RETURN METERS AND TARIFF METERS OF ALL KINDS AND THEIR COMPONENTS FOR USE IN MONITORING CONSUMPTION OF UTILITY COMMODITIES SUCH AS ENERGY, GAS OR FLUIDS; METER TESTING INSTRUMENTS AND COMPONENTS FOR USE IN TESTING METERS, NAMELY, ELECTRICITY METERS, HEAT METERS, GAS METERS, WATER METERS, FLOW METERS, RETURN METERS AND TARIFF METERS; CALIBRATION UNITS AND THEIR COMPONENTS FOR USE IN CALIBRATING METERS, NAMELY, ELECTRICITY METERS, HEAT METERS, GAS METERS, WATER METERS, FLOW METERS, RETURN METERS AND TARIFF METERS; COMPUTERS FOR CHAR-

GING ENERGY CONSUMPTION AND RELATED SERVICES FOR POWER SUPPLY COMPANIES; POWER MONITORING APPARATUS, NAMELY, APPARATUS FOR MONITORING POWER ON ELECTRICAL DISTRIBUTION OR TRANSMISSION NETWORKS; DATABASES, SPECIFICALLY HARDWARE AND SOFTWARE FOR DATA ORGANIZATION, STORAGE AND ACCESS IN THE FIELD OF UTILITY COMMODITY DISTRIBUTION; HARDWARE AND SOFTWARE FOR THE STORAGE OF DATA AND ITS EASY RECOVERY AND ARCHIVING IN THE FIELD OF UTILITY COMMODITY DISTRIBUTION; DATA STORAGE UNITS, SPECIFICALLY HARDWARE AND SOFTWARE FOR THE COLLECTION AND CONSERVATION OF DATA IN THE FIELD OF UTILITY COMMODITY DISTRIBUTION; SOFTWARE, NAMELY, FOR DATA ACQUISITION, TRANSFER AND PROCESSING IN ENERGY SUPPLY NETWORKS AND ALSO FOR ENERGY MANAGEMENT, ENERGY CUSTOMER MANAGEMENT, FOR THE DETERMINATION OF DATA ON ENERGY AND CUSTOMERS, FOR THE ENERGY MARKET AND THE ENERGY TRADE, FOR ENERGY REPORT PRODUCTION, ENERGY BILLING AND ENERGY RATING, FOR THE CALCULATION AND BILLING OF ENERGY COSTS, CALCULATION AND BILLING OF CHARGES AND THE ADMINISTRATION OF ENERGY CUSTOMER PROCESSES; APPARATUS FOR THE COLLECTION, TRANSMISSION AND PROCESSING OF METERING VALUES AND METER DATA, NAMELY, HAND-HELD DATA STORAGE UNITS, MODEMS, DATA PROCESSORS, COMPUTERS, ELECTRONIC REMOTE METER READING TRANSMITTERS AND ELECTRONIC REMOTE METER READING RECEIVERS; PROGRAMMABLE CONTROL AND SWITCHING DEVICES FOR USE IN UTILITY COMMODITY DISTRIBUTION; TIME SWITCHES FOR USE IN THE FIELDS OF POWER AND UTILITY CONTROL; CYCLE CONTROL TIMERS; ELECTRICAL COMPONENTS, NAMELY, ELECTRONIC

CURRENT RECTIFIERS, CONTROLLERS, SOLENOIDS AND MICROELECTRONIC CIRCUITRY THEREFOR, ELECTRONIC SWITCH CIRCUITRY AND SWITCHES FOR ELECTRIC CONTROLLERS, ELECTRICAL EQUIPMENT AND INSTRUMENTS FOR CONTROLLING THE SUPPLY OF ELECTRICITY AND FOR SPEED REGULATING, NAMELY, ELECTRONIC SWITCHES AND ELECTRONIC SWITCH CIRCUITRY, ELECTRIC SWITCHES FOR INCORPORATION INTO ELECTRIC TRANSFORMERS, VOLTAGE REGULATORS, ELECTRIC CURRENT METERS, VOLTMETERS ALARMS AND INDICATORS ALL FOR USE IN INDICATING VARIATIONS IN THE CONDITION OF ELECTRIC CIRCUITS FROM PRE-SET CONDITIONS; CIRCUIT BOARDS; PERMANENT MAGNETS; COMPONENTS FOR ELECTRICAL INSTALLATIONS, SPECIFICALLY SWITCHES, RELAYS, TRANSFORMERS, SWITCHBOARDS, CLAMPS; HOUSINGS FOR ELECTRICAL EQUIPMENT; MEASUREMENT, CONTROL AND REGULATION DEVICES FOR NON-ELECTRICAL VALVES AND THEIR COMPONENTS, NAMELY, METERING VALVES, SAFETY SHUT OFF VALVES CONTROL VALVES, PNEUMATIC VALVES, ACTUATED VALVES, BALL VALVES, DIAPHRAGM VALVES, CHECK VALVES, EXPANSION VALVES AND BY-PASS VALVES; AUTOMATIC FLAME GUARDS AND UV DETECTORS, FLUE GAS TESTERS AND OXYGEN PROBES; DENSITY MONITORING DEVICES FOR GAS VALVES AND COMPONENTS FOR THESE DEVICES; BUILDING AUTOMATION INSTALLATIONS AND THEIR COMPONENTS, NAMELY, CONTROLLERS, SENSORS AND ACTUATORS THAT PROVIDE THE ABILITY TO MONITOR AND CONTROL HEATING, VENTILATION, AIR CONDITIONING, HUMIDITY, LIGHTING, SECURITY SYSTEMS, ELECTRICITY CONSUMPTION, VIDEO SURVEILLANCE AND APPLIANCES VIA REMOTE ACCESS; FIRE ALARM DEVICES, BURGLAR ALARM DEVICES AND LEAK ALARM DEVICES AND SENSORS FOR SUCH DEVICES; MONEY CHANGING MACHINES AND BANK NOTE TESTERS; DEVICES FOR TELEPHONE SYSTEMS, NAMELY, CODE, COIN OR CARD OPERATED TELEPHONES, CHARGE DISPLAYS AND CHARGE PRINTERS, CALL METERS, PULSE COUNTERS, AND PRINTING PULSE COUNTERS; IDENTIFICATION AND AUTHORIZATION DOCUMENTS AND CASH-FREE MEANS OF PAYMENT, NAMELY, CREDIT CARDS, DEBIT CARDS AND SMART CARDS, AS WELL AS THE RELATED SCANNING AND OPERATING DEVICES; MAGNETICALLY CODED CARDS, OPTICALLY CODED CARDS AND CHIP CARDS; SCANNING DEVICES FOR MAGNETICALLY CODED CARDS, OPTICALLY CODED CARDS AND CHIP CARDS; DATA PROCESSING EQUIPMENT IN THE NATURE OF DATA RECORDERS, DATA ENCODERS, DATA TRANSDUCERS, PROCESSING COMPUTERS AND STRUCTURAL PARTS THEREFORE; ELECTRICAL SOLID STATE AND SEMICONDUCTOR COMPONENTS AND MICROELECTRONIC COMPONENTS, NAMELY, MAGNETIC FIELD SENSORS, INTEGRATED CIRCUITS, THERMOELECTRICAL, PIEZOELECTRIC AND HALL-EFFECT ELEMENTS AND COMPONENTS; AND PRINTED CIRCUIT

BOARDS, IN CLASS 9 (U.S. CLS. 21, 23, 26, 36 AND 38).

FIRST USE 12-1-2002; IN COMMERCE 12-1-2002.

FOR: PAPER, CARDBOARD PULP AND GOODS MADE OF THESE MATERIALS, NAMELY, BOXES; PRINTED PRODUCTS, NAMELY, PRINTED FORMS, INSTRUCTION SHEETS, CATALOGUES, PAMPHLETS, FLYERS, BROCHURES, NEWSLETTERS, JOURNALS, MAGAZINES, BOOKS, AND MANUALS ON THE USE AND APPLICATIONS OF TECHNICAL PRODUCTS OF ALL KINDS, ESPECIALLY ABOUT DATA ACQUISITION, TRANSFER AND PROCESSING IN ENERGY SUPPLY NETWORKS AND ALSO FOR ENERGY MANAGEMENT, ENERGY CUSTOMER MANAGEMENT, FOR THE DETERMINATION OF DATA ON ENERGY AND CUSTOMERS, FOR THE ENERGY MARKET AND THE ENERGY TRADE, FOR ENERGY REPORT PRODUCTION, ENERGY BILLING AND ENERGY RATING, FOR THE CALCULATION AND BILLING OF ENERGY COSTS, CALCULATION AND BILLING OF CHARGES AND THE ADMINISTRATION OF ENERGY CUSTOMER PROCESSES, INFORMATION TECHNOLOGY, COMMUNICATIONS TECHNOLOGY LOGISTICS, OPTICS AND MECHANICAL ENGINEERING, BUILDING AUTOMATION; TEACHING AND EDUCATIONAL MEDIA, NAMELY, PAMPHLETS, FLYERS, BROCHURES, NEWSLETTERS, JOURNALS, MAGAZINES, BOOKS, LESSON PLANS, EXAMPLE PROBLEMS, CASE STUDIES AND REFERENCE MANUALS ON THE USE AND APPLICATIONS OF TECHNICAL PRODUCTS OF ALL KINDS, ESPECIALLY ABOUT DATA ACQUISITION, TRANSFER AND PROCESSING IN ENERGY SUPPLY NETWORKS AND ALSO FOR ENERGY MANAGEMENT, ENERGY CUSTOMER MANAGEMENT, FOR THE DETERMINATION OF DATA ON ENERGY AND CUSTOMERS, FOR THE ENERGY MARKET AND THE ENERGY TRADE, FOR ENERGY REPORT PRODUCTION, ENERGY BILLING AND ENERGY RATING, FOR THE CALCULATION AND BILLING OF ENERGY COSTS, CALCULATION AND BILLING OF CHARGES AND THE ADMINISTRATION OF ENERGY CUSTOMER PROCESSES, INFORMATION TECHNOLOGY, COMMUNICATIONS TECHNOLOGY LOGISTICS, OPTICS AND MECHANICAL ENGINEERING, BUILDING AUTOMATION; DOCUMENTATION IN THE FORM OF PRINTED FORMS, INSTRUCTION SHEETS, FLYERS, BROCHURES, BOOKS, AND MANUALS ON THE USE AND APPLICATIONS OF TECHNICAL PRODUCTS OF ALL KINDS, ESPECIALLY ABOUT DATA ACQUISITION, TRANSFER AND PROCESSING IN ENERGY SUPPLY NETWORKS AND ALSO FOR ENERGY MANAGEMENT, ENERGY CUSTOMER MANAGEMENT, FOR THE DETERMINATION OF DATA ON ENERGY AND CUSTOMERS, FOR THE ENERGY MARKET AND THE ENERGY TRADE, FOR ENERGY REPORT PRODUCTION, ENERGY BILLING AND ENERGY RATING, FOR THE CALCULATION AND BILLING OF ENERGY COSTS, CALCULATION AND BILLING OF CHARGES AND THE ADMINISTRATION OF ENERGY CUSTOMER PROCESSES, INFORMATION TECH-

NOLOGY, COMMUNICATIONS TECHNOLOGY LOGISTICS, OPTICS AND MECHANICAL ENGINEERING, BUILDING AUTOMATION; PACKAGING MADE FROM PAPER OR PLASTIC; PLASTIC LAMINATES USED FOR PACKAGING PURPOSES, IN CLASS 16 (U.S. CLS. 2, 5, 22, 23, 29, 37, 38 AND 50).

FIRST USE 12-1-2002; IN COMMERCE 12-1-2002.

FOR: BUSINESS MANAGEMENT; COMPANY ADMINISTRATION SERVICES, NAMELY, ACCOUNTING, BOOKKEEPING, AND PREPARATION OF BUSINESS STATISTICAL INFORMATION; CALCULATION AND BILLING OF ENERGY COSTS; WORK PLANNING, OPERATIONAL PLANNING AND ROUTE PLANNING FOR THIRD PARTIES WITH RESPECT TO THE DETERMINATION OF ENERGY DATA AND EXCHANGE OF ENERGY, CONSUMPTION, FLOW AND RETURN METERS OF ALL KINDS; ACQUISITION, READING, DATA FORMATTING, PREPARATION AND ANALYSIS OF CUSTOMER DATA, UPDATING OF ENERGY DATA; PURCHASE OF ENERGY METERS, CONSUMPTION METERS, FLOW METERS AND RETURN METERS OF ALL KINDS AND OF DATA TRANSFER DEVICES FOR THIRD PARTIES; INDUSTRIAL CONSULTING IN THE NATURE OF ENERGY SUPPLY, DEMAND, CONSUMPTION AND COSTS, AND CUSTOMER INFORMATION SERVICES, NAMELY, DATA PROCESSING, DATA COMMUNICATION AND DATA REPORTING IN THE SERVICE OF THIRD PARTIES; BUSINESS CONSULTING, NAMELY, CONSULTING IN THE AREAS OF THIRD PARTY CUSTOMERS, FORECASTING, BUSINESS RESEARCH, ECONOMIC AND STATISTICAL ANALYSIS; INDUSTRIAL INFRASTRUCTURE MANAGEMENT FOR SALES OUTLETS, NAMELY, MANAGEMENT OF BUILDING AUTOMATION, HEATING, VENTILATION AND AIR CONDITIONING DEVICES, TELECOMMUNICATIONS APPLIANCES, AND IDENTIFICATION AUTHORIZATION AND CASH-FREE MEANS OF PAYMENT DEVICES; SUPPLY CHAIN MANAGEMENT IN THE FIELD OF ENERGY SUPPLY; INFORMATION ACQUISITION AND PROCESSING, NAMELY, ACQUISITION AND PROCESSING OF ENERGY CONSUMPTION AND FLOW, INVOICES AND BILLING STATEMENTS IN THE DOMAIN OF ENERGY SUPPLY, DEMAND, CONSUMPTION AND COSTS; CONDUCT OF ENERGY PRICE NEGOTIATIONS ON BEHALF OF CUSTOMERS; PROVISION OF PRICE AND ENERGY DATA OF ENERGY SUPPLIERS IN THE ENERGY MARKET, TREATMENT OF DATA AND PREPARATION OF GENERAL SURVEYS IN THE ABOVE-MENTIONED DOMAINS; ADMINISTRATION OF ENERGY CUSTOMER PROCESSES, NAMELY, GENERATION AND DELIVERY OF INVOICES AND BILLING STATEMENTS FOR OTHERS, MAINTAINING INFORMATION REGARDING BILLING OF CUSTOMERS AND FOLLOW-UP CORRESPONDENCE REGARDING BILLING, IN CLASS 35 (U.S. CLS. 100, 101 AND 102).

FIRST USE 12-1-2002; IN COMMERCE 12-1-2002.

FOR: EDUCATIONAL SERVICES, NAMELY, CONDUCTING SESSIONS, CLASSES, WORKSHOPS AND SEMINARS IN THE FIELD OF METERING; INDIVIDUAL AND GROUP TUTORING, CONSULTATION AND TRAINING IN THE FIELD OF METERING; ENTERTAINMENT SERVICES, NAMELY, EVENT COORDINATOR AND FACILITATOR IN THE FIELD OF METERING; TRAINING OF THIRD PARTIES IN THE USE AND APPLICATION OF TECHNICAL PRODUCTS OF ALL KINDS; TRAINING IN THE USE OF PRODUCTS RELATING TO ELECTRICAL ENGINEERING AND ELECTRONICS, INFORMATION TECHNOLOGY, COMMUNICATIONS TECHNOLOGY, LOGISTICS, OPTICS AND MECHANICAL ENGINEERING, DEVICES AND SYSTEMS FOR ELECTRICITY, WATER, GAS AND HEAT SUPPLY SYSTEMS, ENERGY MEASURING, TARIFF AND LOAD CONTROL SYSTEMS, ELECTRONIC CREDIT AUTHORIZATION, BILLING AND PAYMENT SYSTEMS, WIRED AND WIRELESS DATA TRANSMISSION DEVICES, BUILDING AUTOMATION, HEATING, VENTILATION AND AIR CONDITIONING SYSTEMS, AS WELL AS EQUIPMENT AND APPARATUS FOR CONTROLLING AND REGULATING SUCH SYSTEMS, IN CLASS 41 (U.S. CLS. 100, 101 AND 107).

FIRST USE 12-1-2002; IN COMMERCE 12-1-2002.

FOR: SCIENTIFIC AND TECHNOLOGICAL SERVICES, NAMELY, SCIENTIFIC AND TECHNOLOGICAL CONSULTING SERVICES, PROJECT STUDIES RELATING TO TECHNOLOGICAL PROCESSES AND APPARATUS IN THE FIELD OF ENERGY SUPPLY AND RESEARCH WORK; INDUSTRIAL ANALYSIS AND RESEARCH SERVICES; DESIGN AND DEVELOPMENT OF COMPUTER HARDWARE AND SOFTWARE; LEGAL CONSULTING AND REPRESENTATION; SERVICES OF ENGINEERS, PHYSICISTS, COMPUTER SCIENTISTS; SOFTWARE DEVELOPMENT; PLANNING AND DEVELOPMENT OF PRODUCTS OF ELECTRICAL ENGINEERING, ELECTRONICS, INFORMATION TECHNOLOGY, COMMUNICATIONS TECHNOLOGY, OPTICS AND MECHANICAL ENGINEERING, ALSO OF DEVICES, APPARATUS AND INSTALLATIONS FOR THE MEASUREMENT AND CONTROL OF PRODUCTION, TRANSPORT AND CONSUMPTION OF ENERGY, ALSO OF DEVICES, APPARATUS AND INSTALLATIONS FOR BUILDING AUTOMATION AND OF HEATING, VENTILATION AND AIR CONDITIONING PLANT AND OF DEVICES AND APPARATUS FOR THE CONTROL AND REGULATION OF SUCH INSTALLATIONS, ALSO OF DEVICES, APPARATUS AND INSTALLATIONS FOR TELECOMMUNICATIONS AND FOR THE REMOTE CONTROL, REMOTE MONITORING AND REMOTE MANAGEMENT OF TELECOMMUNICATIONS APPLIANCES, ALSO OF DEVICES, APPARATUS AND INSTALLATIONS FOR CREDIT AUTHORIZATION AND BILLING AND PAYMENT FOR SERVICES AND MERCHANDISE, AND ALSO OF IDENTIFICATION, AUTHORIZATION AND CASH-FREE MEANS OF PAYMENT; TECHNICAL ADVICE IN THE FIELD OF ENERGY MANAGEMENT, ENERGY CUSTOMER MANAGEMENT, DE-

TERMINATION OF ENERGY DATA AND CUSTOMER DATA, THE ENERGY MARKET AND THE ENERGY TRADE, ENERGY REPORTING, ENERGY BILLING AND ENERGY RATING, CALCULATION AND BILLING OF ENERGY COSTS; SCIENTIFIC ANALYSIS OF ENERGY DATA; DEVELOPMENT, UPDATING AND MAINTENANCE OF SOFTWARE IN THE ABOVE-MENTIONED DOMAIN; TECHNICAL PLANNING OF INSTALLATIONS IN THE ABOVE-MENTIONED DOMAIN, SPECIFICALLY DRAWING UP TARGET SPECIFICATIONS; DRAWING UP TECHNICAL REPORTS IN THE DOMAIN OF DATA ACQUISITION REGARDING ENERGY, CUSTOMERS, THE ENERGY MARKET AND THE ENERGY TRADE; ACCREDITATION, CERTIFICATION, TECHNICAL TESTING AND TECHNICAL OR SCIENTIFIC CONDUCT OF SAMPLE TESTING OF INSTALLATIONS, APPARATUS AND APPLIANCES IN THE FIELD OF ENERGY MANAGEMENT, ENERGY CUSTOMER MANAGEMENT, DETERMINATION OF ENERGY DATA AND CUSTOMER DATA, THE ENERGY MARKET AND THE ENERGY TRADE, ENERGY REPORTING, ENERGY BILLING AND ENERGY RATING, CALCULATION AND BILLING OF ENERGY COSTS; DETECTION OF FRAUD AND ABUSE IN THE ABOVE-MENTIONED DOMAIN; TECHNICAL INFRASTRUCTURE PLANNING FOR SALES OUTLETS, NAMELY, PLANNING OF BUILDING AUTOMATION, HEATING, VENTILA-

TION AND AIR CONDITIONING SYSTEMS, TELECOMMUNICATIONS SYSTEMS, AND IDENTIFICATION AUTHORIZATION AND CASH-FREE MEANS OF PAYMENT SYSTEMS; CALIBRATION AND TESTING OF METERING EQUIPMENT; CALIBRATION AND TESTING OF APPARATUS AND APPLIANCES IN THE FIELD OF ENERGY MANAGEMENT, ENERGY CUSTOMER MANAGEMENT, DETERMINATION OF ENERGY DATA AND CUSTOMER DATA, THE ENERGY MARKET AND THE ENERGY TRADE, ENERGY REPORTING, ENERGY BILLING AND ENERGY RATING, CALCULATION AND BILLING OF ENERGY COSTS, CALCULATION AND BILLING OF CHARGES AND THE ADMINISTRATION OF ENERGY CUSTOMER PROCESSES, IN CLASS 42 (U.S. CLS. 100 AND 101).

FIRST USE 12-1-2002; IN COMMERCE 12-1-2002.

PRIORITY CLAIMED UNDER SEC. 44(D) ON SWITZERLAND APPLICATION NO. 07713/2002, FILED 10-10-2002, REG. NO. 503553, DATED 9-6-2002, EXPIRES 10-10-2012.

OWNER OF U.S. REG. NO. 2,437,910.

SN 76-978,737, FILED 2-4-2003.

SHAILA SETTLES, EXAMINING ATTORNEY



**Int. Cl.: 41**

**Prior U.S. Cls.: 100, 101, and 107**

**United States Patent and Trademark Office**

**Reg. No. 3,395,351**

**Registered Mar. 11, 2008**

**SERVICE MARK  
PRINCIPAL REGISTER**



AKONO ENTERTAINMENT (FLORIDA CORPORATION)  
27501 S. DIXIE HWY, SUITE 403  
NARANJA, FL 33032

FOR: MUSIC PRODUCTION SERVICES, IN CLASS 41 (U.S. CLS. 100, 101 AND 107).

FIRST USE 8-1-2006; IN COMMERCE 8-1-2006.

NO CLAIM IS MADE TO THE EXCLUSIVE RIGHT TO USE "ENTERTAINMENT", APART FROM THE MARK AS SHOWN.

THE MARK CONSISTS OF A LUNAR ECLIPSE DISPLAYED BEHIND THE WORDING "AKONO ENTERTAINMENT".

THE FOREIGN WORDING IN THE MARK TRANSLATES INTO ENGLISH AS IT'S MY TURN.

SN 77-000,073, FILED 9-15-2006.

ANDREA K. NADELMAN, EXAMINING ATTORNEY

**Int. Cl.: 25**

**Prior U.S. Cls.: 22 and 39**

**United States Patent and Trademark Office**

**Reg. No. 3,395,352**

**Registered Mar. 11, 2008**

**TRADEMARK  
PRINCIPAL REGISTER**



SIMENDINGER, THEODORE JOHN (UNITED STATES INDIVIDUAL)  
9260 EAST LAKE PLACE  
GREENWOOD VILLAGE, CO 80111

FIRST USE 1-1-2007; IN COMMERCE 1-1-2007.

FOR: CLOTHING, NAMELY, T-SHIRTS AND SWEATSHIRTS; FOOTWEAR; HEADGEAR, NAMELY, HATS AND CAPS, IN CLASS 25 (U.S. CLS. 22 AND 39).

SN 77-000,322, FILED 9-15-2006.

DAVID MILLER, EXAMINING ATTORNEY

**Int. Cl.: 28**

**Prior U.S. Cls.: 22, 23, 38, and 50**

**United States Patent and Trademark Office**

**Reg. No. 3,395,353**

**Registered Mar. 11, 2008**

**TRADEMARK  
PRINCIPAL REGISTER**

**BALSAM HILL**

RED SLATE BRANDS, INC. (HONG KONG CORPORATION)  
TRINITY CHAMBERS, P.O. BOX 4301  
ROAD TOWN, TORTOLA, BR.VIRGIN ISLANDS

FOR: ARTIFICIAL CHRISTMAS GARLANDS; ARTIFICIAL CHRISTMAS TREES; CHRISTMAS STOCKINGS; CHRISTMAS TREE DECORATIONS; CHRISTMAS TREE ORNAMENTS; CHRISTMAS TREE ORNAMENTS, NAMELY, BELLS; CHRISTMAS TREE SKIRTS; CHRISTMAS TREE STAND COVERS; CHRISTMAS TREE STANDS, IN CLASS 28 (U.S. CLS. 22, 23, 38 AND 50).

FIRST USE 10-1-2006; IN COMMERCE 10-1-2006.

THE MARK CONSISTS OF STANDARD CHARACTERS WITHOUT CLAIM TO ANY PARTICULAR FONT, STYLE, SIZE, OR COLOR.

NO CLAIM IS MADE TO THE EXCLUSIVE RIGHT TO USE "BALSAM", APART FROM THE MARK AS SHOWN.

SN 77-000,539, FILED 9-15-2006.

VIVIAN MICZNIK FIRST, EXAMINING ATTORNEY

**Int. Cl.: 28**

**Prior U.S. Cls.: 22, 23, 38, and 50**

**United States Patent and Trademark Office**

**Reg. No. 3,395,354**

**Registered Mar. 11, 2008**

**TRADEMARK  
PRINCIPAL REGISTER**

**VERMONT SIGNATURE**

RED SLATE BRANDS, INC. (HONG KONG CORPORATION)  
TRINITY CHAMBERS, P.O. BOX 4301  
ROAD TOWN, TORTOLA, BR.VIRGIN ISLANDS

FOR: ARTIFICIAL CHRISTMAS GARLANDS;  
ARTIFICIAL CHRISTMAS TREES, IN CLASS 28  
(U.S. CLS. 22, 23, 38 AND 50).

FIRST USE 10-1-2006; IN COMMERCE 10-1-2006.

THE MARK CONSISTS OF STANDARD CHARACTERS WITHOUT CLAIM TO ANY PARTICULAR FONT, STYLE, SIZE, OR COLOR.

SN 77-000,564, FILED 9-15-2006.

VIVIAN MICZNIK FIRST, EXAMINING ATTORNEY

**Int. Cl.: 28**

**Prior U.S. Cls.: 22, 23, 38, and 50**

**United States Patent and Trademark Office**

**Reg. No. 3,395,355**

**Registered Mar. 11, 2008**

**TRADEMARK  
PRINCIPAL REGISTER**

**NAPA CHRISTMAS**

RED SLATE BRANDS, INC. (HONG KONG CORPORATION)

TRINITY CHAMBERS, P.O. BOX 4301

ROAD TOWN, TORTOLA, BR.VIRGIN ISLANDS

FOR: ARTIFICIAL CHRISTMAS GARLANDS;  
ARTIFICIAL CHRISTMAS TREES, IN CLASS 28  
(U.S. CLS. 22, 23, 38 AND 50).

FIRST USE 10-1-2006; IN COMMERCE 10-1-2006.

THE MARK CONSISTS OF STANDARD CHARACTERS WITHOUT CLAIM TO ANY PARTICULAR FONT, STYLE, SIZE, OR COLOR.

NO CLAIM IS MADE TO THE EXCLUSIVE RIGHT TO USE "CHRISTMAS", APART FROM THE MARK AS SHOWN.

SN 77-000,624, FILED 9-15-2006.

VIVIAN MICZNIK FIRST, EXAMINING ATTORNEY

**Int. Cl.: 44**

**Prior U.S. Cls.: 100 and 101**

**United States Patent and Trademark Office**

**Reg. No. 3,395,356**

**Registered Mar. 11, 2008**

**SERVICE MARK  
PRINCIPAL REGISTER**

**VERMEDX**

VERMONT CLINICAL DECISION SUPPORT, LLC  
(DELAWARE LTD LIAB CO)  
371 PEARL STREET  
BURLINGTON, VT 05401

FOR: MEDICAL SERVICES, NAMELY, AUTOMATED EVALUATION OF LABORATORY RESULTS AND PROVISION OF TREATMENT GUIDELINES AND ALERTS TO TREATMENT NEEDS TO PHYSICIANS AND PATIENTS, IN CLASS 44 (U.S. CLS. 100 AND 101).

FIRST USE 6-1-2006; IN COMMERCE 6-1-2006.

THE MARK CONSISTS OF STANDARD CHARACTERS WITHOUT CLAIM TO ANY PARTICULAR FONT, STYLE, SIZE, OR COLOR.

SN 77-000,634, FILED 9-15-2006.

VIVIAN MICZNIK FIRST, EXAMINING ATTORNEY

**Int. Cl.: 9**

**Prior U.S. Cls.: 21, 23, 26, 36, and 38**

**United States Patent and Trademark Office**

**Reg. No. 3,395,357**

**Registered Mar. 11, 2008**

**TRADEMARK  
PRINCIPAL REGISTER**

**CYOPI**

SERVANTUS CORPORATION (UTAH CORPORATION)  
9728 NORTH 6630 WEST  
HIGHLAND, UT 84003

FOR: COMPUTER SOFTWARE AND HARDWARE FOR USE IN BACKING UP AND CONTROLLING DATA IN A COMPUTER NETWORK, IN CLASS 9 (U.S. CLS. 21, 23, 26, 36 AND 38).

FIRST USE 1-11-2007; IN COMMERCE 12-10-2007.

THE MARK CONSISTS OF STANDARD CHARACTERS WITHOUT CLAIM TO ANY PARTICULAR FONT, STYLE, SIZE, OR COLOR.

SN 77-000,775, FILED 9-15-2006.

PAUL CROWLEY, EXAMINING ATTORNEY

**Int. Cl.: 28**

**Prior U.S. Cls.: 22, 23, 38, and 50**

**United States Patent and Trademark Office**

**Reg. No. 3,395,358**

**Registered Mar. 11, 2008**

**TRADEMARK  
PRINCIPAL REGISTER**

**COLOR+CLEAR**

RED SLATE BRANDS, INC. (HONG KONG CORPORATION)  
TRINITY CHAMBERS, P.O. BOX 4301  
ROAD TOWN, TORTOLA, BR.VIRGIN ISLANDS

FOR: ARTIFICIAL CHRISTMAS TREES, IN CLASS 28 (U.S. CLS. 22, 23, 38 AND 50).

FIRST USE 10-1-2006; IN COMMERCE 10-1-2006.

THE MARK CONSISTS OF STANDARD CHARACTERS WITHOUT CLAIM TO ANY PARTICULAR FONT, STYLE, SIZE, OR COLOR.

SN 77-001,260, FILED 9-18-2006.

VIVIAN MICZNIK FIRST, EXAMINING ATTORNEY



**Int. Cl.: 45**

**Prior U.S. Cls.: 100 and 101**

**United States Patent and Trademark Office**

**Reg. No. 3,395,359**

**Registered Mar. 11, 2008**

**SERVICE MARK  
PRINCIPAL REGISTER**

**HAPPY FOR NO REASON**

SHIMOFF & ASSOCIATES, INC. (FLORIDA CORPORATION)  
57 BAYVIEW DRIVE  
SAN RAFAEL, CA 94901

FOR: PERSONAL GROWTH AND MOTIVATION CONSULTING SERVICES; PROVIDING ON-LINE INFORMATION IN THE FIELD OF SPIRITUALITY, SELF-HELP, AND PERSONAL EMPOWERMENT SUBJECT MATTERS , IN CLASS 45 (U.S. CLS. 100 AND 101).

FIRST USE 7-28-2007; IN COMMERCE 7-28-2007.

THE MARK CONSISTS OF STANDARD CHARACTERS WITHOUT CLAIM TO ANY PARTICULAR FONT, STYLE, SIZE, OR COLOR.

SN 77-001,467, FILED 9-18-2006.

JAMES LOVELACE, EXAMINING ATTORNEY

**Int. Cl.: 3**

**Prior U.S. Cls.: 1, 4, 6, 50, 51, and 52**

**United States Patent and Trademark Office**

**Reg. No. 3,395,360**

**Registered Mar. 11, 2008**

**TRADEMARK  
PRINCIPAL REGISTER**

**BODY ESSENCE SMOOTHIE**

PURETEK CORPORATION (CALIFORNIA CORPORATION)  
1245 AVIATION PLACE  
SAN FERNANDO, CA 91340

OWNER OF U.S. REG. NOS. 2,554,435 AND 2,588,030.

FOR: BODY LOTIONS; SKIN MOISTURIZER, IN CLASS 3 (U.S. CLS. 1, 4, 6, 50, 51 AND 52).

NO CLAIM IS MADE TO THE EXCLUSIVE RIGHT TO USE "BODY", APART FROM THE MARK AS SHOWN.

FIRST USE 8-1-2006; IN COMMERCE 3-1-2007.

SN 77-001,732, FILED 9-18-2006.

THE MARK CONSISTS OF STANDARD CHARACTERS WITHOUT CLAIM TO ANY PARTICULAR FONT, STYLE, SIZE, OR COLOR.

KEVON CHISOLM, EXAMINING ATTORNEY

**Int. Cl.: 41**

**Prior U.S. Cls.: 100, 101, and 107**

**United States Patent and Trademark Office**

**Reg. No. 3,395,361**

**Registered Mar. 11, 2008**

**SERVICE MARK  
PRINCIPAL REGISTER**

**WOODVISION**

MEREDITH CORPORATION (IOWA CORPORATION)  
1716 LOCUST STREET  
DES MOINES, IA 503093023

FOR: EDUCATION AND ENTERTAINMENT SERVICES, NAMELY, PROVIDING A WEBSITE FEATURING AUDIO AND VIDEO FILM CLIPS RELATED TO WOODWORKING TIPS, SKILLS AND PROJECTS, IN CLASS 41 (U.S. CLS. 100, 101 AND 107).

FIRST USE 3-1-2007; IN COMMERCE 3-1-2007.

THE MARK CONSISTS OF STANDARD CHARACTERS WITHOUT CLAIM TO ANY PARTICULAR FONT, STYLE, SIZE, OR COLOR.

OWNER OF U.S. REG. NOS. 1,599,532, 1,752,462, AND 2,080,866.

SN 77-003,080, FILED 9-20-2006.

LAURIE KAUFMAN, EXAMINING ATTORNEY

**Int. Cl.: 38**

**Prior U.S. Cls.: 100, 101, and 104**

**United States Patent and Trademark Office**

**Reg. No. 3,395,362**

**Registered Mar. 11, 2008**

**SERVICE MARK  
PRINCIPAL REGISTER**

# Takalam

CORDIA CORPORATION (NEVADA CORPORATION)  
SUITE 408  
445 HAMILTON AVENUE  
WHITE PLAINS, NY 10601

THE MARK CONSISTS OF STANDARD CHARACTERS WITHOUT CLAIM TO ANY PARTICULAR FONT, STYLE, SIZE, OR COLOR.

FOR: VOICE OVER INTERNET PROTOCOL (VOIP) SERVICES, IN CLASS 38 (U.S. CLS. 100, 101 AND 104).

SN 77-003,249, FILED 9-20-2006.

FIRST USE 5-1-2007; IN COMMERCE 5-1-2007.

HEATHER THOMPSON, EXAMINING ATTORNEY

**Int. Cl.: 38**

**Prior U.S. Cls.: 100, 101, and 104**

**United States Patent and Trademark Office**

**Reg. No. 3,395,363**

**Registered Mar. 11, 2008**

---

**SERVICE MARK  
PRINCIPAL REGISTER**

**Mixpo**

MIXPO PORTFOLIO BROADCASTING INC. (CANADA CORPORATION)  
2100 - 1075 WEST GEORGIA STREET  
VANCOUVER, BC, CANADA V6E 3G2

THE MARK CONSISTS OF STANDARD CHARACTERS WITHOUT CLAIM TO ANY PARTICULAR FONT, STYLE, SIZE, OR COLOR.

FOR: STREAMING OF AUDIO AND VIDEO MATERIAL ON THE INTERNET, IN CLASS 38 (U.S. CLS. 100, 101 AND 104).

SN 77-003,315, FILED 9-20-2006.

FIRST USE 1-29-2007; IN COMMERCE 1-29-2007.

JASON ROTH, EXAMINING ATTORNEY

**Int. Cl.: 41**

**Prior U.S. Cls.: 100, 101, and 107**

**United States Patent and Trademark Office**

**Reg. No. 3,395,364**

**Registered Mar. 11, 2008**

**SERVICE MARK  
PRINCIPAL REGISTER**

**THE HENRY FORD HISTORY  
HUNTERS**

THE EDISON INSTITUTE (MICHIGAN NON-  
PROFIT CORPORATION)  
20900 OAKWOOD BOULEVARD  
DEARBORN, MI 48124

FOR: PROVIDING INFORMATION REGARDING  
MUSEUM EVENTS, ACTIVITIES AND EXHIBI-  
TIONS FOR EDUCATORS TO PLAN GROUP MU-  
SEUM TOURS, IN CLASS 41 (U.S. CLS. 100, 101 AND  
107).

FIRST USE 5-31-2007; IN COMMERCE 5-31-2007.

THE MARK CONSISTS OF STANDARD CHAR-  
ACTERS WITHOUT CLAIM TO ANY PARTICULAR  
FONT, STYLE, SIZE, OR COLOR.

OWNER OF U.S. REG. NOS. 2,064,445 AND  
2,902,382.

THE NAME "HENRY FORD" DOES NOT IDEN-  
TIFY A LIVING INDIVIDUAL.

SN 77-003,364, FILED 9-20-2006.

MARK T. MULLEN, EXAMINING ATTORNEY

**Int. Cl.: 25**

**Prior U.S. Cls.: 22 and 39**

**United States Patent and Trademark Office**

**Reg. No. 3,395,365**

**Registered Mar. 11, 2008**

**TRADEMARK  
PRINCIPAL REGISTER**

**BORN TO BODYGUARD**

PATIRE, THOMAS J. (UNITED STATES INDIVIDUAL)  
UNIT A  
24 WAMPUM ROAD  
PARK RIDGE, NJ 07656

FOR: CLOTHING, NAMELY, T-SHIRTS, SWEAT-SHIRTS, POLO SHIRTS, PANTS AND SWEAT-PANTS, JACKETS, AND HEADWEAR, INCLUDING HATS, CAPS AND DO-RAGS, IN CLASS 25 (U.S. CLS. 22 AND 39).

FIRST USE 5-1-2006; IN COMMERCE 5-1-2006.

THE MARK CONSISTS OF STANDARD CHARACTERS WITHOUT CLAIM TO ANY PARTICULAR FONT, STYLE, SIZE, OR COLOR.

SN 77-004,184, FILED 9-21-2006.

MIDGE BUTLER, EXAMINING ATTORNEY

**Int. Cl.: 5**

**Prior U.S. Cls.: 6, 18, 44, 46, 51, and 52**

**United States Patent and Trademark Office**

**Reg. No. 3,395,366**

**Registered Mar. 11, 2008**

**TRADEMARK  
PRINCIPAL REGISTER**

# Carsufat

THE SCIENTIFIC ADVANTAGE, LLC (NEVADA  
LTD LIAB CO)  
2533 N. CARSON ST. STE 1719  
CARSON CITY, NV 89706

THE MARK CONSISTS OF STANDARD CHAR-  
ACTERS WITHOUT CLAIM TO ANY PARTICULAR  
FONT, STYLE, SIZE, OR COLOR.

FOR: DIETARY AND NUTRITIONAL SUPPLE-  
MENTS, IN CLASS 5 (U.S. CLS. 6, 18, 44, 46, 51 AND  
52).

SN 77-005,770, FILED 9-22-2006.

FIRST USE 3-30-2007; IN COMMERCE 3-30-2007.

ROBIN CHOSID, EXAMINING ATTORNEY



**Int. Cl.: 44**

**Prior U.S. Cls.: 100 and 101**

**United States Patent and Trademark Office**

**Reg. No. 3,395,367**

**Registered Mar. 11, 2008**

**SERVICE MARK  
PRINCIPAL REGISTER**

**See Spot Sleep**

ADVANCED COSMETIC SURGERY & LASER  
CENTER OF HYDE PARK, INC. (OHIO COR-  
PORATION)  
ROOKWOOD TOWER, SUITE 100  
3805 EDWARDS ROAD  
CINCINNATI, OH 45209

FOR: COSMETIC AND PLASTIC SURGERY, IN  
CLASS 44 (U.S. CLS. 100 AND 101).

FIRST USE 12-31-2006; IN COMMERCE 12-31-2006.

THE MARK CONSISTS OF STANDARD CHAR-  
ACTERS WITHOUT CLAIM TO ANY PARTICULAR  
FONT, STYLE, SIZE, OR COLOR.

SN 77-006,622, FILED 9-25-2006.

CYNTHIA SLOAN, EXAMINING ATTORNEY

**Int. Cl.: 44**

**Prior U.S. Cls.: 100 and 101**

**United States Patent and Trademark Office**

**Reg. No. 3,395,368**

**Registered Mar. 11, 2008**

**SERVICE MARK  
PRINCIPAL REGISTER**

**See Spot Eat**

ADVANCED COSMETIC SURGERY & LASER  
CENTER OF HYDE PARK, INC. (OHIO COR-  
PORATION)  
ROOKWOOD TOWER, SUITE 100  
3805 EDWARDS ROAD  
CINCINNATI, OH 45209

FOR: COSMETIC AND PLASTIC SURGERY, IN  
CLASS 44 (U.S. CLS. 100 AND 101).

FIRST USE 12-31-2006; IN COMMERCE 12-31-2006.

THE MARK CONSISTS OF STANDARD CHAR-  
ACTERS WITHOUT CLAIM TO ANY PARTICULAR  
FONT, STYLE, SIZE, OR COLOR.

SN 77-006,629, FILED 9-25-2006.

CYNTHIA SLOAN, EXAMINING ATTORNEY

**Int. Cl.: 44**

**Prior U.S. Cls.: 100 and 101**

**United States Patent and Trademark Office**

**Reg. No. 3,395,369**

**Registered Mar. 11, 2008**

**SERVICE MARK  
PRINCIPAL REGISTER**

**See Spot Drink**

ADVANCED COSMETIC SURGERY & LASER  
CENTER OF HYDE PARK, INC. (OHIO COR-  
PORATION)  
ROOKWOOD TOWER, SUITE 100  
3805 EDWARDS ROAD  
CINCINNATI, OH 45209

FOR: COSMETIC AND PLASTIC SURGERY, IN  
CLASS 44 (U.S. CLS. 100 AND 101).

FIRST USE 11-30-2007; IN COMMERCE 11-30-2007.

THE MARK CONSISTS OF STANDARD CHAR-  
ACTERS WITHOUT CLAIM TO ANY PARTICULAR  
FONT, STYLE, SIZE, OR COLOR.

SN 77-006,640, FILED 9-25-2006.

CYNTHIA SLOAN, EXAMINING ATTORNEY

**Int. Cl.: 44**

**Prior U.S. Cls.: 100 and 101**

**United States Patent and Trademark Office**

**Reg. No. 3,395,370**

**Registered Mar. 11, 2008**

**SERVICE MARK  
PRINCIPAL REGISTER**

**See Spot Fetch**

ADVANCED COSMETIC SURGERY & LASER  
CENTER OF HYDE PARK, INC. (OHIO COR-  
PORATION)  
ROOKWOOD TOWER, SUITE 100  
3805 EDWARDS ROAD  
CINCINNATI, OH 45209

FOR: COSMETIC AND PLASTIC SURGERY, IN  
CLASS 44 (U.S. CLS. 100 AND 101).

FIRST USE 12-31-2006; IN COMMERCE 12-31-2006.

THE MARK CONSISTS OF STANDARD CHAR-  
ACTERS WITHOUT CLAIM TO ANY PARTICULAR  
FONT, STYLE, SIZE, OR COLOR.

SN 77-006,647, FILED 9-25-2006.

CYNTHIA SLOAN, EXAMINING ATTORNEY

**Int. Cl.: 44**

**Prior U.S. Cls.: 100 and 101**

**United States Patent and Trademark Office**

**Reg. No. 3,395,371**

**Registered Mar. 11, 2008**

**SERVICE MARK  
PRINCIPAL REGISTER**

**See Spot Play**

ADVANCED COSMETIC SURGERY & LASER  
CENTER OF HYDE PARK, INC. (OHIO COR-  
PORATION)  
ROOKWOOD TOWER, SUITE 100  
3805 EDWARDS ROAD  
CINCINNATI, OH 45209

FOR: COSMETIC AND PLASTIC SURGERY, IN  
CLASS 44 (U.S. CLS. 100 AND 101).

FIRST USE 4-30-2007; IN COMMERCE 4-30-2007.

THE MARK CONSISTS OF STANDARD CHAR-  
ACTERS WITHOUT CLAIM TO ANY PARTICULAR  
FONT, STYLE, SIZE, OR COLOR.

SN 77-006,653, FILED 9-25-2006.

CYNTHIA SLOAN, EXAMINING ATTORNEY

**Int. Cl.: 44**

**Prior U.S. Cls.: 100 and 101**

**United States Patent and Trademark Office**

**Reg. No. 3,395,372**

**Registered Mar. 11, 2008**

**SERVICE MARK  
PRINCIPAL REGISTER**

**See Spot Run**

ADVANCED COSMETIC SURGERY & LASER  
CENTER OF HYDE PARK, INC. (OHIO COR-  
PORATION)  
ROOKWOOD TOWER, SUITE 100  
3805 EDWARDS ROAD  
CINCINNATI, OH 45209

FOR: COSMETIC AND PLASTIC SURGERY, IN  
CLASS 44 (U.S. CLS. 100 AND 101).

FIRST USE 12-31-2006; IN COMMERCE 12-31-2006.

THE MARK CONSISTS OF STANDARD CHAR-  
ACTERS WITHOUT CLAIM TO ANY PARTICULAR  
FONT, STYLE, SIZE, OR COLOR.

SN 77-006,660, FILED 9-25-2006.

CYNTHIA SLOAN, EXAMINING ATTORNEY

**Int. Cl.: 21**

**Prior U.S. Cls.: 2, 13, 23, 29, 30, 33, 40, and 50**

**United States Patent and Trademark Office**

**Reg. No. 3,395,373**

**Registered Mar. 11, 2008**

**TRADEMARK  
PRINCIPAL REGISTER**

**PELICAN POOL CADDY**

L&B INNOVATIONS, LLC (FLORIDA LIMITED  
LIABILITY CORPORATION)  
5799 SE AULT AVENUE  
STUART, FL 34997

FOR: POOL EQUIPMENT ORGANIZERS, NAME-  
LY, CADDIES FOR HOLDING AND STORING  
POOL CLEANING EQUIPMENT AND POOL PLAY  
EQUIPMENT, IN CLASS 21 (U.S. CLS. 2, 13, 23, 29, 30,  
33, 40 AND 50).

FIRST USE 1-31-2006; IN COMMERCE 3-31-2006.

THE MARK CONSISTS OF STANDARD CHAR-  
ACTERS WITHOUT CLAIM TO ANY PARTICULAR  
FONT, STYLE, SIZE, OR COLOR.

NO CLAIM IS MADE TO THE EXCLUSIVE  
RIGHT TO USE "POOL CADDY", APART FROM  
THE MARK AS SHOWN.

SN 77-007,846, FILED 9-26-2006.

MICHAEL ENGEL, EXAMINING ATTORNEY

**Int. Cl.: 35**

**Prior U.S. Cls.: 100, 101, and 102**

**United States Patent and Trademark Office**

**Reg. No. 3,395,374**

**Registered Mar. 11, 2008**

**SERVICE MARK  
PRINCIPAL REGISTER**

**TRENCHMICE**

COGITO, INC. (WASHINGTON CORPORATION)  
1407 SIXTH AVENUE WEST  
SEATTLE, WA 98119

FIRST USE 12-0-2006; IN COMMERCE 12-0-2006.

FOR: PROVIDING A WEBSITE THAT FEATURES  
INFORMATION ON EMPLOYMENT, JOBS, AND  
CAREERS; AND PROVIDING WEBSITE SERVICES  
IN THE NATURE OF INTERACTIVE CAREER AND  
BUSINESS NETWORKING , IN CLASS 35 (U.S. CLS.  
100, 101 AND 102).

THE MARK CONSISTS OF STANDARD CHAR-  
ACTERS WITHOUT CLAIM TO ANY PARTICULAR  
FONT, STYLE, SIZE, OR COLOR.

SN 77-008,792, FILED 9-27-2006.

ANDREA HACK, EXAMINING ATTORNEY



**Int. Cl.: 7**

**Prior U.S. Cls.: 13, 19, 21, 23, 31, 34, and 35**

**United States Patent and Trademark Office**

**Reg. No. 3,395,375**

**Registered Mar. 11, 2008**

**TRADEMARK  
PRINCIPAL REGISTER**

# BayWash

SONNY'S ENTERPRISES, INC. (DELAWARE  
CORPORATION)  
5605 HIATUS ROAD  
TAMARAC, FL 33321

FOR: AUTOMATIC CAR WASHING MACHINES  
FOR USE BY COMMERCIAL CAR WASH SERVI-  
CES, IN CLASS 7 (U.S. CLS. 13, 19, 21, 23, 31, 34 AND  
35).

FIRST USE 1-31-2006; IN COMMERCE 1-31-2006.

THE MARK CONSISTS OF STANDARD CHAR-  
ACTERS WITHOUT CLAIM TO ANY PARTICULAR  
FONT, STYLE, SIZE, OR COLOR.

SN 77-009,350, FILED 9-28-2006.

DOMINIC J. FERRAIUOLO, EXAMINING ATTOR-  
NEY

**Int. Cl.: 16**

**Prior U.S. Cls.: 2, 5, 22, 23, 29, 37, 38, and 50**

**United States Patent and Trademark Office**

**Reg. No. 3,395,376**

**Registered Mar. 11, 2008**

**TRADEMARK  
PRINCIPAL REGISTER**

**TENNISTABS**

TENNISTABS LLC (COLORADO LTD LIAB CO)  
3141 CAPTAINS LANE  
LONGMONT, CO 80503

THE MARK CONSISTS OF STANDARD CHAR-  
ACTERS WITHOUT CLAIM TO ANY PARTICULAR  
FONT, STYLE, SIZE, OR COLOR.

FOR: TENNIS SCORING TABLETS USED TO  
TRACK SCORES IN TENNIS GAMES, IN CLASS 16  
(U.S. CLS. 2, 5, 22, 23, 29, 37, 38 AND 50).

SN 77-010,067, FILED 9-28-2006.

FIRST USE 10-5-2007; IN COMMERCE 10-5-2007.

MARK PILARO, EXAMINING ATTORNEY

**Int. Cl.: 35**

**Prior U.S. Cls.: 100, 101, and 102**

**United States Patent and Trademark Office**

**Reg. No. 3,395,377**

**Registered Mar. 11, 2008**

**SERVICE MARK  
PRINCIPAL REGISTER**

# Reef-A-Palooza

TRIMBLE, MARC (UNITED STATES INDIVIDUAL)  
1720 SANTIAGO ST.  
SANTA ANA, CA 92706

FOR: ARRANGING AND CONDUCTING TRADE SHOW EXHIBITIONS IN THE FIELD OF MARINE ANIMALS, NAMELY, CORAL AND FISH AND MARINE AQUARIUM HOBBY EQUIPMENT INCLUDING AQUARIUMS, PUMPS AND LIGHTS WHERE THEY ARE EXHIBITED, TRADED, AND SOLD, IN CLASS 35 (U.S. CLS. 100, 101 AND 102).

FIRST USE 8-21-2004; IN COMMERCE 8-21-2004.

THE MARK CONSISTS OF STANDARD CHARACTERS WITHOUT CLAIM TO ANY PARTICULAR FONT, STYLE, SIZE, OR COLOR.

SN 77-010,072, FILED 9-28-2006.

KYLE PEETE, EXAMINING ATTORNEY

**Int. Cl.: 28**

**Prior U.S. Cls.: 22, 23, 38, and 50**

**United States Patent and Trademark Office**

**Reg. No. 3,395,378**

**Registered Mar. 11, 2008**

**TRADEMARK  
PRINCIPAL REGISTER**

**AB ROCKET**

E. MISHAN & SONS, INC. (NEW YORK COR-  
PORATION)  
230 FIFTH AVENUE  
NEW YORK, NY 10001

FOR: MANUALLY-OPERATED EXERCISE  
EQUIPMENT, IN CLASS 28 (U.S. CLS. 22, 23, 38  
AND 50).

FIRST USE 1-27-2007; IN COMMERCE 1-27-2007.

THE MARK CONSISTS OF STANDARD CHAR-  
ACTERS WITHOUT CLAIM TO ANY PARTICULAR  
FONT, STYLE, SIZE, OR COLOR.

NO CLAIM IS MADE TO THE EXCLUSIVE  
RIGHT TO USE "AB", APART FROM THE MARK  
AS SHOWN.

SN 77-010,554, FILED 9-29-2006.

JILL C. ALT, EXAMINING ATTORNEY

**Int. Cl.: 25**

**Prior U.S. Cls.: 22 and 39**

**United States Patent and Trademark Office**

**Reg. No. 3,395,379**

**Registered Mar. 11, 2008**

**TRADEMARK  
PRINCIPAL REGISTER**



THUASNE (FRANCE CORPORATION)  
B. P. 243  
118-120 RU MARIUS AUFAN  
LEVALLOIS PERRET CEDEX, FRANCE 92307

FOR: UNDERWEAR, STOCKINGS, TIGHTS, SUSPENDERS, PANTS, SHORTS, BOXER SHORTS, UNDERSHIRTS, LEGGINGS, TEDDIES (UNDERGARMENTS), LEOTARDS, UNDERPANTS, G-STRINGS, BRAS, BUSTIERS, TAP PANTS, IN CLASS 25 (U.S. CLS. 22 AND 39).

FIRST USE 11-1-2006; IN COMMERCE 11-1-2006.

OWNER OF U.S. REG. NOS. 2,902,706, 3,139,247, AND OTHERS.

NO CLAIM IS MADE TO THE EXCLUSIVE RIGHT TO USE "SPORT" AND "UNDERWEAR", APART FROM THE MARK AS SHOWN.

THE COLOR(S) BLUE, RED AND WHITE IS/ARE CLAIMED AS A FEATURE OF THE MARK.

THE MARK CONSISTS OF A RECTANGLE IN THE COLOR BLUE CONTAINING THE WORDS "THUASNE" AND "UNDERWEAR" IN THE COLOR WHITE, AND ALSO CONTAINING A SMALLER RED RECTANGLE CONTAINING THE WORD "SPORT" IN THE COLOR WHITE; THE WORD "UNDERWEAR" IS CONNECTED TO THE SMALLER RED RECTANGLE WITH A VERTICAL RED LINE AND IS UNDERLINED WITH THE COLOR RED.

SN 77-011,553, FILED 10-2-2006.

FLORENTINA BLANDU, EXAMINING ATTORNEY

**Int. Cl.: 44**

**Prior U.S. Cls.: 100 and 101**

**United States Patent and Trademark Office**

**Reg. No. 3,395,380**

**Registered Mar. 11, 2008**

**SERVICE MARK  
PRINCIPAL REGISTER**

**Never See Spot Again**

ADVANCED COSMETIC SURGERY & LASER  
CENTER OF HYDE PARK, INC. (OHIO COR-  
PORATION)  
ROOKWOOD TOWER, SUITE 100  
3805 EDWARDS ROAD  
CINCINNATI, OH 45209

FOR: COSMETIC AND PLASTIC SURGERY, IN  
CLASS 44 (U.S. CLS. 100 AND 101).

FIRST USE 12-31-2006; IN COMMERCE 12-31-2006.

THE MARK CONSISTS OF STANDARD CHAR-  
ACTERS WITHOUT CLAIM TO ANY PARTICULAR  
FONT, STYLE, SIZE, OR COLOR.

SN 77-011,708, FILED 10-2-2006.

CYNTHIA SLOAN, EXAMINING ATTORNEY

**Int. Cl.: 41**

**Prior U.S. Cls.: 100, 101, and 107**

**United States Patent and Trademark Office**

**Reg. No. 3,395,381**

**Registered Mar. 11, 2008**

**SERVICE MARK  
PRINCIPAL REGISTER**



CAMPBELL, RONALD EDWIN (UNITED STATES  
INDIVIDUAL)  
975 S. RINCON RISING RD.  
TUCSON, AZ 85748

FOR: EDUCATIONAL SERVICES, NAMELY,  
CONDUCTING CLASSES, SEMINARS, AND WORK-  
SHOPS IN THE FIELD OF COMMERCIAL REAL  
ESTATE AND DISTRIBUTION OF COURSE MATE-  
RIAL IN CONNECTION THEREWITH, IN CLASS 41  
(U.S. CLS. 100, 101 AND 107).

FIRST USE 3-1-2007; IN COMMERCE 3-1-2007.

NO CLAIM IS MADE TO THE EXCLUSIVE  
RIGHT TO USE "CERTIFIED COMMERCIAL SPE-  
CIALIST", APART FROM THE MARK AS SHOWN.

SN 77-011,921, FILED 10-2-2006.

ROBERT LAVACHE, EXAMINING ATTORNEY

**Int. Cl.: 40**

**Prior U.S. Cls.: 100, 103, and 106**

**United States Patent and Trademark Office**

**Reg. No. 3,395,382**

**Registered Mar. 11, 2008**

**SERVICE MARK  
PRINCIPAL REGISTER**

**STREAMBANK**

OREGON TROUT, INC. (OREGON CORPORATION)  
65 SW YAMHILL STREET, SUITE 300  
PORTLAND, OR 97204

FOR: ENVIRONMENTAL REMEDIATION AND RESTORATION SERVICES FOR AQUATIC HABITATS, NAMELY, SOIL, STREAM STRUCTURE, HYDROLOGY, AND/OR WATER TREATMENT SERVICES AND PROVIDING INFORMATION REGARDING ENVIRONMENTAL REMEDIATION AND RESTORATION FOR AQUATIC HABITATS, NAMELY, SOIL, STREAM STRUCTURE, HYDROL-

OGY, AND/OR WATER TREATMENT, IN CLASS 40 (U.S. CLS. 100, 103 AND 106).

FIRST USE 8-15-2007; IN COMMERCE 8-15-2007.

THE MARK CONSISTS OF STANDARD CHARACTERS WITHOUT CLAIM TO ANY PARTICULAR FONT, STYLE, SIZE, OR COLOR.

SN 77-012,028, FILED 10-2-2006.

REBECCA GILBERT, EXAMINING ATTORNEY



**Int. Cl.: 35**

**Prior U.S. Cls.: 100, 101, and 102**

**United States Patent and Trademark Office**

**Reg. No. 3,395,383**

**Registered Mar. 11, 2008**

---

**SERVICE MARK  
PRINCIPAL REGISTER**

**UGEAR**

GARZA, RAYNALDO (UNITED STATES INDIVIDUAL)  
14 MONARCH BAY PLAZA, SUITE 475  
MONARCH BEACH, CA 92629

THE MARK CONSISTS OF STANDARD CHARACTERS WITHOUT CLAIM TO ANY PARTICULAR FONT, STYLE, SIZE, OR COLOR.

FOR: ADVERTISING AND COMMERCIAL INFORMATION SERVICES, VIA THE INTERNET, IN CLASS 35 (U.S. CLS. 100, 101 AND 102).

SN 77-012,151, FILED 10-3-2006.

FIRST USE 11-25-2003; IN COMMERCE 10-3-2006.

HANNO RITTNER, EXAMINING ATTORNEY

**Int. Cls.: 35 and 37**

**Prior U.S. Cls.: 100, 101, 102, 103, and 106**

**United States Patent and Trademark Office**

**Reg. No. 3,395,384**

**Registered Mar. 11, 2008**

**SERVICE MARK  
PRINCIPAL REGISTER**

# MICROBUILD

THE GADBERRY GROUP, LLC (ARKANSAS  
LTD LIAB CO)  
801 TECHNOLOGY DRIVE, SUITE D  
LITTLE ROCK, AR 72223

FOR: PROVIDING POPULATION, POPULATION  
DENSITY, AND POPULATION PROJECTION IN-  
FORMATION FOR GEOGRAPHICAL AREAS TO  
OTHERS, IN CLASS 35 (U.S. CLS. 100, 101 AND 102).

FIRST USE 5-0-2006; IN COMMERCE 5-0-2006.

FOR: REAL ESTATE SITE SELECTION AND  
IDENTIFICATION SERVICES FOR RETAIL AND

COMMERCIAL DEVELOPMENT, IN CLASS 37 (U.S.  
CLS. 100, 103 AND 106).

FIRST USE 5-0-2006; IN COMMERCE 5-0-2006.

THE MARK CONSISTS OF STANDARD CHAR-  
ACTERS WITHOUT CLAIM TO ANY PARTICULAR  
FONT, STYLE, SIZE, OR COLOR.

SN 77-012,659, FILED 10-3-2006.

SUSAN LESLIE DUBOIS, EXAMINING ATTORNEY

**Int. Cls.: 6 and 19**

**Prior U.S. Cls.: 1, 2, 12, 13, 14, 23, 25, 33, and 50**

**United States Patent and Trademark Office**

**Reg. No. 3,395,385**

**Registered Mar. 11, 2008**

**TRADEMARK  
PRINCIPAL REGISTER**

**STAYTRUE**

GATES & GARDENS, LLC (WASHINGTON LTD  
LIAB CO), DBA THE IRON GATE SHOPPE,  
SUITE D  
5402 184TH STREET EAST  
PUYALLUP, WA 98375

FOR: METAL FENCING SYSTEMS, NAME-  
LY, METAL FENCING PANELS, METAL PICKET FEN-  
CING, METAL FENCING STAYS, METAL FEN-  
CING POSTS, AND METAL FENCING RAILINGS,  
IN CLASS 6 (U.S. CLS. 2, 12, 13, 14, 23, 25 AND 50).

FIRST USE 2-14-2007; IN COMMERCE 7-3-2007.

FOR: NON-METAL FENCING SYSTEMS, NAME-  
LY, NON-METAL FENCING PANELS, NON-METAL

PICKET FENCING, NON-METAL FENCING STAYS,  
NON-METAL FENCING POSTS, AND NON-METAL  
FENCING RAILINGS, IN CLASS 19 (U.S. CLS. 1, 12,  
33 AND 50).

FIRST USE 2-14-2007; IN COMMERCE 7-3-2007.

THE MARK CONSISTS OF STANDARD CHAR-  
ACTERS WITHOUT CLAIM TO ANY PARTICULAR  
FONT, STYLE, SIZE, OR COLOR.

SN 77-012,837, FILED 10-3-2006.

TEJBIR SINGH, EXAMINING ATTORNEY

**Int. Cl.: 9**

**Prior U.S. Cls.: 21, 23, 26, 36, and 38**

**United States Patent and Trademark Office**

**Reg. No. 3,395,386**

**Registered Mar. 11, 2008**

**TRADEMARK  
PRINCIPAL REGISTER**

**Bringing Music to Life**

ART OF LIFE RECORDS (SOUTH CAROLINA  
LTD LIAB CO)  
529 COLONY DRIVE  
RIDGELAND, SC 29936

THE MARK CONSISTS OF STANDARD CHAR-  
ACTERS WITHOUT CLAIM TO ANY PARTICULAR  
FONT, STYLE, SIZE, OR COLOR.

FOR: PRE-RECORDED CD'S, VIDEO TAPES, LA-  
SER DISKS AND DVD'S FEATURING MUSICAL  
PERFORMANCES, IN CLASS 9 (U.S. CLS. 21, 23, 26,  
36 AND 38).

SN 77-013,048, FILED 10-3-2006.

FIRST USE 8-18-2007; IN COMMERCE 8-18-2007.

KEVIN CORWIN, EXAMINING ATTORNEY

**Int. Cl.: 16**

**Prior U.S. Cls.: 2, 5, 22, 23, 29, 37, 38, and 50**

**United States Patent and Trademark Office**

**Reg. No. 3,395,387**

**Registered Mar. 11, 2008**

**TRADEMARK  
PRINCIPAL REGISTER**

**RECONNECTIVE YOGA**

PEARL, ERIC (UNITED STATES INDIVIDUAL)  
P.O. BOX 3600  
HOLLYWOOD, CA 90078

FOR: PRINTED MATTER AND PAPER GOODS, NAMELY, PRINTED MATTER IN THE FORM OF ART PRINTS AND POSTERS ON THE SUBJECT OF PHYSICAL, EMOTIONAL, SPIRITUAL AND ENERGETIC HEALING; PENCILS; BINDERS; PAPER PRODUCTS, NAMELY, STATIONERY, NOTE PADS AND POSTCARDS; NOTE CARDS; POSTERS; ADDRESS BOOKS, BLANK JOURNAL BOOKS, COFFEE TABLE BOOKS ON THE SUBJECT OF PHYSICAL, EMOTIONAL, SPIRITUAL AND ENERGETIC HEALING, PENS, CRAYONS, PRINTED EDUCATIONAL CARDS FEATURING INFORMATION REGARDING PHYSICAL, EMOTIONAL, SPIRITUAL AND ENERGETIC HEALING; PRINTED NEWSLETTERS, BROCHURES, SEMINARS, PAMPHLETS, FLYERS, AND PRINTED INSTRUCTIONAL AND TEACHING MATERIALS ON THE SUBJECT OF PHYSICAL, EMOTIONAL, SPIRITUAL

AND ENERGETIC HEALING; JOURNALS, AND DIARIES ON THE SUBJECT OF PHYSICAL, EMOTIONAL, SPIRITUAL AND ENERGETIC HEALING, IN CLASS 16 (U.S. CLS. 2, 5, 22, 23, 29, 37, 38 AND 50).

FIRST USE 1-5-2007; IN COMMERCE 1-5-2007.

THE MARK CONSISTS OF STANDARD CHARACTERS WITHOUT CLAIM TO ANY PARTICULAR FONT, STYLE, SIZE, OR COLOR.

OWNER OF U.S. REG. NOS. 2,522,238, 2,967,838, AND OTHERS.

NO CLAIM IS MADE TO THE EXCLUSIVE RIGHT TO USE "YOGA", APART FROM THE MARK AS SHOWN.

SN 77-013,053, FILED 10-3-2006.

LEE-ANNE BERNS, EXAMINING ATTORNEY

**Int. Cl.: 38**

**Prior U.S. Cls.: 100, 101, and 104**

**United States Patent and Trademark Office**

**Reg. No. 3,395,388**

**Registered Mar. 11, 2008**

**SERVICE MARK  
PRINCIPAL REGISTER**

**PHOTOWORKS EMAIL-A-BOOK**

PHOTOWORKS, INC. (WASHINGTON CORPORATION)  
1260 16TH AVENUE WEST  
SEATTLE, WA 98119

FOR: TRANSMISSION OF DIGITAL IMAGES OVER THE INTERNET, NAMELY, TRANSMISSION OF BOOK PROOFS DESIGNED BY OTHERS FEATURING DIGITAL PHOTOGRAPHS, BOOK COVERS, INTERIOR PAGE DESIGN LAYOUTS AND TEXT, IN CLASS 38 (U.S. CLS. 100, 101 AND 104).

FIRST USE 10-25-2006; IN COMMERCE 10-25-2006.

THE MARK CONSISTS OF STANDARD CHARACTERS WITHOUT CLAIM TO ANY PARTICULAR FONT, STYLE, SIZE, OR COLOR.

OWNER OF U.S. REG. NOS. 2,018,625, 2,764,674, AND OTHERS.

NO CLAIM IS MADE TO THE EXCLUSIVE RIGHT TO USE "EMAIL-A-BOOK", APART FROM THE MARK AS SHOWN.

SN 77-013,387, FILED 10-4-2006.

KEVIN DINALLO, EXAMINING ATTORNEY

**Int. Cl.: 3**

**Prior U.S. Cls.: 1, 4, 6, 50, 51, and 52**

**United States Patent and Trademark Office**

**Reg. No. 3,395,389**

**Registered Mar. 11, 2008**

**TRADEMARK  
PRINCIPAL REGISTER**

**FOR EYES**

FOR EYES OPTICAL COMPANY (PENNSYLVANIA CORPORATION)  
285 WEST 74TH PLACE  
HIALEAH, FL 33014

FOR: CARE PRODUCTS FOR OPTICAL DEVICES, NAMELY, SPRAY LENS CLEANER FOR OPTICAL LENSES AND EYEWEAR; DISPOSABLE WIPES IMPREGNATED WITH CHEMICALS OR COMPOUNDS FOR USE IN CLEANING OPTICAL LENSES AND EYEWEAR, IN CLASS 3 (U.S. CLS. 1, 4, 6, 50, 51 AND 52).

FIRST USE 5-1-2005; IN COMMERCE 5-1-2005.

THE MARK CONSISTS OF STANDARD CHARACTERS WITHOUT CLAIM TO ANY PARTICULAR FONT, STYLE, SIZE, OR COLOR.

OWNER OF U.S. REG. NOS. 1,132,442, 2,670,823, AND OTHERS.

SN 77-013,522, FILED 10-4-2006.

JOHN DALIER, EXAMINING ATTORNEY

**Int. Cl.: 16**

**Prior U.S. Cls.: 2, 5, 22, 23, 29, 37, 38, and 50**

**United States Patent and Trademark Office**

**Reg. No. 3,395,390**

**Registered Mar. 11, 2008**

---

**TRADEMARK  
PRINCIPAL REGISTER**

**CHEF DAD**

CHEF DAD, LLC (ARIZONA LTD LIAB CO)  
9825 E. BLUE SKY DRIVE  
SCOTTSDALE, AZ 85262

FOR: COOKBOOKS, IN CLASS 16 (U.S. CLS. 2, 5,  
22, 23, 29, 37, 38 AND 50).

FIRST USE 9-0-2004; IN COMMERCE 10-0-2004.

THE MARK CONSISTS OF STANDARD CHAR-  
ACTERS WITHOUT CLAIM TO ANY PARTICULAR  
FONT, STYLE, SIZE, OR COLOR.

OWNER OF U.S. REG. NO. 2,883,185.

SN 77-014,436, FILED 10-5-2006.

ROBIN CHOSID, EXAMINING ATTORNEY



**Int. Cl.: 28**

**Prior U.S. Cls.: 22, 23, 38, and 50**

**United States Patent and Trademark Office**

**Reg. No. 3,395,391**

**Registered Mar. 11, 2008**

**TRADEMARK  
PRINCIPAL REGISTER**

# Escape Extinction

BACHMANN, SARAH (UNITED KINGDOM IN-  
DIVIDUAL)  
APT 37, MARINA COURT  
GLATEGNY ESPLANADE  
ST PETER PORT, GUERNSEY GY1 1WP

THE MARK CONSISTS OF STANDARD CHAR-  
ACTERS WITHOUT CLAIM TO ANY PARTICULAR  
FONT, STYLE, SIZE, OR COLOR.

FOR: BOARD GAMES, IN CLASS 28 (U.S. CLS. 22,  
23, 38 AND 50).

SN 77-014,493, FILED 10-5-2006.

FIRST USE 12-31-2007; IN COMMERCE 12-31-2007.

KEVIN DINALLO, EXAMINING ATTORNEY

**Int. Cl.: 25**

**Prior U.S. Cls.: 22 and 39**

**United States Patent and Trademark Office**

**Reg. No. 3,395,392**

**Registered Mar. 11, 2008**

**TRADEMARK  
PRINCIPAL REGISTER**

# Orphan Lyrics

ORPHAN LYRICS (ARIZONA LTD LIAB CO)  
SUITE E  
7120 E INDIAN SCHOOL RD  
SCOTTSDALE, AZ 85251

THE MARK CONSISTS OF STANDARD CHAR-  
ACTERS WITHOUT CLAIM TO ANY PARTICULAR  
FONT, STYLE, SIZE, OR COLOR.

FOR: SWEAT SHIRTS; T-SHIRTS, IN CLASS 25  
(U.S. CLS. 22 AND 39).

SN 77-015,670, FILED 10-6-2006.

FIRST USE 8-1-2006; IN COMMERCE 8-29-2007.

KELLY BOULTON, EXAMINING ATTORNEY

**Int. Cl.: 30**

**Prior U.S. Cl.: 46**

**United States Patent and Trademark Office**

**Reg. No. 3,395,393**

**Registered Mar. 11, 2008**

**TRADEMARK  
PRINCIPAL REGISTER**

**FRESCHETTA PIZZAMORÉ**

SCHWAN'S IP, LLC (MINNESOTA LTD LIAB CO)  
115 W. COLLEGE DRIVE  
MARSHALL, MN 56258

OWNER OF U.S. REG. NOS. 2,114,646, 3,006,663,  
AND OTHERS.

FOR: FROZEN PIZZA, IN CLASS 30 (U.S. CL. 46).

SN 77-015,915, FILED 10-6-2006.

FIRST USE 8-13-2007; IN COMMERCE 8-13-2007.

THE MARK CONSISTS OF STANDARD CHAR-  
ACTERS WITHOUT CLAIM TO ANY PARTICULAR  
FONT, STYLE, SIZE, OR COLOR.

ANDREA K. NADELMAN, EXAMINING ATTOR-  
NEY

**Int. Cl.: 25**

**Prior U.S. Cls.: 22 and 39**

**United States Patent and Trademark Office**

**Reg. No. 3,395,394**

**Registered Mar. 11, 2008**

**TRADEMARK  
PRINCIPAL REGISTER**

**RYDIN DIRTY**

GARBER, ERIC (UNITED STATES INDIVIDUAL)  
3768 MAPLEWOOD AVENUE  
LOS ANGELES, CA 90066

WATERPROOF JACKETS AND PANTS; WIND RESISTANT JACKETS; WOMEN'S UNDERWEAR, IN CLASS 25 (U.S. CLS. 22 AND 39).

FOR: BOXER BRIEFS; BOXER SHORTS; BRIEFS; HEADGEAR, NAMELY, BASEBALL CAPS, BEANIES, HATS; JACKETS; JOGGING PANTS; LADIES' UNDERWEAR; PANTIES; PANTIES, SHORTS AND BRIEFS; PANTS; RAIN JACKETS; SHIRTS; SHORT-SLEEVED OR LONG-SLEEVED T-SHIRTS; SHORT-SLEEVED SHIRTS; SLEEVED OR SLEEVELESS JACKETS; SLEEVELESS JERSEYS; SWEAT PANTS; SWEAT SHIRTS; T-SHIRTS; TANK TOPS; TANK-TOPS; THONGS; TRACK PANTS; UNDERWEAR;

FIRST USE 8-21-2007; IN COMMERCE 8-21-2007.

THE MARK CONSISTS OF STANDARD CHARACTERS WITHOUT CLAIM TO ANY PARTICULAR FONT, STYLE, SIZE, OR COLOR.

SN 77-016,469, FILED 10-8-2006.

LINDA POWELL, EXAMINING ATTORNEY

**Int. Cl.: 3**

**Prior U.S. Cls.: 1, 4, 6, 50, 51, and 52**

**United States Patent and Trademark Office**

**Reg. No. 3,395,395**

**Registered Mar. 11, 2008**

**TRADEMARK  
PRINCIPAL REGISTER**

**JILLIAN DEMPSEY**

DEMPSEY, JILLIAN (UNITED STATES INDIVIDUAL)  
661 NORTH HARPER AVENUE SUITE 201  
LOS ANGELES, CA 90048

THE MARK CONSISTS OF STANDARD CHARACTERS WITHOUT CLAIM TO ANY PARTICULAR FONT, STYLE, SIZE, OR COLOR.

FOR: COSMETICS, IN CLASS 3 (U.S. CLS. 1, 4, 6, 50, 51 AND 52).

SN 77-018,405, FILED 10-11-2006.

FIRST USE 2-22-2007; IN COMMERCE 2-22-2007.

KEVON CHISOLM, EXAMINING ATTORNEY

**Int. Cl.: 33**

**Prior U.S. Cls.: 47 and 49**

**United States Patent and Trademark Office**

**Reg. No. 3,395,396**

**Registered Mar. 11, 2008**

**TRADEMARK  
PRINCIPAL REGISTER**

# Under The Radar

BABCOCK ENTERPRISES, INC. (CALIFORNIA  
CORPORATION)  
P.O. BOX 637  
LOMPOC, CA 93438

THE MARK CONSISTS OF STANDARD CHAR-  
ACTERS WITHOUT CLAIM TO ANY PARTICULAR  
FONT, STYLE, SIZE, OR COLOR.

FOR: WINE, IN CLASS 33 (U.S. CLS. 47 AND 49).

SN 77-018,712, FILED 10-11-2006.

FIRST USE 5-1-2007; IN COMMERCE 5-1-2007.

MATTHEW EINSTEIN, EXAMINING ATTORNEY

**Int. Cl.: 9**

**Prior U.S. Cls.: 21, 23, 26, 36, and 38**

**United States Patent and Trademark Office**

**Reg. No. 3,395,397**

**Registered Mar. 11, 2008**

**TRADEMARK  
PRINCIPAL REGISTER**

**DRIFT**

HELIO LLC (DELAWARE LTD LIAB CO)  
SUITE 600  
10960 WILSHIRE BOULEVARD  
LOS ANGELES, CA 90024

FIRST USE 11-8-2006; IN COMMERCE 11-8-2006.

FOR: WIRELESS COMMUNICATION DEVICES, NAMELY, MOBILE HANDSETS IN THE NATURE OF A COMBINATION PERSONAL DIGITAL ASSISTANT, TELEPHONE, CAMERA, GLOBAL POSITIONING AND MAPPING DEVICE, TELEVISION, RADIO, VIDEO AND AUDIO PLAYER AND RECORDER, IN CLASS 9 (U.S. CLS. 21, 23, 26, 36 AND 38).

THE MARK CONSISTS OF STANDARD CHARACTERS WITHOUT CLAIM TO ANY PARTICULAR FONT, STYLE, SIZE, OR COLOR.

SN 77-019,658, FILED 10-12-2006.

VIVIAN MICZNIK FIRST, EXAMINING ATTORNEY

**Int. Cl.: 40**

**Prior U.S. Cls.: 100, 103, and 106**

**United States Patent and Trademark Office**

**Reg. No. 3,395,398**

**Registered Mar. 11, 2008**

---

**SERVICE MARK  
PRINCIPAL REGISTER**

**IF YOU CAN DREAM IT, WE  
CAN SCREEN IT**

MAALOUF, TAREK I. (UNITED STATES INDIVIDUAL)  
P.O. BOX 6885  
HUNTSVILLE, TX 77342

THE MARK CONSISTS OF STANDARD CHARACTERS WITHOUT CLAIM TO ANY PARTICULAR FONT, STYLE, SIZE, OR COLOR.

FOR: CUSTOM SCREEN PRINTING AND EMBROIDERY SERVICES, IN CLASS 40 (U.S. CLS. 100, 103 AND 106).

SN 77-020,149, FILED 10-12-2006.

FIRST USE 7-1-2006; IN COMMERCE 7-1-2006.

KAREN SEVERSON, EXAMINING ATTORNEY



Int. Cl.: 35

Prior U.S. Cls.: 100, 101, and 102

United States Patent and Trademark Office

Reg. No. 3,395,399

Registered Mar. 11, 2008

SERVICE MARK  
PRINCIPAL REGISTER



ALVEY, CRAIG (UNITED STATES INDIVIDUAL)  
69 WINSLOW CEMETERY RD.  
MARSHFIELD, MA 020505508

FOR: ON-LINE ADVERTISING AND MARKET-  
ING SERVICES, IN CLASS 35 (U.S. CLS. 100, 101 AND  
102).

FIRST USE 5-18-2007; IN COMMERCE 5-18-2007.

NO CLAIM IS MADE TO THE EXCLUSIVE  
RIGHT TO USE "CHEAP ADS", APART FROM  
THE MARK AS SHOWN.

THE COLOR(S) RED, BLACK AND WHITE IS/  
ARE CLAIMED AS A FEATURE OF THE MARK.

THE MARK CONSISTS OF THE WORDS  
"WICKED CHEAP ADS" IN BLACK LETTERS ON

A WHITE BACKGROUND ALMOST COMPLETELY  
SURROUNDED BY A RED CIRCLE. THE "C" IN  
"CHEAP" AND THE "A" IN "ADS" ARE BOTH  
CAPITALIZED AND BOTH HAVE A SMALL TEAR  
ON THE UPPER LEFT SIDE. THE RED CIRCLE HAS  
A 3 DIMENSIONAL LOOK CREATED BY ARTISTI-  
CALLY USING SOME BLACK TO OUTLINE THE  
CIRCLE. THE RED CIRCLE BEGINS ABOVE THE  
"I" AND CONTINUES AROUND THE WORDS IN A  
CLOCKWISE DIRECTION. THERE IS A DISTIN-  
GUISHING SWOOSH ABOVE THE "I" AND  
SWOOSH LIKE FLAMES ABOVE THE "K", "E"  
AND "D" IN "WICKED". THE AFOREMENTIONED  
SWOOSHES ARE IN BLACK.

SN 77-020,901, FILED 10-13-2006.

HEATHER THOMPSON, EXAMINING ATTORNEY

**Int. Cl.: 30**

**Prior U.S. Cl.: 46**

**United States Patent and Trademark Office**

**Reg. No. 3,395,400**

**Registered Mar. 11, 2008**

**TRADEMARK  
PRINCIPAL REGISTER**



KELLOGG NORTH AMERICA COMPANY (DE-  
LAWARE CORPORATION)  
ONE KELLOGG SQUARE  
BATTLE CREEK, MI 49016

FOR: GRANOLA-BASED SNACK BARS, IN  
CLASS 30 (U.S. CL. 46).

FIRST USE 6-30-2006; IN COMMERCE 6-30-2006.

OWNER OF U.S. REG. NO. 1,468,538.

NO CLAIM IS MADE TO THE EXCLUSIVE  
RIGHT TO USE "CRUNCHY NUT", APART FROM  
THE MARK AS SHOWN.

THE MARK CONSISTS OF THE STYLIZED  
WORDS "CRUNCHY NUT" WITH THE LETTER  
"C" ON THE WORD "CRUNCHY" SHOWING THE  
FOLLOWING LETTER "R" BEING CRUNCHED.

SN 77-021,313, FILED 10-14-2006.

BARBARA GAYNOR, EXAMINING ATTORNEY

**Int. Cl.: 31**

**Prior U.S. Cls.: 1 and 46**

**United States Patent and Trademark Office**

**Reg. No. 3,395,401**

**Registered Mar. 11, 2008**

**TRADEMARK  
PRINCIPAL REGISTER**

**HEARTS**

E.G. HILL COMPANY, INC. (INDIANA COR-  
PORATION)  
446 NW 18TH STREET  
RICHMOND, IN 47374

THE MARK CONSISTS OF STANDARD CHAR-  
ACTERS WITHOUT CLAIM TO ANY PARTICULAR  
FONT, STYLE, SIZE, OR COLOR.

FOR: ROSES; CUT ROSES; CUT FLOWER ROSES;  
ROSES FOR THE CUT FLOWER TRADE; AND LIVE  
FLOWERING PLANTS, IN CLASS 31 (U.S. CLS. 1  
AND 46).

SN 77-021,874, FILED 10-16-2006.

FIRST USE 2-5-2007; IN COMMERCE 2-5-2007.

MATTHEW PAPPAS, EXAMINING ATTORNEY

**Int. Cl.: 36**

**Prior U.S. Cls.: 100, 101, and 102**

**United States Patent and Trademark Office**

**Reg. No. 3,395,402**

**Registered Mar. 11, 2008**

**SERVICE MARK  
PRINCIPAL REGISTER**



MADISON NATIONAL BANK (UNITED STATES  
A FEDERALLY CHARTERED COMMERCIAL  
BANK)

888 VETERANS MEMORIAL HIGHWAY  
HAUPPAUGE, NY 11788

FOR: BANKING; CHECKING ACCOUNT SERVI-  
CES; COMMERCIAL LENDING SERVICES; CON-  
SUMER LENDING SERVICES; MORTGAGE  
LENDING; SAVINGS ACCOUNT SERVICES; SAV-  
INGS BANK SERVICES, IN CLASS 36 (U.S. CLS. 100,  
101 AND 102).

FIRST USE 2-26-2007; IN COMMERCE 2-26-2007.

THE MARK CONSISTS OF A SCRIPTED LETTER  
"M" WITHIN AN INCOMPLETE OVAL SLANTED  
TOWARDS THE RIGHT.

SN 77-021,902, FILED 10-16-2006.

KEVON CHISOLM, EXAMINING ATTORNEY

**Int. Cl.: 35**

**Prior U.S. Cls.: 100, 101, and 102**

**United States Patent and Trademark Office**

**Reg. No. 3,395,403**

**Registered Mar. 11, 2008**

**SERVICE MARK  
PRINCIPAL REGISTER**

PROVIDING THE TALENT THAT  
DRIVES YOUR BUSINESS  
SUCCESS

FMR LLC (DELAWARE LTD LIAB CO)  
82 DEVONSHIRE STREET  
BOSTON, MA 02109

FIRST USE 1-31-2007; IN COMMERCE 1-31-2007.

FOR: TEMPORARY EMPLOYEE PLACEMENT  
AND RECRUITING SERVICES; PERSONNEL RE-  
CRUITING AND EXECUTIVE SEARCH SERVICES;  
CONSULTING IN THE FIELD OF HUMAN RE-  
SOURCES; BUSINESS ADVICE AND INFORMA-  
TION IN THE FIELD OF HUMAN RESOURCES, IN  
CLASS 35 (U.S. CLS. 100, 101 AND 102).

THE MARK CONSISTS OF STANDARD CHAR-  
ACTERS WITHOUT CLAIM TO ANY PARTICULAR  
FONT, STYLE, SIZE, OR COLOR.

SN 77-022,146, FILED 10-16-2006.

CARYN GLASSER, EXAMINING ATTORNEY

**Int. Cl.: 3**

**Prior U.S. Cls.: 1, 4, 6, 50, 51, and 52**

**United States Patent and Trademark Office**

**Reg. No. 3,395,404**

**Registered Mar. 11, 2008**

**TRADEMARK  
PRINCIPAL REGISTER**

**SO CAL GLOW**

URBAN DECAY COSMETICS, LLC (DELAWARE  
LTD LIAB CO)  
7TH FLOOR  
6100 HOLLYWOOD BLVD.  
HOLLYWOOD, FL 33024

FOR: COSMETICS, NAMELY, SKIN BRONZING  
POWDER, IN CLASS 3 (U.S. CLS. 1, 4, 6, 50, 51 AND  
52).

FIRST USE 1-12-2007; IN COMMERCE 1-12-2007.

THE MARK CONSISTS OF STANDARD CHAR-  
ACTERS WITHOUT CLAIM TO ANY PARTICULAR  
FONT, STYLE, SIZE, OR COLOR.

NO CLAIM IS MADE TO THE EXCLUSIVE  
RIGHT TO USE "SO CAL", APART FROM THE  
MARK AS SHOWN.

SN 77-022,258, FILED 10-16-2006.

GIANCARLO CASTRO, EXAMINING ATTORNEY

**Int. Cl.: 44**

**Prior U.S. Cls.: 100 and 101**

**United States Patent and Trademark Office**

**Reg. No. 3,395,405**

**Registered Mar. 11, 2008**

**SERVICE MARK  
PRINCIPAL REGISTER**

**MAINTENANCE MOISTURE BOUND  
TREATMENTS**

AMOREPACIFIC CORPORATION (REPUBLIC OF KOREA CORPORATION)  
181, 2-KA, HANGANG-RO, YONGSAN-KU  
SEOUL, REPUBLIC OF KOREA 140-777

FOR: MASSAGE; CONSULTATION SERVICES IN THE FIELD OF COSMETICS, MASSAGE, BEAUTY CARE, MAKE-UP, BODY SLIMMING, FACIAL CARE, SKIN CARE, HAIR CARE, SCALP CARE, AND FOOT CARE; BEAUTY SALONS; NAIL CARE SERVICES, NAMELY, NAIL MANICURE, NAIL MASSAGE, NAIL BUFFING, NAIL POLISH AND NAIL MAINTENANCE; HEALTH SPA SERVICES FOR HEALTH AND WELLNESS OF THE BODY AND SPIRIT OFFERED AT A HEALTH RESORT; HEALTH SPA SERVICES, NAMELY, COSMETIC BODY CARE SERVICES; PROVIDING INFORMATION ABOUT COSMETICS, MASSAGE, BEAUTY CARE, MAKE-UP, BODY SLIMMING, FACIAL CARE, SKIN CARE, HAIR CARE, SCALP CARE, AND FOOT CARE; AROMATHERAPY SERVICES; SPA SERVICES FOR BEAUTY AND HEALTH CARE FOR HUMANS, NAMELY, AROMATHERAPY, BALNEOTHERAPY AND THALASSOTHERAPY SERVICES; SLIMMING AND WEIGHT REDUC-

TION TREATMENT, NAMELY, WEIGHT REDUCTION DIET PLANNING AND SUPERVISION; COSMETIC ADVICE, NAMELY OFFERING ADVICE REGARDING THE METHODS OF MAKEUP; ARTIFICIAL SUN TANNING SERVICES; MAKE-UP ANALYSIS; OPERATION OF SAUNA FACILITIES; HEALTH CARE, IN CLASS 44 (U.S. CLS. 100 AND 101).

FIRST USE 9-0-2003; IN COMMERCE 9-0-2003.

THE MARK CONSISTS OF STANDARD CHARACTERS WITHOUT CLAIM TO ANY PARTICULAR FONT, STYLE, SIZE, OR COLOR.

NO CLAIM IS MADE TO THE EXCLUSIVE RIGHT TO USE "MAINTENANCE MOISTURE" AND "TREATMENTS", APART FROM THE MARK AS SHOWN.

SN 77-022,831, FILED 10-17-2006.

SHAILA SETTLES, EXAMINING ATTORNEY

**Int. Cl.: 1**

**Prior U.S. Cls.: 1, 5, 6, 10, 26, and 46**

**United States Patent and Trademark Office**

**Reg. No. 3,395,406**

**Registered Mar. 11, 2008**

**TRADEMARK  
PRINCIPAL REGISTER**

**FLOWPLUS**

CHAMPION TECHNOLOGIES, INC. (TEXAS  
CORPORATION)  
3200 S.W. FREEWAY SUITE 2700  
HOUSTON, TX 77027

THE MARK CONSISTS OF STANDARD CHAR-  
ACTERS WITHOUT CLAIM TO ANY PARTICULAR  
FONT, STYLE, SIZE, OR COLOR.

FOR: CHEMICALS FOR INDUSTRIAL USE,  
NAMELY, DRAG REDUCERS FOR AQUEOUS  
AND HYDROCARBON FLOW SYSTEMS, IN CLASS  
1 (U.S. CLS. 1, 5, 6, 10, 26 AND 46).

SN 77-022,859, FILED 10-17-2006.

FIRST USE 7-28-2003; IN COMMERCE 7-28-2003.

GIANCARLO CASTRO, EXAMINING ATTORNEY



**Int. Cls.: 9, 16, and 41**

**Prior U.S. Cls.: 2, 5, 21, 22, 23, 26, 29, 36, 37, 38, 50,  
100, 101, and 107**

**Reg. No. 3,395,407**

**United States Patent and Trademark Office**

**Registered Mar. 11, 2008**

**TRADEMARK  
SERVICE MARK  
PRINCIPAL REGISTER**

**NARDINE PRODUCTIONS**

CAMPUS CRUSADE FOR CHRIST, INC. (CALI-  
FORNIA CORPORATION)  
ATTN: GENERAL COUNSEL'S OFFICE  
100 LAKE HART DRIVE 3500  
ORLANDO, FL 328320100

FOR: PRE-RECORDED CDS, VCD'S , DVDS,  
VIDEOTAPES, AUDIO TAPES, DISCS, AND MUSI-  
CAL AND VIDEO SOUND RECORDINGS FEATUR-  
ING AND DEALING WITH RELIGION, SPIRITUAL,  
CULTURAL AND RELIGIOUS ISSUES AND VA-  
LUES, IN CLASS 9 (U.S. CLS. 21, 23, 26, 36 AND 38).

FIRST USE 3-8-2007; IN COMMERCE 3-8-2007.

FOR: BOOKS, PAMPHLETS, BOOKLETS, BRO-  
CHURES, LEAFLETS, NEWSLETTERS, AND PRIN-  
TED TEACHING MATERIALS DEALING WITH  
AND IN THE FIELDS OF RELIGION, SPIRITUAL,  
CULTURAL, AND RELIGIOUS ISSUES AND VA-  
LUES, IN CLASS 16 (U.S. CLS. 2, 5, 22, 23, 29, 37, 38  
AND 50).

FIRST USE 3-8-2007; IN COMMERCE 3-8-2007.

FOR: ENTERTAINMENT SERVICES, NAMELY,  
AUDIO RECORDING AND PRODUCTION, PRO-  
DUCTION OF MOTION PICTURE FILMS, DISCS  
AND TAPES; AND DISTRIBUTION OF MOTION  
PICTURES RELATING TO RELIGION, SPIRITUAL,  
CULTURAL AND RELIGIOUS ISSUES AND VA-  
LUES, IN CLASS 41 (U.S. CLS. 100, 101 AND 107).

FIRST USE 3-8-2007; IN COMMERCE 3-8-2007.

THE MARK CONSISTS OF STANDARD CHAR-  
ACTERS WITHOUT CLAIM TO ANY PARTICULAR  
FONT, STYLE, SIZE, OR COLOR.

NO CLAIM IS MADE TO THE EXCLUSIVE  
RIGHT TO USE "PRODUCTIONS", APART FROM  
THE MARK AS SHOWN.

SN 77-023,980, FILED 10-18-2006.

SAMUEL E. SHARPER JR., EXAMINING ATTOR-  
NEY

**Int. Cl.: 9**

**Prior U.S. Cls.: 21, 23, 26, 36, and 38**

**United States Patent and Trademark Office**

**Reg. No. 3,395,408**

**Registered Mar. 11, 2008**

**TRADEMARK  
PRINCIPAL REGISTER**

**PRESCRIPTOR OPTICAL YIELD  
OPTIMIZER**

SHAMIR INSIGHT, INC. (CALIFORNIA CORPORATION)  
9938 VIA PASAR  
SAN DIEGO, CA 92126

FOR: SOFTWARE FOR THE PRODUCTION OF EYEGLASS LENSES, IN CLASS 9 (U.S. CLS. 21, 23, 26, 36 AND 38).

FIRST USE 9-16-2003; IN COMMERCE 9-16-2003.

THE MARK CONSISTS OF STANDARD CHARACTERS WITHOUT CLAIM TO ANY PARTICULAR FONT, STYLE, SIZE, OR COLOR.

NO CLAIM IS MADE TO THE EXCLUSIVE RIGHT TO USE "OPTICAL YIELD OPTIMIZER", APART FROM THE MARK AS SHOWN.

SN 77-024,444, FILED 10-18-2006.

CHERYL CLAYTON, EXAMINING ATTORNEY

**Int. Cl.: 5**

**Prior U.S. Cls.: 6, 18, 44, 46, 51, and 52**

**United States Patent and Trademark Office**

**Reg. No. 3,395,409**

**Registered Mar. 11, 2008**

**TRADEMARK  
PRINCIPAL REGISTER**

**HYDROXYTHIN**

TSN LABS, INC. (UTAH CORPORATION)  
330 WEST 6100 SOUTH  
MURRAY, UT 84107

THE MARK CONSISTS OF STANDARD CHAR-  
ACTERS WITHOUT CLAIM TO ANY PARTICULAR  
FONT, STYLE, SIZE, OR COLOR.

FOR: DIETARY SUPPLEMENTS, IN CLASS 5 (U.S.  
CLS. 6, 18, 44, 46, 51 AND 52).

SN 77-024,678, FILED 10-19-2006.

FIRST USE 11-1-2007; IN COMMERCE 11-1-2007.

TINA L. SNAPP, EXAMINING ATTORNEY

**Int. Cl.: 10**

**Prior U.S. Cls.: 26, 39, and 44**

**United States Patent and Trademark Office**

**Reg. No. 3,395,410**

**Registered Mar. 11, 2008**

**TRADEMARK  
PRINCIPAL REGISTER**



BECTON, DICKINSON AND COMPANY (NEW  
JERSEY CORPORATION)  
1 BECTON DRIVE, MC 090  
FRANKLIN LAKES, NJ 07417

THE MARK CONSISTS OF BLACK AND WHITE  
LETTERS IN A BOX, WITH A RED LETTER "O"  
AND AN ASTERISK AFTER THE LAST WORD.

FOR: MEDICAL DEVICES, NAMELY, NEEDLES  
AND SYRINGES, IN CLASS 10 (U.S. CLS. 26, 39 AND  
44).

SN 77-025,068, FILED 10-19-2006.

FIRST USE 8-23-2007; IN COMMERCE 8-23-2007.

THE COLOR(S) BLACK, WHITE AND RED IS/  
ARE CLAIMED AS A FEATURE OF THE MARK.

IRA J. GOODSaid, EXAMINING ATTORNEY

**Int. Cl.: 42**

**Prior U.S. Cls.: 100 and 101**

**United States Patent and Trademark Office**

**Reg. No. 3,395,411**

**Registered Mar. 11, 2008**

**SERVICE MARK  
PRINCIPAL REGISTER**

**MYPLAN SNAPSHOT**

FMR LLC (DELAWARE LTD LIAB CO)  
82 DEVONSHIRE STREET  
BOSTON, MA 02109

FOR: PROVIDING TEMPORARY USE OF ON-  
LINE NON-DOWNLOADABLE SOFTWARE FOR  
OBTAINING FINANCIAL INFORMATION AND  
ANALYSIS IN THE FIELD OF INVESTMENTS  
AND RETIREMENT PLANNING , IN CLASS 42  
(U.S. CLS. 100 AND 101).

FIRST USE 10-24-2006; IN COMMERCE 10-24-2006.

THE MARK CONSISTS OF STANDARD CHAR-  
ACTERS WITHOUT CLAIM TO ANY PARTICULAR  
FONT, STYLE, SIZE, OR COLOR.

SN 77-025,531, FILED 10-20-2006.

CARYN GLASSER, EXAMINING ATTORNEY

**Int. Cl.: 35**

**Prior U.S. Cls.: 100, 101, and 102**

**United States Patent and Trademark Office**

**Reg. No. 3,395,412**

**Registered Mar. 11, 2008**

**SERVICE MARK  
PRINCIPAL REGISTER**

**FIRST COMMAND FINANCIAL  
SERVICES**

FIRST COMMAND FINANCIAL SERVICES, INC.  
(TEXAS CORPORATION)

1 FIRSTCOMM PLAZA

FORT WORTH, TX 76109

FOR: TAX PREPARATION, IN CLASS 35 (U.S.  
CLS. 100, 101 AND 102).

FIRST USE 2-5-2007; IN COMMERCE 2-5-2007.

THE MARK CONSISTS OF STANDARD CHAR-  
ACTERS WITHOUT CLAIM TO ANY PARTICULAR  
FONT, STYLE, SIZE, OR COLOR.

NO CLAIM IS MADE TO THE EXCLUSIVE  
RIGHT TO USE "FINANCIAL SERVICES", APART  
FROM THE MARK AS SHOWN.

SN 77-027,732, FILED 10-24-2006.

JESSICA A. POWERS, EXAMINING ATTORNEY

**Int. Cl.: 29**

**Prior U.S. Cl.: 46**

**United States Patent and Trademark Office**

**Reg. No. 3,395,413**

**Registered Mar. 11, 2008**

**TRADEMARK  
PRINCIPAL REGISTER**



HARBOR SEAFOOD, INC. (NEW YORK CORPORATION)  
969 LAKEVILLE ROAD  
NEW HYDE PARK, NY 11040

FOR: FROZEN SEAFOOD, IN CLASS 29 (U.S. CL. 46).

FIRST USE 8-31-2006; IN COMMERCE 8-31-2006.

NO CLAIM IS MADE TO THE EXCLUSIVE RIGHT TO USE "SEAFOOD SINGLES" AND "SINCE 1975", APART FROM THE MARK AS SHOWN.

THE COLOR(S) LIGHT BLUE AND BLUE IS/ARE CLAIMED AS A FEATURE OF THE MARK.

THE MARK CONSISTS OF "HSF SINCE 1975" IN LIGHT BLUE AND "SEAFOOD SINGLES" IN BLUE WITH A WAVY LIGHT BLUE LINE BENEATH THE WORDING.

SN 77-028,824, FILED 10-25-2006.

HEATHER THOMPSON, EXAMINING ATTORNEY

**Int. Cl.: 25**

**Prior U.S. Cls.: 22 and 39**

**United States Patent and Trademark Office**

**Reg. No. 3,395,414**

**Registered Mar. 11, 2008**

**TRADEMARK  
PRINCIPAL REGISTER**



SWAGGER CO., LTD. (JAPAN CORPORATION)  
636 BROADWAY  
SUITE 714  
NEW YORK, NY 10012

FOR: BATHING SUITS; BEACH SHOES; BRIEFS;  
CANVAS SHOES; CARGO PANTS; DENIM JACK-  
ETS; DENIMS; DOWN JACKETS; FUR HATS; HATS;  
HEAVY JACKETS; JACKETS; KNIT SHIRTS; LEA-  
THER JACKETS; COATS; TROUSERS; VESTS;  
MEN'S SOCKS; PANTS; POLO SHIRTS; RAIN JACK-  
ETS; SHORT-SLEEVED OR LONG-SLEEVED T-  
SHIRTS; SLEEVED OR SLEEVELESS JACKETS;  
SNEAKERS; SOCKS; SPORTS JACKETS; SPORTS  
SHIRTS; SUEDE JACKETS; SWEAT PANTS; SWEAT

SHIRTS; T-SHIRTS; THERMAL UNDERWEAR; WA-  
TERPROOF JACKETS AND PANTS; WIND RESIS-  
TANT JACKETS; WOOLLY HATS, IN CLASS 25 (U.S.  
CLS. 22 AND 39).

FIRST USE 5-22-2005; IN COMMERCE 5-22-2005.

THE MARK CONSISTS OF A STYLIZED DOLLAR  
SIGN USING A STYLIZED LETTER "S" AND A  
STYLIZED LETTER "W".

SN 77-028,870, FILED 10-25-2006.

DOMINIC FATHY, EXAMINING ATTORNEY



**Int. Cl.: 3**

**Prior U.S. Cls.: 1, 4, 6, 50, 51, and 52**

**United States Patent and Trademark Office**

**Reg. No. 3,395,415**

**Registered Mar. 11, 2008**

**TRADEMARK  
PRINCIPAL REGISTER**

**CLEAN AT LAST**

HIP INNOVATIONS, LLC (VERMONT LTD LIAB  
CO)  
350 PIONEER DRIVE  
WILLISTON, VT 05495

FOR: GENERAL PURPOSE CLEANING PRE-  
PARATIONS FOR HOUSEHOLD USE, IN CLASS 3  
(U.S. CLS. 1, 4, 6, 50, 51 AND 52).

FIRST USE 6-1-2007; IN COMMERCE 6-1-2007.

THE MARK CONSISTS OF STANDARD CHAR-  
ACTERS WITHOUT CLAIM TO ANY PARTICULAR  
FONT, STYLE, SIZE, OR COLOR.

OWNER OF U.S. REG. NO. 2,570,824.

SN 77-029,662, FILED 10-26-2006.

JESSICA A. POWERS, EXAMINING ATTORNEY

**Int. Cl.: 9**

**Prior U.S. Cls.: 21, 23, 26, 36, and 38**

**United States Patent and Trademark Office**

**Reg. No. 3,395,416**

**Registered Mar. 11, 2008**

**TRADEMARK  
PRINCIPAL REGISTER**

**SURE-CONN CONNECTORS**

DSM&T CO., INC. (CALIFORNIA CORPORATION)  
10609 BUSINESS DRIVE  
FONTANA, CA 92337

FOR: ELECTRICAL PLUGS; ELECTRICAL RECEPTACLES, IN CLASS 9 (U.S. CLS. 21, 23, 26, 36 AND 38).

FIRST USE 4-2-2007; IN COMMERCE 4-2-2007.

THE MARK CONSISTS OF STANDARD CHARACTERS WITHOUT CLAIM TO ANY PARTICULAR FONT, STYLE, SIZE, OR COLOR.

NO CLAIM IS MADE TO THE EXCLUSIVE RIGHT TO USE "CONNECTORS", APART FROM THE MARK AS SHOWN.

SN 77-029,748, FILED 10-26-2006.

RAUL CORDOVA, EXAMINING ATTORNEY

**Int. Cl.: 28**

**Prior U.S. Cls.: 22, 23, 38, and 50**

**United States Patent and Trademark Office**

**Reg. No. 3,395,417**

**Registered Mar. 11, 2008**

**TRADEMARK  
PRINCIPAL REGISTER**

**MOVIE MIXER**

MATTEL, INC. (DELAWARE CORPORATION)  
MAIL STOP M1-1518  
333 CONTINENTAL BOULEVARD  
EL SEGUNDO, CA 90245

FOR: TOYS, GAMES AND PLAYTHINGS, NAME-  
LY, DOLLS, DOLL CLOTHING AND DOLL ACCES-  
SORIES, TOY FIGURES AND ACCESSORIES  
THEREFOR, IN CLASS 28 (U.S. CLS. 22, 23, 38 AND  
50).

FIRST USE 5-25-2007; IN COMMERCE 5-25-2007.

THE MARK CONSISTS OF STANDARD CHAR-  
ACTERS WITHOUT CLAIM TO ANY PARTICULAR  
FONT, STYLE, SIZE, OR COLOR.

SN 77-029,990, FILED 10-26-2006.

WILLIAM P. SHANAHAN, EXAMINING ATTOR-  
NEY

**Int. Cl.: 11**

**Prior U.S. Cls.: 13, 21, 23, 31, and 34**

**United States Patent and Trademark Office**

**Reg. No. 3,395,418**

**Registered Mar. 11, 2008**

**TRADEMARK  
PRINCIPAL REGISTER**

**CVP**

SALADO SALES, INC. (TEXAS CORPORATION)  
P.O. BOX 6115  
4747 MCLANE PARKWAY  
TEMPLE, TX 765036115

FOR: ELECTRIC LIGHT BULBS, IN CLASS 11  
(U.S. CLS. 13, 21, 23, 31 AND 34).

FIRST USE 10-16-2006; IN COMMERCE 10-16-2006.

THE MARK CONSISTS OF STANDARD CHAR-  
ACTERS WITHOUT CLAIM TO ANY PARTICULAR  
FONT, STYLE, SIZE, OR COLOR.

OWNER OF U.S. REG. NOS. 1,924,371 AND  
1,962,235.

SN 77-030,131, FILED 10-26-2006.

GEORGE LORENZO, EXAMINING ATTORNEY

**Int. Cl.: 31**

**Prior U.S. Cls.: 1 and 46**

**United States Patent and Trademark Office**

**Reg. No. 3,395,419**

**Registered Mar. 11, 2008**

**TRADEMARK  
PRINCIPAL REGISTER**

**CORA**

GOLDSMITH SEEDS, INC. (CALIFORNIA CORPORATION)  
PO BOX 1349  
GILROY, CA 95021

THE MARK CONSISTS OF STANDARD CHARACTERS WITHOUT CLAIM TO ANY PARTICULAR FONT, STYLE, SIZE, OR COLOR.

FOR: LIVE FLOWERING PLANTS, NAMELY, VINCA PLANTS; PLANT SEEDS, NAMELY, VINCA SEEDS, IN CLASS 31 (U.S. CLS. 1 AND 46).

SN 77-030,413, FILED 10-26-2006.

FIRST USE 1-8-2007; IN COMMERCE 1-8-2007.

JASON LOTT, EXAMINING ATTORNEY

**Int. Cl.: 41**

**Prior U.S. Cls.: 100, 101, and 107**

**United States Patent and Trademark Office**

**Reg. No. 3,395,420**

**Registered Mar. 11, 2008**

**SERVICE MARK  
PRINCIPAL REGISTER**

**TAILORED TO YOU**

FMR LLC (DELAWARE LTD LIAB CO)  
82 DEVONSHIRE STREET  
BOSTON, MA 02109

FOR: SPECIAL EVENT PLANNING; CONSULTATION IN THE FIELD OF WEDDINGS, RELIGIOUS CELEBRATIONS, FAMILY CELEBRATIONS, PARTIES, GALAS AND OTHER SPECIAL EVENTS; ARRANGING OF EXHIBITIONS AND CONFERENCES, IN CLASS 41 (U.S. CLS. 100, 101 AND 107).

FIRST USE 12-5-2006; IN COMMERCE 12-5-2006.

THE MARK CONSISTS OF STANDARD CHARACTERS WITHOUT CLAIM TO ANY PARTICULAR FONT, STYLE, SIZE, OR COLOR.

SN 77-030,979, FILED 10-27-2006.

CARYN GLASSER, EXAMINING ATTORNEY

**Int. Cl.: 41**

**Prior U.S. Cls.: 100, 101, and 107**

**United States Patent and Trademark Office**

**Reg. No. 3,395,421**

**Registered Mar. 11, 2008**

**SERVICE MARK  
PRINCIPAL REGISTER**

**LOW STARS**

CHRISTODAL, JUDE (UNITED STATES INDIVIDUAL)

GOLDRING, HERTZ & LICHTENSTEIN, LLP  
450 N. ROXBURY DR., 8TH FL.

BEVERLY HILLS, CA 90210 AND

GIBBS, DAVE (UNITED STATES INDIVIDUAL)

GOLDRING, HERTZ & LICHTENSTEIN, LLP  
450 N. ROXBURY DR., 8TH FL.

BEVERLY HILLS, CA 90210 AND

SEEFRIED, CHRIS (UNITED STATES INDIVIDUAL)

GOLDRING, HERTZ & LICHTENSTEIN, LLP

450 N. ROXBURY DR., 8TH FL.

BEVERLY HILLS, CA 90210 AND

RUSSO, JEFF (UNITED STATES INDIVIDUAL)

C/O GOLDRING, HERTZ & LICHTENSTEIN, LLP

450 N. ROXBURY DR., 8TH FL.

BEVERLY HILLS, CA 90210

FOR: ENTERTAINMENT SERVICES, NAMELY,  
LIVE PERFORMANCES BY A MUSICAL GROUP, IN  
CLASS 41 (U.S. CLS. 100, 101 AND 107).

FIRST USE 7-14-2007; IN COMMERCE 7-14-2007.

THE MARK CONSISTS OF STANDARD CHARACTERS WITHOUT CLAIM TO ANY PARTICULAR FONT, STYLE, SIZE, OR COLOR.

SN 77-032,134, FILED 10-30-2006.

JULIE GUTTADAURO, EXAMINING ATTORNEY

**Int. Cl.: 30**

**Prior U.S. Cl.: 46**

**United States Patent and Trademark Office**

**Reg. No. 3,395,422**

**Registered Mar. 11, 2008**

**TRADEMARK  
PRINCIPAL REGISTER**

**CHICLUB**

GRUPO BIMBO, S.A. DE C.V. (MEXICO COR-  
PORATION)  
PROLONGACION PASEO DE LA REFORMA  
NO. 1000, COL. PENA BLANCA SANTA FE  
MEXICO CITY, MEXICO 01210

THE MARK CONSISTS OF STANDARD CHAR-  
ACTERS WITHOUT CLAIM TO ANY PARTICULAR  
FONT, STYLE, SIZE, OR COLOR.

FOR: BUBBLE GUM, IN CLASS 30 (U.S. CL. 46).

SN 77-032,936, FILED 10-31-2006.

FIRST USE 10-30-2007; IN COMMERCE 10-30-2007.

HEATHER BIDDULPH, EXAMINING ATTORNEY



**Int. Cl.: 9**

**Prior U.S. Cls.: 21, 23, 26, 36, and 38**

**United States Patent and Trademark Office**

**Reg. No. 3,395,423**

**Registered Mar. 11, 2008**

**TRADEMARK  
PRINCIPAL REGISTER**

**SCOREFITTER**

PINNACLE SYSTEMS, INC. (CALIFORNIA CORPORATION)  
ATTN: TRADEMARK ADMINISTRATOR  
C/O AVID TECHNOLOGY, INC., ONE PARK WEST  
TEWKSBURY, MA 01876

FOR: COMPUTER PROGRAMS FOR EDITING IMAGES, SOUND AND VIDEO; COMPUTER PROGRAMS FOR AUDIO PRODUCTION , IN CLASS 9 (U.S. CLS. 21, 23, 26, 36 AND 38).

FIRST USE 5-0-2007; IN COMMERCE 5-0-2007.

THE MARK CONSISTS OF STANDARD CHARACTERS WITHOUT CLAIM TO ANY PARTICULAR FONT, STYLE, SIZE, OR COLOR.

SN 77-033,306, FILED 10-31-2006.

KELLY BOULTON, EXAMINING ATTORNEY

**Int. Cl.: 30**

**Prior U.S. Cl.: 46**

**United States Patent and Trademark Office**

**Reg. No. 3,395,424**

**Registered Mar. 11, 2008**

**TRADEMARK  
PRINCIPAL REGISTER**

**CARIBBEAN REEF**

CARIBBEAN REEF SPICE COMPANY, LLC  
(COLORADO LTD LIAB CO)

511 17TH STREET  
GOLDEN, CO 80401

FOR: SEASONINGS, SPICES, SEA SALT, COOK-  
ING SALT, AND BARBEQUE DRY RUB, IN CLASS  
30 (U.S. CL. 46).

FIRST USE 10-17-2007; IN COMMERCE 10-17-2007.

THE MARK CONSISTS OF STANDARD CHAR-  
ACTERS WITHOUT CLAIM TO ANY PARTICULAR  
FONT, STYLE, SIZE, OR COLOR.

NO CLAIM IS MADE TO THE EXCLUSIVE  
RIGHT TO USE "CARIBBEAN", APART FROM  
THE MARK AS SHOWN.

SN 77-033,643, FILED 10-31-2006.

DANIEL BRODY, EXAMINING ATTORNEY

**Int. Cl.: 9**

**Prior U.S. Cls.: 21, 23, 26, 36, and 38**

**Reg. No. 3,395,425**

**United States Patent and Trademark Office**

**Registered Mar. 11, 2008**

---

**TRADEMARK  
PRINCIPAL REGISTER**

**DigiScope**

LUCID8 LLC (WASHINGTON LTD LIAB CO)  
SUITE 334  
6947 COAL CREEK PARKWAY S.E.  
NEWCASTLE, WA 98059

FIRST USE 5-1-2007; IN COMMERCE 5-1-2007.

FOR: COMPUTER SOFTWARE, NAMELY, SOFTWARE WITH SPECIFIC ACCESS CAPABILITIES TO DISPLAY, SEARCH, EXTRACT, AND RE-LOCATE DATA BETWEEN VARIOUS LIVE AND OFF-LINE DATABASES AND FILES, IN CLASS 9 (U.S. CLS. 21, 23, 26, 36 AND 38).

THE MARK CONSISTS OF STANDARD CHARACTERS WITHOUT CLAIM TO ANY PARTICULAR FONT, STYLE, SIZE, OR COLOR.

SN 77-034,070, FILED 11-1-2006.

RENEE SERVANCE, EXAMINING ATTORNEY

**Int. Cl.: 33**

**Prior U.S. Cls.: 47 and 49**

**United States Patent and Trademark Office**

**Reg. No. 3,395,426**

**Registered Mar. 11, 2008**

**TRADEMARK  
PRINCIPAL REGISTER**

**COTTESBROOK**

COTTESBROOK WINE COMPANY LIMITED  
(NEW ZEALAND CORPORATION)  
3/8 EXPOPRT AVENUE  
HAREWOOD, NEW ZEALAND 8005

THE MARK CONSISTS OF STANDARD CHAR-  
ACTERS WITHOUT CLAIM TO ANY PARTICULAR  
FONT, STYLE, SIZE, OR COLOR.

FOR: WINES, IN CLASS 33 (U.S. CLS. 47 AND 49).

SN 77-034,481, FILED 11-1-2006.

FIRST USE 1-0-2003; IN COMMERCE 1-0-2003.

MIDGE BUTLER, EXAMINING ATTORNEY

**Int. Cl.: 9**

**Prior U.S. Cls.: 21, 23, 26, 36, and 38**

**United States Patent and Trademark Office**

**Reg. No. 3,395,427**

**Registered Mar. 11, 2008**

**TRADEMARK  
PRINCIPAL REGISTER**

# BottleTalk

BOTTLENOTES, INC. (CALIFORNIA CORPORATION)  
555 BRYANT ST. STE 575  
PALO ALTO, CA 94301

FOR: ONLINE PRERECORDED PROGRAM, NAMELY, DOWNLOADABLE AUDIO AND VIDEO RECORDINGS FEATURING INFORMATION REGARDING WINE AND A WINE CLUB COMMUNITY, IN CLASS 9 (U.S. CLS. 21, 23, 26, 36 AND 38).

FIRST USE 6-1-2007; IN COMMERCE 6-1-2007.

THE MARK CONSISTS OF STANDARD CHARACTERS WITHOUT CLAIM TO ANY PARTICULAR FONT, STYLE, SIZE, OR COLOR.

SN 77-035,392, FILED 11-2-2006.

ERIN FALK, EXAMINING ATTORNEY

**Int. Cl.: 30**

**Prior U.S. Cl.: 46**

**United States Patent and Trademark Office**

**Reg. No. 3,395,428**

**Registered Mar. 11, 2008**

**TRADEMARK  
PRINCIPAL REGISTER**

**SPRINGWELL**

H.C. BRILL COMPANY, INC. (DELAWARE COR-  
PORATION)  
1912 MONTREAL ROAD  
TUCKER, GA 30084

THE MARK CONSISTS OF STANDARD CHAR-  
ACTERS WITHOUT CLAIM TO ANY PARTICULAR  
FONT, STYLE, SIZE, OR COLOR.

FOR: FLOUR, IN CLASS 30 (U.S. CL. 46).

SN 77-035,518, FILED 11-2-2006.

FIRST USE 1-0-2001; IN COMMERCE 1-0-2001.

TIMOTHY FINNEGAN, EXAMINING ATTORNEY

**Int. Cl.: 35**

**Prior U.S. Cls.: 100, 101, and 102**

**United States Patent and Trademark Office**

**Reg. No. 3,395,429**

**Registered Mar. 11, 2008**

**SERVICE MARK  
PRINCIPAL REGISTER**

**SUPERPAGES MOBILE**

IDEARC MEDIA CORP. (DELAWARE CORPORATION)  
2200 W. AIRFIELD DRIVE  
DALLAS/FORT WORTH AIRPORT, TX 752619810

OWNER OF U.S. REG. NOS. 2,022,484, 2,765,993,  
AND 3,086,056.

FOR: TELEPHONE DIRECTORY INFORMATION  
AND BUSINESS LISTINGS AND INFORMATION  
PROVIDED VIA CELL PHONE OR OTHER MOBILE  
DEVICE, IN CLASS 35 (U.S. CLS. 100, 101 AND 102).

NO CLAIM IS MADE TO THE EXCLUSIVE  
RIGHT TO USE "MOBILE", APART FROM THE  
MARK AS SHOWN.

FIRST USE 10-0-2006; IN COMMERCE 10-0-2006.

SN 77-036,267, FILED 11-3-2006.

THE MARK CONSISTS OF STANDARD CHAR-  
ACTERS WITHOUT CLAIM TO ANY PARTICULAR  
FONT, STYLE, SIZE, OR COLOR.

DANIEL BRODY, EXAMINING ATTORNEY

**Int. Cl.: 12**

**Prior U.S. Cls.: 19, 21, 23, 31, 35, and 44**

**United States Patent and Trademark Office**

**Reg. No. 3,395,430**

**Registered Mar. 11, 2008**

**TRADEMARK  
PRINCIPAL REGISTER**

**EZ IN AND OUT**

KELLY-SCISM LLC (NORTH CAROLINA LTD  
LIAB CO)  
320-C FORUM PARKWAY  
RURAL HALL, NC 27045

THE MARK CONSISTS OF STANDARD CHAR-  
ACTERS WITHOUT CLAIM TO ANY PARTICULAR  
FONT, STYLE, SIZE, OR COLOR.

FOR: WHEEL CHAIR LIFTS FOR VEHICLES, IN  
CLASS 12 (U.S. CLS. 19, 21, 23, 31, 35 AND 44).

SN 77-037,191, FILED 11-6-2006.

FIRST USE 4-25-2007; IN COMMERCE 4-25-2007.

ROBIN MITTLER, EXAMINING ATTORNEY



**Int. Cl.: 10**

**Prior U.S. Cls.: 26, 39, and 44**

**United States Patent and Trademark Office**

**Reg. No. 3,395,431**

**Registered Mar. 11, 2008**

**TRADEMARK  
PRINCIPAL REGISTER**

**CO2 EASY**

WESTMED, INC. (ARIZONA CORPORATION)  
SUITE A  
109 INVERNESS DRIVE EAST  
ENGLEWOOD, CO 80112

FOR: MEDICAL DEVICES, NAMELY, CARBON DIOXIDE DETECTORS; CARBON DIOXIDE DETECTORS FOR ASSESSING TRACHEAL TUBE PLACEMENT, CARDIAC OUTPUT AND AIRWAY OBSTRUCTION, IN CLASS 10 (U.S. CLS. 26, 39 AND 44).

FIRST USE 2-19-2007; IN COMMERCE 3-26-2007.

THE MARK CONSISTS OF STANDARD CHARACTERS WITHOUT CLAIM TO ANY PARTICULAR FONT, STYLE, SIZE, OR COLOR.

NO CLAIM IS MADE TO THE EXCLUSIVE RIGHT TO USE "CO2", APART FROM THE MARK AS SHOWN.

SN 77-037,760, FILED 11-6-2006.

ELIZABETH HUGHITT, EXAMINING ATTORNEY

**Int. Cl.: 1**

**Prior U.S. Cls.: 1, 5, 6, 10, 26, and 46**

**Reg. No. 3,395,432**

**United States Patent and Trademark Office**

**Registered Mar. 11, 2008**

**TRADEMARK  
PRINCIPAL REGISTER**

**TYZONE**

TYGER SCIENTIFIC INC. (NEW JERSEY CORPORATION)  
324 STOKES AVE.  
EWING, NJ 08638

THE MARK CONSISTS OF STANDARD CHARACTERS WITHOUT CLAIM TO ANY PARTICULAR FONT, STYLE, SIZE, OR COLOR.

FOR: CHEMICALS FOR USE IN INDUSTRY, IN CLASS 1 (U.S. CLS. 1, 5, 6, 10, 26 AND 46).

SN 77-040,281, FILED 11-9-2006.

FIRST USE 1-14-2008; IN COMMERCE 1-14-2008.

ELIZABETH HUGHITT, EXAMINING ATTORNEY

**Int. Cl.: 9**

**Prior U.S. Cls.: 21, 23, 26, 36, and 38**

**United States Patent and Trademark Office**

**Reg. No. 3,395,433**

**Registered Mar. 11, 2008**

**TRADEMARK  
PRINCIPAL REGISTER**

**PLAY YOUR MUSIC...SHOW  
YOUR SPIRIT**

IFANATIC, LLC (NORTH CAROLINA LTD LIAB  
CO)  
105 SHALON COURT  
APEX, NC 27502

THE MARK CONSISTS OF STANDARD CHAR-  
ACTERS WITHOUT CLAIM TO ANY PARTICULAR  
FONT, STYLE, SIZE, OR COLOR.

FOR: COVERS FOR PORTABLE MUSIC PLAY-  
ERS, NAMELY, MP3 PLAYERS, IN CLASS 9 (U.S.  
CLS. 21, 23, 26, 36 AND 38).

SN 77-040,655, FILED 11-9-2006.

FIRST USE 11-9-2006; IN COMMERCE 11-28-2006.

KEVIN CORWIN, EXAMINING ATTORNEY

**Int. Cl.: 25**

**Prior U.S. Cls.: 22 and 39**

**United States Patent and Trademark Office**

**Reg. No. 3,395,434**

**Registered Mar. 11, 2008**

**TRADEMARK  
PRINCIPAL REGISTER**

**Juz Chillin'**

COVINGTON, DAVID (UNITED STATES INDIVIDUAL)  
7 LONDON COURT  
CARTERSVILLE, GA 30120

FOR: T-SHIRTS, SHIRTS, POLO SHIRTS, SHORTS, JACKETS, PANTS, SWIM SUITS, WRAPS, PAJAMAS, JEANS, BANDANAS, SKULL CAPS, HEADBANDS, JOGGING SUITS, MOCK TURTLE-NECK SWEATERS, SOCKS, SWEAT SHIRTS, PULLOVERS, SWEATERS, VESTS, GLOVES, CARDIGANS, JUMPERS, SHAWLS, APRONS, WRISTBANDS, SHOES,

SPORTS BRAS, BASEBALL CAPS, IN CLASS 25 (U.S. CLS. 22 AND 39).

FIRST USE 5-1-2006; IN COMMERCE 5-1-2006.

THE MARK CONSISTS OF STANDARD CHARACTERS WITHOUT CLAIM TO ANY PARTICULAR FONT, STYLE, SIZE, OR COLOR.

SN 77-041,246, FILED 11-10-2006.

WENDY GOODMAN, EXAMINING ATTORNEY

**Int. Cl.: 42**

**Prior U.S. Cls.: 100 and 101**

**United States Patent and Trademark Office**

**Reg. No. 3,395,435**

**Registered Mar. 11, 2008**

**SERVICE MARK  
PRINCIPAL REGISTER**

**PHARMORPHIX**

SIGMA-ALDRICH BIOTECHNOLOGY L.P. (MISSOURI LIMITED PARTNERSHIP)  
3050 SPRUCE STREET  
ST. LOUIS, MO 63103

FOR: CHEMICAL, PHARMACEUTICAL AND SCIENTIFIC RESEARCH FOR OTHERS; DEVELOPMENT FOR OTHERS OF CHEMICALS, CHEMICAL, BIOCHEMICAL AND PHARMACEUTICAL COMPOUNDS AND INGREDIENTS FOR USE IN THE MANUFACTURE OF CHEMICALS, BIOCHEMICALS AND PHARMACEUTICALS AND FOR USE IN PHARMACEUTICALS, RESEARCH AND FOR

SCIENTIFIC PURPOSES, IN CLASS 42 (U.S. CLS. 100 AND 101).

FIRST USE 7-1-2003; IN COMMERCE 7-1-2003.

THE MARK CONSISTS OF STANDARD CHARACTERS WITHOUT CLAIM TO ANY PARTICULAR FONT, STYLE, SIZE, OR COLOR.

SN 77-041,331, FILED 11-10-2006.

DAVID HOFFMAN, EXAMINING ATTORNEY

**Int. Cl.: 9**

**Prior U.S. Cls.: 21, 23, 26, 36, and 38**

**United States Patent and Trademark Office**

**Reg. No. 3,395,436**

**Registered Mar. 11, 2008**

**TRADEMARK  
PRINCIPAL REGISTER**

**VFA.SPENDMANAGER**

VANDERWEIL FACILITY ADVISORS, INC. (DE-  
LAWARE CORPORATION)  
266 SUMMER STREET  
BOSTON, MA 02210

FOR: COMPUTER SOFTWARE FOR BUDGET-  
ING, PURCHASING AND ANALYZING BUDGET-  
ING AND PURCHASING DATA, IN CLASS 9 (U.S.  
CLS. 21, 23, 26, 36 AND 38).

FIRST USE 1-22-2007; IN COMMERCE 1-22-2007.

THE MARK CONSISTS OF STANDARD CHAR-  
ACTERS WITHOUT CLAIM TO ANY PARTICULAR  
FONT, STYLE, SIZE, OR COLOR.

OWNER OF U.S. REG. NOS. 2,372,552, 2,996,845,  
AND OTHERS.

SN 77-041,400, FILED 11-10-2006.

GINA FINK, EXAMINING ATTORNEY

**Int. Cl.: 42**

**Prior U.S. Cls.: 100 and 101**

**United States Patent and Trademark Office**

**Reg. No. 3,395,437**

**Registered Mar. 11, 2008**

**SERVICE MARK  
PRINCIPAL REGISTER**

**VFA.SPENDMANAGER**

VANDERWEIL FACILITY ADVISORS, INC. (DE-  
LAWARE CORPORATION)  
266 SUMMER STREET  
BOSTON, MA 02210

FOR: APPLICATION SERVICE PROVIDER (ASP)  
FEATURING SOFTWARE FOR BUDGETING, PUR-  
CHASING AND ANALYZING BUDGETING AND  
PURCHASING DATA, IN CLASS 42 (U.S. CLS. 100  
AND 101).

FIRST USE 1-22-2007; IN COMMERCE 1-22-2007.

THE MARK CONSISTS OF STANDARD CHAR-  
ACTERS WITHOUT CLAIM TO ANY PARTICULAR  
FONT, STYLE, SIZE, OR COLOR.

OWNER OF U.S. REG. NOS. 2,372,552, 2,996,845,  
AND OTHERS.

SN 77-041,414, FILED 11-10-2006.

GINA FINK, EXAMINING ATTORNEY

**Int. Cl.: 9**

**Prior U.S. Cls.: 21, 23, 26, 36, and 38**

**United States Patent and Trademark Office**

**Reg. No. 3,395,438**

**Registered Mar. 11, 2008**

**TRADEMARK  
PRINCIPAL REGISTER**

# Run on Sun

NOPEC, INC. (CALIFORNIA CORPORATION)  
655 S RAYMOND AV  
PASADENA, CA 91105

FIRST USE 12-2-2006; IN COMMERCE 2-25-2007.

FOR: APPARATUS FOR CONVERTING ELECTRONIC RADIATION TO ELECTRICAL ENERGY, NAMELY, PHOTOVOLTAIC ROOFING MEMBERS; APPARATUS FOR CONVERTING ELECTRONIC RADIATION TO ELECTRICAL ENERGY, NAMELY, PHOTOVOLTAIC SOLAR MODULES; SOLAR CELLS, IN CLASS 9 (U.S. CLS. 21, 23, 26, 36 AND 38).

THE MARK CONSISTS OF STANDARD CHARACTERS WITHOUT CLAIM TO ANY PARTICULAR FONT, STYLE, SIZE, OR COLOR.

SN 77-042,041, FILED 11-11-2006.

SUSAN LESLIE DUBOIS, EXAMINING ATTORNEY



Int. Cl.: 36

Prior U.S. Cls.: 100, 101, and 102

United States Patent and Trademark Office

Reg. No. 3,395,439

Registered Mar. 11, 2008

SERVICE MARK  
PRINCIPAL REGISTER



NAUTILUS INSURANCE COMPANY (ARIZONA CORPORATION)  
7233 EAST BUTHERUS DRIVE  
SCOTTSDALE, AZ 85260

FOR: PROVIDING ON-LINE INSURANCE RELATED SERVICES, NAMELY, INSURANCE QUOTES AND ISSUANCE OF POLICIES, IN CLASS 36 (U.S. CLS. 100, 101 AND 102).

FIRST USE 3-5-2007; IN COMMERCE 3-5-2007.

THE COLOR GRAY IN THE MARK IS INTENDED TO INDICATE SHADING OR CONTRAST

ONLY AND IS NOT CLAIMED AS A FEATURE OF THE MARK.

THE MARK CONSISTS OF THE WORD "NICQUIK" WITH THE WORDS "SPEED TO MARKET" UNDERNEATH, AN ARROW ABOVE "NICQUIK" WITH A CRESCENT DESIGN ON THE RIGHT SIDE.

SN 77-042,683, FILED 11-13-2006.

HOWARD SMIGA, EXAMINING ATTORNEY

**Int. Cl.: 36**

**Prior U.S. Cls.: 100, 101, and 102**

**United States Patent and Trademark Office**

**Reg. No. 3,395,440**

**Registered Mar. 11, 2008**

**SERVICE MARK  
PRINCIPAL REGISTER**

**NICQUIK**

NAUTILUS INSURANCE COMPANY (ARIZONA  
CORPORATION)  
7233 EAST BUTHERUS DRIVE  
SCOTTSDALE, AZ 85260

THE MARK CONSISTS OF STANDARD CHAR-  
ACTERS WITHOUT CLAIM TO ANY PARTICULAR  
FONT, STYLE, SIZE, OR COLOR.

FOR: PROVIDING ON-LINE INSURANCE RELA-  
TED SERVICES, NAMELY, INSURANCE QUOTES  
AND ISSUANCE OF POLICIES, IN CLASS 36 (U.S.  
CLS. 100, 101 AND 102).

SN 77-042,729, FILED 11-13-2006.

FIRST USE 3-5-2007; IN COMMERCE 3-5-2007.

HOWARD SMIGA, EXAMINING ATTORNEY

Int. Cl.: 30

Prior U.S. Cl.: 46

United States Patent and Trademark Office

Reg. No. 3,395,441

Registered Mar. 11, 2008

TRADEMARK  
PRINCIPAL REGISTER



EMPACADORA LA PAISANA SA DE CV (MEXICO CORPORATION)  
LUCIERNAGA 1169 - B  
GUADALAJARA, JALISCO, MEXICO 44680

FOR: BARBECUE SAUCE; CHILI SAUCE; CONDIMENT, NAMELY, PEPPER SAUCE; HOT SAUCE, IN CLASS 30 (U.S. CL. 46).

FIRST USE 10-2-2006; IN COMMERCE 10-2-2006.

THE COLOR(S) RED, YELLOW, BLACK, ORANGE, GREEN, BEIGE AND WHITE IS/ARE CLAIMED AS A FEATURE OF THE MARK.

THE COLOR RED APPEARS IN THE WORDING "LA PAISANA MEXICANA" AND IN TWO OF THE PEPPERS. THE COLOR YELLOW APPEARS IN THE UNDERLINE BENEATH THE WORDING "LA PAISANA". THE COLOR BLACK APPEARS IN THE FIRST PEPPER, IN LINING AND SHADING OF THE

OTHER FOUR PEPPERS AND IN VARIOUS SHADES OF THE SHADOW OF THE PEPPERS. THE COLOR ORANGE APPEARS IN THE SECOND PEPPER AND IN THE MIDDLE OF FORTH PEPPER, WHICH IS IN RED. THE COLOR GREEN APPEARS IN THE THIRD PEPPER. THE COLOR BEIGE APPEARS IN THE OUTLINE OF THE POLYGON DESIGN, IN SHADING BEHIND THE PEPPERS AND IN VARIOUS SHADES IN THE SQUARE DESIGNS BEHIND THE PEPPERS. THE COLOR WHITE APPEARS IN THE SHADING OF THE POLYGON DESIGN AND UNDER THE PEPPERS.

THE FOREIGN WORDING IN THE MARK TRANSLATES INTO ENGLISH AS "THE MEXICAN COUNTRYWOMAN".

SN 77-043,256, FILED 11-14-2006.

JENNIFER MARTIN, EXAMINING ATTORNEY

**Int. Cl.: 36**

**Prior U.S. Cls.: 100, 101, and 102**

**United States Patent and Trademark Office**

**Reg. No. 3,395,442**

**Registered Mar. 11, 2008**

**SERVICE MARK  
PRINCIPAL REGISTER**

**H-E-B MAX PET INSURANCE**

HEB GROCERY COMPANY, LP (TEXAS LIMITED PARTNERSHIP)  
CORPORATE LAW  
646 SOUTH MAIN  
SAN ANTONIO, TX 78204

FOR: INSURANCE UNDERWRITING IN THE FIELD OF PET HEALTH CARE INSURANCE; AND INSURANCE BROKERAGE IN THE FIELD OF PET HEALTH CARE INSURANCE , IN CLASS 36 (U.S. CLS. 100, 101 AND 102).

FIRST USE 3-0-2007; IN COMMERCE 3-0-2007.

THE MARK CONSISTS OF STANDARD CHARACTERS WITHOUT CLAIM TO ANY PARTICULAR FONT, STYLE, SIZE, OR COLOR.

OWNER OF U.S. REG. NOS. 1,167,845, 3,188,211, AND OTHERS.

NO CLAIM IS MADE TO THE EXCLUSIVE RIGHT TO USE "PET INSURANCE", APART FROM THE MARK AS SHOWN.

SN 77-043,299, FILED 11-14-2006.

BARBARA RUTLAND, EXAMINING ATTORNEY

**Int. Cls.: 6 and 19**

**Prior U.S. Cls.: 1, 2, 12, 13, 14, 23, 25, 33, and 50**

**United States Patent and Trademark Office**

**Reg. No. 3,395,443**

**Registered Mar. 11, 2008**

**TRADEMARK  
PRINCIPAL REGISTER**

**STAY•TRUE**

GATES & GARDENS, LLC (WASHINGTON LTD  
LIAB CO), DBA THE IRON GATE SHOPPE,  
SUITE D  
5402 184TH STREET EAST  
PUYALLUP, WA 98375

FOR: METAL FENCING SYSTEMS, NAMELY,  
METAL FENCING PANELS, METAL PICKET FEN-  
CING, METAL FENCING STAYS, METAL FEN-  
CING POSTS, AND METAL FENCING RAILINGS,  
IN CLASS 6 (U.S. CLS. 2, 12, 13, 14, 23, 25 AND 50).

FIRST USE 2-14-2007; IN COMMERCE 7-3-2007.

FOR: NON-METAL FENCING SYSTEMS, NAME-  
LY, NON-METAL FENCING PANELS, NON-METAL  
PICKET FENCING, NON-METAL FENCING STAYS,  
NON-METAL FENCING POSTS, AND NON-METAL  
FENCING RAILINGS, IN CLASS 19 (U.S. CLS. 1, 12,  
33 AND 50).

FIRST USE 2-14-2007; IN COMMERCE 7-3-2007.

SN 77-044,094, FILED 11-14-2006.

TEJBIR SINGH, EXAMINING ATTORNEY

**Int. Cl.: 28**

**Prior U.S. Cls.: 22, 23, 38, and 50**

**United States Patent and Trademark Office**

**Reg. No. 3,395,444**

**Registered Mar. 11, 2008**

**TRADEMARK  
PRINCIPAL REGISTER**

**ART SUDOKU**

WIENER SPIELKARTENFABRIK FERD. PIAT-  
NIK & SOHNE (AUSTRIA LIMITED PART-  
NERSHIP)

HUTTELDORFERSTRASSE 229-231  
VIENNA, AUSTRIA A-1140

FOR: BOARD GAMES; PUZZLES, IN CLASS 28  
(U.S. CLS. 22, 23, 38 AND 50).

FIRST USE 1-0-2007; IN COMMERCE 1-0-2007.

THE MARK CONSISTS OF STANDARD CHAR-  
ACTERS WITHOUT CLAIM TO ANY PARTICULAR  
FONT, STYLE, SIZE, OR COLOR.

NO CLAIM IS MADE TO THE EXCLUSIVE  
RIGHT TO USE "SUDOKU", APART FROM THE  
MARK AS SHOWN.

SN 77-044,254, FILED 11-15-2006.

DAVID C. REIHNER, EXAMINING ATTORNEY

**Int. Cl.: 41**

**Prior U.S. Cls.: 100, 101, and 107**

**United States Patent and Trademark Office**

**Reg. No. 3,395,445**

**Registered Mar. 11, 2008**

**SERVICE MARK  
PRINCIPAL REGISTER**

ACCEPTED BY LOVE HIMSELF

HUNSUCKER, GREGORY M. (UNITED STATES  
INDIVIDUAL)  
1020 NORTH GLOSTER, NO. 257  
TUPELO, MS 38804

FOR: EDUCATIONAL SERVICES AND PRO-  
GRAMS, NAMELY, PROVIDING INSTRUCTION,  
CONSULTATION AND EDUCATION BY AND  
THROUGH WORKSHOPS, SEMINARS, CLASSES  
AND APPLIED LEARNING IN THE LIFE, WORKS  
AND TEACHINGS OF JESUS CHRIST, IN CLASS 41  
(U.S. CLS. 100, 101 AND 107).

FIRST USE 1-7-2007; IN COMMERCE 1-7-2007.

THE MARK CONSISTS OF STANDARD CHAR-  
ACTERS WITHOUT CLAIM TO ANY PARTICULAR  
FONT, STYLE, SIZE, OR COLOR.

SN 77-044,449, FILED 11-15-2006.

WILLIAM P. SHANAHAN, EXAMINING ATTOR-  
NEY

**Int. Cl.: 3**

**Prior U.S. Cls.: 1, 4, 6, 50, 51, and 52**

**Reg. No. 3,395,446**

**United States Patent and Trademark Office**

**Registered Mar. 11, 2008**

**TRADEMARK  
PRINCIPAL REGISTER**

**IOPE MAGIC EFFECTER**

AMOREPACIFIC CORPORATION (REPUBLIC OF  
KOREA CORPORATION)  
181, 2-KA, HANGANG-RO, YONGSAN-KU  
SEOUL, REPUBLIC OF KOREA 140-777

FOR: NON MEDICATED NOURISHING CREAMS  
FOR THE SKIN; BEAUTY MILK; SKIN MOISTUR-  
IZER; SKIN WHITENING CREAMS AND SKIN  
EXFOLIATOR LOTIONS AND CREAMS, IN CLASS  
3 (U.S. CLS. 1, 4, 6, 50, 51 AND 52).

FIRST USE 1-0-2006; IN COMMERCE 3-0-2006.

THE MARK CONSISTS OF STANDARD CHAR-  
ACTERS WITHOUT CLAIM TO ANY PARTICULAR  
FONT, STYLE, SIZE, OR COLOR.

OWNER OF U.S. REG. NO. 2,297,281.

SN 77-045,380, FILED 11-16-2006.

THOMAS MANOR, EXAMINING ATTORNEY



**Int. Cl.: 32**

**Prior U.S. Cls.: 45, 46, and 48**

**United States Patent and Trademark Office**

**Reg. No. 3,395,447**

**Registered Mar. 11, 2008**

**TRADEMARK  
PRINCIPAL REGISTER**

**MONEY-SHOT**

STRAUB, JERRY A. (UNITED STATES INDIVIDUAL)  
8571 LODI CENTER RD  
LODI, NY 14860

FOR: NON ALCOHOLIC BEVERAGES, NAMELY, CARBONATED BEVERAGES, IN CLASS 32 (U.S. CLS. 45, 46 AND 48).

FIRST USE 3-23-2007; IN COMMERCE 6-12-2007.

THE MARK CONSISTS OF STANDARD CHARACTERS WITHOUT CLAIM TO ANY PARTICULAR FONT, STYLE, SIZE, OR COLOR.

SN 77-045,678, FILED 11-16-2006.

AMOS T. MATTHEWS, JR., EXAMINING ATTORNEY

**Int. Cl.: 18**

**Prior U.S. Cls.: 1, 2, 3, 22, and 41**

**United States Patent and Trademark Office**

**Reg. No. 3,395,448**

**Registered Mar. 11, 2008**

**TRADEMARK  
PRINCIPAL REGISTER**

**LITTLE RANCHES**

LITTLE RANCHES (TEXAS PARTNERSHIP)  
2219 EAGLE ROCK  
HOUSTON, TX 77080

THE MARK CONSISTS OF STANDARD CHAR-  
ACTERS WITHOUT CLAIM TO ANY PARTICULAR  
FONT, STYLE, SIZE, OR COLOR.

FOR: HANDBAGS AND PURSES, IN CLASS 18  
(U.S. CLS. 1, 2, 3, 22 AND 41).

SN 77-046,374, FILED 11-17-2006.

FIRST USE 8-18-2007; IN COMMERCE 8-18-2007.

DANIEL CAPSHAW, EXAMINING ATTORNEY

**Int. Cl.: 14**

**Prior U.S. Cls.: 2, 27, 28, and 50**

**United States Patent and Trademark Office**

**Reg. No. 3,395,449**

**Registered Mar. 11, 2008**

**TRADEMARK  
PRINCIPAL REGISTER**

**ADMIRATION**

COMMEMORATIVE BRANDS, INC. (DELA-  
WARE CORPORATION)  
7211 CIRCLE S ROAD  
AUSTIN, TX 78745

THE MARK CONSISTS OF STANDARD CHAR-  
ACTERS WITHOUT CLAIM TO ANY PARTICULAR  
FONT, STYLE, SIZE, OR COLOR.

FOR: JEWELRY, IN CLASS 14 (U.S. CLS. 2, 27, 28  
AND 50).

SN 77-047,569, FILED 11-20-2006.

FIRST USE 1-11-1998; IN COMMERCE 1-11-1998.

RON FAIRBANKS, EXAMINING ATTORNEY

**Int. Cl.: 39**

**Prior U.S. Cls.: 100 and 105**

**United States Patent and Trademark Office**

**Reg. No. 3,395,450**

**Registered Mar. 11, 2008**

**SERVICE MARK  
PRINCIPAL REGISTER**



FOOTPRINTS AFRICA LLC (NEW YORK LTD  
LIAB CO)  
109 OLD NECK RD  
CENTER MORICHES, NY 11934

FOR: ARRANGING AND CONDUCTING JUNGLE AND SAFARI EXPEDITIONS; ARRANGING TRAVEL TOURS; CONDUCTING SIGHTSEEING TOURS FOR OTHERS; ORGANIZATION OF EXCURSIONS, SIGHTSEEING TOURS, HOLIDAYS, TOURS AND TRAVEL; TOUR GUIDE SERVICES; TRAVEL AGENCY SERVICES, NAMELY, MAKING RESERVATIONS AND BOOKINGS FOR TRANSPORTATION; TRAVEL AND TOUR INFORMATION SERVICE; TRAVEL AND TOUR TICKET RESERVATION SERVICE; TRAVEL BOOKING AGENCIES; TRAVEL INFORMATION SERVICES, IN CLASS 39 (U.S. CLS. 100 AND 105).

FIRST USE 9-14-2007; IN COMMERCE 9-14-2007.

NO CLAIM IS MADE TO THE EXCLUSIVE RIGHT TO USE "AFRICA" OR THE REPRESENTATION OF THE DESIGN OF THE CONTINENT OF AFRICA, APART FROM THE MARK AS SHOWN.

THE MARK CONSISTS OF MAP OF AFRICA WITH A FOOTPRINT IN IT AND THE STYLIZED TEXT OF THE WORDING "FOOTPRINTS AFRICA".

SN 77-047,701, FILED 11-20-2006.

JASON LOTT, EXAMINING ATTORNEY

**Int. Cl.: 9**

**Prior U.S. Cls.: 21, 23, 26, 36, and 38**

**United States Patent and Trademark Office**

**Reg. No. 3,395,451**

**Registered Mar. 11, 2008**

**TRADEMARK  
PRINCIPAL REGISTER**



IGT (NEVADA CORPORATION)  
9295 PROTOTYPE DRIVE  
RENO, NV 895218986

FOR: GAMING MACHINES, NAMELY, DEVICES  
WHICH ACCEPT A WAGER, IN CLASS 9 (U.S. CLS.  
21, 23, 26, 36 AND 38).

FIRST USE 6-22-2007; IN COMMERCE 6-22-2007.

THE MARK CONSISTS OF A RIBBON DESIGN  
WITH THE WORDS "BETTOR" AT THE TOP,  
"CHANCE" AT THE BOTTOM AND "BONUS" IN  
THE MIDDLE OF THE DESIGN.

SN 77-048,196, FILED 11-20-2006.

ROBIN MITTLER, EXAMINING ATTORNEY

**Int. Cl.: 9**

**Prior U.S. Cls.: 21, 23, 26, 36, and 38**

**United States Patent and Trademark Office**

**Reg. No. 3,395,452**

**Registered Mar. 11, 2008**

**TRADEMARK  
PRINCIPAL REGISTER**



IGT (NEVADA CORPORATION)  
9295 PROTOTYPE DRIVE  
RENO, NV 895218986

FOR: GAMING MACHINES, NAMELY, DEVICES  
WHICH ACCEPT A WAGER, IN CLASS 9 (U.S. CLS.  
21, 23, 26, 36 AND 38).

FIRST USE 2-26-2007; IN COMMERCE 3-15-2007.

THE MARK CONSISTS OF A RIBBON DESIGN  
WITH THE WORDS "BETTOR" AT THE TOP,  
"CHANCE" AT THE BOTTOM AND "WAY" IN  
THE MIDDLE OF THE DESIGN.

SN 77-048,209, FILED 11-20-2006.

ROBIN MITTLER, EXAMINING ATTORNEY

Int. Cl.: 33

Prior U.S. Cls.: 47 and 49

United States Patent and Trademark Office

Reg. No. 3,395,453

Registered Mar. 11, 2008

TRADEMARK  
PRINCIPAL REGISTER



HULA GIRL BEVERAGES, LLC (CALIFORNIA  
LTD LIAB CO)  
4802 E. MORADA LANE  
STOCKTON, CA 95212

FOR: ALCOHOLIC BEVERAGES, NAMELY, RUM  
AND RUM BASED BEVERAGES, IN CLASS 33 (U.S.  
CLS. 47 AND 49).

FIRST USE 12-5-2007; IN COMMERCE 12-5-2007.

NO CLAIM IS MADE TO THE EXCLUSIVE  
RIGHT TO USE "BEVERAGES", APART FROM  
THE MARK AS SHOWN.

THE MARK CONSISTS OF THE WORDS "HULA  
GIRL" IN A SLIGHT ARCH IN LARGE FONT  
SEPARATED BY A CHARTOON-TYPE HULA GIRL  
ALL UNDERLINED BY A SWOOPING LINE AND  
THE WORD "BEVERAGES" IN SMALLER FONT  
UNDERNEATH.

SN 77-049,685, FILED 11-22-2006.

LINDA ORNDORFF, EXAMINING ATTORNEY

**Int. Cl.: 19**

**Prior U.S. Cls.: 1, 12, 33, and 50**

**United States Patent and Trademark Office**

**Reg. No. 3,395,454**

**Registered Mar. 11, 2008**

**TRADEMARK  
PRINCIPAL REGISTER**

**DURA-SHIELD**

NICOLIA CONCRETE PRODUCTS INC. (NEW  
YORK CORPORATION)  
640 MUNCY AVE  
LINDENHURST, NY 11757

THE MARK CONSISTS OF STANDARD CHAR-  
ACTERS WITHOUT CLAIM TO ANY PARTICULAR  
FONT, STYLE, SIZE, OR COLOR.

FOR: BUILDING MATERIALS, NAMELY, PA-  
VERS, BRICKS, STONES, CONCRETE AND CE-  
MENT MIXES, IN CLASS 19 (U.S. CLS. 1, 12, 33  
AND 50).

SN 77-052,065, FILED 11-28-2006.

FIRST USE 4-30-2007; IN COMMERCE 4-30-2007.

JASON BLAIR, EXAMINING ATTORNEY



**Int. Cl.: 16**

**Prior U.S. Cls.: 2, 5, 22, 23, 29, 37, 38, and 50**

**United States Patent and Trademark Office**

**Reg. No. 3,395,455**

**Registered Mar. 11, 2008**

**TRADEMARK  
PRINCIPAL REGISTER**

**MIND TRAP MEMORIES**

MIND TRAP MEMORIES, INC. (FLORIDA CORPORATION)  
P.O. BOX 14211  
NORTH PALM BEACH, FL 334084211

FOR: ART PICTURES; ART PRINTS; BLANK JOURNAL BOOKS; BLANK WRITING JOURNALS; CALENDARS; GREETING CARDS; NOTE CARDS; PHOTOGRAPHS; POSTCARDS , IN CLASS 16 (U.S. CLS. 2, 5, 22, 23, 29, 37, 38 AND 50).

FIRST USE 11-1-2006; IN COMMERCE 4-17-2007.

THE MARK CONSISTS OF STANDARD CHARACTERS WITHOUT CLAIM TO ANY PARTICULAR FONT, STYLE, SIZE, OR COLOR.

SN 77-052,106, FILED 11-28-2006.

KATHERINE M. DUBRAY, EXAMINING ATTORNEY

Int. Cl.: 35

Prior U.S. Cls.: 100, 101, and 102

United States Patent and Trademark Office

Reg. No. 3,395,456

Registered Mar. 11, 2008

SERVICE MARK  
PRINCIPAL REGISTER



AMERICAN INTERNATIONAL GROUP, INC.  
(DELAWARE CORPORATION)  
70 PINE STREET  
NEW YORK, NY 10270

FIRST USE 12-1-2006; IN COMMERCE 12-1-2006.

FOR: BUSINESS MANAGEMENT CONSULTING  
SERVICES IN RELATION TO STRATEGY, MAR-  
KETING AND RETAIL SALE OF VARIABLE AN-  
NUITIES, IN CLASS 35 (U.S. CLS. 100, 101 AND 102).

SN 77-053,118, FILED 11-29-2006.

PAULA MAHONEY, EXAMINING ATTORNEY

**Int. Cl.: 5**

**Prior U.S. Cls.: 6, 18, 44, 46, 51, and 52**

**United States Patent and Trademark Office**

**Reg. No. 3,395,457**

**Registered Mar. 11, 2008**

**TRADEMARK  
PRINCIPAL REGISTER**

**WEIGHT DEFENSE**

TARGET BRANDS, INC. (MINNESOTA CORPORATION)  
1000 NICOLLET MALL  
TPS-3165  
MINNEAPOLIS, MN 55403

FOR: MULTI-VITAMIN SUPPLEMENTS, IN CLASS 5 (U.S. CLS. 6, 18, 44, 46, 51 AND 52).

FIRST USE 2-1-2007; IN COMMERCE 2-1-2007.

THE MARK CONSISTS OF STANDARD CHARACTERS WITHOUT CLAIM TO ANY PARTICULAR FONT, STYLE, SIZE, OR COLOR.

NO CLAIM IS MADE TO THE EXCLUSIVE RIGHT TO USE "WEIGHT", APART FROM THE MARK AS SHOWN.

SN 77-053,172, FILED 11-29-2006.

DOMINIC FATHY, EXAMINING ATTORNEY

**Int. Cl.: 35**

**Prior U.S. Cls.: 100, 101, and 102**

**United States Patent and Trademark Office**

**Reg. No. 3,395,458**

**Registered Mar. 11, 2008**

**SERVICE MARK  
PRINCIPAL REGISTER**

**SALES-ADE FROM START TO  
SALES**

AMERICAN INTERNATIONAL GROUP, INC.  
(DELAWARE CORPORATION)  
70 PINE STREET  
NEW YORK, NY 10270

THE MARK CONSISTS OF STANDARD CHAR-  
ACTERS WITHOUT CLAIM TO ANY PARTICULAR  
FONT, STYLE, SIZE, OR COLOR.

FOR: BUSINESS MANAGEMENT CONSULTING  
SERVICES IN RELATION TO MARKETING OF  
FINANCIAL SERVICES, IN CLASS 35 (U.S. CLS.  
100, 101 AND 102).

SN 77-053,176, FILED 11-29-2006.

FIRST USE 12-1-2006; IN COMMERCE 12-1-2006.

PAULA MAHONEY, EXAMINING ATTORNEY

**Int. Cl.: 24**

**Prior U.S. Cls.: 42 and 50**

**United States Patent and Trademark Office**

**Reg. No. 3,395,459**

**Registered Mar. 11, 2008**

**TRADEMARK  
PRINCIPAL REGISTER**

**PürSoft**

SAJE MANAGEMENT, INC. (CALIFORNIA CORPORATION)  
6403 N. WILLARD AVE  
SAN GABRIEL, CA 91775

FOR: SYNTHETIC LEATHER-LIKE MATERIAL COMPOSED OF POLYURETHANE AND POLYESTER FABRIC USED IN THE MANUFACTURING OF OFFICE AND RESIDENTIAL SEATING, IN CLASS 24 (U.S. CLS. 42 AND 50).

FIRST USE 1-7-2007; IN COMMERCE 3-1-2007.

THE MARK CONSISTS OF STANDARD CHARACTERS WITHOUT CLAIM TO ANY PARTICULAR FONT, STYLE, SIZE, OR COLOR.

SN 77-053,460, FILED 11-29-2006.

HEATHER THOMPSON, EXAMINING ATTORNEY

**Int. Cl.: 38**

**Prior U.S. Cls.: 100, 101, and 104**

**United States Patent and Trademark Office**

**Reg. No. 3,395,460**

**Registered Mar. 11, 2008**

**SERVICE MARK  
PRINCIPAL REGISTER**

**CORR ASUGO**

CORR WIRELESS COMMUNICATIONS, LLC  
(ALABAMA LTD LIAB CO)  
600 THIRD AVENUE, EAST  
ONEONTA, AL 35121

FOR: TELEPHONE SERVICES, NAMELY, IN THE  
NATURE OF PRE-PAID WIRELESS TELEPHONE  
AND PERSONAL COMMUNICATION SERVICES,  
IN CLASS 38 (U.S. CLS. 100, 101 AND 104).

FIRST USE 1-1-2007; IN COMMERCE 1-1-2007.

THE MARK CONSISTS OF STANDARD CHAR-  
ACTERS WITHOUT CLAIM TO ANY PARTICULAR  
FONT, STYLE, SIZE, OR COLOR.

OWNER OF U.S. REG. NOS. 2,616,576, 2,638,463,  
AND 2,886,282.

SN 77-053,755, FILED 11-30-2006.

AISHA SALEM, EXAMINING ATTORNEY

**Int. Cl.: 5**

**Prior U.S. Cls.: 6, 18, 44, 46, 51, and 52**

**Reg. No. 3,395,461**

**United States Patent and Trademark Office**

**Registered Mar. 11, 2008**

---

**TRADEMARK  
PRINCIPAL REGISTER**

**SMARTSIGNAL**

FREEDOM HEALTH, LLC (DELAWARE LTD  
LIAB CO)  
7541 VINEMONT CT.  
HUDSON, OH 44231

THE MARK CONSISTS OF STANDARD CHAR-  
ACTERS WITHOUT CLAIM TO ANY PARTICULAR  
FONT, STYLE, SIZE, OR COLOR.

FOR: DIAGNOSTIC TEST KIT FOR DETERMIN-  
ING THE PRESENCE OF ULCERS AND/OR OTHER  
DIGESTIVE TRACT BLEEDING IN EQUINES, IN  
CLASS 5 (U.S. CLS. 6, 18, 44, 46, 51 AND 52).

SN 77-054,496, FILED 11-30-2006.

FIRST USE 8-27-2007; IN COMMERCE 10-1-2007.

KHANH LE, EXAMINING ATTORNEY

**Int. Cl.: 30**

**Prior U.S. Cl.: 46**

**United States Patent and Trademark Office**

**Reg. No. 3,395,462**

**Registered Mar. 11, 2008**

**TRADEMARK  
PRINCIPAL REGISTER**

**GOYA**

GOYA FOODS, INC. (DELAWARE CORPORATION)  
100 SEAVIEW DRIVE  
SECAUCUS, NJ 07096

FOR: FRUIT ICE BAR; ICE CREAM; ICE MILK  
BARS; AND ICE MILK, IN CLASS 30 (U.S. CL. 46).

FIRST USE 3-1-2007; IN COMMERCE 3-1-2007.

THE MARK CONSISTS OF STANDARD CHARACTERS WITHOUT CLAIM TO ANY PARTICULAR FONT, STYLE, SIZE, OR COLOR.

OWNER OF U.S. REG. NOS. 1,739,172, 2,502,127,  
AND OTHERS.

SN 77-054,508, FILED 11-30-2006.

ANDREA HACK, EXAMINING ATTORNEY



**Int. Cl.: 5**

**Prior U.S. Cls.: 6, 18, 44, 46, 51, and 52**

**United States Patent and Trademark Office**

**Reg. No. 3,395,463**

**Registered Mar. 11, 2008**

**TRADEMARK  
PRINCIPAL REGISTER**

**TRUE SELF**

HY-VEE, INC. (IOWA CORPORATION)  
5820 WESTOWN PARKWAY  
WEST DES MOINES, IA 50266

THE MARK CONSISTS OF STANDARD CHAR-  
ACTERS WITHOUT CLAIM TO ANY PARTICULAR  
FONT, STYLE, SIZE, OR COLOR.

FOR: FEMININE HYGIENE PADS, TAMPONS,  
PANTY LINERS, AND CLEANSING TOWELETTES,  
IN CLASS 5 (U.S. CLS. 6, 18, 44, 46, 51 AND 52).

SN 77-054,758, FILED 12-1-2006.

FIRST USE 4-24-2007; IN COMMERCE 4-24-2007.

MARCIE MILONE, EXAMINING ATTORNEY

**Int. Cl.: 36**

**Prior U.S. Cls.: 100, 101, and 102**

**United States Patent and Trademark Office**

**Reg. No. 3,395,464**

**Registered Mar. 11, 2008**

**SERVICE MARK  
PRINCIPAL REGISTER**

STEP OUT TO FIGHT DIABETES

AMERICAN DIABETES ASSOCIATION, INC.  
(OHIO CORPORATION)

1701 N. BEAUREGARD STREET

ALEXANDRIA, VA 22311

FOR: CHARITABLE FUND RAISING, IN CLASS  
36 (U.S. CLS. 100, 101 AND 102).

FIRST USE 4-2-2007; IN COMMERCE 4-2-2007.

THE MARK CONSISTS OF STANDARD CHAR-  
ACTERS WITHOUT CLAIM TO ANY PARTICULAR  
FONT, STYLE, SIZE, OR COLOR.

NO CLAIM IS MADE TO THE EXCLUSIVE  
RIGHT TO USE "DIABETES", APART FROM THE  
MARK AS SHOWN.

SN 77-055,192, FILED 12-1-2006.

LA TONIA FISHER, EXAMINING ATTORNEY

**Int. Cl.: 41**

**Prior U.S. Cls.: 100, 101, and 107**

**United States Patent and Trademark Office**

**Reg. No. 3,395,465**

**Registered Mar. 11, 2008**

**SERVICE MARK  
PRINCIPAL REGISTER**

**BENTLI**

BENTLEY, BRANDON (UNITED STATES INDIVIDUAL)  
7428 JADE CIRCLE  
NORTH RICHLAND HILLS, TX 76180

FIRST USE 11-30-2006; IN COMMERCE 3-23-2007.

FOR: ENTERTAINMENT IN THE NATURE OF LIVE PERFORMANCES BY SINGER/SONGWRITER/MUSICIAN BRANDON BENTLEY; ENTERTAINMENT IN THE NATURE OF VISUAL AND AUDIO PERFORMANCES, NAMELY, MUSICAL BAND, ROCK GROUP, GYMNASTIC, DANCE, AND BALLET PERFORMANCES, IN CLASS 41 (U.S. CLS. 100, 101 AND 107).

THE MARK CONSISTS OF STANDARD CHARACTERS WITHOUT CLAIM TO ANY PARTICULAR FONT, STYLE, SIZE, OR COLOR.

SN 77-055,984, FILED 12-3-2006.

HEATHER BIDDULPH, EXAMINING ATTORNEY

**Int. Cl.: 36**

**Prior U.S. Cls.: 100, 101, and 102**

**United States Patent and Trademark Office**

**Reg. No. 3,395,466**

**Registered Mar. 11, 2008**

**SERVICE MARK  
PRINCIPAL REGISTER**

# Rockmond

ROCKMOND FINANCIAL HOLDINGS, INC. (CALIFORNIA CORPORATION)  
3632 OCEAN RANCH BLVD.  
OCEANSIDE, CA 92056

FOR: MORTGAGE BANKING SERVICES, NAME-  
LY, ORIGINATION, ACQUISITION, SERVICING,  
SECURITIZATION AND BROKERAGE OF MORT-  
GAGE LOANS, IN CLASS 36 (U.S. CLS. 100, 101 AND  
102).

FIRST USE 11-9-2006; IN COMMERCE 11-10-2006.

THE MARK CONSISTS OF STANDARD CHAR-  
ACTERS WITHOUT CLAIM TO ANY PARTICULAR  
FONT, STYLE, SIZE, OR COLOR.

SN 77-056,315, FILED 12-4-2006.

ALYSSA PALADINO, EXAMINING ATTORNEY

**Int. Cl.: 38**

**Prior U.S. Cls.: 100, 101, and 104**

**United States Patent and Trademark Office**

**Reg. No. 3,395,467**

**Registered Mar. 11, 2008**

**SERVICE MARK  
PRINCIPAL REGISTER**

**RIDE SHOTGUN**

NATIONAL ASSOCIATION FOR STOCK CAR  
AUTO RACING, INC. (FLORIDA CORPORATION)  
ATTN: KAREN B. LEETZOW  
1801 W. INTERNATIONAL SPEEDWAY BLVD.  
DAYTONA BEACH, FL 32114

FOR: TELEVISION SUBSCRIPTION BROADCASTING SERVICES, IN CLASS 38 (U.S. CLS. 100, 101 AND 104).

FIRST USE 1-11-2007; IN COMMERCE 1-11-2007.

THE MARK CONSISTS OF STANDARD CHARACTERS WITHOUT CLAIM TO ANY PARTICULAR FONT, STYLE, SIZE, OR COLOR.

SN 77-056,361, FILED 12-4-2006.

VIVIAN MICZNIK FIRST, EXAMINING ATTORNEY

**Int. Cl.: 9**

**Prior U.S. Cls.: 21, 23, 26, 36, and 38**

**United States Patent and Trademark Office**

**Reg. No. 3,395,468**

**Registered Mar. 11, 2008**

**TRADEMARK  
PRINCIPAL REGISTER**



POWER CELL INTERNATIONAL, INC. (ILLINOIS CORPORATION)  
5901 SOUTH TALMAN AVENUE  
CHICAGO, IL 60629

FOR: CARRYING CASES SPECIALLY ADAPTED FOR POCKET CALCULATORS AND CELLPHONES; CASES FOR MOBILE PHONES; CELL PHONE COVERS; CELL PHONES; CELLULAR PHONES; CELLULAR TELEPHONE APPARATUSES; CELLULAR TELEPHONES; COMPUTER APPLICATION SOFTWARE FOR MOBILE PHONES; DECORATIVE CHARMS FOR CELLULAR TELEPHONES; DEVICES FOR HANDS-FREE USE OF MOBILE PHONES; DIGITAL CELLULAR PHONES; DIGITAL PHONES; EAR PHONES; KEYBOARDS FOR MOBILE PHONES; MOBILE PHONE STRAPS; MOTORCYCLE CHARGER FAULT DETECTOR; SPECIALTY HOLSTER FOR CARRYING CELLULAR PHONES; TELEMATICS APPARATUS, NAMELY, WIRELESS INTERNET DEVICES WHICH PROVIDE TELEMAT-

IC SERVICES AND HAVE A CELLULAR PHONE FUNCTION; VIDEO PHONES, IN CLASS 9 (U.S. CLS. 21, 23, 26, 36 AND 38).

FIRST USE 11-0-2006; IN COMMERCE 11-0-2006.

THE COLOR(S) LIGHT BLUE AND RED IS/ARE CLAIMED AS A FEATURE OF THE MARK.

THE MARK CONSISTS OF THE WORD "POWER-CELL". THE WORD "POWER" APPEARS IN LIGHT BLUE. THE WORD "CELL" APPEARS IN RED. THE COMBINED WORD "POWERCELL" IS SURROUNDED BY HALF CIRCLES OF RED AND LIGHT BLUE.

SN 77-056,810, FILED 12-4-2006.

TRACY WHITTAKER-BROWN, EXAMINING ATTORNEY

**Int. Cls.: 39, 41, and 43**

**Prior U.S. Cls.: 100, 101, 105, and 107**

**United States Patent and Trademark Office**

**Reg. No. 3,395,469**

**Registered Mar. 11, 2008**

**SERVICE MARK  
PRINCIPAL REGISTER**

# TRIPSTARTER

HOTWIRE, INC. (DELAWARE CORPORATION)  
SUITE 100  
333 MARKET STREET  
SAN FRANCISCO, CA 94105

FOR: PROVIDING TRAVEL INFORMATION  
SERVICES VIA THE INTERNET, IN CLASS 39 (U.S.  
CLS. 100 AND 105).

FIRST USE 12-12-2006; IN COMMERCE 12-12-2006.

FOR: PROVIDING INFORMATION ABOUT  
SIGHTSEEING ATTRACTIONS AND ENTERTAIN-  
MENT AND CULTURAL EVENTS LOCATED IN  
DIFFERENT GEOGRAPHIC AREAS, IN CLASS 41  
(U.S. CLS. 100, 101 AND 107).

FIRST USE 12-12-2006; IN COMMERCE 12-12-2006.

FOR: PROVIDING LODGING INFORMATION  
SERVICES VIA THE INTERNET, IN CLASS 43 (U.S.  
CLS. 100 AND 101).

FIRST USE 12-12-2006; IN COMMERCE 12-12-2006.

THE MARK CONSISTS OF STANDARD CHAR-  
ACTERS WITHOUT CLAIM TO ANY PARTICULAR  
FONT, STYLE, SIZE, OR COLOR.

SN 77-056,827, FILED 12-4-2006.

LINDA ESTRADA, EXAMINING ATTORNEY

**Int. Cl.: 42**

**Prior U.S. Cls.: 100 and 101**

**United States Patent and Trademark Office**

**Reg. No. 3,395,470**

**Registered Mar. 11, 2008**

---

**SERVICE MARK  
PRINCIPAL REGISTER**

**BSE**

BRADBURY, EMMETT (UNITED STATES INDIVIDUAL)  
9205 SOUTH MICHIGAN AVE.  
CHICAGO, IL 60619

THE MARK CONSISTS OF STANDARD CHARACTERS WITHOUT CLAIM TO ANY PARTICULAR FONT, STYLE, SIZE, OR COLOR.

FOR: COMPUTER SOFTWARE DESIGN FOR OTHERS, IN CLASS 42 (U.S. CLS. 100 AND 101).

SN 77-057,144, FILED 12-5-2006.

FIRST USE 7-0-2007; IN COMMERCE 7-0-2007.

LAURA KOVALSKY, EXAMINING ATTORNEY



**Int. Cl.: 35**

**Prior U.S. Cls.: 100, 101, and 102**

**United States Patent and Trademark Office**

**Reg. No. 3,395,471**

**Registered Mar. 11, 2008**

**SERVICE MARK  
PRINCIPAL REGISTER**



AD GIANTS, LLC (TEXAS LTD LIAB CO)  
8117 PRESTON ROAD, SUITE 260  
DALLAS, TX 75225

THE MARK CONSISTS OF A CIRCLE WITH A  
BACKWARDS LETTER "G" AND A FORWARDS  
LETTER "G" SITTING BACK TO BACK.

FOR: ADVERTISING AND MARKETING, IN  
CLASS 35 (U.S. CLS. 100, 101 AND 102).

SN 77-057,312, FILED 12-5-2006.

FIRST USE 9-8-2004; IN COMMERCE 9-8-2004.

RUDY R. SINGLETON, EXAMINING ATTORNEY

**Int. Cl.: 6**

**Prior U.S. Cls.: 2, 12, 13, 14, 23, 25, and 50**

**Reg. No. 3,395,472**

**United States Patent and Trademark Office**

**Registered Mar. 11, 2008**

**TRADEMARK  
PRINCIPAL REGISTER**

**CONNECTICUT SCREEN WORKS  
SCREEN WALL SYSTEM**

CONNECTICUT SCREEN WORKS, INC. (CON-  
NECTICUT CORPORATION)  
BUILDING "Q"  
121 NORTH PLAINS INDUSTRIAL ROAD  
WALLINGFORD, CT 06492

FOR: METAL WINDOW SCREENS, METAL  
SCREEN DOORS, METAL PORCH SCREENS, ME-  
TAL STORM WINDOWS, AND METAL STORM  
DOORS , IN CLASS 6 (U.S. CLS. 2, 12, 13, 14, 23, 25  
AND 50).

FIRST USE 8-31-2007; IN COMMERCE 8-31-2007.

THE MARK CONSISTS OF STANDARD CHAR-  
ACTERS WITHOUT CLAIM TO ANY PARTICULAR  
FONT, STYLE, SIZE, OR COLOR.

NO CLAIM IS MADE TO THE EXCLUSIVE  
RIGHT TO USE "CONNECTICUT SCREEN" AND  
"SCREEN WALL SYSTEM", APART FROM THE  
MARK AS SHOWN.

SN 77-057,853, FILED 12-6-2006.

JANET LEE, EXAMINING ATTORNEY

**Int. Cl.: 19**

**Prior U.S. Cls.: 1, 12, 33, and 50**

**United States Patent and Trademark Office**

**Reg. No. 3,395,473**

**Registered Mar. 11, 2008**

**TRADEMARK  
PRINCIPAL REGISTER**

**GTI SLAB-ON-GROUND CHAIRS**

GENERAL TECHNOLOGIES, INC. (TEXAS CORPORATION)  
13022 TRINITY DRIVE  
STAFFORD, TX 77477

OWNER OF U.S. REG. NOS. 2,840,181, 2,845,110,  
AND OTHERS.

FOR: NON-METAL CHAIRS USED FOR SUPPORTING REBAR AND TENDONS IN CONSTRUCTION, IN CLASS 19 (U.S. CLS. 1, 12, 33 AND 50).

NO CLAIM IS MADE TO THE EXCLUSIVE RIGHT TO USE "SLAB-ON-GROUND CHAIRS", APART FROM THE MARK AS SHOWN.

FIRST USE 0-0-2007; IN COMMERCE 0-0-2007.

SN 77-058,402, FILED 12-6-2006.

THE MARK CONSISTS OF STANDARD CHARACTERS WITHOUT CLAIM TO ANY PARTICULAR FONT, STYLE, SIZE, OR COLOR.

JULIE GUTTADAURO, EXAMINING ATTORNEY

**Int. Cl.: 19**

**Prior U.S. Cls.: 1, 12, 33, and 50**

**United States Patent and Trademark Office**

**Reg. No. 3,395,474**

**Registered Mar. 11, 2008**

**TRADEMARK  
PRINCIPAL REGISTER**

**GTI INTERSECTIONAL CHAIRS**

GENERAL TECHNOLOGIES, INC. (TEXAS CORPORATION)  
13022 TRINITY DRIVE  
STAFFORD, TX 77477

OWNER OF U.S. REG. NOS. 2,840,181, 2,845,110,  
AND OTHERS.

FOR: NON-METAL CHAIRS USED FOR SUPPORTING REBAR AND TENDONS IN CONSTRUCTION, IN CLASS 19 (U.S. CLS. 1, 12, 33 AND 50).

NO CLAIM IS MADE TO THE EXCLUSIVE RIGHT TO USE "INTERSECTIONAL CHAIRS", APART FROM THE MARK AS SHOWN.

FIRST USE 0-0-2007; IN COMMERCE 0-0-2007.

SN 77-058,421, FILED 12-6-2006.

THE MARK CONSISTS OF STANDARD CHARACTERS WITHOUT CLAIM TO ANY PARTICULAR FONT, STYLE, SIZE, OR COLOR.

JULIE GUTTADAURO, EXAMINING ATTORNEY

**Int. Cl.: 19**

**Prior U.S. Cls.: 1, 12, 33, and 50**

**United States Patent and Trademark Office**

**Reg. No. 3,395,475**

**Registered Mar. 11, 2008**

**TRADEMARK  
PRINCIPAL REGISTER**

**GTI PAVING CHAIRS**

GENERAL TECHNOLOGIES, INC. (TEXAS CORPORATION)  
13022 TRINITY DRIVE  
STAFFORD, TX 77477

OWNER OF U.S. REG. NOS. 2,840,181, 2,845,110,  
AND OTHERS.

FOR: NON-METAL CHAIRS USED FOR SUPPORTING REBAR AND TENDONS IN CONSTRUCTION, IN CLASS 19 (U.S. CLS. 1, 12, 33 AND 50).

NO CLAIM IS MADE TO THE EXCLUSIVE RIGHT TO USE "PAVING CHAIRS", APART FROM THE MARK AS SHOWN.

FIRST USE 0-0-2007; IN COMMERCE 0-0-2007.

SN 77-058,432, FILED 12-6-2006.

THE MARK CONSISTS OF STANDARD CHARACTERS WITHOUT CLAIM TO ANY PARTICULAR FONT, STYLE, SIZE, OR COLOR.

JULIE GUTTADAURO, EXAMINING ATTORNEY

**Int. Cl.: 19**

**Prior U.S. Cls.: 1, 12, 33, and 50**

**United States Patent and Trademark Office**

**Reg. No. 3,395,476**

**Registered Mar. 11, 2008**

**TRADEMARK  
PRINCIPAL REGISTER**

**ZV**

GENERAL TECHNOLOGIES, INC. (TEXAS CORPORATION)  
13022 TRINITY DRIVE  
STAFFORD, TX 77477

FOR: NON-METALLIC POST-TENSIONING CONSTRUCTION COMPONENTS, NAMELY, CHAIRS, BOLSTERS, DUCTS, SEALS FOR CORROSION-PROTECTION TUBES, DUCT SUPPORTS, ANCHORS, DUCT COUPLERS, IN CLASS 19 (U.S. CLS. 1, 12, 33 AND 50).

FIRST USE 0-0-2007; IN COMMERCE 0-0-2007.

THE MARK CONSISTS OF STANDARD CHARACTERS WITHOUT CLAIM TO ANY PARTICULAR FONT, STYLE, SIZE, OR COLOR.

OWNER OF U.S. REG. NOS. 2,418,048 AND 2,798,251.

SN 77-058,443, FILED 12-6-2006.

JULIE GUTTADAURO, EXAMINING ATTORNEY

**Int. Cl.: 19**

**Prior U.S. Cls.: 1, 12, 33, and 50**

**United States Patent and Trademark Office**

**Reg. No. 3,395,477**

**Registered Mar. 11, 2008**

**TRADEMARK  
PRINCIPAL REGISTER**

**Z-VOID**

GENERAL TECHNOLOGIES, INC. (TEXAS CORPORATION)  
13022 TRINITY DRIVE  
STAFFORD, TX 77477

FOR: NON-METALLIC POST-TENSIONING CONSTRUCTION COMPONENTS, NAMELY, CHAIRS, BOLSTERS, DUCTS, SEALS FOR CORROSION-PROTECTION TUBES, DUCT SUPPORTS, ANCHORS, DUCT COUPLERS, IN CLASS 19 (U.S. CLS. 1, 12, 33 AND 50).

FIRST USE 0-0-2007; IN COMMERCE 0-0-2007.

THE MARK CONSISTS OF STANDARD CHARACTERS WITHOUT CLAIM TO ANY PARTICULAR FONT, STYLE, SIZE, OR COLOR.

OWNER OF U.S. REG. NOS. 2,418,048 AND 2,798,251.

SN 77-058,447, FILED 12-6-2006.

JULIE GUTTADAURO, EXAMINING ATTORNEY

**Int. Cl.: 33**

**Prior U.S. Cls.: 47 and 49**

**United States Patent and Trademark Office**

**Reg. No. 3,395,478**

**Registered Mar. 11, 2008**

**TRADEMARK  
PRINCIPAL REGISTER**

**LIMONRITA**

DISTILLERIE STOCK U.S.A., LTD. (NEW YORK  
CORPORATION)  
58-58 LAUREL HILL BOULEVARD  
WOODSIDE, NY 11377

THE MARK CONSISTS OF STANDARD CHAR-  
ACTERS WITHOUT CLAIM TO ANY PARTICULAR  
FONT, STYLE, SIZE, OR COLOR.

FOR: ALCOHOLIC BEVERAGES, NAMELY,  
MIXED COCKTAILS, IN CLASS 33 (U.S. CLS. 47  
AND 49).

SN 77-059,817, FILED 12-8-2006.

FIRST USE 1-0-2007; IN COMMERCE 1-0-2007.

RICHARD A. STRASER, EXAMINING ATTORNEY



**Int. Cl.: 13**

**Prior U.S. Cls.: 2 and 9**

**United States Patent and Trademark Office**

**Reg. No. 3,395,479**

**Registered Mar. 11, 2008**

**TRADEMARK  
PRINCIPAL REGISTER**

**Genuine Novak Adjustable  
Sights**

NOVAK, WAYNE, F. (UNITED STATES INDIVIDUAL)  
1206 30TH STREET  
PARKERSBURG, WV 26101

OWNER OF U.S. REG. NOS. 1,551,485 AND 2,472,719.

FOR: ADJUSTABLE HANDGUN SIGHTS, IN CLASS 13 (U.S. CLS. 2 AND 9).

NO CLAIM IS MADE TO THE EXCLUSIVE RIGHT TO USE "GENUINE" AND "ADJUSTABLE SIGHTS", APART FROM THE MARK AS SHOWN.

FIRST USE 1-1-2007; IN COMMERCE 1-1-2007.

SN 77-060,296, FILED 12-8-2006.

THE MARK CONSISTS OF STANDARD CHARACTERS WITHOUT CLAIM TO ANY PARTICULAR FONT, STYLE, SIZE, OR COLOR.

RAUL CORDOVA, EXAMINING ATTORNEY

**Int. Cls.: 9 and 35**

**Prior U.S. Cls.: 21, 23, 26, 36, 38, 100, 101, and 102**

**United States Patent and Trademark Office**

**Reg. No. 3,395,480**

**Registered Mar. 11, 2008**

**TRADEMARK  
SERVICE MARK  
PRINCIPAL REGISTER**

**BIZTREE**

BIZTREE INC. (CANADA CORPORATION)  
555 RENE-LEVESQUE W. BLVD., SUITE 1500  
MONTREAL, QUEBEC, CANADA H2Z1B1

FOR: COMPUTER PROGRAMMES FOR DOCUMENT MANAGEMENT; COMPUTER PROGRAMS FOR WRITING BUSINESS AND LEGAL DOCUMENTS FROM TEMPLATES; DESKTOP PUBLISHING SOFTWARE; DOWNLOADABLE SOFTWARE FOR WRITING BUSINESS AND LEGAL DOCUMENTS FROM TEMPLATES, IN CLASS 9 (U.S. CLS. 21, 23, 26, 36 AND 38).

FIRST USE 3-6-2001; IN COMMERCE 4-14-2007.

FOR: ADVERTISING AND BUSINESS SERVICES, NAMELY, SECURING AIRTIME ON ALL FORMS OF MEDIA COMMUNICATIONS STATIONS, SYSTEMS, NETWORKS, AND SERVICES FOR THE PURPOSE OF PROMOTING THE GOODS AND SERVICES OF OTHERS; ADVERTISING AND COMMERCIAL INFORMATION SERVICES, VIA THE INTERNET; ADVERTISING VIA ELECTRONIC MEDIA AND SPECIFICALLY THE INTERNET; ADVERTISING, INCLUDING PROMOTION RELATING TO THE SALE OF ARTICLES AND SERVICES FOR THIRD PARTIES BY THE TRANSMISSION OF ADVERTISING MATERIAL AND THE DISSEMINATION OF ADVERTISING MESSAGES ON COMPUTER NETWORKS; AUCTION MANAGEMENT SERVICES PROVIDED TO OTHERS OVER AN ON-LINE WEB SITE ACCESSED THROUGH A GLOBAL COMPUTER NETWORK; BUSINESS NETWORKING; BUSINESS SERVICES, NAMELY, PROVIDING COMPUTER DATABASES REGARDING THE PURCHASE AND SALE OF A WIDE VARIETY OF PRODUCTS AND SERVICES OF OTHERS; BUSINESS SERVICES, NAMELY, MATCHING POTEN-

TIAL PRIVATE INVESTORS WITH ENTREPRENEURS NEEDING FUNDING; BUSINESS SERVICES, NAMELY, REGISTERING, SCREENING, CREDENTIALING, AND ORGANIZING THIRD-PARTY VENDORS, SUPPLIERS, AND CONTRACTORS, AND DOCUMENTATION AND INFORMATION ON BEHALF OF OTHERS; DISSEMINATION OF ADVERTISING FOR OTHERS VIA AN ON-LINE COMMUNICATIONS NETWORK ON THE INTERNET; DISSEMINATION OF ADVERTISING FOR OTHERS VIA THE INTERNET; EMPLOYMENT HIRING, RECRUITING, PLACEMENT, STAFFING AND CAREER NETWORKING SERVICES; GENERAL BUSINESS NETWORKING REFERRAL SERVICES, NAMELY, PROMOTING THE GOODS AND SERVICES OF OTHERS BY PASSING BUSINESS LEADS AND REFERRALS AMONG GROUP MEMBERS; ONLINE BUSINESS NETWORKING SERVICES; PROVIDING A SEARCHABLE ONLINE ADVERTISING GUIDE FEATURING THE GOODS AND SERVICES OF OTHER ON-LINE VENDORS ON THE INTERNET; PROVIDING AN ON-LINE COMMERCIAL INFORMATION DIRECTORY ON THE INTERNET; PROVIDING AND RENTAL OF ADVERTISING SPACE ON THE INTERNET, IN CLASS 35 (U.S. CLS. 100, 101 AND 102).

FIRST USE 3-6-2001; IN COMMERCE 12-4-2006.

THE MARK CONSISTS OF STANDARD CHARACTERS WITHOUT CLAIM TO ANY PARTICULAR FONT, STYLE, SIZE, OR COLOR.

SN 77-060,706, FILED 12-9-2006.

EMILY CARLSEN, EXAMINING ATTORNEY

**Int. Cl.: 30**

**Prior U.S. Cl.: 46**

**United States Patent and Trademark Office**

**Reg. No. 3,395,481**

**Registered Mar. 11, 2008**

**TRADEMARK  
PRINCIPAL REGISTER**

**QBZ**

IMPACT CONFECTIONS, INC. (NEW MEXICO  
CORPORATION)  
888 GARDEN OF THE GODS ROAD  
COLORADO SPRINGS, CO 80908

THE MARK CONSISTS OF STANDARD CHAR-  
ACTERS WITHOUT CLAIM TO ANY PARTICULAR  
FONT, STYLE, SIZE, OR COLOR.

FOR: CANDY, IN CLASS 30 (U.S. CL. 46).

SN 77-060,876, FILED 12-10-2006.

FIRST USE 4-30-2007; IN COMMERCE 4-30-2007.

GISELLE AGOSTO, EXAMINING ATTORNEY

**Int. Cl.: 10**

**Prior U.S. Cls.: 26, 39, and 44**

**United States Patent and Trademark Office**

**Reg. No. 3,395,482**

**Registered Mar. 11, 2008**

**TRADEMARK  
PRINCIPAL REGISTER**

**Oracle**

VERTIFLEX, INC. (DELAWARE CORPORATION)  
1351 CALLE AVANZADO  
SAN CLEMENTE, CA 92673

THE MARK CONSISTS OF STANDARD CHAR-  
ACTERS WITHOUT CLAIM TO ANY PARTICULAR  
FONT, STYLE, SIZE, OR COLOR.

FOR: MEDICAL DEVICES, NAMELY, TISSUE  
MANIPULATORS FOR USE IN SPINAL SURGERY;  
RETRACTORS FOR SPINAL SURGERY, IN CLASS  
10 (U.S. CLS. 26, 39 AND 44).

SN 77-060,926, FILED 12-11-2006.

FIRST USE 6-11-2007; IN COMMERCE 7-17-2007.

ERNEST SHOSHO, EXAMINING ATTORNEY

**Int. Cl.: 16**

**Prior U.S. Cls.: 2, 5, 22, 23, 29, 37, 38, and 50**

**Reg. No. 3,395,483**

**United States Patent and Trademark Office**

**Registered Mar. 11, 2008**

**TRADEMARK  
PRINCIPAL REGISTER**

# KEY CLUB

KIWANIS INTERNATIONAL, INC. (INDIANA CORPORATION)  
3636 WOODVIEW TRACE  
INDIANAPOLIS, IN 46268

FOR: PRINTED MATTER, NAMELY, MAGAZINES DIRECTED TO HIGH SCHOOL STUDENTS FEATURING NEWS AND ARTICLES ON THE SUBJECTS OF CURRENT SOCIAL TRENDS, ACADEMIA, SELF-HELP, LEADERSHIP AND COMMUNITY INVOLVEMENT, IN CLASS 16 (U.S. CLS. 2, 5, 22, 23, 29, 37, 38 AND 50).

FIRST USE 9-1-2007; IN COMMERCE 9-1-2007.

THE MARK CONSISTS OF STANDARD CHARACTERS WITHOUT CLAIM TO ANY PARTICULAR FONT, STYLE, SIZE, OR COLOR.

OWNER OF U.S. REG. NOS. 1,000,332, 1,013,122, AND OTHERS.

SN 77-061,190, FILED 12-11-2006.

JAMES STEIN, EXAMINING ATTORNEY

**Int. Cls.: 36 and 45**

**Prior U.S. Cls.: 100, 101, and 102**

**United States Patent and Trademark Office**

**Reg. No. 3,395,484**

**Registered Mar. 11, 2008**

**SERVICE MARK  
PRINCIPAL REGISTER**

**COMPASS SITE ID**

COMPASS BANCSHARES, INC. (DELAWARE CORPORATION)  
15 SOUTH 20TH STREET, 12TH FLOOR  
BIRMINGHAM, AL 35233

FOR: SITE AUTHENTICATION FEATURE OFFERED IN CONJUNCTION WITH ONLINE BANKING SERVICES, IN CLASS 36 (U.S. CLS. 100, 101 AND 102).

FIRST USE 4-22-2007; IN COMMERCE 4-22-2007.

FOR: AUTHENTICATION SERVICES, NAMELY, AUTHENTICATING USERS, USER IDENTIFICATION INFORMATION AND DIGITAL CERTIFICATES FOR ELECTRONIC TRANSACTIONS BY ONLINE BANKS AND ONLINE BANKING CUSTOMERS, IN CLASS 45 (U.S. CLS. 100 AND 101).

FIRST USE 4-22-2007; IN COMMERCE 4-22-2007.

THE MARK CONSISTS OF STANDARD CHARACTERS WITHOUT CLAIM TO ANY PARTICULAR FONT, STYLE, SIZE, OR COLOR.

OWNER OF U.S. REG. NOS. 1,604,027, 1,876,083, AND OTHERS.

NO CLAIM IS MADE TO THE EXCLUSIVE RIGHT TO USE "SITE ID", APART FROM THE MARK AS SHOWN.

SN 77-062,210, FILED 12-12-2006.

HEATHER BIDDULPH, EXAMINING ATTORNEY

**Int. Cl.: 5**

**Prior U.S. Cls.: 6, 18, 44, 46, 51, and 52**

**Reg. No. 3,395,485**

**United States Patent and Trademark Office**

**Registered Mar. 11, 2008**

---

**TRADEMARK  
PRINCIPAL REGISTER**

**OSTEODENX**

NAIDU L.P. (CALIFORNIA LIMITED PARTNER-  
SHIP)  
981 CORPORATE CENTER DRIVE, SUITE 120  
POMONA, CA 91786

THE MARK CONSISTS OF STANDARD CHAR-  
ACTERS WITHOUT CLAIM TO ANY PARTICULAR  
FONT, STYLE, SIZE, OR COLOR.

FOR: DIETARY SUPPLEMENTS, IN CLASS 5 (U.S.  
CLS. 6, 18, 44, 46, 51 AND 52).

SN 77-063,703, FILED 12-13-2006.

FIRST USE 9-9-2007; IN COMMERCE 9-9-2007.

ERIN FALK, EXAMINING ATTORNEY

**Int. Cl.: 35**

**Prior U.S. Cls.: 100, 101, and 102**

**United States Patent and Trademark Office**

**Reg. No. 3,395,486**

**Registered Mar. 11, 2008**

**SERVICE MARK  
PRINCIPAL REGISTER**

**PgMP**

PROJECT MANAGEMENT INSTITUTE, INC.  
(PENNSYLVANIA CORPORATION)  
FOUR CAMPUS BOULEVARD  
NEWTOWN SQUARE, PA 190733299

FOR: TESTING TO DETERMINE PROFESSIONAL COMPETENCY, NAMELY, TESTING AND EVALUATING OF PROFESSIONALS WORKING IN THE FIELD OF PROGRAM MANAGEMENT TO DETERMINE THEIR LEVEL OF PROFESSIONAL EXPERIENCE AND COMPETENCY IN THE CENTRALIZED, COORDINATED MANAGEMENT OF A GROUP OF PROJECTS AND SHARED RESOURCES TO ACHIEVE A STRATEGIC GOAL; BUSINESS SERVICES FOR OTHERS, NAMELY, CREDENTIALING OF PROGRAM MANAGEMENT PROFESSION-

ALS; AND BUSINESS SERVICES FOR OTHERS, NAMELY, VERIFYING AND MONITORING THE CREDENTIALS OF PROGRAM MANAGEMENT PROFESSIONALS, IN CLASS 35 (U.S. CLS. 100, 101 AND 102).

FIRST USE 3-1-2007; IN COMMERCE 10-1-2007.

THE MARK CONSISTS OF STANDARD CHARACTERS WITHOUT CLAIM TO ANY PARTICULAR FONT, STYLE, SIZE, OR COLOR.

SN 77-063,972, FILED 12-14-2006.

STEVEN PEREZ, EXAMINING ATTORNEY



**Int. Cl.: 7**

**Prior U.S. Cls.: 13, 19, 21, 23, 31, 34, and 35**

**Reg. No. 3,395,487**

**United States Patent and Trademark Office**

**Registered Mar. 11, 2008**

---

**TRADEMARK  
PRINCIPAL REGISTER**

**BARRACUDA PUMPS**

MENARD, INC. (WISCONSIN CORPORATION)

4777 MENARD DRIVE

EAU CLAIRE, WI 54703

FOR: SUMP PUMPS, IN CLASS 7 (U.S. CLS. 13, 19,  
21, 23, 31, 34 AND 35).

FIRST USE 9-0-2007; IN COMMERCE 9-0-2007.

THE MARK CONSISTS OF STANDARD CHAR-  
ACTERS WITHOUT CLAIM TO ANY PARTICULAR  
FONT, STYLE, SIZE, OR COLOR.

NO CLAIM IS MADE TO THE EXCLUSIVE  
RIGHT TO USE "PUMPS", APART FROM THE  
MARK AS SHOWN.

SN 77-064,620, FILED 12-14-2006.

BENJAMIN ALLEN, EXAMINING ATTORNEY

**Int. Cl.: 35**

**Prior U.S. Cls.: 100, 101, and 102**

**United States Patent and Trademark Office**

**Reg. No. 3,395,488**

**Registered Mar. 11, 2008**

**SERVICE MARK  
PRINCIPAL REGISTER**

**OUT IN FRONT**

PROACTIVE ENTERPRISE, INC. (ILLINOIS CORPORATION), DBA PROACTIVE WORLDWIDE, INC.,  
SUITE 400  
3701 ALGONQUIN ROAD  
ROLLING MEADOWS, IL 60008

FOR: BUSINESS CONSULTING AND BUSINESS INFORMATION FOR ENTERPRISES, NAMELY, GATHERING, ANALYZING AND PRESENTING BUSINESS INTELLIGENCE, IN CLASS 35 (U.S. CLS. 100, 101 AND 102).

FIRST USE 5-2-2007; IN COMMERCE 5-2-2007.

THE MARK CONSISTS OF STANDARD CHARACTERS WITHOUT CLAIM TO ANY PARTICULAR FONT, STYLE, SIZE, OR COLOR.

SN 77-064,754, FILED 12-14-2006.

ROBIN MITTLER, EXAMINING ATTORNEY

**Int. Cl.: 12**

**Prior U.S. Cls.: 19, 21, 23, 31, 35, and 44**

**United States Patent and Trademark Office**

**Reg. No. 3,395,489**

**Registered Mar. 11, 2008**

**TRADEMARK  
PRINCIPAL REGISTER**

**ADELANTE**

NEWPORT R&D, INC. (RHODE ISLAND CORPORATION)

1 MARITIME DRIVE

PORTSMOUTH, RI 02871

FOR: BOATS, IN CLASS 12 (U.S. CLS. 19, 21, 23, 31, 35 AND 44).

FIRST USE 12-1-2007; IN COMMERCE 12-1-2007.

THE MARK CONSISTS OF STANDARD CHARACTERS WITHOUT CLAIM TO ANY PARTICULAR FONT, STYLE, SIZE, OR COLOR.

THE ENGLISH TRANSLATION OF THE MARK IS FORWARD.

SN 77-064,891, FILED 12-15-2006.

TRACY WHITTAKER-BROWN, EXAMINING ATTORNEY

**Int. Cl.: 5**

**Prior U.S. Cls.: 6, 18, 44, 46, 51, and 52**

**United States Patent and Trademark Office**

**Reg. No. 3,395,490**

**Registered Mar. 11, 2008**

**TRADEMARK  
PRINCIPAL REGISTER**

**EQUINETRU**

ENVIROSYSTEMS, INC. (NEVADA CORPORATION)  
116 MORLAKE DRIVE, SUITE 201  
MOORESVILLE, NC 28117

FOR: TOPICAL EQUINE VETERINARY PREPARATIONS NAMELY FOR RELIEF FROM THRUSH, SCRATCHES, GIRTH ITCH, RAINROT, RINGWORM, MUD FEVER, DEW POISONING AND FUNGUS RELATED SKIN IRRITATIONS, IN CLASS 5 (U.S. CLS. 6, 18, 44, 46, 51 AND 52).

FIRST USE 11-5-2007; IN COMMERCE 11-5-2007.

THE MARK CONSISTS OF STANDARD CHARACTERS WITHOUT CLAIM TO ANY PARTICULAR FONT, STYLE, SIZE, OR COLOR.

SN 77-065,106, FILED 12-15-2006.

CAROLINE WOOD, EXAMINING ATTORNEY

**Int. Cl.: 3**

**Prior U.S. Cls.: 1, 4, 6, 50, 51, and 52**

**United States Patent and Trademark Office**

**Reg. No. 3,395,491**

**Registered Mar. 11, 2008**

**TRADEMARK  
PRINCIPAL REGISTER**

**Biotene PBF**

LACLEDE, INC. (CALIFORNIA CORPORATION)  
2013 UNIVERSITY DRIVE  
RANCHO DOMINGUEZ, CA 90220

THE MARK CONSISTS OF STANDARD CHAR-  
ACTERS WITHOUT CLAIM TO ANY PARTICULAR  
FONT, STYLE, SIZE, OR COLOR.

FOR: MOUTHWASHES, IN CLASS 3 (U.S. CLS. 1, 4,  
6, 50, 51 AND 52).

SN 77-065,200, FILED 12-15-2006.

FIRST USE 3-1-2007; IN COMMERCE 3-1-2007.

KEVON CHISOLM, EXAMINING ATTORNEY

**Int. Cl.: 36**

**Prior U.S. Cls.: 100, 101, and 102**

**United States Patent and Trademark Office**

**Reg. No. 3,395,492**

**Registered Mar. 11, 2008**

**SERVICE MARK  
PRINCIPAL REGISTER**

**AFLAC NOW CARD**

AMERICAN FAMILY LIFE ASSURANCE COMPANY OF COLUMBUS (NEBRASKA CORPORATION)  
1932 WYNNTON ROAD  
COLUMBUS, GA 31999

FOR: DEBIT CARD SERVICES IN CONNECTION WITH FLEXIBLE SPENDING ACCOUNTS, IN CLASS 36 (U.S. CLS. 100, 101 AND 102).

FIRST USE 1-3-2007; IN COMMERCE 1-3-2007.

THE MARK CONSISTS OF STANDARD CHARACTERS WITHOUT CLAIM TO ANY PARTICULAR FONT, STYLE, SIZE, OR COLOR.

NO CLAIM IS MADE TO THE EXCLUSIVE RIGHT TO USE "CARD", APART FROM THE MARK AS SHOWN.

SN 77-065,560, FILED 12-15-2006.

CHARLOTTE CORWIN, EXAMINING ATTORNEY

**Int. Cl.: 9**

**Prior U.S. Cls.: 21, 23, 26, 36, and 38**

**Reg. No. 3,395,493**

**United States Patent and Trademark Office**

**Registered Mar. 11, 2008**

---

**TRADEMARK  
PRINCIPAL REGISTER**

**SPORT OF KINGS**

MULTIMEDIA GAMES, INC. (TEXAS CORPORATION)  
206 WILD BASIN RD., BLDG B - 4TH FLR  
AUSTIN, TX 78746

THE MARK CONSISTS OF STANDARD CHARACTERS WITHOUT CLAIM TO ANY PARTICULAR FONT, STYLE, SIZE, OR COLOR.

FOR: GAMING MACHINES, NAMELY, ELECTRONIC SLOT AND BINGO MACHINES; VIDEO LOTTERY TERMINALS, IN CLASS 9 (U.S. CLS. 21, 23, 26, 36 AND 38).

SN 77-066,239, FILED 12-18-2006.

FIRST USE 11-1-2007; IN COMMERCE 11-1-2007.

EMILY CARLSEN, EXAMINING ATTORNEY

**Int. Cl.: 42**

**Prior U.S. Cls.: 100 and 101**

**United States Patent and Trademark Office**

**Reg. No. 3,395,494**

**Registered Mar. 11, 2008**

**SERVICE MARK  
PRINCIPAL REGISTER**

**IOTA**

C.G.R.S., INC. (COLORADO CORPORATION)  
P.O. BOX 1489  
FORT COLLINS, CO 80522

FIRST USE 11-12-2007; IN COMMERCE 11-12-2007.

FOR: LEAK DETECTION SERVICES, NAMELY,  
MONITORING OF COMMERCIAL AND INDUS-  
TRIAL SITES FOR DETECTION OF ORGANIC  
AND INORGANIC COMPOUNDS, IN CLASS 42  
(U.S. CLS. 100 AND 101).

THE MARK CONSISTS OF STANDARD CHAR-  
ACTERS WITHOUT CLAIM TO ANY PARTICULAR  
FONT, STYLE, SIZE, OR COLOR.

SN 77-067,322, FILED 12-19-2006.

SARA THOMAS, EXAMINING ATTORNEY



**Int. Cl.: 5**

**Prior U.S. Cls.: 6, 18, 44, 46, 51, and 52**

**United States Patent and Trademark Office**

**Reg. No. 3,395,495**

**Registered Mar. 11, 2008**

**TRADEMARK  
PRINCIPAL REGISTER**

**Ephedrasim**



NATURE'S HEALTH AND NUTRITION INC  
(FLORIDA CORPORATION)  
PO BOX 770866  
MIAMI, FL 33177

FOR: DIETARY AND NUTRITIONAL SUPPLEMENTS; DIETARY FOOD SUPPLEMENTS; DIETARY SUPPLEMENTS; DIETARY SUPPLEMENTS FOR HUMAN CONSUMPTION; FOOD SUPPLEMENTS; HERBAL SUPPLEMENTS; MINERAL NUTRITIONAL SUPPLEMENTS; NUTRITIONAL SUPPLEMENTS, IN CLASS 5 (U.S. CLS. 6, 18, 44, 46, 51 AND 52).

FIRST USE 4-0-2006; IN COMMERCE 2-0-2007.

THE COLOR(S) BLACK AND RED IS/ARE CLAIMED AS A FEATURE OF THE MARK.

THE MARK CONSISTS OF "EPHEDRASIM" IN BLACK AND A RED STREAK BELOW.

SN 77-068,284, FILED 12-20-2006.

ZHALEH DELANEY, EXAMINING ATTORNEY

**Int. Cl.: 30**

**Prior U.S. Cl.: 46**

**United States Patent and Trademark Office**

**Reg. No. 3,395,496**

**Registered Mar. 11, 2008**

**TRADEMARK  
PRINCIPAL REGISTER**

**SUNRISE CROISSANT**

CARL KARCHER ENTERPRISES, INC. (CALI-  
FORNIA CORPORATION)  
6307 CARPINTERIA AVE., SUITE A  
CARPINTERIA, CA 930132901

FOR: SANDWICHES FOR CONSUMPTION ON  
AND OFF THE PREMISES, IN CLASS 30 (U.S. CL. 46).

FIRST USE 5-0-2005; IN COMMERCE 5-0-2005.

THE MARK CONSISTS OF STANDARD CHAR-  
ACTERS WITHOUT CLAIM TO ANY PARTICULAR  
FONT, STYLE, SIZE, OR COLOR.

OWNER OF U.S. REG. NOS. 1,247,828 AND  
1,475,401.

NO CLAIM IS MADE TO THE EXCLUSIVE  
RIGHT TO USE "CROISSANT", APART FROM  
THE MARK AS SHOWN.

SN 77-068,405, FILED 12-20-2006.

JENNIFER HETU, EXAMINING ATTORNEY

**Int. Cl.: 9**

**Prior U.S. Cls.: 21, 23, 26, 36, and 38**

**Reg. No. 3,395,497**

**United States Patent and Trademark Office**

**Registered Mar. 11, 2008**

---

**TRADEMARK  
PRINCIPAL REGISTER**

**DIRECT ADVANTAGE**

SAWGRASS TECHNOLOGIES, INC. (SOUTH  
CAROLINA CORPORATION)  
2233 HIGHWAY 17 NORTH  
MOUNT PLEASANT, SC 29466

THE MARK CONSISTS OF STANDARD CHAR-  
ACTERS WITHOUT CLAIM TO ANY PARTICULAR  
FONT, STYLE, SIZE, OR COLOR.

FOR: COMPUTER PRINTERS, IN CLASS 9 (U.S.  
CLS. 21, 23, 26, 36 AND 38).

SN 77-068,713, FILED 12-20-2006.

FIRST USE 1-15-2007; IN COMMERCE 1-15-2007.

LINDA POWELL, EXAMINING ATTORNEY

**Int. Cl.: 9**

**Prior U.S. Cls.: 21, 23, 26, 36, and 38**

**United States Patent and Trademark Office**

**Reg. No. 3,395,498**

**Registered Mar. 11, 2008**

**TRADEMARK  
PRINCIPAL REGISTER**

**FORTUNE SEEKER**

WMS GAMING INC. (DELAWARE CORPORATION)  
800 SOUTH NORTHPOINT BOULEVARD  
WAUKEGAN, IL 60085

FOR: GAMING MACHINES THAT GENERATE OR DISPLAY WAGER OUTCOMES; GAMING SOFTWARE THAT GENERATES OR DISPLAYS WAGER OUTCOMES OF GAMING MACHINES, IN CLASS 9 (U.S. CLS. 21, 23, 26, 36 AND 38).

FIRST USE 11-13-2007; IN COMMERCE 11-13-2007.

THE MARK CONSISTS OF STANDARD CHARACTERS WITHOUT CLAIM TO ANY PARTICULAR FONT, STYLE, SIZE, OR COLOR.

SN 77-069,044, FILED 12-21-2006.

KIMBERLY FRYE, EXAMINING ATTORNEY

**Int. Cl.: 5**

**Prior U.S. Cls.: 6, 18, 44, 46, 51, and 52**

**United States Patent and Trademark Office**

**Reg. No. 3,395,499**

**Registered Mar. 11, 2008**

**TRADEMARK  
PRINCIPAL REGISTER**

**CORE4LIFE CHROMAX**

NUTRITION 21, INC. (NEW YORK CORPORATION)  
4 MANHATTANVILLE ROAD  
PURCHASE, NY 105772197

THE MARK CONSISTS OF STANDARD CHARACTERS WITHOUT CLAIM TO ANY PARTICULAR FONT, STYLE, SIZE, OR COLOR.

FOR: DIETARY AND NUTRITIONAL SUPPLEMENTS, IN CLASS 5 (U.S. CLS. 6, 18, 44, 46, 51 AND 52).

SN 77-069,235, FILED 12-21-2006.

FIRST USE 9-28-2007; IN COMMERCE 9-28-2007.

PAUL E. FAHRENKOPF, EXAMINING ATTORNEY

**Int. Cl.: 35**

**Prior U.S. Cls.: 100, 101, and 102**

**United States Patent and Trademark Office**

**Reg. No. 3,395,500**

**Registered Mar. 11, 2008**

**SERVICE MARK  
PRINCIPAL REGISTER**



PRO FLOW DYNAMICS, LLC (DELAWARE LTD  
LIAB CO)  
330 S. MAPLE #F+G  
CORONA, CA 92880

FIRST USE 3-1-2007; IN COMMERCE 3-1-2007.

SN 77-071,250, FILED 12-26-2006.

FOR: ONLINE RETAIL STORE SERVICES FEATURING DIVERSE FLUID HANDLING COMPONENTS AND INDUSTRIAL MEASUREMENT SYSTEMS, IN CLASS 35 (U.S. CLS. 100, 101 AND 102).

JASON BLAIR, EXAMINING ATTORNEY

**Int. Cl.: 19**

**Prior U.S. Cls.: 1, 12, 33, and 50**

**United States Patent and Trademark Office**

**Reg. No. 3,395,501**

**Registered Mar. 11, 2008**

**TRADEMARK  
PRINCIPAL REGISTER**

**TERRAMICA**

POTLATCH FOREST PRODUCTS CORPORATION (DELAWARE CORPORATION)  
601 W. RIVERSIDE AVENUE, SUITE 1100  
SPOKANE, WA 99201

THE MARK CONSISTS OF STANDARD CHARACTERS WITHOUT CLAIM TO ANY PARTICULAR FONT, STYLE, SIZE, OR COLOR.

FOR: PARTICLEBOARD, IN CLASS 19 (U.S. CLS. 1, 12, 33 AND 50).

SN 77-071,272, FILED 12-26-2006.

FIRST USE 7-15-2007; IN COMMERCE 7-15-2007.

EMILY CARLSEN, EXAMINING ATTORNEY

Int. Cl.: 31

Prior U.S. Cls.: 1 and 46

United States Patent and Trademark Office

Reg. No. 3,395,502

Registered Mar. 11, 2008

TRADEMARK  
PRINCIPAL REGISTER

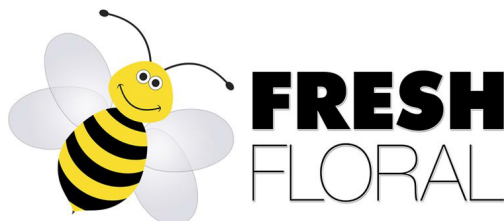

WESTLAND FLORAL COMPANY (CALIFORNIA CORPORATION)  
1400 CRAVENS LANE  
CARPINTERIA, CA 93013

FOR: LIVE FLOWERS, IN CLASS 31 (U.S. CLS. 1 AND 46).

FIRST USE 1-3-2008; IN COMMERCE 1-3-2008.

NO CLAIM IS MADE TO THE EXCLUSIVE RIGHT TO USE "FRESH FLORAL", APART FROM THE MARK AS SHOWN.

THE COLOR(S) BLACK, WHITE, GREY AND YELLOW IS/ARE CLAIMED AS A FEATURE OF THE MARK.

THE MARK CONSISTS OF A HAPPY BUMBLE BEE WITH THE TEXT OF "FRESH FLORAL". THE BUMBLE BEE HAS A BLACK ANTENNA WITH BLACK AND WHITE EYES AND A BLACK SMILE. THE BUMBLE BEE HAS A YELLOW FACE WITH A YELLOW AND BLACK STRIPE BODY. THE WINGS OF THE BEE ARE GREY. NEXT TO THE BEE IN BLACK BOLD FONT IS THE WORD "FRESH". UNDERNEATH THE WORD "FRESH" IN LIGHT BLACK TYPE FONT IS THE WORD "FLORAL".

SN 77-072,183, FILED 12-27-2006.

HENRY S. ZAK, EXAMINING ATTORNEY



**Int. Cl.: 17**

**Prior U.S. Cls.: 1, 5, 12, 13, 35, and 50**

**United States Patent and Trademark Office**

**Reg. No. 3,395,503**

**Registered Mar. 11, 2008**

**TRADEMARK  
PRINCIPAL REGISTER**

**RUBEX**

RUBEX, INC. (OHIO CORPORATION)  
3709 GROVE CITY ROAD  
GROVE CITY, OH 43123

FOR: ADHESIVE SEALANT AND CAULKING  
COMPOUND; ADHESIVE TAPE FOR INDUSTRIAL  
AND COMMERCIAL USE; RUBBER SEALANT FOR  
CAULKING AND ADHESIVE PURPOSES, IN CLASS  
17 (U.S. CLS. 1, 5, 12, 13, 35 AND 50).

FIRST USE 1-17-2007; IN COMMERCE 1-17-2007.

THE MARK CONSISTS OF STANDARD CHAR-  
ACTERS WITHOUT CLAIM TO ANY PARTICULAR  
FONT, STYLE, SIZE, OR COLOR.

SN 77-073,643, FILED 12-29-2006.

JANICE KIM, EXAMINING ATTORNEY

**Int. Cl.: 9**

**Prior U.S. Cls.: 21, 23, 26, 36, and 38**

**United States Patent and Trademark Office**

**Reg. No. 3,395,504**

**Registered Mar. 11, 2008**

**TRADEMARK  
PRINCIPAL REGISTER**

**WHIPPING WILD**

WMS GAMING INC. (DELAWARE CORPORATION)  
800 SOUTH NORTHPOINT BOULEVARD  
WAUKEGAN, IL 60085

FOR: GAMING MACHINES THAT GENERATE OR DISPLAY WAGER OUTCOMES; GAMING SOFTWARE THAT GENERATES OR DISPLAYS WAGER OUTCOMES OF GAMING MACHINES, IN CLASS 9 (U.S. CLS. 21, 23, 26, 36 AND 38).

FIRST USE 9-28-2007; IN COMMERCE 9-28-2007.

THE MARK CONSISTS OF STANDARD CHARACTERS WITHOUT CLAIM TO ANY PARTICULAR FONT, STYLE, SIZE, OR COLOR.

SN 77-074,530, FILED 1-2-2007.

KIMBERLY FRYE, EXAMINING ATTORNEY

**Int. Cl.: 3**

**Prior U.S. Cls.: 1, 4, 6, 50, 51, and 52**

**United States Patent and Trademark Office**

**Reg. No. 3,395,505**

**Registered Mar. 11, 2008**

**TRADEMARK  
PRINCIPAL REGISTER**

# Ready Reeds

GAINES GROUP LLC (TEXAS LTD LIAB CO)  
SUITE A-100  
2901 W. SAM HOUSTON PARKWAY  
HOUSTON, TX 77043

FOR: FRAGRANCES FOR PERSONAL USE;  
ROOM FRAGRANCE REFILLS FOR NON-ELEC-  
TRIC ROOM FRAGRANCE DISPENSERS; ROOM  
FRAGRANCES, IN CLASS 3 (U.S. CLS. 1, 4, 6, 50, 51  
AND 52).

FIRST USE 10-19-2007; IN COMMERCE 10-19-2007.

THE MARK CONSISTS OF STANDARD CHAR-  
ACTERS WITHOUT CLAIM TO ANY PARTICULAR  
FONT, STYLE, SIZE, OR COLOR.

NO CLAIM IS MADE TO THE EXCLUSIVE  
RIGHT TO USE "REEDS", APART FROM THE  
MARK AS SHOWN.

SN 77-075,324, FILED 1-3-2007.

LAURA KOVALSKY, EXAMINING ATTORNEY

**Int. Cl.: 9**

**Prior U.S. Cls.: 21, 23, 26, 36, and 38**

**United States Patent and Trademark Office**

**Reg. No. 3,395,506**

**Registered Mar. 11, 2008**

**TRADEMARK  
PRINCIPAL REGISTER**

**GAME TRAVELER**

R.D.S. INDUSTRIES, INC. (CALIFORNIA CORPORATION)  
1942 W. ARTESIA BLVD.  
TORRANCE, CA 90504

OWNER OF U.S. REG. NO. 2,507,205.

FOR: CARRYING CASES FOR VIDEO GAME CONSOLES AND ACCESSORIES, IN CLASS 9 (U.S. CLS. 21, 23, 26, 36 AND 38).

NO CLAIM IS MADE TO THE EXCLUSIVE RIGHT TO USE "GAME", APART FROM THE MARK AS SHOWN.

FIRST USE 11-30-2007; IN COMMERCE 11-30-2007.

SN 77-075,374, FILED 1-3-2007.

THE MARK CONSISTS OF STANDARD CHARACTERS WITHOUT CLAIM TO ANY PARTICULAR FONT, STYLE, SIZE, OR COLOR.

LAURA KOVALSKY, EXAMINING ATTORNEY

**Int. Cl.: 41**

**Prior U.S. Cls.: 100, 101, and 107**

**United States Patent and Trademark Office**

**Reg. No. 3,395,507**

**Registered Mar. 11, 2008**

**SERVICE MARK  
PRINCIPAL REGISTER**

**AROUND THE NET**

G4 MEDIA, INC. (DELAWARE CORPORATION)  
5750 WILSHIRE BLVD.  
LOS ANGELES, CA 90036

FOR: ENTERTAINMENT IN THE NATURE OF AN ONGOING PODCAST, WEBCAST OR TELEVISION PROGRAM IN THE FIELDS OF THE INTERNET, INTERNET CONTENT, ACTION, ADVENTURE, ARCADE, ANIMATION, COMEDY, STRATEGY, INTERNATIONAL AND FOREIGN LANGUAGE, NEWS, FANTASY, SPORTS, DOCUMENTARY, RACING, MUSIC, GAME OR TALK

AND QUIZ SHOW FORMAT, IN CLASS 41 (U.S. CLS. 100, 101 AND 107).

FIRST USE 1-29-2007; IN COMMERCE 1-29-2007.

THE MARK CONSISTS OF STANDARD CHARACTERS WITHOUT CLAIM TO ANY PARTICULAR FONT, STYLE, SIZE, OR COLOR.

SN 77-076,713, FILED 1-5-2007.

LAURIE KAUFMAN, EXAMINING ATTORNEY

**Int. Cl.: 36**

**Prior U.S. Cls.: 100, 101, and 102**

**United States Patent and Trademark Office**

**Reg. No. 3,395,508**

**Registered Mar. 11, 2008**

**SERVICE MARK  
PRINCIPAL REGISTER**

**MaxMentum**

MAXMENTUM REALTY, LLC (TEXAS LTD LIAB  
CO)  
14227 RIDGE DALE  
SAN ANTONIO, TX 78233

FOR: EVALUATION OF REAL PROPERTY; LEAS-  
ING OF REAL PROPERTY; PROVIDING INFOR-  
MATION IN THE FIELD OF REAL ESTATE VIA  
THE INTERNET; PROVIDING REAL ESTATE LIST-  
INGS AND REAL ESTATE INFORMATION VIA  
THE INTERNET; REAL ESTATE AGENCIES; REAL  
ESTATE APPRAISAL; REAL ESTATE BROKERAGE;  
REAL ESTATE CONSULTATION; REAL ESTATE  
LISTING; REAL ESTATE MANAGEMENT; REAL

ESTATE MULTIPLE LISTING SERVICES; REAL  
ESTATE PROCUREMENT FOR OTHERS, IN CLASS  
36 (U.S. CLS. 100, 101 AND 102).

FIRST USE 2-1-2007; IN COMMERCE 2-1-2007.

THE MARK CONSISTS OF STANDARD CHAR-  
ACTERS WITHOUT CLAIM TO ANY PARTICULAR  
FONT, STYLE, SIZE, OR COLOR.

SN 77-077,404, FILED 1-5-2007.

EMILY CARLSEN, EXAMINING ATTORNEY

**Int. Cl.: 16**

**Prior U.S. Cls.: 2, 5, 22, 23, 29, 37, 38, and 50**

**Reg. No. 3,395,509**

**United States Patent and Trademark Office**

**Registered Mar. 11, 2008**

**TRADEMARK  
PRINCIPAL REGISTER**

**Faithful Sister Magazine**

HOLLEY, PAMELA M. (UNITED STATES INDIVIDUAL)  
813 JOINES ST.  
HIGH POINT, NC 27263

FOR: MAGAZINE PUBLISHED QUARTERLY ON THE SUBJECT OF SELF IMPROVEMENT AND INSPIRATION FOR TEEN GIRLS, IN CLASS 16 (U.S. CLS. 2, 5, 22, 23, 29, 37, 38 AND 50).

FIRST USE 6-1-2007; IN COMMERCE 8-1-2007.

THE MARK CONSISTS OF STANDARD CHARACTERS WITHOUT CLAIM TO ANY PARTICULAR FONT, STYLE, SIZE, OR COLOR.

NO CLAIM IS MADE TO THE EXCLUSIVE RIGHT TO USE "MAGAZINE", APART FROM THE MARK AS SHOWN.

SN 77-077,500, FILED 1-6-2007.

SARA THOMAS, EXAMINING ATTORNEY

**Int. Cl.: 41**

**Prior U.S. Cls.: 100, 101, and 107**

**United States Patent and Trademark Office**

**Reg. No. 3,395,510**

**Registered Mar. 11, 2008**

**SERVICE MARK  
PRINCIPAL REGISTER**

# Boss Whispering

CRAWSHAW, LAURA A. (UNITED STATES IN-  
DIVIDUAL)  
1803 NE 48TH AVE.  
PORTLAND, OR 972132019

FOR: PERSONAL COACHING SERVICES IN THE  
FIELD OF COACHING ABRASIVE EXECUTIVES,  
MANAGERS, AND SUPERVISORS, IN CLASS 41  
(U.S. CLS. 100, 101 AND 107).

FIRST USE 9-15-2007; IN COMMERCE 9-15-2007.

THE MARK CONSISTS OF STANDARD CHAR-  
ACTERS WITHOUT CLAIM TO ANY PARTICULAR  
FONT, STYLE, SIZE, OR COLOR.

NO CLAIM IS MADE TO THE EXCLUSIVE  
RIGHT TO USE "BOSS", APART FROM THE MARK  
AS SHOWN.

SN 77-077,590, FILED 1-7-2007.

BRIAN CALLAGHAN, EXAMINING ATTORNEY



**Int. Cl.: 20**

**Prior U.S. Cls.: 2, 13, 22, 25, 32, and 50**

**Reg. No. 3,395,511**

**United States Patent and Trademark Office**

**Registered Mar. 11, 2008**

---

**TRADEMARK  
PRINCIPAL REGISTER**

**TAKE-A-SEAT**

R & H ENTERPRISES LLC (WISCONSIN LTD  
LIAB CO)  
360 EVELYN AVENUE  
DELAFIELD, WI 53018

THE MARK CONSISTS OF STANDARD CHAR-  
ACTERS WITHOUT CLAIM TO ANY PARTICULAR  
FONT, STYLE, SIZE, OR COLOR.

FOR: COLLAPSIBLE FURNITURE THAT IS AT-  
TACHABLE TO VEHICLES, NAMELY, CHAIRS,  
BENCHES AND TABLES, IN CLASS 20 (U.S. CLS. 2,  
13, 22, 25, 32 AND 50).

SN 77-077,859, FILED 1-8-2007.

FIRST USE 11-29-2007; IN COMMERCE 11-29-2007.

KATHERINE CHANG, EXAMINING ATTORNEY

**Int. Cl.: 35**

**Prior U.S. Cls.: 100, 101, and 102**

**United States Patent and Trademark Office**

**Reg. No. 3,395,512**

**Registered Mar. 11, 2008**

**SERVICE MARK  
PRINCIPAL REGISTER**

**BOND&BOWERY**

C/34 CORPORATION (MARYLAND CORPORATION)  
P. O. BOX 60248  
POTOMAC, MD 20859

FOR: ON-LINE RETAIL STORE SERVICES IN THE FIELDS OF ANTIQUES AND FINE ART; PROVIDING AN ON-LINE SHOWROOM FOR THE GOODS OF OTHERS IN THE FIELDS OF ANTIQUES AND FINE ART , IN CLASS 35 (U.S. CLS. 100, 101 AND 102).

FIRST USE 8-22-2007; IN COMMERCE 8-22-2007.

THE MARK CONSISTS OF STANDARD CHARACTERS WITHOUT CLAIM TO ANY PARTICULAR FONT, STYLE, SIZE, OR COLOR.

SN 77-078,097, FILED 1-8-2007.

MICHAEL KEATING, EXAMINING ATTORNEY

**Int. Cl.: 36**

**Prior U.S. Cls.: 100, 101, and 102**

**United States Patent and Trademark Office**

**Reg. No. 3,395,513**

**Registered Mar. 11, 2008**

---

**SERVICE MARK  
PRINCIPAL REGISTER**

**LIBERTY ADVANTAGE**

FIRST CITIZENS BANCSHARES, INC. (DELA-  
WARE CORPORATION)  
4300 SIX FORKS ROAD  
RALEIGH, NC 27609

THE MARK CONSISTS OF STANDARD CHAR-  
ACTERS WITHOUT CLAIM TO ANY PARTICULAR  
FONT, STYLE, SIZE, OR COLOR.

FOR: BANKING SERVICES, IN CLASS 36 (U.S.  
CLS. 100, 101 AND 102).

SN 77-078,266, FILED 1-8-2007.

FIRST USE 4-1-2007; IN COMMERCE 4-1-2007.

KATHY DE JONGE, EXAMINING ATTORNEY

**Int. Cl.: 13**

**Prior U.S. Cls.: 2 and 9**

**United States Patent and Trademark Office**

**Reg. No. 3,395,514**

**Registered Mar. 11, 2008**

**TRADEMARK  
PRINCIPAL REGISTER**

**SAFESHELL**

THE RICKY GRAY, MIKE HALL AND JEFF  
GREGORY PARTNERSHIP (FLORIDA PART-  
NERSHIP)  
P.O. BOX 1839  
LYNN HAVEN, FL 32444

FOR: FIREARM DISABLING DEVICES, NAME-  
LY, JAMMING DEVICES IN THE NATURE OF  
AMMUNITION LIKE CASINGS, WHICH WHEN  
ACTIVATED, JAM THE FIREARM MAKING IT  
INOPERABLE , IN CLASS 13 (U.S. CLS. 2 AND 9).

FIRST USE 4-0-2007; IN COMMERCE 4-0-2007.

THE MARK CONSISTS OF STANDARD CHAR-  
ACTERS WITHOUT CLAIM TO ANY PARTICULAR  
FONT, STYLE, SIZE, OR COLOR.

SN 77-079,065, FILED 1-9-2007.

JENNIFER MARTIN, EXAMINING ATTORNEY

**Int. Cl.: 10**

**Prior U.S. Cls.: 26, 39, and 44**

**United States Patent and Trademark Office**

**Reg. No. 3,395,515**

**Registered Mar. 11, 2008**

**TRADEMARK  
PRINCIPAL REGISTER**

# NeoDrape

SPECIALTY MEDICAL PRODUCTS, INC. (GEORGIA CORPORATION)  
SUITE 101  
103 SPRINGFIELD CENTER DRIVE  
WOODSTOCK, GA 30188

FOR: POLYETHYLENE OCCLUSIVE SURGICAL DRAPES AND DRAPES USED FOR EXAMINATION PURPOSES DURING REHABILITATION THAT DO NOT BLOCK HEAT , IN CLASS 10 (U.S. CLS. 26, 39 AND 44).

FIRST USE 12-31-2007; IN COMMERCE 12-31-2007.

THE MARK CONSISTS OF STANDARD CHARACTERS WITHOUT CLAIM TO ANY PARTICULAR FONT, STYLE, SIZE, OR COLOR.

SN 77-079,799, FILED 1-10-2007.

SIMON TENG, EXAMINING ATTORNEY

**Int. Cl.: 36**

**Prior U.S. Cls.: 100, 101, and 102**

**United States Patent and Trademark Office**

**Reg. No. 3,395,516**

**Registered Mar. 11, 2008**

**SERVICE MARK  
PRINCIPAL REGISTER**

**SOLD FOR THE CURE**

THE SUSAN G. KOMEN BREAST CANCER  
FOUNDATION, INC. (TEXAS NON-PROFIT  
CORPORATION)  
5005 LBJ FREEWAY, SUITE 250  
DALLAS, TX 75244

FOR: CHARITABLE FUNDRAISING SERVICES,  
NAMELY, RAISING MONEY FOR BREAST CAN-  
CER RESEARCH AND BREAST HEALTH AWARE-  
NESS PROGRAMS, IN CLASS 36 (U.S. CLS. 100, 101  
AND 102).

FIRST USE 3-5-2007; IN COMMERCE 3-5-2007.

THE MARK CONSISTS OF STANDARD CHAR-  
ACTERS WITHOUT CLAIM TO ANY PARTICULAR  
FONT, STYLE, SIZE, OR COLOR.

OWNER OF U.S. REG. NOS. 1,593,469, 2,406,792,  
AND OTHERS.

SN 77-079,996, FILED 1-10-2007.

ELLEN B. AWRICH, EXAMINING ATTORNEY

**Int. Cl.: 35**

**Prior U.S. Cls.: 100, 101, and 102**

**United States Patent and Trademark Office**

**Reg. No. 3,395,517**

**Registered Mar. 11, 2008**

**SERVICE MARK  
PRINCIPAL REGISTER**

**START WITH TRUST**

COUNCIL OF BETTER BUSINESS BUREAUS,  
INC. (DELAWARE CORPORATION)  
SUITE 800  
4200 WILSON BOULEVARD  
ARLINGTON, VA 22203

FOR: INVESTIGATIVE AND INFORMATION  
SERVICES RELATIVE TO BUSINESS AND TRADE  
PRACTICES FOR PROTECTING RESPONSIBLE  
BUSINESS AND THE PUBLIC AGAINST ABUSIVE  
BUSINESS PRACTICES AND FOR ESTABLISHING  
AND MAINTAINING LEGITIMATE ADVERTISING

AND MERCHANDISING PRACTICES, IN CLASS 35  
(U.S. CLS. 100, 101 AND 102).

FIRST USE 10-1-2007; IN COMMERCE 10-1-2007.

THE MARK CONSISTS OF STANDARD CHAR-  
ACTERS WITHOUT CLAIM TO ANY PARTICULAR  
FONT, STYLE, SIZE, OR COLOR.

SN 77-080,561, FILED 1-11-2007.

SARA THOMAS, EXAMINING ATTORNEY

**Int. Cl.: 10**

**Prior U.S. Cls.: 26, 39, and 44**

**United States Patent and Trademark Office**

**Reg. No. 3,395,518**

**Registered Mar. 11, 2008**

**TRADEMARK  
PRINCIPAL REGISTER**

**DPS**  
Dynamic  
Pressure Sensing  

---

TECHNOLOGY

MILESTONE SCIENTIFIC, INC. (DELAWARE  
CORPORATION)  
220 SOUTH ORANGE, SUITE 102  
LIVINGSTON, NJ 07039

FOR: NEEDLE-BASED INJECTION SYSTEMS, IN  
CLASS 10 (U.S. CLS. 26, 39 AND 44).

FIRST USE 2-22-2007; IN COMMERCE 3-14-2007.

NO CLAIM IS MADE TO THE EXCLUSIVE  
RIGHT TO USE "DYNAMIC PRESSURE SENSING  
TECHNOLOGY", APART FROM THE MARK AS  
SHOWN.

SN 77-080,581, FILED 1-11-2007.

SIMON TENG, EXAMINING ATTORNEY



**Int. Cl.: 7**

**Prior U.S. Cls.: 13, 19, 21, 23, 31, 34, and 35**

**Reg. No. 3,395,519**

**United States Patent and Trademark Office**

**Registered Mar. 11, 2008**

**TRADEMARK  
PRINCIPAL REGISTER**

**YUUHATSU**

FERNANDEZ, ROGER (UNITED STATES INDIVIDUAL)  
6804 SW 98TH STREET  
PINECREST, FL 33156

FOR: TURBO AND DIESEL INJECTION SPARE PARTS FOR ENGINES, NAMELY, TURBOCHARGERS, CENTER HOUSING AND ROTATING ASSEMBLY (CHRA) CARTRIDGES FOR TURBOCHARGERS, BEARINGS, THRUST BEARINGS, BUSHINGS, PISTON RINGS, TURBOCHARGER COMPRESSOR WHEELS, BACKPLATES FOR TURBOCHARGER COMPRESSORS; TURBOCHARGER SERVICE KITS FOR ENGINES COMPRISED OF BUSHINGS, PISTON RINGS, ENGINE SEALS, AND O RING ENGINE SEALS FOR TURBOCHARGERS; SPARE PARTS FOR DIESEL INJECTION PUMPS FOR DIESEL ENGINES, NAMELY, NOZZLES, VALVES, PLUNGERS, BARRELS, HEADS AND ROTORS; GASKET KITS FOR THE REPAIR

OF DIESEL INJECTION PUMPS FOR DIESEL ENGINES, COMPOSED OF ENGINE SEALS, GASKETS FOR ENGINES, WASHERS, AND O RING ENGINE SEALS, IN CLASS 7 (U.S. CLS. 13, 19, 21, 23, 31, 34 AND 35).

FIRST USE 4-10-2007; IN COMMERCE 4-12-2007.

THE MARK CONSISTS OF STANDARD CHARACTERS WITHOUT CLAIM TO ANY PARTICULAR FONT, STYLE, SIZE, OR COLOR.

THE FOREIGN WORDING IN THE MARK TRANSLATES INTO ENGLISH AS "INTRODUCE".

SN 77-080,659, FILED 1-11-2007.

STEPHEN AQUILA, EXAMINING ATTORNEY

**Int. Cl.: 3**

**Prior U.S. Cls.: 1, 4, 6, 50, 51, and 52**

**Reg. No. 3,395,520**

**United States Patent and Trademark Office**

**Registered Mar. 11, 2008**

---

**TRADEMARK  
PRINCIPAL REGISTER**

**INTERCEPT**

MINNTECH CORPORATION (MINNESOTA CORPORATION)  
14605 28TH AVENUE NORTH  
MINNEAPOLIS, MN 55447

THE MARK CONSISTS OF STANDARD CHARACTERS WITHOUT CLAIM TO ANY PARTICULAR FONT, STYLE, SIZE, OR COLOR.

FOR: PREMOISTENED DETERGENT WIPES FOR CLEANING MEDICAL DEVICES AND RELATED ACCESSORIES, IN CLASS 3 (U.S. CLS. 1, 4, 6, 50, 51 AND 52).

SN 77-081,612, FILED 1-12-2007.

FIRST USE 8-3-2007; IN COMMERCE 8-3-2007.

JULIE WATSON, EXAMINING ATTORNEY

**Int. Cl.: 21**

**Prior U.S. Cls.: 2, 13, 23, 29, 30, 33, 40, and 50**

**United States Patent and Trademark Office**

**Reg. No. 3,395,521**

**Registered Mar. 11, 2008**

**TRADEMARK  
PRINCIPAL REGISTER**

**BIO GRO**

YUAN CHENG INDUSTRIAL LIMITED (CHINA  
CORPORATION)  
5705, 57TH FLOOR, THE CENTER  
99 QUEEN'S ROAD CENTRAL  
HONG KONG, CHINA 999077

FOR: FLOWER POTS AND VASES, IN CLASS 21  
(U.S. CLS. 2, 13, 23, 29, 30, 33, 40 AND 50).

FIRST USE 1-8-2007; IN COMMERCE 3-10-2007.

THE MARK CONSISTS OF STANDARD CHAR-  
ACTERS WITHOUT CLAIM TO ANY PARTICULAR  
FONT, STYLE, SIZE, OR COLOR.

SN 77-081,651, FILED 1-12-2007.

KATHLEEN M. VANSTON, EXAMINING ATTOR-  
NEY

**Int. Cl.: 16**

**Prior U.S. Cls.: 2, 5, 22, 23, 29, 37, 38, and 50**

**United States Patent and Trademark Office**

**Reg. No. 3,395,522**

**Registered Mar. 11, 2008**

**TRADEMARK  
PRINCIPAL REGISTER**

**VANISHING TABLES**

VOLPE, FRANK J. JR. (UNITED STATES INDIVIDUAL)  
4777 BROOKWOOD COURT  
CARLSBAD, CA 920106577

FOR: ADHESIVE NOTE PADS; PUBLICATIONS, NAMELY, BROCHURES, BOOKLETS, AND TEACHING MATERIALS IN THE FIELD OF MATHEMATICS, IN CLASS 16 (U.S. CLS. 2, 5, 22, 23, 29, 37, 38 AND 50).

FIRST USE 7-1-2007; IN COMMERCE 8-1-2007.

THE MARK CONSISTS OF STANDARD CHARACTERS WITHOUT CLAIM TO ANY PARTICULAR FONT, STYLE, SIZE, OR COLOR.

NO CLAIM IS MADE TO THE EXCLUSIVE RIGHT TO USE "TABLES", APART FROM THE MARK AS SHOWN.

SN 77-082,445, FILED 1-12-2007.

JENNIFER VASQUEZ, EXAMINING ATTORNEY

**Int. Cl.: 42**

**Prior U.S. Cls.: 100 and 101**

**United States Patent and Trademark Office**

**Reg. No. 3,395,523**

**Registered Mar. 11, 2008**

**SERVICE MARK  
PRINCIPAL REGISTER**



EARTHSHINE ENVIRONMENTAL, INC. (FLORIDA CORPORATION)  
9919 CYPRESS SHADOW AVENUE  
TAMPA, FL 33647

FOR: CONSULTING SERVICES IN THE FIELD OF ENVIRONMENTAL ASSESSMENT, COMPLIANCE AND PLANNING; TECHNOLOGY CONSULTATION IN THE FIELD OF ENVIRONMENTAL SCIENCE, ENGINEERING SERVICES, DESIGN FOR OTHERS IN THE FIELD OF ENVIRONMENTAL ENGINEERING, IN CLASS 42 (U.S. CLS. 100 AND 101).

FIRST USE 3-24-2003; IN COMMERCE 3-24-2003.

NO CLAIM IS MADE TO THE EXCLUSIVE RIGHT TO USE "ENVIRONMENTAL INC", APART FROM THE MARK AS SHOWN.

THE COLOR(S) WHITE, BLACK, LIGHT BLUE AND DARK BLUE IS/ARE CLAIMED AS A FEATURE OF THE MARK.

THE MARK CONSISTS OF AN UPSIDE DOWN TEARDROP OUTLINED IN BLACK, WITH A DARK BLUE SKY BACKGROUND. IN THE MIDDLE OF THE TEARDROP IS A WHITE AND LIGHT BLUE FULL MOON WITH AN ILLUMINATED WHITE CRESCENT, WHITE STARS, AND BLACK EVERGREEN TREES. THE WORDING IN THE MARK IS BLACK. THE WORD "EARTHSHINE" HAS BLACK LEAVES EXTENDING DIAGONALLY DOWNWARD FROM THE LETTER "I".

SN 77-082,507, FILED 1-13-2007.

KIMBERLY FRYE, EXAMINING ATTORNEY

**Int. Cl.: 36**

**Prior U.S. Cls.: 100, 101, and 102**

**United States Patent and Trademark Office**

**Reg. No. 3,395,524**

**Registered Mar. 11, 2008**

**SERVICE MARK  
PRINCIPAL REGISTER**

**READ FOR THE CURE**

THE SUSAN G. KOMEN BREAST CANCER  
FOUNDATION, INC. (TEXAS NON-PROFIT  
CORPORATION)

5005 LBJ FREEWAY, SUITE 250  
DALLAS, TX 75244

FOR: CHARITABLE FUNDRAISING SERVICES,  
NAMELY, RAISING MONEY FOR BREAST CAN-  
CER RESEARCH AND BREAST HEALTH AWARE-  
NESS PROGRAMS, IN CLASS 36 (U.S. CLS. 100, 101  
AND 102).

FIRST USE 6-0-2007; IN COMMERCE 6-0-2007.

THE MARK CONSISTS OF STANDARD CHAR-  
ACTERS WITHOUT CLAIM TO ANY PARTICULAR  
FONT, STYLE, SIZE, OR COLOR.

OWNER OF U.S. REG. NOS. 1,593,469, 2,406,792,  
AND OTHERS.

NO CLAIM IS MADE TO THE EXCLUSIVE  
RIGHT TO USE "READ", APART FROM THE  
MARK AS SHOWN.

SN 77-082,936, FILED 1-15-2007.

ELLEN B. AWRICH, EXAMINING ATTORNEY

**Int. Cl.: 9**

**Prior U.S. Cls.: 21, 23, 26, 36, and 38**

**Reg. No. 3,395,525**

**United States Patent and Trademark Office**

**Registered Mar. 11, 2008**

**TRADEMARK  
PRINCIPAL REGISTER**

**GPS TRAVELER**

R.D.S. INDUSTRIES, INC. (CALIFORNIA CORPORATION)

1942 W. ARTESIA BLVD.

TORRANCE, CA 90504

FOR: CARRYING CASES FOR GLOBAL POSITIONING SYSTEMS, CABLE CONNECTORS AND ACCESSORIES, IN CLASS 9 (U.S. CLS. 21, 23, 26, 36 AND 38).

FIRST USE 10-10-2007; IN COMMERCE 10-10-2007.

THE MARK CONSISTS OF STANDARD CHARACTERS WITHOUT CLAIM TO ANY PARTICULAR FONT, STYLE, SIZE, OR COLOR.

OWNER OF U.S. REG. NO. 2,507,205.

NO CLAIM IS MADE TO THE EXCLUSIVE RIGHT TO USE "GPS", APART FROM THE MARK AS SHOWN.

SN 77-083,135, FILED 1-15-2007.

LAURA KOVALSKY, EXAMINING ATTORNEY

**Int. Cl.: 1**

**Prior U.S. Cls.: 1, 5, 6, 10, 26, and 46**

**Reg. No. 3,395,526**

**United States Patent and Trademark Office**

**Registered Mar. 11, 2008**

**TRADEMARK  
PRINCIPAL REGISTER**

**PRO SERIES**

NORTH AMERICAN SALT COMPANY (DELA-  
WARE CORPORATION)  
SUITE 600  
9900 WEST 109TH STREET  
OVERLAND PARK, KS 66210

FOR: DE-ICING AND ICE PREVENTION PRE-  
PARATION FOR ROADWAYS AND SIDEWALKS  
AND OTHER PAVED SURFACES, IN CLASS 1 (U.S.  
CLS. 1, 5, 6, 10, 26 AND 46).

FIRST USE 9-25-2007; IN COMMERCE 9-25-2007.

THE MARK CONSISTS OF STANDARD CHAR-  
ACTERS WITHOUT CLAIM TO ANY PARTICULAR  
FONT, STYLE, SIZE, OR COLOR.

NO CLAIM IS MADE TO THE EXCLUSIVE  
RIGHT TO USE "SERIES", APART FROM THE  
MARK AS SHOWN.

SN 77-083,184, FILED 1-15-2007.

MICHAEL LITZAU, EXAMINING ATTORNEY



**Int. Cl.: 9**

**Prior U.S. Cls.: 21, 23, 26, 36, and 38**

**United States Patent and Trademark Office**

**Reg. No. 3,395,527**

**Registered Mar. 11, 2008**

**TRADEMARK  
PRINCIPAL REGISTER**

# Gametech Mini

GAMETECH INTERNATIONAL, INC. (DELA-  
WARE CORPORATION)  
900 SANDHILL RD.  
RENO, NV 89521

FOR: HAND-HELD COMPUTER DEVICES,  
NAMELY, COMPUTER HARDWARE IN THE NAT-  
URE OF GAMING MACHINES FOR PLAYING  
BINGO AND OTHER GAMES FOR WAGERING  
PURPOSES, IN CLASS 9 (U.S. CLS. 21, 23, 26, 36 AND  
38).

FIRST USE 11-12-2007; IN COMMERCE 11-12-2007.

THE MARK CONSISTS OF STANDARD CHAR-  
ACTERS WITHOUT CLAIM TO ANY PARTICULAR  
FONT, STYLE, SIZE, OR COLOR.

OWNER OF U.S. REG. NOS. 2,927,142 AND  
3,006,830.

NO CLAIM IS MADE TO THE EXCLUSIVE  
RIGHT TO USE "MINI", APART FROM THE MARK  
AS SHOWN.

SN 77-083,273, FILED 1-15-2007.

COLLEEN DOMBROW, EXAMINING ATTORNEY

**Int. Cl.: 36**

**Prior U.S. Cls.: 100, 101, and 102**

**United States Patent and Trademark Office**

**Reg. No. 3,395,528**

**Registered Mar. 11, 2008**

**SERVICE MARK  
PRINCIPAL REGISTER**

**REAL CHEAP ESTATE**

LEE, RUSSELL (UNITED STATES INDIVIDUAL)  
PO BOX 351159  
PALM COAST, FL 321351159

FOR: REAL ESTATE INVESTMENT, IN CLASS 36  
(U.S. CLS. 100, 101 AND 102).

FIRST USE 4-15-2007; IN COMMERCE 4-15-2007.

THE MARK CONSISTS OF STANDARD CHAR-  
ACTERS WITHOUT CLAIM TO ANY PARTICULAR  
FONT, STYLE, SIZE, OR COLOR.

SN 77-083,314, FILED 1-15-2007.

JANICE L. MCMORROW, EXAMINING ATTOR-  
NEY

**Int. Cl.: 9**

**Prior U.S. Cls.: 21, 23, 26, 36, and 38**

**United States Patent and Trademark Office**

**Reg. No. 3,395,529**

**Registered Mar. 11, 2008**

**TRADEMARK  
PRINCIPAL REGISTER**

# TroublePix

NORPIX, INC. (CANADA CORPORATION)  
1751 RICHARDSON ST., SUITE 6117  
MONTREAL, QUEBEC, CANADA H3K1G6

FOR: EVENT CAPTURE UTILITY SOFTWARE THAT PERFORMS VIDEO ACQUISITION OF HIGH RESOLUTION IMAGES DIRECTLY TO A HARD DISK DRIVE AND DIGITAL VIDEO RECORDING SOFTWARE , IN CLASS 9 (U.S. CLS. 21, 23, 26, 36 AND 38).

FIRST USE 12-18-2006; IN COMMERCE 5-2-2007.

THE MARK CONSISTS OF STANDARD CHARACTERS WITHOUT CLAIM TO ANY PARTICULAR FONT, STYLE, SIZE, OR COLOR.

SN 77-083,522, FILED 1-16-2007.

ROSELLE HERRERA, EXAMINING ATTORNEY

**Int. Cl.: 39**

**Prior U.S. Cls.: 100 and 105**

**United States Patent and Trademark Office**

**Reg. No. 3,395,530**

**Registered Mar. 11, 2008**

**SERVICE MARK  
PRINCIPAL REGISTER**

**NUSTAR**

NUSTAR ENERGY L.P. (TEXAS LIMITED PART-  
NERSHIP)  
2330 N. LOOP 1604 WEST  
SAN ANTONIO, TX 78248

THE MARK CONSISTS OF STANDARD CHAR-  
ACTERS WITHOUT CLAIM TO ANY PARTICULAR  
FONT, STYLE, SIZE, OR COLOR.

FOR: DISTRIBUTION AND STORAGE OF OIL  
AND GAS VIA PIPELINES, IN CLASS 39 (U.S. CLS.  
100 AND 105).

SN 77-083,714, FILED 1-16-2007.

FIRST USE 4-2-2007; IN COMMERCE 4-2-2007.

ANGELA M. MICHELI, EXAMINING ATTORNEY

**Int. Cl.: 36**

**Prior U.S. Cls.: 100, 101, and 102**

**United States Patent and Trademark Office**

**Reg. No. 3,395,531**

**Registered Mar. 11, 2008**

**SERVICE MARK  
PRINCIPAL REGISTER**

**QCFASTCASH.COM**

QC SERVICES, INC. (KANSAS CORPORATION)  
9401 INDIAN CREEK PKWAY  
OVERLAND PARK, KS 66210

FOR: CONSUMER LENDING SERVICES; DEBIT  
CARD SERVICES; FINANCIAL SERVICES, NAME-  
LY, MONEY LENDING; INSTALLMENT LOANS;  
TEMPORARY LOANS, IN CLASS 36 (U.S. CLS. 100,  
101 AND 102).

FIRST USE 4-0-2007; IN COMMERCE 4-0-2007.

THE MARK CONSISTS OF STANDARD CHAR-  
ACTERS WITHOUT CLAIM TO ANY PARTICULAR  
FONT, STYLE, SIZE, OR COLOR.

SN 77-083,890, FILED 1-16-2007.

JANET LEE, EXAMINING ATTORNEY

**Int. Cl.: 33**

**Prior U.S. Cls.: 47 and 49**

**United States Patent and Trademark Office**

**Reg. No. 3,395,532**

**Registered Mar. 11, 2008**

**TRADEMARK  
PRINCIPAL REGISTER**

# Suavemente

OLE SOL (CALIFORNIA PARTNERSHIP)  
1639 TROON DR  
SAN JOSE, CA 95116

FOR: TEQUILA, IN CLASS 33 (U.S. CLS. 47 AND  
49).

FIRST USE 11-28-2007; IN COMMERCE 11-28-2007.

THE MARK CONSISTS OF STANDARD CHAR-  
ACTERS WITHOUT CLAIM TO ANY PARTICULAR  
FONT, STYLE, SIZE, OR COLOR.

THE MARK TRANSLATES INTO ENGLISH AS  
"GENTLY" OR "MILDLY".

SN 77-084,566, FILED 1-17-2007.

PAUL F. GAST, EXAMINING ATTORNEY

**Int. Cl.: 35**

**Prior U.S. Cls.: 100, 101, and 102**

**United States Patent and Trademark Office**

**Reg. No. 3,395,533**

**Registered Mar. 11, 2008**

**SERVICE MARK  
PRINCIPAL REGISTER**

**KNOW HOW. CAN DO.**

NEW SOUTH CONSTRUCTION SUPPLY, LLC  
(SOUTH CAROLINA LTD LIAB CO)  
P O BOX 512  
COLUMBIA, SC 29202

FOR: WHOLESALE DISTRIBUTORSHIP SERVICES FOR BUILDING MATERIALS, NAMELY, INSULATION PRODUCTS, DRAINS, VAPOR BARRIERS, FIREPROOFING PRODUCTS, GEOTEXTILE FABRICS, WATERPROOFING PRODUCTS, NAMELY, SEALANTS, COATINGS, EPOXIES, MOISTURE BARRIERS, AND WATER REPELLANTS, MOISTURE CURING PRODUCTS, ROOFING PRODUCTS, EXPANSION JOINTS FOR CONCRETE AND MASONRY, SPECIALTY FLOORING PRODUCTS, NAMELY, DECORATIVE QUARTZ, TROWEL SAND, AND VINYL COLOR CHIPS, FORMING ACCESSORIES, NAMELY, WIRE MESH, REBAR, COLUMN FORMS, STRAIGHT

EDGE AND CURVE FORMS; HAND TOOLS USED IN MASONRY AND CONCRETE INSTALLATION; MASONRY ACCESSORIES, NAMELY, LADDER AND TRUSS WALL REINFORCING, VENEER TIES, CONTROL JOINTS, FLASHINGS, AND LOOSE FILL; AND TOOLS AND ACCESSORIES USED IN CONCRETE AND MASONRY INSTALLATION, IN CLASS 35 (U.S. CLS. 100, 101 AND 102).

FIRST USE 1-12-2007; IN COMMERCE 1-12-2007.

THE MARK CONSISTS OF STANDARD CHARACTERS WITHOUT CLAIM TO ANY PARTICULAR FONT, STYLE, SIZE, OR COLOR.

SN 77-084,675, FILED 1-17-2007.

EMILY CHUO, EXAMINING ATTORNEY

**Int. Cl.: 42**

**Prior U.S. Cls.: 100 and 101**

**United States Patent and Trademark Office**

**Reg. No. 3,395,534**

**Registered Mar. 11, 2008**

**SERVICE MARK  
PRINCIPAL REGISTER**

**USITE**

DONALD CATHERINE (UNITED STATES INDIVIDUAL)  
11 MILAN COURT  
SACRAMENTO, CA 95831

THE MARK CONSISTS OF STANDARD CHARACTERS WITHOUT CLAIM TO ANY PARTICULAR FONT, STYLE, SIZE, OR COLOR.

FOR: DESIGN, CREATION, HOSTING, MAINTENANCE OF WEBSITES FOR OTHERS, IN CLASS 42 (U.S. CLS. 100 AND 101).

SN 77-085,205, FILED 1-17-2007.

FIRST USE 1-1-2007; IN COMMERCE 1-1-2007.

PAUL CROWLEY, EXAMINING ATTORNEY



**Int. Cl.: 16**

**Prior U.S. Cls.: 2, 5, 22, 23, 29, 37, 38, and 50**

**United States Patent and Trademark Office**

**Reg. No. 3,395,535**

**Registered Mar. 11, 2008**

**TRADEMARK  
PRINCIPAL REGISTER**

**memopause**

GUVEN MADELINE (UNITED STATES INDIVIDUAL)  
310 EAST 46TH STREET, APT. 16/G  
NEW YORK, NY 10017

FOR: NOTE BOOKS; NOTE CARDS; NOTE PAD HOLDERS; NOTE PADS; NOTE PAPER; NOTE PAPERS; PAPER NOTE TABLETS; PAPER SHEETS FOR NOTE TAKING; PAPER STATIONERY; STATIONERY; STATIONERY WRITING PAPER AND ENVELOPES; WRITING PAPER; WRITING PAPER HOLDERS; WRITING PAPER PADS, IN CLASS 16 (U.S. CLS. 2, 5, 22, 23, 29, 37, 38 AND 50).

FIRST USE 4-18-2007; IN COMMERCE 4-18-2007.

THE MARK CONSISTS OF STANDARD CHARACTERS WITHOUT CLAIM TO ANY PARTICULAR FONT, STYLE, SIZE, OR COLOR.

SN 77-086,197, FILED 1-18-2007.

JASON LOTT, EXAMINING ATTORNEY

**Int. Cl.: 12**

**Prior U.S. Cls.: 19, 21, 23, 31, 35, and 44**

**United States Patent and Trademark Office**

**Reg. No. 3,395,536**

**Registered Mar. 11, 2008**

**TRADEMARK  
PRINCIPAL REGISTER**

**WHO-RAE SAPPHIRE**

WHO-RAE PTY LTD (AUSTRALIA CORPORATION)  
LEVEL 1, 185 BANK STREET  
SOUTH MELBOURNE, AUSTRALIA 3205

THE MARK CONSISTS OF STANDARD CHARACTERS WITHOUT CLAIM TO ANY PARTICULAR FONT, STYLE, SIZE, OR COLOR.

FOR: FITTED VEHICLE SEAT COVERS, IN CLASS 12 (U.S. CLS. 19, 21, 23, 31, 35 AND 44).

SN 77-087,492, FILED 1-21-2007.

FIRST USE 1-1-2005; IN COMMERCE 4-1-2007.

BENJAMIN OKEKE, EXAMINING ATTORNEY

**Int. Cl.: 37**

**Prior U.S. Cls.: 100, 103, and 106**

**United States Patent and Trademark Office**

**Reg. No. 3,395,537**

**Registered Mar. 11, 2008**

**SERVICE MARK  
PRINCIPAL REGISTER**



MY HEATING AND AIR GUY INC. (GEORGIA CORPORATION)  
P.O. BOX 452  
AUBURN, GA 30011

FOR: INSTALLATION, MAINTENANCE AND REPAIR OF HEATING AND AIR CONDITIONING APPARATUS, IN CLASS 37 (U.S. CLS. 100, 103 AND 106).

FIRST USE 9-1-2006; IN COMMERCE 9-1-2006.

THE MARK CONSISTS OF THE WORD "MY" WITH THE WORD "HEATING" UNDERNEATH; THE DOT OVER THE "I" IN "HEATING" IS IN THE FORM OF A FLAME. BENEATH THAT IS "& AIR GUY". ALL WORDS ARE IN STYLIZED FORM AND IN AN OVAL-LIKE DESIGN.

SN 77-088,847, FILED 1-23-2007.

MARILYN IZZI, EXAMINING ATTORNEY

**Int. Cl.: 7**

**Prior U.S. Cls.: 13, 19, 21, 23, 31, 34, and 35**

**Reg. No. 3,395,538**

**United States Patent and Trademark Office**

**Registered Mar. 11, 2008**

---

**TRADEMARK  
PRINCIPAL REGISTER**

**GERMGUARDIAN**

GUARDIAN TECHNOLOGIES LLC (OHIO LTD  
LIAB CO)  
7700 ST. CLAIR AVENUE  
MENTOR, OH 44060

THE MARK CONSISTS OF STANDARD CHAR-  
ACTERS WITHOUT CLAIM TO ANY PARTICULAR  
FONT, STYLE, SIZE, OR COLOR.

FOR: VACUUM CLEANERS, IN CLASS 7 (U.S.  
CLS. 13, 19, 21, 23, 31, 34 AND 35).

SN 77-088,948, FILED 1-23-2007.

FIRST USE 6-0-2007; IN COMMERCE 6-0-2007.

DAVID MURRAY, EXAMINING ATTORNEY

**Int. Cl.: 45**

**Prior U.S. Cls.: 100 and 101**

**United States Patent and Trademark Office**

**Reg. No. 3,395,539**

**Registered Mar. 11, 2008**

**SERVICE MARK  
PRINCIPAL REGISTER**

**Gift Baskets by Design**

WALLING DEBORAH A (UNITED STATES IN-  
DIVIDUAL)  
15 BENBURB ROAD  
PHOENIXVILLE, PA 19460

FOR: PREPARATION OF CUSTOMIZED GIFT  
BASKETS WITH SELECTED ITEMS REGARDING  
A PARTICULAR OCCASION OR THEME, IN CLASS  
45 (U.S. CLS. 100 AND 101).

FIRST USE 6-25-2006; IN COMMERCE 6-25-2006.

THE MARK CONSISTS OF STANDARD CHAR-  
ACTERS WITHOUT CLAIM TO ANY PARTICULAR  
FONT, STYLE, SIZE, OR COLOR.

NO CLAIM IS MADE TO THE EXCLUSIVE  
RIGHT TO USE "GIFT BASKETS", APART FROM  
THE MARK AS SHOWN.

SN 77-089,514, FILED 1-23-2007.

MARK T. MULLEN, EXAMINING ATTORNEY

**Int. Cl.: 35**

**Prior U.S. Cls.: 100, 101, and 102**

**United States Patent and Trademark Office**

**Reg. No. 3,395,540**

**Registered Mar. 11, 2008**

**SERVICE MARK  
PRINCIPAL REGISTER**



NATIONAL FROZEN AND REFRIGERATED  
FOODS ASSOCIATION, INC. (DELAWARE  
CORPORATION)  
SUITE 300  
4755 LINGLESTOWN ROAD  
HARRISBURG, PA 17112

FOR: ASSOCIATION SERVICES, NAMELY, PRO-  
MOTING THE INTERESTS OF FROZEN AND RE-  
FRIGERATED FOOD MANUFACTURERS AND  
SUPPLIERS , IN CLASS 35 (U.S. CLS. 100, 101 AND  
102).

FIRST USE 3-1-2007; IN COMMERCE 3-1-2007.

NO CLAIM IS MADE TO THE EXCLUSIVE  
RIGHT TO USE "REFRIGERATED FOODS", APART  
FROM THE MARK AS SHOWN.

THE MARK CONSISTS OF THE WORDS "COOL  
TASTY WHOLESOME" AT THE TOP OF A CIRCLE  
WITH DAIRY PRODUCTS AND A BANNER  
ACROSS THE BOTTOM OF THE CIRCLE WITH  
THE WORDS "REFRIGERATED FOODS".

SN 77-090,686, FILED 1-25-2007.

ADA HAN, EXAMINING ATTORNEY

**Int. Cl.: 9**

**Prior U.S. Cls.: 21, 23, 26, 36, and 38**

**United States Patent and Trademark Office**

**Reg. No. 3,395,541**

**Registered Mar. 11, 2008**

**TRADEMARK  
PRINCIPAL REGISTER**

**PLAYERVISION**

LAS VEGAS GAMING, INC. (NEVADA CORPORATION)  
4000 WEST ALI BABA LANE  
LAS VEGAS, NV 89118

FOR: COMPUTER HARDWARE/SOFTWARE FOR GENERATING/TRANSMITTING INFORMATION TO AND FROM GAMING MACHINES, NAMELY, ADVERTISING AND MULTI-MEDIA CONTENT, IN CLASS 9 (U.S. CLS. 21, 23, 26, 36 AND 38).

FIRST USE 10-3-2007; IN COMMERCE 10-3-2007.

THE MARK CONSISTS OF STANDARD CHARACTERS WITHOUT CLAIM TO ANY PARTICULAR FONT, STYLE, SIZE, OR COLOR.

SN 77-091,929, FILED 1-26-2007.

GEOFFREY FOSDICK, EXAMINING ATTORNEY

**Int. Cl.: 29**

**Prior U.S. Cl.: 46**

**United States Patent and Trademark Office**

**Reg. No. 3,395,542**

**Registered Mar. 11, 2008**

**TRADEMARK  
PRINCIPAL REGISTER**

**SALT YOUR OWN!**

CGE ENTERPRISES LLC (DELAWARE LTD LIAB  
CO)  
46 CHESTER MOUNTAIN ROAD P.O. BOX 124  
WESTON, VT 05161

THE MARK CONSISTS OF STANDARD CHAR-  
ACTERS WITHOUT CLAIM TO ANY PARTICULAR  
FONT, STYLE, SIZE, OR COLOR.

FOR: SOUPS, IN CLASS 29 (U.S. CL. 46).

SN 77-092,067, FILED 1-26-2007.

FIRST USE 8-1-2007; IN COMMERCE 8-1-2007.

MICHAEL WEBSTER, EXAMINING ATTORNEY



**Int. Cl.: 38**

**Prior U.S. Cls.: 100, 101, and 104**

**United States Patent and Trademark Office**

**Reg. No. 3,395,543**

**Registered Mar. 11, 2008**

**SERVICE MARK  
PRINCIPAL REGISTER**

**MCCAIN SPACE**

JOHN MCCAIN 2008 - THE EXPLORATORY  
COMMITTEE, INC. (DELAWARE CORPORATION)

P.O. BOX 16118  
ARLINGTON, VA 22215

FOR: PROVIDING ON-LINE ELECTRONIC BULLETIN BOARDS FOR TRANSMISSION OF MESSAGES AMONG USERS IN THE FIELD OF NATIONAL POLICY AND MATTERS OF INTEREST TO THE NATIONAL ELECTORATE, IN CLASS 38 (U.S. CLS. 100, 101 AND 104).

FIRST USE 1-15-2007; IN COMMERCE 1-15-2007.

THE MARK CONSISTS OF STANDARD CHARACTERS WITHOUT CLAIM TO ANY PARTICULAR FONT, STYLE, SIZE, OR COLOR.

NO CLAIM IS MADE TO THE EXCLUSIVE RIGHT TO USE "SPACE", APART FROM THE MARK AS SHOWN.

THE NAME IN THE MARK IDENTIFIES "JOHN MCCAIN", WHOSE CONSENT TO REGISTER IS MADE OF RECORD.

SN 77-092,422, FILED 1-26-2007.

KAREN K. BUSH, EXAMINING ATTORNEY

**Int. Cl.: 41**

**Prior U.S. Cls.: 100, 101, and 107**

**United States Patent and Trademark Office**

**Reg. No. 3,395,544**

**Registered Mar. 11, 2008**

**SERVICE MARK  
PRINCIPAL REGISTER**

# Wrenegade Poker

WRENEGADE'S.COM, INC. (OREGON CORPORATION)  
9250 SW TIGARD STREET  
TIGARD, OR 97223

FOR: CONDUCTING AND PROVIDING ONLINE COMPUTERIZED SERVICES FOR SPECIAL EVENTS FEATURING GAMING CONTESTS AND TOURNAMENTS, IN CLASS 41 (U.S. CLS. 100, 101 AND 107).

FIRST USE 6-7-2006; IN COMMERCE 6-7-2006.

THE MARK CONSISTS OF STANDARD CHARACTERS WITHOUT CLAIM TO ANY PARTICULAR FONT, STYLE, SIZE, OR COLOR.

NO CLAIM IS MADE TO THE EXCLUSIVE RIGHT TO USE "POKER", APART FROM THE MARK AS SHOWN.

SN 77-092,581, FILED 1-26-2007.

PRISCILLA MILTON, EXAMINING ATTORNEY

**Int. Cl.: 1**

**Prior U.S. Cls.: 1, 5, 6, 10, 26, and 46**

**Reg. No. 3,395,545**

**United States Patent and Trademark Office**

**Registered Mar. 11, 2008**

---

**TRADEMARK  
PRINCIPAL REGISTER**

**GlyKool**

LOIKITS INDUSTRIAL SERVICES, INC. (PENNSYLVANIA CORPORATION)  
5250 WEST COPLAY RD.  
WHITEHALL, PA 18052

THE MARK CONSISTS OF STANDARD CHARACTERS WITHOUT CLAIM TO ANY PARTICULAR FONT, STYLE, SIZE, OR COLOR.

FOR: ANTIFREEZING LIQUIDS; HEAT TRANSFER FLUIDS FOR INDUSTRIAL USE, IN CLASS 1 (U.S. CLS. 1, 5, 6, 10, 26 AND 46).

SN 77-093,201, FILED 1-29-2007.

FIRST USE 3-20-2007; IN COMMERCE 3-20-2007.

ELLEN BURNS, EXAMINING ATTORNEY

**Int. Cl.: 5**

**Prior U.S. Cls.: 6, 18, 44, 46, 51, and 52**

**United States Patent and Trademark Office**

**Reg. No. 3,395,546**

**Registered Mar. 11, 2008**

**TRADEMARK  
PRINCIPAL REGISTER**



COMPOUND SOLUTIONS, INC. (CALIFORNIA CORPORATION)  
2215 VINEYARD AVENUE  
ESCONDIDO, CA 92029

THE MARK CONSISTS OF THE LETTERS "LT" AND THE HYPHEN ARE BLUE AND THE WORD "ONE" IS RED.

FOR: DIETARY SUPPLEMENTS, IN CLASS 5 (U.S. CLS. 6, 18, 44, 46, 51 AND 52).

SN 77-094,069, FILED 1-29-2007.

FIRST USE 2-8-2007; IN COMMERCE 8-4-2007.

THE COLOR(S) BLUE AND RED IS/ARE CLAIMED AS A FEATURE OF THE MARK.

JOHN DWYER, EXAMINING ATTORNEY

**Int. Cl.: 34**

**Prior U.S. Cls.: 2, 8, 9, and 17**

**United States Patent and Trademark Office**

**Reg. No. 3,395,547**

**Registered Mar. 11, 2008**

**TRADEMARK  
PRINCIPAL REGISTER**



THOMPSON & CO. OF TAMPA, INC. (FLORIDA CORPORATION)  
5401 HANGAR COURT  
TAMPA, FL 33634

THE MARK CONSISTS OF A REPRESENTATION OF A SHAMROCK APPEARS BEHIND A SYLIZED PRESENTATION OF THE WORD.

FOR: CIGARS, IN CLASS 34 (U.S. CLS. 2, 8, 9 AND 17).

SN 77-094,407, FILED 1-30-2007.

FIRST USE 7-2-2007; IN COMMERCE 7-2-2007.

PAM WILLIS, EXAMINING ATTORNEY

**Int. Cl.: 11**

**Prior U.S. Cls.: 13, 21, 23, 31, and 34**

**United States Patent and Trademark Office**

**Reg. No. 3,395,548**

**Registered Mar. 11, 2008**

**TRADEMARK  
PRINCIPAL REGISTER**

**TOMAHAWK**

FIRST-LIGHT USA, LLC (ILLINOIS LTD LIAB  
CO)  
320 CR 1100 NORTH  
SEYMOUR, IL 61875

THE MARK CONSISTS OF STANDARD CHAR-  
ACTERS WITHOUT CLAIM TO ANY PARTICULAR  
FONT, STYLE, SIZE, OR COLOR.

FOR: FLASHLIGHTS, IN CLASS 11 (U.S. CLS. 13,  
21, 23, 31 AND 34).

SN 77-096,364, FILED 1-31-2007.

FIRST USE 11-30-2007; IN COMMERCE 11-30-2007.

ANDREA HACK, EXAMINING ATTORNEY

**Int. Cl.: 3**

**Prior U.S. Cls.: 1, 4, 6, 50, 51, and 52**

**United States Patent and Trademark Office**

**Reg. No. 3,395,549**

**Registered Mar. 11, 2008**

**TRADEMARK  
PRINCIPAL REGISTER**

**ZERO GRAVITY REPAIRWEAR  
LIFT**

CLINIQUE LABORATORIES, LLC (DELAWARE  
LTD LIAB CO)  
767 FIFTH AVENUE  
NEW YORK, NY 10153

FOR: NON-MEDICATED SKIN CARE PREPARA-  
TIONS, IN CLASS 3 (U.S. CLS. 1, 4, 6, 50, 51 AND 52).

FIRST USE 8-6-2007; IN COMMERCE 8-6-2007.

THE MARK CONSISTS OF STANDARD CHAR-  
ACTERS WITHOUT CLAIM TO ANY PARTICULAR  
FONT, STYLE, SIZE, OR COLOR.

OWNER OF U.S. REG. NOS. 2,737,578 AND  
2,931,869.

SN 77-096,417, FILED 2-1-2007.

TAMARA FRAZIER, EXAMINING ATTORNEY

Int. Cl.: 25

Prior U.S. Cls.: 22 and 39

United States Patent and Trademark Office

Reg. No. 3,395,550

Registered Mar. 11, 2008

TRADEMARK  
PRINCIPAL REGISTER



DISGUISE, INC. (DELAWARE CORPORATION)  
11906 TECH CENTER COURT  
POWAY, CA 92064

FOR: HALLOWEEN AND MASQUERADE COSTUMES AND MASKS SOLD IN CONNECTION THEREWITH; HEADWEAR, FOOTWEAR, GLOVES AND HOSIERY, IN CLASS 25 (U.S. CLS. 22 AND 39).

FIRST USE 8-2-2007; IN COMMERCE 8-2-2007.

THE COLOR(S) LIGHT PINK, DARK PINK, BLACK, WHITE AND GREY IS/ARE CLAIMED AS A FEATURE OF THE MARK.

THE MARK CONSISTS OF THE COLOR LIGHT PINK AS THE BACKGROUND OF THE SQUARE AND RECTANGLE SHAPES COMPRISING TWO SIGNS. THE COLOR DARK PINK APPEARS IN THE CIRCLE ON THE TOP OF THE SIGN POST. THE COLOR BLACK APPEARS IN THE DESIGN AND BORDER OF THE SQUARE SHAPED SIGN AND ON THE BORDER OF THE RECTANGLE SHAPED SIGN AND IN THE LETTERS "KILLER CURVES". THE COLOR GREY APPEARS ON THE SIGN POST. THE COLOR WHITE APPEARS ON THE CIRCLE SHAPES ON THE SIGN POST.

SN 77-096,655, FILED 2-1-2007.

ADA HAN, EXAMINING ATTORNEY



**Int. Cl.: 20**

**Prior U.S. Cls.: 2, 13, 22, 25, 32, and 50**

**Reg. No. 3,395,551**

**United States Patent and Trademark Office**

**Registered Mar. 11, 2008**

**TRADEMARK  
PRINCIPAL REGISTER**

# Cuddoozle

NORCOTT, MARGARET L. (UNITED STATES  
INDIVIDUAL)  
SUITE # A - 224  
4780 ASHFORD DUNWOODY ROAD  
ATLANTA, GA 30338

THE MARK CONSISTS OF STANDARD CHAR-  
ACTERS WITHOUT CLAIM TO ANY PARTICULAR  
FONT, STYLE, SIZE, OR COLOR.

FOR: MATERNITY PILLOWS; NURSING PIL-  
LOWS; PILLOWS, IN CLASS 20 (U.S. CLS. 2, 13, 22,  
25, 32 AND 50).

SN 77-097,387, FILED 2-1-2007.

FIRST USE 3-15-2007; IN COMMERCE 4-1-2007.

GEORGE LORENZO, EXAMINING ATTORNEY

**Int. Cl.: 35**

**Prior U.S. Cls.: 100, 101, and 102**

**United States Patent and Trademark Office**

**Reg. No. 3,395,552**

**Registered Mar. 11, 2008**

---

**SERVICE MARK  
PRINCIPAL REGISTER**

**Disseminator of Knowledge**

IDEA GROUP INC. (PENNSYLVANIA COR-  
PORATION)  
SUITE 200  
701 E. CHOCOLATE AVENUE  
HERSHEY, PA 17033

FOR: BUSINESS INFORMATION MANAGE-  
MENT, IN CLASS 35 (U.S. CLS. 100, 101 AND 102).

FIRST USE 2-2-2007; IN COMMERCE 2-2-2007.

THE MARK CONSISTS OF STANDARD CHAR-  
ACTERS WITHOUT CLAIM TO ANY PARTICULAR  
FONT, STYLE, SIZE, OR COLOR.

SN 77-098,122, FILED 2-2-2007.

KEVON CHISOLM, EXAMINING ATTORNEY

**Int. Cl.: 35**

**Prior U.S. Cls.: 100, 101, and 102**

**United States Patent and Trademark Office**

**Reg. No. 3,395,553**

**Registered Mar. 11, 2008**

**SERVICE MARK  
PRINCIPAL REGISTER**

**ScommesseOnline**

BUSINESS ITALIA LLC (DELAWARE LTD LIAB  
CO)  
113 BARKSDALE PROFESSIONAL CENTER  
NEWARK, DE 197113258

FOR: ADVERTISING VIA ELECTRONIC MEDIA  
AND SPECIFICALLY THE INTERNET, IN CLASS 35  
(U.S. CLS. 100, 101 AND 102).

FIRST USE 5-12-2007; IN COMMERCE 5-12-2007.

THE MARK CONSISTS OF STANDARD CHAR-  
ACTERS WITHOUT CLAIM TO ANY PARTICULAR  
FONT, STYLE, SIZE, OR COLOR.

THE ENGLISH TRANSLATION OF THE WORD  
"SCOMMESSE" IN THE MARK IS "WAGER", "BET"  
OR "GAMBLE".

SN 77-098,580, FILED 2-3-2007.

ANDREA BUTLER, EXAMINING ATTORNEY

**Int. Cl.: 14**

**Prior U.S. Cls.: 2, 27, 28, and 50**

**United States Patent and Trademark Office**

**Reg. No. 3,395,554**

**Registered Mar. 11, 2008**

**TRADEMARK  
PRINCIPAL REGISTER**

**HOLLY LYNN**

CYBERCARTEL INTERNATIONAL, INC. (NEW  
YORK CORPORATION)  
SUITE 300  
3780 COMMERCE COURT  
WHEATFIELD, NY 14120

FOR: BRACELETS; CHARMS; COSTUME JEWEL-  
RY; EARRINGS; JEWELRY; PINS BEING JEWELRY;  
RINGS BEING JEWELRY, IN CLASS 14 (U.S. CLS. 2,  
27, 28 AND 50).

FIRST USE 9-1-2005; IN COMMERCE 9-1-2006.

THE MARK CONSISTS OF STANDARD CHAR-  
ACTERS WITHOUT CLAIM TO ANY PARTICULAR  
FONT, STYLE, SIZE, OR COLOR.

THE NAME "HOLLY LYNN" DOES NOT IDEN-  
TIFY A LIVING INDIVIDUAL.

SN 77-098,912, FILED 2-5-2007.

GEORGE LORENZO, EXAMINING ATTORNEY

**Int. Cl.: 7**

**Prior U.S. Cls.: 13, 19, 21, 23, 31, 34, and 35**

**Reg. No. 3,395,555**

**United States Patent and Trademark Office**

**Registered Mar. 11, 2008**

---

**TRADEMARK  
PRINCIPAL REGISTER**

# TechnoJib

TELESCOPIC LLC (CALIFORNIA LTD LIAB CO)  
430 PAGOSA COURT  
PALMDALE, CA 93551

THE MARK CONSISTS OF STANDARD CHAR-  
ACTERS WITHOUT CLAIM TO ANY PARTICULAR  
FONT, STYLE, SIZE, OR COLOR.

FOR: JIB CRANES, IN CLASS 7 (U.S. CLS. 13, 19, 21,  
23, 31, 34 AND 35).

SN 77-098,960, FILED 2-5-2007.

FIRST USE 11-1-2006; IN COMMERCE 11-1-2006.

CARRIE GENOVESE, EXAMINING ATTORNEY

Int. Cl.: 41

Prior U.S. Cls.: 100, 101, and 107

United States Patent and Trademark Office

Reg. No. 3,395,556

Registered Mar. 11, 2008

SERVICE MARK  
PRINCIPAL REGISTER

The logo for 'The Style Fyle' is written in a cursive, handwritten style. 'The' is in a smaller font size and black. 'Style' and 'Fyle' are in a larger font size. The letters 'S', 't', 'l', 'e', 'F', 'y', and 'l' are black, while the letters 'y' and 'l' in 'Fyle' are red. A red underline swoosh starts under the 'y' in 'Fyle' and loops back under the 'l'.

KERRY DAMIANO, LLC (ARIZONA LTD LIAB  
CO)  
7022 NORH 28TH DRIVE  
PHOENIX, AZ 85051

THE COLOR(S) BLACK AND RED IS/ARE  
CLAIMED AS A FEATURE OF THE MARK.

FOR: ENTERTAINMENT IN THE NATURE OF A  
SERIES OF TELEVISION PROGRAMS DISCUSSING  
AND DESCRIBING THE WORLDWIDE SEARCH  
FOR FASHION, STYLE AND ART IN FABULOUS  
DOMESTIC AND INTERNATIONAL SHOPPING  
DESTINATIONS, IN CLASS 41 (U.S. CLS. 100, 101  
AND 107).

THE MARK CONSISTS OF STYLIZED BLACK  
LETTERS EXCEPT FOR THE LETTER "Y", BOTH  
OF WHICH ARE IN RED.

SN 77-099,605, FILED 2-5-2007.

FIRST USE 6-4-2005; IN COMMERCE 9-14-2005.

TRACY CROSS, EXAMINING ATTORNEY

**Int. Cls.: 35 and 39**

**Prior U.S. Cls.: 100, 101, 102, and 105**

**United States Patent and Trademark Office**

**Reg. No. 3,395,557**

**Registered Mar. 11, 2008**

**SERVICE MARK  
PRINCIPAL REGISTER**

**YRC REGIONAL TRANSPORTATION**

YRC WORLDWIDE INC. (DELAWARE CORPORATION)  
10990 ROE AVENUE  
OVERLAND PARK, KS 66211

FOR: BUSINESS CONSULTING SERVICES RELATING TO PRODUCT DISTRIBUTION, OPERATIONS MANAGEMENT SERVICES, LOGISTICS, REVERSE LOGISTICS, SUPPLY CHAIN, AND PRODUCTION SYSTEMS AND DISTRIBUTION SOLUTIONS; BUSINESS MANAGEMENT SERVICES, NAMELY, MANAGING LOGISTICS, REVERSE LOGISTICS, SUPPLY CHAIN SERVICES, SUPPLY CHAIN VISIBILITY AND SYNCHRONIZATION, SUPPLY AND DEMAND FORECASTING AND PRODUCT DISTRIBUTION PROCESSES FOR OTHERS; TRANSPORTATION LOGISTICS SERVICES, NAMELY, ARRANGING THE TRANSPORTATION OF GOODS FOR OTHERS; TRANSPORTATION LOGISTICS SERVICES, NAMELY, PLANNING AND SCHEDULING SHIPMENTS FOR USERS OF TRANSPORTATION SERVICES; COMPUTERIZED TRACKING AND TRACING OF PACKAGES IN TRANSIT; INFORMATION MANAGEMENT SERVICES, NAMELY, SHIPMENT PROCESSING, PREPARING SHIPPING DOCUMENTS AND INVOICES, TRACKING DOCUMENTS, PACKAGES AND FREIGHT OVER COMPUTER NETWORKS, INTRANETS AND INTERNETS; MONITORING AND TRACKING OF PACKAGE SHIPMENTS; PROVIDING ELECTRONIC TRACKING OF FREIGHT INFORMATION TO OTHERS; TRACKING, LOCATING AND MONITORING OF VEHICLES, MARITIME VESSELS AND AIRCRAFT SERVICES; CUSTOMS CLEARANCE SERVICES; ARRANGING FOR PICKUP, DELIVERY, STORAGE AND TRANSPORTATION OF DOCUMENTS, PACKAGES, FREIGHT AND PARCELS VIA GROUND AND

AIR CARRIERS; ORDER FULFILLMENT SERVICES, IN CLASS 35 (U.S. CLS. 100, 101 AND 102).

FIRST USE 5-0-2005; IN COMMERCE 5-0-2005.

FOR: DOMESTIC AND INTERNATIONAL COMMON CARRIER FREIGHT TRANSPORTATION BY MEANS OF TRUCK, AIR, OR SEA, AND DOMESTIC AND INTERNATIONAL FREIGHT FORWARDING SERVICES; SUPPLY CHAIN, LOGISTICS AND REVERSE LOGISTICS SERVICES, NAMELY, STORAGE, TRANSPORTATION AND DELIVERY OF DOCUMENTS, PACKAGES, RAW MATERIALS, AND OTHER FREIGHT FOR OTHERS BY AIR, RAIL, SHIP OR TRUCK; WAREHOUSING SERVICES, NAMELY, STORAGE, DISTRIBUTION, PICKUP, AND PACKING FOR SHIPMENT OF DOCUMENTS, PACKAGES, RAW MATERIALS, AND OTHER FREIGHT FOR OTHERS, IN CLASS 39 (U.S. CLS. 100 AND 105).

FIRST USE 5-0-2005; IN COMMERCE 5-0-2005.

THE MARK CONSISTS OF STANDARD CHARACTERS WITHOUT CLAIM TO ANY PARTICULAR FONT, STYLE, SIZE, OR COLOR.

OWNER OF U.S. REG. NO. 3,174,011.

NO CLAIM IS MADE TO THE EXCLUSIVE RIGHT TO USE "REGIONAL TRANSPORTATION", APART FROM THE MARK AS SHOWN.

SN 77-100,428, FILED 2-6-2007.

TRACY WHITTAKER-BROWN, EXAMINING ATTORNEY

**Int. Cl.: 38**

**Prior U.S. Cls.: 100, 101, and 104**

**United States Patent and Trademark Office**

**Reg. No. 3,395,558**

**Registered Mar. 11, 2008**

**SERVICE MARK  
PRINCIPAL REGISTER**

**TV THAT'S PLUGGED IN**

G4 MEDIA, INC. (DELAWARE CORPORATION)  
5750 WILSHIRE BLVD.  
LOS ANGELES, CA 90036

FOR: CABLE TELEVISION, SATELLITE TELEVISION AND INTERNET TELEVISION BROADCASTING; STREAMING OF AUDIO AND VIDEO MATERIAL ON THE INTERNET AND VIA BROADBAND AND WIRELESS TRANSMISSION, IN CLASS 38 (U.S. CLS. 100, 101 AND 104).

FIRST USE 3-1-2007; IN COMMERCE 3-1-2007.

THE MARK CONSISTS OF STANDARD CHARACTERS WITHOUT CLAIM TO ANY PARTICULAR FONT, STYLE, SIZE, OR COLOR.

SN 77-101,115, FILED 2-7-2007.

LAURIE KAUFMAN, EXAMINING ATTORNEY



**Int. Cl.: 3**

**Prior U.S. Cls.: 1, 4, 6, 50, 51, and 52**

**United States Patent and Trademark Office**

**Reg. No. 3,395,559**

**Registered Mar. 11, 2008**

**TRADEMARK  
PRINCIPAL REGISTER**



P.E.A. PRODUCTS, INC. (MARYLAND CORPORATION)  
10969 MCCORMICK ROAD  
HUNT VALLEY, MD 21031

FOR: CLEANING PREPARATIONS FOR ENZYMATICALLY CLEANING MEDICAL, DENTAL AND SURGICAL INSTRUMENTS, IN CLASS 3 (U.S. CLS. 1, 4, 6, 50, 51 AND 52).

FIRST USE 4-30-2007; IN COMMERCE 4-30-2007.

THE MARK CONSISTS OF A BATH TUB WITH BRUSHES.

SN 77-102,288, FILED 2-8-2007.

STEPHEN AQUILA, EXAMINING ATTORNEY

**Int. Cl.: 31**

**Prior U.S. Cls.: 1 and 46**

**United States Patent and Trademark Office**

**Reg. No. 3,395,560**

**Registered Mar. 11, 2008**

**TRADEMARK  
PRINCIPAL REGISTER**

**HARVEST IN HARMONY**

LUURTSEMA SALES, INC. (MICHIGAN COR-  
PORATION)  
6672 CENTER INDUSTRIAL DRIVE  
JENISON, MI 49438

THE MARK CONSISTS OF STANDARD CHAR-  
ACTERS WITHOUT CLAIM TO ANY PARTICULAR  
FONT, STYLE, SIZE, OR COLOR.

FOR: LIVING PLANTS, IN CLASS 31 (U.S. CLS. 1  
AND 46).

SN 77-106,369, FILED 2-13-2007.

FIRST USE 1-17-2007; IN COMMERCE 5-2-2007.

ANGELA GAW, EXAMINING ATTORNEY

**Int. Cl.: 33**

**Prior U.S. Cls.: 47 and 49**

**United States Patent and Trademark Office**

**Reg. No. 3,395,561**

**Registered Mar. 11, 2008**

**TRADEMARK  
PRINCIPAL REGISTER**

**WINTERHAWK**

RIO VISTA WINE & SPIRITS, LLC (CALIFORNIA  
LTD LIAB CO)  
5055 GORDON VALLEY ROAD  
FAIRFIELD, CA 94534

THE MARK CONSISTS OF STANDARD CHAR-  
ACTERS WITHOUT CLAIM TO ANY PARTICULAR  
FONT, STYLE, SIZE, OR COLOR.

FOR: WINE, IN CLASS 33 (U.S. CLS. 47 AND 49).

SN 77-106,569, FILED 2-13-2007.

FIRST USE 11-2-2007; IN COMMERCE 12-3-2007.

GEORGE LORENZO, EXAMINING ATTORNEY

**Int. Cl.: 1**

**Prior U.S. Cls.: 1, 5, 6, 10, 26, and 46**

**United States Patent and Trademark Office**

**Reg. No. 3,395,562**

**Registered Mar. 11, 2008**

**TRADEMARK  
PRINCIPAL REGISTER**

**OmniPro**

OMNI PLASTICS, LLC (INDIANA LTD LIAB CO)  
2300 LYNCH ROAD  
EVANSVILLE, IN 47711

FOR: POLYMER BEADS FOR USE IN MANUFACTURING, IN CLASS 1 (U.S. CLS. 1, 5, 6, 10, 26 AND 46).

FIRST USE 12-1-2007; IN COMMERCE 12-1-2007.

THE MARK CONSISTS OF STANDARD CHARACTERS WITHOUT CLAIM TO ANY PARTICULAR FONT, STYLE, SIZE, OR COLOR.

OWNER OF U.S. REG. NO. 3,243,981.

SN 77-106,678, FILED 2-13-2007.

ALEXANDER L. POWERS, EXAMINING ATTORNEY

Int. Cl.: 29

Prior U.S. Cl.: 46

United States Patent and Trademark Office

Reg. No. 3,395,563

Registered Mar. 11, 2008

TRADEMARK  
PRINCIPAL REGISTER



AMERIQUAL GROUP, LLC (INDIANA LTD LIAB  
CO)  
18200 HIGHWAY 41 NORTH  
EVANSVILLE, IN 47724

FOR: PRE-PACKAGED DINNERS CONSISTING  
OF MEAT WITH PASTA, RICE AND VEGETABLES;  
PACKAGED MEALS CONSISTING PRIMARILY OF  
MEAT, FISH, POULTRY OR VEGETABLES, IN  
CLASS 29 (U.S. CL. 46).

FIRST USE 12-1-2007; IN COMMERCE 12-1-2007.

NO CLAIM IS MADE TO THE EXCLUSIVE  
RIGHT TO USE "READY MEAL SELF-HEATING  
EMERGENCY MEAL", APART FROM THE MARK  
AS SHOWN.

THE COLOR(S) RED, WHITE AND BLACK IS/  
ARE CLAIMED AS A FEATURE OF THE MARK.

THE MARK CONSISTS OF A WHITE "A"  
BACKED BY A RED PLATE AND WHITE FORK  
AND "PACK" IN BLACK WITH "READY MEAL" IN  
BLACK SCRIPT BENEATH "APACK" AND THE  
DESCRIPTION "SELF-HEATING EMERGENCY  
MEAL" IN RED AT THE BOTTOM.

SN 77-106,728, FILED 2-13-2007.

EMILY CHUO, EXAMINING ATTORNEY

**Int. Cl.: 11**

**Prior U.S. Cls.: 13, 21, 23, 31, and 34**

**United States Patent and Trademark Office**

**Reg. No. 3,395,564**

**Registered Mar. 11, 2008**

**TRADEMARK  
PRINCIPAL REGISTER**

**VEGAS COWBOY**

DENNER, PAT (UNITED STATES INDIVIDUAL)  
1227 N. CAROUSEL  
SALT LAKE CITY, UT 84116

FOR: TABLELAMPS, IN CLASS 11 (U.S. CLS. 13,  
21, 23, 31 AND 34).

FIRST USE 10-1-2007; IN COMMERCE 10-1-2007.

THE MARK CONSISTS OF STANDARD CHAR-  
ACTERS WITHOUT CLAIM TO ANY PARTICULAR  
FONT, STYLE, SIZE, OR COLOR.

NO CLAIM IS MADE TO THE EXCLUSIVE  
RIGHT TO USE "COWBOY", APART FROM THE  
MARK AS SHOWN.

THE WORDING "COWBOY" HAS NO MEANING  
IN A FOREIGN LANGUAGE.

SN 77-107,703, FILED 2-14-2007.

DORITT L. CARROLL, EXAMINING ATTORNEY

Int. Cl.: 44

Prior U.S. Cls.: 100 and 101

United States Patent and Trademark Office

Reg. No. 3,395,565

Registered Mar. 11, 2008

SERVICE MARK  
PRINCIPAL REGISTER



MAGGIO, CAROLE (UNITED STATES INDIVIDUAL)  
1713 S. CATALINA AVENUE  
REDONDO BEACH, CA 90277

FOR: COSMETIC BODY CARE SERVICES, NAMELY, CELLULITE BODY SCULPTING TREATMENT, IN CLASS 44 (U.S. CLS. 100 AND 101).

FIRST USE 3-31-2007; IN COMMERCE 3-31-2007.

NO CLAIM IS MADE TO THE EXCLUSIVE RIGHT TO USE "LIPO", APART FROM THE MARK AS SHOWN.

THE MARK CONSISTS, IN PART, OF A WOMAN'S BODY ABOVE THE LITERAL ELEMENTS OF THE MARK.

SN 77-108,251, FILED 2-15-2007.

DANNEAN HETZEL, EXAMINING ATTORNEY

**Int. Cl.: 21**

**Prior U.S. Cls.: 2, 13, 23, 29, 30, 33, 40, and 50**

**United States Patent and Trademark Office**

**Reg. No. 3,395,566**

**Registered Mar. 11, 2008**

**TRADEMARK  
PRINCIPAL REGISTER**

**AQUA WAND**

READING ETC. (FLORIDA CORPORATION),  
DBA CREATIVE DESIGN GROUP,  
15TH STREET  
3201 SOUTHWEST  
DEERFIELD BEACH, FL 33442

THE MARK CONSISTS OF STANDARD CHAR-  
ACTERS WITHOUT CLAIM TO ANY PARTICULAR  
FONT, STYLE, SIZE, OR COLOR.

FOR: AQUARIUM CLEANING TOOLS, NAMELY,  
CLEANING SPONGES, NETS AND BRUSHES, IN  
CLASS 21 (U.S. CLS. 2, 13, 23, 29, 30, 33, 40 AND 50).

SN 77-109,300, FILED 2-16-2007.

FIRST USE 6-14-2007; IN COMMERCE 6-14-2007.

DANNEAN HETZEL, EXAMINING ATTORNEY



**Int. Cl.: 33**

**Prior U.S. Cls.: 47 and 49**

**United States Patent and Trademark Office**

**Reg. No. 3,395,567**

**Registered Mar. 11, 2008**

**TRADEMARK  
PRINCIPAL REGISTER**

**DUEL**

DARIOUSH KHALEDI WINERY, LLC (CALI-  
FORNIA LTD LIAB CO)  
4240 SILVERADO TRAIL  
NAPA, CA 94558

THE MARK CONSISTS OF STANDARD CHAR-  
ACTERS WITHOUT CLAIM TO ANY PARTICULAR  
FONT, STYLE, SIZE, OR COLOR.

FOR: WINE, IN CLASS 33 (U.S. CLS. 47 AND 49).

SN 77-109,321, FILED 2-16-2007.

FIRST USE 10-23-2007; IN COMMERCE 10-23-2007.

MICHELLE DUBOIS, EXAMINING ATTORNEY

**Int. Cl.: 10**

**Prior U.S. Cls.: 26, 39, and 44**

**United States Patent and Trademark Office**

**Reg. No. 3,395,568**

**Registered Mar. 11, 2008**

**TRADEMARK  
PRINCIPAL REGISTER**

# VivoResponder

VIVOMETRICS, INC. (DELAWARE CORPORATION)  
SUITE E  
121 N. FIR STREET  
VENTURA, CA 93001

FOR: ELECTRONIC MEDICAL DEVICES, NAME-  
LY, AMBULATORY HEALTH AND FITNESS MON-  
ITORING SYSTEM COMPRISED OF A WEARABLE  
GARMENT WITH EMBEDDED SENSORS AND A  
DIGITAL DEVICE THAT COLLECTS AND RE-  
CORDS PHYSIOLOGIC DATA INCLUDING: RE-  
SPIRATORY, CARDIAC, POSTURE, ACTIVITY,  
TEMPERATURE, GLOBAL POSITION AND OTHER  
AMBULATORY AND PHYSIOLOGIC PARAME-  
TERS, THAT ARE THEN STORED AND/OR TRANS-

MITTED WIRELESSLY TO: DATA DISPLAY  
LOCALLY ON INDIVIDUAL, REMOTE DATA CEN-  
TER FOR ANALYSIS, PERSONAL WEB SITE, AND  
OTHER LOCATIONS, IN CLASS 10 (U.S. CLS. 26, 39  
AND 44).

FIRST USE 2-1-2007; IN COMMERCE 2-1-2007.

THE MARK CONSISTS OF STANDARD CHAR-  
ACTERS WITHOUT CLAIM TO ANY PARTICULAR  
FONT, STYLE, SIZE, OR COLOR.

SN 77-110,775, FILED 2-19-2007.

JAMES MACFARLANE, EXAMINING ATTORNEY

**Int. Cl.: 39**

**Prior U.S. Cls.: 100 and 105**

**United States Patent and Trademark Office**

**Reg. No. 3,395,569**

**Registered Mar. 11, 2008**

**SERVICE MARK  
PRINCIPAL REGISTER**

**CIA SOPHISTICATED PALATE**

THE CULINARY INSTITUTE OF AMERICA  
(NEW YORK CORPORATION)  
1946 CAMPUS DRIVE  
HYDE PARK, NY 12538

THE MARK CONSISTS OF STANDARD CHAR-  
ACTERS WITHOUT CLAIM TO ANY PARTICULAR  
FONT, STYLE, SIZE, OR COLOR.

FOR: ORGANIZATION OF EXCURSIONS, HOLI-  
DAYS, TOURS AND TRAVEL, IN CLASS 39 (U.S.  
CLS. 100 AND 105).

SN 77-111,410, FILED 2-20-2007.

FIRST USE 4-2-2007; IN COMMERCE 4-2-2007.

CHRISTINE COOPER, EXAMINING ATTORNEY

**Int. Cl.: 11**

**Prior U.S. Cls.: 13, 21, 23, 31, and 34**

**United States Patent and Trademark Office**

**Reg. No. 3,395,570**

**Registered Mar. 11, 2008**

**TRADEMARK  
PRINCIPAL REGISTER**

**SCHOLASTIC HEATER**

WEBASTO PRODUCT NORTH AMERICA, INC.  
(MICHIGAN CORPORATION)  
15083 NORTH ROAD  
FENTON, MI 48430

FOR: AFTER-MARKET VEHICLE PREHEATING AND AUXILIARY HEATING SYSTEMS COMPRISED OF ENGINE PREHEATING UNITS FOR VEHICLES; AFTER-MARKET VEHICLE PREHEATING AND AUXILIARY HEATING SYSTEMS COMPRISED OF AUXILIARY HEATING UNITS FOR VEHICLES; AFTER-MARKET VEHICLE PREHEATING AND AUXILIARY HEATING SYSTEMS COMPRISED OF ENGINE PREHEATING UNITS FOR VEHICLES AND AUXILIARY HEATING UNITS FOR VEHICLES, IN CLASS 11 (U.S. CLS. 13, 21, 23, 31 AND 34).

FIRST USE 1-31-1998; IN COMMERCE 1-31-1998.

THE MARK CONSISTS OF STANDARD CHARACTERS WITHOUT CLAIM TO ANY PARTICULAR FONT, STYLE, SIZE, OR COLOR.

NO CLAIM IS MADE TO THE EXCLUSIVE RIGHT TO USE "HEATER" , APART FROM THE MARK AS SHOWN.

SN 77-111,752, FILED 2-20-2007.

DAVID YONTEF, EXAMINING ATTORNEY

**Int. Cl.: 7**

**Prior U.S. Cls.: 13, 19, 21, 23, 31, 34, and 35**

**Reg. No. 3,395,571**

**United States Patent and Trademark Office**

**Registered Mar. 11, 2008**

**TRADEMARK  
PRINCIPAL REGISTER**

**CRICUT SAMPLER**

PROVO CRAFT AND NOVELTY, INC. (UTAH  
CORPORATION)  
151 EAST 3450 NORTH  
SPANISH FORK, UT 84660

FOR: PAPER CUTTING MACHINE FOR CUT-  
TING PAPER, CARDSTOCK, AND OTHER MATE-  
RIALS IN SHEET FORM, IN CLASS 7 (U.S. CLS. 13,  
19, 21, 23, 31, 34 AND 35).

FIRST USE 8-1-2006; IN COMMERCE 8-1-2006.

THE MARK CONSISTS OF STANDARD CHAR-  
ACTERS WITHOUT CLAIM TO ANY PARTICULAR  
FONT, STYLE, SIZE, OR COLOR.

NO CLAIM IS MADE TO THE EXCLUSIVE  
RIGHT TO USE "SAMPLER", APART FROM THE  
MARK AS SHOWN.

SN 77-113,452, FILED 2-22-2007.

TANYA AMOS, EXAMINING ATTORNEY

**Int. Cl.: 30**

**Prior U.S. Cl.: 46**

**United States Patent and Trademark Office**

**Reg. No. 3,395,572**

**Registered Mar. 11, 2008**

**TRADEMARK  
PRINCIPAL REGISTER**

**J9 ESPRESS**

STAR KAY WHITE, INC. (NEW YORK COR-  
PORATION)  
85 BRENNER DRIVE  
CONGERS, NY 109201398

FOR: CANDIES; CHOCOLATE CANDIES, IN  
CLASS 30 (U.S. CL. 46).

FIRST USE 3-26-2007; IN COMMERCE 9-21-2007.

THE MARK CONSISTS OF STANDARD CHAR-  
ACTERS WITHOUT CLAIM TO ANY PARTICULAR  
FONT, STYLE, SIZE, OR COLOR.

THE WORDING "J9" HAS NO MEANING IN A  
FOREIGN LANGUAGE.

SN 77-113,553, FILED 2-22-2007.

CHARLOTTE CORWIN, EXAMINING ATTORNEY

**Int. Cl.: 21**

**Prior U.S. Cls.: 2, 13, 23, 29, 30, 33, 40, and 50**

**United States Patent and Trademark Office**

**Reg. No. 3,395,573**

**Registered Mar. 11, 2008**

**TRADEMARK  
PRINCIPAL REGISTER**

**MOSQUITO SWALLOW**

MOSQUITO SWALLOW LLC (TEXAS LTD LIAB  
CO)  
BLAIR DANCY  
9600 GREAT HILLS TRIAL, SUITE 300 WEST  
AUSTIN, TX 78759

FOR: INSECT TRAPS, IN CLASS 21 (U.S. CLS. 2, 13,  
23, 29, 30, 33, 40 AND 50).

FIRST USE 12-13-2007; IN COMMERCE 12-13-2007.

THE MARK CONSISTS OF STANDARD CHAR-  
ACTERS WITHOUT CLAIM TO ANY PARTICULAR  
FONT, STYLE, SIZE, OR COLOR.

NO CLAIM IS MADE TO THE EXCLUSIVE  
RIGHT TO USE "MOSQUITO", APART FROM THE  
MARK AS SHOWN.

SN 77-113,940, FILED 2-22-2007.

JAMES GRIFFIN, EXAMINING ATTORNEY

**Int. Cl.: 32**

**Prior U.S. Cls.: 45, 46, and 48**

**United States Patent and Trademark Office**

**Reg. No. 3,395,574**

**Registered Mar. 11, 2008**

**TRADEMARK  
PRINCIPAL REGISTER**

**FULL THROTTLE MOTHER**

THE COCA-COLA COMPANY (DELAWARE  
CORPORATION)  
ONE COCA-COLA PLAZA  
ATLANTA, GA 30313

FOR: NON-ALCOHOLIC BEVERAGES, NAMELY,  
ENERGY DRINKS; CONCENTRATES FOR MAK-  
ING NON-ALCOHOLIC BEVERAGES, NAMELY,  
ENERGY DRINKS, IN CLASS 32 (U.S. CLS. 45, 46  
AND 48).

FIRST USE 8-13-2007; IN COMMERCE 8-13-2007.

THE MARK CONSISTS OF STANDARD CHAR-  
ACTERS WITHOUT CLAIM TO ANY PARTICULAR  
FONT, STYLE, SIZE, OR COLOR.

OWNER OF U.S. REG. NOS. 2,955,467 AND  
2,957,843.

SN 77-114,222, FILED 2-23-2007.

ELLEN PERKINS, EXAMINING ATTORNEY



**Int. Cl.: 9**

**Prior U.S. Cls.: 21, 23, 26, 36, and 38**

**Reg. No. 3,395,575**

**United States Patent and Trademark Office**

**Registered Mar. 11, 2008**

---

**TRADEMARK  
PRINCIPAL REGISTER**

**VISTA**

TIFFEN ACQUISITIONS, L.L.C. (DELAWARE  
LTD LIAB CO)  
90 OSER AVENUE  
HAUPPAUGE, NY 11788

THE MARK CONSISTS OF STANDARD CHAR-  
ACTERS WITHOUT CLAIM TO ANY PARTICULAR  
FONT, STYLE, SIZE, OR COLOR.

FOR: CAMERA TRIPODS, IN CLASS 9 (U.S. CLS.  
21, 23, 26, 36 AND 38).

SN 77-114,223, FILED 2-23-2007.

FIRST USE 6-15-2007; IN COMMERCE 6-15-2007.

REBECCA EISINGER, EXAMINING ATTORNEY

Int. Cl.: 42

Prior U.S. Cls.: 100 and 101

United States Patent and Trademark Office

Reg. No. 3,395,576

Registered Mar. 11, 2008

SERVICE MARK  
PRINCIPAL REGISTER



THE CBORD GROUP, INC. (DELAWARE CORPORATION)  
61 BROWN ROAD  
ITHACA, NY 14850

FOR: PROVIDING ONLINE NON-DOWNLOADABLE SOFTWARE FOR MANAGING ACCOUNTS ASSOCIATED WITH AN ID CARD, NAMELY, VIEWING BALANCES, INITIATING AND TRACKING TRANSACTIONS, VIEWING ACCOUNTS HISTORIES, AND REPORTING LOST/STOLEN ID CARD, IN CLASS 42 (U.S. CLS. 100 AND 101).

FIRST USE 6-29-2007; IN COMMERCE 6-29-2007.

NO CLAIM IS MADE TO THE EXCLUSIVE RIGHT TO USE "MANAGEMYID.COM", APART FROM THE MARK AS SHOWN.

THE MARK CONSISTS OF THE WORDS "MANAGEMYID.COM" IN STYLIZED TEXT WITH A STYLIZED PERSON SITTING AT A COMPUTER ON THE LEFT END OF THE WORDS AND A STYLIZED "ID" CARD ABOVE THE FIRST PART OF THE WORD "MANAGE".

SN 77-114,894, FILED 2-23-2007.

KELLEY WELLS, EXAMINING ATTORNEY

**Int. Cl.: 25**

**Prior U.S. Cls.: 22 and 39**

**United States Patent and Trademark Office**

**Reg. No. 3,395,577**

**Registered Mar. 11, 2008**

**TRADEMARK  
PRINCIPAL REGISTER**

**INVISIBLE APRON**

VACCARO, MARY ANNE (UNITED STATES IN-  
DIVIDUAL)  
314 SOUTH 85TH STREET  
OMAHA, NE 68114

NO CLAIM IS MADE TO THE EXCLUSIVE  
RIGHT TO USE "APRON", APART FROM THE  
MARK AS SHOWN.

FOR: APRONS, IN CLASS 25 (U.S. CLS. 22 AND 39).

FIRST USE 11-30-2007; IN COMMERCE 12-18-2007.

SN 77-115,788, FILED 2-26-2007.

THE MARK CONSISTS OF STANDARD CHAR-  
ACTERS WITHOUT CLAIM TO ANY PARTICULAR  
FONT, STYLE, SIZE, OR COLOR.

ZACHARY BELLO, EXAMINING ATTORNEY

Int. Cl.: 33

Prior U.S. Cls.: 47 and 49

United States Patent and Trademark Office

Reg. No. 3,395,578

Registered Mar. 11, 2008

TRADEMARK  
PRINCIPAL REGISTER



BROWN-FORMAN CORPORATION (DELAWARE CORPORATION)  
850 DIXIE HIGHWAY  
LOUISVILLE, KY 40210

THE MARK CONSISTS OF THE WORDS "DREAM IT" AND "LIVE IT" SURROUNDING A DRAWN PICTURE OF THE SUN.

FOR: FLAVORED ALCOHOLIC BEVERAGES, NAMELY, PREPARED ALCOHOLIC COCKTAILS MADE WITH A WINE BASE, IN CLASS 33 (U.S. CLS. 47 AND 49).

SN 77-116,671, FILED 2-26-2007.

FIRST USE 4-10-2007; IN COMMERCE 4-10-2007.

KATHERINE CHANG, EXAMINING ATTORNEY

**Int. Cls.: 35, 37, and 42**

**Prior U.S. Cls.: 100, 101, 102, 103, and 106**

**United States Patent and Trademark Office**

**Reg. No. 3,395,579**

**Registered Mar. 11, 2008**

**SERVICE MARK  
PRINCIPAL REGISTER**

**DOVETEL**

SYNCHRONET, INC. (GEORGIA CORPORATION)  
1090A PACIFIC AVENUE  
BREMEN, GA 30110

FOR: DISTRIBUTORSHIPS IN THE FIELD OF ELECTRICAL AND COMPUTER HARDWARE AND SOFTWARE IN THE FIELD OF TELECOMMUNICATION NETWORKS , IN CLASS 35 (U.S. CLS. 100, 101 AND 102).

FIRST USE 4-17-2006; IN COMMERCE 4-17-2006.

FOR: INSTALLATION AND MAINTENANCE OF TELECOMMUNICATION NETWORKS, IN CLASS 37 (U.S. CLS. 100, 103 AND 106).

FIRST USE 4-17-2006; IN COMMERCE 4-17-2006.

FOR: DESIGN AND DEVELOPMENT OF TELECOMMUNICATION NETWORKS; ENGINEERING SERVICES, NAMELY, ENGINEERING IN THE FIELD OF TELECOMMUNICATION NETWORKS, IN CLASS 42 (U.S. CLS. 100 AND 101).

FIRST USE 4-17-2006; IN COMMERCE 4-17-2006.

THE MARK CONSISTS OF STANDARD CHARACTERS WITHOUT CLAIM TO ANY PARTICULAR FONT, STYLE, SIZE, OR COLOR.

SN 77-117,025, FILED 2-27-2007.

RICHARD A. STRASER, EXAMINING ATTORNEY

**Int. Cl.: 43**

**Prior U.S. Cls.: 100 and 101**

**United States Patent and Trademark Office**

**Reg. No. 3,395,580**

**Registered Mar. 11, 2008**

**SERVICE MARK  
PRINCIPAL REGISTER**

**ROCK WINE & BLUES**

HENDLEY, SCOTT (UNITED STATES INDIVIDUAL)  
1 PAINTED CUP CT.  
THE WOODLANDS, TX 77380

THE MARK CONSISTS OF STANDARD CHARACTERS WITHOUT CLAIM TO ANY PARTICULAR FONT, STYLE, SIZE, OR COLOR.

FOR: RESTAURANT AND BAR SERVICES, IN CLASS 43 (U.S. CLS. 100 AND 101).

SN 77-117,287, FILED 2-27-2007.

FIRST USE 11-10-2007; IN COMMERCE 11-10-2007.

TINA KUAN, EXAMINING ATTORNEY

**Int. Cl.: 26**

**Prior U.S. Cls.: 37, 39, 40, 42, and 50**

**United States Patent and Trademark Office**

**Reg. No. 3,395,581**

**Registered Mar. 11, 2008**

**TRADEMARK  
PRINCIPAL REGISTER**

**FELT FASHIONS**

PROVO CRAFT AND NOVELTY, INC. (UTAH  
CORPORATION)  
151 EAST 3450 NORTH  
SPANISH FORK, UT 84660

FOR: PRECUT SHAPES MADE FROM FELT FOR  
CRAFTING, IN CLASS 26 (U.S. CLS. 37, 39, 40, 42  
AND 50).

FIRST USE 1-28-2007; IN COMMERCE 7-1-2007.

THE MARK CONSISTS OF STANDARD CHAR-  
ACTERS WITHOUT CLAIM TO ANY PARTICULAR  
FONT, STYLE, SIZE, OR COLOR.

NO CLAIM IS MADE TO THE EXCLUSIVE  
RIGHT TO USE "FELT", APART FROM THE MARK  
AS SHOWN.

SN 77-118,616, FILED 2-28-2007.

BENJAMIN ALLEN, EXAMINING ATTORNEY

**Int. Cl.: 33**

**Prior U.S. Cls.: 47 and 49**

**United States Patent and Trademark Office**

**Reg. No. 3,395,582**

**Registered Mar. 11, 2008**

**TRADEMARK  
PRINCIPAL REGISTER**

**GABRIELLA**

VINDAGRA USA INC. (FLORIDA CORPORATION)  
60 WESTWOOD AVE  
DEER PARK, NY 11729

THE MARK CONSISTS OF STANDARD CHARACTERS WITHOUT CLAIM TO ANY PARTICULAR FONT, STYLE, SIZE, OR COLOR.

FOR: CORDIALS; DISTILLED SPIRITS; LIQUEURS; WINE, IN CLASS 33 (U.S. CLS. 47 AND 49).

SN 77-119,012, FILED 2-28-2007.

FIRST USE 6-6-2007; IN COMMERCE 5-30-2007.

MARIAM MAHMOUDI, EXAMINING ATTORNEY



**Int. Cl.: 28**

**Prior U.S. Cls.: 22, 23, 38, and 50**

**United States Patent and Trademark Office**

**Reg. No. 3,395,583**

**Registered Mar. 11, 2008**

---

**TRADEMARK  
PRINCIPAL REGISTER**

**PARADISE LOST**

GLOBAL VR, INC. (DELAWARE CORPORATION)  
2350 ZANKER ROAD  
SAN JOSE, CA 95131

THE MARK CONSISTS OF STANDARD CHARACTERS WITHOUT CLAIM TO ANY PARTICULAR FONT, STYLE, SIZE, OR COLOR.

FOR: COIN-OPERATED VIDEO GAMES, IN CLASS 28 (U.S. CLS. 22, 23, 38 AND 50).

SN 77-120,170, FILED 3-1-2007.

FIRST USE 5-7-2007; IN COMMERCE 5-7-2007.

TASHIA BUNCH, EXAMINING ATTORNEY

**Int. Cl.: 16**

**Prior U.S. Cls.: 2, 5, 22, 23, 29, 37, 38, and 50**

**United States Patent and Trademark Office**

**Reg. No. 3,395,584**

**Registered Mar. 11, 2008**

**TRADEMARK  
PRINCIPAL REGISTER**



DURANTE, TINA MARIE (UNITED STATES IN-  
DIVIDUAL)  
9159 PASEO CRESTA  
SANTEE, CA 92071

FOR: PAINTINGS AND CALLIGRAPHIC  
WORKS, IN CLASS 16 (U.S. CLS. 2, 5, 22, 23, 29, 37,  
38 AND 50).

FIRST USE 6-17-2005; IN COMMERCE 7-12-2006.

THE MARK CONSISTS OF QUILL WITH NIB.

SN 77-121,185, FILED 3-2-2007.

PAUL E. FAHRENKOPF, EXAMINING ATTORNEY

Int. Cl.: 33

Prior U.S. Cls.: 47 and 49

United States Patent and Trademark Office

Reg. No. 3,395,585

Registered Mar. 11, 2008

TRADEMARK  
PRINCIPAL REGISTER

DISEÑO

CONSTELLATION WINES U.S., INC. (NEW  
YORK CORPORATION)

235 NORTH BLOOMFIELD RD.

CANANDAIGUA, NY 144241059

FOR: WINE, IN CLASS 33 (U.S. CLS. 47 AND 49).

FIRST USE 7-0-2007; IN COMMERCE 7-0-2007.

THE MARK CONSISTS OF STANDARD CHAR-  
ACTERS WITHOUT CLAIM TO ANY PARTICULAR  
FONT, STYLE, SIZE, OR COLOR.

THE FOREIGN WORDING IN THE MARK  
TRANSLATES INTO ENGLISH AS "DESIGN".

SN 77-121,231, FILED 3-2-2007.

TINA BROWN, EXAMINING ATTORNEY

**Int. Cl.: 26**

**Prior U.S. Cls.: 37, 39, 40, 42, and 50**

**United States Patent and Trademark Office**

**Reg. No. 3,395,586**

**Registered Mar. 11, 2008**

**TRADEMARK  
PRINCIPAL REGISTER**

# Columpine

PHILIP E. BRINKMANN (UNITED STATES IN-  
DIVIDUAL)  
P.O.BOX 1693  
GRANBY, CO 804461693

THE MARK CONSISTS OF STANDARD CHAR-  
ACTERS WITHOUT CLAIM TO ANY PARTICULAR  
FONT, STYLE, SIZE, OR COLOR.

FOR: ARTIFICIAL FLOWER ARRANGEMENTS;  
ARTIFICIAL FLOWER WREATHS; ARTIFICIAL  
FLOWERS, IN CLASS 26 (U.S. CLS. 37, 39, 40, 42  
AND 50).

SN 77-122,439, FILED 3-5-2007.

FIRST USE 7-30-2007; IN COMMERCE 7-30-2007.

KEVON CHISOLM, EXAMINING ATTORNEY

**Int. Cl.: 36**

**Prior U.S. Cls.: 100, 101, and 102**

**United States Patent and Trademark Office**

**Reg. No. 3,395,587**

**Registered Mar. 11, 2008**

**SERVICE MARK  
PRINCIPAL REGISTER**

**THE DIRECTION FORWARD**

AMERICAN INTERNATIONAL GROUP, INC.  
(DELAWARE CORPORATION)  
70 PINE STREET  
NEW YORK, NY 10270

FOR: INSURANCE UNDERWRITING IN THE  
FIELD OF WORKER'S COMPENSATION, AND IN-  
SURANCE CLAIMS MANAGEMENT, IN CLASS 36  
(U.S. CLS. 100, 101 AND 102).

FIRST USE 8-1-2007; IN COMMERCE 8-1-2007.

THE MARK CONSISTS OF STANDARD CHAR-  
ACTERS WITHOUT CLAIM TO ANY PARTICULAR  
FONT, STYLE, SIZE, OR COLOR.

SN 77-122,451, FILED 3-5-2007.

KELLY MCCOY, EXAMINING ATTORNEY

**Int. Cl.: 9**

**Prior U.S. Cls.: 21, 23, 26, 36, and 38**

**United States Patent and Trademark Office**

**Reg. No. 3,395,588**

**Registered Mar. 11, 2008**

**TRADEMARK  
PRINCIPAL REGISTER**

**FinallySecure**

IT—SEC SWISS AG (SWITZERLAND CORPORATION)  
SEESTRASSE 5  
CHAM, SWITZERLAND 6330

FOR: SOFTWARE FOR IMPLEMENTING THE COMPLETE ENCRYPTION OF BOTH INTERNAL AND EXTERNAL DIGITAL STORAGE MEDIUMS, INCLUDING HARD DRIVES, FLASH DRIVES, OPTICAL DATA, AND ANY OTHER DIGITAL STORAGE DEVICE, IN CLASS 9 (U.S. CLS. 21, 23, 26, 36 AND 38).

FIRST USE 6-29-2007; IN COMMERCE 6-29-2007.

THE COLOR(S) BLACK AND RED IS/ARE CLAIMED AS A FEATURE OF THE MARK.

THE COLOR BLACK APPEARS IN THE WORD "FINALLY" AND THE COLOR RED APPEARS IN THE WORD "SECURE".

SN 77-122,535, FILED 3-5-2007.

DANNEAN HETZEL, EXAMINING ATTORNEY

**Int. Cl.: 30**

**Prior U.S. Cl.: 46**

**United States Patent and Trademark Office**

**Reg. No. 3,395,589**

**Registered Mar. 11, 2008**

**TRADEMARK  
PRINCIPAL REGISTER**

**LITE ACCENTS**

KEN'S FOODS, INC. (MASSACHUSETTS CORPORATION)

1 D'ANGELO DRIVE

MARLBOROUGH, MA 01752

FOR: SALAD DRESSINGS, IN CLASS 30 (U.S. CL. 46).

FIRST USE 9-1-2007; IN COMMERCE 9-1-2007.

THE MARK CONSISTS OF STANDARD CHARACTERS WITHOUT CLAIM TO ANY PARTICULAR FONT, STYLE, SIZE, OR COLOR.

NO CLAIM IS MADE TO THE EXCLUSIVE RIGHT TO USE "LITE", APART FROM THE MARK AS SHOWN.

SN 77-123,164, FILED 3-6-2007.

CHARLES L. JENKINS, EXAMINING ATTORNEY

**Int. Cl.: 5**

**Prior U.S. Cls.: 6, 18, 44, 46, 51, and 52**

**Reg. No. 3,395,590**

**United States Patent and Trademark Office**

**Registered Mar. 11, 2008**

---

**TRADEMARK  
PRINCIPAL REGISTER**

**INTEGRID**

PSS WORLD MEDICAL, INC. (FLORIDA CORPORATION)  
4345 SOUTHPOINT BOULEVARD  
JACKSONVILLE, FL 32216

THE MARK CONSISTS OF STANDARD CHARACTERS WITHOUT CLAIM TO ANY PARTICULAR FONT, STYLE, SIZE, OR COLOR.

FOR: COMPONENT FEATURE OF A WOUND DRESSING THAT ASSISTS IN REMOVAL OF THAT WOUND DRESSING IN ONE PIECE, IN CLASS 5 (U.S. CLS. 6, 18, 44, 46, 51 AND 52).

SN 77-124,369, FILED 3-7-2007.

FIRST USE 7-6-2007; IN COMMERCE 7-6-2007.

MARCIE MILONE, EXAMINING ATTORNEY



**Int. Cl.: 9**

**Prior U.S. Cls.: 21, 23, 26, 36, and 38**

**United States Patent and Trademark Office**

**Reg. No. 3,395,591**

**Registered Mar. 11, 2008**

**TRADEMARK  
PRINCIPAL REGISTER**

**CARNEGIE ACOUSTICS**

CARNEGIE ACOUSTICS (KENTUCKY CORPORATION)  
1001 CARTER AVE.  
ASHLAND, KY 41101

FOR: AUDIO ELECTRONIC COMPONENTS, NAMELY, SURROUND SOUND SYSTEMS, IN CLASS 9 (U.S. CLS. 21, 23, 26, 36 AND 38).

FIRST USE 3-20-2007; IN COMMERCE 3-20-2007.

THE MARK CONSISTS OF STANDARD CHARACTERS WITHOUT CLAIM TO ANY PARTICULAR FONT, STYLE, SIZE, OR COLOR.

NO CLAIM IS MADE TO THE EXCLUSIVE RIGHT TO USE "ACOUSTICS", APART FROM THE MARK AS SHOWN.

SN 77-126,729, FILED 3-9-2007.

ANDREA HACK, EXAMINING ATTORNEY

**Int. Cl.: 40**

**Prior U.S. Cls.: 100, 103, and 106**

**United States Patent and Trademark Office**

**Reg. No. 3,395,592**

**Registered Mar. 11, 2008**

**SERVICE MARK  
PRINCIPAL REGISTER**

**MICROMANAGEMENT**

TRIDENT TECHNOLOGIES, INC. (CALIFORNIA CORPORATION)  
7425 MISSION VALLEY ROAD #207  
SAN DIEGO, CA 92108

FOR: CHEMICAL AND MECHANICAL TREATMENT SERVICES, NAMELY, FOR THE CONTROL AND PREVENTION OF MICRO ORGANISMS, BACTERIA, FUNGI, AND ALGAE IN INDUSTRIAL WATER SYSTEMS, COOLING TOWERS, AIR WASHERS, SCRUBBERS, TANKS, PIPING, POTABLE WATER SYSTEMS, TANKS, PIPING AND PUMPS, DECORATIVE WATER FOUNTAINS, WATER FEATURES, SWIMMING POOLS, WATER SUP-

PLIES, STREAMS, FLUMES, RIVERS, LAKES, AND PONDS, IN CLASS 40 (U.S. CLS. 100, 103 AND 106).

FIRST USE 4-1-2007; IN COMMERCE 4-1-2007.

THE MARK CONSISTS OF STANDARD CHARACTERS WITHOUT CLAIM TO ANY PARTICULAR FONT, STYLE, SIZE, OR COLOR.

SN 77-128,339, FILED 3-12-2007.

REBECCA POVARCHUK, EXAMINING ATTORNEY

**Int. Cl.: 37**

**Prior U.S. Cls.: 100, 103, and 106**

**United States Patent and Trademark Office**

**Reg. No. 3,395,593**

**Registered Mar. 11, 2008**

**SERVICE MARK  
PRINCIPAL REGISTER**

**ELECTRIC-MEDIC**

GILLECE HEATING AND COOLING, INC.  
(PENNSYLVANIA CORPORATION)  
3347 INDUSTRIAL BOULEVARD  
BETHEL PARK, PA 15102

THE MARK CONSISTS OF STANDARD CHAR-  
ACTERS WITHOUT CLAIM TO ANY PARTICULAR  
FONT, STYLE, SIZE, OR COLOR.

FOR: ELECTRICAL CONTRACTOR SERVICES,  
IN CLASS 37 (U.S. CLS. 100, 103 AND 106).

SN 77-128,447, FILED 3-12-2007.

FIRST USE 11-28-2007; IN COMMERCE 11-28-2007.

LEE-ANNE BERNS, EXAMINING ATTORNEY

**Int. Cl.: 5**

**Prior U.S. Cls.: 6, 18, 44, 46, 51, and 52**

**Reg. No. 3,395,594**

**United States Patent and Trademark Office**

**Registered Mar. 11, 2008**

**TRADEMARK  
PRINCIPAL REGISTER**

**ARNICOL**

DISTRIBUIDORA DE ALIMENTOS NATURALES  
Y NUTRICIONALES, S.A. DE C.V. (MEXICO  
SOCIEDAD ANONIMA)  
MANUEL AVILA CAMACHO # 44-A  
MEXICO, MEXICO 09570

THE MARK CONSISTS OF STANDARD CHAR-  
ACTERS WITHOUT CLAIM TO ANY PARTICULAR  
FONT, STYLE, SIZE, OR COLOR.

FOR: OINTMENTS FOR MUSCULAR ILLNESS  
FOR HUMAN, IN CLASS 5 (U.S. CLS. 6, 18, 44, 46, 51  
AND 52).

SN 77-128,928, FILED 3-12-2007.

FIRST USE 1-2-2008; IN COMMERCE 1-2-2008.

CHRISTINA SOBRAL, EXAMINING ATTORNEY

**Int. Cl.: 11**

**Prior U.S. Cls.: 13, 21, 23, 31, and 34**

**United States Patent and Trademark Office**

**Reg. No. 3,395,595**

**Registered Mar. 11, 2008**

**TRADEMARK  
PRINCIPAL REGISTER**

**DESTINY**

MOEN INCORPORATED (DELAWARE COR-  
PORATION)  
25300 AL MOEN DRIVE  
NORTH OLMSTED, OH 440708022

THE MARK CONSISTS OF STANDARD CHAR-  
ACTERS WITHOUT CLAIM TO ANY PARTICULAR  
FONT, STYLE, SIZE, OR COLOR.

FOR: ELECTRICALLY OPERATED PLUMBING  
PRODUCTS, NAMELY, LAVATORY FAUCETS  
AND FAUCET VALVES, IN CLASS 11 (U.S. CLS. 13,  
21, 23, 31 AND 34).

SN 77-130,073, FILED 3-13-2007.

FIRST USE 5-8-2007; IN COMMERCE 5-8-2007.

RON FAIRBANKS, EXAMINING ATTORNEY

**Int. Cl.: 34**

**Prior U.S. Cls.: 2, 8, 9, and 17**

**United States Patent and Trademark Office**

**Reg. No. 3,395,596**

**Registered Mar. 11, 2008**

**TRADEMARK  
PRINCIPAL REGISTER**

**MARLBORO VIRGINIA BLEND**

PHILIP MORRIS USA INC. (VIRGINIA CORPORATION)  
6601 WEST BROAD STREET  
RICHMOND, VA 23230

FOR: CIGARETTES, IN CLASS 34 (U.S. CLS. 2, 8, 9 AND 17).

FIRST USE 9-10-2007; IN COMMERCE 9-10-2007.

THE MARK CONSISTS OF STANDARD CHARACTERS WITHOUT CLAIM TO ANY PARTICULAR FONT, STYLE, SIZE, OR COLOR.

OWNER OF U.S. REG. NOS. 68,502, 938,510, AND OTHERS.

NO CLAIM IS MADE TO THE EXCLUSIVE RIGHT TO USE "VIRGINIA BLEND", APART FROM THE MARK AS SHOWN.

SN 77-130,950, FILED 3-14-2007.

DOMINIC J. FERRAIUOLO, EXAMINING ATTORNEY

**Int. Cls.: 37 and 42**

**Prior U.S. Cls.: 100, 101, 103, and 106**

**United States Patent and Trademark Office**

**Reg. No. 3,395,597**

**Registered Mar. 11, 2008**

**SERVICE MARK  
PRINCIPAL REGISTER**

**MP START**

MOBIUS PARTNERS, LTD. (TEXAS LIMITED  
PARTNERSHIP)  
837 ISOM ROAD  
SAN ANTONIO, TX 78216

FOR: COMPUTER INSTALLATION SERVICES,  
NAMELY, INSTALLATION OF COMPUTER SYS-  
TEMS FOR APPLICATION MANAGEMENT, IN  
CLASS 37 (U.S. CLS. 100, 103 AND 106).

FIRST USE 8-1-2007; IN COMMERCE 8-1-2007.

FOR: COMPUTER INTEGRATION SERVICES,  
NAMELY, INTEGRATION OF COMPUTER SYS-  
TEMS INTO EXISTING NETWORKS; COMPUTER  
CONFIGURATION SERVICES, NAMELY, CONFIG-  
URING OPERATING SYSTEM SOFTWARE ON  
DISKS TO PROVIDE SPECIFIC FUNCTIONS,  
NAMELY, FIREWALL, PRINT SERVER, FILE SER-

VER, WEB SERVER, AND DATABASE FUNCTIONS;  
COMPUTER CONFIGURATION SERVICES, NAME-  
LY, INTEGRATION OF COMPUTER SYSTEMS  
AND NETWORKS IN THE NATURE OF CONFIG-  
URING NEW COMPUTER STORAGE SUBSYSTEMS  
INTO EXISTING COMPUTER SYSTEMS AND NET-  
WORKS, IN CLASS 42 (U.S. CLS. 100 AND 101).

FIRST USE 8-1-2007; IN COMMERCE 8-1-2007.

THE MARK CONSISTS OF STANDARD CHAR-  
ACTERS WITHOUT CLAIM TO ANY PARTICULAR  
FONT, STYLE, SIZE, OR COLOR.

SN 77-130,968, FILED 3-14-2007.

KEVIN CORWIN, EXAMINING ATTORNEY

**Int. Cl.: 30**

**Prior U.S. Cl.: 46**

**United States Patent and Trademark Office**

**Reg. No. 3,395,598**

**Registered Mar. 11, 2008**

**TRADEMARK  
PRINCIPAL REGISTER**

**TASTEMASTER**

LEWIS BROTHERS BAKERIES, INCORPORATED  
D/B/A LEWIS BAKERIES, INC. (MISSOURI  
CORPORATION)  
500 N. FULTON AVENUE  
EVANSVILLE, IN 47710

FOR: BUNS, IN CLASS 30 (U.S. CL. 46).

FIRST USE 9-24-2007; IN COMMERCE 9-24-2007.

THE MARK CONSISTS OF STANDARD CHAR-  
ACTERS WITHOUT CLAIM TO ANY PARTICULAR  
FONT, STYLE, SIZE, OR COLOR.

OWNER OF U.S. REG. NO. 1,360,887.

SN 77-131,223, FILED 3-14-2007.

KEVIN CORWIN, EXAMINING ATTORNEY



**Int. Cl.: 19**

**Prior U.S. Cls.: 1, 12, 33, and 50**

**United States Patent and Trademark Office**

**Reg. No. 3,395,599**

**Registered Mar. 11, 2008**

**TRADEMARK  
PRINCIPAL REGISTER**

**Secur-Clic**

SLONIM INTERNATIONAL, INC. (FLORIDA  
CORPORATION)  
10701 N.W. 107TH COURT  
MEDLEY, FL 33178

THE MARK CONSISTS OF STANDARD CHAR-  
ACTERS WITHOUT CLAIM TO ANY PARTICULAR  
FONT, STYLE, SIZE, OR COLOR.

FOR: LAMINATE FLOORING, IN CLASS 19 (U.S.  
CLS. 1, 12, 33 AND 50).

SN 77-131,495, FILED 3-15-2007.

FIRST USE 12-1-2007; IN COMMERCE 12-1-2007.

CAROLYN CATALDO, EXAMINING ATTORNEY

**Int. Cl.: 35**

**Prior U.S. Cls.: 100, 101, and 102**

**United States Patent and Trademark Office**

**Reg. No. 3,395,600**

**Registered Mar. 11, 2008**

**SERVICE MARK  
PRINCIPAL REGISTER**

**COTÉLAC**

COTELAC FRANCE (FRANCE SOCIETE PAR  
ACTIONS SIMPLIFEE)  
2 CHEMIN DU PASSELET  
LES NEYROLLES, FRANCE 01130

FOR: RETAIL CLOTHING STORES, IN CLASS 35  
(U.S. CLS. 100, 101 AND 102).

FIRST USE 12-3-2007; IN COMMERCE 12-3-2007.

THE MARK CONSISTS OF STANDARD CHAR-  
ACTERS WITHOUT CLAIM TO ANY PARTICULAR  
FONT, STYLE, SIZE, OR COLOR.

OWNER OF U.S. REG. NO. 2,981,760.

SN 77-131,736, FILED 3-15-2007.

SIMON TENG, EXAMINING ATTORNEY

**Int. Cl.: 37**

**Prior U.S. Cls.: 100, 103, and 106**

**United States Patent and Trademark Office**

**Reg. No. 3,395,601**

**Registered Mar. 11, 2008**

**SERVICE MARK  
PRINCIPAL REGISTER**

**ROADSAFE**

DOLLAR RENT A CAR, INC. (OKLAHOMA  
CORPORATION)  
5330 E. 31ST STREET  
TULSA, OK 74153

THE MARK CONSISTS OF STANDARD CHAR-  
ACTERS WITHOUT CLAIM TO ANY PARTICULAR  
FONT, STYLE, SIZE, OR COLOR.

FOR: EMERGENCY ROAD SIDE SERVICES, IN  
CLASS 37 (U.S. CLS. 100, 103 AND 106).

SN 77-132,027, FILED 3-15-2007.

FIRST USE 4-1-2007; IN COMMERCE 4-1-2007.

ALICE BENMAMAN, EXAMINING ATTORNEY

**Int. Cl.: 2**

**Prior U.S. Cls.: 6, 11, and 16**

**United States Patent and Trademark Office**

**Reg. No. 3,395,602**

**Registered Mar. 11, 2008**

**TRADEMARK  
PRINCIPAL REGISTER**

**ALL STRIPE**

TRAFFIC CONTROL SERVICE INC. (CALIFORNIA CORPORATION)

P.O. BOX 4180

FULLERTON, CA 928344180

FOR: PAVEMENT MARKING PAINT, IN CLASS 2 (U.S. CLS. 6, 11 AND 16).

FIRST USE 1-31-2007; IN COMMERCE 1-31-2007.

THE MARK CONSISTS OF STANDARD CHARACTERS WITHOUT CLAIM TO ANY PARTICULAR FONT, STYLE, SIZE, OR COLOR.

NO CLAIM IS MADE TO THE EXCLUSIVE RIGHT TO USE "STRIPE", APART FROM THE MARK AS SHOWN.

SN 77-132,063, FILED 3-15-2007.

KATHERINE STOIDES, EXAMINING ATTORNEY

**Int. Cl.: 2**

**Prior U.S. Cls.: 6, 11, and 16**

**United States Patent and Trademark Office**

**Reg. No. 3,395,603**

**Registered Mar. 11, 2008**

**TRADEMARK  
PRINCIPAL REGISTER**



TRAFFIC CONTROL SERVICE INC. (CALIFORNIA CORPORATION)  
P.O. BOX 4180  
FULLERTON, CA 928344180

FOR: PAVEMENT MARKING PAINT, IN CLASS 2 (U.S. CLS. 6, 11 AND 16).

FIRST USE 1-31-2007; IN COMMERCE 1-31-2007.

NO CLAIM IS MADE TO THE EXCLUSIVE RIGHT TO USE "STRIPE" , APART FROM THE MARK AS SHOWN.

THE MARK CONSISTS OF THE WORDS "ALL STRIPE" IN FRONT OF A ROAD.

SN 77-132,108, FILED 3-15-2007.

KATHERINE STOIDES, EXAMINING ATTORNEY

**Int. Cl.: 3**

**Prior U.S. Cls.: 1, 4, 6, 50, 51, and 52**

**Reg. No. 3,395,604**

**United States Patent and Trademark Office**

**Registered Mar. 11, 2008**

---

**TRADEMARK  
PRINCIPAL REGISTER**

**PROLONG COLOR**

JAFER LIMITED (BERMUDA CORPORATION)  
CLARENDON HOUSE, 2 CHURCH STREET  
HAMILTON, BERMUDA HM12

FOR: NAIL CARE PREPARATIONS; NAIL HARD-  
ENERS; NAIL POLISH; NAIL POLISH BASE COAT;  
NAIL POLISH TOP COAT; AND NAIL ENAMEL, IN  
CLASS 3 (U.S. CLS. 1, 4, 6, 50, 51 AND 52).

FIRST USE 2-4-2006; IN COMMERCE 11-5-2007.

THE MARK CONSISTS OF STANDARD CHAR-  
ACTERS WITHOUT CLAIM TO ANY PARTICULAR  
FONT, STYLE, SIZE, OR COLOR.

NO CLAIM IS MADE TO THE EXCLUSIVE  
RIGHT TO USE "COLOR", APART FROM THE  
MARK AS SHOWN.

SN 77-132,305, FILED 3-15-2007.

DAVID MURRAY, EXAMINING ATTORNEY

**Int. Cl.: 38**

**Prior U.S. Cls.: 100, 101, and 104**

**United States Patent and Trademark Office**

**Reg. No. 3,395,605**

**Registered Mar. 11, 2008**

**SERVICE MARK  
PRINCIPAL REGISTER**



TELAPEX, INC. (MISSISSIPPI CORPORATION)  
25 SOUTH CONGRESS ST.  
JACKSON, MS 39201

FIRST USE 3-16-2007; IN COMMERCE 3-16-2007.

OWNER OF U.S. REG. NO. 3,197,598.

FOR: INTRASTATE AND INTERSTATE TELEPHONE SERVICES; CABLE TELEVISION TRANSMISSION; ELECTRONIC, ELECTRIC, AND DIGITAL TRANSMISSION OF VOICE, DATA, IMAGES, SIGNALS, AND MESSAGES; PROVIDING A HIGH SPEED ACCESS TO AREA NETWORKS AND A GLOBAL COMPUTER INFORMATION NETWORK; AND PROVIDING ACCESS TO TELECOMMUNICATION NETWORKS, IN CLASS 38 (U.S. CLS. 100, 101 AND 104).

THE MARK CONSISTS OF THE WORD "SNAP" FOLLOWED BY AN IMAGE OF SNAPPING FINGERS.

SN 77-133,003, FILED 3-16-2007.

MARY MUNSON, EXAMINING ATTORNEY

**Int. Cl.: 36**

**Prior U.S. Cls.: 100, 101, and 102**

**United States Patent and Trademark Office**

**Reg. No. 3,395,606**

**Registered Mar. 11, 2008**

**SERVICE MARK  
PRINCIPAL REGISTER**

**CRUCIBLE WEALTH MANAGEMENT**

MISSETT GROUP, LTD. (PENNSYLVANIA CORPORATION)  
SUITE 204  
1460 RUSSELL ROAD  
PAOLI, PA 193011236

FOR: FINANCIAL PLANNING SERVICES; FINANCIAL PLANNING FOR RETIREMENT; FINANCIAL PLANNING FOR EDUCATION; INVESTMENT MANAGEMENT AND BROKERAGE SERVICES; FINANCIAL RISK MANAGEMENT; FINANCIAL RISK MANAGEMENT CONSULTING; ADMINISTRATION OF EMPLOYEE BENEFIT PLANS CONCERNING INSURANCE AND FINANCE; INSURANCE CONSULTATION; INSURANCE BROKERAGE SERVICES, IN CLASS 36 (U.S. CLS. 100, 101 AND 102).

FIRST USE 8-16-2007; IN COMMERCE 8-16-2007.

THE MARK CONSISTS OF STANDARD CHARACTERS WITHOUT CLAIM TO ANY PARTICULAR FONT, STYLE, SIZE, OR COLOR.

NO CLAIM IS MADE TO THE EXCLUSIVE RIGHT TO USE "WEALTH MANAGEMENT", APART FROM THE MARK AS SHOWN.

SN 77-134,445, FILED 3-19-2007.

MARK SPARACINO, EXAMINING ATTORNEY



**Int. Cl.: 36**

**Prior U.S. Cls.: 100, 101, and 102**

**United States Patent and Trademark Office**

**Reg. No. 3,395,607**

**Registered Mar. 11, 2008**

**SERVICE MARK  
PRINCIPAL REGISTER**



CLEAR MOUNTAIN BANK, INC. (WEST VIRGINIA CORPORATION)  
P.O. BOX 205  
BRUCETON MILLS, WV 26525

FOR: SAVINGS ACCOUNT SERVICES, IN CLASS 36 (U.S. CLS. 100, 101 AND 102).

FIRST USE 1-2-2008; IN COMMERCE 1-2-2008.

NO CLAIM IS MADE TO THE EXCLUSIVE RIGHT TO USE "HEALTH SAVINGS ACCOUNT", APART FROM THE MARK AS SHOWN.

THE COLOR(S) BLUE, GREEN, AND WHITE IS/ARE CLAIMED AS A FEATURE OF THE MARK.

THE MARK CONSISTS OF THE WORDS "HSAVER" IN GREEN; "HEALTH SAVINGS ACCOUNT" IN BLUE; AND A BLUE DOCTOR BAG WITH A GREEN CROSS IN A WHITE CIRCLE IN THE MIDDLE.

SN 77-134,926, FILED 3-19-2007.

TOBY BULLOFF, EXAMINING ATTORNEY

**Int. Cl.: 33**

**Prior U.S. Cls.: 47 and 49**

**United States Patent and Trademark Office**

**Reg. No. 3,395,608**

**Registered Mar. 11, 2008**

**TRADEMARK  
PRINCIPAL REGISTER**

**HURRICANE CLASS 5**

FLORIDA ORANGE GROVES, INC. (FLORIDA  
CORPORATION)  
1500 PASADENA AVENUE SOUTH  
S. PASADENA, FL 33707

THE MARK CONSISTS OF STANDARD CHAR-  
ACTERS WITHOUT CLAIM TO ANY PARTICULAR  
FONT, STYLE, SIZE, OR COLOR.

FOR: RED WINE; WHITE WINE; WINES, IN  
CLASS 33 (U.S. CLS. 47 AND 49).

SN 77-136,219, FILED 3-21-2007.

FIRST USE 3-20-2007; IN COMMERCE 3-20-2007.

RICHARD A. STRASER, EXAMINING ATTORNEY

**Int. Cl.: 9**

**Prior U.S. Cls.: 21, 23, 26, 36, and 38**

**United States Patent and Trademark Office**

**Reg. No. 3,395,609**

**Registered Mar. 11, 2008**

**TRADEMARK  
PRINCIPAL REGISTER**

**XTI Technology**

THERMOTEKNIK SYSTEMS LTD. (UNITED  
KINGDOM LTD LIAB CO)  
TEKNIX HOUSE, 2 PEMBROKE AVENUE  
WATERBEACH, CAMBRIDGE, UNITED KING-  
DOM CB259QR

FOR: INFRARED CAMERAS, IN CLASS 9 (U.S.  
CLS. 21, 23, 26, 36 AND 38).

FIRST USE 3-22-2007; IN COMMERCE 10-12-2007.

THE MARK CONSISTS OF STANDARD CHAR-  
ACTERS WITHOUT CLAIM TO ANY PARTICULAR  
FONT, STYLE, SIZE, OR COLOR.

NO CLAIM IS MADE TO THE EXCLUSIVE  
RIGHT TO USE "TECHNOLOGY", APART FROM  
THE MARK AS SHOWN.

SN 77-136,423, FILED 3-21-2007.

KIMBERLY FRYE, EXAMINING ATTORNEY

**Int. Cl.: 41**

**Prior U.S. Cls.: 100, 101, and 107**

**United States Patent and Trademark Office**

**Reg. No. 3,395,610**

**Registered Mar. 11, 2008**

**SERVICE MARK  
PRINCIPAL REGISTER**

**WHISKYTREE**

HARB, JONATHAN (UNITED STATES INDIVIDUAL)  
5 NEVADA STREET  
SAN RAFAEL, CA 94901

FOR: ENTERTAINMENT, NAMELY, PREPARATION OF SPECIAL EFFECTS; FILM STUDIOS; MOVIE STUDIOS; OPERATING OF FILM STUDIOS; PRODUCTION OF VIDEO AND CREATION OF VISUAL EFFECTS FOR OTHERS FOR USE IN DVDS, TELEVISION PROGRAMS AND ON WEBSITES; PRODUCTION OF VISUAL EFFECTS FOR VIDEOS, DVDS, TELEVISION AND FOR INTERNET WEBSITES; PROVIDING AUDIO OR VIDEO STU-

DIOS; SOUND RECORDING STUDIOS; SPECIAL EFFECTS ANIMATION SERVICES FOR FILM AND VIDEO, IN CLASS 41 (U.S. CLS. 100, 101 AND 107).

FIRST USE 6-13-2007; IN COMMERCE 6-13-2007.

THE MARK CONSISTS OF STANDARD CHARACTERS WITHOUT CLAIM TO ANY PARTICULAR FONT, STYLE, SIZE, OR COLOR.

SN 77-137,260, FILED 3-22-2007.

REBECCA EISINGER, EXAMINING ATTORNEY

**Int. Cl.: 27**

**Prior U.S. Cls.: 19, 20, 37, 42, and 50**

**Reg. No. 3,395,611**

**United States Patent and Trademark Office**

**Registered Mar. 11, 2008**

---

**TRADEMARK  
PRINCIPAL REGISTER**

# Minas Clay

TRADE AM INTERNATIONAL, INC. (TEXAS  
CORPORATION)  
6580 JIMMY CARTER BLVD.  
NORCROSS, GA 30071

THE MARK CONSISTS OF STANDARD CHAR-  
ACTERS WITHOUT CLAIM TO ANY PARTICULAR  
FONT, STYLE, SIZE, OR COLOR.

FOR: RUGS, IN CLASS 27 (U.S. CLS. 19, 20, 37, 42  
AND 50).

SN 77-138,910, FILED 3-23-2007.

FIRST USE 1-4-2008; IN COMMERCE 1-4-2008.

TINA KUAN, EXAMINING ATTORNEY

**Int. Cl.: 20**

**Prior U.S. Cls.: 2, 13, 22, 25, 32, and 50**

**Reg. No. 3,395,612**

**United States Patent and Trademark Office**

**Registered Mar. 11, 2008**

---

**TRADEMARK  
PRINCIPAL REGISTER**

**UBrand**

WARFORD, MICHELLE R. (UNITED STATES  
INDIVIDUAL), DBA TIRESWING VENTURES,  
LLC,  
1617 RALSTON AVE.  
BURLINGAME, CA 94010

FIRST USE 9-28-2007; IN COMMERCE 11-6-2007.

FOR: POLYMER BASED LABELS, NAMELY,  
PLASTIC, PVC AND RUBBER LABELS, FOR IDEN-  
TIFICATION AND PERSONALIZATION OF LUG-  
GAGE, BAGS, BACKPACKS, SHOES, OUTDOOR  
CLOTHING AND EQUIPMENT, SPORTING  
GOODS, AND OTHER PERSONAL ITEMS, IN  
CLASS 20 (U.S. CLS. 2, 13, 22, 25, 32 AND 50).

THE MARK CONSISTS OF STANDARD CHAR-  
ACTERS WITHOUT CLAIM TO ANY PARTICULAR  
FONT, STYLE, SIZE, OR COLOR.

SN 77-139,430, FILED 3-23-2007.

LINDA POWELL, EXAMINING ATTORNEY

**Int. Cl.: 45**

**Prior U.S. Cls.: 100 and 101**

**United States Patent and Trademark Office**

**Reg. No. 3,395,613**

**Registered Mar. 11, 2008**

**SERVICE MARK  
PRINCIPAL REGISTER**

# Related World

RELATED WORLD INC (GEORGIA CORPORATION)  
12821 DOE DRIVE  
ALPHARETTA, GA 30004

FOR: INTERNET BASED SOCIAL NETWORKING, INTRODUCTION, AND DATING SERVICES; ONLINE SOCIAL NETWORKING SERVICES, IN CLASS 45 (U.S. CLS. 100 AND 101).

FIRST USE 12-24-2007; IN COMMERCE 12-24-2007.

THE MARK CONSISTS OF STANDARD CHARACTERS WITHOUT CLAIM TO ANY PARTICULAR FONT, STYLE, SIZE, OR COLOR.

SN 77-139,559, FILED 3-24-2007.

MARK T. MULLEN, EXAMINING ATTORNEY

**Int. Cl.: 44**

**Prior U.S. Cls.: 100 and 101**

**United States Patent and Trademark Office**

**Reg. No. 3,395,614**

**Registered Mar. 11, 2008**

**SERVICE MARK  
PRINCIPAL REGISTER**

**Hiatus**

HIATUS, L.L.C. (TEXAS LTD LIAB CO)  
5734 MERCEDES AVE  
DALLAS, TX 75206

THE MARK CONSISTS OF STANDARD CHAR-  
ACTERS WITHOUT CLAIM TO ANY PARTICULAR  
FONT, STYLE, SIZE, OR COLOR.

FOR: HEALTH SPA SERVICES, NAMELY, COS-  
METIC BODY CARE SERVICES; MASSAGE, IN  
CLASS 44 (U.S. CLS. 100 AND 101).

SN 77-139,724, FILED 3-25-2007.

FIRST USE 11-1-2007; IN COMMERCE 12-1-2007.

C. DIONNE CLYBURN, EXAMINING ATTORNEY



**Int. Cl.: 44**

**Prior U.S. Cls.: 100 and 101**

**United States Patent and Trademark Office**

**Reg. No. 3,395,615**

**Registered Mar. 11, 2008**

**SERVICE MARK  
PRINCIPAL REGISTER**

**CAREALLIES QUIT TODAY**

CIGNA INTELLECTUAL PROPERTY, INC. (DE-  
LAWARE CORPORATION)  
590 NAAMANS ROAD  
CLAYMONT, DE 19703

FOR: HEALTH CARE SERVICES IN THE NAT-  
URE OF A TOBACCO CESSATION PROGRAM, IN  
CLASS 44 (U.S. CLS. 100 AND 101).

FIRST USE 6-12-2007; IN COMMERCE 6-12-2007.

THE MARK CONSISTS OF STANDARD CHAR-  
ACTERS WITHOUT CLAIM TO ANY PARTICULAR  
FONT, STYLE, SIZE, OR COLOR.

OWNER OF U.S. REG. NO. 3,224,484.

SN 77-139,916, FILED 3-26-2007.

DORITT L. CARROLL, EXAMINING ATTORNEY

**Int. Cls.: 16 and 36**

**Prior U.S. Cls.: 2, 5, 22, 23, 29, 37, 38, 50, 100, 101, and 102**

**United States Patent and Trademark Office**

**Reg. No. 3,395,616**

**Registered Mar. 11, 2008**

**TRADEMARK  
SERVICE MARK  
PRINCIPAL REGISTER**

**TisBest**

TISBEST, LLC (WASHINGTON LTD LIAB CO)  
506 SECOND AVE., 29TH FLOOR  
SEATTLE, WA 98104

FOR: GREETING CARDS, IN CLASS 16 (U.S. CLS. 2, 5, 22, 23, 29, 37, 38 AND 50).

FIRST USE 6-1-2007; IN COMMERCE 6-1-2007.

FOR: CHARITABLE FUND-RAISING SERVICES UTILIZING PRINTED OR ELECTRONIC CONTRIBUTION CARDS ACQUIRED BY DONORS AS GIFTS AND USED BY THE RECIPIENTS OF CARDS

TO DIRECT DONATION OF COLLECTED FUNDS TO SELECTED CHARITIES, IN CLASS 36 (U.S. CLS. 100, 101 AND 102).

FIRST USE 6-1-2007; IN COMMERCE 6-1-2007.

THE MARK CONSISTS OF STANDARD CHARACTERS WITHOUT CLAIM TO ANY PARTICULAR FONT, STYLE, SIZE, OR COLOR.

SN 77-140,044, FILED 3-26-2007.

BONNIE LUKEN, EXAMINING ATTORNEY

**Int. Cl.: 28**

**Prior U.S. Cls.: 22, 23, 38, and 50**

**United States Patent and Trademark Office**

**Reg. No. 3,395,617**

**Registered Mar. 11, 2008**

**TRADEMARK  
PRINCIPAL REGISTER**

**BALZAC 2**

CATALYST APPLIED TECHNOLOGIES INC.  
(NEW YORK CORPORATION)  
146 WEST 57TH STREET - SUITE 33D  
NEW YORK, NY 10019

FOR: GAMES AND PLAYTHINGS, NAMELY,  
PLAY BALLS, IN CLASS 28 (U.S. CLS. 22, 23, 38  
AND 50).

FIRST USE 8-20-2007; IN COMMERCE 12-5-2007.

THE MARK CONSISTS OF STANDARD CHAR-  
ACTERS WITHOUT CLAIM TO ANY PARTICULAR  
FONT, STYLE, SIZE, OR COLOR.

OWNER OF U.S. REG. NOS. 1,582,755 AND  
1,650,855.

SN 77-142,351, FILED 3-28-2007.

RON FAIRBANKS, EXAMINING ATTORNEY

**Int. Cl.: 41**

**Prior U.S. Cls.: 100, 101, and 107**

**United States Patent and Trademark Office**

**Reg. No. 3,395,618**

**Registered Mar. 11, 2008**

**SERVICE MARK  
PRINCIPAL REGISTER**

# DAMAGES

SONY PICTURES TELEVISION INC. (DELA-  
WARE CORPORATION)  
10202 W. WASHINGTON BLVD.  
CULVER CITY, CA 90232 AND  
BLUEBUSH PRODUCTIONS, LLC (DELAWARE  
LTD LIAB CO)  
10201 WEST PICO BOULEVARD  
LOS ANGELES, CA 90064

FOR: ENTERTAINMENT SERVICES IN THE  
NATURE OF A DRAMATIC TELEVISION SERIES,  
IN CLASS 41 (U.S. CLS. 100, 101 AND 107).

FIRST USE 7-4-2007; IN COMMERCE 7-4-2007.

THE MARK CONSISTS OF STANDARD CHAR-  
ACTERS WITHOUT CLAIM TO ANY PARTICULAR  
FONT, STYLE, SIZE, OR COLOR.

SN 77-143,310, FILED 3-29-2007.

SANI KHOURI, EXAMINING ATTORNEY

**Int. Cl.: 9**

**Prior U.S. Cls.: 21, 23, 26, 36, and 38**

**Reg. No. 3,395,619**

**United States Patent and Trademark Office**

**Registered Mar. 11, 2008**

**TRADEMARK  
PRINCIPAL REGISTER**

**PROLITE**

COMMSCOPE, INC. OF NORTH CAROLINA  
(NORTH CAROLINA CORPORATION)  
1100 COMMSCOPE PLACE, SE  
HICKORY, NC 28602

THE MARK CONSISTS OF STANDARD CHAR-  
ACTERS WITHOUT CLAIM TO ANY PARTICULAR  
FONT, STYLE, SIZE, OR COLOR.

FOR: COMMUNICATIONS CABLES, NAMELY,  
COAXIAL, FIBER OPTIC, AND TWISTED PAIR  
CABLES AND HYBRIDS THEREOF, AND CABLE  
CONNECTORS THEREFORE, IN CLASS 9 (U.S. CLS.  
21, 23, 26, 36 AND 38).

SN 77-143,626, FILED 3-29-2007.

FIRST USE 8-31-2005; IN COMMERCE 8-31-2005.

WILLIAM P. SHANAHAN, EXAMINING ATTOR-  
NEY

**Int. Cls.: 35 and 42**

**Prior U.S. Cls.: 100, 101, and 102**

**United States Patent and Trademark Office**

**Reg. No. 3,395,620**

**Registered Mar. 11, 2008**

**SERVICE MARK  
PRINCIPAL REGISTER**

The logo for maxmetrics features the word "maxmetrics" in a lowercase, sans-serif font. The "x" is stylized with a blue dot above it, and the "i" has a blue dot above it. The "m" and "t" are also in a dark blue color, while the other letters are black.

MILLER, GLORIA J (UNITED STATES INDIVIDUAL)  
SCHILLERSTR 15  
WIESLOCH, FED REP GERMANY 69168

FOR: ADVICE RELATING TO THE ORGANIZATION AND MANAGEMENT OF BUSINESS; ADVISORY SERVICES RELATING TO BUSINESS MANAGEMENT AND BUSINESS OPERATIONS; BUSINESS MANAGEMENT CONSULTANCY AND ADVISORY SERVICES; INFORMATION, ADVISORY AND CONSULTANCY SERVICES RELATING TO BUSINESS AND MANAGEMENT OR BUSINESS ADMINISTRATION, INCLUDING SUCH SERVICES PROVIDED ON LINE OR VIA THE INTERNET; MANAGEMENT AND BUSINESS CONSULTING SERVICES IN THE FIELD OF PROGRAM/PROJECT MANAGEMENT, CHANGE MANAGEMENT, PERFORMANCE MANAGEMENT, GLOBAL SOURCING, AND REVENUE GROWTH, IN CLASS 35 (U.S. CLS. 100, 101 AND 102).

FIRST USE 4-22-2007; IN COMMERCE 7-9-2007.

FOR: TECHNOLOGICAL CONSULTATION IN THE TECHNOLOGY FIELD OF BUSINESS INTELLIGENCE, ANALYTICS, PERFORMANCE MANAGEMENT, AND DATA WAREHOUSING, IN CLASS 42 (U.S. CLS. 100 AND 101).

FIRST USE 4-22-2007; IN COMMERCE 7-9-2007.

THE COLOR(S) BLACK AND TURQUOISE IS/ARE CLAIMED AS A FEATURE OF THE MARK.

THE MARK CONSISTS OF A TURQUOISE "X" WITH A DOT ON TOP TO LOOK LIKE THE IMAGE OF A PERSON, AN "I" WITH A TURQUOISE DOT; THE "T" IS CUSTOM FORMATTED, AND ALL LETTERS ARE BLACK EXCEPT THE "X" AND "I".

SN 77-145,684, FILED 4-1-2007.

JORDAN BAKER, EXAMINING ATTORNEY

**Int. Cl.: 9**

**Prior U.S. Cls.: 21, 23, 26, 36, and 38**

**United States Patent and Trademark Office**

**Reg. No. 3,395,621**

**Registered Mar. 11, 2008**

**TRADEMARK  
PRINCIPAL REGISTER**

**SONIC RUSH ADVENTURE**

KABUSHIKI KAISHA SEGA (JAPAN CORPORATION), DBA SEGA CORPORATION,  
2-12, HANEDA 1-CHOME, OHTA-KU  
TOKYO, JAPAN

FOR: VIDEO GAME SOFTWARE, IN CLASS 9  
(U.S. CLS. 21, 23, 26, 36 AND 38).

FIRST USE 9-18-2007; IN COMMERCE 9-18-2007.

THE MARK CONSISTS OF STANDARD CHARACTERS WITHOUT CLAIM TO ANY PARTICULAR FONT, STYLE, SIZE, OR COLOR.

OWNER OF U.S. REG. NOS. 1,945,715, 3,137,214,  
AND OTHERS.

SN 77-145,964, FILED 4-2-2007.

DAVID MILLER, EXAMINING ATTORNEY

**Int. Cl.: 22**

**Prior U.S. Cls.: 1, 2, 7, 19, 22, 42, and 50**

**Reg. No. 3,395,622**

**United States Patent and Trademark Office**

**Registered Mar. 11, 2008**

---

**TRADEMARK  
PRINCIPAL REGISTER**

**SIMPLY COMFORT**

CAPSTONE INDUSTRIES, INC. (FLORIDA CORPORATION)  
350 JIM MORAN BLVD.  
SUITE 120  
DEERFIELD BEACH, FL 33442

THE MARK CONSISTS OF STANDARD CHARACTERS WITHOUT CLAIM TO ANY PARTICULAR FONT, STYLE, SIZE, OR COLOR.

FOR: CUSHIONING NOT OF RUBBER OR PLASTIC IN THE NATURE OF STUFFING, IN CLASS 22 (U.S. CLS. 1, 2, 7, 19, 22, 42 AND 50).

SN 77-146,406, FILED 4-2-2007.

FIRST USE 5-1-2007; IN COMMERCE 11-1-2007.

MICHAEL LEWIS, EXAMINING ATTORNEY



**Int. Cl.: 7**

**Prior U.S. Cls.: 13, 19, 21, 23, 31, 34, and 35**

**Reg. No. 3,395,623**

**United States Patent and Trademark Office**

**Registered Mar. 11, 2008**

**TRADEMARK  
PRINCIPAL REGISTER**



SHETTERLY, THOMAS H. (UNITED STATES  
INDIVIDUAL)  
2125 OVERLOOK DRIVE  
WALNUT CREEK, CA 94597

FOR: BLADES FOR POWER SAWS; POWER SAW  
BLADES, IN CLASS 7 (U.S. CLS. 13, 19, 21, 23, 31, 34  
AND 35).

FIRST USE 5-15-2007; IN COMMERCE 5-15-2007.

NO CLAIM IS MADE TO THE EXCLUSIVE  
RIGHT TO USE "BLADE", APART FROM THE  
MARK AS SHOWN.

THE MARK CONSISTS OF A STYLIZED BOAR'S  
HEAD AND THE WORDS "BOAR BLADE".

SN 77-146,440, FILED 4-2-2007.

STEVEN JACKSON, EXAMINING ATTORNEY

**Int. Cl.: 13**

**Prior U.S. Cls.: 2 and 9**

**United States Patent and Trademark Office**

**Reg. No. 3,395,624**

**Registered Mar. 11, 2008**

**TRADEMARK  
PRINCIPAL REGISTER**

**OPERATION PHANTOM FURY**

B.J. ALAN COMPANY (OHIO CORPORATION)  
555 MARTIN LUTHER KING, JR. BLVD.  
YOUNGSTOWN, OH 445021102

FOR: FIREWORKS, IN CLASS 13 (U.S. CLS. 2 AND  
9).

FIRST USE 5-23-2005; IN COMMERCE 5-23-2005.

THE MARK CONSISTS OF STANDARD CHAR-  
ACTERS WITHOUT CLAIM TO ANY PARTICULAR  
FONT, STYLE, SIZE, OR COLOR.

OWNER OF U.S. REG. NOS. 2,580,167, 3,252,958,  
AND OTHERS.

SN 77-147,056, FILED 4-3-2007.

ELLEN B. AWRICH, EXAMINING ATTORNEY

**Int. Cl.: 43**

**Prior U.S. Cls.: 100 and 101**

**United States Patent and Trademark Office**

**Reg. No. 3,395,625**

**Registered Mar. 11, 2008**

**SERVICE MARK  
PRINCIPAL REGISTER**

**BROOKSHIRE**

INTERSTATE LODGING, INC. (KENTUCKY  
CORPORATION)  
P. O. BOX 301  
WARFIELD, KY 41267

THE MARK CONSISTS OF STANDARD CHAR-  
ACTERS WITHOUT CLAIM TO ANY PARTICULAR  
FONT, STYLE, SIZE, OR COLOR.

FOR: HOTEL SERVICES, IN CLASS 43 (U.S. CLS.  
100 AND 101).

SN 77-148,356, FILED 4-4-2007.

FIRST USE 12-1-2007; IN COMMERCE 12-1-2007.

DAVID C. REIHNER, EXAMINING ATTORNEY

**Int. Cl.: 16**

**Prior U.S. Cls.: 2, 5, 22, 23, 29, 37, 38, and 50**

**United States Patent and Trademark Office**

**Reg. No. 3,395,626**

**Registered Mar. 11, 2008**

**TRADEMARK  
PRINCIPAL REGISTER**

**SHINE AT JUSTICE**

TWEEN BRANDS INVESTMENT, LLC (OHIO  
LTD LIAB CO)  
8323 WALTON PKWY  
NEW ALBANY, OH 43054

FOR: PENS; MARKERS; DIARIES; ART PADS;  
BINDERS; PENCIL SHARPENERS; PENCILS; ERA-  
SERS; TEMPORARY TATTOOS, IN CLASS 16 (U.S.  
CLS. 2, 5, 22, 23, 29, 37, 38 AND 50).

FIRST USE 10-20-2005; IN COMMERCE 8-21-2006.

THE MARK CONSISTS OF STANDARD CHAR-  
ACTERS WITHOUT CLAIM TO ANY PARTICULAR  
FONT, STYLE, SIZE, OR COLOR.

OWNER OF U.S. REG. NOS. 2,990,417 AND  
3,006,487.

SN 77-150,757, FILED 4-6-2007.

JANICE KIM, EXAMINING ATTORNEY

**Int. Cl.: 36**

**Prior U.S. Cls.: 100, 101, and 102**

**United States Patent and Trademark Office**

**Reg. No. 3,395,627**

**Registered Mar. 11, 2008**

**SERVICE MARK  
PRINCIPAL REGISTER**

**SUCCESSFUL RETIREMENT  
STRATEGIES WORKSHOP**

COVENANT RELIANCE PRODUCERS, LLC  
(TENNESSEE LTD LIAB CO)

SUITE 301

26 CENTURY PLACE

NASHVILLE, TN 37214

FOR: FINANCIAL PLANNING, IN CLASS 36 (U.S.  
CLS. 100, 101 AND 102).

FIRST USE 3-31-2007; IN COMMERCE 3-31-2007.

THE MARK CONSISTS OF STANDARD CHAR-  
ACTERS WITHOUT CLAIM TO ANY PARTICULAR  
FONT, STYLE, SIZE, OR COLOR.

NO CLAIM IS MADE TO THE EXCLUSIVE  
RIGHT TO USE "RETIREMENT STRATEGIES  
WORKSHOP", APART FROM THE MARK AS  
SHOWN.

SN 77-151,515, FILED 4-9-2007.

TOBY BULLOFF, EXAMINING ATTORNEY

**Int. Cl.: 35**

**Prior U.S. Cls.: 100, 101, and 102**

**United States Patent and Trademark Office**

**Reg. No. 3,395,628**

**Registered Mar. 11, 2008**

**SERVICE MARK  
PRINCIPAL REGISTER**

Z SQUARED MEDIA, LLC (OHIO LTD LIAB CO)  
3317 W. 155TH ST  
CLEVELAND, OH 44111

FOR: ADVERTISING AND COMMERCIAL INFORMATION SERVICES, VIA THE INTERNET, IN CLASS 35 (U.S. CLS. 100, 101 AND 102).

FIRST USE 4-25-2007; IN COMMERCE 7-23-2007.

THE COLOR(S) BLACK AND ORANGE IS/ARE CLAIMED AS A FEATURE OF THE MARK.

THE MARK CONSISTS OF THE COLOR BLACK APPEARS IN THE WORD JUNTA AND IN THE LINE DESIGN; THE COLOR ORANGE APPEARS IN THE NUMBER 42.

SN 77-152,038, FILED 4-9-2007.

DAVID MURRAY, EXAMINING ATTORNEY

**Int. Cl.: 5**

**Prior U.S. Cls.: 6, 18, 44, 46, 51, and 52**

**United States Patent and Trademark Office**

**Reg. No. 3,395,629**

**Registered Mar. 11, 2008**

**TRADEMARK  
PRINCIPAL REGISTER**

**ANIMALARIA**

FLOW, INC. (OREGON CORPORATION)  
6127 SW CORBETT  
PORTLAND, OR 97239

THE MARK CONSISTS OF STANDARD CHAR-  
ACTERS WITHOUT CLAIM TO ANY PARTICULAR  
FONT, STYLE, SIZE, OR COLOR.

FOR: MEDICAL DIAGNOSTIC REAGENTS;  
MEDICAL DIAGNOSTIC TEST STRIPS FOR USE  
IN THE FIELD OF MALARIA DETECTION, IN  
CLASS 5 (U.S. CLS. 6, 18, 44, 46, 51 AND 52).

SN 77-152,672, FILED 4-10-2007.

FIRST USE 6-17-2007; IN COMMERCE 6-17-2007.

BENJAMIN ALLEN, EXAMINING ATTORNEY

**Int. Cl.: 42**

**Prior U.S. Cls.: 100 and 101**

**United States Patent and Trademark Office**

**Reg. No. 3,395,630**

**Registered Mar. 11, 2008**

**SERVICE MARK  
PRINCIPAL REGISTER**

**accessaftp**

ARCANNA, INC. (NEW YORK CORPORATION)  
650 CENTRAL AVENUE  
PEEKSKILL, NY 10566

FOR: PROVIDING ONLINE NON-DOWNLOAD-  
ABLE SOFTWARE FOR DIGITAL ASSET MANAGE-  
MENT OF ELECTRONICALLY STORED  
INFORMATION PERTAINING TO PACKAGED  
GOODS, IN CLASS 42 (U.S. CLS. 100 AND 101).

FIRST USE 1-1-2006; IN COMMERCE 1-1-2006.

THE MARK CONSISTS OF THE WORD "ACCES-  
SA" COMBINED WITH "FTP" USING ARROWS IN  
THE LETTERS TO CONVEY MOVEMENT.

SN 77-153,427, FILED 4-10-2007.

REBECCA EISINGER, EXAMINING ATTORNEY



**Int. Cl.: 10**

**Prior U.S. Cls.: 26, 39, and 44**

**United States Patent and Trademark Office**

**Reg. No. 3,395,631**

**Registered Mar. 11, 2008**

**TRADEMARK  
PRINCIPAL REGISTER**

**VALUECLIP**

ALLEGIANCE CORPORATION (DELAWARE  
CORPORATION)  
1430 WAUKEGAN ROAD, KB-1A  
MCGAW PARK, IL 60085

FOR: SURGICAL PREOPERATIVE HAIR RE-  
MOVAL CLIPPER SYSTEM COMPRISED OF ELEC-  
TRIC CLIPPERS, HANDLES, CLIPPER BLADES  
AND CLIPPER CHARGERS, IN CLASS 10 (U.S.  
CLS. 26, 39 AND 44).

FIRST USE 9-28-2007; IN COMMERCE 9-28-2007.

THE MARK CONSISTS OF STANDARD CHAR-  
ACTERS WITHOUT CLAIM TO ANY PARTICULAR  
FONT, STYLE, SIZE, OR COLOR.

SN 77-153,768, FILED 4-11-2007.

AISHA SALEM, EXAMINING ATTORNEY

Int. Cl.: 33

Prior U.S. Cls.: 47 and 49

United States Patent and Trademark Office

Reg. No. 3,395,632

Registered Mar. 11, 2008

TRADEMARK  
PRINCIPAL REGISTER

ANAHIT

ASHOT ROSTOMIAN (UNITED STATES INDIVIDUAL)  
P.O. BOX 873  
GLENDALE, CA 912090873

FOR: VODKA, ALCOHOLIC BEVERAGES, NAMELY, TEQUILA AND WHISKEY; DISTILLED SPIRITS; VODKA; ALCOHOLIC APERITIF BITTERS; ALCOHOLIC BEVERAGE PRODUCED FROM A BREWED MALT BASE WITH NATURAL FLAVORS; ALCOHOLIC BEVERAGES OF FRUIT; ALCOHOLIC BITTERS; ALCOHOLIC COCKTAILS CONTAINING MILK; ALCOHOLIC COFFEE-BASED BEVERAGE; ALCOHOLIC EGG NOG; ALCOHOLIC ESSENCES; ALCOHOLIC EXTRACTS; ALCOHOLIC FRUIT EXTRACTS; ALCOHOLIC MALT COOLERS; ALCOHOLIC PUNCH; ALCO-

HOLIC TEA-BASED BEVERAGE; APERITIFS WITH A DISTILLED ALCOHOLIC LIQUOR BASE; PREPARED ALCOHOLIC COCKTAIL; RUM; DISTILLED SPIRITS; COGNAC; WINE, IN CLASS 33 (U.S. CLS. 47 AND 49).

FIRST USE 3-5-2007; IN COMMERCE 5-27-2007.

THE MARK CONSISTS OF STANDARD CHARACTERS WITHOUT CLAIM TO ANY PARTICULAR FONT, STYLE, SIZE, OR COLOR.

SN 77-154,675, FILED 4-12-2007.

BENJAMIN ALLEN, EXAMINING ATTORNEY

**Int. Cl.: 30**

**Prior U.S. Cl.: 46**

**United States Patent and Trademark Office**

**Reg. No. 3,395,633**

**Registered Mar. 11, 2008**

**TRADEMARK  
PRINCIPAL REGISTER**

**PLENTIFUL EARTH**

RONNOCO COFFEE COMPANY (MISSOURI  
CORPORATION)  
4241 SARPY AVENUE  
ST. LOUIS, MO 63110

THE MARK CONSISTS OF STANDARD CHAR-  
ACTERS WITHOUT CLAIM TO ANY PARTICULAR  
FONT, STYLE, SIZE, OR COLOR.

FOR: COFFEE, IN CLASS 30 (U.S. CL. 46).

SN 77-155,294, FILED 4-12-2007.

FIRST USE 4-0-2007; IN COMMERCE 4-0-2007.

RON FAIRBANKS, EXAMINING ATTORNEY

**Int. Cl.: 30**

**Prior U.S. Cl.: 46**

**United States Patent and Trademark Office**

**Reg. No. 3,395,634**

**Registered Mar. 11, 2008**

**TRADEMARK  
PRINCIPAL REGISTER**

**SOUR MANIA**

CADBURY ADAMS USA LLC (DELAWARE LTD  
LIAB CO)

389 INTERPACE PARKWAY

PARSIPPANY, NJ 07054

FOR: CONFECTIONERY, NAMELY, CHEWING  
GUM, IN CLASS 30 (U.S. CL. 46).

FIRST USE 11-30-2007; IN COMMERCE 11-30-2007.

THE MARK CONSISTS OF STANDARD CHAR-  
ACTERS WITHOUT CLAIM TO ANY PARTICULAR  
FONT, STYLE, SIZE, OR COLOR.

NO CLAIM IS MADE TO THE EXCLUSIVE  
RIGHT TO USE "SOUR", APART FROM THE MARK  
AS SHOWN.

SN 77-156,242, FILED 4-13-2007.

G. MAYERSCHOFF, EXAMINING ATTORNEY

Int. Cl.: 34

Prior U.S. Cls.: 2, 8, 9, and 17

United States Patent and Trademark Office

Reg. No. 3,395,635

Registered Mar. 11, 2008

TRADEMARK  
PRINCIPAL REGISTER



PURE AROMA CIGARS, INC. (FLORIDA CORPORATION)  
14843 SW 67TH LANE  
MIAMI, FL 33193

FOR: CIGAR BANDS; CIGAR BOXES; CIGAR CASES; CIGAR HUMIDIFIERS; CIGAR LIGHTERS; CIGAR TUBES; CIGARS; HUMIDORS, IN CLASS 34 (U.S. CLS. 2, 8, 9 AND 17).

FIRST USE 3-12-2007; IN COMMERCE 3-12-2007.

NO CLAIM IS MADE TO THE EXCLUSIVE RIGHT TO USE "CIGARS" AND "TOTALMENTE A MANO", APART FROM THE MARK AS SHOWN.

THE COLOR(S) GREEN/GOLD, GOLDENROD AND CRIMSON IS/ARE CLAIMED AS A FEATURE OF THE MARK.

THE MARK CONSISTS OF A COAT OF ARMS IN A GREEN/GOLD COLOR, FEATURING A CROWN ABOVE A BANNER WITH THE WORDS "PURE AROMA CIGARS" APPEARING IN CRIMSON. THE WORD "DECROSSIER" IN A CIRCULAR FORM APPEARS IN GOLDENROD AT THE HELM. THE STYLIZED LETTERS "DC" IN GOLDENROD APPEAR WITHIN THE SHIELD WHICH IS FILLED AND OUTLINED IN CRIMSON. BENEATH THE SHIELD IS THE WORD "D'CROSSIER" IN GREEN/GOLD ABOVE THE WORDS "TOTALMENTE A MANO" IN SCRIPT, ABOVE A STYLIZED LINE.

THE FOREIGN WORDING IN THE MARK TRANSLATES INTO ENGLISH AS "TOTALLY BY HAND" (TOTALMENTE A MANO).

SN 77-157,735, FILED 4-16-2007.

RICHARD A. STRASER, EXAMINING ATTORNEY

**Int. Cl.: 33**

**Prior U.S. Cls.: 47 and 49**

**United States Patent and Trademark Office**

**Reg. No. 3,395,636**

**Registered Mar. 11, 2008**

**TRADEMARK  
PRINCIPAL REGISTER**

**RUSTIC CREEK**

BARONESS SMALL ESTATES, INC. (COLORADO  
CORPORATION)  
2395 WEST 2ND AVENUE  
DENVER, CO 80223

THE MARK CONSISTS OF STANDARD CHAR-  
ACTERS WITHOUT CLAIM TO ANY PARTICULAR  
FONT, STYLE, SIZE, OR COLOR.

FOR: WHITE WINE; WINES; RED WINE, IN  
CLASS 33 (U.S. CLS. 47 AND 49).

SN 77-159,902, FILED 4-18-2007.

FIRST USE 8-22-2007; IN COMMERCE 8-22-2007.

MATTHEW EINSTEIN, EXAMINING ATTORNEY

**Int. Cl.: 19**

**Prior U.S. Cls.: 1, 12, 33, and 50**

**United States Patent and Trademark Office**

**Reg. No. 3,395,637**

**Registered Mar. 11, 2008**

**TRADEMARK  
PRINCIPAL REGISTER**

# Formulate

DAVIS ENERGY GROUP, INC. (CALIFORNIA  
CORPORATION)  
123 C STREET  
DAVIS, CA 95616

THE MARK CONSISTS OF STANDARD CHAR-  
ACTERS WITHOUT CLAIM TO ANY PARTICULAR  
FONT, STYLE, SIZE, OR COLOR.

FOR: CONSTRUCTION MATERIAL, NAMELY,  
NONMETAL EXTERIOR BOARDS, IN CLASS 19  
(U.S. CLS. 1, 12, 33 AND 50).

SN 77-167,503, FILED 4-27-2007.

FIRST USE 12-6-2006; IN COMMERCE 5-30-2007.

ARETHA SOMERVILLE, EXAMINING ATTORNEY

**Int. Cl.: 25**

**Prior U.S. Cls.: 22 and 39**

**United States Patent and Trademark Office**

**Reg. No. 3,395,638**

**Registered Mar. 11, 2008**

**TRADEMARK  
PRINCIPAL REGISTER**

**SLIPPEROOZ**

DEER STAGS, INC. (NEW YORK CORPORATION)  
1414 AVENUE OF THE AMERICAS  
NEW YORK, NY 10019

THE MARK CONSISTS OF STANDARD CHARACTERS WITHOUT CLAIM TO ANY PARTICULAR FONT, STYLE, SIZE, OR COLOR.

FOR: FOOTWEAR, IN CLASS 25 (U.S. CLS. 22 AND 39).

SN 77-169,477, FILED 4-30-2007.

FIRST USE 5-0-2007; IN COMMERCE 5-0-2007.

AMY ALFIERI, EXAMINING ATTORNEY



**Int. Cl.: 1**

**Prior U.S. Cls.: 1, 5, 6, 10, 26, and 46**

**Reg. No. 3,395,639**

**United States Patent and Trademark Office**

**Registered Mar. 11, 2008**

---

**TRADEMARK  
PRINCIPAL REGISTER**

**OBEE**

TRILOGY ESSENTIALS INTERNATIONAL, INC.  
(TENNESSEE CORPORATION)  
3251 POPLAR AVENUE, SUITE 15  
MEMPHIS, TN 38111

FOR: PLANT EXTRACTS, NAMELY, OAK BARK  
EXTRACT, USED IN THE MANUFACTURE OF  
TOPICAL SKIN OINTMENTS/CREAMS AND DIET-  
ARY SUPPLEMENTS, IN CLASS 1 (U.S. CLS. 1, 5, 6,  
10, 26 AND 46).

FIRST USE 6-22-2007; IN COMMERCE 6-22-2007.

THE MARK CONSISTS OF STANDARD CHAR-  
ACTERS WITHOUT CLAIM TO ANY PARTICULAR  
FONT, STYLE, SIZE, OR COLOR.

SN 77-172,164, FILED 5-3-2007.

ALICE BENMAMAN, EXAMINING ATTORNEY

**Int. Cl.: 9**

**Prior U.S. Cls.: 21, 23, 26, 36, and 38**

**United States Patent and Trademark Office**

**Reg. No. 3,395,640**

**Registered Mar. 11, 2008**

**TRADEMARK  
PRINCIPAL REGISTER**

**THE PURPLE COUCH**

MOVING PICTURES, INC. (CALIFORNIA CORPORATION)  
1206 CORTE ENCANTO  
SAN MARCOS, CA 92069

FOR: AUDIO RECORDINGS FEATURING PERSONAL STORYTELLING PRESENTATIONS AND PERSONAL INTERVIEWS; VIDEO RECORDINGS FEATURING PERSONAL STORYTELLING PRESENTATIONS AND PERSONAL INTERVIEWS, IN CLASS 9 (U.S. CLS. 21, 23, 26, 36 AND 38).

FIRST USE 9-1-2007; IN COMMERCE 9-1-2007.

THE MARK CONSISTS OF STANDARD CHARACTERS WITHOUT CLAIM TO ANY PARTICULAR FONT, STYLE, SIZE, OR COLOR.

SN 77-180,831, FILED 5-14-2007.

ZACHARY BELLO, EXAMINING ATTORNEY

**Int. Cls.: 16 and 41**

**Prior U.S. Cls.: 2, 5, 22, 23, 29, 37, 38, 50, 100, 101, and 107**

**United States Patent and Trademark Office**

**Reg. No. 3,395,641**

**Registered Mar. 11, 2008**

**TRADEMARK  
SERVICE MARK  
PRINCIPAL REGISTER**

**IT IS 5 MINUTES TO MIDNIGHT**

BULLETIN OF THE ATOMIC SCIENTISTS (ILLINOIS NON-PROFIT CORPORATION)  
77 W. WASHINGTON ST., SUITE 2120  
CHICAGO, IL 60602

FOR: MAGAZINES IN THE FIELD OF SCIENCE AND WORLD AFFAIRS, IN CLASS 16 (U.S. CLS. 2, 5, 22, 23, 29, 37, 38 AND 50).

FIRST USE 1-19-2006; IN COMMERCE 1-19-2006.

FOR: PROVIDING AN ONLINE MAGAZINE IN THE FIELD OF SCIENCE AND WORLD AFFAIRS, IN CLASS 41 (U.S. CLS. 100, 101 AND 107).

FIRST USE 1-17-2007; IN COMMERCE 1-17-2007.

THE MARK CONSISTS OF STANDARD CHARACTERS WITHOUT CLAIM TO ANY PARTICULAR FONT, STYLE, SIZE, OR COLOR.

SN 77-181,306, FILED 5-15-2007.

RUSS HERMAN, EXAMINING ATTORNEY

**Int. Cl.: 43**

**Prior U.S. Cls.: 100 and 101**

**United States Patent and Trademark Office**

**Reg. No. 3,395,642**

**Registered Mar. 11, 2008**

**SERVICE MARK  
PRINCIPAL REGISTER**

**TIMES TO GO**

TIMES GRILL RESTAURANT GROUP, LLC  
(FLORIDA LTD LIAB CO)  
12148 MANDARIN ROAD  
JACKSONVILLE, FL 32223

OWNER OF U.S. REG. NO. 3,144,659.

FOR: RESTAURANT SERVICES, IN CLASS 43  
(U.S. CLS. 100 AND 101).

NO CLAIM IS MADE TO THE EXCLUSIVE  
RIGHT TO USE "TO GO", APART FROM THE  
MARK AS SHOWN.

FIRST USE 6-1-2006; IN COMMERCE 5-1-2007.

SN 77-186,318, FILED 5-21-2007.

THE MARK CONSISTS OF STANDARD CHAR-  
ACTERS WITHOUT CLAIM TO ANY PARTICULAR  
FONT, STYLE, SIZE, OR COLOR.

MATTHEW EINSTEIN, EXAMINING ATTORNEY

**Int. Cl.: 36**

**Prior U.S. Cls.: 100, 101, and 102**

**United States Patent and Trademark Office**

**Reg. No. 3,395,643**

**Registered Mar. 11, 2008**

**SERVICE MARK  
PRINCIPAL REGISTER**

**LEXELECT**

AMERICAN INTERNATIONAL GROUP, INC.  
(DELAWARE CORPORATION)  
70 PINE STREET  
NEW YORK, NY 10270

FOR: INSURANCE UNDERWRITING IN THE  
FIELD OF LIABILITY INSURANCE FOR POLITI-  
CAL CAMPAIGNS, IDENTITY THEFT, PROPERTY  
AND CASUALTY, AUTOMOBILE LIABILITY, AND  
EMPLOYMENT PRACTICES LIABILITY, IN CLASS  
36 (U.S. CLS. 100, 101 AND 102).

FIRST USE 10-1-2007; IN COMMERCE 10-1-2007.

THE MARK CONSISTS OF STANDARD CHAR-  
ACTERS WITHOUT CLAIM TO ANY PARTICULAR  
FONT, STYLE, SIZE, OR COLOR.

SN 77-194,019, FILED 5-31-2007.

MATTHEW EINSTEIN, EXAMINING ATTORNEY

**Int. Cl.: 5**

**Prior U.S. Cls.: 6, 18, 44, 46, 51, and 52**

**United States Patent and Trademark Office**

**Reg. No. 3,395,644**

**Registered Mar. 11, 2008**

**TRADEMARK  
PRINCIPAL REGISTER**

**SMART E**

BODYONICS, LTD. (DELAWARE CORPORATION)

200 ADAMS BOULEVARD

FARMINGDALE, NY 11735

FOR: DIETARY SUPPLEMENTS, IN CLASS 5 (U.S. CLS. 6, 18, 44, 46, 51 AND 52).

FIRST USE 9-6-2007; IN COMMERCE 9-6-2007.

THE MARK CONSISTS OF STANDARD CHARACTERS WITHOUT CLAIM TO ANY PARTICULAR FONT, STYLE, SIZE, OR COLOR.

NO CLAIM IS MADE TO THE EXCLUSIVE RIGHT TO USE "E", APART FROM THE MARK AS SHOWN.

SN 77-198,607, FILED 6-5-2007.

JOHN HWANG, EXAMINING ATTORNEY

**Int. Cl.: 25**

**Prior U.S. Cls.: 22 and 39**

**United States Patent and Trademark Office**

**Reg. No. 3,395,645**

**Registered Mar. 11, 2008**

**TRADEMARK  
PRINCIPAL REGISTER**

**ORIGINAL INTENT**

DVS SHOE CO., INC. (CALIFORNIA CORPORATION)  
955 FRANCISCO STREET  
TORRANCE, CA 90502

FOR: CLOTHING, NAMELY, SHIRTS, T-SHIRTS, SWEATERS, JACKETS, SWEATSHIRTS, BELTS, HATS, CAPS, SKATEBOARD SHOES, ATHLETIC FOOTWEAR, SNEAKERS, FOOTWEAR AND HEADWEAR, IN CLASS 25 (U.S. CLS. 22 AND 39).

FIRST USE 5-31-2006; IN COMMERCE 5-31-2006.

THE MARK CONSISTS OF STANDARD CHARACTERS WITHOUT CLAIM TO ANY PARTICULAR FONT, STYLE, SIZE, OR COLOR.

SN 77-975,110, FILED 9-22-2006.

KATHERINE CHANG, EXAMINING ATTORNEY

**Int. Cls.: 35 and 41**

**Prior U.S. Cls.: 100, 101, 102, and 107**

**United States Patent and Trademark Office**

**Reg. No. 3,395,646**

**Registered Mar. 11, 2008**

**SERVICE MARK  
PRINCIPAL REGISTER**



THE FILMCATCHER COMPANY, LLC (NEW YORK LTD LIAB CO)  
333 WEST 52ND STREET, SUITE 1002  
NEW YORK, NY 10019

FOR: ONLINE RETAIL STORE SERVICES FEATURING MOTION PICTURES AND DVDS, IN CLASS 35 (U.S. CLS. 100, 101 AND 102).

FIRST USE 10-1-2007; IN COMMERCE 10-1-2007.

FOR: DISTRIBUTION OF MOTION PICTURES; PROVIDING A WEBSITE FEATURING INFORMATION ABOUT MOTION PICTURES, IN CLASS 41 (U.S. CLS. 100, 101 AND 107).

FIRST USE 5-1-2007; IN COMMERCE 5-1-2007.

THE COLOR(S) DARK RED, LIGHT RED, BROWN, ORANGE, DARK YELLOW AND LIGHT YELLOW IS/ARE CLAIMED AS A FEATURE OF THE MARK.

THE COLOR DARK RED APPEARS IN THE HEAD OF THE BIRD. THE COLOR LIGHT RED APPEARS IN THE EYE OF THE BIRD. THE COLOR BROWN APPEARS IN THE TAIL AND TALONS OF THE BIRD. THE COLORS ORANGE, DARK YELLOW AND LIGHT YELLOW APPEAR IN THE WINGS OF THE BIRD.

THE MARK CONSISTS OF A STYLIZED DEPICTION OF A BIRD WITH A DARK RED HEAD, A LIGHT RED EYE, A BROWN TAIL AND TALONS, AND ORANGE, DARK YELLOW AND LIGHT YELLOW WINGS.

SN 77-975,147, FILED 10-12-2006.

MICHAEL WEBSTER, EXAMINING ATTORNEY



**Int. Cls.: 35 and 41**

**Prior U.S. Cls.: 100, 101, 102, and 107**

**United States Patent and Trademark Office**

**Reg. No. 3,395,647**

**Registered Mar. 11, 2008**

**SERVICE MARK  
PRINCIPAL REGISTER**

# FILMCATCHER

THE FILMCATCHER COMPANY, LLC (NEW YORK LTD LIAB CO)  
333 WEST 52ND STREET, SUITE 1002  
NEW YORK, NY 10019

FOR: ONLINE RETAIL STORE SERVICES FEATURING MOTION PICTURES AND DVDS, IN CLASS 35 (U.S. CLS. 100, 101 AND 102).

FIRST USE 10-1-2007; IN COMMERCE 10-1-2007.

FOR: DISTRIBUTION OF MOTION PICTURES; PROVIDING A WEBSITE FEATURING INFORMA-

TION ABOUT MOTION PICTURES, IN CLASS 41 (U.S. CLS. 100, 101 AND 107).

FIRST USE 5-1-2007; IN COMMERCE 5-1-2007.

THE MARK CONSISTS OF STANDARD CHARACTERS WITHOUT CLAIM TO ANY PARTICULAR FONT, STYLE, SIZE, OR COLOR.

SN 77-975,148, FILED 10-11-2006.

ANTHONY RINKER, EXAMINING ATTORNEY

**Int. Cl.: 9**

**Prior U.S. Cls.: 21, 23, 26, 36, and 38**

**United States Patent and Trademark Office**

**Reg. No. 3,395,648**

**Registered Mar. 11, 2008**

---

**TRADEMARK  
PRINCIPAL REGISTER**

**MICROVIPER**

P W ALLEN & COMPANY (ENGLAND COR-  
PORATION)  
ALLEN HOUSE, ALEXANDRA WAY, ASHCHURCH  
BUSINESS CENTRE  
TEWKESBURY, UNITED KINGDOM GL20 8TD

FOR: ELECTRONIC MICROSCOPES, PARTS AND  
FITTINGS FOR ALL THE AFORESAID GOODS, IN  
CLASS 9 (U.S. CLS. 21, 23, 26, 36 AND 38).

FIRST USE 5-31-2001; IN COMMERCE 2-5-2003.

OWNER OF UNITED KINGDOM REG. NO.  
2271080, DATED 5-25-2001, EXPIRES 5-25-2011.

SN 78-095,193, FILED 11-27-2001.

MICHELE SWAIN, EXAMINING ATTORNEY

**Int. Cl.: 41**

**Prior U.S. Cls.: 100, 101, and 107**

**United States Patent and Trademark Office**

**Reg. No. 3,395,649**

**Registered Mar. 11, 2008**

**SERVICE MARK  
PRINCIPAL REGISTER**

**EXECUTIVE FOCUSED SELLING**

EXECUTIVE CONVERSATION, INC. (WASHINGTON CORPORATION)  
1421 34TH AVENUE  
SUITE 300  
SEATTLE, WA 98122

FOR: EDUCATIONAL SERVICES, NAMELY, CONDUCTING SESSIONS, CLASSES AND SEMINARS IN PERSON AND ONLINE IN THE FIELDS OF BUSINESS MANAGEMENT, SALES AND MARKETING, CUSTOMER RELATIONSHIPS, PUBLIC AND PRIVATE SECTOR CUSTOMER AND ACCOUNT DEVELOPMENT AND CONCERNS, FINANCIAL ANALYSIS AND ACCOUNTING TECHNIQUES, ENTERPRISE PLANNING AND MANAGEMENT, ADMINISTRATION, EDUCATION, BUSINESS ACUMEN AND PERSONAL AND INTERPERSONAL SKILLS, AND INDIVIDUAL AND GROUP TUTORING, CONSULTATION AND TRAINING PROVIDED IN CONNECTION THERE-

WITH; COURSE MATERIALS IN THE NATURE OF COMPUTER PROGRAMS, TEXT BOOKS, WORKBOOKS, LESSON PLANS, EXAMPLE PROBLEMS, CASE STUDIES AND BUSINESS DESCRIPTIONS DISTRIBUTED ONLY FOR USE IN CONNECTION THEREWITH AND NOT SOLD SEPARATELY THEREFROM, IN CLASS 41 (U.S. CLS. 100, 101 AND 107).

FIRST USE 12-31-1998; IN COMMERCE 12-31-2000.

NO CLAIM IS MADE TO THE EXCLUSIVE RIGHT TO USE "SELLING", APART FROM THE MARK AS SHOWN.

SN 78-129,334, FILED 5-16-2002.

DOMINIC J. FERRAIUOLO, EXAMINING ATTORNEY

**Int. Cl.: 9**

**Prior U.S. Cls.: 21, 23, 26, 36, and 38**

**United States Patent and Trademark Office**

**Reg. No. 3,395,650**

**Registered Mar. 11, 2008**

---

**TRADEMARK  
PRINCIPAL REGISTER**

**SMARTRADIO**

BROADCOM CORPORATION (CALIFORNIA  
CORPORATION)  
5300 CALIFORNIA AVENUE  
IRVINE, CA 92617

FIRST USE 7-20-2002; IN COMMERCE 7-20-2002.

SN 78-145,441, FILED 7-18-2002.

FOR: COMPUTER HARDWARE; INTEGRATED  
CIRCUITS; AND SOFTWARE FOR CONTROLLING  
AND USING INTEGRATED CIRCUITS, IN CLASS 9  
(U.S. CLS. 21, 23, 26, 36 AND 38).

PAULA MAYS, EXAMINING ATTORNEY

**Int. Cls.: 18 and 25**

**Prior U.S. Cls.: 1, 2, 3, 22, 39, and 41**

**United States Patent and Trademark Office**

**Reg. No. 3,395,651**

**Registered Mar. 11, 2008**

**TRADEMARK  
PRINCIPAL REGISTER**



ESPRIT IP LIMITED (BR.VIRGIN ISLANDS CORPORATION)  
P.O. BOX 957  
OFFSHORE INCORPORATIONS CENTRE  
ROAD TOWN, TORTOLA, BR.VIRGIN ISLANDS

FOR: COIN CASES, IN CLASS 18 (U.S. CLS. 1, 2, 3, 22 AND 41).

FIRST USE 0-0-2004; IN COMMERCE 0-0-2004.

FOR: WOMEN'S WEARING APPAREL, NAMELY, DRESSES, COATS, SHORTS, SHIRTS, PANTS, SWEATERS, JACKETS, T-SHIRTS, BLOUSES, KNIT TOPS, HALTERS, SMOCK TOPS, VESTS, WIND

RESISTANT JACKETS, SWEATSHIRTS, SWEAT-PANTS, BELTS, CAPS, HATS, GLOVES, SHAWLS, SCARVES, LEGGINGS, DENIM PANTS, KNIT PANTS AND SKIRTS, IN CLASS 25 (U.S. CLS. 22 AND 39).

FIRST USE 0-0-2004; IN COMMERCE 0-0-2004.

OWNER OF U.S. REG. NOS. 1,670,308 AND 2,418,424.

SN 78-148,900, FILED 7-30-2002.

RUDY R. SINGLETON, EXAMINING ATTORNEY

**Int. Cl.: 16**

**Prior U.S. Cls.: 2, 5, 22, 23, 29, 37, 38, and 50**

**United States Patent and Trademark Office**

**Reg. No. 3,395,652**

**Registered Mar. 11, 2008**

**TRADEMARK  
PRINCIPAL REGISTER**

**POOH**

DISNEY ENTERPRISES, INC. (DELAWARE CORPORATION)  
500 SOUTH BUENA VISTA STREET  
BURBANK, CA 91521

OWNER OF U.S. REG. NOS. 2,159,158, 2,623,099,  
AND OTHERS.

FOR: PENS; STICKERS; NON-CALIBRATED  
DRAWING RULERS, IN CLASS 16 (U.S. CLS. 2, 5,  
22, 23, 29, 37, 38 AND 50).

SN 78-159,758, FILED 8-30-2002.

FIRST USE 5-0-2007; IN COMMERCE 5-0-2007.

ADA HAN, EXAMINING ATTORNEY

**Int. Cl.: 36**

**Prior U.S. Cls.: 100, 101, and 102**

**United States Patent and Trademark Office**

**Reg. No. 3,395,653**

**Registered Mar. 11, 2008**

**SERVICE MARK  
PRINCIPAL REGISTER**

**LAND CAPITAL ASSET MANAGEMENT**

LAND CAPITAL GROUP, INC. (TEXAS CORPORATION)  
1741 SIDEWINDER DRIVE, SUITE 201  
PARK CITY, UT 84060

FOR: REAL ESTATE MANAGEMENT; MANAGING AND OPERATING SHOPPING CENTERS; LEASING OF SHOPPING CENTER SPACE, IN CLASS 36 (U.S. CLS. 100, 101 AND 102).

FIRST USE 2-0-2006; IN COMMERCE 2-0-2006.

NO CLAIM IS MADE TO THE EXCLUSIVE RIGHT TO USE "ASSET MANAGEMENT", APART FROM THE MARK AS SHOWN.

SEC. 2(F) AS TO "LAND CAPITAL".

SN 78-162,659, FILED 9-10-2002.

TINA L. SNAPP, EXAMINING ATTORNEY

**Int. Cl.: 9**

**Prior U.S. Cls.: 21, 23, 26, 36, and 38**

**United States Patent and Trademark Office**

**Reg. No. 3,395,654**

**Registered Mar. 11, 2008**

**TRADEMARK  
PRINCIPAL REGISTER**

**PCU**

ISYS TECHNOLOGIES, INC. (NEVADA CORPORATION)  
229 SOUTH MAIN, SUITE 1300  
SALT LAKE CITY, UT 84111

FOR: COMPUTERS, COMPUTER HARDWARE,  
AND COMPUTER ACCESSORIES, NAMELY, COMPUTER CARRYING CASES, COMPUTER CHASSIS, COMPUTER EXPANSION BOARDS, COMPUTER

INTERFACE BOARDS, COMPUTER PERIPHERALS, IN CLASS 9 (U.S. CLS. 21, 23, 26, 36 AND 38).

FIRST USE 8-0-2007; IN COMMERCE 8-0-2007.

SN 78-169,387, FILED 9-30-2002.

CAROLINE WOOD, EXAMINING ATTORNEY



**Int. Cls.: 10 and 12**

**Prior U.S. Cls.: 19, 21, 23, 26, 31, 35, 39, and 44**

**United States Patent and Trademark Office**

**Reg. No. 3,395,655**

**Registered Mar. 11, 2008**

**TRADEMARK  
PRINCIPAL REGISTER**

**KOSMODISK**

STUDIO MODERNA SA (SWITZERLAND CORPORATION)  
VIA PRETORIO 22  
LUGANO, SWITZERLAND 6900

FOR: SEAT COVERS, NAMELY, SEAT OVERLAYS FOR THERAPEUTIC AND MEDICAL PURPOSES; COMFORT PADS, NAMELY, ORTHOPEDIC SUPPORTS AND NON-ELECTRIC MASSAGE APPARATUS, IN CLASS 10 (U.S. CLS. 26, 39 AND 44).

FIRST USE 11-28-2007; IN COMMERCE 11-28-2007.

FOR: VEHICLE SEAT COVERS; COMFORT PADS FOR VEHICLE SEATS; VEHICLE SEAT CUSHIONS, IN CLASS 12 (U.S. CLS. 19, 21, 23, 31, 35 AND 44).

FIRST USE 11-28-2007; IN COMMERCE 11-28-2007.

SN 78-170,435, FILED 10-2-2002.

ROBIN CHOSID, EXAMINING ATTORNEY

**Int. Cl.: 5**

**Prior U.S. Cls.: 6, 18, 44, 46, 51, and 52**

**United States Patent and Trademark Office**

**Reg. No. 3,395,656**

**Registered Mar. 11, 2008**

**TRADEMARK  
PRINCIPAL REGISTER**

**CLEAR MIGRAINE**

CLEAR PRODUCTS, INC. (CALIFORNIA CORPORATION)  
6156 MISSION GORGE ROAD, SUITE C  
SAN DIEGO, CA 92120

NO CLAIM IS MADE TO THE EXCLUSIVE RIGHT TO USE "MIGRAINE", APART FROM THE MARK AS SHOWN.

FOR: HERBAL SUPPLEMENTS FOR THE RELIEF OF MIGRAINE HEADACHES, IN CLASS 5 (U.S. CLS. 6, 18, 44, 46, 51 AND 52).

SN 78-181,529, FILED 11-4-2002.

FIRST USE 3-31-2003; IN COMMERCE 3-31-2003.

JORDAN BAKER, EXAMINING ATTORNEY

**Int. Cl.: 5**

**Prior U.S. Cls.: 6, 18, 44, 46, 51, and 52**

**United States Patent and Trademark Office**

**Reg. No. 3,395,657**

**Registered Mar. 11, 2008**

**TRADEMARK  
PRINCIPAL REGISTER**

**CLEAR HEADACHE**

CLEAR PRODUCTS, INC. (CALIFORNIA CORPORATION)  
6156 MISSION GORGE ROAD, SUITE C  
SAN DIEGO, CA 92120

FOR: HERBAL REMEDY FOR THE RELIEF OF HEADACHE PAIN, IN CLASS 5 (U.S. CLS. 6, 18, 44, 46, 51 AND 52).

FIRST USE 3-31-2003; IN COMMERCE 3-31-2003.

NO CLAIM IS MADE TO THE EXCLUSIVE RIGHT TO USE "HEADACHE", APART FROM THE MARK AS SHOWN.

SN 78-188,175, FILED 11-22-2002.

REBECCA EISINGER, EXAMINING ATTORNEY

**Int. Cl.: 9**

**Prior U.S. Cls.: 21, 23, 26, 36, and 38**

**United States Patent and Trademark Office**

**Reg. No. 3,395,658**

**Registered Mar. 11, 2008**

---

**TRADEMARK  
PRINCIPAL REGISTER**

**SILENTSHIELD**

IMEDCO AG (SWITZERLAND CORPORATION)  
INDUSTRIESTRASSE WEST 14  
CH-4614 HAGENDORF, SWITZERLAND

EQUIPMENT, AND PARTS THEREFOR , IN CLASS  
9 (U.S. CLS. 21, 23, 26, 36 AND 38).

FIRST USE 11-29-2006; IN COMMERCE 11-29-2006.

FOR: SOUNDPROOF RADIO FREQUENCY (RF)  
ROOM ENCLOSURES FOR RF SHIELDING AND  
FOR ACOUSTICALLY INSULATING ELECTRONIC

SN 78-189,854, FILED 11-29-2002.

ALICE BENMAMAN, EXAMINING ATTORNEY

**Int. Cl.: 9**

**Prior U.S. Cls.: 21, 23, 26, 36, and 38**

**United States Patent and Trademark Office**

**Reg. No. 3,395,659**

**Registered Mar. 11, 2008**

**TRADEMARK  
PRINCIPAL REGISTER**

**MICROCLAMP**

SENSORMATIC ELECTRONICS CORPORATION  
(NEVADA CORPORATION)  
6600 CONGRESS AVENUE  
BOCA RATON, FL 33487

FIRST USE 11-29-2006; IN COMMERCE 11-29-2006.

OWNER OF U.S. REG. NOS. 1,409,971, 1,905,662,  
AND OTHERS.

FOR: FASTENER FOR USE IN ATTACHING  
ELECTRONIC ARTICLE SURVEILLANCE DEVICES  
TO CLOTHING OR OTHER CONSUMER PRO-  
DUCTS, IN CLASS 9 (U.S. CLS. 21, 23, 26, 36 AND 38).

SN 78-193,494, FILED 12-11-2002.

LINDA ESTRADA, EXAMINING ATTORNEY

**Int. Cls.: 10 and 16**

**Prior U.S. Cls.: 2, 5, 22, 23, 26, 29, 37, 38, 39, 44, and 50**

**Reg. No. 3,395,660**

**United States Patent and Trademark Office**

**Registered Mar. 11, 2008**

---

**TRADEMARK  
PRINCIPAL REGISTER**

**DELIVERING WHAT'S NEXT**

BOSTON SCIENTIFIC SCIMED, INC. (MINNESOTA CORPORATION)

ONE SCIMED PLACE  
MAPLE GROVE, MN 55311

FOR: HOUSE MARK COVERING A FULL LINE OF MEDICAL DEVICES FOR USE IN CARDIOVASCULAR, NEUROVASCULAR, UROLOGY, ONCOLOGY AND ENDOSCOPY PROCEDURES, IN CLASS 10 (U.S. CLS. 26, 39 AND 44).

FIRST USE 3-27-2003; IN COMMERCE 3-27-2003.

FOR: PRINTED PUBLICATIONS, NAMELY, PAMPHLETS, BROCHURES, NEWSLETTERS, AND JOURNALS FEATURING MEDICAL DEVICES FOR USE IN CARDIOVASCULAR, NEUROVASCULAR, UROLOGY, ONCOLOGY AND ENDOSCOPY PROCEDURES, IN CLASS 16 (U.S. CLS. 2, 5, 22, 23, 29, 37, 38 AND 50).

FIRST USE 3-27-2003; IN COMMERCE 3-27-2003.

SN 78-195,858, FILED 12-18-2002.

KHANH LE, EXAMINING ATTORNEY

**Int. Cls.: 3, 18, and 25**

**Prior U.S. Cls.: 1, 2, 3, 4, 6, 22, 39, 41, 50, 51, and 52**

**United States Patent and Trademark Office**

**Reg. No. 3,395,661**

**Registered Mar. 11, 2008**

**TRADEMARK  
PRINCIPAL REGISTER**



CAPINEL S.A. (URUGUAY CORPORATION)  
BUENOS AIRES NO. 484  
PISO 2, ESCRITORIO 10  
MONTEVIDEO, URUGUAY

FOR: SADDLE SOAPS, PERFUMES AND COLOGNES, IN CLASS 3 (U.S. CLS. 1, 4, 6, 50, 51 AND 52).

FIRST USE 0-0-1997; IN COMMERCE 9-0-2006.

FOR: BAGS, NAMELY, HANDBAGS, ALL-PURPOSE SPORT BAGS, CARRY-ON BAGS, DUFFEL BAGS, AND TRAVEL BAGS, IN CLASS 18 (U.S. CLS. 1, 2, 3, 22 AND 41).

FIRST USE 9-0-1987; IN COMMERCE 9-0-1987.

FOR: CLOTHING, NAMELY, SHIRTS, SWEATSHIRTS, JACKETS, VESTS, PANTS, SHORTS, SWEATERS, CAPS, AND POLO UNIFORMS, IN CLASS 25 (U.S. CLS. 22 AND 39).

FIRST USE 0-0-1995; IN COMMERCE 0-0-1995.

OWNER OF U.S. REG. NO. 1,748,598.

SN 78-217,632, FILED 2-21-2003.

KIM SAITO, EXAMINING ATTORNEY

**Int. Cl.: 44**

**Prior U.S. Cls.: 100 and 101**

**United States Patent and Trademark Office**

**Reg. No. 3,395,662**

**Registered Mar. 11, 2008**

**SERVICE MARK  
PRINCIPAL REGISTER**

**PASSION**

MASCOLO, TERRY (UNITED STATES INDIVI-  
DUAL)  
CPH 10  
1915 BRICKELL  
MIAMI, FL 33129

FIRST USE 11-1-2006; IN COMMERCE 11-1-2006.

SN 78-219,965, FILED 2-27-2003.

FOR: HAIRDRESSING SALONS, IN CLASS 44  
(U.S. CLS. 100 AND 101).

CURTIS FRENCH, EXAMINING ATTORNEY



**Int. Cl.: 9**

**Prior U.S. Cls.: 21, 23, 26, 36, and 38**

**United States Patent and Trademark Office**

**Reg. No. 3,395,663**

**Registered Mar. 11, 2008**

**TRADEMARK  
PRINCIPAL REGISTER**

**SHOUT! FACTORY**

RETROPOLIS LLC (DELAWARE LTD LIAB JT ST  
CO)  
2042 A ARMACOST AVENUE  
LOS ANGELES, CA 90025

FOR: SOUND RECORDINGS AND DOWNLOAD-  
ABLE SOUND RECORDINGS FEATURING  
SOUNDTRACKS FROM THEATRICAL STAGE  
PRODUCTIONS, COMEDY ROUTINES, DOCU-  
MENTARIES, UNSCRIPTED REALITY PRO-  
GRAMS, MOTION PICTURES FEATURING  
GENERAL FEATURE ENTERTAINMENT, LIVE  
ACTION, SCIENCE FICTION AND DRAMA AND  
TELEVISION PROGRAMS FEATURING SITCOMS,  
GAMES, DRAMA AND LIVE ACTION; AND VIDEO  
RECORDINGS, DVDS AND DOWNLOADABLE VI-

DEO RECORDINGS FEATURING THEATRICAL  
STAGE PRODUCTIONS, COMEDY ROUTINES,  
DOCUMENTARIES, MOTION PICTURES FEATUR-  
ING GENERAL FEATURE ENTERTAINMENT,  
LIVE ACTION, SCIENCE FICTION, AND DRAMA  
AND TELEVISION PROGRAMS FEATURING SIT-  
COMS, GAMES, DRAMA AND LIVE ACTION, IN  
CLASS 9 (U.S. CLS. 21, 23, 26, 36 AND 38).

FIRST USE 1-6-2005; IN COMMERCE 1-6-2005.

SN 78-220,402, FILED 2-28-2003.

TARAH HARDY, EXAMINING ATTORNEY

**Int. Cl.: 14**

**Prior U.S. Cls.: 2, 27, 28, and 50**

**United States Patent and Trademark Office**

**Reg. No. 3,395,664**

**Registered Mar. 11, 2008**

---

**TRADEMARK  
PRINCIPAL REGISTER**

**ZELYAH**

EASTERN JEWELRY & PREMIUMS, INC. (NE-  
VADA CORPORATION)  
2416 ALPINE MEADOWS AVE.  
HENDERSON, NV 89074

FIRST USE 4-2-2007; IN COMMERCE 4-2-2007.

SN 78-234,276, FILED 4-4-2003.

FOR: JEWELRY, IN CLASS 14 (U.S. CLS. 2, 27, 28  
AND 50).

PAM WILLIS, EXAMINING ATTORNEY

**Int. Cl.: 10**

**Prior U.S. Cls.: 26, 39, and 44**

**United States Patent and Trademark Office**

**Reg. No. 3,395,665**

**Registered Mar. 11, 2008**

---

**TRADEMARK  
PRINCIPAL REGISTER**

**ENDONOL**

GUIDANCE ENDODONTICS, LLC (NEW MEXICO CORPORATION)  
7520 MONTGOMERY BLVD. NE  
ALBUQUERQUE, NM 87109

FIRST USE 7-18-2006; IN COMMERCE 7-18-2006.

SN 78-235,877, FILED 4-9-2003.

FOR: ENDODONTIC APPARATUS AND INSTRUMENTS, NAMELY, DRILL BITS FOR USE IN DENTAL APPLICATIONS, IN CLASS 10 (U.S. CLS. 26, 39 AND 44).

LOURDES AYALA, EXAMINING ATTORNEY

**Int. Cl.: 9**

**Prior U.S. Cls.: 21, 23, 26, 36, and 38**

**United States Patent and Trademark Office**

**Reg. No. 3,395,666**

**Registered Mar. 11, 2008**

**TRADEMARK  
PRINCIPAL REGISTER**

**WAVEREADY**

JDS UNIPHASE CORPORATION (DELAWARE CORPORATION)  
430 NORTH MCCARTHY BLVD.  
MILPITAS, CA 95035

FOR: TELECOMMUNICATION FIBER OPTIC SYSTEMS, NAMELY, OPTICAL CIRCUITS AND DEVICES FOR USE IN METRO ACCESS, NAMELY, DIRECT MODULATED LASERS, SEMICONDUCTOR LASERS, LASER TRANSMITTER MODULES, CONTINUOUS WAVE LASERS, DIRECTLY MODULATED LASERS, LIGHT EMITTING DIODES, LASER DIODES, SOLID-STATE LASERS, OPTICAL SIGNAL CONVERTERS, RECEIVER MODULES, RECEIVER MODULES WITH CLOCK OR DATA RECOVERY CIRCUITS, VIDEO-ON-DEMAND MODULES; PHOTODETECTORS, PHOTODIODES, TRANSCEIVERS, TRANSPONDERS, MULTIPLEXERS, DENSE WAVELENGTH DIVISION MULTIPLEX COUPLERS, COARSE WAVELENGTH DIVISION MULTIPLEX COUPLERS, WIDEBAND COUPLERS, ADD-DROP MULTIPLEXERS, FIBER OPTIC MODEMS, OPTICAL GRATINGS, MULTIPLE CHANNEL OPTICAL INTERFACE UNITS, ACCESS COUPLERS, ATTENUATORS, EMULATORS, FILTERS, ACTIVE COUPLERS, INTERFEROMETER COMPONENTS, NAMELY, PHOTODETECTORS AND PHOTODIODES, ISOLATORS, WAVEGUIDES, POLARIZATION COMPONENTS, NAMELY, OPTICAL ATTENUATORS, MODULATORS, ERBIUM-DOPED FIBER AMPLIFIERS, PUMP LASERS, FIBER OPTIC EXTENDERS, LINK ENCLOSURES, AMPLIFIERS MODULES, OPTICAL FIBER AMPLIFIER COMPONENTS, NAMELY, CIRCUIT BOARDS, OPTICAL AMPLIFIERS, ELECTRICAL AMPLIFIERS, INTEGRATED CIRCUITS, PUMP LASERS AND LASERS NOT FOR MEDICAL USE, OPTICAL SWITCHES, MICROELECTRONIC MECHANICAL SWITCHES, OPTICAL PATCH CORDS, JUMPER CABLES; SINGLE MODE FIBERS; MULTI MODE FIBERS; FIBER OPTIC TRANSCIEVERS; FIBER OPTIC TRANSMITTERS; FIBER OPTIC RECEIVERS, PARALLEL OPTICAL INTERFACE; OPTICAL EQUIPMENT, NAMELY,

LASERS, FIBER OPTIC TRANSMITTERS, SEMI-CONDUCTOR LASERS, LASER TRANSMITTER MODULES, CONTINUOUS WAVE LASERS, DIRECTLY MODULATED LASERS, LIGHT EMITTING DIODES, LASER DIODES, SOLID-STATE LASERS, OPTICAL TERMINATIONS, OPTICAL SIGNAL CONVERTERS, RECEIVER MODULES, RECEIVER MODULES WITH CLOCK OR DATA RECOVERY CIRCUITS, HIGH GAIN OPTICAL/ELECTRICAL RECEIVERS AND CONVERTERS, PHOTODETECTORS, PHOTODIODES, TRANSCEIVERS, TRANSPONDERS, MULTIPLEXERS, DENSE WAVELENGTH DIVISION MULTIPLEX COUPLERS, COARSE WAVELENGTH DIVISION MULTIPLEX COUPLERS, WIDEBAND COUPLERS, ADD-DROP MULTIPLEXERS, FIBER OPTIC MODEMS, OPTICAL GRATINGS, MULTIPLE CHANNEL OPTICAL INTERFACE UNITS, ACCESS COUPLERS, ATTENUATORS, EMULATORS, FILTERS, ACTIVE COUPLERS, INTERFEROMETER COMPONENTS, NAMELY, PHOTODETECTORS AND PHOTODIODES, ISOLATORS, WAVEGUIDES, POLARIZATION COMPONENTS, NAMELY, OPTICAL ATTENUATORS, MODULATORS, WAVELENGTH LOCKERS, ERBIUM-DOPED FIBER AMPLIFIERS, PUMP LASERS, FIBER OPTIC EXTENDERS, LINK ENCLOSURES, FIBER OPTIC REGENERATOR MODULES, AMPLIFIERS MODULES, OPTICAL FIBER AMPLIFIER COMPONENTS, NAMELY, CIRCUIT BOARDS, OPTICAL AMPLIFIERS, ELECTRICAL AMPLIFIERS, INTEGRATED CIRCUITS, PUMP LASERS AND LASERS NOT FOR MEDICAL USE, OPTICAL SWITCHES, MICROELECTRONIC MECHANICAL SWITCHES, OPTICAL PATCH CORDS, JUMPER CABLES; FIBER OPTIC SWITCHES, PATH PROTECTION, NAMELY, TRANSPONDERS, EQUIPMENT PROTECTION, NAMELY, OPTICAL SPLITTERS, MICRO-ELECTRO-MECHANICAL SWITCHES; FIBER OPTIC GENERATORS FOR USE IN TELECOMMUNICATIONS AND DATA COMMUNICATIONS SYSTEMS; SIGNAL BOOSTERS, NAMELY, OPTICAL AND ELECTRICAL AMPLIFIERS; OPTICAL COUPLERS FOR USE IN TELECOMMU-

NICATION AND DATA COMMUNICATION SYSTEMS; BI-DIRECTIONAL TRANSPONDERS AND AMPLIFIERS; UNIDIRECTIONAL TRANSPONDERS AND AMPLIFIERS; OPTICAL WAVE GUIDES; FIBER OPTIC DEMULTIPLEXERS AND MULTIPLEXERS FOR COARSE WAVELENGTH DIVISION MULTIPLEXING; FIBER OPTIC DEMULTIPLEXERS AND MULTIPLEXERS FOR DENSE WAVELENGTH DIVISION MULTIPLEXING; AMPLIFIERS; ELECTRO-OPTIC COMPONENTS FOR WAVELENGTH TERMINATION, NAMELY, RECEIVER MODULES, RECEIVER MODULES WITH CLOCK OR DATA RECOVERY CIRCUITS, HIGH GAIN OPTICAL/ELECTRICAL RECEIVERS AND CONVERTERS, PHOTODETECTORS, PHOTO-DIODES, TRANSCEIVERS, TRANSPONDERS, MUL-

TIPLEXERS, ADD-DROP MULTIPLEXERS, MULTIPLE CHANNEL OPTICAL INTERFACE UNITS, ACCESS COUPLERS, EMULATORS, MODULATORS; TELECOMMUNICATIONS AND FIBER OPTICS, NAMELY, COMPUTER SOFTWARE FOR MANAGEMENT, CONTROL, MONITORING, AND FAULT DETECTION FOR TELECOMMUNICATIONS AND FIBER OPTIC SYSTEMS, IN CLASS 9 (U.S. CLS. 21, 23, 26, 36 AND 38).

FIRST USE 6-28-2004; IN COMMERCE 6-28-2006.

SN 78-249,938, FILED 5-14-2003.

JANICE L. MCMORROW, EXAMINING ATTORNEY

**Int. Cl.: 29**

**Prior U.S. Cl.: 46**

**United States Patent and Trademark Office**

**Reg. No. 3,395,667**

**Registered Mar. 11, 2008**

---

**TRADEMARK  
PRINCIPAL REGISTER**

**NAKED SHRIMP**

R & R RESOURCES, INC. (NEW JERSEY CORPORATION)  
3 SOUTH ARLENE DRIVE  
WEST LONG BRANCH, NJ 07764

NO CLAIM IS MADE TO THE EXCLUSIVE RIGHT TO USE "SHRIMP", APART FROM THE MARK AS SHOWN.

FOR: PEELED AND DE-VEINED SHRIMP WITH AND WITHOUT THE TAIL, IN CLASS 29 (U.S. CL. 46).

SN 78-253,040, FILED 5-22-2003.

FIRST USE 11-29-2007; IN COMMERCE 11-29-2007.

SHAUNIA CARLYLE, EXAMINING ATTORNEY

**Int. Cl.: 30**

**Prior U.S. Cl.: 46**

**United States Patent and Trademark Office**

**Reg. No. 3,395,668**

**Registered Mar. 11, 2008**

---

**TRADEMARK  
PRINCIPAL REGISTER**

**CLASSICO**

TRADEMARK MANAGEMENT COMPANY (DE-  
LAWARE CORPORATION)  
2541 NORTH STOKESBERRY PLACE, SUITE 100  
MERIDIAN, ID 83646

FOR: SAUCES, IN CLASS 30 (U.S. CL. 46).

FIRST USE 10-5-1982; IN COMMERCE 10-5-1982.

THE FOREIGN WORDING IN THE MARK  
TRANSLATES INTO ENGLISH AS "CLASSIC".

SN 78-255,124, FILED 5-28-2003.

RICHARD WHITE, EXAMINING ATTORNEY

**Int. Cl.: 25**

**Prior U.S. Cls.: 22 and 39**

**United States Patent and Trademark Office**

**Reg. No. 3,395,669**

**Registered Mar. 11, 2008**

**TRADEMARK  
PRINCIPAL REGISTER**

**HANES SPORT**

HBI BRANDED APPAREL LIMITED, INC. (DE-  
LAWARE CORPORATION)  
1000 EAST HANES MILL ROAD  
C/O CHRYSTAL PETTITT / LAW DEPARTMENT  
WINSTON-SALEM, NC 27105

FOR: TANK TOPS, SKORTS AND JACKETS,  
NAMELY, SLEEVELESS ZIP-UP JACKETS, IN  
CLASS 25 (U.S. CLS. 22 AND 39).

FIRST USE 3-31-2003; IN COMMERCE 3-31-2003.

OWNER OF U.S. REG. NO. 2,468,157.

NO CLAIM IS MADE TO THE EXCLUSIVE  
RIGHT TO USE "SPORT", APART FROM THE  
MARK AS SHOWN.

SN 78-258,013, FILED 6-4-2003.

CHERYL CLAYTON, EXAMINING ATTORNEY



**Int. Cl.: 38**

**Prior U.S. Cls.: 100, 101, and 104**

**United States Patent and Trademark Office**

**Reg. No. 3,395,670**

**Registered Mar. 11, 2008**

---

**SERVICE MARK  
PRINCIPAL REGISTER**

**PLANCOM**

PLANCOM, INC (CALIFORNIA CORPORATION),  
DBA PLANCOM CALIFORNIA, INC.,  
302 STATE PLACE  
ESCONDIDO, CA 92029

FIRST USE 7-31-1993; IN COMMERCE 7-31-1993.

SN 78-258,504, FILED 6-4-2003.

FOR: TELECOMMUNICATIONS CONSULTA-  
TION, IN CLASS 38 (U.S. CLS. 100, 101 AND 104).

CURTIS FRENCH, EXAMINING ATTORNEY

**Int. Cl.: 25**

**Prior U.S. Cls.: 22 and 39**

**United States Patent and Trademark Office**

**Reg. No. 3,395,671**

**Registered Mar. 11, 2008**

**TRADEMARK  
PRINCIPAL REGISTER**

**DDICHOTOMY**

ELVIS, DAMEIAN, A. (UNITED STATES INDIVIDUAL)  
440 WEST 24TH STREET, APT 10F  
NEW YORK, NY 10011

FOR: CLOTHES, FOOTWEAR AND HEADWEAR FOR MEN WOMEN AND CHILDREN, NAMELY, HATS, CAPS, SCARF, SHIRTS, T-SHIRTS, SWEATERS, TOPS, BOTTOMS, JEANS, JACKETS, PANTS, SKIRTS, BRAS, PANTIES, UNDERWEAR, DRESSES,

GLOVES, SUITS, AND SHOES, IN CLASS 25 (U.S. CLS. 22 AND 39).

FIRST USE 1-1-2003; IN COMMERCE 1-1-2003.

SN 78-261,882, FILED 6-12-2003.

LOURDES AYALA, EXAMINING ATTORNEY

**Int. Cls.: 25 and 35**

**Prior U.S. Cls.: 22, 39, 100, 101, and 102**

**Reg. No. 3,395,672**

**United States Patent and Trademark Office**

**Registered Mar. 11, 2008**

---

**TRADEMARK  
SERVICE MARK  
PRINCIPAL REGISTER**

**BAGGATAWAY**

COMMONWEALTH LACROSSE COMPANY, LLC  
(MASSACHUSETTS LTD LIAB CO)  
509 EAST CENTRAL STREET  
FRANKLIN, MA 02038

FOR: CLOTHING, NAMELY, SHIRTS, T-SHIRTS,  
SWEATSHIRTS, PANTS, SWEATPANTS, SHORTS,  
HATS, SOCKS, AND JACKETS , IN CLASS 25 (U.S.  
CLS. 22 AND 39).

FIRST USE 11-15-2003; IN COMMERCE 11-15-2003.

FOR: RETAIL STORE SERVICES, MAIL ORDER  
CATALOG SERVICES, AND ON-LINE RETAIL  
STORE SERVICES, FEATURING SPORTING  
GOODS AND EQUIPMENT, FOOTWEAR, APPA-  
REL, AND HEADGEAR, IN CLASS 35 (U.S. CLS.  
100, 101 AND 102).

FIRST USE 11-15-2003; IN COMMERCE 11-15-2003.

SN 78-269,692, FILED 7-2-2003.

BILL DAWE, EXAMINING ATTORNEY

**Int. Cl.: 33**

**Prior U.S. Cls.: 47 and 49**

**United States Patent and Trademark Office**

**Reg. No. 3,395,673**

**Registered Mar. 11, 2008**

---

**TRADEMARK  
PRINCIPAL REGISTER**

**FINCA LOS LEYVA**

AUGUSTA LLC (FLORIDA LTD LIAB CO)  
6950 NW 77TH CT.  
MIAMI, FL 33166

THE PHRASE "FINCA LOS LEYVA" IN THE  
MARK TRANSLATES INTO ENGLISH AS "THE  
LEYVA FARM".

FOR: WINE, IN CLASS 33 (U.S. CLS. 47 AND 49).

SN 78-270,066, FILED 7-2-2003.

FIRST USE 7-0-2003; IN COMMERCE 7-0-2003.

KELLY BOULTON, EXAMINING ATTORNEY

**Int. Cl.: 9**

**Prior U.S. Cls.: 21, 23, 26, 36, and 38**

**United States Patent and Trademark Office**

**Reg. No. 3,395,674**

**Registered Mar. 11, 2008**

**TRADEMARK  
PRINCIPAL REGISTER**

**DEEPIE**

SYBENGA, JOHN R. (UNITED STATES INDIVIDUAL)  
905 SOUTH 8TH STREET  
P.O.BOX 322  
OSKALOOSA, IA 52577

FOR: THREE DIMENSIONAL (3-D) MOVIE EQUIPMENT, NAMELY, MOTION PICTURE PRO-

JECTORS AND MOTION PICTURE CAMERAS, IN CLASS 9 (U.S. CLS. 21, 23, 26, 36 AND 38).

FIRST USE 6-25-2002; IN COMMERCE 6-25-2002.

SN 78-273,285, FILED 7-11-2003.

TINA L. SNAPP, EXAMINING ATTORNEY

**Int. Cls.: 5 and 10**

**Prior U.S. Cls.: 6, 18, 26, 39, 44, 46, 51, and 52**

**United States Patent and Trademark Office**

**Reg. No. 3,395,675**

**Registered Mar. 11, 2008**

**TRADEMARK  
PRINCIPAL REGISTER**

**PLUS**

PLUS ENDOPROTHETIK AG (SWITZERLAND CORPORATION)  
ERLENSTRASSE 4A  
ROTKREUZ, SWITZERLAND 6343

FOR: KNEE IMPLANTS AND THEIR COMPONENTS; HIP-JOINT, KNEE-JOINT, AND SHOULDER JOINT IMPLANTS, IN CLASS 5 (U.S. CLS. 6, 18, 44, 46, 51 AND 52).

FIRST USE 1-1-2005; IN COMMERCE 8-1-2003.

FOR: SURGICAL AND MEDICAL APPARATUS AND INSTRUMENTS AND THEIR COMPONENTS, NAMELY, OSTEOSYNTHETIC INSTRUMENTS, NAMELY, RASPS, DRILLS, SCREW DRIVERS, MONKEY WRENCHES, AND HAMMERS FOR OSTEOSYNTHETIC USE; NAMELY, BONE SCREWS; ; CERCLAGES, PROSTHESES AND IMPLANTS; ARTIFICIAL LIMBS; IMPLANTS, NAMELY, OSTEOSYNTHETIC IMPLANTS; ARTIFICIAL IMPLANTS FOR , KNEE IMPLANTS AND THEIR COMPO-

NENTS; ENDOPROSTHESES, NAMELY, HIP PROSTHESES; METAPHYSICALLY ANCHORED HIP PROSTHESES AND THEIR COMPONENTS; ENDO-PROSTHETIC FIXTURES, NAMELY, AND SCREWS; HIP-JOINT, KNEE-JOINT, AND SHOULDER-JOINT IMPLANTS; PARTS AND FITTINGS FOR ALL THE AFORESAID GOODS, IN CLASS 10 (U.S. CLS. 26, 39 AND 44).

FIRST USE 1-1-2005; IN COMMERCE 8-1-2003.

PRIORITY CLAIMED UNDER SEC. 44(D) ON SWITZERLAND APPLICATION NO. 03871/2003, FILED 7-23-2003.

OWNER OF U.S. REG. NOS. 1,909,893, 2,494,600, AND OTHERS.

SN 78-282,282, FILED 8-1-2003.

CURTIS FRENCH, EXAMINING ATTORNEY

**Int. Cl.: 25**

**Prior U.S. Cls.: 22 and 39**

**United States Patent and Trademark Office**

**Reg. No. 3,395,676**

**Registered Mar. 11, 2008**

**TRADEMARK  
PRINCIPAL REGISTER**

**FIFTY-50**

ALLURA IMPORTS INC. (NEW YORK CORPORATION)  
112 WEST 34TH STREET  
NEW YORK, NY 10120

FOR: CLOTHING NAMELY, JEANS, SHIRTS, SKIRTS, DRESSES, HATS, BLOUSES, TOPS, PANTS, SHORTS, T-SHIRTS, SWEATSHIRTS, SWEAT-PANTS, SHORTS SETS, BATHING SUITS, TANK TOPS, MUSCLE SHIRTS, ATHLETIC JERSEYS,

GLOVES, MITTENS, AND HATS NOT INCLUDING SHOES, IN CLASS 25 (U.S. CLS. 22 AND 39).

FIRST USE 11-0-2003; IN COMMERCE 11-0-2003.

SN 78-288,548, FILED 8-18-2003.

ROSELLE HERRERA, EXAMINING ATTORNEY

**Int. Cl.: 39**

**Prior U.S. Cls.: 100 and 105**

**United States Patent and Trademark Office**

**Reg. No. 3,395,677**

**Registered Mar. 11, 2008**

**SERVICE MARK  
PRINCIPAL REGISTER**

**DIRECTRV**

CRITICAL MEDIA LLC (ARIZONA LTD LIAB  
CO)  
P.O. BOX 11385  
GLENDALE, AZ 853181385

FIRST USE 8-20-2007; IN COMMERCE 8-20-2007.

SN 78-291,315, FILED 8-22-2003.

FOR: PROVIDING AN ON-LINE COMPUTER  
DATABASE IN THE FIELD OF RECREATIONAL  
VEHICLE RENTALS, IN CLASS 39 (U.S. CLS. 100  
AND 105).

LEIGH CAROLINE CASE, EXAMINING ATTOR-  
NEY



**Int. Cl.: 7**

**Prior U.S. Cls.: 13, 19, 21, 23, 31, 34, and 35**

**Reg. No. 3,395,678**

**United States Patent and Trademark Office**

**Registered Mar. 11, 2008**

---

**TRADEMARK  
PRINCIPAL REGISTER**

**RIGHT LIGHT**

ATLAS MATERIAL TESTING TECHNOLOGY,  
L.L.C. (DELAWARE LTD LIAB CO)  
4114 N. RAVENSWOOD AVENUE  
CHICAGO, IL 60613

FIRST USE 5-22-2007; IN COMMERCE 5-22-2007.

SN 78-292,788, FILED 8-27-2003.

FOR: FILTERS FOR MACHINES THAT TEST  
WEATHER RESISTANCE, IN CLASS 7 (U.S. CLS.  
13, 19, 21, 23, 31, 34 AND 35).

MONIQUE MILLER, EXAMINING ATTORNEY

**Int. Cls.: 35 and 42**

**Prior U.S. Cls.: 100, 101, and 102**

**United States Patent and Trademark Office**

**Reg. No. 3,395,679**

**Registered Mar. 11, 2008**

**SERVICE MARK  
PRINCIPAL REGISTER**

**TOM FORD**

FORD, THOMAS C. (UNITED STATES INDIVIDUAL)  
2906 THOUSAND OAKS DRIVE  
AUSTIN, TX 78746

FOR: RETAIL BOUTIQUE STORE SERVICES AND RETAIL STORE AND MAIL ORDER SERVICES, FEATURING CLOTHING, ACCESSORIES, SHOES, NECKTIES, SCARVES, BELTS, FOOTWEAR, SHIRTS, SWEATERS, COATS, SUITS, DRESSING GOWNS, HATS, SOCKS, DRESSES AND BATHING SUITS; TECHNICAL CONSULTANCY AND ADVISING IN THE ESTABLISHMENT OF RETAIL BOUTIQUE STORES AND RETAIL STORES, FEATURING CLOTHING, ACCESSORIES, SHOES, NECKTIES, SCARVES, BELTS, FOOTWEAR, SHIRTS, SWEATERS, COATS, SUITS, DRESSING GOWNS, HATS, SOCKS, DRESSED AND BATHING SUITS, IN CLASS 35 (U.S. CLS. 100, 101 AND 102).

FIRST USE 4-12-2007; IN COMMERCE 4-12-2007.

FOR: DESIGN SERVICES FOR OTHERS IN THE FIELD OF CLOTHING; DESIGN SERVICES FOR OTHERS IN THE FIELD OF CLOTHING AND FASHION ACCESSORIES, IN CLASS 42 (U.S. CLS. 100 AND 101).

FIRST USE 4-12-2007; IN COMMERCE 4-12-2007.

THE NAME "TOM FORD" IDENTIFIES A LIVING INDIVIDUAL WHOSE CONSENT IS OF RECORD.

SN 78-296,023, FILED 9-4-2003.

MARY BOAGNI, EXAMINING ATTORNEY

**Int. Cl.: 30**

**Prior U.S. Cl.: 46**

**United States Patent and Trademark Office**

**Reg. No. 3,395,680**

**Registered Mar. 11, 2008**

**TRADEMARK  
PRINCIPAL REGISTER**

**SAN LORENZO**

CHIPURNOI INCORPORATED (NEW YORK  
CORPORATION)  
SHARON-ON-THE-GREEN  
SHARON, CT 06069

FIRST USE 11-30-2006; IN COMMERCE 4-30-2007.

SN 78-300,439, FILED 9-15-2003.

FOR: CANDY AND CONFECTIONERY PRO-  
DUCTS, NAMELY, COOKIES AND CAKES, IN  
CLASS 30 (U.S. CL. 46).

KARANENDRA S. CHHINA, EXAMINING ATTOR-  
NEY

**Int. Cl.: 6**

**Prior U.S. Cls.: 2, 12, 13, 14, 23, 25, and 50**

**United States Patent and Trademark Office**

**Reg. No. 3,395,681**

**Registered Mar. 11, 2008**

---

**TRADEMARK  
PRINCIPAL REGISTER**

**SAFE DOOR SYSTEMS**

GRIFFIN, JAMES PATRICK JR. (CANADA IN-  
DIVIDUAL)  
26 CRESCENTWOOD RD  
TORONTO, CANADA M1N 1E3

FOR: METAL REINFORCING PLATES FOR  
DOORS AND DOOR FRAMES OF HOME, COM-  
MERCIAL AND INDUSTRIAL BUILDINGS, IN  
CLASS 6 (U.S. CLS. 2, 12, 13, 14, 23, 25 AND 50).

FIRST USE 1-0-2002; IN COMMERCE 6-22-2002.

NO CLAIM IS MADE TO THE EXCLUSIVE  
RIGHT TO USE "DOOR SYSTEMS", APART FROM  
THE MARK AS SHOWN.

SN 78-301,128, FILED 9-16-2003.

CURTIS FRENCH, EXAMINING ATTORNEY

**Int. Cl.: 43**

**Prior U.S. Cls.: 100 and 101**

**United States Patent and Trademark Office**

**Reg. No. 3,395,682**

**Registered Mar. 11, 2008**

**SERVICE MARK  
PRINCIPAL REGISTER**

**JAMES CLUB**

J.H. NEVADA INC. (NEVADA CORPORATION)  
C/O JAMES HOTEL SCOTTSDALE, LLC  
450 WEST 15 STREET, 5 FL.  
NEW YORK, NY 10011

FIRST USE 3-17-2006; IN COMMERCE 3-17-2006.

NO CLAIM IS MADE TO THE EXCLUSIVE  
RIGHT TO USE "CLUB", APART FROM THE MARK  
AS SHOWN.

FOR: HOTEL AND HEALTH RESORT SERVICES,  
NAMELY, PROVIDING FOOD AND LODGING  
THAT SPECIALIZE IN PROMOTING PATRONS'  
GENERAL HEALTH AND WELL-BEING, IN CLASS  
43 (U.S. CLS. 100 AND 101).

SN 78-304,610, FILED 9-24-2003.

BARBARA GAYNOR, EXAMINING ATTORNEY

**Int. Cl.: 9**

**Prior U.S. Cls.: 21, 23, 26, 36, and 38**

**United States Patent and Trademark Office**

**Reg. No. 3,395,683**

**Registered Mar. 11, 2008**

**TRADEMARK  
PRINCIPAL REGISTER**

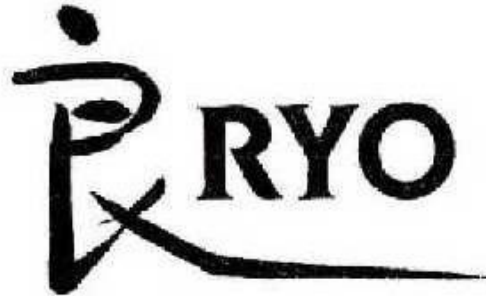

RYO LIMITED (HONG KONG CORPORATION)  
FLAT E, 7TH FLOOR  
SUN FAI COMMERCIAL BLDG.576 RECLAMA-  
TION STREET576 RECLAMATION STREET  
MONGKOK KOWLOON, HONG KONG

FOR: PORTABLE, PROGRAMMABLE ELECTRO-  
NIC DIARIES AND CALCULATORS, IN CLASS 9  
(U.S. CLS. 21, 23, 26, 36 AND 38).

FIRST USE 3-31-2004; IN COMMERCE 3-31-2004.

THE DESIGN FEATURE IN THE MARK CON-  
SISTS OF A STYLIZED LETTER "R."

SN 78-308,066, FILED 10-1-2003.

STEVEN R. FINE, EXAMINING ATTORNEY

**Int. Cl.: 36**

**Prior U.S. Cls.: 100, 101, and 102**

**United States Patent and Trademark Office**

**Reg. No. 3,395,684**

**Registered Mar. 11, 2008**

---

**SERVICE MARK  
PRINCIPAL REGISTER**

**RETIREMENT QUOTIENT**

SCHWEGMANN, PHILLIP, A. (UNITED STATES  
INDIVIDUAL)  
PHELPHS BUILDING  
506 EAST 4TH STREET  
CINCINNATI, OH 45202

NO CLAIM IS MADE TO THE EXCLUSIVE  
RIGHT TO USE "RETIREMENT", APART FROM  
THE MARK AS SHOWN.

FOR: FINANCIAL PLANNING, IN CLASS 36 (U.S.  
CLS. 100, 101 AND 102).

SN 78-310,440, FILED 10-7-2003.

FIRST USE 8-0-1993; IN COMMERCE 1-0-2005.

DORITT L. CARROLL, EXAMINING ATTORNEY

**Int. Cl.: 25**

**Prior U.S. Cls.: 22 and 39**

**United States Patent and Trademark Office**

**Reg. No. 3,395,685**

**Registered Mar. 11, 2008**

**TRADEMARK  
PRINCIPAL REGISTER**

**KINOBI**

KABUSHIKI KAISHA MONTBELL (JAPAN CORPORATION)  
33-20 SHINMACHI 1-CHOME, NISHI-KU  
OSAKA, JAPAN

FOR: MEN'S, WOMEN'S AND CHILDREN'S CLOTHING, NAMELY, JACKETS, INSULATED JACKETS, COATS, RAINWEAR, SHIRTS, SLEEVELESS SHIRTS, T-SHIRTS, POLO SHIRTS, LONG SLEEVE SHIRTS, SWEAT SHIRTS, PULLOVERS, SWEATERS, VESTS, PARKAS, PANTS, SHORT PANTS, KNICKERS, LONG PANTS, SPATS, INSULATED PANTS, OVERALLS, TIGHTS, SHORTS, ONE-PIECE EXPEDITION SUITS, ONE-PIECE SUITS FOR OUTERWEAR, UNDERWEAR, WATERPROOF CLOTHING, NAMELY, JACKETS, COATS, RAINWEAR SHIRTS, PANTS, PULLOVERS, SWEATERS, VESTS, PARKAS, PONCHOS; CLOTHING FOR CAMPING AND OUTDOOR ACTIVITIES, NAMELY,

TURTLENECKS, MANTELS, PONCHOS; FOOTWEAR, FOOTWEAR SOLD IN SPORTING GOODS AND GYMNASTICS STORES, BOOTS, SANDALS, SOCKS; HEADGEAR, NAMELY, HATS, CAPS; HAT BANDS, HEAD BANDS, NECK BANDS, WRIST BANDS, SWEAT BANDS; GAITERS, BALACLAVAS, SCARVES, SUSPENDERS, GLOVES, MITTENS, MUFFLERS; PLASTIC BABY BIBS AND PLASTIC SKI BIBS, IN CLASS 25 (U.S. CLS. 22 AND 39).

FIRST USE 2-0-1990; IN COMMERCE 2-0-1990.

THE ENGLISH TRANSLATION OF THE WORDING "KINOBI" IS "FUNCTIONAL BEAUTY".

SN 78-314,831, FILED 10-16-2003.

SUSAN STIGLITZ, EXAMINING ATTORNEY



**Int. Cl.: 16**

**Prior U.S. Cls.: 2, 5, 22, 23, 29, 37, 38, and 50**

**United States Patent and Trademark Office**

**Reg. No. 3,395,686**

**Registered Mar. 11, 2008**

**TRADEMARK  
PRINCIPAL REGISTER**

**ADVICE YOU CAN TRUST**

PHILLIPS-VAN BUREN, INC. (DELAWARE CORPORATION)  
1880 CENTURY PARK EAST, SUITE 1400  
LOS ANGELES, CA 90067

FOR: PRINTED PUBLICATIONS, NAMELY, ARTICLES, CIRCULARS, COLUMNS, MAGAZINES, NEWSLETTERS, CALENDARS AND PAMPHLETS FEATURING INFORMATION REGARDING CAREER, ETIQUETTE, WORKPLACE ISSUES, GOAL SETTING, HEALTH ISSUES, NAMELY, SEXUALITY, SELF-CONFIDENCE, SELF-ESTEEM, FITNESS, DIET, EXERCISE, THERAPY, BODY IMAGE, DRUGS, ALCOHOL, SUBSTANCE ABUSE, SOBRIETY, PUBERTY, RELATIONSHIPS, NAMELY, LEADERSHIP, CITIZENSHIP, INTERNET DATING, SINGLES, FAMILY, SIBLINGS, CARE GIVING, ELDERLY, SINGLE MOTHERS AND FATHERS, BLENDED FAMILIES, WEDDINGS, FRIENDSHIP, INCEST, RACISM, DOMESTIC VIOLENCE, SUPPORT FOR FAMILIES OF PRISONERS, SURVIVING DIVORCE, SEX, GAY RIGHTS, EFFECTIVE COM-

MUNICATION, ACTS OF KINDNESS, ADOPTION, EMPOWERING MEN AND WOMEN, COPING WITH TRAUMA, FUNERAL MATTERS, CRISIS MANAGEMENT, DEATH, HOLIDAY COPING, GRIEF, LIFE AND DEATH, FINANCE, NAMELY, MONEY, SAVINGS, INVESTMENTS, CREDIT, DEBT, COLLEGE, TRAVEL, CULTURES AND RELIGION, GRAMMAR, FRAUD, URBAN LEGENDS, PET CARE AND SAFETY, TRIBUTES, VIOLENCE, SAFETY, ENTERTAINING, LETTERS, CORRESPONDENCE, BOOKS, SOCIALIZING, ORGANIZATION, HOUSEHOLD MANAGEMENT, COOKING, RECIPES, PERSONAL GROWTH, STUDENTS AND SCHOOL, IN CLASS 16 (U.S. CLS. 2, 5, 22, 23, 29, 37, 38 AND 50).

FIRST USE 3-6-2007; IN COMMERCE 3-6-2007.

SN 78-317,306, FILED 10-22-2003.

IRA J. GOODSaid, EXAMINING ATTORNEY

**Int. Cl.: 41**

**Prior U.S. Cls.: 100, 101, and 107**

**United States Patent and Trademark Office**

**Reg. No. 3,395,687**

**Registered Mar. 11, 2008**

**SERVICE MARK  
PRINCIPAL REGISTER**

**APOLLO THEATRE**

THE APOLLO THEATRE FOUNDATION, INC.  
(NEW YORK NON-PROFIT CORPORATION)  
253 WEST 125TH STREET  
NEW YORK, NY 10027

OWNER OF U.S. REG. NO. 2,652,642.

FOR: ENTERTAINMENT SERVICES IN THE  
NATURE OF STAGING LIVE PERFORMANCES  
FEATURING MUSIC, SINGING, DRAMA, COME-  
DY, DANCE, THE SPOKEN WORD , IN CLASS 41  
(U.S. CLS. 100, 101 AND 107).

NO CLAIM IS MADE TO THE EXCLUSIVE  
RIGHT TO USE "THEATRE", APART FROM THE  
MARK AS SHOWN.

SN 78-321,460, FILED 10-31-2003.

FIRST USE 12-31-1914; IN COMMERCE 12-31-1914.

KIMBERLY FRYE, EXAMINING ATTORNEY

**Int. Cl.: 1**

**Prior U.S. Cls.: 1, 5, 6, 10, 26, and 46**

**United States Patent and Trademark Office**

**Reg. No. 3,395,688**

**Registered Mar. 11, 2008**

---

**TRADEMARK  
PRINCIPAL REGISTER**

**KINEMED**

KINEMED, INC. (DELAWARE CORPORATION)  
5980 HORTON STREET, SUITE 400  
EMERYVILLE, CA 946082012

FIRST USE 11-1-2003; IN COMMERCE 11-1-2003.

SN 78-321,776, FILED 10-31-2003.

FOR: DIAGNOSTIC PREPARATIONS FOR SCIENTIFIC OR RESEARCH USE, IN CLASS 1 (U.S. CLS. 1, 5, 6, 10, 26 AND 46).

JAMES A. RAUEN, EXAMINING ATTORNEY

**Int. Cl.: 19**

**Prior U.S. Cls.: 1, 12, 33, and 50**

**United States Patent and Trademark Office**

**Reg. No. 3,395,689**

**Registered Mar. 11, 2008**

---

**TRADEMARK  
PRINCIPAL REGISTER**

**TUFDEK**

TUFF INDUSTRIES INC. (CANADA CORPORATION)  
1939 KIRSCHNER ROAD  
KELOWNA, BRITISH COLUMBIA, CANADA V1T  
7X8

PRIORITY CLAIMED UNDER SEC. 44(D) ON  
CANADA APPLICATION NO. 1194570, FILED 10-22-  
2003, REG. NO. TMA632,136, DATED 2-7-2005, EX-  
PIRES 2-7-2020.

FOR: EXTERIOR VINYL FLOORING AND ROOF-  
ING, IN CLASS 19 (U.S. CLS. 1, 12, 33 AND 50).

SN 78-323,070, FILED 11-4-2003.

FIRST USE 10-10-2007; IN COMMERCE 10-10-2007.

RICHARD WHITE, EXAMINING ATTORNEY

**Int. Cl.: 9**

**Prior U.S. Cls.: 21, 23, 26, 36, and 38**

**United States Patent and Trademark Office**

**Reg. No. 3,395,690**

**Registered Mar. 11, 2008**

**TRADEMARK  
PRINCIPAL REGISTER**

**PROWORKS**

DELAWARE CAPITAL FORMATION, INC. (DE-  
LAWARE CORPORATION)  
501 SILVERSIDE ROAD, SUITE 5  
WILMINGTON, DE 19809

FOR: COMPUTER SOFTWARE PROGRAM FOR  
DOCUMENTING, INSTRUCTING AND REPORT-  
ING PROCESS-RELATED INFORMATION AND  
DATA FOR A SEQUENCE OF PROCESSING STEPS,  
EXCLUSIVE OF PROGRAMMED OPERATIONAL  
CONTROL OVER SYSTEM HARDWARE, IN CLASS  
9 (U.S. CLS. 21, 23, 26, 36 AND 38).

FIRST USE 9-7-2007; IN COMMERCE 9-7-2007.

THE MARK CONSISTS OF STANDARD CHAR-  
ACTERS WITHOUT CLAIM TO ANY PARTICULAR  
FONT, STYLE, SIZE, OR COLOR.

SN 78-324,795, FILED 11-7-2003.

CHRIS WELLS, EXAMINING ATTORNEY

**Int. Cl.: 3**

**Prior U.S. Cls.: 1, 4, 6, 50, 51, and 52**

**United States Patent and Trademark Office**

**Reg. No. 3,395,691**

**Registered Mar. 11, 2008**

**TRADEMARK  
PRINCIPAL REGISTER**

**NANOGENIC  
TECHNOLOGY**

PHARMWEST, INC. (NEVADA CORPORATION)  
46410 ADMIRALTY WAY, SUITE 423  
MARINA DEL REY, CA 90292

FOR: COSMETICS AND NON-MEDICATED SKIN  
CARE PREPARATIONS, IN CLASS 3 (U.S. CLS. 1, 4, 6,  
50, 51 AND 52).

FIRST USE 11-5-2007; IN COMMERCE 11-5-2007.

THE MARK CONSISTS OF STANDARD CHAR-  
ACTERS WITHOUT CLAIM TO ANY PARTICULAR  
FONT, STYLE, SIZE, OR COLOR.

NO CLAIM IS MADE TO THE EXCLUSIVE  
RIGHT TO USE "TECHNOLOGY", APART FROM  
THE MARK AS SHOWN.

SN 78-326,967, FILED 11-12-2003.

JANICE L. MCMORROW, EXAMINING ATTOR-  
NEY

**Int. Cls.: 16, 39, and 43**

**Prior U.S. Cls.: 2, 5, 22, 23, 29, 37, 38, 50, 100, 101, and 105**

**Reg. No. 3,395,692**

**United States Patent and Trademark Office**

**Registered Mar. 11, 2008**

**TRADEMARK  
SERVICE MARK  
PRINCIPAL REGISTER**

**TED**

UNITED AIR LINES, INC. (DELAWARE CORPORATION)  
1200 EAST ALGONQUIN ROAD  
ELK GROVE TOWNSHIP, IL 60007

FOR: PRINTED MATTER AND PUBLICATIONS, NAMELY, NEWSLETTERS AND MAGAZINES PERTAINING TO TRAVEL AND TRANSPORTATION; PAPER IDENTIFICATION CARDS AND TAGS; PAMPHLETS, BROCHURES, PRINTED TICKETS AND COUPONS IN RELATION TO AIRLINE SERVICES AND TRAVEL RESERVATION SERVICES, IN CLASS 16 (U.S. CLS. 2, 5, 22, 23, 29, 37, 38 AND 50).

FIRST USE 11-6-2003; IN COMMERCE 2-12-2004.

FOR: TRANSPORTATION OF PERSONS, PROPERTY AND MAIL BY AIR; TRAVEL AGENCY SERVICES, NAMELY, MAKING RESERVATIONS, BOOKINGS AND ARRANGEMENTS FOR TRAVEL AND TRANSPORTATION; AIRLINE TRANSPORTATION SERVICES FEATURING LOUNGE SERVICES FOR AIR TRAVELERS, IN CLASS 39 (U.S. CLS. 100 AND 105).

FIRST USE 11-6-2003; IN COMMERCE 2-12-2004.

FOR: TRAVEL SERVICES, NAMELY, MAKING RESERVATIONS AND BOOKINGS FOR TEMPORARY LODGING FOR OTHERS, IN CLASS 43 (U.S. CLS. 100 AND 101).

FIRST USE 11-6-2003; IN COMMERCE 2-12-2004.

THE MARK CONSISTS OF STANDARD CHARACTERS WITHOUT CLAIM TO ANY PARTICULAR FONT, STYLE, SIZE, OR COLOR.

PRIORITY CLAIMED UNDER SEC. 44(D) ON FED REP GERMANY APPLICATION NO. 30352502.9, FILED 10-10-2003.

SN 78-327,626, FILED 11-13-2003.

MARK RADEMACHER, EXAMINING ATTORNEY

**Int. Cl.: 16**

**Prior U.S. Cls.: 2, 5, 22, 23, 29, 37, 38, and 50**

**Reg. No. 3,395,693**

**United States Patent and Trademark Office**

**Registered Mar. 11, 2008**

**TRADEMARK  
PRINCIPAL REGISTER**

**Glyphco**

HAWKINS, JACQUELINE MACKENZIE (UNI-  
TED STATES INDIVIDUAL)  
401 OLD CHURCH ROAD  
GREENWICH, CT 06830

THE MARK CONSISTS OF STANDARD CHAR-  
ACTERS WITHOUT CLAIM TO ANY PARTICULAR  
FONT, STYLE, SIZE, OR COLOR.

FOR: CHILDREN'S BOOKS, IN CLASS 16 (U.S.  
CLS. 2, 5, 22, 23, 29, 37, 38 AND 50).

SN 78-329,195, FILED 11-17-2003.

FIRST USE 11-8-2007; IN COMMERCE 11-8-2007.

AMY HELLA, EXAMINING ATTORNEY



**Int. Cl.: 9**

**Prior U.S. Cls.: 21, 23, 26, 36, and 38**

**United States Patent and Trademark Office**

**Reg. No. 3,395,694**

**Registered Mar. 11, 2008**

**TRADEMARK  
PRINCIPAL REGISTER**

**BINASEC**

SMITH, CHARLES (UNITED STATES INDIVIDUAL)  
75 MERRYDALE ROAD  
SAN RAFAEL, CA 949034046

THE MARK CONSISTS OF STANDARD CHARACTERS WITHOUT CLAIM TO ANY PARTICULAR FONT, STYLE, SIZE, OR COLOR.

FOR: DESKTOP COMPUTERS, LAPTOPS, NOTEBOOKS, AND PERIPHERALS, IN CLASS 9 (U.S. CLS. 21, 23, 26, 36 AND 38).

SN 78-329,373, FILED 11-18-2003.

FIRST USE 1-1-2003; IN COMMERCE 7-1-2005.

RONALD MCMORROW, EXAMINING ATTORNEY

**Int. Cl.: 29**

**Prior U.S. Cl.: 46**

**United States Patent and Trademark Office**

**Reg. No. 3,395,695**

**Registered Mar. 11, 2008**

**TRADEMARK  
PRINCIPAL REGISTER**



QUANTUM FOODS, LLC (DELAWARE LTD  
LIAB CO)  
750 SOUTH SCHMIDT ROAD  
BOLINGBROOK, IL 60440

FOR: FULLY COOKED ENTREES CONSISTING  
PRIMARILY OF MEAT, POULTRY, OR SEAFOOD,  
IN CLASS 29 (U.S. CL. 46).

FIRST USE 3-15-2004; IN COMMERCE 3-15-2004.

OWNER OF U.S. REG. NO. 2,818,886.

NO CLAIM IS MADE TO THE EXCLUSIVE  
RIGHT TO USE "GOURMET ORIENTAL CLAS-  
SICS", APART FROM THE MARK AS SHOWN.

THE MARK CONSISTS OF WORDS "SIMPLY  
GOURMET" WITH A HEART DOTTING THE "I,"  
UNDERLINED, OVER AN OVAL ALSO CONTAIN-  
ING THE DESIGN OF AN OVEN WITH A WAVY  
LINE TO THE LEFT AND DIRECTED UPWARDS  
TO INDICATE HEAT, APPEARING TO THE LEFT  
AND ABOVE THE WORDING "ORIENTAL CLAS-  
SICS" APPEARING IN A CURVED LINE.

SN 78-330,282, FILED 11-19-2003.

JASON TURNER, EXAMINING ATTORNEY

**Int. Cl.: 14**

**Prior U.S. Cls.: 2, 27, 28, and 50**

**United States Patent and Trademark Office**

**Reg. No. 3,395,696**

**Registered Mar. 11, 2008**

**TRADEMARK  
PRINCIPAL REGISTER**

**BRIGHTFIRE**

MARTIN, RAPAPORT (UNITED STATES INDIVIDUAL)  
133 E.WARM SPRINGS ROAD  
LAS VEGAS, NV 89119

THE MARK CONSISTS OF STANDARD CHARACTERS WITHOUT CLAIM TO ANY PARTICULAR FONT, STYLE, SIZE, OR COLOR.

FOR: JEWELRY, DIAMONDS, PRECIOUS GEMSTONES, SEMI-PRECIOUS GEMSTONES, PRECIOUS GEMS, SEMI-PRECIOUS GEMS AND WATCHES, IN CLASS 14 (U.S. CLS. 2, 27, 28 AND 50).

SN 78-332,763, FILED 11-25-2003.

FIRST USE 11-22-2007; IN COMMERCE 11-22-2007.

REBECCA SMITH, EXAMINING ATTORNEY

**Int. Cl.: 21**

**Prior U.S. Cls.: 2, 13, 23, 29, 30, 33, 40, and 50**

**United States Patent and Trademark Office**

**Reg. No. 3,395,697**

**Registered Mar. 11, 2008**

**TRADEMARK  
PRINCIPAL REGISTER**

**HBII-CLEAR**

ENGINEERED GLASS PRODUCTS, LLC (DELA-  
WARE LTD LIAB CO)  
2857 SOUTH HALSTED STREET  
CHICAGO, IL 60608

FOR: HEAT REFLECTIVE GLASS FOR USE IN  
VIEWING AREAS IN COMMERCIAL OVENS AND  
COMMERCIAL MICROWAVE OVENS, COMMER-  
CIAL REFRIGERATORS AND FREEZERS, AND  
FOR USE IN HOUSEHOLD OVENS AND HOUSE-  
HOLD MICROWAVE OVENS, IN CLASS 21 (U.S.  
CLS. 2, 13, 23, 29, 30, 33, 40 AND 50).

FIRST USE 7-30-2007; IN COMMERCE 7-30-2007.

THE MARK CONSISTS OF STANDARD CHAR-  
ACTERS WITHOUT CLAIM TO ANY PARTICULAR  
FONT, STYLE, SIZE, OR COLOR.

OWNER OF U.S. REG. NOS. 2,424,545 AND  
2,426,202.

SN 78-332,931, FILED 11-25-2003.

NAAKWAMA ANKRAH, EXAMINING ATTORNEY

Int. Cl.: 9

Prior U.S. Cls.: 21, 23, 26, 36, and 38

Reg. No. 3,395,698

United States Patent and Trademark Office

Registered Mar. 11, 2008

TRADEMARK  
PRINCIPAL REGISTER

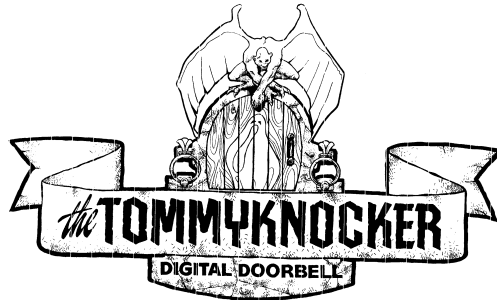

STEINETZ, SCOTT (UNITED STATES INDIVIDUAL)  
29 TRACEY LANE  
SPARTA, NJ 07871

NO CLAIM IS MADE TO THE EXCLUSIVE RIGHT TO USE "DIGITAL DOORBELL", APART FROM THE MARK AS SHOWN.

FOR: ELECTRIC DOORBELLS, IN CLASS 9 (U.S. CLS. 21, 23, 26, 36 AND 38).

SN 78-333,104, FILED 11-25-2003.

FIRST USE 4-21-2004; IN COMMERCE 4-21-2004.

ELLEN B. AWRICH, EXAMINING ATTORNEY

**Int. Cl.: 25**

**Prior U.S. Cls.: 22 and 39**

**United States Patent and Trademark Office**

**Reg. No. 3,395,699**

**Registered Mar. 11, 2008**

**TRADEMARK  
PRINCIPAL REGISTER**

**GothSpeed**

FRAGOSO, OSCAR L (UNITED STATES INDIVIDUAL)  
2222 ROSWELL AVENUE  
LONG BEACH, CA 90815

FOR: SHIRTS, PANTS, SHOES, JACKETS, HATS, HELMETS, BOOTS, AND GLOVES, IN CLASS 25 (U.S. CLS. 22 AND 39).

FIRST USE 9-1-2004; IN COMMERCE 11-12-2007.

THE MARK CONSISTS OF STANDARD CHARACTERS WITHOUT CLAIM TO ANY PARTICULAR FONT, STYLE, SIZE, OR COLOR.

SN 78-337,381, FILED 12-5-2003.

KARANENDRA S. CHHINA, EXAMINING ATTORNEY

**Int. Cl.: 9**

**Prior U.S. Cls.: 21, 23, 26, 36, and 38**

**Reg. No. 3,395,700**

**United States Patent and Trademark Office**

**Registered Mar. 11, 2008**

---

**TRADEMARK  
PRINCIPAL REGISTER**

**SPECTRAPULSE**

AUDIO-TECHNICA U.S., INC. (DELAWARE  
CORPORATION)  
1221 COMMERCE DRIVE  
STOW, OH 44224

THE MARK CONSISTS OF STANDARD CHAR-  
ACTERS WITHOUT CLAIM TO ANY PARTICULAR  
FONT, STYLE, SIZE, OR COLOR.

FOR: AUDIO AND DATA TRANSDUCER  
TRANSRECEIVERS, IN CLASS 9 (U.S. CLS. 21, 23,  
26, 36 AND 38).

SN 78-337,738, FILED 12-8-2003.

FIRST USE 10-0-2007; IN COMMERCE 10-0-2007.

KIM SAITO, EXAMINING ATTORNEY

**Int. Cl.: 41**

**Prior U.S. Cls.: 100, 101, and 107**

**United States Patent and Trademark Office**

**Reg. No. 3,395,701**

**Registered Mar. 11, 2008**

**SERVICE MARK  
PRINCIPAL REGISTER**

**MONEY BUNNY**

GAMELOGIC INC. (DELAWARE CORPORATION)  
SUITE 312  
411 WAVERLY OAKS ROAD  
WALTHAM, MA 02452

FOR: ENTERTAINMENT SERVICES, NAMELY,  
CONDUCTING INTERACTIVE GAMES VIA THE  
INTERNET, IN CLASS 41 (U.S. CLS. 100, 101 AND  
107).

FIRST USE 11-30-2007; IN COMMERCE 11-30-2007.

THE MARK CONSISTS OF STANDARD CHARACTERS WITHOUT CLAIM TO ANY PARTICULAR FONT, STYLE, SIZE, OR COLOR.

SN 78-338,922, FILED 12-10-2003.

TARAH HARDY, EXAMINING ATTORNEY



**Int. Cls.: 1 and 5**

**Prior U.S. Cls.: 1, 5, 6, 10, 18, 26, 44, 46, 51, and 52**

**United States Patent and Trademark Office**

**Reg. No. 3,395,702**

**Registered Mar. 11, 2008**

**TRADEMARK  
PRINCIPAL REGISTER**

# Diversity Navigator

BIOVENTURES, INC. (DELAWARE CORPORATION)

1435 KENSINGTON SQUARE COURT  
MURFREESBORO, TN 37130

FOR: REAGENTS FOR USE IN GENETIC, MEDICAL AND SCIENTIFIC ANALYSIS AND RESEARCH, NAMELY ANALYZING, DETECTING, QUANTIFYING AND SEQUENCING POLYPEPTIDES AND POLYNUCLEOTIDES, INCLUDING POLYPEPTIDE VARIANTS, POLYNUCLEOTIDE VARIANTS, GENETIC MUTATIONS, SINGLE NUCLEOTIDE POLYMORPHISMS, HAPLOTYPES AND HETEROZYGOSITY AND FOR USE IN IDENTIFYING DISEASES; ASSAYS AND KITS COMPRISED PRIMARILY OF REAGENTS, WITH OR WITHOUT REAGENT CARRIERS, FOR USE IN GENETIC, MEDICAL AND SCIENTIFIC ANALYSIS AND RESEARCH FOR ANALYZING, DETECTING, QUANTIFYING AND SEQUENCING POLYPEPTIDES AND POLYNUCLEOTIDES, INCLUDING POLYPEPTIDE VARIANTS, POLYNUCLEOTIDE VARIANTS, GENETIC MUTATIONS, SINGLE NUCLEOTIDE POLYMORPHISMS, HAPLOTYPES AND HETEROZYGOSITY AND FOR USE IN IDENTIFYING DISEASES; REAGENTS FOR USE IN MEDICAL RESEARCH, NAMELY ANALYZING, DETECTING, QUANTIFYING AND SEQUENCING POLYPEPTIDES AND POLYNUCLEOTIDES, INCLUDING POLYPEPTIDE VARIANTS, POLYNUCLEOTIDE VARIANTS, GENETIC MUTATIONS, SINGLE NUCLEOTIDE POLYMORPHISMS, HAPLOTYPES AND HETEROZYGOSITY AND FOR USE IN IDENTIFYING DISEASES; ASSAYS AND KITS COMPRISED PRIMARILY OF REAGENTS, WITH OR WITHOUT REAGENT CARRIERS, FOR USE IN

MEDICAL RESEARCH FOR ANALYZING, DETECTING, QUANTIFYING AND SEQUENCING POLYPEPTIDES AND POLYNUCLEOTIDES, INCLUDING POLYPEPTIDE VARIANTS, POLYNUCLEOTIDE VARIANTS, GENETIC MUTATIONS, SINGLE NUCLEOTIDE POLYMORPHISMS, HAPLOTYPES AND HETEROZYGOSITY AND FOR USE IN IDENTIFYING DISEASES, IN CLASS 1 (U.S. CLS. 1, 5, 6, 10, 26 AND 46).

FIRST USE 8-31-2003; IN COMMERCE 8-31-2003.

FOR: REAGENTS CONSISTING OF FLUORESCENT LABELED POLYNUCLEOTIDE SEQUENCES FOR DETECTION OF GENETIC MATERIALS, FOR CLINICAL OR MEDICAL LABORATORY USE; REAGENTS FOR USE IN MEDICAL ANALYSIS, NAMELY ANALYZING, DETECTING, QUANTIFYING AND SEQUENCING POLYPEPTIDES AND POLYNUCLEOTIDES, INCLUDING POLYPEPTIDE VARIANTS, POLYNUCLEOTIDE VARIANTS, GENETIC MUTATIONS, SINGLE NUCLEOTIDE POLYMORPHISMS, HAPLOTYPES AND HETEROZYGOSITY AND FOR USE IN IDENTIFYING DISEASES; ASSAYS AND KITS COMPRISED PRIMARILY OF REAGENTS, WITH OR WITHOUT REAGENT CARRIERS, FOR USE IN MEDICAL ANALYSIS FOR ANALYZING, DETECTING, QUANTIFYING AND SEQUENCING POLYPEPTIDES AND POLYNUCLEOTIDES, INCLUDING POLYPEPTIDE VARIANTS, POLYNUCLEOTIDE VARIANTS, GENETIC MUTATIONS, SINGLE NUCLEOTIDE POLYMORPHISMS, HAPLOTYPES AND HETEROZYGOSITY AND FOR USE IN IDENTIFYING DISEASES, IN CLASS 5 (U.S. CLS. 6, 18, 44, 46, 51 AND 52).

FIRST USE 8-31-2003; IN COMMERCE 8-31-2003.

THE MARK CONSISTS OF STANDARD CHARACTERS WITHOUT CLAIM TO ANY PARTICULAR FONT, STYLE, SIZE, OR COLOR.

OWNER OF U.S. REG. NOS. 2,677,599, 2,688,366, AND 2,841,595.

SN 78-349,047, FILED 1-7-2004.

SUE LAWRENCE, EXAMINING ATTORNEY

**Int. Cl.: 36**

**Prior U.S. Cls.: 100, 101, and 102**

**United States Patent and Trademark Office**

**Reg. No. 3,395,703**

**Registered Mar. 11, 2008**

**SERVICE MARK  
PRINCIPAL REGISTER**

**HOG WILD FOR KIDS**

SAN DIEGO HARLEY DAVIDSON CO., INC.  
(CALIFORNIA CORPORATION)  
C/O APRIL WURSTER  
12544 HIGH BLUFF DR.  
SAN DIEGO, CA 92130

THE MARK CONSISTS OF STANDARD CHARACTERS WITHOUT CLAIM TO ANY PARTICULAR FONT, STYLE, SIZE, OR COLOR.

FOR: CHARITABLE FUND-RAISING SERVICES,  
IN CLASS 36 (U.S. CLS. 100, 101 AND 102).

SN 78-351,453, FILED 1-13-2004.

FIRST USE 7-25-2007; IN COMMERCE 7-25-2007.

CAROLINE WOOD, EXAMINING ATTORNEY

**Int. Cl.: 12**

**Prior U.S. Cls.: 19, 21, 23, 31, 35, and 44**

**United States Patent and Trademark Office**

**Reg. No. 3,395,704**

**Registered Mar. 11, 2008**

**TRADEMARK  
PRINCIPAL REGISTER**

# WORLDPARTS

BECK/ARNLEY WORLDPARTS CORPORATION  
(DELAWARE CORPORATION)  
2375 MIDWAY LANE  
SMYRNA, TN 371675881

FOR: VEHICLE PARTS AND ACCESSORIES, NAMELY, TRANSMISSION FILTERS, WHEEL BEARING SPACERS, COLLARS, AND LOCK RINGS, CLUTCHES, CLUTCH DISCS, CLUTCH RELEASE BEARINGS, PRESSURE PLATES, FLY-WHEEL RING GEARS, TRANSMISSION MODULATORS, HYDRAULIC CLUTCH AND BRAKE CYLINDERS, BRAKE MASTER CYLINDERS, BRAKE CALIPERS AND CALIPER PISTONS, BRAKE SHOES, BRAKE PADS, BRAKE DISCS, BRAKE DRUMS, BRAKE HARDWARE, SHIMS AND ADJUSTERS, CLUTCH CABLES, BRAKE CABLES, ACCELERATOR AND CHOKE CABLES, HEATER AND HOOD RELEASE CABLES, UNIVER-

SAL JOINTS, CONSTANT VELOCITY JOINTS AND BOOTS, STEERING RACK AND BOOTS, TRANSMISSION MOUNTS, DRIVE SHAFTS, STEERING RACK PUMPS, SHOCK ABSORBERS; FUEL TANK CAPS, WIPER ARMS AND BLADES, WASHER PUMPS, WIPER MOTORS, IN CLASS 12 (U.S. CLS. 19, 21, 23, 31, 35 AND 44).

FIRST USE 9-1-1972; IN COMMERCE 9-1-1972.

THE MARK CONSISTS OF STANDARD CHARACTERS WITHOUT CLAIM TO ANY PARTICULAR FONT, STYLE, SIZE, OR COLOR.

SN 78-357,426, FILED 1-26-2004.

DAVID TAYLOR, EXAMINING ATTORNEY

**Int. Cl.: 25**

**Prior U.S. Cls.: 22 and 39**

**United States Patent and Trademark Office**

**Reg. No. 3,395,705**

**Registered Mar. 11, 2008**

**TRADEMARK  
PRINCIPAL REGISTER**

**GENUINE WRANGLER**

WRANGLER APPAREL CORP. (DELAWARE  
CORPORATION)  
3411 SILVERSIDE ROAD  
WILMINGTON, DE 19810

FOR: JEANS AND CASUAL PANTS, IN CLASS 25  
(U.S. CLS. 22 AND 39).

FIRST USE 6-29-2004; IN COMMERCE 6-29-2004.

THE MARK CONSISTS OF STANDARD CHAR-  
ACTERS WITHOUT CLAIM TO ANY PARTICULAR  
FONT, STYLE, SIZE, OR COLOR.

OWNER OF U.S. REG. NOS. 441,727, 2,575,862,  
AND OTHERS.

NO CLAIM IS MADE TO THE EXCLUSIVE  
RIGHT TO USE "GENUINE", APART FROM THE  
MARK AS SHOWN.

SN 78-361,444, FILED 2-3-2004.

TOBY BULLOFF, EXAMINING ATTORNEY

**Int. Cl.: 14**

**Prior U.S. Cls.: 2, 27, 28, and 50**

**United States Patent and Trademark Office**

**Reg. No. 3,395,706**

**Registered Mar. 11, 2008**

**TRADEMARK  
PRINCIPAL REGISTER**

**GEAR ON ASSIGNMENT**

NATIONAL GEOGRAPHIC SOCIETY (D.C. CORPORATION)  
1145 17TH STREET, N.W.  
WASHINGTON, DC 20036

FOR: WATCHES, IN CLASS 14 (U.S. CLS. 2, 27, 28 AND 50).

FIRST USE 8-30-2007; IN COMMERCE 8-30-2007.

THE MARK CONSISTS OF STANDARD CHARACTERS WITHOUT CLAIM TO ANY PARTICULAR FONT, STYLE, SIZE, OR COLOR.

OWNER OF U.S. REG. NOS. 1,601,445 AND 2,571,216.

SN 78-374,376, FILED 2-26-2004.

CHERYL CLAYTON, EXAMINING ATTORNEY

Int. Cl.: 41

Prior U.S. Cls.: 100, 101, and 107

United States Patent and Trademark Office

Reg. No. 3,395,707

Registered Mar. 11, 2008

SERVICE MARK  
PRINCIPAL REGISTER



ELAINE RENE PRODUCTIONS, LLC (CALIFORNIA LTD LIAB CO)  
6644 LEMONA AVENUE  
VAN NUYS, CA 91405

FOR: PRODUCTION OF AN ONGOING TELEVISION PROGRAM REGARDING WOMEN ANGLERS AND SPORT FISHING, IN CLASS 41 (U.S. CLS. 100, 101 AND 107).

FIRST USE 8-3-2004; IN COMMERCE 8-3-2004.

THE COLOR(S) BLACK, WHITE AND YELLOW IS/ARE CLAIMED AS A FEATURE OF THE MARK.

THE COLOR BLACK APPEARS IN THE FISHING ROD IMAGE AND IT'S FISHING LINE. THE COLOR WHITE APPEARS AS THE BACKGROUND OF THE ENTIRE MARK. THE COLOR YELLOW APPEARS IN THE LETTERS THAT SPELLS THE WORDS "REEL SISTERS".

SN 78-378,412, FILED 3-4-2004.

BRETT J. GOLDEN, EXAMINING ATTORNEY

**Int. Cl.: 36**

**Prior U.S. Cls.: 100, 101, and 102**

**United States Patent and Trademark Office**

**Reg. No. 3,395,708**

**Registered Mar. 11, 2008**

---

**SERVICE MARK  
PRINCIPAL REGISTER**

**GREENLEAF**

GREENLEAF HOME LOANS (CALIFORNIA  
CORPORATION)  
27919 JEFFERSON AVENUE, SUITE 200  
TEMECULA, CA 92590

FOR: RESIDENTIAL AND COMMERCIAL REAL  
ESTATE MORTGAGE BROKERAGE SERVICES,  
ESPECIALLY ONLINE REAL ESTATE MORTGAGE  
BROKERAGE SERVICES , IN CLASS 36 (U.S. CLS.  
100, 101 AND 102).

FIRST USE 4-1-2004; IN COMMERCE 4-1-2004.

THE MARK CONSISTS OF STANDARD CHAR-  
ACTERS WITHOUT CLAIM TO ANY PARTICULAR  
FONT, STYLE, SIZE, OR COLOR.

SN 78-380,871, FILED 3-9-2004.

BRIDGETT SMITH, EXAMINING ATTORNEY



**Int. Cl.: 9**

**Prior U.S. Cls.: 21, 23, 26, 36, and 38**

**United States Patent and Trademark Office**

**Reg. No. 3,395,709**

**Registered Mar. 11, 2008**

**TRADEMARK  
PRINCIPAL REGISTER**

**SWEET DIAMOND**

KONAMI GAMING, INC. (NEVADA CORPORATION)  
585 TRADE CENTER DRIVE  
LAS VEGAS, NV 89119

FOR: GAMING EQUIPMENT, NAMELY, SLOT MACHINES, GAMING MACHINES, AND GAME SOFTWARE USED THEREWITH, IN CLASS 9 (U.S. CLS. 21, 23, 26, 36 AND 38).

FIRST USE 5-26-2005; IN COMMERCE 5-26-2005.

THE MARK CONSISTS OF STANDARD CHARACTERS WITHOUT CLAIM TO ANY PARTICULAR FONT, STYLE, SIZE, OR COLOR.

SN 78-382,426, FILED 3-11-2004.

BRIAN PINO, EXAMINING ATTORNEY

**Int. Cls.: 29 and 30**

**Prior U.S. Cl.: 46**

**United States Patent and Trademark Office**

**Reg. No. 3,395,710**

**Registered Mar. 11, 2008**

**TRADEMARK  
PRINCIPAL REGISTER**

**CUSTOM CULINARY**

GRIFFITH LABORATORIES INTERNATIONAL,  
INC. (DELAWARE CORPORATION)  
ONE GRIFFITH CENTER  
ALSIP, IL 60803

FOR: FOOD STOCKS, NAMELY, SEAFOOD  
STOCKS, BEEF STOCKS, CHICKEN STOCKS, VE-  
GETABLE STOCKS AND SOUP STOCKS, IN CLASS  
29 (U.S. CL. 46).

FIRST USE 4-0-2005; IN COMMERCE 4-0-2005.

FOR: FLAVORING ADDITIVES FOR NON-NU-  
TRITIONAL PURPOSES FOR USE AS A FLAVOR-  
ING, INGREDIENT OR FILLER; FOOD  
THICKENERS; GRAVY BASES; GRAVY MIXES;  
SAUCES AND SAUCE MIXES, NAMELY, AU JUS,  
DEMI-GLACE, HOLLANDAISE, BÉARNAISE, BÉ-  
CHAMEL, ALFREDO, ITALIAN, CHICKEN FLA-

VORED, BEEF FLAVORED, AND CHEESE  
FLAVORED; MEAT TENDERIZERS; MARINADES;  
AND DESSERT MOUSSES, IN CLASS 30 (U.S. CL. 46).

FIRST USE 4-0-2005; IN COMMERCE 4-0-2005.

THE MARK CONSISTS OF STANDARD CHAR-  
ACTERS WITHOUT CLAIM TO ANY PARTICULAR  
FONT, STYLE, SIZE, OR COLOR.

NO CLAIM IS MADE TO THE EXCLUSIVE  
RIGHT TO USE "CULINARY", APART FROM THE  
MARK AS SHOWN.

SN 78-388,302, FILED 3-22-2004.

GINA HAYES, EXAMINING ATTORNEY

**Int. Cl.: 11**

**Prior U.S. Cls.: 13, 21, 23, 31, and 34**

**United States Patent and Trademark Office**

**Reg. No. 3,395,711**

**Registered Mar. 11, 2008**

**TRADEMARK  
PRINCIPAL REGISTER**

**CRYOWAVE**

THE BOC GROUP, INC. (DELAWARE CORPORATION)  
575 MOUNTAIN AVENUE MURRAY HILL  
NEW PROVIDENCE, NJ 07974

THE MARK CONSISTS OF STANDARD CHARACTERS WITHOUT CLAIM TO ANY PARTICULAR FONT, STYLE, SIZE, OR COLOR.

FOR: REFRIGERATION EQUIPMENT, NAMELY, FOOD AND BEVERAGE CHILLING UNITS AND FREEZERS, IN CLASS 11 (U.S. CLS. 13, 21, 23, 31 AND 34).

SN 78-393,673, FILED 3-31-2004.

FIRST USE 1-2-2004; IN COMMERCE 7-1-2005.

JIM RINGLE, EXAMINING ATTORNEY

**Int. Cl.: 28**

**Prior U.S. Cls.: 22, 23, 38, and 50**

**United States Patent and Trademark Office**

**Reg. No. 3,395,712**

**Registered Mar. 11, 2008**

---

**TRADEMARK  
PRINCIPAL REGISTER**

**PRINCESS AND THE  
PAUPER**

MATTEL, INC. (DELAWARE CORPORATION)  
333 CONTINENTAL BLVD.  
EL SEGUNDO, CA 902455012

FOR: TOYS, GAMES, AND PLAYTHINGS, NAME-  
LY, DOLLS, DOLL CLOTHING AND DOLL ACCES-  
SORIES; TOY FIGURES AND ACCESSORIES  
THEREFOR, IN CLASS 28 (U.S. CLS. 22, 23, 38 AND  
50).

FIRST USE 12-31-2004; IN COMMERCE 12-31-2004.

THE MARK CONSISTS OF STANDARD CHAR-  
ACTERS WITHOUT CLAIM TO ANY PARTICULAR  
FONT, STYLE, SIZE, OR COLOR.

SN 78-397,711, FILED 4-7-2004.

ESTHER BELENKER, EXAMINING ATTORNEY

**Int. Cl.: 21**

**Prior U.S. Cls.: 2, 13, 23, 29, 30, 33, 40, and 50**

**Reg. No. 3,395,713**

**United States Patent and Trademark Office**

**Registered Mar. 11, 2008**

**TRADEMARK  
PRINCIPAL REGISTER**

**LITTERDUMP**

LYNCH, MARY ANN (UNITED STATES INDIVIDUAL)  
1075 PEACHTREE BATTLE AVE.  
ATLANTA, GA 30327

THE MARK CONSISTS OF STANDARD CHARACTERS WITHOUT CLAIM TO ANY PARTICULAR FONT, STYLE, SIZE, OR COLOR.

FOR: CAT LITTER BOX, IN CLASS 21 (U.S. CLS. 2, 13, 23, 29, 30, 33, 40 AND 50).

SN 78-398,099, FILED 4-7-2004.

FIRST USE 10-12-2007; IN COMMERCE 10-12-2007.

ADA HAN, EXAMINING ATTORNEY

**Int. Cl.: 9**

**Prior U.S. Cls.: 21, 23, 26, 36, and 38**

**United States Patent and Trademark Office**

**Reg. No. 3,395,714**

**Registered Mar. 11, 2008**

**TRADEMARK  
PRINCIPAL REGISTER**

**SMART. COOL. SAFE.**

AIGNER-CLARK LLC (COLORADO LTD LIAB  
CO)  
9220 KIMMER DRIVE, SUITE 215  
LONE TREE, CO 80124

FIRST USE 10-9-2007; IN COMMERCE 10-9-2007.

FOR: AUDIOVISUAL AND AUDIO PROGRAM-  
MING THAT CONVEY DECISION-MAKING STRA-  
TEGIES REGARDING PERSONAL SAFETY,  
NAMELY, CD-ROMS AND SOFTWARE, ALL FEA-  
TURING MUSIC, NATURAL SOUNDS, SPOKEN  
WORDS, PHOTOGRAPHIC IMAGES AND GRA-  
PHIC IMAGES, IN CLASS 9 (U.S. CLS. 21, 23, 26, 36  
AND 38).

THE MARK CONSISTS OF STANDARD CHAR-  
ACTERS WITHOUT CLAIM TO ANY PARTICULAR  
FONT, STYLE, SIZE, OR COLOR.

SN 78-398,235, FILED 4-7-2004.

GIANCARLO CASTRO, EXAMINING ATTORNEY

**Int. Cl.: 33**

**Prior U.S. Cls.: 47 and 49**

**United States Patent and Trademark Office**

**Reg. No. 3,395,715**

**Registered Mar. 11, 2008**

**TRADEMARK  
PRINCIPAL REGISTER**

**HOTEL CALIFORNIA**

HOTEL CALIFORNIA TEQUILA S. DE R.L. DE  
C.V. (MEXICO SOCIEDAD DE RESPONSABIL-  
IDAD LIMITADA)  
CALLE BENITO JUAREZ  
S/N ENTRE MORELOS Y MARQUEZ DE LEON  
COL. CENTRO, TODOS SANTOS, MEXICO 23305

FOR: TEQUILA, IN CLASS 33 (U.S. CLS. 47 AND  
49).

FIRST USE 4-1-2004; IN COMMERCE 11-20-2007.

THE MARK CONSISTS OF STANDARD CHAR-  
ACTERS WITHOUT CLAIM TO ANY PARTICULAR  
FONT, STYLE, SIZE, OR COLOR.

SN 78-398,360, FILED 4-8-2004.

AMY HELLA, EXAMINING ATTORNEY

**Int. Cl.: 9**

**Prior U.S. Cls.: 21, 23, 26, 36, and 38**

**United States Patent and Trademark Office**

**Reg. No. 3,395,716**

**Registered Mar. 11, 2008**

**TRADEMARK  
PRINCIPAL REGISTER**

**TREASURES OF  
VENICE**

ATRONIC INTERNATIONAL GMBH (FED REP  
GERMANY CORPORATION)  
BORSIGSTRASSE 26  
32312 LÜBBECKE, FED REP GERMANY 32312

FOR: ELECTRIC AND ELECTRONIC APPARATUS, INSTRUMENTS, DEVICES AND MACHINES, NAMELY, AUTOMATED COIN DISPENSING MACHINES, COIN AND MONEY BILL OPERATED AMUSEMENT MACHINES OPERABLE ALSO WITH MAGNETIC CARDS, MICRO-PROCESSORS AND COMPUTER CHIPS; MECHANISMS FOR COIN-OPERATED MACHINES, NAMELY, COIN, BILL AND CHIP-CONTROLLED GAMING MACHINES; APPARATUS FOR BILLING OPERATIONS OF COIN-OPERATED MACHINES, NAMELY, COMPUTER SOFTWARE USED TO GENERATE BILLS IN CONNECTION WITH COIN OPERATED GAMING MACHINES, COMPUTERS AND COMPUTER HARDWARE; COMPUTER PRINTERS FOR USE IN CONNECTION WITH GAMING AND GAMBLING MACHINES; PRINTED ELECTRONIC CIRCUITS FOR APPARATUS AND CARDS BEARING INTEGRATED CIRCUITS; MONEY CHANGE MACHINES; VENDING MACHINES PROVIDING CHIPS, COUPONS AND GAME CARDS; ENTERTAINMENT AND CASINO GAMING AND GAM-

BLING EQUIPMENT, NAMELY, SLOT MACHINES; GAMING EQUIPMENT, NAMELY, GAMING MACHINES, VIDEO SLOT MACHINES AND PARTS THEREFOR; DROP-DOWN CAROUSELS FOR GAMING AND SLOT MACHINES, NAMELY, HOPPERS; TV MONITORS, LCD- MONITORS ALL FOR GAMBLING MACHINES; ELECTRONIC CASINO GAMING MACHINES; COMPUTER GAME CARTRIDGES AND ENCODED SMART CARDS CONTAINING OPERATING PROGRAMS FOR ELECTRONIC POCKET GAMES; ELECTRONIC PARLOR GAMES AND VIDEO GAMES; MAGNETIC DATA CARRIERS PROGRAMMED FOR ELECTRONIC VIDEO AND AUDIO DISPLAY AND OPERATION FOR ALL AFORE-STATED GAMES, IN CLASS 9 (U.S. CLS. 21, 23, 26, 36 AND 38).

FIRST USE 8-19-2004; IN COMMERCE 8-19-2004.

THE MARK CONSISTS OF STANDARD CHARACTERS WITHOUT CLAIM TO ANY PARTICULAR FONT, STYLE, SIZE, OR COLOR.

SN 78-398,610, FILED 4-8-2004.

JENNIFER VASQUEZ, EXAMINING ATTORNEY



**Int. Cls.: 38, 39, 40, and 42**

**Prior U.S. Cls.: 100, 101, 103, 104, 105, and 106**

**United States Patent and Trademark Office**

**Reg. No. 3,395,717**

**Registered Mar. 11, 2008**

**SERVICE MARK  
PRINCIPAL REGISTER**

**UP**

ASCENT MEDIA GROUP, LLC (DELAWARE  
LTD LIAB CO)

520 BROADWAY, 5TH FLOOR  
SANTA MONICA, CA 90401

FOR: DISTRIBUTION OF DIGITAL AUDIO AND VIDEO MEDIA VIA A GLOBAL COMPUTER NETWORK, NAMELY, INTERNET BROADCAST DISTRIBUTION OF AUDIO AND VISUAL MEDIA CONTENT, NAMELY, RADIO, TELEVISION AND INTERACTIVE MEDIA BROADCASTING VIA THE INTERNET; DIGITAL MEDIA CONTENT DISTRIBUTION SERVICES, NAMELY, SATELLITE TRANSMISSION SERVICES, MICROWAVE TRANSMISSION SERVICES, FIBER-OPTIC TRANSMISSION SERVICES, PROVIDING CONNECTIONS TO A DIGITAL NETWORK FOR ELECTRONIC TRANSMISSION OF DIGITAL AUDIO/VISUAL DATA; OPTICAL TRANSFER AND DIGITAL DISTRIBUTION OF DIGITAL DATA VIA A GLOBAL COMPUTER NETWORK, SATELLITE NETWORK, FIBER-OPTIC NETWORK AND/OR MICROWAVE TRANSMISSION NETWORK; PROVIDING STREAMING VIDEO SERVICES VIA A GLOBAL COMPUTER NETWORK; STREAMING OF AUDIO AND VIDEO MATERIAL ON THE INTERNET; ELECTRONIC, ELECTRIC AND DIGITAL TRANSMISSION OF AUDIO, VISUAL, VOICE, AUDIOVISUAL DATA, AND SIGNALS; SECURE DATA TRANSMISSION SERVICES VIA SATELLITE, MICROWAVE, FIBER-OPTIC AND GLOBAL COMPUTER NETWORK, IN CLASS 38 (U.S. CLS. 100, 101 AND 104).

FIRST USE 2-18-2004; IN COMMERCE 2-18-2004.

FOR: DIGITAL STORAGE OF MOTION PICTURE FILMS AND VIDEOTAPES AND AUDIO MEDIA; STORAGE OF ELECTRONIC MEDIA, NAMELY, DIGITAL IMAGES, TEXT, AUDIO AND AUDIO VISUAL DATA; DIGITAL STORAGE SERVICES FOR ARCHIVING DATABASES, IMAGES AND OTHER ELECTRONIC DATA; DIGITAL ARCHIVING OF AUDIO AND VIDEO MEDIA, NAMELY, STORAGE OF ANALOG- AND DIGITAL-FORMAT AUDIO, VISUAL AND AUDIO/VISUAL MEDIA WORKS FOR OTHERS, IN CLASS 39 (U.S. CLS. 100 AND 105).

FIRST USE 2-18-2004; IN COMMERCE 2-18-2004.

FOR: ENCODING, TRANSCODING AND DIGITAL AND ANALOG FORMAT CONVERSION OF ANALOG AND DIGITAL AUDIO AND VIDEO MEDIA, NAMELY, MOTION PICTURE FILM, FILM AND VIDEO DATA COMPRESSION, FILM-TO-VIDEOTAPE, VIDEOTAPE-TO-FILM, TAPE-TO-TAPE AND DATA-TO-FILM TRANSFERS AND DUPLICATIONS, AND CONSULTATION SERVICES RELATED TO THE FOREGOING, VIDEO TRANSFER SERVICES, NAMELY, PROVIDING CONVERSION OF PROGRAMS RECORDED ON VIDEO TAPE FROM ONE VIDEO TAPE STANDARDS FORMAT TO ANOTHER VIDEO TAPE STANDARDS FORMAT, ELECTRONICALLY PRODUCING MOTION PICTURE FILM FROM VIDEO TAPE TRANSFER RECORDINGS, BROADCAST STANDARDS CONVERSION, DIGITAL ENCODING OF INTERACTIVE MULTIMEDIA DATA FROM ONE TO ANOTHER FORMAT, FORMAT CONVERSION OF FILM AND VIDEO TAPE TO ONE ANOTHER AND TO DIGITAL

MEDIA FORMATS, IN CLASS 40 (U.S. CLS. 100, 103 AND 106).

FIRST USE 2-18-2004; IN COMMERCE 2-18-2004.

FOR: HOSTING OF DIGITAL CONTENT ON THE INTERNET; DATA ENCRYPTION SERVICES, IN CLASS 42 (U.S. CLS. 100 AND 101).

FIRST USE 2-18-2004; IN COMMERCE 2-18-2004.

THE MARK CONSISTS OF STANDARD CHARACTERS WITHOUT CLAIM TO ANY PARTICULAR FONT, STYLE, SIZE, OR COLOR.

SN 78-402,420, FILED 4-15-2004.

JULIE WATSON, EXAMINING ATTORNEY

**Int. Cl.: 5**

**Prior U.S. Cls.: 6, 18, 44, 46, 51, and 52**

**United States Patent and Trademark Office**

**Reg. No. 3,395,718**

**Registered Mar. 11, 2008**

**TRADEMARK  
PRINCIPAL REGISTER**

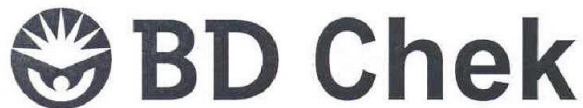

BECTON, DICKINSON AND COMPANY (NEW  
JERSEY CORPORATION)  
1 BECTON DRIVE, MC 090  
FRANKLIN LAKES, NJ 074171880

FOR: RAPID DIAGNOSTIC TEST KITS CONSIST-  
ING OF DIAGNOSTIC REAGENTS FOR MEDICAL  
USE, IN CLASS 5 (U.S. CLS. 6, 18, 44, 46, 51 AND 52).

FIRST USE 11-12-2007; IN COMMERCE 11-12-2007.

OWNER OF U.S. REG. NOS. 2,510,232, 2,711,880,  
AND OTHERS.

THE MARK CONSISTS OF A SHADED CIRCLE  
WITH SUNBURST AND PARTIAL ARC DESIGN.

SN 78-402,549, FILED 4-15-2004.

DARRYL SPRUILL, EXAMINING ATTORNEY

**Int. Cl.: 22**

**Prior U.S. Cls.: 1, 2, 7, 19, 22, 42, and 50**

**United States Patent and Trademark Office**

**Reg. No. 3,395,719**

**Registered Mar. 11, 2008**

**TRADEMARK  
PRINCIPAL REGISTER**

**ARTFUL SHELTER**

SOUTHBRIDGE, INC. (NORTH CAROLINA CORPORATION)  
P.O. BOX 19539  
ASHEVILLE, NC 28815

OWNER OF U.S. REG. NO. 3,064,436.

FOR: TENTS, IN CLASS 22 (U.S. CLS. 1, 2, 7, 19, 22, 42 AND 50).

NO CLAIM IS MADE TO THE EXCLUSIVE RIGHT TO USE "SHELTER", APART FROM THE MARK AS SHOWN.

FIRST USE 9-22-2007; IN COMMERCE 9-22-2007.

SN 78-404,277, FILED 4-19-2004.

THE MARK CONSISTS OF STANDARD CHARACTERS WITHOUT CLAIM TO ANY PARTICULAR FONT, STYLE, SIZE, OR COLOR.

CURTIS FRENCH, EXAMINING ATTORNEY

Int. Cl.: 43

Prior U.S. Cls.: 100 and 101

United States Patent and Trademark Office

Reg. No. 3,395,720

Registered Mar. 11, 2008

SERVICE MARK  
PRINCIPAL REGISTER



GRAND VICTORIA CASINO

ELGIN RIVERBOAT RESORT (ILLINOIS JOINT  
VENTURE)  
250 SOUTH GROVE  
ELGIN, IL 60120

FOR: RESORT LODGING; HEALTH RESORT  
SERVICES, NAMELY, PROVIDING FOOD AND  
LODGING THAT SPECIALIZE IN PROMOTING  
PATRONS' GENERAL HEALTH AND WELL-  
BEING; RESTAURANT, BAR AND LOUNGE SER-  
VICES; PROVIDING FACILITIES FOR CONVEN-  
TIONS, EXHIBITIONS, BANQUETS, SOCIAL  
FUNCTIONS, AND TRADE SHOWS; CAFETERIAS;  
SNACK BARS; CATERING; CAFES; DELICATES-  
SENS; SALAD BARS, IN CLASS 43 (U.S. CLS. 100  
AND 101).

FIRST USE 4-0-2004; IN COMMERCE 4-0-2004.

OWNER OF U.S. REG. NOS. 1,940,568, 2,314,812,  
AND OTHERS.

NO CLAIM IS MADE TO THE EXCLUSIVE  
RIGHT TO USE "CASINO", APART FROM THE  
MARK AS SHOWN.

SN 78-404,468, FILED 4-19-2004.

WARREN L. OLANDRIA, EXAMINING ATTOR-  
NEY

**Int. Cl.: 5**

**Prior U.S. Cls.: 6, 18, 44, 46, 51, and 52**

**United States Patent and Trademark Office**

**Reg. No. 3,395,721**

**Registered Mar. 11, 2008**

**TRADEMARK  
PRINCIPAL REGISTER**

**AAKG-TECH**

PUMP US TRADEMARK LTD. (CANADA CORPORATION)  
5100 SPECTRUM WAY  
MISSISSAUGA, ONTARIO, CANADA L4W 5S2

FOR: FOOD SUPPLEMENTS FOR BODY BUILDING, FOOD AND SPORT NUTRITIONAL SUPPLEMENTS FOR STRENGTH PERFORMANCE ENHANCEMENT, DIETARY INGREDIENTS IN THE FORM OF INGREDIENT BLENDS COMPRISING, AMINO ACIDS AND SALTS OF AMINO ACIDS FOR USE IN FOODS, AND NUTRITIONAL SUPPLEMENTS IN THE FORM OF TABLETS, CAPSULES, CAPLETS, POWDERS, NAMELY, HERBALS, AMI-

NO ACIDS, VITAMIN, MINERALS, AND OTHER NUTRIENTS, IN CLASS 5 (U.S. CLS. 6, 18, 44, 46, 51 AND 52).

FIRST USE 6-0-2004; IN COMMERCE 6-0-2004.

THE MARK CONSISTS OF STANDARD CHARACTERS WITHOUT CLAIM TO ANY PARTICULAR FONT, STYLE, SIZE, OR COLOR.

SN 78-408,872, FILED 4-27-2004.

RICHARD WHITE, EXAMINING ATTORNEY

**Int. Cl.: 9**

**Prior U.S. Cls.: 21, 23, 26, 36, and 38**

**Reg. No. 3,395,722**

**United States Patent and Trademark Office**

**Registered Mar. 11, 2008**

---

**TRADEMARK  
PRINCIPAL REGISTER**

**LIGHT VIPER**

FIBERPLEX INC. (DELAWARE CORPORATION)  
10840-412 GUILFORD ROAD  
ANNAPOLIS JUNCTION, MD 20701

FOR: OPTICAL CONVERTERS, NAMELY, CONVERTERS FOR CONVERTING OPTICAL SIGNALS TO ELECTRICAL SIGNALS, IN CLASS 9 (U.S. CLS. 21, 23, 26, 36 AND 38).

FIRST USE 1-31-2004; IN COMMERCE 1-31-2004.

THE MARK CONSISTS OF STANDARD CHARACTERS WITHOUT CLAIM TO ANY PARTICULAR FONT, STYLE, SIZE, OR COLOR.

NO CLAIM IS MADE TO THE EXCLUSIVE RIGHT TO USE LIGHT, APART FROM THE MARK AS SHOWN.

SN 78-409,429, FILED 4-28-2004.

MARK RADEMACHER, EXAMINING ATTORNEY

**Int. Cl.: 9**

**Prior U.S. Cls.: 21, 23, 26, 36, and 38**

**Reg. No. 3,395,723**

**United States Patent and Trademark Office**

**Registered Mar. 11, 2008**

---

**TRADEMARK  
PRINCIPAL REGISTER**

**MoxyCard**

ONE28 MARKETING GROUP, LLC (FLORIDA  
LTD LIAB CO)  
14639 MIRASOL MANOR COURT  
TAMPA, FL 33626

THE MARK CONSISTS OF STANDARD CHAR-  
ACTERS WITHOUT CLAIM TO ANY PARTICULAR  
FONT, STYLE, SIZE, OR COLOR.

FOR: CREDIT CARD IN THE FORM OF AN  
OPTICAL DISC, IN CLASS 9 (U.S. CLS. 21, 23, 26, 36  
AND 38).

SN 78-415,438, FILED 5-8-2004.

FIRST USE 12-5-2005; IN COMMERCE 12-5-2005.

ROBERT LORENZO, EXAMINING ATTORNEY



**Int. Cl.: 10**

**Prior U.S. Cls.: 26, 39, and 44**

**Reg. No. 3,395,724**

**United States Patent and Trademark Office**

**Registered Mar. 11, 2008**

**TRADEMARK  
PRINCIPAL REGISTER**

**HER FIT**

CARNEVALE, JERRY ALLEN (UNITED STATES  
INDIVIDUAL)  
4 ANDREW LANE  
SANDIA PARK, NM 87047

THE MARK CONSISTS OF STANDARD CHAR-  
ACTERS WITHOUT CLAIM TO ANY PARTICULAR  
FONT, STYLE, SIZE, OR COLOR.

FOR: FEMALE CONDOM, IN CLASS 10 (U.S. CLS.  
26, 39 AND 44).

SN 78-415,905, FILED 5-10-2004.

FIRST USE 10-13-2007; IN COMMERCE 10-13-2007.

PAUL E. FAHRENKOPF, EXAMINING ATTORNEY

**Int. Cl.: 19**

**Prior U.S. Cls.: 1, 12, 33, and 50**

**United States Patent and Trademark Office**

**Reg. No. 3,395,725**

**Registered Mar. 11, 2008**

**TRADEMARK  
PRINCIPAL REGISTER**

**TAPEREDGE**

TRI CUSTOM MANUFACTURING, LLC (UTAH  
LTD LIAB CO)  
PO BOX 6263  
NORTH LOGAN, UT 84341

THE MARK CONSISTS OF STANDARD CHAR-  
ACTERS WITHOUT CLAIM TO ANY PARTICULAR  
FONT, STYLE, SIZE, OR COLOR.

FOR: NON-METAL BUILDING MATERIALS,  
NAMELY, BALUSTERS, IN CLASS 19 (U.S. CLS. 1,  
12, 33 AND 50).

SN 78-415,985, FILED 5-10-2004.

FIRST USE 11-10-2004; IN COMMERCE 11-10-2004.

MICHAEL WEBSTER, EXAMINING ATTORNEY

**Int. Cl.: 14**

**Prior U.S. Cls.: 2, 27, 28, and 50**

**United States Patent and Trademark Office**

**Reg. No. 3,395,726**

**Registered Mar. 11, 2008**

**TRADEMARK  
PRINCIPAL REGISTER**

**MARCCO**

HIRSCH ARMBANDER GMBH (AUSTRIA  
GMBH)  
HIRSCHSTRASSE 5  
KLAGENFURT, AUSTRIA A 9020

FOR: JEWELRY; CLOCKS, CASINGS FOR  
CLOCKS AND WATCHES; DRIVES AND REGU-  
LATING UNITS FOR CLOCKS AND WATCHES  
THEREFOR; WATCH STRAPS; WATCH BANDS;  
CASES FOR CLOCKS AND WATCH-MAKING;  
WATCH GLASSES; WATCH CHAINS; PENDANTS  
FOR WATCH CHAINS; MOVEMENTS FOR CLOCKS  
AND WATCHES; WORKS OF WATCHES AND  
CLOCKS, NAMELY, CLOCK AND WATCH HANDS,  
DIALS FOR CLOCK-AND-WATCH-MAKING,  
PARTS FOR WATCHES, WATCH AND CLOCK

SPRINGS, WATCH WINDERS AND WATCH WIND-  
ING BUTTONS; BUCKLES FOR WATCH STRAPS;  
ALL MADE OF PLASTIC, CERAMIC, METAL, LEA-  
THER, AND PRECIOUS METALS THEREFOR, IN  
CLASS 14 (U.S. CLS. 2, 27, 28 AND 50).

FIRST USE 11-26-2007; IN COMMERCE 11-26-2007.

THE MARK CONSISTS OF STANDARD CHAR-  
ACTERS WITHOUT CLAIM TO ANY PARTICULAR  
FONT, STYLE, SIZE, OR COLOR.

SN 78-418,071, FILED 5-13-2004.

RAMONA ORTIGA, EXAMINING ATTORNEY

**Int. Cl.: 7**

**Prior U.S. Cls.: 13, 19, 21, 23, 31, 34, and 35**

**Reg. No. 3,395,727**

**United States Patent and Trademark Office**

**Registered Mar. 11, 2008**

**TRADEMARK  
PRINCIPAL REGISTER**

**RotaRing**

DYNAMIC SEALING TECHNOLOGIES, INC.  
(MINNESOTA CORPORATION)  
SUITE 100  
13941 LINCOLN STREET NE  
HAM LAKE, MN 55304

FOR: ROTATING UNION ASSEMBLY DEVICE  
FOR TRANSFERRING FLUID OR GAS FROM  
STATIONARY SUPPLY TO ROTATING EQUIP-  
MENT WITH INTEGRATED ELECTRICAL SLIP  
RING FOR TRANSFERRING ELECTRICAL POWER  
FROM STATIONARY SUPPLY TO ROTATING

EQUIPMENT, IN CLASS 7 (U.S. CLS. 13, 19, 21, 23,  
31, 34 AND 35).

FIRST USE 1-1-2006; IN COMMERCE 1-1-2006.

THE MARK CONSISTS OF STANDARD CHAR-  
ACTERS WITHOUT CLAIM TO ANY PARTICULAR  
FONT, STYLE, SIZE, OR COLOR.

SN 78-423,167, FILED 5-21-2004.

JASON TURNER, EXAMINING ATTORNEY

**Int. Cls.: 9 and 42**

**Prior U.S. Cls.: 21, 23, 26, 36, 38, 100, and 101**

**United States Patent and Trademark Office**

**Reg. No. 3,395,728**

**Registered Mar. 11, 2008**

**TRADEMARK  
SERVICE MARK  
PRINCIPAL REGISTER**



AMBIENT CORPORATION (DELAWARE CORPORATION)  
79 CHAPEL STREET  
NEWTON, MA 02458

FOR: COMPUTER SOFTWARE PROGRAMS RELATING TO TELECOMMUNICATIONS, NAMELY, BROWSER SOFTWARE USED TO ACCESS, VIEW AND TRANSMIT INFORMATION AND DATA FROM WEBSITES ON GLOBAL NETWORKS; TELECOMMUNICATIONS SYSTEMS COMPOSED OF TERMINAL, EXCHANGE UNITS, RELAY STATIONS, BASE STATIONS, REPEATERS, TRANSCIVERS, TRANSMITTERS, SIGNAL ROUTERS, AND DIGITAL SIGNAL PROCESSORS FOR TELECOMMUNICATIONS NETWORKS; TELECOMMUNICATIONS EQUIPMENT, NAMELY, COMPUTER HARDWARE FOR THE TRANSMISSION AND RECEIVING OF VOICE AND DATA INFORMATION, COMPUTER MODEMS, ELECTRICAL CABLES, ELECTRICAL CONDUITS, ELECTRICAL CIRCUITS, ELECTRICAL POWER SUPPLIES, AND

ELECTRICAL SWITCHES, IN CLASS 9 (U.S. CLS. 21, 23, 26, 36 AND 38).

FIRST USE 0-0-2000; IN COMMERCE 0-0-2000.

FOR: PRODUCT DEVELOPMENT, NAMELY, DESIGNING AND ENGINEERING TELECOMMUNICATIONS, INTERNET AND ELECTRONIC SYSTEMS, SERVICES, AND EQUIPMENT; DEVELOPMENT OF NEW TECHNOLOGY FOR OTHERS IN THE FIELD OF COMPUTERS AND TELECOMMUNICATIONS; CONSULTING SERVICES IN THE FIELD OF COMPUTERS, IN CLASS 42 (U.S. CLS. 100 AND 101).

FIRST USE 0-0-2000; IN COMMERCE 0-0-2000.

SN 78-425,546, FILED 5-26-2004.

DAVID TOOLEY, EXAMINING ATTORNEY

**Int. Cl.: 25**

**Prior U.S. Cls.: 22 and 39**

**United States Patent and Trademark Office**

**Reg. No. 3,395,729**

**Registered Mar. 11, 2008**

**TRADEMARK  
PRINCIPAL REGISTER**

# Fleurette Passport

BLUM & FINK, INC. (NEW YORK CORPORATION)  
158 WEST 29TH STREET  
NEW YORK, NY 10001

FOR: CLOTHING, NAMELY, COATS AND JACKETS, IN CLASS 25 (U.S. CLS. 22 AND 39).

FIRST USE 8-23-2007; IN COMMERCE 8-23-2007.

THE MARK CONSISTS OF STANDARD CHARACTERS WITHOUT CLAIM TO ANY PARTICULAR FONT, STYLE, SIZE, OR COLOR.

OWNER OF U.S. REG. NO. 1,882,306.

THE ENGLISH TRANSLATION OF FLEURETTE IS LITTLE FLOWER OR "FLOWERET".

SN 78-426,066, FILED 5-27-2004.

KARANENDRA S. CHHINA, EXAMINING ATTORNEY

**Int. Cl.: 10**

**Prior U.S. Cls.: 26, 39, and 44**

**United States Patent and Trademark Office**

**Reg. No. 3,395,730**

**Registered Mar. 11, 2008**

**TRADEMARK  
PRINCIPAL REGISTER**

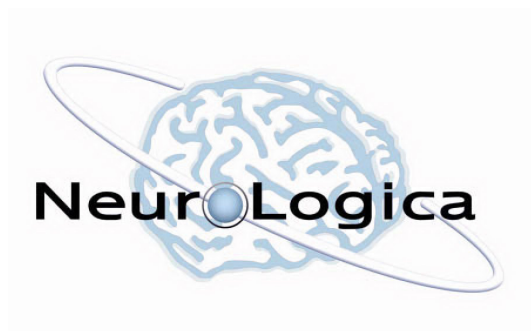

NEUROLOGICA CORP. (MASSACHUSETTS CORPORATION)  
14 ELECTRONICS AVE.  
DANVERS, MA 019231011

FOR: MEDICAL IMAGING EQUIPMENT, NAME-  
LY, ELECTROMAGNETIC MEDICAL DIAGNOSTIC  
IMAGING APPARATUS AND PERIPHERALS AND  
SOFTWARE SOLD AS AN INTEGRAL COMPO-  
NENT THEREFORE, IN CLASS 10 (U.S. CLS. 26, 39  
AND 44).

FIRST USE 1-11-2007; IN COMMERCE 1-11-2007.

THE COLOR(S) BLUE, WHITE AND BLACK IS/  
ARE CLAIMED AS A FEATURE OF THE MARK.

THE BLUE IMAGE OF BRAIN ENCIRCLED BY A  
WHITE RING SHADED IN BLUE, WITH THE  
STYLIZED WORD NEUROLOGICA SUPERIM-  
POSED OVER THE BRAIN AND THE RING, WITH  
A STYLIZED LETTER "O" IN NEUROLOGICA  
FORMED BY A BLUE CIRCLE WITH A BLACK  
RING IN SURROUNDING CONFIGURATION,  
AND WITH THE REMAINDER OF THE LETTERS  
IN BLACK.

SN 78-426,502, FILED 5-27-2004.

ANGELA GAW, EXAMINING ATTORNEY

**Int. Cl.: 9**

**Prior U.S. Cls.: 21, 23, 26, 36, and 38**

**United States Patent and Trademark Office**

**Reg. No. 3,395,731**

**Registered Mar. 11, 2008**

**TRADEMARK  
PRINCIPAL REGISTER**

**NEAREDGE**

CROSSROADS SYSTEMS, INC. (DELAWARE  
CORPORATION)  
11000 N. MOPAC EXPRESSWAY  
AUSTIN, TX 78759

THE MARK CONSISTS OF STANDARD CHAR-  
ACTERS WITHOUT CLAIM TO ANY PARTICULAR  
FONT, STYLE, SIZE, OR COLOR.

FOR: COMPUTER SOFTWARE FOR BACKUP,  
STORAGE AND RESTORATION OF DATA, IN  
CLASS 9 (U.S. CLS. 21, 23, 26, 36 AND 38).

SN 78-426,913, FILED 5-28-2004.

FIRST USE 11-14-2007; IN COMMERCE 11-14-2007.

TARAH HARDY, EXAMINING ATTORNEY



**Int. Cl.: 38**

**Prior U.S. Cls.: 100, 101, and 104**

**United States Patent and Trademark Office**

**Reg. No. 3,395,732**

**Registered Mar. 11, 2008**

**SERVICE MARK  
PRINCIPAL REGISTER**



TRAIL BLAZERS, INC. (OREGON CORPORATION)  
ONE CENTER COURT, SUITE 200  
PORTLAND, OR 97227

FOR: AUDIO BROADCASTING; CABLE TELEVISION BROADCASTING; RADIO BROADCASTING; SUBSCRIPTION TELEVISION BROADCASTING; TELEVISION BROADCASTING; VIDEO BROADCASTING; WEBCASTING SERVICES IN THE NATURE OF PROVIDING ON-LINE CHAT ROOMS AND ON-LINE INTERACTIVE CHAT ROOMS WITH GUESTS FOR TRANSMISSION OF MESSAGES AMONG COMPUTER USERS CONCERNING THE FIELD OF BASKETBALL; BROADCASTING PROGRAMS OVER THE INTERNET; PROVIDING ON-LINE ELECTRONIC BULLETIN BOARDS FOR TRANSMISSION OF MESSAGES AMONG COMPUTER USERS CONCERNING THE FIELD OF BASKETBALL; PROVIDING ACCESS TO INTERACTIVE POLLING IN THE FIELD OF BASKETBALL OVER

THE INTERNET, IN CLASS 38 (U.S. CLS. 100, 101 AND 104).

FIRST USE 11-1-2007, THE MARK WAS FIRST USED ANYWHERE IN A DIFFERENT FORM OTHER THAN THAT SOUGHT TO BE REGISTERED ON 10/16/1970.; IN COMMERCE 11-1-2007, THE MARK WAS FIRST USED IN COMMERCE IN A DIFFERENT FORM OTHER THAN THAT SOUGHT TO BE REGISTERED ON 10/16/1970..

OWNER OF U.S. REG. NOS. 932,026, 2,770,324, AND OTHERS.

SEC. 2(F) AS TO "PORTLAND".

SN 78-427,243, FILED 5-28-2004.

RICHARD A. STRASER, EXAMINING ATTORNEY

Int. Cl.: 33

Prior U.S. Cls.: 47 and 49

**United States Patent and Trademark Office**

**Reg. No. 3,395,733**

Registered Mar. 11, 2008

**TRADEMARK  
PRINCIPAL REGISTER**

**flawless**

GUTIERREZ, JERROD S (UNITED STATES IN-  
DIVIDUAL)  
9957 PASATIEMPO PL  
MORENO VALLEY, CA 92557

THE MARK CONSISTS OF STANDARD CHAR-  
ACTERS WITHOUT CLAIM TO ANY PARTICULAR  
FONT, STYLE, SIZE, OR COLOR.

FOR: DISTILLED LIQUORS, IN CLASS 33 (U.S.  
CLS. 47 AND 49).

SN 78-427,331, FILED 5-28-2004.

FIRST USE 5-20-2007; IN COMMERCE 5-20-2007.

BRIAN PINO, EXAMINING ATTORNEY

**Int. Cl.: 14**

**Prior U.S. Cls.: 2, 27, 28, and 50**

**United States Patent and Trademark Office**

**Reg. No. 3,395,734**

**Registered Mar. 11, 2008**

**TRADEMARK  
PRINCIPAL REGISTER**

**DRAGONITE**

WALTON, JAMES (UNITED STATES INDIVIDUAL)  
10 TAMARAC CT  
PAGOSA SPRINGS, CO 81147

THE MARK CONSISTS OF STANDARD CHARACTERS WITHOUT CLAIM TO ANY PARTICULAR FONT, STYLE, SIZE, OR COLOR.

FOR: JEWELRY, NAMELY, JEWELRY WITHOUT QUARTZ, IN CLASS 14 (U.S. CLS. 2, 27, 28 AND 50).

SN 78-428,256, FILED 6-1-2004.

FIRST USE 11-0-2004; IN COMMERCE 11-0-2004.

MONIQUE MILLER, EXAMINING ATTORNEY

Int. Cls.: 29, 30, and 32

Prior U.S. Cls.: 45, 46, and 48

United States Patent and Trademark Office

Reg. No. 3,395,735

Registered Mar. 11, 2008

TRADEMARK  
PRINCIPAL REGISTER

SMART SPOT

PEPSICO, INC. (NORTH CAROLINA CORPORATION)  
700 ANDERSON HILL ROAD  
PURCHASE, NY 10577

FOR: POTATO-BASED SNACKS, NAMELY, POTATO CHIPS, POTATO CRISPS AND PUFFED POTATO SNACKS; PROCESSED LENTIL-BASED DISHES, NAMELY, LENTIL PILAF AND FELAFEL MIX; BEEF JERKY, IN CLASS 29 (U.S. CL. 46).

FIRST USE 10-1-2004; IN COMMERCE 10-1-2004.

FOR: TEA; OATMEAL AND ROLLED OATS; GRAIN-BASED SNACK FOODS; GRANOLA BARS; RICE CAKES; SAUCES AND SALSA; CORN-BASED SNACK FOODS, NAMELY, TORTILLA CHIPS, CORN CHIPS AND PUFFED CORN SNACKS, MULTIGRAIN CHIPS; PRETZELS; POPPED POPCORN; GRAIN AND RICE-BASED DISHES, NAMELY, TABOULE, COUSCOUS, SPANISH RICE, RICE PILAF, WHEAT PILAF, CHICKEN-FLAVORED RICE PILAF, BARELY PILAF, CURRY RICE AND LONG AND WILD RICE PILAF; RICE; NOODLES; ALIMENTARY PASTES; PREPARED AND PARTLY PREPARED MIXES CONSISTING PRIMARILY OF RICE, ALIMENTARY PASTE, NOODLES, OR RICE

AND ALIMENTARY PASTE, IN CLASS 30 (U.S. CL. 46).

FIRST USE 10-1-2004; IN COMMERCE 10-1-2004.

FOR: DRINKING WATER; NON-ALCOHOLIC SPORTS DRINKS AND POWDER FOR MAKING THE SAME; NON-ALCOHOLIC AND NON-CARBONATED FRUIT-FLAVORED DRINKS; FRUIT JUICE AND FRUIT JUICE DRINKS, AND SYRUPS AND CONCENTRATES FOR MAKING THE SAME; FRUIT-FLAVORED CARBONATED OR NON-CARBONATED DRINKING WATER; SOFT DRINKS, AND SYRUPS AND CONCENTRATES FOR MAKING THE SAME; SMOOTHIES CONSISTING OF FRUIT JUICE, FRUIT AND YOGURT, IN CLASS 32 (U.S. CLS. 45, 46 AND 48).

FIRST USE 10-1-2004; IN COMMERCE 10-1-2004.

THE MARK CONSISTS OF STANDARD CHARACTERS WITHOUT CLAIM TO ANY PARTICULAR FONT, STYLE, SIZE, OR COLOR.

SN 78-428,377, FILED 6-2-2004.

GRETTA YAO, EXAMINING ATTORNEY

**Int. Cl.: 3**

**Prior U.S. Cls.: 1, 4, 6, 50, 51, and 52**

**United States Patent and Trademark Office**

**Reg. No. 3,395,736**

**Registered Mar. 11, 2008**

**TRADEMARK  
PRINCIPAL REGISTER**

**FIRM OFFER**

BEAUTYBANK INC. (DELAWARE CORPORATION)  
767 FIFTH AVENUE  
NEW YORK, NY 10153

FOR: COSMETICS; FRAGRANCES FOR PERSONAL USE; NON-MEDICATED SKINCARE PREPARATIONS; HAIRCARE PREPARATIONS; TOILETRIES, NAMELY, BATH AND BODY SOAPS, CLEANSERS, GELS, LOTIONS, CREAMS AND SPRAYS; NON-MEDICATED SUN CARE PREPARATIONS, IN CLASS 3 (U.S. CLS. 1, 4, 6, 50, 51 AND 52).

FIRST USE 6-6-2005; IN COMMERCE 7-24-2005.

THE MARK CONSISTS OF STANDARD CHARACTERS WITHOUT CLAIM TO ANY PARTICULAR FONT, STYLE, SIZE, OR COLOR.

SN 78-434,547, FILED 6-14-2004.

WILLIAM P. SHANAHAN, EXAMINING ATTORNEY

**Int. Cl.: 16**

**Prior U.S. Cls.: 2, 5, 22, 23, 29, 37, 38, and 50**

**Reg. No. 3,395,737**

**United States Patent and Trademark Office**

**Registered Mar. 11, 2008**

**TRADEMARK  
PRINCIPAL REGISTER**

**MILLIONAIRE  
DENTIST**

GEMS PUBLISHING, USA, INC. (MASSACHU-  
SETTS CORPORATION)  
12 WALNUT STREET  
FRAMINGHAM, MA 01702

FOR: PERIODICAL PUBLICATION IN THE  
FIELD OF HEALTHCARE OR DENTAL PRACTICE  
MANAGEMENT AND MARKETING, IN CLASS 16  
(U.S. CLS. 2, 5, 22, 23, 29, 37, 38 AND 50).

FIRST USE 10-28-2005; IN COMMERCE 10-28-2005.

THE MARK CONSISTS OF STANDARD CHAR-  
ACTERS WITHOUT CLAIM TO ANY PARTICULAR  
FONT, STYLE, SIZE, OR COLOR.

NO CLAIM IS MADE TO THE EXCLUSIVE  
RIGHT TO USE "DENTIST", APART FROM THE  
MARK AS SHOWN.

SN 78-436,137, FILED 6-16-2004.

KATHERINE STOIDES, EXAMINING ATTORNEY

Int. Cl.: 35

Prior U.S. Cls.: 100, 101, and 102

United States Patent and Trademark Office

Reg. No. 3,395,738

Registered Mar. 11, 2008

**SERVICE MARK  
PRINCIPAL REGISTER**



EPANA NETWORKS, INC. (DELAWARE CORPORATION)  
1250 BROADWAY, 30TH FLOOR  
NEW YORK, NY 10001

FOR: DISTRIBUTORSHIP OF PRE-PAID CALLING CARDS, IN CLASS 35 (U.S. CLS. 100, 101 AND 102).

FIRST USE 4-15-2004; IN COMMERCE 4-15-2004.

NO CLAIM IS MADE TO THE EXCLUSIVE RIGHT TO USE "DISTRIBUTION", APART FROM THE MARK AS SHOWN.

THE COLOR(S) YELLOW IS/ARE CLAIMED AS A FEATURE OF THE MARK.

THE MARK CONSISTS OF A TILTED YELLOW SQUARE.

SN 78-436,372, FILED 6-16-2004.

LAURA KOVALSKY, EXAMINING ATTORNEY

**Int. Cl.: 12**

**Prior U.S. Cls.: 19, 21, 23, 31, 35, and 44**

**Reg. No. 3,395,739**

**United States Patent and Trademark Office**

**Registered Mar. 11, 2008**

**TRADEMARK  
PRINCIPAL REGISTER**



YUSIN BRAKE CORP. (TAIWAN CORPORATION)  
1F, NO. 23, LANE 377, FANG-AN RD.  
CHIAYI CITY, TAIWAN

FOR: LAND VEHICLE PARTS, NAMELY, SHOCK ABSORBERS, BRAKE ASSEMBLIES, BRAKE ROTORS, BRAKE DRUMS, BRAKE SHOES, BRAKE LININGS, BRAKE MASTER CYLINDERS, BRAKE WHEEL CYLINDERS, BRAKE MASTER CYLINDER REPAIR KITS SOLD TOGETHER AS A UNIT, BRAKE HOSES, DISC BRAKE PADS, DISC BRAKE PLATES, DISC BRAKE REPAIR KITS SOLD TOGETHER AS A UNIT, ANTI-LOCK BRAKE SYSTEMS, CLUTCH MASTER CYLINDERS, CLUTCH OPERATING CYLINDERS, CLUTCH MASTER CYLINDER REPAIR KITS SOLD TOGETHER AS A UNIT,

CLUTCH OPERATING CYLINDER REPAIR KITS SOLD TOGETHER AS A UNIT, BRAKE CYLINDER RUBBER CUPS, AND BRAKE CYLINDER RUBBER BOOTS; AND HYDRAULIC BRAKE SYSTEMS FOR AUTOMOBILES, IN CLASS 12 (U.S. CLS. 19, 21, 23, 31, 35 AND 44).

FIRST USE 11-1-2007; IN COMMERCE 11-1-2007.

THE MARK CONSISTS IN PART OF THE STYLIZED LETTER "Y".

SN 78-437,269, FILED 6-17-2004.

MARY BOAGNI, EXAMINING ATTORNEY



**Int. Cl.: 42**

**Prior U.S. Cls.: 100 and 101**

**United States Patent and Trademark Office**

**Reg. No. 3,395,740**

**Registered Mar. 11, 2008**

**SERVICE MARK  
PRINCIPAL REGISTER**

**CROSSFINDER**

CREDIT SUISSE SECURITIES (USA) LLC (DELA-  
WARE LTD LIAB CO)  
ONE MADISON AVENUE  
NEW YORK, NY 10010

FOR: PROVIDING TEMPORARY USE OF NON-  
DOWNLOADABLE SOFTWARE FOR BROKERAGE  
SERVICES FOR AUTOMATIC MATCHING OF BUY-  
ERS AND SELLERS FOR TRADING OF SECURI-  
TIES, IN CLASS 42 (U.S. CLS. 100 AND 101).

FIRST USE 3-16-2005; IN COMMERCE 2-1-2007.

THE MARK CONSISTS OF STANDARD CHAR-  
ACTERS WITHOUT CLAIM TO ANY PARTICULAR  
FONT, STYLE, SIZE, OR COLOR.

SN 78-439,599, FILED 6-22-2004.

MICHAEL TANNER, EXAMINING ATTORNEY

**Int. Cl.: 28**

**Prior U.S. Cls.: 22, 23, 38, and 50**

**United States Patent and Trademark Office**

**Reg. No. 3,395,741**

**Registered Mar. 11, 2008**

**TRADEMARK  
PRINCIPAL REGISTER**



BOSS INTERNATIONAL LLC (COLORADO CORPORATION)  
1801 13TH ST., SUITE 306  
BOULDER, CO 80302

THE MARK CONSISTS OF STANDARD CHARACTERS WITHOUT CLAIM TO ANY PARTICULAR FONT, STYLE, SIZE, OR COLOR.

FOR: STEEL GOLF CLUB SHAFTS, IN CLASS 28 (U.S. CLS. 22, 23, 38 AND 50).

SN 78-440,291, FILED 6-23-2004.

FIRST USE 6-23-2004; IN COMMERCE 6-23-2004.

KIMBERLY FRYE, EXAMINING ATTORNEY

**Int. Cls.: 41 and 43**

**Prior U.S. Cls.: 100, 101, and 107**

**United States Patent and Trademark Office**

**Reg. No. 3,395,742**

**Registered Mar. 11, 2008**

**SERVICE MARK  
PRINCIPAL REGISTER**

**ER COMPASS**

EXCLUSIVE RESORTS, LLC (DELAWARE LTD  
LIAB CO)  
TOWER 3, SUITE 300, 1515 ARAPAHOE STREET  
DENVER, CO 80202

FOR: PROVIDING INFORMATION TO OTHERS  
VIA THE INTERNET REGARDING ENTERTAIN-  
MENT, SPORTING, AND CULTURAL ACTIVITIES  
AND EVENTS IN PARTICULAR GEOGRAPHIC  
AREAS; MAKING RESERVATIONS FOR OTHERS  
REGARDING ENTERTAINMENT, SPORTING,  
AND CULTURAL ACTIVITIES AND EVENTS IN  
PARTICULAR GEOGRAPHIC AREAS, IN CLASS 41  
(U.S. CLS. 100, 101 AND 107).

FIRST USE 1-0-2006; IN COMMERCE 1-0-2006.

FOR: PROVIDING INFORMATION TO OTHERS  
VIA THE INTERNET RELATED TO RESORT LOD-  
GING SERVICES, AMENITIES RELATED THERE-  
TO, AND THE AVAILABILITY THEREOF;

RESERVATION OF TEMPORARY LODGING AC-  
COMMODATIONS FOR TRAVELERS; PROVIDING  
INFORMATION TO OTHERS VIA THE INTERNET  
REGARDING RESTAURANTS, CLUBS, PUBS, AND  
OTHER ESTABLISHMENTS FOR THE CONSUMP-  
TION OF FOOD AND DRINK; PROVIDING INFOR-  
MATION VIA THE INTERNET TO MEMBERS  
REGARDING MEMBERSHIP IN A LUXURY RESI-  
DENCE CLUB, IN CLASS 43 (U.S. CLS. 100 AND 101).

FIRST USE 1-0-2006; IN COMMERCE 1-0-2006.

THE MARK CONSISTS OF STANDARD CHAR-  
ACTERS WITHOUT CLAIM TO ANY PARTICULAR  
FONT, STYLE, SIZE, OR COLOR.

SN 78-444,020, FILED 6-30-2004.

DAVID I, EXAMINING ATTORNEY

**Int. Cl.: 35**

**Prior U.S. Cls.: 100, 101, and 102**

**United States Patent and Trademark Office**

**Reg. No. 3,395,743**

**Registered Mar. 11, 2008**

**SERVICE MARK  
PRINCIPAL REGISTER**



CHINESE INFORMATION & NETWORKING AS-  
SOCIATION (CALIFORNIA NON-PROFIT AS-  
SOCIATION)

4675 STEVENS CREEK BLVD., SUITE 101  
SANTA CLARA, CA 95051

FOR: ASSOCIATION SERVICES, NAMELY, PRO-  
MOTING THE INTERESTS OF BUSINESS PROFES-  
SIONALS AND ENTREPRENEURS; ADVERTISING  
AGENCIES, NAMELY, PROMOTING THE GOODS  
AND SERVICES OF OTHERS IN THE U.S; AND  
AMONG ASIA PACIFIC RIM COUNTRIES IN THE  
FIELDS OF HIGH TECHNOLOGY, BIOTECHNOL-  
OGY, BIOINFORMATICS, COMPUTER SOFT-  
WARE, CONTENT AND MEDIA TECHNOLOGY,  
INFORMATION TECHNOLOGY, INTERNET IN-  
FORMATION TECHNOLOGY, COMPUTER AND  
COMMUNICATIONS NETWORKING; ARRAN-

GING AND CONDUCTING BUSINESS CONFEREN-  
CES; BUSINESS NETWORKING; PROVIDING  
FACILITIES FOR BUSINESS MEETINGS; ASSOCIA-  
TION SERVICES, NAMELY, PROMOTING COOP-  
ERATION AND COLLABORATION AMONG  
CHINESE BUSINESS PROFESSIONAL ASSOCIA-  
TIONS; CONSULTING SERVICES IN THE FIELD  
PROFESSIONAL CAREER DEVELOPMENT, IN  
CLASS 35 (U.S. CLS. 100, 101 AND 102).

FIRST USE 1-1-1993; IN COMMERCE 1-1-1993.

THE STIPPLING IS A FEATURE OF THE MARK.

SN 78-445,716, FILED 7-2-2004.

CURTIS FRENCH, EXAMINING ATTORNEY

Int. Cl.: 42

Prior U.S. Cls.: 100 and 101

United States Patent and Trademark Office

Reg. No. 3,395,744

Registered Mar. 11, 2008

SERVICE MARK  
PRINCIPAL REGISTER

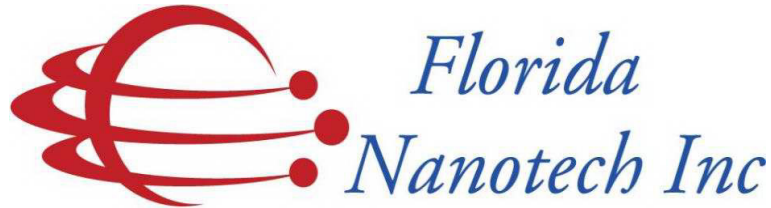

FLORIDA NANOTECH INC (FLORIDA CORPORATION)  
9815 WOODBAY DRIVE  
TAMPA, FL 33626

FOR: PROVIDING TECHNICAL INFORMATION VIA THE INTERNET ON THE SUBJECT OF NANOTECHNOLOGY; DESIGN AND TESTING FOR NEW PRODUCT DEVELOPMENT; DESIGN FOR OTHERS IN THE FIELD OF NANOTECHNOLOGY; RESEARCH AND DEVELOPMENT FOR NEW PRODUCTS FOR OTHERS; SCIENTIFIC RESEARCH; LICENSING OF INTELLECTUAL PROPERTY; TECHNICAL CONSULTATION AND RESEARCH IN THE FIELD OF NANOTECHNOLOGY; SCIENTIFIC RESEARCH AND DEVELOPMENT OF EQUIPMENT, PROCESSES, AND APPLICATIONS FOR OTHERS IN THE FIELD OF NANOTECHNOLOGY; DESIGN FOR OTHERS OF NANOTECHNOLOGY COMPONENTS, ASSEMBLERS AND NANO, MACRO AND MICRO DEVICES, IN CLASS 42 (U.S. CLS. 100 AND 101).

FIRST USE 1-1-2006; IN COMMERCE 1-1-2006.

NO CLAIM IS MADE TO THE EXCLUSIVE RIGHT TO USE "FLORIDA NANOTECH INC", APART FROM THE MARK AS SHOWN.

THE COLORS RED AND BLUE ARE CLAIMED AS A FEATURE OF THE MARK.

THE COLOR BLUE APPEARS IN THE WORDING "FLORIDA NANOTECH INC", AND THE COLOR RED APPEARS IN THE OUTLINE OF THE SPHERE DESIGN AND IN THE THREE DOTS REVOLVING AROUND THE SPHERE DESIGN OF THE MARK.

THE MARK CONSISTS OF AN OUTLINE OF A SPHERE IN THE COLOR RED WITH THREE RED DOTS REVOLVING AROUND THE SPHERE DESIGN, AND CONSISTS OF THE WORDING "FLORIDA NANOTECH INC".

SN 78-445,787, FILED 7-3-2004.

ANDREW RHIM, EXAMINING ATTORNEY

**Int. Cl.: 44**

**Prior U.S. Cls.: 100 and 101**

**United States Patent and Trademark Office**

**Reg. No. 3,395,745**

**Registered Mar. 11, 2008**

**SERVICE MARK  
PRINCIPAL REGISTER**

**Klynn Nichol,  
Psychotherapist**

HAZELTON, BRYAN C. (UNITED STATES INDIVIDUAL)  
2617 ROCKAWAY AVENUE  
OCEANSIDE, NY 11572

FOR: PROVIDING INFORMATION IN THE FIELD OF PSYCHOTHERAPEUTIC CONCEPTS VIA WEBSITES ON GLOBAL COMPUTER NETWORKS, IN CLASS 44 (U.S. CLS. 100 AND 101).

FIRST USE 5-4-2006; IN COMMERCE 5-4-2006.

THE MARK CONSISTS OF STANDARD CHARACTERS WITHOUT CLAIM TO ANY PARTICULAR FONT, STYLE, SIZE, OR COLOR.

NO CLAIM IS MADE TO THE EXCLUSIVE RIGHT TO USE "PSYCHOTHERAPIST", APART FROM THE MARK AS SHOWN.

THE NAME "KLYNN NICHOL" DOES NOT IDENTIFY A LIVING INDIVIDUAL.

SN 78-446,369, FILED 7-6-2004.

MICHAEL SOUDERS, EXAMINING ATTORNEY

**Int. Cl.: 10**

**Prior U.S. Cls.: 26, 39, and 44**

**United States Patent and Trademark Office**

**Reg. No. 3,395,746**

**Registered Mar. 11, 2008**

**TRADEMARK  
PRINCIPAL REGISTER**

**IVENA-CAP**

BENNETT, TIONNE A. (UNITED STATES INDIVIDUAL)

#3202

1371 S. WALNUT ST.  
ANAHEIM, CA 92802

FOR: CATHETER SECURING DEVICE, IN CLASS  
10 (U.S. CLS. 26, 39 AND 44).

FIRST USE 7-25-2007; IN COMMERCE 7-25-2007.

THE COLOR(S) BLUE AND BLACK IS/ARE  
CLAIMED AS A FEATURE OF THE MARK.

THE MARK CONSISTS OF THE MARK "IVENA-CAP" IS PRODUCED WITH: IV = BLUE ENA- = BLACK CAP = BLUE.

SN 78-447,957, FILED 7-8-2004.

MICHAEL WEBSTER, EXAMINING ATTORNEY

**Int. Cl.: 41**

**Prior U.S. Cls.: 100, 101, and 107**

**United States Patent and Trademark Office**

**Reg. No. 3,395,747**

**Registered Mar. 11, 2008**

**SERVICE MARK  
PRINCIPAL REGISTER**

# Word In Action

JACKSON II, WILEY (UNITED STATES INDIVIDUAL)  
277 CLIFTON STREET  
ATLANTA, GA 30317

FOR: ENTERTAINMENT, NAMELY, A CONTINUING RELIGIOUS SHOW BROADCAST OVER TELEVISION, SATELLITE, AUDIO, AND VIDEO MEDIA, IN CLASS 41 (U.S. CLS. 100, 101 AND 107).

FIRST USE 11-29-1987; IN COMMERCE 11-29-1987.

THE MARK CONSISTS OF STANDARD CHARACTERS WITHOUT CLAIM TO ANY PARTICULAR FONT, STYLE, SIZE, OR COLOR.

SN 78-452,288, FILED 7-17-2004.

ANGELA M. MICHELI, EXAMINING ATTORNEY



**Int. Cl.: 3**

**Prior U.S. Cls.: 1, 4, 6, 50, 51, and 52**

**United States Patent and Trademark Office**

**Reg. No. 3,395,748**

**Registered Mar. 11, 2008**

**TRADEMARK  
PRINCIPAL REGISTER**

**WHITE PERLE**

JEN USA INC. (DELAWARE CORPORATION)  
1280 JERSEY AVENUE  
NEW BRUNSWICK, NJ 08902

FOR: COLOR COSMETICS, NAMELY, LIPSTICKS, LIP LIPSTICK LINERS, LIP GLOSS, EYELINERS, EYE SHADOWS, BLUSHERS, FACE POWDERS, FOUNDATION, MASCARAS, NAIL POLISHES, EYEBROW PENCILS; SKIN TREATMENT PRODUCTS, NAMELY, CLEANSERS, TONERS, MOISTURIZERS, EYE CREAMS, HAND AND BODY LOTIONS, BODY AND SHOWER GELS, AND FACIAL SOAP, NAIL CARE PREPARATIONS AND NAIL POLISH REMOVERS; FRAGRANCE PRODUCTS, NAMELY, COLOGNE, PERFUME, TOILET WATER, SCENTED SOAPS, BODY POWDERS, BATH OILS; SUN SCREEN PREPARATIONS; HAIR CARE PRODUCTS, NAMELY, HAIR COLORING,

HAIR BLEACHES, HAIR LIGHTENERS, HIGHLIGHTING PREPARATIONS; SHAMPOOS; CONDITIONERS, HAIR COLORING STAIN REMOVERS; HAIR GELS, MOUSSES, HAIR SPRAYS AND STYLING LOTIONS, AND HAIR CARE PREPARATIONS, NAMELY, HAIR BODY AND ROOT LIFT GELS, IN CLASS 3 (U.S. CLS. 1, 4, 6, 50, 51 AND 52).

FIRST USE 12-8-2006; IN COMMERCE 12-8-2006.

THE MARK CONSISTS OF STANDARD CHARACTERS WITHOUT CLAIM TO ANY PARTICULAR FONT, STYLE, SIZE, OR COLOR.

SN 78-457,394, FILED 7-27-2004.

CHERYL CLAYTON, EXAMINING ATTORNEY

**Int. Cl.: 3**

**Prior U.S. Cls.: 1, 4, 6, 50, 51, and 52**

**United States Patent and Trademark Office**

**Reg. No. 3,395,749**

**Registered Mar. 11, 2008**

**TRADEMARK  
PRINCIPAL REGISTER**

**CLEAN SWEEP**

CONOPCO, INC. (NEW YORK CORPORATION)  
33 BENEDICT PLACE  
GREENWICH, CT 06830

FOR: FACIAL CLEANSING TOWELETTES, IN  
CLASS 3 (U.S. CLS. 1, 4, 6, 50, 51 AND 52).

FIRST USE 1-31-2004; IN COMMERCE 1-31-2004.

THE MARK CONSISTS OF STANDARD CHAR-  
ACTERS WITHOUT CLAIM TO ANY PARTICULAR  
FONT, STYLE, SIZE, OR COLOR.

OWNER OF U.S. REG. NO. 2,653,080.

SN 78-458,831, FILED 7-29-2004.

PATRICIA EVANKO, EXAMINING ATTORNEY

**Int. Cl.: 6**

**Prior U.S. Cls.: 2, 12, 13, 14, 23, 25, and 50**

**United States Patent and Trademark Office**

**Reg. No. 3,395,750**

**Registered Mar. 11, 2008**

**TRADEMARK  
PRINCIPAL REGISTER**

**ZINTRO**

IMSA-MEX, S.A. DE C.V. (MEXICO CORPORATION)  
AV. UNIVERSIDAD NO. 992 NTE.  
SAN NICOLAS DE LOS GARZA, N.L., MEXICO

FOR: BUILDING MATERIALS OF METAL, NAMELY, BUILDING PANELS, ROOFING, ROOFING TILES, DECKING, CEILING PANELS, FLOOR TILES, DOOR AND WINDOW FRAMES AND CASINGS, BOARDS FOR FLOORING, GIRDERS AND JOISTS; METAL LOAD BEARING CONSTRUCTIONS, NAMELY, FRAMEWORK FOR BUILDINGS, REINFORCING MATERIALS FOR BUILDINGS, BUILDING BOARDS, BUILDING PANELS, BUILDING LININGS, AND BUILDING WALL CLADDING; STEEL, UNWROUGHT AND PARTLY WROUGHT COMMON METALS AND THEIR ALLOYS AND STEEL IN THE FORM OF STRIPS, HOOPS, COILS, SHEETS, TUBES AND PLATES; ROLLED STEEL

SHEETS, COATED STEEL SHEETS, ALUMINIZED STEEL SHEETS, AND GALVANIZED STEEL SHEETS, IN CLASS 6 (U.S. CLS. 2, 12, 13, 14, 23, 25 AND 50).

FIRST USE 0-0-1999; IN COMMERCE 0-0-1999.

THE MARK CONSISTS OF STANDARD CHARACTERS WITHOUT CLAIM TO ANY PARTICULAR FONT, STYLE, SIZE, OR COLOR.

OWNER OF U.S. REG. NOS. 248,307, 2,646,895, AND OTHERS.

SN 78-464,382, FILED 8-9-2004.

ALICE SUE CARRUTHERS, EXAMINING ATTORNEY

**Int. Cl.: 43**

**Prior U.S. Cls.: 100 and 101**

**United States Patent and Trademark Office**

**Reg. No. 3,395,751**

**Registered Mar. 11, 2008**

**SERVICE MARK  
PRINCIPAL REGISTER**

**SAGE SIGNATURE  
SERVICE**

SAGE DINING SERVICES, INC. (DELAWARE CORPORATION)  
222 BOSLEY AVENUE  
TOWSON, MD 21204

FOR: DINING SERVICES, NAMELY, CATERING AND CONTRACT FOOD SERVICES OFFERED ON-SITE TO PUBLIC AND PRIVATE BUSINESSES AND INSTITUTIONS, IN CLASS 43 (U.S. CLS. 100 AND 101).

FIRST USE 1-31-2007; IN COMMERCE 1-31-2007.

THE MARK CONSISTS OF STANDARD CHARACTERS WITHOUT CLAIM TO ANY PARTICULAR FONT, STYLE, SIZE, OR COLOR.

OWNER OF U.S. REG. NOS. 2,467,001, 2,712,358, AND 2,733,649.

NO CLAIM IS MADE TO THE EXCLUSIVE RIGHT TO USE "SERVICE", APART FROM THE MARK AS SHOWN.

SN 78-465,097, FILED 8-10-2004.

TOBY BULLOFF, EXAMINING ATTORNEY

**Int. Cl.: 9**

**Prior U.S. Cls.: 21, 23, 26, 36, and 38**

**United States Patent and Trademark Office**

**Reg. No. 3,395,752**

**Registered Mar. 11, 2008**

**TRADEMARK  
PRINCIPAL REGISTER**

**MEXICO EN LA  
SANGRE**

UNIVISION COMMUNICATIONS INC. (DELA-  
WARE CORPORATION)  
5999 CENTER DRIVE  
LOS ANGELES, CA 90045

FOR: PHONOGRAPH RECORDS, SOUND RE-  
CORDINGS, COMPACT DISCS AND PRE-RECOR-  
DED CASSETTE TAPES ALL FEATURING MUSIC,  
IN CLASS 9 (U.S. CLS. 21, 23, 26, 36 AND 38).

FIRST USE 11-0-2004; IN COMMERCE 11-0-2004.

THE MARK CONSISTS OF STANDARD CHAR-  
ACTERS WITHOUT CLAIM TO ANY PARTICULAR  
FONT, STYLE, SIZE, OR COLOR.

THE FOREIGN WORDING IN THE MARK  
TRANSLATES INTO ENGLISH AS "MEXICO IN  
THE BLOOD".

SN 78-466,511, FILED 8-12-2004.

MATTHEW KLINE, EXAMINING ATTORNEY

**Int. Cl.: 41**

**Prior U.S. Cls.: 100, 101, and 107**

**United States Patent and Trademark Office**

**Reg. No. 3,395,753**

**Registered Mar. 11, 2008**

**SERVICE MARK  
PRINCIPAL REGISTER**

**jeli-deli**

SANTORO, LUCIO AND SANTORO, MEERA  
(UNITED KINGDOM PARTNERSHIP)  
ROTUNDA POINT 11 HARTFIELD CRESCENT  
11 HARTFIELD CRESCENT WIMBLEDON  
LONDON, UNITED KINGDOM SW19 3RL

FOR: ENTERTAINMENT SERVICES, NAMELY, THE PRODUCTION, RECORDING AND DISTRIBUTION OF MOTION PICTURE FILMS, RADIO AND TELEVISION PROGRAMS; PUBLICATION SERVICES, NAMELY, PUBLICATION OF BOOKS, MAGAZINES, JOURNALS, AND CARTOON STRIPS; MUSIC PUBLISHING SERVICES; RENTAL OF VIDEOTAPES, CINEMATOGRAPHIC FILMS, SOUND AND VIDEO RECORDINGS; PROVIDING INFORMATION VIA AN ELECTRONIC GLOBAL COMPUTER NETWORK IN THE FIELD OF ENTERTAINMENT RELATING SPECIFICALLY TO

MUSIC, MOVIES, AND TELEVISION; PROVIDING INFORMATION FOR AND ACTUAL ENTERTAINMENT VIA ELECTRONIC GLOBAL COMMUNICATIONS NETWORK IN THE NATURE OF ANIMATED PROGRAMS AND PRODUCTION OF ANIMATED MOTION FILMS FOR DISTRIBUTION VIA A GLOBAL COMPUTER NETWORK, IN CLASS 41 (U.S. CLS. 100, 101 AND 107).

FIRST USE 11-0-2003; IN COMMERCE 10-1-2007.

OWNER OF U.S. REG. NOS. 2,683,739, 2,768,185, AND 2,768,186.

SN 78-467,739, FILED 8-16-2004.

JASON LOTT, EXAMINING ATTORNEY

Int. Cl.: 41

Prior U.S. Cls.: 100, 101, and 107

United States Patent and Trademark Office

Reg. No. 3,395,754

Registered Mar. 11, 2008

SERVICE MARK  
PRINCIPAL REGISTER

*tutti cuti*

LUCIO SANTORO AND MEERA SANTORO  
PARTNERSHIP, THE (UNITED KINGDOM  
PARTNERSHIP)  
ROTUNDA POINT  
11 HARTFIELD CRESCENT WIMBLEDON  
LONDON, UNITED KINGDOM SW19 3RL

FOR: ENTERTAINMENT SERVICES, NAMELY,  
THE PRODUCTION, RECORDING AND DISTRIBUTION  
OF MOTION PICTURE FILMS, RADIO AND  
TELEVISION PROGRAMS; PUBLICATION SERVICES,  
NAMELY PUBLICATION OF BOOKS, MAGAZINES,  
JOURNALS, AND CARTOON STRIPS; MUSIC  
PUBLISHING SERVICES; RENTAL OF VIDEOTAPES,  
CINEMATOGRAPHIC FILMS, SOUND AND VIDEO  
RECORDINGS; PROVIDING INFORMATION VIA AN  
ELECTRONIC GLOBAL COMPUTER NETWORK IN THE  
FIELD OF ENTERTAINMENT RELATING SPECIFICALLY  
TO MUSIC, MOVIES, AND TELEVISION; PROVIDING

INFORMATION FOR AND ACTUAL ENTERTAINMENT  
VIA ELECTRONIC GLOBAL COMMUNICATIONS  
NETWORK IN THE NATURE OF ANIMATED  
PROGRAMS AND PRODUCTION OF ANIMATED  
MOTION FILMS FOR DISTRIBUTION VIA A  
GLOBAL COMPUTER NETWORK, IN CLASS 41  
(U.S. CLS. 100, 101 AND 107).

FIRST USE 10-0-2003; IN COMMERCE 10-14-2007.

OWNER OF U.S. REG. NOS. 2,780,665, 2,830,740,  
AND 2,899,753.

THE ENGLISH TRANSLATION OF THE WORD  
"TUTTI" IN THE MARK IS "ALL".

SN 78-467,741, FILED 8-16-2004.

JASON LOTT, EXAMINING ATTORNEY

**Int. Cl.: 35**

**Prior U.S. Cls.: 100, 101, and 102**

**United States Patent and Trademark Office**

**Reg. No. 3,395,755**

**Registered Mar. 11, 2008**

**SERVICE MARK  
PRINCIPAL REGISTER**

**WE MAKE IT EASIER**

HANCOCK LUMBER COMPANY, INC. (MAINE CORPORATION)  
PO BOX 299  
CASCO, ME 04015

FOR: RETAIL STORE SERVICES FEATURING LUMBER, LUMBER SHAVINGS, SAW DUST AND BARK MULCH, A VARIETY OF KITCHEN AND BATHROOM MATERIALS AND APPLIANCES, FLOORING, WINDOWS, DOORS AND OTHER BUILDING MATERIALS, PLUMBING SUPPLIES, ROOFING MATERIALS, DOCK SYSTEMS AND ITEMS USED IN HOME BUILDING, REMODELING

AND/OR IMPROVEMENT, IN CLASS 35 (U.S. CLS. 100, 101 AND 102).

FIRST USE 12-31-2004; IN COMMERCE 12-31-2004.

THE MARK CONSISTS OF STANDARD CHARACTERS WITHOUT CLAIM TO ANY PARTICULAR FONT, STYLE, SIZE, OR COLOR.

SN 78-469,805, FILED 8-18-2004.

MICHAEL TANNER, EXAMINING ATTORNEY



**Int. Cl.: 10**

**Prior U.S. Cls.: 26, 39, and 44**

**United States Patent and Trademark Office**

**Reg. No. 3,395,756**

**Registered Mar. 11, 2008**

**TRADEMARK  
PRINCIPAL REGISTER**

**HANCOCK II ULTRA**

MEDTRONIC, INC. (MINNESOTA CORPORATION)  
710 MEDTRONIC PARKWAY  
MINNEAPOLIS, MN 554325604

FOR: HEART VALVE BIOPROSTHESES AND INSTRUMENTS FOR USE THEREWITH, NAMELY, OBTURATOR, TROCAR AND TROCAR BLADES, IN CLASS 10 (U.S. CLS. 26, 39 AND 44).

FIRST USE 3-20-2006; IN COMMERCE 3-20-2006.

THE MARK CONSISTS OF STANDARD CHARACTERS WITHOUT CLAIM TO ANY PARTICULAR FONT, STYLE, SIZE, OR COLOR.

OWNER OF U.S. REG. NO. 1,178,981.

SN 78-470,219, FILED 8-19-2004.

MIDGE BUTLER, EXAMINING ATTORNEY

**Int. Cl.: 20**

**Prior U.S. Cls.: 2, 13, 22, 25, 32, and 50**

**United States Patent and Trademark Office**

**Reg. No. 3,395,757**

**Registered Mar. 11, 2008**

**TRADEMARK  
PRINCIPAL REGISTER**



IDEASTREAM CONSUMER PRODUCTS, LLC  
(DELAWARE LTD LIAB CO)  
4011 BROOKPARK ROAD  
PARMA, OH 44134

FOR: OFFICE STORAGE CONTAINERS, NAME-  
LY, NON-METAL MONEY BOXES AND NON-ME-  
TAL CRAFT BOXES; AND NON-METAL

CONTAINERS FOR FIRST-AID KITS SOLD EMPTY  
, IN CLASS 20 (U.S. CLS. 2, 13, 22, 25, 32 AND 50).

FIRST USE 2-28-2003; IN COMMERCE 2-28-2003.

SN 78-474,306, FILED 8-26-2004.

DORITT L. CARROLL, EXAMINING ATTORNEY

**Int. Cls.: 8, 11, 14, and 21**

**Prior U.S. Cls.: 2, 13, 21, 23, 27, 28, 29, 30, 31, 33, 34, 40, 44, and 50**

**Reg. No. 3,395,758**

**United States Patent and Trademark Office**

**Registered Mar. 11, 2008**

**TRADEMARK  
PRINCIPAL REGISTER**



XINHUI RI XING STAINLESS STEEL PRODUCTS COMPANY LIMITED (CHINA LIMITED COMPANY)

SIQIAN QIANFENG INDUSTRY DEVELOPING DISTRICT, XINHUI DISTRICT  
JIANGMEN CITY, GUANGDONG PROVINCE, CHINA

FOR: CUTLERY, NAMELY, FORKS, KNIVES, NAMELY, CHEFS' KNIVES AND KITCHEN KNIVES, SPOONS, ALL OF PRECIOUS METAL, NON-ELECTRIC CAN OPENERS, IN CLASS 8 (U.S. CLS. 23, 28 AND 44).

FIRST USE 10-31-2003; IN COMMERCE 10-31-2004.

FOR: ELECTRIC COOKWARE, NAMELY, RICE COOKERS, PRESSURE COOKERS, PASTA COOKERS, STOVES, COFFEE MAKERS, TOASTERS, MICROWAVE OVENS FOR INDUSTRIAL USE, MICROWAVE OVENS FOR COOKING, INDUCTION COOKERS, BROILERS AND ROASTERS, OVENS, NAMELY, BAKING OVENS AND TOASTER OVENS, ELECTRIC KETTLES, ELECTRIC FRYING PANS, IN CLASS 11 (U.S. CLS. 13, 21, 23, 31 AND 34).

FIRST USE 10-31-2003; IN COMMERCE 10-31-2004.

FOR: COOKWARE, NAMELY, POTS AND PANS, ALL OF PRECIOUS METAL, IN CLASS 14 (U.S. CLS. 2, 27, 28 AND 50).

FIRST USE 10-31-2003; IN COMMERCE 10-31-2004.

FOR: COOKWARE, NAMELY, POTS AND PANS, BAKEWARE, KITCHENWARE AND HOUSEHOLD UTENSILS, NAMELY, WHISKS, SPATULAS, SERVING SPOONS, LADLES, MASHERS, SPAGHETTI SERVERS, ROLLING PINS, CUTTING BOARDS, BOWL SETS, PLATES, FUNNELS, GARLIC PRESSES, VEGETABLE AND CHEESE GRATERS, STRAINERS, CONTAINERS FOR HOUSEHOLD OR KITCHEN USE NOT OF PRECIOUS METAL, NON-ELECTRIC KETTLES, STOCKPOTS, CASSEROLES, SAUCEPANS, NON-ELECTRIC FRYING PANS, PLATES, DRINKING GLASSES, IN CLASS 21 (U.S. CLS. 2, 13, 23, 29, 30, 33, 40 AND 50).

FIRST USE 10-31-2003; IN COMMERCE 10-31-2004.

PRIORITY CLAIMED UNDER SEC. 44(D) ON CANADA APPLICATION NO. 121923700, FILED 6-4-2004.

THE MARK CONSISTS OF THE WORD "HOMICHEF" UNDERNEATH THREE SIDEWAYS V-SHAPED LINES AND ONE HORIZONTAL LINE.

SN 78-475,368, FILED 8-29-2004.

STEPHANIE ALI, EXAMINING ATTORNEY

**Int. Cls.: 9 and 42**

**Prior U.S. Cls.: 21, 23, 26, 36, 38, 100, and 101**

**United States Patent and Trademark Office**

**Reg. No. 3,395,759**

**Registered Mar. 11, 2008**

**TRADEMARK  
SERVICE MARK  
PRINCIPAL REGISTER**

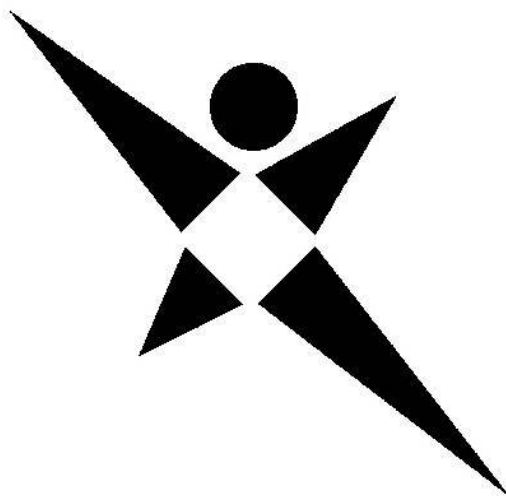

WEST CORPORATION (DELAWARE CORPORATION)  
11808 MIRACLE HILLS DRIVE  
OMAHA, NE 68154

FOR: COMPUTER SOFTWARE AND PLATFORMS FOR PERFORMING WORKFORCE MANAGEMENT, NAMELY, FOR COMPUTING THE OPTIMAL NUMBER OF TELESERVICES AGENT POSITIONS TO STAFF DURING A PREDEFINED OPERATIONS PERIOD BASED ON CALL VOLUME ANTICIPATED FOR THAT PERIOD, FOR SCHEDULING AGENTS TO FILL THOSE POSITIONS DURING THAT PERIOD, FOR DISSEMINATING SCHEDULES TO THOSE AGENTS, FOR FACILITATING AGENTS' TRADING OF SHIFTS AND VOLUNTEERING FOR ADDITIONAL OR REDUCED HOURS, FOR INCENTIVISING AGENTS TO ACCEPT ADDITIONAL SHIFTS, AND FOR MONITORING ADHERENCE OF SUCH AGENTS TO THEIR ASSIGNED SHIFT, GATHERING AND

REPORTING ON CALL STATISTICS, FORECASTING STAFFING LEVEL REQUIREMENTS, MONITORING AND REPORTING ON SCHEDULE ADHERENCE, SCHEDULING AND RECORDING STAFF TRAINING EVENTS, ENABLING STAFF TO SIGN UP FOR EXTRA HOURS AND/OR DOWNTIME, AND ENABLING STAFF TO TRADE SHIFTS WITH EACH OTHER, IN CLASS 9 (U.S. CLS. 21, 23, 26, 36 AND 38).

FIRST USE 12-31-1994; IN COMMERCE 2-28-2007.

FOR: INTERNET WEB SITE HOSTING SERVICES, IN CLASS 42 (U.S. CLS. 100 AND 101).

FIRST USE 12-31-1994; IN COMMERCE 2-28-2007.

SN 78-477,233, FILED 9-1-2004.

JANICE L. MCMORROW, EXAMINING ATTORNEY

**Int. Cl.: 41**

**Prior U.S. Cls.: 100, 101, and 107**

**United States Patent and Trademark Office**

**Reg. No. 3,395,760**

**Registered Mar. 11, 2008**

**SERVICE MARK  
PRINCIPAL REGISTER**

**COGNIFIT**

COGNIFIT LTD. (ISRAEL CORPORATION)  
AREA 7  
BUILDING 1  
YOQNEAM ILIT, ISRAEL 26902

FOR: EDUCATIONAL TRAINING SERVICES,  
NAMELY, PROVIDING WORKSHOPS IN THE  
FIELD OF ASSESSING, TRAINING, IMPROVING  
AND TESTING COGNITIVE SKILLS, IN CLASS 41  
(U.S. CLS. 100, 101 AND 107).

FIRST USE 10-31-2007; IN COMMERCE 10-31-2007.

THE MARK CONSISTS OF STANDARD CHAR-  
ACTERS WITHOUT CLAIM TO ANY PARTICULAR  
FONT, STYLE, SIZE, OR COLOR.

SN 78-482,217, FILED 9-13-2004.

LA TONIA FISHER, EXAMINING ATTORNEY

**Int. Cl.: 41**

**Prior U.S. Cls.: 100, 101, and 107**

**United States Patent and Trademark Office**

**Reg. No. 3,395,761**

**Registered Mar. 11, 2008**

**SERVICE MARK  
PRINCIPAL REGISTER**

**STEAL THAT STYLE**

CBS STUDIOS INC. (DELAWARE CORPORATION)  
51 WEST 52ND STREET  
NEW YORK, NY 10019

THE MARK CONSISTS OF STANDARD CHARACTERS WITHOUT CLAIM TO ANY PARTICULAR FONT, STYLE, SIZE, OR COLOR.

FOR: ENTERTAINMENT IN THE NATURE OF AN ONGOING TELEVISION SEGMENT OF A TELEVISION SERIES DEVOTED TO ENTERTAINMENT NEWS, IN CLASS 41 (U.S. CLS. 100, 101 AND 107).

SN 78-483,493, FILED 9-14-2004.

FIRST USE 9-20-2004; IN COMMERCE 9-20-2004.

MICHELLE DUBOIS, EXAMINING ATTORNEY

**Int. Cls.: 7 and 11**

**Prior U.S. Cls.: 13, 19, 21, 23, 31, 34, and 35**

**United States Patent and Trademark Office**

**Reg. No. 3,395,762**

**Registered Mar. 11, 2008**

**TRADEMARK  
PRINCIPAL REGISTER**

**HOYER DEEPBLUE**

TETRA LAVAL HOLDINGS & FINANCE S.A.  
(SWITZERLAND CORPORATION)  
AVENUE GÉNÉRAL-GUISAN  
70 CH-1009  
PULLY, SWITZERLAND

FOR: MACHINES AND EQUIPMENT FOR THE  
PRODUCTION OF FOOD PRODUCTS, NAMELY,  
FILLING MACHINES, EXTRUSION MACHINES, IN  
CLASS 7 (U.S. CLS. 13, 19, 21, 23, 31, 34 AND 35).

FIRST USE 12-31-2003; IN COMMERCE 5-31-2005.

FOR: FREEZERS, IN CLASS 11 (U.S. CLS. 13, 21, 23,  
31 AND 34).

FIRST USE 12-31-2003; IN COMMERCE 5-31-2005.

THE MARK CONSISTS OF STANDARD CHAR-  
ACTERS WITHOUT CLAIM TO ANY PARTICULAR  
FONT, STYLE, SIZE, OR COLOR.

SN 78-483,844, FILED 9-15-2004.

NICHOLAS ALTREE, EXAMINING ATTORNEY

**Int. Cl.: 9**

**Prior U.S. Cls.: 21, 23, 26, 36, and 38**

**United States Patent and Trademark Office**

**Reg. No. 3,395,763**

**Registered Mar. 11, 2008**

---

**TRADEMARK  
PRINCIPAL REGISTER**

**SEASIDE FRIES**

IGT (NEVADA CORPORATION)  
9295 PROTOTYPE DRIVE  
RENO, NV 895218986

THE MARK CONSISTS OF STANDARD CHAR-  
ACTERS WITHOUT CLAIM TO ANY PARTICULAR  
FONT, STYLE, SIZE, OR COLOR.

FOR: GAMING MACHINES, NAMELY, DEVICES  
WHICH ACCEPT A WAGER, IN CLASS 9 (U.S. CLS.  
21, 23, 26, 36 AND 38).

SN 78-485,068, FILED 9-16-2004.

FIRST USE 10-23-2006; IN COMMERCE 1-23-2007.

WON TEAK OH, EXAMINING ATTORNEY



**Int. Cls.: 18, 20, 24, 25, and 28**

**Prior U.S. Cls.: 1, 2, 3, 13, 22, 23, 25, 32, 38, 39, 41, 42,  
and 50**

**Reg. No. 3,395,764**

**United States Patent and Trademark Office**

**Registered Mar. 11, 2008**

**TRADEMARK  
PRINCIPAL REGISTER**

**KING OF BUCKS**

BASS PRO TRADEMARKS, L.L.C. (MISSOURI  
LTD LIAB CO)  
2500 EAST KEARNEY  
SPRINGFIELD, MO 65898

FOR: WALLETTS, IN CLASS 18 (U.S. CLS. 1, 2, 3, 22  
AND 41).

FIRST USE 10-0-2007; IN COMMERCE 10-0-2007.

FOR: PILLOWS, IN CLASS 20 (U.S. CLS. 2, 13, 22,  
25, 32 AND 50).

FIRST USE 10-0-2005; IN COMMERCE 10-0-2005.

FOR: BED BLANKETS AND THROWS, IN CLASS  
24 (U.S. CLS. 42 AND 50).

FIRST USE 9-0-2005; IN COMMERCE 9-0-2005.

FOR: MEN'S APPAREL, NAMELY, T-SHIRTS,  
CAPS, AND CASUAL SPORTSHIRTS, IN CLASS 25  
(U.S. CLS. 22 AND 39).

FIRST USE 8-0-2005; IN COMMERCE 8-0-2005.

FOR: CHRISTMAS TREE ORNAMENTS, IN  
CLASS 28 (U.S. CLS. 22, 23, 38 AND 50).

FIRST USE 10-0-2007; IN COMMERCE 10-0-2007.

THE MARK CONSISTS OF STANDARD CHAR-  
ACTERS WITHOUT CLAIM TO ANY PARTICULAR  
FONT, STYLE, SIZE, OR COLOR.

OWNER OF U.S. REG. NO. 2,120,188.

SN 78-485,228, FILED 9-17-2004.

DORITT L. CARROLL, EXAMINING ATTORNEY

**Int. Cls.: 37 and 42**

**Prior U.S. Cls.: 100, 101, 103, and 106**

**United States Patent and Trademark Office**

**Reg. No. 3,395,765**

**Registered Mar. 11, 2008**

**SERVICE MARK  
PRINCIPAL REGISTER**

**HP BLADESYSTEM**

HEWLETT-PACKARD DEVELOPMENT COMPAN-  
NY, L.P. (TEXAS LIMITED PARTNERSHIP)  
20555 STATE HIGHWAY 249  
HOUSTON, TX 77070

FOR: INSTALLATION, MAINTENANCE AND  
REPAIR OF COMPUTER HARDWARE, IN CLASS  
37 (U.S. CLS. 100, 103 AND 106).

FIRST USE 5-14-2007; IN COMMERCE 5-14-2007.

FOR: TECHNICAL CONSULTING SERVICES IN  
THE FIELD OF COMPUTER HARDWARE AND  
COMPUTER SOFTWARE; INSTALLATION, MAIN-  
TENANCE AND REPAIR OF COMPUTER SOFT-  
WARE, IN CLASS 42 (U.S. CLS. 100 AND 101).

FIRST USE 5-14-2007; IN COMMERCE 5-14-2007.

THE MARK CONSISTS OF STANDARD CHAR-  
ACTERS WITHOUT CLAIM TO ANY PARTICULAR  
FONT, STYLE, SIZE, OR COLOR.

OWNER OF U.S. REG. NOS. 643,882, 862,308, AND  
OTHERS.

NO CLAIM IS MADE TO THE EXCLUSIVE  
RIGHT TO USE "BLADESYSTEM" , APART FROM  
THE MARK AS SHOWN.

SN 78-487,571, FILED 9-22-2004.

ELISSA GARBER KON, EXAMINING ATTORNEY

**Int. Cl.: 6**

**Prior U.S. Cls.: 2, 12, 13, 14, 23, 25, and 50**

**Reg. No. 3,395,766**

**United States Patent and Trademark Office**

**Registered Mar. 11, 2008**

**TRADEMARK  
PRINCIPAL REGISTER**

**ALERIS**

COMMONWEALTH INDUSTRIES, INC. (DELA-  
WARE CORPORATION)  
PNC PLAZA - 19TH FLOOR  
500 W. JEFFERSON STREET  
LOUISVILLE, KY 402022823

FOR: ALUMINUM AND ZINC METAL IN INGOT  
OR MOLTEN FORM; AND ALUMINUM AND ALU-  
MINUM ALLOYS SOLD IN COILS, ROLLS, AND  
SHEETS FOR USE BY CUSTOMERS IN THE ALU-  
MINUM INDUSTRY, INCLUDING BUILDING,  
CONSUMER DURABLES, AUTOMOTIVE, ELEC-  
TRICAL, PACKAGING, TRANSPORTATION, AND

FOOD AND BEVERAGE SECTORS, IN CLASS 6 (U.S.  
CLS. 2, 12, 13, 14, 23, 25 AND 50).

FIRST USE 12-9-2004; IN COMMERCE 12-9-2004.

THE MARK CONSISTS OF STANDARD CHAR-  
ACTERS WITHOUT CLAIM TO ANY PARTICULAR  
FONT, STYLE, SIZE, OR COLOR.

SN 78-487,642, FILED 9-22-2004.

KIMBERLY FRYE, EXAMINING ATTORNEY

**Int. Cl.: 40**

**Prior U.S. Cls.: 100, 103, and 106**

**United States Patent and Trademark Office**

**Reg. No. 3,395,767**

**Registered Mar. 11, 2008**

**SERVICE MARK  
PRINCIPAL REGISTER**

**ALERIS**

COMMONWEALTH INDUSTRIES, INC. (DELA-  
WARE CORPORATION)  
PNC PLAZA - 19TH FLOOR  
500 W. JEFFERSON STREET  
LOUISVILLE, KY 402022823

FOR: RECYCLING SERVICES; TREATMENT  
AND PROCESSING OF ALUMINUM AND ZINC  
ALLOYS; MANUFACTURE OF ALUMINUM PRO-  
DUCTS, NAMELY, ALUMINUM AND ALUMINUM  
ALLOYS SOLD IN COILS, ROLLS, AND SHEETS  
FOR USE BY CUSTOMERS IN THE ALUMINUM  
INDUSTRY, INCLUDING BUILDING, CONSUMER  
DURABLE, AUTOMOTIVE, ELECTRICAL, PACKA-

GING, TRANSPORTATION, AND FOOD AND BEV-  
ERAGE SECTORS, TO THE SPECIFICATION OF  
OTHERS, IN CLASS 40 (U.S. CLS. 100, 103 AND 106).

FIRST USE 12-9-2004; IN COMMERCE 12-9-2004.

THE MARK CONSISTS OF STANDARD CHAR-  
ACTERS WITHOUT CLAIM TO ANY PARTICULAR  
FONT, STYLE, SIZE, OR COLOR.

SN 78-487,646, FILED 9-22-2004.

KIMBERLY FRYE, EXAMINING ATTORNEY

**Int. Cl.: 28**

**Prior U.S. Cls.: 22, 23, 38, and 50**

**United States Patent and Trademark Office**

**Reg. No. 3,395,768**

**Registered Mar. 11, 2008**

**TRADEMARK  
PRINCIPAL REGISTER**

**HOOK IT UP**

HOOK IT UP, INC. (UTAH CORPORATION)  
2594 SOUTH 500 EAST  
VERNAL, UT 84078

THE MARK CONSISTS OF STANDARD CHARACTERS WITHOUT CLAIM TO ANY PARTICULAR FONT, STYLE, SIZE, OR COLOR.

FOR: CHRISTMAS TREE ORNAMENTS, NAME-  
LY, DECORATIVE HOOKS FOR CHRISTMAS OR-  
NAMENTS, IN CLASS 28 (U.S. CLS. 22, 23, 38 AND  
50).

SN 78-490,788, FILED 9-28-2004.

FIRST USE 10-0-2004; IN COMMERCE 10-0-2004.

BERYL GARDNER, EXAMINING ATTORNEY

**Int. Cl.: 9**

**Prior U.S. Cls.: 21, 23, 26, 36, and 38**

**United States Patent and Trademark Office**

**Reg. No. 3,395,769**

**Registered Mar. 11, 2008**

**TRADEMARK  
PRINCIPAL REGISTER**

**WHOLE LOTTA KENO**

SPIELO MANUFACTURING ULC (CANADA CORPORATION)

328 URQUHART AVENUE

MONCTON, NEW BRUNSWICK, CANADA E1H 2R6

FOR: RECONFIGURABLE CASINO AND LOTTERY GAMING EQUIPMENT, NAMELY, SLOT MACHINES, AND OPERATIONAL COMPUTER GAME SOFTWARE THEREFOR, IN CLASS 9 (U.S. CLS. 21, 23, 26, 36 AND 38).

FIRST USE 3-17-2004; IN COMMERCE 3-17-2004.

THE MARK CONSISTS OF STANDARD CHARACTERS WITHOUT CLAIM TO ANY PARTICULAR FONT, STYLE, SIZE, OR COLOR.

NO CLAIM IS MADE TO THE EXCLUSIVE RIGHT TO USE "KENO", APART FROM THE MARK AS SHOWN.

THE WORDING "KENO" HAS NO MEANING IN A FOREIGN LANGUAGE.

SN 78-492,031, FILED 9-30-2004.

PRISCILLA MILTON, EXAMINING ATTORNEY

**Int. Cls.: 25 and 41**

**Prior U.S. Cls.: 22, 39, 100, 101, and 107**

**United States Patent and Trademark Office**

**Reg. No. 3,395,770**

**Registered Mar. 11, 2008**

**TRADEMARK  
SERVICE MARK  
PRINCIPAL REGISTER**

# The Mamasitas

MAMASITAS TENNESSEE PARTNERSHIP (TENNESSEE PARTNERSHIP)  
110 MIDDLETON CIRCLE  
NASHVILLE, TN 37215

FOR: MERCHANDISE, CLOTHING, AND OTHER WEARABLES THAT ARE COMMONLY ASSOCIATED WITH RECORDING ARTISTS, NAMELY, T-SHIRTS, TANK TOPS, CLOTHING CAPS AND HATS, SWEATSHIRTS, JACKETS, UNDERWEAR, LINGERIE, PANTIES, SHORTS, CLOTHING TOPS, SWEATERS, BANDANAS, PAJAMAS, IN CLASS 25 (U.S. CLS. 22 AND 39).

FIRST USE 3-1-2004; IN COMMERCE 7-1-2005.

FOR: ENTERTAINMENT IN THE NATURE OF LIVE MUSICAL PERFORMANCES; ENTERTAINMENT IN THE NATURE OF VISUAL AND AUDIO PERFORMANCES; ENTERTAINMENT, NAMELY, LIVE MUSIC CONCERTS, PERSONAL APPEARANCES BY ARTISTS AND MUSICIANS; ENTERTAINMENT SERVICES, NAMELY, PROVIDING MUSIC,

VIDEOS, INTERVIEWS, GAMES, MEMORABILIA, PHOTOGRAPHS, INTERACTIVE FAN SERVICES, COMMENTARY, INFORMATION AND GENERAL ENTERTAINMENT BY MEANS OF WEBSITES, SATELLITE, COMPUTER NETWORKS, THE INTERNET, WIRELESS DEVICES, AND OTHER MEANS OF COMMUNICATION, IN CLASS 41 (U.S. CLS. 100, 101 AND 107).

FIRST USE 10-1-2005; IN COMMERCE 10-1-2005.

THE MARK CONSISTS OF STANDARD CHARACTERS WITHOUT CLAIM TO ANY PARTICULAR FONT, STYLE, SIZE, OR COLOR.

THE SLANG TRANSLATION OF MAMASITAS IS PRETTY LADIES, WHILE THE LITERAL TRANSLATION IS LITTLE MOTHERS.

SN 78-492,910, FILED 10-1-2004.

BRIAN PINO, EXAMINING ATTORNEY

**Int. Cl.: 28**

**Prior U.S. Cls.: 22, 23, 38, and 50**

**United States Patent and Trademark Office**

**Reg. No. 3,395,771**

**Registered Mar. 11, 2008**

**TRADEMARK  
PRINCIPAL REGISTER**

**WordSlam!**

FASIG, MICHAEL W. (UNITED STATES INDIVIDUAL)  
1909 STEUBEN ROAD  
READING, PA 19602

THE MARK CONSISTS OF STANDARD CHARACTERS WITHOUT CLAIM TO ANY PARTICULAR FONT, STYLE, SIZE, OR COLOR.

FOR: CARD GAMES, IN CLASS 28 (U.S. CLS. 22, 23, 38 AND 50).

SN 78-494,283, FILED 10-4-2004.

FIRST USE 11-27-2007; IN COMMERCE 11-27-2007.

DARRYL SPRUILL, EXAMINING ATTORNEY



**Int. Cl.: 6**

**Prior U.S. Cls.: 2, 12, 13, 14, 23, 25, and 50**

**United States Patent and Trademark Office**

**Reg. No. 3,395,772**

**Registered Mar. 11, 2008**

**TRADEMARK  
PRINCIPAL REGISTER**

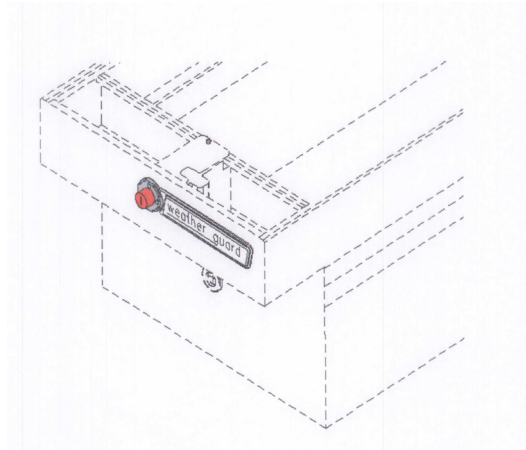

KNAACK LLC (DELAWARE LTD LIAB CO)  
420 E. TERRA COTTA AVENUE  
CRYSTAL LAKE, IL 60014

FOR: STORAGE UNITS MADE OF METAL, IN  
CLASS 6 (U.S. CLS. 2, 12, 13, 14, 23, 25 AND 50).

FIRST USE 10-31-2004; IN COMMERCE 10-31-2004.

OWNER OF U.S. REG. NOS. 1,661,625 AND  
1,663,369.

THE COLOR(S) RED AND SILVER IS/ARE  
CLAIMED AS A FEATURE OF THE MARK.

THE MARK CONSISTS OF RED AND SILVER AS  
APPLIED TO A PUSHBUTTON OF A LOCK ON A  
STORAGE UNIT MADE OF METAL, THE PUSH-  
BUTTON LOCATED ADJACENT TO THE WORD-  
ING "WEATHER GUARD". THE DOTTED  
OUTLINE OF THE GOODS IS INTENDED TO SHOW  
THE POSITION OF THE MARK AND IS NOT PART  
OF THE MARK AS SHOWN.

SEC. 2(F).

SN 78-494,540, FILED 10-5-2004.

ARETHA SOMERVILLE, EXAMINING ATTORNEY

**Int. Cl.: 25**

**Prior U.S. Cls.: 22 and 39**

**United States Patent and Trademark Office**

**Reg. No. 3,395,773**

**Registered Mar. 11, 2008**

**TRADEMARK  
PRINCIPAL REGISTER**

**RIVERTEK**

SIMMS FISHING PRODUCTS LLC (DELAWARE  
LTD LIAB CO)  
101 EVERGREEN DRIVE  
BOZEMAN, MT 59715

THE MARK CONSISTS OF STANDARD CHAR-  
ACTERS WITHOUT CLAIM TO ANY PARTICULAR  
FONT, STYLE, SIZE, OR COLOR.

FOR: CLOTHING, NAMELY, RAINWEAR, IN  
CLASS 25 (U.S. CLS. 22 AND 39).

SN 78-495,896, FILED 10-6-2004.

FIRST USE 12-28-2005; IN COMMERCE 12-28-2005.

JOHN WILKE, EXAMINING ATTORNEY

**Int. Cl.: 35**

**Prior U.S. Cls.: 100, 101, and 102**

**United States Patent and Trademark Office**

**Reg. No. 3,395,774**

**Registered Mar. 11, 2008**

**SERVICE MARK  
PRINCIPAL REGISTER**

**FIRST SUPPORT SERVICES**



FIRSTGROUP AMERICA, INC. (FLORIDA CORPORATION)  
ONE CENTENNIAL PLAZA, SUITE 500  
705 CENTRAL AVENUE  
CINCINNATI, OH 45202

FIRST USE 10-1-2004; IN COMMERCE 10-1-2004.

OWNER OF U.S. REG. NOS. 2,615,040, 2,813,786,  
AND OTHERS.

FOR: BUSINESS MANAGEMENT OF VEHICLE FLEETS AND VEHICLE FLEET FACILITIES; CONSULTING SERVICES IN THE FIELD OF BUSINESS MANAGEMENT FOR VEHICLE FLEETS AND VEHICLE FLEET FACILITIES; AND CONSULTING SERVICES IN THE FIELD OF BUSINESS MANAGEMENT OF TELECOMMUNICATIONS SYSTEMS FOR VEHICLE FLEETS, IN CLASS 35 (U.S. CLS. 100, 101 AND 102).

NO CLAIM IS MADE TO THE EXCLUSIVE RIGHT TO USE "SUPPORT SERVICES", APART FROM THE MARK AS SHOWN.

SN 78-498,263, FILED 10-12-2004.

ALEXANDER L. POWERS, EXAMINING ATTORNEY

**Int. Cl.: 9**

**Prior U.S. Cls.: 21, 23, 26, 36, and 38**

**United States Patent and Trademark Office**

**Reg. No. 3,395,775**

**Registered Mar. 11, 2008**

**TRADEMARK  
PRINCIPAL REGISTER**

**BIG X WILD**

WMS GAMING INC. (DELAWARE CORPORATION)  
800 SOUTH NORTHPOINT BOULEVARD  
WAUKEGAN, IL 60085

THE MARK CONSISTS OF STANDARD CHARACTERS WITHOUT CLAIM TO ANY PARTICULAR FONT, STYLE, SIZE, OR COLOR.

FOR: GAMING MACHINES, IN CLASS 9 (U.S. CLS. 21, 23, 26, 36 AND 38).

SN 78-499,065, FILED 10-13-2004.

FIRST USE 11-13-2007; IN COMMERCE 11-13-2007.

NAAKWAMA ANKRAH, EXAMINING ATTORNEY

**Int. Cl.: 16**

**Prior U.S. Cls.: 2, 5, 22, 23, 29, 37, 38, and 50**

**United States Patent and Trademark Office**

**Reg. No. 3,395,776**

**Registered Mar. 11, 2008**

**TRADEMARK  
PRINCIPAL REGISTER**

**SNAP-N-STORE**

IDEASTREAM CONSUMER PRODUCTS, LLC  
(DELAWARE LTD LIAB CO)  
4011 BROOKPARK ROAD  
PARMA, OH 44134

THE MARK CONSISTS OF STANDARD CHAR-  
ACTERS WITHOUT CLAIM TO ANY PARTICULAR  
FONT, STYLE, SIZE, OR COLOR.

FOR: INCLINED DOCUMENT SEPARATORS;  
AND DESK TOP TELEPHONE STANDS BEING  
DESKTOP ORGANIZERS, IN CLASS 16 (U.S. CLS.  
2, 5, 22, 23, 29, 37, 38 AND 50).

SN 78-500,374, FILED 10-15-2004.

FIRST USE 2-28-2006; IN COMMERCE 2-28-2006.

AMEETA JORDAN, EXAMINING ATTORNEY

**Int. Cl.: 25**

**Prior U.S. Cls.: 22 and 39**

**United States Patent and Trademark Office**

**Reg. No. 3,395,777**

**Registered Mar. 11, 2008**

**TRADEMARK  
PRINCIPAL REGISTER**

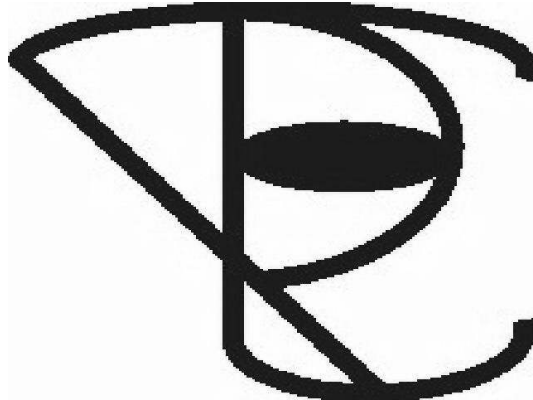

PONCY, EDWIN L (UNITED STATES INDIVIDUAL)  
609 TIBET AVENUE  
SAVANNAH, GA 31406

THE MARK CONSISTS, IN PART, OF THE STYLIZED LETTERS, "ELP", AND DESIGN.

FOR: SHIRTS, PANTS, AND SHOES, IN CLASS 25 (U.S. CLS. 22 AND 39).

SN 78-502,483, FILED 10-19-2004.

FIRST USE 11-15-2004; IN COMMERCE 10-20-2005.

BARBARA A. GOLD, EXAMINING ATTORNEY

**Int. Cl.: 20**

**Prior U.S. Cls.: 2, 13, 22, 25, 32, and 50**

**United States Patent and Trademark Office**

**Reg. No. 3,395,778**

**Registered Mar. 11, 2008**

**TRADEMARK  
PRINCIPAL REGISTER**

# Rubber Bandits

RUBBER BANDITS LLC (COLORADO LTD LIAB  
CO)  
6697 GUNPARK DRIVE, SUITE 201  
BOULDER, CO 80301

THE MARK CONSISTS OF STANDARD CHAR-  
ACTERS WITHOUT CLAIM TO ANY PARTICULAR  
FONT, STYLE, SIZE, OR COLOR.

FOR: BLANK, PRINTED, OR PARTIALLY PRIN-  
TED LABELS OF PLASTIC ATTACHED TO ELAS-  
TIC BANDS, IN CLASS 20 (U.S. CLS. 2, 13, 22, 25, 32  
AND 50).

SN 78-502,492, FILED 10-19-2004.

FIRST USE 5-31-2005; IN COMMERCE 5-31-2005.

LOURDES AYALA, EXAMINING ATTORNEY

**Int. Cl.: 9**

**Prior U.S. Cls.: 21, 23, 26, 36, and 38**

**Reg. No. 3,395,779**

**United States Patent and Trademark Office**

**Registered Mar. 11, 2008**

---

**TRADEMARK  
PRINCIPAL REGISTER**

**ZONEPRO**

HARMAN INTERNATIONAL INDUSTRIES, INC.  
CORPORATED (DELAWARE CORPORATION)  
LEGAL DEPARTMENT  
8500 BALBOA BLVD.  
NORTHRIDGE, CA 91329

THE MARK CONSISTS OF STANDARD CHAR-  
ACTERS WITHOUT CLAIM TO ANY PARTICULAR  
FONT, STYLE, SIZE, OR COLOR.

FOR: SIGNAL PROCESSORS FOR BACK-  
GROUND MUSIC APPLICATIONS, IN CLASS 9  
(U.S. CLS. 21, 23, 26, 36 AND 38).

SN 78-502,682, FILED 10-20-2004.

FIRST USE 1-3-2005; IN COMMERCE 1-3-2005.

BILL DAWE, EXAMINING ATTORNEY



**Int. Cl.: 11**

**Prior U.S. Cls.: 13, 21, 23, 31, and 34**

**United States Patent and Trademark Office**

**Reg. No. 3,395,780**

**Registered Mar. 11, 2008**

---

**TRADEMARK  
PRINCIPAL REGISTER**

**ADNY**

ADESSO INC. (NEW YORK CORPORATION)  
21 PENN PLAZA, SUITE 909  
NEW YORK, NY 10001

THE MARK CONSISTS OF STANDARD CHAR-  
ACTERS WITHOUT CLAIM TO ANY PARTICULAR  
FONT, STYLE, SIZE, OR COLOR.

FOR: LAMPS, IN CLASS 11 (U.S. CLS. 13, 21, 23, 31  
AND 34).

SN 78-505,343, FILED 10-25-2004.

FIRST USE 11-0-2004; IN COMMERCE 1-0-2005.

PRISCILLA MILTON, EXAMINING ATTORNEY

**Int. Cl.: 7**

**Prior U.S. Cls.: 13, 19, 21, 23, 31, 34, and 35**

**United States Patent and Trademark Office**

**Reg. No. 3,395,781**

**Registered Mar. 11, 2008**

**TRADEMARK  
PRINCIPAL REGISTER**

**QUICK CLICK**

SCOTECH SYSTEMS INC. (CANADA CORPORATION)  
4435 LAKELSE AVENUE  
TERRACE, BRITISH COLUMBIA, CANADA V8G  
1P1

FOR: VACUUM CLEANERS; VACUUM CLEANER HOSES; SUCTION NOZZLES FOR VACUUM CLEANERS; VACUUM CLEANER ATTACHMENTS, NAMELY, BRUSHES, CREVICE TOOLS, UPHOLSTERY TOOLS, WANDS, WALL OUTLETS, ADAPTERS AND COMPONENTS THEREFOR; VACUUM CLEANER BAGS, IN CLASS 7 (U.S. CLS. 13, 19, 21, 23, 31, 34 AND 35).

FIRST USE 1-3-2004; IN COMMERCE 4-10-2006.

THE MARK CONSISTS OF STANDARD CHARACTERS WITHOUT CLAIM TO ANY PARTICULAR FONT, STYLE, SIZE, OR COLOR.

OWNER OF CANADA REG. NO. TMA681875,  
DATED 2-19-2007, EXPIRES 2-19-2022.

SN 78-506,388, FILED 10-26-2004.

JENNY PARK, EXAMINING ATTORNEY

**Int. Cl.: 21**

**Prior U.S. Cls.: 2, 13, 23, 29, 30, 33, 40, and 50**

**United States Patent and Trademark Office**

**Reg. No. 3,395,782**

**Registered Mar. 11, 2008**

**TRADEMARK  
PRINCIPAL REGISTER**

**PORT-A-PEN**

UNITED PET GROUP INC (DELAWARE COR-  
PORATION)  
463 OHIO PIKE, STE 303  
CINCINNATI, OH 45255

THE MARK CONSISTS OF STANDARD CHAR-  
ACTERS WITHOUT CLAIM TO ANY PARTICULAR  
FONT, STYLE, SIZE, OR COLOR.

FOR: PORTABLE CAGES FOR HOUSEHOLD  
PETS, IN CLASS 21 (U.S. CLS. 2, 13, 23, 29, 30, 33, 40  
AND 50).

SN 78-506,778, FILED 10-27-2004.

FIRST USE 12-30-2004; IN COMMERCE 12-30-2004.

REBECCA SMITH, EXAMINING ATTORNEY

**Int. Cl.: 39**

**Prior U.S. Cls.: 100 and 105**

**United States Patent and Trademark Office**

**Reg. No. 3,395,783**

**Registered Mar. 11, 2008**

**SERVICE MARK  
PRINCIPAL REGISTER**

**ECOMAGINATION**

GENERAL ELECTRIC COMPANY (NEW YORK CORPORATION)  
1 RIVER ROAD  
SCHENECTADY, NY 12345

FOR: LEASING OF AUTOMOBILES, AIRCRAFT, RAILCARS, MARINE VESSELS, CARGO CONTAINERS AND SHIPPING CONTAINERS; CONSULTING SERVICES IN THE FIELD OF POWER DISTRIBUTION; PROVIDING INFORMATION IN THE FIELD OF POWER DISTRIBUTION, IN CLASS 39 (U.S. CLS. 100 AND 105).

FIRST USE 10-31-2007; IN COMMERCE 10-31-2007.

THE MARK CONSISTS OF STANDARD CHARACTERS WITHOUT CLAIM TO ANY PARTICULAR FONT, STYLE, SIZE, OR COLOR.

SN 78-512,463, FILED 11-5-2004.

JUDITH HELFMAN, EXAMINING ATTORNEY

**Int. Cl.: 25**

**Prior U.S. Cls.: 22 and 39**

**United States Patent and Trademark Office**

**Reg. No. 3,395,784**

**Registered Mar. 11, 2008**

**TRADEMARK  
PRINCIPAL REGISTER**

**MIGUELINA**

MIGUELINA, INC. (DELAWARE CORPORATION)  
20 WEST 36TH ST.  
NEW YORK, NY 10018

THE MARK CONSISTS OF STANDARD CHARACTERS WITHOUT CLAIM TO ANY PARTICULAR FONT, STYLE, SIZE, OR COLOR.

FOR: FOOTWEAR INCLUDING SHOES, BOOTS, SLIPPERS AND SANDALS, IN CLASS 25 (U.S. CLS. 22 AND 39).

SN 78-513,295, FILED 11-8-2004.

FIRST USE 7-1-2007; IN COMMERCE 7-1-2007.

DAVID TOOLEY, EXAMINING ATTORNEY

**Int. Cl.: 1**

**Prior U.S. Cls.: 1, 5, 6, 10, 26, and 46**

**United States Patent and Trademark Office**

**Reg. No. 3,395,785**

**Registered Mar. 11, 2008**

**TRADEMARK  
PRINCIPAL REGISTER**

**PHYCAP**

PHYNEXUS, INC. (CALIFORNIA CORPORATION)  
IP DEPT.  
3670 CHARTER PARK DRIVE SUITE A  
SAN JOSE, CA 95136

FOR: BIOTECHNOLOGY ANALYSIS INSTRUMENTATION, SUPPLIES AND TECHNOLOGY, NAMELY, CHEMICALS AND REAGENTS FOR USE IN ADSORPTIVE AND CHROMATOGRAPHIC SEPARATION METHODS FOR THE ANALYSIS OF PROTEINS, POLYNUCLEOTIDES, POLYSACCHAR-

IDES, LIPIDS AND OTHER BIOMOLECULES, IN CLASS 1 (U.S. CLS. 1, 5, 6, 10, 26 AND 46).

FIRST USE 2-10-2005; IN COMMERCE 2-10-2005.

THE MARK CONSISTS OF STANDARD CHARACTERS WITHOUT CLAIM TO ANY PARTICULAR FONT, STYLE, SIZE, OR COLOR.

SN 78-513,395, FILED 11-8-2004.

BILL DAWE, EXAMINING ATTORNEY

**Int. Cl.: 10**

**Prior U.S. Cls.: 26, 39, and 44**

**United States Patent and Trademark Office**

**Reg. No. 3,395,786**

**Registered Mar. 11, 2008**

**TRADEMARK  
PRINCIPAL REGISTER**

**RELIADOSE**

THE BLAINE COMPANY, INC. (KENTUCKY  
CORPORATION)  
1717 DIXIE HIGHWAY  
SUITE 700  
FORT WRIGHT, KY 41011

FOR: FLUID DELIVERY DEVICE FOR INFANTS  
AND TODDLERS, COMPRISING AN ORAL DOS-  
ING SYRINGE, BOTTLE, AND SPECIALIZED NIP-  
PLE WHICH DELIVERS VITAMINS,  
CONCENTRATES, NUTRITIONAL SUBSTANCES,  
SUSPENSIONS, PRESCRIBED OR OVER THE  
COUNTER MEDICINE, ALONG WITH OTHER SE-

PARATE FLUIDS TO THE RECIPIENT, IN CLASS 10  
(U.S. CLS. 26, 39 AND 44).

FIRST USE 3-22-2007; IN COMMERCE 3-22-2007.

THE MARK CONSISTS OF STANDARD CHAR-  
ACTERS WITHOUT CLAIM TO ANY PARTICULAR  
FONT, STYLE, SIZE, OR COLOR.

SN 78-514,604, FILED 11-10-2004.

STEVEN R. FOSTER, EXAMINING ATTORNEY

**Int. Cl.: 25**

**Prior U.S. Cls.: 22 and 39**

**United States Patent and Trademark Office**

**Reg. No. 3,395,787**

**Registered Mar. 11, 2008**

**TRADEMARK  
PRINCIPAL REGISTER**

**GRASS IS GREENER**

LARRY HANSEL CLOTHING, LLC (CALIFORNIA LTD LIAB CO)  
2300 S. EASTERN AVENUE  
COMMERCE, CA 90040

FOR: MEN'S, WOMEN'S AND CHILDREN'S CLOTHING AND ACCESSORIES, NAMELY, TOPS, BOTTOMS, T-SHIRTS, JEANS, SHORTS, DRESSES, SKIRTS, UNDERWEAR, HOSIERY, SWIMWEAR, BATHROBES, JACKETS, COATS, RAINWEAR, BELTS, SCARVES, GLOVES, HEADWEAR AND FOOTWEAR, NAMELY, SHOES, SNEAKERS,

BOOTS, SANDALS AND SLIPPERS, IN CLASS 25 (U.S. CLS. 22 AND 39).

FIRST USE 7-31-2007; IN COMMERCE 7-31-2007.

THE MARK CONSISTS OF STANDARD CHARACTERS WITHOUT CLAIM TO ANY PARTICULAR FONT, STYLE, SIZE, OR COLOR.

SN 78-514,605, FILED 11-10-2004.

INGA ERVIN, EXAMINING ATTORNEY



**Int. Cl.: 9**

**Prior U.S. Cls.: 21, 23, 26, 36, and 38**

**United States Patent and Trademark Office**

**Reg. No. 3,395,788**

**Registered Mar. 11, 2008**

**TRADEMARK  
PRINCIPAL REGISTER**

**ONE TINT**

THE SHERWIN-WILLIAMS COMPANY (OHIO  
CORPORATION)  
101 PROSPECT AVENUE NW  
CLEVELAND, OH 441151075

FOR: COMPUTER SOFTWARE USED IN CON-  
NECTION WITH ELECTRONIC COLOR FORMU-  
LATING APPARATUS USED TO MEASURE COLOR  
AND TO DISPENSE PIGMENTS AND COLORANTS  
FOR ADDITION TO PAINTS AND COATINGS, IN  
CLASS 9 (U.S. CLS. 21, 23, 26, 36 AND 38).

FIRST USE 7-26-2007; IN COMMERCE 7-26-2007.

THE MARK CONSISTS OF STANDARD CHAR-  
ACTERS WITHOUT CLAIM TO ANY PARTICULAR  
FONT, STYLE, SIZE, OR COLOR.

NO CLAIM IS MADE TO THE EXCLUSIVE  
RIGHT TO USE "TINT", APART FROM THE MARK  
AS SHOWN.

SN 78-515,022, FILED 11-11-2004.

INGA ERVIN, EXAMINING ATTORNEY

**Int. Cl.: 41**

**Prior U.S. Cls.: 100, 101, and 107**

**United States Patent and Trademark Office**

**Reg. No. 3,395,789**

**Registered Mar. 11, 2008**

**SERVICE MARK  
PRINCIPAL REGISTER**

**CRIMINOLOGYNOW**

CENGAGE LEARNING, INC. (DELAWARE CORPORATION)  
200 FIRST STAMFORD PLACE  
STAMFORD, CT 06902

THE MARK CONSISTS OF STANDARD CHARACTERS WITHOUT CLAIM TO ANY PARTICULAR FONT, STYLE, SIZE, OR COLOR.

FOR: ONLINE WEBSITE PROVIDING EDUCATIONAL INSTRUCTION ON THE SUBJECT OF CRIMINOLOGY, IN CLASS 41 (U.S. CLS. 100, 101 AND 107).

SN 78-515,061, FILED 11-11-2004.

FIRST USE 6-6-2004; IN COMMERCE 6-6-2004.

CARRIE GENOVESE, EXAMINING ATTORNEY

**Int. Cl.: 41**

**Prior U.S. Cls.: 100, 101, and 107**

**United States Patent and Trademark Office**

**Reg. No. 3,395,790**

**Registered Mar. 11, 2008**

**SERVICE MARK  
PRINCIPAL REGISTER**

**SOCIOLOGYNOW**

CENGAGE LEARNING, INC. (DELAWARE CORPORATION)  
200 FIRST STAMFORD PLACE  
STAMFORD, CT 06902

FOR: ONLINE WEBSITE PROVIDING EDUCATIONAL INSTRUCTION ON THE SUBJECT OF CRIMINAL JUSTICE, IN CLASS 41 (U.S. CLS. 100, 101 AND 107).

FIRST USE 8-1-2004; IN COMMERCE 8-1-2004.

THE MARK CONSISTS OF STANDARD CHARACTERS WITHOUT CLAIM TO ANY PARTICULAR FONT, STYLE, SIZE, OR COLOR.

SN 78-515,078, FILED 11-11-2004.

CARRIE GENOVESE, EXAMINING ATTORNEY

**Int. Cl.: 41**

**Prior U.S. Cls.: 100, 101, and 107**

**United States Patent and Trademark Office**

**Reg. No. 3,395,791**

**Registered Mar. 11, 2008**

**SERVICE MARK  
PRINCIPAL REGISTER**

**PSYCHOLOGYNOW**

CENGAGE LEARNING, INC. (DELAWARE CORPORATION)  
200 FIRST STAMFORD PLACE  
STAMFORD, CT 06902

FOR: ONLINE WEBSITE PROVIDING EDUCATIONAL INSTRUCTION ON THE SUBJECT OF PSYCHOLOGY, IN CLASS 41 (U.S. CLS. 100, 101 AND 107).

FIRST USE 8-1-2004; IN COMMERCE 8-1-2004.

THE MARK CONSISTS OF STANDARD CHARACTERS WITHOUT CLAIM TO ANY PARTICULAR FONT, STYLE, SIZE, OR COLOR.

SN 78-515,088, FILED 11-11-2004.

CARRIE GENOVESE, EXAMINING ATTORNEY

**Int. Cl.: 41**

**Prior U.S. Cls.: 100, 101, and 107**

**United States Patent and Trademark Office**

**Reg. No. 3,395,792**

**Registered Mar. 11, 2008**

**SERVICE MARK  
PRINCIPAL REGISTER**

**STATISTICSNOW**

CENGAGE LEARNING, INC. (DELAWARE CORPORATION)  
200 FIRST STAMFORD PLACE  
STAMFORD, CT 06902

FOR: ONLINE WEBSITE PROVIDING EDUCATIONAL INSTRUCTION ON THE SUBJECT OF STATISTICS, IN CLASS 41 (U.S. CLS. 100, 101 AND 107).

FIRST USE 10-15-2004; IN COMMERCE 10-15-2004.

THE MARK CONSISTS OF STANDARD CHARACTERS WITHOUT CLAIM TO ANY PARTICULAR FONT, STYLE, SIZE, OR COLOR.

SN 78-515,126, FILED 11-11-2004.

CARRIE GENOVESE, EXAMINING ATTORNEY

**Int. Cl.: 36**

**Prior U.S. Cls.: 100, 101, and 102**

**United States Patent and Trademark Office**

**Reg. No. 3,395,793**

**Registered Mar. 11, 2008**

**SERVICE MARK  
PRINCIPAL REGISTER**

**WATERFORD VILLAGE  
BANK**

FLEMMING, KATHLEEN K. (UNITED STATES  
INDIVIDUAL)

72 CROWN ROYAL DRIVE

WILLIAMSVILLE, NY 14221

FOR: BANKING SERVICES, IN CLASS 36 (U.S.  
CLS. 100, 101 AND 102).

FIRST USE 11-11-2004; IN COMMERCE 11-11-2004.

THE MARK CONSISTS OF STANDARD CHAR-  
ACTERS WITHOUT CLAIM TO ANY PARTICULAR  
FONT, STYLE, SIZE, OR COLOR.

NO CLAIM IS MADE TO THE EXCLUSIVE  
RIGHT TO USE BANK, APART FROM THE MARK  
AS SHOWN.

SN 78-515,131, FILED 11-11-2004.

CAROL SPILS, EXAMINING ATTORNEY

**Int. Cls.: 14 and 18**

**Prior U.S. Cls.: 1, 2, 3, 22, 27, 28, 41, and 50**

**United States Patent and Trademark Office**

**Reg. No. 3,395,794**

**Registered Mar. 11, 2008**

**TRADEMARK  
PRINCIPAL REGISTER**



L.C. LICENSING, INC. (DELAWARE CORPORATION)

1441 BROADWAY  
NEW YORK, NY 10018

FOR: WATCHES; JEWELRY, NAMELY, NECKLACES, BRACELETS, PENDANTS AND JEWELRY PINS, IN CLASS 14 (U.S. CLS. 2, 27, 28 AND 50).

FIRST USE 10-0-2006; IN COMMERCE 10-0-2006.

FOR: SPORTS BAGS, PURSES, HANDBAGS AND WALLETS, IN CLASS 18 (U.S. CLS. 1, 2, 3, 22 AND 41).

FIRST USE 5-22-2006; IN COMMERCE 5-22-2006.

THE MARK CONSISTS OF THE IMAGE OF A DOG.

SN 78-515,407, FILED 11-11-2004.

JULIE WATSON, EXAMINING ATTORNEY

**Int. Cl.: 41**

**Prior U.S. Cls.: 100, 101, and 107**

**United States Patent and Trademark Office**

**Reg. No. 3,395,795**

**Registered Mar. 11, 2008**

**SERVICE MARK  
PRINCIPAL REGISTER**

**MATHNOW**

CENGAGE LEARNING, INC. (DELAWARE CORPORATION)  
200 FIRST STAMFORD PLACE  
STAMFORD, CT 06902

FOR: ONLINE WEBSITE PROVIDING EDUCATIONAL INSTRUCTION ON THE SUBJECT OF MATH, IN CLASS 41 (U.S. CLS. 100, 101 AND 107).

FIRST USE 10-1-2004; IN COMMERCE 10-1-2004.

THE MARK CONSISTS OF STANDARD CHARACTERS WITHOUT CLAIM TO ANY PARTICULAR FONT, STYLE, SIZE, OR COLOR.

SN 78-519,516, FILED 11-18-2004.

CARRIE GENOVESE, EXAMINING ATTORNEY



**Int. Cl.: 5**

**Prior U.S. Cls.: 6, 18, 44, 46, 51, and 52**

**United States Patent and Trademark Office**

**Reg. No. 3,395,796**

**Registered Mar. 11, 2008**

**TRADEMARK  
PRINCIPAL REGISTER**

**LETAIRIS**

GILEAD COLORADO, INC. (DELAWARE CORPORATION)  
7575 WEST 103RD AVENUE  
SUITE 102  
WESTMINSTER, CO 80021

FOR: PHARMACEUTICAL PREPARATIONS FOR THE TREATMENT OF DISEASES AND DISORDERS IN THE CARDIOVASCULAR, CARDIAC, VASCULAR AND HEMATOLOGY FIELDS , IN CLASS 5 (U.S. CLS. 6, 18, 44, 46, 51 AND 52).

FIRST USE 6-18-2007; IN COMMERCE 6-18-2007.

THE MARK CONSISTS OF STANDARD CHARACTERS WITHOUT CLAIM TO ANY PARTICULAR FONT, STYLE, SIZE, OR COLOR.

SN 78-521,260, FILED 11-22-2004.

KATHERINE CHANG, EXAMINING ATTORNEY

**Int. Cl.: 41**

**Prior U.S. Cls.: 100, 101, and 107**

**United States Patent and Trademark Office**

**Reg. No. 3,395,797**

**Registered Mar. 11, 2008**

**SERVICE MARK  
PRINCIPAL REGISTER**



FLORIDA ATLANTIC UNIVERSITY (FLORIDA  
STATE UNIVERSITY)  
777 GLADES ROAD  
BOCA RATON, FL 33431

FOR: EDUCATIONAL SERVICES AT THE UNI-  
VERSITY LEVEL, IN CLASS 41 (U.S. CLS. 100, 101  
AND 107).

FIRST USE 11-22-2004; IN COMMERCE 2-28-2005.

OWNER OF U.S. REG. NO. 844,765.

NO CLAIM IS MADE TO THE EXCLUSIVE  
RIGHT TO USE "FLORIDA", "UNIVERSITY", AND  
"EST. 1961", APART FROM THE MARK AS SHOWN.

SN 78-521,840, FILED 11-23-2004.

JENNIFER VASQUEZ, EXAMINING ATTORNEY

**Int. Cls.: 3 and 5**

**Prior U.S. Cls.: 1, 4, 6, 18, 44, 46, 50, 51, and 52**

**United States Patent and Trademark Office**

**Reg. No. 3,395,798**

**Registered Mar. 11, 2008**

**TRADEMARK  
PRINCIPAL REGISTER**

**EVERYDAY LIVING**

THE KROGER CO. OF MICHIGAN (MICHIGAN CORPORATION)

18334 LAUREL PARK DRIVE NORTH  
LIVONIA, MI 481522686

FOR: DISHWASHING DETERGENTS; HOUSEHOLD BLEACH; HOUSEHOLD CLEANING PREPARATIONS; BATHROOM CLEANERS; WINDOW CLEANERS; FABRIC SOFTENERS; LAUNDRY DETERGENTS; LAUNDRY ADDITIVES, NAMELY, BLEACH, STARCH, AND SOIL AND STAIN REMOVERS, IN CLASS 3 (U.S. CLS. 1, 4, 6, 50, 51 AND 52).

FIRST USE 8-14-2005; IN COMMERCE 8-14-2005.

FOR: DISINFECTANTS FOR HOUSEHOLD PURPOSES, IN CLASS 5 (U.S. CLS. 6, 18, 44, 46, 51 AND 52).

FIRST USE 8-14-2005; IN COMMERCE 8-14-2005.

THE MARK CONSISTS OF STANDARD CHARACTERS WITHOUT CLAIM TO ANY PARTICULAR FONT, STYLE, SIZE, OR COLOR.

OWNER OF U.S. REG. NOS. 1,750,179, 2,651,686, AND OTHERS.

SN 78-522,206, FILED 11-23-2004.

KARANENDRA S. CHHINA, EXAMINING ATTORNEY

**Int. Cl.: 43**

**Prior U.S. Cls.: 100 and 101**

**United States Patent and Trademark Office**

**Reg. No. 3,395,799**

**Registered Mar. 11, 2008**

**SERVICE MARK  
PRINCIPAL REGISTER**



TRIPLE T ENTERPRISES, INC. (IDAHO CORPORATION)  
408 EAST 41ST STREET  
BOISE, ID 83714

FOR: RESTAURANTS, RESTAURANTS FEATURING HOME DELIVERY, AND CATERING, IN CLASS 43 (U.S. CLS. 100 AND 101).

FIRST USE 5-30-2006; IN COMMERCE 5-30-2006.

OWNER OF U.S. REG. NOS. 2,879,076 AND 2,879,077.

NO CLAIM IS MADE TO THE EXCLUSIVE RIGHT TO USE "PIZZERIA GRILL", APART FROM THE MARK AS SHOWN.

SN 78-522,308, FILED 11-23-2004.

LEIGH LOWRY, EXAMINING ATTORNEY

**Int. Cl.: 34**

**Prior U.S. Cls.: 2, 8, 9, and 17**

**United States Patent and Trademark Office**

**Reg. No. 3,395,800**

**Registered Mar. 11, 2008**

**TRADEMARK  
PRINCIPAL REGISTER**



EWESTERN INC. (WASHINGTON CORPORATION)  
1124 E. IVY ST  
COLVILLE, WA 99114

FOR: CIGARETTE FILTERS, IN CLASS 34 (U.S. CLS. 2, 8, 9 AND 17).

FIRST USE 3-1-2005; IN COMMERCE 4-5-2006.

THE COLORS BLUE AND RED ARE CLAIMED AS A FEATURE OF THE MARK.

THE TERM "SANDA" IS BLUE, AND "PRO" IS RED.

SN 78-522,467, FILED 11-24-2004.

IRA J. GOODSID, EXAMINING ATTORNEY

**Int. Cl.: 35**

**Prior U.S. Cls.: 100, 101, and 102**

**United States Patent and Trademark Office**

**Reg. No. 3,395,801**

**Registered Mar. 11, 2008**

---

**SERVICE MARK  
PRINCIPAL REGISTER**

**In Crowd**

TONI & GUY (USA) LIMITED (UNITED KING-  
DOM CORPORATION)  
2311 MIDWAY ROAD  
CARROLLTON, TX 75006

FOR: RETAIL STORE SERVICES FEATURING  
HAIR CARE, SKIN CARE AND COSMETIC PRO-  
DUCTS, IN CLASS 35 (U.S. CLS. 100, 101 AND 102).

FIRST USE 1-1-2005; IN COMMERCE 1-1-2005.

THE MARK CONSISTS OF STANDARD CHAR-  
ACTERS WITHOUT CLAIM TO ANY PARTICULAR  
FONT, STYLE, SIZE, OR COLOR.

SN 78-523,619, FILED 11-29-2004.

SANI KHOURI, EXAMINING ATTORNEY

**Int. Cl.: 25**

**Prior U.S. Cls.: 22 and 39**

**United States Patent and Trademark Office**

**Reg. No. 3,395,802**

**Registered Mar. 11, 2008**

**TRADEMARK  
PRINCIPAL REGISTER**



PREMIUMWEAR, INC. (DELAWARE CORPORATION)  
5500 FELTL ROAD  
MINNETONKA, MN 55343

FOR: APPAREL, NAMELY, MEN'S AND WOMEN'S TOPS, SHIRTS, PULLOVER WINDSHIRTS, PANTS, SHORTS, SWEAT SHIRTS, JACKETS, HATS; ACTIVEWEAR, NAMELY, JACKETS, PULLOVER WINDSHIRTS, SWEATERS, SHIRTS, SHORTS, PANTS, WARM-UP SUITS, SWEATSUITS, SWEAT SHIRTS; AND SPORTSWEAR, NAMELY, SHORTS, JACKETS, PULLOVER WINDSHIRTS, SHIRTS,

PANTS, SWEAT SHIRTS, IN CLASS 25 (U.S. CLS. 22 AND 39).

FIRST USE 3-12-2004; IN COMMERCE 10-13-2004.

THE MARK CONSISTS OF THE WORDS "COOL SWING" ENCLOSED IN A PARTIAL OVAL.

SN 78-523,888, FILED 11-29-2004.

AISHA CLARKE, EXAMINING ATTORNEY

**Int. Cl.: 9**

**Prior U.S. Cls.: 21, 23, 26, 36, and 38**

**United States Patent and Trademark Office**

**Reg. No. 3,395,803**

**Registered Mar. 11, 2008**

**TRADEMARK  
PRINCIPAL REGISTER**

**STIL-PRO**

SOURCE III, INC. (CALIFORNIA CORPORATION)  
3941 PARK DRIVE #20-342  
EL DORADO HILLS, CA 95762

THE MARK CONSISTS OF STANDARD CHARACTERS WITHOUT CLAIM TO ANY PARTICULAR FONT, STYLE, SIZE, OR COLOR.

FOR: COMPUTER SOFTWARE FOR DESIGN AND TESTING OF INTEGRATED CIRCUITS, IN CLASS 9 (U.S. CLS. 21, 23, 26, 36 AND 38).

SN 78-526,855, FILED 12-3-2004.

FIRST USE 11-24-2004; IN COMMERCE 11-24-2004.

AMY GEARIN, EXAMINING ATTORNEY



**Int. Cl.: 16**

**Prior U.S. Cls.: 2, 5, 22, 23, 29, 37, 38, and 50**

**United States Patent and Trademark Office**

**Reg. No. 3,395,804**

**Registered Mar. 11, 2008**

**TRADEMARK  
PRINCIPAL REGISTER**

**The Happy Thoughts Family**

SIKKINK, TRACI A. (UNITED STATES INDIVIDUAL)  
446 S. HIGHLAND  
LOS ANGELES, CA 90036

FOR: GREETING CARDS, IN CLASS 16 (U.S. CLS. 2, 5, 22, 23, 29, 37, 38 AND 50).

FIRST USE 6-1-2004; IN COMMERCE 6-1-2007.

THE COLOR(S) BLACK AND YELLOW IS/ARE CLAIMED AS A FEATURE OF THE MARK.

THE COLOR YELLOW APPEARS IN THE SMILEY FACE DESIGN, EXCEPT FOR THE EYES, MOUTH, AND OUTLINE OF THE DESIGN. THE REMAINDER OF THE MARK, INCLUDING THE ADDITIONAL WORDING, APPEARS IN BLACK.

SN 78-527,871, FILED 12-6-2004.

BRIAN PINO, EXAMINING ATTORNEY

**Int. Cl.: 3**

**Prior U.S. Cls.: 1, 4, 6, 50, 51, and 52**

**United States Patent and Trademark Office**

**Reg. No. 3,395,805**

**Registered Mar. 11, 2008**

**TRADEMARK  
PRINCIPAL REGISTER**

**HEADSHOT**

TONI & GUY (USA) LIMITED (UNITED KING-  
DOM CORPORATION)  
2311 MIDWAY ROAD  
CARROLLTON, TX 75006

FOR: HAIR CARE PREPARATIONS AND PRO-  
DUCTS, NAMELY, SHAMPOO, CONDITIONER,  
HAIR TONIC, HAIR GEL, HAIR SPRAY, HAIR  
MOUSSE, HAIR POMADE, HAIR DYE, HAIR  
SCULPTING GEL, HAIR COLOR GEL, HAIR LO-  
TION, HAIR CREAM AND BODY LOTION, IN  
CLASS 3 (U.S. CLS. 1, 4, 6, 50, 51 AND 52).

FIRST USE 9-1-2007; IN COMMERCE 9-1-2007.

THE MARK CONSISTS OF STANDARD CHAR-  
ACTERS WITHOUT CLAIM TO ANY PARTICULAR  
FONT, STYLE, SIZE, OR COLOR.

SN 78-529,156, FILED 12-8-2004.

LINDA E. BLOHM, EXAMINING ATTORNEY

**Int. Cl.: 12**

**Prior U.S. Cls.: 19, 21, 23, 31, 35, and 44**

**Reg. No. 3,395,806**

**United States Patent and Trademark Office**

**Registered Mar. 11, 2008**

**TRADEMARK  
PRINCIPAL REGISTER**

**SPECTRUM  
AERONAUTICAL**

SPECTRUM AERONAUTICAL, LLC (DELA-  
WARE CORPORATION)  
2036 PALOMAR AIRPORT ROAD  
CARLSBAD, CA 92011

FOR: AIRBORNE VEHICLES AND AIRCRAFT,  
NAMELY, JET AIRCRAFT FOR GENERAL AVIA-  
TION, IN CLASS 12 (U.S. CLS. 19, 21, 23, 31, 35 AND  
44).

FIRST USE 10-1-2005; IN COMMERCE 10-1-2005.

THE MARK CONSISTS OF STANDARD CHAR-  
ACTERS WITHOUT CLAIM TO ANY PARTICULAR  
FONT, STYLE, SIZE, OR COLOR.

NO CLAIM IS MADE TO THE EXCLUSIVE  
RIGHT TO USE "AERONAUTICAL", APART FROM  
THE MARK AS SHOWN.

SN 78-529,317, FILED 12-8-2004.

TIMOTHY FINNEGAN, EXAMINING ATTORNEY

**Int. Cl.: 6**

**Prior U.S. Cls.: 2, 12, 13, 14, 23, 25, and 50**

**Reg. No. 3,395,807**

**United States Patent and Trademark Office**

**Registered Mar. 11, 2008**

---

**TRADEMARK  
PRINCIPAL REGISTER**

**Glacier Bay**

HOMER TLC, INC. (DELAWARE CORPORATION)  
1404 SOCIETY DRIVE  
CLAYMONT, DE 19703

FOR: HARDWARE EXCLUSIVELY AVAILABLE THROUGH RETAIL STORE SERVICES, ON-LINE RETAIL STORE SERVICES AND RETAIL MAIL ORDER SERVICES, NAMELY, ROBE HOOKS MADE OF METAL; SHOWER BARS MADE OF METAL, IN CLASS 6 (U.S. CLS. 2, 12, 13, 14, 23, 25 AND 50).

FIRST USE 7-16-2007; IN COMMERCE 7-16-2007.

THE MARK CONSISTS OF STANDARD CHARACTERS WITHOUT CLAIM TO ANY PARTICULAR FONT, STYLE, SIZE, OR COLOR.

OWNER OF U.S. REG. NOS. 2,474,553 AND 2,528,497.

SN 78-529,631, FILED 12-9-2004.

CHRISTOPHER BUONGIORNO, EXAMINING ATTORNEY

**Int. Cl.: 9**

**Prior U.S. Cls.: 21, 23, 26, 36, and 38**

**Reg. No. 3,395,808**

**United States Patent and Trademark Office**

**Registered Mar. 11, 2008**

**TRADEMARK  
PRINCIPAL REGISTER**



NITROSECURITY, INC. (DELAWARE CORPORATION)  
SUITE 325  
230 COMMERCE WAY  
PORTSMOUTH, NH 03801

FOR: COMPUTER NETWORKING HARDWARE AND SOFTWARE UTILIZING SIGNATURE ANALYSIS, ANOMALY DETECTION METHODS, AND A FULL-FEATURED FIREWALL, WHICH ALL ACT TOGETHER, TO BLOCK VIRUSES, WORMS, HACK-

ERS, AND OTHER MALICIOUS TRAFFIC FROM ENTERING A NETWORK AND CAUSING DAMAGES, IN CLASS 9 (U.S. CLS. 21, 23, 26, 36 AND 38).

FIRST USE 5-25-2005; IN COMMERCE 5-31-2005.

SN 78-529,773, FILED 12-9-2004.

MARIAM MAHMOUDI, EXAMINING ATTORNEY

Int. Cl.: 37

Prior U.S. Cls.: 100, 103, and 106

**United States Patent and Trademark Office**

**Reg. No. 3,395,809**

Registered Mar. 11, 2008

---

**SERVICE MARK  
PRINCIPAL REGISTER**

panXpress

HYDROSTEEL LLC (DELAWARE PARTNER-  
SHIP)  
2708 BAYNARD BLVD.  
WILMINGTON, DE 19802

FOR: MAINTENANCE AND/OR REPAIR OF MU-  
SICAL INSTRUMENTS, NAMELY, STEEL DRUMS,  
IN CLASS 37 (U.S. CLS. 100, 103 AND 106).

FIRST USE 1-1-2005; IN COMMERCE 1-1-2005.

THE MARK CONSISTS OF STANDARD CHAR-  
ACTERS WITHOUT CLAIM TO ANY PARTICULAR  
FONT, STYLE, SIZE, OR COLOR.

SN 78-534,751, FILED 12-17-2004.

REBECCA EISINGER, EXAMINING ATTORNEY

**Int. Cl.: 36**

**Prior U.S. Cls.: 100, 101, and 102**

**United States Patent and Trademark Office**

**Reg. No. 3,395,810**

**Registered Mar. 11, 2008**

**SERVICE MARK  
PRINCIPAL REGISTER**

**SABADELLATLÁNTICO**

BANCO DE SABADELL, S.A. (SPAIN CORPORATION)  
PL. DE CATALUNYA, 1  
SABADELL, SPAIN 08201

FOR: BANKING SERVICES; REAL ESTATE BROKERAGE SERVICES; SAVINGS ACCOUNT SERVICES; FINANCIAL ANALYSIS AND CONSULTATION SERVICES; CAPITAL INVESTMENT CONSULTATION; ISSUANCE OF TRAVELER'S CHECKS; MUTUAL FUND INVESTMENT SERVICES; CREDIT CONSULTATION SERVICES; SAFETY DEPOSIT BOX SERVICES; CREDIT CARD ISSUANCE; FINANCIAL EVALUATION FOR INSURANCE PURPOSES; FACTORING AGENCY SERVICES; BAIL BONDING SERVICES; FINANCING SERVICES; FUNDS INVESTMENT; FINANCIAL CLEARING HOUSES; FINANCIAL SPONSORSHIP OF SPORTS AND CULTURAL

EVENTS; INSURANCE BROKERAGE; CREDIT CARD SERVICES; ELECTRONIC FUNDS TRANSFER, IN CLASS 36 (U.S. CLS. 100, 101 AND 102).

FIRST USE 4-21-2004; IN COMMERCE 12-21-2004.

THE MARK CONSISTS OF STANDARD CHARACTERS WITHOUT CLAIM TO ANY PARTICULAR FONT, STYLE, SIZE, OR COLOR.

OWNER OF SPAIN REG. NO. 2.592.374, DATED 9-14-2004, EXPIRES 4-21-2014.

OWNER OF U.S. REG. NO. 2,423,832.

SN 78-536,108, FILED 12-21-2004.

LA TONIA FISHER, EXAMINING ATTORNEY

**Int. Cl.: 18**

**Prior U.S. Cls.: 1, 2, 3, 22, and 41**

**Reg. No. 3,395,811**

**United States Patent and Trademark Office**

**Registered Mar. 11, 2008**

**TRADEMARK  
PRINCIPAL REGISTER**

**Chelsey Henry**

SECONDWAVE, INC. (WASHINGTON CORPORATION)  
119 WEST DENNY WAY, SUITE M217  
SEATTLE, WA 98109

FOR: HANDBAGS, PURSES, ATTACHÉ CASES, DIAPER BAGS, MESSENGER BAGS; TOTE BAGS, DUFFLE BAGS, CLUTCHES, COIN CASES, CREDIT CARD CASES, COSMETIC CASES SOLD EMPTY, TOILETRY CASES SOLD EMPTY, LUGGAGE, KEY CASES, IDENTIFICATION TAGS FOR LUGGAGE, IN CLASS 18 (U.S. CLS. 1, 2, 3, 22 AND 41).

FIRST USE 5-3-2004; IN COMMERCE 8-4-2004.

THE MARK CONSISTS OF STANDARD CHARACTERS WITHOUT CLAIM TO ANY PARTICULAR FONT, STYLE, SIZE, OR COLOR.

THE NAME "CHELSEY HENRY" DOES NOT IDENTIFY A LIVING INDIVIDUAL.

SN 78-537,691, FILED 12-23-2004.

KARANENDRA S. CHHINA, EXAMINING ATTORNEY



**Int. Cls.: 9 and 42**

**Prior U.S. Cls.: 21, 23, 26, 36, 38, 100, and 101**

**United States Patent and Trademark Office**

**Reg. No. 3,395,812**

**Registered Mar. 11, 2008**

**TRADEMARK  
SERVICE MARK  
PRINCIPAL REGISTER**

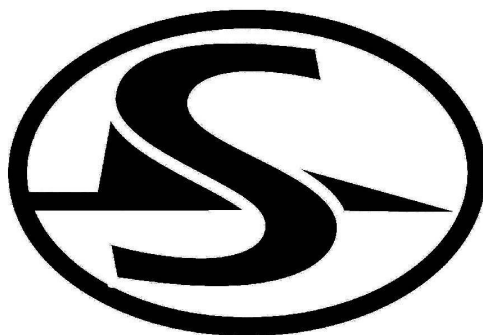

MEHL GRIFFIN & BARTEK LTD. (MARYLAND CORPORATION)  
2001 JEFFERSON DAVIS HIGHWAY SUITE 209  
ARLINGTON, VA 22202

FOR: COMPUTER SOFTWARE IN THE FIELD OF DATA MONITORING AND TRACKING AND DETECTION USED TO MONITOR, ANALYZE, AND REPORT ON COMPUTER NETWORK TRAFFIC AND ACCESS; COMPUTER SOFTWARE USED TO MONITOR AND MANAGE DATA, INFORMATION, APPLICATIONS, AND RELATED TRAFFIC ON COMPUTER NETWORKS, THE INTERNET, AND INTRANETS AND INSTRUCTION MANUALS SOLD AS A UNIT; ELECTRONIC DETECTION DEVICES, NAMELY, DEVICES THAT EMIT, RECEIVE, AND MEASURE ULTRASONIC TONES TO DETECT ANIMATE AND INANIMATE ARTICLES, PARTICLES, AND SUBSTANCES; ELECTRONIC DETECTION DEVICES, NAMELY, CHEMICAL AND BIOLOGICAL DETECTOR APPARATUS AND INSTRUMENTS; ELECTRONIC DETECTION DEVI-

CES, NAMELY, APPARATUS AND INSTRUMENTS FOR DETECTING EXPLOSIVES, DRUGS, AND CONTRABAND, IN CLASS 9 (U.S. CLS. 21, 23, 26, 36 AND 38).

FIRST USE 10-4-2007; IN COMMERCE 10-4-2007.

FOR: CUSTOM DESIGNING TO THE ORDER AND SPECIFICATION OF OTHERS OF COMPUTER SOFTWARE; COMPUTER CONSULTATION SERVICES, NAMELY, MONITORING, ANALYZING, AND REPORTING ON COMPUTER NETWORK TRAFFIC AND THE DATA TRANSMITTED ON SUCH NETWORKS, IN CLASS 42 (U.S. CLS. 100 AND 101).

FIRST USE 10-4-2007; IN COMMERCE 10-4-2007.

SN 78-538,007, FILED 12-23-2004.

BENJAMIN OKEKE, EXAMINING ATTORNEY

**Int. Cl.: 5**

**Prior U.S. Cls.: 6, 18, 44, 46, 51, and 52**

**Reg. No. 3,395,813**

**United States Patent and Trademark Office**

**Registered Mar. 11, 2008**

**TRADEMARK  
PRINCIPAL REGISTER**

**STRATAGRAFT**

STRATATECH CORPORATION (DELAWARE  
CORPORATION)  
505 SOUTH ROSA ROAD  
MADISON, WI 53719

THE MARK CONSISTS OF STANDARD CHAR-  
ACTERS WITHOUT CLAIM TO ANY PARTICULAR  
FONT, STYLE, SIZE, OR COLOR.

FOR: BIOENGINEERED TISSUES FOR SURGI-  
CAL IMPLANTATION, IN CLASS 5 (U.S. CLS. 6, 18,  
44, 46, 51 AND 52).

SN 78-540,747, FILED 1-1-2005.

FIRST USE 1-16-2007; IN COMMERCE 1-16-2007.

ODESSA BIBBINS, EXAMINING ATTORNEY

**Int. Cl.: 25**

**Prior U.S. Cls.: 22 and 39**

**United States Patent and Trademark Office**

**Reg. No. 3,395,814**

**Registered Mar. 11, 2008**

**TRADEMARK  
PRINCIPAL REGISTER**

**DM13**

SOFRO, DAVID B. (UNITED STATES INDIVIDUAL)  
1130 SOUTH FLOWER STREET  
SUITE 204  
LOS ANGELES, CA 90015

FIRST USE 2-1-2005; IN COMMERCE 2-1-2005.

SN 78-545,044, FILED 1-10-2005.

FOR: CLOTHING, T-SHIRTS, SWEATERS, DRESS SHIRTS, HATS, PANTS, SHORTS, SOCKS, SHOES, UNDERPANTS, IN CLASS 25 (U.S. CLS. 22 AND 39).

CYNTHIA SLOAN, EXAMINING ATTORNEY

**Int. Cl.: 10**

**Prior U.S. Cls.: 26, 39, and 44**

**United States Patent and Trademark Office**

**Reg. No. 3,395,815**

**Registered Mar. 11, 2008**

**TRADEMARK  
PRINCIPAL REGISTER**

**SEAVIVAL**

SEAVIVAL, LLC (OHIO LTD LIAB CO)  
SUITE 201G  
333 14TH STREET  
TOLEDO, OH 43624

SPIRATORY STIMULATION, IN CLASS 10 (U.S.  
CLS. 26, 39 AND 44).

FIRST USE 9-25-2007; IN COMMERCE 9-25-2007.

FOR: EMERGENCY MEDICAL KIT COMPRISED  
PRIMARILY OF A FLOTATION CLOSED CON-  
TAINER, EMERGENCY OXYGEN KIT, EMERGEN-  
CY MEDICAL SHEARS, EMERGENCY LIGHTING,  
BLANKETS, BANDAGES AND DRESSINGS, DISIN-  
FECTANT AND CLEANSING SOLUTIONS, HOT  
AND COLD PACKS, AND INHALENTS FOR RE-

THE MARK CONSISTS OF STANDARD CHAR-  
ACTERS WITHOUT CLAIM TO ANY PARTICULAR  
FONT, STYLE, SIZE, OR COLOR.

SN 78-546,316, FILED 1-12-2005.

INGA ERVIN, EXAMINING ATTORNEY

**Int. Cls.: 1, 3, 7, and 16**

**Prior U.S. Cls.: 1, 2, 4, 5, 6, 10, 13, 19, 21, 22, 23, 26, 29, 31, 34, 35, 37, 38, 46, 50, 51, and 52**

**Reg. No. 3,395,816**

**United States Patent and Trademark Office**

**Registered Mar. 11, 2008**

**TRADEMARK  
PRINCIPAL REGISTER**

**DEFINING  
EXCELLENCE**

DAY INTERNATIONAL, INC. (DELAWARE CORPORATION)  
130 WEST SECOND STREET  
DAYTON, OH 45402

FOR: PRINTING PRESSROOM CHEMICALS, NAMELY, FOUNTAIN SOLUTIONS, ALCOHOL SUBSTITUTES, SILICONES, ANTI-MARKING SOLUTIONS, INDUSTRIAL DETERGENTS, DEGLAZERS, SURFACTANTS, DAMPENING SOLUTIONS, ANTI-SET OFF POWDERS, ADHESIVES AND CHEMICALS FOR TREATING PAPER AND MACHINERY, ALL FOR USE IN PRINTING PROCESSES, IN CLASS 1 (U.S. CLS. 1, 5, 6, 10, 26 AND 46).

FIRST USE 2-14-2005; IN COMMERCE 2-14-2005.

FOR: CLEANING PREPARATIONS, CLEANING SOLVENTS, AND DETERGENTS, ALL FOR USE IN PRINTING PROCESSES, IN CLASS 3 (U.S. CLS. 1, 4, 6, 50, 51 AND 52).

FIRST USE 2-14-2005; IN COMMERCE 2-14-2005.

FOR: PRINTING ROLLERS, PARTICLE REMOVING ROLLERS FOR PRINTING PRESSES; MACHINE PARTS, NAMELY, DIE CUTTING MATS, BLANKETS, COVERS AND ACCESSORIES, NAMELY, CHANNEL ADAPTORS; BUSINESS MACHINERY PARTS, NAMELY, MICRO CELLULAR PADS AND ROLLERS AND VULCANIZED ROLLS, BEING PARTS OF MACHINES OR FOR USE AS PARTS OF MACHINES, MACHINE PARTS FOR PRINTING MACHINES, NAMELY, PRINTING SLEEVES, METAL BACK BLANKETS, AND IMAGE TRANSFER

BELTS, IMAGE TRANSFER DRUMS, IMAGE TRANSFER CYLINDERS, CLEANING APPARATUS FOR PRINTING PRESSES COMPRISED OF INK SOLVENT DISPENSERS AND LIQUID REMOVAL MACHINES, FILTERS FOR SOLUTIONS USED IN PRINTING EQUIPMENT AND MACHINES, AND PARTS FOR THE AFOREMENTIONED GOODS; PARTS FOR PRINTING MACHINES, NAMELY, FLEXOGRAPHIC PRINTING SLEEVES, CARRIERS, AND BRIDGES, IN CLASS 7 (U.S. CLS. 13, 19, 21, 23, 31, 34 AND 35).

FIRST USE 2-14-2005; IN COMMERCE 2-14-2005.

FOR: PARTS FOR PRINTING EQUIPMENT AND MACHINES, PRINTING BLANKETS NOT MADE OF TEXTILE, PRINTING BLANKETS NOT MADE OF TEXTILE ACCESSORIES, NAMELY, BARS SOLD AS COMPONENTS OF PRINTING BLANKET ASSEMBLIES, INK ROLLERS FOR USE IN MACHINES, AND PARTS FOR THE AFOREMENTIONED GOODS, IN CLASS 16 (U.S. CLS. 2, 5, 22, 23, 29, 37, 38 AND 50).

FIRST USE 2-14-2005; IN COMMERCE 2-14-2005.

THE MARK CONSISTS OF STANDARD CHARACTERS WITHOUT CLAIM TO ANY PARTICULAR FONT, STYLE, SIZE, OR COLOR.

SN 78-551,960, FILED 1-21-2005.

AMOS T. MATTHEWS, JR., EXAMINING ATTORNEY

**Int. Cl.: 12**

**Prior U.S. Cls.: 19, 21, 23, 31, 35, and 44**

**Reg. No. 3,395,817**

**United States Patent and Trademark Office**

**Registered Mar. 11, 2008**

---

**TRADEMARK  
PRINCIPAL REGISTER**

**TRU-SEAL**

GUNITE CORPORATION (DELAWARE CORPORATION)  
302 PEOPLES AVENUE  
ROCKFORD, IL 61104

FOR: SEALING SYSTEM COMPRISED OF A ONE  
PIECE LINK BOOT, A MACHINED IN RETAINING  
GROOVE, AND BELLOWS WHICH ALLOW FOR  
GREATER STRETCH AND FLEXIBILITY OF THE  
LINK BOOT, FOR THE ADJUSTING LINK ON  
AUTOMATIC BRAKE ADJUSTERS USED ON COM-  
MERCIAL TRUCKS, TRUCK TRACTORS AND

SEMI-TRAILERS WITH AIR BRAKE, IN CLASS 12  
(U.S. CLS. 19, 21, 23, 31, 35 AND 44).

FIRST USE 12-1-2004; IN COMMERCE 12-1-2004.

THE MARK CONSISTS OF STANDARD CHAR-  
ACTERS WITHOUT CLAIM TO ANY PARTICULAR  
FONT, STYLE, SIZE, OR COLOR.

SN 78-552,733, FILED 1-24-2005.

WON TEAK OH, EXAMINING ATTORNEY

**Int. Cl.: 25**

**Prior U.S. Cls.: 22 and 39**

**United States Patent and Trademark Office**

**Reg. No. 3,395,818**

**Registered Mar. 11, 2008**

**TRADEMARK  
PRINCIPAL REGISTER**



SOULARD RESTORATION GROUP, INC. (MISSOURI NON-PROFIT CORPORATION)  
PO BOX 13312  
SAINT LOUIS, MO 63157

FOR: BASEBALL CAPS; WOOL CAPS; GLOVES; FLEECE PULL-OVERS; SWEATSHIRTS; T-SHIRTS; GYM SHORTS; BOXER SHORTS, IN CLASS 25 (U.S. CLS. 22 AND 39).

FIRST USE 12-1-2004; IN COMMERCE 2-1-2005.

NO CLAIM IS MADE TO THE EXCLUSIVE RIGHT TO USE "SOULARD SAINT LOUIS", APART FROM THE MARK AS SHOWN.

THE COLOR(S) RED AND GOLD IS/ARE CLAIMED AS A FEATURE OF THE MARK.

THE MARK CONSISTS OF A REPRESENTATION OF A CAST-IRON STAR, A DECORATIVE NUT FOR A JOIST ROD USED IN BRICK HOME CONSTRUCTION IN THE 19TH CENTURY, SITS IN THE UPPER LEFT CORNER OF THE MARK. THE BODY OF THE STAR IS RED WITH GOLD TRIM AND HIGHLIGHTS. THE WORD SOULARD APPEARS IN A BANNER WITH WORDS SAINT LOUIS BENEATH THE BANNER AND TO THE RIGHT. THE WORDS AND BANNER ARE IN THE SAME GOLD AS USED ON THE STAR.

SN 78-553,516, FILED 1-25-2005.

CURTIS FRENCH, EXAMINING ATTORNEY

**Int. Cl.: 36**

**Prior U.S. Cls.: 100, 101, and 102**

**United States Patent and Trademark Office**

**Reg. No. 3,395,819**

**Registered Mar. 11, 2008**

**SERVICE MARK  
PRINCIPAL REGISTER**

**PALMFUND**

PALMFUND MANAGEMENT, LLC (DELAWARE  
LTD LIAB CO)  
ARISTIDES FIALLO CABRAL NO. 4 GASCUE  
SANTO DOMINGO, DOMINICAN REP

THE MARK CONSISTS OF STANDARD CHAR-  
ACTERS WITHOUT CLAIM TO ANY PARTICULAR  
FONT, STYLE, SIZE, OR COLOR.

FOR: PRIVATE EQUITY INVESTMENT AND  
MANAGEMENT SERVICES, IN CLASS 36 (U.S.  
CLS. 100, 101 AND 102).

SN 78-554,397, FILED 1-26-2005.

FIRST USE 11-1-2005; IN COMMERCE 11-1-2005.

JEFF DEFORD, EXAMINING ATTORNEY



**Int. Cl.: 9**

**Prior U.S. Cls.: 21, 23, 26, 36, and 38**

**Reg. No. 3,395,820**

**United States Patent and Trademark Office**

**Registered Mar. 11, 2008**

**TRADEMARK  
PRINCIPAL REGISTER**

**EPACT**

THE CHARLOTTE-MECKLENBURG HOSPITAL  
AUTHORITY (NORTH CAROLINA HOSPITAL  
AUTHORITY), DBA CAROLINAS HEALTH-  
CARE SYSTEM,  
1001 BLYTHE BOULEVARD  
CHARLOTTE, NC 28023

FOR: ELECTRONIC PATIENT INFORMATION  
MANAGEMENT SYSTEM COMPRISED OF COM-  
PUTER HARDWARE AND COMPUTER SOFT-  
WARE FOR USE TO COMPILE A DATABASE FOR  
ORGANIZING, MAINTAINING, AND FACILITAT-  
ING ACCESS TO PATIENT INFORMATION BY

MEDICAL PERSONNEL, IN CLASS 9 (U.S. CLS. 21,  
23, 26, 36 AND 38).

FIRST USE 10-2-2006; IN COMMERCE 10-2-2006.

THE MARK CONSISTS OF STANDARD CHAR-  
ACTERS WITHOUT CLAIM TO ANY PARTICULAR  
FONT, STYLE, SIZE, OR COLOR.

SN 78-555,750, FILED 1-28-2005.

GIANCARLO CASTRO, EXAMINING ATTORNEY

Int. Cl.: 9

Prior U.S. Cls.: 21, 23, 26, 36, and 38

United States Patent and Trademark Office

Reg. No. 3,395,821

Registered Mar. 11, 2008

TRADEMARK  
PRINCIPAL REGISTER

PET ALIEN

TAFFY PRODUCTIONS, LLC (CALIFORNIA LTD  
LIAB CO)  
21300 OXNARD STREET, SUITE 100  
WOODLAND HILLS, CA 91367

FOR: PRE-RECORDED DIGITAL VIDEO DISCS  
ALL FEATURING ANIMATED CARTOONS FOR  
ENTERTAINMENT OF CHILDREN; SOUND AND  
VIDEO RECORDINGS FEATURING A SERIES OF  
CHILDREN'S PROGRAMS; VIDEO GAME CAR-  
TRIDGES, VIDEO GAMES RECORDED ON CD-  
ROM FOR USE IN VIDEO GAME MACHINES;  
COMPUTER PRODUCTS, NAMELY, GAME CAR-  
TRIDGES FOR COMPUTER VIDEO GAMES AND  
VIDEO OUTPUT GAME MACHINES AND IN-  
STRUCTIONAL MATERIALS SOLD AS A UNIT,  
CHILDREN'S COMPUTER GAME SOFTWARE ALL  
FEATURING ANIMATED CARTOON SERIES AND

THEIR CHARACTERS INCORPORATING MUSIC,  
VIDEO, ANIMATION, AND INTERACTIVE COM-  
PONENTS, IN CLASS 9 (U.S. CLS. 21, 23, 26, 36 AND  
38).

FIRST USE 10-18-2005; IN COMMERCE 10-18-2005.

THE MARK CONSISTS OF STANDARD CHAR-  
ACTERS WITHOUT CLAIM TO ANY PARTICULAR  
FONT, STYLE, SIZE, OR COLOR.

OWNER OF U.S. REG. NO. 2,226,748.

SN 78-555,833, FILED 1-28-2005.

ELLEN PERKINS, EXAMINING ATTORNEY

**Int. Cl.: 4**

**Prior U.S. Cls.: 1, 6, and 15**

**United States Patent and Trademark Office**

**Reg. No. 3,395,822**

**Registered Mar. 11, 2008**

**TRADEMARK  
PRINCIPAL REGISTER**

**SHREDCARE**

INTEK AMERICA, INC. (CALIFORNIA CORPORATION)  
3460 TORRANCE BOULEVARD  
SUITE 205  
TORRANCE, CA 90503

THE MARK CONSISTS OF STANDARD CHARACTERS WITHOUT CLAIM TO ANY PARTICULAR FONT, STYLE, SIZE, OR COLOR.

FOR: MACHINE OIL FOR USE IN PAPER SHREDDERS AND MEDIA SHREDDERS, IN CLASS 4 (U.S. CLS. 1, 6 AND 15).

SN 78-556,065, FILED 1-28-2005.

FIRST USE 12-7-2005; IN COMMERCE 12-7-2005.

INGA ERVIN, EXAMINING ATTORNEY

**Int. Cl.: 40**

**Prior U.S. Cls.: 100, 103, and 106**

**United States Patent and Trademark Office**

**Reg. No. 3,395,823**

**Registered Mar. 11, 2008**

**SERVICE MARK  
PRINCIPAL REGISTER**

**Make Sure Every  
Customer Leaves  
Happy**

CYCLE SYSTEMS, INC. (VIRGINIA CORPORATION)  
2580 BROADWAY STREET S.W.  
ROANOKE, VA 24014

THE MARK CONSISTS OF STANDARD CHARACTERS WITHOUT CLAIM TO ANY PARTICULAR FONT, STYLE, SIZE, OR COLOR.

FOR: RECYCLING OF MATERIALS, IN CLASS 40  
(U.S. CLS. 100, 103 AND 106).

SN 78-557,777, FILED 2-1-2005.

FIRST USE 6-19-2007; IN COMMERCE 6-19-2007.

JASON ROTH, EXAMINING ATTORNEY

Int. Cl.: 11

Prior U.S. Cls.: 13, 21, 23, 31, and 34

United States Patent and Trademark Office

Reg. No. 3,395,824

Registered Mar. 11, 2008

TRADEMARK  
PRINCIPAL REGISTER

The logo for Hi-Velocity Systems features the words "Hi-Velocity" in a large, bold, italicized sans-serif font. Below "Hi-Velocity" is the word "Systems" in a smaller, italicized sans-serif font. A horizontal line with a slight curve is positioned between the two words. The entire logo has a stippled or textured appearance.

ENERGY SAVING PRODUCTS LTD. (CANADA  
CORPORATION)  
12615 - 124 STREET  
EDMONTON, ALBERTA, CANADA T5L 0N8

FOR: COMMERCIAL AND RESIDENTIAL HEAT-  
ING, VENTILATING AND AIR CONDITIONING  
SYSTEMS COMPRISED OF HEAT PUMPS, FANS,  
WATER COILS, ELECTRIC COILS, REFRIGERANT  
COILS, FILTERS, HUMIDIFIERS AND DUCTING,  
IN CLASS 11 (U.S. CLS. 13, 21, 23, 31 AND 34).

FIRST USE 10-17-2007; IN COMMERCE 10-17-2007.

NO CLAIM IS MADE TO THE EXCLUSIVE  
RIGHT TO USE "HI-VELOCITY SYSTEMS", APART  
FROM THE MARK AS SHOWN.

THE STIPPLING IS FOR SHADING PURPOSES.

SN 78-559,060, FILED 2-2-2005.

MICHAEL LEWIS, EXAMINING ATTORNEY

**Int. Cl.: 21**

**Prior U.S. Cls.: 2, 13, 23, 29, 30, 33, 40, and 50**

**Reg. No. 3,395,825**

**United States Patent and Trademark Office**

**Registered Mar. 11, 2008**

---

**TRADEMARK  
PRINCIPAL REGISTER**

**E-Z GRIP**

ARCHER WIRE INTERNATIONAL CORP. (ILLINOIS CORPORATION)  
7300 S. NARRAGANSETT  
BEDFORD PARK, IL 60638

THE MARK CONSISTS OF STANDARD CHARACTERS WITHOUT CLAIM TO ANY PARTICULAR FONT, STYLE, SIZE, OR COLOR.

FOR: COOKING UTENSILS, NAMELY, WIRE BASKETS FOR USE IN FRYING FOODS, IN CLASS 21 (U.S. CLS. 2, 13, 23, 29, 30, 33, 40 AND 50).

SN 78-559,223, FILED 2-2-2005.

FIRST USE 3-29-2005; IN COMMERCE 3-29-2005.

MARILYN IZZI, EXAMINING ATTORNEY

**Int. Cl.: 9**

**Prior U.S. Cls.: 21, 23, 26, 36, and 38**

**United States Patent and Trademark Office**

**Reg. No. 3,395,826**

**Registered Mar. 11, 2008**

**TRADEMARK  
PRINCIPAL REGISTER**

**VERISIGHT**

HUMANA INC. (DELAWARE CORPORATION)  
500 WEST MAIN STREET  
LOUISVILLE, KY 40202

FOR: SOFTWARE PROGRAM FOR USE IN MANAGEMENT AND ANALYSIS OF POPULATION DATA AND FOR USE IN MODELING ANTICIPATED EVENTS, IN CLASS 9 (U.S. CLS. 21, 23, 26, 36 AND 38).

FIRST USE 10-31-2004; IN COMMERCE 10-31-2004.

THE MARK CONSISTS OF STANDARD CHARACTERS WITHOUT CLAIM TO ANY PARTICULAR FONT, STYLE, SIZE, OR COLOR.

SN 78-559,583, FILED 2-3-2005.

TINA L. SNAPP, EXAMINING ATTORNEY

Int. Cls.: 25 and 41

Prior U.S. Cls.: 22, 39, 100, 101, and 107

United States Patent and Trademark Office

Reg. No. 3,395,827

Registered Mar. 11, 2008

**TRADEMARK  
SERVICE MARK  
PRINCIPAL REGISTER**



PBPREVIEW.COM, INC. (WASHINGTON CORPORATION)  
14525 SW MILLIKAN WAY RCM# 6556  
BEAVERTON, OR 970052343

FOR: ATHLETIC CLOTHING, NAMELY, SHIRTS, JERSEYS, SHORTS, PANTS, T-SHIRTS, CAPS, HATS AND VISORS, IN CLASS 25 (U.S. CLS. 22 AND 39).

FIRST USE 11-1-2006; IN COMMERCE 11-1-2006.

FOR: PROVIDING A WEBSITE FEATURING INFORMATION ABOUT PAINTBALL COMPETITIONS AND PRODUCTS, IN CLASS 41 (U.S. CLS. 100, 101 AND 107).

FIRST USE 11-1-2006; IN COMMERCE 11-1-2006.

SN 78-560,295, FILED 2-3-2005.

LESLEY LAMOTHE, EXAMINING ATTORNEY



**Int. Cl.: 3**

**Prior U.S. Cls.: 1, 4, 6, 50, 51, and 52**

**United States Patent and Trademark Office**

**Reg. No. 3,395,828**

**Registered Mar. 11, 2008**

**TRADEMARK  
PRINCIPAL REGISTER**

**HARD CURL**

LABORATOIRE GARNIER & CIE (FRANCE SO-  
CIE TE EN NOM COLLECTIF)

281, RUE SAINT-HONORE

PARIS, FRANCE 75008

FOR: GELS FOR HAIR STYLING, IN CLASS 3  
(U.S. CLS. 1, 4, 6, 50, 51 AND 52).

FIRST USE 5-0-2005; IN COMMERCE 5-0-2005.

THE MARK CONSISTS OF STANDARD CHAR-  
ACTERS WITHOUT CLAIM TO ANY PARTICULAR  
FONT, STYLE, SIZE, OR COLOR.

NO CLAIM IS MADE TO THE EXCLUSIVE  
RIGHT TO USE "CURL", APART FROM THE MARK  
AS SHOWN.

SN 78-562,600, FILED 2-8-2005.

STEVEN R. FINE, EXAMINING ATTORNEY

**Int. Cls.: 1 and 9**

**Prior U.S. Cls.: 1, 5, 6, 10, 21, 23, 26, 36, 38, and 46**

**United States Patent and Trademark Office**

**Reg. No. 3,395,829**

**Registered Mar. 11, 2008**

**TRADEMARK  
PRINCIPAL REGISTER**

**BIOITRAQ**

APPLERA CORPORATION (DELAWARE CORPORATION)  
850 LINCOLN CENTRE DRIVE  
FOSTER CITY, CA 94401

FOR: REAGENTS FOR SCIENTIFIC OR MEDICAL RESEARCH USE; DIAGNOSTIC REAGENTS FOR SCIENTIFIC OR RESEARCH USE, IN CLASS 1 (U.S. CLS. 1, 5, 6, 10, 26 AND 46).

FIRST USE 6-12-2006; IN COMMERCE 6-12-2006.

FOR: LABORATORY INSTRUMENTS AND SUPPLIES, NAMELY, A BIOMARKER DISCOVERY SYSTEM COMPRISED OF MASS SPECTROMETER

AND/OR LIQUID CHROMATOGRAPHER, AND OPERATING SOFTWARE SOLD TOGETHER THEREWITH, IN CLASS 9 (U.S. CLS. 21, 23, 26, 36 AND 38).

FIRST USE 6-12-2006; IN COMMERCE 6-12-2006.

THE MARK CONSISTS OF STANDARD CHARACTERS WITHOUT CLAIM TO ANY PARTICULAR FONT, STYLE, SIZE, OR COLOR.

SN 78-565,157, FILED 2-10-2005.

ESTHER A. BORSUK, EXAMINING ATTORNEY

**Int. Cls.: 9, 16, and 42**

**Prior U.S. Cls.: 2, 5, 21, 22, 23, 26, 29, 36, 37, 38, 50,  
100, and 101**

**Reg. No. 3,395,830**

**United States Patent and Trademark Office**

**Registered Mar. 11, 2008**

**TRADEMARK  
SERVICE MARK  
PRINCIPAL REGISTER**

**DS8000**

INTERNATIONAL BUSINESS MACHINES COR-  
PORATION (NEW YORK CORPORATION)  
NEW ORCHARD ROAD  
ARMONK, NY 10504

FOR: COMPUTER HARDWARE AND COMPU-  
TER SOFTWARE FOR USE IN DATA STORAGE,  
DATA ENCRYPTION, CONSOLIDATION OF DATA,  
DISASTER TOLERANCE AND RECOVERY FOR  
DATA, DATA PROTECTION, AND NETWORK  
SHARING, AND INSTRUCTION MANUALS SOLD  
AS A UNIT THEREWITH, IN CLASS 9 (U.S. CLS. 21,  
23, 26, 36 AND 38).

FIRST USE 10-12-2004; IN COMMERCE 10-12-2004.

FOR: PRINTED MATTER, NAMELY, BRO-  
CHURES, MAGAZINES, WRITTEN PRESENTA-  
TIONS AND TEACHING MATERIALS IN THE

FIELD OF DATA STORAGE, IN CLASS 16 (U.S.  
CLS. 2, 5, 22, 23, 29, 37, 38 AND 50).

FIRST USE 10-12-2004; IN COMMERCE 10-12-2004.

FOR: COMPUTER CONSULTATION AND DE-  
SIGN SERVICES IN THE FIELD OF DATA STO-  
RAGE, IN CLASS 42 (U.S. CLS. 100 AND 101).

FIRST USE 10-12-2004; IN COMMERCE 10-12-2004.

THE MARK CONSISTS OF STANDARD CHAR-  
ACTERS WITHOUT CLAIM TO ANY PARTICULAR  
FONT, STYLE, SIZE, OR COLOR.

SN 78-565,407, FILED 2-11-2005.

MONIQUE MILLER, EXAMINING ATTORNEY

**Int. Cl.: 9**

**Prior U.S. Cls.: 21, 23, 26, 36, and 38**

**United States Patent and Trademark Office**

**Reg. No. 3,395,831**

**Registered Mar. 11, 2008**

**TRADEMARK  
PRINCIPAL REGISTER**

**LIFE AMPLIFIED**

MARANTZ AMERICA, INC. (CALIFORNIA CORPORATION)  
1100 MAPLEWOOD DRIVE  
ITASCA, IL 60143

FOR: HOME AUDIO AND VIDEO PRODUCTS, NAMELY, TUNERS, AMPLIFIERS, PREAMPLIFIERS, RECEIVERS, EQUALIZERS, MICROPHONES, ANALOG AND DIGITAL AUDIO CASSETTE DECKS, TURNTABLES, COMPACT DISC (CD) PLAYERS, COMPACT DISC (CD) CHANGERS, LOUDSPEAKERS, TELEVISIONS, VIDEO MONITORS, PROJECTORS AND RECEIVERS, VIDEO RECORDERS AND PLAYERS, VIDEO DISC PLAYERS, DVD PLAYERS, AND REMOTE CONTROL UNITS FOR USE THEREWITH; AND PORTABLE

AUDIO AND VIDEO PRODUCTS, NAMELY, MICROPHONES, CASSETTE DECKS, AND VIDEO CAMCORDERS, IN CLASS 9 (U.S. CLS. 21, 23, 26, 36 AND 38).

FIRST USE 7-0-2004; IN COMMERCE 7-0-2004.

THE MARK CONSISTS OF STANDARD CHARACTERS WITHOUT CLAIM TO ANY PARTICULAR FONT, STYLE, SIZE, OR COLOR.

SN 78-565,716, FILED 2-11-2005.

TARAH HARDY, EXAMINING ATTORNEY

**Int. Cl.: 36**

**Prior U.S. Cls.: 100, 101, and 102**

**United States Patent and Trademark Office**

**Reg. No. 3,395,832**

**Registered Mar. 11, 2008**

**SERVICE MARK  
PRINCIPAL REGISTER**



ON HOLIDAY, L.L.C. (MASSACHUSETTS LTD  
LIAB CO)  
77 BARLEY NECK ROAD  
ORLEANS, MA 02653

THE MARK CONSISTS OF STANDARD CHAR-  
ACTERS WITHOUT CLAIM TO ANY PARTICULAR  
FONT, STYLE, SIZE, OR COLOR.

FOR: ACCEPTING AND ADMINISTERING  
MONETARY CHARITABLE CONTRIBUTIONS, IN  
CLASS 36 (U.S. CLS. 100, 101 AND 102).

SN 78-566,834, FILED 2-14-2005.

FIRST USE 4-5-2006; IN COMMERCE 4-5-2006.

MARLENE BELL, EXAMINING ATTORNEY

**Int. Cl.: 44**

**Prior U.S. Cls.: 100 and 101**

**United States Patent and Trademark Office**

**Reg. No. 3,395,833**

**Registered Mar. 11, 2008**

**SERVICE MARK  
PRINCIPAL REGISTER**

**LOOKS GOOD ON YOU**

HEALTH PUBLISHING, INC. (DELAWARE CORPORATION)  
2100 LAKESHORE DRIVE  
NEW YORK, NY 35209

THE MARK CONSISTS OF STANDARD CHARACTERS WITHOUT CLAIM TO ANY PARTICULAR FONT, STYLE, SIZE, OR COLOR.

FOR: PROVIDING INFORMATION ABOUT THE BODY, BEAUTY, MIND, FITNESS, AND FOOD NUTRITION VIA A GLOBAL COMPUTER NETWORK, IN CLASS 44 (U.S. CLS. 100 AND 101).

SN 78-568,611, FILED 2-16-2005.

FIRST USE 5-31-2005; IN COMMERCE 5-31-2005.

JULIE WATSON, EXAMINING ATTORNEY

Int. Cl.: 4

Prior U.S. Cls.: 1, 6, and 15

United States Patent and Trademark Office

Reg. No. 3,395,834

Registered Mar. 11, 2008

TRADEMARK  
PRINCIPAL REGISTER

Palm Creations by  
Nature's Finest

RUG DOCTOR, INC. (DELAWARE CORPORATION)  
4701 OLD SHEPARD PLACE  
PLANO, TX 75093

FOR: CANDLES, IN CLASS 4 (U.S. CLS. 1, 6 AND 15).

FIRST USE 10-30-2006; IN COMMERCE 10-30-2006.

THE MARK CONSISTS OF STANDARD CHARACTERS WITHOUT CLAIM TO ANY PARTICULAR FONT, STYLE, SIZE, OR COLOR.

OWNER OF U.S. REG. NOS. 2,580,451, 2,717,459, AND OTHERS.

NO CLAIM IS MADE TO THE EXCLUSIVE RIGHT TO USE "PALM", APART FROM THE MARK AS SHOWN.

SN 78-569,189, FILED 2-17-2005.

ANGELA GAW, EXAMINING ATTORNEY

**Int. Cl.: 38**

**Prior U.S. Cls.: 100, 101, and 104**

**United States Patent and Trademark Office**

**Reg. No. 3,395,835**

**Registered Mar. 11, 2008**

**SERVICE MARK  
PRINCIPAL REGISTER**

**eGovDirect  
Benchmark**

NYSE GROUP, INC. (DELAWARE CORPORATION)  
11 WALL STREET  
NEW YORK, NY 10005

FOR: ELECTRONIC TRANSMISSION OF FINANCIAL, BUSINESS AND CORPORATE INFORMATION, NAMELY, INFORMATION REGARDING NEW YORK STOCK EXCHANGE PUBLICLY TRADED COMPANIES, TO USERS VIA A GLOBAL COMPUTER NETWORK, IN CLASS 38 (U.S. CLS. 100, 101 AND 104).

FIRST USE 4-0-2005; IN COMMERCE 4-0-2005.

THE MARK CONSISTS OF STANDARD CHARACTERS WITHOUT CLAIM TO ANY PARTICULAR FONT, STYLE, SIZE, OR COLOR.

SN 78-569,248, FILED 2-17-2005.

MORGAN WYNNE, EXAMINING ATTORNEY



**Int. Cl.: 41**

**Prior U.S. Cls.: 100, 101, and 107**

**United States Patent and Trademark Office**

**Reg. No. 3,395,836**

**Registered Mar. 11, 2008**

**SERVICE MARK  
PRINCIPAL REGISTER**



BOYNE MOUNTAIN RECREATION, L.L.C. (DE-  
LAWARE LIMITED LIABILITY CORPORA-  
TION)  
SUITE 300  
600 NORTH BUFFALO GROVE ROAD  
BUFFALO GROVE, IL 60089

FIRST USE 5-27-2005; IN COMMERCE 5-27-2005.

SN 78-570,979, FILED 2-18-2005.

FOR: ENTERTAINMENT SERVICES, NAMELY,  
WATER PARK AND THEME PARK SERVICES, IN  
CLASS 41 (U.S. CLS. 100, 101 AND 107).

JUDITH HELFMAN, EXAMINING ATTORNEY

**Int. Cls.: 21, 25, and 29**

**Prior U.S. Cls.: 2, 13, 22, 23, 29, 30, 33, 39, 40, 46, and 50**

**United States Patent and Trademark Office**

**Reg. No. 3,395,837**

**Registered Mar. 11, 2008**

**TRADEMARK  
PRINCIPAL REGISTER**

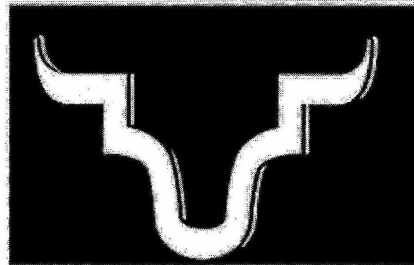

LINK SNACKS, INC. (WISCONSIN CORPORATION)  
ONE SNACKFOOD LANE  
P.O. BOX 397  
MINONG, WI 54859

FOR: CUPS AND MUGS, IN CLASS 21 (U.S. CLS. 2, 13, 23, 29, 30, 33, 40 AND 50).

FIRST USE 2-0-2007; IN COMMERCE 2-0-2007.

FOR: CLOTHING, NAMELY, SHIRTS, HATS, JACKETS, SWEATSHIRTS, IN CLASS 25 (U.S. CLS. 22 AND 39).

FIRST USE 6-0-2006; IN COMMERCE 6-0-2006.

FOR: MEAT SNACKS, IN CLASS 29 (U.S. CL. 46).

FIRST USE 5-0-2005; IN COMMERCE 5-0-2005.

SN 78-571,758, FILED 2-21-2005.

RENEE MCCRAY, EXAMINING ATTORNEY

**Int. Cl.: 3**

**Prior U.S. Cls.: 1, 4, 6, 50, 51, and 52**

**United States Patent and Trademark Office**

**Reg. No. 3,395,838**

**Registered Mar. 11, 2008**

**TRADEMARK  
PRINCIPAL REGISTER**



PLANTE, VANESSA (UNITED STATES INDIVIDUAL)  
1968 W. HOLT AVE  
POMONA, CA 91768

FOR: FACIAL MAKEUP, MASCARA, AND ARTIFICIAL EYELASHES, IN CLASS 3 (U.S. CLS. 1, 4, 6, 50, 51 AND 52).

FIRST USE 3-31-2005; IN COMMERCE 3-31-2005.

NO CLAIM IS MADE TO THE EXCLUSIVE RIGHT TO USE "EYELASH EXTENSIONS", APART FROM THE MARK AS SHOWN.

THE COLOR(S) BLACK, WHITE AND BLUE IS/ARE CLAIMED AS A FEATURE OF THE MARK.

THE COLORS BLACK, WHITE AND BLUE APPEAR IN THE EYE. THE COLOR BLACK APPEARS IN THE EYELASHES AND IN WORDING "ILASH EXTENSIONS".

SN 78-571,832, FILED 2-21-2005.

RAMONA ORTIGA, EXAMINING ATTORNEY

**Int. Cl.: 9**

**Prior U.S. Cls.: 21, 23, 26, 36, and 38**

**Reg. No. 3,395,839**

**United States Patent and Trademark Office**

**Registered Mar. 11, 2008**

**TRADEMARK  
PRINCIPAL REGISTER**

**FULCRUM**

BROADCOM CORPORATION (CALIFORNIA CORPORATION)  
5300 CALIFORNIA AVENUE  
IRVINE, CA 92617

FOR: SOFTWARE FOR DATA STORAGE MANAGEMENT; SOFTWARE ENABLING PORTABILITY AND NETWORKING ACROSS DIFFERENT COMPUTER HARDWARE PLATFORMS; COMPUTER PERIPHERALS, NAMELY, CONTROLLER CARDS, IN CLASS 9 (U.S. CLS. 21, 23, 26, 36 AND 38).

FIRST USE 3-11-2005; IN COMMERCE 3-11-2005.

THE MARK CONSISTS OF STANDARD CHARACTERS WITHOUT CLAIM TO ANY PARTICULAR FONT, STYLE, SIZE, OR COLOR.

SN 78-572,649, FILED 2-22-2005.

ELLEN PERKINS, EXAMINING ATTORNEY

**Int. Cl.: 35**

**Prior U.S. Cls.: 100, 101, and 102**

**United States Patent and Trademark Office**

**Reg. No. 3,395,840**

**Registered Mar. 11, 2008**

**SERVICE MARK  
PRINCIPAL REGISTER**

**CONSIGNMENT PAL**

MILLER, LINDA (UNITED STATES INDIVIDUAL)  
18431 EMERALD FOREST DR.  
SAN ANTONIO, TX 78259

FOR: RETAIL AND CONSIGNMENT, LIQUIDATION, TRADE, THRIFT AND SECOND HAND SERVICES WHEREBY GOODS ARE RECEIVED OR PICKED UP FOR AUCTIONS ON ONLINE AUCTION SITES, ANTIQUE SHOWS, LIVE AUCTIONS, FLEA MARKETS AND RETAIL OUTLETS IN THE NATURE OF CLOTHING AND FURNITURE CONSIGNMENT STORES, ART GALLERIES AND ANTIQUE OUTLETS, FEATURING FURNITURE, DECORATIVE ITEMS, COLLECTIBLES, CARS, RECREATIONAL VEHICLES, MOTORCYCLES, BOATS, AUDIO AND AUDIOVISUAL RECORDINGS, MUSICAL INSTRUMENTS, BOOKS, JEWELRY, WATCHES, CELLULAR TELEPHONES, COMPUTERS AND COMPUTER ACCESSORIES, CLOTHING, SHOES AND PERSONAL ACCESSORIES, CAMERAS AND PHOTOGRAPHY EQUIPMENT, CONSUMER ELECTRONICS, VIDEO GAMES, TOOLS AND POWER TOOLS, ARCHITECTURAL ELEMENTS, SPORTING GOODS, TOYS

AND HOBBY ITEMS, SPORTS MEMORABILIA, COINS, STAMPS, CRAFTING MATERIALS, ANTIQUES, HEALTH AND BEAUTY GOODS, GIFT BASKETS, POTTERY AND GLASS, DOLLS AND PLUSH TOYS, GIFT CERTIFICATES, TICKETS, HOUSEHOLD ITEMS, ENTERTAINMENT MEMORABILIA, REAL ESTATE, PICTURES AND PAINTINGS, SCULPTURES, AND ART SUPPLIES, IN CLASS 35 (U.S. CLS. 100, 101 AND 102).

FIRST USE 3-9-2005; IN COMMERCE 3-9-2005.

THE MARK CONSISTS OF STANDARD CHARACTERS WITHOUT CLAIM TO ANY PARTICULAR FONT, STYLE, SIZE, OR COLOR.

NO CLAIM IS MADE TO THE EXCLUSIVE RIGHT TO USE "CONSIGNMENT", APART FROM THE MARK AS SHOWN.

SN 78-576,113, FILED 2-28-2005.

MARLENE BELL, EXAMINING ATTORNEY

**Int. Cl.: 7**

**Prior U.S. Cls.: 13, 19, 21, 23, 31, 34, and 35**

**Reg. No. 3,395,841**

**United States Patent and Trademark Office**

**Registered Mar. 11, 2008**

---

**TRADEMARK  
PRINCIPAL REGISTER**

**BIG EASY**

LOADMASTER ENGINEERING, INC. (TEXAS  
CORPORATION)  
6935 BRITTMOORE ROAD  
HOUSTON, TX 77041

THE MARK CONSISTS OF STANDARD CHAR-  
ACTERS WITHOUT CLAIM TO ANY PARTICULAR  
FONT, STYLE, SIZE, OR COLOR.

FOR: WELL DRILLING RIGS, NAMELY, MOD-  
ULAR DRILLING RIGS, MOBILE DRILLING RIGS  
AND FAST MOVING DRILLING RIGS, IN CLASS 7  
(U.S. CLS. 13, 19, 21, 23, 31, 34 AND 35).

SN 78-577,592, FILED 3-1-2005.

FIRST USE 9-11-2005; IN COMMERCE 9-11-2005.

ELLEN PERKINS, EXAMINING ATTORNEY

**Int. Cls.: 30 and 43**

**Prior U.S. Cls.: 46, 100, and 101**

**United States Patent and Trademark Office**

**Reg. No. 3,395,842**

**Registered Mar. 11, 2008**

**TRADEMARK  
SERVICE MARK  
PRINCIPAL REGISTER**

# Cajun Coffee House

CAJUN COFFEE HOUSE, LLC (LOUISIANA LTD  
LIAB CO)  
370 STONEBRIDGE BLVD.  
BOSSIER CITY, LA 71111

FOR: PREPARED COFFEE AND COFFEE-BASED  
BEVERAGES, IN CLASS 30 (U.S. CL. 46).

FIRST USE 5-31-2005; IN COMMERCE 5-31-2005.

FOR: COFFEE SHOP FEATURING PREPARED  
COFFEES AND COFFEE-BASED BEVERAGES AND  
RELATED BAKED GOODS, IN CLASS 43 (U.S. CLS.  
100 AND 101).

FIRST USE 5-31-2005; IN COMMERCE 5-31-2005.

THE MARK CONSISTS OF STANDARD CHAR-  
ACTERS WITHOUT CLAIM TO ANY PARTICULAR  
FONT, STYLE, SIZE, OR COLOR.

NO CLAIM IS MADE TO THE EXCLUSIVE  
RIGHT TO USE "COFFEE HOUSE", APART FROM  
THE MARK AS SHOWN.

SN 78-580,597, FILED 3-4-2005.

KARANENDRA S. CHHINA, EXAMINING ATTOR-  
NEY

Int. Cls.: 30 and 43

Prior U.S. Cls.: 46, 100, and 101

United States Patent and Trademark Office

Reg. No. 3,395,843

Registered Mar. 11, 2008

TRADEMARK  
SERVICE MARK  
PRINCIPAL REGISTER



CAJUN COFFEE HOUSE, LLC (LOUISIANA LTD  
LIAB CO)  
370 STONEBRIDGE BLVD  
BOSSIER CITY, LA 71111

THE COLOR(S) RED, BLUE, GREEN, BROWN,  
BLACK AND WHITE IS/ARE CLAIMED AS A  
FEATURE OF THE MARK.

FOR: PREPARED COFFEE AND COFFEE-BASED  
BEVERAGES, IN CLASS 30 (U.S. CL. 46).

FIRST USE 5-31-2005; IN COMMERCE 5-31-2005.

FOR: COFFEE SHOPS FEATURING PREPARED  
COFFEE AND COFFEE-BASED BEVERAGES AND  
RELATED BAKED GOODS, IN CLASS 43 (U.S. CLS.  
100 AND 101).

FIRST USE 5-31-2005; IN COMMERCE 5-31-2005.

NO CLAIM IS MADE TO THE EXCLUSIVE  
RIGHT TO USE "THE REPRESENTATION OF THE  
MAP OF LOUISIANA" AND "COFFEE HOUSE",  
APART FROM THE MARK AS SHOWN.

THE FRONT OF THE HAT IS RED; THE CLOTH-  
ING AND THE OUTER PORTION OF THE EYE  
BALLS ARE BLUE; THE ALLIGATOR IS GREEN;  
THE WORDING "CAJUN", DONUT, COFFEE CUP,  
BANNER, OUTER CIRCLE, MAP OF "LOUISIANA",  
AND THE ALLIGATOR BACKGROUND ARE  
BROWN; "COFFEE HOUSE", "THE BEST JAVA IN  
THE SWAMP", AND THE EYE PUPILS ARE BLACK;  
AND THE BACK PORTION OF THE HAT, OUTER  
PORTION OF THE EYES, TEETH AND THE STEAM  
ARE WHITE.

SN 78-580,622, FILED 3-4-2005.

KARANENDRA S. CHHINA, EXAMINING ATTOR-  
NEY



**Int. Cls.: 30, 35, and 43**

**Prior U.S. Cls.: 46, 100, 101, and 102**

**United States Patent and Trademark Office**

**Reg. No. 3,395,844**

**Registered Mar. 11, 2008**

**TRADEMARK  
SERVICE MARK  
PRINCIPAL REGISTER**

**TEAGSCHWENDNER**

TEAGSCHWENDNER USA, INC. (DELAWARE CORPORATION)  
1160 NORTH STATE STREET  
CHICAGO, IL 60610

FOR: TEA, NON-ALCOHOLIC BEVERAGES MADE WITH TEA AND PRODUCTS COMMONLY KNOWN AS TEA, CANDIES, SUGAR AND FLAVORINGS FOR TEA BEVERAGES , IN CLASS 30 (U.S. CL. 46).

FIRST USE 4-25-2000; IN COMMERCE 11-7-2001.

FOR: RETAIL STORE SERVICES, INTERNET RETAIL STORE SERVICES AND MAIL ORDER CATALOG SERVICES FEATURING TEA, TEA-BASED BEVERAGES, BAKERY AND CANDY ITEMS, HONEY, SYRUPS AND FLAVORING FOR TEA AND UTENSILS AND ACCESSORIES FOR PREPARING,

SERVING AND DRINKING TEA, IN CLASS 35 (U.S. CLS. 100, 101 AND 102).

FIRST USE 4-25-2000; IN COMMERCE 11-7-2001.

FOR: CAFE RESTAURANT SERVICES AND TEA BAR SERVICES , IN CLASS 43 (U.S. CLS. 100 AND 101).

FIRST USE 4-25-2000; IN COMMERCE 3-21-2005.

THE MARK CONSISTS OF STANDARD CHARACTERS WITHOUT CLAIM TO ANY PARTICULAR FONT, STYLE, SIZE, OR COLOR.

SN 78-580,727, FILED 3-4-2005.

LA TONIA FISHER, EXAMINING ATTORNEY

**Int. Cls.: 9 and 36**

**Prior U.S. Cls.: 21, 23, 26, 36, 38, 100, 101, and 102**

**United States Patent and Trademark Office**

**Reg. No. 3,395,845**

**Registered Mar. 11, 2008**

**TRADEMARK  
SERVICE MARK  
PRINCIPAL REGISTER**

**SKYZONE**

SKYZONE ENTERTAINMENT, INC. (NEW JERSEY CORPORATION)  
PARKER PLAZA 400 KELBY STREET, 17TH FL.  
FORT LEE, NJ 07024

FOR: ELECTRONIC GAME PROGRAMS, IN CLASS 9 (U.S. CLS. 21, 23, 26, 36 AND 38).

FIRST USE 9-10-2004; IN COMMERCE 9-10-2004.

FOR: PROVIDING INFORMATION TO OTHERS ON FINANCE, IN CLASS 36 (U.S. CLS. 100, 101 AND 102).

FIRST USE 9-10-2004; IN COMMERCE 9-10-2004.

THE MARK CONSISTS OF STANDARD CHARACTERS WITHOUT CLAIM TO ANY PARTICULAR FONT, STYLE, SIZE, OR COLOR.

SN 78-581,548, FILED 3-7-2005.

CHERYL CLAYTON, EXAMINING ATTORNEY

**Int. Cl.: 3**

**Prior U.S. Cls.: 1, 4, 6, 50, 51, and 52**

**Reg. No. 3,395,846**

**United States Patent and Trademark Office**

**Registered Mar. 11, 2008**

**TRADEMARK  
PRINCIPAL REGISTER**

**RADAR**

BOOM LLC (DELAWARE LTD LIAB CO)  
2ND FLOOR  
800 THIRD AVENUE  
NEW YORK, NY 10022

FIRST USE 10-15-2007; IN COMMERCE 10-15-2007.

FOR: NON-MEDICATED LIP BALM, NON-MEDI-  
CATED LIP MOISTURIZER, PERFUME, COLOGNE,  
EAU DE TOILETTE, EAU DE PARFUM, AFTER-  
SHAVE, ANTIPERSPIRANTS, PERSONAL DEO-  
DORANTS, SHAVING BALM, SHAVING GEL,  
SHAVING LOTION, IN CLASS 3 (U.S. CLS. 1, 4, 6,  
50, 51 AND 52).

THE MARK CONSISTS OF STANDARD CHAR-  
ACTERS WITHOUT CLAIM TO ANY PARTICULAR  
FONT, STYLE, SIZE, OR COLOR.

SN 78-581,935, FILED 3-7-2005.

CHERYL CLAYTON, EXAMINING ATTORNEY

**Int. Cl.: 9**

**Prior U.S. Cls.: 21, 23, 26, 36, and 38**

**Reg. No. 3,395,847**

**United States Patent and Trademark Office**

**Registered Mar. 11, 2008**

**TRADEMARK  
PRINCIPAL REGISTER**

**CellLux**

PERKINELMER LAS, INC. (DELAWARE CORPORATION)  
940 WINTER STREET  
WALTHAM, MA 02451

FOR: LABORATORY EQUIPMENT, FOR USE IN PERFORMING CELL-BASED ASSAYS, IN PARTICULAR BY MEANS OF FLUORESCENCE DETECTION, NAMELY, SCIENTIFIC APPARATUS FOR MEASURING CELLULAR FLUORESCENCE; SCIENTIFIC APPARATUS, NAMELY, CELLULAR FLUORESCENCE WORKSTATIONS CONSISTING PRIMARILY OF MICRO-TITER PLATE READERS, AUTOMATED LIQUID-FLOW AND LIQUID-LEVEL CONTROL MACHINES AND INSTRUMENTS, COMPUTERS AND DATA ANALYSIS AND REPORTING SOFTWARE FOR ANALYZING AND

REPORTING DATA OBTAINED FROM THE WORKSTATION CONCERNING CELLULAR FLUORESCENCE, IN CLASS 9 (U.S. CLS. 21, 23, 26, 36 AND 38).

FIRST USE 1-0-2005; IN COMMERCE 1-0-2005.

THE MARK CONSISTS OF STANDARD CHARACTERS WITHOUT CLAIM TO ANY PARTICULAR FONT, STYLE, SIZE, OR COLOR.

SN 78-583,424, FILED 3-9-2005.

ANDREA K. NADELMAN, EXAMINING ATTORNEY

Int. Cls.: 16 and 25

Prior U.S. Cls.: 2, 5, 22, 23, 29, 37, 38, 39, and 50

United States Patent and Trademark Office

Reg. No. 3,395,848

Registered Mar. 11, 2008

TRADEMARK  
PRINCIPAL REGISTER



*keepin it kool*

KEEPIN IT KOOL (MICHIGAN LIMITED LIABILITY CORPORATION)  
16172 FENMORE  
DETROIT, MI 48235

FOR: BUSINESS STATIONERY, IN CLASS 16 (U.S. CLS. 2, 5, 22, 23, 29, 37, 38 AND 50).

FIRST USE 7-18-2006; IN COMMERCE 11-6-2007.

FOR: SHIRTS, T-SHIRTS, SKIRTS, HATS, IN CLASS 25 (U.S. CLS. 22 AND 39).

FIRST USE 8-1-2004; IN COMMERCE 9-20-2004.

THE MARK CONSISTS OF A BACKWARD "K", A LOWER-CASE "I", AND A NORMAL "K", WHICH ARE THE INITIALS FOR "KEEPIN IT KOOL". THE THREE LETTERS FORM THE SHAPE OF A BUTTERFLY.

SN 78-584,128, FILED 3-9-2005.

KEVIN CORWIN, EXAMINING ATTORNEY

**Int. Cls.: 16 and 25**

**Prior U.S. Cls.: 2, 5, 22, 23, 29, 37, 38, 39, and 50**

**United States Patent and Trademark Office**

**Reg. No. 3,395,849**

**Registered Mar. 11, 2008**

**TRADEMARK  
PRINCIPAL REGISTER**



KEEPIN IT KOOL (MICHIGAN LIMITED LIABILITY CORPORATION)  
16172 FENMORE  
DETROIT, MI 48235

FOR: BUSINESS STATIONERY, IN CLASS 16 (U.S. CLS. 2, 5, 22, 23, 29, 37, 38 AND 50).

FIRST USE 7-18-2006; IN COMMERCE 11-6-2007.

FOR: SHIRTS, T-SHIRTS, SKIRTS, HATS, IN CLASS 25 (U.S. CLS. 22 AND 39).

FIRST USE 8-1-2004; IN COMMERCE 9-20-2004.

THE MARK CONSISTS OF A BACKWARD "K", A LOWER-CASE "I", AND A NORMAL "K", WHICH ARE THE INITIALS FOR "KEEPIN IT KOOL". THE THREE LETTERS FORM THE SHAPE OF A BUTTERFLY.

SN 78-584,826, FILED 3-10-2005.

KEVIN CORWIN, EXAMINING ATTORNEY

**Int. Cl.: 7**

**Prior U.S. Cls.: 13, 19, 21, 23, 31, 34, and 35**

**Reg. No. 3,395,850**

**United States Patent and Trademark Office**

**Registered Mar. 11, 2008**

**TRADEMARK  
PRINCIPAL REGISTER**

**SecureUSA**

SECUREUSA (GEORGIA CORPORATION)  
SUITE 160  
4250 KEITH BRIDGE RD  
CUMMING, GA 30040

FIRST USE 12-0-1999; IN COMMERCE 12-0-1999.

FOR: POWER OPERATED LIFT METAL BOLLARDS, CONCRETE BOLLARDS AND METAL GUARD BARRIERS FOR SECURITY PURPOSES; POWER OPERATED WEDGE SECURITY BARRIERS, RISING PLATE SECURITY BARRIERS, IN CLASS 7 (U.S. CLS. 13, 19, 21, 23, 31, 34 AND 35).

THE MARK CONSISTS OF STANDARD CHARACTERS WITHOUT CLAIM TO ANY PARTICULAR FONT, STYLE, SIZE, OR COLOR.

SN 78-587,441, FILED 3-15-2005.

G. MAYERSCHOFF, EXAMINING ATTORNEY

**Int. Cls.: 21 and 31**

**Prior U.S. Cls.: 1, 2, 13, 23, 29, 30, 33, 40, 46, and 50**

**United States Patent and Trademark Office**

**Reg. No. 3,395,851**

**Registered Mar. 11, 2008**

**TRADEMARK  
PRINCIPAL REGISTER**

**SCOOP FREE**

LUCKY LITTER, LLC (DELAWARE LTD LIAB  
CO)  
SUITE 2506  
1730 NORTH CLARK STREET  
CHICAGO, IL 60614

FOR: CAT LITTER BOXES, IN CLASS 21 (U.S. CLS.  
2, 13, 23, 29, 30, 33, 40 AND 50).

FIRST USE 7-26-2005; IN COMMERCE 10-0-2005.

FOR: CAT LITTER; CARTRIDGES CONTAINING  
LITTER FOR CAT LITTER BOXES, IN CLASS 31  
(U.S. CLS. 1 AND 46).

FIRST USE 7-26-2005; IN COMMERCE 10-0-2005.

THE MARK CONSISTS OF STANDARD CHAR-  
ACTERS WITHOUT CLAIM TO ANY PARTICULAR  
FONT, STYLE, SIZE, OR COLOR.

SN 78-587,795, FILED 3-15-2005.

TAMARA FRAZIER, EXAMINING ATTORNEY



**Int. Cl.: 13**

**Prior U.S. Cls.: 2 and 9**

**United States Patent and Trademark Office**

**Reg. No. 3,395,852**

**Registered Mar. 11, 2008**

**TRADEMARK  
PRINCIPAL REGISTER**

**MUZZLE HATZ**

COLE, CHRISTOPHER N. (UNITED STATES IN-  
DIVIDUAL)  
P.O. BOX 1515  
CLATSKANIE, OR 97016

FOR: FLEXIBLE ADHESIVE DISKS USED TO  
COVER THE MUZZLES OF RIFLES AND GUNS  
TO KEEP THE BARREL FREE OF MOISTURE AND  
DEBRIS, IN CLASS 13 (U.S. CLS. 2 AND 9).

FIRST USE 6-13-2005; IN COMMERCE 6-13-2005.

THE MARK CONSISTS OF STANDARD CHAR-  
ACTERS WITHOUT CLAIM TO ANY PARTICULAR  
FONT, STYLE, SIZE, OR COLOR.

NO CLAIM IS MADE TO THE EXCLUSIVE  
RIGHT TO USE "MUZZLE", APART FROM THE  
MARK AS SHOWN.

SN 78-588,928, FILED 3-16-2005.

STEVEN R. FOSTER, EXAMINING ATTORNEY

**Int. Cl.: 40**

**Prior U.S. Cls.: 100, 103, and 106**

**United States Patent and Trademark Office**

**Reg. No. 3,395,853**

**Registered Mar. 11, 2008**

**SERVICE MARK  
PRINCIPAL REGISTER**

The logo for Aleris features the word "Aleris" in a bold, italicized serif font. A thick, black, curved swoosh arches over the top of the letters, starting from the left and ending under the 's'.

COMMONWEALTH INDUSTRIES, INC. (DELA-  
WARE CORPORATION)  
PNC PLAZA - 19TH FLOOR  
500 W. JEFFERSON STREET  
LOUISVILLE, KY 40202

INDUSTRY, INCLUDING BUILDING, CONSUMER  
DURABLE, AUTOMOTIVE, ELECTRICAL, PACKA-  
GING, TRANSPORTATION, AND FOOD AND BEV-  
ERAGE SECTORS, TO THE SPECIFICATION OF  
OTHERS, IN CLASS 40 (U.S. CLS. 100, 103 AND 106).

FOR: RECYCLING SERVICES; TREATMENT  
AND PROCESSING OF ALUMINUM AND ZINC  
ALLOYS; MANUFACTURE OF ALUMINUM PRO-  
DUCTS, NAMELY, ALUMINUM AND ALUMINUM  
ALLOYS SOLD IN COILS, ROLLS, AND SHEETS  
FOR USE BY CUSTOMERS IN THE ALUMINUM

FIRST USE 12-9-2004; IN COMMERCE 12-9-2004.

SN 78-590,362, FILED 3-18-2005.

KIMBERLY FRYE, EXAMINING ATTORNEY

**Int. Cl.: 6**

**Prior U.S. Cls.: 2, 12, 13, 14, 23, 25, and 50**

**Reg. No. 3,395,854**

**United States Patent and Trademark Office**

**Registered Mar. 11, 2008**

---

**TRADEMARK  
PRINCIPAL REGISTER**

The logo for Aleris features the word "Aleris" in a bold, italicized, sans-serif font. A thick, black, curved swoosh arches over the letters, starting from the left and ending under the 's'.

COMMONWEALTH INDUSTRIES, INC. (DELA-  
WARE CORPORATION)  
PNC PLAZA - 19TH FLOOR  
500 W. JEFFERSON STREET  
LOUISVILLE, KY 40202

CONSUMER DURABLES, AUTOMOTIVE, ELEC-  
TRICAL, PACKAGING, TRANSPORTATION, AND  
FOOD AND BEVERAGE SECTORS, IN CLASS 6 (U.S.  
CLS. 2, 12, 13, 14, 23, 25 AND 50).

FOR: ALUMINUM AND ZINC METAL IN INGOT  
OR MOLTEN FORM; AND ALUMINUM AND ALU-  
MINUM ALLOYS SOLD IN COILS, ROLLS, AND  
SHEETS FOR USE BY CUSTOMERS IN THE ALU-  
MINUM INDUSTRY, INCLUDING BUILDING,

FIRST USE 12-9-2004; IN COMMERCE 12-9-2004.

SN 78-590,370, FILED 3-18-2005.

KIMBERLY FRYE, EXAMINING ATTORNEY

Int. Cl.: 37

Prior U.S. Cls.: 100, 103, and 106

**United States Patent and Trademark Office**

**Reg. No. 3,395,855**

Registered Mar. 11, 2008

**SERVICE MARK  
PRINCIPAL REGISTER**

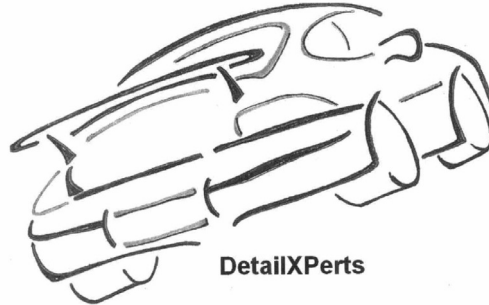

WILLIAMS, EMMANUEL H (UNITED STATES  
INDIVIDUAL)  
625 EAST GRAND BLVD  
DETROIT, MI 48207

FOR: VEHICLE DETAILING, IN CLASS 37 (U.S.  
CLS. 100, 103 AND 106).

FIRST USE 6-18-2007; IN COMMERCE 10-15-2007.

NO CLAIM IS MADE TO THE EXCLUSIVE  
RIGHT TO USE "DETAIL EXPERTS", APART FROM  
THE MARK AS SHOWN.

SEC. 2(F).

SN 78-591,107, FILED 3-20-2005.

PATRICIA EVANKO, EXAMINING ATTORNEY

**Int. Cl.: 21**

**Prior U.S. Cls.: 2, 13, 23, 29, 30, 33, 40, and 50**

**United States Patent and Trademark Office**

**Reg. No. 3,395,856**

**Registered Mar. 11, 2008**

**TRADEMARK  
PRINCIPAL REGISTER**

# Vine Things

MCKEOUGH, JENNIFER C. (UNITED STATES  
INDIVIDUAL)  
6 OWLS COVE PLACE  
THE WOODLANDS, TX 77382

FOR: WINE ACCESSORIES FOR HOME USE,  
NAMELY, COOLERS FOR WINE, CORKSCREWS,  
WINE BUCKETS, GLASS BEVERAGWARE, DE-  
CANTERS, COCKTAIL SHAKERS AND WINE BOT-  
TLE CRADLES, IN CLASS 21 (U.S. CLS. 2, 13, 23, 29,  
30, 33, 40 AND 50).

FIRST USE 2-15-2007; IN COMMERCE 2-15-2007.

THE MARK CONSISTS OF STANDARD CHAR-  
ACTERS WITHOUT CLAIM TO ANY PARTICULAR  
FONT, STYLE, SIZE, OR COLOR.

SN 78-591,397, FILED 3-21-2005.

RONALD MCMORROW, EXAMINING ATTORNEY

**Int. Cl.: 9**

**Prior U.S. Cls.: 21, 23, 26, 36, and 38**

**United States Patent and Trademark Office**

**Reg. No. 3,395,857**

**Registered Mar. 11, 2008**

**TRADEMARK  
PRINCIPAL REGISTER**

**CRAZY BILLIONS**

VIDEO GAMING TECHNOLOGIES, INC. (TENNESSEE CORPORATION)  
278 DOUG WARPOOLE RD., SUITE 309  
SMYRNA, TN 29376

FOR: COMPUTER SOFTWARE OR FIRMWARE FOR GAMES OF CHANCE ON ANY COMPUTERIZED PLATFORM, INCLUDING DEDICATED GAMING CONSOLES, VIDEO BASED SLOT MACHINES, REEL BASED SLOT MACHINES, AND VIDEO LOTTERY TERMINALS; GAMING DEVICES, NAMELY, GAMING MACHINES, SLOT MACHINES, BINGO MACHINES, WITH OR WITHOUT

VIDEO OUTPUT, IN CLASS 9 (U.S. CLS. 21, 23, 26, 36 AND 38).

FIRST USE 1-0-2007; IN COMMERCE 1-0-2007.

THE MARK CONSISTS OF STANDARD CHARACTERS WITHOUT CLAIM TO ANY PARTICULAR FONT, STYLE, SIZE, OR COLOR.

SN 78-591,862, FILED 3-21-2005.

KYLE PEETE, EXAMINING ATTORNEY

**Int. Cls.: 16 and 17**

**Prior U.S. Cls.: 1, 2, 5, 12, 13, 22, 23, 29, 35, 37, 38, and 50**

**United States Patent and Trademark Office**

**Reg. No. 3,395,858**

**Registered Mar. 11, 2008**

**TRADEMARK  
PRINCIPAL REGISTER**

# Green Earth Films

CREATIVE FILM CORPORATION (NEW JERSEY CORPORATION)  
700 VASSAR AVE  
LAKEWOOD, NJ 08701

FOR: BIODEGRADEABLE PLASTIC FILM FOR HOUSEHOLD PACKAGING PURPOSES, IN CLASS 16 (U.S. CLS. 2, 5, 22, 23, 29, 37, 38 AND 50).

FIRST USE 1-8-2007; IN COMMERCE 1-8-2007.

FOR: BIODEGRADABLE DECORATIVE PLASTIC FILM FOR INDUSTRIAL OR COMMERCIAL PACKAGING USE, IN CLASS 17 (U.S. CLS. 1, 5, 12, 13, 35 AND 50).

FIRST USE 1-8-2007; IN COMMERCE 1-8-2007.

THE MARK CONSISTS OF STANDARD CHARACTERS WITHOUT CLAIM TO ANY PARTICULAR FONT, STYLE, SIZE, OR COLOR.

NO CLAIM IS MADE TO THE EXCLUSIVE RIGHT TO USE "FILMS", APART FROM THE MARK AS SHOWN.

SN 78-591,880, FILED 3-21-2005.

MICHAEL SOUDERS, EXAMINING ATTORNEY

**Int. Cl.: 28**

**Prior U.S. Cls.: 22, 23, 38, and 50**

**United States Patent and Trademark Office**

**Reg. No. 3,395,859**

**Registered Mar. 11, 2008**

**TRADEMARK  
PRINCIPAL REGISTER**

**PERFECT COMPANIONS**

THE ASHTON-DRAKE GALLERIES, LTD. (DE-  
LAWARE CORPORATION)  
9200 N. MARYLAND AVE.  
NILES, IL 60714

FOR: TOYS, NAMELY, PLUSH ANIMALS; PLUSH  
ORNAMENTS, NAMELY, SOFT STUFFED ANI-  
MALS AND DOLLS; DOLLS AND DOLL ACCES-  
SORIES, IN CLASS 28 (U.S. CLS. 22, 23, 38 AND 50).

FIRST USE 6-1-2005; IN COMMERCE 6-1-2005.

THE MARK CONSISTS OF STANDARD CHAR-  
ACTERS WITHOUT CLAIM TO ANY PARTICULAR  
FONT, STYLE, SIZE, OR COLOR.

OWNER OF U.S. REG. NO. 2,595,742.

SN 78-593,052, FILED 3-23-2005.

SAMUEL E. SHARPER JR., EXAMINING ATTOR-  
NEY



**Int. Cl.: 41**

**Prior U.S. Cls.: 100, 101, and 107**

**United States Patent and Trademark Office**

**Reg. No. 3,395,860**

**Registered Mar. 11, 2008**

**SERVICE MARK  
PRINCIPAL REGISTER**

**CUPPA COFFEE  
STUDIOS**

CUPPA COFFEE ANIMATION INC. (CANADA CORPORATION)  
53 ONTARIO STREET  
TORONTO, ONTARIO, CANADA M5A 2V1

FOR: ANIMATION PRODUCTION SERVICES, IN CLASS 41 (U.S. CLS. 100, 101 AND 107).

FIRST USE 2-0-2005; IN COMMERCE 2-0-2005.

THE MARK CONSISTS OF STANDARD CHARACTERS WITHOUT CLAIM TO ANY PARTICULAR FONT, STYLE, SIZE, OR COLOR.

PRIORITY CLAIMED UNDER SEC. 44(D) ON CANADA APPLICATION NO. 1250605, FILED 3-15-2005, REG. NO. TMA666309, DATED 6-19-2006, EXPIRES 6-19-2021.

OWNER OF U.S. REG. NO. 2,248,569.

NO CLAIM IS MADE TO THE EXCLUSIVE RIGHT TO USE "STUDIOS", APART FROM THE MARK AS SHOWN.

SN 78-593,292, FILED 3-23-2005.

JASON ROTH, EXAMINING ATTORNEY

**Int. Cl.: 16**

**Prior U.S. Cls.: 2, 5, 22, 23, 29, 37, 38, and 50**

**United States Patent and Trademark Office**

**Reg. No. 3,395,861**

**Registered Mar. 11, 2008**

**TRADEMARK  
PRINCIPAL REGISTER**

**POWER RANGERS  
MYSTIC FORCE**

BVS ENTERTAINMENT, INC. (DELAWARE  
CORPORATION)  
500 SOUTH BUENA VISTA STREET  
BURBANK, CA 91521

FOR: COLORING BOOKS; STICKERS; DECORATIVE PAPER CENTERPIECES; ENVELOPES; GREETING CARDS; PAPER PARTY FAVORS; PAPER PARTY HATS; PAPER PARTY DECORATIONS; PAPER NAPKINS; PAPER TABLE CLOTHS; PEN OR PENCIL HOLDERS; PENCILS; POSTERS; PRINTED CERTIFICATES; BOOKS FEATURING STORIES FOR CHILDREN, IN CLASS 16 (U.S. CLS. 2, 5, 22, 23, 29, 37, 38 AND 50).

FIRST USE 9-0-2007; IN COMMERCE 9-0-2007.

THE MARK CONSISTS OF STANDARD CHARACTERS WITHOUT CLAIM TO ANY PARTICULAR FONT, STYLE, SIZE, OR COLOR.

OWNER OF U.S. REG. NOS. 2,286,770, 2,506,456, AND OTHERS.

SN 78-594,712, FILED 3-24-2005.

ALEX KEAM, EXAMINING ATTORNEY

**Int. Cls.: 1 and 9**

**Prior U.S. Cls.: 1, 5, 6, 10, 21, 23, 26, 36, 38, and 46**

**United States Patent and Trademark Office**

**Reg. No. 3,395,862**

**Registered Mar. 11, 2008**

**TRADEMARK  
PRINCIPAL REGISTER**

**GENLANTIS**

GENE THERAPY SYSTEMS, INC. (DELAWARE CORPORATION)  
10190 TELESIS COURT  
SAN DIEGO, CA 92121

FOR: FULL LINE OF REAGENTS FOR SCIENTIFIC, LABORATORY AND MEDICAL RESEARCH USE; CELLS FOR SCIENTIFIC, LABORATORY AND MEDICAL RESEARCH USE, IN CLASS 1 (U.S. CLS. 1, 5, 6, 10, 26 AND 46).

FIRST USE 2-24-2005; IN COMMERCE 3-21-2005.

FOR: LABORATORY EQUIPMENT AND SUPPLIES, NAMELY, CUVETTES, CENTRIFUGES, BENCHTOP COOLERS FOR CELLS AND RE-

AGENTS, DISPENSING BOTTLES FOR LABORATORY REAGENTS AND SUPPLIES, GEL DESTAINING BAGS, STORAGE CONTAINERS FOR ASSAY PLATES, IN CLASS 9 (U.S. CLS. 21, 23, 26, 36 AND 38).

FIRST USE 2-24-2005; IN COMMERCE 4-6-2005.

THE MARK CONSISTS OF STANDARD CHARACTERS WITHOUT CLAIM TO ANY PARTICULAR FONT, STYLE, SIZE, OR COLOR.

SN 78-594,793, FILED 3-24-2005.

MICHAEL KEATING, EXAMINING ATTORNEY

**Int. Cl.: 42**

**Prior U.S. Cls.: 100 and 101**

**United States Patent and Trademark Office**

**Reg. No. 3,395,863**

**Registered Mar. 11, 2008**

**SERVICE MARK  
PRINCIPAL REGISTER**

**MAKE YOUR WISHES  
KNOWN**

WARNER, JAN L. (UNITED STATES INDIVIDUAL)  
P.O. BOX 11704  
COLUMBIA, SC 29211

FOR: COMPUTER SERVICES, NAMELY, PROVIDING ON-LINE LEGAL INFORMATION ABOUT ADVANCE DIRECTIVES; PROVIDING TEMPLATES FOR THE DEVELOPMENT OF COMPUTER GENERATED ADVANCE DIRECTIVES OVER THE INTERNET, IN CLASS 42 (U.S. CLS. 100 AND 101).

FIRST USE 9-4-2007; IN COMMERCE 9-4-2007.

THE MARK CONSISTS OF STANDARD CHARACTERS WITHOUT CLAIM TO ANY PARTICULAR FONT, STYLE, SIZE, OR COLOR.

OWNER OF U.S. REG. NO. 1,720,268.

SN 78-595,704, FILED 3-26-2005.

KARANENDRA S. CHHINA, EXAMINING ATTORNEY

**Int. Cl.: 42**

**Prior U.S. Cls.: 100 and 101**

**United States Patent and Trademark Office**

**Reg. No. 3,395,864**

**Registered Mar. 11, 2008**

**SERVICE MARK  
PRINCIPAL REGISTER**

**OMINI**

SUNGARD BUSINESS SYSTEMS LLC (DELA-  
WARE LTD LIAB CO)  
C/O THE CORPORATION TRUST COMPANY  
1209 ORANGE STREET  
WILMINGTON, DE 19801

FOR: APPLICATION SERVICE PROVIDER FOR  
PENSION AND BENEFIT PLAN RECORDKEEPING,  
PROCESSING, MANAGEMENT AND ADMINIS-  
TRATION SOFTWARE , IN CLASS 42 (U.S. CLS. 100  
AND 101).

FIRST USE 7-0-2005; IN COMMERCE 7-0-2005.

THE MARK CONSISTS OF STANDARD CHAR-  
ACTERS WITHOUT CLAIM TO ANY PARTICULAR  
FONT, STYLE, SIZE, OR COLOR.

OWNER OF U.S. REG. NOS. 1,793,489, 2,343,864,  
AND OTHERS.

SN 78-597,215, FILED 3-29-2005.

JOHN GARTNER, EXAMINING ATTORNEY

**Int. Cl.: 30**

**Prior U.S. Cl.: 46**

**United States Patent and Trademark Office**

**Reg. No. 3,395,865**

**Registered Mar. 11, 2008**

**TRADEMARK  
PRINCIPAL REGISTER**

*Soft & Smooth*

SARA LEE BAKERY GROUP, INC. (DELAWARE  
CORPORATION)  
3500 LACEY ROAD  
DOWNERS GROVE, MO 60515

FIRST USE 7-17-2005; IN COMMERCE 7-17-2005.

SN 78-599,038, FILED 3-31-2005.

FOR: BREAD, BUNS, AND ROLLS, IN CLASS 30  
(U.S. CL. 46).

JEAN IM, EXAMINING ATTORNEY

**Int. Cl.: 35**

**Prior U.S. Cls.: 100, 101, and 102**

**United States Patent and Trademark Office**

**Reg. No. 3,395,866**

**Registered Mar. 11, 2008**

**SERVICE MARK  
PRINCIPAL REGISTER**

**N-of-8**



STINSON BRAND INNOVATION (ILLINOIS CORPORATION)  
3046 NORTH HOYNE AVENUE  
CHICAGO, IL 60618

FOR: BUSINESS MARKETING CONSULTING; BRAND CONSULTING ADVERTISING SERVICES, NAMELY, CREATING CORPORATE AND BRAND IDENTITY FOR OTHERS; ADVERTISING SERVICES, IN CLASS 35 (U.S. CLS. 100, 101 AND 102).

FIRST USE 5-13-2004; IN COMMERCE 5-13-2004.

THE COLOR(S) RED, GOLD, TAN, AND WHITE IS/ARE CLAIMED AS A FEATURE OF THE MARK.

THE MARK CONSISTS OF THE COLOR RED APPEARS IN THE CLOUD AND LIGHTNING DESIGN OUTLINED IN THE COLOR WHITE, THE JAGGED LINES APPEAR IN THE COLORS GOLD AND TAN, AND THE COLORS RED AND WHITE APPEAR IN THE CIRCLE ENCOMPASSING THE CLOUD DESIGN AND THE WORDING "N-OF-8".

SN 78-599,381, FILED 3-31-2005.

MICHELE SWAIN, EXAMINING ATTORNEY

**Int. Cl.: 16**

**Prior U.S. Cls.: 2, 5, 22, 23, 29, 37, 38, and 50**

**Reg. No. 3,395,867**

**United States Patent and Trademark Office**

**Registered Mar. 11, 2008**

**TRADEMARK  
PRINCIPAL REGISTER**

**SNOWGLOBE CARDS**

SNOWGLOBE CARDS INC. (ILLINOIS CORPORATION)  
2670 CONSTITUTION COURT  
LINDENHURST, IL 60046

FOR: CUSTOMIZED AND NON-CUSTOMIZED  
GREETING CARDS, IN CLASS 16 (U.S. CLS. 2, 5,  
22, 23, 29, 37, 38 AND 50).

FIRST USE 10-31-2005; IN COMMERCE 10-31-2005.

THE MARK CONSISTS OF STANDARD CHARACTERS WITHOUT CLAIM TO ANY PARTICULAR FONT, STYLE, SIZE, OR COLOR.

NO CLAIM IS MADE TO THE EXCLUSIVE RIGHT TO USE "CARDS", APART FROM THE MARK AS SHOWN.

SN 78-601,245, FILED 4-4-2005.

DOMINICK J. SALEMI, EXAMINING ATTORNEY



**Int. Cl.: 25**

**Prior U.S. Cls.: 22 and 39**

**United States Patent and Trademark Office**

**Reg. No. 3,395,868**

**Registered Mar. 11, 2008**

**TRADEMARK  
PRINCIPAL REGISTER**

**TRIDIVA**

CLANCY-GARVEY, KELLY (UNITED STATES  
INDIVIDUAL)  
3717 E LIVINGSTON DR #10  
LONG BEACH, CA 90803

THE MARK CONSISTS OF STANDARD CHAR-  
ACTERS WITHOUT CLAIM TO ANY PARTICULAR  
FONT, STYLE, SIZE, OR COLOR.

FOR: ATHLETIC CLOTHING, NAMELY, TANK  
TOPS, SHIRTS, AND HATS; CASUAL CLOTHING,  
NAMELY, TANK TOPS, SHIRTS, AND HATS, IN  
CLASS 25 (U.S. CLS. 22 AND 39).

SN 78-601,884, FILED 4-5-2005.

FIRST USE 5-22-2005; IN COMMERCE 5-22-2005.

ELISSA GARBER KON, EXAMINING ATTORNEY

**Int. Cl.: 30**

**Prior U.S. Cl.: 46**

**United States Patent and Trademark Office**

**Reg. No. 3,395,869**

**Registered Mar. 11, 2008**

**TRADEMARK  
PRINCIPAL REGISTER**

**SIMPLY SMOOTH**

THE PROCTER & GAMBLE COMPANY (OHIO  
CORPORATION)  
ONE PROCTER & GAMBLE PLAZA  
CINCINNATI, OH 45202

NO CLAIM IS MADE TO THE EXCLUSIVE  
RIGHT TO USE "SMOOTH", APART FROM THE  
MARK AS SHOWN.

FOR: COFFEE, IN CLASS 30 (U.S. CL. 46).

FIRST USE 4-3-2006; IN COMMERCE 4-3-2006.

SN 78-602,904, FILED 4-6-2005.

THE MARK CONSISTS OF STANDARD CHAR-  
ACTERS WITHOUT CLAIM TO ANY PARTICULAR  
FONT, STYLE, SIZE, OR COLOR.

WON TEAK OH, EXAMINING ATTORNEY

**Int. Cl.: 29**

**Prior U.S. Cl.: 46**

**United States Patent and Trademark Office**

**Reg. No. 3,395,870**

**Registered Mar. 11, 2008**

**TRADEMARK  
PRINCIPAL REGISTER**

**WELCOME TO MY  
FAMILY**

PAUL SORVINO FOODS, INC. (DELAWARE  
CORPORATION)  
4001 KENNETT PIKE, SUITE 134  
GREENVILLE, DE 19807

THE MARK CONSISTS OF STANDARD CHAR-  
ACTERS WITHOUT CLAIM TO ANY PARTICULAR  
FONT, STYLE, SIZE, OR COLOR.

FOR: FRESH AND PROCESSED FISH IN GEN-  
ERAL FOR FOOD PURPOSES AND SEAFOOD IN  
GENERAL, IN CLASS 29 (U.S. CL. 46).

SN 78-603,083, FILED 4-6-2005.

FIRST USE 9-0-2005; IN COMMERCE 9-0-2005.

BRENDAN REGAN, EXAMINING ATTORNEY

**Int. Cl.: 32**

**Prior U.S. Cls.: 45, 46, and 48**

**United States Patent and Trademark Office**

**Reg. No. 3,395,871**

**Registered Mar. 11, 2008**

**TRADEMARK  
PRINCIPAL REGISTER**

**RENEGADE**

SHEETZ OF DELAWARE, INC. (DELAWARE  
CORPORATION)  
501 SILVERSIDE ROAD, SUITE 67  
WILMINGTON, DE 19809

THE MARK CONSISTS OF STANDARD CHAR-  
ACTERS WITHOUT CLAIM TO ANY PARTICULAR  
FONT, STYLE, SIZE, OR COLOR.

FOR: ISOTONIC DRINKS, IN CLASS 32 (U.S. CLS.  
45, 46 AND 48).

SN 78-603,216, FILED 4-6-2005.

FIRST USE 11-14-2005; IN COMMERCE 11-14-2005.

KIM SAITO, EXAMINING ATTORNEY

**Int. Cl.: 30**

**Prior U.S. Cl.: 46**

**United States Patent and Trademark Office**

**Reg. No. 3,395,872**

**Registered Mar. 11, 2008**

**TRADEMARK  
PRINCIPAL REGISTER**



MARINI, MATTHEW, A. (UNITED STATES IN-  
DIVIDUAL)  
800 N. REMBRANDT AVE.  
ROYAL OAK, MI 48067

FIRST USE 9-24-2007; IN COMMERCE 9-24-2007.

SN 78-604,264, FILED 4-7-2005.

FOR: READY TO DRINK COFFEE BEVERAGES,  
IN CLASS 30 (U.S. CL. 46).

KATHY DE JONGE, EXAMINING ATTORNEY

**Int. Cl.: 19**

**Prior U.S. Cls.: 1, 12, 33, and 50**

**United States Patent and Trademark Office**

**Reg. No. 3,395,873**

**Registered Mar. 11, 2008**

---

**TRADEMARK  
PRINCIPAL REGISTER**

**FallingWater**

CENTURY TILE, INC. (CALIFORNIA CORPORATION)  
3555 LOMITA BOULEVARD, SUITE H  
TORRANCE, CA 90505

THE MARK CONSISTS OF STANDARD CHARACTERS WITHOUT CLAIM TO ANY PARTICULAR FONT, STYLE, SIZE, OR COLOR.

FOR: INTERLOCKING MOSIAC SLATE TILE SHEETS, IN CLASS 19 (U.S. CLS. 1, 12, 33 AND 50).

SN 78-604,320, FILED 4-7-2005.

FIRST USE 8-0-2005; IN COMMERCE 8-0-2005.

SUE LAWRENCE, EXAMINING ATTORNEY

**Int. Cl.: 28**

**Prior U.S. Cls.: 22, 23, 38, and 50**

**United States Patent and Trademark Office**

**Reg. No. 3,395,874**

**Registered Mar. 11, 2008**

**TRADEMARK  
PRINCIPAL REGISTER**

**GAME ON!**

LYONS GROUP, LTD. (MASSACHUSETTS CORPORATION)  
7 LANDSDOWNE STREET  
BOSTON, MA 02215

THE MARK CONSISTS OF STANDARD CHARACTERS WITHOUT CLAIM TO ANY PARTICULAR FONT, STYLE, SIZE, OR COLOR.

FOR: SPORTING GOODS, NAMELY, GOLF BAGS AND GOLF BALLS, IN CLASS 28 (U.S. CLS. 22, 23, 38 AND 50).

SN 78-606,719, FILED 4-12-2005.

FIRST USE 10-31-2006; IN COMMERCE 10-31-2006.

BILL DAWE, EXAMINING ATTORNEY

**Int. Cl.: 41**

**Prior U.S. Cls.: 100, 101, and 107**

**United States Patent and Trademark Office**

**Reg. No. 3,395,875**

**Registered Mar. 11, 2008**

**SERVICE MARK  
PRINCIPAL REGISTER**

DEPARTMENT OF FARMLAND  
SECURITY

ROSEMARY REED AND MICHAEL S. HURDEL-  
BRINK (D.C. PARTNERSHIP)  
1621 CONNECTICUT AVENUE, NW -4TH FLOOR  
WASHINGTON, DC 20009

FOR: ENTERTAINMENT SERVICES IN THE  
NATURE OF LIVE ACTION, COMEDY AND ANI-  
MATED THEATRICAL FILM PRODUCTION, VI-  
DEO CASSETTE AND DVD PRODUCTION AND  
ON-GOING TELEVISION AND RADIO PROGRAMS  
IN THE FIELD OF PARODY AND COMEDY; IN-  
TERNET SERVICES, NAMELY, PROVIDING IN-  
FORMATION VIA A GLOBAL COMPUTER  
NETWORK ABOUT LIVE ACTION, COMEDY,  
AND ANIMATED WEBSITE PROGRAMS, WEBSITE  
AUDIOVISUAL ENTERTAINMENT, AND LIVE AC-  
TION, COMEDY AND ANIMATED THEATRICAL

FILMS, VIDEOS, TELEVISION AND RADIO PRO-  
GRAMS; PRODUCTION OF LIVE ACTION, COME-  
DY AND ANIMATED FILMS FOR DISTRIBUTION  
VIA A GLOBAL COMPUTER NETWORK, IN CLASS  
41 (U.S. CLS. 100, 101 AND 107).

FIRST USE 3-1-2006; IN COMMERCE 3-1-2006.

THE MARK CONSISTS OF STANDARD CHAR-  
ACTERS WITHOUT CLAIM TO ANY PARTICULAR  
FONT, STYLE, SIZE, OR COLOR.

SN 78-606,829, FILED 4-12-2005.

KAELIE KUNG, EXAMINING ATTORNEY



**Int. Cl.: 5**

**Prior U.S. Cls.: 6, 18, 44, 46, 51, and 52**

**United States Patent and Trademark Office**

**Reg. No. 3,395,876**

**Registered Mar. 11, 2008**

**TRADEMARK  
PRINCIPAL REGISTER**

**QU 985**

QUERCEGEN PHARMA LLC (DELAWARE LTD  
LIAB CO)  
275 GROVE STREET  
SUITE 2-400  
NEWTON, MA 02466

FIRST USE 9-11-2007; IN COMMERCE 9-11-2007.

THE MARK CONSISTS OF STANDARD CHAR-  
ACTERS WITHOUT CLAIM TO ANY PARTICULAR  
FONT, STYLE, SIZE, OR COLOR.

FOR: NUTRITIONAL ADDITIVES FOR USE IN  
FOODS, BEVERAGES AND DIETARY SUPPLE-  
MENTS FOR HUMAN CONSUMPTION, IN CLASS  
5 (U.S. CLS. 6, 18, 44, 46, 51 AND 52).

SN 78-608,295, FILED 4-13-2005.

ODESSA BIBBINS, EXAMINING ATTORNEY

**Int. Cl.: 35**

**Prior U.S. Cls.: 100, 101, and 102**

**United States Patent and Trademark Office**

**Reg. No. 3,395,877**

**Registered Mar. 11, 2008**

**SERVICE MARK  
PRINCIPAL REGISTER**

# Age-Less Skincare

FREEZE 24/7 INTERNATIONAL LLC (NEW  
YORK LTD LIAB CO)  
49 WEST 57TH STREET, 3RD FLOOR  
NEW YORK, NY 10019

FOR: DISTRIBUTORSHIPS IN THE FIELD OF  
SKIN CARE PRODUCTS; RETAIL STORE SERVICES  
FEATURING SKIN CARE PRODUCTS, IN CLASS 35  
(U.S. CLS. 100, 101 AND 102).

FIRST USE 4-30-2005; IN COMMERCE 4-30-2005.

THE MARK CONSISTS OF STANDARD CHAR-  
ACTERS WITHOUT CLAIM TO ANY PARTICULAR  
FONT, STYLE, SIZE, OR COLOR.

NO CLAIM IS MADE TO THE EXCLUSIVE  
RIGHT TO USE "SKINCARE", APART FROM THE  
MARK AS SHOWN.

SN 78-608,308, FILED 4-13-2005.

SKYE YOUNG, EXAMINING ATTORNEY

**Int. Cl.: 9**

**Prior U.S. Cls.: 21, 23, 26, 36, and 38**

**United States Patent and Trademark Office**

**Reg. No. 3,395,878**

**Registered Mar. 11, 2008**

**TRADEMARK  
PRINCIPAL REGISTER**

**PLATINUM SERIES  
INTELLIGENT TRANSMITTER**

HARRIS CORPORATION (DELAWARE CORPORATION)  
1025 WEST NASA BOULEVARD  
MELBOURNE, FL 32919

OWNER OF U.S. REG. NO. 1,762,496.

FOR: RADIO BROADCAST TRANSMITTERS  
AND REPLACEMENT PARTS THEREFOR, IN  
CLASS 9 (U.S. CLS. 21, 23, 26, 36 AND 38).

NO CLAIM IS MADE TO THE EXCLUSIVE  
RIGHT TO USE "SERIES INTELLIGENT TRANSMITTER",  
APART FROM THE MARK AS SHOWN.

FIRST USE 12-28-2006; IN COMMERCE 12-28-2006.

SN 78-609,796, FILED 4-15-2005.

THE MARK CONSISTS OF STANDARD CHARACTERS  
WITHOUT CLAIM TO ANY PARTICULAR  
FONT, STYLE, SIZE, OR COLOR.

STEVEN PEREZ, EXAMINING ATTORNEY

**Int. Cl.: 10**

**Prior U.S. Cls.: 26, 39, and 44**

**United States Patent and Trademark Office**

**Reg. No. 3,395,879**

**Registered Mar. 11, 2008**

**TRADEMARK  
PRINCIPAL REGISTER**

**G20**

SIEMENS MEDICAL SOLUTIONS USA, INC.  
(DELAWARE CORPORATION)  
51 VALLEY STREAM PARKWAY  
MALVERN, PA 19355

FOR: ULTRASOUND DIAGNOSTIC SYSTEM,  
COMPRISING, ULTRASOUND DIAGNOSTIC AP-  
PARATUS, ULTRASOUND PLATFORM AND RE-  
LATED SOFTWARE FOR OPERATING  
ULTRASOUND MACHINES, AND FOR RECORD-  
ING, PROCESSING AND DISPLAYING INFORMA-  
TION OBTAINED DURING ULTRASOUND  
DIAGNOSTIC PROCEDURES SOLD AS A UNIT

WITH ULTRASOUND SYSTEMS, IN CLASS 10  
(U.S. CLS. 26, 39 AND 44).

FIRST USE 4-0-2004; IN COMMERCE 4-0-2004.

THE MARK CONSISTS OF STANDARD CHAR-  
ACTERS WITHOUT CLAIM TO ANY PARTICULAR  
FONT, STYLE, SIZE, OR COLOR.

SN 78-610,231, FILED 4-15-2005.

KAREN K. BUSH, EXAMINING ATTORNEY

**Int. Cl.: 9**

**Prior U.S. Cls.: 21, 23, 26, 36, and 38**

**Reg. No. 3,395,880**

**United States Patent and Trademark Office**

**Registered Mar. 11, 2008**

**TRADEMARK  
PRINCIPAL REGISTER**

The logo for eNfusion features the word "eNfusion" in a sans-serif font. The letter "N" is significantly larger and bolder than the other letters, and it has a thick horizontal bar extending to the left from its base. The "e" is lowercase and positioned to the left of the "N". The "fusion" part is in a lighter weight than the "N".

EMS TECHNOLOGIES, INC. (GEORGIA CORPORATION)  
660 ENGINEERING DRIVE  
NORCROSS, GA 30092

LOW NOISE AMPLIFIERS SOLD AS A UNIT FOR PROVIDING VOICE, DATA, VIDEO COMMUNICATIONS TO PASSENGERS AND CREW IN AIRCRAFT, IN CLASS 9 (U.S. CLS. 21, 23, 26, 36 AND 38).

FOR: ANTENNAS, RADOMES, SATELLITE COMMUNICATION TRANSCIEVERS, AIRCRAFT MOUNTED ANTENNAS, EMERGENCY LOCATOR TRANSMITTERS, AND SYSTEMS COMPRISED OF RADOMES, SATELLITE COMMUNICATION TRANSCIEVERS, AIRCRAFT MOUNTED ANTENNAS, HIGH POWER AMPLIFIERS, DIPLEXERS,

FIRST USE 6-6-2007; IN COMMERCE 6-6-2007.

SN 78-611,583, FILED 4-19-2005.

DEBRA LEE, EXAMINING ATTORNEY

**Int. Cl.: 9**

**Prior U.S. Cls.: 21, 23, 26, 36, and 38**

**United States Patent and Trademark Office**

**Reg. No. 3,395,881**

**Registered Mar. 11, 2008**

**TRADEMARK  
PRINCIPAL REGISTER**



EMS TECHNOLOGIES, INC. (GEORGIA CORPORATION)  
660 ENGINEERING DRIVE  
NORCROSS, GA 30092

FOR: ANTENNAS, RADOMES, SATELLITE COMMUNICATION TRANSCEIVERS, AIRCRAFT MOUNTED ANTENNAS, EMERGENCY LOCATOR TRANSMITTERS, AND SYSTEMS COMPRISED OF RADOMES, SATELLITE COMMUNICATION TRANSCEIVERS, AIRCRAFT MOUNTED ANTENNAS, HIGH POWER AMPLIFIERS, DIPLEXERS, LOW NOISE AMPLIFIERS SOLD AS A UNIT FOR PROVIDING VOICE, DATA, VIDEO COMMUNICATIONS TO PASSENGERS AND CREW IN AIRCRAFT, IN CLASS 9 (U.S. CLS. 21, 23, 26, 36 AND 38).

FIRST USE 12-31-2006; IN COMMERCE 12-31-2006.

NO CLAIM IS MADE TO THE EXCLUSIVE RIGHT TO USE "BROADBAND", APART FROM THE MARK AS SHOWN.

THE COLOR(S) BLACK, GRAY, AND BLUE IS/ ARE CLAIMED AS A FEATURE OF THE MARK.

THE COLOR BLUE APPEARS ON THE LETTER "N" AND ON THE LINE UNDER THE LETTER "N"; THE COLOR GREY APPEARS ON THE LETTER "E" AND ON THE WORD "FUSION"; AND THE COLOR BLACK APPEARS ON THE WORD "BROADBAND".

SN 78-611,598, FILED 4-19-2005.

DEBRA LEE, EXAMINING ATTORNEY

**Int. Cls.: 9, 35, and 42**

**Prior U.S. Cls.: 21, 23, 26, 36, 38, 100, 101, and 102**

**United States Patent and Trademark Office**

**Reg. No. 3,395,882**

**Registered Mar. 11, 2008**

**TRADEMARK  
SERVICE MARK  
PRINCIPAL REGISTER**

**X on**

X ON WIRELESS CORPORATION (WASHINGTON CORPORATION)  
3500 SE 175TH AVENUE  
VANCOUVER, WA 98683

FOR: WIRELESS AND WIRED ELECTRONIC, ELECTRICAL AND ELECTRO-OPTICAL PRODUCTS, NAMELY, FLOOD SENSORS THAT RESPOND WHEN THEY COME IN CONTACT WITH WATER, PRESSURE SWITCHES THAT OPEN OR CLOSE DUE TO WATER PRESSURE ON THEM, THERMISTERS WHOSE RESISTANCE AND HENCE THE CURRENT FLOWING THROUGH THEM CHANGES DUE TO CHANGE IN TEMPERATURE WHEN THEY COME IN CONTACT WITH WATER, SIMPLE PARALLEL CONDUCTIVE ELECTRODES USED TO CLOSE AN ELECTRIC CIRCUIT WHEN THEY COME IN CONTACT WITH WATER, MAGNETIC SWITCHES, AUDIO/VIDEO TRANSCIEVER EQUIPMENT USED FOR THE TRANSMISSION AND RECEPTION OF ANALOG/DIGITAL DATA, NAMELY, AUDIO/VIDEO AMPLIFIERS, RADIO-FREQUENCY TRANSCIEVERS, MODULATORS AND DEMODULATORS, SUPER-HETERODYNE RECEPTION; FOR BOTH INDOOR AND OUTDOOR USE, IN CLASS 9 (U.S. CLS. 21, 23, 26, 36 AND 38).

FIRST USE 9-22-2007; IN COMMERCE 9-22-2007.

FOR: BUSINESS CONSULTATION AND BUSINESS MANAGEMENT CONSULTATION REGARDING MARKETING ACTIVITIES AND LAUNCHING OF NEW PRODUCTS IN FOREIGN AND GLOBAL MARKETS; CONDUCTING MARKET RESEARCH AND SURVEYS IN FOREIGN MARKETS; BUSINESS CONSULTATION IN THE FIELD OF INFORMATION TECHNOLOGY REQUIREMENTS FOR OPERATION IN FOREIGN COUNTRIES TO CATER TO LOCAL AND/OR GLOBAL DEMANDS; BUSINESS CONSULTATION IN THE FIELD OF OFFSHORE BUSINESS SETUP, AND PREPARING

BUSINESS REPORTS RELATED THERETO; BUSINESS CONSULTATION IN THE FIELD OF OUTSOURCING TO A FOREIGN COUNTRY, EITHER BY SETTING UP OPERATIONS IN FOREIGN COUNTRIES DIRECTLY OR THROUGH A JOINT VENTURE WITH FOREIGN BUSINESSES, AND PREPARING BUSINESS REPORTS RELATED THERETO, IN CLASS 35 (U.S. CLS. 100, 101 AND 102).

FIRST USE 6-17-2006; IN COMMERCE 6-17-2006.

FOR: RESEARCH AND DEVELOPMENT OF TECHNOLOGIES IN THE FIELDS OF WIRELESS AND WIRED ELECTRONIC, ELECTRICAL, ELECTRO-OPTICAL AND ELECTRO-MECHANICAL PRODUCTS AND THEIR CONTROL AND MONITORING SOFTWARE; TECHNICAL CONSULTATION IN THE FIELD OF DESIGN, DEVELOPMENT, TESTING AND VALIDATION OF ELECTRONIC, ELECTRICAL AND ELECTRO-MECHANICAL PRODUCTS AND COMPUTER HARDWARE AND SOFTWARE; DEVELOPMENT OF TECHNOLOGIES AND THE FABRICATION OF CIRCUITS FOR WIRELESS AND WIRED COMMUNICATION, CONSUMER ELECTRONICS, INDUSTRIAL ELECTRONICS, AUTOMOTIVE PRODUCTS, AGRICULTURAL EQUIPMENTS, POWER TOOLS, ENERGY CONVERSION SYSTEMS THAT WORK ON RENEWABLE AND NON-RENEWABLE ENERGY SOURCES; AND ALL OTHER ELECTRONIC AND ELECTRICAL PRODUCTS; PRODUCT QUALITY CONTROL AND RELIABILITY ANALYSIS FOR OTHERS; MAINTENANCE OF CONTROL AND MONITORING SOFTWARE FOR WIRELESS AND WIRED ELECTRONIC, ELECTRICAL, ELECTRO-OPTICAL AND ELECTRO-MECHANICAL PRODUCTS, IN CLASS 42 (U.S. CLS. 100 AND 101).

FIRST USE 6-17-2006; IN COMMERCE 6-17-2006.

THE MARK CONSISTS OF STANDARD CHARACTERS WITHOUT CLAIM TO ANY PARTICULAR FONT, STYLE, SIZE, OR COLOR.

SN 78-613,795, FILED 4-21-2005.

GIANCARLO CASTRO, EXAMINING ATTORNEY



**Int. Cl.: 9**

**Prior U.S. Cls.: 21, 23, 26, 36, and 38**

**United States Patent and Trademark Office**

**Reg. No. 3,395,883**

**Registered Mar. 11, 2008**

**TRADEMARK  
PRINCIPAL REGISTER**

**REPORT CENTRAL**

FOCUS TECHNOLOGIES, LLC (TEXAS LIMITED  
LIABILITY CORPORATION)  
18333 PRESTON RD, STE. 475  
DALLAS, TX 75252

FOR: COMPUTER SOFTWARE FOR BUSINESS  
INFORMATION INTEGRATION, IN CLASS 9 (U.S.  
CLS. 21, 23, 26, 36 AND 38).

FIRST USE 4-18-2005; IN COMMERCE 4-18-2005.

THE MARK CONSISTS OF STANDARD CHAR-  
ACTERS WITHOUT CLAIM TO ANY PARTICULAR  
FONT, STYLE, SIZE, OR COLOR.

NO CLAIM IS MADE TO THE EXCLUSIVE  
RIGHT TO USE "REPORT", APART FROM THE  
MARK AS SHOWN.

SN 78-614,748, FILED 4-22-2005.

KEVIN DINALLO, EXAMINING ATTORNEY

**Int. Cl.: 18**

**Prior U.S. Cls.: 1, 2, 3, 22, and 41**

**United States Patent and Trademark Office**

**Reg. No. 3,395,884**

**Registered Mar. 11, 2008**

**TRADEMARK  
PRINCIPAL REGISTER**

**THE MONTECITO UMBRELLA**

S.B. DESIGNS, INC. (CALIFORNIA CORPORATION)  
PO BOX 6884  
SANTA BARBARA, CA 93160

FOR: MARKET UMBRELLAS, IN CLASS 18 (U.S. CLS. 1, 2, 3, 22 AND 41).

FIRST USE 7-2-2007; IN COMMERCE 7-2-2007.

THE MARK CONSISTS OF STANDARD CHARACTERS WITHOUT CLAIM TO ANY PARTICULAR FONT, STYLE, SIZE, OR COLOR.

NO CLAIM IS MADE TO THE EXCLUSIVE RIGHT TO USE "UMBRELLA", APART FROM THE MARK AS SHOWN.

THE FOREIGN WORDING IN THE MARK TRANSLATES INTO ENGLISH AS "LITTLE MOUNTAIN".

SN 78-615,306, FILED 4-22-2005.

DORITT L. CARROLL, EXAMINING ATTORNEY

**Int. Cl.: 19**

**Prior U.S. Cls.: 1, 12, 33, and 50**

**United States Patent and Trademark Office**

**Reg. No. 3,395,885**

**Registered Mar. 11, 2008**

**TRADEMARK  
PRINCIPAL REGISTER**

**BOARD SOLUTIONS**

ROYAL MOULDINGS LIMITED (NEVADA CORPORATION)  
135 BEAR CREEK ROAD  
P.O. BOX 610  
MARION, VA 243540610

FOR: BUILDING MATERIALS, NAMELY, CELLULAR VINYL PVC BOARDS, IN CLASS 19 (U.S. CLS. 1, 12, 33 AND 50).

FIRST USE 4-25-2005; IN COMMERCE 4-25-2005.

THE MARK CONSISTS OF STANDARD CHARACTERS WITHOUT CLAIM TO ANY PARTICULAR FONT, STYLE, SIZE, OR COLOR.

NO CLAIM IS MADE TO THE EXCLUSIVE RIGHT TO USE "BOARD", APART FROM THE MARK AS SHOWN.

SN 78-616,118, FILED 4-25-2005.

RENEE SERVANCE, EXAMINING ATTORNEY

**Int. Cls.: 7 and 12**

**Prior U.S. Cls.: 13, 19, 21, 23, 31, 34, 35, and 44**

**United States Patent and Trademark Office**

**Reg. No. 3,395,886**

**Registered Mar. 11, 2008**

**TRADEMARK  
PRINCIPAL REGISTER**



VIALINK CORP. (NORTH CAROLINA CORPORATION)  
7516 PRECISION DRIVE  
RALEIGH, NC 27613

FOR: SHOCK ABSORBERS FOR LAWN MOWERS, IN CLASS 7 (U.S. CLS. 13, 19, 21, 23, 31, 34 AND 35).

FIRST USE 9-9-2005; IN COMMERCE 9-9-2005.

FOR: BRUSH GUARDS FOR USE ON UTILITY VEHICLES AND ALL-TERRAIN VEHICLES; RACKS FOR USE ON THE HOODS OF UTILITY VEHICLES AND ALL-TERRAIN VEHICLES TO CARRY CARGO; UTILITY VEHICLE AND ALL-TERRAIN VEHICLE BUMPERS; HARD TOPS AND SOFT TOPS FOR UTILITY VEHICLES AND ALL-TERRAIN VEHICLES; UTILITY VEHICLE AND ALL-TERRAIN VEHICLE WINDSHIELDS; CAB ENCLOSURES FOR UTILITY VEHICLES AND ALL-TERRAIN VEHICLES; CAB GUARDS FOR UTILITY VEHICLES AND ALL-TERRAIN VEHICLES; SHOCK ABSORBERS FOR UTILITY VEHICLES AND ALL-TERRAIN VEHICLES; GUN RACKS FOR UTILITY VEHICLES AND ALL-TERRAIN VEHICLES; UTILI-

TY VEHICLE AND ALL-TERRAIN VEHICLE CARGO BAGS; MODULAR UTILITY VEHICLE AND ALL-TERRAIN VEHICLE ROOF CARRYING RACKS; UTILITY VEHICLE AND ALL-TERRAIN VEHICLE CONSOLES, NAMELY, PLASTIC AND METAL HOUSING FOR HOLDING ELECTRONIC EQUIPMENT AND ITEM STORAGE PURPOSES, AND FOR CHARGING THE BATTERY OF SAID VEHICLES; UTILITY VEHICLE AND ALL-TERRAIN VEHICLE SEAT COVERS; UTILITY VEHICLE AND ALL-TERRAIN VEHICLE PARTS, NAMELY, STEERING WHEELS AND GEAR LEVER SHIFTER KNOBS, UTILITY VEHICLE AND ALL-TERRAIN VEHICLE SKID PLATES TO PROTECT THE SUSPENSION AND SHOCK ABSORBERS; UTILITY VEHICLE AND ALL-TERRAIN VEHICLE SEMI-FITTED COVERS, IN CLASS 12 (U.S. CLS. 19, 21, 23, 31, 35 AND 44).

FIRST USE 8-18-2005; IN COMMERCE 8-18-2005.

SN 78-617,268, FILED 4-26-2005.

WARREN L. OLANDRIA, EXAMINING ATTORNEY

**Int. Cl.: 10**

**Prior U.S. Cls.: 26, 39, and 44**

**United States Patent and Trademark Office**

**Reg. No. 3,395,887**

**Registered Mar. 11, 2008**

**TRADEMARK  
PRINCIPAL REGISTER**

**Tu°Tu**

WEON, KIM TAE (REPUBLIC OF KOREA INDIVIDUAL)  
103-102, LG XI APT. ICHON 1-DONG  
YONGSAN-GU  
SEOUL, REPUBLIC OF KOREA

FOR: ULTRAVIOLET RADIATOR UNITS FOR THERAPEUTIC PURPOSES; INFRARED RADIATOR UNITS FOR THERAPEUTIC PURPOSES; LAMPS FOR MEDICAL PURPOSES; STERILIZATION UNITS FOR DENTAL PURPOSES; INTRORAL LIGHT POLYMERIZATION APPARATUS FOR DENTAL PURPOSES; ORTHODONTIC MACHINES AND INSTRUMENTS FOR DENTAL PUR-

POSES; AND LAMPS FOR DENTAL PURPOSES, IN CLASS 10 (U.S. CLS. 26, 39 AND 44).

FIRST USE 4-28-2004; IN COMMERCE 5-1-2004.

THE MARK CONSISTS OF STANDARD CHARACTERS WITHOUT CLAIM TO ANY PARTICULAR FONT, STYLE, SIZE, OR COLOR.

SN 78-617,675, FILED 4-27-2005.

ALICE BENMAMAN, EXAMINING ATTORNEY

**Int. Cl.: 12**

**Prior U.S. Cls.: 19, 21, 23, 31, 35, and 44**

**United States Patent and Trademark Office**

**Reg. No. 3,395,888**

**Registered Mar. 11, 2008**

**TRADEMARK  
PRINCIPAL REGISTER**

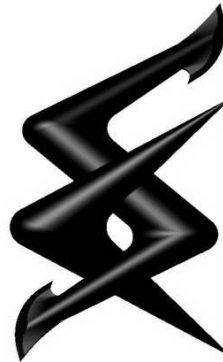

SPEEDWAY CHOPPERS, LLC (INDIANA LTD  
LIAB CO)  
140B GASOLINE ALLEY  
INDIANAPOLIS, IN 46222

FIRST USE 12-20-2004; IN COMMERCE 9-2-2005.

SN 78-617,854, FILED 4-27-2005.

FOR: MOTORCYCLES AND STRUCTURAL  
PARTS THEREFOR, IN CLASS 12 (U.S. CLS. 19, 21,  
23, 31, 35 AND 44).

RONALD MCMORROW, EXAMINING ATTORNEY

**Int. Cls.: 18 and 20**

**Prior U.S. Cls.: 1, 2, 3, 13, 22, 25, 32, 41, and 50**

**United States Patent and Trademark Office**

**Reg. No. 3,395,889**

**Registered Mar. 11, 2008**

**TRADEMARK  
PRINCIPAL REGISTER**

**FETCHING**

ACCESSORY NETWORK GROUP LLC (NEW  
YORK LTD LIAB CO)  
350 FIFTH AVENUE  
NEW YORK, NY 10118

FOR: CLOTHING FOR DOGS, INCLUDING  
SWEATERS, SLICKERS, CARRIERS AND UMBRELLAS,  
IN CLASS 18 (U.S. CLS. 1, 2, 3, 22 AND 41).

FIRST USE 3-31-2005; IN COMMERCE 3-31-2005.

FOR: BEDS FOR DOGS, IN CLASS 20 (U.S. CLS. 2,  
13, 22, 25, 32 AND 50).

FIRST USE 3-31-2005; IN COMMERCE 3-31-2005.

THE MARK CONSISTS OF STANDARD CHARACTERS  
WITHOUT CLAIM TO ANY PARTICULAR FONT, STYLE,  
SIZE, OR COLOR.

SN 78-619,210, FILED 4-28-2005.

PRISCILLA MILTON, EXAMINING ATTORNEY

**Int. Cl.: 29**

**Prior U.S. Cl.: 46**

**United States Patent and Trademark Office**

**Reg. No. 3,395,890**

**Registered Mar. 11, 2008**

**TRADEMARK  
PRINCIPAL REGISTER**

**REDEFINING GREAT BEEF**

CARGILL MEAT SOLUTIONS CORPORATION  
(DELAWARE CORPORATION)  
151 NORTH MAIN  
WICHITA, KS 67202

NO CLAIM IS MADE TO THE EXCLUSIVE  
RIGHT TO USE "GREAT BEEF", APART FROM  
THE MARK AS SHOWN.

FOR: BEEF, IN CLASS 29 (U.S. CL. 46).

FIRST USE 12-31-2005; IN COMMERCE 12-31-2005.

SN 78-622,820, FILED 5-4-2005.

THE MARK CONSISTS OF STANDARD CHAR-  
ACTERS WITHOUT CLAIM TO ANY PARTICULAR  
FONT, STYLE, SIZE, OR COLOR.

BRIDGETT SMITH, EXAMINING ATTORNEY



**Int. Cl.: 25**

**Prior U.S. Cls.: 22 and 39**

**United States Patent and Trademark Office**

**Reg. No. 3,395,891**

**Registered Mar. 11, 2008**

**TRADEMARK  
PRINCIPAL REGISTER**



DAN POST BOOT COMPANY (TENNESSEE CORPORATION)  
C/O MCRAE INDUSTRIES, INC.  
400 NORTH MAIN STREET  
MT. GILEAD, NC 27306

FOR: FOOTWEAR, NAMELY, SHOES AND BOOTS, IN CLASS 25 (U.S. CLS. 22 AND 39).

FIRST USE 8-0-2006; IN COMMERCE 8-0-2006.

OWNER OF U.S. REG. NO. 1,495,199.

SN 78-623,418, FILED 5-5-2005.

JASON LOTT, EXAMINING ATTORNEY

**Int. Cl.: 41**

**Prior U.S. Cls.: 100, 101, and 107**

**United States Patent and Trademark Office**

**Reg. No. 3,395,892**

**Registered Mar. 11, 2008**

**SERVICE MARK  
PRINCIPAL REGISTER**

***SKILLS***



INTERNATIONAL SOCCER SKILLS ACADEMY  
(NEW YORK CORPORATION)  
P.O. BOX 17005  
ROCHESTER, NY 14617

OF THE DESCRIPTIVE PICTORIAL DESIGN OF A  
SOCCER BALL, APART FROM THE MARK AS  
SHOWN.

FOR: COACHING AND INSTRUCTION SERVI-  
CES IN THE FIELD OF SOCCER, IN CLASS 41 (U.S.  
CLS. 100, 101 AND 107).

THE MARK CONSISTS OF THE WORD "SKILLS"  
OVER A PICTURE OF A SOCCER BALL AND A  
GLOBE.

FIRST USE 0-0-2004; IN COMMERCE 0-0-2004.

SN 78-623,524, FILED 5-5-2005.

NO CLAIM IS MADE TO THE EXCLUSIVE  
RIGHT TO USE "SKILLS" AND REPRESENTATION

SALLY SHIH, EXAMINING ATTORNEY

Int. Cl.: 9

Prior U.S. Cls.: 21, 23, 26, 36, and 38

United States Patent and Trademark Office

Reg. No. 3,395,893

Registered Mar. 11, 2008

TRADEMARK  
PRINCIPAL REGISTER

*aCSP*

ADVANCED SEMICONDUCTOR ENGINEERING, INC. (TAIWAN CORPORATION)  
NO.26, JINGSAN RD., NANTZ CHIU  
KAOHSIUNG, TAIWAN 811

FIRST USE 11-0-2007; IN COMMERCE 11-0-2007.

SN 78-624,241, FILED 5-5-2005.

FOR: INTEGRATED CIRCUITS; INTEGRATED CIRCUITS THAT CONTAIN SOLDER BALLS; SEMICONDUCTOR DEVICE, IN CLASS 9 (U.S. CLS. 21, 23, 26, 36 AND 38).

AMOS T. MATTHEWS, JR., EXAMINING ATTORNEY

**Int. Cl.: 31**

**Prior U.S. Cls.: 1 and 46**

**United States Patent and Trademark Office**

**Reg. No. 3,395,894**

**Registered Mar. 11, 2008**

**TRADEMARK  
PRINCIPAL REGISTER**

**KIBBLES DELIGHT**

SUNSHINE MILLS, INC. (DELAWARE CORPORATION)

PO BOX 676

RED BAY, AL 35582

FOR: PET FOOD, IN CLASS 31 (U.S. CLS. 1 AND 46).

FIRST USE 11-19-2007; IN COMMERCE 11-19-2007.

THE MARK CONSISTS OF STANDARD CHARACTERS WITHOUT CLAIM TO ANY PARTICULAR FONT, STYLE, SIZE, OR COLOR.

NO CLAIM IS MADE TO THE EXCLUSIVE RIGHT TO USE "KIBBLES", APART FROM THE MARK AS SHOWN.

SN 78-625,319, FILED 5-9-2005.

MICHAEL TANNER, EXAMINING ATTORNEY

**Int. Cl.: 9**

**Prior U.S. Cls.: 21, 23, 26, 36, and 38**

**United States Patent and Trademark Office**

**Reg. No. 3,395,895**

**Registered Mar. 11, 2008**

---

**TRADEMARK  
PRINCIPAL REGISTER**

**OCEAN PEARL**

IGT (NEVADA CORPORATION)  
9295 PROTOTYPE DRIVE  
RENO, NV 895218986

THE MARK CONSISTS OF STANDARD CHAR-  
ACTERS WITHOUT CLAIM TO ANY PARTICULAR  
FONT, STYLE, SIZE, OR COLOR.

FOR: GAMING MACHINES, NAMELY, DEVICES  
WHICH ACCEPT A WAGER, IN CLASS 9 (U.S. CLS.  
21, 23, 26, 36 AND 38).

SN 78-625,512, FILED 5-9-2005.

FIRST USE 4-13-2007; IN COMMERCE 5-11-2007.

DAVID C. REIHNER, EXAMINING ATTORNEY

Int. Cl.: 25

Prior U.S. Cls.: 22 and 39

**United States Patent and Trademark Office**

**Reg. No. 3,395,896**

Registered Mar. 11, 2008

**TRADEMARK  
PRINCIPAL REGISTER**



FINOCCHIARO, JOHN ROCKY (UNITED STATES INDIVIDUAL)  
SUITE 480  
150 S. LOS ROBLES AVENUE  
PASADENA, CA 91101

FOR: SHIRTS, APRONS, HEADWEAR, IN CLASS 25 (U.S. CLS. 22 AND 39).

FIRST USE 11-0-2003; IN COMMERCE 11-0-2003.

THE MARK CONSISTS OF A STYLIZED OUTLINE AROUND THE WORDING "WILL COOK FOR SEX".

SEC. 2(F).

SN 78-626,117, FILED 5-9-2005.

RON FAIRBANKS, EXAMINING ATTORNEY

**Int. Cls.: 5 and 42**

**Prior U.S. Cls.: 6, 18, 44, 46, 51, 52, 100, and 101**

**United States Patent and Trademark Office**

**Reg. No. 3,395,897**

**Registered Mar. 11, 2008**

**TRADEMARK  
SERVICE MARK  
PRINCIPAL REGISTER**



PROMETHEUS LABORATORIES INC. (CALIFORNIA CORPORATION)  
9410 CARROLL PARK DRIVE  
SAN DIEGO, CA 92121

FOR: PHARMACEUTICAL PREPARATIONS USED FOR THE TREATMENT OF GASTROINTESTINAL DISORDERS AND DISEASES, INFLAMMATORY AND AUTOIMMUNE DISORDERS AND DISEASES, CARDIOVASCULAR DISORDERS AND DISEASES, METABOLIC DISORDERS AND DISEASES, INFECTIOUS DISORDERS AND DISEASES, MUSCULOSKELETAL DISORDERS AND DISEASES, IMMUNE MODULATION AND MANAGEMENT OF SIDE EFFECTS ASSOCIATED WITH RENAL DISORDERS AND CANCER; DIAGNOSTIC PREPARATIONS FOR CLINICAL OR MEDICAL LABORATORY USE; AND DIAGNOSTIC REAGENTS FOR CLINICAL OR MEDICAL LABORATORY USE, IN CLASS 5 (U.S. CLS. 6, 18, 44, 46, 51 AND 52).

FIRST USE 9-0-2005; IN COMMERCE 9-0-2005.

FOR: MEDICAL LABORATORY SERVICES, NAMELY, LABORATORY TESTING, EVALUATION, AND RESEARCH SERVICES; MEDICAL LA-

BORATORY SERVICES, NAMELY, DISEASE MANAGEMENT AND PATHOLOGY SERVICES; AND MEDICAL LABORATORY SERVICES, NAMELY, PROVIDING MEDICAL LABORATORY INFORMATION TO HEALTH CARE PROVIDERS, MANAGED CARE PROVIDERS AND PATIENTS VIA GLOBAL COMPUTER NETWORKS, IN CLASS 42 (U.S. CLS. 100 AND 101).

FIRST USE 6-0-2005; IN COMMERCE 6-0-2005.

THE COLOR(S) PURPLE AND GREEN IS/ARE CLAIMED AS A FEATURE OF THE MARK.

THE COLOR PURPLE APPEARS ON THE SEMICIRCULAR DESIGN THAT COMPRISES THE LEFT HALF OF THE MARK, AND THE COLOR GREEN APPEARS ON THE SEMICIRCULAR DESIGN THAT COMPRISES THE RIGHT HALF OF THE MARK.

SN 78-626,502, FILED 5-10-2005.

DORITT L. CARROLL, EXAMINING ATTORNEY

Int. Cl.: 9

Prior U.S. Cls.: 21, 23, 26, 36, and 38

United States Patent and Trademark Office

Reg. No. 3,395,898

Registered Mar. 11, 2008

TRADEMARK  
PRINCIPAL REGISTER



BANDAI CO., LTD. (JAPAN CORPORATION)  
1-4-8 KOMAGATA, TAITO-KU  
TOKYO, JAPAN 111-8081

FOR: PRE-RECORDED DVDS AND VIDEODISKS FEATURING AN ANIMATED SERIES; DOWNLOADABLE STILL AND ANIMATED GRAPHICS AND ANIMATED TELEVISION SERIES, AND DOWNLOADABLE MUSIC VIA A GLOBAL COMPUTER NETWORK FOR COMPUTERS AND WIRELESS DEVICES; COMPUTER PROGRAMS FOR ELECTRONIC COMPUTER GAMES; PRERECORDED COMPACT DISC FEATURING MUSIC, IN CLASS 9 (U.S. CLS. 21, 23, 26, 36 AND 38).

FIRST USE 7-22-2005; IN COMMERCE 4-25-2006.

OWNER OF JAPAN REG. NO. 4874611, DATED 6-24-2005, EXPIRES 6-24-2015.

THE FOREIGN WORDING IN THE MARK TRANSLATES INTO ENGLISH AS SYMPHONY POEM EUREKA SEVEN.

THE NON-LATIN CHARACTER(S) IN THE MARK TRANSLITERATES INTO KOKYOSHIHEN EUREKA SEVEN, AND THIS MEANS SYMPHONY POEM EUREKA SABUN IN ENGLISH.

SN 78-627,164, FILED 5-10-2005.

RON FAIRBANKS, EXAMINING ATTORNEY



**Int. Cl.: 10**

**Prior U.S. Cls.: 26, 39, and 44**

**United States Patent and Trademark Office**

**Reg. No. 3,395,899**

**Registered Mar. 11, 2008**

**TRADEMARK  
PRINCIPAL REGISTER**

**SOLARPROBE**

OLYMPUS AMERICA, INC. (NEW YORK COR-  
PORATION)  
3500 CORPORATE PARKWAY  
CENTER VALLEY, PA 18034

FOR: ENDOSCOPIC PROBES USED FOR HEMOS-  
TASIS, IN CLASS 10 (U.S. CLS. 26, 39 AND 44).

FIRST USE 7-0-2006; IN COMMERCE 7-0-2006.

THE MARK CONSISTS OF STANDARD CHAR-  
ACTERS WITHOUT CLAIM TO ANY PARTICULAR  
FONT, STYLE, SIZE, OR COLOR.

THE WORDING "SOLARPROBE" HAS NO  
MEANING IN A FOREIGN LANGUAGE.

SN 78-627,429, FILED 5-11-2005.

MARK SPARACINO, EXAMINING ATTORNEY

**Int. Cl.: 30**

**Prior U.S. Cl.: 46**

**United States Patent and Trademark Office**

**Reg. No. 3,395,900**

**Registered Mar. 11, 2008**

**TRADEMARK  
PRINCIPAL REGISTER**



CARABEANER COFFEE, INC. (IOWA CORPORATION)  
1218 N. BRADY ST.  
DAVENPORT, IA 52803

FOR: COFFEE; COFFEE BEANS; PREPARED COFFEE AND COFFEE-BASED BEVERAGES, IN CLASS 30 (U.S. CL. 46).

FIRST USE 6-15-2005; IN COMMERCE 6-15-2005.

NO CLAIM IS MADE TO THE EXCLUSIVE RIGHT TO USE "COFFEE", APART FROM THE MARK AS SHOWN.

THE COLORS BLACK, BROWN, WHITE, YELLOW, RED, ORANGE, AND GRAY ARE CLAIMED AS A FEATURE OF THE MARK.

THE COLOR BROWN APPEARS IN THE WORDING "CARABEANER COFFEE", THE LETTERS OF WHICH ARE STYLIZED AND BORDERED BY A RECTANGULAR BANNER THAT IS YELLOW. THE LITERAL ELEMENT AND RECTANGULAR BANNER OF THE MARK OVERLAY A CRUSTACEAN-LIKE FIGURE HAVING RED EYES AND AN ORANGE AND RED BODY; THE BODY AND EYES ARE OUTLINED IN BLACK; THE CRUSTACEAN-LIKE FIGURE IS SHOWN GRASPING A GRAY AND YELLOW CARABINER BETWEEN ITS CLAWS. THE CARABINER AS WELL AS THE ENTIRE LOGO IS OUTLINED BY A CONTINUOUS BLACK LINE. THE BACKGROUND OF THE MARK IS WHITE.

SN 78-628,194, FILED 5-11-2005.

JIM RINGLE, EXAMINING ATTORNEY

**Int. Cls.: 6, 11, and 19**

**Prior U.S. Cls.: 1, 2, 12, 13, 14, 21, 23, 25, 31, 33, 34,  
and 50**

**Reg. No. 3,395,901**

**United States Patent and Trademark Office**

**Registered Mar. 11, 2008**

**TRADEMARK  
PRINCIPAL REGISTER**

# LATITUDES

UNIVERSAL FOREST PRODUCTS, INC. (MICHIGAN CORPORATION)  
2801 EAST BELTLINE NE  
GRAND RAPIDS, MI 49505

FOR: METAL RAILINGS USED IN BUILDING CONSTRUCTIONS FOR DECKS, BALCONIES, PORCHES AND PATIOS; ORNAMENTAL CAPS OF METAL USED IN BUILDING CONSTRUCTIONS FOR FENCES, DECKS, BALCONIES, PORCHES, PATIOS, AND SIGNAGE; METAL FENCING; OTHER METAL DECORATIVE COMPONENTS USED IN BUILDING CONSTRUCTIONS, NAMELY, DECORATIVE METALWORK FOR OUTDOOR ORNAMENTATION, IN CLASS 6 (U.S. CLS. 2, 12, 13, 14, 23, 25 AND 50).

FIRST USE 3-0-2007; IN COMMERCE 5-0-2007.

FOR: ELECTRICAL AND SOLAR LIGHTING FIXTURES AND PARTS THEREOF, IN CLASS 11 (U.S. CLS. 13, 21, 23, 31 AND 34).

FIRST USE 3-0-2007; IN COMMERCE 5-0-2007.

FOR: NON-METAL RAILINGS USED IN BUILDING CONSTRUCTION FOR DECKS, BALCONIES, PORCHES AND PATIOS; NON-METAL FENCING; OTHER NON-METAL DECORATIVE COMPONENTS USED IN BUILDING CONSTRUCTIONS, NAMELY, POST CAPS AND FINIALS FOR OUTDOOR ORNAMENTATION; NON-METAL LATTICE USED IN BUILDING CONSTRUCTION, IN CLASS 19 (U.S. CLS. 1, 12, 33 AND 50).

FIRST USE 3-0-2007; IN COMMERCE 5-0-2007.

THE MARK CONSISTS OF STANDARD CHARACTERS WITHOUT CLAIM TO ANY PARTICULAR FONT, STYLE, SIZE, OR COLOR.

OWNER OF U.S. REG. NO. 2,939,888.

SN 78-628,761, FILED 5-12-2005.

KEVIN CORWIN, EXAMINING ATTORNEY

**Int. Cl.: 42**

**Prior U.S. Cls.: 100 and 101**

**United States Patent and Trademark Office**

**Reg. No. 3,395,902**

**Registered Mar. 11, 2008**

**SERVICE MARK  
PRINCIPAL REGISTER**

**TAXOLOGY  
SOLUTIONS, LLC**

TAXOLOGY SOLUTIONS LLC (DELAWARE LTD  
LIAB CO)  
38 BUCHANAN RD  
SALEM, MA 01970

FOR: COMPUTER SALES TAX SOFTWARE DE-  
VELOPMENT, IN CLASS 42 (U.S. CLS. 100 AND 101).

FIRST USE 8-30-2007; IN COMMERCE 8-30-2007.

NO CLAIM IS MADE TO THE EXCLUSIVE  
RIGHT TO USE "SOLUTION LLC", APART FROM  
THE MARK AS SHOWN.

SN 78-628,985, FILED 5-12-2005.

AMOS T. MATTHEWS, JR., EXAMINING ATTOR-  
NEY

**Int. Cl.: 41**

**Prior U.S. Cls.: 100, 101, and 107**

**United States Patent and Trademark Office**

**Reg. No. 3,395,903**

**Registered Mar. 11, 2008**

**SERVICE MARK  
PRINCIPAL REGISTER**

**Just Playin' Sport**

MILLER, GAIL BARBONE (UNITED STATES  
INDIVIDUAL)  
19 OVERHILL ROAD  
NORTH SCITUATE, RI 02857

THE MARK CONSISTS OF STANDARD CHAR-  
ACTERS WITHOUT CLAIM TO ANY PARTICULAR  
FONT, STYLE, SIZE, OR COLOR.

FOR: PUBLICATION OF TEXTS, BOOKS, MAGA-  
ZINES AND OTHER PRINTED MATTER, IN CLASS  
41 (U.S. CLS. 100, 101 AND 107).

SN 78-629,238, FILED 5-12-2005.

FIRST USE 11-1-2005; IN COMMERCE 11-1-2005.

NICHOLAS ALTREE, EXAMINING ATTORNEY

**Int. Cl.: 3**

**Prior U.S. Cls.: 1, 4, 6, 50, 51, and 52**

**Reg. No. 3,395,904**

**United States Patent and Trademark Office**

**Registered Mar. 11, 2008**

---

**TRADEMARK  
PRINCIPAL REGISTER**

**STILETTO**

SUPRE, INC. (TEXAS CORPORATION)  
SUITE 700  
15770 NORTH DALLAS PARKWAY  
DALLAS, TX 75248

FIRST USE 12-15-2006; IN COMMERCE 12-15-2006.

THE MARK CONSISTS OF STANDARD CHARACTERS WITHOUT CLAIM TO ANY PARTICULAR FONT, STYLE, SIZE, OR COLOR.

FOR: SKIN CARE PRODUCTS, NAMELY, INDOOR AND OUTDOOR SUN TANNING PREPARATIONS, SUNLESS TANNING PREPARATIONS, BATH AND SHOWER GELS AND SKIN MOISTURIZERS, IN CLASS 3 (U.S. CLS. 1, 4, 6, 50, 51 AND 52).

SN 78-629,392, FILED 5-13-2005.

SALLY SHIH, EXAMINING ATTORNEY

**Int. Cl.: 41**

**Prior U.S. Cls.: 100, 101, and 107**

**United States Patent and Trademark Office**

**Reg. No. 3,395,905**

**Registered Mar. 11, 2008**

**SERVICE MARK  
PRINCIPAL REGISTER**

**PLAY\*A\*LOT**

FISHERS FAMILY ENTERTAINMENT CENTER,  
LLC (INDIANA LTD LIAB CO)  
10501 TAVAREZ COURT  
FORTVILLE, IN 46040

THE MARK CONSISTS OF STANDARD CHAR-  
ACTERS WITHOUT CLAIM TO ANY PARTICULAR  
FONT, STYLE, SIZE, OR COLOR.

FOR: PROVIDING RECREATIONAL AREAS IN  
THE NATURE OF CHILDREN'S PLAY AREAS, IN  
CLASS 41 (U.S. CLS. 100, 101 AND 107).

SN 78-630,830, FILED 5-16-2005.

FIRST USE 8-31-2005; IN COMMERCE 8-31-2005.

TIMOTHY FINNEGAN, EXAMINING ATTORNEY

**Int. Cl.: 39**

**Prior U.S. Cls.: 100 and 105**

**United States Patent and Trademark Office**

**Reg. No. 3,395,906**

**Registered Mar. 11, 2008**

**SERVICE MARK  
PRINCIPAL REGISTER**

**ALADIA**

SISTEMAS AEREOS DE MEXICO, S.A. DE C.V.  
(MEXICO CORPORATION)  
COLONIA MIRADOR CENTRO  
IGNACIO L. VALLARTA NO. 811 SUR  
MONTERREY, MEXICO 64070

FOR: TRANSPORTING PASSENGERS AND  
FREIGHT BY AIR; TRAVEL AGENCY SERVICES,  
NAMELY, MAKING RESERVATIONS AND BOOK-  
INGS FOR TRANSPORTATION BY AIR AND LAND  
AND TOURS AND DESIGNING AND ARRANGING  
TRAVEL PACKAGES AND TOURS; PACKAGING  
AND STORAGE OF GOODS, IN CLASS 39 (U.S. CLS.  
100 AND 105).

FIRST USE 12-1-2006; IN COMMERCE 4-0-2007.

THE MARK CONSISTS OF STANDARD CHAR-  
ACTERS WITHOUT CLAIM TO ANY PARTICULAR  
FONT, STYLE, SIZE, OR COLOR.

PRIORITY CLAIMED UNDER SEC. 44(D) ON  
MEXICO APPLICATION NO. 0062469, FILED 4-22-  
2005, REG. NO. 889376, DATED 4-22-2005, EXPIRES 4-  
22-2015.

THE WORDING "ALADIA" HAS NO MEANING  
IN THE FOREIGN LANGUAGE.

SN 78-632,010, FILED 5-18-2005.

BRIDGETT SMITH, EXAMINING ATTORNEY



**Int. Cl.: 14**

**Prior U.S. Cls.: 2, 27, 28, and 50**

**United States Patent and Trademark Office**

**Reg. No. 3,395,907**

**Registered Mar. 11, 2008**

**TRADEMARK  
PRINCIPAL REGISTER**

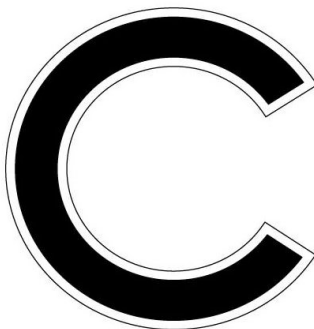

CHICAGO NATIONAL LEAGUE BALL CLUB,  
INC. (DELAWARE CORPORATION)  
1060 WEST ADDISON STREET  
CHICAGO, IL 60613

FOR: JEWELRY, NAMELY, BRACELETS,  
CHARMS, EARRINGS, PENDANTS, COSTUME  
JEWELRY, SILICONE OR RUBBER BRACELETS  
AND WRISTBANDS IN THE NATURE OF BRACE-  
LETS, MEDALLIONS, ORNAMENTAL METAL  
PINS, LAPEL PINS, MONEY CLIPS OF PRECIOUS  
METAL, KEY CHAINS OF PRECIOUS METAL, KEY  
RINGS OF PRECIOUS METAL, IN CLASS 14 (U.S.  
CLS. 2, 27, 28 AND 50).

FIRST USE 12-0-2005; IN COMMERCE 12-0-2005.

OWNER OF U.S. REG. NOS. 1,297,664, 2,667,880,  
AND OTHERS.

THE MARK CONSISTS OF THE LETTER "C" IN  
STYLIZED FORM.

SN 78-633,649, FILED 5-19-2005.

WILLIAM BRECKENFELD, EXAMINING ATTOR-  
NEY

**Int. Cl.: 16**

**Prior U.S. Cls.: 2, 5, 22, 23, 29, 37, 38, and 50**

**Reg. No. 3,395,908**

**United States Patent and Trademark Office**

**Registered Mar. 11, 2008**

---

**TRADEMARK  
PRINCIPAL REGISTER**

**SEAL TEAR**

BISON BAG CO. INC. (NEW YORK CORPORATION)  
5404 CROWN DRIVE  
LOCKPORT, NY 14094

FOR: FLEXIBLE PLASTIC PACKAGING, NAME-  
LY, PLASTIC BAGS, IN CLASS 16 (U.S. CLS. 2, 5, 22,  
23, 29, 37, 38 AND 50).

FIRST USE 2-0-2007; IN COMMERCE 2-0-2007.

THE MARK CONSISTS OF STANDARD CHAR-  
ACTERS WITHOUT CLAIM TO ANY PARTICULAR  
FONT, STYLE, SIZE, OR COLOR.

NO CLAIM IS MADE TO THE EXCLUSIVE  
RIGHT TO USE "SEAL", APART FROM THE MARK  
AS SHOWN.

SN 78-634,302, FILED 5-20-2005.

ANNE MADDEN, EXAMINING ATTORNEY

Int. Cl.: 35

Prior U.S. Cls.: 100, 101, and 102

United States Patent and Trademark Office

Reg. No. 3,395,909

Registered Mar. 11, 2008

**SERVICE MARK  
PRINCIPAL REGISTER**



**Patient Navigation  
in Cancer Care**  
Guiding patients to quality outcomes

PHARMACIA & UPJOHN COMPANY LLC (DE-  
LAWARE LTD LIAB CO)  
100 ROUTE 206 NORTH  
PEAPACK, NJ 07977

FOR: PROVIDING CONSUMER INFORMATION  
IN THE FIELD OF ONCOLOGY PATIENTS USING  
THE HEALTHCARE SYSTEM THROUGH THE DIS-  
TRIBUTION OF TOOLKITS, CONSISTING OF PRIN-  
TED MATERIALS, BOOKLETS, FORMS,  
POWERPOINT PRESENTATIONS, MANUALS AND  
CD-ROMS, IN CLASS 35 (U.S. CLS. 100, 101 AND 102).

FIRST USE 8-0-2005; IN COMMERCE 8-0-2005.

NO CLAIM IS MADE TO THE EXCLUSIVE  
RIGHT TO USE "PATIENT NAVIGATION IN CAN-  
CER CARE", APART FROM THE MARK AS  
SHOWN.

SN 78-635,224, FILED 5-23-2005.

BILL DAWE, EXAMINING ATTORNEY

**Int. Cl.: 36**

**Prior U.S. Cls.: 100, 101, and 102**

**United States Patent and Trademark Office**

**Reg. No. 3,395,910**

**Registered Mar. 11, 2008**

**SERVICE MARK  
PRINCIPAL REGISTER**

**GOLD KEY**

COMPASS BANCSHARES, INC. (DELAWARE CORPORATION)  
12TH FLOOR  
15 SOUTH 20TH STREET  
BIRMINGHAM, AL 35233

FOR: PROVIDING PERSONALIZED AND INDIVIDUALLY TAILORED RISK ASSESSMENTS IN THE FIELD OF INSURANCE; PROVIDING RISK MANAGEMENT AND FINANCIAL PLANNING INSURANCE SOLUTIONS; INSURANCE ACCOUNT MANAGEMENT AND INSURANCE ADMINISTRA-

TIVE SERVICES TO SELECT CUSTOMERS, IN CLASS 36 (U.S. CLS. 100, 101 AND 102).

FIRST USE 4-1-2002; IN COMMERCE 4-1-2002.

THE MARK CONSISTS OF STANDARD CHARACTERS WITHOUT CLAIM TO ANY PARTICULAR FONT, STYLE, SIZE, OR COLOR.

SN 78-636,701, FILED 5-25-2005.

ANDREA SAUNDERS, EXAMINING ATTORNEY

Int. Cl.: 36

Prior U.S. Cls.: 100, 101, and 102

United States Patent and Trademark Office

Reg. No. 3,395,911

Registered Mar. 11, 2008

SERVICE MARK  
PRINCIPAL REGISTER

**AVELO**  

---

**MORTGAGE**

ARCHON GROUP, L.P. (DELAWARE LIMITED  
PARTNERSHIP)  
6011 CONNECTION DRIVE  
IRVING, TX 75039

FOR: MORTGAGE LENDING SERVICES, MORT-  
GAGE UNDERWRITING SERVICES AND MORT-  
GAGE BROKERAGE SERVICES; LOAN  
ORIGINATION AND LOAN SERVICING SERVICES;  
CONSULTING SERVICES IN THE FIELD OF RESI-  
DENTIAL MORTGAGE LENDING SERVICES, IN  
CLASS 36 (U.S. CLS. 100, 101 AND 102).

FIRST USE 4-8-2005; IN COMMERCE 4-8-2005.

NO CLAIM IS MADE TO THE EXCLUSIVE  
RIGHT TO USE "MORTGAGE", APART FROM  
THE MARK AS SHOWN.

THE MARK CONSISTS OF THE WORDS "AVELO  
MORTGAGE" IN STYLIZED FORM WITH A LINE  
BETWEEN THEM.

SN 78-638,089, FILED 5-26-2005.

JEFFERY COWARD, EXAMINING ATTORNEY

**Int. Cl.: 9**

**Prior U.S. Cls.: 21, 23, 26, 36, and 38**

**Reg. No. 3,395,912**

**United States Patent and Trademark Office**

**Registered Mar. 11, 2008**

**TRADEMARK  
PRINCIPAL REGISTER**

**BODY REFORM**

BODY REFORM PHYSICAL THERAPIES, INC.  
(CALIFORNIA CORPORATION)  
15515 W. SUNSET BOULEVARD, #308  
PACIFIC PALISADES, CA 90272

FOR: PRE-RECORDED VIDEOTAPES AND DVDS  
FEATURING EXERCISE PROGRAMS FOR REHA-  
BILITATION, INJURY PREVENTION, AND AGE-  
RELATED DISABILITIES, IN CLASS 9 (U.S. CLS. 21,  
23, 26, 36 AND 38).

FIRST USE 11-2-2007; IN COMMERCE 11-2-2007.

THE MARK CONSISTS OF STANDARD CHAR-  
ACTERS WITHOUT CLAIM TO ANY PARTICULAR  
FONT, STYLE, SIZE, OR COLOR.

NO CLAIM IS MADE TO THE EXCLUSIVE  
RIGHT TO USE "BODY", APART FROM THE  
MARK AS SHOWN.

SN 78-638,270, FILED 5-26-2005.

TARAH HARDY, EXAMINING ATTORNEY

**Int. Cl.: 44**

**Prior U.S. Cls.: 100 and 101**

**United States Patent and Trademark Office**

**Reg. No. 3,395,913**

**Registered Mar. 11, 2008**

**SERVICE MARK  
PRINCIPAL REGISTER**

**Greener By Design**

GREENER BY DESIGN, INC. (NEW YORK CORPORATION)  
87 WOLFS LANE  
PELHAM, NY 10803

THE MARK CONSISTS OF STANDARD CHARACTERS WITHOUT CLAIM TO ANY PARTICULAR FONT, STYLE, SIZE, OR COLOR.

FOR: LANDSCAPING SERVICES, NAMELY, GARDENING AND GARDENING DESIGN FOR OTHERS, IN CLASS 44 (U.S. CLS. 100 AND 101).

SN 78-639,404, FILED 5-27-2005.

FIRST USE 6-1-2005; IN COMMERCE 1-1-2006.

ELI HELLMAN, EXAMINING ATTORNEY

**Int. Cl.: 44**

**Prior U.S. Cls.: 100 and 101**

**United States Patent and Trademark Office**

**Reg. No. 3,395,914**

**Registered Mar. 11, 2008**

**SERVICE MARK  
PRINCIPAL REGISTER**

**Tanmax**

BEILKE, GALEN (UNITED STATES INDIVIDUAL)  
3397 E. BLUEJAY DR.  
CHANDLER, AZ 85249

THE MARK CONSISTS OF STANDARD CHARACTERS WITHOUT CLAIM TO ANY PARTICULAR FONT, STYLE, SIZE, OR COLOR.

FOR: TANNING SALONS, IN CLASS 44 (U.S. CLS. 100 AND 101).

SN 78-639,505, FILED 5-28-2005.

FIRST USE 3-0-2005; IN COMMERCE 1-0-2006.

JOHN HWANG, EXAMINING ATTORNEY



**Int. Cl.: 3**

**Prior U.S. Cls.: 1, 4, 6, 50, 51, and 52**

**United States Patent and Trademark Office**

**Reg. No. 3,395,915**

**Registered Mar. 11, 2008**

**TRADEMARK  
PRINCIPAL REGISTER**



THEME GARAGE, INC (TEXAS CORPORATION)  
2205 STONEGATE  
DENTON, TX 76205

LEATHER CLEANER AND CONDITIONER, IN  
CLASS 3 (U.S. CLS. 1, 4, 6, 50, 51 AND 52).

FIRST USE 6-24-2005; IN COMMERCE 6-24-2005.

FOR: CLEANING PRODUCTS FOR AUTOMO-  
BILES, NAMELY, AUTOMOBILE CLEANERS; AU-  
TOMOBILE POLISH; AND AUTOMOBILE WAX;

SN 78-640,992, FILED 6-1-2005.

DAWN FELDMAN, EXAMINING ATTORNEY

**Int. Cl.: 9**

**Prior U.S. Cls.: 21, 23, 26, 36, and 38**

**United States Patent and Trademark Office**

**Reg. No. 3,395,916**

**Registered Mar. 11, 2008**

**TRADEMARK  
PRINCIPAL REGISTER**

# ACTION INFO

ACTION ENGINE CORPORATION (DELAWARE CORPORATION)  
2331 130TH AVE. NE, 2ND FLOOR  
BELLEVUE, WA 98005

FOR: COMPUTER SOFTWARE FOR MOBILE ELECTRONIC DEVICES AND APPLICATION SOFTWARE USED IN MOBILE ELECTRONIC DEVICES TO ENABLE THEM TO RETRIEVE, DOWNLOAD, DISPLAY, SEND AND MANAGE AUDIO, VIDEO, GRAPHICAL AND TEXTUAL DATA SENT VIA COMPUTER AND COMMUNICATIONS NETWORKS AND INSTRUCTIONAL MANUALS, TECHNICAL REFERENCE AND EVALUATION GUIDES, IN PRINTED OR ELECTRONIC FORM, ON MAGNETIC AND OPTICAL COMPUTER-READABLE MEDIA OR DOWNLOADABLE VIA COMPUTER AND COMMUNICATIONS NETWORKS PROVIDED AS A UNIT WITH THE FOREGOING, IN CLASS 9 (U.S. CLS. 21, 23, 26, 36 AND 38).

FIRST USE 6-30-2007; IN COMMERCE 6-30-2007.

THE MARK CONSISTS OF STANDARD CHARACTERS WITHOUT CLAIM TO ANY PARTICULAR FONT, STYLE, SIZE, OR COLOR.

OWNER OF U.S. REG. NOS. 2,716,604, 2,837,265, AND OTHERS.

NO CLAIM IS MADE TO THE EXCLUSIVE RIGHT TO USE "INFO", APART FROM THE MARK AS SHOWN.

SN 78-642,473, FILED 6-2-2005.

RUDY R. SINGLETON, EXAMINING ATTORNEY

**Int. Cl.: 35**

**Prior U.S. Cls.: 100, 101, and 102**

**United States Patent and Trademark Office**

**Reg. No. 3,395,917**

**Registered Mar. 11, 2008**

**SERVICE MARK  
PRINCIPAL REGISTER**

**MEMOIRE.COM**

HEARTS ON FIRE COMPANY LLC (MASSACHU-  
SETTS LTD LIAB CO)  
99 SUMMER STREET  
BOSTON, MA 02110

OWNER OF U.S. REG. NOS. 1,267,420, 1,878,581,  
AND 1,878,582.

FOR: PROVIDING CONSUMER AND RETAIL  
INFORMATION IN THE FIELD OF JEWELRY, IN  
CLASS 35 (U.S. CLS. 100, 101 AND 102).

THE ENGLISH TRANSLATION OF THE WORD  
"MEMOIRE" IN THE MARK IS "MEMORY".

FIRST USE 4-18-2007; IN COMMERCE 4-18-2007.

SN 78-642,972, FILED 6-3-2005.

THE MARK CONSISTS OF STANDARD CHAR-  
ACTERS WITHOUT CLAIM TO ANY PARTICULAR  
FONT, STYLE, SIZE, OR COLOR.

AMY HELLA, EXAMINING ATTORNEY

**Int. Cl.: 41**

**Prior U.S. Cls.: 100, 101, and 107**

**United States Patent and Trademark Office**

**Reg. No. 3,395,918**

**Registered Mar. 11, 2008**

**SERVICE MARK  
PRINCIPAL REGISTER**

**EMMERMAN'S RED FILE**

EMMERMAN, MICHAEL N. (UNITED STATES  
INDIVIDUAL)  
151 EAST 63RD STREET  
NEW YORK, NY 10021

FOR: EDUCATION SERVICES, NAMELY, SEMI-  
NARS, CONFERENCES, LECTURES AND WORK-  
SHOPS IN THE FIELD OF PHYSICAL AND  
FINANCIAL PREPAREDNESS PROGRAMS TO  
HELP INDIVIDUALS AND ORGANIZATIONS PRE-  
PARE FOR DISRUPTIONS AND DISASTERS, AND  
DISTRIBUTING EDUCATIONAL, TUTORIAL AND  
REFERENCE MATERIAL IN CONNECTION

THEREWITH, IN CLASS 41 (U.S. CLS. 100, 101 AND  
107).

FIRST USE 10-10-2007; IN COMMERCE 10-10-2007.

THE MARK CONSISTS OF STANDARD CHAR-  
ACTERS WITHOUT CLAIM TO ANY PARTICULAR  
FONT, STYLE, SIZE, OR COLOR.

SN 78-643,236, FILED 6-3-2005.

TOBY BULLOFF, EXAMINING ATTORNEY

**Int. Cl.: 1**

**Prior U.S. Cls.: 1, 5, 6, 10, 26, and 46**

**Reg. No. 3,395,919**

**United States Patent and Trademark Office**

**Registered Mar. 11, 2008**

---

**TRADEMARK  
PRINCIPAL REGISTER**

**MICRO-TECH**

RSA MICROTECH, LLC. (DELAWARE LTD LIAB  
CO)  
4001 LEXINGTON AVE NORTH  
ARDEN HILLS, MN 55126

THE MARK CONSISTS OF STANDARD CHAR-  
ACTERS WITHOUT CLAIM TO ANY PARTICULAR  
FONT, STYLE, SIZE, OR COLOR.

FOR: MICRONUTRIENT FERTILIZER, IN CLASS  
1 (U.S. CLS. 1, 5, 6, 10, 26 AND 46).

SN 78-643,968, FILED 6-6-2005.

FIRST USE 3-5-2004; IN COMMERCE 3-5-2004.

DAVID MILLER, EXAMINING ATTORNEY

**Int. Cl.: 25**

**Prior U.S. Cls.: 22 and 39**

**United States Patent and Trademark Office**

**Reg. No. 3,395,920**

**Registered Mar. 11, 2008**

**TRADEMARK  
PRINCIPAL REGISTER**



DEREK ANDREW INC. (WASHINGTON CORPORATION)  
901 - 104TH AVENUE N.E., SUITE 200  
BELLEVUE, WA 98004

FIRST USE 1-25-2003; IN COMMERCE 1-25-2003.

OWNER OF U.S. REG. NO. 2,810,487.

FOR: BLOUSES, SHIRTS, CAMISOLES, KNIT TOPS, TANK TOPS, T-SHIRTS, SWEATSHIRTS, PANTS, SWEAT PANTS, JEANS, SHORTS, SKIRTS, DRESSES, VESTS, SWEATERS, JACKETS, COATS, SCARVES, HATS, CAPS, BELTS, IN CLASS 25 (U.S. CLS. 22 AND 39).

SN 78-645,341, FILED 6-7-2005.

LEIGH CAROLINE CASE, EXAMINING ATTORNEY

**Int. Cl.: 25**

**Prior U.S. Cls.: 22 and 39**

**United States Patent and Trademark Office**

**Reg. No. 3,395,921**

**Registered Mar. 11, 2008**

**TRADEMARK  
PRINCIPAL REGISTER**

**BODY VEILS**

CHARLES KOMAR & SONS, INC. (NEW YORK  
CORPORATION)  
16 EAST 34TH STREET  
NEW YORK, NY 10016

THE MARK CONSISTS OF STANDARD CHAR-  
ACTERS WITHOUT CLAIM TO ANY PARTICULAR  
FONT, STYLE, SIZE, OR COLOR.

FOR: CLOTHING, NAMELY, UNDERWEAR, IN  
CLASS 25 (U.S. CLS. 22 AND 39).

SN 78-645,676, FILED 6-7-2005.

FIRST USE 1-0-2006; IN COMMERCE 1-0-2006.

CAROLYN CATALDO, EXAMINING ATTORNEY

**Int. Cls.: 3 and 40**

**Prior U.S. Cls.: 1, 4, 6, 50, 51, 52, 100, 103, and 106**

**United States Patent and Trademark Office**

**Reg. No. 3,395,922**

**Registered Mar. 11, 2008**

**TRADEMARK  
SERVICE MARK  
PRINCIPAL REGISTER**

**ANNAÉ**

ANNAE ENTERPRISES, LLC (COLORADO LTD  
LIAB CO)

200 ALDER LANE

BOULDER, CO 80304

FOR: SKIN CARE PRODUCTS, NAMELY, NON-MEDICATED SKIN SERUM AND NON-MEDICATED SKIN CARE PREPARATIONS, BODY AND BEAUTY CARE PREPARATIONS , IN CLASS 3 (U.S. CLS. 1, 4, 6, 50, 51 AND 52).

FIRST USE 11-0-2003; IN COMMERCE 11-0-2003.

FOR: CUSTOM MANUFACTURE OF SKIN CARE PRODUCTS, IN CLASS 40 (U.S. CLS. 100, 103 AND 106).

FIRST USE 11-0-2003; IN COMMERCE 11-0-2003.

THE MARK CONSISTS OF STANDARD CHARACTERS WITHOUT CLAIM TO ANY PARTICULAR FONT, STYLE, SIZE, OR COLOR.

SN 78-645,824, FILED 6-7-2005.

SAMUEL E. SHARPER JR., EXAMINING ATTORNEY



**Int. Cl.: 35**

**Prior U.S. Cls.: 100, 101, and 102**

**United States Patent and Trademark Office**

**Reg. No. 3,395,923**

**Registered Mar. 11, 2008**

---

**SERVICE MARK  
PRINCIPAL REGISTER**

**MICROANALYTIX**

INDUCTIS GROUP LLC (DELAWARE LTD LIAB  
CO)  
SUITE 105  
571 CENTRAL AVENUE  
PROVIDENCE, NJ 079741547

FOR: BUSINESS MANAGEMENT CONSULTING  
SERVICES AND BUSINESS OUTSOURCING SERVI-  
CES IN THE FIELD OF BUSINESS DATA ANALY-  
TICS, IN CLASS 35 (U.S. CLS. 100, 101 AND 102).

FIRST USE 7-1-2005; IN COMMERCE 7-1-2005.

THE MARK CONSISTS OF STANDARD CHAR-  
ACTERS WITHOUT CLAIM TO ANY PARTICULAR  
FONT, STYLE, SIZE, OR COLOR.

SN 78-646,378, FILED 6-8-2005.

BILL DAWE, EXAMINING ATTORNEY

**Int. Cl.: 16**

**Prior U.S. Cls.: 2, 5, 22, 23, 29, 37, 38, and 50**

**Reg. No. 3,395,924**

**United States Patent and Trademark Office**

**Registered Mar. 11, 2008**

**TRADEMARK  
PRINCIPAL REGISTER**

**MEDCENTERTODAY**

TARQUINIO, GREGG T. (UNITED STATES IN-  
DIVIDUAL)  
2817 WEST END AVE.  
SUITE 126-377  
NASHVILLE, TN 37203

FOR: PRINTED PUBLICATIONS, NAMELY,  
NEWSLETTERS FEATURING NEWS AND INFOR-  
MATION THAT AFFECTS THE MEDICAL PROFES-  
SION AND OTHER INFORMATION ABOUT  
BUSINESS PRODUCTS AND SERVICES, PROFES-  
SIONAL DEVELOPMENT AND MEDICAL PRAC-

TICE OPPORTUNITIES, IN CLASS 16 (U.S. CLS. 2, 5,  
22, 23, 29, 37, 38 AND 50).

FIRST USE 8-27-2007; IN COMMERCE 8-27-2007.

THE MARK CONSISTS OF STANDARD CHAR-  
ACTERS WITHOUT CLAIM TO ANY PARTICULAR  
FONT, STYLE, SIZE, OR COLOR.

SN 78-646,606, FILED 6-8-2005.

STEPHANIE ALI, EXAMINING ATTORNEY

**Int. Cl.: 37**

**Prior U.S. Cls.: 100, 103, and 106**

**United States Patent and Trademark Office**

**Reg. No. 3,395,925**

**Registered Mar. 11, 2008**

**SERVICE MARK  
PRINCIPAL REGISTER**

**Moka·Loving Care**

CHINA MIST TEA COMPANY (ARIZONA CORPORATION)

7435 EAST TIERRA BUENA LANE

SCOTTSDALE, AZ 852601608

FOR: MAINTENANCE SERVICES AND PROVIDING A MAINTENANCE PROGRAM FOR THE CARE AND MAINTENANCE OF ESPRESSO MACHINES, COFFEE GRINDERS AND COFFEE BREWING MACHINES; PROVIDING INFORMATION REGARDING THE MAINTENANCE OF ESPRESSO MACHINES, COFFEE GRINDERS AND COFFEE BREWING MACHINES, IN CLASS 37 (U.S. CLS. 100, 103 AND 106).

FIRST USE 12-5-2007; IN COMMERCE 12-5-2007.

OWNER OF U.S. REG. NOS. 1,920,208 AND 2,978,631.

NO CLAIM IS MADE TO THE EXCLUSIVE RIGHT TO USE "CARE", APART FROM THE MARK AS SHOWN.

THE COLOR(S) BROWN AND BLACK IS/ARE CLAIMED AS A FEATURE OF THE MARK.

THE MARK CONSISTS OF A BROWN COFFEE BEAN REPRESENTING THE LETTER O IN THE WORDING "MOKA LOVING CARE" THAT APPEARS IN BROWN AND IS TRIMMED IN BLACK WITH A SMALL BLACK HEART SEPARATING THE WORDS "MOKA" AND "LOVING".

THE ENGLISH TRANSLATION OF THE FRENCH WORD "MOKA" IS MOCHA.

SN 78-646,702, FILED 6-8-2005.

MARILYN IZZI, EXAMINING ATTORNEY

Int. Cl.: 36

Prior U.S. Cls.: 100, 101, and 102

United States Patent and Trademark Office

Reg. No. 3,395,926

Registered Mar. 11, 2008

SERVICE MARK  
PRINCIPAL REGISTER



LIBERTY FINANCIAL GROUP, INC. (WASHINGTON CORPORATION)  
205 108TH AVE NE SUITE 270  
BELLEVUE, WA 98004

FOR: MORTGAGE BANKING SERVICES, NAME-  
LY, ORIGINATION, ACQUISITION, SERVICING,  
SECURITIZING, AND BROKERAGE OF MORT-  
GAGE LOANS IN ALABAMA, ALASKA, ARIZONA,  
ARKANSAS, CALIFORNIA, COLORADO, CONNEC-  
TICUT, DELAWARE, DISTRICT OF COLUMBIA,  
FLORIDA, GEORGIA, HAWAII, IDAHO, ILLINOIS,  
INDIANA, IOWA, KANSAS, KENTUCKY, LOUISI-  
ANA, MAINE, MARYLAND, MASSACHUSETTS,  
MICHIGAN, MINNESOTA, MISSISSIPPI, MIS-  
SOURI, MONTANA, NEBRASKA, NEVADA, NEW  
HAMPSHIRE, NEW JERSEY, NEW MEXICO, NEW  
YORK, NORTH CAROLINA, NORTH DAKOTA,  
OHIO, OKLAHOMA, OREGON, PENNSYLVANIA,  
RHODE ISLAND, SOUTH CAROLINA, SOUTH DA-  
KOTA, TENNESSEE, TEXAS, UTAH, VERMONT,  
VIRGINIA, WASHINGTON, WEST VIRGINIA, WIS-  
CONSIN, AND WYOMING, IN CLASS 36 (U.S. CLS.  
100, 101 AND 102).

FIRST USE 4-1-2002; IN COMMERCE 4-1-2002.

NO CLAIM IS MADE TO THE EXCLUSIVE  
RIGHT TO USE "FINANCIAL GROUP", APART  
FROM THE MARK AS SHOWN.

THE COLOR(S) RED, BLUE AND WHITE IS/ARE  
CLAIMED AS A FEATURE OF THE MARK.

THE MARK CONSISTS OF THE COLOR BLUE IN  
THE TOP LEFT CORNER; ALTERNATING WHITE  
AND RED STRIPES; A WHITE STAR; THE WORD-  
ING IN THE MARK IS IN THE COLOR BLUE; AND  
THE BACKGROUND COLOR OF THE MARK IS  
WHITE.

SN 78-647,084, FILED 6-9-2005.

BILL DAWE, EXAMINING ATTORNEY

**Int. Cl.: 16**

**Prior U.S. Cls.: 2, 5, 22, 23, 29, 37, 38, and 50**

**Reg. No. 3,395,927**

**United States Patent and Trademark Office**

**Registered Mar. 11, 2008**

**TRADEMARK  
PRINCIPAL REGISTER**

**BE THE BOSS OF YOUR BODY**

SELF-REGULATION SOLUTIONS, LLC (MINNESOTA LTD LIAB CO)  
11681 VISTA DRIVE  
MINNETONKA, MN 55343

FOR: SERIES OF NON-FICTION BOOKS FOR CHILDREN AND YOUNG ADULTS IN THE FIELDS OF HEALTH, HEALTH MANAGEMENT, NUTRITION AND EXERCISE; STICKERS , IN CLASS 16 (U.S. CLS. 2, 5, 22, 23, 29, 37, 38 AND 50).

FIRST USE 8-1-2007; IN COMMERCE 8-1-2007.

THE MARK CONSISTS OF STANDARD CHARACTERS WITHOUT CLAIM TO ANY PARTICULAR FONT, STYLE, SIZE, OR COLOR.

SN 78-647,236, FILED 6-9-2005.

HEATHER BIDDULPH, EXAMINING ATTORNEY

**Int. Cl.: 25**

**Prior U.S. Cls.: 22 and 39**

**United States Patent and Trademark Office**

**Reg. No. 3,395,928**

**Registered Mar. 11, 2008**

**TRADEMARK  
PRINCIPAL REGISTER**

**TOUGHSKINS**

SEARS BRANDS, LLC (ILLINOIS LTD LIAB CO)  
3333 BEVERLY ROAD  
HOFFMAN ESTATES, IL 60179

FOR: CHILDREN'S APPAREL, NAMELY, TOPS,  
BOTTOMS, JACKETS, GLOVES, HOSIERY, AND  
FOOTWEAR, IN CLASS 25 (U.S. CLS. 22 AND 39).

FIRST USE 1-0-2005; IN COMMERCE 1-0-2005.

THE MARK CONSISTS OF STANDARD CHAR-  
ACTERS WITHOUT CLAIM TO ANY PARTICULAR  
FONT, STYLE, SIZE, OR COLOR.

SN 78-647,760, FILED 6-9-2005.

SAMUEL E. SHARPER JR., EXAMINING ATTOR-  
NEY

**Int. Cl.: 9**

**Prior U.S. Cls.: 21, 23, 26, 36, and 38**

**United States Patent and Trademark Office**

**Reg. No. 3,395,929**

**Registered Mar. 11, 2008**

**TRADEMARK  
PRINCIPAL REGISTER**

**TAI PAN**

IGT (NEVADA CORPORATION)  
9295 PROTOTYPE DRIVE  
RENO, NV 895218986

THE MARK CONSISTS OF STANDARD CHAR-  
ACTERS WITHOUT CLAIM TO ANY PARTICULAR  
FONT, STYLE, SIZE, OR COLOR.

FOR: GAMING MACHINES, NAMELY, DEVICES  
WHICH ACCEPT A WAGER, IN CLASS 9 (U.S. CLS.  
21, 23, 26, 36 AND 38).

SN 78-648,318, FILED 6-10-2005.

FIRST USE 11-6-2006; IN COMMERCE 11-6-2006.

ANNE MADDEN, EXAMINING ATTORNEY

**Int. Cl.: 9**

**Prior U.S. Cls.: 21, 23, 26, 36, and 38**

**Reg. No. 3,395,930**

**United States Patent and Trademark Office**

**Registered Mar. 11, 2008**

---

**TRADEMARK  
PRINCIPAL REGISTER**

**LIFERX**

INSIGHT EQUITY A.P.X., LP (TEXAS LIMITED  
PARTNERSHIP), DBA VISION-EASE LENS,  
SUITE 250  
1400 CIVIC PLACE  
SOUTHLAKE, TX 76092

FOR: OPHTHALMIC LENSES FOR EYEGASSES,  
IN CLASS 9 (U.S. CLS. 21, 23, 26, 36 AND 38).

FIRST USE 12-0-2005; IN COMMERCE 12-0-2005.

THE MARK CONSISTS OF STANDARD CHAR-  
ACTERS WITHOUT CLAIM TO ANY PARTICULAR  
FONT, STYLE, SIZE, OR COLOR.

OWNER OF U.S. REG. NOS. 1,742,188, 2,569,678,  
AND OTHERS.

SN 78-648,506, FILED 6-10-2005.

BILL DAWE, EXAMINING ATTORNEY



**Int. Cl.: 5**

**Prior U.S. Cls.: 6, 18, 44, 46, 51, and 52**

**United States Patent and Trademark Office**

**Reg. No. 3,395,931**

**Registered Mar. 11, 2008**

**TRADEMARK  
PRINCIPAL REGISTER**

**EPITRAM**

EPICARE LTD. (DELAWARE CORPORATION)  
66 MADISON AVE  
NEW YORK, NY 10016

THE MARK CONSISTS OF STANDARD CHAR-  
ACTERS WITHOUT CLAIM TO ANY PARTICULAR  
FONT, STYLE, SIZE, OR COLOR.

FOR: PHARMACEUTICAL PREPARATIONS FOR  
WOUND CARE AND BURN CARE, AND FOR THE  
TREATMENT OF SKIN DISORDERS, IN CLASS 5  
(U.S. CLS. 6, 18, 44, 46, 51 AND 52).

SN 78-650,256, FILED 6-14-2005.

FIRST USE 7-31-2007; IN COMMERCE 7-31-2007.

REBECCA SMITH, EXAMINING ATTORNEY

**Int. Cl.: 9**

**Prior U.S. Cls.: 21, 23, 26, 36, and 38**

**Reg. No. 3,395,932**

**United States Patent and Trademark Office**

**Registered Mar. 11, 2008**

---

**TRADEMARK  
PRINCIPAL REGISTER**

**INTERPRETER**

MASTER METER, INC. (TEXAS CORPORATION)  
101 REGENCY PARKWAY  
MANSFIELD, TX 76063

THE MARK CONSISTS OF STANDARD CHARACTERS WITHOUT CLAIM TO ANY PARTICULAR FONT, STYLE, SIZE, OR COLOR.

FOR: UTILITY METER REGISTERS, NAMELY, WATER METER REGISTERS AND UTILITY METERS, NAMELY, WATER METERS, IN CLASS 9 (U.S. CLS. 21, 23, 26, 36 AND 38).

SN 78-650,925, FILED 6-15-2005.

FIRST USE 1-31-2007; IN COMMERCE 1-31-2007.

RICHARD WHITE, EXAMINING ATTORNEY

**Int. Cl.: 28**

**Prior U.S. Cls.: 22, 23, 38, and 50**

**United States Patent and Trademark Office**

**Reg. No. 3,395,933**

**Registered Mar. 11, 2008**

**TRADEMARK  
PRINCIPAL REGISTER**

**komomo**

AMZ DESIGN CO., LTD. (JAPAN CORPORATION)  
404-1, RO, ASAHI-SHI  
CHIBA, JAPAN 289-2516

THE MARK CONSISTS OF STANDARD CHARACTERS WITHOUT CLAIM TO ANY PARTICULAR FONT, STYLE, SIZE, OR COLOR.

FOR: FISHING EQUIPMENT, NAMELY, FISHING LURES, IN CLASS 28 (U.S. CLS. 22, 23, 38 AND 50).

SN 78-650,931, FILED 6-15-2005.

FIRST USE 9-0-2006; IN COMMERCE 9-0-2006.

DANIEL CAPSHAW, EXAMINING ATTORNEY

**Int. Cl.: 29**

**Prior U.S. Cl.: 46**

**United States Patent and Trademark Office**

**Reg. No. 3,395,934**

**Registered Mar. 11, 2008**

**TRADEMARK  
PRINCIPAL REGISTER**

**VONE**

GREEN SPOT (THAILAND) LIMITED (THAILAND CORPORATION)  
244 SRINAGARINDRA ROAD, HUA MAK  
BANG KAPI  
BANGKOK, THAILAND 10240

FOR: SOYMILK AND SOY BEVERAGES, NAME-  
LY, SOY BEAN BASED NON-CARBONATED NON  
ALCOHOLIC BEVERAGE, IN CLASS 29 (U.S. CL. 46).

FIRST USE 7-20-2007; IN COMMERCE 7-20-2007.

THE MARK CONSISTS OF STANDARD CHAR-  
ACTERS WITHOUT CLAIM TO ANY PARTICULAR  
FONT, STYLE, SIZE, OR COLOR.

THE WORDING "VONE" HAS NO MEANING IN  
A FOREIGN LANGUAGE.

SN 78-652,709, FILED 6-17-2005.

SHAUNIA CARLYLE, EXAMINING ATTORNEY

**Int. Cl.: 29**

**Prior U.S. Cl.: 46**

**United States Patent and Trademark Office**

**Reg. No. 3,395,935**

**Registered Mar. 11, 2008**

**TRADEMARK  
PRINCIPAL REGISTER**

**VAMINO**

GREEN SPOT (THAILAND) LIMITED (THAILAND CORPORATION)  
244 SRINAGARINDRA ROAD, HUA MAK  
BANG KAPI  
BANGKOK, THAILAND 10240

FOR: SOY MILK AND SOY BEVERAGES, NAME-  
LY, SOY BEAN FOOD BASED NON-CARBONATED  
NON-ALCOHOLIC BEVERAGE, IN CLASS 29 (U.S.  
CL. 46).

FIRST USE 2-13-2007; IN COMMERCE 2-13-2007.

THE MARK CONSISTS OF STANDARD CHAR-  
ACTERS WITHOUT CLAIM TO ANY PARTICULAR  
FONT, STYLE, SIZE, OR COLOR.

SN 78-652,710, FILED 6-17-2005.

CYNTHIA SLOAN, EXAMINING ATTORNEY

**Int. Cl.: 28**

**Prior U.S. Cls.: 22, 23, 38, and 50**

**United States Patent and Trademark Office**

**Reg. No. 3,395,936**

**Registered Mar. 11, 2008**

**TRADEMARK  
PRINCIPAL REGISTER**



AMZ DESIGN CO. LTD. (JAPAN CORPORATION)  
404-1, RO, ASAHI-SHI  
CHIBA, JAPAN 2892516

FIRST USE 9-0-2006; IN COMMERCE 9-0-2006.

SN 78-652,757, FILED 6-17-2005.

FOR: FISHING EQUIPMENT, NAMELY, FISHING LURES, IN CLASS 28 (U.S. CLS. 22, 23, 38 AND 50).

KAREN BRACEY, EXAMINING ATTORNEY

**Int. Cl.: 28**

**Prior U.S. Cls.: 22, 23, 38, and 50**

**United States Patent and Trademark Office**

**Reg. No. 3,395,937**

**Registered Mar. 11, 2008**

**TRADEMARK  
PRINCIPAL REGISTER**

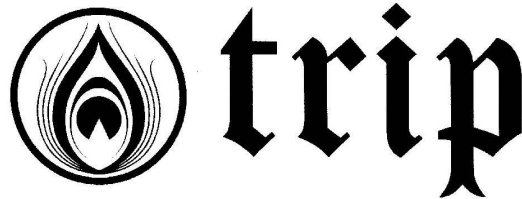

AMZ DESIGN CO., LTD. (JAPAN CORPORATION)  
404-1, RO, ASAHI-SHI  
CHIBA, JAPAN 2892516

FIRST USE 9-0-2006; IN COMMERCE 9-0-2006.

SN 78-652,761, FILED 6-17-2005.

FOR: FISHING EQUIPMENT, NAMELY, FISHING LURES, IN CLASS 28 (U.S. CLS. 22, 23, 38 AND 50).

PAUL CROWLEY, EXAMINING ATTORNEY

**Int. Cl.: 20**

**Prior U.S. Cls.: 2, 13, 22, 25, 32, and 50**

**United States Patent and Trademark Office**

**Reg. No. 3,395,938**

**Registered Mar. 11, 2008**

**TRADEMARK  
PRINCIPAL REGISTER**

# Printologie

DOMINGUEZ, ELAINE (UNITED STATES INDIVIDUAL)  
C/O HUGH JANOW, ESQ.  
ONE BLUE HILL PLAZA, SUITE 1006 P.O. BOX  
1586 P.O. BOX 1586  
PEARL RIVER, NY 10965

THE MARK CONSISTS OF STANDARD CHARACTERS WITHOUT CLAIM TO ANY PARTICULAR FONT, STYLE, SIZE, OR COLOR.

FOR: PILLOWS, IN CLASS 20 (U.S. CLS. 2, 13, 22, 25, 32 AND 50).

SN 78-652,829, FILED 6-17-2005.

FIRST USE 8-2-2007; IN COMMERCE 8-2-2007.

PAUL F. GAST, EXAMINING ATTORNEY



Int. Cl.: 41

Prior U.S. Cls.: 100, 101, and 107

United States Patent and Trademark Office

Reg. No. 3,395,939

Registered Mar. 11, 2008

**SERVICE MARK  
PRINCIPAL REGISTER**



REMEMBERING ADAM INCORPORATED  
(PENNSYLVANIA CORPORATION)  
110 VALLEY LANE  
CARROLLTOWN, PA 15722

FOR: EDUCATIONAL SERVICES, NAMELY,  
CONDUCTING CLASSES AND SEMINARS PER-  
TAINING TO SUBSTANCE ABUSE PREVENTION,  
IN CLASS 41 (U.S. CLS. 100, 101 AND 107).

FIRST USE 10-1-1998; IN COMMERCE 10-1-1998.

THE COLOR(S) RED, BLUE, GREEN, YELLOW,  
ORANGE, WHITE, AND BLACK IS/ARE CLAIMED  
AS A FEATURE OF THE MARK.

THE DESIGN PORTION OF THE MARK CON-  
SISTS OF A BUTTERFLY ON TOP OF A HEART.  
THE BUTTERFLY HAS A BLACK AND WHITE  
BODY, BLACK ANTENNA, AND IS OUTLINED IN  
BLACK; THE WINGS, FROM TOP TO BOTTOM,  
ARE BLUE, GREEN, YELLOW AND ORANGE; THE  
HEART IS RED WITH A BLACK CENTER; AND  
THE WORDING IS BLACK.

SN 78-653,049, FILED 6-17-2005.

ALICE SUE CARRUTHERS, EXAMINING ATTOR-  
NEY

**Int. Cl.: 41**

**Prior U.S. Cls.: 100, 101, and 107**

**United States Patent and Trademark Office**

**Reg. No. 3,395,940**

**Registered Mar. 11, 2008**

**SERVICE MARK  
PRINCIPAL REGISTER**

THE CURE FOR THE COMMON  
CASINO

155 EAST TROPICANA, LLC (NEVADA LTD  
LIAB CO)  
115 E. TROPICANA AVENUE  
LAS VEGAS, NV 89109

FOR: CASINO SERVICES; ENTERTAINMENT  
SERVICES, NAMELY, LIVE ENTERTAINMENT  
FEATURING MUSICIANS AND SINGERS, DAN-  
CERS, MAGICIANS, ACTORS, ACROBATS, COME-  
DIANS AND PRERECORDED MUSIC AND VIDEO,  
IN CLASS 41 (U.S. CLS. 100, 101 AND 107).

FIRST USE 2-2-2006; IN COMMERCE 2-2-2006.

THE MARK CONSISTS OF STANDARD CHAR-  
ACTERS WITHOUT CLAIM TO ANY PARTICULAR  
FONT, STYLE, SIZE, OR COLOR.

SN 78-653,359, FILED 6-17-2005.

KATHRYN COWARD, EXAMINING ATTORNEY

**Int. Cl.: 9**

**Prior U.S. Cls.: 21, 23, 26, 36, and 38**

**Reg. No. 3,395,941**

**United States Patent and Trademark Office**

**Registered Mar. 11, 2008**

---

**TRADEMARK  
PRINCIPAL REGISTER**

**LUCKY LUIGI'S PIZZERIA**

BALLY GAMING INTERNATIONAL, INC. (DE-  
LAWARE CORPORATION)  
ATTN: PAM BOWSHER, LAW DEPT.  
6601 SOUTH BERMUDA ROAD  
LAS VEGAS, NV 89119

FOR: GAMING DEVICES, NAMELY, ELECTRO-  
NIC SLOT MACHINES, WITH OR WITHOUT VIDEO  
OUTPUT, IN CLASS 9 (U.S. CLS. 21, 23, 26, 36 AND  
38).

FIRST USE 6-15-2006; IN COMMERCE 6-15-2006.

THE MARK CONSISTS OF STANDARD CHAR-  
ACTERS WITHOUT CLAIM TO ANY PARTICULAR  
FONT, STYLE, SIZE, OR COLOR.

SN 78-653,546, FILED 6-17-2005.

DOMINICK J. SALEMI, EXAMINING ATTORNEY

**Int. Cl.: 16**

**Prior U.S. Cls.: 2, 5, 22, 23, 29, 37, 38, and 50**

**Reg. No. 3,395,942**

**United States Patent and Trademark Office**

**Registered Mar. 11, 2008**

---

**TRADEMARK  
PRINCIPAL REGISTER**

**AUTOBIN**

SMURFIT-STONE CONTAINER ENTERPRISES,  
INC. (DELAWARE CORPORATION)  
150 N. MICHIGAN AVENUE  
CHICAGO, IL 60601

THE MARK CONSISTS OF STANDARD CHAR-  
ACTERS WITHOUT CLAIM TO ANY PARTICULAR  
FONT, STYLE, SIZE, OR COLOR.

FOR: CORRUGATED CONTAINERS FOR HOLD-  
ING FOOD ITEMS, IN CLASS 16 (U.S. CLS. 2, 5, 22, 23,  
29, 37, 38 AND 50).

SN 78-653,985, FILED 6-20-2005.

FIRST USE 10-22-2007; IN COMMERCE 10-22-2007.

REBECCA SMITH, EXAMINING ATTORNEY

**Int. Cls.: 39, 40, and 45**

**Prior U.S. Cls.: 100, 101, 103, 105, and 106**

**United States Patent and Trademark Office**

**Reg. No. 3,395,943**

**Registered Mar. 11, 2008**

**SERVICE MARK  
PRINCIPAL REGISTER**

# AUTHENTIFAX

AUTHENTIDATE HOLDING CORP. (DELA-  
WARE CORPORATION)  
300 CONNELL DRIVE, 5TH FLOOR  
CONNELL CORPORATE CENTER  
BERKELEY HEIGHTS, NJ 07922

FOR: ELECTRONIC STORAGE AND RETRIEVAL  
OF DOCUMENTS AND DATA FILES, IN CLASS 39  
(U.S. CLS. 100 AND 105).

FIRST USE 2-0-2005; IN COMMERCE 2-0-2005.

FOR: CONVERSION OF DOCUMENTS INTO  
ELECTRONIC, MAGNETIC, OPTICAL OR OTHER  
FORMATS; CODING OF DOCUMENTS AND DATA  
FILES, IN CLASS 40 (U.S. CLS. 100, 103 AND 106).

FIRST USE 2-0-2005; IN COMMERCE 2-0-2005.

FOR: DOCUMENT AND DATA MANAGEMENT  
AND PROCESSING SERVICES, NAMELY, AU-  
THENTICATION, TIME STAMPING AND VERIFI-  
CATION OF DOCUMENTS AND DATA FILES, IN  
CLASS 45 (U.S. CLS. 100 AND 101).

FIRST USE 2-0-2005; IN COMMERCE 2-0-2005.

THE MARK CONSISTS OF STANDARD CHAR-  
ACTERS WITHOUT CLAIM TO ANY PARTICULAR  
FONT, STYLE, SIZE, OR COLOR.

SN 78-656,193, FILED 6-22-2005.

NAAKWAMA ANKRAH, EXAMINING ATTORNEY

**Int. Cl.: 35**

**Prior U.S. Cls.: 100, 101, and 102**

**United States Patent and Trademark Office**

**Reg. No. 3,395,944**

**Registered Mar. 11, 2008**

**SERVICE MARK  
PRINCIPAL REGISTER**

# Beachside Produce

REAL PRODUCE, LLC (CALIFORNIA LTD LIAB  
CO)  
P.O. BOX 909  
GUADALUPE, CA 93434

FOR: WHOLESALE DISTRIBUTORSHIPS FEATURING AGRICULTURAL PRODUCE, IN CLASS 35 (U.S. CLS. 100, 101 AND 102).

FIRST USE 11-1-2005; IN COMMERCE 11-1-2005.

THE MARK CONSISTS OF STANDARD CHARACTERS WITHOUT CLAIM TO ANY PARTICULAR FONT, STYLE, SIZE, OR COLOR.

NO CLAIM IS MADE TO THE EXCLUSIVE RIGHT TO USE "PRODUCE", APART FROM THE MARK AS SHOWN.

SN 78-656,413, FILED 6-22-2005.

CHARLES L. JENKINS, EXAMINING ATTORNEY

**Int. Cls.: 16, 35, and 41**

**Prior U.S. Cls.: 2, 5, 22, 23, 29, 37, 38, 50, 100, 101, 102, and 107**

**Reg. No. 3,395,945**

**United States Patent and Trademark Office**

**Registered Mar. 11, 2008**

**TRADEMARK  
SERVICE MARK  
PRINCIPAL REGISTER**



INTERNATIONAL SOCIETY FOR MEDICAL PUBLICATION PROFESSIONALS (NEW JERSEY CORPORATION)

PO BOX 2523

BRIARCLIFF MANOR, NY 10510

FOR: PRINTED MATERIALS, NAMELY, EDUCATIONAL AND INFORMATIONAL PUBLICATIONS, BOOKS, JOURNALS, MAGAZINES, REPORTS, NEWSLETTERS, BULLETINS, BROCHURES, PROFESSIONAL KNOWLEDGE EXAMINATIONS AND ANSWER SHEETS, HANDBOOKS, AND STUDY GUIDES RELATED TO THE FIELD OF MEDICAL PUBLICATION PROFESSIONALS; DIRECTORY OF ASSOCIATION'S MEMBERS AND CERTIFICANTS, IN CLASS 16 (U.S. CLS. 2, 5, 22, 23, 29, 37, 38 AND 50).

FIRST USE 3-31-2005; IN COMMERCE 3-31-2005.

FOR: ASSOCIATION SERVICES, NAMELY, PROMOTING THE INTERESTS OF MEDICAL PUBLICATION PROFESSIONALS, MAINTAINING A REGISTRY OF MEMBERS AND CERTIFICANTS IN THE FIELD OF MEDICAL PUBLICATION PROFESSIONALS, ON-LINE DIRECTORY OF MEMBERS AND CERTIFICANTS IN THE FIELD OF MEDICAL PUBLICATION PROFESSIONALS, BUSINESS NETWORK SERVICES, TESTING TO DETERMINE PROFESSIONAL KNOWLEDGE OR COMPETENCY, VERIFYING AND MONITORING THE CREDENTIALS OF MEDICAL PUBLICATION PROFESSIONALS; PLANNING AND COORDINAT-

ING PROFESSIONAL FAIR EXHIBITIONS IN THE FIELD OF MEDICAL PUBLICATION PROFESSIONALS, IN CLASS 35 (U.S. CLS. 100, 101 AND 102).

FIRST USE 3-31-2005; IN COMMERCE 3-31-2005.

FOR: EDUCATIONAL SERVICES, NAMELY, PROFESSIONAL SEMINARS AND CONFERENCES, CONTINUING PROFESSIONAL EDUCATION CLASSES, COURSE DEVELOPMENT, EDUCATIONAL EXAMINATION SERVICES, REVIEW COURSES FOR EXAMINATIONS, IN THE PROFESSIONAL FIELD OF MEDICAL PUBLICATIONS; PUBLISHING OF BOOKS, JOURNALS, MAGAZINES, REPORTS, NEWSLETTERS, BULLETINS, BROCHURES, PROFESSIONAL KNOWLEDGE EXAMINATIONS AND ANSWER SHEETS, HANDBOOKS AND STUDY GUIDES RELATED TO THE FIELD OF MEDICAL PUBLICATION PROFESSIONALS, IN CLASS 41 (U.S. CLS. 100, 101 AND 107).

FIRST USE 3-31-2005; IN COMMERCE 3-31-2005.

NO CLAIM IS MADE TO THE EXCLUSIVE RIGHT TO USE "INTERNATIONAL SOCIETY FOR MEDICAL PUBLICATION PROFESSIONALS" AND THE CADUCEUS SYMBOL, APART FROM THE MARK AS SHOWN.

THE COLOR(S) GREEN AND BLUE IS/ARE CLAIMED AS A FEATURE OF THE MARK.

THE MARK CONSISTS OF THE WORDS "ISMPP INTERNATIONAL SOCIETY FOR MEDICAL PUBLICATION PROFESSIONALS" AND THE DESIGN OF THE CADUCEUS. THE LETTERS "ISMPP" AND THE CADUCEUS DESIGN ARE GREEN. THE WORDS "INTERNATIONAL SOCIETY FOR MEDICAL PUBLICATION PROFESSIONALS" ARE BLUE.

COLOR IS CLAIMED AS A FEATURE OF THE MARK.

SN 78-656,632, FILED 6-23-2005.

SHAUNIA CARLYLE, EXAMINING ATTORNEY



**Int. Cl.: 33**

**Prior U.S. Cls.: 47 and 49**

**United States Patent and Trademark Office**

**Reg. No. 3,395,946**

**Registered Mar. 11, 2008**

**TRADEMARK  
PRINCIPAL REGISTER**

**El Sabor de México**

LIBER INVESTMENTS, LLC (TEXAS LTD LIAB  
CO)  
7750 BROADWAY  
SAN ANTONIO, TX 78209

FOR: TEQUILA, MEZCAL, AND ALCOHOLIC  
BEVERAGES OF FRUIT AND LIQUOR, IN CLASS  
33 (U.S. CLS. 47 AND 49).

FIRST USE 4-1-2006; IN COMMERCE 4-1-2006.

THE MARK CONSISTS OF STANDARD CHAR-  
ACTERS WITHOUT CLAIM TO ANY PARTICULAR  
FONT, STYLE, SIZE, OR COLOR.

NO CLAIM IS MADE TO THE EXCLUSIVE  
RIGHT TO USE "MÉXICO", APART FROM THE  
MARK AS SHOWN.

THE FOREIGN WORDING IN THE MARK  
TRANSLATES INTO ENGLISH AS "THE TASTE OF  
MEXICO".

SN 78-658,277, FILED 6-25-2005.

JOHN E. MICHOS, EXAMINING ATTORNEY

**Int. Cl.: 33**

**Prior U.S. Cls.: 47 and 49**

**United States Patent and Trademark Office**

**Reg. No. 3,395,947**

**Registered Mar. 11, 2008**

**TRADEMARK  
PRINCIPAL REGISTER**

# The Taste of Mexico

LIBER INVESTMENTS, LLC (TEXAS LTD LIAB  
CO)  
7750 BROADWAY  
SAN ANTONIO, TX 78209

FOR: TEQUILA, MEZCAL, ALCOHOLIC BEV-  
ERAGES OF FRUIT, AND LIQUOR, IN CLASS 33  
(U.S. CLS. 47 AND 49).

FIRST USE 4-1-2006; IN COMMERCE 4-1-2006.

THE MARK CONSISTS OF STANDARD CHAR-  
ACTERS WITHOUT CLAIM TO ANY PARTICULAR  
FONT, STYLE, SIZE, OR COLOR.

NO CLAIM IS MADE TO THE EXCLUSIVE  
RIGHT TO USE "MEXICO", APART FROM THE  
MARK AS SHOWN.

SN 78-658,280, FILED 6-25-2005.

JOHN HWANG, EXAMINING ATTORNEY

**Int. Cls.: 9, 16, 35, 37, 41, and 42**

**Prior U.S. Cls.: 2, 5, 21, 22, 23, 26, 29, 36, 37, 38, 50,  
100, 101, 102, 103, 106, and 107**

**Reg. No. 3,395,948**

**United States Patent and Trademark Office**

**Registered Mar. 11, 2008**

**TRADEMARK  
SERVICE MARK  
PRINCIPAL REGISTER**

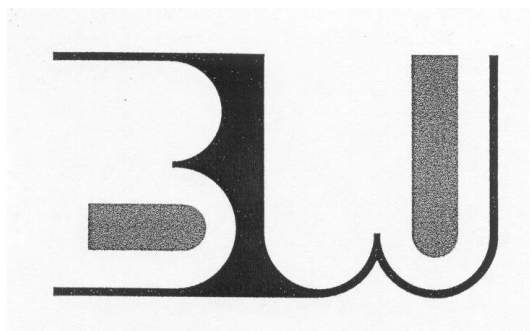

BOHME & WEIHS SYSTEMTECHNIK GMBH &  
CO. KG (FED REP GERMANY LIMITED  
PARTNERSHIP)  
ENGELSFELD 9  
SPROCKHOVEL, FED REP GERMANY 45549

FOR: BLANK MAGNETIC DATA CARRIERS;  
BLANK CD-ROMS FOR SOUND OR VIDEO RE-  
CORDING; COMPUTERS FOR USE IN DATA PRO-  
CESSING, IN CLASS 9 (U.S. CLS. 21, 23, 26, 36 AND  
38).

FIRST USE 10-15-1985; IN COMMERCE 6-30-2001.

FOR: PRINTED MATTER, NAMELY, BOOKS,  
MAGAZINES, BROCHURES, PAMPHLETS, PERI-  
ODICALS, MANUALS, AND JOURNALS, ALL IN  
THE COMPUTER FIELD, IN CLASS 16 (U.S. CLS. 2, 5,  
22, 23, 29, 37, 38 AND 50).

FIRST USE 10-15-1985; IN COMMERCE 6-30-2001.

FOR: MARKET RESEARCH AND MARKET  
ANALYSIS; BUSINESS ADMINISTRATION CON-  
SULTANCY; BUSINESS ORGANIZATION AND OP-  
ERATION CONSULTANCY, IN CLASS 35 (U.S. CLS.  
100, 101 AND 102).

FIRST USE 10-15-1985; IN COMMERCE 6-30-2001.

FOR: INSTALLATION AND REPAIR OF QUAL-  
ITY ASSURANCE SYSTEMS, IN CLASS 37 (U.S. CLS.  
100, 103 AND 106).

FIRST USE 10-15-1985; IN COMMERCE 6-30-2001.

FOR: TRAINING SERVICES IN THE FIELD OF  
QUALITY ASSURANCE, IN CLASS 41 (U.S. CLS. 100,  
101 AND 107).

FIRST USE 10-15-1985; IN COMMERCE 6-30-2001.

FOR: COMPUTER PROGRAMMING FOR OTH-  
ERS, NAMELY, DESIGNING PROGRAMS IN THE  
FIELD OF QUALITY ASSURANCE AND REMOTE  
MAINTENANCE OF QUALITY ASSURANCE SYS-  
TEMS; RENTAL OF COMPUTERS DESIGNED TO  
AID WITH QUALITY ASSURANCE PROCESSES, IN  
CLASS 42 (U.S. CLS. 100 AND 101).

FIRST USE 10-15-1985; IN COMMERCE 6-30-2001.

OWNER OF ERPN CMNTY TM OFC REG. NO.  
001322940, DATED 8-7-2001, EXPIRES 9-27-2009.

THE COLOR(S) GRAY, BLACK AND WHITE IS/  
ARE CLAIMED AS A FEATURE OF THE MARK.

THE COLOR GRAY APPEARS WITHIN THE  
LOWER LOBE OF THE LETTER "B" AND WITHIN  
THE RIGHT LOBE OF THE LETTER "W". THE  
COLOR WHITE APPEARS IN THE REMAINDER OF  
BOTH LETTERS. THE COLOR BLACK SUR-  
ROUNDS THE LETTERS ON THREE SIDES OF  
EACH LETTER INCLUDING THE AREA BETWEEN  
THE LETTERS.

SN 78-658,671, FILED 6-27-2005.

ELLEN PERKINS, EXAMINING ATTORNEY

**Int. Cl.: 9**

**Prior U.S. Cls.: 21, 23, 26, 36, and 38**

**Reg. No. 3,395,949**

**United States Patent and Trademark Office**

**Registered Mar. 11, 2008**

---

**TRADEMARK  
PRINCIPAL REGISTER**

**LADY BUG**

ELINK, LLC (OKLAHOMA LTD LIAB CO)  
8311 W. SUNSET RD., SUITE 110  
LAS VEGAS, NV 89113

THE MARK CONSISTS OF STANDARD CHAR-  
ACTERS WITHOUT CLAIM TO ANY PARTICULAR  
FONT, STYLE, SIZE, OR COLOR.

FOR: GAMING MACHINES, NAMELY, BINGO-  
RELATED GAMES AND SLOT MACHINES, IN  
CLASS 9 (U.S. CLS. 21, 23, 26, 36 AND 38).

SN 78-659,656, FILED 6-28-2005.

FIRST USE 11-13-2007; IN COMMERCE 11-13-2007.

DAYNA BROWNE, EXAMINING ATTORNEY

**Int. Cls.: 10, 11, and 21**

**Prior U.S. Cls.: 2, 13, 21, 23, 26, 29, 30, 31, 33, 34, 39, 40, 44, and 50**

**Reg. No. 3,395,950**

**United States Patent and Trademark Office**

**Registered Mar. 11, 2008**

**TRADEMARK  
PRINCIPAL REGISTER**

# Born Free

BORN FREE HOLDINGS LTD. (ISRAEL CORPORATION)  
3, HASADNAOT STREET  
HERZELIA, ISRAEL 46728

FOR: BABY BOTTLES, NIPPLES FOR BABY BOTTLES, CUPS ADAPTED FOR FEEDING BABIES AND CHILDREN, BABY BOTTLE HANDLES, NIPPLE COVERS FOR BABY BOTTLES, SEALING DISCS FOR BABY BOTTLES AND PARTS THEREOF, IN CLASS 10 (U.S. CLS. 26, 39 AND 44).

FIRST USE 6-0-2006; IN COMMERCE 6-0-2006.

FOR: BABY BOTTLE STERILIZERS, STERILIZERS AND PARTS AND FITTINGS THEREOF FOR BABY BOTTLE NIPPLES, PACIFIERS, TEE-THING RINGS, CUPS, SPOUTS FOR CUPS, HANDLES FOR CUPS, FEEDING DISHES AND FEEDING UTENSILS, IN CLASS 11 (U.S. CLS. 13, 21, 23, 31 AND 34).

FIRST USE 1-0-2007; IN COMMERCE 1-0-2007.

FOR: INFANTS' AND CHILDREN'S DRINKING CUPS NOT OF PRECIOUS METALS, ATTACHMENTS FOR INFANTS' AND CHILDREN'S DRINKING CUPS, NAMELY, NON-SPILL VALVES FOR USE WITH CUPS, SPOUTS FOR CUPS, HANDLES FOR CUPS; BRUSHES FOR CLEANING FEEDING EQUIPMENT, NAMELY, BOTTLE CLEANING BRUSHES, NIPPLE CLEANING BRUSHES, CHILDREN'S CUP VENT CLEANING BRUSHES, IN CLASS 21 (U.S. CLS. 2, 13, 23, 29, 30, 33, 40 AND 50).

FIRST USE 6-0-2006; IN COMMERCE 6-0-2006.

THE MARK CONSISTS OF STANDARD CHARACTERS WITHOUT CLAIM TO ANY PARTICULAR FONT, STYLE, SIZE, OR COLOR.

SN 78-659,831, FILED 6-28-2005.

CHRISTOPHER BUONGIORNO, EXAMINING ATTORNEY

**Int. Cl.: 41**

**Prior U.S. Cls.: 100, 101, and 107**

**United States Patent and Trademark Office**

**Reg. No. 3,395,951**

**Registered Mar. 11, 2008**

**SERVICE MARK  
PRINCIPAL REGISTER**

**ECHO MOUNTAIN**

EMJ SQUAW PASS, LLC (COLORADO LIMITED  
LIABILITY COMPANY)  
2646 JULIAN STREET  
DENVER, CO 80211

FOR: SKI AND SNOWBOARD RESORT SERVICES; ARRANGING SKI RACING AND SNOWBOARD COMPETITIONS; PROVIDING INSTRUCTION IN THE FIELD OF SKIING AND SNOWBOARDING; PROVIDING TERRAIN PARK FACILITIES FOR SKIERS AND SNOWBOARDERS, IN CLASS 41 (U.S. CLS. 100, 101 AND 107).

FIRST USE 8-30-2007; IN COMMERCE 8-30-2007.

THE MARK CONSISTS OF STANDARD CHARACTERS WITHOUT CLAIM TO ANY PARTICULAR FONT, STYLE, SIZE, OR COLOR.

NO CLAIM IS MADE TO THE EXCLUSIVE RIGHT TO USE "MOUNTAIN", APART FROM THE MARK AS SHOWN.

SN 78-660,326, FILED 6-28-2005.

DORITT L. CARROLL, EXAMINING ATTORNEY

**Int. Cl.: 20**

**Prior U.S. Cls.: 2, 13, 22, 25, 32, and 50**

**United States Patent and Trademark Office**

**Reg. No. 3,395,952**

**Registered Mar. 11, 2008**

**TRADEMARK  
PRINCIPAL REGISTER**

**BABIES MATTER**

DEL VALLE, CATHERINE J. (UNITED STATES  
INDIVIDUAL)  
2665 CLUB MESA PLACE  
COSTA MESA, CA 92627

FOR: BABY FURNITURE, NAMELY, ROCKING  
CHAIRS, WALKERS, PLAYPENS, CHANGING TA-  
BLES, CRIBS, DRESSERS, CRADLES, HIGH  
CHAIRS, AND BASSINETS , IN CLASS 20 (U.S.  
CLS. 2, 13, 22, 25, 32 AND 50).

FIRST USE 4-0-2007; IN COMMERCE 4-0-2007.

THE MARK CONSISTS OF STANDARD CHAR-  
ACTERS WITHOUT CLAIM TO ANY PARTICULAR  
FONT, STYLE, SIZE, OR COLOR.

NO CLAIM IS MADE TO THE EXCLUSIVE  
RIGHT TO USE "BABIES", APART FROM THE  
MARK AS SHOWN.

SN 78-662,242, FILED 6-30-2005.

REBECCA EISINGER, EXAMINING ATTORNEY



**Int. Cl.: 41**

**Prior U.S. Cls.: 100, 101, and 107**

**United States Patent and Trademark Office**

**Reg. No. 3,395,953**

**Registered Mar. 11, 2008**

**SERVICE MARK  
PRINCIPAL REGISTER**

**BREAKING THE VIDEO**

VIACOM INTERNATIONAL INC. (DELAWARE  
CORPORATION)  
1515 BROADWAY  
NEW YORK, NY 10036

FOR: ENTERTAINMENT SERVICES IN THE  
NATURE OF AN ON-GOING TELEVISION SERIES,  
FEATURING LIVE ACTION, COMEDY AND DRA-  
MA; PROVIDING ONLINE INFORMATION IN THE  
FIELD OF ENTERTAINMENT CONCERNING TEL-  
EVISION PROGRAMS, IN CLASS 41 (U.S. CLS. 100,  
101 AND 107).

FIRST USE 3-15-2007; IN COMMERCE 3-15-2007.

THE MARK CONSISTS OF STANDARD CHAR-  
ACTERS WITHOUT CLAIM TO ANY PARTICULAR  
FONT, STYLE, SIZE, OR COLOR.

SN 78-662,547, FILED 7-1-2005.

CHRISTOPHER BUONGIORNO, EXAMINING AT-  
TORNEY

**Int. Cl.: 44**

**Prior U.S. Cls.: 100 and 101**

**United States Patent and Trademark Office**

**Reg. No. 3,395,954**

**Registered Mar. 11, 2008**

**SERVICE MARK  
PRINCIPAL REGISTER**

**SUGAR**

CLARIAN HEALTH PARTNERS, INC. (INDIANA CORPORATION)  
1701 N. SENATE BLVD.  
INDIANAPOLIS, IN 46202 AND  
DIABETES INNOVATIONS LLC (INDIANA LTD LIAB CO)  
13795 HICKORY RIDGE CT.  
CARMEL, IN 46032

FOR: MEDICAL SERVICES, NAMELY, TREATMENT OF HYPERGLYCEMIC INDIVIDUALS IN AN IN-PATIENT ENVIRONMENT, IN CLASS 44 (U.S. CLS. 100 AND 101).

FIRST USE 6-30-2006; IN COMMERCE 6-30-2006.

THE MARK CONSISTS OF STANDARD CHARACTERS WITHOUT CLAIM TO ANY PARTICULAR FONT, STYLE, SIZE, OR COLOR.

SN 78-662,569, FILED 7-1-2005.

KELLY BOULTON, EXAMINING ATTORNEY

**Int. Cls.: 16 and 41**

**Prior U.S. Cls.: 2, 5, 22, 23, 29, 37, 38, 50, 100, 101, and 107**

**Reg. No. 3,395,955**

**United States Patent and Trademark Office**

**Registered Mar. 11, 2008**

**TRADEMARK  
SERVICE MARK  
PRINCIPAL REGISTER**

**ENGAGED & CONFUSED**

WEDDINGS IN HOUSTON, LP (TEXAS LIMITED PARTNERSHIP)  
SUITE 210  
800 WILCREST DRIVE  
HOUSTON, TX 77042

FOR: MAGAZINES FEATURING INFORMATION IN THE FIELDS OF WEDDING CONSULTATION AND WEDDING PLANNING SERVICES , IN CLASS 16 (U.S. CLS. 2, 5, 22, 23, 29, 37, 38 AND 50).

FIRST USE 2-21-2007; IN COMMERCE 2-21-2007.

FOR: WEDDING CONSULTING AND PLANNING SERVICES OFFERED IN PERSON AT BRI-

DAL SHOWS; PROVIDING ON-LINE WEDDING CONSULTING AND PLANNING SERVICES VIA THE INTERNET, IN CLASS 41 (U.S. CLS. 100, 101 AND 107).

FIRST USE 2-21-2007; IN COMMERCE 2-21-2007.

THE MARK CONSISTS OF STANDARD CHARACTERS WITHOUT CLAIM TO ANY PARTICULAR FONT, STYLE, SIZE, OR COLOR.

SN 78-662,747, FILED 7-1-2005.

JORDAN BAKER, EXAMINING ATTORNEY

**Int. Cl.: 35**

**Prior U.S. Cls.: 100, 101, and 102**

**United States Patent and Trademark Office**

**Reg. No. 3,395,956**

**Registered Mar. 11, 2008**

**SERVICE MARK  
PRINCIPAL REGISTER**

**LOCKED DOWN**

UNIFIED WESTERN GROCERS, INC. (CALIFORNIA CORPORATION)  
5200 SHEILA STREET  
COMMERCE, CA 90040

THE MARK CONSISTS OF STANDARD CHARACTERS WITHOUT CLAIM TO ANY PARTICULAR FONT, STYLE, SIZE, OR COLOR.

FOR: RETAIL SUPERMARKET SERVICES, IN CLASS 35 (U.S. CLS. 100, 101 AND 102).

SN 78-663,128, FILED 7-1-2005.

FIRST USE 5-1-2005; IN COMMERCE 5-1-2005.

DAVID YONTEF, EXAMINING ATTORNEY

**Int. Cl.: 9**

**Prior U.S. Cls.: 21, 23, 26, 36, and 38**

**United States Patent and Trademark Office**

**Reg. No. 3,395,957**

**Registered Mar. 11, 2008**

**TRADEMARK  
PRINCIPAL REGISTER**

**K2V**

KONAMI GAMING, INC. (NEVADA CORPORATION)  
585 TRADE CENTER DRIVE  
LAS VEGAS, NV 89119

FOR: GAMING MACHINES INCLUDING SLOT MACHINES AND GAME SOFTWARE USED THEREWITH; REPLACEMENT AND STRUCTURAL PARTS AND FITTINGS FOR THE AFORESAID GOODS; NONE OF THE FOREGOING GAMING MACHINES, SLOT MACHINES OR GAME SOFTWARE BEING OR BEING FOR COMPUTER GAME PLAYERS, PERSONAL VIDEO GAMES, SPORTS VIDEOS, ARCADE GAMES AND MACHINES, CON-

SOLE GAMES AND THE HANDHELD ELECTRONIC GAMES, IN CLASS 9 (U.S. CLS. 21, 23, 26, 36 AND 38).

FIRST USE 10-13-2005; IN COMMERCE 10-13-2005.

THE MARK CONSISTS OF STANDARD CHARACTERS WITHOUT CLAIM TO ANY PARTICULAR FONT, STYLE, SIZE, OR COLOR.

SN 78-663,180, FILED 7-2-2005.

ANNE MADDEN, EXAMINING ATTORNEY

**Int. Cl.: 41**

**Prior U.S. Cls.: 100, 101, and 107**

**United States Patent and Trademark Office**

**Reg. No. 3,395,958**

**Registered Mar. 11, 2008**

**SERVICE MARK  
PRINCIPAL REGISTER**

**AMA MX LITES**

AMERICAN MOTORCYCLIST ASSOCIATION  
(OHIO CORPORATION)  
13515 YARMOUTH DRIVE  
PICKERINGTON, OH 43147

FOR: ENTERTAINMENT AND RULE MAKING SERVICES, NAMELY, CONDUCTING, ORGANIZING, SANCTIONING, OFFICIATING AND MAKING RULES FOR MOTORCYCLE RACING COMPETITIONS, IN CLASS 41 (U.S. CLS. 100, 101 AND 107).

FIRST USE 1-1-2005; IN COMMERCE 1-1-2005.

THE MARK CONSISTS OF STANDARD CHARACTERS WITHOUT CLAIM TO ANY PARTICULAR FONT, STYLE, SIZE, OR COLOR.

OWNER OF U.S. REG. NOS. 2,949,917, 2,953,672, AND OTHERS.

NO CLAIM IS MADE TO THE EXCLUSIVE RIGHT TO USE "MX LITES", APART FROM THE MARK AS SHOWN.

SN 78-663,687, FILED 7-5-2005.

CYNTHIA SLOAN, EXAMINING ATTORNEY

**Int. Cl.: 28**

**Prior U.S. Cls.: 22, 23, 38, and 50**

**United States Patent and Trademark Office**

**Reg. No. 3,395,959**

**Registered Mar. 11, 2008**

**TRADEMARK  
PRINCIPAL REGISTER**

**GIRLS FROM THE PARK**

OELKE, MARCAINE (UNITED STATES INDIVIDUAL)  
2176 CHATSWORTH BLVD.  
SAN DIEGO, CA 92107

FOR: ACTION FIGURES AND ACCESSORIES THEREFOR; ACTION SKILL GAMES; ADULTS' AND CHILDREN'S PARTY GAMES; AERO-DYNAMIC DISK FOR USE IN PLAYING CATCHING GAMES; BABY MULTIPLE ACTIVITY TOYS; BADMINTON GAME PLAYING EQUIPMENT; BADMINTON SETS; BALLOONS; BASEBALL BATS; BASEBALL BATTING GLOVES; BASEBALL GLOVES; BASEBALL MITTS; BASEBALLS; BASKETBALLS; BATH TOYS; BEACH BALLS; BEAN BAGS; BOARD GAMES; CASES FOR PLAY ACCESSORIES; CASES FOR TOY STRUCTURES; CHECKER SETS; CHEERLEADING POM-POMS; CHESS SETS; COLLECTABLE TOY FIGURES; CONSTRUCTION TOYS; COSTUME MASKS; DOG TOYS; DOLL ACCESSORIES; DOLL CASES; DOLL CLOTHING; DOLL COSTUMES; DOLL FURNITURE; DOLL HOUSE FURNISHINGS; DOLL HOUSES; DOLLS AND ACCESSORIES THEREFOR; DRAWING TOYS; GOLF BAG COVERS; GOLF BAGS; GOLF BALL MARKERS; GOLF BALLS; GOLF CLUB HEADS; GOLF CLUBS; GOLF TEES; BASEBALL BATS; ICE SKATES; IN-LINE SKATES; INFANT TOYS; MUSICAL TOYS; PET TOYS; PLAYGROUND BALLS;

PLUSH TOYS; RACQUET BALL RACKETS; RACQUET BALLS; SKATEBOARDS; SKIS; SKI BINDINGS AND PARTS THEREFOR; SKI BRAKES; SKI EDGES; SKI POLES; SKI ROPES; SKI SCRAPERS; SKI WAX; SKIM BOARDS; SKIPPING ROPE; SNOW BOARDS; SNOW BOARD BINDINGS; SNOW SAUCERS; SNOW SKIS; SNOW SKI BINDINGS, SNOW SLEDS FOR RECREATIONAL USE; SOCCER BALLS; SOFTBALL BATS; SOFTBALL GLOVES; SOFTBALL MITTS; SPORT BALLS; SURFBOARD WAX; SURFBOARDS; SWING SETS; TABLE TENNIS BALLS; TABLE TENNIS NETS; TABLE TENNIS PADDLES; TABLE TENNIS RACKETS; TABLE TENNIS TABLES; TENNIS BALLS; TENNIS NETS; TENNIS RACKET COVERS; TENNIS RACKET STRINGS; TENNIS RACKETS; TETHER BALLS, IN CLASS 28 (U.S. CLS. 22, 23, 38 AND 50).

FIRST USE 12-1-2005; IN COMMERCE 12-1-2005.

THE MARK CONSISTS OF STANDARD CHARACTERS WITHOUT CLAIM TO ANY PARTICULAR FONT, STYLE, SIZE, OR COLOR.

SN 78-663,706, FILED 7-5-2005.

WON TEAK OH, EXAMINING ATTORNEY

**Int. Cl.: 25**

**Prior U.S. Cls.: 22 and 39**

**United States Patent and Trademark Office**

**Reg. No. 3,395,960**

**Registered Mar. 11, 2008**

**TRADEMARK  
PRINCIPAL REGISTER**

# Deadly Girl Couture

PRISS & EMPRESS DESIGNS, LLC (NEVADA  
LTD LIAB CO)  
1324 LEXINGTON AVENUE  
SUITE 234  
NEW YORK, NY 10128

FOR: CLOTHING, NAMELY, SHIRTS, T-SHIRTS,  
TANK TOPS, SWEATERS, PANTS, SWEATSHIRTS,  
SWEATPANTS, JACKETS, UNDERWEAR,  
SCARVES, PAJAMA TOPS, PAJAMA BOTTOMS,  
BRAS, AND HEADWEAR, NAMELY, HATS, CAPS,  
BASEBALL HATS, FOR ALL MEN, WOMEN AND  
CHILDREN, IN CLASS 25 (U.S. CLS. 22 AND 39).

FIRST USE 4-22-2006; IN COMMERCE 4-22-2006.

THE MARK CONSISTS OF STANDARD CHAR-  
ACTERS WITHOUT CLAIM TO ANY PARTICULAR  
FONT, STYLE, SIZE, OR COLOR.

NO CLAIM IS MADE TO THE EXCLUSIVE  
RIGHT TO USE "COUTURE", APART FROM THE  
MARK AS SHOWN.

SN 78-664,636, FILED 7-6-2005.

ESTHER A. BORSUK, EXAMINING ATTORNEY



**Int. Cls.: 6 and 20**

**Prior U.S. Cls.: 2, 12, 13, 14, 22, 23, 25, 32, and 50**

**United States Patent and Trademark Office**

**Reg. No. 3,395,961**

**Registered Mar. 11, 2008**

**TRADEMARK  
PRINCIPAL REGISTER**

**NEX-SYS**

POROUS MEDIA CORPORATION (MINNESOTA CORPORATION)  
4301 WEST DAVIS  
CONROE, TX 77304

FOR: PRESSURE VESSELS IN THE NATURE OF METAL STORAGE TANKS AND PARTS, THEREOF, NAMELY, PRESSURE VESSELS INTERNALS RETROFIT USING A NEW SEMI-PERMANENT TUBE-SHEET ATTACHED TO THE EXISTING OLD TUBE-SHEET, IN CLASS 6 (U.S. CLS. 2, 12, 13, 14, 23, 25 AND 50).

FIRST USE 10-23-2007; IN COMMERCE 10-23-2007.

FOR: PRESSURE VESSELS IN THE NATURE OF NON-METAL STORAGE TANKS AND PARTS

THEREOF, NAMELY, PRESSURE VESSELS INTERNALS RETROFIT USING A NEW SEMI-PERMANENT TUBE-SHEET ATTACHED TO THE EXISTING OLD TUBE-SHEET, IN CLASS 20 (U.S. CLS. 2, 13, 22, 25, 32 AND 50).

FIRST USE 10-23-2007; IN COMMERCE 10-23-2007.

THE MARK CONSISTS OF STANDARD CHARACTERS WITHOUT CLAIM TO ANY PARTICULAR FONT, STYLE, SIZE, OR COLOR.

SN 78-666,357, FILED 7-8-2005.

KARANENDRA S. CHHINA, EXAMINING ATTORNEY

**Int. Cl.: 29**

**Prior U.S. Cl.: 46**

**United States Patent and Trademark Office**

**Reg. No. 3,395,962**

**Registered Mar. 11, 2008**

**TRADEMARK  
PRINCIPAL REGISTER**

A TASTE FOR HEALTHY LIVING

LES VIANDES DU BRETON INC. (CANADA CORPORATION)  
150, CHEMIN DES RAYMOND  
RIVIERE-DU-LOUP (QUEBEC), CANADA G5R 5X8

FOR: MEAT PRODUCTS, NAMELY, FRESH PORK MEAT; MEAT PRODUCTS, NAMELY, FRESH AND FROZEN MEAT PIECES AND CUTS; MEAT THAT HAS BEEN MARINATED AND PREPARED BY SMOKING, BY COOKING, WITH BRINE, AND WITH SALT; DELICATESSEN PRODUCTS, NAMELY, HAM, SLICED HAM, BACON, SAUSAGE, PORK PATE, LIVER PATE AND DELICATESSEN PRODUCTS, NAMELY, PROCESSED PORK; FOOD,

NAMELY, PREPARED READY-TO-GO MEALS MADE PRIMARILY OF MEAT, IN CLASS 29 (U.S. CL. 46).

FIRST USE 9-0-2007; IN COMMERCE 9-0-2007.

THE MARK CONSISTS OF STANDARD CHARACTERS WITHOUT CLAIM TO ANY PARTICULAR FONT, STYLE, SIZE, OR COLOR.

SN 78-667,470, FILED 7-11-2005.

DEBRA LEE, EXAMINING ATTORNEY

Int. Cl.: 25

Prior U.S. Cls.: 22 and 39

United States Patent and Trademark Office

Reg. No. 3,395,963

Registered Mar. 11, 2008

TRADEMARK  
PRINCIPAL REGISTER

# Victor Valore

JC ATTIRE (MARYLAND LTD LIAB CO)  
416 UNIVERSITY DRIVE  
WALDORF, MD 20602

FOR: SHIRTS, PANTS, SHOES, CAPS FOR FORMAL AND INFORMAL WEAR, BELTS FOR PANTS AND SKIRTS, SKIRTS, BEANIES, ATHLETIC UNIFORMS, ANKLE SOCKS, SHIRTS FOR SUITS, SHIRT FRONTS, DRESSES, SKORTS, SLACKS, SLEEVELESS JERSEYS, SLEEVED AND SLEEVELESS JACKETS, SPORT COATS, SPORT SHIRTS, SPORTS JACKETS, SPORTS JERSEYS AND BREECHES FOR SPORTS, SPORTS UNIFORMS, SPORTS SHIRTS, SPORTS SHIRTS WITH SHORT SLEEVES, SUEDE JACKETS, SUIT COATS, SUITS, SUITS OF LEATHER, SUN VISORS, SWEAT BANDS, SWEAT PANTS, SWEAT SHIRTS, SWEAT SHORTS, SWEAT SUITS, SWEATBANDS, SWEATERS, SWEAT SOCKS, TEDDIES, TENNIS SHOES, TENNIS WEAR, TRACK-SUITS, TRAINING SHOES, TRAINING SUITS, TURTLENECK SWEATERS, TURTLENECKS, TUXEDO BELTS, TUXEDOS, TWIN SETS, T-SHIRTS, UNDER-ARM CLOTHING SHIELDS, UNDERCLOTHES, UNDERGARMENTS, UNDERPANTS, UNDERSHIRTS, VESTED SUITS, VESTS, VISORS, VOLLEYBALL SHOES, V-NECK SWEATERS, WAIST BELTS, WIND COATS, WIND RESISTANT JACKETS, WIND SHIRTS, WRIST BANDS, WRAPS FOR WOMEN'S HEADS AND BODY, SLIPPERS, SKI JACKETS,

OVERCOATS, OVERALLS, OPEN-NECKED SHIRTS, POCKET KERCHIEFS, POLO SHIRTS, PONCHOS, PULLOVERS, ROBES, RIDING COATS, GOLF SHOES, GOWNS, GREATCOATS, HAT BANDS, HATS, HEAD BANDS, HEAD SCARVES, HEAD SWEATBANDS, HEAD WEAR, JEANS, KNICKERS, KNIT SHIRTS, LAB COATS, LACE BOOTS, LADIES' BOOTS, LADIES' SUITS, LADIES' UNDERWEAR, DICKIES, DOWN JACKETS, DRESS SUITS, FUR COATS AND JACKETS, FUR HATS, GOLF CAPS AND CHAPS, IN CLASS 25 (U.S. CLS. 22 AND 39).

FIRST USE 12-5-2005; IN COMMERCE 2-1-2006.

THE MARK CONSISTS OF STANDARD CHARACTERS WITHOUT CLAIM TO ANY PARTICULAR FONT, STYLE, SIZE, OR COLOR.

THE NAME(S), PORTRAIT(S), AND/OR SIGNATURE(S) SHOWN IN THE MARK DOES NOT IDENTIFY A PARTICULAR LIVING INDIVIDUAL.

THE FOREIGN WORDING IN THE MARK TRANSLATES INTO ENGLISH AS VALUE.

SN 78-669,878, FILED 7-13-2005.

MICHAEL WEBSTER, EXAMINING ATTORNEY

**Int. Cls.: 5 and 30**

**Prior U.S. Cls.: 6, 18, 44, 46, 51, and 52**

**United States Patent and Trademark Office**

**Reg. No. 3,395,964**

**Registered Mar. 11, 2008**

**TRADEMARK  
PRINCIPAL REGISTER**

**PORTABLE POWER**

JELLY BELLY CANDY COMPANY (CALIFORNIA CORPORATION)  
ONE JELLY BELLY LANE  
FAIRFIELD, CA 94533

FOR: DIETARY AND NUTRITIONAL SUPPLEMENTS, NAMELY, CANDY FORTIFIED WITH DIETARY AND NUTRITIONAL SUPPLEMENTS, IN CLASS 5 (U.S. CLS. 6, 18, 44, 46, 51 AND 52).

FIRST USE 1-0-2006; IN COMMERCE 1-0-2006.

FOR: CANDY, IN CLASS 30 (U.S. CL. 46).

FIRST USE 1-0-2006; IN COMMERCE 1-0-2006.

THE MARK CONSISTS OF STANDARD CHARACTERS WITHOUT CLAIM TO ANY PARTICULAR FONT, STYLE, SIZE, OR COLOR.

SN 78-670,712, FILED 7-14-2005.

REBECCA EISINGER, EXAMINING ATTORNEY

Int. Cl.: 35

Prior U.S. Cls.: 100, 101, and 102

United States Patent and Trademark Office

Reg. No. 3,395,965

Registered Mar. 11, 2008

**SERVICE MARK  
PRINCIPAL REGISTER**

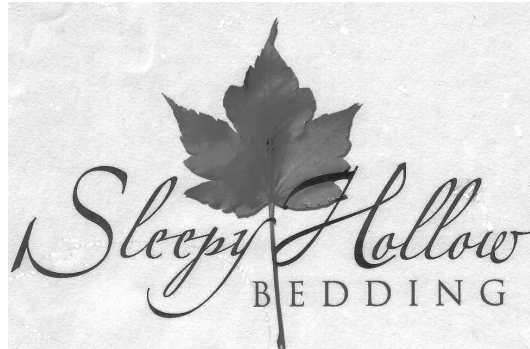

SLEEPY HOLLOW BEDDING, INC. (MISSISSIPPI CORPORATION)  
107 STAUB STREET  
FULTON, MS 38843

FOR: WHOLESALE AND RETAIL STORE SERVICES, ON-LINE RETAIL STORE SERVICES, AND MAIL ORDER CATALOG SERVICES FEATURING SLEEP RELATED PRODUCTS AND ACCESSORIES, NAMELY, MATTRESSES, MATTRESS FOUNDATIONS, BEDS, BEDROOM FURNITURE AND BED LINENS, IN CLASS 35 (U.S. CLS. 100, 101 AND 102).

FIRST USE 10-10-2004; IN COMMERCE 12-31-2004.

NO CLAIM IS MADE TO THE EXCLUSIVE RIGHT TO USE "BEDDING", APART FROM THE MARK AS SHOWN.

SN 78-672,048, FILED 7-17-2005.

BARNEY CHARLON, EXAMINING ATTORNEY

**Int. Cls.: 6, 14, and 16**

**Prior U.S. Cls.: 2, 5, 12, 13, 14, 22, 23, 25, 27, 28, 29,  
37, 38, and 50**

**Reg. No. 3,395,966**

**United States Patent and Trademark Office**

**Registered Mar. 11, 2008**

**TRADEMARK  
PRINCIPAL REGISTER**

**EXPRESSIVE ESSENTIALS**

PETER PEPPER PRODUCTS, INC. (CALIFORNIA CORPORATION)  
P.O. BOX 5769  
COMPTON, CA 90224

FOR: METAL COAT HOOKS, IN CLASS 6 (U.S. CLS. 2, 12, 13, 14, 23, 25 AND 50).

FIRST USE 1-2-2007; IN COMMERCE 1-2-2007.

FOR: CLOCKS, IN CLASS 14 (U.S. CLS. 2, 27, 28 AND 50).

FIRST USE 1-2-2007; IN COMMERCE 1-2-2007.

FOR: BULLETIN BOARDS, MESSAGE BOARDS, COMMUNICATION BOARDS AND SLATE BOARDS FOR WRITING; FLIP CHART EASELS AND TRIPODS, IN CLASS 16 (U.S. CLS. 2, 5, 22, 23, 29, 37, 38 AND 50).

FIRST USE 1-2-2007; IN COMMERCE 1-2-2007.

THE MARK CONSISTS OF STANDARD CHARACTERS WITHOUT CLAIM TO ANY PARTICULAR FONT, STYLE, SIZE, OR COLOR.

SN 78-673,833, FILED 7-19-2005.

SAIMA MAKHDOOM, EXAMINING ATTORNEY

**Int. Cls.: 16, 28, and 41**

**Prior U.S. Cls.: 2, 5, 22, 23, 29, 37, 38, 50, 100, 101, and 107**

**Reg. No. 3,395,967**

**United States Patent and Trademark Office**

**Registered Mar. 11, 2008**

**TRADEMARK  
SERVICE MARK  
PRINCIPAL REGISTER**

**GEE BEE**

KW INTELLECTUAL PROPERTIES, INC. (FLORIDA CORPORATION)  
1400 BROADWAY BOULEVARD, SE  
POLK CITY, FL 33868

FOR: DECALS; CHILDREN'S BOOKS; CALENDARS; GREETING CARDS; DRAWINGS; COLORING BOOKS; POSTERS; POSTCARDS, IN CLASS 16 (U.S. CLS. 2, 5, 22, 23, 29, 37, 38 AND 50).

FIRST USE 6-22-2007; IN COMMERCE 6-22-2007.

FOR: RUBBER BALLS; ACTION FIGURES AND ACCESSORIES THEREFORE; ACTION SKILL GAMES; BEAN BAG DOLLS; STUFFED TOYS; BALLOONS; GOLF BALLS; TENNIS BALLS; BATH-TUB TOYS; CHRISTMAS TREE DECORATIONS; BOARD GAMES; BUILDING BLOCKS; EQUIPMENT SOLD AS A UNIT FOR CARD GAMES; DOLLS AND DOLL CLOTHES; DOLL ACCESSORIES; TOY COSMETICS FOR CHILDREN; CRIB TOYS; ELECTRIC ACTION TOYS; GOLF GLOVES; GOLF BALL TEES; PUZZLES; KITES; MOBILES; MUSIC BOX TOYS; PARTY FAVORS IN THE FORM OF SMALL TOYS; INFLATABLE POOL TOYS; MECHANICAL ACTION TOYS; JUMP ROPES; TARGET GAMES; DISC-TYPE TOSS TOYS; BOW AND ARROW TOYS; TOY VEHICLES; TOY CARS; TOY TRUCKS; TOY PAIL AND SHOVEL SETS; ROLLER SKATES; TOY MODEL HOBBYCRAFT KITS; TOY ROCKETS; TOY GUNS; TOY HOLSTERS; MUSICAL

TOYS; TOY BADMINTON SETS; BUBBLE-BLOWING WANDS AND SOLUTION SETS; TOY FIGURINES; TOY BANKS; PUPPETS; YO-YOS; SKATEBOARDS; TOY SCOOTERS; FACE MASKS; HAND-HELD UNIT FOR PLAYING ELECTRONIC GAMES; PLAYING CARDS, IN CLASS 28 (U.S. CLS. 22, 23, 38 AND 50).

FIRST USE 6-22-2007; IN COMMERCE 6-22-2007.

FOR: ENTERTAINMENT SERVICES, NAMELY, PROVIDING ENTERTAINMENT INFORMATION RELATING TO AVIATION AND PROVIDING AMUSEMENT PARK AND THEME PARK SERVICES; ENTERTAINMENT SERVICES IN THE NATURE OF A LIVE AMUSEMENT PARK SHOW; ENTERTAINMENT SERVICES IN THE NATURE OF AIR SHOWS, IN CLASS 41 (U.S. CLS. 100, 101 AND 107).

FIRST USE 7-7-2003; IN COMMERCE 7-7-2003.

THE MARK CONSISTS OF STANDARD CHARACTERS WITHOUT CLAIM TO ANY PARTICULAR FONT, STYLE, SIZE, OR COLOR.

OWNER OF U.S. REG. NO. 2,580,570.

SN 78-674,093, FILED 7-20-2005.

BERYL GARDNER, EXAMINING ATTORNEY

**Int. Cl.: 11**

**Prior U.S. Cls.: 13, 21, 23, 31, and 34**

**United States Patent and Trademark Office**

**Reg. No. 3,395,968**

**Registered Mar. 11, 2008**

**TRADEMARK  
PRINCIPAL REGISTER**

**PORTLAND**

NEWFREY LLC (DELAWARE LIMITED LIABILITY COMPANY)  
1207 DRUMMOND PLAZA  
NEWARK, DE 19711

FOR: PLUMBING PRODUCTS, NAMELY, FAUCETS, FAUCET FILTERS, AERATORS FOR FAUCETS, SHOWERHEADS, FAUCET HANDLES, LEVERS, SPOUTS, VALVES, POP-UP DRAINS, IN CLASS 11 (U.S. CLS. 13, 21, 23, 31 AND 34).

FIRST USE 1-30-2006; IN COMMERCE 1-30-2006.

THE MARK CONSISTS OF STANDARD CHARACTERS WITHOUT CLAIM TO ANY PARTICULAR FONT, STYLE, SIZE, OR COLOR.

SN 78-674,994, FILED 7-21-2005.

JILL C. ALT, EXAMINING ATTORNEY



**Int. Cl.: 36**

**Prior U.S. Cls.: 100, 101, and 102**

**United States Patent and Trademark Office**

**Reg. No. 3,395,969**

**Registered Mar. 11, 2008**

**SERVICE MARK  
PRINCIPAL REGISTER**

**VOICES OF COLOR**

WAL-MART STORES, INC. (DELAWARE CORPORATION)  
702 S.W. 8TH ST.  
BENTONVILLE, AR 727160520

FOR: FINANCIAL SPONSORSHIP OF EDUCATIONAL AND ENTERTAINMENT PROGRAMS AND EVENTS, CULTURAL AND ART EXHIBITIONS, AND FESTIVALS, IN CLASS 36 (U.S. CLS. 100, 101 AND 102).

FIRST USE 7-31-2005; IN COMMERCE 7-31-2005.

THE MARK CONSISTS OF STANDARD CHARACTERS WITHOUT CLAIM TO ANY PARTICULAR FONT, STYLE, SIZE, OR COLOR.

SN 78-675,520, FILED 7-21-2005.

ESTHER A. BORSUK, EXAMINING ATTORNEY

Prior U.S. Cl.: A

United States Patent and Trademark Office

Reg. No. 3,395,970

Registered Mar. 11, 2008

CERTIFICATION MARK  
GOODS  
PRINCIPAL REGISTER



TRANSGLOBAL ALLIANCES ID, INC. (DELA-  
WARE CORPORATION)  
501 DIMICK DRIVE  
FAIRFIELD, IA 52556

FOR: FOODS AND THEIR INGREDIENTS, AND  
FOOD INGREDIENTS, IN CLASS A (U.S. CL. A).

FIRST USE 5-22-2007; IN COMMERCE 5-22-2007.

NO CLAIM IS MADE TO THE EXCLUSIVE  
RIGHT TO USE "ID CERT ID CERTIFIED", APART  
FROM THE MARK AS SHOWN.

THE CERTIFICATION MARK, IS USED BY AU-  
THORIZED PERSONS, TO CERTIFY THAT FOODS  
AND FOOD INGREDIENTS WHICH ARE PRO-  
DUCED BY OTHERS ARE NOT GENETICALLY  
MODIFIED OR DERIVED FROM GENETICALLY  
MODIFIED PLANTS.

SN 78-676,012, FILED 7-22-2005.

ODESSA BIBBINS, EXAMINING ATTORNEY

**Int. Cl.: 41**

**Prior U.S. Cls.: 100, 101, and 107**

**United States Patent and Trademark Office**

**Reg. No. 3,395,971**

**Registered Mar. 11, 2008**

**SERVICE MARK  
PRINCIPAL REGISTER**

**ABEL'S OFFERING**

ABEL'S OFFERING, LLC (ILLINOIS LTD LIAB  
CO)  
800 ECHO LANE  
GLENVIEW, IL 60025

THE MARK CONSISTS OF STANDARD CHAR-  
ACTERS WITHOUT CLAIM TO ANY PARTICULAR  
FONT, STYLE, SIZE, OR COLOR.

FOR: ENTERTAINMENT, NAMELY, LIVE PER-  
FORMANCES BY A MUSICAL BAND, IN CLASS 41  
(U.S. CLS. 100, 101 AND 107).

SN 78-676,395, FILED 7-22-2005.

FIRST USE 11-30-2004; IN COMMERCE 11-30-2004.

JOHN GARTNER, EXAMINING ATTORNEY

**Int. Cls.: 41 and 44**

**Prior U.S. Cls.: 100, 101, and 107**

**United States Patent and Trademark Office**

**Reg. No. 3,395,972**

**Registered Mar. 11, 2008**

**SERVICE MARK  
PRINCIPAL REGISTER**

**DR. J'S FAMILY WEIGHT LOSS  
PROGRAM**

JOHNSON, JOYCE D. (UNITED STATES INDIVIDUAL)  
SUITE 204  
6744 CLAYTON ROAD  
ST. LOUIS, MO 63117

FOR: HEALTH CLUB SERVICES, NAMELY, PROVIDING INSTRUCTION AND EQUIPMENT IN THE FIELD OF PHYSICAL EXERCISE; PERSONAL TRAINING SERVICES, NAMELY, STRENGTH AND CONDITIONING TRAINING; TRAINING SERVICES IN THE FIELD OF WEIGHT REDUCTION DIET PLANNING AND SUPERVISION, IN CLASS 41 (U.S. CLS. 100, 101 AND 107).

FIRST USE 6-1-2006; IN COMMERCE 6-1-2006.

FOR: FOOD NUTRITION CONSULTATION; WEIGHT REDUCTION DIET PLANNING AND SUPERVISION, IN CLASS 44 (U.S. CLS. 100 AND 101).

FIRST USE 6-1-2006; IN COMMERCE 6-1-2006.

THE MARK CONSISTS OF STANDARD CHARACTERS WITHOUT CLAIM TO ANY PARTICULAR FONT, STYLE, SIZE, OR COLOR.

NO CLAIM IS MADE TO THE EXCLUSIVE RIGHT TO USE "FAMILY WEIGHT LOSS PROGRAM", APART FROM THE MARK AS SHOWN.

THE NAME DR. J IDENTIFIES A LIVING INDIVIDUAL WHOSE CONSENT IS OF RECORD.

SN 78-678,566, FILED 7-26-2005.

DAVID YONTEF, EXAMINING ATTORNEY

**Int. Cl.: 44**

**Prior U.S. Cls.: 100 and 101**

**United States Patent and Trademark Office**

**Reg. No. 3,395,973**

**Registered Mar. 11, 2008**

**SERVICE MARK  
PRINCIPAL REGISTER**

**HOVEROUND CUSTOM FIT**

HOVEROUND CORPORATION (FLORIDA CORPORATION)  
2151 WHITFIELD INDUSTRIAL WAY  
SARASOTA, FL 34243

FOR: FITTING OF PERSONAL MOBILITY VEHICLES TO INDIVIDUAL PATIENT REQUESTS FEATURING PATIENT ASSESSMENT AND PHYSIOLOGICAL MEASUREMENT, IN CLASS 44 (U.S. CLS. 100 AND 101).

FIRST USE 1-10-2005; IN COMMERCE 1-10-2005.

THE MARK CONSISTS OF STANDARD CHARACTERS WITHOUT CLAIM TO ANY PARTICULAR FONT, STYLE, SIZE, OR COLOR.

OWNER OF U.S. REG. NO. 1,798,621.

NO CLAIM IS MADE TO THE EXCLUSIVE RIGHT TO USE "CUSTOM FIT", APART FROM THE MARK AS SHOWN.

SN 78-680,474, FILED 7-28-2005.

BARBARA GAYNOR, EXAMINING ATTORNEY

**Int. Cl.: 9**

**Prior U.S. Cls.: 21, 23, 26, 36, and 38**

**United States Patent and Trademark Office**

**Reg. No. 3,395,974**

**Registered Mar. 11, 2008**

**TRADEMARK  
PRINCIPAL REGISTER**

**HOT HOT SUPER JACKPOT**

WMS GAMING INC. (DELAWARE CORPORATION)  
800 SOUTH NORTHPOINT BOULEVARD  
WAUKEGAN, IL 60085

FOR: GAMING MACHINES, IN CLASS 9 (U.S. CLS. 21, 23, 26, 36 AND 38).

FIRST USE 11-14-2006; IN COMMERCE 11-14-2006.

THE MARK CONSISTS OF STANDARD CHARACTERS WITHOUT CLAIM TO ANY PARTICULAR FONT, STYLE, SIZE, OR COLOR.

OWNER OF U.S. REG. NO. 3,016,293.

NO CLAIM IS MADE TO THE EXCLUSIVE RIGHT TO USE "SUPER JACKPOT", APART FROM THE MARK AS SHOWN.

SN 78-683,697, FILED 8-2-2005.

WILLIAM BRECKENFELD, EXAMINING ATTORNEY

**Int. Cl.: 11**

**Prior U.S. Cls.: 13, 21, 23, 31, and 34**

**United States Patent and Trademark Office**

**Reg. No. 3,395,975**

**Registered Mar. 11, 2008**

**TRADEMARK  
PRINCIPAL REGISTER**

**EUTEK SYSTEMS**

WILSON, GEORGE E. (UNITED STATES INDIVIDUAL)  
12800 N.E. SALMON CREEK AVENUE  
#119  
VANCOUVER, WA 98686

FOR: WATER TREATMENT EQUIPMENT FOR USE IN REMOVING SOLIDS FROM WATER, NAMELY, MACHINES FOR THE REDUCTION OF SOLIDS AND SOLID CAPTURE FROM WASTEWATER AND PROCESS WATER STREAMS, IN CLASS 11 (U.S. CLS. 13, 21, 23, 31 AND 34).

FIRST USE 8-17-1982; IN COMMERCE 8-17-1982.

THE MARK CONSISTS OF STANDARD CHARACTERS WITHOUT CLAIM TO ANY PARTICULAR FONT, STYLE, SIZE, OR COLOR.

OWNER OF U.S. REG. NO. 1,017,637.

NO CLAIM IS MADE TO THE EXCLUSIVE RIGHT TO USE "SYSTEMS", APART FROM THE MARK AS SHOWN.

SN 78-684,364, FILED 8-3-2005.

WENDY JUN, EXAMINING ATTORNEY

**Int. Cl.: 3**

**Prior U.S. Cls.: 1, 4, 6, 50, 51, and 52**

**Reg. No. 3,395,976**

**United States Patent and Trademark Office**

**Registered Mar. 11, 2008**

**TRADEMARK  
PRINCIPAL REGISTER**

**Skin2O**

WANER, JANE (UNITED STATES INDIVIDUAL)  
15 SHACKLEFORD DR. SUITE B  
LITTLE ROCK, AR 72211

THE MARK CONSISTS OF STANDARD CHARACTERS WITHOUT CLAIM TO ANY PARTICULAR FONT, STYLE, SIZE, OR COLOR.

FOR: NON-MEDICATED SKINCARE PREPARATIONS AND COSMETICS, IN CLASS 3 (U.S. CLS. 1, 4, 6, 50, 51 AND 52).

SN 78-685,073, FILED 8-3-2005.

FIRST USE 1-0-2007; IN COMMERCE 1-0-2007.

DORITT L. CARROLL, EXAMINING ATTORNEY



**Int. Cl.: 11**

**Prior U.S. Cls.: 13, 21, 23, 31, and 34**

**United States Patent and Trademark Office**

**Reg. No. 3,395,977**

**Registered Mar. 11, 2008**

**TRADEMARK  
PRINCIPAL REGISTER**

**AQUAREEF**

ENVIRONMENTAL DYNAMICS, INC. (MISSOURI CORPORATION)  
5601 PARIS ROAD  
COLUMBIA, MO 65202

FOR: WATER PURIFYING APPARATUS COMPRISED OF FLEXIBLE PLASTIC STRIP MEDIA CONSISTING OF CLUSTERS OF FLEXIBLE PLASTIC STRIPS CONNECTED WITH A FLOATING SUPPORT CABLE TO BE USED IN WATER OR WASTE WATER TREATMENT VESSELS TO PROVIDE SURFACE AREA FOR THE GROWTH AND ACCUMULATION OF ORGANISMS, NAMELY, AEROBIC AND ANAEROBIC BACTERIOLOGICAL MICRO-ORGANISMS USEFUL IN THE TREATMENT OF WATER AND WASTE WATER FOR REMOVING SOLUBLE AND INSOLUBLE ORGAN-

IC WASTE CONTAINED IN THE WATER AND WASTE WATER, IN CLASS 11 (U.S. CLS. 13, 21, 23, 31 AND 34).

FIRST USE 1-0-2007; IN COMMERCE 1-0-2007.

THE MARK CONSISTS OF STANDARD CHARACTERS WITHOUT CLAIM TO ANY PARTICULAR FONT, STYLE, SIZE, OR COLOR.

OWNER OF U.S. REG. NO. 1,438,975.

SN 78-686,310, FILED 8-5-2005.

BILL DAWE, EXAMINING ATTORNEY

**Int. Cl.: 11**

**Prior U.S. Cls.: 13, 21, 23, 31, and 34**

**United States Patent and Trademark Office**

**Reg. No. 3,395,978**

**Registered Mar. 11, 2008**

**TRADEMARK  
PRINCIPAL REGISTER**

**BIOREEF**

ENVIRONMENTAL DYNAMICS, INC. (MISSOURI CORPORATION)  
5601 PARIS RD.  
COLUMBIA, MO 65202

FOR: WATER PURIFYING APPARATUS COMPRISED OF FLEXIBLE PLASTIC STRIP MEDIA CONSISTING OF CLUSTERS OF FLEXIBLE PLASTIC STRIPS CONNECTED WITH A FLOATING SUPPORT CABLE TO BE USED IN WATER OR WASTE WATER TREATMENT VESSELS TO PROVIDE SURFACE AREA FOR THE GROWTH AND ACCUMULATION OF ORGANISMS, NAMELY, AEROBIC AND ANAEROBIC BACTERIOLOGICAL MICRO-ORGANISMS USEFUL IN THE TREATMENT OF WATER AND WASTE WATER FOR REMOVING SOLUBLE AND INSOLUBLE ORGAN-

IC WASTE CONTAINED IN THE WATER AND WASTE WATER, IN CLASS 11 (U.S. CLS. 13, 21, 23, 31 AND 34).

FIRST USE 12-0-2005; IN COMMERCE 12-0-2005.

THE MARK CONSISTS OF STANDARD CHARACTERS WITHOUT CLAIM TO ANY PARTICULAR FONT, STYLE, SIZE, OR COLOR.

OWNER OF U.S. REG. NO. 1,438,975.

SN 78-686,376, FILED 8-5-2005.

BILL DAWE, EXAMINING ATTORNEY

**Int. Cl.: 42**

**Prior U.S. Cls.: 100 and 101**

**United States Patent and Trademark Office**

**Reg. No. 3,395,979**

**Registered Mar. 11, 2008**

**SERVICE MARK  
PRINCIPAL REGISTER**

**kram-co**

TRAGESER, MARK (UNITED STATES INDIVIDUAL)  
1788 S. GARTH AVE.  
LOS ANGELES, CA 90035

THE MARK CONSISTS OF STANDARD CHARACTERS WITHOUT CLAIM TO ANY PARTICULAR FONT, STYLE, SIZE, OR COLOR.

FOR: INVENTION AND DESIGN SERVICES, NAMELY, THE INVENTION, DESIGN AND DEVELOPMENT OF NEW PRODUCTS AND PROCESSES, IN CLASS 42 (U.S. CLS. 100 AND 101).

SN 78-688,069, FILED 8-8-2005.

FIRST USE 9-12-2006; IN COMMERCE 9-12-2006.

SALLY SHIH, EXAMINING ATTORNEY

**Int. Cl.: 28**

**Prior U.S. Cls.: 22, 23, 38, and 50**

**United States Patent and Trademark Office**

**Reg. No. 3,395,980**

**Registered Mar. 11, 2008**

**TRADEMARK  
PRINCIPAL REGISTER**

**QUINAULT**

G. LOOMIS, INC. (WASHINGTON CORPORATION)  
1359 DOWN RIVER DRIVE  
WOODLAND, WA 98674

FOR: ARTIFICIAL FISHING BAIT, FISHING HOOKS, FISHING LURE BOXES, FISHING LURES, FISHING POLES, FISHING REELS, FISHING ROD BLANKS, FISHING RODS, FISHING TACKLE BOXES, FISHING TACKLE AND WEIGHTS FOR FISHING LINES, IN CLASS 28 (U.S. CLS. 22, 23, 38 AND 50).

FIRST USE 11-17-2005; IN COMMERCE 11-18-2005.

THE MARK CONSISTS OF STANDARD CHARACTERS WITHOUT CLAIM TO ANY PARTICULAR FONT, STYLE, SIZE, OR COLOR.

SN 78-690,721, FILED 8-11-2005.

KATHY DE JONGE, EXAMINING ATTORNEY

**Int. Cl.: 43**

**Prior U.S. Cls.: 100 and 101**

**United States Patent and Trademark Office**

**Reg. No. 3,395,981**

**Registered Mar. 11, 2008**

**SERVICE MARK  
PRINCIPAL REGISTER**



TRINITY YOUTH SERVICES (CALIFORNIA CORPORATION)  
1460 COOLEY DRIVE  
COLTON, CA 92324

FOR: PROVIDING JUVENILE CORRECTIONS SERVICES, NAMELY, SHORT- AND LONG-TERM RESIDENTIAL SERVICES TO HELP COURT-ORDERED YOUTHS, IN CLASS 43 (U.S. CLS. 100 AND 101).

FIRST USE 6-1-2005; IN COMMERCE 6-1-2005.

NO CLAIM IS MADE TO THE EXCLUSIVE RIGHT TO USE "YOUTH SERVICES", APART FROM THE MARK AS SHOWN.

THE MARK CONSISTS OF THE WORDS "TRINITY YOUTH SERVICES" WITH AN ARC IN THE FORM OF A STYLIZED LETTER "C" CUTTING THROUGH THE WORD "TRINITY".

SN 78-691,797, FILED 8-12-2005.

ALYSSA PALADINO, EXAMINING ATTORNEY

Int. Cl.: 43

Prior U.S. Cls.: 100 and 101

United States Patent and Trademark Office

Reg. No. 3,395,982

Registered Mar. 11, 2008

**SERVICE MARK  
PRINCIPAL REGISTER**



BAUMGARTNER, MATTHEW (UNITED STATES  
INDIVIDUAL)  
352 STATE ST., PENTHOUSE #4  
ALBANY, NY 12210

FOR: BAR SERVICES; CAFE-RESTAURANTS, IN  
CLASS 43 (U.S. CLS. 100 AND 101).

FIRST USE 3-1-2001; IN COMMERCE 3-1-2001.

THE COLOR(S) RED, BROWN, BLACK, WHITE,  
BLUE, GREEN, YELLOW, ORANGE, GRAY AND  
PINK IS/ARE CLAIMED AS A FEATURE OF THE  
MARK.

THE COLORS BROWN, PINK, AND GREEN  
APPEAR IN THE DESIGN OF THE WOMAN; THE  
COLORS RED, WHITE, BLUE AND BLACK APPEAR

IN THE BIKINI AND SCARF; THE COLORS  
BROWN, GRAY AND WHITE APPEAR IN THE  
GOGGLES AND CAP, GLOVES AND SADDLE;  
THE COLORS BROWN AND RED AND GRAY  
APPEAR IN THE BOOTS; THE COLORS GREEN,  
RED, ORANGE, YELLOW AND WHITE APPEAR IN  
THE BOMB AND TAIL, AND THE COLORS WHITE,  
GREEN AND BROWN APPEAR IN THE SAND-  
WICH.

THE MARK CONSISTS OF A GIRL SITUATED  
ON TOP OF A BOMB HOLDING A SANDWICH IN  
HER LEFT HAND.

SN 78-692,382, FILED 8-15-2005.

KAPIL BHANOT, EXAMINING ATTORNEY

**Int. Cl.: 41**

**Prior U.S. Cls.: 100, 101, and 107**

**United States Patent and Trademark Office**

**Reg. No. 3,395,983**

**Registered Mar. 11, 2008**

**SERVICE MARK  
PRINCIPAL REGISTER**

**iSchool**

UNIVERSITY OF NORTH CAROLINA AT  
GREENSBORO, THE (NORTH CAROLINA  
EDUCATIONAL INSTITUTION)  
303 MOSSMAN BUILDING  
1000 SPRING GARDEN STREET  
GREENSBORO, NC 27412

FOR: EDUCATION SERVICES IN THE NATURE  
OF COURSES AT THE UNIVERSITY LEVEL FOR  
HIGH SCHOOL STUDENTS , IN CLASS 41 (U.S. CLS.  
100, 101 AND 107).

FIRST USE 8-25-2005; IN COMMERCE 5-30-2007.

THE MARK CONSISTS OF STANDARD CHAR-  
ACTERS WITHOUT CLAIM TO ANY PARTICULAR  
FONT, STYLE, SIZE, OR COLOR.

SN 78-692,814, FILED 8-15-2005.

MICHAEL GAAFAR, EXAMINING ATTORNEY

**Int. Cls.: 35 and 41**

**Prior U.S. Cls.: 100, 101, 102, and 107**

**United States Patent and Trademark Office**

**Reg. No. 3,395,984**

**Registered Mar. 11, 2008**

**SERVICE MARK  
PRINCIPAL REGISTER**

**YSF YOUTH SPORTS FESTIVAL**

BEWI PRODUCTIONS, INC. (NEW YORK CORPORATION)  
240 BEAR HILL ROAD  
WALTHAM, MA 02154

FOR: ORGANIZING EXHIBITIONS FOR MARKETING PURPOSES; ORGANIZING TRADE SHOWS IN THE FIELDS OF SPORTS, SPORTS EQUIPMENT AND CLOTHING, AND ENTERTAINMENT, IN CLASS 35 (U.S. CLS. 100, 101 AND 102).

FIRST USE 9-11-2007; IN COMMERCE 9-11-2007.

FOR: ORGANIZING EXHIBITIONS AND CONFERENCES FOR EDUCATIONAL, CULTURAL, SPORTING AND ENTERTAINMENT PURPOSES, IN CLASS 41 (U.S. CLS. 100, 101 AND 107).

FIRST USE 9-11-2007; IN COMMERCE 9-11-2007.

THE MARK CONSISTS OF STANDARD CHARACTERS WITHOUT CLAIM TO ANY PARTICULAR FONT, STYLE, SIZE, OR COLOR.

NO CLAIM IS MADE TO THE EXCLUSIVE RIGHT TO USE "YOUTH SPORTS FESTIVAL", APART FROM THE MARK AS SHOWN.

SN 78-692,898, FILED 8-15-2005.

MONIQUE MILLER, EXAMINING ATTORNEY



**Int. Cl.: 14**

**Prior U.S. Cls.: 2, 27, 28, and 50**

**United States Patent and Trademark Office**

**Reg. No. 3,395,985**

**Registered Mar. 11, 2008**

**TRADEMARK  
PRINCIPAL REGISTER**

**BLACK EAGLE**

CITIZEN HOLDINGS KABUSHIKI KAISHA (JAPAN CORPORATION), TA CITIZEN HOLDINGS CO., LTD.,  
1-12, 6-CHOME TANASHI-CHO  
NISHI-TOKYO-SHI  
TOKYO 188-8511, JAPAN

THE MARK CONSISTS OF STANDARD CHARACTERS WITHOUT CLAIM TO ANY PARTICULAR FONT, STYLE, SIZE, OR COLOR.

FOR: WATCHES, IN CLASS 14 (U.S. CLS. 2, 27, 28 AND 50).

SN 78-693,513, FILED 8-16-2005.

FIRST USE 1-1-2006; IN COMMERCE 1-1-2006.

NELSON SNYDER, EXAMINING ATTORNEY

**Int. Cls.: 38 and 42**

**Prior U.S. Cls.: 100, 101, and 104**

**United States Patent and Trademark Office**

**Reg. No. 3,395,986**

**Registered Mar. 11, 2008**

**SERVICE MARK  
PRINCIPAL REGISTER**



FIBERNET TELECOM GROUP, INC. (NEW YORK CORPORATION)  
570 LEXINGTON AVENUE  
NEW YORK, NY 10022

FOR: COMMUNICATIONS SERVICES, NAMELY, PROVIDING BROADBAND CONNECTIVITY FOR DATA, VOICE AND VIDEO TRANSMISSION ON ITS FIBER OPTIC NETWORKS IN MAJOR METROPOLITAN AREAS; PROVIDING ACCESS MANAGEMENT SERVICES, NAMELY, THE EXCLUSIVE RIGHT TO MANAGE TELECOMMUNICATION NETWORKS IN BUILDINGS, IN CLASS 38 (U.S. CLS. 100, 101 AND 104).

FIRST USE 10-11-2005; IN COMMERCE 10-11-2005.

FOR: COMPUTER COLOCATION SERVICES, NAMELY, PROVIDING CUSTOMERS WITH THE

ABILITY TO LOCATE THEIR COMMUNICATIONS AND NETWORKING EQUIPMENT AT CARRIER POINT FACILITIES; COMPUTER NETWORK DESIGN SERVICES FOR OTHERS, IN CLASS 42 (U.S. CLS. 100 AND 101).

FIRST USE 10-11-2005; IN COMMERCE 10-11-2005.

NO CLAIM IS MADE TO THE EXCLUSIVE RIGHT TO USE "FIBERNET", APART FROM THE MARK AS SHOWN.

SN 78-693,888, FILED 8-16-2005.

TRACY WHITTAKER-BROWN, EXAMINING ATTORNEY

Int. Cl.: 25

Prior U.S. Cls.: 22 and 39

United States Patent and Trademark Office

Reg. No. 3,395,987

Registered Mar. 11, 2008

TRADEMARK  
PRINCIPAL REGISTER



YAVOY INC. (FLORIDA CORPORATION)  
UNIT 11  
8870 SW 40TH STREET  
MIAMI, FL 33165

FOR: BELTS; CLOTHING, NAMELY, WESTERN  
SHIRTS, PANTS, SUITS AND JEANS; TOPS, IN  
CLASS 25 (U.S. CLS. 22 AND 39).

FIRST USE 7-14-2005; IN COMMERCE 7-28-2005.

OWNER OF U.S. REG. NOS. 1,911,520, 1,916,576,  
AND OTHERS.

NO CLAIM IS MADE TO THE EXCLUSIVE  
RIGHT TO USE "WESTERN GEAR", APART FROM  
THE MARK AS SHOWN.

THE COLOR(S) BLACK, SILVER AND GOLD IS/  
ARE CLAIMED AS A FEATURE OF THE MARK.

THE MARK CONSISTS OF BLACK BACK-  
GROUND WITH SILVER LETTERS AND GOLD  
SHADOW.

SN 78-694,655, FILED 8-17-2005.

RUDY R. SINGLETON, EXAMINING ATTORNEY

**Int. Cl.: 30**

**Prior U.S. Cl.: 46**

**United States Patent and Trademark Office**

**Reg. No. 3,395,988**

**Registered Mar. 11, 2008**

**TRADEMARK  
PRINCIPAL REGISTER**

**PESTOS WITH PANACHE BY  
LAUREN**

PESTOS WITH PANACHE BY LAUREN, INC.  
(NEW YORK CORPORATION)  
176 JOHNSON STREET, UNIT 8-E  
BROOKLYN, NY 11201

FOR: SAUCES, IN CLASS 30 (U.S. CL. 46).

FIRST USE 6-12-2006; IN COMMERCE 7-2-2007.

THE MARK CONSISTS OF STANDARD CHAR-  
ACTERS WITHOUT CLAIM TO ANY PARTICULAR  
FONT, STYLE, SIZE, OR COLOR.

NO CLAIM IS MADE TO THE EXCLUSIVE  
RIGHT TO USE "PESTOS", APART FROM THE  
MARK AS SHOWN.

THE NAME "LAUREN" IDENTIFIES A LIVING  
INDIVIDUAL WHOSE CONSENT IS OF RECORD.

SN 78-695,240, FILED 8-18-2005.

MARGARET POWER, EXAMINING ATTORNEY

**Int. Cl.: 34**

**Prior U.S. Cls.: 2, 8, 9, and 17**

**United States Patent and Trademark Office**

**Reg. No. 3,395,989**

**Registered Mar. 11, 2008**

**TRADEMARK  
PRINCIPAL REGISTER**

**MASQUERADE**

K. HANSOTIA & CO., INC. (FLORIDA CORPORATION)  
3705 N.W. 115 AVENUE, BAY #5  
MIAMI, FL 33178

FOR: TOBACCO, CIGARETTES, CIGARS; ARTICLES FOR SMOKERS NOT OF PRECIOUS METAL, NAMELY, CIGARETTE LIGHTERS, CIGARETTE CASES, CIGAR CASES, CIGARETTE HOLDERS, AND CIGAR HOLDERS, IN CLASS 34 (U.S. CLS. 2, 8, 9 AND 17).

FIRST USE 3-4-2007; IN COMMERCE 6-8-2007.

THE MARK CONSISTS OF STANDARD CHARACTERS WITHOUT CLAIM TO ANY PARTICULAR FONT, STYLE, SIZE, OR COLOR.

SN 78-696,246, FILED 8-19-2005.

JAY BESCH, EXAMINING ATTORNEY

**Int. Cl.: 19**

**Prior U.S. Cls.: 1, 12, 33, and 50**

**United States Patent and Trademark Office**

**Reg. No. 3,395,990**

**Registered Mar. 11, 2008**

**TRADEMARK  
PRINCIPAL REGISTER**

**NEOPOLITAN**

SMITH & FONG COMPANY (CALIFORNIA CORPORATION)  
475 SIXTH STREET  
SAN FRANCISCO, CA 94103

THE MARK CONSISTS OF STANDARD CHARACTERS WITHOUT CLAIM TO ANY PARTICULAR FONT, STYLE, SIZE, OR COLOR.

FOR: FLOOR BOARDS; FLOOR PANELS; LAMINATE FLOORING; WOODEN FLOORING, IN CLASS 19 (U.S. CLS. 1, 12, 33 AND 50).

SN 78-696,466, FILED 8-19-2005.

FIRST USE 11-18-2005; IN COMMERCE 11-22-2005.

KHANH LE, EXAMINING ATTORNEY

Int. Cls.: 16, 25, and 41

Prior U.S. Cls.: 2, 5, 22, 23, 29, 37, 38, 39, 50, 100, 101,  
and 107

Reg. No. 3,395,991

United States Patent and Trademark Office

Registered Mar. 11, 2008

TRADEMARK  
SERVICE MARK  
PRINCIPAL REGISTER



RESHAPING THE WORLD LLC (MAINE LTD  
LIAB CO)  
997 PEQUAWKET TRAIL  
WEST BALDWIN, ME 04091

FOR: GREETING CARDS; MESSAGE CARDS LAMINATED IN PLASTIC; POSTCARDS; CALENDARS; DESK CALENDARS; POCKET CALENDARS; PRINTED CALENDARS; WALL CALENDARS; CALENDAR DESK PADS; STATIONERY; STATIONERY WRITING PAPER AND ENVELOPES; BUMPER STICKERS; STICKERS; PAPER TAGS; CARDBOARD HANG TAGS; PAMPHLETS, FLIERS, AND PRINTED INSTRUCTIONAL, EDUCATIONAL, AND TEACHING MATERIALS USED IN CONNECTION WITH THE FIELDS OF MEDITATION, MINDFULNESS, METAPHYSICAL DEVELOPMENT, CHANNELING, SPIRITUAL DEVELOPMENT, SPIRITUAL GROWTH, SPIRITUAL PRACTICES, YOGA, MARTIAL ARTS, NEW AGE PHILOSOPHY, ART, DANCE, MOVEMENT, WRITING, MUSIC, PSYCHOTHERAPY, COUNSELING, GROUP PROCESS, BREATHING, BREATHWORK, EXERCISE, ENERGY WORK, CRYSTAL AND STONE HEALING, PSYCHIC AND MEDIUM DEVELOPMENT, SOUND HEALING, WELL-BEING, WELLNESS, TRANSPERSONAL WORK, HEALING ARTS, SELF-HELP, TRANSFORMATIONAL WORK, SELF-DEVELOPMENT, SELF-IMPROVEMENT, SELF-FULFILLMENT, SELF-KNOWLEDGE, SELF-AWARENESS, SELF-ACCEPTANCE, SELF-RESPONSIBILITY, PERSONAL GROWTH, CREATIVE PROCESS, IMAGINATION, METAPHOR AND MEANING, NARRATIVE WORK, OUTDOOR EDU-

CATION, AND CHILD AND FAMILY DEVELOPMENT; POSTERS; MOUNTED POSTERS; UNMOUNTED POSTERS; PRINTED PAPER SIGNS; PAPER FLAGS; PAPER BANNERS; ART PRINTS; COLOR PRINTS; LITHOGRAPHIC PRINTS; PHOTOGRAPHIC PRINTS; PICTORIAL PRINTS; BOOKS AND MAGAZINES PERTAINING TO THE FIELDS OF MEDITATION, MINDFULNESS, METAPHYSICAL DEVELOPMENT, CHANNELING, SPIRITUAL DEVELOPMENT, SPIRITUAL GROWTH, SPIRITUAL PRACTICES, YOGA, MARTIAL ARTS, NEW AGE PHILOSOPHY, ART, DANCE, MOVEMENT, WRITING, MUSIC, PSYCHOTHERAPY, COUNSELING, GROUP PROCESS, BREATHING, BREATHWORK, EXERCISE, ENERGY WORK, CRYSTAL AND STONE HEALING, PSYCHIC AND MEDIUM DEVELOPMENT, SOUND HEALING, WELL-BEING, WELLNESS, TRANSPERSONAL WORK, HEALING ARTS, SELF-HELP, TRANSFORMATIONAL WORK, SELF-DEVELOPMENT, SELF-IMPROVEMENT, SELF-FULFILLMENT, SELF-KNOWLEDGE, SELF-AWARENESS, SELF-ACCEPTANCE, SELF-RESPONSIBILITY, PERSONAL GROWTH, CREATIVE PROCESS, IMAGINATION, METAPHOR AND MEANING, NARRATIVE WORK, OUTDOOR EDUCATION, AND CHILD AND FAMILY DEVELOPMENT; NOTE PADS; PAPER NAPKINS; PAPER TABLE CLOTHS; PAPER MATS; PAPER PLACEMATS; TABLE MATS OF PAPER; PENS; PENCILS; PEN AND PENCIL CASES AND BOXES; PAPER BAGS AND SACKS; PAPER GIFT BAGS; FABRIC GIFT BAGS AND SACKS; WRAPPING PAPER; GIFT WRAPPING PAPER; TOILET

PAPER; FACIAL TISSUES; TISSUE PAPER; FOLDERS; FILE FOLDERS; PAPER FOLDERS; ENVELOPES; CARDBOARD BOXES; PAPER BOXES; STATIONERY BOXES; ADDRESS LABELS; ADHESIVE LABELS; PHOTOGRAPHS; PHOTOGRAPH ALBUMS; TEMPORARY TATTOOS; PLASTIC OR PAPER BAGS FOR MERCHANDISE PACKAGING; PAPER POUCHES FOR PACKAGING; AND PAPER MAIL POUCHES, IN CLASS 16 (U.S. CLS. 2, 5, 22, 23, 29, 37, 38 AND 50).

FIRST USE 9-1-2005; IN COMMERCE 9-1-2005.

FOR: WRISTBANDS; HATS; BASEBALL CAPS; HEAD BANDS; EAR MUFFS; SCARVES; NECKTIES; MITTENS; GLOVES; T-SHIRTS; SHIRTS; TURTLENECKS; SWEATERS; SWEATSHIRTS; BLOUSES; VESTS; TANK TOPS; CAMISOLES; COATS; JACKETS; FLEECE PULLOVERS; BELTS; SKIRTS; PANTS; DRESSES; KILTS; LEG WARMERS; SWEATPANTS; WATERPROOF PANTS; WIND RESISTANT PANTS; SHORTS; CAPRI PANTS; BATHING SUITS; SHOES; SOCKS; SNEAKERS; SANDALS; SLIPPERS; TIGHTS; BANDANAS; CHILDREN'S AND INFANTS' CLOTH BIBS; AND CHILDREN'S AND INFANTS' SHOES AND BOOTS, IN CLASS 25 (U.S. CLS. 22 AND 39).

FIRST USE 9-1-2005; IN COMMERCE 9-1-2005.

FOR: EDUCATIONAL AND ENTERTAINMENT SERVICES, NAMELY, CONDUCTING CLASSES, COURSES, SEMINARS, CONFERENCES, WORKSHOPS, SUMMER CAMPS, LIVE MUSICAL CONCERTS AND CULTURAL ACTIVITIES IN THE

FIELDS OF MEDITATION, MINDFULNESS, METAPHYSICAL DEVELOPMENT, CHANNELING, SPIRITUAL DEVELOPMENT, SPIRITUAL GROWTH, SPIRITUAL PRACTICES, YOGA, MARTIAL ARTS, NEW AGE PHILOSOPHY, ART, DANCE, MOVEMENT, WRITING, MUSIC, PSYCHOTHERAPY, COUNSELING, GROUP PROCESS, BREATHING, BREATHWORK, EXERCISE, ENERGY WORK, CRYSTAL AND STONE HEALING, PSYCHIC AND MEDIUM DEVELOPMENT, SOUND HEALING, WELL-BEING, WELLNESS, TRANSPERSONAL WORK, HEALING ARTS, SELF-HELP, TRANSFORMATIONAL WORK, SELF-DEVELOPMENT, SELF-IMPROVEMENT, SELF-FULFILLMENT, SELF-KNOWLEDGE, SELF-AWARENESS, SELF-ACCEPTANCE, SELF-RESPONSIBILITY, PERSONAL GROWTH, CREATIVE PROCESS, IMAGINATION, METAPHOR AND MEANING, NARRATIVE WORK, OUTDOOR EDUCATION, AND CHILD AND FAMILY DEVELOPMENT; AND DISTRIBUTING COURSE MATERIALS IN CONNECTION THEREWITH, IN CLASS 41 (U.S. CLS. 100, 101 AND 107).

FIRST USE 9-1-2005; IN COMMERCE 9-1-2005.

THE MARK CONSISTS OF THE WORDS "RE-SHAPING THE WORLD" SET FORTH IN A CIRCULAR SHAPE AND SURROUNDING A STAR DESIGN.

SN 78-697,486, FILED 8-22-2005.

MARGARET POWER, EXAMINING ATTORNEY



Int. Cls.: 25 and 41

Prior U.S. Cls.: 22, 39, 100, 101, and 107

United States Patent and Trademark Office

Reg. No. 3,395,992

Registered Mar. 11, 2008

TRADEMARK  
SERVICE MARK  
PRINCIPAL REGISTER



PEREZ, IVAN SEVILLANO (SPAIN INDIVIDUAL)  
C/ AZOR NO. 17  
28024 MADRID, SPAIN

FOR: CLOTHING, FOOTWEAR AND HEAD-WEAR, NAMELY, TROUSERS, T-SHIRTS, SHIRTS, SWEATERS, HUNTING CAPS, AND SHOES, IN CLASS 25 (U.S. CLS. 22 AND 39).

FIRST USE 3-0-2005; IN COMMERCE 3-0-2005.

FOR: ENTERTAINMENT SERVICES, NAMELY, PROVIDING MUSICAL PERFORMANCES BY A

LIVE BAND, IN CLASS 41 (U.S. CLS. 100, 101 AND 107).

FIRST USE 3-0-2005; IN COMMERCE 3-0-2005.

THE MARK CONSISTS OF THE WORD "HUECCO" IN SPECIAL TYPE STYLE APPEARING ON THE HAIR OF A FIGURE.

SN 78-697,648, FILED 8-22-2005.

GIANCARLO CASTRO, EXAMINING ATTORNEY

**Int. Cl.: 35**

**Prior U.S. Cls.: 100, 101, and 102**

**United States Patent and Trademark Office**

**Reg. No. 3,395,993**

**Registered Mar. 11, 2008**

**SERVICE MARK  
PRINCIPAL REGISTER**

**GOBROADBAND**

TELESERVICES, INC. (CALIFORNIA CORPORATION)  
SUITE 100  
8344 CLAIREMONT BLVD.  
SAN DIEGO, CA 92111

FOR: COMPARATIVE MARKETING AND ADVERTISING SERVICES FOR PROVIDERS OF RESIDENTIAL AND BUSINESS TELECOMMUNICATIONS SERVICES, NAMELY, FOR PROVIDERS OF BROADBAND CABLE, DSL, FIBER-OPTIC AND SATELLITE INTERNET AC-

CESS SERVICES, IN CLASS 35 (U.S. CLS. 100, 101 AND 102).

FIRST USE 12-1-2007; IN COMMERCE 12-1-2007.

THE MARK CONSISTS OF STANDARD CHARACTERS WITHOUT CLAIM TO ANY PARTICULAR FONT, STYLE, SIZE, OR COLOR.

SN 78-697,882, FILED 8-22-2005.

LINDA POWELL, EXAMINING ATTORNEY

**Int. Cl.: 29**

**Prior U.S. Cl.: 46**

**United States Patent and Trademark Office**

**Reg. No. 3,395,994**

**Registered Mar. 11, 2008**

**TRADEMARK  
PRINCIPAL REGISTER**

**FRESH TAKES**

DOLE FOOD COMPANY, INC. (DELAWARE  
CORPORATION)  
ONE DOLE DRIVE  
WESTLAKE VILLAGE, CA 91362

FOR: CUT VEGETABLES; PRE-CUT VEGETABLE  
SALAD; VEGETABLE SALADS, IN CLASS 29 (U.S.  
CL. 46).

FIRST USE 10-1-2007; IN COMMERCE 10-1-2007.

THE MARK CONSISTS OF STANDARD CHAR-  
ACTERS WITHOUT CLAIM TO ANY PARTICULAR  
FONT, STYLE, SIZE, OR COLOR.

NO CLAIM IS MADE TO THE EXCLUSIVE  
RIGHT TO USE "FRESH", APART FROM THE  
MARK AS SHOWN.

SN 78-697,891, FILED 8-22-2005.

PRISCILLA MILTON, EXAMINING ATTORNEY

**Int. Cl.: 41**

**Prior U.S. Cls.: 100, 101, and 107**

**United States Patent and Trademark Office**

**Reg. No. 3,395,995**

**Registered Mar. 11, 2008**

**SERVICE MARK  
PRINCIPAL REGISTER**

**ROCK THE BOAT**

VERSUS, L.P. (DELAWARE LIMITED PARTNER-  
SHIP)  
281 TRESSER BOULEVARD  
TWO STAMFORD PLAZA  
STAMFORD, CT 06901

FOR: PRODUCTION OF TELEVISION AND  
CABLE TELEVISION PROGRAMS; DISTRIBUTION  
OF TELEVISION PROGRAMMING TO CABLE TEL-  
EVISION SYSTEMS; PROVIDING INFORMATION  
RELATING TO TELEVISION PROGRAMMING VIA  
A GLOBAL COMPUTER NETWORK, IN CLASS 41  
(U.S. CLS. 100, 101 AND 107).

FIRST USE 11-6-2005; IN COMMERCE 11-6-2005.

THE MARK CONSISTS OF STANDARD CHAR-  
ACTERS WITHOUT CLAIM TO ANY PARTICULAR  
FONT, STYLE, SIZE, OR COLOR.

SN 78-698,026, FILED 8-23-2005.

JENNY PARK, EXAMINING ATTORNEY

**Int. Cls.: 35 and 42**

**Prior U.S. Cls.: 100, 101, and 102**

**United States Patent and Trademark Office**

**Reg. No. 3,395,996**

**Registered Mar. 11, 2008**

**SERVICE MARK  
PRINCIPAL REGISTER**

**MONITOR TECHNOLOGIES**

MONITOR COMPANY GROUP LIMITED PART-  
NERSHIP (DELAWARE LIMITED PARTNER-  
SHIP)  
TWO CANAL PARK  
CAMBRIDGE, MA 02141

FOR: BUSINESS CONSULTING, NAMELY, PRO-  
VIDING CONSULTATION TO BUSINESSES CON-  
CERNING MANAGEMENT STRATEGY, IN CLASS  
35 (U.S. CLS. 100, 101 AND 102).

FIRST USE 5-0-2004; IN COMMERCE 5-0-2004.

FOR: PROVIDING TEMPORARY USE OF ON-  
LINE NON-DOWNLOADABLE COMPUTER SOFT-  
WARE FOR DATA ANALYSIS IN THE FIELD OF  
BUSINESS AND TECHNOLOGY CONSULTING;  
TECHNOLOGY CONSULTING IN THE FIELD OF

BUSINESS MANAGEMENT, IN CLASS 42 (U.S. CLS.  
100 AND 101).

FIRST USE 3-0-2004; IN COMMERCE 3-0-2004.

THE MARK CONSISTS OF STANDARD CHAR-  
ACTERS WITHOUT CLAIM TO ANY PARTICULAR  
FONT, STYLE, SIZE, OR COLOR.

NO CLAIM IS MADE TO THE EXCLUSIVE  
RIGHT TO USE "TECHNOLOGIES", APART FROM  
THE MARK AS SHOWN.

SN 78-698,351, FILED 8-23-2005.

ROBIN CHOSID, EXAMINING ATTORNEY

**Int. Cl.: 36**

**Prior U.S. Cls.: 100, 101, and 102**

**United States Patent and Trademark Office**

**Reg. No. 3,395,997**

**Registered Mar. 11, 2008**

**SERVICE MARK  
PRINCIPAL REGISTER**

AMERICAN DREAM RESIDENTIAL

ANDY MAY GROUP, LLC (FLORIDA LTD LIAB  
CO)  
1009 SALCOMB LANE  
RALEIGH, NC 27614

FOR: MORTGAGE PROCUREMENT FOR OTHERS AND MORTGAGE LENDING FOR RESIDENTIAL SINGLE FAMILY REAL ESTATE, IN CLASS 36 (U.S. CLS. 100, 101 AND 102).

FIRST USE 9-1-2005; IN COMMERCE 9-1-2005.

THE MARK CONSISTS OF STANDARD CHARACTERS WITHOUT CLAIM TO ANY PARTICULAR FONT, STYLE, SIZE, OR COLOR.

NO CLAIM IS MADE TO THE EXCLUSIVE RIGHT TO USE "RESIDENTIAL", APART FROM THE MARK AS SHOWN.

SN 78-700,569, FILED 8-25-2005.

CHRISTOPHER BUONGIORNO, EXAMINING ATTORNEY

**Int. Cls.: 6 and 19**

**Prior U.S. Cls.: 1, 2, 12, 13, 14, 23, 25, 33, and 50**

**United States Patent and Trademark Office**

**Reg. No. 3,395,998**

**Registered Mar. 11, 2008**

**TRADEMARK  
PRINCIPAL REGISTER**

**BORROWED SPACES**

BORROWED SPACES INC. (CANADA CORPORATION)  
1600A KINGSTON ROAD  
TORONTO, ONTARIO, CANADA M1N 1S5

FOR: MODULAR BUILDING COMPONENTS, NAMELY, METAL DOOR, WALL AND CEILING PANELS; METAL DOOR, WALL AND CEILING PANEL INSERTS, METAL POST TOP CONNECTORS, METAL POST CAPS, AND METAL BRACKETS FOR USE IN THE CONSTRUCTION AND ASSEMBLY OF INDOOR AND OUTDOOR SCREENS, STRUCTURES AND FENCES, IN CLASS 6 (U.S. CLS. 2, 12, 13, 14, 23, 25 AND 50).

FIRST USE 10-23-2006; IN COMMERCE 10-23-2006.

FOR: MODULAR BUILDING COMPONENTS, NAMELY, NON-METAL BEAMS, NON-METAL POSTS, NON-METAL DOOR, WALL AND CEILING PANELS; NON-METAL DOOR, WALL AND PANEL

INSERTS; AND NON-METAL TRELLISES FOR USE IN THE CONSTRUCTION AND ASSEMBLY OF INDOOR AND OUTDOOR SCREENS, STRUCTURES AND FENCES, IN CLASS 19 (U.S. CLS. 1, 12, 33 AND 50).

FIRST USE 10-23-2006; IN COMMERCE 10-23-2006.

THE MARK CONSISTS OF STANDARD CHARACTERS WITHOUT CLAIM TO ANY PARTICULAR FONT, STYLE, SIZE, OR COLOR.

PRIORITY CLAIMED UNDER SEC. 44(D) ON CANADA APPLICATION NO. 1,249,054, FILED 3-2-2005, REG. NO. TMA668758, DATED 7-26-2006, EXPIRES 7-26-2021.

SN 78-702,562, FILED 8-29-2005.

TINA BROWN, EXAMINING ATTORNEY

**Int. Cl.: 9**

**Prior U.S. Cls.: 21, 23, 26, 36, and 38**

**United States Patent and Trademark Office**

**Reg. No. 3,395,999**

**Registered Mar. 11, 2008**

**TRADEMARK  
PRINCIPAL REGISTER**

# Advanced CSP

ADVANCED SEMICONDUCTOR ENGINEER-  
ING, INC. (TAIWAN CORPORATION)  
NO. 26, JINGSAN RD., NANTZ CHIU  
KAOHSIUNG, TAIWAN 811

FOR: INTEGRATED CIRCUITS INCORPORAT-  
ING SOLDER BALLS; SEMICONDUCTOR DEVI-  
CES, IN CLASS 9 (U.S. CLS. 21, 23, 26, 36 AND 38).

FIRST USE 11-0-2007; IN COMMERCE 11-0-2007.

THE MARK CONSISTS OF STANDARD CHAR-  
ACTERS WITHOUT CLAIM TO ANY PARTICULAR  
FONT, STYLE, SIZE, OR COLOR.

NO CLAIM IS MADE TO THE EXCLUSIVE  
RIGHT TO USE "CSP", APART FROM THE MARK  
AS SHOWN.

SN 78-703,917, FILED 8-31-2005.

ROBIN CHOSID, EXAMINING ATTORNEY



**Int. Cls.: 4 and 37**

**Prior U.S. Cls.: 1, 6, 15, 100, 103, and 106**

**Reg. No. 3,396,000**

**United States Patent and Trademark Office**

**Registered Mar. 11, 2008**

**TRADEMARK  
SERVICE MARK  
PRINCIPAL REGISTER**

**MAGNUM COAL**

TROUT COAL HOLDINGS, LLC (DELAWARE  
LTD LIAB CO)  
500 LEE STREET EAST, SUITE 900  
CHARLESTON, WV 25301

THE MARK CONSISTS OF STANDARD CHAR-  
ACTERS WITHOUT CLAIM TO ANY PARTICULAR  
FONT, STYLE, SIZE, OR COLOR.

FOR: COAL, IN CLASS 4 (U.S. CLS. 1, 6 AND 15).

NO CLAIM IS MADE TO THE EXCLUSIVE  
RIGHT TO USE "COAL COMPANY", APART FROM  
THE MARK AS SHOWN.

FIRST USE 4-4-2006; IN COMMERCE 4-4-2006.

FOR: COAL MINING EXTRACTION , IN CLASS  
37 (U.S. CLS. 100, 103 AND 106).

SN 78-704,746, FILED 8-31-2005.

FIRST USE 4-4-2006; IN COMMERCE 4-4-2006.

MATTHEW KLINE, EXAMINING ATTORNEY

**Int. Cl.: 9**

**Prior U.S. Cls.: 21, 23, 26, 36, and 38**

**Reg. No. 3,396,001**

**United States Patent and Trademark Office**

**Registered Mar. 11, 2008**

---

**TRADEMARK  
PRINCIPAL REGISTER**



GREAT AMERICAN INSURANCE CO. (OHIO CORPORATION)  
580 WALNUT STREET  
CINCINNATI, OH 45202

FOR: WEB BASED PROCESSING SYSTEM COMPRISED OF COMPUTER SOFTWARE FOR QUOTING, DATA ENTRY AND ACCOUNT REVIEW FOR USE INTERNALLY AND BY INSURANCE PRODU-

CERS IN UNDERWRITING CROP INSURANCE, IN CLASS 9 (U.S. CLS. 21, 23, 26, 36 AND 38).

FIRST USE 2-8-2007; IN COMMERCE 2-8-2007.

SN 78-705,165, FILED 9-1-2005.

KATHERINE STOIDES, EXAMINING ATTORNEY

**Int. Cl.: 36**

**Prior U.S. Cls.: 100, 101, and 102**

**United States Patent and Trademark Office**

**Reg. No. 3,396,002**

**Registered Mar. 11, 2008**

**SERVICE MARK  
PRINCIPAL REGISTER**

**JANUS SMART PORTFOLIOS**

JANUS INTERNATIONAL HOLDING LLC (NE-  
VADA LTD LIAB CO)  
ATTN CHARLES FLEMING  
151 DETROIT ST  
DENVER, CO 80206

FOR: INVESTING THE FUNDS OF OTHERS;  
MUTUAL FUND INVESTMENT AND INVEST-  
MENT ADVISORY SERVICES, IN CLASS 36 (U.S.  
CLS. 100, 101 AND 102).

FIRST USE 9-1-2005; IN COMMERCE 9-1-2005.

THE MARK CONSISTS OF STANDARD CHAR-  
ACTERS WITHOUT CLAIM TO ANY PARTICULAR  
FONT, STYLE, SIZE, OR COLOR.

OWNER OF U.S. REG. NOS. 1,469,367, 2,875,438,  
AND OTHERS.

NO CLAIM IS MADE TO THE EXCLUSIVE  
RIGHT TO USE "PORTFOLIOS", APART FROM  
THE MARK AS SHOWN.

SN 78-705,494, FILED 9-1-2005.

MICHAEL TANNER, EXAMINING ATTORNEY

**Int. Cls.: 7, 9, and 11**

**Prior U.S. Cls.: 13, 19, 21, 23, 26, 31, 34, 35, 36, and 38**

**United States Patent and Trademark Office**

**Reg. No. 3,396,003**

**Registered Mar. 11, 2008**

**TRADEMARK  
PRINCIPAL REGISTER**

**SYMETIX**

KEY TECHNOLOGY, INC. (OREGON CORPORATION)  
150 AVERY  
WALLA WALLA, WA 99362

FOR: PHARMACEUTICAL PROCESSING EQUIPMENT, NAMELY, A CONVEYOR FOR TRANSPORTING PHARMACEUTICALS ALONG A COURSE OF TRAVEL; AN AIR SORTING MANIFOLD FOR SORTING PHARMACEUTICALS POSITIONED CONVEYOR; A GRADER; POLISHER; AND A DRYER FOR DRYING PHARMACEUTICAL PRODUCTS TRAVELING ALONG A CONVEYOR, IN CLASS 7 (U.S. CLS. 13, 19, 21, 23, 31, 34 AND 35).

FIRST USE 5-1-2007; IN COMMERCE 5-1-2007.

FOR: PHARMACEUTICAL PROCESSING EQUIPMENT, NAMELY, A CAMERA FOR INSPECTING PHARMACEUTICALS TRAVELING ALONG A CONVEYOR, IN CLASS 9 (U.S. CLS. 21, 23, 26, 36 AND 38).

FIRST USE 5-1-2007; IN COMMERCE 5-1-2007.

FOR: PHARMACEUTICAL PROCESSING EQUIPMENT, NAMELY, A SOURCE OF LIGHTING FOR ILLUMINATING A CONVEYOR WHICH IS TRANSPORTING PHARMACEUTICALS, IN CLASS 11 (U.S. CLS. 13, 21, 23, 31 AND 34).

FIRST USE 5-1-2007; IN COMMERCE 5-1-2007.

THE MARK CONSISTS OF STANDARD CHARACTERS WITHOUT CLAIM TO ANY PARTICULAR FONT, STYLE, SIZE, OR COLOR.

SN 78-705,684, FILED 9-1-2005.

MARIA-VICTORIA SUAREZ, EXAMINING ATTORNEY

**Int. Cls.: 35, 36, and 42**

**Prior U.S. Cls.: 100, 101, and 102**

**United States Patent and Trademark Office**

**Reg. No. 3,396,004**

**Registered Mar. 11, 2008**

**SERVICE MARK  
PRINCIPAL REGISTER**

# INFLECTION

INFLECTION HR LLC (ARIZONA LTD LIAB CO)  
424 EAST SOUTHERN AVENUE  
SUITE 103  
TEMPE, AZ 85282

FOR: CONSULTING SERVICES IN THE FIELD OF HUMAN RESOURCES; CONSULTING SERVICES IN THE FIELD OF PAYROLL MANAGEMENT; CONSULTING SERVICES IN THE FIELD OF TAX MANAGEMENT, PAYROLL PREPARATION SERVICES AND PAYROLL TAX PREPARATION SERVICES, IN CLASS 35 (U.S. CLS. 100, 101 AND 102).

FIRST USE 6-0-2002; IN COMMERCE 6-0-2002.

FOR: INSURANCE SERVICES, NAMELY, INSURANCE ADMINISTRATION SERVICES; PAYROLL TAX DEBITING SERVICES, IN CLASS 36 (U.S. CLS. 100, 101 AND 102).

FIRST USE 6-0-2002; IN COMMERCE 6-0-2002.

FOR: CONSULTING SERVICES IN THE FIELD OF EMPLOYMENT LAW; COMPUTER CONSULTING IN THE FIELD OF HUMAN RESOURCES INFORMATION SYSTEMS, NAMELY, PROVIDING ADVICE REGARDING USE OF COMPUTER SYSTEMS AND SOFTWARE FOR HUMAN RESOURCES FUNCTIONS; COMPUTER SERVICES, NAMELY, PROVIDING USE OF ONLINE NON-DOWNLOADABLE SOFTWARE, APPLICATIONS AND TOOLS IN THE FIELD OF HUMAN RESOURCES, IN CLASS 42 (U.S. CLS. 100 AND 101).

FIRST USE 6-0-2002; IN COMMERCE 6-0-2002.

THE MARK CONSISTS OF STANDARD CHARACTERS WITHOUT CLAIM TO ANY PARTICULAR FONT, STYLE, SIZE, OR COLOR.

OWNER OF U.S. REG. NO. 2,943,093.

SN 78-706,438, FILED 9-2-2005.

TRACY CROSS, EXAMINING ATTORNEY

**Int. Cls.: 3 and 5**

**Prior U.S. Cls.: 1, 4, 6, 18, 44, 46, 50, 51, and 52**

**United States Patent and Trademark Office**

**Reg. No. 3,396,005**

**Registered Mar. 11, 2008**

**TRADEMARK  
PRINCIPAL REGISTER**

**BELLE-AIMÉE**

BELLE-AIMÉE, INC. (CALIFORNIA CORPORATION)  
SUITE C  
14281 BROOKHURST ST.  
GARDEN GROVE, CA 92843

FOR: SKIN CLARIFIERS; SKIN CONDITIONERS; SKIN CREAMS; SKIN LIGHTENING CREAMS; SKIN MOISTURIZER; SKIN TEXTURIZERS; SKIN TONERS; SUNSCREEN CREAMS; WRINKLE REMOVING SKIN CARE PREPARATIONS; AFTER SUN CREAMS; AGE SPOT REDUCING CREAMS; ANTI-AGING CREAM; ANTI-FRECKLE CREAMS; ANTI-WRINKLE CREAMS; BEAUTY CREAMS FOR BODY CARE; CLEANSING CREAMS COSMETIC; CREAMS FOR CELLULITE REDUCTION; EXFOLIANT CREAMS; LOTIONS FOR CELLULITE REDUCTION; LOTIONS FOR FACE AND BODY CARE; MAKE-UP REMOVING LOTIONS; MAKE-UP REMOVING MILK, GEL, LOTIONS AND CREAMS; MEDICATED SOAPS; SKIN CLEANSERS; SKIN LOTIONS; SKIN SOAP, IN CLASS 3 (U.S. CLS. 1, 4, 6, 50, 51 AND 52).

FIRST USE 2-4-2005; IN COMMERCE 2-4-2005.

FOR: ACNE TREATMENT PREPARATIONS; MULTI-VITAMIN PREPARATIONS; NUTRITIONAL SUPPLEMENTS; VITAMINS; DIET CAPSULES; DIET PILLS; VITAMIN AND MINERAL PREPARATIONS FOR MEDICAL USE; VITAMIN AND MINERAL SUPPLEMENTS; VITAMIN C PREPARATIONS; VITAMIN PREPARATIONS, IN CLASS 5 (U.S. CLS. 6, 18, 44, 46, 51 AND 52).

FIRST USE 2-4-2005; IN COMMERCE 2-4-2005.

THE MARK CONSISTS OF STANDARD CHARACTERS WITHOUT CLAIM TO ANY PARTICULAR FONT, STYLE, SIZE, OR COLOR.

THE FOREIGN WORDING IN THE MARK TRANSLATES INTO ENGLISH AS "BEAUTIFUL-LOVED".

SN 78-706,802, FILED 9-5-2005.

NORA BUCHANAN WILL, EXAMINING ATTORNEY

**Int. Cl.: 41**

**Prior U.S. Cls.: 100, 101, and 107**

**United States Patent and Trademark Office**

**Reg. No. 3,396,006**

**Registered Mar. 11, 2008**

**SERVICE MARK  
PRINCIPAL REGISTER**

**MIAMIHATTAN**

IDEA CENTRAL, INC. (FLORIDA CORPORATION)  
19576 CRYSTAL ROCK DRIVE, SUITE 12  
GERMANTOWN, MD 20874

FOR: COMPUTER SERVICES, NAMELY, PROVIDING ON-LINE MAGAZINES IN THE FIELD OF TRAVEL, IN CLASS 41 (U.S. CLS. 100, 101 AND 107).

FIRST USE 11-6-2006; IN COMMERCE 11-6-2006.

THE MARK CONSISTS OF STANDARD CHARACTERS WITHOUT CLAIM TO ANY PARTICULAR FONT, STYLE, SIZE, OR COLOR.

SN 78-707,834, FILED 9-7-2005.

CARRIE GENOVESE, EXAMINING ATTORNEY

**Int. Cl.: 16**

**Prior U.S. Cls.: 2, 5, 22, 23, 29, 37, 38, and 50**

**Reg. No. 3,396,007**

**United States Patent and Trademark Office**

**Registered Mar. 11, 2008**

---

**TRADEMARK  
PRINCIPAL REGISTER**

**DOCUHOLDER**

DEFLECTO CORPORATION (DELAWARE CORPORATION)  
7035 EAST 86TH STREET  
INDIANAPOLIS, IN 46250

THE MARK CONSISTS OF STANDARD CHARACTERS WITHOUT CLAIM TO ANY PARTICULAR FONT, STYLE, SIZE, OR COLOR.

FOR: DESK TOP LITERATURE RACK FOR STORAGE AND DISPLAY OF PRINTED MATERIAL ADAPTABLE FOR WALL MOUNTING, IN CLASS 16 (U.S. CLS. 2, 5, 22, 23, 29, 37, 38 AND 50).

SN 78-708,168, FILED 9-7-2005.

FIRST USE 2-8-2007; IN COMMERCE 2-8-2007.

CURTIS FRENCH, EXAMINING ATTORNEY



**Int. Cl.: 36**

**Prior U.S. Cls.: 100, 101, and 102**

**United States Patent and Trademark Office**

**Reg. No. 3,396,008**

**Registered Mar. 11, 2008**

**SERVICE MARK  
PRINCIPAL REGISTER**



ENTERTAINMENT PUBLICATIONS, INC. (MI-  
CHIGAN CORPORATION)  
1414 E. MAPLE ROAD  
TROY, MI 480834019

FOR: CHARITABLE FUNDRAISING SERVICES  
EFFECTED THROUGH THE DISTRIBUTION OF  
BOOKS CONTAINING COUPONS AND CARDS  
WHICH ENTITLES THE HOLDER TO RECEIVE  
DISCOUNTS ON DINING, HOTEL ACCOMMODA-  
TION, CONSUMER MERCHANDISE, TRAVEL, MO-  
VIES, SPORTS, THEATER AND OTHER LEISURE  
ACTIVITIES; CREDIT CARD SERVICES; CREDIT

CARD SERVICES FEATURING A REWARDS PRO-  
GRAM, IN CLASS 36 (U.S. CLS. 100, 101 AND 102).

FIRST USE 7-1-2007; IN COMMERCE 7-1-2007.

OWNER OF U.S. REG. NOS. 1,718,106, 2,345,502,  
AND 2,643,821.

SN 78-710,139, FILED 9-9-2005.

AMY GEARIN, EXAMINING ATTORNEY

**Int. Cls.: 1, 5, 40, and 42**

**Prior U.S. Cls.: 1, 5, 6, 10, 18, 26, 44, 46, 51, 52, 100, 101, 103, and 106**

**Reg. No. 3,396,009**

**United States Patent and Trademark Office**

**Registered Mar. 11, 2008**

**TRADEMARK  
SERVICE MARK  
PRINCIPAL REGISTER**

# SAFC Biosciences

SIGMA-ALDRICH BIOTECHNOLOGY LP (MISSOURI LIMITED PARTNERSHIP)  
3050 SPRUCE STREET  
ST. LOUIS, MO 63103

FOR: FULL LINE OF CHEMICALS FOR MANUFACTURING, RESEARCH, AND SCIENTIFIC USE, IN CLASS 1 (U.S. CLS. 1, 5, 6, 10, 26 AND 46).

FIRST USE 9-15-2005; IN COMMERCE 1-3-2006.

FOR: FULL LINE OF PHARMACEUTICAL PREPARATIONS FOR IN VITRO PHARMACEUTICAL DIAGNOSTIC PREPARATIONS FOR MEDICAL USE; A FULL LINE OF DIAGNOSTIC AND THERAPEUTIC PREPARATIONS AND SUBSTANCES FOR IN VIVO USE; A FULL LINE OF COMPOUNDS, NAMELY VITAMIN AND MINERAL PREPARATIONS FOR USE AS INGREDIENTS IN PHARMACEUTICAL PREPARATIONS, IN CLASS 5 (U.S. CLS. 6, 18, 44, 46, 51 AND 52).

FIRST USE 9-15-2005; IN COMMERCE 1-3-2006.

FOR: CUSTOM MANUFACTURE FOR OTHERS OF CHEMICALS FOR USE IN MANUFACTURE, RESEARCH, AND SCIENCE; CUSTOM MANUFACTURE

FOR OTHERS OF COMPOUNDS FOR USE IN PHARMACEUTICAL PREPARATIONS, IN CLASS 40 (U.S. CLS. 100, 103 AND 106).

FIRST USE 9-15-2005; IN COMMERCE 1-3-2006.

FOR: CHEMICAL AND SCIENTIFIC RESEARCH FOR OTHERS; DEVELOPMENT FOR OTHERS OF CHEMICALS, COMPOUNDS AND INGREDIENTS FOR USE IN MANUFACTURE, PHARMACEUTICALS, RESEARCH AND FOR SCIENTIFIC PURPOSES, IN CLASS 42 (U.S. CLS. 100 AND 101).

FIRST USE 9-15-2005; IN COMMERCE 1-3-2006.

THE MARK CONSISTS OF STANDARD CHARACTERS WITHOUT CLAIM TO ANY PARTICULAR FONT, STYLE, SIZE, OR COLOR.

NO CLAIM IS MADE TO THE EXCLUSIVE RIGHT TO USE "BIOSCIENCES", APART FROM THE MARK AS SHOWN.

SN 78-710,338, FILED 9-9-2005.

SANJEEV VOHRA, EXAMINING ATTORNEY

**Int. Cl.: 11**

**Prior U.S. Cls.: 13, 21, 23, 31, and 34**

**United States Patent and Trademark Office**

**Reg. No. 3,396,010**

**Registered Mar. 11, 2008**

**TRADEMARK  
PRINCIPAL REGISTER**

**SSR**

CATACEL CORP. (OHIO CORPORATION)  
7998 GOTHAM ROAD  
GARRETTSVILLE, OH 44231

FOR: CATALYTIC REACTORS FOR USE IN INDUSTRIAL PROCESSES, NAMELY, HYDROGEN, SYNGAS AND AMMONIA PRODUCTION, PETRO-CHEMICAL REACTIONS AND PROCESSES, HYDROCARBON PROCESSING, AND GAS AND LIQUID CHEMICAL CONVERSIONS, IN CLASS 11 (U.S. CLS. 13, 21, 23, 31 AND 34).

FIRST USE 12-31-2005; IN COMMERCE 12-31-2005.

THE MARK CONSISTS OF STANDARD CHARACTERS WITHOUT CLAIM TO ANY PARTICULAR FONT, STYLE, SIZE, OR COLOR.

SN 78-710,819, FILED 9-12-2005.

AMOS T. MATTHEWS, JR., EXAMINING ATTORNEY

**Int. Cl.: 35**

**Prior U.S. Cls.: 100, 101, and 102**

**United States Patent and Trademark Office**

**Reg. No. 3,396,011**

**Registered Mar. 11, 2008**

**SERVICE MARK  
PRINCIPAL REGISTER**

# WORK PERKS

FIRST HORIZON NATIONAL CORPORATION  
(TENNESSEE CORPORATION)  
165 MADISON AVENUE, SUITE 300  
MEMPHIS, TN 38103

FOR: PROMOTING THE SALE OF FINANCIAL  
SERVICES THROUGH THE ADMINISTRATION OF  
A CUSTOMER INCENTIVE PROGRAM, IN CLASS  
35 (U.S. CLS. 100, 101 AND 102).

FIRST USE 2-0-2005; IN COMMERCE 2-0-2005.

THE MARK CONSISTS OF STANDARD CHAR-  
ACTERS WITHOUT CLAIM TO ANY PARTICULAR  
FONT, STYLE, SIZE, OR COLOR.

NO CLAIM IS MADE TO THE EXCLUSIVE  
RIGHT TO USE "PERKS", APART FROM THE  
MARK AS SHOWN.

SN 78-710,880, FILED 9-12-2005.

MARIAM MAHMOUDI, EXAMINING ATTORNEY

**Int. Cl.: 1**

**Prior U.S. Cls.: 1, 5, 6, 10, 26, and 46**

**Reg. No. 3,396,012**

**United States Patent and Trademark Office**

**Registered Mar. 11, 2008**

---

**TRADEMARK  
PRINCIPAL REGISTER**

**HEL-FIRE**

HELENA HOLDING COMPANY (DELAWARE  
CORPORATION)  
300 DELAWARE AVENUE, 9TH FLOOR - DE 5403  
WILMINGTON, DE 19801

THE MARK CONSISTS OF STANDARD CHAR-  
ACTERS WITHOUT CLAIM TO ANY PARTICULAR  
FONT, STYLE, SIZE, OR COLOR.

FOR: ADJUVANTS FOR USE WITH HERBICIDES  
FOR AGRICULTURAL USE; SPRAY ADJUVANTS  
FOR USE WITH PESTICIDES FOR AGRICULTUR-  
AL USE, IN CLASS 1 (U.S. CLS. 1, 5, 6, 10, 26 AND 46).

SN 78-711,986, FILED 9-13-2005.

FIRST USE 3-3-2007; IN COMMERCE 3-3-2007.

JAY BESCH, EXAMINING ATTORNEY

**Int. Cl.: 3**

**Prior U.S. Cls.: 1, 4, 6, 50, 51, and 52**

**United States Patent and Trademark Office**

**Reg. No. 3,396,013**

**Registered Mar. 11, 2008**

**TRADEMARK  
PRINCIPAL REGISTER**

**LUMAR OF BEVERLY HILLS**

LUMAR OF BEVERLY HILLS, INC. (CALIFORNIA CORPORATION)  
468 N. CAMDEN DR. SUITE 200  
BEVERLY HILL, CA 90210

FOR: BODY SPRAY USED AS A PERSONAL DEODORANT AND AS FRAGRANCE; HAIR AND SKIN CONDITIONERS; COSMETIC PRODUCTS IN THE FORM OF AEROSOLS FOR SKIN CARE; ESSENTIAL OILS FOR USE IN MANUFACTURING OF FRAGRANCES; ESSENTIAL OILS FOR USE IN THE MANUFACTURE OF SCENTED PRODUCTS; FRAGRANCE EMITTING WICKS FOR ROOM FRAGRANCE; FRAGRANCES FOR PERSONAL USE; MAKE-UP PRODUCTS FOR THE FACE AND BODY; ROOM FRAGRANCES; SACHET-LIKE EYE PILLOWS CONTAINING FRAGRANCES; SHAMPOOS; SKIN CARE PRODUCTS, NAMELY, NON-MEDICA-

TED SKIN SERUM, IN CLASS 3 (U.S. CLS. 1, 4, 6, 50, 51 AND 52).

FIRST USE 5-19-2006; IN COMMERCE 5-19-2006.

THE MARK CONSISTS OF STANDARD CHARACTERS WITHOUT CLAIM TO ANY PARTICULAR FONT, STYLE, SIZE, OR COLOR.

NO CLAIM IS MADE TO THE EXCLUSIVE RIGHT TO USE "BEVERLY HILLS", APART FROM THE MARK AS SHOWN.

SN 78-712,284, FILED 9-13-2005.

GIANCARLO CASTRO, EXAMINING ATTORNEY

**Int. Cl.: 12**

**Prior U.S. Cls.: 19, 21, 23, 31, 35, and 44**

**United States Patent and Trademark Office**

**Reg. No. 3,396,014**

**Registered Mar. 11, 2008**

**TRADEMARK  
PRINCIPAL REGISTER**

ERB ENERGY RETURN BICYCLE

GROENDAL, MARK (UNITED STATES INDIVIDUAL)  
3988 BURLINGAME S.W.  
WYOMING, MI 49509

NO CLAIM IS MADE TO THE EXCLUSIVE  
RIGHT TO USE "ENERGY RETURN BICYCLES",  
APART FROM THE MARK AS SHOWN.

FOR: BICYCLES, IN CLASS 12 (U.S. CLS. 19, 21, 23,  
31, 35 AND 44).

SN 78-712,844, FILED 9-14-2005.

FIRST USE 8-31-2006; IN COMMERCE 8-31-2006.

THE MARK CONSISTS OF STANDARD CHARACTERS  
WITHOUT CLAIM TO ANY PARTICULAR  
FONT, STYLE, SIZE, OR COLOR.

DOMINIC J. FERRAIUOLO, EXAMINING ATTORNEY

**Int. Cl.: 3**

**Prior U.S. Cls.: 1, 4, 6, 50, 51, and 52**

**United States Patent and Trademark Office**

**Reg. No. 3,396,015**

**Registered Mar. 11, 2008**

**TRADEMARK  
PRINCIPAL REGISTER**

**New Victorian by Jessica  
McClintock**

JESSICA MCCLINTOCK, INC. (CALIFORNIA CORPORATION)  
1400 SIXTEENTH STREET  
SAN FRANCISCO, CA 94103

OWNER OF U.S. REG. NOS. 1,557,518 AND 1,994,234.

FOR: FRAGRANCE FOR PERSONAL USE, IN CLASS 3 (U.S. CLS. 1, 4, 6, 50, 51 AND 52).

THE NAME "JESSICA MCCLINTOCK" IDENTIFIES A LIVING INDIVIDUAL WHOSE CONSENT IS OF RECORD.

FIRST USE 11-23-2005; IN COMMERCE 11-23-2005.

SN 78-713,678, FILED 9-15-2005.

THE MARK CONSISTS OF STANDARD CHARACTERS WITHOUT CLAIM TO ANY PARTICULAR FONT, STYLE, SIZE, OR COLOR.

KYLE PEETE, EXAMINING ATTORNEY



**Int. Cl.: 24**

**Prior U.S. Cls.: 42 and 50**

**United States Patent and Trademark Office**

**Reg. No. 3,396,016**

**Registered Mar. 11, 2008**

**TRADEMARK  
PRINCIPAL REGISTER**

**DREAMEX**

FIBERWEB COROVIN GMBH (FED REP GER-  
MANY CORPORATION)  
WOLTOFER STRASSE 124  
D-31224 PEINE, FED REP GERMANY

FOR: ELASTIC FABRIC FOR USE IN THE MAN-  
UFACTURE OF LAUNDERABLE AND DISPOSABLE  
ARTICLES OF CLOTHING, NAMELY,  
UNDERWEAR, PANTIES, AND TRAINING PANTS,  
DISPOSABLE PERSONAL HYGIENE ARTICLES,  
NAMELY, BABY DIAPERS, ADULT INCONTINENT  
DIAPERS, FEMININE HYGIENE ARTICLES, WIPES,  
AND BED LINENS, MEDICAL SUPPLIES, NAMELY,  
OSTOMY BAGS, SURGICAL DRAPES, AND WIPES,  
FILTERS, AND FABRIC FOR GENERAL INDUS-

TRIAL USE, NAMELY, FOR THE MANUFACTURE  
OF INDUSTRIAL PROTECTIVE APPAREL AND  
COVERS FOR EQUIPMENT, IN CLASS 24 (U.S.  
CLS. 42 AND 50).

FIRST USE 3-19-2007; IN COMMERCE 3-19-2007.

THE MARK CONSISTS OF STANDARD CHAR-  
ACTERS WITHOUT CLAIM TO ANY PARTICULAR  
FONT, STYLE, SIZE, OR COLOR.

SN 78-714,724, FILED 9-16-2005.

RAMONA ORTIGA, EXAMINING ATTORNEY

**Int. Cl.: 16**

**Prior U.S. Cls.: 2, 5, 22, 23, 29, 37, 38, and 50**

**Reg. No. 3,396,017**

**United States Patent and Trademark Office**

**Registered Mar. 11, 2008**

---

**TRADEMARK  
PRINCIPAL REGISTER**

**EK SUCCESS**

E. K. SUCCESS, LTD. (NEW JERSEY CORPORATION)  
261 RIVER ROAD  
CLIFTON, NJ 07014

FIRST USE 1-1-1978; IN COMMERCE 1-1-1978.

FOR: STATIONERY PRODUCTS, NAMELY, SELF-MADE PAPER OR CARDSTOCK INVITATIONS, PHOTO ALBUMS, SCRAPBOOKING ALBUMS, KEEPSAKE FABRIC ALBUMS, AND STICKERS, IN CLASS 16 (U.S. CLS. 2, 5, 22, 23, 29, 37, 38 AND 50).

THE MARK CONSISTS OF STANDARD CHARACTERS WITHOUT CLAIM TO ANY PARTICULAR FONT, STYLE, SIZE, OR COLOR.

SN 78-714,729, FILED 9-16-2005.

PAM WILLIS, EXAMINING ATTORNEY

Int. Cl.: 29

Prior U.S. Cl.: 46

United States Patent and Trademark Office

Reg. No. 3,396,018

Registered Mar. 11, 2008

TRADEMARK  
PRINCIPAL REGISTER



FIRST BONSMARA, INC. (TEXAS CORPORATION)  
SUITE 118  
2500 S. COULTER  
AMARILLO, TX 79106

FOR: MEAT, IN CLASS 29 (U.S. CL. 46).

FIRST USE 1-23-2006; IN COMMERCE 1-23-2006.

NO CLAIM IS MADE TO THE EXCLUSIVE RIGHT TO USE "THE TENDER BEEF", "BONSMARA" AND "NATURAL BEEF COMPANY", APART FROM THE MARK AS SHOWN.

SN 78-714,987, FILED 9-16-2005.

KARANENDRA S. CHHINA, EXAMINING ATTORNEY

**Int. Cls.: 16, 24, and 25**

**Prior U.S. Cls.: 2, 5, 22, 23, 29, 37, 38, 39, 42, and 50**

**Reg. No. 3,396,019**

**United States Patent and Trademark Office**

**Registered Mar. 11, 2008**

**TRADEMARK  
PRINCIPAL REGISTER**

# KERIS

PT. BATIK KERIS (INDONESIA CORPORATION)  
KALURAHAN CEMANI, KECAMATAN GROGOL  
KABUPATEN SUKOHARJO  
JAWA TENGAH, INDONESIA

FOR: ADHESIVE BANDS FOR STATIONERY OR HOUSEHOLD PURPOSES; ADVERTISEMENT BOARDS OF PAPER OR CARDBOARD; ALBUMS, NAMELY, PHOTOGRAPH ALBUMS; ALMANACS; GARBAGE BAGS OF PAPER OR PLASTIC; ENVELOPES, POUCHES AND BAGS OF PAPER OR PLASTIC FOR PACKAGING; LOOSE-LEAF BINDERS; BINDING STRIPS FOR BOOKBINDING; BLINDS OF PAPER; BLUEPRINTS; BOOKLETS IN THE FIELD OF BATIK FABRICS AND DESIGNS; BOOKS IN THE FIELD OF BATIK FABRICS AND DESIGNS; PAPER BOXES FOR PENS; BOXES OF CARDBOARD OR PAPER; PLASTIC BUBBLE PACKS FOR WRAPPING OR PACKAGING; CALENDARS; CARDBOARD; CARDBOARD ARTICLES, NAMELY, CARTONS, CONTAINERS; CATALOGUES IN THE FIELD OF BATIK FABRICS AND DESIGNS; STATIONERY COVERS; EMBROIDERY DESIGNS PATTERN ENGRAVINGS; ENVELOPES FOR STATIONERY USE; GREETING CARDS; PASSPORT HOLDERS; HOLDERS FOR CHECKBOOKS; LUMINOUS PAPER; NOTE BOOKS; PACKING PAPER; PAPER, NAMELY, ART AND COPIER PAPER; PENCILS; PHOTOGRAPHS; PICTURES; POSTCARDS; POSTERS; PRINTED MATTER, NAMELY, MAGAZINES AND BROCHURES IN THE FIELD OF BATIK FABRICS AND DESIGNS; WRAPPING PAPER, IN CLASS 16 (U.S. CLS. 2, 5, 22, 23, 29, 37, 38 AND 50).

FIRST USE 5-27-1920; IN COMMERCE 2-3-1999.

FOR: BED BLANKETS; BED CLOTHES, NAMELY, LAP ROBES; BED COVERS, NAMELY, BED

SPREADS, COMFORTERS; BLINDS OF TEXTILE; BROCADES; CALICO; CANVAS FOR TAPESTRY OR EMBROIDERY; CHEESE CLOTH; CHENILLE FABRIC; CHEVIOT FABRIC; COTTON FABRICS; COVERS FOR CUSHIONS; DAMASK; DIAPERED LINEN; DIMITY; ELASTIC WOVEN MATERIAL; TRACED CLOTH FOR EMBROIDERY; FABRIC; FABRICS FOR TEXTILE USE; HANDKERCHIEFS OF TEXTILE; HOUSEHOLD LINEN; NON-WOVEN TEXTILE FABRICS; PILLOW SHAMS; VELVET; WOOLEN CLOTH; WOOLEN FABRIC, IN CLASS 24 (U.S. CLS. 42 AND 50).

FIRST USE 5-27-1920; IN COMMERCE 2-3-1999.

FOR: APRONS; BANDANAS, NECKERCHIEFS; BODICES, LINGERIE; BRASSIERES; BREECHES; CAMISOLES; COATS; UNDERCLOTHING, NAMELY, CORSETS; CUFFS; FOOTWEAR; HOODS; MANTILLAS; MASQUERADE COSTUMES; PAJAMAS; PANTS; SARIS; SASHES FOR WEAR; SCARF; SHIRT; SHOES; SKIRTS; SLIPPERS; STOCKINGS; SWEATERS; T-SHIRTS; TOPCOATS; TROUSER STRAPS; TROUSERS; UNDERWEAR; UNIFORMS; VEILS, IN CLASS 25 (U.S. CLS. 22 AND 39).

FIRST USE 5-27-1920; IN COMMERCE 2-3-1999.

THE MARK CONSISTS OF STANDARD CHARACTERS WITHOUT CLAIM TO ANY PARTICULAR FONT, STYLE, SIZE, OR COLOR.

THE FOREIGN WORDING IN THE MARK TRANSLATES INTO ENGLISH AS CEREMONIAL KNIFE.

SN 78-715,615, FILED 9-19-2005.

NAAKWAMA ANKRAH, EXAMINING ATTORNEY

Int. Cl.: 5

Prior U.S. Cls.: 6, 18, 44, 46, 51, and 52

United States Patent and Trademark Office

Reg. No. 3,396,020

Registered Mar. 11, 2008

TRADEMARK  
PRINCIPAL REGISTER



FARCENT ENTERPRISE CO., LTD. (TAIWAN CORPORATION)  
13F, NO. 230, CHENG TEH ROAD, SEC. 3  
TAIPEI, TAIWAN

FOR: MEDICATED BATH PREPARATIONS; INSECTICIDES; PESTICIDES; BACTERICIDES; ALL-PURPOSE DISINFECTANTS; AIR FRESHENERS; AIR DEODORANTS; REFRIGERATOR DEODORIZERS; CLOTHES DEODORIZERS; ACTIVE CARBON DEODORIZERS FOR REFRIGERATORS, IN CLASS 5 (U.S. CLS. 6, 18, 44, 46, 51 AND 52).

FIRST USE 2-24-2005; IN COMMERCE 10-22-2005.

OWNER OF U.S. REG. NO. 1,762,396.

THE COLOR(S) RED AND WHITE IS/ARE CLAIMED AS A FEATURE OF THE MARK.

THE MARK CONSISTS OF THE TERM "FARCENT" IN WHITE SURROUNDED BY A PARTIAL TRIANGLE IN THE COLOR RED OVER THE CHINESE CHARACTERS IN THE LOWER PORTION OF THE MARK WHICH APPEAR IN THE COLOR RED.

THE NON-LATIN CHARACTERS IN THE MARK TRANSLITERATE TO "HUA," "HSIEN," AND "TZU," AND LITERALLY TRANSLATE TO "FLOWER," "A GOD," AND "CHILD" RESPECTIVELY, BUT WHEN COMBINED HAVE A MEANING OF "FLOWER FAIRY" IN ENGLISH.

SN 78-716,884, FILED 9-20-2005.

JEFFERY COWARD, EXAMINING ATTORNEY

**Int. Cl.: 5**

**Prior U.S. Cls.: 6, 18, 44, 46, 51, and 52**

**Reg. No. 3,396,021**

**United States Patent and Trademark Office**

**Registered Mar. 11, 2008**

**TRADEMARK  
PRINCIPAL REGISTER**



OREXIGEN THERAPEUTICS, INC. (DELAWARE CORPORATION)  
12481 HIGH BLUFF DRIVE  
SUITE 160  
SAN DIEGO, CA 92130

FIRST USE 10-2-2007; IN COMMERCE 10-2-2007.

FOR: PHARMACEUTICAL PREPARATIONS AND SUBSTANCES FOR THE TREATMENT OF OBESITY, INDUCEMENT OF WEIGHT LOSS, AND PREVENTION OF WEIGHT GAIN , IN CLASS 5 (U.S. CLS. 6, 18, 44, 46, 51 AND 52).

NO CLAIM IS MADE TO THE EXCLUSIVE RIGHT TO USE "OREXIGEN", APART FROM THE MARK AS SHOWN.

SN 78-718,907, FILED 9-22-2005.

JORDAN BAKER, EXAMINING ATTORNEY

**Int. Cl.: 5**

**Prior U.S. Cls.: 6, 18, 44, 46, 51, and 52**

**United States Patent and Trademark Office**

**Reg. No. 3,396,022**

**Registered Mar. 11, 2008**

**TRADEMARK  
PRINCIPAL REGISTER**

# Cooling Care

ANDERSON, MARK L. (UNITED STATES INDIVIDUAL)  
P.O. BOX 39  
SPRING VALLEY, WI 54767

THE MARK CONSISTS OF STANDARD CHARACTERS WITHOUT CLAIM TO ANY PARTICULAR FONT, STYLE, SIZE, OR COLOR.

FOR: BREAST-NURSING PADS, IN CLASS 5 (U.S. CLS. 6, 18, 44, 46, 51 AND 52).

SN 78-720,642, FILED 9-26-2005.

FIRST USE 9-1-2005; IN COMMERCE 3-1-2006.

ANTHONY RINKER, EXAMINING ATTORNEY

**Int. Cl.: 9**

**Prior U.S. Cls.: 21, 23, 26, 36, and 38**

**Reg. No. 3,396,023**

**United States Patent and Trademark Office**

**Registered Mar. 11, 2008**

---

**TRADEMARK  
PRINCIPAL REGISTER**

**MANTRA**

TIZOR SYSTEMS, INC. (DELAWARE CORPORATION)  
SUITE 650  
2 CLOCK TOWER PLACE  
MAYNARD, MA 01745

THE MARK CONSISTS OF STANDARD CHARACTERS WITHOUT CLAIM TO ANY PARTICULAR FONT, STYLE, SIZE, OR COLOR.

FOR: COMPUTER SOFTWARE FOR DATA AUDITING AND PROTECTION PURPOSES, IN CLASS 9 (U.S. CLS. 21, 23, 26, 36 AND 38).

SN 78-720,767, FILED 9-26-2005.

FIRST USE 10-18-2005; IN COMMERCE 10-18-2005.

MELISSA VALLILLO, EXAMINING ATTORNEY



**Int. Cl.: 45**

**Prior U.S. Cls.: 100 and 101**

**United States Patent and Trademark Office**

**Reg. No. 3,396,024**

**Registered Mar. 11, 2008**

**SERVICE MARK  
PRINCIPAL REGISTER**

**I HAVE A FRIEND**

HOSPICE OF SANTA BARBARA, INC. (CALIFORNIA NON-PROFIT CORPORATION)  
2050 ALAMEDA PADRE SERRA  
SANTA BARBARA, CA 93101

FOR: CHARITABLE SERVICES, NAMELY, MENTORING IN THE NATURE OF GRIEF COUNSELING OF CHILDREN AND TEENAGERS WHO ARE COPING WITH THE LOSS OF A PARENT OR SIBLING, IN CLASS 45 (U.S. CLS. 100 AND 101).

FIRST USE 10-15-2007; IN COMMERCE 10-15-2007.

THE MARK CONSISTS OF STANDARD CHARACTERS WITHOUT CLAIM TO ANY PARTICULAR FONT, STYLE, SIZE, OR COLOR.

SN 78-721,711, FILED 9-27-2005.

COLLEEN KEARNEY, EXAMINING ATTORNEY

**Int. Cls.: 9 and 16**

**Prior U.S. Cls.: 2, 5, 21, 22, 23, 26, 29, 36, 37, 38, and 50**

**United States Patent and Trademark Office**

**Reg. No. 3,396,025**

**Registered Mar. 11, 2008**

**TRADEMARK  
PRINCIPAL REGISTER**

**FLUGRAM**

NOVARTIS VACCINES AND DIAGNOSTICS,  
INC. (DELAWARE CORPORATION)  
4560 HORTON STREET  
ENERYVILLE, CA 10017

FOR: MAGNETICALLY ENCODED PRE-PAID  
INFLUENZA IMMUNIZATION PURCHASE  
CARDS, IN CLASS 9 (U.S. CLS. 21, 23, 26, 36 AND 38).

FIRST USE 9-17-2007; IN COMMERCE 9-17-2007.

FOR: NON-MAGNETICALLY ENCODED PRE-  
PAID INFLUENZA IMMUNIZATION PURCHASE

CARDS, IN CLASS 16 (U.S. CLS. 2, 5, 22, 23, 29, 37, 38  
AND 50).

FIRST USE 10-2-2006; IN COMMERCE 10-2-2006.

THE MARK CONSISTS OF STANDARD CHAR-  
ACTERS WITHOUT CLAIM TO ANY PARTICULAR  
FONT, STYLE, SIZE, OR COLOR.

SN 78-721,969, FILED 9-28-2005.

KARANENDRA S. CHHINA, EXAMINING ATTOR-  
NEY

**Int. Cls.: 31 and 35**

**Prior U.S. Cls.: 1, 46, 100, 101, and 102**

**United States Patent and Trademark Office**

**Reg. No. 3,396,026**

**Registered Mar. 11, 2008**

**TRADEMARK  
SERVICE MARK  
PRINCIPAL REGISTER**

**A RESOURCE THAT LASTS  
FOREVER**

GREENWOOD RESOURCES, INC. (NEVADA  
CORPORATION)  
SUITE 1020  
121 SW SALMON STREET  
PORTLAND, OR 97204

FOR: LIVING TREES, NAMELY, POPLAR, IN  
CLASS 31 (U.S. CLS. 1 AND 46).

FIRST USE 1-1-2005; IN COMMERCE 1-1-2005.

FOR: FOREST MANAGEMENT; FOREST MAN-  
AGEMENT CONSULTATION, IN CLASS 35 (U.S.  
CLS. 100, 101 AND 102).

FIRST USE 1-1-2005; IN COMMERCE 1-1-2005.

THE MARK CONSISTS OF STANDARD CHAR-  
ACTERS WITHOUT CLAIM TO ANY PARTICULAR  
FONT, STYLE, SIZE, OR COLOR.

SN 78-723,965, FILED 9-30-2005.

DOMINICK J. SALEMI, EXAMINING ATTORNEY

**Int. Cl.: 9**

**Prior U.S. Cls.: 21, 23, 26, 36, and 38**

**United States Patent and Trademark Office**

**Reg. No. 3,396,027**

**Registered Mar. 11, 2008**

**TRADEMARK  
PRINCIPAL REGISTER**

**Teaching the world to  
invest**

BOLOTO GROUP (ARIZONA CORPORATION)  
5223 E. VILLA RITA DR  
SCOTTSDALE, AZ 85254

THE MARK CONSISTS OF STANDARD CHAR-  
ACTERS WITHOUT CLAIM TO ANY PARTICULAR  
FONT, STYLE, SIZE, OR COLOR.

FOR: EDUCATIONAL SOFTWARE FEATURING  
INSTRUCTION IN THE FIELD OF FINANCIAL  
ANALYSIS, FINANCIAL MANAGEMENT, AND FI-  
NANCIAL PLANNING, IN CLASS 9 (U.S. CLS. 21, 23,  
26, 36 AND 38).

SN 78-725,014, FILED 10-3-2005.

FIRST USE 7-1-2005; IN COMMERCE 10-1-2005.

WARREN L. OLANDRIA, EXAMINING ATTOR-  
NEY

**Int. Cl.: 25**

**Prior U.S. Cls.: 22 and 39**

**United States Patent and Trademark Office**

**Reg. No. 3,396,028**

**Registered Mar. 11, 2008**

**TRADEMARK  
PRINCIPAL REGISTER**

**MASSEYS**

MASON COMPANIES, INC. (WISCONSIN CORPORATION)  
1251 FIRST AVENUE  
CHIPPEWA FALLS, WI 54774

OWNER OF U.S. REG. NO. 1,743,239.

SEC. 2(F).

FOR: FOOTWEAR, IN CLASS 25 (U.S. CLS. 22 AND 39).

FIRST USE 4-7-2006; IN COMMERCE 4-7-2006.

SN 78-725,492, FILED 10-3-2005.

THE MARK CONSISTS OF STANDARD CHARACTERS WITHOUT CLAIM TO ANY PARTICULAR FONT, STYLE, SIZE, OR COLOR.

STEPHANIE ALI, EXAMINING ATTORNEY

**Int. Cl.: 25**

**Prior U.S. Cls.: 22 and 39**

**United States Patent and Trademark Office**

**Reg. No. 3,396,029**

**Registered Mar. 11, 2008**

**TRADEMARK  
PRINCIPAL REGISTER**



PAUL M. TEDESCO AND LAMAR J. LINDSAY  
PARTNERSHIP, THE (CALIFORNIA PART-  
NERSHIP)  
39 BROWNFIELD LANE  
POMONA, CA 91766

FIRST USE 2-15-2005; IN COMMERCE 2-15-2005.

SN 78-725,709, FILED 10-3-2005.

FOR: CLOTHING, NAMELY, SHIRTS, PANTS,  
HATS, UNDERWEAR, SOCKS, JACKETS, SWEAT-  
SHIRTS, BELTS, SUSPENDERS, AND FOOTWEAR,  
IN CLASS 25 (U.S. CLS. 22 AND 39).

KATHERINE E. HALMEN, EXAMINING ATTOR-  
NEY

**Int. Cl.: 43**

**Prior U.S. Cls.: 100 and 101**

**United States Patent and Trademark Office**

**Reg. No. 3,396,030**

**Registered Mar. 11, 2008**

---

**SERVICE MARK  
PRINCIPAL REGISTER**

**PEACE**

SIX CONTINENTS HOTELS, INC. (DELAWARE  
CORPORATION)  
THREE RAVINIA DRIVE  
SUITE 100  
ATLANTA, GA 303462149

THE MARK CONSISTS OF STANDARD CHAR-  
ACTERS WITHOUT CLAIM TO ANY PARTICULAR  
FONT, STYLE, SIZE, OR COLOR.

FOR: HOTEL SERVICES, IN CLASS 43 (U.S. CLS.  
100 AND 101).

SN 78-725,882, FILED 10-4-2005.

FIRST USE 7-0-2005; IN COMMERCE 7-0-2005.

SIMON TENG, EXAMINING ATTORNEY

**Int. Cl.: 20**

**Prior U.S. Cls.: 2, 13, 22, 25, 32, and 50**

**United States Patent and Trademark Office**

**Reg. No. 3,396,031**

**Registered Mar. 11, 2008**

**TRADEMARK  
PRINCIPAL REGISTER**

**SOFT PLEASURES**

CHARLESTON BAY, LLC (NEW YORK LTD  
LIAB CO)  
7100 GRAYBEARD COURT  
CHARLOTTE, NC 28226

THE MARK CONSISTS OF STANDARD CHAR-  
ACTERS WITHOUT CLAIM TO ANY PARTICULAR  
FONT, STYLE, SIZE, OR COLOR.

FOR: PILLOWS, IN CLASS 20 (U.S. CLS. 2, 13, 22,  
25, 32 AND 50).

SN 78-726,814, FILED 10-5-2005.

FIRST USE 7-31-2007; IN COMMERCE 7-31-2007.

DANNEAN HETZEL, EXAMINING ATTORNEY



Int. Cl.: 35

Prior U.S. Cls.: 100, 101, and 102

United States Patent and Trademark Office

Reg. No. 3,396,032

Registered Mar. 11, 2008

SERVICE MARK  
PRINCIPAL REGISTER



AMERICAN RESORT DEVELOPMENT ASSOCIATION (D.C. CORPORATION)  
1201 15TH ST. NW  
WASHINGTON, DC 20005

FOR: ASSOCIATION SERVICES, NAMELY, PROMOTING THE INTERESTS OF THE RECREATIONAL, RESORT, TIME SHARING, PLANNED COMMUNITY, AND CAMPGROUND DEVELOPMENT INDUSTRIES BY PROGRAMS OF ADVOCACY AND LOBBYING; ARRANGING AND CONDUCTING BUSINESS CONFERENCES AND TRADE SHOWS IN THE FIELDS OF TIME SHARING AND RESORT DEVELOPMENT; PROVIDING AND CONDUCTING BUSINESS SURVEYS AND STUDIES; AND PROVIDING BUSINESS INFORMATION ON PERTINENT LEGISLATION AND MARKET TRENDS IN THE RECREATIONAL, RESORT, TIME SHARING, PLANNED COMMUNITY, AND CAMPGROUND DEVELOPMENT INDUSTRIES, IN CLASS 35 (U.S. CLS. 100, 101 AND 102).

FIRST USE 9-16-2007; IN COMMERCE 9-16-2007.

OWNER OF U.S. REG. NOS. 1,424,383, 1,424,384, AND 2,429,992.

NO CLAIM IS MADE TO THE EXCLUSIVE RIGHT TO USE "RESORT DEVELOPMENT ASSOCIATION", APART FROM THE MARK AS SHOWN.

THE MARK CONSISTS OF IN PART THE FANCIFUL REPRESENTATION OF A HOUSE.

SEC. 2(F) AS TO "AMERICAN RESORT DEVELOPMENT ASSOCIATION".

SN 78-726,839, FILED 10-5-2005.

G. MAYERSCHOFF, EXAMINING ATTORNEY

**Int. Cl.: 41**

**Prior U.S. Cls.: 100, 101, and 107**

**United States Patent and Trademark Office**

**Reg. No. 3,396,033**

**Registered Mar. 11, 2008**

**SERVICE MARK  
PRINCIPAL REGISTER**

**FEARLESS ENGINEERING**

BOARD OF REGENTS, THE UNIVERSITY OF  
TEXAS SYSTEM (TEXAS STATE AGENCY)  
201 WEST 7TH STREET  
AUSTIN, TX 78701

FOR: EDUCATIONAL SERVICES, NAMELY,  
PROVIDING CLASSES, COURSES OF INSTRU-  
TION, SEMINARS, TRAINING, WORKSHOPS IN  
THE FIELDS OF ENGINEERING, MATH AND  
SCIENCES, AND DISTRIBUTING EDUCATIONAL  
MATERIALS IN CONNECTION THEREWITH; PRO-  
VIDING EDUCATIONAL SPEAKERS FOR PUBLIC  
LECTURES; AND ORGANIZING EXHIBITIONS  
FOR EDUCATIONAL PURPOSES IN THE FIELDS  
OF ENGINEERING, MATH AND SCIENCE, IN  
CLASS 41 (U.S. CLS. 100, 101 AND 107).

FIRST USE 11-15-2006; IN COMMERCE 11-15-2006.

THE MARK CONSISTS OF STANDARD CHAR-  
ACTERS WITHOUT CLAIM TO ANY PARTICULAR  
FONT, STYLE, SIZE, OR COLOR.

NO CLAIM IS MADE TO THE EXCLUSIVE  
RIGHT TO USE "ENGINEERING" , APART FROM  
THE MARK AS SHOWN.

SN 78-727,317, FILED 10-5-2005.

SANJEEV VOHRA, EXAMINING ATTORNEY

Int. Cl.: 14

Prior U.S. Cls.: 2, 27, 28, and 50

United States Patent and Trademark Office

Reg. No. 3,396,034

Registered Mar. 11, 2008

TRADEMARK  
PRINCIPAL REGISTER



AZPB LIMITED PARTNERSHIP (DELAWARE  
LIMITED PARTNERSHIP)  
BANK ONE BALLPARK  
401 EAST JEFFERSON STREET  
PHOENIX, AZ 85004

FOR: JEWELRY, NAMELY, BRACELETS,  
CHARMS, EARRINGS, RINGS, BELLY RINGS,  
NECKLACES, PENDANTS, WATCHES, COSTUME  
JEWELRY, RUBBER OR SILICONE BRACELETS  
AND/OR WRISTBANDS IN THE NATURE OF A  
BRACELET, MEDALLIONS, ORNAMENTAL ME-  
TAL PINS, LAPEL PINS, CUFF LINKS, METAL  
BELT BUCKLES OF PRECIOUS METAL, TIE  
TACKS, TIE PINS, MONEY CLIPS OF PRECIOUS  
METAL, CLOCKS, WALL CLOCKS, ALARM

CLOCKS, FOB WATCHES, NON-MONETARY CO-  
INS OF PRECIOUS METAL, CLOCKS INCORPORA-  
TED INTO KEY CHAINS; KEY CHAINS OF  
PRECIOUS METAL; AND KEY RINGS OF PRE-  
CIOUS METAL, IN CLASS 14 (U.S. CLS. 2, 27, 28 AND  
50).

FIRST USE 1-0-1998; IN COMMERCE 1-0-1998.

OWNER OF U.S. REG. NOS. 2,243,911, 3,360,571,  
AND OTHERS.

SN 78-727,729, FILED 10-6-2005.

INGRID C. EULIN, EXAMINING ATTORNEY

**Int. Cl.: 25**

**Prior U.S. Cls.: 22 and 39**

**United States Patent and Trademark Office**

**Reg. No. 3,396,035**

**Registered Mar. 11, 2008**

**TRADEMARK  
PRINCIPAL REGISTER**

**CANADIAN GRAFFITI**

LUIGI GORDONI INTERNATIONAL (USA) INC.  
(NEW YORK CORPORATION)  
1175 58TH STREET  
BROOKLYN, NY 11219

THE MARK CONSISTS OF STANDARD CHAR-  
ACTERS WITHOUT CLAIM TO ANY PARTICULAR  
FONT, STYLE, SIZE, OR COLOR.

FOR: T-SHIRTS, SWEATERS AND BLOUSES, IN  
CLASS 25 (U.S. CLS. 22 AND 39).

SN 78-728,194, FILED 10-6-2005.

FIRST USE 2-0-2006; IN COMMERCE 2-0-2006.

DEBRA LEE, EXAMINING ATTORNEY

**Int. Cls.: 14, 18, 25, 26, and 28**

**Prior U.S. Cls.: 1, 2, 3, 22, 23, 27, 28, 37, 38, 39, 40, 41, 42, and 50**

**Reg. No. 3,396,036**

**United States Patent and Trademark Office**

**Registered Mar. 11, 2008**

**TRADEMARK  
PRINCIPAL REGISTER**

**ONCE UPON A DREAM**

CHRISTMAS TREE SHOPS, INC. (MASSACHUSETTS CORPORATION)  
261 WHITE'S PATH  
SOUTH YARMOUTH, MA 02664

FOR: COSTUME JEWELRY, IN CLASS 14 (U.S. CLS. 2, 27, 28 AND 50).

FIRST USE 5-10-2006; IN COMMERCE 5-10-2006.

FOR: PURSES, IN CLASS 18 (U.S. CLS. 1, 2, 3, 22 AND 41).

FIRST USE 5-10-2006; IN COMMERCE 5-10-2006.

FOR: APPAREL, NAMELY, SLIPPERS, DRESSES, SKIRTS, BLOUSES, MASQUERADE COSTUMES, HATS, GLOVES, CAPES AND TUTUS, IN CLASS 25 (U.S. CLS. 22 AND 39).

FIRST USE 5-10-2006; IN COMMERCE 5-10-2006.

FOR: HAIR ACCESSORIES, NAMELY, RIBBONS, CLIPS, BARRETTES, CROWNS, AND HAIR ORNA-

MENTS IN THE FORM OF HEADBANDS AND COMBS, IN CLASS 26 (U.S. CLS. 37, 39, 40, 42 AND 50).

FIRST USE 5-10-2006; IN COMMERCE 5-10-2006.

FOR: TOYS, NAMELY, TOY MAKE-UP KITS COMPRISED OF ONE OR MORE OF PRETEND MAKE-UP, PRETEND COSMETICS, APPLICATORS FOR COSMETICS AND MAKE-UP, NAIL POLISHES AND AN APPARATUS FOR HOLDING THE FOREGOING; CROWNS AND WANDS, IN CLASS 28 (U.S. CLS. 22, 23, 38 AND 50).

FIRST USE 5-10-2006; IN COMMERCE 5-10-2006.

THE MARK CONSISTS OF STANDARD CHARACTERS WITHOUT CLAIM TO ANY PARTICULAR FONT, STYLE, SIZE, OR COLOR.

SN 78-728,899, FILED 10-7-2005.

SETH A. RAPPAPORT, EXAMINING ATTORNEY

**Int. Cl.: 16**

**Prior U.S. Cls.: 2, 5, 22, 23, 29, 37, 38, and 50**

**United States Patent and Trademark Office**

**Reg. No. 3,396,037**

**Registered Mar. 11, 2008**

**TRADEMARK  
PRINCIPAL REGISTER**

**MASTER MEMORIZER**

MACIE PUBLISHING COMPANY (NEW JERSEY  
CORPORATION)  
10 ASTRO PLACE SUITE 100  
ROCKAWAY, NJ 07866

FOR: AWARD CERTIFICATES ASSOCIATED  
WITH AN EDUCATIONAL CURRICULUM RE-  
WARD PROGRAM FOR PROMOTING ACHIEVE-  
MENT IN PLAYING MUSICAL INSTRUMENTS , IN  
CLASS 16 (U.S. CLS. 2, 5, 22, 23, 29, 37, 38 AND 50).

FIRST USE 10-21-2005; IN COMMERCE 10-21-2005.

THE MARK CONSISTS OF STANDARD CHAR-  
ACTERS WITHOUT CLAIM TO ANY PARTICULAR  
FONT, STYLE, SIZE, OR COLOR.

SN 78-729,122, FILED 10-7-2005.

ELLEN BURNS, EXAMINING ATTORNEY

**Int. Cl.: 3**

**Prior U.S. Cls.: 1, 4, 6, 50, 51, and 52**

**United States Patent and Trademark Office**

**Reg. No. 3,396,038**

**Registered Mar. 11, 2008**

**TRADEMARK  
PRINCIPAL REGISTER**

**POWDERFUL**

PRESCRIPTIVES INC. (DELAWARE CORPORATION)  
767 FIFTH AVENUE  
NEW YORK, NY 10153

FOR: CONCEALERS FOR UNDER EYES; COSMETICS; CREAMY FACE POWDER; CREAMY FOUNDATION; LOOSE FACE POWDER; PRESSED FACE POWDER, IN CLASS 3 (U.S. CLS. 1, 4, 6, 50, 51 AND 52).

FIRST USE 9-1-2002; IN COMMERCE 9-1-2002.

THE MARK CONSISTS OF STANDARD CHARACTERS WITHOUT CLAIM TO ANY PARTICULAR FONT, STYLE, SIZE, OR COLOR.

SN 78-731,714, FILED 10-12-2005.

JASON LOTT, EXAMINING ATTORNEY

**Int. Cl.: 29**

**Prior U.S. Cl.: 46**

**United States Patent and Trademark Office**

**Reg. No. 3,396,039**

**Registered Mar. 11, 2008**

**TRADEMARK  
PRINCIPAL REGISTER**



MICHAEL FOODS OF DELAWARE, INC. (DELA-  
WARE CORPORATION)  
301 CARLSON PARKWAY  
MINNETONKA, MN 55305

FOR: PREPARED EGG PRODUCTS FOR FOOD  
SERVICE AND RETAIL OUTLETS, IN CLASS 29  
(U.S. CL. 46).

FIRST USE 1-1-2006; IN COMMERCE 1-1-2006.

OWNER OF U.S. REG. NO. 1,862,085.

SN 78-732,639, FILED 10-13-2005.

SHAUNIA CARLYLE, EXAMINING ATTORNEY



**Int. Cls.: 16 and 35**

**Prior U.S. Cls.: 2, 5, 22, 23, 29, 37, 38, 50, 100, 101, and 102**

**Reg. No. 3,396,040**

**United States Patent and Trademark Office**

**Registered Mar. 11, 2008**

**TRADEMARK  
SERVICE MARK  
PRINCIPAL REGISTER**

**GRADPAK**

GRAD MOMENTS, LLC (NEW JERSEY LTD  
LIAB CO)  
BUILDING 1  
1930 HECK AVENUE  
NEPTUNE, NJ 07754

FOR: PRINTED VISUALS IN THE NATURE OF  
AWARD CERTIFICATES, COUPONS, ADVERTISE-  
MENTS, DIPLOMAS, CERTIFICATES OF COURSE  
COMPLETION, CERTIFICATE OF SKILL QUALIFI-  
CATIONS, CERTIFICATE OF TEST RESULTS, PHO-  
TOGRAPHS, HOLOGRAPHIC IMAGES,  
PROMOTIONAL MATERIALS, IN CLASS 16 (U.S.  
CLS. 2, 5, 22, 23, 29, 37, 38 AND 50).

FIRST USE 8-10-2005; IN COMMERCE 8-10-2005.

FOR: PROMOTING THE SALE OF GOODS AND  
SERVICES OF OTHERS THROUGH THE DISTRIBUTION OF PRINTED MATERIALS, IN CLASS 35 (U.S. CLS. 100, 101 AND 102).

FIRST USE 8-10-2005; IN COMMERCE 8-10-2005.

THE MARK CONSISTS OF STANDARD CHAR-  
ACTERS WITHOUT CLAIM TO ANY PARTICULAR  
FONT, STYLE, SIZE, OR COLOR.

SN 78-734,583, FILED 10-17-2005.

JOHN WILKE, EXAMINING ATTORNEY

Int. Cl.: 12

Prior U.S. Cls.: 19, 21, 23, 31, 35, and 44

United States Patent and Trademark Office

Reg. No. 3,396,041

Registered Mar. 11, 2008

TRADEMARK  
PRINCIPAL REGISTER



LESLIE, HEATHER ANN (UNITED STATES IN-  
DIVIDUAL)  
1425 S. STEELE STREET  
DENVER, CO 80210

THE MARK CONSISTS OF ORGANIC SHAPE  
WITH RETRO TEXT OF WORDS "SHADYBABY".  
AN ABSTRACT STAR/SATELLITE FORM IN UPPER  
RIGHT CORNER.

FOR: UMBRELLAS TO BE AFFIXED TO BABY  
STROLLER, IN CLASS 12 (U.S. CLS. 19, 21, 23, 31, 35  
AND 44).

SN 78-734,962, FILED 10-18-2005.

FIRST USE 5-22-2006; IN COMMERCE 1-1-2007.

JENNY PARK, EXAMINING ATTORNEY

**Int. Cl.: 41**

**Prior U.S. Cls.: 100, 101, and 107**

**United States Patent and Trademark Office**

**Reg. No. 3,396,042**

**Registered Mar. 11, 2008**

**SERVICE MARK  
PRINCIPAL REGISTER**

**PAWS FOR PATRIOTS**

SOUTHEASTERN GUIDE DOGS, INC. (FLORIDA  
NON-PROFIT CORPORATION)  
4210 77TH STREET EAST  
PALMETTO, FL 34221

FOR: PROVIDING NON-PROFIT TRAINING OF  
GUIDE DOGS AND NON-PROFIT TRAINING OF  
BLINDED MEMBERS OF THE MILITARY WHO  
RECEIVE GUIDE DOGS, IN CLASS 41 (U.S. CLS. 100,  
101 AND 107).

FIRST USE 12-16-2006; IN COMMERCE 12-16-2006.

THE MARK CONSISTS OF STANDARD CHAR-  
ACTERS WITHOUT CLAIM TO ANY PARTICULAR  
FONT, STYLE, SIZE, OR COLOR.

OWNER OF U.S. REG. NO. 1,774,486.

SN 78-735,997, FILED 10-19-2005.

BRENDAN MCCAULEY, EXAMINING ATTORNEY

**Int. Cl.: 10**

**Prior U.S. Cls.: 26, 39, and 44**

**United States Patent and Trademark Office**

**Reg. No. 3,396,043**

**Registered Mar. 11, 2008**

**TRADEMARK  
PRINCIPAL REGISTER**

**N-85**

NELLCOR PURITAN BENNETT INCORPORATED (DELAWARE CORPORATION)  
4280 HACIENDA DRIVE  
PLEASANTON, CA 94588

THE MARK CONSISTS OF STANDARD CHARACTERS WITHOUT CLAIM TO ANY PARTICULAR FONT, STYLE, SIZE, OR COLOR.

FOR: MEDICAL DEVICES, NAMELY, PULSE OXIMETERS, IN CLASS 10 (U.S. CLS. 26, 39 AND 44).

SN 78-736,113, FILED 10-19-2005.

FIRST USE 7-13-2006; IN COMMERCE 7-13-2006.

LAURA KOVALSKY, EXAMINING ATTORNEY

**Int. Cl.: 44**

**Prior U.S. Cls.: 100 and 101**

**United States Patent and Trademark Office**

**Reg. No. 3,396,044**

**Registered Mar. 11, 2008**

**SERVICE MARK  
PRINCIPAL REGISTER**



**QUALITY MEDICAL IMAGING**

QUALITY MEDICAL IMAGING, LLC (NEVADA  
LTD LIAB CO)  
2490 PROFESSIONAL COURT  
SUITE 110  
LAS VEGAS, NV 89128

NO CLAIM IS MADE TO THE EXCLUSIVE  
RIGHT TO USE "QUALITY MEDICAL IMAGING",  
APART FROM THE MARK AS SHOWN.

FOR: MEDICAL IMAGING SERVICES, IN CLASS  
44 (U.S. CLS. 100 AND 101).

SN 78-736,446, FILED 10-19-2005.

FIRST USE 4-27-2005; IN COMMERCE 4-27-2005.

DAVID YONTEF, EXAMINING ATTORNEY

**Int. Cl.: 9**

**Prior U.S. Cls.: 21, 23, 26, 36, and 38**

**United States Patent and Trademark Office**

**Reg. No. 3,396,045**

**Registered Mar. 11, 2008**

**TRADEMARK  
PRINCIPAL REGISTER**

**DIRECTLIFT**

OVERHEAD DOOR CORPORATION (INDIANA  
CORPORATION)  
SUITE 200  
2501 SOUTH STATE HWY 121  
LEWISVILLE, TX 75067

FOR: ELECTRONIC DOOR OPERATORS, ELEC-  
TRONIC GARAGE DOOR OPERATORS, ELECTRO-  
NIC RESIDENTIAL GARAGE DOOR OPERATORS,  
IN CLASS 9 (U.S. CLS. 21, 23, 26, 36 AND 38).

FIRST USE 4-0-2007; IN COMMERCE 4-0-2007.

THE MARK CONSISTS OF STANDARD CHAR-  
ACTERS WITHOUT CLAIM TO ANY PARTICULAR  
FONT, STYLE, SIZE, OR COLOR.

SN 78-736,919, FILED 10-20-2005.

DANIEL CAPSHAW, EXAMINING ATTORNEY

**Int. Cl.: 5**

**Prior U.S. Cls.: 6, 18, 44, 46, 51, and 52**

**Reg. No. 3,396,046**

**United States Patent and Trademark Office**

**Registered Mar. 11, 2008**

---

**TRADEMARK  
PRINCIPAL REGISTER**

**BADGE**

ISAGRO USA, INC. (DELAWARE CORPORATION)  
SUITE 240  
430 DAVIS DRIVE  
MORRISVILLE, NC 27560

THE MARK CONSISTS OF STANDARD CHARACTERS WITHOUT CLAIM TO ANY PARTICULAR FONT, STYLE, SIZE, OR COLOR.

FOR: FUNGICIDES, IN CLASS 5 (U.S. CLS. 6, 18, 44, 46, 51 AND 52).

SN 78-737,298, FILED 10-20-2005.

FIRST USE 3-16-2006; IN COMMERCE 3-16-2006.

MARK PILARO, EXAMINING ATTORNEY

**Int. Cl.: 10**

**Prior U.S. Cls.: 26, 39, and 44**

**United States Patent and Trademark Office**

**Reg. No. 3,396,047**

**Registered Mar. 11, 2008**

**TRADEMARK  
PRINCIPAL REGISTER**

**ENEMAGRA**

HIGH ISLAND HEALTH, LLC (TEXAS LTD LIAB  
CO)  
P.O. BOX 55427  
HOUSTON, TX 77255

THE MARK CONSISTS OF STANDARD CHAR-  
ACTERS WITHOUT CLAIM TO ANY PARTICULAR  
FONT, STYLE, SIZE, OR COLOR.

FOR: PROSTATE MASSAGERS, IN CLASS 10 (U.S.  
CLS. 26, 39 AND 44).

SN 78-737,534, FILED 10-20-2005.

FIRST USE 9-21-1998; IN COMMERCE 9-21-1998.

AMEETA JORDAN, EXAMINING ATTORNEY



**Int. Cl.: 10**

**Prior U.S. Cls.: 26, 39, and 44**

**United States Patent and Trademark Office**

**Reg. No. 3,396,048**

**Registered Mar. 11, 2008**

**TRADEMARK  
PRINCIPAL REGISTER**

**TRÉS**

COLLEGE PARK INDUSTRIES, INC. (MICHIGAN CORPORATION)  
17505 HELRO DRIVE  
FRASER, MI 48026

FOR: PROSTHETIC DEVICES, NAMELY, ARTIFICIAL FOOT AND ANKLE LIMBS, IN CLASS 10 (U.S. CLS. 26, 39 AND 44).

FIRST USE 9-0-2006; IN COMMERCE 9-0-2006.

THE MARK CONSISTS OF STANDARD CHARACTERS WITHOUT CLAIM TO ANY PARTICULAR FONT, STYLE, SIZE, OR COLOR.

THE ENGLISH TRANSLATION OF THE FRENCH WORDING "TRÉS" IS "VERY."

SN 78-738,897, FILED 10-24-2005.

KRISTIN DAHLING, EXAMINING ATTORNEY

**Int. Cls.: 35 and 41**

**Prior U.S. Cls.: 100, 101, 102, and 107**

**United States Patent and Trademark Office**

**Reg. No. 3,396,049**

**Registered Mar. 11, 2008**

**SERVICE MARK  
PRINCIPAL REGISTER**

**KT WAY**

KEPNER-TREGOE, INC. (DELAWARE CORPORATION)  
17 RESEARCH ROAD  
PRINCETON, NJ 08542

FOR: BUSINESS MANAGEMENT RESEARCH;  
BUSINESS CONSULTING SERVICES, IN CLASS 35  
(U.S. CLS. 100, 101 AND 102).

FIRST USE 9-0-2006; IN COMMERCE 9-0-2006.

FOR: EDUCATIONAL SERVICES, NAMELY,  
PROVIDING COURSES, WORKSHOPS AND SEMINARS  
IN THE FIELD OF BUSINESS PROBLEM ANALYSIS,  
BUSINESS DECISION MAKING AND BUSINESS  
MANAGEMENT; BUSINESS PROJECT

MANAGEMENT WORKSHOPS, IN CLASS 41 (U.S.  
CLS. 100, 101 AND 107).

FIRST USE 9-0-2006; IN COMMERCE 9-0-2006.

THE MARK CONSISTS OF STANDARD CHARACTERS  
WITHOUT CLAIM TO ANY PARTICULAR FONT,  
STYLE, SIZE, OR COLOR.

OWNER OF U.S. REG. NOS. 1,019,619, 2,556,546,  
AND OTHERS.

SN 78-739,442, FILED 10-24-2005.

LAURIE KAUFMAN, EXAMINING ATTORNEY

**Int. Cl.: 33**

**Prior U.S. Cls.: 47 and 49**

**United States Patent and Trademark Office**

**Reg. No. 3,396,050**

**Registered Mar. 11, 2008**

**TRADEMARK  
PRINCIPAL REGISTER**



LA FORTUNA S.A. (CHILE CORPORATION)  
CAMINO A LA COSTA N 901  
LONTUE, CHILE

FOR: WINES, IN CLASS 33 (U.S. CLS. 47 AND 49).

FIRST USE 2-28-2005; IN COMMERCE 5-31-2007.

NO CLAIM IS MADE TO THE EXCLUSIVE  
RIGHT TO USE "LONTUE VALLEY CHILE", APART  
FROM THE MARK AS SHOWN.

THE MARK CONSISTS OF A RECTANGLE CON-  
TAINING THE WORD VENTURA AND THE  
FRONT HALF OF AN ABSTRACT ANIMAL WITH  
THE WORDS LONTUE VALLEY CHILE.

SN 78-739,980, FILED 10-25-2005.

KATHERINE CONNOLLY, EXAMINING ATTOR-  
NEY

**Int. Cl.: 35**

**Prior U.S. Cls.: 100, 101, and 102**

**United States Patent and Trademark Office**

**Reg. No. 3,396,051**

**Registered Mar. 11, 2008**

**SERVICE MARK  
PRINCIPAL REGISTER**

**G2**

B. GOULD JEWELRY, INC. (SOUTH CAROLINA CORPORATION)  
17 PRINCESS STREET  
CHARLESTON, SC 29401

FOR: RETAIL STORE SERVICES FEATURING JEWELRY; MAIL ORDER SERVICES FEATURING JEWELRY; WHOLESALE STORES FEATURING JEWELRY; DIRECT RESPONSE RETAIL SERVICES BY MEANS OF TELEVISION IN THE FIELD OF JEWELRY, IN CLASS 35 (U.S. CLS. 100, 101 AND 102).

FIRST USE 3-12-2004; IN COMMERCE 3-12-2004.

THE MARK CONSISTS OF STANDARD CHARACTERS WITHOUT CLAIM TO ANY PARTICULAR FONT, STYLE, SIZE, OR COLOR.

SN 78-740,748, FILED 10-26-2005.

DANIEL BRODY, EXAMINING ATTORNEY

**Int. Cl.: 9**

**Prior U.S. Cls.: 21, 23, 26, 36, and 38**

**Reg. No. 3,396,052**

**United States Patent and Trademark Office**

**Registered Mar. 11, 2008**

**TRADEMARK  
PRINCIPAL REGISTER**



IMAGINE SOLUTIONS, L.P. (TEXAS LIMITED  
PARTNERSHIP)  
SUITE 790  
1501 LYNDON B JOHNSON FREEWAY  
DALLAS, TX 75234

FOR: COMPUTER SOFTWARE FOR IMAGING  
PURPOSES, NAMELY DOCUMENT IMAGE PRO-  
CESSING INCLUDING MANAGING, SCANNING,  
IMAGING, SORTING, INDEXING, DATA EXTRAC-

TION AND ELECTRONIC DELIVERY OF DOCU-  
MENT IMAGES, IN CLASS 9 (U.S. CLS. 21, 23, 26, 36  
AND 38).

FIRST USE 11-30-2005; IN COMMERCE 11-30-2005.

SN 78-740,890, FILED 10-26-2005.

MELISSA VALLILLO, EXAMINING ATTORNEY

**Int. Cl.: 34**

**Prior U.S. Cls.: 2, 8, 9, and 17**

**United States Patent and Trademark Office**

**Reg. No. 3,396,053**

**Registered Mar. 11, 2008**

**TRADEMARK  
PRINCIPAL REGISTER**

**AROMA-TICO**

EL CENTAURO DE ORO, LTDA. (COSTA RICA  
CORPORATION)  
300 METERS SUR DE LA ESCUELA DE LA  
SANTA MARTA, MERCEDES SUR, PURISCAL  
SAN JOSE, COSTA RICA

THE MARK CONSISTS OF STANDARD CHAR-  
ACTERS WITHOUT CLAIM TO ANY PARTICULAR  
FONT, STYLE, SIZE, OR COLOR.

FOR: CIGARS, IN CLASS 34 (U.S. CLS. 2, 8, 9 AND  
17).

SN 78-740,918, FILED 10-26-2005.

FIRST USE 1-0-2006; IN COMMERCE 1-0-2006.

SEAN CROWLEY, EXAMINING ATTORNEY

**Int. Cl.: 41**

**Prior U.S. Cls.: 100, 101, and 107**

**United States Patent and Trademark Office**

**Reg. No. 3,396,054**

**Registered Mar. 11, 2008**

**SERVICE MARK  
PRINCIPAL REGISTER**



CONTINUING EDUCATION COORDINATING  
BOARD FOR EMERGENCY MEDICAL SER-  
VICES, INC. (TEXAS CORPORATION)  
5111 MILL RUN ROAD  
DALLAS, TX 75244

FOR: PROVIDING CONTINUING MEDICAL  
EDUCATION COURSES, IN CLASS 41 (U.S. CLS.  
100, 101 AND 107).

FIRST USE 7-1-1992; IN COMMERCE 1-1-1993.

THE MARK CONSISTS OF A CROSS WITH  
ARROWS THAT EMIT FROM THE LEFT-HAND  
SIDE OF THE CROSS WITH THE LETTERS "CEC-  
BEMS" SET IN THE MIDDLE OF THE CROSS.

SN 78-741,043, FILED 10-26-2005.

MICHAEL LEWIS, EXAMINING ATTORNEY

**Int. Cl.: 36**

**Prior U.S. Cls.: 100, 101, and 102**

**United States Patent and Trademark Office**

**Reg. No. 3,396,055**

**Registered Mar. 11, 2008**

**SERVICE MARK  
PRINCIPAL REGISTER**

**The Bank by the Side of  
the Road that is Always a  
Friend**

THE BATH STATE BANK (INDIANA CORPORATION)  
PO BOX 10  
3095 BATH ROAD  
BATH, IN 47010

FOR: BANKING SERVICES, IN CLASS 36 (U.S. CLS. 100, 101 AND 102).

FIRST USE 1-1-1995; IN COMMERCE 1-1-1995.

THE MARK CONSISTS OF STANDARD CHARACTERS WITHOUT CLAIM TO ANY PARTICULAR FONT, STYLE, SIZE, OR COLOR.

NO CLAIM IS MADE TO THE EXCLUSIVE RIGHT TO USE "BANK", APART FROM THE MARK AS SHOWN.

SN 78-743,565, FILED 10-31-2005.

DORITT L. CARROLL, EXAMINING ATTORNEY



**Int. Cl.: 1**

**Prior U.S. Cls.: 1, 5, 6, 10, 26, and 46**

**United States Patent and Trademark Office**

**Reg. No. 3,396,056**

**Registered Mar. 11, 2008**

**TRADEMARK  
PRINCIPAL REGISTER**



JIFFY INTERNATIONAL AS (NORWAY CORPORATION)  
MARKENSGATE 2A  
N-4610 KRISTIANSAND, NORWAY

FOR: GROWING MEDIA FOR PLANTS AND TREES; MOLDED HORTICULTURAL PLUGS, PRINCIPALLY OF GROWING MEDIA, FOR GROWING PLANTS AND TREES; GROWING MEDIA COMPRISED OF POTTING SOIL, COMPOST, COIR, PEAT MOSS AND/OR MINERAL WOOL FOR USE IN AGRICULTURE, HORTICULTURE AND FORESTRY, POTTING SOIL; POTS PRINCIPALLY OF PEAT FOR HORTICULTURAL USE; SOIL IMPROVING AGENTS; PELLETS, PRINCIPALLY OF PEAT, FOR HORTICULTURAL USE; CONTAINERS FOR STARTING AND GROWING PLANTS IN THE FORM OF EXPANDABLE PELLETS OF PEAT MOSS ENCLOSED IN PLASTIC MESH JACKETS, IN CLASS 1 (U.S. CLS. 1, 5, 6, 10, 26 AND 46).

FIRST USE 11-0-2006; IN COMMERCE 11-0-2006.

OWNER OF U.S. REG. NOS. 834,188, 931,054, AND OTHERS.

THE COLOR(S) GREEN AND RED IS/ARE CLAIMED AS A FEATURE OF THE MARK.

THE MARK CONSISTS OF THE DOT OVER THE LETTER "I" IS IN RED, AND THE REMAINDER OF THE WORD "JIFFY" IS IN GREEN.

SN 78-743,753, FILED 10-31-2005.

JENNIFER VASQUEZ, EXAMINING ATTORNEY

**Int. Cl.: 25**

**Prior U.S. Cls.: 22 and 39**

**United States Patent and Trademark Office**

**Reg. No. 3,396,057**

**Registered Mar. 11, 2008**

**TRADEMARK  
PRINCIPAL REGISTER**



GANDER MOUNTAIN COMPANY (MINNESOTA CORPORATION)  
SUITE 1300  
180 EAST FIFTH STREET  
ST. PAUL, MN 55101

FOR: CLOTHING, NAMELY, COATS, JACKETS, PARKAS, OVERALLS, PANTS, SHIRTS, GLOVES AND MITTENS; RAINWEAR; HEADWEAR; FOOTWEAR, IN CLASS 25 (U.S. CLS. 22 AND 39).

FIRST USE 1-31-2005; IN COMMERCE 1-31-2005.

OWNER OF U.S. REG. NOS. 2,659,032, 2,810,950, AND OTHERS.

NO CLAIM IS MADE TO THE EXCLUSIVE RIGHT TO USE "SERIES", APART FROM THE MARK AS SHOWN.

THE MARK CONSISTS OF THE TERM "GUIDE" WITH A LINE BELOW AND THE TERM "SERIES" BELOW THE LINE AND THE DESIGN OF A FLYING GOOSE OVER MOUNTAIN WITHIN A CIRCLE TO THE RIGHT OF THE WORDS.

SN 78-744,655, FILED 11-1-2005.

GIANCARLO CASTRO, EXAMINING ATTORNEY

Int. Cl.: 25

Prior U.S. Cls.: 22 and 39

United States Patent and Trademark Office

Reg. No. 3,396,058

Registered Mar. 11, 2008

TRADEMARK  
PRINCIPAL REGISTER



KRULL, PATRICIA, N (UNITED STATES INDIVIDUAL)  
8039 LT. WM. CLARK RD.  
PARKER, CO 80134

FOR: ANKLE BOOTS; ANKLE GARTERS; ANKLE SOCKS; BERMUDA SHORTS; BOXER SHORTS; BRAS; BRIEFS ; CAPRI PANTS; CROP TOPS; DENIMS; FLEECE SHORTS; GYM SHORTS; HALTER TOPS; HAT BANDS; HATS; HEADWEAR; JOGGING PANTS; LADIES' UNDERWEAR; LEATHER PANTS; LINGERIE; PANTIES; PANTS; SHORT SETS; SHORT TROUSERS; SHORT-SLEEVED OR LONG-SLEEVED T-SHIRTS; SHORT-SLEEVED SHIRTS; SKI PANTS; SKIRT SUITS; SKIRTS; DRESSES; SMALL HATS; STRAPLESS BRAS; SWEAT PANTS; SWEAT SHORTS; TANK TOPS; THONGS; TOPS; UNDERWEAR; WALKING SHORTS; WOMEN'S UNDERWEAR; WRIST BANDS, IN CLASS 25 (U.S. CLS. 22 AND 39).

FIRST USE 1-15-2006; IN COMMERCE 1-15-2006.

NO CLAIM IS MADE TO THE EXCLUSIVE RIGHT TO USE "THE SQUEEZE BRA" AND "FASH-

IONS & DESIGNS", APART FROM THE MARK AS SHOWN.

THE COLORS HOT PINK AND WHITE ARE CLAIMED AS FEATURES OF THE MARK.

THE MARK CONSISTS OF THE STYLIZED WORDING "THE SQUEEZE, THE SQUEEZE BRA, FASHIONS AND DESIGNS" DISPLAYED IN HOT PINK COLOR AGAINST A WHITE BACKGROUND; THE STYLIZED LETTER "W" IN THE TERM "SQUEEZE" IS DISPLAYED IN A FONT THAT DIFFERS FROM THE OTHER LETTERS IN THE TERM; THE LETTER "W" IS DISPLAYED IN A FONT THAT DIFFERS FROM THE OTHER LETTERS IN THE TERM.

SN 78-745,371, FILED 11-2-2005.

CHRISTOPHER BUONGIORNO, EXAMINING ATTORNEY

**Int. Cl.: 36**

**Prior U.S. Cls.: 100, 101, and 102**

**United States Patent and Trademark Office**

**Reg. No. 3,396,059**

**Registered Mar. 11, 2008**

**SERVICE MARK  
PRINCIPAL REGISTER**

**ALARE**

ALARE CAPITAL PARTNERS, LLC (DELAWARE  
LTD LIAB CO)  
14861 NORTH SCOTTSDALE ROAD, SUITE 105  
SCOTTSDALE, AZ 85254

FOR: ADVICE RELATING TO INVESTMENTS;  
BUSINESS BROKERAGE; BUSINESS FINANCE  
PROCUREMENT SERVICES; CAPITAL INVEST-  
MENT CONSULTATION; COMMERCIAL LEND-  
ING SERVICES; EQUITY CAPITAL INVESTMENT;  
FACILITATING AND ARRANGING FOR THE FI-  
NANCING OF LIFE SCIENCE AND BIOTECHNOL-  
OGY COMPANIES; FINANCIAL CONSULTATION;  
FINANCIAL DUE DILIGENCE; FINANCIAL IN-  
VESTMENT IN THE FIELD OF LIFE SCIENCES;  
FINANCIAL RESEARCH; FINANCIAL SERVICES  
IN THE FIELD OF MONEY LENDING; INVEST-  
MENT ADVICE; INVESTMENT BANKING SERVI-  
CES; INVESTMENT CONSULTATION;  
INVESTMENT MANAGEMENT; INVESTMENT  
SERVICES, NAMELY, ASSET ACQUISITION, CON-  
SULTATION, DEVELOPMENT AND MANAGE-  
MENT SERVICES; MANAGEMENT OF CAPITAL  
INVESTMENT FUNDS, INCLUDING VENTURE  
FUNDS, BRIDGE LOAN FUNDS, MEZZANINE

FUNDS AND BUY OUT FUNDS, INCLUDING  
LEVERAGED BUY OUTS AND INVESTMENTS IN  
FINANCIALLY DISTRESSED OR UNDERPER-  
FORMING COMPANIES; PROVIDING WORKING  
CAPITAL; VENTURE CAPITAL FUNDING SERVI-  
CES TO EMERGING AND START-UP COMPANIES;  
VENTURE CAPITAL SERVICES, NAMELY, PRO-  
VIDING FINANCING TO EMERGING AND START-  
UP COMPANIES, IN CLASS 36 (U.S. CLS. 100, 101  
AND 102).

FIRST USE 5-28-2006; IN COMMERCE 5-28-2006.

THE MARK CONSISTS OF STANDARD CHAR-  
ACTERS WITHOUT CLAIM TO ANY PARTICULAR  
FONT, STYLE, SIZE, OR COLOR.

THE FOREIGN WORDING IN THE MARK  
TRANSLATES INTO ENGLISH AS WING.

SN 78-745,545, FILED 11-2-2005.

REBECCA SMITH, EXAMINING ATTORNEY

**Int. Cl.: 33**

**Prior U.S. Cls.: 47 and 49**

**United States Patent and Trademark Office**

**Reg. No. 3,396,060**

**Registered Mar. 11, 2008**

**TRADEMARK  
PRINCIPAL REGISTER**

**Khor**

S&S SPIRITS L.L.C. (ARIZONA LTD LIAB CO)  
4818 E BROADWAY  
TUCSON, AZ 85711

THE MARK CONSISTS OF STANDARD CHAR-  
ACTERS WITHOUT CLAIM TO ANY PARTICULAR  
FONT, STYLE, SIZE, OR COLOR.

FOR: DISTILLED SPIRITS; VODKA, IN CLASS 33  
(U.S. CLS. 47 AND 49).

SN 78-746,346, FILED 11-3-2005.

FIRST USE 3-13-2006; IN COMMERCE 5-5-2007.

TANYA AMOS, EXAMINING ATTORNEY

**Int. Cls.: 9, 16, and 41**

**Prior U.S. Cls.: 2, 5, 21, 22, 23, 26, 29, 36, 37, 38, 50,  
100, 101, and 107**

**Reg. No. 3,396,061**

**United States Patent and Trademark Office**

**Registered Mar. 11, 2008**

**TRADEMARK  
SERVICE MARK  
PRINCIPAL REGISTER**

**WILD SCOTCHMEN**

WILD SCOTSMAN WHISKY AND SPIRITS LIM-  
ITED (OHIO LTD LIAB CO)  
P.O. BOX 36399  
CINCINNATI, OH 45236

FOR: CINEMATOGRAPHIC FILMS FEATURING  
ANECDOTES, ETIQUETTE, SOCIAL CULTURE,  
AND COCKTAIL TECHNIQUES AND RECIPES  
RELATING TO SCOTCH WHISKY, IN CLASS 9  
(U.S. CLS. 21, 23, 26, 36 AND 38).

FIRST USE 10-10-2006; IN COMMERCE 10-10-2006.

FOR: NEWSLETTERS IN THE FIELD OF SCOTCH  
WHISKY RELATING ANECDOTES, ETIQUETTE,  
SOCIAL CULTURE, COCKTAIL MAKING TECHNI-  
QUES AND RECIPES, IN CLASS 16 (U.S. CLS. 2, 5, 22,  
23, 29, 37, 38 AND 50).

FIRST USE 12-12-2006; IN COMMERCE 12-12-2006.

FOR: ENTERTAINMENT SERVICES, NAMELY,  
PERSONAL APPEARANCES BY COSTUMED PER-  
SONAGES IN CHARACTER FEATURING SCOTCH  
WHISKY TASTINGS, COCKTAIL MAKING, RE-  
CIPES, ANECDOTES, SOCIAL CULTURE, NEWS  
AND INFORMATION RELATING TO SCOTCH  
WHISKY, IN CLASS 41 (U.S. CLS. 100, 101 AND 107).

FIRST USE 11-28-2005; IN COMMERCE 11-28-2005.

THE MARK CONSISTS OF STANDARD CHAR-  
ACTERS WITHOUT CLAIM TO ANY PARTICULAR  
FONT, STYLE, SIZE, OR COLOR.

SN 78-747,865, FILED 11-4-2005.

KARANENDRA S. CHHINA, EXAMINING ATTOR-  
NEY

**Int. Cl.: 5**

**Prior U.S. Cls.: 6, 18, 44, 46, 51, and 52**

**Reg. No. 3,396,062**

**United States Patent and Trademark Office**

**Registered Mar. 11, 2008**

---

**TRADEMARK  
PRINCIPAL REGISTER**

**CARDIO-E**

SOURCE ONE GLOBAL PARTNERS, LLC (ILLI-  
NOIS LTD LIAB CO)  
2723 NORTH HERMITAGE AVENUE  
CHICAGO, IL 60614

THE MARK CONSISTS OF STANDARD CHAR-  
ACTERS WITHOUT CLAIM TO ANY PARTICULAR  
FONT, STYLE, SIZE, OR COLOR.

FOR: DIETARY SUPPLEMENTS, IN CLASS 5 (U.S.  
CLS. 6, 18, 44, 46, 51 AND 52).

SN 78-748,167, FILED 11-7-2005.

FIRST USE 10-20-2006; IN COMMERCE 10-20-2006.

JULIE WATSON, EXAMINING ATTORNEY

**Int. Cls.: 1 and 2**

**Prior U.S. Cls.: 1, 5, 6, 10, 11, 16, 26, and 46**

**United States Patent and Trademark Office**

**Reg. No. 3,396,063**

**Registered Mar. 11, 2008**

**TRADEMARK  
PRINCIPAL REGISTER**

**OMYA**

OMYA AG (SWITZERLAND AKTIENGESELL-  
SCHAFT (AG))  
BASLERSTR, 42  
OFTRINGEN/ARGAU, SWITZERLAND 4665

FOR: CHEMICALS FOR USE IN THE MANUFAC-  
TURE OF PLASTICS, PAPER, PIGMENTS, INDIA  
RUBBER, RUBBER, FOOD, PHARMACEUTICALS,  
AND COSMETICS; CALCIUM CARBONATE; CON-  
CRETE ADDITIVES AND CONCRETE ADMIX-  
TURES, IN CLASS 1 (U.S. CLS. 1, 5, 6, 10, 26 AND 46).

FIRST USE 1-1-1977; IN COMMERCE 1-1-1977.

FOR: PIGMENTS AND COLORANTS, IN CLASS 2  
(U.S. CLS. 6, 11 AND 16).

FIRST USE 1-1-1977; IN COMMERCE 1-1-1977.

THE MARK CONSISTS OF STANDARD CHAR-  
ACTERS WITHOUT CLAIM TO ANY PARTICULAR  
FONT, STYLE, SIZE, OR COLOR.

OWNER OF ERPN CMNTY TM OFC REG. NO.  
0006397999, DATED 11-10-1999, EXPIRES 9-16-2017.

OWNER OF U.S. REG. NOS. 2,502,000, 2,932,264,  
AND 3,029,665.

SN 78-748,405, FILED 11-7-2005.

JULIE WATSON, EXAMINING ATTORNEY



Int. Cl.: 37

Prior U.S. Cls.: 100, 103, and 106

United States Patent and Trademark Office

Reg. No. 3,396,064

Registered Mar. 11, 2008

SERVICE MARK  
PRINCIPAL REGISTER



H.M. GEIGER, INC (TENNESSEE CORPORATION)  
6019 SHALLOWFORD ROAD  
CHATTANOOGA, TN 37421

FOR: PAINTING OF AUTOMOBILES, TRUCKS AND OTHER VEHICLES; AND BODY REPAIR AND FINISHING OF AUTOMOBILES, TRUCKS AND OTHER VEHICLES FOR OTHERS, IN CLASS 37 (U.S. CLS. 100, 103 AND 106).

FIRST USE 11-1-2006; IN COMMERCE 11-1-2006.

NO CLAIM IS MADE TO THE EXCLUSIVE RIGHT TO USE "AUTO PAINTING", APART FROM THE MARK AS SHOWN.

THE COLORS GREEN, PEACH AND WHITE ARE CLAIMED AS A FEATURE OF THE MARK.

THE COLOR GREEN APPEARS IN THE LEAFY PORTION OF THE TREE, THE OUTLINE OF THE TRUNK OF THE TREE, IN THE GRASS AT THE BASE OF THE TREE AND IN THE WORDING "AUTO PAINTING"; THE COLOR PEACH APPEARS IN THE WORDING "PEACHTREE", IN THE TRUNK OF THE TREE AND IN THE PEACHES ON THE TREE; AND THE COLOR WHITE APPEARS AS BACKGROUND IN THE MARK.

SN 78-748,834, FILED 11-7-2005.

BILL DAWE, EXAMINING ATTORNEY

**Int. Cl.: 9**

**Prior U.S. Cls.: 21, 23, 26, 36, and 38**

**United States Patent and Trademark Office**

**Reg. No. 3,396,065**

**Registered Mar. 11, 2008**

**TRADEMARK  
PRINCIPAL REGISTER**

**INNOVATION THROUGH  
TECHNOLOGY**

MICREL, INCORPORATED (CALIFORNIA CORPORATION)  
1849 FORTUNE DRIVE  
SAN JOSE, CA 95131

THE MARK CONSISTS OF STANDARD CHARACTERS WITHOUT CLAIM TO ANY PARTICULAR FONT, STYLE, SIZE, OR COLOR.

FOR: SEMICONDUCTOR DEVICES AND INTEGRATED CIRCUITS, IN CLASS 9 (U.S. CLS. 21, 23, 26, 36 AND 38).

SN 78-748,906, FILED 11-7-2005.

FIRST USE 1-24-2007; IN COMMERCE 1-24-2007.

EVELYN BRADLEY, EXAMINING ATTORNEY

**Int. Cl.: 41**

**Prior U.S. Cls.: 100, 101, and 107**

**United States Patent and Trademark Office**

**Reg. No. 3,396,066**

**Registered Mar. 11, 2008**

**SERVICE MARK  
PRINCIPAL REGISTER**

**RALLY MONDAY**

MAJOR LEAGUE BASEBALL PROPERTIES, INC.  
(NEW YORK CORPORATION)  
245 PARK AVENUE  
NEW YORK, NY 10167

FOR: ENTERTAINMENT SERVICES, NAMELY, BASEBALL GAMES, COMPETITIONS AND EXHIBITIONS RENDERED LIVE AND THROUGH BROADCAST MEDIA INCLUDING TELEVISION AND RADIO, AND VIA A GLOBAL COMPUTER NETWORK OR A COMMERCIAL ON-LINE SERVICE; INFORMATION SERVICES, NAMELY, PROVIDING INFORMATION IN THE FIELD OF SPORTS, ENTERTAINMENT AND RELATED TOPICS, AND PROVIDING FOR INFORMATIONAL MESSAGES RELATING THERETO; ENTERTAINMENT SERVICES, NAMELY, PRODUCTION OF PROGRAMMING BROADCAST VIA TELEVISION, RADIO AND A GLOBAL COMPUTER NETWORK OR A COMMERCIAL ON-LINE SERVICE; ORGANIZING

COMMUNITY SPORTING EVENTS; ORGANIZING AND CONDUCTING SPORTS CONTESTS AND SWEEPSTAKES, IN CLASS 41 (U.S. CLS. 100, 101 AND 107).

FIRST USE 10-4-2004; IN COMMERCE 10-4-2004.

THE MARK CONSISTS OF STANDARD CHARACTERS WITHOUT CLAIM TO ANY PARTICULAR FONT, STYLE, SIZE, OR COLOR.

NO CLAIM IS MADE TO THE EXCLUSIVE RIGHT TO USE "RALLY", APART FROM THE MARK AS SHOWN.

SN 78-750,708, FILED 11-9-2005.

ELLEN PERKINS, EXAMINING ATTORNEY

**Int. Cl.: 41**

**Prior U.S. Cls.: 100, 101, and 107**

**United States Patent and Trademark Office**

**Reg. No. 3,396,067**

**Registered Mar. 11, 2008**

**SERVICE MARK  
PRINCIPAL REGISTER**

**MLB DELIVERY MAN OF THE  
YEAR AWARD**

MAJOR LEAGUE BASEBALL PROPERTIES, INC.  
(NEW YORK CORPORATION)  
245 PARK AVENUE  
NEW YORK, NY 10167

FOR: ENTERTAINMENT SERVICES, NAMELY, BASEBALL GAMES, COMPETITIONS AND EXHIBITIONS RENDERED LIVE AND THROUGH BROADCAST MEDIA INCLUDING TELEVISION AND RADIO, AND VIA A GLOBAL COMPUTER NETWORK OR A COMMERCIAL ON-LINE SERVICE; INFORMATION SERVICES, NAMELY, PROVIDING INFORMATION IN THE FIELD OF SPORTS, ENTERTAINMENT AND RELATED TOPICS, AND PROVIDING FOR INFORMATIONAL MESSAGES RELATING THERETO; ORGANIZING AND CONDUCTING SPORTS CONTESTS AND SWEEPSTAKES; PROVIDING RECOGNITION AND INCENTIVES BY THE WAY OF AWARDS TO DEMONSTRATE EXCELLENCE IN THE FIELD OF

BASEBALL, IN CLASS 41 (U.S. CLS. 100, 101 AND 107).

FIRST USE 3-31-2005; IN COMMERCE 3-31-2005.

THE MARK CONSISTS OF STANDARD CHARACTERS WITHOUT CLAIM TO ANY PARTICULAR FONT, STYLE, SIZE, OR COLOR.

OWNER OF U.S. REG. NOS. 2,779,958, 2,971,015, AND OTHERS.

NO CLAIM IS MADE TO THE EXCLUSIVE RIGHT TO USE "MAN OF THE YEAR AWARD", APART FROM THE MARK AS SHOWN.

SN 78-750,720, FILED 11-9-2005.

KELLY BOULTON, EXAMINING ATTORNEY

**Int. Cl.: 35**

**Prior U.S. Cls.: 100, 101, and 102**

**United States Patent and Trademark Office**

**Reg. No. 3,396,068**

**Registered Mar. 11, 2008**

**SERVICE MARK  
PRINCIPAL REGISTER**

**BAGSBUY.COM**

SHOEBUY.COM INC (DELAWARE CORPORATION)  
16TH FLOOR  
101 ARCH STREET  
BOSTON, MA 02110

FOR: COMPUTERIZED ON-LINE RETAIL STORE SERVICES FEATURING BAGS, NAMELY, HANDBAGS, GARMENT BAGS, SLINGS, BACKPACKS, TOTE BAGS, TOILETRY BAGS, DAYPACKS, DUFFLE BAGS, SPORTS BAGS, DIAPER BAGS, COMPUTER BAGS, LUGGAGE, SUITCASES, ORGANIZERS, WALLETS, BRIEFCASES, BAG ACCESSORIES, AND TRAVEL ACCESSORIES, IN CLASS 35 (U.S. CLS. 100, 101 AND 102).

FIRST USE 10-1-2005; IN COMMERCE 10-1-2005.

THE MARK CONSISTS OF STANDARD CHARACTERS WITHOUT CLAIM TO ANY PARTICULAR FONT, STYLE, SIZE, OR COLOR.

OWNER OF U.S. REG. NOS. 2,518,099 AND 2,871,916.

SN 78-751,084, FILED 11-10-2005.

SHANNON TWOHIG, EXAMINING ATTORNEY

**Int. Cl.: 35**

**Prior U.S. Cls.: 100, 101, and 102**

**United States Patent and Trademark Office**

**Reg. No. 3,396,069**

**Registered Mar. 11, 2008**

**SERVICE MARK  
PRINCIPAL REGISTER**

**BAGSBUY**

SHOEBUY.COM INC (DELAWARE CORPORATION)  
16TH FLOOR  
101 ARCH STREET  
BOSTON, MA 02110

FOR: COMPUTERIZED ON-LINE RETAIL STORE SERVICES FEATURING BAGS, NAMELY, HANDBAGS, GARMENT BAGS, SLINGS, BACKPACKS, TOTE BAGS, TOILETRY BAGS, DAYPACKS, DUFFLE BAGS, SPORTS BAGS, DIAPER BAGS, COMPUTER BAGS, LUGGAGE, SUITCASES, ORGANIZERS, WALLETS, BRIEFCASES, BAG ACCESSORIES, AND TRAVEL ACCESSORIES, IN CLASS 35 (U.S. CLS. 100, 101 AND 102).

FIRST USE 10-1-2005; IN COMMERCE 10-1-2005.

THE MARK CONSISTS OF STANDARD CHARACTERS WITHOUT CLAIM TO ANY PARTICULAR FONT, STYLE, SIZE, OR COLOR.

OWNER OF U.S. REG. NOS. 2,518,099 AND 2,871,916.

SN 78-751,110, FILED 11-10-2005.

SHANNON TWOHIG, EXAMINING ATTORNEY

**Int. Cl.: 30**

**Prior U.S. Cl.: 46**

**United States Patent and Trademark Office**

**Reg. No. 3,396,070**

**Registered Mar. 11, 2008**

**TRADEMARK  
PRINCIPAL REGISTER**

**ASIAN ZING**

BUFFALO WILD WINGS, INC. (MINNESOTA  
CORPORATION)  
SUITE 700  
1600 UTICA AVENUE SOUTH  
MINNEAPOLIS, MN 55416

FOR: FLAVORED SAUCES, IN CLASS 30 (U.S. CL.  
46).

FIRST USE 2-28-2006; IN COMMERCE 2-28-2006.

THE MARK CONSISTS OF STANDARD CHAR-  
ACTERS WITHOUT CLAIM TO ANY PARTICULAR  
FONT, STYLE, SIZE, OR COLOR.

NO CLAIM IS MADE TO THE EXCLUSIVE  
RIGHT TO USE "ASIAN", APART FROM THE  
MARK AS SHOWN.

SN 78-751,315, FILED 11-10-2005.

DANNEAN HETZEL, EXAMINING ATTORNEY

**Int. Cl.: 35**

**Prior U.S. Cls.: 100, 101, and 102**

**United States Patent and Trademark Office**

**Reg. No. 3,396,071**

**Registered Mar. 11, 2008**

**SERVICE MARK  
PRINCIPAL REGISTER**

**BRANDWORTH**

THE TRACEY EDWARDS COMPANY, INC.  
(NEW HAMPSHIRE CORPORATION)  
900 ELM STREET, 8TH FLOOR  
MANCHESTER, NH 03105

FOR: ADVERTISING AGENCY SERVICES; BUSINESS CONSULTING SERVICES IN THE FIELD OF MARKETING, ADVERTISING AND SALES; ADVERTISING CONSULTANCY; BRAND CONSULTATION; ADVERTISING SERVICES, NAMELY, CREATING BRAND AND CORPORATE IDENTITY FOR OTHERS, IN CLASS 35 (U.S. CLS. 100, 101 AND 102).

FIRST USE 10-10-2007; IN COMMERCE 10-10-2007.

THE MARK CONSISTS OF STANDARD CHARACTERS WITHOUT CLAIM TO ANY PARTICULAR FONT, STYLE, SIZE, OR COLOR.

SN 78-751,533, FILED 11-10-2005.

BILL DAWE, EXAMINING ATTORNEY



**Int. Cls.: 38 and 45**

**Prior U.S. Cls.: 100, 101, and 104**

**United States Patent and Trademark Office**

**Reg. No. 3,396,072**

**Registered Mar. 11, 2008**

**SERVICE MARK  
PRINCIPAL REGISTER**

**DATOPIA**

FIRST MEDIA GROUP INC. (CANADA CORPORATION)  
536 KIPLING AVENUE  
TORONTO, CANADA M8Z 5E3

FOR: PROVIDING ON-LINE CHAT ROOMS FOR TRANSMISSION OF MESSAGES AMONG COMPUTER USERS IN THE FIELD OF DATING, FRIENDSHIP AND GENERAL INTEREST , IN CLASS 38 (U.S. CLS. 100, 101 AND 104).

FIRST USE 10-31-2006; IN COMMERCE 10-31-2006.

FOR: TELEPHONE DATING SERVICES; COMPUTER DATING SERVICES ACCESSIBLE BY GLOBAL

COMPUTER NETWORK, IN CLASS 45 (U.S. CLS. 100 AND 101).

FIRST USE 10-31-2006; IN COMMERCE 10-31-2006.

THE MARK CONSISTS OF STANDARD CHARACTERS WITHOUT CLAIM TO ANY PARTICULAR FONT, STYLE, SIZE, OR COLOR.

SN 78-751,643, FILED 11-10-2005.

STEVEN PEREZ, EXAMINING ATTORNEY

**Int. Cls.: 35 and 42**

**Prior U.S. Cls.: 100, 101, and 102**

**United States Patent and Trademark Office**

**Reg. No. 3,396,073**

**Registered Mar. 11, 2008**

**SERVICE MARK  
PRINCIPAL REGISTER**

**Affinitive**

AFFINITIVE LLC (NEW YORK LIMITED LIABILITY COMPANY)  
135 WEST 26TH STREET, 8TH FLOOR  
NEW YORK, NY 10001

FOR: BUSINESS MARKETING SERVICES; ADVERTISING AND PROMOTION OF GOODS AND SERVICES OF OTHERS; MARKET RESEARCH; DATABASE MARKETING SERVICES; CUSTOMER RELATIONSHIP MANAGEMENT; GRASS ROOTS MARKETING CAMPAIGNS FOR OTHERS ARRANGED VIA THE INTERNET; ORGANIZATION AND AUTOMATION OF DIRECT CONSUMER-TO-CONSUMER MARKETING CAMPAIGNS VIA THE INTERNET; PROMOTIONAL MARKETING SERVICES; DIRECT MARKETING SERVICES; ORGANIZING AND FACILITATING AN ONLINE FORUM OF CONSUMER BASED MARKETERS FOR THE PROMOTION OF NEW PRODUCTS AND SERVICES OF OTHERS; CONDUCTING MARKETING STUDIES AND CONSUMER RESEARCH; DEVELOPING PROMOTIONAL CAMPAIGNS FOR BUSINESSES; PROMOTING THE GOODS AND SERVICES OF OTHERS BY MEANS OF A CUSTOMER ONLINE PROGRAM FEATURING CONSUMER-TO-CONSUMER COMMUNICATIONS AND CONSUMER-TO-BUSINESS FEEDBACK COMMUNICATIONS; PROMOTING THE GOODS AND SERVICES OF OTHERS BY MEANS OF WORD-OF-MOUTH AND NONTRADITIONAL MARKETING PRO-

GRAMS; PROVIDING INFORMATION ABOUT THE GOODS AND SERVICES OF OTHERS VIA THE INTERNET, IN CLASS 35 (U.S. CLS. 100, 101 AND 102).

FIRST USE 12-1-2005; IN COMMERCE 1-1-2006.

FOR: APPLICATION SERVICE PROVIDER (ASP) FEATURING PROGRAM MANAGEMENT SOFTWARE IN THE FIELD OF WORD-OF-MOUTH AND BUSINESS MARKETING SERVICES, IN CLASS 42 (U.S. CLS. 100 AND 101).

FIRST USE 12-1-2005; IN COMMERCE 1-1-2006.

THE COLOR(S) GRAY AND ORANGE IS/ARE CLAIMED AS A FEATURE OF THE MARK.

THE COLOR ORANGE APPEARS IN THE EXCLAMATION POINT AND THE COLOR GRAY APPEARS IN THE REMAINING LETTERS OF THE WORD "AFFINITIVE".

SN 78-752,122, FILED 11-11-2005.

DANNEAN HETZEL, EXAMINING ATTORNEY

**Int. Cl.: 11**

**Prior U.S. Cls.: 13, 21, 23, 31, and 34**

**United States Patent and Trademark Office**

**Reg. No. 3,396,074**

**Registered Mar. 11, 2008**

**TRADEMARK  
PRINCIPAL REGISTER**

**MOVING REHABILITATION  
FORWARD**

ENCORE MEDICAL ASSET CORPORATION (NE-  
VADA CORPORATION)  
PO BOX 530759  
HENDERSON, NV 890530759

THE MARK CONSISTS OF STANDARD CHAR-  
ACTERS WITHOUT CLAIM TO ANY PARTICULAR  
FONT, STYLE, SIZE, OR COLOR.

FOR: CABINETS FOR HEATING AND COOLING  
THERAPEUTIC PACKS, IN CLASS 11 (U.S. CLS. 13,  
21, 23, 31 AND 34).

SN 78-752,696, FILED 11-12-2005.

FIRST USE 11-30-2007; IN COMMERCE 11-30-2007.

KELLY BOULTON, EXAMINING ATTORNEY

**Int. Cl.: 42**

**Prior U.S. Cls.: 100 and 101**

**United States Patent and Trademark Office**

**Reg. No. 3,396,075**

**Registered Mar. 11, 2008**

**SERVICE MARK  
PRINCIPAL REGISTER**

# AlphaSimplex

WINNINGHAM, HORACE G (UNITED STATES  
INDIVIDUAL)  
POB 265, 3610 CR 405  
ANDERSON, TX 77830

FOR: DESIGN ENGINEERING FOR OTHERS OF  
CRYOGENIC FACILITIES AND PROCESSES,  
NAMELY THE CUSTOM DESIGN AND ENGINEER-  
ING OF CRYOGENIC RECEIVING AND REGASI-  
FICATION TERMINAL FACILITIES AND  
FACILITIES FOR RECEIVING, STORING, SHIP-  
PING, DISTRIBUTING, OR VAPORIZING LIQUE-  
FIED NATURAL GAS AND THE CUSTOM DESIGN  
AND ENGINEERING OF CRYOGENIC ETHANE  
AND HEAVIER HYDROCARBON RECOVERY,  
AND THE CUSTOM DESIGN AND ENGINEERING  
OF CRYOGENIC RECEIVING AND REGASIFICA-

TION TERMINAL FACILITIES AND FACILITIES  
FOR CONDITIONING RICH LIQUEFIED NATUR-  
AL GAS TO MAKE LEAN LIQUEFIED NATURAL  
GAS PROCESSES FOR THE LIQUEFIED NATURAL  
GAS INDUSTRY, IN CLASS 42 (U.S. CLS. 100 AND  
101).

FIRST USE 11-2-2006; IN COMMERCE 1-29-2007.

THE MARK CONSISTS OF STANDARD CHAR-  
ACTERS WITHOUT CLAIM TO ANY PARTICULAR  
FONT, STYLE, SIZE, OR COLOR.

SN 78-752,794, FILED 11-13-2005.

SEAN CROWLEY, EXAMINING ATTORNEY

**Int. Cl.: 25**

**Prior U.S. Cls.: 22 and 39**

**United States Patent and Trademark Office**

**Reg. No. 3,396,076**

**Registered Mar. 11, 2008**

**TRADEMARK  
PRINCIPAL REGISTER**

**JILLYGIRL**

WANSERSKI, JILL (UNITED STATES INDIVIDUAL)  
225 E. 47TH STREET, APT. 4C  
NEW YORK, NY 10010

FOR: CLOTHING, NAMELY, T-SHIRTS, BLOUSES, SHIRTS, TANK SHIRTS, JEANS, PANTS, TROUSERS, SWEATERS, VESTS, DRESSES, SKIRTS, JACKETS, COATS, HATS, IN CLASS 25 (U.S. CLS. 22 AND 39).

FIRST USE 7-31-2005; IN COMMERCE 7-31-2005.

THE MARK CONSISTS OF STANDARD CHARACTERS WITHOUT CLAIM TO ANY PARTICULAR FONT, STYLE, SIZE, OR COLOR.

SN 78-753,342, FILED 11-14-2005.

JANICE KIM, EXAMINING ATTORNEY

**Int. Cl.: 3**

**Prior U.S. Cls.: 1, 4, 6, 50, 51, and 52**

**United States Patent and Trademark Office**

**Reg. No. 3,396,077**

**Registered Mar. 11, 2008**

**TRADEMARK  
PRINCIPAL REGISTER**

**SOOTHE WIPES**

L. PERRIGO COMPANY (MICHIGAN CORPORATION)

117 WATER STREET

ALLEGAN, MI 49010

FOR: DISPOSABLE WIPES FOR PERSONAL HYGIENE, IN CLASS 3 (U.S. CLS. 1, 4, 6, 50, 51 AND 52).

FIRST USE 10-3-2006; IN COMMERCE 10-3-2006.

THE MARK CONSISTS OF STANDARD CHARACTERS WITHOUT CLAIM TO ANY PARTICULAR FONT, STYLE, SIZE, OR COLOR.

NO CLAIM IS MADE TO THE EXCLUSIVE RIGHT TO USE "WIPES", APART FROM THE MARK AS SHOWN.

SN 78-755,054, FILED 11-16-2005.

ZACHARY BELLO, EXAMINING ATTORNEY

**Int. Cl.: 5**

**Prior U.S. Cls.: 6, 18, 44, 46, 51, and 52**

**Reg. No. 3,396,078**

**United States Patent and Trademark Office**

**Registered Mar. 11, 2008**

---

**TRADEMARK  
PRINCIPAL REGISTER**

**KITCHENSAFE**

ST. GABRIEL LABORATORIES, LLC (VIRGINIA  
LTD LIAB CO)  
14044 LITCHFIELD DRIVE  
ORANGE, VA 22960

THE MARK CONSISTS OF STANDARD CHAR-  
ACTERS WITHOUT CLAIM TO ANY PARTICULAR  
FONT, STYLE, SIZE, OR COLOR.

FOR: INSECTICIDE FOR HOME USE, IN CLASS 5  
(U.S. CLS. 6, 18, 44, 46, 51 AND 52).

SN 78-756,018, FILED 11-17-2005.

FIRST USE 3-31-2006; IN COMMERCE 10-20-2006.

CHARLES L. JENKINS, EXAMINING ATTORNEY

**Int. Cl.: 3**

**Prior U.S. Cls.: 1, 4, 6, 50, 51, and 52**

**Reg. No. 3,396,079**

**United States Patent and Trademark Office**

**Registered Mar. 11, 2008**

**TRADEMARK  
PRINCIPAL REGISTER**



CORAL HEAD, INC. (CALIFORNIA CORPORATION)  
1988 W. 169TH STREET  
GARDENA, CA 90247

FIRST USE 6-9-2006; IN COMMERCE 6-9-2006.

OWNER OF U.S. REG. NOS. 1,377,301, 2,475,043,  
AND OTHERS.

FOR: SUNCARE PRODUCTS, NAMELY, SUNSCREEN AND SUN BLOCK PREPARATIONS; TANNING LOTIONS, CREAMS, OILS, SPRAYS, AND STICKS; AFTER-SUN CREAMS AND LOTIONS; SKIN MOISTURIZERS AND LIP BALM; PATCHES CONTAINING SUNSCREEN AND SUN BLOCK FOR USE ON THE SKIN, IN CLASS 3 (U.S. CLS. 1, 4, 6, 50, 51 AND 52).

THE MARK CONSISTS OF THE HAWAIIAN SUN, A VOLCANIC ERUPTION, THE HAWAIIAN ISLAND AND THE SURF.

SN 78-756,096, FILED 11-17-2005.

DAVID HOFFMAN, EXAMINING ATTORNEY



**Int. Cls.: 21 and 25**

**Prior U.S. Cls.: 2, 13, 22, 23, 29, 30, 33, 39, 40, and 50**

**United States Patent and Trademark Office**

**Reg. No. 3,396,080**

**Registered Mar. 11, 2008**

**TRADEMARK  
PRINCIPAL REGISTER**

**ENVISION STUDIO**

SHOPKO STORES OPERATING CO., LLC (DELA-  
WARE LTD LIAB CO)  
700 PILGRIM WAY  
GREEN BAY, WI 54304

FOR: GLASS AND PLASTIC BEVERAGE WARE,  
GLASS AND PLASTIC SERVING BOWLS; CANDLE  
HOLDERS NOT OF PRECIOUS METAL; PLATES,  
CUPS, SOUP BOWLS, AND MUGS, IN CLASS 21 (U.S.  
CLS. 2, 13, 23, 29, 30, 33, 40 AND 50).

FIRST USE 2-4-2007; IN COMMERCE 2-4-2007.

FOR: WOMEN'S APPAREL, NAMELY, PANTS, IN  
CLASS 25 (U.S. CLS. 22 AND 39).

FIRST USE 8-1-2006; IN COMMERCE 8-1-2006.

THE MARK CONSISTS OF STANDARD CHAR-  
ACTERS WITHOUT CLAIM TO ANY PARTICULAR  
FONT, STYLE, SIZE, OR COLOR.

NO CLAIM IS MADE TO THE EXCLUSIVE  
RIGHT TO USE "STUDIO" IN CLASS 025, APART  
FROM THE MARK AS SHOWN.

SN 78-757,090, FILED 11-18-2005.

CURTIS FRENCH, EXAMINING ATTORNEY

**Int. Cl.: 3**

**Prior U.S. Cls.: 1, 4, 6, 50, 51, and 52**

**United States Patent and Trademark Office**

**Reg. No. 3,396,081**

**Registered Mar. 11, 2008**

**TRADEMARK  
PRINCIPAL REGISTER**

**(VOLUM)OLOGIE**

THE PROCTER & GAMBLE COMPANY (OHIO  
CORPORATION)  
ONE PROCTER & GAMBLE PLAZA  
CINCINNATI, OH 45202

THE MARK CONSISTS OF STANDARD CHAR-  
ACTERS WITHOUT CLAIM TO ANY PARTICULAR  
FONT, STYLE, SIZE, OR COLOR.

FOR: HAIR CARE PREPARATIONS, IN CLASS 3  
(U.S. CLS. 1, 4, 6, 50, 51 AND 52).

SN 78-757,376, FILED 11-18-2005.

FIRST USE 11-13-2006; IN COMMERCE 11-13-2006.

ROSELLE HERRERA, EXAMINING ATTORNEY

**Int. Cl.: 9**

**Prior U.S. Cls.: 21, 23, 26, 36, and 38**

**Reg. No. 3,396,082**

**United States Patent and Trademark Office**

**Registered Mar. 11, 2008**

**TRADEMARK  
PRINCIPAL REGISTER**

**iGMind**

4028546 CANADA INC. (CANADA CORPORATION)  
2381 BRISTOL CIRCLE  
UNIT B-203  
OAKVILLE, ONTARIO L6H 5S9

FOR: COMPUTER SOFTWARE CONSISTING OF A PROCESSING ENGINE USED TO PROVIDE GAMING STATISTICAL BEHAVIORAL ANALYSIS OF PLAYER GAME DATA INFORMATION AND TRENDS FROM SLOT MACHINES, TABLE GAME DATA AND OTHER CASINO SYSTEMS, IN CLASS 9 (U.S. CLS. 21, 23, 26, 36 AND 38).

FIRST USE 10-6-2006; IN COMMERCE 10-6-2006.

THE MARK CONSISTS OF STANDARD CHARACTERS WITHOUT CLAIM TO ANY PARTICULAR FONT, STYLE, SIZE, OR COLOR.

PRIORITY CLAIMED UNDER SEC. 44(D) ON CANADA APPLICATION NO. 1279960, FILED 11-17-2005, REG. NO. TMA675377, DATED 10-20-2006, EXPIRES 10-20-2021.

SN 78-757,402, FILED 11-18-2005.

LAURIE KAUFMAN, EXAMINING ATTORNEY

**Int. Cl.: 41**

**Prior U.S. Cls.: 100, 101, and 107**

**United States Patent and Trademark Office**

**Reg. No. 3,396,083**

**Registered Mar. 11, 2008**

**SERVICE MARK  
PRINCIPAL REGISTER**

**ASSOCIA UNIVERSITY**

ASSOCIATIONS, INC. (TEXAS CORPORATION)  
5401 N. CENTRAL EXPWY., SUITE 300  
DALLAS, TX 75205

FOR: EDUCATIONAL SERVICES, NAMELY, ARRANGING AND CONDUCTING ONLINE COURSES OF INSTRUCTION IN THE FIELDS OF BUSINESS SKILLS, COMMUNICATION SKILLS, WRITING SKILLS, HUMAN RESOURCE MANAGEMENT, PERSONAL RELATIONSHIPS, COMPUTER TRAINING, ACCOUNTING AND FINANCE, BUDGET PLANNING, BUILDING AND FACILITY MAINTENANCE, COMMUNITY ASSOCIATION MANAGEMENT, REAL ESTATE, AND REAL ESTATE AND PROPERTY MANAGEMENT, IN CLASS 41 (U.S. CLS. 100, 101 AND 107).

FIRST USE 10-1-2005; IN COMMERCE 10-1-2005.

THE MARK CONSISTS OF STANDARD CHARACTERS WITHOUT CLAIM TO ANY PARTICULAR FONT, STYLE, SIZE, OR COLOR.

NO CLAIM IS MADE TO THE EXCLUSIVE RIGHT TO USE "UNIVERSITY" , APART FROM THE MARK AS SHOWN.

SN 78-757,496, FILED 11-18-2005.

SOPHIA S. KIM, EXAMINING ATTORNEY

**Int. Cl.: 10**

**Prior U.S. Cls.: 26, 39, and 44**

**United States Patent and Trademark Office**

**Reg. No. 3,396,084**

**Registered Mar. 11, 2008**

**TRADEMARK  
PRINCIPAL REGISTER**

**RAPIDSORB**

SYNTHES (U.S.A.) (PENNSYLVANIA PARTNER-  
SHIP)  
1302 WRIGHTS LANE EAST  
WEST CHESTER, PA 19380

FOR: SURGICAL IMPLANTS MADE OF ARTIFI-  
CIAL AND NONLIVING MATERIALS AND IN-  
STRUMENTS FOR GUIDING, INSERTING AND  
SECURING SAID IMPLANTS FOR USE IN SUR-  
GERY FOR FRACTURE AND RECONSTRUCTION  
PROCEDURES CONCERNING THE CRANIOFA-  
CIAL SKELETON, IN CLASS 10 (U.S. CLS. 26, 39  
AND 44).

FIRST USE 10-0-2007; IN COMMERCE 10-0-2007.

THE MARK CONSISTS OF STANDARD CHAR-  
ACTERS WITHOUT CLAIM TO ANY PARTICULAR  
FONT, STYLE, SIZE, OR COLOR.

SN 78-760,069, FILED 11-23-2005.

ROSELLE HERRERA, EXAMINING ATTORNEY

**Int. Cl.: 26**

**Prior U.S. Cls.: 37, 39, 40, 42, and 50**

**United States Patent and Trademark Office**

**Reg. No. 3,396,085**

**Registered Mar. 11, 2008**

**TRADEMARK  
PRINCIPAL REGISTER**

**Starfall**

PANCIL, LLC (CALIFORNIA LTD LIAB CO)  
PO BOX 1046  
LA JOLLA, CA 92038

FOR: SHOE LACES, IN CLASS 26 (U.S. CLS. 37, 39,  
40, 42 AND 50).

FIRST USE 8-10-2007; IN COMMERCE 8-13-2007.

THE MARK CONSISTS OF STANDARD CHAR-  
ACTERS WITHOUT CLAIM TO ANY PARTICULAR  
FONT, STYLE, SIZE, OR COLOR.

OWNER OF U.S. REG. NOS. 2,721,805, 2,883,345,  
AND OTHERS.

SN 78-760,413, FILED 11-23-2005.

HEATHER THOMPSON, EXAMINING ATTORNEY

**Int. Cl.: 9**

**Prior U.S. Cls.: 21, 23, 26, 36, and 38**

**Reg. No. 3,396,086**

**United States Patent and Trademark Office**

**Registered Mar. 11, 2008**

---

**TRADEMARK  
PRINCIPAL REGISTER**

**600V-trol**

QUABBIN WIRE & CABLE CO., INC (MASSACHUSETTS CORPORATION)  
10 MAPLE ST  
WARE, MA 010821597

FOR: REDUCED DIAMETER 600 VOLT COPPER CABLE FOR USE WITHIN AND INTERCONNECTING ELECTRONIC APPARATUS, IN CLASS 9 (U.S. CLS. 21, 23, 26, 36 AND 38).

FIRST USE 11-1-2005; IN COMMERCE 1-1-2006.

THE MARK CONSISTS OF STANDARD CHARACTERS WITHOUT CLAIM TO ANY PARTICULAR FONT, STYLE, SIZE, OR COLOR.

THE WORDING "600V-TROL" HAS NO MEANING IN A FOREIGN LANGUAGE.

SN 78-760,658, FILED 11-23-2005.

CHARLES L. JENKINS, EXAMINING ATTORNEY

**Int. Cl.: 11**

**Prior U.S. Cls.: 13, 21, 23, 31, and 34**

**United States Patent and Trademark Office**

**Reg. No. 3,396,087**

**Registered Mar. 11, 2008**

**TRADEMARK  
PRINCIPAL REGISTER**

**Starfall**

PANCIL, LLC (CALIFORNIA LTD LIAB CO)  
PO BOX 1046  
LA JOLLA, CA 92038

FOR: ELECTRIC NIGHT LIGHTS, IN CLASS 11  
(U.S. CLS. 13, 21, 23, 31 AND 34).

FIRST USE 8-2-2007; IN COMMERCE 8-7-2007.

THE MARK CONSISTS OF STANDARD CHAR-  
ACTERS WITHOUT CLAIM TO ANY PARTICULAR  
FONT, STYLE, SIZE, OR COLOR.

OWNER OF U.S. REG. NOS. 2,721,805, 2,883,345,  
AND OTHERS.

SN 78-761,037, FILED 11-26-2005.

HEATHER THOMPSON, EXAMINING ATTORNEY



**Int. Cl.: 9**

**Prior U.S. Cls.: 21, 23, 26, 36, and 38**

**United States Patent and Trademark Office**

**Reg. No. 3,396,088**

**Registered Mar. 11, 2008**

**TRADEMARK  
PRINCIPAL REGISTER**



CHEER APPAREL, LLC (NORTH CAROLINA  
LIMITED LIABILITY COMPANY)  
520 ELLIOT STREET, SUITE 200  
CHARLOTTE, NC 28202

FIRST USE 11-28-2007; IN COMMERCE 11-28-2007.

SN 78-761,070, FILED 11-26-2005.

FOR: PROTECTIVE APPAREL FOR CHEER-  
LEADING, IN CLASS 9 (U.S. CLS. 21, 23, 26, 36 AND  
38).

BRIAN PINO, EXAMINING ATTORNEY

**Int. Cl.: 39**

**Prior U.S. Cls.: 100 and 105**

**United States Patent and Trademark Office**

**Reg. No. 3,396,089**

**Registered Mar. 11, 2008**

**SERVICE MARK  
PRINCIPAL REGISTER**



SISTEMAS AEREOS DE MEXICO, S.A. DE C.V.  
(MEXICO CORPORATION)  
COLONIA MIRADOR CENTRO  
IGNACIO L. VALLARTA NO. 811 SUR  
MONTERREY, MEXICO 64070

FOR: TRANSPORTING PASSENGERS AND  
FREIGHT BY AIR; TRAVEL AGENCY SERVICES,  
NAMELY MAKING RESERVATIONS AND BOOK-  
INGS FOR TRANSPORTATION BY AIR AND LAND  
AND TOURS AND DESIGNING AND ARRANGING  
TRAVEL PACKAGES AND TOURS; PACKAGING  
AND STORAGE OF GOODS, IN CLASS 39 (U.S. CLS.  
100 AND 105).

FIRST USE 12-0-2006; IN COMMERCE 4-0-2007.

PRIORITY CLAIMED UNDER SEC. 44(D) ON  
MEXICO APPLICATION NO. 0104194, FILED 7-4-  
2005, REG. NO. 901026, DATED 9-26-2005, EXPIRES 7-  
4-2015.

SN 78-761,152, FILED 11-27-2005.

BRIDGETT SMITH, EXAMINING ATTORNEY

**Int. Cl.: 39**

**Prior U.S. Cls.: 100 and 105**

**United States Patent and Trademark Office**

**Reg. No. 3,396,090**

**Registered Mar. 11, 2008**

**SERVICE MARK  
PRINCIPAL REGISTER**

ALADIA

SISTEMAS AEREOS DE MEXICO, S.A. DE C.V.  
(MEXICO CORPORATION)  
COLONIA MIRADOR CENTRO  
IGNACIO L. VALLARTA NO. 811 SUR  
MONTERREY, MEXICO 64070

FOR: TRANSPORTING PASSENGERS AND  
FREIGHT BY AIR; TRAVEL AGENCY SERVICES,  
NAMELY, MAKING RESERVATIONS AND BOOK-  
INGS FOR TRANSPORTATION BY AIR AND LAND  
AND TOURS AND DESIGNING AND ARRANGING  
TRAVEL PACKAGES AND TOURS; PACKAGING  
AND STORAGE OF GOODS, IN CLASS 39 (U.S. CLS.  
100 AND 105).

FIRST USE 12-0-2006; IN COMMERCE 4-0-2007.

PRIORITY CLAIMED UNDER SEC. 44(D) ON  
MEXICO APPLICATION NO. 0160000, FILED 10-7-  
2005, REG. NO. 913466, DATED 12-13-2005, EXPIRES  
10-7-2015.

SN 78-761,156, FILED 11-27-2005.

BRIDGETT SMITH, EXAMINING ATTORNEY

**Int. Cl.: 35**

**Prior U.S. Cls.: 100, 101, and 102**

**United States Patent and Trademark Office**

**Reg. No. 3,396,091**

**Registered Mar. 11, 2008**

**SERVICE MARK  
PRINCIPAL REGISTER**

**PIZZA TODAY'S NORTHEAST  
PIZZA SHOW**

MACFADDEN PROTECH, LLC (DELAWARE  
LTD LIAB CO)  
137 EAST MARKET STREET  
NEW ALBANY, IN 47150

FOR: ASSOCIATION SERVICES, NAMELY, PROMOTING THE INTERESTS OF THE PIZZA INDUSTRY; CONDUCTING TRADE SHOWS IN THE FIELD OF PIZZA, PIZZA INGREDIENTS, ITALIAN FOOD AND SNACK FOODS, IN CLASS 35 (U.S. CLS. 100, 101 AND 102).

FIRST USE 5-1-2006; IN COMMERCE 5-1-2006.

THE MARK CONSISTS OF STANDARD CHARACTERS WITHOUT CLAIM TO ANY PARTICULAR FONT, STYLE, SIZE, OR COLOR.

OWNER OF U.S. REG. NO. 1,496,722.

NO CLAIM IS MADE TO THE EXCLUSIVE RIGHT TO USE "PIZZA" AND "NORTHEAST PIZZA SHOW", APART FROM THE MARK AS SHOWN.

SN 78-761,634, FILED 11-28-2005.

JAY BESCH, EXAMINING ATTORNEY

**Int. Cl.: 9**

**Prior U.S. Cls.: 21, 23, 26, 36, and 38**

**Reg. No. 3,396,092**

**United States Patent and Trademark Office**

**Registered Mar. 11, 2008**

**TRADEMARK  
PRINCIPAL REGISTER**



ADVENT SOFTWARE, INC. (DELAWARE CORPORATION)  
600 TOWNSEND STREET  
5TH FLOOR  
SAN FRANCISCO, CA 94103

FIRST USE 11-12-2007; IN COMMERCE 11-12-2007.

OWNER OF U.S. REG. NOS. 2,517,374, 3,051,748,  
AND OTHERS.

FOR: COMPUTER SOFTWARE, AND MANUALS SOLD AS A UNIT, FOR USE IN THE FIELDS OF FINANCIAL MANAGEMENT, INVESTMENT TRACKING, PORTFOLIO ANALYSIS, PORTFOLIO MANAGEMENT, INVESTMENT REPORTING, INVESTMENT PERFORMANCE MANAGEMENT, FINANCIAL INSTRUMENT TRADES TRACKING, ACCOUNT RECONCILIATION AND ACCOUNTING, IN CLASS 9 (U.S. CLS. 21, 23, 26, 36 AND 38).

THE MARK CONSISTS OF THE "ADVENT" LOGO MARK WITH THE SANS SERIF CHARACTERS "APX".

SN 78-763,696, FILED 11-30-2005.

ANTHONY RINKER, EXAMINING ATTORNEY

**Int. Cls.: 41 and 44**

**Prior U.S. Cls.: 100, 101, and 107**

**United States Patent and Trademark Office**

**Reg. No. 3,396,093**

**Registered Mar. 11, 2008**

**SERVICE MARK  
PRINCIPAL REGISTER**



RECOVERY CONNECTION, LLC (FLORIDA LTD  
LIAB CO)  
2999 N.E. 191ST STREET, SUITE 905  
AVENTURA, FL 33180

FOR: PROVIDING INFORMATION AND RE-  
SOURCES IN THE FIELD OF EDUCATIONAL PRO-  
GRAMS ON THE SUBJECT OF DRUG AND  
ALCOHOL ADDICTION AND THE TREATMENT  
OF DRUG AND ALCOHOL ADDICTION, IN CLASS  
41 (U.S. CLS. 100, 101 AND 107).

FIRST USE 1-31-2007; IN COMMERCE 1-31-2007.

FOR: PROVIDING INFORMATION AND RE-  
SOURCES IN THE FIELD OF HEALTHCARE FOR

TREATMENT, REHABILITATION, AFTERCARE  
AND RECOVERY OF DRUG AND ALCOHOL AD-  
DICTION, IN CLASS 44 (U.S. CLS. 100 AND 101).

FIRST USE 1-31-2007; IN COMMERCE 1-31-2007.

NO CLAIM IS MADE TO THE EXCLUSIVE  
RIGHT TO USE "RECOVERY", APART FROM THE  
MARK AS SHOWN.

SN 78-765,455, FILED 12-2-2005.

MICHELLE DUBOIS, EXAMINING ATTORNEY

**Int. Cl.: 21**

**Prior U.S. Cls.: 2, 13, 23, 29, 30, 33, 40, and 50**

**United States Patent and Trademark Office**

**Reg. No. 3,396,094**

**Registered Mar. 11, 2008**

**TRADEMARK  
PRINCIPAL REGISTER**

**SONOMA EXPRESS COOKER**

MERCHANT MEDIA, LLC (MASSACHUSETTS  
LTD LIAB CO)

10 CALIFORNIA AVENUE

FRAMINGHAM, MA 01701

FOR: COOKING POTS AND PANS; NON-ELEC-  
TRIC STOVETOP STEAMERS; STOVETOP MEAT  
AND VEGETABLE SMOKERS; STOVETOP COOK-  
ING GRILLES, IN CLASS 21 (U.S. CLS. 2, 13, 23, 29, 30,  
33, 40 AND 50).

FIRST USE 11-1-2006; IN COMMERCE 11-1-2006.

THE MARK CONSISTS OF STANDARD CHAR-  
ACTERS WITHOUT CLAIM TO ANY PARTICULAR  
FONT, STYLE, SIZE, OR COLOR.

NO CLAIM IS MADE TO THE EXCLUSIVE  
RIGHT TO USE "COOKER", APART FROM THE  
MARK AS SHOWN.

THE WORDING "SONOMA" HAS NO MEANING  
IN A FOREIGN LANGUAGE.

SN 78-765,627, FILED 12-2-2005.

KEVON CHISOLM, EXAMINING ATTORNEY

**Int. Cl.: 44**

**Prior U.S. Cls.: 100 and 101**

**United States Patent and Trademark Office**

**Reg. No. 3,396,095**

**Registered Mar. 11, 2008**

**SERVICE MARK  
PRINCIPAL REGISTER**

**LABRADOR**

BIOSIGNIA, INC. (DELAWARE CORPORATION)  
1822 NC HIGHWAY 54 SUITE 350  
DURHAM, NC 27713

FOR: MEDICAL EVALUATION SERVICES FOR OTHERS, NAMELY, FUNCTIONAL ASSESSMENT OF CLIENT'S PATIENT PROBABILITIES OF DEVELOPING DISEASES, CHRONIC DISEASES, CANCERS, AND PROVIDING RECOMMENDATIONS FOR UTILIZATION OF HEALTH CARE SERVICES, IN CLASS 44 (U.S. CLS. 100 AND 101).

FIRST USE 1-1-2006; IN COMMERCE 1-1-2006.

THE MARK CONSISTS OF STANDARD CHARACTERS WITHOUT CLAIM TO ANY PARTICULAR FONT, STYLE, SIZE, OR COLOR.

SN 78-766,330, FILED 12-5-2005.

KIMBERLY FRYE, EXAMINING ATTORNEY



**Int. Cl.: 42**

**Prior U.S. Cls.: 100 and 101**

**United States Patent and Trademark Office**

**Reg. No. 3,396,096**

**Registered Mar. 11, 2008**

**SERVICE MARK  
PRINCIPAL REGISTER**

**MYFARES**

SABREMARK LIMITED PARTNERSHIP (DELA-  
WARE LIMITED PARTNERSHIP)  
3150 SABRE DRIVE  
SOUTHLAKE, TX 76092

FOR: PROVIDING TEMPORARY USE OF NON-  
DOWNLOADABLE INTERNET ACCESSIBLE SOFT-  
WARE FOR USE IN THE TRAVEL INDUSTRY FOR  
INPUTTING, EDITING, TRACKING, MANAGING  
AND DISTRIBUTING FARE DATA VIA A GLOBAL  
COMPUTER NETWORK, IN CLASS 42 (U.S. CLS. 100  
AND 101).

FIRST USE 2-0-2006; IN COMMERCE 2-0-2006.

THE MARK CONSISTS OF STANDARD CHAR-  
ACTERS WITHOUT CLAIM TO ANY PARTICULAR  
FONT, STYLE, SIZE, OR COLOR.

SN 78-767,555, FILED 12-6-2005.

PAUL CROWLEY, EXAMINING ATTORNEY

**Int. Cl.: 35**

**Prior U.S. Cls.: 100, 101, and 102**

**United States Patent and Trademark Office**

**Reg. No. 3,396,097**

**Registered Mar. 11, 2008**

**SERVICE MARK  
PRINCIPAL REGISTER**

**VASTARDIS**

VASTARDIS CAPITAL SERVICES HOLDINGS LP  
(DELAWARE LIMITED PARTNERSHIP)  
30TH FLOOR  
41 MADISON AVENUE  
NEW YORK, NY 10010

FOR: FUND ADMINISTRATION AND COMPLIANCE SERVICES RENDERED TO FINANCIAL INVESTMENT INSTITUTIONS, NAMELY, ACCOUNTING, RECORD KEEPING AND REGULATORY REPORTING OF INFORMATION RELATING TO INVESTMENT FUNDS; BUSINESS OPERATIONS SERVICES, NAMELY, PROVIDING OFFICE FUNCTIONS FOR INVESTMENT ORGA-

NIZATIONS; BUSINESS APPRAISAL AND EVALUATION SERVICES; BUSINESS CONSULTING SERVICES, IN CLASS 35 (U.S. CLS. 100, 101 AND 102).

FIRST USE 12-5-2005; IN COMMERCE 12-5-2005.

THE MARK CONSISTS OF STANDARD CHARACTERS WITHOUT CLAIM TO ANY PARTICULAR FONT, STYLE, SIZE, OR COLOR.

SN 78-767,932, FILED 12-6-2005.

KAELIE KUNG, EXAMINING ATTORNEY

**Int. Cl.: 38**

**Prior U.S. Cls.: 100, 101, and 104**

**United States Patent and Trademark Office**

**Reg. No. 3,396,098**

**Registered Mar. 11, 2008**

**SERVICE MARK  
PRINCIPAL REGISTER**

**FOX NEWS TALK**

TWENTIETH CENTURY FOX FILM CORPORATION (DELAWARE CORPORATION)  
10201 WEST PICO BOULEVARD  
LOS ANGELES, CA 90035

FOR: RADIO TRANSMISSION SERVICES, IN CLASS 38 (U.S. CLS. 100, 101 AND 104).

FIRST USE 1-2-2006; IN COMMERCE 1-2-2006.

THE MARK CONSISTS OF STANDARD CHARACTERS WITHOUT CLAIM TO ANY PARTICULAR FONT, STYLE, SIZE, OR COLOR.

OWNER OF U.S. REG. NOS. 2,083,588, 2,945,312, AND OTHERS.

NO CLAIM IS MADE TO THE EXCLUSIVE RIGHT TO USE "NEWS TALK", APART FROM THE MARK AS SHOWN.

SN 78-768,306, FILED 12-7-2005.

BRIDGETT SMITH, EXAMINING ATTORNEY

**Int. Cls.: 3, 14, 18, 24, and 25**

**Prior U.S. Cls.: 1, 2, 3, 4, 6, 22, 27, 28, 39, 41, 42, 50, 51, and 52**

**Reg. No. 3,396,099**

**United States Patent and Trademark Office**

**Registered Mar. 11, 2008**

**TRADEMARK  
PRINCIPAL REGISTER**

**WORD ON DESIGNS**

WORD ON DESIGNS, INC. (TEXAS CORPORATION)  
SUITE 703  
3333 CUMMINS  
HOUSTON, TX 77027

FOR: BATH SOAPS IN LIQUID, SOLID OR GEL FORM; BODY AND BEAUTY CARE COSMETICS; BODY CREAM SOAP; BODY LOTION; COLOGNE; COSMETIC CREAMS; COSMETIC CREAMS FOR SKIN CARE; COSMETIC OILS; COSMETIC PREPARATIONS FOR BODY CARE; COSMETIC SOAPS; COSMETICS; EAU DE COLOGNE; FACE CREAMS FOR COSMETIC USE; FRAGRANCES FOR PERSONAL USE; HAND SOAPS; LIQUID SOAP; LIQUID SOAPS FOR HANDS, FACE AND BODY; NON-MEDICATED TOILETRIES; PERFUME; PERFUMED SOAPS; SOAPS; TOILET SOAPS, IN CLASS 3 (U.S. CLS. 1, 4, 6, 50, 51 AND 52).

FIRST USE 10-0-2007; IN COMMERCE 10-0-2007.

FOR: NECKLACES; WATCHES, IN CLASS 14 (U.S. CLS. 2, 27, 28 AND 50).

FIRST USE 7-0-2007; IN COMMERCE 7-0-2007.

FOR: HANDBAGS; LUGGAGE; PURSES; TOTE BAGS, IN CLASS 18 (U.S. CLS. 1, 2, 3, 22 AND 41).

FIRST USE 10-0-2007; IN COMMERCE 10-0-2007.

FOR: BED SHEETS; BED SPREADS; PILLOW CASES; PILLOW SHAMS; TOWELS; WASHCLOTHS, IN CLASS 24 (U.S. CLS. 42 AND 50).

FIRST USE 10-0-2007; IN COMMERCE 10-0-2007.

FOR: BELTS; BLOUSES; COATS; DRESSES; KNIT SHIRTS; PANTS; POLO SHIRTS; SHIRTS; SHOES; SHORTS; SKIRTS; SLACKS; SOCKS; SWEATERS; T-SHIRTS; UNDERGARMENTS, IN CLASS 25 (U.S. CLS. 22 AND 39).

FIRST USE 10-0-2007; IN COMMERCE 10-0-2007.

THE MARK CONSISTS OF STANDARD CHARACTERS WITHOUT CLAIM TO ANY PARTICULAR FONT, STYLE, SIZE, OR COLOR.

NO CLAIM IS MADE TO THE EXCLUSIVE RIGHT TO USE "DESIGNS", APART FROM THE MARK AS SHOWN.

SN 78-768,779, FILED 12-7-2005.

PAUL F. GAST, EXAMINING ATTORNEY

**Int. Cls.: 3, 14, 18, 24, and 25**

**Prior U.S. Cls.: 1, 2, 3, 4, 6, 22, 27, 28, 39, 41, 42, 50, 51, and 52**

**Reg. No. 3,396,100**

**United States Patent and Trademark Office**

**Registered Mar. 11, 2008**

**TRADEMARK  
PRINCIPAL REGISTER**

**WO**

WORD ON DESIGNS, INC. (TEXAS CORPORATION)  
3333 CUMMINS  
SUITE 703  
HOUSTON, TX 77027

FOR: BATH SOAPS IN LIQUID, SOLID OR GEL FORM; BODY AND BEAUTY CARE COSMETICS; BODY CREAM SOAP; BODY LOTION; COLOGNE; COSMETIC CREAMS; COSMETIC CREAMS FOR SKIN CARE; COSMETIC OILS; COSMETIC PREPARATIONS FOR BODY CARE; COSMETIC SOAPS; COSMETICS; EAU DE COLOGNE; FACE CREAMS FOR COSMETIC USE; FRAGRANCES FOR PERSONAL USE; HAND SOAPS; LIQUID SOAP; LIQUID SOAPS FOR HANDS, FACE AND BODY; NON-MEDICATED TOILETRIES; PERFUME; PERFUMED SOAPS; SOAPS; TOILET SOAPS, IN CLASS 3 (U.S. CLS. 1, 4, 6, 50, 51 AND 52).

FIRST USE 10-0-2007; IN COMMERCE 10-0-2007.

FOR: WATCH BANDS; WATCH BRACELETS; WATCH CASES; WATCH CLASPS; WATCH FACES; WATCH PARTS; WATCH STRAPS, IN CLASS 14 (U.S. CLS. 2, 27, 28 AND 50).

FIRST USE 7-0-2007; IN COMMERCE 7-0-2007.

FOR: HANDBAGS; LUGGAGE; PURSES AND TOTE BAGS, IN CLASS 18 (U.S. CLS. 1, 2, 3, 22 AND 41).

FIRST USE 10-0-2007; IN COMMERCE 10-0-2007.

FOR: BED SHEETS; BED SPREADS; PILLOW CASES; PILLOW SHAMS; TOWELS; WASHCLOTHS, IN CLASS 24 (U.S. CLS. 42 AND 50).

FIRST USE 10-0-2007; IN COMMERCE 10-0-2007.

FOR: BELTS; BLOUSES; COATS; DRESSES; KNIT SHIRTS; PANTS; POLO SHIRTS; SHIRTS; SHOES; SHORTS; SKIRTS; SLACKS; SOCKS; SWEATERS; T-SHIRTS; UNDERGARMENTS, IN CLASS 25 (U.S. CLS. 22 AND 39).

FIRST USE 10-0-2007; IN COMMERCE 10-0-2007.

THE MARK CONSISTS OF STANDARD CHARACTERS WITHOUT CLAIM TO ANY PARTICULAR FONT, STYLE, SIZE, OR COLOR.

SN 78-768,793, FILED 12-7-2005.

PAUL F. GAST, EXAMINING ATTORNEY

**Int. Cls.: 3, 14, 18, 24, and 25**

**Prior U.S. Cls.: 1, 2, 3, 4, 6, 22, 27, 28, 39, 41, 42, 50, 51, and 52**

**Reg. No. 3,396,101**

**United States Patent and Trademark Office**

**Registered Mar. 11, 2008**

**TRADEMARK  
PRINCIPAL REGISTER**

**YOU ARE A MESSENGER.  
WHAT IS YOUR MESSAGE?**

WORD ON DESIGNS, INC. (TEXAS CORPORATION)  
SUITE 703  
3333 CUMMINS  
HOUSTON, TX 77027

FOR: BATH SOAPS IN LIQUID, SOLID OR GEL FORM; BODY AND BEAUTY CARE COSMETICS; BODY CREAM SOAP; BODY LOTION; COLOGNE; COSMETIC CREAMS; COSMETIC CREAMS FOR SKIN CARE; COSMETIC OILS; COSMETIC PREPARATIONS FOR BODY CARE; COSMETIC SOAPS; COSMETICS; EAU DE COLOGNE; FACE CREAMS FOR COSMETIC USE; FRAGRANCES FOR PERSONAL USE; HAND SOAPS; LIQUID SOAP; LIQUID SOAPS FOR HANDS, FACE AND BODY; NON-MEDICATED TOILETRIES; PERFUME; PERFUMED SOAPS; SOAPS; TOILET SOAPS, IN CLASS 3 (U.S. CLS. 1, 4, 6, 50, 51 AND 52).

FIRST USE 10-0-2007; IN COMMERCE 10-0-2007.

FOR: NECKLACES; WATCHES, IN CLASS 14 (U.S. CLS. 2, 27, 28 AND 50).

FIRST USE 7-0-2007; IN COMMERCE 7-0-2007.

FOR: HANDBAGS; LUGGAGE; PURSES; TOTE BAGS, IN CLASS 18 (U.S. CLS. 1, 2, 3, 22 AND 41).

FIRST USE 10-0-2007; IN COMMERCE 10-0-2007.

FOR: BED SHEETS; BED SPREADS; PILLOW CASES; PILLOW SHAMS; TOWELS; WASHCLOTHS, IN CLASS 24 (U.S. CLS. 42 AND 50).

FIRST USE 10-0-2007; IN COMMERCE 10-0-2007.

FOR: BELTS; BLOUSES; COATS; DRESSES; KNIT SHIRTS; PANTS; POLO SHIRTS; SHIRTS; SHOES; SHORTS; SKIRTS; SLACKS; SOCKS; SWEATERS; T-SHIRTS; UNDERGARMENTS, IN CLASS 25 (U.S. CLS. 22 AND 39).

FIRST USE 10-0-2007; IN COMMERCE 10-0-2007.

THE MARK CONSISTS OF STANDARD CHARACTERS WITHOUT CLAIM TO ANY PARTICULAR FONT, STYLE, SIZE, OR COLOR.

SN 78-768,810, FILED 12-7-2005.

PAUL F. GAST, EXAMINING ATTORNEY

**Int. Cl.: 34**

**Prior U.S. Cls.: 2, 8, 9, and 17**

**United States Patent and Trademark Office**

**Reg. No. 3,396,102**

**Registered Mar. 11, 2008**

**TRADEMARK  
PRINCIPAL REGISTER**

**EL SUBLIMADO**

MARTY, JEAN-CLAUDE (FRANCE INDIVIDUAL)  
3 RUE LITRE  
PARIS, FRANCE 75006

FOR: TOBACCOS, NAMELY, CIGARS, IN CLASS  
34 (U.S. CLS. 2, 8, 9 AND 17).

FIRST USE 10-1-2007; IN COMMERCE 10-1-2007.

THE MARK CONSISTS OF STANDARD CHARACTERS WITHOUT CLAIM TO ANY PARTICULAR FONT, STYLE, SIZE, OR COLOR.

THE FOREIGN WORDING IN THE MARK TRANSLATES INTO ENGLISH AS THE SUBLIME.

SN 78-769,342, FILED 12-8-2005.

ATTIYA MALIK, EXAMINING ATTORNEY

**Int. Cl.: 25**

**Prior U.S. Cls.: 22 and 39**

**United States Patent and Trademark Office**

**Reg. No. 3,396,103**

**Registered Mar. 11, 2008**

**TRADEMARK  
PRINCIPAL REGISTER**

**BREECHAPS**

RIVENDALE DESIGNS, LLC (COLORADO LTD  
LIAB CO)  
1312 ELM STREET  
DENVER, CO 80220

THE MARK CONSISTS OF STANDARD CHAR-  
ACTERS WITHOUT CLAIM TO ANY PARTICULAR  
FONT, STYLE, SIZE, OR COLOR.

FOR: CLOTHING, NAMELY, ENGLISH STYLE  
RIDING PANTS, IN CLASS 25 (U.S. CLS. 22 AND 39).

SN 78-769,457, FILED 12-8-2005.

FIRST USE 2-2-2006; IN COMMERCE 2-2-2006.

ADA HAN, EXAMINING ATTORNEY



**Int. Cl.: 25**

**Prior U.S. Cls.: 22 and 39**

**United States Patent and Trademark Office**

**Reg. No. 3,396,104**

**Registered Mar. 11, 2008**

**TRADEMARK  
PRINCIPAL REGISTER**

**Antonella** 

PROTELA S.A. (COLOMBIA CORPORATION)  
TRANSVERSAL 93 NO. 65 A - 82  
BOGOTÁ, COLOMBIA

OWNER OF U.S. REG. NO. 1,871,399.

FOR: BATHING SUITS; BATHROBES; BEACH-  
WEAR; BIKINIS; BRASSIERES; HOSIERY; LADIES'  
UNDERWEAR; LINGERIE; PAJAMAS; PANTIES;  
SWIM WEAR; SWIMSUITS; TANGAS, IN CLASS 25  
(U.S. CLS. 22 AND 39).

THE MARK CONSISTS OF THE WORD ANTO-  
NELLA IN STYLIZED LETTERS FOLLOWED BY  
THE DRAWING OF A SMALL STRAWBERRY.

SN 78-769,911, FILED 12-9-2005.

FIRST USE 1-3-1976; IN COMMERCE 1-11-1987.

DAVID ELTON, EXAMINING ATTORNEY

**Int. Cl.: 1**

**Prior U.S. Cls.: 1, 5, 6, 10, 26, and 46**

**Reg. No. 3,396,105**

**United States Patent and Trademark Office**

**Registered Mar. 11, 2008**

**TRADEMARK  
PRINCIPAL REGISTER**

**LIFEGUARD**

AQUARIA, INC. (CALIFORNIA CORPORATION)  
6100 CONDOR DRIVE  
MOORPARK, CA 93020

THE MARK CONSISTS OF STANDARD CHARACTERS WITHOUT CLAIM TO ANY PARTICULAR FONT, STYLE, SIZE, OR COLOR.

FOR: WATER CONDITIONING CHEMICAL FOR AQUARIUM AND ORNAMENTAL FISH POND WATER, NAMELY AN OXIDATION CHEMICAL FOR THE PREVENTION OF BACTERIAL, FUNGAL, VIRAL, AND PARASITIC GROWTH IN FISH, IN CLASS 1 (U.S. CLS. 1, 5, 6, 10, 26 AND 46).

OWNER OF U.S. REG. NO. 2,948,142.

SN 78-771,544, FILED 12-12-2005.

FIRST USE 3-31-2006; IN COMMERCE 3-31-2006.

JASON BLAIR, EXAMINING ATTORNEY

**Int. Cl.: 7**

**Prior U.S. Cls.: 13, 19, 21, 23, 31, 34, and 35**

**Reg. No. 3,396,106**

**United States Patent and Trademark Office**

**Registered Mar. 11, 2008**

**TRADEMARK  
PRINCIPAL REGISTER**

**PBT**

OMTEC, CORP. (MASSACHUSETTS CORPORATION)  
181 LIBERTY STREET  
MARLBOROUGH, MA 01752

THE MARK CONSISTS OF STANDARD CHARACTERS WITHOUT CLAIM TO ANY PARTICULAR FONT, STYLE, SIZE, OR COLOR.

FOR: MATERIAL HANDLING EQUIPMENT  
NAMELY, BALL TRANSFERS, IN CLASS 7 (U.S.  
CLS. 13, 19, 21, 23, 31, 34 AND 35).

SN 78-771,891, FILED 12-13-2005.

FIRST USE 9-0-2007; IN COMMERCE 9-0-2007.

LESLEY LAMOTHE, EXAMINING ATTORNEY

**Int. Cl.: 9**

**Prior U.S. Cls.: 21, 23, 26, 36, and 38**

**United States Patent and Trademark Office**

**Reg. No. 3,396,107**

**Registered Mar. 11, 2008**

**TRADEMARK  
PRINCIPAL REGISTER**



DIRECTV, INC. (CALIFORNIA CORPORATION)  
2230 E. IMPERIAL HIGHWAY  
EL SEGUNDO, CA 90245

FOR: AMPLIFIERS; ANTENNAS; AUDIO TAPE RECORDERS; AUDIO-VIDEO RECEIVERS; COMPUTER HARDWARE; COMPUTER SOFTWARE FOR USE WITH TELECOMMUNICATIONS PRODUCTS, NAMELY, RECEIVERS, RECEIVER MODULES, MODULATORS, TRANSMITTERS, MULTIPLEXERS, DECODER BOXES, DATA PROCESSORS, TELEVISION AND VIDEO RECORDERS, INTEGRATED CIRCUITS, SET-TOP BOXES PRIMARILY COMPRISED OF A RECEIVER AND CIRCUITRY; COMPUTERS AND INSTRUCTIONAL MANUALS SOLD AS A UNIT; DIGITAL VIDEO RECORDERS; PRE-AMPLIFIERS; PROGRAMMABLE DIGITAL TELEVISION RECORDERS; RECEIVERS FOR SATELLITES; REMOTE CONTROLS FOR OPERATING TELEVISION EQUIPMENT, VIDEO EQUIPMENT AND COMPUTER EQUIPMENT;

SATELLITE RECEIVERS; SET-TOP BOXES; TELEVISION RECEIVERS; TELEVISION SETS; TELEVISION TRANSMITTERS; VIDEO PROJECTORS; VIDEO TAPE RECORDERS, IN CLASS 9 (U.S. CLS. 21, 23, 26, 36 AND 38).

FIRST USE 7-1-2005; IN COMMERCE 7-1-2005.

OWNER OF U.S. REG. NOS. 2,418,301, 2,715,585, AND OTHERS.

THE MARK CONSISTS OF A CYCLONE STYLE DESIGN IN A RECTANGLE. "DIRECTV" APPEARS ON THE LOWER EDGE AND "PLUS" WRITTEN VERTICALLY, FROM BOTTOM TO TOP, APPEARS ON THE RIGHT EDGE. A "+" DESIGN APPEARS AT THE CORNER.

SN 78-772,509, FILED 12-13-2005.

KYLE PEETE, EXAMINING ATTORNEY

Int. Cl.: 38

Prior U.S. Cls.: 100, 101, and 104

United States Patent and Trademark Office

Reg. No. 3,396,108

Registered Mar. 11, 2008

**SERVICE MARK  
PRINCIPAL REGISTER**



DIRECTV, INC. (CALIFORNIA CORPORATION)  
2230 E. IMPERIAL HIGHWAY  
EL SEGUNDO, CA 90245

FOR: AUDIO BROADCASTING; BROADCASTING PROGRAMS VIA A GLOBAL COMPUTER NETWORK; COMMUNICATION VIA COMPUTER TERMINALS, BY DIGITAL TRANSMISSION OR BY SATELLITE; COMMUNICATIONS SERVICES, NAMELY, TRANSMITTING STREAMED SOUND AND AUDIO-VISUAL RECORDINGS VIA THE INTERNET; DATA TRANSMISSION AND RECEPTION SERVICES VIA TELECOMMUNICATION MEANS; DELIVERY OF MESSAGES BY ELECTRONIC TRANSMISSION; ELECTRONIC MAIL SERVICES; ELECTRONIC MESSAGE TRANSMISSION; ELECTRONIC, ELECTRIC, AND DIGITAL TRANSMISSION OF VOICE, DATA, IMAGES, SIGNALS, AND MESSAGES; PAY-PER-VIEW TELEVISION TRANSMISSION SERVICES; PROVIDING ACCESS TO TELECOMMUNICATION NETWORKS; PROVIDING MULTIPLE-USER ACCESS TO A GLOBAL COMPUTER INFORMATION NETWORK; SATELLITE TELEVISION BROADCASTING; SATELLITE TRANSMISSION SERVICES; SUBSCRIPTION TELE-

VISION BROADCASTING; TELEVISION BROADCASTING; TELEVISION TRANSMISSION SERVICES; TRANSMISSION OF MESSAGES OVER ELECTRONIC MEDIA; TRANSMISSION OF SOUND AND VISION VIA SATELLITE OR INTERACTIVE MULTIMEDIA NETWORKS; VIDEO BROADCASTING; VIDEO-ON-DEMAND TRANSMISSION SERVICES, IN CLASS 38 (U.S. CLS. 100, 101 AND 104).

FIRST USE 7-1-2005; IN COMMERCE 7-1-2005.

OWNER OF U.S. REG. NOS. 2,418,301, 2,715,585, AND OTHERS.

THE MARK CONSISTS OF A CYCLONE STYLE DESIGN IN A RECTANGLE. "DIRECTV" APPEARS ON THE LOWER EDGE AND "PLUS" WRITTEN VERTICALLY, FROM BOTTOM TO TOP, APPEARS ON THE RIGHT EDGE. A "+" DESIGN APPEARS AT THE CORNER.

SN 78-772,638, FILED 12-13-2005.

KYLE PEETE, EXAMINING ATTORNEY

**Int. Cl.: 9**

**Prior U.S. Cls.: 21, 23, 26, 36, and 38**

**United States Patent and Trademark Office**

**Reg. No. 3,396,109**

**Registered Mar. 11, 2008**

**TRADEMARK  
PRINCIPAL REGISTER**



DIRECTV, INC. (CALIFORNIA CORPORATION)  
2230 E. IMPERIAL HIGHWAY  
EL SEGUNDO, CA 90245

FOR: AMPLIFIERS; ANTENNAS; AUDIO TAPE RECORDERS; AUDIO-VIDEO RECEIVERS; COMPUTER HARDWARE; COMPUTER SOFTWARE FOR USE WITH TELECOMMUNICATIONS PRODUCTS, NAMELY, RECEIVERS, RECEIVER MODULES, MODULATORS, TRANSMITTERS, MULTIPLEXERS, DECODER BOXES, DATA PROCESSORS, TELEVISION AND VIDEO RECORDERS, INTEGRATED CIRCUITS, SET-TOP BOXES PRIMARILY COMPRISED OF A RECEIVER AND CIRCUITRY; COMPUTERS AND INSTRUCTIONAL MANUALS SOLD AS A UNIT; DIGITAL VIDEO RECORDERS; PRE-AMPLIFIERS; PROGRAMMABLE DIGITAL TELEVISION RECORDERS; RECEIVERS FOR SATELLITES; REMOTE CONTROLS FOR OPERATING TELEVISION EQUIPMENT, VIDEO EQUIPMENT AND COMPUTER EQUIPMENT; SATELLITE RECEIVERS; SET-TOP BOXES; TELEVISION RECEIVERS; TELEVISION SETS; TELEVISION

TRANSMITTERS; VIDEO PROJECTORS; AND VIDEO TAPE RECORDERS, IN CLASS 9 (U.S. CLS. 21, 23, 26, 36 AND 38).

FIRST USE 8-1-2006; IN COMMERCE 8-1-2006.

OWNER OF U.S. REG. NOS. 2,418,301, 2,715,585, AND OTHERS.

NO CLAIM IS MADE TO THE EXCLUSIVE RIGHT TO USE "HDDVR", APART FROM THE MARK AS SHOWN.

THE MARK CONSISTS OF A CYCLONE STYLE DESIGN IN A RECTANGLE. "DIRECTV" APPEARS ON THE LOWER EDGE AND "HDDVR" WRITTEN VERTICALLY, FROM BOTTOM TO TOP, APPEARS ON THE RIGHT EDGE. A "+" DESIGN APPEARS AT THE CORNER.

SN 78-772,645, FILED 12-13-2005.

KYLE PEETE, EXAMINING ATTORNEY

Int. Cl.: 42

Prior U.S. Cls.: 100 and 101

United States Patent and Trademark Office

Reg. No. 3,396,110

Registered Mar. 11, 2008

SERVICE MARK  
PRINCIPAL REGISTER



BROADRIDGE SECURITIES PROCESSING SOLUTIONS, INC. (DELAWARE CORPORATION)  
2 JOURNAL SQUARE PLAZA  
JERSEY CITY, NJ 07306

FOR: PROVIDING TEMPORARY USE OF NON-DOWNLOADABLE ONLINE SOFTWARE FOR CREATING AND MANAGING INFORMATIONAL MATERIALS IN THE BROKERAGE AND FINANCIAL PLANNING SERVICES FIELDS, IN CLASS 42 (U.S. CLS. 100 AND 101).

FIRST USE 9-30-2005; IN COMMERCE 9-30-2005.

NO CLAIM IS MADE TO THE EXCLUSIVE RIGHT TO USE "ON-DEMAND COMMUNICATIONS SYSTEM", APART FROM THE MARK AS SHOWN.

SN 78-772,648, FILED 12-13-2005.

SOPHIA S. KIM, EXAMINING ATTORNEY

**Int. Cl.: 38**

**Prior U.S. Cls.: 100, 101, and 104**

**United States Patent and Trademark Office**

**Reg. No. 3,396,111**

**Registered Mar. 11, 2008**

**SERVICE MARK  
PRINCIPAL REGISTER**



DIRECTV, INC. (CALIFORNIA CORPORATION)  
2230 E. IMPERIAL HIGHWAY  
EL SEGUNDO, CA 90245

FOR: AUDIO BROADCASTING; COMMUNICATION VIA COMPUTER TERMINALS, BY DIGITAL TRANSMISSION OR BY SATELLITE; DATA TRANSMISSION AND RECEPTION SERVICES VIA TELECOMMUNICATION MEANS; DELIVERY OF MESSAGES BY ELECTRONIC TRANSMISSION; ELECTRONIC, ELECTRIC, AND DIGITAL TRANSMISSION OF VOICE, DATA, IMAGES, SIGNALS, AND MESSAGES; PAY-PER-VIEW TELEVISION TRANSMISSION SERVICES; PROVIDING ACCESS TO TELECOMMUNICATION NETWORKS; SATELLITE TELEVISION BROADCASTING; SATELLITE TRANSMISSION SERVICES; SUBSCRIPTION TELEVISION BROADCASTING; TELEVISION BROADCASTING; TELEVISION TRANSMISSION SERVICES; TRANSMISSION OF MESSAGES OVER ELECTRONIC MEDIA; TRANSMISSION OF SOUND AND VISION VIA SATELLITE OR INTERACTIVE MULTIMEDIA NETWORKS; VIDEO BROADCAST-

ING; VIDEO-ON-DEMAND TRANSMISSION SERVICES, IN CLASS 38 (U.S. CLS. 100, 101 AND 104).

FIRST USE 8-1-2006; IN COMMERCE 8-1-2006.

OWNER OF U.S. REG. NOS. 2,418,301, 2,715,585, AND OTHERS.

NO CLAIM IS MADE TO THE EXCLUSIVE RIGHT TO USE "HDDVR", APART FROM THE MARK AS SHOWN.

THE MARK CONSISTS OF A CYCLONE STYLE DESIGN IN A RECTANGLE. "DIRECTV" APPEARS ON THE LOWER EDGE AND "HDDVR" WRITTEN VERTICALLY, FROM BOTTOM TO TOP, APPEARS ON THE RIGHT EDGE. A "+" DESIGN APPEARS AT THE CORNER.

SN 78-772,651, FILED 12-13-2005.

KYLE PEETE, EXAMINING ATTORNEY



**Int. Cl.: 41**

**Prior U.S. Cls.: 100, 101, and 107**

**United States Patent and Trademark Office**

**Reg. No. 3,396,112**

**Registered Mar. 11, 2008**

**SERVICE MARK  
PRINCIPAL REGISTER**



DIRECTV, INC. (CALIFORNIA CORPORATION)  
2230 E. IMPERIAL HIGHWAY  
EL SEGUNDO, CA 90245

FIRST USE 8-1-2006; IN COMMERCE 8-1-2006.

FOR: DISTRIBUTION OF TELEVISION PROGRAMS FOR OTHERS; ENTERTAINMENT SERVICES, NAMELY, PROVIDING TELEVISION PROGRAMMING IN THE FIELD OF ENTERTAINMENT, GENERAL NEWS, CURRENT EVENTS, SPORTS AND WEATHER; ENTERTAINMENT IN THE NATURE OF ON-GOING TELEVISION PROGRAMS IN THE FIELD OF ENTERTAINMENT, GENERAL NEWS, CURRENT EVENTS, SPORTS AND WEATHER; ENTERTAINMENT SERVICES, NAMELY, PROVIDING ON-LINE REVIEWS OF MOVIES; ENTERTAINMENT SERVICES, NAMELY, PROVIDING PRERECORDED MUSIC, ALL ON-LINE VIA A GLOBAL COMPUTER NETWORK; PROVIDING RATINGS FOR TELEVISION, MOVIE AND VIDEO CONTENT, IN CLASS 41 (U.S. CLS. 100, 101 AND 107).

OWNER OF U.S. REG. NOS. 2,418,301, 2,715,585, AND OTHERS.

NO CLAIM IS MADE TO THE EXCLUSIVE RIGHT TO USE "HDDVR", APART FROM THE MARK AS SHOWN.

THE MARK CONSISTS OF A CYCLONE STYLE DESIGN IN A RECTANGLE. "DIRECTV" APPEARS ON THE LOWER EDGE AND "HDDVR" WRITTEN VERTICALLY, FROM BOTTOM TO TOP, APPEARS ON THE RIGHT EDGE. A "+" DESIGN APPEARS AT THE CORNER.

SN 78-772,713, FILED 12-13-2005.

KYLE PEETE, EXAMINING ATTORNEY

**Int. Cl.: 36**

**Prior U.S. Cls.: 100, 101, and 102**

**United States Patent and Trademark Office**

**Reg. No. 3,396,113**

**Registered Mar. 11, 2008**

**SERVICE MARK  
PRINCIPAL REGISTER**

PLATINUM WEALTH PARTNERS

PLATINUM WEALTH PARTNERS, INC. (FLOR-  
IDA CORPORATION)  
100 NORTH TAMPA STREET  
SUITE 1600  
TAMPA, FL 33602

FOR: FINANCIAL SERVICES, NAMELY, INVEST-  
MENT ADVISORY SERVICES FOR RETAIL INVES-  
TORS AND ESTATE PLANNING, IN CLASS 36 (U.S.  
CLS. 100, 101 AND 102).

FIRST USE 5-29-2007; IN COMMERCE 5-29-2007.

THE MARK CONSISTS OF STANDARD CHAR-  
ACTERS WITHOUT CLAIM TO ANY PARTICULAR  
FONT, STYLE, SIZE, OR COLOR.

SN 78-773,076, FILED 12-14-2005.

PAUL F. GAST, EXAMINING ATTORNEY

Int. Cl.: 28

Prior U.S. Cls.: 22, 23, 38, and 50

United States Patent and Trademark Office

Reg. No. 3,396,114

Registered Mar. 11, 2008

TRADEMARK  
PRINCIPAL REGISTER



HENFAIR REMOTE CONTROL TECHNOLOGY  
RESEARCH & DEVELOPMENT LIMITED  
(HONG KONG LTD LIAB CO)  
109-111 GLOUCESTER ROAD  
ROOM 1001-1002, TUNG WAI COMMERCIAL BLDG  
WAN CHAI, HONG KONG

FOR: TOY AIR PISTOLS; RADIO-CONTROLLED  
TOY VEHICLES; SCALE MODEL VEHICLES; TOYS,  
NAMELY, REMOTE-CONTROLLED HELICOP-  
TERS, REMOTE-CONTROLLED AIRPLANES, RE-  
MOTE-CONTROLLED CARS, REMOTE-  
CONTROLLED BOATS, REMOTE-CONTROLLED  
SUBMARINES; REMOTE-CONTROLLED CYBER  
TOYS, NAMELY, REMOTE-CONTROLLED STUNT  
VEHICLES, REMOTE-CONTROLLED DINOSAURS,  
REMOTE-CONTROLLED FLYING SAUCERS; RE-  
MOTE-CONTROLLED HOBBY TOY MODEL VEHI-

CLES; REMOTE-CONTROLLED TOY ROBOTS, IN  
CLASS 28 (U.S. CLS. 22, 23, 38 AND 50).

FIRST USE 1-10-2006; IN COMMERCE 2-12-2006.

THE COLOR(S) BLUE AND GREY IS/ARE  
CLAIMED AS A FEATURE OF THE MARK.

THE COLOR GREY APPEARS IN THE "X" DE-  
SIGN AND IN THE SHADOW OF THE "X" DESIGN  
IN THE MARK. THE COLOR BLUE APPEARS IN  
THE WORDING "HEN-TECH" IN THE MARK.

SN 78-773,369, FILED 12-14-2005.

MAUREEN DALL, EXAMINING ATTORNEY

**Int. Cls.: 5 and 29**

**Prior U.S. Cls.: 6, 18, 44, 46, 51, and 52**

**United States Patent and Trademark Office**

**Reg. No. 3,396,115**

**Registered Mar. 11, 2008**

**TRADEMARK  
PRINCIPAL REGISTER**

**HAPPY BABY**

NURTURE, INC. (MINNESOTA CORPORATION)  
175 COLUMBIA HEIGHTS  
#2F  
BROOKLYN, NY 112012156

FOR: BABY FOOD; INFANT MEALS, IN CLASS 5  
(U.S. CLS. 6, 18, 44, 46, 51 AND 52).

FIRST USE 5-14-2006; IN COMMERCE 5-14-2006.

FOR: PREPARED MEALS FOR TODDLERS CON-  
SISTING PRIMARILY OF MEAT, FISH, POULTRY  
OR VEGETABLES, IN CLASS 29 (U.S. CL. 46).

FIRST USE 5-14-2006; IN COMMERCE 5-14-2006.

THE MARK CONSISTS OF STANDARD CHAR-  
ACTERS WITHOUT CLAIM TO ANY PARTICULAR  
FONT, STYLE, SIZE, OR COLOR.

NO CLAIM IS MADE TO THE EXCLUSIVE  
RIGHT TO USE "BABY", APART FROM THE MARK  
AS SHOWN.

SN 78-773,475, FILED 12-14-2005.

JAMES LOVELACE, EXAMINING ATTORNEY

**Int. Cls.: 36 and 43**

**Prior U.S. Cls.: 100, 101, and 102**

**United States Patent and Trademark Office**

**Reg. No. 3,396,116**

**Registered Mar. 11, 2008**

**SERVICE MARK  
PRINCIPAL REGISTER**

**HOUSE OF SWEDEN**

STATENS FASTIGHETSVERK (SWEDEN GOV-  
ERNMENT AGENCY)  
BOX 2263  
JÄRNTORGET 84  
STOCKHOLM, SWEDEN SE-10316

FOR: LEASING OF APARTMENTS, IN CLASS 36  
(U.S. CLS. 100, 101 AND 102).

FIRST USE 8-0-2005; IN COMMERCE 8-0-2005.

FOR: PROVISION OF CONFERENCE, EXHIBI-  
TION AND MEETING FACILITIES, IN CLASS 43  
(U.S. CLS. 100 AND 101).

FIRST USE 8-0-2005; IN COMMERCE 8-0-2005.

NO CLAIM IS MADE TO THE EXCLUSIVE  
RIGHT TO USE "SWEDEN", APART FROM THE  
MARK AS SHOWN.

THE MARK CONSISTS OF THE WORDS "HOUSE  
OF SWEDEN" WITH VERTICAL LINES RUNNING  
THROUGH ALL THE LETTERS.

SN 78-773,526, FILED 12-14-2005.

CURTIS FRENCH, EXAMINING ATTORNEY

Int. Cl.: 41

Prior U.S. Cls.: 100, 101, and 107

United States Patent and Trademark Office

Reg. No. 3,396,117

Registered Mar. 11, 2008

SERVICE MARK  
PRINCIPAL REGISTER



BUMP IN THE ROAD ENTERPRISES LLC (VERMONT LTD LIAB CO)  
949 CIDER MILL ROAD  
CORNWALL, VT 05753

FOR: ENTERTAINMENT IN THE NATURE OF BASKETBALL GAMES; ENTERTAINMENT IN THE NATURE OF COMPETITIONS IN THE FIELD OF BASKETBALL; ENTERTAINMENT SERVICES, NAMELY, ARRANGING AND CONDUCTING OF COMPETITIONS FOR BASKETBALL; PROVIDING VARIOUS FACILITIES FOR AN ARRAY OF SPORTING EVENTS, SPORTS AND ATHLETIC COMPETITIONS AND AWARDS PROGRAMMES, IN CLASS 41 (U.S. CLS. 100, 101 AND 107).

FIRST USE 12-14-2005; IN COMMERCE 12-14-2005.

NO CLAIM IS MADE TO THE EXCLUSIVE RIGHT TO USE "VERMONT", APART FROM THE MARK AS SHOWN.

THE MARK CONSISTS OF THE WORDS "VERMONT FROST HEAVES" WITH A BASKETBALL USED AND THE LETTER "O" AND FROST HANGING FROM THE BASKETBALL.

SN 78-773,870, FILED 12-15-2005.

PETER B. BROMAGHIM, EXAMINING ATTORNEY

Int. Cl.: 41

Prior U.S. Cls.: 100, 101, and 107

United States Patent and Trademark Office

Reg. No. 3,396,118

Registered Mar. 11, 2008

SERVICE MARK  
PRINCIPAL REGISTER

YOU  
THE OWNER'S  
MANUAL

ROIZEN, MICHAEL F. (UNITED STATES INDIVIDUAL)  
18600 S. PARK BLVD.  
SHAKER HEIGHTS, OH 44122 AND  
OZ, MEHMET C. (UNITED STATES INDIVIDUAL)  
MILSTEIN 7-435  
177 FORT WASHINGTON AVENUE  
NEW YORK, NY 10032

FOR: ENTERTAINMENT SERVICES, NAMELY,  
PRODUCTION OF RADIO AND TELEVISION PROGRAMS,  
IN CLASS 41 (U.S. CLS. 100, 101 AND 107).

FIRST USE 2-15-2007; IN COMMERCE 2-15-2007.

THE MARK CONSISTS OF THE WORDS "YOU:  
THE OWNER'S MANUAL" AND INSIDE THE LETTER "O"  
IN THE WORD "YOU" APPEARS A CLOSED FIST WITH  
AN EXTENDED INDEX FINGER.

SN 78-773,937, FILED 12-15-2005.

LOURDES AYALA, EXAMINING ATTORNEY

**Int. Cl.: 41**

**Prior U.S. Cls.: 100, 101, and 107**

**United States Patent and Trademark Office**

**Reg. No. 3,396,119**

**Registered Mar. 11, 2008**

**SERVICE MARK  
PRINCIPAL REGISTER**

**American Music Project**

REMOTE DIGITAL MEDIA, INC (NEW JERSEY CORPORATION)  
122 CHRISTOPHER STREET  
MONTCLAIR, NJ 07042

FOR: ENTERTAINMENT IN THE NATURE OF ON-GOING TELEVISION PROGRAMS IN THE FIELD OF MUSICAL PRODUCTIONS AND CONCERTS; ENTERTAINMENT IN THE NATURE OF ORCHESTRA PERFORMANCES; ENTERTAINMENT IN THE NATURE OF SYMPHONY ORCHESTRA PERFORMANCES; ENTERTAINMENT IN THE NATURE OF VISUAL AND AUDIO PERFORMANCES, AND MUSICAL, VARIETY, NEWS AND COMEDY SHOWS; ENTERTAINMENT IN THE NATURE OF VISUAL AND AUDIO PERFORMANCES, NAMELY, MUSICAL BAND, ROCK GROUP, GYMNASTIC, DANCE, AND BALLET PERFORMANCES; ENTERTAINMENT IN THE NATURE OF MUSICAL FESTIVALS; ENTERTAINMENT, NAMELY, LIVE PERFORMANCES BY A MUSICAL BAND; ENTERTAINMENT, NAMELY, PRODUCTION OF TAPED TELEVISION SERIES OF MUSICAL PERFORMANCES; ENTERTAINMENT SERVICES, NAMELY, PROVIDING A TELEVISION PROGRAM IN THE FIELD OF MUSICAL PERFOR-

MANCE VIA A GLOBAL COMPUTER NETWORK; ENTERTAINMENT SERVICES, NAMELY, PROVIDING A WEB SITE FEATURING MUSICAL PERFORMANCES, MUSICAL VIDEOS, RELATED FILM CLIPS, PHOTOGRAPHS, AND OTHER MULTIMEDIA MATERIALS; ENTERTAINMENT, NAMELY, LIVE MUSIC CONCERTS; ENTERTAINMENT, NAMELY, LIVE PERFORMANCES BY MUSICAL BANDS; ENTERTAINMENT, NAMELY, LIVE PERFORMANCES BY ROCK GROUPS, IN CLASS 41 (U.S. CLS. 100, 101 AND 107).

FIRST USE 4-8-2006; IN COMMERCE 4-8-2006.

THE MARK CONSISTS OF STANDARD CHARACTERS WITHOUT CLAIM TO ANY PARTICULAR FONT, STYLE, SIZE, OR COLOR.

NO CLAIM IS MADE TO THE EXCLUSIVE RIGHT TO USE "AMERICAN MUSIC", APART FROM THE MARK AS SHOWN.

SN 78-775,562, FILED 12-17-2005.

MARGERY A. TIERNEY, EXAMINING ATTORNEY



**Int. Cl.: 9**

**Prior U.S. Cls.: 21, 23, 26, 36, and 38**

**United States Patent and Trademark Office**

**Reg. No. 3,396,120**

**Registered Mar. 11, 2008**

**TRADEMARK  
PRINCIPAL REGISTER**



SUSTAIN RECORDS, LLC (TEXAS LTD LIAB CO)  
631 WATER STREET SUITE A  
KERRVILLE, TX 78028

FOR: AUDIO RECORDINGS FEATURING MUSIC; DOWNLOADABLE MUSICAL SOUND RECORDINGS; MUSICAL SOUND RECORDINGS; MUSICAL VIDEO RECORDINGS; VIDEO RECORDINGS FEATURING MUSIC; VISUAL RECORDINGS AND AUDIO VISUAL RECORDINGS FEATURING MUSIC AND ANIMATION, IN CLASS 9 (U.S. CLS. 21, 23, 26, 36 AND 38).

FIRST USE 1-1-2006; IN COMMERCE 2-21-2006.

NO CLAIM IS MADE TO THE EXCLUSIVE RIGHT TO USE "RECORDS", APART FROM THE MARK AS SHOWN.

THE MARK CONSISTS OF THE WORD "SUSTAIN" WITH A SEMICIRCLE OVER THE "I" IN SUSTAIN, AN OFFSET TO THE RIGHT LINE BELOW THE WORD "SUSTAIN" WITH UPWARD EDGES AND AN UPWARD POINT IN THE MIDDLE, AND THE WORD "RECORDS" DIRECTLY BELOW AND ALIGNED WITH SUCH LINE.

SN 78-775,709, FILED 12-18-2005.

VIVIAN MICZNIK FIRST, EXAMINING ATTORNEY

**Int. Cl.: 1**

**Prior U.S. Cls.: 1, 5, 6, 10, 26, and 46**

**Reg. No. 3,396,121**

**United States Patent and Trademark Office**

**Registered Mar. 11, 2008**

---

**TRADEMARK  
PRINCIPAL REGISTER**

# Spray Assist

MEDINA AGRICULTURE PRODUCTS CO., INC.  
(TEXAS CORPORATION)  
HIGHWAY 90 WEST  
HONDO, TX 78861

FOR: CHEMICAL ADDITIVES FOR USE IN HERBICIDE, DEFOLIANT AND INSECTICIDE SPRAYS TO INCREASE EFFECTIVENESS, IN CLASS 1 (U.S. CLS. 1, 5, 6, 10, 26 AND 46).

FIRST USE 3-15-2005; IN COMMERCE 12-28-2005.

THE MARK CONSISTS OF STANDARD CHARACTERS WITHOUT CLAIM TO ANY PARTICULAR FONT, STYLE, SIZE, OR COLOR.

NO CLAIM IS MADE TO THE EXCLUSIVE RIGHT TO USE "SPRAY", APART FROM THE MARK AS SHOWN.

SN 78-776,247, FILED 12-19-2005.

CAROL SPILS, EXAMINING ATTORNEY

**Int. Cl.: 36**

**Prior U.S. Cls.: 100, 101, and 102**

**United States Patent and Trademark Office**

**Reg. No. 3,396,122**

**Registered Mar. 11, 2008**

---

**SERVICE MARK  
PRINCIPAL REGISTER**



SELECTHEALTH, INC. (UTAH CORPORATION)  
36 SO. STATE STREET, SUITE 2200  
SALT LAKE CITY, UT 84111

FIRST USE 4-3-2006; IN COMMERCE 4-3-2006.

FOR: UNDERWRITING AND ADMINISTRATION OF MEDICAL, HEALTH AND PRESCRIPTION DRUG INSURANCE PLANS, IN CLASS 36 (U.S. CLS. 100, 101 AND 102).

SN 78-776,591, FILED 12-19-2005.

DORITT L. CARROLL, EXAMINING ATTORNEY

**Int. Cl.: 28**

**Prior U.S. Cls.: 22, 23, 38, and 50**

**United States Patent and Trademark Office**

**Reg. No. 3,396,123**

**Registered Mar. 11, 2008**

**TRADEMARK  
PRINCIPAL REGISTER**

**TONGUE TANGLERS**

ENGINUITY LLC (CALIFORNIA LTD LIAB CO)  
4183 PARK BLVD  
PALO ALTO, CA 94306

THE MARK CONSISTS OF STANDARD CHAR-  
ACTERS WITHOUT CLAIM TO ANY PARTICULAR  
FONT, STYLE, SIZE, OR COLOR.

FOR: EQUIPMENT SOLD AS A UNIT FOR PLAY-  
ING BOARD GAMES, IN CLASS 28 (U.S. CLS. 22, 23,  
38 AND 50).

SN 78-776,710, FILED 12-19-2005.

FIRST USE 2-20-2005; IN COMMERCE 10-16-2007.

INGA ERVIN, EXAMINING ATTORNEY

**Int. Cl.: 5**

**Prior U.S. Cls.: 6, 18, 44, 46, 51, and 52**

**United States Patent and Trademark Office**

**Reg. No. 3,396,124**

**Registered Mar. 11, 2008**

**TRADEMARK  
PRINCIPAL REGISTER**

**RL-EX6**

SIX STAR US TRADEMARK LTD. (CANADA  
CORPORATION)  
5100 SPECTRUM WAY  
MISSISSAUGA, ONTARIO, CANADA L4W 5S2

FOR: INGREDIENT BLEND SOLD AS A COMPO-  
NENT OF NUTRITIONAL SUPPLEMENTS FOR  
BODY BUILDING, IN CLASS 5 (U.S. CLS. 6, 18, 44,  
46, 51 AND 52).

FIRST USE 3-0-2006; IN COMMERCE 3-0-2006.

THE MARK CONSISTS OF STANDARD CHAR-  
ACTERS WITHOUT CLAIM TO ANY PARTICULAR  
FONT, STYLE, SIZE, OR COLOR.

SN 78-777,696, FILED 12-20-2005.

KARANENDRA S. CHHINA, EXAMINING ATTOR-  
NEY

**Int. Cls.: 7, 37, 40, and 42**

**Prior U.S. Cls.: 13, 19, 21, 23, 31, 34, 35, 100, 101, 103,  
and 106**

**Reg. No. 3,396,125**

**United States Patent and Trademark Office**

**Registered Mar. 11, 2008**

**TRADEMARK  
SERVICE MARK  
PRINCIPAL REGISTER**

# ET PROCESS

SUNHO BIODIESEL CORPORATION (BR.VIRGIN ISLANDS CORPORATION)  
OMC CHAMBERS, P.O. BOX 3152  
ROAD TOWN, TORTOLA, BR.VIRGIN ISLANDS

FOR: CHEMICAL PROCESSING EQUIPMENT, NAMELY, ENZYME REACTORS AND BIOREACTORS FOR PRODUCTION OF NON-GASOLINE PRODUCTS, NAMELY, BIODIESEL, LUBRICANT, SURFACTANT AND OLEOCHEMICAL PRODUCTS, IN CLASS 7 (U.S. CLS. 13, 19, 21, 23, 31, 34 AND 35).

FIRST USE 4-30-2006; IN COMMERCE 4-30-2006.

FOR: INSTALLATION, MAINTENANCE AND REPAIR OF HARDWARE FOR PRODUCTION OF NON-GASOLINE PRODUCTS, NAMELY, BIODIESEL PRODUCTS, IN CLASS 37 (U.S. CLS. 100, 103 AND 106).

FIRST USE 4-30-2006; IN COMMERCE 4-30-2006.

FOR: EDIBLE AND NON-EDIBLE OIL TREATMENT SERVICES, NAMELY, REFINING OF REFINED EDIBLE AND NON-EDIBLE OILS FOR USE IN THE PRODUCTION OF ENERGY AND NON-GASOLINE FUEL, IN CLASS 40 (U.S. CLS. 100, 103 AND 106).

FIRST USE 4-30-2006; IN COMMERCE 4-30-2006.

FOR: BIODIESEL CONSULTATION SERVICES, NAMELY, TECHNICAL CONSULTATION IN THE

FIELD OF BIODIESEL REFINING AND PRODUCTION HARDWARE AND TROUBLESHOOTING TECHNICAL PROBLEMS WITH SOFTWARE USED IN BIODIESEL REFINING; PROVIDING TURNKEY SERVICES IN THE FIELD OF BIODIESEL PRODUCTION, NAMELY, TECHNICAL CONSULTATION IN THE FIELD OF DESIGNING AND IMPLEMENTING MANUFACTURING AND REFINING PROCESSES AND SYSTEMS FOR CONVERTING VEGETABLE OILS INTO NON-GASOLINE PRODUCTS, NAMELY, BIODIESEL OR THE EQUIVALENTS, NAMELY, BIODIESEL LUBRICANT, SURFACTANT AND OLEOCHEMICAL PRODUCTS FOR OTHERS; INSTALLATION, MAINTENANCE AND REPAIR OF SOFTWARE FOR PRODUCTION OF NON-GASOLINE PRODUCTS, NAMELY, BIODIESEL PRODUCTS, IN CLASS 42 (U.S. CLS. 100 AND 101).

FIRST USE 4-30-2006; IN COMMERCE 4-30-2006.

THE MARK CONSISTS OF STANDARD CHARACTERS WITHOUT CLAIM TO ANY PARTICULAR FONT, STYLE, SIZE, OR COLOR.

NO CLAIM IS MADE TO THE EXCLUSIVE RIGHT TO USE "PROCESS", APART FROM THE MARK AS SHOWN.

SN 78-778,322, FILED 12-21-2005.

MICHAEL WIENER, EXAMINING ATTORNEY

**Int. Cl.: 32**

**Prior U.S. Cls.: 45, 46, and 48**

**United States Patent and Trademark Office**

**Reg. No. 3,396,126**

**Registered Mar. 11, 2008**

**TRADEMARK  
PRINCIPAL REGISTER**



EMBOTELLADORA EL JAROCHO, S.A. DE C.V.  
(MEXICO CORPORATION)  
CARRETERA CORDOBA-VERACRUZ  
ZONA INDUSTRIAL; KILOMETRO 339  
CORDOBA, MEXICO 94690

FOR: CONCENTRATES, SYRUPS OR POWDERS  
USED IN THE PREPARATION OF SOFT DRINKS;  
DRINKING WATER; FLAVORED WATERS; FRUIT  
JUICE BASES; FRUIT JUICES; MINERAL WATER;  
SODA WATER; SOFT DRINKS; SOY-BASED BEV-  
ERAGES NOT BEING MILK SUBSTITUTES, IN  
CLASS 32 (U.S. CLS. 45, 46 AND 48).

FIRST USE 9-0-1965; IN COMMERCE 8-0-2007.

THE COLOR(S) BLUE AND WHITE IS/ARE  
CLAIMED AS A FEATURE OF THE MARK.

THE MARK CONSISTS OF A BOY WEARING A  
HAT AND SCARF IN A BLUE WATER DROP SHAPE  
OUTLINED IN WHITE. BENEATH THE BOY IS THE  
WORD JAROCHITO IN WHITE SET AGAINST A  
BLUE BACKGROUND.

SN 78-778,394, FILED 12-21-2005.

SEAN CROWLEY, EXAMINING ATTORNEY

**Int. Cls.: 41 and 44**

**Prior U.S. Cls.: 100, 101, and 107**

**United States Patent and Trademark Office**

**Reg. No. 3,396,127**

**Registered Mar. 11, 2008**

**SERVICE MARK  
PRINCIPAL REGISTER**

# Pause Therapy

ILANI, DORIT SUSAN (UNITED STATES INDIVIDUAL)  
P.O. BOX 264  
DESERT HOT SPRINGS, CA 92240

FOR: MEDITATION TRAINING IN THE FORM OF INDIVIDUAL INSTRUCTION FEATURING HOLISTIC AND SPIRITUAL STRESS REDUCTION TECHNIQUES OFFERED AT SPAS, RESORTS, RETREATS, HOMES AND RELIGIOUS FACILITIES, IN CLASS 41 (U.S. CLS. 100, 101 AND 107).

FIRST USE 7-11-2006; IN COMMERCE 7-11-2006.

FOR: HYPNOTHERAPY SERVICES AND RELAXATION THERAPY IN THE NATURE OF AUTOGENOUS TRAINING FEATURING HOLISTIC AND SPIRITUAL STRESS REDUCTION TECHNIQUES

OFFERED AT SPAS, RESORTS, RETREATS, HOMES AND RELIGIOUS FACILITIES, IN CLASS 44 (U.S. CLS. 100 AND 101).

FIRST USE 7-11-2006; IN COMMERCE 7-11-2006.

THE MARK CONSISTS OF STANDARD CHARACTERS WITHOUT CLAIM TO ANY PARTICULAR FONT, STYLE, SIZE, OR COLOR.

NO CLAIM IS MADE TO THE EXCLUSIVE RIGHT TO USE "THERAPY", APART FROM THE MARK AS SHOWN.

SN 78-778,413, FILED 12-21-2005.

ALYSSA PALADINO, EXAMINING ATTORNEY



**Int. Cl.: 28**

**Prior U.S. Cls.: 22, 23, 38, and 50**

**Reg. No. 3,396,128**

**United States Patent and Trademark Office**

**Registered Mar. 11, 2008**

---

**TRADEMARK  
PRINCIPAL REGISTER**



**ALIGNMENT INSERT MANAGEMENT**

AS DESIGNS, LLC (PENNSYLVANIA LTD LIAB  
CO)  
722 WILEY AVENUE, MILLER PARK  
FRANKLIN, PA 16323

NO CLAIM IS MADE TO THE EXCLUSIVE  
RIGHT TO USE "ALIGNMENT INSERT", APART  
FROM THE MARK AS SHOWN.

FOR: GOLF CLUBS, IN CLASS 28 (U.S. CLS. 22, 23,  
38 AND 50).

SN 78-778,725, FILED 12-21-2005.

FIRST USE 12-26-2007; IN COMMERCE 12-26-2007.

ADA HAN, EXAMINING ATTORNEY

**Int. Cls.: 16, 18, 21, 25, and 41**

**Prior U.S. Cls.: 1, 2, 3, 5, 13, 22, 23, 29, 30, 33, 37, 38, 39, 40, 41, 50, 100, 101, and 107**

**Reg. No. 3,396,129**

**United States Patent and Trademark Office**

**Registered Mar. 11, 2008**

**TRADEMARK  
SERVICE MARK  
PRINCIPAL REGISTER**



BOARD OF REGENTS, THE UNIVERSITY OF  
TEXAS SYSTEM (TEXAS STATE AGENCY)  
201 WEST 7TH STREET  
AUSTIN, TX 78701

FOR: STATIONERY, WRITING NOTEBOOKS,  
POCKET FOLDERS, BINDERS, DECALS, CALEN-  
DARS, PENS, BOOKENDS, IN CLASS 16 (U.S. CLS. 2,  
5, 22, 23, 29, 37, 38 AND 50).

FIRST USE 2-15-2006; IN COMMERCE 2-15-2006.

FOR: LUGGAGE, GARMENT BAGS FOR TRAVEL,  
DUFFEL BAGS, OVERNIGHT BAGS, BACK-  
PACKS, IN CLASS 18 (U.S. CLS. 1, 2, 3, 22 AND 41).

FIRST USE 2-15-2006; IN COMMERCE 2-15-2006.

FOR: DRINKING GLASSES, MUGS, TUMBLERS,  
SHOT GLASSES, IN CLASS 21 (U.S. CLS. 2, 13, 23, 29,  
30, 33, 40 AND 50).

FIRST USE 2-15-2006; IN COMMERCE 2-15-2006.

FOR: CLOTHING, NAMELY, CAPS, JACKETS,  
COATS, SHIRTS, WARM-UP SUITS, WARM-UP  
PANTS, BELTS, FOOTWEAR, T-SHIRTS, SWEAT-  
TERS, RAINCOATS, PONCHOS, HAT BANDS,  
SWEAT BANDS, SWEATSHIRTS, SWEATPANTS,  
TAMS, BANDANNAS, RUNNING AND ATHLETIC  
SHORTS, SCARVES, CLOTH BABY BIBS, BABY  
PANTIES AND DRESSES, BABY BOOTIES, BABY

SHIRTS, BABY PANTS, WRIST BANDS, TANK  
TOPS, HATS, WIND SUITS, JERSEYS, HALF-PANTS,  
TIGHTS, BIKER SHORTS, SWIM WEAR, SOCKS,  
BOXER SHORTS, BODY SUITS, AND TIES, IN  
CLASS 25 (U.S. CLS. 22 AND 39).

FIRST USE 2-15-2006; IN COMMERCE 2-15-2006.

FOR: EDUCATIONAL SERVICES, NAMELY,  
PROVIDING COLLEGE AND GRADUATE LEVEL  
COURSES OF INSTRUCTION; EDUCATIONAL  
AND ENTERTAINMENT SERVICES, NAMELY,  
PROVIDING MOTIVATIONAL AND EDUCATION-  
AL SPEAKERS; EDUCATIONAL SERVICES, NAME-  
LY, COURSES AT THE UNIVERSITY LEVEL  
FEATURING OPPORTUNITIES TO PARTICIPATE  
IN RESEARCH PROGRAMS; ENTERTAINMENT  
SERVICES IN THE NATURE OF COMPETITIONS  
AND EVENTS IN THE FIELD OF COLLEGE ATH-  
LETICS, IN CLASS 41 (U.S. CLS. 100, 101 AND 107).

FIRST USE 2-15-2006; IN COMMERCE 2-15-2006.

SEC. 2(F) AS TO "THE UNIVERSITY OF TEXAS  
ARLINGTON".

SN 78-779,383, FILED 12-22-2005.

ROBIN CHOSID, EXAMINING ATTORNEY

**Int. Cl.: 22**

**Prior U.S. Cls.: 1, 2, 7, 19, 22, 42, and 50**

**United States Patent and Trademark Office**

**Reg. No. 3,396,130**

**Registered Mar. 11, 2008**

**TRADEMARK  
PRINCIPAL REGISTER**

**COVERTECH**

ALPHASOURCE INC. (PENNSYLVANIA COR-  
PORATION)  
4837-49 N. STENTON AVENUE  
PHILADELPHIA, PA 19144

THE MARK CONSISTS OF STANDARD CHAR-  
ACTERS WITHOUT CLAIM TO ANY PARTICULAR  
FONT, STYLE, SIZE, OR COLOR.

FOR: TARPAULINS, IN CLASS 22 (U.S. CLS. 1, 2, 7,  
19, 22, 42 AND 50).

SN 78-779,862, FILED 12-22-2005.

FIRST USE 7-20-2007; IN COMMERCE 8-17-2007.

TARAH HARDY, EXAMINING ATTORNEY

**Int. Cls.: 16, 35, and 41**

**Prior U.S. Cls.: 2, 5, 22, 23, 29, 37, 38, 50, 100, 101, 102, and 107**

**Reg. No. 3,396,131**

**United States Patent and Trademark Office**

**Registered Mar. 11, 2008**

**TRADEMARK  
SERVICE MARK  
PRINCIPAL REGISTER**

**THE VOICE OF AUTISM**

AUTISM SOCIETY OF AMERICA, INC. (D.C.  
NON-PROFIT CORPORATION)  
SUITE 300  
7910 WOODMONT AVENUE  
BETHESDA, MD 20814

FOR: PUBLICATIONS, NAMELY, NEWSLETTERS, MANUALS, BOOKLETS, BROCHURES AND PAMPHLETS, ALL CONCERNING AUTISTIC CHILDREN AND ADULTS; MEETING REPORTS, ANNUAL REPORTS, AND MEETING PROGRAMS CONCERNING AUTISTIC CHILDREN AND ADULTS DISTRIBUTED TO PERSONS OUTSIDE THE ORGANIZATION; POSTERS, MEMORANDUM PADS, AND CARDBOARD OR PAPER COVERS FOR COLLECTION CANS SOLD SEPARATELY, IN CLASS 16 (U.S. CLS. 2, 5, 22, 23, 29, 37, 38 AND 50).

FIRST USE 9-30-2005; IN COMMERCE 9-30-2005.

FOR: PROMOTING PUBLIC AWARENESS OF AUTISM AND DEVELOPMENTAL DISABILITIES, IN CLASS 35 (U.S. CLS. 100, 101 AND 102).

FIRST USE 9-30-2005; IN COMMERCE 9-30-2005.

FOR: EDUCATION SERVICES, NAMELY, CONDUCTING CONFERENCES, CLASSES, SEMINARS, WORKSHOPS AND MEETINGS CONCERNING AUTISTIC CHILDREN AND ADULTS, AND CONCERNING AUTISM AWARENESS, IN CLASS 41 (U.S. CLS. 100, 101 AND 107).

FIRST USE 7-31-2006; IN COMMERCE 7-31-2006.

THE MARK CONSISTS OF STANDARD CHARACTERS WITHOUT CLAIM TO ANY PARTICULAR FONT, STYLE, SIZE, OR COLOR.

OWNER OF U.S. REG. NO. 2,473,689.

NO CLAIM IS MADE TO THE EXCLUSIVE RIGHT TO USE "AUTISM", APART FROM THE MARK AS SHOWN.

SN 78-779,893, FILED 12-22-2005.

BENJAMIN OKEKE, EXAMINING ATTORNEY

**Int. Cls.: 21 and 31**

**Prior U.S. Cls.: 1, 2, 13, 23, 29, 30, 33, 40, 46, and 50**

**Reg. No. 3,396,132**

**United States Patent and Trademark Office**

**Registered Mar. 11, 2008**

**TRADEMARK  
PRINCIPAL REGISTER**

**MUGALOON**

TELEFLORA LLC (DELAWARE LTD LIAB CO)  
11444 W. OLYMPIC BLVD., 10TH FLOOR  
LOS ANGELES, CA 90064

THE MARK CONSISTS OF STANDARD CHARACTERS WITHOUT CLAIM TO ANY PARTICULAR FONT, STYLE, SIZE, OR COLOR.

FOR: FLORAL CONTAINERS AND MUGS WITH FLORAL ARRANGEMENTS SOLD AS A UNIT, IN CLASS 21 (U.S. CLS. 2, 13, 23, 29, 30, 33, 40 AND 50).

OWNER OF U.S. REG. NOS. 776,336, 2,128,187, AND OTHERS.

FIRST USE 5-0-2007; IN COMMERCE 5-0-2007.

SN 78-780,243, FILED 12-23-2005.

FOR: LIVE-CUT FLORAL ARRANGEMENTS, IN CLASS 31 (U.S. CLS. 1 AND 46).

FIRST USE 5-0-2007; IN COMMERCE 5-0-2007.

DOMINIC J. FERRAIUOLO, EXAMINING ATTORNEY

**Int. Cl.: 12**

**Prior U.S. Cls.: 19, 21, 23, 31, 35, and 44**

**United States Patent and Trademark Office**

**Reg. No. 3,396,133**

**Registered Mar. 11, 2008**

**TRADEMARK  
PRINCIPAL REGISTER**



COLLECTORS CHOICE, LTD (WISCONSIN CORPORATION)  
6400 LODI-SPRINGFIELD RD  
DANE, WI 53529

FOR: STRUCTURAL PARTS FOR AUTOMOBILES, IN CLASS 12 (U.S. CLS. 19, 21, 23, 31, 35 AND 44).

FIRST USE 1-2-2006; IN COMMERCE 9-0-2006.

THE MARK CONSISTS OF A BLACK AND WHITE IMAGE OF A CURVED ROAD BUILDING TO A SNAKE HEAD WITHIN A FIVE-SIDED POLYGON.

SN 78-780,997, FILED 12-27-2005.

WENDY GOODMAN, EXAMINING ATTORNEY

**Int. Cl.: 9**

**Prior U.S. Cls.: 21, 23, 26, 36, and 38**

**Reg. No. 3,396,134**

**United States Patent and Trademark Office**

**Registered Mar. 11, 2008**

**TRADEMARK  
PRINCIPAL REGISTER**

**FOXNANO**

HON HAI PRECISION INDUSTRY CO., LTD.  
(TAIWAN CORPORATION)  
NO. 2, TZU YU STREET  
TU-CHENG CITY, TAIPEI HSIEN, TAIWAN

THE MARK CONSISTS OF STANDARD CHAR-  
ACTERS WITHOUT CLAIM TO ANY PARTICULAR  
FONT, STYLE, SIZE, OR COLOR.

FOR: ELECTRIC WIRES AND CABLES; ELEC-  
TRICAL WIRING HARNESS AND ELECTRICAL  
CABLE ASSEMBLIES, IN CLASS 9 (U.S. CLS. 21, 23,  
26, 36 AND 38).

SN 78-782,543, FILED 12-29-2005.

FIRST USE 8-8-2007; IN COMMERCE 11-6-2007.

SANI KHOURI, EXAMINING ATTORNEY

**Int. Cl.: 9**

**Prior U.S. Cls.: 21, 23, 26, 36, and 38**

**Reg. No. 3,396,135**

**United States Patent and Trademark Office**

**Registered Mar. 11, 2008**

---

**TRADEMARK  
PRINCIPAL REGISTER**

**NANOFOX**

HON HAI PRECISION INDUSTRY CO., LTD.  
(TAIWAN CORPORATION)  
NO. 2, TZU YU STREET  
TU-CHENG CITY, TAIPEI HSIEN, TAIWAN

THE MARK CONSISTS OF STANDARD CHAR-  
ACTERS WITHOUT CLAIM TO ANY PARTICULAR  
FONT, STYLE, SIZE, OR COLOR.

FOR: ELECTRIC WIRES AND CABLES; ELEC-  
TRICAL WIRING HARNESS AND ELECTRICAL  
CABLE ASSEMBLIES, IN CLASS 9 (U.S. CLS. 21, 23,  
26, 36 AND 38).

SN 78-782,553, FILED 12-29-2005.

FIRST USE 9-6-2007; IN COMMERCE 11-12-2007.

SANI KHOURI, EXAMINING ATTORNEY



**Int. Cl.: 31**

**Prior U.S. Cls.: 1 and 46**

**United States Patent and Trademark Office**

**Reg. No. 3,396,136**

**Registered Mar. 11, 2008**

**TRADEMARK  
PRINCIPAL REGISTER**

**SELOMET**

AB AGRI LIMITED (UNITED KINGDOM LIMITED COMPANY)  
10 GROSVENOR STREET  
WESTON CENTRE  
LONDON, UNITED KINGDOM W1K 4QY

FOR: ANIMAL FEED INGREDIENTS, NAMELY, NON-MEDICATED ANIMAL FEED ADDITIVES, IN CLASS 31 (U.S. CLS. 1 AND 46).

FIRST USE 11-0-2007; IN COMMERCE 11-0-2007.

THE MARK CONSISTS OF STANDARD CHARACTERS WITHOUT CLAIM TO ANY PARTICULAR FONT, STYLE, SIZE, OR COLOR.

PRIORITY CLAIMED UNDER SEC. 44(D) ON CHINA APPLICATION NO. 4777021, FILED 7-14-2005.

SN 78-782,590, FILED 12-29-2005.

CAROLYN CATALDO, EXAMINING ATTORNEY

**Int. Cl.: 37**

**Prior U.S. Cls.: 100, 103, and 106**

**United States Patent and Trademark Office**

**Reg. No. 3,396,137**

**Registered Mar. 11, 2008**

**SERVICE MARK  
PRINCIPAL REGISTER**



INTERNATIONAL PIPELINING TECHNOLOGIES, INC. (CALIFORNIA CORPORATION)  
SUITE H  
8250 CAMINO SANTA FE  
LA JOLLA, CA 92037

FOR: PIPELINE REHABILITATION, RESTORATION AND MAINTENANCE SERVICES, NAMELY, REHABILITATION, RESTORATION AND MAINTENANCE OF CURED IN PLACE PIPE, WATER PIPES,

SEWER PIPES AND INDUSTRIAL PIPES, IN CLASS 37 (U.S. CLS. 100, 103 AND 106).

FIRST USE 12-0-2005; IN COMMERCE 12-0-2005.

SN 78-783,980, FILED 1-3-2006.

CAROLINE WOOD, EXAMINING ATTORNEY

**Int. Cl.: 41**

**Prior U.S. Cls.: 100, 101, and 107**

**United States Patent and Trademark Office**

**Reg. No. 3,396,138**

**Registered Mar. 11, 2008**

**SERVICE MARK  
PRINCIPAL REGISTER**

**People Potential Group**

PEOPLE POTENTIAL GROUP, INC. (MINNESOTA CORPORATION)  
4388 DORCHESTER DRIVE  
WOODBURY, MN 55129

FOR: PERSONAL COACHING SERVICES IN THE FIELD OF CAREER DEVELOPMENT; TRAINING SERVICES IN THE FIELD OF CAREER DEVELOPMENT, IN CLASS 41 (U.S. CLS. 100, 101 AND 107).

FIRST USE 9-12-2006; IN COMMERCE 9-12-2006.

THE MARK CONSISTS OF STANDARD CHARACTERS WITHOUT CLAIM TO ANY PARTICULAR FONT, STYLE, SIZE, OR COLOR.

NO CLAIM IS MADE TO THE EXCLUSIVE RIGHT TO USE "GROUP", APART FROM THE MARK AS SHOWN.

SN 78-784,141, FILED 1-3-2006.

CAROLINE WOOD, EXAMINING ATTORNEY

**Int. Cl.: 36**

**Prior U.S. Cls.: 100, 101, and 102**

**United States Patent and Trademark Office**

**Reg. No. 3,396,139**

**Registered Mar. 11, 2008**

**SERVICE MARK  
PRINCIPAL REGISTER**

**CAVEOBENEFITS**

AUGEO AFFINITY MARKETING, LLC (MINNE-  
SOTA LIMITED LIABILITY CORPORATION)  
2561 TERRITORIAL ROAD  
ST. PAUL, MN 55114

FOR: INSURANCE AND ADMINISTRATION  
SERVICES IN THE FIELD OF GROUP, INDIVIDUAL  
AND EMPLOYEE BENEFITS, IN CLASS 36 (U.S. CLS.  
100, 101 AND 102).

FIRST USE 3-7-2006; IN COMMERCE 3-7-2006.

THE MARK CONSISTS OF STANDARD CHAR-  
ACTERS WITHOUT CLAIM TO ANY PARTICULAR  
FONT, STYLE, SIZE, OR COLOR.

SN 78-784,289, FILED 1-3-2006.

ANNE MADDEN, EXAMINING ATTORNEY

**Int. Cl.: 9**

**Prior U.S. Cls.: 21, 23, 26, 36, and 38**

**United States Patent and Trademark Office**

**Reg. No. 3,396,140**

**Registered Mar. 11, 2008**

**TRADEMARK  
PRINCIPAL REGISTER**

**METAGON**

DECISION SUPPORT 2, LLC (NORTH CAROLINA LTD LIAB CO)  
624 MATTHEWS-MINT HILL ROAD  
SUITE 100  
MATTHEWS, NC 28105

FOR: COMPUTER SOFTWARE AND HARDWARE  
USED IN DATA INTEGRATION, DATA ACCESS  
AND ELECTION MANAGEMENT, IN CLASS 9 (U.S.  
CLS. 21, 23, 26, 36 AND 38).

FIRST USE 7-9-2007; IN COMMERCE 7-9-2007.

THE MARK CONSISTS OF STANDARD CHARACTERS WITHOUT CLAIM TO ANY PARTICULAR FONT, STYLE, SIZE, OR COLOR.

SN 78-786,363, FILED 1-6-2006.

JOHN WILKE, EXAMINING ATTORNEY

**Int. Cl.: 9**

**Prior U.S. Cls.: 21, 23, 26, 36, and 38**

**United States Patent and Trademark Office**

**Reg. No. 3,396,141**

**Registered Mar. 11, 2008**

**TRADEMARK  
PRINCIPAL REGISTER**

**POWERED BY PRESS-SENSE**

PRESS-SENSE LTD. (ISRAEL CORPORATION)  
5, HADAS ST., NORTH INDUSTRIAL ZONE  
OR AKIVA, ISRAEL

THE MARK CONSISTS OF STANDARD CHAR-  
ACTERS WITHOUT CLAIM TO ANY PARTICULAR  
FONT, STYLE, SIZE, OR COLOR.

FOR: COMPUTER SOFTWARE FOR USE IN THE  
MANAGEMENT, PRODUCTION AND INTEGRA-  
TION OF PRINT HOUSE OPERATIONS, IN CLASS 9  
(U.S. CLS. 21, 23, 26, 36 AND 38).

SN 78-786,412, FILED 1-6-2006.

FIRST USE 2-18-2004; IN COMMERCE 2-18-2004.

HANNO RITTNER, EXAMINING ATTORNEY

**Int. Cl.: 7**

**Prior U.S. Cls.: 13, 19, 21, 23, 31, 34, and 35**

**United States Patent and Trademark Office**

**Reg. No. 3,396,142**

**Registered Mar. 11, 2008**

**TRADEMARK  
PRINCIPAL REGISTER**

**AIR MATE**

THE GORMAN-RUPP COMPANY (OHIO CORPORATION)

305 BOWMAN STREET

MANSFIELD, OH 44903

FOR: AIR RELEASE VALVES USED WITH PUMPS, IN CLASS 7 (U.S. CLS. 13, 19, 21, 23, 31, 34 AND 35).

FIRST USE 5-9-2006; IN COMMERCE 5-9-2006.

THE MARK CONSISTS OF STANDARD CHARACTERS WITHOUT CLAIM TO ANY PARTICULAR FONT, STYLE, SIZE, OR COLOR.

NO CLAIM IS MADE TO THE EXCLUSIVE RIGHT TO USE "AIR", APART FROM THE MARK AS SHOWN.

SN 78-786,598, FILED 1-6-2006.

VIVIAN MICZNIK FIRST, EXAMINING ATTORNEY

**Int. Cl.: 35**

**Prior U.S. Cls.: 100, 101, and 102**

**United States Patent and Trademark Office**

**Reg. No. 3,396,143**

**Registered Mar. 11, 2008**

**SERVICE MARK  
PRINCIPAL REGISTER**

**HEALTHMAID**

BAIER, LANCE G. (UNITED STATES INDIVIDUAL)  
64 HAROLD ROAD  
FARMINGTON, CT 06032

FOR: ONLINE RETAIL STORE SERVICES FEATURING VITAMINS, NUTRITIONAL SUPPLEMENTS, SKIN CARE PRODUCTS, BEAUTY PRODUCTS, SPORTING GOODS AND CLOTHING, IN CLASS 35 (U.S. CLS. 100, 101 AND 102).

FIRST USE 3-14-2007; IN COMMERCE 3-14-2007.

THE MARK CONSISTS OF STANDARD CHARACTERS WITHOUT CLAIM TO ANY PARTICULAR FONT, STYLE, SIZE, OR COLOR.

SN 78-786,847, FILED 1-6-2006.

PAULA MAHONEY, EXAMINING ATTORNEY



**Int. Cl.: 35**

**Prior U.S. Cls.: 100, 101, and 102**

**United States Patent and Trademark Office**

**Reg. No. 3,396,144**

**Registered Mar. 11, 2008**

**SERVICE MARK  
PRINCIPAL REGISTER**



THINKING CAP, INC. (SOUTH CAROLINA CORPORATION)  
131 FALLS STREET, SUITE 101  
GREENVILLE, SC 29601

FOR: ON-LINE RETAIL STORE SERVICES FEATURING SOCIAL EXPRESSION PRODUCTS DESIGNED TO FACILITATE RELATIONSHIPS, NAMELY, STATIONERY, CARDS, GIFTS, COLLECTIBLES, CALENDARS, WRAPPING PAPER, ORGA-

NIZERS, PARTY PRODUCTS, APPAREL, ACCESSORIES AND GAMES, IN CLASS 35 (U.S. CLS. 100, 101 AND 102).

FIRST USE 5-21-2006; IN COMMERCE 5-21-2006.

SN 78-787,384, FILED 1-9-2006.

HOWARD SMIGA, EXAMINING ATTORNEY

**Int. Cls.: 35 and 42**

**Prior U.S. Cls.: 100, 101, and 102**

**United States Patent and Trademark Office**

**Reg. No. 3,396,145**

**Registered Mar. 11, 2008**

**SERVICE MARK  
PRINCIPAL REGISTER**

**WORKFORCE EDGE CONSULTING**

WORKFORCE EDGE CONSULTING INC. (CANADA CORPORATION)  
14450 CARRS LANDING  
WINFIELD, BRITISH COLUMBIA, CANADA V4V 1A7

FOR: EMPLOYMENT AND EMPLOYMENT MANAGEMENT CONSULTING SERVICES AND BUSINESS PRACTICE DEVELOPMENT AND MANAGEMENT SERVICES, IN CLASS 35 (U.S. CLS. 100, 101 AND 102).

FIRST USE 12-20-2007; IN COMMERCE 2-11-2006.

FOR: INFORMATION TECHNOLOGY CONSULTING SERVICES RELATING TO EMPLOY-

MENT AND WORKFORCE MANAGEMENT, IN CLASS 42 (U.S. CLS. 100 AND 101).

FIRST USE 12-20-2007; IN COMMERCE 2-11-2006.

THE MARK CONSISTS OF STANDARD CHARACTERS WITHOUT CLAIM TO ANY PARTICULAR FONT, STYLE, SIZE, OR COLOR.

NO CLAIM IS MADE TO THE EXCLUSIVE RIGHT TO USE "WORKFORCE" AND "CONSULTING", APART FROM THE MARK AS SHOWN.

SN 78-787,927, FILED 1-9-2006.

BRENDAN MCCAULEY, EXAMINING ATTORNEY

**Int. Cl.: 41**

**Prior U.S. Cls.: 100, 101, and 107**

**United States Patent and Trademark Office**

**Reg. No. 3,396,146**

**Registered Mar. 11, 2008**

**SERVICE MARK  
PRINCIPAL REGISTER**

**Parker-Anderson Learning  
Centers**

PARKER-ANDERSON LEARNING CENTERS  
(CALIFORNIA LTD LIAB CO)  
1627 HIGHLAND AVENUE  
GLENDALE, CA 91202

FOR: EDUCATIONAL SERVICES, NAMELY,  
CONDUCTING COURSES OF INSTRUCTION,  
WORKSHOPS, AND SEMINARS RELATING TO  
THE FIELDS OF MATH, READING, TEST PRE-  
PARATION, THE SCIENCES, HISTORY, CHESS,  
ROBOTICS AND ENGINEERING, IN CLASS 41  
(U.S. CLS. 100, 101 AND 107).

FIRST USE 7-1-2006; IN COMMERCE 7-1-2006.

THE MARK CONSISTS OF STANDARD CHAR-  
ACTERS WITHOUT CLAIM TO ANY PARTICULAR  
FONT, STYLE, SIZE, OR COLOR.

NO CLAIM IS MADE TO THE EXCLUSIVE  
RIGHT TO USE "LEARNING CENTERS", APART  
FROM THE MARK AS SHOWN.

SN 78-787,934, FILED 1-9-2006.

BERYL GARDNER, EXAMINING ATTORNEY

**Int. Cl.: 41**

**Prior U.S. Cls.: 100, 101, and 107**

**United States Patent and Trademark Office**

**Reg. No. 3,396,147**

**Registered Mar. 11, 2008**

**SERVICE MARK  
PRINCIPAL REGISTER**

**CUISINE POPULAIRE**

CUISINE POPULAIRE, INC. (ILLINOIS CORPORATION)  
3253 N. KEDZIE STREET  
CHICAGO, IL 60618

FOR: ENTERTAINMENT SERVICES, NAMELY WINE AND FOOD TASTINGS; PRESENTATION OF LIVE SHOW PERFORMANCES RELATING TO FOOD AND WINE; ON-GOING TELEVISION SERIES IN THE FIELD OF FOOD AND WINE; ON-GOING TELEVISION ENTERTAINMENT PROGRAMS RELATING TO FOOD AND WINE; CONTINUING ENTERTAINMENT SHOW BROADCAST OVER TELEVISION, AUDIO AND VIDEO MEDIA AND A GLOBAL COMPUTER NETWORK RELATING TO FOOD AND WINE; PRODUCTION OF TELEVISION AND RADIO PROGRAMS, FILMS, SOUND AND VIDEO RECORDINGS, CD-ROM'S AND DVD'S; ORGANIZING EXHIBITIONS, CULTURAL ACTIVITIES, STAGE SHOWS AND COMPETITIONS FOR ENTERTAINMENT RELATING TO FOOD AND WINE; PUBLICATION OF ELECTRONIC EDUCATIONAL AND INSTRUCTIONAL MATERIALS ALL RELATING TO FOOD AND WINE;

PROVIDING ONLINE ELECTRONIC PUBLICATIONS IN THE NATURE OF NEWSLETTERS IN THE FIELD OF FOOD AND WINE, IN CLASS 41 (U.S. CLS. 100, 101 AND 107).

FIRST USE 2-0-2006; IN COMMERCE 2-0-2006.

THE MARK CONSISTS OF STANDARD CHARACTERS WITHOUT CLAIM TO ANY PARTICULAR FONT, STYLE, SIZE, OR COLOR.

NO CLAIM IS MADE TO THE EXCLUSIVE RIGHT TO USE "CUISINE", APART FROM THE MARK AS SHOWN.

THE FOREIGN WORDING IN THE MARK TRANSLATES INTO ENGLISH AS POPULAR CUISINE.

SN 78-788,280, FILED 1-10-2006.

JENNIFER DIXON, EXAMINING ATTORNEY

**Int. Cl.: 10**

**Prior U.S. Cls.: 26, 39, and 44**

**United States Patent and Trademark Office**

**Reg. No. 3,396,148**

**Registered Mar. 11, 2008**

**TRADEMARK  
PRINCIPAL REGISTER**

**Stand Up and Be Heard**

HARRIS, GAIL (UNITED STATES INDIVIDUAL)  
805 BROADMOOR STREET  
NASHVILLE, TN 37216

THE MARK CONSISTS OF STANDARD CHAR-  
ACTERS WITHOUT CLAIM TO ANY PARTICULAR  
FONT, STYLE, SIZE, OR COLOR.

FOR: ADULT SEXUAL AIDS, NAMELY, ARTIFI-  
CAL PENISES, PENIS ENLARGERS, VIBRATORS,  
BENWA BALLS, ARTIFICIAL VAGINAS, AND DIL-  
DOS, IN CLASS 10 (U.S. CLS. 26, 39 AND 44).

SN 78-788,391, FILED 1-10-2006.

FIRST USE 3-31-2007; IN COMMERCE 3-31-2007.

WON TEAK OH, EXAMINING ATTORNEY

**Int. Cl.: 19**

**Prior U.S. Cls.: 1, 12, 33, and 50**

**United States Patent and Trademark Office**

**Reg. No. 3,396,149**

**Registered Mar. 11, 2008**

**TRADEMARK  
PRINCIPAL REGISTER**

# CERAMEXT

CERAMEXT LLC (NEVADA LTD LIAB CO)  
6121 LAKESIDE DR., SUITE 260  
RENO, NV 89511

FOR: CERAMIC TILE AND TILE PRODUCTS, NAMELY, CERAMIC OR SYNTHETIC-STONE BUILDING MATERIALS, NAMELY, FLOOR TILE, WALL TILE, FLAT OR CURVED ROOF TILE, HEAT-REFLECTIVE ROOF TILE, DECORATIVE TILE, PAVERS, COBBLES, PAVING TILE, BUILDING CLADDING OR BUILDING FACING, BRICK, BLOCKS, SIDING, PANELS, COUNTERTOPS, AND AGGREGATE FOR ROAD BASE; FLOORING, ROOFING, DECORATIVE, OR SURFACE MATERIALS, NAMELY, POLISHED, HONED, GLAZED, EMBOSSED, ETCHED, OR NATURAL-SURFACE TILE FOR FLOORS, ROOFS, WALLS, OR DECORATIVE USE; ROCK MATERIALS USED IN THE MANUFACTURE OF COUNTERTOPS, WALL CLADDING, FIREPLACE SURROUNDS, RESIDENTIAL AND COMMERCIAL CONSTRUCTION MATERIAL, NAMELY, CERAMIC BRICK OR TILE, SYNTHETIC-STONE BRICK OR TILE; GLAZED OR

UNGLAZED CERAMIC TILE, NON-METAL FLOOR TILE, WALL TILE, NON-METAL FLOOR TRIM TILE, GLASS MOSAIC TILE, NON-METAL QUARRY TILE, STRUCTURAL BRICK, DECORATIVE BRICK, FACING BRICK, BLOCK BRICK; NON-METAL BUILDING MATERIAL, NAMELY, ARCHITECTURAL FASCIA, LANDSCAPING BRICK, PAVING BRICK, FACING BRICK, BUILDING COPING, CERAMIC SIDING, SYNTHETIC-STONE SIDING, AND NON-METAL DECORATIVE MOLDINGS AND DECORATIVE TRIM FOR USE IN BUILDING CONSTRUCTION, IN CLASS 19 (U.S. CLS. 1, 12, 33 AND 50).

FIRST USE 11-1-2006; IN COMMERCE 11-1-2006.

THE MARK CONSISTS OF STANDARD CHARACTERS WITHOUT CLAIM TO ANY PARTICULAR FONT, STYLE, SIZE, OR COLOR.

SN 78-788,893, FILED 1-10-2006.

ANDREA SAUNDERS, EXAMINING ATTORNEY

**Int. Cl.: 36**

**Prior U.S. Cls.: 100, 101, and 102**

**United States Patent and Trademark Office**

**Reg. No. 3,396,150**

**Registered Mar. 11, 2008**

**SERVICE MARK  
PRINCIPAL REGISTER**

**Nancy knows Sugarmill Woods**

PONTICOS, NANCY S. P.A. (UNITED STATES  
INDIVIDUAL)  
7 BYRSONIMA COURT WEST  
HOMOSASSA, FL 34446

THE MARK CONSISTS OF STANDARD CHAR-  
ACTERS WITHOUT CLAIM TO ANY PARTICULAR  
FONT, STYLE, SIZE, OR COLOR.

FOR: ASSESSMENT AND MANAGEMENT OF  
REAL ESTATE, IN CLASS 36 (U.S. CLS. 100, 101 AND  
102).

SN 78-789,342, FILED 1-11-2006.

FIRST USE 11-5-2006; IN COMMERCE 11-5-2006.

EMILY CARLSEN, EXAMINING ATTORNEY

**Int. Cl.: 19**

**Prior U.S. Cls.: 1, 12, 33, and 50**

**United States Patent and Trademark Office**

**Reg. No. 3,396,151**

**Registered Mar. 11, 2008**

**TRADEMARK  
PRINCIPAL REGISTER**



CERAMEXT LLC (NEVADA LTD LIAB CO)  
6121 LAKESIDE DR., SUITE 260  
RENO, NV 89511

FOR: CERAMIC TILE AND TILE PRODUCTS, NAMELY, CERAMIC OR SYNTHETIC-STONE BUILDING MATERIALS, NAMELY, FLOOR TILE, WALL TILE, FLAT OR CURVED ROOF TILE, HEAT-REFLECTIVE ROOF TILE, DECORATIVE TILE, PAVERS, COBBLES, PAVING TILE, BUILDING CLADDING OR BUILDING FACING, BRICK, BLOCKS, SIDING, PANELS, COUNTERTOPS, AND AGGREGATE FOR ROAD BASE; FLOORING, ROOFING, DECORATIVE, OR SURFACE MATERIALS, NAMELY, POLISHED, HONED, GLAZED, EMBOSSED, ETCHED, OR NATURAL-SURFACE TILE FOR FLOORS, ROOFS, WALLS, OR DECORATIVE USE; ROCK MATERIALS USED IN THE MANUFACTURE OF COUNTERTOPS, WALL CLADDING, FIREPLACE SURROUNDS, RESIDENTIAL AND COMMERCIAL CONSTRUCTION MATERIAL, NAMELY, CERAMIC BRICK OR TILE, SYNTHETIC-STONE BRICK OR TILE; GLAZED OR

UNGLAZED CERAMIC TILE, NON-METAL FLOOR TILE, WALL TILE, NON-METAL FLOOR TRIM TILE, GLASS MOSAIC TILE, NON-METAL QUARRY TILE, STRUCTURAL BRICK, DECORATIVE BRICK, FACING BRICK, BLOCK BRICK; NON-METAL BUILDING MATERIAL, NAMELY, ARCHITECTURAL FASCIA, LANDSCAPING BRICK, PAVING BRICK, FACING BRICK, BUILDING COPING, CERAMIC SIDING, SYNTHETIC-STONE SIDING, AND NON-METAL DECORATIVE MOLDINGS AND DECORATIVE TRIM FOR USE IN BUILDING CONSTRUCTION, IN CLASS 19 (U.S. CLS. 1, 12, 33 AND 50).

FIRST USE 11-1-2006; IN COMMERCE 11-1-2006.

THE MARK CONSISTS OF THE LETTERS "CERAM" IN LARGE FONT WITH THE LETTERS "EXT" IN SMALLER FONT IN DECENDING ORDER.

SN 78-789,716, FILED 1-11-2006.

ANDREA SAUNDERS, EXAMINING ATTORNEY



**Int. Cl.: 36**

**Prior U.S. Cls.: 100, 101, and 102**

**United States Patent and Trademark Office**

**Reg. No. 3,396,152**

**Registered Mar. 11, 2008**

**SERVICE MARK  
PRINCIPAL REGISTER**

**ASSOCIA CARES**

ASSOCIATIONS, INC. (TEXAS CORPORATION)  
5401 N. CENTRAL EXPRESSWAY  
SUITE 300  
DALLAS, TX 75205

FOR: CHARITABLE SERVICES, NAMELY, PHILANTHROPIC SERVICES CONCERNING MONETARY DONATIONS IN THE NATURE OF PROVIDING FINANCIAL ASSISTANCE AND SUPPORT TO VICTIMS OF DISASTERS AND POVERTY, IN CLASS 36 (U.S. CLS. 100, 101 AND 102).

FIRST USE 2-4-2006; IN COMMERCE 12-6-2006.

THE MARK CONSISTS OF STANDARD CHARACTERS WITHOUT CLAIM TO ANY PARTICULAR FONT, STYLE, SIZE, OR COLOR.

OWNER OF U.S. REG. NOS. 2,931,177, 3,005,586, AND OTHERS.

SN 78-791,093, FILED 1-13-2006.

SOPHIA S. KIM, EXAMINING ATTORNEY

**Int. Cl.: 29**

**Prior U.S. Cl.: 46**

**United States Patent and Trademark Office**

**Reg. No. 3,396,153**

**Registered Mar. 11, 2008**

**TRADEMARK  
PRINCIPAL REGISTER**

SWEET, CREAMY, SATISFYING

WHITEWAVE SERVICES, INC. (DELAWARE  
CORPORATION)

#546

300 DELAWARE AVENUE  
WILMINGTON, DE 19801

THE MARK CONSISTS OF STANDARD CHAR-  
ACTERS WITHOUT CLAIM TO ANY PARTICULAR  
FONT, STYLE, SIZE, OR COLOR.

FOR: NON-DAIRY CREAMER, IN CLASS 29 (U.S.  
CL. 46).

SN 78-791,147, FILED 1-13-2006.

FIRST USE 3-15-2006; IN COMMERCE 3-15-2006.

LYDIA BELZER, EXAMINING ATTORNEY

**Int. Cl.: 33**

**Prior U.S. Cls.: 47 and 49**

**United States Patent and Trademark Office**

**Reg. No. 3,396,154**

**Registered Mar. 11, 2008**

**TRADEMARK  
PRINCIPAL REGISTER**

**AMBLESIDE**

KINGSTON ESTATE WINES PTY LTD (AUSTRALIA COMPANY)  
STURT HIGHWAY  
KINGSTON-ON-MURRAY, AUSTRALIA 5331

FOR: WINES, IN CLASS 33 (U.S. CLS. 47 AND 49).

FIRST USE 11-1-2007; IN COMMERCE 11-1-2007.

THE MARK CONSISTS OF STANDARD CHARACTERS WITHOUT CLAIM TO ANY PARTICULAR FONT, STYLE, SIZE, OR COLOR.

SN 78-791,826, FILED 1-13-2006.

LEIGH CAROLINE CASE, EXAMINING ATTORNEY

**Int. Cl.: 9**

**Prior U.S. Cls.: 21, 23, 26, 36, and 38**

**United States Patent and Trademark Office**

**Reg. No. 3,396,155**

**Registered Mar. 11, 2008**

**TRADEMARK  
PRINCIPAL REGISTER**

**CPACKET NETWORKS**

CPACKET NETWORKS INC. (DELAWARE CORPORATION)  
2061 LANDINGS DRIVE  
MOUNTAIN VIEW, CA 94043

FOR: COMPUTER HARDWARE AND COMPUTER SOFTWARE FOR USE IN MONITORING, SECURING, RESPONDING TO AND CONTROLLING COMPUTER AND COMMUNICATIONS NETWORK TRAFFIC, IN CLASS 9 (U.S. CLS. 21, 23, 26, 36 AND 38).

FIRST USE 3-1-2006; IN COMMERCE 3-1-2006.

THE MARK CONSISTS OF STANDARD CHARACTERS WITHOUT CLAIM TO ANY PARTICULAR FONT, STYLE, SIZE, OR COLOR.

NO CLAIM IS MADE TO THE EXCLUSIVE RIGHT TO USE "NETWORKS", APART FROM THE MARK AS SHOWN.

SN 78-792,010, FILED 1-15-2006.

MICHAEL GAFFAR, EXAMINING ATTORNEY

**Int. Cl.: 9**

**Prior U.S. Cls.: 21, 23, 26, 36, and 38**

**United States Patent and Trademark Office**

**Reg. No. 3,396,156**

**Registered Mar. 11, 2008**

**TRADEMARK  
PRINCIPAL REGISTER**

**STEELWORKS**

STEELCLOUD, INC. (VIRGINIA CORPORATION)  
SUITE 210  
14040 PARK CENTER ROAD  
HERNDON, VA 20171

THE MARK CONSISTS OF STANDARD CHAR-  
ACTERS WITHOUT CLAIM TO ANY PARTICULAR  
FONT, STYLE, SIZE, OR COLOR.

FOR: COMPUTER SOFTWARE MANAGEMENT  
UTILITY PROGRAMS FOR COMPUTING APPLI-  
ANCES, IN CLASS 9 (U.S. CLS. 21, 23, 26, 36 AND 38).

SN 78-792,954, FILED 1-17-2006.

FIRST USE 1-18-2006; IN COMMERCE 5-30-2006.

WILLIAM ROSSMAN, EXAMINING ATTORNEY

Prior U.S. Cl.: B

United States Patent and Trademark Office

Reg. No. 3,396,157

Registered Mar. 11, 2008

CERTIFICATION MARK  
SERVICES  
PRINCIPAL REGISTER

International PrimeQX

PINK SHEETS LLC (DELAWARE LTD LIAB CO)  
304 HUDSON STREET  
NEW YORK, NY 10013

FOR: FINANCIAL INVESTMENT SERVICES IN  
THE FORM OF FINANCIAL SECURITIES, NAME-  
LY, STOCKS, IN CLASS B (U.S. CL. B).

FIRST USE 4-0-2007; IN COMMERCE 4-0-2007.

THE MARK CONSISTS OF STANDARD CHAR-  
ACTERS WITHOUT CLAIM TO ANY PARTICULAR  
FONT, STYLE, SIZE, OR COLOR.

NO CLAIM IS MADE TO THE EXCLUSIVE  
RIGHT TO USE "INTERNATIONAL", APART  
FROM THE MARK AS SHOWN.

IN CERTIFIER'S OPINION AND IN ACCOR-  
DANCE WITH CERTIFIER'S PUBLISHED STAN-  
DARDS, THE INTERNATIONAL ISSUER OF THE  
SUBJECT SECURITY IS A COMPANY WITH ON-  
GOING OPERATIONS, AUDITED FINANCIAL AND  
APPROPRIATE OTHER DISCLOSURES, REPORTS  
AND CERTIFICATIONS AND IS LISTED ON A  
FOREIGN STOCK EXCHANGE. OWNER WILL LA-  
TER PROVIDE A COPY OF THE STANDARDS THE  
OWNER WILL USE TO DETERMINE WHETHER  
THE SERVICES WILL BE CERTIFIED. THE OWNER  
WILL NOT ENGAGE IN THE PRODUCTION OR  
MARKETING OF THE GOODS OR SERVICES TO  
WHICH THE MARK IS APPLIED.

SN 78-794,080, FILED 1-18-2006.

JESSICA A. POWERS, EXAMINING ATTORNEY

**Int. Cl.: 35**

**Prior U.S. Cls.: 100, 101, and 102**

**United States Patent and Trademark Office**

**Reg. No. 3,396,158**

**Registered Mar. 11, 2008**

**SERVICE MARK  
PRINCIPAL REGISTER**

**SPECTRUM INKJETS**

EBABYLON, INC. (CALIFORNIA CORPORATION)  
30699 RUSSELL RANCH ROAD, SUITE 250  
WESTLAKE VILLAGE, CA 91362

FOR: ONLINE RETAIL STORES FEATURING  
INKJET PRINTER CARTRIDGES, INKJET PRIN-  
TER INK, FILLED INKJET PRINTER INK CAR-  
TRIDGES, TONERS, TONER CARTRIDGES AND  
RELATED ACCESSORIES, IN CLASS 35 (U.S. CLS.  
100, 101 AND 102).

FIRST USE 9-0-2006; IN COMMERCE 9-0-2006.

THE MARK CONSISTS OF STANDARD CHAR-  
ACTERS WITHOUT CLAIM TO ANY PARTICULAR  
FONT, STYLE, SIZE, OR COLOR.

NO CLAIM IS MADE TO THE EXCLUSIVE  
RIGHT TO USE "INKJETS", APART FROM THE  
MARK AS SHOWN.

SN 78-794,319, FILED 1-18-2006.

BILL DAWE, EXAMINING ATTORNEY

**Int. Cl.: 9**

**Prior U.S. Cls.: 21, 23, 26, 36, and 38**

**United States Patent and Trademark Office**

**Reg. No. 3,396,159**

**Registered Mar. 11, 2008**

**TRADEMARK  
PRINCIPAL REGISTER**

**GAS-GUARD**

SIEMENS POWER TRANSMISSION & DISTRIBUTION, INC. (DELAWARE CORPORATION)  
4700 FALLS OF NEUSE ROAD  
RALEIGH, NC 27609

FOR: COMPUTER SOFTWARE AND HARDWARE USED IN THE FIELD OF POWER GENERATION AND TRANSMISSION FOR MEASURING, ANALYZING, REPORTING AND MONITORING OPERATING CONDITIONS OF ELECTRICAL TRANSFORMERS AND REACTORS AND CIRCUIT BREAKERS, IN CLASS 9 (U.S. CLS. 21, 23, 26, 36 AND 38).

FIRST USE 4-30-2007; IN COMMERCE 4-30-2007.

THE MARK CONSISTS OF STANDARD CHARACTERS WITHOUT CLAIM TO ANY PARTICULAR FONT, STYLE, SIZE, OR COLOR.

SN 78-794,646, FILED 1-19-2006.

KAREN K. BUSH, EXAMINING ATTORNEY



**Int. Cl.: 41**

**Prior U.S. Cls.: 100, 101, and 107**

**United States Patent and Trademark Office**

**Reg. No. 3,396,160**

**Registered Mar. 11, 2008**

**SERVICE MARK  
PRINCIPAL REGISTER**

**JUR**

THOMSON SCIENTIFIC INC. (PENNSYLVANIA CORPORATION)  
3501 MARKET STREET  
PHILADELPHIA, PA 19104

FOR: PROVIDING AN ONLINE COMPUTER DATABASE FOR USE BY LIBRARIANS PROVIDING REPORTS BY PUBLISHERS ON HOW OFTEN AN ELECTRONIC PUBLICATION HAS BEEN USED; PUBLICATIONS AND CITATION DATA SHOWING LIBRARIANS HOW OFTEN THEIR USERS HAVE BEEN REFERRING TO A JOURNAL WHILE PUBLISHING THEIR OWN PAPERS; PROVIDING LIBRARIANS WITH DATA AS TO HOW OFTEN A JOURNAL HAS BEEN LEVERAGED WHEN CUS-

TOMERS ARE CONDUCTING SEARCHES WITH APPLICANT'S PROPRIETARY DATABASE, IN CLASS 41 (U.S. CLS. 100, 101 AND 107).

FIRST USE 6-11-2006; IN COMMERCE 6-11-2006.

THE MARK CONSISTS OF STANDARD CHARACTERS WITHOUT CLAIM TO ANY PARTICULAR FONT, STYLE, SIZE, OR COLOR.

SN 78-794,684, FILED 1-19-2006.

SUSAN STIGLITZ, EXAMINING ATTORNEY

**Int. Cl.: 9**

**Prior U.S. Cls.: 21, 23, 26, 36, and 38**

**United States Patent and Trademark Office**

**Reg. No. 3,396,161**

**Registered Mar. 11, 2008**

**TRADEMARK  
PRINCIPAL REGISTER**

**CPACKET**

CPACKET NETWORKS INC. (DELAWARE CORPORATION)  
2061 LANDINGS DRIVE  
MOUNTAIN VIEW, CA 94043

FOR: COMPUTER HARDWARE AND COMPUTER SOFTWARE FOR USE IN MONITORING, SECURING, RESPONDING TO AND CONTROLLING COMPUTER AND COMMUNICATIONS NETWORK TRAFFIC, IN CLASS 9 (U.S. CLS. 21, 23, 26, 36 AND 38).

FIRST USE 3-1-2006; IN COMMERCE 3-1-2006.

THE MARK CONSISTS OF STANDARD CHARACTERS WITHOUT CLAIM TO ANY PARTICULAR FONT, STYLE, SIZE, OR COLOR.

SN 78-794,735, FILED 1-19-2006.

MICHAEL GAAFAR, EXAMINING ATTORNEY

**Int. Cl.: 40**

**Prior U.S. Cls.: 100, 103, and 106**

**United States Patent and Trademark Office**

**Reg. No. 3,396,162**

**Registered Mar. 11, 2008**

**SERVICE MARK  
PRINCIPAL REGISTER**

**CPACKET**

CPACKET NETWORKS INC. (DELAWARE CORPORATION)  
2061 LANDINGS DRIVE  
MOUNTAIN VIEW, CA 94043

FOR: CUSTOM MANUFACTURE OF COMPUTER HARDWARE WITH OR CONTAINING COMPUTER SOFTWARE FOR USE IN MONITORING, SECURING, RESPONDING TO AND CONTROLLING COMPUTER AND COMMUNICATIONS NETWORK TRAFFIC, IN CLASS 40 (U.S. CLS. 100, 103 AND 106).

FIRST USE 3-1-2006; IN COMMERCE 3-1-2006.

THE MARK CONSISTS OF STANDARD CHARACTERS WITHOUT CLAIM TO ANY PARTICULAR FONT, STYLE, SIZE, OR COLOR.

SN 78-794,736, FILED 1-19-2006.

MICHAEL GAAFAR, EXAMINING ATTORNEY

**Int. Cl.: 37**

**Prior U.S. Cls.: 100, 103, and 106**

**United States Patent and Trademark Office**

**Reg. No. 3,396,163**

**Registered Mar. 11, 2008**

**SERVICE MARK  
PRINCIPAL REGISTER**

**BRIDGEMONT**

THE UNIVERSE, LLC (TENNESSEE LTD LIAB  
CO)  
2736 COLONIAL DRIVE  
CORDOVA, TN 37863

THE MARK CONSISTS OF STANDARD CHAR-  
ACTERS WITHOUT CLAIM TO ANY PARTICULAR  
FONT, STYLE, SIZE, OR COLOR.

FOR: COMMERCIAL REAL ESTATE DEVELOP-  
MENT, IN CLASS 37 (U.S. CLS. 100, 103 AND 106).

SN 78-795,476, FILED 1-20-2006.

FIRST USE 4-1-2007; IN COMMERCE 4-1-2007.

RICHARD A. STRASER, EXAMINING ATTORNEY

**Int. Cl.: 9**

**Prior U.S. Cls.: 21, 23, 26, 36, and 38**

**United States Patent and Trademark Office**

**Reg. No. 3,396,164**

**Registered Mar. 11, 2008**

**TRADEMARK  
PRINCIPAL REGISTER**

**EZLab**

NORITSU KOKI CO., LTD. (JAPAN CORPORATION)  
579-1 UMEHARA  
WAKAYAMA-SHI, JAPAN

FOR: COMPUTER SOFTWARE FOR RECEIVING PHOTO PRINT ORDERS ON-LINE, PHOTO PROCESSING, PHOTO PRINTING AND MAKING APPROPRIATE ARRANGEMENTS OF THESE PROCEDURES, IN CLASS 9 (U.S. CLS. 21, 23, 26, 36 AND 38).

FIRST USE 1-5-2006; IN COMMERCE 1-5-2006.

THE MARK CONSISTS OF STANDARD CHARACTERS WITHOUT CLAIM TO ANY PARTICULAR FONT, STYLE, SIZE, OR COLOR.

SN 78-795,741, FILED 1-20-2006.

LAURA KOVALSKY, EXAMINING ATTORNEY

**Int. Cl.: 25**

**Prior U.S. Cls.: 22 and 39**

**United States Patent and Trademark Office**

**Reg. No. 3,396,165**

**Registered Mar. 11, 2008**

**TRADEMARK  
PRINCIPAL REGISTER**

**IPAD**

COCONUT GROVE PADS, INC. (CANADA COR-  
PORATION)  
525 DENISON STREET  
UNIT 1  
MARKHAM, ONTARIO, CANADA L3R 1B8

FOR: BRAS; LINGERIE; PANTIES; PADS FOR  
USE IN BRAS, IN CLASS 25 (U.S. CLS. 22 AND 39).

FIRST USE 11-15-2007; IN COMMERCE 11-15-2007.

THE MARK CONSISTS OF STANDARD CHAR-  
ACTERS WITHOUT CLAIM TO ANY PARTICULAR  
FONT, STYLE, SIZE, OR COLOR.

SN 78-795,771, FILED 1-20-2006.

MICHAEL GAAFAR, EXAMINING ATTORNEY

**Int. Cl.: 29**

**Prior U.S. Cl.: 46**

**United States Patent and Trademark Office**

**Reg. No. 3,396,166**

**Registered Mar. 11, 2008**

**TRADEMARK  
PRINCIPAL REGISTER**

**FLAVOR ESCAPE**

THE PROCTER & GAMBLE COMPANY (OHIO  
CORPORATION)  
ONE PROCTER & GAMBLE PLAZA  
CINCINNATI, OH 45202

THE MARK CONSISTS OF STANDARD CHAR-  
ACTERS WITHOUT CLAIM TO ANY PARTICULAR  
FONT, STYLE, SIZE, OR COLOR.

FOR: SNACK FOODS, NAMELY, POTATO  
CRISPS, IN CLASS 29 (U.S. CL. 46).

SN 78-797,098, FILED 1-23-2006.

FIRST USE 3-5-2007; IN COMMERCE 3-5-2007.

SUZANNE BLANE, EXAMINING ATTORNEY

Prior U.S. Cl.: B

United States Patent and Trademark Office

Reg. No. 3,396,167

Registered Mar. 11, 2008

CERTIFICATION MARK  
SERVICES  
PRINCIPAL REGISTER



INTERNATIONAL SOCIETY FOR PHARMACEU-  
TICAL ENGINEERING, INC. (FLORIDA COR-  
PORATION)  
3109 W. MARTIN LUTHER KING JR., STE 250  
TAMPA, FL 33607

FOR: PHARMACEUTICAL ENGINEERING AND  
MANUFACTURING, IN CLASS B (U.S. CL. B).

FIRST USE 7-6-2007; IN COMMERCE 7-6-2007.

OWNER OF U.S. REG. NOS. 2,176,601 AND  
3,035,224.

NO CLAIM IS MADE TO THE EXCLUSIVE  
RIGHT TO USE "CERTIFIED PHARMACEUTICAL  
INDUSTRY PROFESSIONAL", APART FROM THE  
MARK AS SHOWN.

THIS CERTIFICATION MARK, AS INTENDED  
TO BE USED BY AUTHORIZED PERSONS, IS  
INTENDED TO CERTIFY THAT THE SERVICES  
ARE BEING PERFORMED BY PROFESSIONALS  
WHO HAVE PASSED AN EXAMINATION AND  
PERFORM AT ESTABLISHED STANDARDS OF  
KNOWLEDGE, EXPERIENCE AND COMPETENCE  
REQUIRED TO EXCEL IN THE PHARMACEUTI-  
CAL ENGINEERING AND MANUFACTURING  
PROFESSION.

SN 78-797,364, FILED 1-23-2006.

JUSTINE D. PARKER, EXAMINING ATTORNEY



**Int. Cl.: 21**

**Prior U.S. Cls.: 2, 13, 23, 29, 30, 33, 40, and 50**

**Reg. No. 3,396,168**

**United States Patent and Trademark Office**

**Registered Mar. 11, 2008**

---

**TRADEMARK  
PRINCIPAL REGISTER**

**SNACK 'N MORE**

GOLDEN G.T. LLC (ILLINOIS LTD LIAB CO)  
3720 WEST TOUHY AVENUE  
SKOKIE, IL 60076

THE MARK CONSISTS OF STANDARD CHAR-  
ACTERS WITHOUT CLAIM TO ANY PARTICULAR  
FONT, STYLE, SIZE, OR COLOR.

FOR: HOUSEWARES, NAMELY, HOUSEHOLD  
CONTAINERS MADE OF NON-PRECIOUS METAL  
HAVING POURING SPOUTS TO DISPENSE DRY  
FOOD, COFFEE, AND POWDERS, NAMELY,  
SWEETENERS AND SPICES , IN CLASS 21 (U.S.  
CLS. 2, 13, 23, 29, 30, 33, 40 AND 50).

NO CLAIM IS MADE TO THE EXCLUSIVE  
RIGHT TO USE "SNACK", APART FROM THE  
MARK AS SHOWN.

SN 78-798,028, FILED 1-24-2006.

FIRST USE 3-0-2005; IN COMMERCE 1-10-2006.

DOMINIC FATHY, EXAMINING ATTORNEY

**Int. Cl.: 36**

**Prior U.S. Cls.: 100, 101, and 102**

**United States Patent and Trademark Office**

**Reg. No. 3,396,169**

**Registered Mar. 11, 2008**

**SERVICE MARK  
PRINCIPAL REGISTER**

**LISTWISE REALTY SERVICES**

MORGENSTERN & ASSOCIATES LLC (DELA-  
WARE LTD LIAB CO)  
111 CORNING ROAD, SUITE 185  
CARY, NC 27518

FOR: REAL ESTATE SERVICES, NAMELY, REAL  
ESTATE AGENCIES; RESIDENTIAL REAL ESTATE  
SERVICES, NAMELY, REAL ESTATE AGENCIES;  
PROVIDING AN ON-LINE COMPUTER DATABASE  
FEATURING REAL ESTATE LISTINGS, IN CLASS  
36 (U.S. CLS. 100, 101 AND 102).

FIRST USE 4-0-2006; IN COMMERCE 4-0-2006.

THE MARK CONSISTS OF STANDARD CHAR-  
ACTERS WITHOUT CLAIM TO ANY PARTICULAR  
FONT, STYLE, SIZE, OR COLOR.

NO CLAIM IS MADE TO THE EXCLUSIVE  
RIGHT TO USE "REALTY SERVICES", APART  
FROM THE MARK AS SHOWN.

SN 78-798,301, FILED 1-24-2006.

MICHELE SWAIN, EXAMINING ATTORNEY

**Int. Cl.: 41**

**Prior U.S. Cls.: 100, 101, and 107**

**United States Patent and Trademark Office**

**Reg. No. 3,396,170**

**Registered Mar. 11, 2008**

**SERVICE MARK  
PRINCIPAL REGISTER**

**SPORTS TV INSIDER**

SPORTS TV INSIDER, LLC (CALIFORNIA LTD  
LIAB CO)  
41916 CREEK BEND PLACE  
LEESBURG, VA 20175

FOR: ENTERTAINMENT SERVICES, NAMELY,  
PROVIDING INTERACTIVE AND CUSTOMIZED  
BROADCAST AND INTERNET PROGRAM LIST-  
INGS AND GUIDES, IN CLASS 41 (U.S. CLS. 100, 101  
AND 107).

FIRST USE 6-30-2006; IN COMMERCE 6-30-2006.

THE MARK CONSISTS OF STANDARD CHAR-  
ACTERS WITHOUT CLAIM TO ANY PARTICULAR  
FONT, STYLE, SIZE, OR COLOR.

NO CLAIM IS MADE TO THE EXCLUSIVE  
RIGHT TO USE "SPORTS" OR "TV", APART FROM  
THE MARK AS SHOWN.

SN 78-798,466, FILED 1-24-2006.

GRETTA YAO, EXAMINING ATTORNEY

**Int. Cl.: 41**

**Prior U.S. Cls.: 100, 101, and 107**

**United States Patent and Trademark Office**

**Reg. No. 3,396,171**

**Registered Mar. 11, 2008**

**SERVICE MARK  
PRINCIPAL REGISTER**

**TV ADVISOR PLUS**

SPORTS TV INSIDER, LLC (CALIFORNIA LTD  
LIAB CO)  
41916 CREEK BEND PLACE  
LEESBURG, VA 20175

FOR: ENTERTAINMENT SERVICES, NAMELY,  
PROVIDING INTERACTIVE AND CUSTOMIZED  
BROADCAST AND INTERNET PROGRAM LIST-  
INGS AND GUIDES, IN CLASS 41 (U.S. CLS. 100, 101  
AND 107).

FIRST USE 6-30-2006; IN COMMERCE 6-30-2006.

THE MARK CONSISTS OF STANDARD CHAR-  
ACTERS WITHOUT CLAIM TO ANY PARTICULAR  
FONT, STYLE, SIZE, OR COLOR.

NO CLAIM IS MADE TO THE EXCLUSIVE  
RIGHT TO USE "TV", APART FROM THE MARK  
AS SHOWN.

SN 78-798,468, FILED 1-24-2006.

GRETTA YAO, EXAMINING ATTORNEY

**Int. Cl.: 9**

**Prior U.S. Cls.: 21, 23, 26, 36, and 38**

**United States Patent and Trademark Office**

**Reg. No. 3,396,172**

**Registered Mar. 11, 2008**

**TRADEMARK  
PRINCIPAL REGISTER**

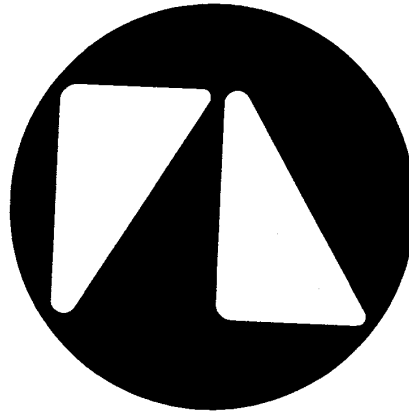

RIVETED LP, LLLP (DELAWARE LIMITED LIABILITY LIMITED PARTNERSHIP)  
1900 N. CENTRAL EXPRESSWAY  
SUITE 1900  
DALLAS, TX 75206

FIRST USE 3-31-2006; IN COMMERCE 3-31-2006.

THE MARK CONSISTS OF STYLIZED R & L  
SIMILAR TO TRIANGLES.

FOR: COMPUTER SOFTWARE FOR USE IN  
DATA RESEARCH, INTERNET BROWSING, RE-  
PORT WRITING, BOOK AUTHORSHIP AND IN-  
FORMATION STORAGE, IN CLASS 9 (U.S. CLS. 21,  
23, 26, 36 AND 38).

SN 78-799,068, FILED 1-25-2006.

BRIAN NEVILLE, EXAMINING ATTORNEY

**Int. Cl.: 10**

**Prior U.S. Cls.: 26, 39, and 44**

**United States Patent and Trademark Office**

**Reg. No. 3,396,173**

**Registered Mar. 11, 2008**

**TRADEMARK  
PRINCIPAL REGISTER**

**CERCOL**

DIAMICS, INC. (CALIFORNIA CORPORATION)  
SUITE 200  
SIX HAMILTON LANDING  
NOVATO, CA 94949

THE MARK CONSISTS OF STANDARD CHAR-  
ACTERS WITHOUT CLAIM TO ANY PARTICULAR  
FONT, STYLE, SIZE, OR COLOR.

FOR: CERVICAL TISSUE SAMPLE COLLECTOR,  
IN CLASS 10 (U.S. CLS. 26, 39 AND 44).

SN 78-799,144, FILED 1-25-2006.

FIRST USE 1-11-2006; IN COMMERCE 1-11-2006.

ROBIN CHOSID, EXAMINING ATTORNEY

**Int. Cl.: 39**

**Prior U.S. Cls.: 100 and 105**

**United States Patent and Trademark Office**

**Reg. No. 3,396,174**

**Registered Mar. 11, 2008**

**SERVICE MARK  
PRINCIPAL REGISTER**

**GREATWIDE AMERICAN  
TRANSFREIGHT**

GREATWIDE LOGISTICS SERVICES, INC. (DE-  
LAWARE CORPORATION)  
SUITE 300-S  
12404 PARK CENTRAL DRIVE  
DALLAS, TX 75251

FOR: FREIGHT TRANSPORTATION BY TRUCK;  
AND TRANSPORT BROKERAGE, IN CLASS 39 (U.S.  
CLS. 100 AND 105).

FIRST USE 11-1-2006; IN COMMERCE 11-1-2006.

THE MARK CONSISTS OF STANDARD CHAR-  
ACTERS WITHOUT CLAIM TO ANY PARTICULAR  
FONT, STYLE, SIZE, OR COLOR.

NO CLAIM IS MADE TO THE EXCLUSIVE  
RIGHT TO USE "AMERICAN" AND "TRANS-  
FREIGHT", APART FROM THE MARK AS SHOWN.

SN 78-800,403, FILED 1-26-2006.

PATRICIA EVANKO, EXAMINING ATTORNEY

**Int. Cl.: 39**

**Prior U.S. Cls.: 100 and 105**

**United States Patent and Trademark Office**

**Reg. No. 3,396,175**

**Registered Mar. 11, 2008**

**SERVICE MARK  
PRINCIPAL REGISTER**

# Safari and Beyond

SAFARI AND BEYOND LLC (CONNECTICUT  
LTD LIAB CO)  
20 GREY ROCKS RD  
WILTON, CT 06897

FOR: TRAVEL INFORMATION SERVICES,  
NAMELY, INFORMATION AND ADVICE ON SA-  
FARI EXPEDITIONS; ARRANGING AND CON-  
DUCTING SAFARI EXPEDITIONS; TRAVEL  
BOOKING AGENCIES, NAMELY, MAKING RESER-  
VATIONS AND BOOKINGS FOR SAFARI EXPEDI-  
TIONS, IN CLASS 39 (U.S. CLS. 100 AND 105).

FIRST USE 9-6-2006; IN COMMERCE 9-6-2006.

THE MARK CONSISTS OF STANDARD CHAR-  
ACTERS WITHOUT CLAIM TO ANY PARTICULAR  
FONT, STYLE, SIZE, OR COLOR.

NO CLAIM IS MADE TO THE EXCLUSIVE  
RIGHT TO USE "SAFARI", APART FROM THE  
MARK AS SHOWN.

SN 78-800,504, FILED 1-26-2006.

KEVIN DINALLO, EXAMINING ATTORNEY



**Int. Cl.: 36**

**Prior U.S. Cls.: 100, 101, and 102**

**United States Patent and Trademark Office**

**Reg. No. 3,396,176**

**Registered Mar. 11, 2008**

**SERVICE MARK  
PRINCIPAL REGISTER**



RESULTS HOMEBUYERS, INC. (MINNESOTA CORPORATION)  
3005 W. 135TH STREET  
BURNSVILLE, MN 55337

FOR: REAL ESTATE BROKERAGE AND ACQUISITION SERVICES, IN CLASS 36 (U.S. CLS. 100, 101 AND 102).

FIRST USE 2-9-2006; IN COMMERCE 3-30-2006.

OWNER OF U.S. REG. NOS. 2,987,933 AND 3,039,166.

THE COLOR(S) WHITE, BROWN, GOLD AND RED IS/ARE CLAIMED AS A FEATURE OF THE MARK.

THE COLOR WHITE APPEARS INSIDE THE PORTION OF THE WORDING IN THE MARK THAT

READS "1-800-SELL-NOW" AND ALONG THE ROOF EAVE OF THE HOUSE DEPICTED IN THE MARK; THE COLOR BROWN APPEARS AS THE OUTLINE OF THE WORDING "1-800-SELL-NOW" AND THE OUTLINE OF THE HOUSE, ON THE SIDE OF THE HOUSE AND THE SIDE OF THE CHIMNEY OF THE HOUSE; THE COLOR GOLD APPEARS ON THE ROOF OF THE HOUSE, THE FRONT OF THE HOUSE, THE FRONT OF THE CHIMNEY OF THE HOUSE, IN THE WINDOW AND DOORKNOB OF THE HOUSE; THE COLOR RED APPEARS ON THE DOOR OF THE HOUSE AND AS THE BACKGROUND AT THE TOP ABOVE THE BROWN BACKGROUND FIELD.

SN 78-800,953, FILED 1-27-2006.

KAREN BRACEY, EXAMINING ATTORNEY

**Int. Cl.: 10**

**Prior U.S. Cls.: 26, 39, and 44**

**United States Patent and Trademark Office**

**Reg. No. 3,396,177**

**Registered Mar. 11, 2008**

**TRADEMARK  
PRINCIPAL REGISTER**

**PATHCHIP**

PATHWORK DIAGNOSTICS, INC. (DELAWARE  
CORPORATION)  
1196 BORREGAS AVENUE, SUITE 200  
SUNNYVALE, CA 94089

THE MARK CONSISTS OF STANDARD CHAR-  
ACTERS WITHOUT CLAIM TO ANY PARTICULAR  
FONT, STYLE, SIZE, OR COLOR.

FOR: MEDICAL DIAGNOSTIC APPARATUS FOR  
DIAGNOSIS OF CANCERS, IN CLASS 10 (U.S. CLS.  
26, 39 AND 44).

SN 78-800,995, FILED 1-27-2006.

FIRST USE 7-10-2007; IN COMMERCE 7-10-2007.

DANNEAN HETZEL, EXAMINING ATTORNEY

**Int. Cl.: 35**

**Prior U.S. Cls.: 100, 101, and 102**

**United States Patent and Trademark Office**

**Reg. No. 3,396,178**

**Registered Mar. 11, 2008**

**SERVICE MARK  
PRINCIPAL REGISTER**

**BOOTBIZ**

JGEAR, INC. (WISCONSIN CORPORATION)  
1211 RICKMEYER DRIVE  
FOND DU LAC, WI 54937

THE MARK CONSISTS OF STANDARD CHAR-  
ACTERS WITHOUT CLAIM TO ANY PARTICULAR  
FONT, STYLE, SIZE, OR COLOR.

FOR: RETAIL STORE SERVICES FEATURING  
SHOES, BOOTS, FOOTWEAR, WORK ACCESSOR-  
IES AND CLOTHING, IN CLASS 35 (U.S. CLS. 100, 101  
AND 102).

SN 78-802,108, FILED 1-30-2006.

FIRST USE 1-20-2006; IN COMMERCE 1-20-2006.

SEAN CROWLEY, EXAMINING ATTORNEY

Int. Cl.: 41

Prior U.S. Cls.: 100, 101, and 107

United States Patent and Trademark Office

Reg. No. 3,396,179

Registered Mar. 11, 2008

**SERVICE MARK  
PRINCIPAL REGISTER**



RADIO BOOK NETWORK, LLC (MICHIGAN  
LTD LIAB CO)  
1820 N. EVERY ROAD  
MASON, MI 48854

NO CLAIM IS MADE TO THE EXCLUSIVE  
RIGHT TO USE "RADIO BOOK NETWORK",  
APART FROM THE MARK AS SHOWN.

FOR: PRODUCTION OF RADIO PROGRAMS;  
AND THE PRODUCTION OF RADIO PROGRAMS  
OVER THE INTERNET; AND ENTERTAINMENT IN  
THE NATURE OF A CONTINUING TALK AUDIO  
BOOK DELIVERED AND TRANSMITTED OVER  
RADIO AND THE INTERNET, IN CLASS 41 (U.S.  
CLS. 100, 101 AND 107).

THE MARK CONSISTS OF A MICROPHONE  
AND OPEN BOOK.

SN 78-802,675, FILED 1-30-2006.

FIRST USE 12-31-2006; IN COMMERCE 12-31-2006.

NAAKWAMA ANKRAH, EXAMINING ATTORNEY

**Int. Cl.: 9**

**Prior U.S. Cls.: 21, 23, 26, 36, and 38**

**United States Patent and Trademark Office**

**Reg. No. 3,396,180**

**Registered Mar. 11, 2008**

**TRADEMARK  
PRINCIPAL REGISTER**

# Nethra Imaging

NETHRA IMAGING INC. (DELAWARE CORPORATION)  
10710 NORTH TANTAU AVE  
CUPERTINO, CA 95014

FOR: COMPUTER HARDWARE, NAMELY, IMAGE PROCESSORS, AND SOFTWARE FOR IMAGE PROCESSING, IN CLASS 9 (U.S. CLS. 21, 23, 26, 36 AND 38).

FIRST USE 11-19-2003; IN COMMERCE 1-15-2005.

THE MARK CONSISTS OF STANDARD CHARACTERS WITHOUT CLAIM TO ANY PARTICULAR FONT, STYLE, SIZE, OR COLOR.

NO CLAIM IS MADE TO THE EXCLUSIVE RIGHT TO USE "IMAGING", APART FROM THE MARK AS SHOWN.

SN 78-803,035, FILED 1-31-2006.

BRIAN PINO, EXAMINING ATTORNEY

**Int. Cl.: 8**

**Prior U.S. Cls.: 23, 28, and 44**

**United States Patent and Trademark Office**

**Reg. No. 3,396,181**

**Registered Mar. 11, 2008**

**TRADEMARK  
PRINCIPAL REGISTER**

**J-250 SERIES**

AMES TRUE TEMPER PROPERTIES, INC. (MI-  
CHIGAN CORPORATION)  
300 DELAWARE AVENUE, SUITE 1704  
WILMINGTON, DE 19801

FOR: MANUALLY OPERATED HAND TOOLS,  
NAMELY, FERTILIZER SCOOPS, IN CLASS 8 (U.S.  
CLS. 23, 28 AND 44).

FIRST USE 7-0-2007; IN COMMERCE 7-0-2007.

THE MARK CONSISTS OF STANDARD CHAR-  
ACTERS WITHOUT CLAIM TO ANY PARTICULAR  
FONT, STYLE, SIZE, OR COLOR.

NO CLAIM IS MADE TO THE EXCLUSIVE  
RIGHT TO USE "SERIES", APART FROM THE  
MARK AS SHOWN.

SN 78-803,265, FILED 1-31-2006.

JASON TURNER, EXAMINING ATTORNEY

**Int. Cl.: 16**

**Prior U.S. Cls.: 2, 5, 22, 23, 29, 37, 38, and 50**

**United States Patent and Trademark Office**

**Reg. No. 3,396,182**

**Registered Mar. 11, 2008**

**TRADEMARK  
PRINCIPAL REGISTER**

**COMP-LETE**

FORTUNE PLASTICS, INC. (CONNECTICUT  
CORPORATION)  
P.O. BOX 637 1 WILLIAMS LANE  
OLD SAYBROOK, CT 06475

FOR: COMPOSTABLE AND BIOGRADABLE  
GARBAGE BAGS AND CAN LINERS, IN CLASS 16  
(U.S. CLS. 2, 5, 22, 23, 29, 37, 38 AND 50).

FIRST USE 5-1-2005; IN COMMERCE 5-1-2005.

THE MARK CONSISTS OF STANDARD CHAR-  
ACTERS WITHOUT CLAIM TO ANY PARTICULAR  
FONT, STYLE, SIZE, OR COLOR.

SN 78-803,518, FILED 1-31-2006.

CAROLINE WOOD, EXAMINING ATTORNEY

Prior U.S. Cl.: B

United States Patent and Trademark Office

Reg. No. 3,396,183

Registered Mar. 11, 2008

**CERTIFICATION MARK  
SERVICES  
PRINCIPAL REGISTER**



INTERSTATE RENEWABLE ENERGY COUNCIL,  
INC. (IREC) (FLORIDA CORPORATION)  
P.O. BOX 1156  
LATHAM, NY 12110

FOR: RENEWABLE ENERGY, ENERGY EFFICIENCY, AND DISTRIBUTED GENERATION INSTRUCTIONAL SERVICES, IN CLASS B (U.S. CL. B).

FIRST USE 4-17-2007; IN COMMERCE 10-5-2007.

OWNER OF U.S. REG. NO. 2,862,079.

NO CLAIM IS MADE TO THE EXCLUSIVE RIGHT TO USE "INTERSTATE RENEWABLE ENERGY COUNCIL ACCREDITED TRAINING PROGRAM", APART FROM THE MARK AS SHOWN.

THE COLOR(S) GREEN, BLACK, AND WHITE IS/ARE CLAIMED AS A FEATURE OF THE MARK.

THE MARK CONSISTS OF THE WORDS "IREC INTERSTATE RENEWABLE ENERGY COUNCIL ISPQ ACCREDITED TRAINING PROGRAM," INCLUDING A DESIGN CONSISTING OF A CIRCLE WITH DIAGONAL LINES, AND A STYLIZED LETTER Q. THE WORDS "IREC", "ACCREDITED", AND IREC'S CORPORATE DESIGN ARE IN GREEN. THE REMAINING WORDING APPEARS IN BLACK ON A WHITE BACKGROUND AND SURROUNDED BY BLACK LINING. THE LINING IN THE GLOBE MADE UP OF THE LETTER "Q" IS BLACK; THE

CIRCLE NEXT TO IREC IS GREEN WITH WHITE HIGHLIGHTS.

THE CERTIFICATION MARK CERTIFIES THAT AUTHORIZED INSTITUTIONS AND ORGANIZATIONS HAVE MET SPECIFIC COMPETENCE, RESOURCES, AND CAPABILITY REQUIREMENTS ESTABLISHED BY THE CERTIFIER (APPLICANT) WITH RESPECT TO DEFINED INSTRUCTIONAL SERVICES RELATING TO RENEWABLE ENERGY, ENERGY EFFICIENCY, AND/OR DISTRIBUTED GENERATION KNOWLEDGE AND SKILLS. THESE CERTIFICATION REQUIREMENTS INCLUDE THE SATISFACTION OF APPLICABLE TRAINING COURSE PERFORMANCE REQUIREMENTS, THE USE OF APPROPRIATE TRAINING PROGRAM FACILITIES, AND THE DEVELOPMENT AND MAINTENANCE OF – A DEFINED SYLLABUS AND/OR CURRICULUM FOR EACH RELEVANT PROGRAM, CONSISTENT WITH AN INDUSTRY-APPROVED TASK ANALYSIS; MEASURABLE OBJECTIVE CRITERIA TO EVALUATE STUDENT LEARNING; A DOCUMENTED MANAGEMENT SYSTEM; AND, DEFINED POLICIES AND PROCEDURES FOR THE RESOLUTION OF COMPLAINTS, DISPUTES, AND APPEALS CONCERNING THE TRAINING PROCESS, TRAINING CONTENT, AND THE PERFORMANCE OF TRAINED PERSONS.

SN 78-804,709, FILED 2-1-2006.

LINDA MICKLEBURGH, EXAMINING ATTORNEY



**Int. Cl.: 1**

**Prior U.S. Cls.: 1, 5, 6, 10, 26, and 46**

**Reg. No. 3,396,184**

**United States Patent and Trademark Office**

**Registered Mar. 11, 2008**

**TRADEMARK  
PRINCIPAL REGISTER**

**JUST ENOUGH TO GLUE IT  
RIGHT**

AMERICAN GREASE STICK COMPANY (MICHIGAN LIMITED PARTNERSHIP), DBA AGS,  
2651 HOYT STREET, P.O. BOX 729  
MUSKEGON, MI 49443

THE MARK CONSISTS OF STANDARD CHARACTERS WITHOUT CLAIM TO ANY PARTICULAR FONT, STYLE, SIZE, OR COLOR.

FOR: GLUE FOR USE IN THE MARINE INDUSTRY, AUTOMOTIVE INDUSTRY, AGRICULTURAL INDUSTRY, FURNITURE INDUSTRY AND MANUFACTURING INDUSTRY , IN CLASS 1 (U.S. CLS. 1, 5, 6, 10, 26 AND 46).

SN 78-805,343, FILED 2-2-2006.

FIRST USE 10-30-2007; IN COMMERCE 10-30-2007.

DOMINIC J. FERRAIUOLO, EXAMINING ATTORNEY

**Int. Cl.: 16**

**Prior U.S. Cls.: 2, 5, 22, 23, 29, 37, 38, and 50**

**United States Patent and Trademark Office**

**Reg. No. 3,396,185**

**Registered Mar. 11, 2008**

**TRADEMARK  
PRINCIPAL REGISTER**

**JUST ENOUGH TO GLUE IT  
RIGHT**

AMERICAN GREASE STICK COMPANY (MICHIGAN LIMITED PARTNERSHIP), DBA AGS,  
2651 HOYT STREET, P.O. BOX 729  
MUSKEGON, MI 49443

FOR: GLUE FOR HOUSEHOLD PURPOSES, IN  
CLASS 16 (U.S. CLS. 2, 5, 22, 23, 29, 37, 38 AND 50).

FIRST USE 10-30-2007; IN COMMERCE 10-30-2007.

THE MARK CONSISTS OF STANDARD CHARACTERS WITHOUT CLAIM TO ANY PARTICULAR FONT, STYLE, SIZE, OR COLOR.

SN 78-805,349, FILED 2-2-2006.

DOMINIC J. FERRAIUOLO, EXAMINING ATTORNEY

**Int. Cl.: 1**

**Prior U.S. Cls.: 1, 5, 6, 10, 26, and 46**

**Reg. No. 3,396,186**

**United States Patent and Trademark Office**

**Registered Mar. 11, 2008**

**TRADEMARK  
PRINCIPAL REGISTER**

**RYNO-WELD**

AMERICAN GREASE STICK COMPANY (MICHIGAN LIMITED PARTNERSHIP), DBA AGS,  
2651 HOYT STREET, P.O. BOX 729  
MUSKEGON, MI 49443

FOR: GLUE FOR USE IN THE MARINE INDUSTRY, AUTOMOTIVE INDUSTRY, AGRICULTURAL INDUSTRY, FURNITURE INDUSTRY AND MANUFACTURING INDUSTRY, IN CLASS 1 (U.S. CLS. 1, 5, 6, 10, 26 AND 46).

FIRST USE 11-1-2007; IN COMMERCE 11-1-2007.

THE MARK CONSISTS OF STANDARD CHARACTERS WITHOUT CLAIM TO ANY PARTICULAR FONT, STYLE, SIZE, OR COLOR.

SN 78-805,363, FILED 2-2-2006.

DOMINIC J. FERRAIUOLO, EXAMINING ATTORNEY

**Int. Cl.: 1**

**Prior U.S. Cls.: 1, 5, 6, 10, 26, and 46**

**Reg. No. 3,396,187**

**United States Patent and Trademark Office**

**Registered Mar. 11, 2008**

---

**TRADEMARK  
PRINCIPAL REGISTER**

**SUPRA-GLUE**

AMERICAN GREASE STICK COMPANY (MICHIGAN LIMITED PARTNERSHIP), DBA AGS,  
2651 HOYT STREET, P.O. BOX 729  
MUSKEGON, MI 49443

FOR: GLUE FOR USE IN THE MARINE INDUSTRY, AUTOMOTIVE INDUSTRY, AGRICULTURAL INDUSTRY, FURNITURE INDUSTRY AND MANUFACTURING INDUSTRY, IN CLASS 1 (U.S. CLS. 1, 5, 6, 10, 26 AND 46).

FIRST USE 11-1-2007; IN COMMERCE 11-1-2007.

THE MARK CONSISTS OF STANDARD CHARACTERS WITHOUT CLAIM TO ANY PARTICULAR FONT, STYLE, SIZE, OR COLOR.

SN 78-805,378, FILED 2-2-2006.

DOMINIC J. FERRAIUOLO, EXAMINING ATTORNEY

**Int. Cl.: 37**

**Prior U.S. Cls.: 100, 103, and 106**

**United States Patent and Trademark Office**

**Reg. No. 3,396,188**

**Registered Mar. 11, 2008**

**SERVICE MARK  
PRINCIPAL REGISTER**

**THE WORKING WOMAN'S  
WATER WARRIOR**



PLUMBERS' SUCCESS INTERNATIONAL, LLC  
(MISSOURI LTD LIAB CO)  
SUITE 1800  
7777 BONHOMME  
ST. LOUIS, MO 63105

THE DESIGN PORTION OF THE MARK CON-  
SISTS OF A STYLIZED PLUMBER DRESSED AS A  
ROMAN SOLDIER.

FOR: REPAIR, MAINTENANCE, AND INSTAL-  
LATION SERVICES IN THE FIELD OF PLUMBING,  
IN CLASS 37 (U.S. CLS. 100, 103 AND 106).

SN 78-808,129, FILED 2-6-2006.

FIRST USE 5-0-2006; IN COMMERCE 5-0-2006.

ROBERT STRUCK, EXAMINING ATTORNEY

**Int. Cl.: 37**

**Prior U.S. Cls.: 100, 103, and 106**

**United States Patent and Trademark Office**

**Reg. No. 3,396,189**

**Registered Mar. 11, 2008**

**SERVICE MARK  
PRINCIPAL REGISTER**



PLUMBERS' SUCCESS INTERNATIONAL, LLC  
(MISSOURI LTD LIAB CO)  
SUITE 1800  
7777 BONHOMME  
ST. LOUIS, MO 63105

FOR: REPAIR, MAINTENANCE, AND INSTAL-  
LATION SERVICES IN THE FIELD OF PLUMBING,  
IN CLASS 37 (U.S. CLS. 100, 103 AND 106).

FIRST USE 5-0-2006; IN COMMERCE 5-0-2006.

THE DESIGN PORTION OF THE MARK CON-  
SISTS OF A STYLIZED HOUSE ON WHEELS.

SN 78-808,138, FILED 2-6-2006.

ROBERT STRUCK, EXAMINING ATTORNEY

**Int. Cl.: 35**

**Prior U.S. Cls.: 100, 101, and 102**

**United States Patent and Trademark Office**

**Reg. No. 3,396,190**

**Registered Mar. 11, 2008**

**SERVICE MARK  
PRINCIPAL REGISTER**

**DON'T PREDICT. PREPARE.**

ASD SPECIALTY HEALTHCARE, INC. (CALIFORNIA CORPORATION), DBA AMERISOUR-CEBERGEN SPECIALTY GROUP,  
3101 GAYLORD PARKWAY, 1N-186  
FRISCO, TX 75034

FOR: PHARMACEUTICAL MANAGEMENT SERVICES FOR OTHERS, NAMELY, INVENTORY MANAGEMENT, REPLENISHING AND RESETTING SERVICES AND AUTOMATED INVENTORY MONITORING SERVICES, IN CLASS 35 (U.S. CLS. 100, 101 AND 102).

FIRST USE 12-6-2005; IN COMMERCE 2-10-2006.

THE MARK CONSISTS OF STANDARD CHARACTERS WITHOUT CLAIM TO ANY PARTICULAR FONT, STYLE, SIZE, OR COLOR.

SN 78-808,228, FILED 2-6-2006.

AMEETA JORDAN, EXAMINING ATTORNEY

**Int. Cls.: 35 and 40**

**Prior U.S. Cls.: 100, 101, 102, 103, and 106**

**United States Patent and Trademark Office**

**Reg. No. 3,396,191**

**Registered Mar. 11, 2008**

**SERVICE MARK  
PRINCIPAL REGISTER**

**ULTIMATE VEHICLE PROTECTION**

CLEARBRA FRANCHISING, LLC (UTAH LTD  
LIAB CO)  
452 EAST 500 SOUTH  
SALT LAKE CITY, UT 84111

FOR: RETAIL STORES FEATURING SURFACE  
PROTECTANT COATING AND FEATURING SUR-  
FACE PROTECTANT COATING FOR AUTOMO-  
BILES, BOATS, ALL-TERRAIN VEHICLES,  
RECREATIONAL VEHICLES, OTHER VEHICLES,  
HOODS, HEADLIGHTS, FENDERS, QUARTER PA-  
NELS, PARK LIGHTS AND ANY VEHICLE SUR-  
FACE, IN CLASS 35 (U.S. CLS. 100, 101 AND 102).

FIRST USE 12-14-2005; IN COMMERCE 12-14-2005.

FOR: APPLICATION OF PROTECTIVE COAT-  
INGS, NAMELY, SURFACE PROTECTANT COAT-  
ING FOR AUTOMOBILES, BOATS, ALL-TERRAIN  
VEHICLES, RECREATIONAL VEHICLES, OTHER

VEHICLES, HOODS, HEADLIGHTS, FENDERS,  
QUARTER PANELS, PARK LIGHTS AND ANY  
VEHICLE SURFACE, IN CLASS 40 (U.S. CLS. 100,  
103 AND 106).

FIRST USE 12-14-2005; IN COMMERCE 12-14-2005.

THE MARK CONSISTS OF STANDARD CHAR-  
ACTERS WITHOUT CLAIM TO ANY PARTICULAR  
FONT, STYLE, SIZE, OR COLOR.

NO CLAIM IS MADE TO THE EXCLUSIVE  
RIGHT TO USE "VEHICLE PROTECTION", APART  
FROM THE MARK AS SHOWN.

SN 78-808,778, FILED 2-7-2006.

BRENDAN REGAN, EXAMINING ATTORNEY



**Int. Cl.: 11**

**Prior U.S. Cls.: 13, 21, 23, 31, and 34**

**United States Patent and Trademark Office**

**Reg. No. 3,396,192**

**Registered Mar. 11, 2008**

**TRADEMARK  
PRINCIPAL REGISTER**

**MUIRFIELD**

MOEN INCORPORATED (DELAWARE CORPORATION)  
25300 AL MOEN DRIVE  
NORTH OLMSTED, OH 440708022

FOR: FAUCETS, NAMELY, LAVATORY FAUCETS, KITCHEN FAUCETS AND FAUCET HANDLES; AND PLUMBING ACCESSORIES, NAMELY, KITCHEN SINK SPRAYERS, IN CLASS 11 (U.S. CLS. 13, 21, 23, 31 AND 34).

FIRST USE 5-31-2006; IN COMMERCE 5-31-2006.

THE MARK CONSISTS OF STANDARD CHARACTERS WITHOUT CLAIM TO ANY PARTICULAR FONT, STYLE, SIZE, OR COLOR.

SN 78-809,641, FILED 2-8-2006.

LINDA ORNDORFF, EXAMINING ATTORNEY

**Int. Cl.: 16**

**Prior U.S. Cls.: 2, 5, 22, 23, 29, 37, 38, and 50**

**United States Patent and Trademark Office**

**Reg. No. 3,396,193**

**Registered Mar. 11, 2008**

**TRADEMARK  
PRINCIPAL REGISTER**

**SHOCK SHIELD**

HENKEL CORPORATION (DELAWARE CORPORATION)  
THE TRIAD, SUITE 200  
2200 RENAISSANCE BLVD.  
GULPH MILLS, PA 19406

FOR: CELLULAR CUSHIONING PACKAGING MATERIAL WHICH CONTAINS ENTRAPPED BUBBLES OF AIR OR OTHER GASES, IN CLASS 16 (U.S. CLS. 2, 5, 22, 23, 29, 37, 38 AND 50).

FIRST USE 5-23-2006; IN COMMERCE 5-23-2006.

THE MARK CONSISTS OF STANDARD CHARACTERS WITHOUT CLAIM TO ANY PARTICULAR FONT, STYLE, SIZE, OR COLOR.

SN 78-810,101, FILED 2-8-2006.

PAUL F. GAST, EXAMINING ATTORNEY

**Int. Cl.: 28**

**Prior U.S. Cls.: 22, 23, 38, and 50**

**United States Patent and Trademark Office**

**Reg. No. 3,396,194**

**Registered Mar. 11, 2008**

**TRADEMARK  
PRINCIPAL REGISTER**

**SIMPLICITY**

SIMPLICITY PATTERN CO. INC. (DELAWARE CORPORATION)  
2 PARK AVENUE, 12TH FLOOR  
NEW YORK, NY 10016

FOR: HOBBY CRAFT KITS COMPRISED OF FABRIC, DECORATIVE TRIMS, AND PRINTED INSTRUCTION SHEETS FOR MAKING DOG COATS, BAGS, BELTS, ACCESSORIES, OR COSTUMES; HOBBY CRAFT KITS COMPRISED OF FABRIC, DECORATIVE TRIMS, AND PRINTED INSTRUCTION SHEETS FOR USE IN LEARNING HOW TO SEW, IN CLASS 28 (U.S. CLS. 22, 23, 38 AND 50).

FIRST USE 6-30-2005; IN COMMERCE 6-30-2005.

THE MARK CONSISTS OF STANDARD CHARACTERS WITHOUT CLAIM TO ANY PARTICULAR FONT, STYLE, SIZE, OR COLOR.

OWNER OF U.S. REG. NOS. 514,739, 1,482,464, AND OTHERS.

SN 78-810,830, FILED 2-9-2006.

RONALD MCMORROW, EXAMINING ATTORNEY

**Int. Cls.: 9 and 11**

**Prior U.S. Cls.: 13, 21, 23, 26, 31, 34, 36, and 38**

**United States Patent and Trademark Office**

**Reg. No. 3,396,195**

**Registered Mar. 11, 2008**

**TRADEMARK  
PRINCIPAL REGISTER**

**STORMTRACKER**

VECTOR PRODUCTS, INC. (FLORIDA CORPORATION)  
SUITE 3000  
8100 S.W. 10TH STREET  
PLANTATION, FL 33324

FOR: COMBINATION TV AND LANTERN-STYLE FLASHLIGHT AND LED/AM/FM WEATHER BAND RADIO WITH INCLEMENT WEATHER WARNING SYSTEM, DYNAMO-POWERED AND RECHARGEABLE CAPABILITIES SOLD AS A UNIT; AM/FM WEATHER BAND RADIO WITH INCLEMENT WEATHER WARNING SYSTEM, DYNAMO-POWERED AND RECHARGEABLE CAPABILITIES, IN CLASS 9 (U.S. CLS. 21, 23, 26, 36 AND 38).

FIRST USE 2-28-2005; IN COMMERCE 2-28-2005.

FOR: COMBINATION ELECTRIC LANTERN, FLASHLIGHT AND LED/AM/FM WEATHER BAND RADIO WITH INCLEMENT WEATHER WARNING SYSTEM, DYNAMO-POWERED AND RECHARGEABLE CAPABILITIES, SOLD AS A UNIT, IN CLASS 11 (U.S. CLS. 13, 21, 23, 31 AND 34).

FIRST USE 2-28-2005; IN COMMERCE 2-28-2005.

THE MARK CONSISTS OF STANDARD CHARACTERS WITHOUT CLAIM TO ANY PARTICULAR FONT, STYLE, SIZE, OR COLOR.

SN 78-810,834, FILED 2-9-2006.

MATTHEW EINSTEIN, EXAMINING ATTORNEY

**Int. Cl.: 5**

**Prior U.S. Cls.: 6, 18, 44, 46, 51, and 52**

**United States Patent and Trademark Office**

**Reg. No. 3,396,196**

**Registered Mar. 11, 2008**

**TRADEMARK  
PRINCIPAL REGISTER**



VENTANA MEDICAL SYSTEMS INC. (DELA-  
WARE CORPORATION)  
1910 INNOVATION PARK DRIVE  
TUCSON, AZ 85755

FOR: REAGENTS AND CHEMICAL STAINS FOR  
CLINICAL OR MEDICAL LABORATORY USE, IN  
CLASS 5 (U.S. CLS. 6, 18, 44, 46, 51 AND 52).

FIRST USE 5-23-2006; IN COMMERCE 5-23-2006.

OWNER OF U.S. REG. NOS. 1,796,632, 2,954,739,  
AND OTHERS.

NO CLAIM IS MADE TO THE EXCLUSIVE  
RIGHT TO USE "HD" OR "H&E", APART FROM  
THE MARK AS SHOWN.

THE FOREIGN WORDING IN THE MARK  
TRANSLATES INTO ENGLISH AS WINDOW.

SN 78-811,508, FILED 2-9-2006.

LESLEY LAMOTHE, EXAMINING ATTORNEY

**Int. Cl.: 41**

**Prior U.S. Cls.: 100, 101, and 107**

**United States Patent and Trademark Office**

**Reg. No. 3,396,197**

**Registered Mar. 11, 2008**

**SERVICE MARK  
PRINCIPAL REGISTER**

**SISTERSPEAK**

JOHNSON PUBLISHING COMPANY, INC. (ILLINOIS CORPORATION)  
820 SOUTH MICHIGAN AVENUE  
CHICAGO, IL 60601

FOR: ENTERTAINMENT AND EDUCATIONAL SERVICES, NAMELY, DEVELOPING AND CONDUCTING CONFERENCES, RETREATS AND SEMINARS FOCUSED ON WOMEN AND LIFESTYLE ISSUES AFFECTING WOMEN, IN CLASS 41 (U.S. CLS. 100, 101 AND 107).

FIRST USE 10-6-2005; IN COMMERCE 10-6-2005.

THE MARK CONSISTS OF STANDARD CHARACTERS WITHOUT CLAIM TO ANY PARTICULAR FONT, STYLE, SIZE, OR COLOR.

OWNER OF U.S. REG. NO. 2,604,777.

SN 78-812,466, FILED 2-10-2006.

MARY I. SPARROW, EXAMINING ATTORNEY

**Int. Cl.: 35**

**Prior U.S. Cls.: 100, 101, and 102**

**United States Patent and Trademark Office**

**Reg. No. 3,396,198**

**Registered Mar. 11, 2008**

---

**SERVICE MARK  
PRINCIPAL REGISTER**

**70 THE NEW 50**

DEVELOPMENT DIMENSIONS INTERNATIONAL, INC. (DELAWARE CORPORATION)  
1225 WASHINGTON PIKE  
PITTSBURGH, PA 150172838

FOR: COUNSELING BUSINESSES IN THE IMPLEMENTATION OF MANAGED RETIREMENT OF EXECUTIVE EMPLOYEES AS COMPARED TO AGE-BASED RETIREMENT, IN CLASS 35 (U.S. CLS. 100, 101 AND 102).

FIRST USE 6-30-2005; IN COMMERCE 7-27-2006.

THE MARK CONSISTS OF STANDARD CHARACTERS WITHOUT CLAIM TO ANY PARTICULAR FONT, STYLE, SIZE, OR COLOR.

SN 78-814,053, FILED 2-14-2006.

ALLISON SCHRODY, EXAMINING ATTORNEY

**Int. Cls.: 25, 39, 41, and 43**

**Prior U.S. Cls.: 22, 39, 100, 101, 105, and 107**

**United States Patent and Trademark Office**

**Reg. No. 3,396,199**

**Registered Mar. 11, 2008**

**TRADEMARK  
SERVICE MARK  
PRINCIPAL REGISTER**

**TURNBERRY ISLE RESORT &  
CLUB**

TURNBERRY DEVELOPMENT, LLC (FLORIDA  
LTD LIAB CO)  
19501 BISCAYNE BLVD., SUITE 400  
AVENTURA, FL 33180

FOR: CLOTHING, NAMELY, CASUAL SHIRTS,  
SUN VISORS, IN CLASS 25 (U.S. CLS. 22 AND 39).

FIRST USE 0-0-1986; IN COMMERCE 0-0-1986.

FOR: MARINA SERVICES, IN CLASS 39 (U.S. CLS.  
100 AND 105).

FIRST USE 0-0-1986; IN COMMERCE 0-0-1986.

FOR: PROVIDING FACILITIES FOR GOLF AND  
TENNIS; HEALTH CLUB SERVICES, NAMELY  
PROVIDING USE OF EXERCISE EQUIPMENT;  
PROVIDING FITNESS AND EXERCISE FACIL-  
ITIES, IN CLASS 41 (U.S. CLS. 100, 101 AND 107).

FIRST USE 0-0-1986; IN COMMERCE 0-0-1986.

FOR: RESORT, HOTEL AND RESTAURANT SER-  
VICES, IN CLASS 43 (U.S. CLS. 100 AND 101).

FIRST USE 0-0-1986; IN COMMERCE 0-0-1986.

THE MARK CONSISTS OF STANDARD CHAR-  
ACTERS WITHOUT CLAIM TO ANY PARTICULAR  
FONT, STYLE, SIZE, OR COLOR.

OWNER OF U.S. REG. NOS. 2,372,444, 3,010,146,  
AND OTHERS.

NO CLAIM IS MADE TO THE EXCLUSIVE  
RIGHT TO USE "RESORT & CLUB", APART FROM  
THE MARK AS SHOWN.

SN 78-814,260, FILED 2-14-2006.

ZACHARY BELLO, EXAMINING ATTORNEY



**Int. Cls.: 25, 39, 41, and 43**

**Prior U.S. Cls.: 22, 39, 100, 101, 105, and 107**

**United States Patent and Trademark Office**

**Reg. No. 3,396,200**

**Registered Mar. 11, 2008**

**TRADEMARK  
SERVICE MARK  
PRINCIPAL REGISTER**



TURNBERRY DEVELOPMENT, LLC (FLORIDA  
LTD LIAB CO)  
19501 BISCAYNE BLVD., SUITE 400  
AVENTURA, FL 33180

FOR: CLOTHING, NAMELY, CASUAL SHIRTS,  
SUN VISORS, IN CLASS 25 (U.S. CLS. 22 AND 39).

FIRST USE 0-0-1986; IN COMMERCE 0-0-1986.

FOR: MARINA SERVICES, IN CLASS 39 (U.S. CLS.  
100 AND 105).

FIRST USE 0-0-1986; IN COMMERCE 0-0-1986.

FOR: PROVIDING FACILITIES FOR GOLF AND  
TENNIS; HEALTH CLUB SERVICES, NAMELY,  
PROVIDING USE OF EXERCISE EQUIPMENT;  
PROVIDING FITNESS AND EXERCISE FACIL-  
ITIES, IN CLASS 41 (U.S. CLS. 100, 101 AND 107).

FIRST USE 0-0-1986; IN COMMERCE 0-0-1986.

FOR: RESORT, HOTEL AND RESTAURANT SER-  
VICES, IN CLASS 43 (U.S. CLS. 100 AND 101).

FIRST USE 0-0-1986; IN COMMERCE 0-0-1986.

OWNER OF U.S. REG. NOS. 2,372,444, 3,010,146,  
AND OTHERS.

NO CLAIM IS MADE TO THE EXCLUSIVE  
RIGHT TO USE "RESORT & CLUB", APART FROM  
THE MARK AS SHOWN.

THE COLOR(S) GOLD AND WHITE IS/ARE  
CLAIMED AS A FEATURE OF THE MARK.

THE MARK CONSISTS OF CIRCLE DESIGN IN  
GOLD WITH WAVY WHITE LINES; THE WORDS  
"TURNBERRY ISLE RESORT & CLUB" ARE IN  
GOLD.

SN 78-814,270, FILED 2-14-2006.

ZACHARY BELLO, EXAMINING ATTORNEY

**Int. Cl.: 35**

**Prior U.S. Cls.: 100, 101, and 102**

**United States Patent and Trademark Office**

**Reg. No. 3,396,201**

**Registered Mar. 11, 2008**

**SERVICE MARK  
PRINCIPAL REGISTER**

**VIVE LA VIDA Y RECUERDA  
QUE TOME LO QUE TOME, LA  
VIDA TOMA VISA**

VISA INTERNATIONAL SERVICE ASSOCIATION  
(DELAWARE CORPORATION)  
M1-11A  
900 METRO CENTER BOULEVARD  
FOSTER CITY, CA 94404

FOR: PROMOTING THE SALE OF GOODS AND SERVICES OF OTHERS BY MEANS OF ADVERTISEMENTS, COUPONS, DISCOUNTS AND INCENTIVES IN THE NATURE OF REWARD POINTS AND VALUE ADDED OFFERS GENERATED IN CONNECTION WITH THE USE OF PAYMENT CARDS; PROMOTING SPORTS COMPETITIONS AND EVENTS OF OTHERS; PROMOTING CONCERTS AND CULTURAL EVENTS OF OTHERS, IN CLASS 35 (U.S. CLS. 100, 101 AND 102).

FIRST USE 5-1-2006; IN COMMERCE 5-1-2006.

THE MARK CONSISTS OF STANDARD CHARACTERS WITHOUT CLAIM TO ANY PARTICULAR FONT, STYLE, SIZE, OR COLOR.

OWNER OF U.S. REG. NO. 2,887,439.

THE ENGLISH TRANSLATION OF THE WORD "VIVE LA VIDA Y RECUERDA QUE TOME LO QUE TOME, LA VIDA TOMA VISA" IN THE MARK IS LIVE LIFE AND NO MATTER WHAT IT TAKES, LIFE TAKES VISA.

SN 78-814,331, FILED 2-14-2006.

SUSAN STIGLITZ, EXAMINING ATTORNEY

**Int. Cl.: 25**

**Prior U.S. Cls.: 22 and 39**

**United States Patent and Trademark Office**

**Reg. No. 3,396,202**

**Registered Mar. 11, 2008**

**TRADEMARK  
PRINCIPAL REGISTER**

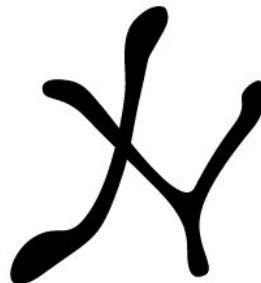

KKB HOLDINGS, INC. (FLORIDA CORPORATION)  
1742 INDIANA AVENUE  
ORLANDO, FL 32789

FOR: APPAREL, NAMELY, MEN'S SHIRTS, TROUSERS, BELTS, SCARVES, GLOVES, UNDERWEAR, T-SHIRTS, NECK TIES, SHORTS, SOCKS, JEANS, SWEATERS, HEADGEAR, NAMELY, HATS AND CAPS, OUTERWEAR, NAMELY, COATS, JACKETS, AND WIND RESISTANT JACKETS, WO-

MEN'S SHIRTS, BELTS, SCARVES, GLOVES, UNDERWEAR, SOCKS, BLOUSES, SKIRTS, DRESSES, HEADGEAR, NAMELY, HATS AND CAPS; FOOTWEAR, IN CLASS 25 (U.S. CLS. 22 AND 39).

FIRST USE 9-0-2005; IN COMMERCE 9-0-2005.

SN 78-814,517, FILED 2-14-2006.

CURTIS FRENCH, EXAMINING ATTORNEY

**Int. Cls.: 35 and 41**

**Prior U.S. Cls.: 100, 101, 102, and 107**

**United States Patent and Trademark Office**

**Reg. No. 3,396,203**

**Registered Mar. 11, 2008**

**SERVICE MARK  
PRINCIPAL REGISTER**

**NICKIE C AND THE  
AUCTIONETTES**

NICKIE C AND THE AUCTIONETTES, LTD.  
(ILLINOIS CORPORATION)  
640 MASLUND CT.  
N. BARRINGTON, IL 60010

FOR: AUCTIONEERING SERVICES, IN CLASS 35  
(U.S. CLS. 100, 101 AND 102).

FIRST USE 9-22-2006; IN COMMERCE 9-22-2006.

FOR: ENTERTAINMENT SERVICES IN THE  
NATURE OF VISUAL AND AUDIO PERFORMAN-  
CES, NAMELY MUSICAL BAND AND DANCE  
PERFORMANCES, IN CLASS 41 (U.S. CLS. 100, 101  
AND 107).

FIRST USE 9-22-2006; IN COMMERCE 9-22-2006.

THE MARK CONSISTS OF STANDARD CHAR-  
ACTERS WITHOUT CLAIM TO ANY PARTICULAR  
FONT, STYLE, SIZE, OR COLOR.

THE NAME "NICKIE C" IDENTIFIES A LIVING  
INDIVIDUAL WHOSE CONSENT IS OF RECORD.

SN 78-814,647, FILED 2-14-2006.

DAWN FELDMAN, EXAMINING ATTORNEY

**Int. Cl.: 28**

**Prior U.S. Cls.: 22, 23, 38, and 50**

**United States Patent and Trademark Office**

**Reg. No. 3,396,204**

**Registered Mar. 11, 2008**

**TRADEMARK  
PRINCIPAL REGISTER**

# Slice Halter

FOGARTY, DENNIS (FLORIDA SOLE PROPRIETORSHIP)  
5120 CERROMAR DRIVE  
NAPLES, FL 34112

FOR: GOLF CLUB SWING AIDS, NAMELY, PADS, GUIDES, SUPPORTS, AND LIKE MATERIAL, FOR TRAINING ATHLETIC SWING, SWINGING MOTIONS FOR SPORTS, AND RELATED ATHLETIC MOTIONS; AND PADS, GUIDES, AND SUPPORTS AND LIKE MATERIAL FOR TRAINING ATHLETIC SWING, SWINGING MOTIONS FOR SPORTS, AND RELATED ATHLETIC MOTIONS, FOR PROPER ARM PLACEMENT AND ARM RE-

LATION TO BODY FOR TRUER SWING PLANE AND MORE POWERFUL IMPACT, IN CLASS 28 (U.S. CLS. 22, 23, 38 AND 50).

FIRST USE 1-1-2007; IN COMMERCE 1-1-2007.

THE MARK CONSISTS OF STANDARD CHARACTERS WITHOUT CLAIM TO ANY PARTICULAR FONT, STYLE, SIZE, OR COLOR.

SN 78-814,811, FILED 2-14-2006.

BRENDAN REGAN, EXAMINING ATTORNEY

**Int. Cl.: 5**

**Prior U.S. Cls.: 6, 18, 44, 46, 51, and 52**

**United States Patent and Trademark Office**

**Reg. No. 3,396,205**

**Registered Mar. 11, 2008**

**TRADEMARK  
PRINCIPAL REGISTER**

**COSMO-IN D**

COSMOAGRO, S.A. (COLOMBIA SOCIEDAD AN-  
ONIMA)  
ZONA FRANCA DEL PACIFICO  
KM 6, VIA YUMBO- AEROPUERTO  
PALMIRA VALLE, COLOMBIA

FOR: HERBICIDES, INSECTICIDES, PESTICIDES  
AND FUNGICIDES FOR HOME, GARDEN AND  
LAWN USE AND FOR PROFESSIONAL USE, IN  
CLASS 5 (U.S. CLS. 6, 18, 44, 46, 51 AND 52).

FIRST USE 12-31-1998; IN COMMERCE 7-10-2007.

THE MARK CONSISTS OF STANDARD CHAR-  
ACTERS WITHOUT CLAIM TO ANY PARTICULAR  
FONT, STYLE, SIZE, OR COLOR.

OWNER OF COLOMBIA REG. NO. 169163, DA-  
TED 11-29-1994, EXPIRES 11-29-2014.

SN 78-815,103, FILED 2-15-2006.

RAMONA ORTIGA, EXAMINING ATTORNEY

**Int. Cl.: 8**

**Prior U.S. Cls.: 23, 28, and 44**

**United States Patent and Trademark Office**

**Reg. No. 3,396,206**

**Registered Mar. 11, 2008**

**TRADEMARK  
PRINCIPAL REGISTER**

**ARTILLERY**

ARTILLERY TOOLS, LLC (OREGON LTD LIAB  
CO)  
10260 SW HOODVIEW DRIVE  
TIGARD, OR 97224

THE MARK CONSISTS OF STANDARD CHAR-  
ACTERS WITHOUT CLAIM TO ANY PARTICULAR  
FONT, STYLE, SIZE, OR COLOR.

FOR: HAND TOOLS, NAMELY, PRY BARS, IN  
CLASS 8 (U.S. CLS. 23, 28 AND 44).

SN 78-816,366, FILED 2-16-2006.

FIRST USE 11-28-2007; IN COMMERCE 11-28-2007.

REBECCA EISINGER, EXAMINING ATTORNEY

**Int. Cl.: 41**

**Prior U.S. Cls.: 100, 101, and 107**

**United States Patent and Trademark Office**

**Reg. No. 3,396,207**

**Registered Mar. 11, 2008**

**SERVICE MARK  
PRINCIPAL REGISTER**

**UNIVERSAL RECORDS SOUTH**

UNIVERSAL CITY STUDIOS LLLP (DELAWARE  
LIMITED LIABILITY LIMITED PARTNER-  
SHIP)  
100 UNIVERSAL CITY PLAZA  
UNIVERSAL CITY, CA 91608

FOR: PRODUCTION, DISTRIBUTION AND PUBLISHING OF MUSIC, FAN CLUBS, DEVELOPMENT AND DISSEMINATION OF EDUCATIONAL MATERIALS OF OTHERS IN THE FIELD OF MUSIC AND ENTERTAINMENT; PRODUCTION OF SOUND RECORDINGS; RECORD PRODUCTION; VIDEOTAPE PRODUCTION; PUBLICATION OF BOOKS AND MAGAZINES, ENTERTAINMENT IN THE NATURE OF ONGOING RADIO PROGRAMS, ENTERTAINMENT IN THE NATURE OF LIVE CONCERTS AND PERFORMANCES BY MUSICAL ARTISTS AND GROUPS, ENTERTAINMENT SERVICES, NAMELY, PERSONAL APPEARANCES BY MUSICAL GROUPS, MUSICAL ARTISTS AND CELEBRITIES; ENTERTAINMENT SERVICES IN THE NATURE OF PERFORMANCES BY MUSICAL ARTISTS THROUGH THE MEDIUM OF TELEVISION PROGRAMS, RADIO PROGRAMS AND RECORDINGS, ENTERTAINMENT SERVICES RENDERED BY MUSICAL ARTISTS, NAMELY, RECORDING PERFORMANCES; ENTERTAINMENT SERVICES, NAMELY, PROVIDING A WEBSITE FEATURING MUSICAL PERFORMANCES, MUSICAL VIDEOS, PHOTOGRAPHS, AND MULTIMEDIA MATERIALS, ENTERTAINMENT SERVICES, NAMELY, PROVIDING ON-LINE REVIEWS OF MUSIC, MUSI-

CAL ARTISTS AND MUSIC VIDEOS, ENTERTAINMENT SERVICES, NAMELY, PROVIDING PRE-RECORDED MUSIC, INFORMATION IN THE FIELD OF MUSIC AND COMMENTARY AND ARTICLES ABOUT MUSIC, ALL ON-LINE VIA A GLOBAL COMPUTER NETWORK; CONDUCTING ENTERTAINMENT EXHIBITIONS IN THE NATURE OF MUSIC FESTIVALS, ENTERTAINMENT SERVICES, NAMELY, CONDUCTING EXHIBITIONS IN THE FIELD OF MUSIC AND THE ARTS; ORGANIZING EXHIBITIONS FOR ENTERTAINMENT PURPOSES FEATURING MUSIC AND THE ARTS, AND PUBLISHING OF WEB MAGAZINE, IN CLASS 41 (U.S. CLS. 100, 101 AND 107).

FIRST USE 5-0-2006; IN COMMERCE 5-0-2006.

THE MARK CONSISTS OF STANDARD CHARACTERS WITHOUT CLAIM TO ANY PARTICULAR FONT, STYLE, SIZE, OR COLOR.

OWNER OF U.S. REG. NOS. 889,475, 2,889,475, AND OTHERS.

NO CLAIM IS MADE TO THE EXCLUSIVE RIGHT TO USE "RECORDS", APART FROM THE MARK AS SHOWN.

SN 78-816,495, FILED 2-16-2006.

LOURDES AYALA, EXAMINING ATTORNEY



**Int. Cl.: 36**

**Prior U.S. Cls.: 100, 101, and 102**

**United States Patent and Trademark Office**

**Reg. No. 3,396,208**

**Registered Mar. 11, 2008**

**SERVICE MARK  
PRINCIPAL REGISTER**

**INSTREAM FINANCIAL**

HENNESSEY CAPITAL SOLUTIONS, INC. (MI-  
CHIGAN CORPORATION)  
26321 WOODWARD AVENUE  
HUNTINGTON WOODS, MI 48070

FOR: FINANCIAL RISK MANAGEMENT; IN-  
VESTMENT SERVICES, NAMELY, ASSET ACQUI-  
SITION, CONSULTATION, DEVELOPMENT AND  
MANAGEMENT SERVICES , IN CLASS 36 (U.S.  
CLS. 100, 101 AND 102).

FIRST USE 4-0-2006; IN COMMERCE 4-0-2006.

THE MARK CONSISTS OF STANDARD CHAR-  
ACTERS WITHOUT CLAIM TO ANY PARTICULAR  
FONT, STYLE, SIZE, OR COLOR.

NO CLAIM IS MADE TO THE EXCLUSIVE  
RIGHT TO USE "FINANCIAL", APART FROM  
THE MARK AS SHOWN.

SN 78-817,372, FILED 2-17-2006.

ANGELA M. MICHELI, EXAMINING ATTORNEY

**Int. Cl.: 3**

**Prior U.S. Cls.: 1, 4, 6, 50, 51, and 52**

**United States Patent and Trademark Office**

**Reg. No. 3,396,209**

**Registered Mar. 11, 2008**

**TRADEMARK  
PRINCIPAL REGISTER**

**ELIXIR  
SUPERIEUR**

SHISEIDO COMPANY, LTD. (JAPAN CORPORATION)  
7-5-5 GINZA, CHUO-KU  
TOKYO, JAPAN 104-8010

FOR: NON-MEDICATED SKIN CARE PREPARATIONS; COSMETICS AND MAKEUP, IN CLASS 3 (U.S. CLS. 1, 4, 6, 50, 51 AND 52).

FIRST USE 11-28-2007; IN COMMERCE 11-28-2007.

OWNER OF U.S. REG. NOS. 1,794,073 AND 1,969,311.

NO CLAIM IS MADE TO THE EXCLUSIVE RIGHT TO USE "SUPERIEUR", APART FROM THE MARK AS SHOWN.

THE MARK CONSISTS OF THE WORD ELIXIR WITH THE WORD SUPERIEUR CENTERED DIRECTLY BELOW.

SN 78-817,736, FILED 2-17-2006.

AMOS T. MATTHEWS, JR., EXAMINING ATTORNEY

**Int. Cl.: 9**

**Prior U.S. Cls.: 21, 23, 26, 36, and 38**

**United States Patent and Trademark Office**

**Reg. No. 3,396,210**

**Registered Mar. 11, 2008**

**TRADEMARK  
PRINCIPAL REGISTER**

**THE COLOR OF YOU**

NOVARTIS AG (SWITZERLAND CORPORATION)  
CH-4002  
BASEL, SWITZERLAND

THE MARK CONSISTS OF STANDARD CHARACTERS WITHOUT CLAIM TO ANY PARTICULAR FONT, STYLE, SIZE, OR COLOR.

FOR: CONTACT LENSES, IN CLASS 9 (U.S. CLS. 21, 23, 26, 36 AND 38).

SN 78-817,846, FILED 2-17-2006.

FIRST USE 1-1-2006; IN COMMERCE 1-1-2006.

REBECCA SMITH, EXAMINING ATTORNEY

**Int. Cl.: 33**

**Prior U.S. Cls.: 47 and 49**

**United States Patent and Trademark Office**

**Reg. No. 3,396,211**

**Registered Mar. 11, 2008**

**TRADEMARK  
PRINCIPAL REGISTER**

**GRACIA**

VIÑEDOS Y BODEGAS CORPORA S.A. (CHILE  
CORPORATION)  
AVENIDA ANDRES BELLO 2777, OF. 2801  
PISO 28, LAS CONDES  
SANTIAGO, CHILE

THE MARK CONSISTS OF STANDARD CHAR-  
ACTERS WITHOUT CLAIM TO ANY PARTICULAR  
FONT, STYLE, SIZE, OR COLOR.

THE FOREIGN WORDING IN THE MARK  
TRANSLATES INTO ENGLISH AS "GRACE".

FOR: WINE, IN CLASS 33 (U.S. CLS. 47 AND 49).

SN 78-817,847, FILED 2-17-2006.

FIRST USE 11-30-1986; IN COMMERCE 6-30-1996.

JASON LOTT, EXAMINING ATTORNEY

**Int. Cl.: 28**

**Prior U.S. Cls.: 22, 23, 38, and 50**

**United States Patent and Trademark Office**

**Reg. No. 3,396,212**

**Registered Mar. 11, 2008**

**TRADEMARK  
PRINCIPAL REGISTER**

**IRON ATHLETE**

LUCKY CRAFT CO., LTD. (JAPAN CORPORATION)  
21 KANAYAHONGOU  
OYABE-SHI, TOYAMA, JAPAN

THE MARK CONSISTS OF STANDARD CHARACTERS WITHOUT CLAIM TO ANY PARTICULAR FONT, STYLE, SIZE, OR COLOR.

FOR: FISHING EQUIPMENT, NAMELY, FISHING LINES, IN CLASS 28 (U.S. CLS. 22, 23, 38 AND 50).

SN 78-817,992, FILED 2-17-2006.

FIRST USE 2-17-2006; IN COMMERCE 2-17-2006.

RONALD MCMORROW, EXAMINING ATTORNEY

**Int. Cl.: 34**

**Prior U.S. Cls.: 2, 8, 9, and 17**

**United States Patent and Trademark Office**

**Reg. No. 3,396,213**

**Registered Mar. 11, 2008**

**TRADEMARK  
PRINCIPAL REGISTER**

**BOOT CUT**

K. HANSOTIA & CO., INC. (FLORIDA CORPORATION)  
3705 N.W. 115 AVENUE, BAY #5  
MIAMI, FL 33178

FOR: TOBACCO, CIGARETTES, CIGARS; ARTICLES FOR SMOKERS NOT OF PRECIOUS METAL, NAMELY, CIGARETTE LIGHTERS, CIGARETTE CASES, CIGAR CASES, CIGARETTE HOLDERS, AND CIGAR HOLDERS, IN CLASS 34 (U.S. CLS. 2, 8, 9 AND 17).

FIRST USE 1-9-2006; IN COMMERCE 2-4-2006.

THE MARK CONSISTS OF STANDARD CHARACTERS WITHOUT CLAIM TO ANY PARTICULAR FONT, STYLE, SIZE, OR COLOR.

SN 78-818,650, FILED 2-20-2006.

BRIDGETT SMITH, EXAMINING ATTORNEY

**Int. Cls.: 40 and 42**

**Prior U.S. Cls.: 100, 101, 103, and 106**

**United States Patent and Trademark Office**

**Reg. No. 3,396,214**

**Registered Mar. 11, 2008**

---

**SERVICE MARK  
PRINCIPAL REGISTER**

# GOT APPEAL?

CENTRIC LABORATORIES, INC. (MICHIGAN CORPORATION)  
1805 PLAINFIELD AVE., N.E.  
GRAND RAPIDS, MI 49505

FOR: MANUFACTURE OF DENTAL VENEERS,  
IN CLASS 40 (U.S. CLS. 100, 103 AND 106).

FIRST USE 12-21-2007; IN COMMERCE 12-21-2007.

FOR: CUSTOM DESIGN OF DENTAL VENEERS,  
IN CLASS 42 (U.S. CLS. 100 AND 101).

FIRST USE 12-21-2007; IN COMMERCE 12-21-2007.

THE MARK CONSISTS OF STANDARD CHARACTERS WITHOUT CLAIM TO ANY PARTICULAR FONT, STYLE, SIZE, OR COLOR.

SN 78-818,875, FILED 2-20-2006.

JERI J. FICKES, EXAMINING ATTORNEY

**Int. Cl.: 8**

**Prior U.S. Cls.: 23, 28, and 44**

**Reg. No. 3,396,215**

**United States Patent and Trademark Office**

**Registered Mar. 11, 2008**

**TRADEMARK  
PRINCIPAL REGISTER**

**JACKSON**

AMES TRUE TEMPER PROPERTIES, INC. (MICHIGAN CORPORATION)  
300 DELAWARE AVENUE, SUITE 1704  
WILMINGTON, DE 19801

FOR: HAND TOOLS NAMELY, SPADES, FORKS, SCOOPS, FRUIT PICKERS, WEEDERS, SPOONS, HOOKS, LUTES, COME-A-LONG (RATCHET LEVER HOIST), SOD CUTTER/REMOVER, CONCRETE FLOATS, BULB PLANTER, REPLACEMENT HANDLES FOR LONG-HANDLED TOOLS, SNOW SHOVELS, SNOW PUSHERS, SNOW SCOOPS, SNOW ROOF RAKES, ICE SCRAPERS, SNOW SLEIGHT SHOVEL, SNOW BRUSHES, SNOW PLOWS, ICE CHISELS, HAND SCRAPERS, REPLACEMENT HANDLES FOR MANUALLY OPERATED SNOW REMOVAL TOOLS, AXES, WEDGES, MATTOCKS, PICKS, TAMPERS, WRECKING BARS, RIPPING CHISELS, PUNCHES, REPLACEMENT HANDLES FOR STRIKING TOOLS, HAND TROWELS, HAND SPADES, HAND CULTIVATORS, HAND WEEDERS, BULB PLANTERS, HAND TRANSPLANTERS, MULTI-PURPOSE HAND TOOL COMPRISED OF A TROWEL HAVING A SERRA-

TED EDGE THAT ACTS AS A KNIFE FOR PLANTERS AND LANDSCAPERS, REPLACEMENT HANDLES FOR SMALL HAND TOOLS, PRUNERS, GRASS SHEARS, HEDGE SHEARS, LOPPERS, SAWS, POLE TREE TRIMMERS, GARDEN SCISSORS, FLORAL SHEARS, BUSH HOOKS, BANK BLADES, WEED CUTTERS, GRASS WHIPS, GRASS HOOKS, FLORAL SNIPS, BOW SAWS, FOLDING SAWS, DOUBLE-EDGE SAWS, REPLACEMENT BLADES, MACHETE CORN KNIVES, AND WEED HOOKS, IN CLASS 8 (U.S. CLS. 23, 28 AND 44).

FIRST USE 7-0-1997; IN COMMERCE 7-0-1997.

THE MARK CONSISTS OF STANDARD CHARACTERS WITHOUT CLAIM TO ANY PARTICULAR FONT, STYLE, SIZE, OR COLOR.

OWNER OF U.S. REG. NOS. 708,354 AND 708,388.

SN 78-818,968, FILED 2-20-2006.

KATHERINE STOIDES, EXAMINING ATTORNEY



**Int. Cl.: 13**

**Prior U.S. Cls.: 2 and 9**

**United States Patent and Trademark Office**

**Reg. No. 3,396,216**

**Registered Mar. 11, 2008**

**TRADEMARK  
PRINCIPAL REGISTER**

**CHIFLADOR**

ALAMO FIREWORKS, INC. (TEXAS CORPORATION)  
P.O. BOX 200710  
SAN ANTONIO, TX 782200710

FOR: FIREWORKS, NOT INCLUDING FIREWORKS THAT WHISTLE, IN CLASS 13 (U.S. CLS. 2 AND 9).

FIRST USE 9-0-2006; IN COMMERCE 9-0-2006.

THE MARK CONSISTS OF STANDARD CHARACTERS WITHOUT CLAIM TO ANY PARTICULAR FONT, STYLE, SIZE, OR COLOR.

THE FOREIGN WORDING IN THE MARK TRANSLATES INTO ENGLISH AS WHISTLER.

SN 78-819,060, FILED 2-20-2006.

ELLEN PERKINS, EXAMINING ATTORNEY

**Int. Cl.: 44**

**Prior U.S. Cls.: 100 and 101**

**United States Patent and Trademark Office**

**Reg. No. 3,396,217**

**Registered Mar. 11, 2008**

**SERVICE MARK  
PRINCIPAL REGISTER**

**THINNER BY THE MINUTE**

LA WEIGHT LOSS FRANCHISE COMPANY (DE-  
LAWARE CORPORATION)  
SUITE 150  
747 DRESHER ROAD  
HORSHAM, PA 19044

THE MARK CONSISTS OF STANDARD CHAR-  
ACTERS WITHOUT CLAIM TO ANY PARTICULAR  
FONT, STYLE, SIZE, OR COLOR.

FOR: WEIGHT REDUCTION, DIET PLANNING,  
DIETARY COUNSELING AND SUPERVISION SER-  
VICES, IN CLASS 44 (U.S. CLS. 100 AND 101).

SN 78-819,103, FILED 2-20-2006.

FIRST USE 11-30-2006; IN COMMERCE 11-30-2006.

HANNO RITTNER, EXAMINING ATTORNEY

**Int. Cl.: 9**

**Prior U.S. Cls.: 21, 23, 26, 36, and 38**

**United States Patent and Trademark Office**

**Reg. No. 3,396,218**

**Registered Mar. 11, 2008**

**TRADEMARK  
PRINCIPAL REGISTER**



JAYS AB (SWEDEN CORPORATION)  
KOPPARBERG SVÄGEN 8  
VÄSTERÅS, SWEDEN 72213

FOR: EARPHONES, EARPHONE SLEEVES, AND  
HEADSET MICROPHONES FOR CONSUMERS, IN  
CLASS 9 (U.S. CLS. 21, 23, 26, 36 AND 38).

FIRST USE 9-28-2006; IN COMMERCE 9-28-2006.

THE MARK CONSISTS OF A STYLIZED LETTER  
"A" WITH A TRIANGLE REPRESENTING THE  
HORIZONTAL PORTION OF THE LETTER, DEPICTED  
ABOVE A STYLIZED LETTER "Y," WITH  
SPACE BETWEEN THE BOTTOM OF THE "A"  
AND THE TOP OF THE "Y."

SN 78-820,081, FILED 2-21-2006.

JAMES MACFARLANE, EXAMINING ATTORNEY

**Int. Cl.: 12**

**Prior U.S. Cls.: 19, 21, 23, 31, 35, and 44**

**Reg. No. 3,396,219**

**United States Patent and Trademark Office**

**Registered Mar. 11, 2008**

**TRADEMARK  
PRINCIPAL REGISTER**

**AFTERMARKET REPLACEMENT  
SOLUTIONS**

AFTERMARKET REPLACEMENT SOLUTIONS,  
LLC (MICHIGAN LTD LIAB CO)  
2637 E. TEN MILE ROAD  
WARREN, MI 48091

FOR: AFTERMARKET, NON-STRUCTURAL AUTOMOTIVE VEHICLE AND ENGINE PARTS, NAMELY, AXLE AND WHEEL BEARINGS, DRIVE AND TRANSMISSION BELTS, DISC BRAKES, BRAKE BACKING PLATES, BRAKE BOOSTERS, BRAKE CABLES, BRAKE CALIPERS, BRAKE DRUMS AND ROTORS, BRAKE HARDWARE, BRAKE HOSES, BRAKE LINES AND FITTINGS, BRAKE PADS, BRAKE SHINS, BRAKE SHOES, CLUTCH CABLES, ACCELERATOR CABLES, ALTERNATOR CABLES, CALIPER BRACKETS, CLUTCHES, CLUTCH MECHANISMS, VALVES AND LININGS FOR VEHICLE CLUTCHES, CLUTCH PILOT BUSHINGS, COIL SPRINGS, DRIVE SHAFTS, AXLE AND STEERING BOOT KITS FOR USE WITH LAND VEHICLES, LAND VEHICLE ENGINE REBUILD KITS, SOLD AS A UNIT, ENGINES, FOUR WHEEL DRIVE WHEEL HUBS, FUEL TANKS AND STRAPS, GAS CAPS, GEARS FOR VEHICLES, HORNS, TURN SIGNALS, MIRRORS, NAMELY,

REARVIEW AND SIDEVIEW MIRRORS, LIDS, NAMELY, VEHICLE HOODS AND TRUNK SUPPORTS, MOTOR MOUNTS, SHOCK ABSORBERS, STRUTS AND STRUT BEARING PLATES, LAND VEHICLE TRANSMISSIONS AND REPLACEMENT PARTS THEREOF, UNIVERSAL JOINTS, WHEEL BRAKE CYLINDERS, WHEEL STUDS AND LUG NUTS FOR VEHICLE WHEELS, WINDOW LIFT MOTORS, WIPER BLADES AND WIPER MOTORS, IN CLASS 12 (U.S. CLS. 19, 21, 23, 31, 35 AND 44).

FIRST USE 12-0-2005; IN COMMERCE 12-0-2005.

THE MARK CONSISTS OF STANDARD CHARACTERS WITHOUT CLAIM TO ANY PARTICULAR FONT, STYLE, SIZE, OR COLOR.

NO CLAIM IS MADE TO THE EXCLUSIVE RIGHT TO USE "AFTERMARKET REPLACEMENT", APART FROM THE MARK AS SHOWN.

SN 78-821,395, FILED 2-23-2006.

JESSICA A. POWERS, EXAMINING ATTORNEY

**Int. Cl.: 25**

**Prior U.S. Cls.: 22 and 39**

**United States Patent and Trademark Office**

**Reg. No. 3,396,220**

**Registered Mar. 11, 2008**

**TRADEMARK  
PRINCIPAL REGISTER**

**BYA DENIM**

BYA, LLC (ILLINOIS LTD LIAB CO)  
#1604  
525 W. HAWTHORNE PLACE  
CHICAGO, IL 60657

FOR: CLOTHING, NAMELY, PANTS, JEANS, IN  
CLASS 25 (U.S. CLS. 22 AND 39).

FIRST USE 8-0-2006; IN COMMERCE 8-0-2006.

THE MARK CONSISTS OF STANDARD CHAR-  
ACTERS WITHOUT CLAIM TO ANY PARTICULAR  
FONT, STYLE, SIZE, OR COLOR.

NO CLAIM IS MADE TO THE EXCLUSIVE  
RIGHT TO USE "DENIM", APART FROM THE  
MARK AS SHOWN.

SN 78-821,745, FILED 2-23-2006.

RICHARD A. STRASER, EXAMINING ATTORNEY

**Int. Cl.: 34**

**Prior U.S. Cls.: 2, 8, 9, and 17**

**United States Patent and Trademark Office**

**Reg. No. 3,396,221**

**Registered Mar. 11, 2008**

**TRADEMARK  
PRINCIPAL REGISTER**

**MARAUDER**

K. HANSOTIA & CO., INC. (FLORIDA CORPORATION)  
3705 N.W. 115 AVENUE, BAY #5  
MIAMI, FL 33178

FOR: TOBACCO, CIGARETTES, CIGARS; ARTICLES FOR SMOKERS NOT OF PRECIOUS METAL, NAMELY, CIGARETTE LIGHTERS, CIGARETTE CASES, CIGAR CASES, CIGARETTE HOLDERS, AND CIGAR HOLDERS, IN CLASS 34 (U.S. CLS. 2, 8, 9 AND 17).

FIRST USE 4-6-2006; IN COMMERCE 5-7-2006.

THE MARK CONSISTS OF STANDARD CHARACTERS WITHOUT CLAIM TO ANY PARTICULAR FONT, STYLE, SIZE, OR COLOR.

SN 78-822,658, FILED 2-24-2006.

BRIDGETT SMITH, EXAMINING ATTORNEY

**Int. Cl.: 34**

**Prior U.S. Cls.: 2, 8, 9, and 17**

**United States Patent and Trademark Office**

**Reg. No. 3,396,222**

**Registered Mar. 11, 2008**

**TRADEMARK  
PRINCIPAL REGISTER**

**RAJA**

K. HANSOTIA & CO., INC. (FLORIDA CORPORATION)  
3705 N.W. 115 AVENUE, BAY #5  
MIAMI, FL 33178

FOR: TOBACCO, CIGARETTES, CIGARS; ARTICLES FOR SMOKERS NOT OF PRECIOUS METAL, NAMELY, CIGARETTE LIGHTERS, CIGARETTE CASES, CIGAR CASES, CIGARETTE HOLDERS, AND CIGAR HOLDERS, IN CLASS 34 (U.S. CLS. 2, 8, 9 AND 17).

FIRST USE 1-15-2006; IN COMMERCE 2-8-2006.

THE MARK CONSISTS OF STANDARD CHARACTERS WITHOUT CLAIM TO ANY PARTICULAR FONT, STYLE, SIZE, OR COLOR.

SN 78-822,677, FILED 2-24-2006.

BRIDGETT SMITH, EXAMINING ATTORNEY

**Int. Cl.: 28**

**Prior U.S. Cls.: 22, 23, 38, and 50**

**United States Patent and Trademark Office**

**Reg. No. 3,396,223**

**Registered Mar. 11, 2008**

**TRADEMARK  
PRINCIPAL REGISTER**

**GC OS**

BRIDGESTONE SPORTS CO., LTD. (JAPAN CORPORATION)

6-22-7, MINAMI-OI, SHINAGAWA-KU

TOKYO, JAPAN 140

FOR: GOLF CLUBS; HEAD COVERS FOR GOLF CLUBS, IN CLASS 28 (U.S. CLS. 22, 23, 38 AND 50).

FIRST USE 8-0-2006; IN COMMERCE 8-0-2006.

THE MARK CONSISTS OF STANDARD CHARACTERS WITHOUT CLAIM TO ANY PARTICULAR FONT, STYLE, SIZE, OR COLOR.

NO CLAIM IS MADE TO THE EXCLUSIVE RIGHT TO USE "OS", APART FROM THE MARK AS SHOWN.

SN 78-822,745, FILED 2-24-2006.

JOHN GARTNER, EXAMINING ATTORNEY



**Int. Cl.: 35**

**Prior U.S. Cls.: 100, 101, and 102**

**United States Patent and Trademark Office**

**Reg. No. 3,396,224**

**Registered Mar. 11, 2008**

---

**SERVICE MARK  
PRINCIPAL REGISTER**

**AiCollection**

STAPLES THE OFFICE SUPERSTORE, LLC (DE-  
LAWARE CORPORATION)  
500 STAPLES DRIVE  
FRAMINGHAM, MA 02110

FOR: PROMOTING THE SALE OF GOODS AND  
SERVICES OF OTHERS THROUGH THE CUSTOM  
PREPARATION OF SPECIALTY APPAREL, PRO-

MOTIONAL ITEMS AND INCENTIVE MERCHAN-  
DISE , IN CLASS 35 (U.S. CLS. 100, 101 AND 102).

FIRST USE 1-24-2006; IN COMMERCE 1-24-2006.

SN 78-823,209, FILED 2-24-2006.

ODESSA BIBBINS, EXAMINING ATTORNEY

**Int. Cls.: 9, 39, and 42**

**Prior U.S. Cls.: 21, 23, 26, 36, 38, 100, 101, and 105**

**United States Patent and Trademark Office**

**Reg. No. 3,396,225**

**Registered Mar. 11, 2008**

**TRADEMARK  
SERVICE MARK  
PRINCIPAL REGISTER**



CITY CARSHARE (CALIFORNIA NONPROFIT  
PUBLIC-BENEFIT CORPORATION)  
1182 MARKET STREET, SUITE 300  
SAN FRANCISCO, CA 94102

FOR: COMPUTER PROGRAMS, COMPUTER  
SOFTWARE, AND COMPUTER HARDWARE FOR  
USE IN RESERVING, TRACKING, MAINTAINING,  
OPERATING, SCHEDULING AND COMMUNICAT-  
ING WITH VEHICLES AND OTHER MOVEABLE  
HARD ASSETS AND FOR USE IN PROVIDING  
SECURE ACCESS TO BUILDINGS, PARKING LOTS,  
AND OTHER PHYSICAL ENCLOSURES, IN CLASS 9  
(U.S. CLS. 21, 23, 26, 36 AND 38).

FIRST USE 10-1-2006; IN COMMERCE 10-1-2006.

FOR: VEHICLE RENTAL SERVICES, NAMELY,  
VEHICLE TIMESHARING SERVICE ALLOWING  
INDIVIDUALS TO SHARE USE OF AUTOMOBILES  
PRIMARILY FOR SHORT-DISTANCE TRIPS AND  
MAKING RESERVATIONS FOR THE USE OF AU-  
TOMOBILES PRIMARILY FOR SHORT-DISTANCE  
TRIPS, IN CLASS 39 (U.S. CLS. 100 AND 105).

FIRST USE 10-1-2006; IN COMMERCE 10-1-2006.

FOR: APPLICATION SERVICE PROVIDER,  
NAMELY, HOSTING COMPUTER SOFTWARE AP-  
PLICATIONS OF OTHERS; PROVIDING TECHNICAL  
SUPPORT SERVICES, NAMELY,

MONITORING OF NETWORK SYSTEMS AND  
TROUBLESHOOTING PROBLEMS IN COMPUTER  
PROGRAMS, COMPUTER SOFTWARE, AND COM-  
PUTER HARDWARE FOR RESERVING, TRACK-  
ING, MAINTAINING, OPERATING, SCHEDULING  
AND COMMUNICATING WITH VEHICLES AND  
OTHER MOVEABLE HARD ASSETS, IN CLASS 42  
(U.S. CLS. 100 AND 101).

FIRST USE 10-1-2006; IN COMMERCE 10-1-2006.

NO CLAIM IS MADE TO THE EXCLUSIVE  
RIGHT TO USE "FLEET", APART FROM THE  
MARK AS SHOWN.

THE COLOR(S) ORANGE AND GRAY IS/ARE  
CLAIMED AS A FEATURE OF THE MARK.

THE MARK CONSISTS OF THE WORD "LIVE" IN  
ORANGE FOLLOWED BY TWO TOUCHING  
RHOMBOID SHAPES, ONE ON TOP OF THE OTHER  
SO THAT THEY FORM A RIGHT POINTING AR-  
ROW HEAD, THE TOP RHOMBUS BEING ORANGE  
AND THE BOTTOM RHOMBUS BEING GRAY,  
FOLLOWED BY THE WORD "FLEET" IN GRAY.

SN 78-825,312, FILED 2-28-2006.

MICHAEL TANNER, EXAMINING ATTORNEY

**Int. Cl.: 12**

**Prior U.S. Cls.: 19, 21, 23, 31, 35, and 44**

**Reg. No. 3,396,226**

**United States Patent and Trademark Office**

**Registered Mar. 11, 2008**

---

**TRADEMARK  
PRINCIPAL REGISTER**

**TRILLIUM**

BE AEROSPACE, INC. (DELAWARE CORPORATION)  
1400 CORPORATE WAY  
WELLINGTON, FL 33414

THE MARK CONSISTS OF STANDARD CHARACTERS WITHOUT CLAIM TO ANY PARTICULAR FONT, STYLE, SIZE, OR COLOR.

FOR: AIRCRAFT PASSENGER SEATS, IN CLASS 12 (U.S. CLS. 19, 21, 23, 31, 35 AND 44).

SN 78-827,006, FILED 3-2-2006.

FIRST USE 1-3-2006; IN COMMERCE 1-3-2006.

PAUL E. FAHRENKOPF, EXAMINING ATTORNEY

**Int. Cl.: 3**

**Prior U.S. Cls.: 1, 4, 6, 50, 51, and 52**

**Reg. No. 3,396,227**

**United States Patent and Trademark Office**

**Registered Mar. 11, 2008**

**TRADEMARK  
PRINCIPAL REGISTER**

**CORE THERAPY**

EXHALE ENTERPRISES, INC. (DELAWARE  
CORPORATION)  
SUITE 1304  
200 WEST 57TH  
NEW YORK, NY 10019

FOR: FACE AND BODY CARE PREPARATIONS  
AND COSMETICS, NAMELY, SOAP, NON-MEDI-  
CATED LOTIONS AND COSMETIC PREPARA-  
TIONS FOR SKIN CARE AND PROTECTION;  
SHAMPOOS AND HAIR CONDITIONERS, IN  
CLASS 3 (U.S. CLS. 1, 4, 6, 50, 51 AND 52).

FIRST USE 3-0-2006; IN COMMERCE 3-0-2006.

THE MARK CONSISTS OF STANDARD CHAR-  
ACTERS WITHOUT CLAIM TO ANY PARTICULAR  
FONT, STYLE, SIZE, OR COLOR.

OWNER OF U.S. REG. NO. 2,796,257.

NO CLAIM IS MADE TO THE EXCLUSIVE  
RIGHT TO USE "THERAPY", APART FROM THE  
MARK AS SHOWN.

SN 78-827,169, FILED 3-2-2006.

WILLIAM P. SHANAHAN, EXAMINING ATTOR-  
NEY

**Int. Cl.: 9**

**Prior U.S. Cls.: 21, 23, 26, 36, and 38**

**Reg. No. 3,396,228**

**United States Patent and Trademark Office**

**Registered Mar. 11, 2008**

---

**TRADEMARK  
PRINCIPAL REGISTER**

**UNITED**

UNITED TECHNOLOGY GROUP, INC. (NEVADA CORPORATION)  
SUITE K513  
4012 S. RAINBOW BLVD.  
LAS VEGAS, NV 94506

THE MARK CONSISTS OF STANDARD CHARACTERS WITHOUT CLAIM TO ANY PARTICULAR FONT, STYLE, SIZE, OR COLOR.

FOR: LIGHTING BALLASTS, IN CLASS 9 (U.S. CLS. 21, 23, 26, 36 AND 38).

SN 78-827,710, FILED 3-2-2006.

FIRST USE 12-1-2006; IN COMMERCE 12-1-2006.

WENDY GOODMAN, EXAMINING ATTORNEY

**Int. Cl.: 35**

**Prior U.S. Cls.: 100, 101, and 102**

**United States Patent and Trademark Office**

**Reg. No. 3,396,229**

**Registered Mar. 11, 2008**

**SERVICE MARK  
PRINCIPAL REGISTER**

**KEY INGREDIENT**

KEY INGREDIENT, INC. (DELAWARE CORPORATION)  
3601 SOUTH CONGRESS AVENUE  
SUITE D-102  
AUSTIN, TX 78704

THE MARK CONSISTS OF STANDARD CHARACTERS WITHOUT CLAIM TO ANY PARTICULAR FONT, STYLE, SIZE, OR COLOR.

FOR: ONLINE RETAIL STORE SERVICES FEATURING RECIPE BOOKS AND RECIPES, IN CLASS 35 (U.S. CLS. 100, 101 AND 102).

SN 78-829,715, FILED 3-6-2006.

FIRST USE 9-18-2007; IN COMMERCE 9-18-2007.

BERNICE MIDDLETON, EXAMINING ATTORNEY

**Int. Cl.: 9**

**Prior U.S. Cls.: 21, 23, 26, 36, and 38**

**United States Patent and Trademark Office**

**Reg. No. 3,396,230**

**Registered Mar. 11, 2008**

**TRADEMARK  
PRINCIPAL REGISTER**

**MICRO SPOT**

GALAXY AUDIO (KANSAS CORPORATION)  
601 E. PAWNEE  
WICHITA, KS 67211

FOR: MICROPHONE STAND MOUNTABLE PERSONAL VOCAL MONITORS; WALL MOUNTABLE PAGING SPEAKERS FOR USE IN DISTRIBUTED SYSTEMS, IN CLASS 9 (U.S. CLS. 21, 23, 26, 36 AND 38).

FIRST USE 1-18-2007; IN COMMERCE 1-18-2007.

OWNER OF U.S. REG. NO. 1,107,848.

NO CLAIM IS MADE TO THE EXCLUSIVE RIGHT TO USE "MICRO", APART FROM THE MARK AS SHOWN.

THE COLOR(S) BLACK AND RED IS/ARE CLAIMED AS A FEATURE OF THE MARK.

THE MARK CONSISTS OF MICRO SPOT IS IN THE COLORS BLACK AND RED, ALL LETTERS IN THE NAME ARE BLACK EXCEPT THE SOLID RED O IN THE WORD SPOT. THE FONT IS AVALON BOLD.

SN 78-829,835, FILED 3-6-2006.

BRIAN PINO, EXAMINING ATTORNEY

**Int. Cl.: 38**

**Prior U.S. Cls.: 100, 101, and 104**

**United States Patent and Trademark Office**

**Reg. No. 3,396,231**

**Registered Mar. 11, 2008**

**SERVICE MARK  
PRINCIPAL REGISTER**



NATCO COMMUNICATIONS, INC. (ARKANSAS CORPORATION)  
301 EAST MAIN STREET  
FLIPPIN, AR 72634

FOR: CELLULAR TELEPHONE COMMUNICATION; CELLULAR TELEPHONE SERVICES; COMMUNICATION SERVICES, NAMELY, ELECTRONIC TRANSMISSION OF DATA AND DOCUMENTS AMONG USERS OF COMPUTERS; DATA COMMUNICATION BY ELECTRONIC MAIL; ELECTRONIC MAIL SERVICES; TELEPHONE COMMUNICATION SERVICES, IN CLASS 38 (U.S. CLS. 100, 101 AND 104).

FIRST USE 11-14-2007; IN COMMERCE 11-14-2007.

OWNER OF U.S. REG. NOS. 2,011,539, 2,941,867, AND OTHERS.

NO CLAIM IS MADE TO THE EXCLUSIVE RIGHT TO USE "CELLULAR", APART FROM THE MARK AS SHOWN.

THE MARK CONSISTS OF A STYLIZED GLOBE COMPRISING THREE CURVED LINES AND THE WORDS NATCO CELLULAR.

SN 78-831,441, FILED 3-7-2006.

CHERYL CLAYTON, EXAMINING ATTORNEY



**Int. Cl.: 25**

**Prior U.S. Cls.: 22 and 39**

**United States Patent and Trademark Office**

**Reg. No. 3,396,232**

**Registered Mar. 11, 2008**

**TRADEMARK  
PRINCIPAL REGISTER**

**PASSION FOR COMFORT**

HBI BRANDED APPAREL ENTERPRISES, LLC  
(DELAWARE LTD LIAB CO)  
1000 EAST HANES MILL ROAD  
WINSTON-SALEM, NC 27105

THE MARK CONSISTS OF STANDARD CHAR-  
ACTERS WITHOUT CLAIM TO ANY PARTICULAR  
FONT, STYLE, SIZE, OR COLOR.

FOR: BRAS AND PANTIES, IN CLASS 25 (U.S.  
CLS. 22 AND 39).

SN 78-832,164, FILED 3-8-2006.

FIRST USE 12-31-2006; IN COMMERCE 12-31-2006.

SANI KHOURI, EXAMINING ATTORNEY

**Int. Cl.: 19**

**Prior U.S. Cls.: 1, 12, 33, and 50**

**United States Patent and Trademark Office**

**Reg. No. 3,396,233**

**Registered Mar. 11, 2008**

**TRADEMARK  
PRINCIPAL REGISTER**

**LEVELPATCH**

BASF CONSTRUCTION CHEMICALS, LLC (DE-  
LAWARE LTD LIAB CO)  
23700 CHAGRIN BLVD  
CLEVELAND, OH 44122

THE MARK CONSISTS OF STANDARD CHAR-  
ACTERS WITHOUT CLAIM TO ANY PARTICULAR  
FONT, STYLE, SIZE, OR COLOR.

FOR: CEMENTITIOUS MIXTURES FOR FLOORS,  
IN CLASS 19 (U.S. CLS. 1, 12, 33 AND 50).

SN 78-833,264, FILED 3-9-2006.

FIRST USE 5-0-2006; IN COMMERCE 5-0-2006.

ROBERT LAVACHE, EXAMINING ATTORNEY

**Int. Cl.: 31**

**Prior U.S. Cls.: 1 and 46**

**United States Patent and Trademark Office**

**Reg. No. 3,396,234**

**Registered Mar. 11, 2008**

**TRADEMARK  
PRINCIPAL REGISTER**

**HOMEZOO**

RUBEN, CHRISTOPHER (UNITED STATES IN-  
DIVIDUAL)  
SUITE 100  
5108 CHAD DRIVE  
TYLER, TX 757033919

FOR: PET FOOD, NAMELY, EDIBLE PET TOYS-  
FOOD AND TREATS FOR PETS INCLUDING  
DOGS, CATS, BIRDS, FISH, REPTILES, HORSES,  
HAMSTERS, GERBILS, FERRETS, RABBITS, SU-  
GAR-GLIDERS AND GUINEA PIGS, IN CLASS 31  
(U.S. CLS. 1 AND 46).

FIRST USE 10-22-2007; IN COMMERCE 10-22-2007.

THE MARK CONSISTS OF STANDARD CHAR-  
ACTERS WITHOUT CLAIM TO ANY PARTICULAR  
FONT, STYLE, SIZE, OR COLOR.

SN 78-833,628, FILED 3-9-2006.

GRETTA YAO, EXAMINING ATTORNEY

**Int. Cls.: 11, 20, and 21**

**Prior U.S. Cls.: 2, 13, 21, 22, 23, 25, 29, 30, 31, 32, 33,  
34, 40, and 50**

**Reg. No. 3,396,235**

**United States Patent and Trademark Office**

**Registered Mar. 11, 2008**

**TRADEMARK  
PRINCIPAL REGISTER**



COMERCIAL SALGAR S.A. (SPAIN JOINT STOCK COMPANY)  
CARRETERA DE LOGRONO KM 9,5  
ZARAGOZA, SPAIN 50080

FOR: APPARATUS FOR LIGHTING, HEATING, STEAM GENERATING, COOKING, REFRIGERATING, DRYING, VENTILATING, WATER SUPPLY AND SANITARY PURPOSES, NAMELY, ELECTRIC LIGHTING FIXTURES, ELECTRIC HEATING FANS, ELECTRIC STOVES, REFRIGERATORS, ELECTRIC CLOTHES DRYING MACHINES FOR HOUSEHOLD PURPOSES, VENTILATING EXHAUST FANS, AND TAP WATER FAUCETS; RAW OR PARTLY WORKED REEDS; FOOT STOOLS, NAMELY, SHOWER TRAY WOODEN FOOT BOARD, IN CLASS 11 (U.S. CLS. 13, 21, 23, 31 AND 34).

FIRST USE 3-2-2000; IN COMMERCE 3-2-2000.

FOR: FURNITURE, NAMELY, MIRRORS, ELECTRICALLY LIGHTED MIRRORS, FRAMES, NAMELY, FURNITURE FRAMES, PICTURE FRAMES AND MIRROR FRAMES; BATHROOM FURNITURE, NAMELY, BATHROOM SHELVING, BATH SCREENS, BATHROOM VANITIES, IN CLASS 20 (U.S. CLS. 2, 13, 22, 25, 32 AND 50).

FIRST USE 3-2-2000; IN COMMERCE 3-2-2000.

FOR: TRAYS NOT OF PRECIOUS METAL FOR USE IN THE SHOWER; HOUSEHOLD OR KITCHEN UTENSILS AND CONTAINERS IN THE NATURE OF NON-METALLIC BATHROOM ACCESSORIES, NAMELY, HOOKS, RINGS AND BARS FOR HANGING TOWELS AND BATHROOM APPAREL; TOWEL RACKS; TOILET PAPER ROLL HOLDER; SOAP AND SPONGE DISH, HOLDER AND TUMBLER CONTAINER; AND TOILET BRUSH HOLDERS, IN CLASS 21 (U.S. CLS. 2, 13, 23, 29, 30, 33, 40 AND 50).

FIRST USE 3-2-2000; IN COMMERCE 3-2-2000.

OWNER OF U.S. REG. NO. 1,382,031.

THE COLOR(S) BLUE AND WHITE IS/ARE CLAIMED AS A FEATURE OF THE MARK.

THE MARK CONSISTS OF THE STYLIZED WORD SALGAR IN BLUE, NEXT TO A WHITE SWAN PARTIALLY IN A BLUE RECTANGLE WITH HORIZONTAL WHITE LINES AT THE BOTTOM.

SN 78-834,092, FILED 3-10-2006.

INGRID C. EULIN, EXAMINING ATTORNEY

**Int. Cl.: 30**

**Prior U.S. Cl.: 46**

**United States Patent and Trademark Office**

**Reg. No. 3,396,236**

**Registered Mar. 11, 2008**

**TRADEMARK  
PRINCIPAL REGISTER**

**360'S**

C.P. TWIST, LLC (WISCONSIN LTD LIAB CO)  
12065 LAKESHORE DRIVE  
MEQUON, WI 53092

THE MARK CONSISTS OF STANDARD CHAR-  
ACTERS WITHOUT CLAIM TO ANY PARTICULAR  
FONT, STYLE, SIZE, OR COLOR.

FOR: PRETZEL BALLS COATED WITH CHEESE,  
IN CLASS 30 (U.S. CL. 46).

SN 78-834,101, FILED 3-10-2006.

FIRST USE 4-19-2006; IN COMMERCE 11-4-2006.

LYDIA BELZER, EXAMINING ATTORNEY

**Int. Cl.: 33**

**Prior U.S. Cls.: 47 and 49**

**United States Patent and Trademark Office**

**Reg. No. 3,396,237**

**Registered Mar. 11, 2008**

**TRADEMARK  
PRINCIPAL REGISTER**

**EDUCATED GUESS**

ROOTS RUN DEEP LLC (DELAWARE LTD LIAB  
CO)  
6358 HEATHER RIDGE WAY BUILDING C #F&S  
YOUNTVILLE, CA 94599

THE MARK CONSISTS OF STANDARD CHAR-  
ACTERS WITHOUT CLAIM TO ANY PARTICULAR  
FONT, STYLE, SIZE, OR COLOR.

FOR: WINES, IN CLASS 33 (U.S. CLS. 47 AND 49).

SN 78-834,692, FILED 3-10-2006.

FIRST USE 7-26-2007; IN COMMERCE 7-26-2007.

MARY BOAGNI, EXAMINING ATTORNEY

Int. Cl.: 35

Prior U.S. Cls.: 100, 101, and 102

United States Patent and Trademark Office

Reg. No. 3,396,238

Registered Mar. 11, 2008

SERVICE MARK  
PRINCIPAL REGISTER



WHITE CAP CONSTRUCTION SUPPLY, INC.  
(DELAWARE CORPORATION)  
3120 AIRWAY AVE.  
COSTA MESA, CA 92626

OWNER OF U.S. REG. NOS. 1,478,065, 3,048,812,  
AND OTHERS.

FOR: RETAIL STORES, WHOLESALE STORES  
AND DISTRIBUTORSHIP SERVICES IN THE FIELD  
OF CONSTRUCTION SUPPLIES, CONCRETE AC-  
CESSORIES, EROSION CONTROL MATERIALS,  
ELECTRICAL SUPPLIES, FIRST AID SUPPLIES,  
LIGHTING SUPPLIES, POWER TOOLS, TILT UP  
FORMS, FASTENERS AND ADHESIVES, IN CLASS  
35 (U.S. CLS. 100, 101 AND 102).

NO CLAIM IS MADE TO THE EXCLUSIVE  
RIGHT TO USE "CUSTOM SHOP", "COAST TO  
COAST", "1976" AND "2006", APART FROM THE  
MARK AS SHOWN.

SN 78-834,816, FILED 3-10-2006.

FIRST USE 5-1-2006; IN COMMERCE 5-1-2006.

REBECCA SMITH, EXAMINING ATTORNEY

**Int. Cl.: 35**

**Prior U.S. Cls.: 100, 101, and 102**

**United States Patent and Trademark Office**

**Reg. No. 3,396,239**

**Registered Mar. 11, 2008**

**SERVICE MARK  
PRINCIPAL REGISTER**



WHITE CAP CONSTRUCTION SUPPLY, INC.  
(DELAWARE CORPORATION)  
3120 AIRWAY AVE.  
COSTA MESA, CA 92626

FIRST USE 5-1-2006; IN COMMERCE 5-1-2006.

OWNER OF U.S. REG. NOS. 1,478,065, 3,048,812,  
AND OTHERS.

FOR: RETAIL STORES, WHOLESALE STORES  
AND DISTRIBUTORSHIP SERVICES IN THE FIELD  
OF CONSTRUCTION SUPPLIES, CONCRETE AC-  
CESSORIES, EROSION CONTROL MATERIALS,  
ELECTRICAL SUPPLIES, FIRST AID SUPPLIES,  
LIGHTING SUPPLIES, POWER TOOLS, TILT UP  
FORMS, FASTENERS AND ADHESIVES, IN CLASS  
35 (U.S. CLS. 100, 101 AND 102).

NO CLAIM IS MADE TO THE EXCLUSIVE  
RIGHT TO USE "CUSTOM SHOP" AND "1976"  
AND "2006", APART FROM THE MARK AS SHOWN.

SN 78-834,827, FILED 3-10-2006.

REBECCA SMITH, EXAMINING ATTORNEY



**Int. Cl.: 6**

**Prior U.S. Cls.: 2, 12, 13, 14, 23, 25, and 50**

**United States Patent and Trademark Office**

**Reg. No. 3,396,240**

**Registered Mar. 11, 2008**

**TRADEMARK  
PRINCIPAL REGISTER**

**BREEZ-THRU**

AMH ALUMINUM, INC. (FLORIDA CORPORATION)  
6300 TEX POINT  
HOMOSASSA, FL 34448

THE MARK CONSISTS OF STANDARD CHARACTERS WITHOUT CLAIM TO ANY PARTICULAR FONT, STYLE, SIZE, OR COLOR.

FOR: METAL SCREENED POOL AND PATIO ENCLOSURE HAVING REMOVABLE SCREEN PANELS, IN CLASS 6 (U.S. CLS. 2, 12, 13, 14, 23, 25 AND 50).

SN 78-835,112, FILED 3-12-2006.

FIRST USE 10-31-2006; IN COMMERCE 10-31-2006.

LINDA MICKLEBURGH, EXAMINING ATTORNEY

Int. Cls.: 35 and 41

Prior U.S. Cls.: 100, 101, 102, and 107

United States Patent and Trademark Office

Reg. No. 3,396,241

Registered Mar. 11, 2008

SERVICE MARK  
PRINCIPAL REGISTER



**Know what's below.  
Call before you dig.**

COMMON GROUND ALLIANCE (D.C. CORPORATION)  
SUITE 300  
14500 AVION PARKWAY  
CHANTILLY, VA 20151

FOR: PROMOTION AND MARKETING SERVICES RELATING TO THE USE OF THE TELEPHONE FOR CONNECTING EXCAVATORS AND CONSUMERS TO NORTH AMERICAN NOTIFICATION CENTERS WHICH CONTACT UTILITY COMPANIES TO MARK THE LOCATION OF UNDERGROUND FACILITIES PRIOR TO EXCAVATION, IN CLASS 35 (U.S. CLS. 100, 101 AND 102).

FIRST USE 3-0-2007; IN COMMERCE 3-0-2007.

FOR: EDUCATION SERVICES, NAMELY, SEMINARS, CLASSES, WORKSHOPS, AND ON-LINE VERSIONS OF THE SAME RELATING TO THE USE OF THE TELEPHONE FOR CONNECTING EXCAVATORS AND CONSUMERS TO NORTH AMERICAN NOTIFICATION CENTERS WHICH CONTACT UTILITY COMPANIES TO MARK THE LOCATION OF UNDERGROUND FACILITIES

PRIOR TO EXCAVATION AND DISTRIBUTION OF COURSE MATERIALS IN CONNECTION THEREWITH, IN CLASS 41 (U.S. CLS. 100, 101 AND 107).

FIRST USE 3-0-2007; IN COMMERCE 3-0-2007.

THE COLOR(S) BLACK, YELLOW, GREEN, GRAY, AND BROWN IS/ARE CLAIMED AS A FEATURE OF THE MARK.

THE MARK CONSISTS OF THE NUMERALS "811" IN YELLOW WITH A STYLIZED LIGHT AND DARK GRAY SHOVEL HEAD EXTENDING FROM THE MIDDLE "1". THE SHOVEL IS PENETRATING A STYLIZED PIECE OF GROUND COLORED IN GREEN AND BROWN AND THE IMAGES ARE ALL OUTLINED IN BLACK.

SN 78-836,105, FILED 3-13-2006.

SUE LAWRENCE, EXAMINING ATTORNEY

**Int. Cl.: 9**

**Prior U.S. Cls.: 21, 23, 26, 36, and 38**

**United States Patent and Trademark Office**

**Reg. No. 3,396,242**

**Registered Mar. 11, 2008**

**TRADEMARK  
PRINCIPAL REGISTER**

**AVOX**

CENTRADE M.E. LTD. (JAPAN CORPORATION)  
24-9 1-CHOME, TAITOU, TAITOU-KU  
TOKYO, JAPAN 110-0016

FOR: FLASH MEMORY CARDS FOR STORING  
DATA FOR DIGITAL CAMERAS, MP3 PLAYERS  
AND MOBILE PHONES; DIGITAL SETS AND DIGI-  
TAL MEDIA, NAMELY, TECHNOLOGY THAT CAN  
MANAGE, STORE, PROTECT AND DISTRIBUTE  
DIGITAL VIDEO, AUDIO AND IMAGES, NAMELY,  
BLANK DVD MEDIA TO STORE DATA FROM

RECORDERS, IN CLASS 9 (U.S. CLS. 21, 23, 26, 36  
AND 38).

FIRST USE 1-1-1997; IN COMMERCE 11-30-2006.

THE MARK CONSISTS OF STANDARD CHAR-  
ACTERS WITHOUT CLAIM TO ANY PARTICULAR  
FONT, STYLE, SIZE, OR COLOR.

SN 78-836,926, FILED 3-14-2006.

PAUL F. GAST, EXAMINING ATTORNEY

**Int. Cl.: 41**

**Prior U.S. Cls.: 100, 101, and 107**

**United States Patent and Trademark Office**

**Reg. No. 3,396,243**

**Registered Mar. 11, 2008**

**SERVICE MARK  
PRINCIPAL REGISTER**

**R GYM**

MCDONALD'S CORPORATION (DELAWARE  
CORPORATION)  
ONE MCDONALD'S PLAZA  
OAK BROOK, IL 60523

FOR: PROVIDING CHILDREN'S PLAYGROUND  
FACILITIES FOR RECREATION ACTIVITIES, IN  
CLASS 41 (U.S. CLS. 100, 101 AND 107).

FIRST USE 1-31-2006; IN COMMERCE 1-31-2006.

THE MARK CONSISTS OF STANDARD CHAR-  
ACTERS WITHOUT CLAIM TO ANY PARTICULAR  
FONT, STYLE, SIZE, OR COLOR.

NO CLAIM IS MADE TO THE EXCLUSIVE  
RIGHT TO USE "GYM", APART FROM THE MARK  
AS SHOWN.

SN 78-837,944, FILED 3-15-2006.

JULIE WATSON, EXAMINING ATTORNEY

**Int. Cls.: 37 and 42**

**Prior U.S. Cls.: 100, 101, 103, and 106**

**United States Patent and Trademark Office**

**Reg. No. 3,396,244**

**Registered Mar. 11, 2008**

**SERVICE MARK  
PRINCIPAL REGISTER**

**SIQURA**

OPTELECOM-NKF, INC. (DELAWARE CORPORATION)  
12920 CLOVERLEAF CENTER DRIVE  
GERMANTOWN, MD 20874

FOR: INSTALLATION FOR OTHERS OF PARTIAL AND/OR TURNKEY SYSTEMS, NAMELY, INTERNET PROTOCOL BASED VIDEO SURVEILLANCE SYSTEMS, IN CLASS 37 (U.S. CLS. 100, 103 AND 106).

FIRST USE 4-5-2006; IN COMMERCE 4-5-2006.

FOR: COMPUTER CONSULTING SERVICES FOR OTHERS, NAMELY, IN THE FIELD OF HARDWARE AND SOFTWARE; DESIGN SERVICES FOR

OTHERS, NAMELY, IN THE FIELD OF HARDWARE AND SOFTWARE, IN CLASS 42 (U.S. CLS. 100 AND 101).

FIRST USE 4-5-2006; IN COMMERCE 4-5-2006.

THE MARK CONSISTS OF STANDARD CHARACTERS WITHOUT CLAIM TO ANY PARTICULAR FONT, STYLE, SIZE, OR COLOR.

SN 78-838,482, FILED 3-16-2006.

REBECCA POVARCHUK, EXAMINING ATTORNEY

**Int. Cl.: 5**

**Prior U.S. Cls.: 6, 18, 44, 46, 51, and 52**

**United States Patent and Trademark Office**

**Reg. No. 3,396,245**

**Registered Mar. 11, 2008**

**TRADEMARK  
PRINCIPAL REGISTER**

**ANTI-FLAMME**

EBOS GROUP LIMITED (NEW ZEALAND CORPORATION)  
324 CASHEL STREET  
CHRISTCHURCH, NEW ZEALAND

FOR: SKIN AND BODY CREAMS, LOTIONS AND RUBS OF A PHARMACEUTICAL OR MEDICATED NATURE, NAMELY MEDICATED MASSAGE CREAMS, IN CLASS 5 (U.S. CLS. 6, 18, 44, 46, 51 AND 52).

FIRST USE 8-1-2002; IN COMMERCE 8-1-2002.

THE MARK CONSISTS OF STANDARD CHARACTERS WITHOUT CLAIM TO ANY PARTICULAR FONT, STYLE, SIZE, OR COLOR.

SN 78-839,614, FILED 3-17-2006.

DARRYL SPRUILL, EXAMINING ATTORNEY

**Int. Cl.: 14**

**Prior U.S. Cls.: 2, 27, 28, and 50**

**United States Patent and Trademark Office**

**Reg. No. 3,396,246**

**Registered Mar. 11, 2008**

**TRADEMARK  
PRINCIPAL REGISTER**

**WAVES OF LOVE**

DANGLER, PAUL J. (UNITED STATES INDIVIDUAL)  
SUITE 200  
1695 10TH ST.  
SARASOTA, FL 34236

THE MARK CONSISTS OF STANDARD CHARACTERS WITHOUT CLAIM TO ANY PARTICULAR FONT, STYLE, SIZE, OR COLOR.

FOR: JEWELRY, IN CLASS 14 (U.S. CLS. 2, 27, 28 AND 50).

SN 78-839,685, FILED 3-17-2006.

FIRST USE 6-15-2006; IN COMMERCE 6-15-2006.

JAMES STEIN, EXAMINING ATTORNEY

**Int. Cls.: 40 and 42**

**Prior U.S. Cls.: 100, 101, 103, and 106**

**United States Patent and Trademark Office**

**Reg. No. 3,396,247**

**Registered Mar. 11, 2008**

**SERVICE MARK  
PRINCIPAL REGISTER**

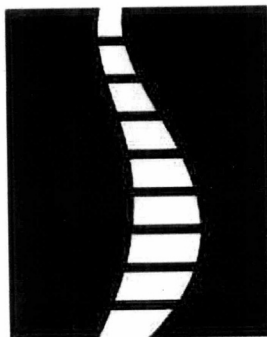

SPINEFRONTIER, LLS (DELAWARE LIMITED LIABILITY SERIES)  
100 CUMMING CENTER, SUITE 240C  
BEVERLY, MA 01915

FOR: CUSTOM MANUFACTURING OF GOODS FOR TREATING DISEASES OF THE SPINE, SUCH AS OPERATIVE INSTRUMENTS, IMPLANTABLE AND NON-IMPLANTABLE MEDICAL DEVICES, DIAGNOSTIC EQUIPMENT AND REHABILITATION AIDS, IN CLASS 40 (U.S. CLS. 100, 103 AND 106).

FIRST USE 1-2-2008; IN COMMERCE 1-2-2008.

FOR: PRODUCT DEVELOPMENT AND DESIGN FOR OTHERS IN THE FIELD OF SPINAL DISEASE

TREATMENT, RELATING TO GOODS SUCH AS OPERATIVE INSTRUMENTS, IMPLANTABLE AND NON-IMPLANTABLE MEDICAL DEVICES, DIAGNOSTIC EQUIPMENT AND REHABILITATION AIDS, IN CLASS 42 (U.S. CLS. 100 AND 101).

FIRST USE 1-2-2008; IN COMMERCE 1-2-2008.

THE MARK CONSISTS OF BLOCKS OF VARYING SIZE ARRANGED ALONG A CURVED PATHWAY TO REPRESENT A HUMAN SPINE.

SN 78-840,862, FILED 3-20-2006.

NICHOLAS ALTREE, EXAMINING ATTORNEY



Int. Cls.: 29, 30, and 32

Prior U.S. Cls.: 45, 46, and 48

United States Patent and Trademark Office

Reg. No. 3,396,248

Registered Mar. 11, 2008

TRADEMARK  
PRINCIPAL REGISTER

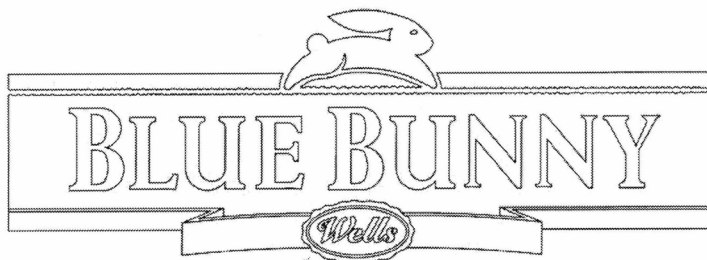

WELLS' DAIRY, INC. (IOWA CORPORATION)  
ONE BLUE BUNNY DRIVE, P.O. BOX 1310  
LE MARS, IA 51031

FOR: EGG NOG; BUTTER; MILK, CULTURED MILK; YOGURT; SOUR CREAM; SNACK DIP; COTTAGE CHEESE, BUTTERMILK, IN CLASS 29 (U.S. CL. 46).

FIRST USE 4-0-2004; IN COMMERCE 4-0-2004.

FOR: ICE CREAM; SHERBET; SORBET; FRUIT ICES; ICE CREAM NOVELTIES; FROZEN PUD-DINGS; FROZEN YOGURT; FROZEN CONFEC-

TIONS; LITE ICE CREAM SOFT SERVE MIX; SOFT SERVE FROZEN YOGURT, IN CLASS 30 (U.S. CL. 46).

FIRST USE 11-0-2003; IN COMMERCE 11-0-2003.

FOR: FRUIT JUICE; FRUIT DRINKS, IN CLASS 32 (U.S. CLS. 45, 46 AND 48).

FIRST USE 12-0-2006; IN COMMERCE 12-0-2006.

SN 78-841,468, FILED 3-20-2006.

CHERYL CLAYTON, EXAMINING ATTORNEY

**Int. Cl.: 20**

**Prior U.S. Cls.: 2, 13, 22, 25, 32, and 50**

**Reg. No. 3,396,249**

**United States Patent and Trademark Office**

**Registered Mar. 11, 2008**

---

**TRADEMARK  
PRINCIPAL REGISTER**

**TRENDLINES**

NORTH AMERICAN ENCLOSURES, INC. (NEW  
YORK CORPORATION)  
65 JETSON LANE  
CENTRAL ISLIP, NY 11722

THE MARK CONSISTS OF STANDARD CHAR-  
ACTERS WITHOUT CLAIM TO ANY PARTICULAR  
FONT, STYLE, SIZE, OR COLOR.

FOR: WOOD PICTURE FRAMES, IN CLASS 20  
(U.S. CLS. 2, 13, 22, 25, 32 AND 50).

SN 78-841,884, FILED 3-21-2006.

FIRST USE 11-3-2005; IN COMMERCE 3-0-2006.

DAVID C. REIHNER, EXAMINING ATTORNEY

**Int. Cls.: 5, 10, 36, 41, 42, and 44**

**Prior U.S. Cls.: 6, 18, 26, 39, 44, 46, 51, 52, 100, 101, 102, and 107**

**Reg. No. 3,396,250**

**United States Patent and Trademark Office**

**Registered Mar. 11, 2008**

**TRADEMARK  
SERVICE MARK  
PRINCIPAL REGISTER**



KING PHARMACEUTICALS, INC. (TENNESSEE CORPORATION)  
501 FIFTH ST.  
BRISTOL, TN 37620

FOR: FULL LINE OF PHARMACEUTICAL PREPARATIONS, IN CLASS 5 (U.S. CLS. 6, 18, 44, 46, 51 AND 52).

FIRST USE 6-8-2006; IN COMMERCE 6-8-2006.

FOR: MEDICAL DEVICES, NAMELY, AUTO-INJECTORS, NERVE AGENT AUTO-INJECTOR KITS CONSISTING PRIMARILY OF AUTO-INJECTORS FILLED WITH PHARMACEUTICALS FOR IMMEDIATE AND PORTABLE SELF-ADMINISTRATION OF EMERGENCY TREATMENT, AND MEDICAL SYRINGES, IN CLASS 10 (U.S. CLS. 26, 39 AND 44).

FIRST USE 6-8-2006; IN COMMERCE 6-8-2006.

FOR: CHARITABLE SERVICES, NAMELY, A PATIENT ASSISTANCE PROGRAM THAT PROVIDES CHARITABLE CONTRIBUTIONS IN THE FORM OF FINANCIAL ASSISTANCE TO CHARITIES TO ASSIST NEEDY MEDICAL PATIENTS IN OBTAINING PRESCRIPTION PHARMACEUTICALS, IN CLASS 36 (U.S. CLS. 100, 101 AND 102).

FIRST USE 6-8-2006; IN COMMERCE 6-8-2006.

FOR: EDUCATIONAL SERVICES, NAMELY, PROVIDING INCENTIVES TO PEOPLE AND ORGANIZATIONS TO DEMONSTRATE EXCELLENCE IN THE FIELD OF PHILANTHROPY, KINDNESS AND HUMANITARIAN EFFORT, THROUGH THE ISSUANCE OF AWARDS, IN CLASS 41 (U.S. CLS. 100, 101 AND 107).

FIRST USE 6-8-2006; IN COMMERCE 6-8-2006.

FOR: RESEARCH AND DEVELOPMENT IN THE FIELD OF PHARMACEUTICALS, IN CLASS 42 (U.S. CLS. 100 AND 101).

FIRST USE 6-8-2006; IN COMMERCE 6-8-2006.

FOR: CHARITABLE SERVICES, NAMELY, A PATIENT ASSISTANCE PROGRAM TO PROVIDE DRUGS FREE OF CHARGE TO NEEDY MEDICAL PATIENTS WITHOUT PRESCRIPTION DRUG COVERAGE, IN CLASS 44 (U.S. CLS. 100 AND 101).

FIRST USE 6-8-2006; IN COMMERCE 6-8-2006.

SN 78-842,009, FILED 3-21-2006.

STEVEN JACKSON, EXAMINING ATTORNEY

**Int. Cls.: 41 and 42**

**Prior U.S. Cls.: 100, 101, and 107**

**United States Patent and Trademark Office**

**Reg. No. 3,396,251**

**Registered Mar. 11, 2008**

**SERVICE MARK  
PRINCIPAL REGISTER**

**ROYALTYSOURCE**

AUS CONSULTANTS, INC. (NEW JERSEY CORPORATION)  
P.O. BOX 1050  
MOORESTOWN, NJ 08057

FOR: EDUCATIONAL SERVICES, NAMELY, PROVIDING CLASSES, SEMINARS AND WORKSHOPS IN THE FIELD OF FINANCIAL VALUATIONS, IN CLASS 41 (U.S. CLS. 100, 101 AND 107).

FIRST USE 10-10-2007; IN COMMERCE 10-10-2007.

FOR: PROVIDING ON-LINE NON-DOWNLOADABLE SOFTWARE FOR USE IN FINANCIAL VA-

LUATION IN THE FIELD OF INTELLECTUAL PROPERTY, IN CLASS 42 (U.S. CLS. 100 AND 101).

FIRST USE 10-10-2007; IN COMMERCE 10-10-2007.

THE MARK CONSISTS OF STANDARD CHARACTERS WITHOUT CLAIM TO ANY PARTICULAR FONT, STYLE, SIZE, OR COLOR.

OWNER OF U.S. REG. NO. 2,327,433.

SN 78-842,982, FILED 3-22-2006.

ANNE E. GUSTASON, EXAMINING ATTORNEY

**Int. Cl.: 31**

**Prior U.S. Cls.: 1 and 46**

**United States Patent and Trademark Office**

**Reg. No. 3,396,252**

**Registered Mar. 11, 2008**

**TRADEMARK  
PRINCIPAL REGISTER**

**THE FUTURE IS GROWING**

WEYERHAEUSER COMPANY (WASHINGTON  
CORPORATION)  
33663 WEYERHAEUSER WAY SOUTH  
FEDERAL WAY, WA 98003

FOR: PLANTS, NAMELY, TREE SEEDLINGS, IN  
CLASS 31 (U.S. CLS. 1 AND 46).

FIRST USE 1-1-1999; IN COMMERCE 1-1-1999.

THE MARK CONSISTS OF STANDARD CHAR-  
ACTERS WITHOUT CLAIM TO ANY PARTICULAR  
FONT, STYLE, SIZE, OR COLOR.

OWNER OF U.S. REG. NOS. 2,721,548, 2,769,391,  
AND 2,825,462.

SN 78-843,075, FILED 3-22-2006.

GIANCARLO CASTRO, EXAMINING ATTORNEY

**Int. Cl.: 35**

**Prior U.S. Cls.: 100, 101, and 102**

**United States Patent and Trademark Office**

**Reg. No. 3,396,253**

**Registered Mar. 11, 2008**

**SERVICE MARK  
PRINCIPAL REGISTER**

**Caring Matters**



**"It's Who We Are...It's What We do"**

FEDERATED WHOLESALE, INC. (GEORGIA CORPORATION)  
6095-D NORTHBELT DRIVE  
NORCROSS, GA 30071

FOR: WHOLESALE STORES FEATURING PERSONAL CARE AND PROMOTIONAL PRODUCTS, NAMELY, PERSONAL HYGIENE PRODUCTS, CLOTHING, TOTE BAGS, UMBRELLAS, LAPEL PINS, WALLETS, CANDY, LANYARDS, TELEPHONE CARDS, PENS, CLOCKS, PLAYING CARDS, BOOKS, MIRRORS, EMERGENCY FOIL RESCUE

BLANKETS, IN CLASS 35 (U.S. CLS. 100, 101 AND 102).

FIRST USE 3-31-2006; IN COMMERCE 3-31-2006.

THE MARK CONSISTS OF A FLAG OUTLINE IN A HEART, WHICH IS SUPPORTED BY TWO HANDS.

SN 78-843,524, FILED 3-22-2006.

MARY BOAGNI, EXAMINING ATTORNEY

**Int. Cl.: 41**

**Prior U.S. Cls.: 100, 101, and 107**

**United States Patent and Trademark Office**

**Reg. No. 3,396,254**

**Registered Mar. 11, 2008**

**SERVICE MARK  
PRINCIPAL REGISTER**

**UPS**

UNITED PARCEL SERVICE OF AMERICA, INC.  
(DELAWARE CORPORATION)  
55 GLENLAKE PARKWAY, NE  
ATLANTA, GA 30328

FOR: EDUCATIONAL SERVICES, NAMELY,  
CONDUCTING SEMINARS AND TRAINING CLAS-  
SES IN THE FIELD OF LOGISTICS INVOLVING  
SUPPLY CHAIN SOLUTIONS RELATING TO  
TRANSPORTATION AND DELIVERY SERVICES  
AND DISTRIBUTING COURSE MATERIALS IN  
CONNECTION THEREWITH, IN CLASS 41 (U.S.  
CLS. 100, 101 AND 107).

FIRST USE 3-1-2003; IN COMMERCE 3-1-2003.

THE MARK CONSISTS OF STANDARD CHAR-  
ACTERS WITHOUT CLAIM TO ANY PARTICULAR  
FONT, STYLE, SIZE, OR COLOR.

OWNER OF U.S. REG. NOS. 514,285, 735,064, AND  
OTHERS.

SN 78-844,630, FILED 3-23-2006.

CHARLOTTE CORWIN, EXAMINING ATTORNEY

**Int. Cl.: 20**

**Prior U.S. Cls.: 2, 13, 22, 25, 32, and 50**

**Reg. No. 3,396,255**

**United States Patent and Trademark Office**

**Registered Mar. 11, 2008**

---

**TRADEMARK  
PRINCIPAL REGISTER**

**Peteriors**

MUNSON, PAULA L (UNITED STATES INDIVIDUAL)  
8632 9TH AVE SW  
SEATTLE, WA 98106

FOR: BEDS FOR HOUSEHOLD PETS, IN CLASS  
20 (U.S. CLS. 2, 13, 22, 25, 32 AND 50).

FIRST USE 9-1-2006; IN COMMERCE 11-1-2006.

THE MARK CONSISTS OF STANDARD CHARACTERS WITHOUT CLAIM TO ANY PARTICULAR FONT, STYLE, SIZE, OR COLOR.

SN 78-846,994, FILED 3-27-2006.

CHRISTOPHER BUONGIORNO, EXAMINING ATTORNEY



**Int. Cl.: 5**

**Prior U.S. Cls.: 6, 18, 44, 46, 51, and 52**

**Reg. No. 3,396,256**

**United States Patent and Trademark Office**

**Registered Mar. 11, 2008**

---

**TRADEMARK  
PRINCIPAL REGISTER**

**OXYGEN BRIDGE**

BIOPURE CORPORATION (DELAWARE CORPORATION)  
11 HURLEY STREET  
CAMBRIDGE, MA 02141

FOR: OXYGEN CARRYING AND OXYGEN DELIVERY FLUIDS FOR VETERINARY USE; BLOOD SUBSTITUTES FOR VETERINARY USE, IN CLASS 5 (U.S. CLS. 6, 18, 44, 46, 51 AND 52).

FIRST USE 12-12-2007; IN COMMERCE 12-12-2007.

THE MARK CONSISTS OF STANDARD CHARACTERS WITHOUT CLAIM TO ANY PARTICULAR FONT, STYLE, SIZE, OR COLOR.

NO CLAIM IS MADE TO THE EXCLUSIVE RIGHT TO USE OXYGEN, APART FROM THE MARK AS SHOWN.

SN 78-847,457, FILED 3-28-2006.

KEVON CHISOLM, EXAMINING ATTORNEY

**Int. Cl.: 41**

**Prior U.S. Cls.: 100, 101, and 107**

**United States Patent and Trademark Office**

**Reg. No. 3,396,257**

**Registered Mar. 11, 2008**

**SERVICE MARK  
PRINCIPAL REGISTER**

**STYLE STAGE NYC**

CAPSTAR RADIO OPERATING COMPANY (DE-  
LAWARE CORPORATION)  
200 EAST BASSE ROAD  
SAN ANTONIO, TX 78209

FOR: ENTERTAINMENT SERVICES IN THE  
NATURE OF NON-TELEVISED LIVE MUSICAL  
PERFORMANCES AND FASHION SHOWS, IN  
CLASS 41 (U.S. CLS. 100, 101 AND 107).

FIRST USE 4-7-2006; IN COMMERCE 4-7-2006.

THE MARK CONSISTS OF STANDARD CHAR-  
ACTERS WITHOUT CLAIM TO ANY PARTICULAR  
FONT, STYLE, SIZE, OR COLOR.

NO CLAIM IS MADE TO THE EXCLUSIVE  
RIGHT TO USE "NYC", APART FROM THE MARK  
AS SHOWN.

SN 78-847,520, FILED 3-28-2006.

PAULA MAHONEY, EXAMINING ATTORNEY

**Int. Cls.: 9 and 35**

**Prior U.S. Cls.: 21, 23, 26, 36, 38, 100, 101, and 102**

**United States Patent and Trademark Office**

**Reg. No. 3,396,258**

**Registered Mar. 11, 2008**

**TRADEMARK  
SERVICE MARK  
PRINCIPAL REGISTER**

# TARGETSPOT

TARGETSPOT, INC. (DELAWARE CORPORATION)  
242 WEST 36TH STREET, 3RD FLOOR  
NEW YORK, NY 10018

FOR: COMPUTER SOFTWARE USED FOR ADVERTISING AND ADVERTISEMENT SERVICES, NAMELY, THE CREATION, PLACING AND MANAGEMENT OF ON-LINE ADVERTISEMENTS, ADVERTISING CAMPAIGNS, AND ADVERTISING ACCOUNTS; COMPUTER SOFTWARE USED FOR THE CREATION AND MANAGEMENT OF AUCTIONS AND BIDDING SYSTEMS IN THE FIELD OF ADVERTISING AND ADVERTISING PLACEMENT; DATABASE MANAGEMENT SOFTWARE IN THE FIELD OF ADVERTISING, IN CLASS 9 (U.S. CLS. 21, 23, 26, 36 AND 38).

FIRST USE 2-0-2006; IN COMMERCE 2-0-2006.

FOR: AUCTION MANAGEMENT SERVICES PROVIDED TO OTHERS AND ACCESSED THROUGH A GLOBAL COMPUTER NETWORK; ORGANIZING, ARRANGING AND CONDUCTING INTERNET AUCTION SALES IN THE FIELD OF

INTERNET RADIO ADVERTISING; PROVIDING A WEB SITE WHEREBY ADVERTISERS IDENTIFY AND BID ON MULTIPLE ADVERTISING OPPORTUNITIES; ON-LINE TRADING SERVICES IN WHICH SELLER POSTS ADVERTISEMENT OPPORTUNITIES TO BE AUCTIONED AND BIDDING IS DONE VIA THE INTERNET; ADVERTISING AND BUSINESS SERVICES, NAMELY, SECURING AIR-TIME ON INTERNET RADIO COMMUNICATIONS STATIONS, SYSTEMS, NETWORKS, AND SERVICES FOR THE PURPOSE OF PROMOTING THE GOODS AND SERVICES OF OTHERS, IN CLASS 35 (U.S. CLS. 100, 101 AND 102).

FIRST USE 2-0-2006; IN COMMERCE 2-0-2006.

THE MARK CONSISTS OF STANDARD CHARACTERS WITHOUT CLAIM TO ANY PARTICULAR FONT, STYLE, SIZE, OR COLOR.

SN 78-847,615, FILED 3-28-2006.

JASON TURNER, EXAMINING ATTORNEY

**Int. Cl.: 5**

**Prior U.S. Cls.: 6, 18, 44, 46, 51, and 52**

**United States Patent and Trademark Office**

**Reg. No. 3,396,259**

**Registered Mar. 11, 2008**

**TRADEMARK  
PRINCIPAL REGISTER**

**DELICATE PETALS**

S. C. JOHNSON & SON, INC. (WISCONSIN CORPORATION)  
1525 HOWE STREET  
RACINE, WI 53403

THE MARK CONSISTS OF STANDARD CHARACTERS WITHOUT CLAIM TO ANY PARTICULAR FONT, STYLE, SIZE, OR COLOR.

FOR: AIR FRESHENERS, IN CLASS 5 (U.S. CLS. 6, 18, 44, 46, 51 AND 52).

SN 78-849,057, FILED 3-29-2006.

FIRST USE 2-20-2007; IN COMMERCE 2-20-2007.

GIANCARLO CASTRO, EXAMINING ATTORNEY

**Int. Cl.: 35**

**Prior U.S. Cls.: 100, 101, and 102**

**United States Patent and Trademark Office**

**Reg. No. 3,396,260**

**Registered Mar. 11, 2008**

**SERVICE MARK  
PRINCIPAL REGISTER**

**AETNA PHARMACY NETWORK  
ACCESS**

AETNA INC. (PENNSYLVANIA CORPORATION)  
980 JOLLY ROAD  
BLUE BELL, PA 19422

OWNER OF U.S. REG. NOS. 822,577, 1,939,424,  
AND OTHERS.

FOR: PROMOTING THE GOODS AND SERVICES  
OF OTHERS THROUGH THE DISTRIBUTION OF  
DISCOUNT CARDS, IN CLASS 35 (U.S. CLS. 100, 101  
AND 102).

NO CLAIM IS MADE TO THE EXCLUSIVE  
RIGHT TO USE "PHARMACY NETWORK", APART  
FROM THE MARK AS SHOWN.

FIRST USE 12-31-2005; IN COMMERCE 12-31-2005.

SN 78-850,268, FILED 3-30-2006.

THE MARK CONSISTS OF STANDARD CHAR-  
ACTERS WITHOUT CLAIM TO ANY PARTICULAR  
FONT, STYLE, SIZE, OR COLOR.

JOHN HWANG, EXAMINING ATTORNEY

**Int. Cl.: 11**

**Prior U.S. Cls.: 13, 21, 23, 31, and 34**

**United States Patent and Trademark Office**

**Reg. No. 3,396,261**

**Registered Mar. 11, 2008**

**TRADEMARK  
PRINCIPAL REGISTER**

**CORRINE**

MOEN INCORPORATED (DELAWARE CORPORATION)  
25300 AL MOEN DRIVE  
NORTH OLMSTED, OH 440708022

THE MARK CONSISTS OF STANDARD CHARACTERS WITHOUT CLAIM TO ANY PARTICULAR FONT, STYLE, SIZE, OR COLOR.

FOR: FAUCETS, NAMELY, KITCHEN FAUCET AND FAUCET HANDLES; AND PLUMBING ACCESSORIES, NAMELY, KITCHEN SINK SPRAYERS, IN CLASS 11 (U.S. CLS. 13, 21, 23, 31 AND 34).

SN 78-850,313, FILED 3-30-2006.

FIRST USE 10-31-2006; IN COMMERCE 10-31-2006.

LINDA ORNDORFF, EXAMINING ATTORNEY

**Int. Cl.: 25**

**Prior U.S. Cls.: 22 and 39**

**United States Patent and Trademark Office**

**Reg. No. 3,396,262**

**Registered Mar. 11, 2008**

**TRADEMARK  
PRINCIPAL REGISTER**

**MaxGrip**

ALPHA PRO TECH, INC. (OKLAHOMA CORPORATION)  
1287 WEST FAIRWAY DRIVE  
NOGALES, AZ 85621

THE MARK CONSISTS OF STANDARD CHARACTERS WITHOUT CLAIM TO ANY PARTICULAR FONT, STYLE, SIZE, OR COLOR.

FOR: DISPOSABLE CLOTHING, NAMELY, SHOE COVERS AND BOOT COVERS FOR USE IN THE INDUSTRIAL SAFETY MARKET, IN CLASS 25 (U.S. CLS. 22 AND 39).

SN 78-850,320, FILED 3-30-2006.

FIRST USE 10-16-2006; IN COMMERCE 2-1-2007.

JENNIFER VASQUEZ, EXAMINING ATTORNEY

**Int. Cl.: 28**

**Prior U.S. Cls.: 22, 23, 38, and 50**

**United States Patent and Trademark Office**

**Reg. No. 3,396,263**

**Registered Mar. 11, 2008**

**TRADEMARK  
PRINCIPAL REGISTER**

**WILD WATER**

MATTEL, INC. (DELAWARE CORPORATION)  
M1-1518  
333 CONTINENTAL BLVD.  
EL SEGUNDO, CA 902455012

FOR: TOYS, GAMES AND PLAYTHINGS, NAME-  
LY, TOY VEHICLES AND ACCESSORIES THERE-  
FOR, IN CLASS 28 (U.S. CLS. 22, 23, 38 AND 50).

FIRST USE 5-18-2007; IN COMMERCE 5-18-2007.

THE MARK CONSISTS OF STANDARD CHAR-  
ACTERS WITHOUT CLAIM TO ANY PARTICULAR  
FONT, STYLE, SIZE, OR COLOR.

OWNER OF U.S. REG. NO. 2,968,379.

SN 78-851,507, FILED 3-31-2006.

CARRIE GENOVESE, EXAMINING ATTORNEY



**Int. Cl.: 45**

**Prior U.S. Cls.: 100 and 101**

**United States Patent and Trademark Office**

**Reg. No. 3,396,264**

**Registered Mar. 11, 2008**

**SERVICE MARK  
PRINCIPAL REGISTER**

**RETURN2YOU**

ROI SOLUTIONS, LLC (TEXAS LTD LIAB CO)  
1205 S. WHITE CHAPEL BLVD.  
SUITE 100  
SOUTHLAKE, TX 760929333

FOR: LOST AND FOUND LOCATOR SERVICES FOR PERSONAL AND CORPORATE ITEMS VIA A GLOBAL INTERNET-BASED PRODUCT REGISTRY DATABASE, NAMELY, ASSISTING OTHERS IN RECOVERING LOST ITEMS BY PROVIDING A SUBSCRIBER-BASED REGISTRY SERVICE, OFFERING INCENTIVES FOR THE RETURN OF ITEMS LOST BY THE SUBSCRIBERS AND COOR-

DINATING THE RETURN OF LOST ITEMS TO THE SUBSCRIBERS, IN CLASS 45 (U.S. CLS. 100 AND 101).

FIRST USE 5-1-2006; IN COMMERCE 5-1-2006.

THE MARK CONSISTS OF STANDARD CHARACTERS WITHOUT CLAIM TO ANY PARTICULAR FONT, STYLE, SIZE, OR COLOR.

SN 78-851,759, FILED 3-31-2006.

DOMINIC J. FERRAIUOLO, EXAMINING ATTORNEY

**Int. Cl.: 45**

**Prior U.S. Cls.: 100 and 101**

**United States Patent and Trademark Office**

**Reg. No. 3,396,265**

**Registered Mar. 11, 2008**

**SERVICE MARK  
PRINCIPAL REGISTER**



ROI SOLUTIONS, LLC (TEXAS LTD LIAB CO)  
1205 S. WHITE CHAPEL BLVD.  
SUITE 100  
SOUTHLAKE, TX 760929333

FOR: LOST AND FOUND LOCATOR SERVICES  
FOR PERSONAL AND CORPORATE ITEMS VIA A  
GLOBAL INTERNET-BASED PRODUCT REGISTRY  
DATABASE, NAMELY, ASSISTING OTHERS IN  
RECOVERING LOST ITEMS BY PROVIDING A  
SUBSCRIBER-BASED REGISTRY SERVICE, OF-

FERING INCENTIVES FOR THE RETURN OF  
ITEMS LOST BY THE SUBSCRIBERS AND COOR-  
DINATING THE RETURN OF LOST ITEMS TO THE  
SUBSCRIBERS, IN CLASS 45 (U.S. CLS. 100 AND 101).

FIRST USE 5-1-2006; IN COMMERCE 5-1-2006.

SN 78-851,776, FILED 3-31-2006.

DOMINIC J. FERRAIUOLO, EXAMINING ATTOR-  
NEY

**Int. Cl.: 14**

**Prior U.S. Cls.: 2, 27, 28, and 50**

**United States Patent and Trademark Office**

**Reg. No. 3,396,266**

**Registered Mar. 11, 2008**

**TRADEMARK  
PRINCIPAL REGISTER**

# Arctos Elite

HALLE, DOROTHEA, ANNA (FED REP GERMA-  
NY INDIVIDUAL)  
FELDSTRASSE 10  
AARBERGEN, FED REP GERMANY 65326

FOR: CASES FOR WATCHES AND CLOCKS;  
MECHANICAL AND AUTOMATIC WATCHES;  
WATCH PARTS, IN CLASS 14 (U.S. CLS. 2, 27, 28  
AND 50).

FIRST USE 12-0-2006; IN COMMERCE 12-0-2006.

THE MARK CONSISTS OF STANDARD CHAR-  
ACTERS WITHOUT CLAIM TO ANY PARTICULAR  
FONT, STYLE, SIZE, OR COLOR.

NO CLAIM IS MADE TO THE EXCLUSIVE  
RIGHT TO USE "ELITE", APART FROM THE  
MARK AS SHOWN.

SN 78-851,854, FILED 3-31-2006.

BARBARA A. GOLD, EXAMINING ATTORNEY

**Int. Cl.: 10**

**Prior U.S. Cls.: 26, 39, and 44**

**United States Patent and Trademark Office**

**Reg. No. 3,396,267**

**Registered Mar. 11, 2008**

**TRADEMARK  
PRINCIPAL REGISTER**

**ADVANCED CUSTOMVUE**

VISX, INCORPORATED (DELAWARE CORPORATION)  
3400 CENTRAL EXPRESSWAY  
SANTA CLARA, CA 95051

FOR: MEDICAL DEVICES, NAMELY, OPHTHALMOLOGICAL SURGERY SYSTEMS COMPRISED PRIMARILY OF A LASER SOURCE FOR ABLATION OF THE EYE, AN OPTICAL SENSING DEVICE FOR TAKING MEASUREMENTS AND REFRACTIVE DIAGNOSIS, AND PARTS AND ACCESSORIES THEREFOR INCLUDING INSTRUCTIONAL MANUAL, SOFTWARE AND DATA SHEETS ALL SOLD AS A UNIT, IN CLASS 10 (U.S. CLS. 26, 39 AND 44).

FIRST USE 10-31-2006; IN COMMERCE 10-31-2006.

THE MARK CONSISTS OF STANDARD CHARACTERS WITHOUT CLAIM TO ANY PARTICULAR FONT, STYLE, SIZE, OR COLOR.

OWNER OF U.S. REG. NOS. 2,897,343 AND 2,898,243.

SN 78-851,881, FILED 3-31-2006.

BERYL GARDNER, EXAMINING ATTORNEY

**Int. Cl.: 32**

**Prior U.S. Cls.: 45, 46, and 48**

**United States Patent and Trademark Office**

**Reg. No. 3,396,268**

**Registered Mar. 11, 2008**

**TRADEMARK  
PRINCIPAL REGISTER**

**HEALTH IN EVERY DROP**

NUTRIGEN INTERNATIONAL, INC. (NEW  
YORK CORPORATION)  
76 SCOTT AVENUE  
STATEN ISLAND, NY 10305

THE MARK CONSISTS OF STANDARD CHAR-  
ACTERS WITHOUT CLAIM TO ANY PARTICULAR  
FONT, STYLE, SIZE, OR COLOR.

FOR: ENERGY DRINKS; FRUIT DRINKS; FRUIT  
JUICES; FRUIT-FLAVORED DRINKS; HERBAL JUI-  
CES; SPORTS DRINKS, IN CLASS 32 (U.S. CLS. 45, 46  
AND 48).

SN 78-852,112, FILED 4-2-2006.

FIRST USE 11-17-2007; IN COMMERCE 11-17-2007.

JAY BESCH, EXAMINING ATTORNEY

**Int. Cl.: 29**

**Prior U.S. Cl.: 46**

**United States Patent and Trademark Office**

**Reg. No. 3,396,269**

**Registered Mar. 11, 2008**

**TRADEMARK  
PRINCIPAL REGISTER**

**HEALTH IN EVERY SPOON**

NUTRIGENE INTERNATIONAL, INC. (NEW  
YORK CORPORATION)  
76 SCOTT AVENUE  
STATEN ISLAND, NY 10305

THE MARK CONSISTS OF STANDARD CHAR-  
ACTERS WITHOUT CLAIM TO ANY PARTICULAR  
FONT, STYLE, SIZE, OR COLOR.

FOR: DRINKING YOGURTS; YOGURT; YO-  
GURT-BASED BEVERAGES, IN CLASS 29 (U.S. CL.  
46).

SN 78-852,115, FILED 4-2-2006.

FIRST USE 11-17-2007; IN COMMERCE 11-17-2007.

JAY BESCH, EXAMINING ATTORNEY

**Int. Cl.: 41**

**Prior U.S. Cls.: 100, 101, and 107**

**United States Patent and Trademark Office**

**Reg. No. 3,396,270**

**Registered Mar. 11, 2008**

**SERVICE MARK  
PRINCIPAL REGISTER**

**A STEP FURTHER**

WATSON, DESIREE (UNITED STATES INDIVIDUAL)  
14 SOUTH ORANGE AVENUE, SUITE 1R  
SOUTH ORANGE, NJ 07079

FOR: EDUCATION SERVICES, NAMELY, PROVIDING CLASSES, WORKSHOPS AND SEMINARS IN THE FIELD OF INTEGRATED HEALTH CARE OPTIONS, IN CLASS 41 (U.S. CLS. 100, 101 AND 107).

FIRST USE 9-17-2007; IN COMMERCE 9-17-2007.

THE MARK CONSISTS OF STANDARD CHARACTERS WITHOUT CLAIM TO ANY PARTICULAR FONT, STYLE, SIZE, OR COLOR.

SN 78-852,425, FILED 4-3-2006.

INGA ERVIN, EXAMINING ATTORNEY

**Int. Cl.: 27**

**Prior U.S. Cls.: 19, 20, 37, 42, and 50**

**United States Patent and Trademark Office**

**Reg. No. 3,396,271**

**Registered Mar. 11, 2008**

**TRADEMARK  
PRINCIPAL REGISTER**

**CREATE-A-SCENE**

HOFFMASTER GROUP, INC. (DELAWARE CORPORATION)  
2920 N. MAIN STREET  
OSHKOSH, WI 54903

THE MARK CONSISTS OF STANDARD CHARACTERS WITHOUT CLAIM TO ANY PARTICULAR FONT, STYLE, SIZE, OR COLOR.

FOR: DECORATIVE PLASTIC SHEETS AND SHEETING IN THE NATURE OF ROLLS FOR USE AS WALL COVERINGS, IN CLASS 27 (U.S. CLS. 19, 20, 37, 42 AND 50).

SN 78-853,124, FILED 4-4-2006.

FIRST USE 8-0-2006; IN COMMERCE 8-0-2006.

SARA THOMAS, EXAMINING ATTORNEY



**Int. Cl.: 9**

**Prior U.S. Cls.: 21, 23, 26, 36, and 38**

**United States Patent and Trademark Office**

**Reg. No. 3,396,272**

**Registered Mar. 11, 2008**

**TRADEMARK  
PRINCIPAL REGISTER**

yap

YAP INC. (DELAWARE CORPORATION)  
1410 WEST MOREHEAD STREET  
SUITE 100  
CHARLOTTE, NC 28208

FOR: SOFTWARE TO ALLOW VOICE AND VISUAL ENABLED TEXT, CHAT, INSTANT AND EMAIL MESSAGING, CALENDARING AND SEARCH QUERIES ON AN INTERNET READY DEVICE SUCH AS A MOBILE PHONE, NOTEBOOK OR DESKTOP COMPUTER OR HOME ENTERTAIN-

MENT CONSOLE, IN CLASS 9 (U.S. CLS. 21, 23, 26, 36 AND 38).

FIRST USE 8-23-2007; IN COMMERCE 8-23-2007.

THE MARK CONSISTS OF STANDARD CHARACTERS WITHOUT CLAIM TO ANY PARTICULAR FONT, STYLE, SIZE, OR COLOR.

SN 78-854,023, FILED 4-4-2006.

SHARON MEIER, EXAMINING ATTORNEY

Int. Cl.: 41

Prior U.S. Cls.: 100, 101, and 107

United States Patent and Trademark Office

Reg. No. 3,396,273

Registered Mar. 11, 2008

SERVICE MARK  
PRINCIPAL REGISTER



HOOPS L.P. (DELAWARE LIMITED PARTNER-  
SHIP)  
175 TOYOTA PLAZA, SUITE 150  
MEMPHIS, TN 38103

FOR: ENTERTAINMENT AND EDUCATIONAL SERVICES IN THE NATURE OF ONGOING TELEVISION AND RADIO PROGRAMS IN THE FIELD OF BASKETBALL AND RENDERING LIVE BASKETBALL GAMES AND BASKETBALL EXHIBITIONS; THE PRODUCTION AND DISTRIBUTION OF RADIO AND TELEVISION BROADCASTS OF BASKETBALL GAMES, BASKETBALL EVENTS AND PROGRAMS IN THE FIELD OF BASKETBALL; CONDUCTING AND ARRANGING BASKETBALL CLINICS AND CAMPS, COACHES CLINICS AND CAMPS, DANCE TEAM CLINICS AND CAMPS AND BASKETBALL EVENTS; ENTERTAINMENT SERVICES IN THE NATURE OF PERSONAL APPEARANCES BY A COSTUMED MASCOT AND/OR DANCE TEAM AT BASKETBALL GAMES AND EXHIBITIONS, CLINICS, CAMPS, PROMOTIONS, AND OTHER BASKETBALL-RELATED EVENTS, SPECIAL EVENTS AND PARTIES; FAN CLUB SERVICES; ENTERTAINMENT SERVICES, NAMELY PROVIDING A WEBSITE FEATURING THE FOLLOWING CONTENT: TELEVISION HIGHLIGHTS, INTERACTIVE TELEVISION HIGHLIGHTS, VIDEO RECORDINGS, VIDEO STREAM RECORDINGS,

INTERACTIVE VIDEO HIGHLIGHT SELECTIONS, RADIO PROGRAMS, RADIO HIGHLIGHTS, AND AUDIO RECORDINGS IN THE FIELD OF BASKETBALL, BASKETBALL NEWS IN THE NATURE OF INFORMATION, STATISTICS, AND TRIVIA ABOUT BASKETBALL, ON-LINE COMPUTER GAMES, VIDEO GAMES, INTERACTIVE VIDEO GAMES, ACTION SKILL GAMES, ARCADE GAMES, ADULTS' AND CHILDREN'S PARTY GAMES, BOARD GAMES, PUZZLES, AND TRIVIA GAMES, PROVIDING ON-LINE MAGAZINES, GUIDES, NEWSLETTERS, COLORING BOOKS, GAME SCHEDULES OVER THE INTERNET, PROVIDING AN ONLINE COMPUTER DATABASE IN THE FIELD OF BASKETBALL, IN CLASS 41 (U.S. CLS. 100, 101 AND 107).

FIRST USE 11-1-2005; IN COMMERCE 10-1-2005.

OWNER OF U.S. REG. NOS. 2,861,210, 3,056,500, AND OTHERS.

NO CLAIM IS MADE TO THE EXCLUSIVE RIGHT TO USE "MEMPHIS", APART FROM THE MARK AS SHOWN.

SN 78-854,395, FILED 4-5-2006.

KATHRYN COWARD, EXAMINING ATTORNEY

**Int. Cl.: 17**

**Prior U.S. Cls.: 1, 5, 12, 13, 35, and 50**

**Reg. No. 3,396,274**

**United States Patent and Trademark Office**

**Registered Mar. 11, 2008**

---

**TRADEMARK  
PRINCIPAL REGISTER**

**PRO-FLAT**

ROBERTS IRRIGATION PRODUCTS, INC. (CALIFORNIA CORPORATION)  
700 RANCHEROS DRIVE  
SAN MARCOS, CA 92069

THE MARK CONSISTS OF STANDARD CHARACTERS WITHOUT CLAIM TO ANY PARTICULAR FONT, STYLE, SIZE, OR COLOR.

FOR: IRRIGATION HOSES, IN CLASS 17 (U.S. CLS. 1, 5, 12, 13, 35 AND 50).

SN 78-854,587, FILED 4-5-2006.

FIRST USE 9-17-2004; IN COMMERCE 9-17-2004.

MARGARET POWER, EXAMINING ATTORNEY

**Int. Cl.: 39**

**Prior U.S. Cls.: 100 and 105**

**United States Patent and Trademark Office**

**Reg. No. 3,396,275**

**Registered Mar. 11, 2008**

**SERVICE MARK  
PRINCIPAL REGISTER**



GONZALEZ TRUCKING SA DE CV (MEXICO CORPORATION)  
AV. DE LA CONVENCION NORTE 312  
AGUASCALIENTES, MEXICO 20140

FOR: TRANSPORT OF GOODS; TRANSPORTATION OF FURNITURE OF OTHERS BY TRUCKS; TRUCK TRANSPORT, IN CLASS 39 (U.S. CLS. 100 AND 105).

FIRST USE 10-26-2006; IN COMMERCE 10-26-2006.

NO CLAIM IS MADE TO THE EXCLUSIVE RIGHT TO USE "TRUCKING", APART FROM THE MARK AS SHOWN.

THE COLOR(S) WHITE, BLUE, NAVY BLUE, AND RED IS/ARE CLAIMED AS A FEATURE OF THE MARK.

THE COLOR WHITE APPEARS INSIDE THE WHEELS AND THE WINDOWS OF THE TRUCK. THE COLOR NAVY BLUE APPEARS AS THE OUTLINE OF THE CAB, THE WINDOWS AND THE WHEELS OF THE TRUCK AND IN THE TERM "TRUCKING". THE COLOR BLUE APPEARS ON THE CAB OF THE TRUCK. THE COLOR RED APPEARS IN THE TERM "GONZALEZ" AND ON THE TRUCK BED BENEATH THIS TERM.

SN 78-854,951, FILED 4-5-2006.

MICHAEL WIENER, EXAMINING ATTORNEY

**Int. Cl.: 41**

**Prior U.S. Cls.: 100, 101, and 107**

**United States Patent and Trademark Office**

**Reg. No. 3,396,276**

**Registered Mar. 11, 2008**

**SERVICE MARK  
PRINCIPAL REGISTER**

**DIAMONDJACKS CASINO**

LEGENDS GAMING, LLC (DELAWARE LTD  
LIAB CO)

160 S. LA GRANGE ROAD

FRANKFORT, IL 60423

FOR: CASINOS, IN CLASS 41 (U.S. CLS. 100, 101  
AND 107).

FIRST USE 7-0-2006; IN COMMERCE 7-0-2006.

THE MARK CONSISTS OF STANDARD CHAR-  
ACTERS WITHOUT CLAIM TO ANY PARTICULAR  
FONT, STYLE, SIZE, OR COLOR.

NO CLAIM IS MADE TO THE EXCLUSIVE  
RIGHT TO USE "CASINO", APART FROM THE  
MARK AS SHOWN.

SN 78-855,973, FILED 4-6-2006.

LA TONIA FISHER, EXAMINING ATTORNEY

**Int. Cl.: 6**

**Prior U.S. Cls.: 2, 12, 13, 14, 23, 25, and 50**

**United States Patent and Trademark Office**

**Reg. No. 3,396,277**

**Registered Mar. 11, 2008**

**TRADEMARK  
PRINCIPAL REGISTER**

**BOOM BOOM HUCKJAM**

BBHJ - GENERAL PARTNERSHIP (CALIFORNIA  
PARTNERSHIP)  
1611-A SOUTH MELROSE DR., #362  
VISTA, CA 92081

FOR: METAL KEY CHAINS, IN CLASS 6 (U.S.  
CLS. 2, 12, 13, 14, 23, 25 AND 50).

FIRST USE 10-31-2003; IN COMMERCE 10-31-2003.

THE MARK CONSISTS OF STANDARD CHAR-  
ACTERS WITHOUT CLAIM TO ANY PARTICULAR  
FONT, STYLE, SIZE, OR COLOR.

OWNER OF U.S. REG. NO. 3,083,485.

SN 78-856,212, FILED 4-7-2006.

BONNIE LUKEN, EXAMINING ATTORNEY

**Int. Cls.: 9, 16, and 41**

**Prior U.S. Cls.: 2, 5, 21, 22, 23, 26, 29, 36, 37, 38, 50,  
100, 101, and 107**

**Reg. No. 3,396,278**

**United States Patent and Trademark Office**

**Registered Mar. 11, 2008**

**TRADEMARK  
SERVICE MARK  
PRINCIPAL REGISTER**

**RELIGION COMPASS**

BLACKWELL PUBLISHING INC. (DELAWARE  
CORPORATION)  
350 MAIN STREET  
MALDEN, MA 02148

FOR: ELECTRONIC BOOKS, JOURNALS, IN-  
STRUCTIONAL AND EDUCATIONAL MATERIALS  
IN THE FIELD OF RELIGION; DOWNLOADABLE  
ELECTRONIC PUBLICATIONS, NAMELY, BOOKS,  
JOURNALS, INSTRUCTIONAL AND EDUCATION-  
AL MATERIALS IN THE FIELD OF RELIGION, IN  
CLASS 9 (U.S. CLS. 21, 23, 26, 36 AND 38).

FIRST USE 1-1-2007; IN COMMERCE 1-1-2007.

FOR: BOOKS, PRINTED INSTRUCTIONAL AND  
EDUCATIONAL MATERIALS, AND JOURNALS IN  
THE FIELD OF RELIGION, IN CLASS 16 (U.S. CLS. 2,  
5, 22, 23, 29, 37, 38 AND 50).

FIRST USE 1-1-2007; IN COMMERCE 1-1-2007.

FOR: PUBLICATION OF BOOKS, JOURNALS,  
INSTRUCTIONAL AND EDUCATIONAL MATERI-  
ALS; PUBLICATION OF ELECTRONIC BOOKS,  
JOURNALS, INSTRUCTIONAL AND EDUCATION-  
AL MATERIALS VIA THE INTERNET, IN CLASS 41  
(U.S. CLS. 100, 101 AND 107).

FIRST USE 1-1-2007; IN COMMERCE 1-1-2007.

THE MARK CONSISTS OF STANDARD CHAR-  
ACTERS WITHOUT CLAIM TO ANY PARTICULAR  
FONT, STYLE, SIZE, OR COLOR.

NO CLAIM IS MADE TO THE EXCLUSIVE  
RIGHT TO USE "RELIGION", APART FROM THE  
MARK AS SHOWN.

SN 78-856,335, FILED 4-7-2006.

CAROLYN CATALDO, EXAMINING ATTORNEY

**Int. Cls.: 6 and 19**

**Prior U.S. Cls.: 1, 2, 12, 13, 14, 23, 25, 33, and 50**

**United States Patent and Trademark Office**

**Reg. No. 3,396,279**

**Registered Mar. 11, 2008**

**TRADEMARK  
PRINCIPAL REGISTER**

 **CONSERVAGLASS**

FOUR SEASONS SOLAR PRODUCTS LLC (NEW YORK LTD LIAB CO)  
5005 VETERANS MEMORIAL HIGHWAY  
HOLBROOK, NY 11741

FOR: METAL CONSERVATORIES; METAL GLASSHOUSES; METAL GREENHOUSES; METAL WINDOW FRAMES; METAL DOOR FRAMES; METAL GLAZING BARS; METAL RIDGE BEAMS; METAL EAVES; METAL BEAMS; METAL GUTTERS; DECORATIVE METAL MOLDINGS, CRESTING AND FINIALS; METAL WINDOWS; METAL GLAZED WINDOWS, IN CLASS 6 (U.S. CLS. 2, 12, 13, 14, 23, 25 AND 50).

FIRST USE 10-0-2005; IN COMMERCE 1-0-2006.

FOR: NON-METAL CONSERVATORIES; NON-METAL WINDOW FRAMES; NON-METAL DOOR

FRAMES; NON-METAL GLAZING BARS; NON-METAL RIDGE BEAMS; NON-METAL GUTTERS; DECORATIVE NON-METAL MOLDINGS, CRESTING AND FINIALS; GLASS FOR BUILDINGS; GLAZED GLASS FOR BUILDINGS; GLASS FOR WINDOWS; GLAZED GLASS FOR WINDOWS; GLASS FOR DOORS; GLAZED GLASS FOR DOORS; PLASTIC ROOFING PANELS; TRANSLUCENT PLASTIC ROOFING PANELS, IN CLASS 19 (U.S. CLS. 1, 12, 33 AND 50).

FIRST USE 10-0-2005; IN COMMERCE 1-0-2006.

SN 78-856,589, FILED 4-7-2006.

TANYA AMOS, EXAMINING ATTORNEY



**Int. Cl.: 35**

**Prior U.S. Cls.: 100, 101, and 102**

**United States Patent and Trademark Office**

**Reg. No. 3,396,280**

**Registered Mar. 11, 2008**

---

**SERVICE MARK  
PRINCIPAL REGISTER**

**Habitat for Your Sanity**

CARROLL, ELAIN (UNITED STATES INDIVIDUAL)  
3036 43RD CT. NW  
OLYMPIA, WA 98502

FOR: PROVIDING ORGANIZING SERVICES FOR INDIVIDUALS AT HOME, IN HOME OFFICES AND IN BUSINESS OFFICES, THAT PROVIDES HELP WITH TIME AND PAPER MANAGEMENT, IN CLASS 35 (U.S. CLS. 100, 101 AND 102).

FIRST USE 4-1-2006; IN COMMERCE 4-1-2006.

THE MARK CONSISTS OF STANDARD CHARACTERS WITHOUT CLAIM TO ANY PARTICULAR FONT, STYLE, SIZE, OR COLOR.

SN 78-859,019, FILED 4-11-2006.

MARTHA FROMM, EXAMINING ATTORNEY

**Int. Cl.: 10**

**Prior U.S. Cls.: 26, 39, and 44**

**Reg. No. 3,396,281**

**United States Patent and Trademark Office**

**Registered Mar. 11, 2008**

---

**TRADEMARK  
PRINCIPAL REGISTER**

**MX-1**

MASIMO CORPORATION (DELAWARE CORPORATION)  
40 PARKER  
IRVINE, CA 92618

THE MARK CONSISTS OF STANDARD CHARACTERS WITHOUT CLAIM TO ANY PARTICULAR FONT, STYLE, SIZE, OR COLOR.

FOR: MEDICAL APPARATUS, NAMELY, PATIENT MONITORS, IN CLASS 10 (U.S. CLS. 26, 39 AND 44).

SN 78-859,141, FILED 4-11-2006.

FIRST USE 9-30-2005; IN COMMERCE 9-30-2005.

DANNEAN HETZEL, EXAMINING ATTORNEY

**Int. Cl.: 16**

**Prior U.S. Cls.: 2, 5, 22, 23, 29, 37, 38, and 50**

**Reg. No. 3,396,282**

**United States Patent and Trademark Office**

**Registered Mar. 11, 2008**

**TRADEMARK  
PRINCIPAL REGISTER**

**AFTER THE BELL**

SCHOLASTIC INC. (NEW YORK CORPORATION)  
557 BROADWAY  
NEW YORK, NY 10012

FOR: PRINTED EDUCATIONAL MATERIALS FOR THE IMPROVEMENT OF READING, FLUENCY, WRITING, VOCABULARY, COMPREHENSION AND TEST SKILLS, STUDENT WORKBOOKS, READING SKILLS CARDS, FLUENCY CARDS, TEACHING GUIDES, CHILDREN'S BOOKS ON A VARIETY OF SUBJECTS, AND POSTERS, ALL SOLD AS A UNIT, IN CLASS 16 (U.S. CLS. 2, 5, 22, 23, 29, 37, 38 AND 50).

FIRST USE 8-1-2006; IN COMMERCE 8-1-2006.

THE MARK CONSISTS OF STANDARD CHARACTERS WITHOUT CLAIM TO ANY PARTICULAR FONT, STYLE, SIZE, OR COLOR.

OWNER OF U.S. REG. NO. 3,056,854.

SN 78-859,579, FILED 4-12-2006.

GINA FINK, EXAMINING ATTORNEY

Int. Cl.: 16

Prior U.S. Cls.: 2, 5, 22, 23, 29, 37, 38, and 50

United States Patent and Trademark Office

Reg. No. 3,396,283

Registered Mar. 11, 2008

TRADEMARK  
PRINCIPAL REGISTER

*After the Bell*

SCHOLASTIC INC. (NEW YORK CORPORATION)  
557 BROADWAY  
NEW YORK, NY 10012

FOR: PRINTED EDUCATIONAL MATERIALS FOR THE IMPROVEMENT OF READING, FLUENCY, WRITING, VOCABULARY, COMPREHENSION AND TEST SKILLS, STUDENT WORKBOOKS, READING SKILLS CARDS, FLUENCY CARDS, TEACHING GUIDES, CHILDREN'S BOOKS ON A VARIETY OF SUBJECTS, AND POSTERS, ALL

SOLD AS A UNIT, IN CLASS 16 (U.S. CLS. 2, 5, 22, 23, 29, 37, 38 AND 50).

FIRST USE 8-1-2006; IN COMMERCE 8-1-2006.

OWNER OF U.S. REG. NO. 3,056,854.

SN 78-859,587, FILED 4-12-2006.

GINA FINK, EXAMINING ATTORNEY

Int. Cl.: 33

Prior U.S. Cls.: 47 and 49

United States Patent and Trademark Office

Reg. No. 3,396,284

Registered Mar. 11, 2008

TRADEMARK  
PRINCIPAL REGISTER

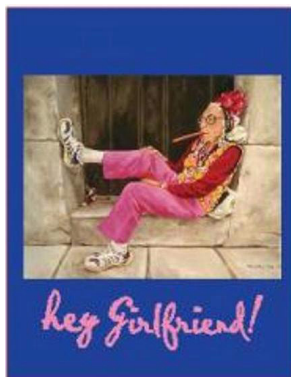

CARIBBEAN CONNECTION, INC. (NEVADA CORPORATION)  
34225 RANCHO CALIFORNIA. RD  
TEMECULA, CA 92591

FOR: GRAPE WINE, IN CLASS 33 (U.S. CLS. 47 AND 49).

FIRST USE 8-1-2006; IN COMMERCE 8-1-2006.

THE COLOR(S) WHITE, TAN, BROWN, BLACK, RED, ORANGE, YELLOW AND BLUE IS/ARE CLAIMED AS A FEATURE OF THE MARK.

THE MARK CONSISTS OF THE DRAWING OF AN OLD WOMAN SITTING IN A DOOR STOOP WITH THE WORDS "HEY GIRLFRIEND!" UNDERNEATH. THE COLORS TAN AND BROWN APPEAR IN THE STEPS, GROUND, AND WOODEN DOOR IN

THE BACKGROUND; THE COLOR BROWN APPEARS ON THE CIGAR AND THE RIM OF THE WOMAN'S EYGLASSES; THE COLOR WHITE APPEARS IN THE WOMAN'S SNEAKERS, SOCKS AND HAIR; THE COLOR PINK APPEARS IN THE WOMAN'S PANTS AND IN THE STYLIZED LETTERS AND EXCLAMATION POINT OF THE WORDS "HEY GIRLFRIEND"; THE COLOR RED APPEARS IN THE WOMAN'S SHIRT AND HAT; THE COLORS ORANGE AND YELLOW APPEAR IN THE WOMAN'S VEST; THE COLOR BLACK APPEARS AS STRIPES AND LINES IN THE WOMAN'S SNEAKERS; THE COLOR BLUE APPEARS IN THE RECTANGULAR BORDER SURROUNDING THE DRAWING OF THE WOMAN.

SN 78-861,218, FILED 4-13-2006.

CARYN GLASSER, EXAMINING ATTORNEY

**Int. Cl.: 10**

**Prior U.S. Cls.: 26, 39, and 44**

**United States Patent and Trademark Office**

**Reg. No. 3,396,285**

**Registered Mar. 11, 2008**

**TRADEMARK  
PRINCIPAL REGISTER**

**ARE YOU GELLIN'?**

SCHERING-PLOUGH HEALTHCARE PRO-  
DUCTS, INC. (DELAWARE CORPORATION)  
3030 JACKSON AVENUE  
MEMPHIS, TN 38151

THE MARK CONSISTS OF STANDARD CHAR-  
ACTERS WITHOUT CLAIM TO ANY PARTICULAR  
FONT, STYLE, SIZE, OR COLOR.

FOR: ELECTRIC AND BATTERY POWERED  
BODY MASSAGERS, IN CLASS 10 (U.S. CLS. 26, 39  
AND 44).

SN 78-861,550, FILED 4-14-2006.

FIRST USE 8-31-2005; IN COMMERCE 8-31-2005.

BERYL GARDNER, EXAMINING ATTORNEY

**Int. Cl.: 16**

**Prior U.S. Cls.: 2, 5, 22, 23, 29, 37, 38, and 50**

**United States Patent and Trademark Office**

**Reg. No. 3,396,286**

**Registered Mar. 11, 2008**

**TRADEMARK  
PRINCIPAL REGISTER**

**CALBUM**

INNOVATIVE ALLIANCE, INC. (TEXAS CORPORATION)  
6511 BARFIELD AVENUE  
DALLAS, TX 75252

THE MARK CONSISTS OF STANDARD CHARACTERS WITHOUT CLAIM TO ANY PARTICULAR FONT, STYLE, SIZE, OR COLOR.

FOR: CALENDARS, IN CLASS 16 (U.S. CLS. 2, 5, 22, 23, 29, 37, 38 AND 50).

SN 78-861,757, FILED 4-14-2006.

FIRST USE 9-0-2007; IN COMMERCE 9-0-2007.

TIMOTHY FINNEGAN, EXAMINING ATTORNEY

**Int. Cl.: 9**

**Prior U.S. Cls.: 21, 23, 26, 36, and 38**

**United States Patent and Trademark Office**

**Reg. No. 3,396,287**

**Registered Mar. 11, 2008**

**TRADEMARK  
PRINCIPAL REGISTER**

# TouchMate

ELLSWORTH, DAVID (AUSTRALIA INDIVIDUAL)  
1191 HIGHLAND VIEW  
LEXINGTON, TX 78947

THE MARK CONSISTS OF STANDARD CHARACTERS WITHOUT CLAIM TO ANY PARTICULAR FONT, STYLE, SIZE, OR COLOR.

FOR: COMPUTER-BASED INTERACTIVE KIOSKS FOR A WIDE VARIETY OF USES, IN CLASS 9 (U.S. CLS. 21, 23, 26, 36 AND 38).

SN 78-862,040, FILED 4-14-2006.

FIRST USE 1-1-2003; IN COMMERCE 1-1-2006.

SUSAN STIGLITZ, EXAMINING ATTORNEY



**Int. Cl.: 5**

**Prior U.S. Cls.: 6, 18, 44, 46, 51, and 52**

**Reg. No. 3,396,288**

**United States Patent and Trademark Office**

**Registered Mar. 11, 2008**

---

**TRADEMARK  
PRINCIPAL REGISTER**

**VANILLA & BAKING**

THE PROCTER & GAMBLE COMPANY (OHIO  
CORPORATION)  
ONE PROCTER & GAMBLE PLAZA  
CINCINNATI, OH 45202

FOR: HOUSEHOLD DEODORIZER AND AIR  
FRESHENERS, IN CLASS 5 (U.S. CLS. 6, 18, 44, 46,  
51 AND 52).

FIRST USE 9-30-2006; IN COMMERCE 9-30-2006.

THE MARK CONSISTS OF STANDARD CHAR-  
ACTERS WITHOUT CLAIM TO ANY PARTICULAR  
FONT, STYLE, SIZE, OR COLOR.

NO CLAIM IS MADE TO THE EXCLUSIVE  
RIGHT TO USE "VANILLA", APART FROM THE  
MARK AS SHOWN.

SN 78-864,760, FILED 4-19-2006.

BILL DAWE, EXAMINING ATTORNEY

**Int. Cl.: 31**

**Prior U.S. Cls.: 1 and 46**

**United States Patent and Trademark Office**

**Reg. No. 3,396,289**

**Registered Mar. 11, 2008**

**TRADEMARK  
PRINCIPAL REGISTER**

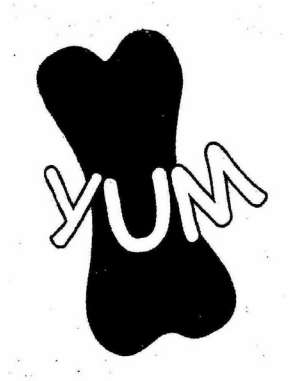

BOWMAN, SHERYL (UNITED STATES INDIVIDUAL)  
7540 PERSHING BLVD.  
KENOSHA, WI 53142

FIRST USE 3-16-2007; IN COMMERCE 3-16-2007.

SN 78-865,616, FILED 4-20-2006.

FOR: FRESH BAKED DOG TREATS, IN CLASS 31  
(U.S. CLS. 1 AND 46).

KIMBERLY FRYE, EXAMINING ATTORNEY

**Int. Cl.: 17**

**Prior U.S. Cls.: 1, 5, 12, 13, 35, and 50**

**United States Patent and Trademark Office**

**Reg. No. 3,396,290**

**Registered Mar. 11, 2008**

**TRADEMARK  
PRINCIPAL REGISTER**

**POLYSEAMSEAL**

HENKEL CORPORATION (DELAWARE CORPORATION)  
2200 RENAISSANCE BLVD.  
GULPH MILLS, PA 19406

FOR: MASKING TAPE, IN CLASS 17 (U.S. CLS. 1, 5, 12, 13, 35 AND 50).

FIRST USE 8-15-2006; IN COMMERCE 8-15-2006.

THE MARK CONSISTS OF STANDARD CHARACTERS WITHOUT CLAIM TO ANY PARTICULAR FONT, STYLE, SIZE, OR COLOR.

OWNER OF U.S. REG. NOS. 677,552 AND 1,872,128.

SN 78-865,880, FILED 4-20-2006.

PAUL F. GAST, EXAMINING ATTORNEY

**Int. Cl.: 3**

**Prior U.S. Cls.: 1, 4, 6, 50, 51, and 52**

**United States Patent and Trademark Office**

**Reg. No. 3,396,291**

**Registered Mar. 11, 2008**

**TRADEMARK  
PRINCIPAL REGISTER**

**TAHITIAN WATERFALL**

THE PROCTER & GAMBLE COMPANY (OHIO  
CORPORATION)  
ONE PROCTER & GAMBLE PLAZA  
CINCINNATI, OH 45202

THE MARK CONSISTS OF STANDARD CHAR-  
ACTERS WITHOUT CLAIM TO ANY PARTICULAR  
FONT, STYLE, SIZE, OR COLOR.

FOR: FABRIC SOFTENERS AND CONDITION-  
ERS, IN CLASS 3 (U.S. CLS. 1, 4, 6, 50, 51 AND 52).

SN 78-866,066, FILED 4-20-2006.

FIRST USE 2-5-2005; IN COMMERCE 2-5-2007.

BILL DAWE, EXAMINING ATTORNEY

**Int. Cl.: 25**

**Prior U.S. Cls.: 22 and 39**

**United States Patent and Trademark Office**

**Reg. No. 3,396,292**

**Registered Mar. 11, 2008**

**TRADEMARK  
PRINCIPAL REGISTER**

**WHAT'S YOUR FAVORITE COLOR**

LIZ ROACHE STUDIOS, INC. (MASSACHUSETTS  
CORPORATION)  
7A ABBOTT STREET  
WELLESLEY, MA 02482

FOR: ATHLETIC FOOTWEAR; BATHING SUITS;  
BEACH COVERUPS; BEACH FOOTWEAR; BELTS;  
BOTTOMS; CAPS; COATS; FLIP FLOPS; FOOT-  
WEAR; FOOTWEAR NOT FOR SPORTS; GOLF  
SHIRTS; HEADWEAR; INFANT AND TODDLER  
ONE PIECE CLOTHING; JERSEYS; PAJAMAS;  
PANTS; PUMPS; SHIFTS; SHIRTS; SHORTS;  
SHOULDER WRAPS; SKIRTS AND DRESSES;  
SPORT SHIRTS; SWIM TRUNKS; T-SHIRTS; FOOT-

WEAR THONGS; TIES; TOPS; UNDERWEAR;  
WRAPS, IN CLASS 25 (U.S. CLS. 22 AND 39).

FIRST USE 6-0-2006; IN COMMERCE 6-0-2006.

THE MARK CONSISTS OF STANDARD CHAR-  
ACTERS WITHOUT CLAIM TO ANY PARTICULAR  
FONT, STYLE, SIZE, OR COLOR.

SN 78-866,172, FILED 4-20-2006.

SUSAN LESLIE DUBOIS, EXAMINING ATTORNEY

**Int. Cls.: 9, 25, and 41**

**Prior U.S. Cls.: 21, 22, 23, 26, 36, 38, 39, 100, 101, and 107**

**United States Patent and Trademark Office**

**Reg. No. 3,396,293**

**Registered Mar. 11, 2008**

**TRADEMARK  
SERVICE MARK  
PRINCIPAL REGISTER**

**FUTURE CLOUDS AND RADAR**

HARRISON, ROBERT (UNITED STATES INDIVIDUAL)  
1605 CHELSEA LANE  
AUSTIN, TX 78704

FOR: MUSICAL SOUND RECORDINGS FEATURING MUSIC, IN CLASS 9 (U.S. CLS. 21, 23, 26, 36 AND 38).

FIRST USE 12-0-2006; IN COMMERCE 12-0-2006.

FOR: SHIRTS, IN CLASS 25 (U.S. CLS. 22 AND 39).

FIRST USE 3-17-2006; IN COMMERCE 3-17-2006.

FOR: ENTERTAINMENT, NAMELY, LIVE PERFORMANCES BY A MUSICAL GROUP, IN CLASS 41 (U.S. CLS. 100, 101 AND 107).

FIRST USE 3-17-2006; IN COMMERCE 3-17-2006.

THE MARK CONSISTS OF STANDARD CHARACTERS WITHOUT CLAIM TO ANY PARTICULAR FONT, STYLE, SIZE, OR COLOR.

SN 78-866,246, FILED 4-20-2006.

MARY ROSSMAN, EXAMINING ATTORNEY

**Int. Cl.: 9**

**Prior U.S. Cls.: 21, 23, 26, 36, and 38**

**United States Patent and Trademark Office**

**Reg. No. 3,396,294**

**Registered Mar. 11, 2008**

**TRADEMARK  
PRINCIPAL REGISTER**

**SOHO**

BACK TO BASIC PRODUCTS, LLC (ILLINOIS  
LTD LIAB CO)  
120 LAKEVIEW PARKWAY  
VERNON HILLS, IL 60061

THE MARK CONSISTS OF STANDARD CHAR-  
ACTERS WITHOUT CLAIM TO ANY PARTICULAR  
FONT, STYLE, SIZE, OR COLOR.

FOR: ELECTRIC CLOTHING IRONS, STEAM  
IRONS, IN CLASS 9 (U.S. CLS. 21, 23, 26, 36 AND 38).

SN 78-866,703, FILED 4-21-2006.

FIRST USE 6-0-2007; IN COMMERCE 6-0-2007.

CARYN GLASSER, EXAMINING ATTORNEY

**Int. Cl.: 9**

**Prior U.S. Cls.: 21, 23, 26, 36, and 38**

**United States Patent and Trademark Office**

**Reg. No. 3,396,295**

**Registered Mar. 11, 2008**

**TRADEMARK  
PRINCIPAL REGISTER**

**LIFECHAT**

MICROSOFT CORPORATION (WASHINGTON CORPORATION)  
ONE MICROSOFT WAY  
REDMOND, WA 980526399

FOR: COMPUTER HARDWARE AND PERIPHERALS; COMPUTER SOFTWARE FOR USE AS AN INTERFACE WITH HEADSETS FOR USE WITH COMPUTERS; AND HEADSETS FOR USE WITH COMPUTERS, IN CLASS 9 (U.S. CLS. 21, 23, 26, 36 AND 38).

FIRST USE 1-0-2007; IN COMMERCE 1-0-2007.

THE MARK CONSISTS OF STANDARD CHARACTERS WITHOUT CLAIM TO ANY PARTICULAR FONT, STYLE, SIZE, OR COLOR.

SN 78-867,183, FILED 4-21-2006.

DAVID ELTON, EXAMINING ATTORNEY



**Int. Cls.: 35 and 36**

**Prior U.S. Cls.: 100, 101, and 102**

**United States Patent and Trademark Office**

**Reg. No. 3,396,296**

**Registered Mar. 11, 2008**

**SERVICE MARK  
PRINCIPAL REGISTER**

**WELLS FARGO ONLINE PAYMENT  
SUITE**

WELLS FARGO & COMPANY (DELAWARE  
CORPORATION)  
1700 WELLS FARGO CENTER  
MAC N9305-176, SIXTH AND MARQUETTE  
MINNEAPOLIS, MN 55479

FOR: ADMINISTRATION OF BUSINESS PAY-  
ROLL FOR OTHERS, IN CLASS 35 (U.S. CLS. 100,  
101 AND 102).

FIRST USE 4-24-2006; IN COMMERCE 4-24-2006.

FOR: ELECTRONIC PAYMENT, NAMELY, ELEC-  
TRONIC PROCESSING AND TRANSMISSION OF  
INVOICE, BILL, TAX, ANNUITY AND DISTRIBUTION  
PAYMENT DATA, IN CLASS 36 (U.S. CLS. 100,  
101 AND 102).

FIRST USE 4-24-2006; IN COMMERCE 4-24-2006.

THE MARK CONSISTS OF STANDARD CHAR-  
ACTERS WITHOUT CLAIM TO ANY PARTICULAR  
FONT, STYLE, SIZE, OR COLOR.

OWNER OF U.S. REG. NOS. 2,526,696, 2,673,226,  
AND OTHERS.

NO CLAIM IS MADE TO THE EXCLUSIVE  
RIGHT TO USE "ONLINE PAYMENT SUITE" ,  
APART FROM THE MARK AS SHOWN.

SN 78-867,712, FILED 4-24-2006.

LYDIA BELZER, EXAMINING ATTORNEY

**Int. Cls.: 39, 42, and 45**

**Prior U.S. Cls.: 100, 101, and 105**

**United States Patent and Trademark Office**

**Reg. No. 3,396,297**

**Registered Mar. 11, 2008**

**SERVICE MARK  
PRINCIPAL REGISTER**



MJW CORPORATION INC. (NEW YORK CORPORATION)  
UNIVERSITY PARK  
1900 SWEET HOME ROAD  
AMHERST, NY 142283359

FOR: ELECTRONIC STORAGE ON A GLOBAL COMPUTER NETWORK OF SITE SPECIFIC BEHAVIOR-BASED SAFETY OBSERVATION DATA AND GATHERING, ANALYSIS AND REPORTING TOOLS, IN CLASS 39 (U.S. CLS. 100 AND 105).

FIRST USE 6-16-2005; IN COMMERCE 6-16-2005.

FOR: COMPUTER SERVICES, NAMELY, MAINTAINING WEBSITES AND COMPUTER SOFTWARE FOR OTHERS OVER A GLOBAL COMPUTER NETWORK, SUCH WEBSITES AND COMPUTER SOFTWARE FEATURING BEHAVIOR-

BASED SAFETY OBSERVATION DATA AND GATHERING, ANALYSIS AND REPORTING TOOLS, IN CLASS 42 (U.S. CLS. 100 AND 101).

FIRST USE 9-26-2007; IN COMMERCE 9-26-2007.

FOR: CONSULTATION SERVICES IN THE FIELD OF THE SAFETY NEEDS OF COMMERCIAL AND INDUSTRIAL COMPANIES, IN CLASS 45 (U.S. CLS. 100 AND 101).

FIRST USE 9-26-2007; IN COMMERCE 9-26-2007.

OWNER OF U.S. REG. NO. 2,976,869.

SN 78-867,903, FILED 4-24-2006.

LYDIA BELZER, EXAMINING ATTORNEY

**Int. Cl.: 14**

**Prior U.S. Cls.: 2, 27, 28, and 50**

**United States Patent and Trademark Office**

**Reg. No. 3,396,298**

**Registered Mar. 11, 2008**

**TRADEMARK  
PRINCIPAL REGISTER**

**ARIELLA COLLECTION**

GLITTERING (CALIFORNIA CORPORATION)  
11155 KNOTT AVE, SUITE A B  
CYPRESS, CA 90630

FOR: JEWELRY, NAMELY, FASHION JEWELRY,  
RINGS, EARRINGS, BRACELETS, NECKLACES,  
PENDANTS, BANGLES, PINS, TOE RINGS, ANKLE  
BRACELETS, CHARMS AND BROOCHES, IN  
CLASS 14 (U.S. CLS. 2, 27, 28 AND 50).

FIRST USE 3-31-2006; IN COMMERCE 3-31-2006.

THE MARK CONSISTS OF STANDARD CHAR-  
ACTERS WITHOUT CLAIM TO ANY PARTICULAR  
FONT, STYLE, SIZE, OR COLOR.

NO CLAIM IS MADE TO THE EXCLUSIVE  
RIGHT TO USE "COLLECTION", APART FROM  
THE MARK AS SHOWN.

SN 78-868,439, FILED 4-24-2006.

MARY MUNSON, EXAMINING ATTORNEY

**Int. Cl.: 31**

**Prior U.S. Cls.: 1 and 46**

**United States Patent and Trademark Office**

**Reg. No. 3,396,299**

**Registered Mar. 11, 2008**

**TRADEMARK  
PRINCIPAL REGISTER**

**HEALTHY NATURALS**

THE IAMS COMPANY (OHIO CORPORATION)  
ONE PROCTER & GAMBLE PLAZA  
CINCINNATI, OH 45202

FOR: FOODSTUFFS FOR ANIMALS, IN CLASS 31  
(U.S. CLS. 1 AND 46).

FIRST USE 6-18-2007; IN COMMERCE 6-18-2007.

THE MARK CONSISTS OF STANDARD CHAR-  
ACTERS WITHOUT CLAIM TO ANY PARTICULAR  
FONT, STYLE, SIZE, OR COLOR.

NO CLAIM IS MADE TO THE EXCLUSIVE  
RIGHT TO USE "NATURALS", APART FROM THE  
MARK AS SHOWN.

SN 78-868,880, FILED 4-25-2006.

WILLIAM ROSSMAN, EXAMINING ATTORNEY

Int. Cl.: 25

Prior U.S. Cls.: 22 and 39

United States Patent and Trademark Office

Reg. No. 3,396,300

Registered Mar. 11, 2008

TRADEMARK  
PRINCIPAL REGISTER



SBC/SPORTO CORP. (MASSACHUSETTS CORPORATION)  
65 SPRAGUE STREET  
BOSTON, MA 02136

NO CLAIM IS MADE TO THE EXCLUSIVE RIGHT TO USE "STUDIO", APART FROM THE MARK AS SHOWN.

FOR: CLOTHING, NAMELY, FOOTWEAR, IN CLASS 25 (U.S. CLS. 22 AND 39).

SN 78-871,532, FILED 4-27-2006.

FIRST USE 2-28-2005; IN COMMERCE 9-30-2005.

OWNER OF U.S. REG. NO. 2,974,460.

BRIAN PINO, EXAMINING ATTORNEY

**Int. Cl.: 9**

**Prior U.S. Cls.: 21, 23, 26, 36, and 38**

**United States Patent and Trademark Office**

**Reg. No. 3,396,301**

**Registered Mar. 11, 2008**

**TRADEMARK  
PRINCIPAL REGISTER**

**UAID**

PREMIER ELECTION SOLUTIONS, INC. (DELA-  
WARE CORPORATION)  
1253 ALLEN STATION PARKWAY  
ALLEN, TX 75002

FOR: ACCESSIBILITY DEVICES FOR VOTING  
MACHINES, NAMELY, PNEUMATIC SIP AND  
PUFF POINTING DEVICES, HEADPHONES AND  
10-KEY KEYPADS, FOR THE PURPOSE OF EN-  
ABLING INDIVIDUALS TO ACCESS INFORMA-  
TION ON ELECTRONIC VOTING MACHINES  
AND TO INPUT THE INDIVIDUAL'S VOTE, IN  
CLASS 9 (U.S. CLS. 21, 23, 26, 36 AND 38).

FIRST USE 12-26-2007; IN COMMERCE 12-26-2007.

THE MARK CONSISTS OF STANDARD CHAR-  
ACTERS WITHOUT CLAIM TO ANY PARTICULAR  
FONT, STYLE, SIZE, OR COLOR.

SN 78-871,611, FILED 4-27-2006.

MATTHEW EINSTEIN, EXAMINING ATTORNEY

**Int. Cl.: 28**

**Prior U.S. Cls.: 22, 23, 38, and 50**

**United States Patent and Trademark Office**

**Reg. No. 3,396,302**

**Registered Mar. 11, 2008**

---

**TRADEMARK  
PRINCIPAL REGISTER**

**SNIPE-IT**

RUDELL, ELLIOT (UNITED STATES INDIVIDUAL), DBA RUDELL DESIGN,  
1619 GRAMERCY AVENUE  
TORRANCE, CA 90501

THE MARK CONSISTS OF STANDARD CHARACTERS WITHOUT CLAIM TO ANY PARTICULAR FONT, STYLE, SIZE, OR COLOR.

FOR: MULTI-PLAYER GAME WHEREIN PLAYERS ANSWER RANDOM QUESTIONS DURING A SPECIFIC PERIOD OF TIME, IN CLASS 28 (U.S. CLS. 22, 23, 38 AND 50).

SN 78-872,753, FILED 4-28-2006.

FIRST USE 7-9-2007; IN COMMERCE 7-9-2007.

JOHN WILKE, EXAMINING ATTORNEY

**Int. Cl.: 40**

**Prior U.S. Cls.: 100, 103, and 106**

**United States Patent and Trademark Office**

**Reg. No. 3,396,303**

**Registered Mar. 11, 2008**

**SERVICE MARK  
PRINCIPAL REGISTER**



HERNANDEZ, GERMAN (UNITED STATES IN-  
DIVIDUAL)  
APT. 1327  
51 SW 11TH ST.  
MIAMI, FL 33130

FOR: IMPRINTING MESSAGES ON T-SHIRTS, IN  
CLASS 40 (U.S. CLS. 100, 103 AND 106).

FIRST USE 1-12-2007; IN COMMERCE 1-12-2007.

THE COLOR(S) BLACK AND WHITE IS/ARE  
CLAIMED AS A FEATURE OF THE MARK.

THE MARK CONSISTS OF A BLACK RECTAN-  
GLE SURROUNDED BY A WHITE FRAME WHICH  
IS THEN SURROUNDED BY A BLACK FRAME.  
THE TEXT "EVIL CLOTHES FOR EVIL PEOPLE" IS  
FEATURED IN THREE LINES IN WHITE LOWER-  
CASE TEXT FONT CASLON ANTIQUE.

SN 78-872,774, FILED 4-29-2006.

JULIE GUTTADAURO, EXAMINING ATTORNEY



**Int. Cl.: 3**

**Prior U.S. Cls.: 1, 4, 6, 50, 51, and 52**

**United States Patent and Trademark Office**

**Reg. No. 3,396,304**

**Registered Mar. 11, 2008**

**TRADEMARK  
PRINCIPAL REGISTER**

**ELASTESSE**

PROCTER & GAMBLE COMPANY, THE (OHIO  
CORPORATION)  
ONE PROCTER & GAMBLE PLAZA  
CINCINNATI, OH 45202

FOR: CHEMICAL COMPOSITION SOLD AS AN  
INTEGRAL COMPONENT OF HAIR CARE PRE-  
PARATIONS, IN CLASS 3 (U.S. CLS. 1, 4, 6, 50, 51  
AND 52).

FIRST USE 1-22-2007; IN COMMERCE 1-22-2007.

THE MARK CONSISTS OF STANDARD CHAR-  
ACTERS WITHOUT CLAIM TO ANY PARTICULAR  
FONT, STYLE, SIZE, OR COLOR.

OWNER OF U.S. REG. NO. 1,964,613.

SN 78-873,092, FILED 5-1-2006.

JOHN SCHUYLER YARD, EXAMINING ATTOR-  
NEY

**Int. Cl.: 35**

**Prior U.S. Cls.: 100, 101, and 102**

**United States Patent and Trademark Office**

**Reg. No. 3,396,305**

**Registered Mar. 11, 2008**

**SERVICE MARK  
PRINCIPAL REGISTER**

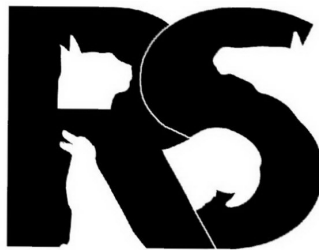

HARVARD DRUG GROUP, LLC (MICHIGAN  
CORPORATION)  
31778 ENTERPRISE  
LIVONIA, MI 48150

FOR: DISTRIBUTORSHIPS IN THE FIELD OF  
VETERINARY AND MEDICAL SUPPLIES, EQUIP-  
MENT AND PHARMACEUTICALS, IN CLASS 35  
(U.S. CLS. 100, 101 AND 102).

FIRST USE 5-0-2006; IN COMMERCE 5-0-2006.

THE MARK CONSISTS OF THE LETTERS "RS" IN  
A STYLIZED FORM.

SN 78-873,616, FILED 5-1-2006.

TINA L. SNAPP, EXAMINING ATTORNEY

**Int. Cl.: 36**

**Prior U.S. Cls.: 100, 101, and 102**

**United States Patent and Trademark Office**

**Reg. No. 3,396,306**

**Registered Mar. 11, 2008**

**SERVICE MARK  
PRINCIPAL REGISTER**

**PEDALS THE BUNNY**

AMERICAN LEBANESE SYRIAN ASSOCIATED  
CHARITIES, INC. (ILLINOIS CORPORATION)  
501 ST. JUDE PLACE  
MEMPHIS, TN 381051942

THE MARK CONSISTS OF STANDARD CHAR-  
ACTERS WITHOUT CLAIM TO ANY PARTICULAR  
FONT, STYLE, SIZE, OR COLOR.

FOR: CHARITABLE FUND-RAISING, IN CLASS  
36 (U.S. CLS. 100, 101 AND 102).

SN 78-873,679, FILED 5-1-2006.

FIRST USE 8-31-2006; IN COMMERCE 8-31-2006.

WON TEAK OH, EXAMINING ATTORNEY

**Int. Cls.: 9 and 42**

**Prior U.S. Cls.: 21, 23, 26, 36, 38, 100, and 101**

**United States Patent and Trademark Office**

**Reg. No. 3,396,307**

**Registered Mar. 11, 2008**

**TRADEMARK  
SERVICE MARK  
PRINCIPAL REGISTER**

**TRANSSSEND**

BLUETOOTH SIG, INC. (DELAWARE CORPORATION)  
SUITE 250  
500 108TH AVENUE, NE  
BELLEVUE, WA 98004

FOR: COMPUTER SOFTWARE THAT ENABLES USERS TO SELECT AND DOWNLOAD INFORMATION FROM WEB PAGES TO MOBILE AND STATIONARY COMPUTER HARDWARE AND TELECOMMUNICATIONS DEVICES, IN CLASS 9 (U.S. CLS. 21, 23, 26, 36 AND 38).

FIRST USE 10-0-2006; IN COMMERCE 10-0-2006.

FOR: COMPUTER SERVICES, NAMELY, PROVIDING TEMPORARY ON-LINE USE OF NON-DOWNLOADABLE SOFTWARE THAT FACILITATES THE SELECTION AND DOWNLOADING OF INFORMATION FROM WEB PAGES TO MOBILE AND STATIONARY COMPUTER HARDWARE AND TELECOMMUNICATIONS DEVICES;

COMPUTER TECHNICAL SUPPORT, NAMELY, TROUBLESHOOTING OF COMPUTER HARDWARE AND SOFTWARE; COMPUTER CONSULTING AND INTEGRATION SERVICES RELATING TO THE DEVELOPMENT AND DEPLOYMENT OF WEB PAGES THAT ENABLE USERS TO SELECT AND DOWNLOAD INFORMATION FROM WEB PAGES TO MOBILE AND STATIONARY COMPUTER HARDWARE AND TELECOMMUNICATIONS DEVICES, IN CLASS 42 (U.S. CLS. 100 AND 101).

FIRST USE 9-0-2007; IN COMMERCE 9-0-2007.

THE MARK CONSISTS OF STANDARD CHARACTERS WITHOUT CLAIM TO ANY PARTICULAR FONT, STYLE, SIZE, OR COLOR.

SN 78-873,802, FILED 5-1-2006.

ROBIN CHOSID, EXAMINING ATTORNEY

**Int. Cl.: 42**

**Prior U.S. Cls.: 100 and 101**

**United States Patent and Trademark Office**

**Reg. No. 3,396,308**

**Registered Mar. 11, 2008**

**SERVICE MARK  
PRINCIPAL REGISTER**

**WILDFIREWEB**

WILDFIREWEB (CALIFORNIA PARTNERSHIP)  
18820 MELVIN AVENUE  
SONOMA, CA 95476

FIRST USE 2-26-2006; IN COMMERCE 2-26-2006.

FOR: APPLICATION SERVICE PROVIDER (ASP)  
FEATURING SOFTWARE FOR USE IN DESIGN-  
ING, CREATING, AND MAINTAINING WEB-SITE  
CONTENT; APPLICATION SERVICE PROVIDER  
(ASP), NAMELY, HOSTING COMPUTER SOFT-  
WARE APPLICATIONS OF OTHERS, IN CLASS 42  
(U.S. CLS. 100 AND 101).

THE MARK CONSISTS OF STANDARD CHAR-  
ACTERS WITHOUT CLAIM TO ANY PARTICULAR  
FONT, STYLE, SIZE, OR COLOR.

SN 78-873,806, FILED 5-1-2006.

ESTHER BELENKER, EXAMINING ATTORNEY

**Int. Cl.: 16**

**Prior U.S. Cls.: 2, 5, 22, 23, 29, 37, 38, and 50**

**United States Patent and Trademark Office**

**Reg. No. 3,396,309**

**Registered Mar. 11, 2008**

**TRADEMARK  
PRINCIPAL REGISTER**

**TRUE**

HALLMARK LICENSING, INC. (DELAWARE  
CORPORATION)  
MD 339  
2440 PERSHING ROAD  
KANSAS CITY, MO 64108

FOR: GREETING CARDS, IN CLASS 16 (U.S. CLS.  
2, 5, 22, 23, 29, 37, 38 AND 50).

FIRST USE 4-30-2007; IN COMMERCE 4-30-2007.

THE MARK CONSISTS OF STANDARD CHAR-  
ACTERS WITHOUT CLAIM TO ANY PARTICULAR  
FONT, STYLE, SIZE, OR COLOR.

SN 78-876,269, FILED 5-4-2006.

DOMINIC J. FERRAIUOLO, EXAMINING ATTOR-  
NEY

Int. Cl.: 18

Prior U.S. Cls.: 1, 2, 3, 22, and 41

**United States Patent and Trademark Office**

**Reg. No. 3,396,310**

Registered Mar. 11, 2008

**TRADEMARK  
PRINCIPAL REGISTER**



WATTS, LAURA E. (UNITED STATES INDIVIDUAL)  
5800 BUENA VISTA AVENUE  
OAKLAND, CA 94618

THE MARK CONSISTS OF STYLIZED IMAGE OF  
BABY IN DIAPERS.

FOR: DIAPER BAGS, IN CLASS 18 (U.S. CLS. 1, 2, 3,  
22 AND 41).

SN 78-876,320, FILED 5-4-2006.

FIRST USE 12-6-2006; IN COMMERCE 12-6-2006.

INGA ERVIN, EXAMINING ATTORNEY

**Int. Cl.: 3**

**Prior U.S. Cls.: 1, 4, 6, 50, 51, and 52**

**United States Patent and Trademark Office**

**Reg. No. 3,396,311**

**Registered Mar. 11, 2008**

**TRADEMARK  
PRINCIPAL REGISTER**

**VIO**

LI, ZHAO P. (CHINA INDIVIDUAL)  
1420 BENITO AVE  
ALHAMBRA, CA 91803

SOAPS FOR TOILET PURPOSES, IN CLASS 3 (U.S. CLS. 1, 4, 6, 50, 51 AND 52).

FIRST USE 7-24-2007; IN COMMERCE 7-24-2007.

FOR: ANTIBACTERIAL SOAP; BODY CREAM SOAP; COSMETIC SOAPS; CREAM SOAPS; DEODORANT SOAP; DETERGENT SOAP; DISINFECTANT SOAPS; DISINFECTING PERFUMED SOAPS; HAND CREAM; HAND CREAMS; HAND LOTIONS; HAND SOAPS; LIQUID SOAPS; LIQUID SOAPS FOR HANDS, FACE AND BODY; PERFUMED SOAPS; SKIN SOAP; SOAPS FOR BODY CARE; SOAPS FOR HOUSEHOLD USE; SOAPS FOR PERSONAL USE;

THE MARK CONSISTS OF STANDARD CHARACTERS WITHOUT CLAIM TO ANY PARTICULAR FONT, STYLE, SIZE, OR COLOR.

SN 78-876,571, FILED 5-4-2006.

LEIGH LOWRY, EXAMINING ATTORNEY



**Int. Cl.: 19**

**Prior U.S. Cls.: 1, 12, 33, and 50**

**United States Patent and Trademark Office**

**Reg. No. 3,396,312**

**Registered Mar. 11, 2008**

**TRADEMARK  
PRINCIPAL REGISTER**



ROBERT E. PLATT (UNITED STATES INDIVIDUAL)  
220 VICTORIA ROAD  
YOUNGSTOWN, OH 445152090

FENCE CONSTRUCTION, IN CLASS 19 (U.S. CLS. 1, 12, 33 AND 50).

FIRST USE 1-1-2006; IN COMMERCE 1-1-2006.

FOR: NON-METAL BASE AND MOUNTING KITS COMPRISING FENCE CLIPS, FENCE CONNECTORS, FENCE SPACERS, FENCE BRACKETS, FENCE POST MOUNTING STABILIZERS, ANCHORS, LEVELING BOLTS, MOUNTING PLATES AND FENCE POST METAL CORES FOR USE IN

THE MARK CONSISTS OF STYLIZED WORD "COASTAL" CENTERED IN A STYLIZED OVAL..

SN 78-876,604, FILED 5-4-2006.

KELLY BOULTON, EXAMINING ATTORNEY

**Int. Cl.: 27**

**Prior U.S. Cls.: 19, 20, 37, 42, and 50**

**United States Patent and Trademark Office**

**Reg. No. 3,396,313**

**Registered Mar. 11, 2008**

**TRADEMARK  
PRINCIPAL REGISTER**

**TURFBIND**

TEXTILE MANAGEMENT ASSOCIATES, INC.  
(GEORGIA CORPORATION)  
1906 SOUTH HAMILTON STREET  
DALTON, GA 30720

FOR: SYNTHETIC TURF SYSTEMS CONSISTING  
OF LAYERS OF MAN-MADE GRASSES OF FIBERS  
AND FILAMENTS AND SURFACE COVERINGS OF  
FIBERS OR FILAMENTS, IN CLASS 27 (U.S. CLS. 19,  
20, 37, 42 AND 50).

FIRST USE 12-12-2006; IN COMMERCE 12-12-2006.

THE MARK CONSISTS OF STANDARD CHAR-  
ACTERS WITHOUT CLAIM TO ANY PARTICULAR  
FONT, STYLE, SIZE, OR COLOR.

SN 78-876,833, FILED 5-4-2006.

DANIEL CAPSHAW, EXAMINING ATTORNEY

**Int. Cl.: 7**

**Prior U.S. Cls.: 13, 19, 21, 23, 31, 34, and 35**

**United States Patent and Trademark Office**

**Reg. No. 3,396,314**

**Registered Mar. 11, 2008**

**TRADEMARK  
PRINCIPAL REGISTER**

**WINNER SAFEXIT**

WINNER GLOBAL LLC (DELAWARE LTD LIAB  
CO)  
32 W. STATE ST.  
SHARON, PA 16146

FOR: LIFE-SAVING SAFETY MECHANISM,  
NAMELY, A CONTROLLED DESCENT DEVICE  
COMPRISED OF SEVERAL DESCENT SLOWING  
MECHANISMS ALLOWING FOR THE REGULA-  
TED DESCENT AT A FIXED AND SAFE SPEED, A  
HARNESS ATTACHED AT EITHER END OF A  
STEEL FIBER CABLE, AND AN ASSORTMENT OF  
ACCESSORIES ATTACHED THERETO, IN CLASS 7  
(U.S. CLS. 13, 19, 21, 23, 31, 34 AND 35).

FIRST USE 8-16-2006; IN COMMERCE 8-16-2006.

THE MARK CONSISTS OF STANDARD CHAR-  
ACTERS WITHOUT CLAIM TO ANY PARTICULAR  
FONT, STYLE, SIZE, OR COLOR.

SN 78-877,350, FILED 5-5-2006.

DOMINIC J. FERRAIUOLO, EXAMINING ATTOR-  
NEY

**Int. Cl.: 41**

**Prior U.S. Cls.: 100, 101, and 107**

**United States Patent and Trademark Office**

**Reg. No. 3,396,315**

**Registered Mar. 11, 2008**

**SERVICE MARK  
PRINCIPAL REGISTER**



JUDY KIDD GRIFFIN (NORTH CAROLINA  
SOLE PROPRIETORSHIP)

P.O. BOX 13343

RESEARCH TRIANGLE PARK, NC 27709

FOR: TRAINING SERVICES AND PERSONAL  
COACHING SERVICES IN THE FIELD OF BUSI-  
NESS WRITING, IN CLASS 41 (U.S. CLS. 100, 101  
AND 107).

FIRST USE 1-1-1991; IN COMMERCE 1-1-1991.

THE COLOR(S) YELLOW AND BLACK IS/ARE  
CLAIMED AS A FEATURE OF THE MARK.

THE MARK CONSISTS OF THE COLOR YELLOW  
APPEARS IN TWO PENCILS POSITIONED AT  
RIGHT ANGLES AND BLACK IN THE WORDING  
WRITE ANGLES.

SN 78-877,401, FILED 5-5-2006.

ALICE BENMAMAN, EXAMINING ATTORNEY

**Int. Cl.: 35**

**Prior U.S. Cls.: 100, 101, and 102**

**United States Patent and Trademark Office**

**Reg. No. 3,396,316**

**Registered Mar. 11, 2008**

**SERVICE MARK  
PRINCIPAL REGISTER**

**GLOBAL SOLUTIONS**

THE GEM GROUP, INC. (MASSACHUSETTS CORPORATION), DBA GEMLINE,  
9 INTERNATIONAL WAY  
LAWRENCE, MA 01843

FOR: CATALOG ORDERING SERVICES FEATURING BAGS, CASES AND BUSINESS ACCESSORIES IMPORTED TO THE ORDER AND SPECIFICATION OF OTHERS , IN CLASS 35 (U.S. CLS. 100, 101 AND 102).

FIRST USE 6-30-2006; IN COMMERCE 6-30-2006.

THE MARK CONSISTS OF STANDARD CHARACTERS WITHOUT CLAIM TO ANY PARTICULAR FONT, STYLE, SIZE, OR COLOR.

NO CLAIM IS MADE TO THE EXCLUSIVE RIGHT TO USE "GLOBAL", APART FROM THE MARK AS SHOWN.

SN 78-877,548, FILED 5-5-2006.

GEORGIA CARTY, EXAMINING ATTORNEY

**Int. Cl.: 28**

**Prior U.S. Cls.: 22, 23, 38, and 50**

**United States Patent and Trademark Office**

**Reg. No. 3,396,317**

**Registered Mar. 11, 2008**

**TRADEMARK  
PRINCIPAL REGISTER**



NOMACO, INC. (NORTH CAROLINA CORPORATION)  
501 NMC DRIVE  
ZEBULON, NC 27597

FOR: CONSTRUCTION TOYS, NAMELY, CONSTRUCTION TOYS FEATURING FLEXIBLE FOAM RODS; CONSTRUCTION TOYS, NAMELY, FLEXIBLE FOAM FOR CONSTRUCTING FORTS, TENTS, AND PLAY STRUCTURES; CONSTRUCTION TOYS, NAMELY, FLEXIBLE FOAM SHAPES, FIGURES AND CONNECTORS FOR JOINING FOAM RODS; FLEXIBLE FOAM FLOTATION TOYS, NAMELY, POOL FLOATS, BATH FLOATS, WATER LOUN-

TERS, AND KICK BOARD FLOTATION DEVICES ALL FOR RECREATIONAL USE, IN CLASS 28 (U.S. CLS. 22, 23, 38 AND 50).

FIRST USE 12-15-2005; IN COMMERCE 12-15-2005.

NO CLAIM IS MADE TO THE EXCLUSIVE RIGHT TO USE "FOAM", APART FROM THE MARK AS SHOWN.

SN 78-878,877, FILED 5-8-2006.

DORITT L. CARROLL, EXAMINING ATTORNEY

**Int. Cl.: 28**

**Prior U.S. Cls.: 22, 23, 38, and 50**

**United States Patent and Trademark Office**

**Reg. No. 3,396,318**

**Registered Mar. 11, 2008**

**TRADEMARK  
PRINCIPAL REGISTER**

**FUN ON A MISSION**

NOMACO, INC. (NORTH CAROLINA CORPORATION)  
510 NMC DRIVE  
ZEBULON, NC 27597

FOR: CONSTRUCTION TOYS, NAMELY, CONSTRUCTION TOYS FEATURING FLEXIBLE FOAM RODS; CONSTRUCTION TOYS, NAMELY, FLEXIBLE FOAM FOR CONSTRUCTING FORTS, TENTS, AND PLAY STRUCTURES; CONSTRUCTION TOYS, NAMELY, FLEXIBLE FOAM SHAPES, FIGURES AND CONNECTORS FOR JOINING FOAM RODS; FLEXIBLE FOAM FLOTATION TOYS, NAMELY POOL FLOATS, BATH FLOATS, WATER LOUN-

TERS, AND KICK BOARD FLOTATION DEVICES ALL FOR RECREATIONAL USE, IN CLASS 28 (U.S. CLS. 22, 23, 38 AND 50).

FIRST USE 12-15-2005; IN COMMERCE 12-15-2005.

THE MARK CONSISTS OF STANDARD CHARACTERS WITHOUT CLAIM TO ANY PARTICULAR FONT, STYLE, SIZE, OR COLOR.

SN 78-878,891, FILED 5-8-2006.

DORITT L. CARROLL, EXAMINING ATTORNEY

**Int. Cls.: 14, 16, and 25**

**Prior U.S. Cls.: 2, 5, 22, 23, 27, 28, 29, 37, 38, 39, and 50**

**Reg. No. 3,396,319**

**United States Patent and Trademark Office**

**Registered Mar. 11, 2008**

**TRADEMARK  
PRINCIPAL REGISTER**



STRZEMIECZNY, ALAN, LEE (UNITED STATES INDIVIDUAL)  
16320 RANCHO ESCONDIDO DR.  
RIVERSIDE, CA 92506 AND  
STRZEMIECZNY, SHIRLEY, MARLENE (UNITED STATES INDIVIDUAL)  
16320 RANCHO ESCONDIDO DR.  
RIVERSIDE, CA 92506

FOR: ANKLE BRACELETS; BONNET PINS OF PRECIOUS METAL; BRACELETS; BRACELETS OF PRECIOUS METAL; CHARITY BRACELETS; CHARMS; CLOISONNE PINS; CUFF-LINKS; HAT PINS OF PRECIOUS METAL; IDENTIFICATION BRACELETS; JEWELRY PINS FOR USE ON HATS; KEY HOLDERS OF PRECIOUS METALS; KEY RINGS OF PRECIOUS METAL; LAPEL PINS; MEDALLIONS; NAPKIN RINGS OF PRECIOUS METAL; NECK CHAINS; NECKLACES; ORNAMENTAL LAPEL PINS; ORNAMENTAL PINS; PINS BEING JEWELRY; RINGS; RINGS BEING JEWELRY; RUBBER OR SILICON WRISTBANDS IN THE NATURE OF A BRACELET; SERVIETTE RINGS OF PRECIOUS METAL; TIE BARS; TIE CLIPS; TIE FASTENERS; TIE PINS; TIE TACKS; WATCH BANDS AND STRAPS; WATCH BRACELETS; WATCH STRAPS; WATCH STRAPS MADE OF METAL OR LEATHER OR PLASTIC, IN CLASS 14 (U.S. CLS. 2, 27, 28 AND 50).

FIRST USE 11-14-2001; IN COMMERCE 7-1-2007.

FOR: ADDRESS PLATES; ADHESIVE NOTE PADS; ADHESIVE NOTE PAPER; ADVERTISING SIGNS OF PAPER OR CARDBOARD; ANNOUNCEMENT CARDS; APPLIQUES IN THE FORM OF DECALS; BALL PENS; BALL POINT PENS; BALL-

POINT PENS; BLANK OR PARTIALLY PRINTED POSTCARDS; BOOK COVERS; BOOKMARKS; BUMPER STICKERS; CHECK BOOKS; CHECKBOOK COVERS; COIN HOLDERS; COLOR PENCILS; COLOR PENCILS; CORRESPONDENCE CARDS; DECALS; DECORATIONS FOR PENCILS; DECORATIVE PENCIL-TOP ORNAMENTS; DESK STANDS AND HOLDERS FOR PENS, PENCILS, AND INK; DOCUMENT COVERS; FOUNTAIN PENS; GREETING CARDS; HOLDERS FOR SUCH STICKY TAPES; HOLIDAY CARDS; INK PENS; MAGNETIC BOARDS; MAGNETIC PAPER; NOTE BOOKS; NOTE CARDS; NOTE PADS; NOTE PAPER; NOTE PAPERS; OCCASION CARDS; PAPER NOTE TABLETS; PAPER SHEETS FOR NOTE TAKING; PEN AND PENCIL CASES AND BOXES; PEN AND PENCIL TRAYS; PEN CASES; PEN OR PENCIL HOLDERS; PENCIL BOXES; PENCIL CASES; PENCIL OR PEN BOXES; PENCIL ORNAMENTS (STATIONERY); PENCILS; PLASTIC PAGES FOR HOLDING PAPER, CARDS; POCKET PEN SHIELDS; PRAYER BOOKS; PRINTED GREETING CARDS WITH ELECTRONIC INFORMATION STORED THEREIN; PROTECTIVE COVERS FOR BOOKS; PROTECTIVE COVERS FOR SHEETS OR PAPER AND PAGES OF BOOKS AND THE LIKE; RELIGIOUS BOOKS; ROLLER BALL PENS; SKETCH BOOKS; STICKERS; MAGNETIC DECALS AND TRANSFERS FOR CAR, REFRIGERATORS, AND OTHER METAL OBJECTS, IN CLASS 16 (U.S. CLS. 2, 5, 22, 23, 29, 37, 38 AND 50).

FIRST USE 8-10-2006; IN COMMERCE 8-10-2006.

FOR: BASEBALL CAPS; CAMP SHIRTS; CAP VISORS; CAPS; CAPS WITH VISORS; DRESS SHIRTS; GOLF CAPS; GOLF SHIRTS; HAT BANDS; HATS; HEAD SCARVES; HEAD SWEATBANDS;



HEAD WEAR; HEADBANDS AGAINST SWEATING; HEADGEAR, NAMELY, HATS, CAP, BANDS; OPEN-NECKED SHIRTS; POLO SHIRTS; SCARVES; SHIRT FRONTS; SHIRTS; SHORT-SLEEVED OR LONG-SLEEVED T-SHIRTS; SHORT-SLEEVED SHIRTS; SHOULDER SCARVES; SILK SCARVES; SPORT SHIRTS; SPORTS SHIRTS; SPORTS SHIRTS WITH SHORT SLEEVES; SWEAT BANDS; SWEAT PANTS; SWEAT SHIRTS; SWEAT SHORTS; SWEAT SUITS; T-SHIRTS; TIES; TROUSERS FOR SWEATING; WIND SHIRTS; WRIST BANDS, IN CLASS 25 (U.S. CLS. 22 AND 39).

FIRST USE 7-9-2006; IN COMMERCE 7-9-2006.

THE MARK CONSISTS OF AN OVAL CONTAINING A HILL WITH THREE CROSSES. THE LETTERS WTRU ARE INSCRIBED ON THE HILL UNDER THE CROSSES. THE LETTERS STAND FOR "WHICH THIEF ARE YOU" OR "WHICH THIEF RU".

SN 78-880,115, FILED 5-9-2006.

SOPHIA S. KIM, EXAMINING ATTORNEY

**Int. Cls.: 35, 36, and 45**

**Prior U.S. Cls.: 100, 101, and 102**

**United States Patent and Trademark Office**

**Reg. No. 3,396,320**

**Registered Mar. 11, 2008**

**SERVICE MARK  
PRINCIPAL REGISTER**

**ZIKHARA**

ZIKHARA, INC. (NEW YORK CORPORATION)  
200 EAST 82ND STREET, SUITE 17B  
NEW YORK, NY 10028

FOR: ORGANIZING AND MAINTAINING PERSONAL RECORDS AND INFORMATION FOR INDIVIDUALS CONCERNING LEGAL, FINANCIAL, ACCOUNTING, TRUSTS AND ESTATES, REAL ESTATE AND INSURANCE, IN CLASS 35 (U.S. CLS. 100, 101 AND 102).

FIRST USE 2-16-2006; IN COMMERCE 3-29-2006.

FOR: FINANCIAL PLANNING; FINANCIAL ANALYSIS AND CONSULTATION AND MANAGEMENT OF PERSONAL FINANCES FOR OTHERS, IN CLASS 36 (U.S. CLS. 100, 101 AND 102).

FIRST USE 2-16-2006; IN COMMERCE 3-29-2006.

FOR: PERSONAL ASSISTANT SERVICES, NAMELY, PROVIDING VALET AND CONCIERGE SERVICES FOR OTHERS, IN CLASS 45 (U.S. CLS. 100 AND 101).

FIRST USE 2-16-2006; IN COMMERCE 3-29-2006.

THE MARK CONSISTS OF STANDARD CHARACTERS WITHOUT CLAIM TO ANY PARTICULAR FONT, STYLE, SIZE, OR COLOR.

SN 78-880,247, FILED 5-10-2006.

EDWARD NELSON, EXAMINING ATTORNEY

**Int. Cl.: 29**

**Prior U.S. Cl.: 46**

**United States Patent and Trademark Office**

**Reg. No. 3,396,321**

**Registered Mar. 11, 2008**

**TRADEMARK  
PRINCIPAL REGISTER**



DAWSON, SUSAN S (UNITED STATES INDIVIDUAL)  
457 GRAYSVILLE RD.  
RINGGOLD, GA 30736

FOR: SOUPS, GARDEN SALADS, IN CLASS 29  
(U.S. CL. 46).

FIRST USE 11-1-2007; IN COMMERCE 11-1-2007.

NO CLAIM IS MADE TO THE EXCLUSIVE RIGHT TO USE "SOUPS, SALADS & SUBS", AND THE UNIVERSAL PROHIBITION SYMBOL, APART FROM THE MARK AS SHOWN.

THE COLORS RED, BLUE, BLACK, AND ORANGE ARE CLAIMED AS A FEATURE OF THE MARK.

THE WORDING IS IN THE COLOR BLUE, THE UNIVERSAL PROHIBITION SYMBOL IS IN THE COLOR RED, THE FRYING PAN DESIGN IS IN THE COLOR BLACK, AND THE FLAME IS IN THE COLOR ORANGE.

SN 78-880,258, FILED 5-10-2006.

JOHN GARTNER, EXAMINING ATTORNEY

**Int. Cl.: 5**

**Prior U.S. Cls.: 6, 18, 44, 46, 51, and 52**

**Reg. No. 3,396,322**

**United States Patent and Trademark Office**

**Registered Mar. 11, 2008**

---

**TRADEMARK  
PRINCIPAL REGISTER**

**Tenkoz Establish ATZ  
Herbicide**

TENKOZ, INC. (GEORGIA CORPORATION)  
SUITE 330  
100 NORTH POINT CENTER EAST  
ALPHARETTA, GA 300228242

FOR: HERBICIDE FOR AGRICULTURAL USE,  
IN CLASS 5 (U.S. CLS. 6, 18, 44, 46, 51 AND 52).

FIRST USE 11-1-2005; IN COMMERCE 2-1-2006.

THE MARK CONSISTS OF STANDARD CHAR-  
ACTERS WITHOUT CLAIM TO ANY PARTICULAR  
FONT, STYLE, SIZE, OR COLOR.

NO CLAIM IS MADE TO THE EXCLUSIVE  
RIGHT TO USE "ATZ HERBICIDE", APART FROM  
THE MARK AS SHOWN.

SN 78-881,381, FILED 5-11-2006.

GIANCARLO CASTRO, EXAMINING ATTORNEY

**Int. Cl.: 5**

**Prior U.S. Cls.: 6, 18, 44, 46, 51, and 52**

**United States Patent and Trademark Office**

**Reg. No. 3,396,323**

**Registered Mar. 11, 2008**

**TRADEMARK  
PRINCIPAL REGISTER**

**Tenkoz Establish Lite  
Herbicide**

TENKOZ, INC. (GEORGIA CORPORATION)  
SUITE 330  
100 NORTH POINT CENTER EAST  
ALPHARETTA, GA 300228242

FOR: HERBICIDE FOR AGRICULTURAL USE,  
IN CLASS 5 (U.S. CLS. 6, 18, 44, 46, 51 AND 52).

FIRST USE 11-1-2005; IN COMMERCE 2-1-2006.

THE MARK CONSISTS OF STANDARD CHAR-  
ACTERS WITHOUT CLAIM TO ANY PARTICULAR  
FONT, STYLE, SIZE, OR COLOR.

NO CLAIM IS MADE TO THE EXCLUSIVE  
RIGHT TO USE "LITE HERBICIDE", APART FROM  
THE MARK AS SHOWN.

SN 78-881,389, FILED 5-11-2006.

GIANCARLO CASTRO, EXAMINING ATTORNEY

**Int. Cl.: 33**

**Prior U.S. Cls.: 47 and 49**

**United States Patent and Trademark Office**

**Reg. No. 3,396,324**

**Registered Mar. 11, 2008**

**TRADEMARK  
PRINCIPAL REGISTER**

**LE TOURMENT VERT**

MCKENZIE RIVER CORPORATION (CALIFORNIA CORPORATION)  
1160 BATTERY STREET, SUITE 30  
SAN FRANCISCO, CA 94111

FOR: DISTILLED SPIRITS, IN CLASS 33 (U.S. CLS. 47 AND 49).

FIRST USE 11-13-2007; IN COMMERCE 11-13-2007.

THE MARK CONSISTS OF STANDARD CHARACTERS WITHOUT CLAIM TO ANY PARTICULAR FONT, STYLE, SIZE, OR COLOR.

NO CLAIM IS MADE TO THE EXCLUSIVE RIGHT TO USE "VERT", APART FROM THE MARK AS SHOWN.

THE FOREIGN WORDING IN THE MARK TRANSLATES INTO ENGLISH AS THE GREEN CURSE.

SN 78-882,388, FILED 5-12-2006.

ALYSSA PALADINO, EXAMINING ATTORNEY

**Int. Cl.: 35**

**Prior U.S. Cls.: 100, 101, and 102**

**United States Patent and Trademark Office**

**Reg. No. 3,396,325**

**Registered Mar. 11, 2008**

**SERVICE MARK  
PRINCIPAL REGISTER**



U.S. DAIRY EXPORT COUNCIL (D.C. CORPORATION)  
SUITE 900  
10255 WEST HIGGINS ROAD  
ROSEMONT, IL 600185616

FOR: ASSOCIATION SERVICES, NAMELY, PROMOTING THE INTEREST OF U.S. DAIRY SUPPLIERS AND EXPORTERS, IN CLASS 35 (U.S. CLS. 100, 101 AND 102).

FIRST USE 9-1-2006; IN COMMERCE 9-1-2006.

THE COLOR(S) BLACK, WHITE, GRAY AND PINK IS/ARE CLAIMED AS A FEATURE OF THE MARK.

THE MARK CONSISTS OF A BLACK AND WHITE COW, WITH GRAY SHADING ON ITS UNDERSIDE, WITH ITS SPOTS IN THE FORM OF A MAP OF THE CONTINENTS, WITH ITS UDDERS AND NOSE IN PINK. THE COW IS AGAINST A WHITE RECTANGULAR BACKGROUND WITH GRAY SHADING AT THE BOTTOM.

SN 78-883,453, FILED 5-15-2006.

ELISSA GARBER KON, EXAMINING ATTORNEY

**Int. Cl.: 29**

**Prior U.S. Cl.: 46**

**United States Patent and Trademark Office**

**Reg. No. 3,396,326**

**Registered Mar. 11, 2008**

**TRADEMARK  
PRINCIPAL REGISTER**

**EL QUESO DE BUENA LECHE**

IBE BUSINESS ENTERPRISE AG (SWITZER-  
LAND CORPORATION)  
BAARERSTRASSE 86  
ZUG, SWITZERLAND 6300

FOR: CHEESE, IN CLASS 29 (U.S. CL. 46).

FIRST USE 1-31-2007; IN COMMERCE 1-31-2007.

THE MARK CONSISTS OF STANDARD CHAR-  
ACTERS WITHOUT CLAIM TO ANY PARTICULAR  
FONT, STYLE, SIZE, OR COLOR.

NO CLAIM IS MADE TO THE EXCLUSIVE  
RIGHT TO USE "QUESO", APART FROM THE  
MARK AS SHOWN.

THE FOREIGN WORDING IN THE MARK  
TRANSLATES INTO ENGLISH AS THE CHEESE  
FROM GOOD MILK, THE CHEESE WITH INTEG-  
RITY OR THE CHEESE IN GOOD FAITH.

SN 78-884,513, FILED 5-16-2006.

MARK PILARO, EXAMINING ATTORNEY



**Int. Cls.: 38, 39, 40, and 42**

**Prior U.S. Cls.: 100, 101, 103, 104, 105, and 106**

**United States Patent and Trademark Office**

**Reg. No. 3,396,327**

**Registered Mar. 11, 2008**

**SERVICE MARK  
PRINCIPAL REGISTER**



DIGITAL NOW, INC. (VIRGINIA CORPORATION)

512 HERNDON PARKWAY, SUITE F  
HERNDON, VA 20171

FOR: PROVISION OF ACCESS TO DIGITAL CONTENT, MEDIA, AND IMAGES AND ELECTRONICALLY-STORED DATA, INFORMATION, COMPUTER FILES, PHOTOGRAPHS, VIDEOS, TEXT AND DOCUMENTS STORED ELECTRONICALLY IN CENTRAL FILES, IN CLASS 38 (U.S. CLS. 100, 101 AND 104).

FIRST USE 3-29-2006; IN COMMERCE 10-4-2006.

FOR: NETWORK BASED AND WIRELESS BASED STORAGE OF DIGITAL CONTENT, MEDIA, AND IMAGES AND ELECTRONICALLY-STORED DATA, INFORMATION, COMPUTER FILES, PHOTOGRAPHS, VIDEOS, TEXT AND DOCUMENTS; PROVIDING ONLINE STORAGE OF DIGITAL CONTENT, MEDIA, AND IMAGES AND ELECTRONICALLY-STORED DATA, INFORMATION, COMPUTER FILES, PHOTOGRAPHS, VIDEOS, TEXT AND DOCUMENTS; ELECTRONIC STORAGE OF DIGITAL CONTENT, MEDIA, AND IMAGES AND ELECTRONICALLY-STORED DATA, INFORMATION, COMPUTER FILES, PHOTOGRAPHS, VIDEOS, TEXT AND DOCUMENTS; COMPUTER SERVICES, NAMELY, STORAGE OF RESOURCES AVAILABLE ON COMPUTER NETWORKS, IN CLASS 39 (U.S. CLS. 100 AND 105).

FIRST USE 3-29-2006; IN COMMERCE 10-4-2006.

FOR: PHOTOFINISHING; PRINTING OF IMAGES; ELECTRONIC IMAGING, SCANNING, DIGITIZING, ALTERATION AND RETOUCHING OF DIGITAL CONTENT, MEDIA, AND IMAGES AND PHOTOS AND VIDEOS; PRINTING SERVICES, NAMELY, PRINTING OF PHOTOGRAPHIC FILM AND DIGITAL IMAGES ONTO PHOTOGRAPHIC PAPER AND CLOTHING, BAGS, BLANKETS, MERCHANDISE; CUSTOM MANUFACTURE OF MEDIA ACCESSORIES, NAMELY, POST CARDS, GREETING CARDS, AND CALENDARS, IN CLASS 40 (U.S. CLS. 100, 103 AND 106).

FIRST USE 3-29-2006; IN COMMERCE 10-4-2006.

FOR: PROVIDING ELECTRONIC SERVICES ENABLING USERS TO MANAGE, ANNOTATE, SAVE, SHARE, SEARCH FOR, BROWSE AND RELOCATE INFORMATION AVAILABLE ON THE INTERNET AND ON OTHER PUBLIC AND PRIVATE COMPUTER NETWORKS AND COMPUTERS, NAMELY, PROVIDING TEMPORARY USE OF ONLINE NON-DOWNLOADABLE HOSTED SOFTWARE FOR USE TO MANAGE, ANNOTATE, SAVE, SHARE, SEARCH FOR, BROWSE AND RELOCATE INFORMATION AVAILABLE ON THE INTERNET AND ON OTHER PUBLIC AND PRIVATE COMPUTER NETWORKS AND COMPUTERS; COMPUTER SERVICES, NAMELY, CREATING INDEXES OF RESOURCES AVAILABLE ON COMPUTER NETWORKS; PROVIDING CUSTOMIZED ON-LINE WEBPAGES FEATURING USER-DEFINED INFORMATION; HOSTING COMPUTER SOFTWARE APPLICATIONS OF OTHERS; TRANSFER SERVICE FOR CONTENT, MEDIA, AND IMAGES FROM A DIGITAL CAPTURE DEVICE TO A COMPUTER OR

NETWORK; TRANSFER SERVICE FOR CONTENT,  
MEDIA, AND IMAGES FROM ONE MEDIA TO A  
COMPUTER OR NETWORK, IN CLASS 42 (U.S. CLS.  
100 AND 101).

SN 78-884,558, FILED 5-16-2006.

FIRST USE 3-29-2006; IN COMMERCE 10-4-2006.

KEVIN DINALLO, EXAMINING ATTORNEY

**Int. Cls.: 8 and 21**

**Prior U.S. Cls.: 2, 13, 23, 28, 29, 30, 33, 40, 44, and 50**

**United States Patent and Trademark Office**

**Reg. No. 3,396,328**

**Registered Mar. 11, 2008**

**TRADEMARK  
PRINCIPAL REGISTER**

**Denmark Tools for Cooks**

TABLETOPS UNLIMITED, INC (CALIFORNIA CORPORATION)  
23000 AVALON BLVD  
CARSON, CA 90745

FOR: CUTLERY; NAMELY, KITCHEN KNIVES, IN CLASS 8 (U.S. CLS. 23, 28 AND 44).

FIRST USE 10-22-2007; IN COMMERCE 10-22-2007.

FOR: COOKWARE; NAMELY, PANS, CASSEROLE DISH, BAKING DISH, CUPS, PLATES, BOWLS, SAUCER, IN CLASS 21 (U.S. CLS. 2, 13, 23, 29, 30, 33, 40 AND 50).

FIRST USE 12-20-2007; IN COMMERCE 12-20-2007.

THE MARK CONSISTS OF STANDARD CHARACTERS WITHOUT CLAIM TO ANY PARTICULAR FONT, STYLE, SIZE, OR COLOR.

NO CLAIM IS MADE TO THE EXCLUSIVE RIGHT TO USE "TOOLS FOR COOKS", APART FROM THE MARK AS SHOWN.

SN 78-886,815, FILED 5-18-2006.

MARY MUNSON, EXAMINING ATTORNEY

**Int. Cl.: 5**

**Prior U.S. Cls.: 6, 18, 44, 46, 51, and 52**

**Reg. No. 3,396,329**

**United States Patent and Trademark Office**

**Registered Mar. 11, 2008**

**TRADEMARK  
PRINCIPAL REGISTER**

**THE TRUSTED, PROVEN  
FORMULA FOR IMMUNE SUPPORT.**

**DAIWA PHARMACEUTICAL CO., LTD. (JAPAN  
CORPORATION)  
1-16-19 SANGENJAYA, SETAGAYA-KU  
TOKYO, JAPAN 154-0024**

**THE MARK CONSISTS OF STANDARD CHAR-  
ACTERS WITHOUT CLAIM TO ANY PARTICULAR  
FONT, STYLE, SIZE, OR COLOR.**

**FOR: NUTRACEUTICALS FOR USE AS DIETARY  
SUPPLEMENTS; NUTRITIONAL AND DIETARY  
SUPPLEMENTS; FUNCTIONAL FOODS AND  
FUNCTIONAL FOOD ADDITIVES, NAMELY, DIET-  
ARY FIBER, ENZYMATICALLY MODIFIED RICE  
BRAN AND DERIVATIVES THEREOF, FOR USE AS  
A FOOD SUPPLEMENT, IN CLASS 5 (U.S. CLS. 6, 18,  
44, 46, 51 AND 52).**

**NO CLAIM IS MADE TO THE EXCLUSIVE  
RIGHT TO USE "IMMUNE", APART FROM THE  
MARK AS SHOWN.**

**SN 78-887,704, FILED 5-19-2006.**

**FIRST USE 8-10-2005; IN COMMERCE 8-10-2005.**

**SEAN CROWLEY, EXAMINING ATTORNEY**

**Int. Cl.: 1**

**Prior U.S. Cls.: 1, 5, 6, 10, 26, and 46**

**Reg. No. 3,396,330**

**United States Patent and Trademark Office**

**Registered Mar. 11, 2008**

---

**TRADEMARK  
PRINCIPAL REGISTER**

**FLIGHTGUARD**

THE DOW CHEMICAL COMPANY (DELAWARE  
CORPORATION)  
TRADEMARK & COPYRIGHT PRACTICE GROUP  
2030 DOW CENTER  
MIDLAND, MI 48674

THE MARK CONSISTS OF STANDARD CHAR-  
ACTERS WITHOUT CLAIM TO ANY PARTICULAR  
FONT, STYLE, SIZE, OR COLOR.

FOR: AIRCRAFT ANTI-ICING AND DE-ICING  
CHEMICALS, IN CLASS 1 (U.S. CLS. 1, 5, 6, 10, 26  
AND 46).

SN 78-888,733, FILED 5-22-2006.

FIRST USE 10-4-2006; IN COMMERCE 10-4-2006.

CURTIS FRENCH, EXAMINING ATTORNEY

**Int. Cls.: 18 and 25**

**Prior U.S. Cls.: 1, 2, 3, 22, 39, and 41**

**United States Patent and Trademark Office**

**Reg. No. 3,396,331**

**Registered Mar. 11, 2008**

**TRADEMARK  
PRINCIPAL REGISTER**

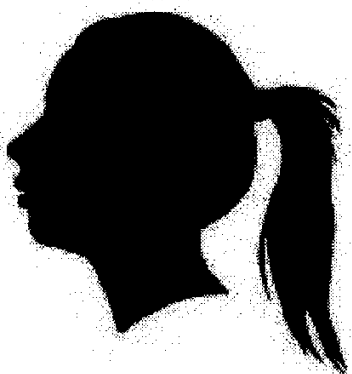

GENERIC YOUTH, LLC (CALIFORNIA LTD  
LIAB CO)  
6705 SEASHORE DRIVE  
NEWPORT BEACH, CA 92663

FOR: BACKPACKS, KNAPSACKS, DAYPACKS,  
IN CLASS 18 (U.S. CLS. 1, 2, 3, 22 AND 41).

FIRST USE 7-0-2004; IN COMMERCE 7-0-2004.

FOR: CLOTHING, NAMELY, SHIRTS, T-SHIRTS,  
SWEAT SHIRTS, SWEAT PANTS, JEANS, PANTS,  
SHORTS, SKIRTS, DRESSES, JACKETS, SWEATERS,  
VESTS, COVER-UPS, BOXER SHORTS, CAPS, IN  
CLASS 25 (U.S. CLS. 22 AND 39).

FIRST USE 7-0-2004; IN COMMERCE 7-0-2004.

THE NAME(S), PORTRAIT(S), AND/OR SIGNA-  
TURE(S) SHOWN IN THE MARK IDENTIFIES  
COCO GABRIELLE YOKOYAMA, WHOSE CON-  
SENT(S) TO REGISTER IS SUBMITTED.

THE MARK CONSISTS OF A SILHOUETTE OF A  
YOUNG WOMAN'S HEAD IN PROFILE FACING  
LEFT.

SN 78-889,129, FILED 5-22-2006.

DORITT L. CARROLL, EXAMINING ATTORNEY

**Int. Cl.: 9**

**Prior U.S. Cls.: 21, 23, 26, 36, and 38**

**United States Patent and Trademark Office**

**Reg. No. 3,396,332**

**Registered Mar. 11, 2008**

**TRADEMARK  
PRINCIPAL REGISTER**

# ChiralMotion

SYNAPTICS, INC. (DELAWARE CORPORATION)  
SUITE 130  
3120 SCOTT BLVD.  
SANTA CLARA, CA 95054

THE MARK CONSISTS OF STANDARD CHARACTERS WITHOUT CLAIM TO ANY PARTICULAR FONT, STYLE, SIZE, OR COLOR.

FOR: GRAPHICAL USER INTERFACE SOFTWARE, IN CLASS 9 (U.S. CLS. 21, 23, 26, 36 AND 38).

SN 78-890,029, FILED 5-23-2006.

FIRST USE 1-8-2007; IN COMMERCE 1-8-2007.

JOHN WILKE, EXAMINING ATTORNEY

**Int. Cl.: 1**

**Prior U.S. Cls.: 1, 5, 6, 10, 26, and 46**

**Reg. No. 3,396,333**

**United States Patent and Trademark Office**

**Registered Mar. 11, 2008**

---

**TRADEMARK  
PRINCIPAL REGISTER**

**HIGHSOLV**

CLARIANT SPECIALTY FINE CHEMICALS  
(FRANCE) (FRANCE CORPORATION)  
70 AVENUE DU GENERAL DE GAULLE  
PUTEAUX, FRANCE 92800

FOR: SOLVENTS FOR INDUSTRIAL WATER-  
BASED APPLICATIONS IN THE FIELD OF PAINTS  
AND COATINGS, FOUNDRY, CLEANING AND  
DEGREASING, IN CLASS 1 (U.S. CLS. 1, 5, 6, 10, 26  
AND 46).

FIRST USE 5-4-2007; IN COMMERCE 5-4-2007.

THE MARK CONSISTS OF STANDARD CHAR-  
ACTERS WITHOUT CLAIM TO ANY PARTICULAR  
FONT, STYLE, SIZE, OR COLOR.

SN 78-890,381, FILED 5-23-2006.

JULIE GUTTADAURO, EXAMINING ATTORNEY



**Int. Cl.: 36**

**Prior U.S. Cls.: 100, 101, and 102**

**United States Patent and Trademark Office**

**Reg. No. 3,396,334**

**Registered Mar. 11, 2008**

**SERVICE MARK  
PRINCIPAL REGISTER**

**MONACO FINANCIAL SERVICES**

MONACO COACH CORPORATION (DELAWARE  
CORPORATION)  
91320 COBURG INDUSTRIAL WAY  
COBURG, OR 97408

OWNER OF U.S. REG. NO. 2,655,209.

FOR: WHOLESALE AND RETAIL FINANCING  
PROGRAMS FOR RECREATIONAL VEHICLES, IN  
CLASS 36 (U.S. CLS. 100, 101 AND 102).

NO CLAIM IS MADE TO THE EXCLUSIVE  
RIGHT TO USE "FINANCIAL SERVICES", APART  
FROM THE MARK AS SHOWN.

FIRST USE 6-13-2006; IN COMMERCE 6-13-2006.

SN 78-891,457, FILED 5-24-2006.

THE MARK CONSISTS OF STANDARD CHAR-  
ACTERS WITHOUT CLAIM TO ANY PARTICULAR  
FONT, STYLE, SIZE, OR COLOR.

DARRYL SPRUILL, EXAMINING ATTORNEY

**Int. Cl.: 36**

**Prior U.S. Cls.: 100, 101, and 102**

**United States Patent and Trademark Office**

**Reg. No. 3,396,335**

**Registered Mar. 11, 2008**

**SERVICE MARK  
PRINCIPAL REGISTER**



SNOWCREEK INVESTMENT COMPANY L.P.  
(CALIFORNIA LIMITED PARTNERSHIP)  
2716 OCEAN PARK BOULEVARD  
SUITE 1064  
SANTA MONICA, CA 90405

FOR: REAL ESTATE INVESTMENT; REAL ESTATE LISTING; REAL ESTATE BROKERAGE; LEASING OF REAL ESTATE; ASSESSMENT AND MANAGEMENT OF REAL ESTATE; REAL ESTATE AGENCIES; REAL ESTATE SERVICES, NAMELY, RENTAL OF VACATION HOMES, CONDOMINIUMS, CABINS, AND VILLAS, IN CLASS 36 (U.S. CLS. 100, 101 AND 102).

THE COLOR(S) GOLD AND YELLOW IS/ARE CLAIMED AS A FEATURE OF THE MARK.

THE MARK CONSISTS OF A SNOWFLAKE WITH THE WORDING "SNOWCREEK" UNDERNEATH THE SNOWFLAKE AND THE COLOR GOLD APPEARS IN THE SNOWFLAKE AND THE COLOR YELLOW APPEARS IN THE WORDING "SNOW-CREEK".

SN 78-891,596, FILED 5-24-2006.

FIRST USE 12-31-1978; IN COMMERCE 12-31-1978.

MICHAEL WEBSTER, EXAMINING ATTORNEY

**Int. Cl.: 3**

**Prior U.S. Cls.: 1, 4, 6, 50, 51, and 52**

**United States Patent and Trademark Office**

**Reg. No. 3,396,336**

**Registered Mar. 11, 2008**

**TRADEMARK  
PRINCIPAL REGISTER**

**MANHATTAN MAGIC**

KLAMER, ANDREW LOREN (UNITED STATES  
INDIVIDUAL)  
10537 CLEARWOOD CT.  
LOS ANGELES, CA 90077

FOR: PERSONAL CARE COSMETICS, NAMELY,  
SHOWER AND BATH PRODUCTS, NAMELY,  
SHAMPOO, HAIR CONDITIONER, BATH GELS,  
BUBBLE BATH, BATH SALTS, BATH SCRUBS,  
HAIR PRODUCTS NAMELY HAIR GEL AND STY-  
LING MOUSSE; HAND CREAMS, SKIN LOTIONS,  
LIP BALMS, SKIN MOISTURIZERS, BODY SOAPS,  
FACE SOAPS, AND SUNTAN LOTIONS CONTAIN-  
ING SUNSCREEN; PERSONAL DEODORANTS  
AND BODY SPRAYS, PERSONAL WATER MISTING  
SPRAYS IN THE NATURE OF BODY SPRAYS,  
NAMELY WATER IN ATOMIZED CONTAINERS

USED TO PRODUCE A COOLING EFFECT; ARO-  
MATHERAPY PRODUCTS, NAMELY, AROMA-  
THERAPY CREAMS, OILS AND LOTIONS, IN  
CLASS 3 (U.S. CLS. 1, 4, 6, 50, 51 AND 52).

FIRST USE 12-21-2006; IN COMMERCE 12-21-2006.

THE MARK CONSISTS OF STANDARD CHAR-  
ACTERS WITHOUT CLAIM TO ANY PARTICULAR  
FONT, STYLE, SIZE, OR COLOR.

SN 78-892,193, FILED 5-24-2006.

ANDREA K. NADELMAN, EXAMINING ATTOR-  
NEY

**Int. Cl.: 28**

**Prior U.S. Cls.: 22, 23, 38, and 50**

**United States Patent and Trademark Office**

**Reg. No. 3,396,337**

**Registered Mar. 11, 2008**

---

**TRADEMARK  
PRINCIPAL REGISTER**

**AMONTE**

WARRIOR SPORTS, INC. (MICHIGAN CORPORATION)  
32125 HOLLINGSWORTH AVE.  
WARREN, MI 48092

THE MARK CONSISTS OF STANDARD CHARACTERS WITHOUT CLAIM TO ANY PARTICULAR FONT, STYLE, SIZE, OR COLOR.

FOR: SPORTS EQUIPMENT FOR USE IN THE GAMES OF LACROSSE, NAMELY LACROSSE HEADS AND LACROSSE STICKS, IN CLASS 28 (U.S. CLS. 22, 23, 38 AND 50).

SN 78-892,865, FILED 5-25-2006.

FIRST USE 10-24-2006; IN COMMERCE 10-24-2006.

LOURDES AYALA, EXAMINING ATTORNEY

**Int. Cl.: 20**

**Prior U.S. Cls.: 2, 13, 22, 25, 32, and 50**

**United States Patent and Trademark Office**

**Reg. No. 3,396,338**

**Registered Mar. 11, 2008**

**TRADEMARK  
PRINCIPAL REGISTER**

**AMALIO RUSSO**

YABLONKA, GREGORIO (ARGENTINA INDIVIDUAL)

AV. DEL LIBERTADOR 4934, 1º

BUENOS AIRES, ARGENTINA

FOR: FURNITURE, IN CLASS 20 (U.S. CLS. 2, 13, 22, 25, 32 AND 50).

FIRST USE 0-0-1990; IN COMMERCE 1-5-1991.

THE MARK CONSISTS OF STANDARD CHARACTERS WITHOUT CLAIM TO ANY PARTICULAR FONT, STYLE, SIZE, OR COLOR.

THE NAME(S), PORTRAIT(S), AND/OR SIGNATURE(S) SHOWN IN THE MARK DOES NOT IDENTIFY A PARTICULAR LIVING INDIVIDUAL.

SN 78-895,699, FILED 5-30-2006.

GISELLE AGOSTO, EXAMINING ATTORNEY

**Int. Cl.: 21**

**Prior U.S. Cls.: 2, 13, 23, 29, 30, 33, 40, and 50**

**United States Patent and Trademark Office**

**Reg. No. 3,396,339**

**Registered Mar. 11, 2008**

**TRADEMARK  
PRINCIPAL REGISTER**

**BABU**

BABU, INC. (D.C. CORPORATION)  
319 FIFTH STREET, S.E.  
WASHINGTON, DC 20003

THE MARK CONSISTS OF STANDARD CHAR-  
ACTERS WITHOUT CLAIM TO ANY PARTICULAR  
FONT, STYLE, SIZE, OR COLOR.

FOR: DISHES, NAMELY, PET FEEDING DISHES,  
IN CLASS 21 (U.S. CLS. 2, 13, 23, 29, 30, 33, 40 AND 50).

SN 78-897,136, FILED 5-31-2006.

FIRST USE 11-30-2006; IN COMMERCE 11-30-2006.

MICHAEL GAAFAR, EXAMINING ATTORNEY

**Int. Cl.: 25**

**Prior U.S. Cls.: 22 and 39**

**United States Patent and Trademark Office**

**Reg. No. 3,396,340**

**Registered Mar. 11, 2008**

**TRADEMARK  
PRINCIPAL REGISTER**

**WICKED WEST**

EXPRESS, LLC (DELAWARE LTD LIAB CO)  
ONE LIMITED PARKWAY  
ATTN: KATHY HAMILTON  
COLUMBUS, OH 43230

THE MARK CONSISTS OF STANDARD CHAR-  
ACTERS WITHOUT CLAIM TO ANY PARTICULAR  
FONT, STYLE, SIZE, OR COLOR.

FOR: CLOTHING, NAMELY, JEANS, PANTS,  
DENIMS, IN CLASS 25 (U.S. CLS. 22 AND 39).

SN 78-897,338, FILED 5-31-2006.

FIRST USE 10-31-2006; IN COMMERCE 10-31-2006.

ROBERT STRUCK, EXAMINING ATTORNEY

**Int. Cl.: 30**

**Prior U.S. Cl.: 46**

**United States Patent and Trademark Office**

**Reg. No. 3,396,341**

**Registered Mar. 11, 2008**

**TRADEMARK  
PRINCIPAL REGISTER**

# Pearls of Wisdom

BEDARE LLC (CONNECTICUT LTD LIAB CO)  
42 STONEBROOK LANE  
COS COB, CT 06807

THE MARK CONSISTS OF STANDARD CHAR-  
ACTERS WITHOUT CLAIM TO ANY PARTICULAR  
FONT, STYLE, SIZE, OR COLOR.

FOR: CANDY, CHOCOLATE, CHOCOLATE POW-  
DER, CHOCOLATE SYRUP, CHOCOLATE CHIPS,  
COCOA, COCOA MIXES, FROZEN CONFECTIONS,  
IN CLASS 30 (U.S. CL. 46).

SN 78-897,744, FILED 6-1-2006.

FIRST USE 9-15-2007; IN COMMERCE 9-15-2007.

JASON LOTT, EXAMINING ATTORNEY



**Int. Cl.: 9**

**Prior U.S. Cls.: 21, 23, 26, 36, and 38**

**Reg. No. 3,396,342**

**United States Patent and Trademark Office**

**Registered Mar. 11, 2008**

---

**TRADEMARK  
PRINCIPAL REGISTER**

**TrueElement**

D3 LED, LLC (DELAWARE LIMITED LIABILITY CORPORATION)  
SUITE 1412  
380 MOUNTAIN ROAD  
UNION CITY, NJ 07087

FOR: LED DIGITAL DISPLAYS FOR COMMERCIAL USAGE, LED LUMINOUS SIGNS FOR COMMERCIAL USAGE, LED DISPLAYS FOR COMMERCIAL USAGE, IN CLASS 9 (U.S. CLS. 21, 23, 26, 36 AND 38).

FIRST USE 8-13-2007; IN COMMERCE 8-13-2007.

THE MARK CONSISTS OF STANDARD CHARACTERS WITHOUT CLAIM TO ANY PARTICULAR FONT, STYLE, SIZE, OR COLOR.

SN 78-898,822, FILED 6-2-2006.

ANDREA K. NADELMAN, EXAMINING ATTORNEY

**Int. Cl.: 25**

**Prior U.S. Cls.: 22 and 39**

**United States Patent and Trademark Office**

**Reg. No. 3,396,343**

**Registered Mar. 11, 2008**

**TRADEMARK  
PRINCIPAL REGISTER**

**NO BAD DAYS**

SAMPLE, SCOTT T (UNITED STATES INDIVIDUAL), DBA NO BAD DAYS,  
40758 CARTIER ST  
MURRIETA, CA 92563

THE MARK CONSISTS OF STANDARD CHARACTERS WITHOUT CLAIM TO ANY PARTICULAR FONT, STYLE, SIZE, OR COLOR.

FOR: HATS; JACKETS; PANTS; SHIRTS; SHORTS; SWEATERS; SWIMSUITS; T-SHIRTS, IN CLASS 25 (U.S. CLS. 22 AND 39).

SN 78-898,963, FILED 6-2-2006.

FIRST USE 7-1-1998; IN COMMERCE 11-26-2002.

KEVIN CORWIN, EXAMINING ATTORNEY

**Int. Cls.: 12, 35, and 37**

**Prior U.S. Cls.: 19, 21, 23, 31, 35, 44, 100, 101, 102, 103, and 106**

**Reg. No. 3,396,344**

**United States Patent and Trademark Office**

**Registered Mar. 11, 2008**

**TRADEMARK  
SERVICE MARK  
PRINCIPAL REGISTER**



BIG O TIRES, INC. (NEVADA CORPORATION)  
SUITE 2-D  
12650 EAST BRIARWOOD AVENUE  
CENTENNIAL, CO 80112

FOR: TIRES, IN CLASS 12 (U.S. CLS. 19, 21, 23, 31, 35 AND 44).

FIRST USE 9-6-2005; IN COMMERCE 3-23-2006.

FOR: RETAIL STORES FEATURING VEHICLE PARTS AND ACCESSORIES; RETAIL TIRE STORES, IN CLASS 35 (U.S. CLS. 100, 101 AND 102).

FIRST USE 9-6-2005; IN COMMERCE 9-6-2005.

FOR: VEHICLE REPAIR AND MAINTENANCE, IN CLASS 37 (U.S. CLS. 100, 103 AND 106).

FIRST USE 9-6-2005; IN COMMERCE 9-6-2005.

THE COLOR(S) GRAY, BLUE, RED, BLACK AND WHITE IS/ARE CLAIMED AS A FEATURE OF THE MARK.

THE MARK CONSISTS OF GRAY FIGURE WITH BLACK PAWS AND HAIR, RED SHIRT WITH WHITE LETTERING, RED NOSE, BLUE, BLACK AND WHITE EYES.

SN 78-899,189, FILED 6-2-2006.

CAROLYN CATALDO, EXAMINING ATTORNEY

**Int. Cl.: 9**

**Prior U.S. Cls.: 21, 23, 26, 36, and 38**

**United States Patent and Trademark Office**

**Reg. No. 3,396,345**

**Registered Mar. 11, 2008**

**TRADEMARK  
PRINCIPAL REGISTER**

**CANTATA**

DIALOGIC CORPORATION (CANADA CORPORATION)  
9800 CAVENDISH BLVD., 5TH FLOOR  
MONTREAL, CANADA H4M 2V9

FOR: COMPUTER HARDWARE IN THE FIELD OF VOICE AND DATA COMMUNICATIONS; COMPUTER SOFTWARE IN THE FIELD OF VOICE AND DATA COMMUNICATIONS, NAMELY, COMPUTER SOFTWARE FOR ENABLING USERS TO CREATE AND DELIVER COMMUNICATIONS APPLICATIONS, IN CLASS 9 (U.S. CLS. 21, 23, 26, 36 AND 38).

FIRST USE 3-16-2006; IN COMMERCE 3-16-2006.

THE MARK CONSISTS OF STANDARD CHARACTERS WITHOUT CLAIM TO ANY PARTICULAR FONT, STYLE, SIZE, OR COLOR.

SN 78-901,271, FILED 6-6-2006.

JORDAN BAKER, EXAMINING ATTORNEY

**Int. Cl.: 36**

**Prior U.S. Cls.: 100, 101, and 102**

**United States Patent and Trademark Office**

**Reg. No. 3,396,346**

**Registered Mar. 11, 2008**

**SERVICE MARK  
PRINCIPAL REGISTER**



MONACO COACH CORPORATION (DELAWARE CORPORATION)  
91320 COBURG INDUSTRIAL WAY  
COBURG, OR 97408

NO CLAIM IS MADE TO THE EXCLUSIVE RIGHT TO USE "FINANCIAL SERVICES", APART FROM THE MARK AS SHOWN.

FOR: WHOLESALE AND RETAIL FINANCING PROGRAMS FOR RECREATIONAL VEHICLES, IN CLASS 36 (U.S. CLS. 100, 101 AND 102).

SN 78-901,418, FILED 6-6-2006.

FIRST USE 6-13-2006; IN COMMERCE 6-13-2006.

DARRYL SPRUILL, EXAMINING ATTORNEY

**Int. Cls.: 32 and 33**

**Prior U.S. Cls.: 45, 46, 47, 48, and 49**

**United States Patent and Trademark Office**

**Reg. No. 3,396,347**

**Registered Mar. 11, 2008**

**TRADEMARK  
PRINCIPAL REGISTER**

**UNCLE SAM**

UNCLE SAM REALTY INC. (CALIFORNIA CORPORATION)  
3857 PELL PLACE #301  
SAN DIEGO, CA 92130

FOR: BEER; COLAS; ENERGY DRINKS; FRUIT DRINKS; SOFT DRINKS, IN CLASS 32 (U.S. CLS. 45, 46 AND 48).

FIRST USE 11-30-2007; IN COMMERCE 11-30-2007.

FOR: ALCOHOLIC PUNCH; WINE; WINE COOLERS, IN CLASS 33 (U.S. CLS. 47 AND 49).

FIRST USE 11-30-2007; IN COMMERCE 11-30-2007.

THE MARK CONSISTS OF STANDARD CHARACTERS WITHOUT CLAIM TO ANY PARTICULAR FONT, STYLE, SIZE, OR COLOR.

SN 78-901,559, FILED 6-6-2006.

JENNIFER MARTIN, EXAMINING ATTORNEY

**Int. Cl.: 9**

**Prior U.S. Cls.: 21, 23, 26, 36, and 38**

**Reg. No. 3,396,348**

**United States Patent and Trademark Office**

**Registered Mar. 11, 2008**

---

**TRADEMARK  
PRINCIPAL REGISTER**

**VISION**

VIAFLO (DELAWARE CORPORATION)  
2 WENTWORTH DRIVE  
HUDSON, NH 03051

THE MARK CONSISTS OF STANDARD CHAR-  
ACTERS WITHOUT CLAIM TO ANY PARTICULAR  
FONT, STYLE, SIZE, OR COLOR.

FOR: HAND-HELD PIPETTORS FOR USE IN  
CLINICAL AND RESEARCH LABORATORIES, IN  
CLASS 9 (U.S. CLS. 21, 23, 26, 36 AND 38).

SN 78-902,063, FILED 6-6-2006.

FIRST USE 10-1-2007; IN COMMERCE 10-1-2007.

LINDA ORNDORFF, EXAMINING ATTORNEY

**Int. Cl.: 9**

**Prior U.S. Cls.: 21, 23, 26, 36, and 38**

**Reg. No. 3,396,349**

**United States Patent and Trademark Office**

**Registered Mar. 11, 2008**

---

**TRADEMARK  
PRINCIPAL REGISTER**

**izzit**

THE PALMER R CHITESTER FUND, INC.  
(PENNSYLVANIA CORPORATION)  
SUITE 1  
2002 FILMORE AVENUE  
ERIE, PA 16506

THE MARK CONSISTS OF STANDARD CHAR-  
ACTERS WITHOUT CLAIM TO ANY PARTICULAR  
FONT, STYLE, SIZE, OR COLOR.

FOR: PRE-RECORDED EDUCATIONAL VIDEO  
TAPES IN THE FIELD OF SOCIAL STUDIES, IN  
CLASS 9 (U.S. CLS. 21, 23, 26, 36 AND 38).

SN 78-903,418, FILED 6-8-2006.

FIRST USE 9-19-2006; IN COMMERCE 9-19-2006.

BARBARA GAYNOR, EXAMINING ATTORNEY



**Int. Cl.: 36**

**Prior U.S. Cls.: 100, 101, and 102**

**United States Patent and Trademark Office**

**Reg. No. 3,396,350**

**Registered Mar. 11, 2008**

**SERVICE MARK  
PRINCIPAL REGISTER**

**QuickClear**

RT LAWRENCE CORPORATION (CALIFORNIA  
CORPORATION)  
14111 FREEWAY DRIVE SUITE 200  
SANTA FE SPRINGS, CA 90670

THE MARK CONSISTS OF STANDARD CHAR-  
ACTERS WITHOUT CLAIM TO ANY PARTICULAR  
FONT, STYLE, SIZE, OR COLOR.

FOR: ELECTRONIC PAYMENT, NAMELY, ELEC-  
TRONIC PROCESSING AND TRANSMISSION OF  
BILL PAYMENT DATA, IN CLASS 36 (U.S. CLS. 100,  
101 AND 102).

SN 78-903,906, FILED 6-8-2006.

FIRST USE 3-22-2007; IN COMMERCE 3-22-2007.

KAREN K. BUSH, EXAMINING ATTORNEY

**Int. Cls.: 35 and 45**

**Prior U.S. Cls.: 100, 101, and 102**

**United States Patent and Trademark Office**

**Reg. No. 3,396,351**

**Registered Mar. 11, 2008**

**SERVICE MARK  
PRINCIPAL REGISTER**

**STRAT B**

STRAT B, INC. (NEW YORK CORPORATION)  
134 SPRING STREET  
NEW YORK, NY 10012

FIRST USE 1-4-2007; IN COMMERCE 1-4-2007.

FOR: BUSINESS CONSULTATION SERVICES;  
BUSINESS DEVELOPMENT SERVICES, NAMELY,  
PROVIDING STARTUP SUPPORT FOR BUSINES-  
SES, IN CLASS 35 (U.S. CLS. 100, 101 AND 102).

THE MARK CONSISTS OF STANDARD CHAR-  
ACTERS WITHOUT CLAIM TO ANY PARTICULAR  
FONT, STYLE, SIZE, OR COLOR.

FIRST USE 2-16-2006; IN COMMERCE 2-16-2006.

SN 78-904,687, FILED 6-9-2006.

FOR: PERSONAL LIFESTYLE CONSULTING  
SERVICES, IN CLASS 45 (U.S. CLS. 100 AND 101).

DOMINIC J. FERRAIUOLO, EXAMINING ATTOR-  
NEY

**Int. Cl.: 9**

**Prior U.S. Cls.: 21, 23, 26, 36, and 38**

**Reg. No. 3,396,352**

**United States Patent and Trademark Office**

**Registered Mar. 11, 2008**

**TRADEMARK  
PRINCIPAL REGISTER**



UPLAYME, INC. (DELAWARE CORPORATION)  
30 CROSBY STREET, UNIT 3B  
NEW YORK, NY 10013

THE MARK CONSISTS OF THE WORD MARK  
"UPLAYME" WITH A DESIGN OF A TRIANGLE  
INSIDE A CIRCLE MADE UP OF SMALLER CIRCLE  
DOTS.

FOR: SOFTWARE ENABLING USERS TO FORM  
ONLINE COMMUNITIES BASED ON SUCH USERS'  
CONSUMPTION OF DIGITAL CONTENT, IN CLASS  
9 (U.S. CLS. 21, 23, 26, 36 AND 38).

SN 78-905,061, FILED 6-9-2006.

FIRST USE 5-1-2006; IN COMMERCE 5-1-2006.

GIANCARLO CASTRO, EXAMINING ATTORNEY

**Int. Cl.: 30**

**Prior U.S. Cl.: 46**

**United States Patent and Trademark Office**

**Reg. No. 3,396,353**

**Registered Mar. 11, 2008**

**TRADEMARK  
PRINCIPAL REGISTER**

**JOSEPHINE'S**

FAMIGLIA CATERING SERVICES, INC. (FLOR-  
IDA CORPORATION)  
20652 N.W. 27TH AVENUE  
BOCA RATON, FL 33434

THE MARK CONSISTS OF STANDARD CHAR-  
ACTERS WITHOUT CLAIM TO ANY PARTICULAR  
FONT, STYLE, SIZE, OR COLOR.

FOR: SALAD DRESSINGS, IN CLASS 30 (U.S. CL.  
46).

SN 78-907,120, FILED 6-13-2006.

FIRST USE 6-12-2007; IN COMMERCE 6-12-2007.

SANJEEV VOHRA, EXAMINING ATTORNEY

**Int. Cl.: 37**

**Prior U.S. Cls.: 100, 103, and 106**

**United States Patent and Trademark Office**

**Reg. No. 3,396,354**

**Registered Mar. 11, 2008**

**SERVICE MARK  
PRINCIPAL REGISTER**

**IBLUE**

INA ACQUISITION CORP. (DELAWARE CORPORATION)  
NEMOURS BUILDING, SUITE 1410  
1007 ORANGE STREET  
WILMINGTON, DE 19801

FOR: REPAIR AND RECONSTRUCTION OF EXISTING WATER AND GAS MAINS AND INDUSTRIAL PIPELINES BY INSTALLING A LINER WITHIN THE EXISTING CONDUIT AND REINSTATEMENT OF EXISTING SERVICE CONNECTIONS FROM WITHIN THE LINED CONDUIT AND

ESTABLISHING SERVICE CONNECTIONS EXTERNALLY, IN CLASS 37 (U.S. CLS. 100, 103 AND 106).

FIRST USE 7-31-2007; IN COMMERCE 7-31-2007.

THE MARK CONSISTS OF STANDARD CHARACTERS WITHOUT CLAIM TO ANY PARTICULAR FONT, STYLE, SIZE, OR COLOR.

SN 78-907,362, FILED 6-13-2006.

PATRICIA EVANKO, EXAMINING ATTORNEY

**Int. Cl.: 36**

**Prior U.S. Cls.: 100, 101, and 102**

**United States Patent and Trademark Office**

**Reg. No. 3,396,355**

**Registered Mar. 11, 2008**

**SERVICE MARK  
PRINCIPAL REGISTER**



HERITAGE OAKS BANK (CALIFORNIA CORPORATION)  
ATTN: LEGAL DEPARTMENT  
545 12TH STREET  
PASO ROBLES, CA 93446

THE COLOR(S) WHITE, GREEN AND GOLD IS/ARE CLAIMED AS A FEATURE OF THE MARK.

FOR: BANKING; ON-LINE BANKING SERVICES; PROVIDING BANK ACCOUNT INFORMATION BY TELEPHONE, IN CLASS 36 (U.S. CLS. 100, 101 AND 102).

THE MARK CONSISTS OF THE WORDS "HERITAGE OAKS BANK" IN GREEN ACCOMPANIED BY A WHITE AND GOLD ACORN INSIDE OF A GREEN CIRCLE AND THE WORDS "EXPECT MORE" IN GOLD.

FIRST USE 9-5-2006; IN COMMERCE 9-5-2006.

OWNER OF U.S. REG. NO. 2,808,243.

SN 78-907,393, FILED 6-13-2006.

NO CLAIM IS MADE TO THE EXCLUSIVE RIGHT TO USE "BANK", APART FROM THE MARK AS SHOWN.

KEVON CHISOLM, EXAMINING ATTORNEY

**Int. Cl.: 36**

**Prior U.S. Cls.: 100, 101, and 102**

**United States Patent and Trademark Office**

**Reg. No. 3,396,356**

**Registered Mar. 11, 2008**

**SERVICE MARK  
PRINCIPAL REGISTER**

**WACHOVIA PAYMENT BENEFIT  
PLUS**

WACHOVIA CORPORATION (NORTH CAROLINA CORPORATION)  
ONE WACHOVIA CENTER, 30TH FLOOR (NC0630)  
301 S. COLLEGE STREET  
CHARLOTTE, NC 282880630

FOR: DEBT CANCELLATION SERVICES THAT WILL CANEL A MONTHLY PAYMENT OBLIGATION OF AN ENROLLED CUSTOMER IN THE EVENT OF INVOLUNTARY JOB LOSS, HOSPITALIZATION, DISABILITY, EMPLOYER-APPROVED LEAVE OF ABSENCE, OR FEDERAL DECLARED DISASTER, IN CLASS 36 (U.S. CLS. 100, 101 AND 102).

FIRST USE 7-1-2006; IN COMMERCE 7-1-2006.

THE MARK CONSISTS OF STANDARD CHARACTERS WITHOUT CLAIM TO ANY PARTICULAR FONT, STYLE, SIZE, OR COLOR.

OWNER OF U.S. REG. NOS. 1,729,833, 2,805,546, AND OTHERS.

SN 78-909,030, FILED 6-15-2006.

GIANCARLO CASTRO, EXAMINING ATTORNEY

**Int. Cl.: 41**

**Prior U.S. Cls.: 100, 101, and 107**

**United States Patent and Trademark Office**

**Reg. No. 3,396,357**

**Registered Mar. 11, 2008**

**SERVICE MARK  
PRINCIPAL REGISTER**

# Bonagraphic Arts

JONES, CHARLES BRUCE (UNITED STATES  
INDIVIDUAL)  
1844 CORD 4762  
SULPHUR SPRINGS, TX 75482

FOR: COMPOSITION OF MUSIC FOR OTHERS;  
ENTERTAINMENT, NAMELY, LIVE MUSIC CON-  
CERTS; MUSIC COMPOSITION AND TRANSCRIP-  
TION FOR OTHERS; MUSIC PRODUCTION  
SERVICES; MUSIC TRANSCRIPTION FOR OTH-  
ERS; PHOTOGRAPHY SERVICES; PORTRAIT PHO-  
TOGRAPHY; PRESENTATION OF MUSICAL  
PERFORMANCE, IN CLASS 41 (U.S. CLS. 100, 101  
AND 107).

FIRST USE 5-19-2006; IN COMMERCE 5-19-2006.

THE MARK CONSISTS OF STANDARD CHAR-  
ACTERS WITHOUT CLAIM TO ANY PARTICULAR  
FONT, STYLE, SIZE, OR COLOR.

NO CLAIM IS MADE TO THE EXCLUSIVE  
RIGHT TO USE "ARTS", APART FROM THE MARK  
AS SHOWN.

SN 78-909,669, FILED 6-15-2006.

MATTHEW PAPPAS, EXAMINING ATTORNEY



**Int. Cl.: 12**

**Prior U.S. Cls.: 19, 21, 23, 31, 35, and 44**

**Reg. No. 3,396,358**

**United States Patent and Trademark Office**

**Registered Mar. 11, 2008**

---

**TRADEMARK  
PRINCIPAL REGISTER**

**E-merge**

POWERGROUP INTERNATIONAL GROUP, LLC  
(GEORGIA LTD LIAB CO)  
3123 WASHINGTON ROAD  
AUGUSTA, GA 30907

THE MARK CONSISTS OF STANDARD CHAR-  
ACTERS WITHOUT CLAIM TO ANY PARTICULAR  
FONT, STYLE, SIZE, OR COLOR.

FOR: LAND VEHICLES, NAMELY, ON-ROAD,  
LOW-SPEED ELECTRIC VEHICLES, IN CLASS 12  
(U.S. CLS. 19, 21, 23, 31, 35 AND 44).

SN 78-909,760, FILED 6-16-2006.

FIRST USE 11-12-2005; IN COMMERCE 1-5-2007.

ESTHER A. BORSUK, EXAMINING ATTORNEY

**Int. Cl.: 35**

**Prior U.S. Cls.: 100, 101, and 102**

**United States Patent and Trademark Office**

**Reg. No. 3,396,359**

**Registered Mar. 11, 2008**

---

**SERVICE MARK  
PRINCIPAL REGISTER**

**DELIVERING SUCCESS**

CROSSTEX ENERGY, L.P. (DELAWARE LIMITED PARTNERSHIP)  
2501 CEDAR SPRINGS, SUITE 100  
DALLAS, TX 75201

THE MARK CONSISTS OF STANDARD CHARACTERS WITHOUT CLAIM TO ANY PARTICULAR FONT, STYLE, SIZE, OR COLOR.

FOR: BUSINESS MARKETING SERVICES, IN CLASS 35 (U.S. CLS. 100, 101 AND 102).

SN 78-910,477, FILED 6-16-2006.

FIRST USE 9-1-2006; IN COMMERCE 9-1-2006.

JENNIFER MARTIN, EXAMINING ATTORNEY

**Int. Cl.: 9**

**Prior U.S. Cls.: 21, 23, 26, 36, and 38**

**Reg. No. 3,396,360**

**United States Patent and Trademark Office**

**Registered Mar. 11, 2008**

---

**TRADEMARK  
PRINCIPAL REGISTER**

**VisionTune**

NETHRA IMAGING INC. (DELAWARE CORPORATION)  
10710 NORTH TANTAU AVE  
CUPERTINO, CA 95014

THE MARK CONSISTS OF STANDARD CHARACTERS WITHOUT CLAIM TO ANY PARTICULAR FONT, STYLE, SIZE, OR COLOR.

FOR: COMPUTER HARDWARE AND SOFTWARE FOR IMAGE PROCESSING, IN CLASS 9 (U.S. CLS. 21, 23, 26, 36 AND 38).

SN 78-912,087, FILED 6-20-2006.

FIRST USE 3-17-2006; IN COMMERCE 3-23-2007.

BILL DAWE, EXAMINING ATTORNEY

**Int. Cl.: 9**

**Prior U.S. Cls.: 21, 23, 26, 36, and 38**

**Reg. No. 3,396,361**

**United States Patent and Trademark Office**

**Registered Mar. 11, 2008**

---

**TRADEMARK  
PRINCIPAL REGISTER**

**EnVision**

NETHRA IMAGING INC. (DELAWARE CORPORATION)  
10710 NORTH TANTAU AVE  
CUPERTINO, CA 95014

THE MARK CONSISTS OF STANDARD CHARACTERS WITHOUT CLAIM TO ANY PARTICULAR FONT, STYLE, SIZE, OR COLOR.

FOR: COMPUTER HARDWARE AND SOFTWARE FOR IMAGE PROCESSING, IN CLASS 9 (U.S. CLS. 21, 23, 26, 36 AND 38).

SN 78-912,093, FILED 6-20-2006.

FIRST USE 3-17-2006; IN COMMERCE 3-23-2007.

BILL DAWE, EXAMINING ATTORNEY

**Int. Cl.: 21**

**Prior U.S. Cls.: 2, 13, 23, 29, 30, 33, 40, and 50**

**United States Patent and Trademark Office**

**Reg. No. 3,396,362**

**Registered Mar. 11, 2008**

**TRADEMARK  
PRINCIPAL REGISTER**

**ALPINE CUISINE**

SOULAHIAN, RAFFY (UNITED STATES INDIVIDUAL)  
6431 BANDINI BLVD  
COMMERCE, CA 90040

THE MARK CONSISTS OF STANDARD CHARACTERS WITHOUT CLAIM TO ANY PARTICULAR FONT, STYLE, SIZE, OR COLOR.

FOR: POTS AND PANS, IN CLASS 21 (U.S. CLS. 2, 13, 23, 29, 30, 33, 40 AND 50).

SN 78-912,133, FILED 6-20-2006.

FIRST USE 6-0-2006; IN COMMERCE 6-0-2006.

ARETHA SOMERVILLE, EXAMINING ATTORNEY

**Int. Cl.: 9**

**Prior U.S. Cls.: 21, 23, 26, 36, and 38**

**United States Patent and Trademark Office**

**Reg. No. 3,396,363**

**Registered Mar. 11, 2008**

---

**TRADEMARK  
PRINCIPAL REGISTER**

# PerfectColor

NETHRA IMAGING INC. (DELAWARE CORPORATION)  
10710 NORTH TANTAU AVE  
CUPERTINO, CA 95014

THE MARK CONSISTS OF STANDARD CHARACTERS WITHOUT CLAIM TO ANY PARTICULAR FONT, STYLE, SIZE, OR COLOR.

FOR: COMPUTER HARDWARE AND SOFTWARE FOR IMAGE PROCESSING, IN CLASS 9 (U.S. CLS. 21, 23, 26, 36 AND 38).

SN 78-912,169, FILED 6-20-2006.

FIRST USE 3-17-2006; IN COMMERCE 3-23-2007.

BILL DAWE, EXAMINING ATTORNEY

**Int. Cl.: 25**

**Prior U.S. Cls.: 22 and 39**

**United States Patent and Trademark Office**

**Reg. No. 3,396,364**

**Registered Mar. 11, 2008**

**TRADEMARK  
PRINCIPAL REGISTER**

**NO BAD DAYS**

SAMPLE, SCOTT THOMAS (UNITED STATES  
INDIVIDUAL)  
40758 CARTIER ST.  
MURRIETA, CA 92563

FOR: CAPS; HATS; KNITTED CAPS; SHIRTS;  
SHORT-SLEEVED OR LONG-SLEEVED T-SHIRTS;  
T-SHIRTS; BOARD SHORTS; BOXER SHORTS;  
GOLF SHIRTS; JACKETS; KNIT SHIRTS; PANTIES,  
SHORTS AND BRIEFS; PANTS; POLO SHIRTS;  
SHORTS; SUN VISORS; SWEAT SHIRTS; SWEA-  
TERS; SWIMSUITS, IN CLASS 25 (U.S. CLS. 22 AND  
39).

FIRST USE 7-1-1998; IN COMMERCE 11-26-2002.

THE MARK CONSISTS OF STANDARD CHAR-  
ACTERS WITHOUT CLAIM TO ANY PARTICULAR  
FONT, STYLE, SIZE, OR COLOR.

OWNER OF U.S. REG. NO. 2,219,259.

SEC. 2(F).

SN 78-913,274, FILED 6-21-2006.

LINDA POWELL, EXAMINING ATTORNEY

**Int. Cls.: 9, 36, and 42**

**Prior U.S. Cls.: 21, 23, 26, 36, 38, 100, 101, and 102**

**United States Patent and Trademark Office**

**Reg. No. 3,396,365**

**Registered Mar. 11, 2008**

**TRADEMARK  
SERVICE MARK  
PRINCIPAL REGISTER**

**FUNDAMENTAL 1500**

RESEARCH AFFILIATES, LLC (CALIFORNIA  
LTD LIAB CO)  
155 NORTH LAKE AVENUE, SUITE 900  
PASADENA, CA 91101

FOR: COMPUTER SOFTWARE FOR USE IN PROVIDING FINANCIAL AND INVESTMENT INFORMATION SERVICES, NAMELY, PREPARATION OF A FINANCIAL INDEX, A FINANCIAL BENCHMARK, SECURITIES ANALYSIS, CLASSIFICATION AND REPORTING, MUTUAL FUND INVESTING SERVICES, AND ELECTRONICALLY TRADED FUND; ALL FOR THE PROVISION OF AN INDEX-BASED PORTFOLIO OF SECURITIES AND AN INDEX-BASED MUTUAL FUND, IN CLASS 9 (U.S. CLS. 21, 23, 26, 36 AND 38).

FIRST USE 11-3-2006; IN COMMERCE 11-3-2006.

FOR: FINANCIAL SERVICES, NAMELY, PROVIDING FINANCIAL AND INVESTMENT INFORMATION SERVICES IN THE NATURE OF A FINANCIAL INDEX, A FINANCIAL BENCHMARK, SECURITIES ANALYSIS, CLASSIFICATION AND REPORTING SERVICES; MUTUAL FUND INVESTING SERVICES; SECURITIES BROKERAGE SERVICES, NAMELY, ELECTRONICALLY TRADED FUNDS, INDEX BASED DERIVATIVES, AN IN-

DEX-BASED PORTFOLIO OF SECURITIES AND AN INDEX-BASED MUTUAL FUND, IN CLASS 36 (U.S. CLS. 100, 101 AND 102).

FIRST USE 11-3-2006; IN COMMERCE 11-3-2006.

FOR: PROVIDING TEMPORARY USE OF NON-DOWNLOADABLE COMPUTER SOFTWARE FOR INVESTMENT STRATEGY IN THE FIELD OF INVESTING OVER COMPUTER NETWORKS, INTRANET AND THE INTERNET, IN CLASS 42 (U.S. CLS. 100 AND 101).

FIRST USE 11-3-2006; IN COMMERCE 11-3-2006.

THE MARK CONSISTS OF STANDARD CHARACTERS WITHOUT CLAIM TO ANY PARTICULAR FONT, STYLE, SIZE, OR COLOR.

NO CLAIM IS MADE TO THE EXCLUSIVE RIGHT TO USE "1500", APART FROM THE MARK AS SHOWN.

SN 78-913,435, FILED 6-21-2006.

MICHELE SWAIN, EXAMINING ATTORNEY



**Int. Cls.: 9, 36, and 42**

**Prior U.S. Cls.: 21, 23, 26, 36, 38, 100, 101, and 102**

**United States Patent and Trademark Office**

**Reg. No. 3,396,366**

**Registered Mar. 11, 2008**

**TRADEMARK  
SERVICE MARK  
PRINCIPAL REGISTER**

**FUNDAMENTAL 2500**

RESEARCH AFFILIATES, LLC (CALIFORNIA  
LTD LIAB CO)  
155 NORTH LAKE AVENUE, SUITE 900  
PASADENA, CA 91101

FOR: COMPUTER SOFTWARE FOR USE IN PROVIDING FINANCIAL AND INVESTMENT INFORMATION SERVICES, NAMELY, PREPARATION OF A FINANCIAL INDEX, A FINANCIAL BENCHMARK, SECURITIES ANALYSIS, CLASSIFICATION AND REPORTING, MUTUAL FUND INVESTING SERVICES, AND ELECTRONICALLY TRADED FUND; ALL FOR THE PROVISION OF AN INDEX-BASED PORTFOLIO OF SECURITIES AND AN INDEX-BASED MUTUAL FUND, IN CLASS 9 (U.S. CLS. 21, 23, 26, 36 AND 38).

FIRST USE 11-3-2006; IN COMMERCE 11-3-2006.

FOR: FINANCIAL SERVICES, NAMELY, PROVIDING FINANCIAL AND INVESTMENT INFORMATION SERVICES IN THE NATURE OF A FINANCIAL INDEX, A FINANCIAL BENCHMARK, SECURITIES ANALYSIS, CLASSIFICATION AND REPORTING SERVICES; MUTUAL FUND INVESTING SERVICES; SECURITIES BROKERAGE SERVICES, NAMELY, ELECTRONICALLY TRADED FUNDS, INDEX BASED DERIVATIVES, AN IN-

DEX-BASED PORTFOLIO OF SECURITIES AND AN INDEX-BASED MUTUAL FUND, IN CLASS 36 (U.S. CLS. 100, 101 AND 102).

FIRST USE 11-3-2006; IN COMMERCE 11-3-2006.

FOR: PROVIDING TEMPORARY USE OF NON-DOWNLOADABLE COMPUTER SOFTWARE FOR INVESTMENT STRATEGY IN THE FIELD OF INVESTING OVER COMPUTER NETWORKS, INTRANET AND THE INTERNET, IN CLASS 42 (U.S. CLS. 100 AND 101).

FIRST USE 11-3-2006; IN COMMERCE 11-3-2006.

THE MARK CONSISTS OF STANDARD CHARACTERS WITHOUT CLAIM TO ANY PARTICULAR FONT, STYLE, SIZE, OR COLOR.

NO CLAIM IS MADE TO THE EXCLUSIVE RIGHT TO USE "2500", APART FROM THE MARK AS SHOWN.

SN 78-913,488, FILED 6-21-2006.

MICHELE SWAIN, EXAMINING ATTORNEY

**Int. Cl.: 37**

**Prior U.S. Cls.: 100, 103, and 106**

**United States Patent and Trademark Office**

**Reg. No. 3,396,367**

**Registered Mar. 11, 2008**

**SERVICE MARK  
PRINCIPAL REGISTER**

RECYCLE YOUR CAR AMERICA

CHARITY DEVELOPMENT, LLC (DELAWARE  
LTD LIAB CO)  
255 MAPLE COURT, SUITE 220  
VENTURA, CA 93003

FOR: ENVIRONMENTAL DISPOSAL SERVICES  
OF UNWANTED AND DISABLED VEHICLES, IN  
CLASS 37 (U.S. CLS. 100, 103 AND 106).

FIRST USE 11-1-2007; IN COMMERCE 11-1-2007.

THE MARK CONSISTS OF STANDARD CHAR-  
ACTERS WITHOUT CLAIM TO ANY PARTICULAR  
FONT, STYLE, SIZE, OR COLOR.

SN 78-914,263, FILED 6-22-2006.

KARANENDRA S. CHHINA, EXAMINING ATTOR-  
NEY

**Int. Cl.: 37**

**Prior U.S. Cls.: 100, 103, and 106**

**United States Patent and Trademark Office**

**Reg. No. 3,396,368**

**Registered Mar. 11, 2008**

---

**SERVICE MARK  
PRINCIPAL REGISTER**

**JUNK MY RIDE**

CHARITY DEVELOPMENT, LLC (DELAWARE  
LTD LIAB CO)  
255 MAPLE COURT, SUITE 220  
VENTURA, CA 93003

FOR: ENVIRONMENTAL DISPOSAL SERVICES  
OF UNWANTED AND DISABLED VEHICLES, IN  
CLASS 37 (U.S. CLS. 100, 103 AND 106).

FIRST USE 11-5-2006; IN COMMERCE 11-5-2006.

THE MARK CONSISTS OF STANDARD CHAR-  
ACTERS WITHOUT CLAIM TO ANY PARTICULAR  
FONT, STYLE, SIZE, OR COLOR.

SN 78-914,292, FILED 6-22-2006.

KARANENDRA S. CHHINA, EXAMINING ATTOR-  
NEY

**Int. Cl.: 17**

**Prior U.S. Cls.: 1, 5, 12, 13, 35, and 50**

**United States Patent and Trademark Office**

**Reg. No. 3,396,369**

**Registered Mar. 11, 2008**

**TRADEMARK  
PRINCIPAL REGISTER**

# E-Z Pour Insulation

US GREENFIBER, LLC (DELAWARE LTD LIAB  
CO)

2500 DISTRIBUTION ST.

CHARLOTTE, NC 28203

FOR: BUILDING INSULATION, IN CLASS 17 (U.S.  
CLS. 1, 5, 12, 13, 35 AND 50).

FIRST USE 10-30-2006; IN COMMERCE 10-30-2006.

THE MARK CONSISTS OF STANDARD CHAR-  
ACTERS WITHOUT CLAIM TO ANY PARTICULAR  
FONT, STYLE, SIZE, OR COLOR.

NO CLAIM IS MADE TO THE EXCLUSIVE  
RIGHT TO USE "POUR INSULATION", APART  
FROM THE MARK AS SHOWN.

SN 78-915,253, FILED 6-23-2006.

JIM RINGLE, EXAMINING ATTORNEY

Int. Cl.: 43

Prior U.S. Cls.: 100 and 101

United States Patent and Trademark Office

Reg. No. 3,396,370

Registered Mar. 11, 2008

SERVICE MARK  
PRINCIPAL REGISTER



HAPPY MAILMAN, LP (TEXAS LIMITED PART-  
NERSHIP)  
#162, 1781 SPYGLASS DRIVE  
AUSTIN, TX 78746

NO CLAIM IS MADE TO THE EXCLUSIVE  
RIGHT TO USE "DOG DAYCARE" AND "BOARD-  
ING", APART FROM THE MARK AS SHOWN.

FOR: KENNEL SERVICES FOR DOMESTICATED  
ANIMALS, IN CLASS 43 (U.S. CLS. 100 AND 101).

SN 78-915,711, FILED 6-23-2006.

FIRST USE 8-15-2006; IN COMMERCE 8-15-2006.

DAWN FELDMAN, EXAMINING ATTORNEY

**Int. Cls.: 37 and 42**

**Prior U.S. Cls.: 100, 101, 103, and 106**

**United States Patent and Trademark Office**

**Reg. No. 3,396,371**

**Registered Mar. 11, 2008**

**SERVICE MARK  
PRINCIPAL REGISTER**

# V-PILOT

HALLIBURTON ENERGY SERVICES, INC. (DE-  
LAWARE CORPORATION)

1-B-121

2601 BELTLINE ROAD  
CARROLLTON, TX 75006

FOR: WELL DRILLING SERVICES, NAMELY,  
USE OF DOWNHOLE TOOLS WITH AUTOMATED  
TRAJECTORY CORRECTION CAPABILITY, IN  
CLASS 37 (U.S. CLS. 100, 103 AND 106).

FIRST USE 2-28-2007; IN COMMERCE 2-28-2007.

FOR: WELL DRILLING SERVICES, NAMELY,  
USE OF AN INFORMATION SYSTEM CAPABLE  
OF RECEIVING AND MONITORING REAL-TIME

AT-BIT MEASUREMENTS AND TOOL STATUS, IN  
CLASS 42 (U.S. CLS. 100 AND 101).

FIRST USE 2-28-2007; IN COMMERCE 2-28-2007.

THE MARK CONSISTS OF STANDARD CHAR-  
ACTERS WITHOUT CLAIM TO ANY PARTICULAR  
FONT, STYLE, SIZE, OR COLOR.

OWNER OF U.S. REG. NOS. 2,551,019 AND  
2,613,171.

SN 78-916,512, FILED 6-26-2006.

DEZMONA MIZELLE, EXAMINING ATTORNEY

**Int. Cl.: 36**

**Prior U.S. Cls.: 100, 101, and 102**

**United States Patent and Trademark Office**

**Reg. No. 3,396,372**

**Registered Mar. 11, 2008**

**SERVICE MARK  
PRINCIPAL REGISTER**

**DITECH ESIGNATURE**

GMAC MORTGAGE LLC (DELAWARE LTD  
LIAB CO)  
2711 CENTERVILLE ROAD  
SUITE 400  
WILMINGTON, DE 19808

FOR: HOME EQUITY LOANS; MORTGAGE  
LENDING, IN CLASS 36 (U.S. CLS. 100, 101 AND 102).

FIRST USE 4-19-2007; IN COMMERCE 4-19-2007.

THE MARK CONSISTS OF STANDARD CHAR-  
ACTERS WITHOUT CLAIM TO ANY PARTICULAR  
FONT, STYLE, SIZE, OR COLOR.

OWNER OF U.S. REG. NOS. 2,158,800, 3,080,195,  
AND OTHERS.

SN 78-917,057, FILED 6-26-2006.

ELLEN PERKINS, EXAMINING ATTORNEY

**Int. Cl.: 4**

**Prior U.S. Cls.: 1, 6, and 15**

**United States Patent and Trademark Office**

**Reg. No. 3,396,373**

**Registered Mar. 11, 2008**

**TRADEMARK  
PRINCIPAL REGISTER**

# Plastofuel

GARTHE, JAMES WARREN (UNITED STATES  
INDIVIDUAL)

4774 EBERLE ROAD

PETERSBURG, PA 16669 AND

LAMONT, WILLIAM JAMES, JR. (UNITED STATES  
INDIVIDUAL)

617 BERKSHIRE DRIVE

STATE COLLEGE, PA 16803 AND

ORZOLEK, MICHAEL D. (UNITED STATES INDI-  
VIDUAL)

106 EAST CLEARVIEW AVE.

STATE COLLEGE, PA 16803

FOR: PLASTIC-DERIVED FUEL MADE FROM  
DENSIFIED WASTE AND NON-RECYCLABLE  
PLASTICS, IN CLASS 4 (U.S. CLS. 1, 6 AND 15).

FIRST USE 4-25-1995; IN COMMERCE 5-15-2001.

THE MARK CONSISTS OF STANDARD CHAR-  
ACTERS WITHOUT CLAIM TO ANY PARTICULAR  
FONT, STYLE, SIZE, OR COLOR.

SN 78-917,462, FILED 6-27-2006.

KEVON CHISOLM, EXAMINING ATTORNEY



**Int. Cl.: 24**

**Prior U.S. Cls.: 42 and 50**

**United States Patent and Trademark Office**

**Reg. No. 3,396,374**

**Registered Mar. 11, 2008**

**TRADEMARK  
PRINCIPAL REGISTER**

**LONDON TOWER**

HMS FABRICS (NEW YORK CORPORATION)  
SUITE 503  
730 5TH AVENUE  
NEW YORK, NY 10019

THE MARK CONSISTS OF STANDARD CHAR-  
ACTERS WITHOUT CLAIM TO ANY PARTICULAR  
FONT, STYLE, SIZE, OR COLOR.

FOR: MERINO WOOL FABRICS, MERINO  
WOOL-POLYESTER MIXED FABRICS, IN CLASS  
24 (U.S. CLS. 42 AND 50).

SN 78-917,651, FILED 6-27-2006.

FIRST USE 5-15-2007; IN COMMERCE 5-15-2007.

NICHOLAS ALTREE, EXAMINING ATTORNEY

**Int. Cl.: 5**

**Prior U.S. Cls.: 6, 18, 44, 46, 51, and 52**

**Reg. No. 3,396,375**

**United States Patent and Trademark Office**

**Registered Mar. 11, 2008**

---

**TRADEMARK  
PRINCIPAL REGISTER**

**Simply Pure**

EVER SCIENTIFIC (PENNSYLVANIA CORPORATION)  
337 GORDON DRIVE  
EXTON, PA 19341

THE MARK CONSISTS OF STANDARD CHARACTERS WITHOUT CLAIM TO ANY PARTICULAR FONT, STYLE, SIZE, OR COLOR.

FOR: PRESCRIPTION GLUCOSE DRINK WITH NO ADDED COLOR OR FLAVOR USED FOR MEDICAL TESTING, IN CLASS 5 (U.S. CLS. 6, 18, 44, 46, 51 AND 52).

SN 78-918,602, FILED 6-28-2006.

FIRST USE 10-1-2007; IN COMMERCE 10-1-2007.

INGRID C. EULIN, EXAMINING ATTORNEY

**Int. Cl.: 42**

**Prior U.S. Cls.: 100 and 101**

**United States Patent and Trademark Office**

**Reg. No. 3,396,376**

**Registered Mar. 11, 2008**

**SERVICE MARK  
PRINCIPAL REGISTER**

The logo for SoundGene features the word "Sound" in a dark blue serif font, followed by "Gene" in a green serif font. To the right of "Gene" are three light blue sound waves of increasing size, suggesting audio or sound.

PEDIATRIX MEDICAL GROUP, INC. (FLORIDA CORPORATION)

1301 CONCORD TERRACE

SUNRISE, FL 333232825

FOR: LABORATORY RESEARCH IN THE FIELD OF EARLY DETECTION AND INTERVENTION FOR PRE-LINGUAL HEARING LOSS, IN CLASS 42 (U.S. CLS. 100 AND 101).

FIRST USE 1-0-2007; IN COMMERCE 1-0-2007.

THE COLOR(S) DARK BLUE, LIGHT BLUE AND GREEN IS/ARE CLAIMED AS A FEATURE OF THE MARK.

THE TERM "SOUND" IS DARK BLUE. THE TERM "GENE" IS GREEN. THE SOUND WAVES ARE LIGHT BLUE.

SN 78-918,938, FILED 6-28-2006.

MICHAEL KEATING, EXAMINING ATTORNEY

**Int. Cl.: 42**

**Prior U.S. Cls.: 100 and 101**

**United States Patent and Trademark Office**

**Reg. No. 3,396,377**

**Registered Mar. 11, 2008**

**SERVICE MARK  
PRINCIPAL REGISTER**

**LIVEFILE**

SOMMER, HANS (UNITED STATES INDIVIDUAL)  
567 GULARTE RD.  
ARROYO GRANDE, CA 93420

THE MARK CONSISTS OF STANDARD CHARACTERS WITHOUT CLAIM TO ANY PARTICULAR FONT, STYLE, SIZE, OR COLOR.

FOR: APPLICATION SERVICE PROVIDER (ASP), NAMELY, HOSTING COMPUTER SOFTWARE APPLICATIONS OF OTHERS, IN CLASS 42 (U.S. CLS. 100 AND 101).

SN 78-920,083, FILED 6-29-2006.

FIRST USE 1-22-2007; IN COMMERCE 1-22-2007.

HEATHER THOMPSON, EXAMINING ATTORNEY

**Int. Cl.: 9**

**Prior U.S. Cls.: 21, 23, 26, 36, and 38**

**United States Patent and Trademark Office**

**Reg. No. 3,396,378**

**Registered Mar. 11, 2008**

**TRADEMARK  
PRINCIPAL REGISTER**

**SAMBA PARTY**

KONAMI GAMING, INC. (NEVADA CORPORATION)  
585 TRADE CENTER DRIVE  
LAS VEGAS, NV 89119

FOR: ELECTRONIC GAME PROGRAMS; GAMING EQUIPMENT, NAMELY, SLOT MACHINES WITH OR WITHOUT VIDEO OUTPUT; GAMING MACHINES; MACHINES FOR PLAYING GAMES OF CHANCE; SLOT MACHINES, IN CLASS 9 (U.S. CLS. 21, 23, 26, 36 AND 38).

FIRST USE 11-12-2006; IN COMMERCE 11-12-2006.

THE MARK CONSISTS OF STANDARD CHARACTERS WITHOUT CLAIM TO ANY PARTICULAR FONT, STYLE, SIZE, OR COLOR.

SN 78-920,394, FILED 6-29-2006.

MATTHEW EINSTEIN, EXAMINING ATTORNEY

**Int. Cl.: 28**

**Prior U.S. Cls.: 22, 23, 38, and 50**

**United States Patent and Trademark Office**

**Reg. No. 3,396,379**

**Registered Mar. 11, 2008**

**TRADEMARK  
PRINCIPAL REGISTER**

**CLUB STYLE SHANI**

MATTEL, INC. (DELAWARE CORPORATION)  
MAIL STOP M1-1518  
333 CONTINENTAL BOULEVARD  
EL SEGUNDO, CA 90245

THE MARK CONSISTS OF STANDARD CHARACTERS WITHOUT CLAIM TO ANY PARTICULAR FONT, STYLE, SIZE, OR COLOR.

FOR: TOYS, GAMES AND PLAYTHINGS, NAME-  
LY, DOLLS, DOLL CLOTHING AND DOLL ACCES-  
SORIES, TOY FIGURES AND ACCESSORIES  
THEREFOR, IN CLASS 28 (U.S. CLS. 22, 23, 38 AND  
50).

OWNER OF U.S. REG. NO. 2,732,379.

SN 78-920,907, FILED 6-30-2006.

FIRST USE 9-10-2007; IN COMMERCE 9-10-2007.

ELIZABETH BEYER, EXAMINING ATTORNEY

**Int. Cl.: 35**

**Prior U.S. Cls.: 100, 101, and 102**

**United States Patent and Trademark Office**

**Reg. No. 3,396,380**

**Registered Mar. 11, 2008**

**SERVICE MARK  
PRINCIPAL REGISTER**

**ANSWER ELITE SERVICES**

ANSWER FINANCIAL INC. (DELAWARE CORPORATION)  
15910 VENTURA BLVD. SUITE 1400  
ENCINO, CA 91436

FOR: INSURANCE MATCHING SERVICES, NAMELY, MATCHING CONSUMER REQUESTS FOR INSURANCE POLICY QUOTES TO PRE-QUALIFIED INSURANCE BROKERS, AGENTS, AND AGENCIES; PROMOTION OF AUTO INSURANCE, HOME INSURANCE, ON BEHALF OF THIRD PARTIES; AND PROVIDING INSURANCE AGENT REFERRALS, IN CLASS 35 (U.S. CLS. 100, 101 AND 102).

FIRST USE 9-28-2007; IN COMMERCE 9-28-2007.

THE MARK CONSISTS OF STANDARD CHARACTERS WITHOUT CLAIM TO ANY PARTICULAR FONT, STYLE, SIZE, OR COLOR.

OWNER OF U.S. REG. NOS. 2,364,874, 2,508,653, AND 2,566,638.

NO CLAIM IS MADE TO THE EXCLUSIVE RIGHT TO USE "SERVICES", APART FROM THE MARK AS SHOWN.

SN 78-921,868, FILED 7-3-2006.

JANET LEE, EXAMINING ATTORNEY

**Int. Cl.: 41**

**Prior U.S. Cls.: 100, 101, and 107**

**United States Patent and Trademark Office**

**Reg. No. 3,396,381**

**Registered Mar. 11, 2008**

**SERVICE MARK  
PRINCIPAL REGISTER**

**EGONOMICS**

VERACITY LC (UTAH LIMITED LIABILITY  
COMPANY)  
100 WEST CANYON CREST  
ALPINE, UT 84004

FOR: EDUCATIONAL SERVICES, NAMELY,  
SEMINARS, WORKSHOPS AND CLASSES ALL IN  
THE FIELDS OF LEADERSHIP, MANAGEMENT,  
SALES AND COMMUNICATIONS, AND IMPROV-  
ING PERSONAL PERFORMANCE, BUSINESS MAN-  
AGEMENT ABILITIES AND SALES SKILLS, IN  
CLASS 41 (U.S. CLS. 100, 101 AND 107).

FIRST USE 4-30-2006; IN COMMERCE 4-30-2006.

THE MARK CONSISTS OF STANDARD CHAR-  
ACTERS WITHOUT CLAIM TO ANY PARTICULAR  
FONT, STYLE, SIZE, OR COLOR.

SN 78-922,530, FILED 7-5-2006.

LAURIE KAUFMAN, EXAMINING ATTORNEY



**Int. Cl.: 8**

**Prior U.S. Cls.: 23, 28, and 44**

**United States Patent and Trademark Office**

**Reg. No. 3,396,382**

**Registered Mar. 11, 2008**

**TRADEMARK  
PRINCIPAL REGISTER**

**STYLE SELECT**

DART CONTAINER CORPORATION (NEVADA  
CORPORATION)  
500 HOGSBACK ROAD  
MASON, MI 48854

FOR: PLASTIC FLATWARE, NAMELY, KNIVES,  
FORKS, AND SPOONS, IN CLASS 8 (U.S. CLS. 23, 28  
AND 44).

FIRST USE 12-17-2007; IN COMMERCE 12-17-2007.

THE MARK CONSISTS OF STANDARD CHAR-  
ACTERS WITHOUT CLAIM TO ANY PARTICULAR  
FONT, STYLE, SIZE, OR COLOR.

OWNER OF U.S. REG. NO. 3,082,840.

SN 78-922,726, FILED 7-5-2006.

ALLISON SCHRODY, EXAMINING ATTORNEY

**Int. Cl.: 41**

**Prior U.S. Cls.: 100, 101, and 107**

**United States Patent and Trademark Office**

**Reg. No. 3,396,383**

**Registered Mar. 11, 2008**

**SERVICE MARK  
PRINCIPAL REGISTER**

**CURBSIDE FITNESS**

CURBSIDE FITNESS LLC (MISSOURI LTD LIAB  
CO)  
515 NORTH AND SOUTH ROAD  
ST. LOUIS, MO 63130

FOR: PROVIDING MOBILE FITNESS FACILITIES, NAMELY, PROVIDING A FITNESS FACILITY WITHIN A MOTOR VEHICLE WHICH CAN BE DRIVEN TO, PLACED IN AND USED AT VARIOUS LOCATIONS; AND PHYSICAL FITNESS INSTRUCTION, IN CLASS 41 (U.S. CLS. 100, 101 AND 107).

FIRST USE 8-11-2006; IN COMMERCE 8-11-2006.

THE MARK CONSISTS OF STANDARD CHARACTERS WITHOUT CLAIM TO ANY PARTICULAR FONT, STYLE, SIZE, OR COLOR.

NO CLAIM IS MADE TO THE EXCLUSIVE RIGHT TO USE "FITNESS", APART FROM THE MARK AS SHOWN.

SN 78-923,713, FILED 7-6-2006.

BILL DAWE, EXAMINING ATTORNEY

**Int. Cl.: 20**

**Prior U.S. Cls.: 2, 13, 22, 25, 32, and 50**

**Reg. No. 3,396,384**

**United States Patent and Trademark Office**

**Registered Mar. 11, 2008**

---

**TRADEMARK  
PRINCIPAL REGISTER**

**MIX ON COMMAND**

JPRO DAIRY INTERNATIONAL, INC. (CALI-  
FORNIA CORPORATION)  
23552 BERMUDA DUNES  
MISSION VIEJO, CA 92692

THE MARK CONSISTS OF STANDARD CHAR-  
ACTERS WITHOUT CLAIM TO ANY PARTICULAR  
FONT, STYLE, SIZE, OR COLOR.

FOR: CONTAINERS, NOT OF METAL FOR COM-  
MERCIAL USE; PLASTIC CLOSURES FOR CON-  
TAINERS, IN CLASS 20 (U.S. CLS. 2, 13, 22, 25, 32  
AND 50).

SN 78-924,084, FILED 7-6-2006.

FIRST USE 8-3-2007; IN COMMERCE 8-3-2007.

DAVID C. REIHNER, EXAMINING ATTORNEY

**Int. Cl.: 20**

**Prior U.S. Cls.: 2, 13, 22, 25, 32, and 50**

**Reg. No. 3,396,385**

**United States Patent and Trademark Office**

**Registered Mar. 11, 2008**

---

**TRADEMARK  
PRINCIPAL REGISTER**

**MOC**

JPRO DAIRY INTERNATIONAL, INC. (CALI-  
FORNIA CORPORATION)  
23552 BERMUDA DUNES  
MISSION VIEJO, CA 92692

THE MARK CONSISTS OF STANDARD CHAR-  
ACTERS WITHOUT CLAIM TO ANY PARTICULAR  
FONT, STYLE, SIZE, OR COLOR.

FOR: CONTAINERS, NOT OF METAL FOR COM-  
MERCIAL USE; PLASTIC CLOSURES FOR CON-  
TAINERS, IN CLASS 20 (U.S. CLS. 2, 13, 22, 25, 32  
AND 50).

SN 78-924,086, FILED 7-6-2006.

FIRST USE 8-3-2007; IN COMMERCE 8-3-2007.

DAVID C. REIHNER, EXAMINING ATTORNEY

Int. Cl.: 36

Prior U.S. Cls.: 100, 101, and 102

United States Patent and Trademark Office

Reg. No. 3,396,386

Registered Mar. 11, 2008

SERVICE MARK  
PRINCIPAL REGISTER

THE SHOPS AT



STARWOOD INVESTMENTS, LP (TEXAS LIMITED PARTNERSHIP)  
7015 SNIDER PLAZA, SUITE 202  
DALLAS, TX 75205

FOR: LEASING OF OFFICE SPACE; OPERATING MARKETPLACES FOR SELLERS OF GOODS AND/OR SERVICES; SHOPPING CENTER SERVICES, NAMELY, RENTAL OF SHOPPING CENTER SPACE, IN CLASS 36 (U.S. CLS. 100, 101 AND 102).

FIRST USE 5-23-2007; IN COMMERCE 5-23-2007.

NO CLAIM IS MADE TO THE EXCLUSIVE RIGHT TO USE "THE SHOPS", APART FROM THE MARK AS SHOWN.

THE MARK CONSISTS OF THE WORDS "THE SHOPS AT STARWOOD" AND A STYLIZED CIRCLE DESIGN WITH A STAR IN ITS CENTER.

SN 78-924,895, FILED 7-7-2006.

MICHAEL WEBSTER, EXAMINING ATTORNEY

**Int. Cl.: 35**

**Prior U.S. Cls.: 100, 101, and 102**

**United States Patent and Trademark Office**

**Reg. No. 3,396,387**

**Registered Mar. 11, 2008**

**SERVICE MARK  
PRINCIPAL REGISTER**

**BLUMO**

CRYSTAL LOGIC, INC (ARIZONA CORPORATION)  
1222 E SARAGOSA STREET  
CHANDLER, AZ 85225

FOR: PROVIDING MARKETING SERVICES, NAMELY, DEVELOPMENT OF INTERACTIVE PROMOTIONAL AND TARGETED ADVERTISING CAMPAIGNS FOR THE INTERNET AND MOBILE DEVICES USING THE INTERNET , IN CLASS 35 (U.S. CLS. 100, 101 AND 102).

FIRST USE 4-9-2007; IN COMMERCE 4-9-2007.

THE MARK CONSISTS OF STANDARD CHARACTERS WITHOUT CLAIM TO ANY PARTICULAR FONT, STYLE, SIZE, OR COLOR.

THE WORDING "BLUMO" HAS NO MEANING IN A FOREIGN LANGUAGE.

SN 78-925,208, FILED 7-9-2006.

BILL DAWE, EXAMINING ATTORNEY

**Int. Cl.: 41**

**Prior U.S. Cls.: 100, 101, and 107**

**United States Patent and Trademark Office**

**Reg. No. 3,396,388**

**Registered Mar. 11, 2008**

**SERVICE MARK  
PRINCIPAL REGISTER**

**ESCALERA**

MOORMAN, ANANDA M (UNITED STATES INDIVIDUAL)

1106 2ND STREET #333

ENCINITAS, CA 92024 AND

WAY, DANNY R. (UNITED STATES INDIVIDUAL)

1106 2ND STREET

ENCINITAS, CA 92024 AND

CHRIST, TREVOR D. (UNITED STATES INDIVIDUAL)

1106 2ND STREET

ENCINITAS, CA 92024

FOR: ENTERTAINMENT SERVICES, NAMELY,  
MUSICAL BAND PERFORMANCES, IN CLASS 41  
(U.S. CLS. 100, 101 AND 107).

FIRST USE 8-22-2007; IN COMMERCE 8-22-2007.

THE MARK CONSISTS OF STANDARD CHARACTERS WITHOUT CLAIM TO ANY PARTICULAR FONT, STYLE, SIZE, OR COLOR.

THE ENGLISH TRANSLATION OF THE SPANISH WORD "ESCALERA" IN THE MARK IS "STAIRCASE".

SN 78-925,296, FILED 7-9-2006.

DOMINICK J. SALEMI, EXAMINING ATTORNEY

**Int. Cl.: 7**

**Prior U.S. Cls.: 13, 19, 21, 23, 31, 34, and 35**

**United States Patent and Trademark Office**

**Reg. No. 3,396,389**

**Registered Mar. 11, 2008**

**TRADEMARK  
PRINCIPAL REGISTER**

**OPTISHELL PLUS**

FATA HUNTER, INC. (DELAWARE CORPORATION)  
1040 IOWA AVENUE, SUITE 100  
RIVERSIDE, CA 92507

FOR: MACHINE PART, NAMELY, A CASTER  
ROLL SHELL FOR METAL CASTING MACHINES,  
IN CLASS 7 (U.S. CLS. 13, 19, 21, 23, 31, 34 AND 35).

FIRST USE 7-10-2006; IN COMMERCE 7-10-2006.

THE MARK CONSISTS OF STANDARD CHARACTERS WITHOUT CLAIM TO ANY PARTICULAR FONT, STYLE, SIZE, OR COLOR.

OWNER OF U.S. REG. NO. 3,095,981.

SN 78-926,206, FILED 7-10-2006.

LINDA ESTRADA, EXAMINING ATTORNEY



**Int. Cl.: 9**

**Prior U.S. Cls.: 21, 23, 26, 36, and 38**

**United States Patent and Trademark Office**

**Reg. No. 3,396,390**

**Registered Mar. 11, 2008**

**TRADEMARK  
PRINCIPAL REGISTER**

**PROSPEC**

LUX PRODUCTS CORPORATION (NEW JERSEY  
CORPORATION)  
6000 I COMMERCE PARKWAY  
MT. LAUREL, NJ 08054

THE MARK CONSISTS OF STANDARD CHAR-  
ACTERS WITHOUT CLAIM TO ANY PARTICULAR  
FONT, STYLE, SIZE, OR COLOR.

FOR: THERMOSTATS, IN CLASS 9 (U.S. CLS. 21,  
23, 26, 36 AND 38).

SN 78-926,577, FILED 7-11-2006.

FIRST USE 7-16-2007; IN COMMERCE 7-16-2007.

JASON ROTH, EXAMINING ATTORNEY

**Int. Cl.: 16**

**Prior U.S. Cls.: 2, 5, 22, 23, 29, 37, 38, and 50**

**United States Patent and Trademark Office**

**Reg. No. 3,396,391**

**Registered Mar. 11, 2008**

**TRADEMARK  
PRINCIPAL REGISTER**

**PEACEFUL BUDDHA**

ELIJO DESIGNS, INC. (CALIFORNIA CORPORATION)  
7745 ALABAMA AVENUE #16  
CANOGA PARK, CA 91304

FOR: NOTEPADS, POSTERS, CALENDARS, STATIONERY, DIARIES, PAPER NAPKINS, PAPER TABLE CLOTHS, PAPER PLACE MATS, BALL POINT PENS, FELT PENS, PENCILS, GREETING CARDS, WRAPPING PAPER, BLANK JOURNAL BOOKS, GIFT WRAPPING PAPER, IN CLASS 16 (U.S. CLS. 2, 5, 22, 23, 29, 37, 38 AND 50).

FIRST USE 2-1-2004; IN COMMERCE 2-1-2004.

THE MARK CONSISTS OF STANDARD CHARACTERS WITHOUT CLAIM TO ANY PARTICULAR FONT, STYLE, SIZE, OR COLOR.

SN 78-926,670, FILED 7-11-2006.

KARANENDRA S. CHHINA, EXAMINING ATTORNEY

**Int. Cl.: 16**

**Prior U.S. Cls.: 2, 5, 22, 23, 29, 37, 38, and 50**

**United States Patent and Trademark Office**

**Reg. No. 3,396,392**

**Registered Mar. 11, 2008**

**TRADEMARK  
PRINCIPAL REGISTER**

**LITTLE LUCKY BUDDHA**

ELIJO DESIGNS, INC. (CALIFORNIA CORPORATION)  
7745 ALABAMA AVENUE #16  
CANOGA PARK, CA 91304

FOR: NOTEPADS, POSTERS, CALENDARS, STATIONERY, DIARIES, PAPER NAPKINS, PAPER TABLE CLOTHS, PAPER PLACE MATS, BALL POINT PENS, FELT PENS, PENCILS, GREETING CARDS, WRAPPING PAPER, BLANK JOURNAL BOOKS, GIFT WRAPPING PAPER, IN CLASS 16 (U.S. CLS. 2, 5, 22, 23, 29, 37, 38 AND 50).

FIRST USE 2-1-2004; IN COMMERCE 2-1-2004.

THE MARK CONSISTS OF STANDARD CHARACTERS WITHOUT CLAIM TO ANY PARTICULAR FONT, STYLE, SIZE, OR COLOR.

SN 78-926,819, FILED 7-11-2006.

KARANENDRA S. CHHINA, EXAMINING ATTORNEY

**Int. Cl.: 25**

**Prior U.S. Cls.: 22 and 39**

**United States Patent and Trademark Office**

**Reg. No. 3,396,393**

**Registered Mar. 11, 2008**

**TRADEMARK  
PRINCIPAL REGISTER**

**SHAKE YOUR BUDDHA**

ELIJO DESIGNS, INC. (CALIFORNIA CORPORATION)  
7745 ALABAMA AVENUE #16  
CANOGA PARK, CA 91304

FOR: APRONS, ATHLETIC UNIFORMS, BANDANAS, SWEAT BANDS, WRIST BANDS, NECK BANDS, BASEBALL CAPS, BATHROBES, CLOTHING BELTS, CLOTH BIBS, SKI BIBS, BLOOMERS, BOTTOMS, BOXER SHORTS, UNDERWEAR, BRIEFS, CAPS, DUNGAREES, GYM SHORTS, HATS, HEAD WEAR, INFANTWEAR, JEANS, JERSEYS, KERCHIEFS, LINGERIE, LOUNGEWEAR, NIGHT SHIRTS, PAJAMAS, PANTIES, PANTS, SWEAT PANTS, PONCHOS, PULLOVERS, ROBES, SANDALS, SARONGS, SHIRTS, UNDERSHIRTS, SWEAT SHIRTS, SPORT SHIRTS, SHORTS, SWEAT SHORTS, BERMUDA SHORTS, SLEEP MASKS,

SLEEPWEAR, SLIPPERS, SOCKS, TIES, SHOES, JACKETS, SWEAT SUITS, WARMUP SUITS, SUN VISORS, T-SHIRTS, TANK TOPS, THERMAL UNDERWEAR, TOPS, UNDERCLOTHES, UNDERGARMENTS, UNDERPANTS AND VISORS, IN CLASS 25 (U.S. CLS. 22 AND 39).

FIRST USE 2-1-2004; IN COMMERCE 2-1-2004.

THE MARK CONSISTS OF STANDARD CHARACTERS WITHOUT CLAIM TO ANY PARTICULAR FONT, STYLE, SIZE, OR COLOR.

SN 78-926,971, FILED 7-11-2006.

KARANENDRA S. CHHINA, EXAMINING ATTORNEY

**Int. Cl.: 38**

**Prior U.S. Cls.: 100, 101, and 104**

**United States Patent and Trademark Office**

**Reg. No. 3,396,394**

**Registered Mar. 11, 2008**

**SERVICE MARK  
PRINCIPAL REGISTER**

**GOSEETELL**

GOSEETELL NETWORK, INC. (OREGON CORPORATION)

#20

2327 NW NORTHUP STREET  
PORTLAND, OR 97210

FOR: PROVIDING ON-LINE CHAT ROOMS AND ON-LINE BULLETIN BOARDS FOR TRANSMISSION OF MESSAGES AMONG COMPUTER USERS CONCERNING TRAVEL; PROVIDING ACCESS TO AN INTERACTIVE COMPUTER DATABASE IN THE FIELD OF TRAVEL INFORMATION, HOTELS, RESTAURANTS, ADVENTURE PARKS, RECREATIONAL PARKS, FOREST PARKS, AMUSEMENT PARKS, THEME PARKS, MUSICAL EVENTS, THEATRICAL EVENTS, LIVE DRAMATIC EVENTS,

FILMS, SPORTING EVENTS, DINING, ART EXHIBITIONS, GROUND TRAFFIC, PARKING, SHOPPING, DESTINATION INFORMATION, AND TRANSPORTATION BY AIR, TRAIN, BUS OR BOAT, IN CLASS 38 (U.S. CLS. 100, 101 AND 104).

FIRST USE 2-0-2006; IN COMMERCE 2-0-2006.

THE MARK CONSISTS OF STANDARD CHARACTERS WITHOUT CLAIM TO ANY PARTICULAR FONT, STYLE, SIZE, OR COLOR.

SN 78-927,178, FILED 7-11-2006.

CAROLINE WOOD, EXAMINING ATTORNEY

**Int. Cl.: 20**

**Prior U.S. Cls.: 2, 13, 22, 25, 32, and 50**

**United States Patent and Trademark Office**

**Reg. No. 3,396,395**

**Registered Mar. 11, 2008**

**TRADEMARK  
PRINCIPAL REGISTER**



STEELCASE INC. (MICHIGAN CORPORATION)  
901 44TH STREET SE  
PO BOX 1967  
GRAND RAPIDS, MI 49501

THE MARK CONSISTS OF PLURALITY OF  
OVERLAPPING CIRCLES AND ARCS.

FOR: FURNITURE, IN CLASS 20 (U.S. CLS. 2, 13,  
22, 25, 32 AND 50).

SN 78-927,375, FILED 7-12-2006.

FIRST USE 6-12-2006; IN COMMERCE 6-12-2006.

SEAN CROWLEY, EXAMINING ATTORNEY

**Int. Cl.: 20**

**Prior U.S. Cls.: 2, 13, 22, 25, 32, and 50**

**United States Patent and Trademark Office**

**Reg. No. 3,396,396**

**Registered Mar. 11, 2008**

---

**TRADEMARK  
PRINCIPAL REGISTER**

**nurture**

STEELCASE INC. (MICHIGAN CORPORATION)  
901 44TH STREET SE  
PO BOX 1967  
GRAND RAPIDS, MI 49501

FIRST USE 6-12-2006; IN COMMERCE 6-12-2006.

SN 78-927,443, FILED 7-12-2006.

FOR: FURNITURE, IN CLASS 20 (U.S. CLS. 2, 13,  
22, 25, 32 AND 50).

SEAN CROWLEY, EXAMINING ATTORNEY

**Int. Cl.: 35**

**Prior U.S. Cls.: 100, 101, and 102**

**United States Patent and Trademark Office**

**Reg. No. 3,396,397**

**Registered Mar. 11, 2008**

**SERVICE MARK  
PRINCIPAL REGISTER**

**DiamondJacks Rewards Club**

LEGENDS GAMING, LLC (DELAWARE LTD  
LIAB CO)  
160 S. LAGRANGE ROAD  
FRANKFORT, IL 60423

FOR: CASINO CUSTOMER LOYALTY PRO-  
GRAM AND CUSTOMER CLUB SERVICES, FOR  
PROMOTIONAL AND/OR ADVERTISING PURPO-  
SES, IN CLASS 35 (U.S. CLS. 100, 101 AND 102).

FIRST USE 7-0-2006; IN COMMERCE 7-0-2006.

THE MARK CONSISTS OF STANDARD CHAR-  
ACTERS WITHOUT CLAIM TO ANY PARTICULAR  
FONT, STYLE, SIZE, OR COLOR.

NO CLAIM IS MADE TO THE EXCLUSIVE  
RIGHT TO USE "REWARDS CLUB", APART FROM  
THE MARK AS SHOWN.

SN 78-928,584, FILED 7-13-2006.

JANET LEE, EXAMINING ATTORNEY



**Int. Cls.: 9 and 38**

**Prior U.S. Cls.: 21, 23, 26, 36, 38, 100, 101, and 104**

**United States Patent and Trademark Office**

**Reg. No. 3,396,398**

**Registered Mar. 11, 2008**

**TRADEMARK  
SERVICE MARK  
PRINCIPAL REGISTER**

# ISOCIAL

ISOCIAL INC. (DELAWARE CORPORATION)  
FLOOR 3  
1375 BROADWAY  
NEW YORK, NY 100187030

FOR: APPARATUS FOR TRANSMISSION OF COMMUNICATION, NAMELY, A WIRELESS DEVICE, CONSISTING OF A WIRELESS TRANSCIEVER, A MICROPROCESSOR, MEMORY, AND A DISPLAY SCREEN, IN CLASS 9 (U.S. CLS. 21, 23, 26, 36 AND 38).

FIRST USE 2-1-2006; IN COMMERCE 2-1-2006.

FOR: WIRELESS COMMUNICATIONS SERVICES, NAMELY, AUTOMATICALLY IDENTIFYING THE PRESENCE OF MEMBERS OF AN INTEREST GROUP CARRYING WIRELESS IDENTIFICATION

(ID) TRANSCIEVERS LOCATED WITHIN A TRANSMITTANCE RANGE FROM EACH OTHER, AND COMMUNICATING MESSAGES TO/FROM OR BETWEEN THE MEMBERS VIA A SECURED WIRELESS SERVICE SO THAT IDENTITIES AND PRIVACY OF THE MEMBERS ARE PROTECTED , IN CLASS 38 (U.S. CLS. 100, 101 AND 104).

FIRST USE 2-1-2006; IN COMMERCE 2-1-2006.

THE MARK CONSISTS OF STANDARD CHARACTERS WITHOUT CLAIM TO ANY PARTICULAR FONT, STYLE, SIZE, OR COLOR.

SN 78-928,805, FILED 7-13-2006.

LINDA E. BLOHM, EXAMINING ATTORNEY

**Int. Cl.: 3**

**Prior U.S. Cls.: 1, 4, 6, 50, 51, and 52**

**United States Patent and Trademark Office**

**Reg. No. 3,396,399**

**Registered Mar. 11, 2008**

**TRADEMARK  
PRINCIPAL REGISTER**

**BODY ESSENCE ORGANICS**

PURETEK CORPORATION (CALIFORNIA CORPORATION)  
1245 AVIATION PLACE  
SAN FERNANDO, CA 91340

OWNER OF U.S. REG. NOS. 2,554,435 AND 2,588,030.

FOR: BODY AND BEAUTY CARE PREPARATIONS; BODY LOTIONS, IN CLASS 3 (U.S. CLS. 1, 4, 6, 50, 51 AND 52).

NO CLAIM IS MADE TO THE EXCLUSIVE RIGHT TO USE "BODY" OR "ORGANICS", APART FROM THE MARK AS SHOWN.

FIRST USE 9-1-2006; IN COMMERCE 3-1-2007.

SN 78-928,940, FILED 7-13-2006.

THE MARK CONSISTS OF STANDARD CHARACTERS WITHOUT CLAIM TO ANY PARTICULAR FONT, STYLE, SIZE, OR COLOR.

KEVON CHISOLM, EXAMINING ATTORNEY

**Int. Cl.: 14**

**Prior U.S. Cls.: 2, 27, 28, and 50**

**Reg. No. 3,396,400**

**United States Patent and Trademark Office**

**Registered Mar. 11, 2008**

**TRADEMARK  
PRINCIPAL REGISTER**

**TTWOLF**

WANG, PING (CHINA INDIVIDUAL)  
7-3 A, ZUOTINGYOUYUAN NORTH, LILANG  
ROAD  
LONGGANG DISTRICT, SHENZHEN CITY  
GUANGDONG PROVINCE, CHINA

FOR: PRECIOUS METALS AND THEIR ALLOYS,  
NAMELY, SILVER; JEWELRY CHAINS; RINGS  
BEING JEWELRY; WATCHES; TIE CLIPS; PLATI-  
NUM AND ITS ALLOYS; COSTUME JEWELRY;  
JADE BEING JEWELRY; DESKTOP STATUARY  
MADE OF PRECIOUS METAL; FIGURINES OF  
PRECIOUS METAL; SCULPTURES MADE OF PRE-  
CIOUS METAL; STATUES OF PRECIOUS METAL;

EPERGNES OF PRECIOUS METALS, IN CLASS 14  
(U.S. CLS. 2, 27, 28 AND 50).

FIRST USE 10-10-2006; IN COMMERCE 8-20-2007.

THE MARK CONSISTS OF STANDARD CHAR-  
ACTERS WITHOUT CLAIM TO ANY PARTICULAR  
FONT, STYLE, SIZE, OR COLOR.

THE WORDING "TTWOLF" HAS NO MEANING  
IN A FOREIGN LANGUAGE.

SN 78-929,314, FILED 7-13-2006.

CORY BOONE, EXAMINING ATTORNEY

**Int. Cl.: 35**

**Prior U.S. Cls.: 100, 101, and 102**

**United States Patent and Trademark Office**

**Reg. No. 3,396,401**

**Registered Mar. 11, 2008**

**SERVICE MARK  
PRINCIPAL REGISTER**

# SPOTS DATA

CERTIFIED ASSET EXCHANGE, INC. (DELA-  
WARE CORPORATION)  
P.O. BOX 6280  
NEWPORT BEACH, CA 92658

FOR: PROVIDING INFORMATION ABOUT THE  
TRADING PRICES FOR PRECIOUS METALS, IN  
CLASS 35 (U.S. CLS. 100, 101 AND 102).

FIRST USE 7-0-2006; IN COMMERCE 7-0-2006.

THE MARK CONSISTS OF STANDARD CHAR-  
ACTERS WITHOUT CLAIM TO ANY PARTICULAR  
FONT, STYLE, SIZE, OR COLOR.

NO CLAIM IS MADE TO THE EXCLUSIVE  
RIGHT TO USE "DATA", APART FROM THE  
MARK AS SHOWN.

SN 78-929,330, FILED 7-13-2006.

SKYE YOUNG, EXAMINING ATTORNEY

**Int. Cl.: 28**

**Prior U.S. Cls.: 22, 23, 38, and 50**

**Reg. No. 3,396,402**

**United States Patent and Trademark Office**

**Registered Mar. 11, 2008**

---

**TRADEMARK  
PRINCIPAL REGISTER**

**WINTER**

CLEARWATER MARINE AQUARIUM, INC.  
(FLORIDA CORPORATION)  
249 WINDWARD PASSAGE  
CLEARWATER, FL 34630

FOR: INFLATABLE BATH TOYS; INFLATABLE TOYS; MODELED PLASTIC TOY FIGURINES; PLUSH TOYS; SQUEEZE TOYS; STUFFED TOY ANIMALS; STUFFED TOYS; WATER SQUIRTING TOYS, IN CLASS 28 (U.S. CLS. 22, 23, 38 AND 50).

FIRST USE 8-0-2006; IN COMMERCE 8-0-2006.

THE MARK CONSISTS OF STANDARD CHARACTERS WITHOUT CLAIM TO ANY PARTICULAR FONT, STYLE, SIZE, OR COLOR.

SN 78-929,575, FILED 7-14-2006.

CHERYL CLAYTON, EXAMINING ATTORNEY

**Int. Cl.: 41**

**Prior U.S. Cls.: 100, 101, and 107**

**United States Patent and Trademark Office**

**Reg. No. 3,396,403**

**Registered Mar. 11, 2008**

**SERVICE MARK  
PRINCIPAL REGISTER**

**ACP PRESS**

AMERICAN COLLEGE OF PHYSICIANS, INC.  
(DELAWARE NON-PROFIT CORPORATION)  
190 N. INDEPENDENCE MALL WEST  
PHILADELPHIA, PA 191061572

FOR: PUBLISHING OF BOOKS AND HAND-  
BOOKS IN THE FIELD OF MEDICINE FOR THE  
PURPOSE OF EDUCATING, INFORMING AND  
ENTERTAINING PHYSICIANS; PUBLISHING OF  
ELECTRONIC PUBLICATIONS, IN THE FIELD OF  
MEDICINE, IN CLASS 41 (U.S. CLS. 100, 101 AND  
107).

FIRST USE 11-0-2007; IN COMMERCE 11-0-2007.

THE MARK CONSISTS OF STANDARD CHAR-  
ACTERS WITHOUT CLAIM TO ANY PARTICULAR  
FONT, STYLE, SIZE, OR COLOR.

OWNER OF U.S. REG. NOS. 1,868,783, 2,654,293,  
AND OTHERS.

NO CLAIM IS MADE TO THE EXCLUSIVE  
RIGHT TO USE "PRESS", APART FROM THE  
MARK AS SHOWN.

SN 78-929,869, FILED 7-14-2006.

ANDREA BUTLER, EXAMINING ATTORNEY

**Int. Cl.: 9**

**Prior U.S. Cls.: 21, 23, 26, 36, and 38**

**Reg. No. 3,396,404**

**United States Patent and Trademark Office**

**Registered Mar. 11, 2008**

---

**TRADEMARK  
PRINCIPAL REGISTER**

**WINNER'S SECRETS**

USA FINANCIAL MARKETING CORPORATION  
(MICHIGAN CORPORATION)  
6020 EAST FULTON STREET  
ADA, MI 49301

THE MARK CONSISTS OF STANDARD CHAR-  
ACTERS WITHOUT CLAIM TO ANY PARTICULAR  
FONT, STYLE, SIZE, OR COLOR.

FOR: COMPACT DISCS FEATURING FINAN-  
CIAL SALES AND MARKETING TECHNIQUES, IN  
CLASS 9 (U.S. CLS. 21, 23, 26, 36 AND 38).

SN 78-930,006, FILED 7-14-2006.

FIRST USE 7-18-2006; IN COMMERCE 7-18-2006.

MICHAEL KAZAZIAN, EXAMINING ATTORNEY

**Int. Cl.: 45**

**Prior U.S. Cls.: 100 and 101**

**United States Patent and Trademark Office**

**Reg. No. 3,396,405**

**Registered Mar. 11, 2008**

**SERVICE MARK  
PRINCIPAL REGISTER**

**LIMEADE**

LIMEADE, INC. (WASHINGTON CORPORATION)  
SUITE 200  
2002 156TH AVE NE  
BELLEVUE, WA 98007

FOR: PROVIDING ONLINE HOLISTIC WELL-BEING AND PERSONALITY TYPING AND ASSESSMENT; PROVIDING ONLINE INFORMATION FOR SELF-HELP IN PERSONAL DEVELOPMENT, NAMELY, PROVIDING INFORMATION AND TOOLS FOR USE IN SETTING, TRACKING AND

EVALUATING PERSONAL DEVELOPMENT GOALS, IN CLASS 45 (U.S. CLS. 100 AND 101).

FIRST USE 8-21-2006; IN COMMERCE 8-21-2006.

THE MARK CONSISTS OF STANDARD CHARACTERS WITHOUT CLAIM TO ANY PARTICULAR FONT, STYLE, SIZE, OR COLOR.

SN 78-930,388, FILED 7-15-2006.

KAREN BRACEY, EXAMINING ATTORNEY



**Int. Cl.: 30**

**Prior U.S. Cl.: 46**

**United States Patent and Trademark Office**

**Reg. No. 3,396,406**

**Registered Mar. 11, 2008**

**TRADEMARK  
PRINCIPAL REGISTER**

**ORIENT EMPORIUM TEA CO.**

COTT BEVERAGES INC. (GEORGIA CORPORATION)  
5519 WEST IDLEWILD AVENUE  
TAMPA, FL 33634

NO CLAIM IS MADE TO THE EXCLUSIVE RIGHT TO USE "ORIENT" OR "TEA CO.", APART FROM THE MARK AS SHOWN.

FOR: TEAS, IN CLASS 30 (U.S. CL. 46).

FIRST USE 8-0-2006; IN COMMERCE 8-0-2006.

SN 78-930,813, FILED 7-17-2006.

THE MARK CONSISTS OF STANDARD CHARACTERS WITHOUT CLAIM TO ANY PARTICULAR FONT, STYLE, SIZE, OR COLOR.

LYDIA BELZER, EXAMINING ATTORNEY

**Int. Cl.: 5**

**Prior U.S. Cls.: 6, 18, 44, 46, 51, and 52**

**United States Patent and Trademark Office**

**Reg. No. 3,396,407**

**Registered Mar. 11, 2008**

**TRADEMARK  
PRINCIPAL REGISTER**

**TORRENT**

SIPCAM AGRO USA, INC. (GEORGIA CORPORATION)  
300 COLONIAL CENTER PARKWAY  
ROSWELL, GA 30076

THE MARK CONSISTS OF STANDARD CHARACTERS WITHOUT CLAIM TO ANY PARTICULAR FONT, STYLE, SIZE, OR COLOR.

FOR: PESTICIDES, IN CLASS 5 (U.S. CLS. 6, 18, 44, 46, 51 AND 52).

SN 78-931,047, FILED 7-17-2006.

FIRST USE 3-0-2007; IN COMMERCE 3-0-2007.

CAROLYN CATALDO, EXAMINING ATTORNEY

**Int. Cls.: 35 and 41**

**Prior U.S. Cls.: 100, 101, 102, and 107**

**United States Patent and Trademark Office**

**Reg. No. 3,396,408**

**Registered Mar. 11, 2008**

**SERVICE MARK  
PRINCIPAL REGISTER**

**TRACKDOWN MUSIC**

KORBIN'S PRODUCTIONS, INC. (CALIFORNIA CORPORATION)

1450 RISING GLEN ROAD  
LOS ANGELES, CA 90069

FOR: COMMERCIAL ADMINISTRATION OF THE LICENSING OF MUSICAL COMPOSITIONS AND SOUND RECORDINGS OF OTHERS; MANAGING LICENSE RIGHTS FOR MUSIC FOR OTHERS; ENTERTAINMENT SERVICES, NAMELY, DISTRIBUTION OF PRERECORDED SOUND RECORDINGS AND MUSICAL COMPOSITIONS, IN CLASS 35 (U.S. CLS. 100, 101 AND 102).

FIRST USE 6-21-2006; IN COMMERCE 3-26-2007.

FOR: MUSIC PRODUCTION SERVICES, IN CLASS 41 (U.S. CLS. 100, 101 AND 107).

FIRST USE 6-21-2006; IN COMMERCE 3-26-2007.

THE MARK CONSISTS OF STANDARD CHARACTERS WITHOUT CLAIM TO ANY PARTICULAR FONT, STYLE, SIZE, OR COLOR.

NO CLAIM IS MADE TO THE EXCLUSIVE RIGHT TO USE "MUSIC" , APART FROM THE MARK AS SHOWN.

SN 78-931,348, FILED 7-17-2006.

NAKIA HENRY, EXAMINING ATTORNEY

**Int. Cl.: 42**

**Prior U.S. Cls.: 100 and 101**

**United States Patent and Trademark Office**

**Reg. No. 3,396,409**

**Registered Mar. 11, 2008**

**SERVICE MARK  
PRINCIPAL REGISTER**

**MISSION ZERO**

INTERFACE, INC. (GEORGIA CORPORATION)  
SUITE 2000  
2859 PACES FERRY ROAD  
ATLANTA, GA 30339

THE MARK CONSISTS OF STANDARD CHAR-  
ACTERS WITHOUT CLAIM TO ANY PARTICULAR  
FONT, STYLE, SIZE, OR COLOR.

FOR: DESIGN OF CARPET AND FABRIC FOR  
OTHERS, IN CLASS 42 (U.S. CLS. 100 AND 101).

SN 78-931,588, FILED 7-18-2006.

FIRST USE 6-6-2006; IN COMMERCE 6-6-2006.

ATTIYA MALIK, EXAMINING ATTORNEY

**Int. Cl.: 29**

**Prior U.S. Cl.: 46**

**United States Patent and Trademark Office**

**Reg. No. 3,396,410**

**Registered Mar. 11, 2008**

**TRADEMARK  
PRINCIPAL REGISTER**

**GOURMET SOLUTIONS**

BRIMSTONE ORIGINALS, LLC (FLORIDA LIMITED LIABILITY CORPORATION)

6700 150TH AVENUE N.

#438

CLEARWATER, FL 33764

FOR: JELLIES, IN CLASS 29 (U.S. CL. 46).

FIRST USE 8-1-2006; IN COMMERCE 1-1-2007.

THE MARK CONSISTS OF STANDARD CHARACTERS WITHOUT CLAIM TO ANY PARTICULAR FONT, STYLE, SIZE, OR COLOR.

NO CLAIM IS MADE TO THE EXCLUSIVE RIGHT TO USE "GOURMET", APART FROM THE MARK AS SHOWN.

SN 78-931,889, FILED 7-18-2006.

DEZMONA MIZELLE, EXAMINING ATTORNEY

**Int. Cl.: 9**

**Prior U.S. Cls.: 21, 23, 26, 36, and 38**

**United States Patent and Trademark Office**

**Reg. No. 3,396,411**

**Registered Mar. 11, 2008**

**TRADEMARK  
PRINCIPAL REGISTER**

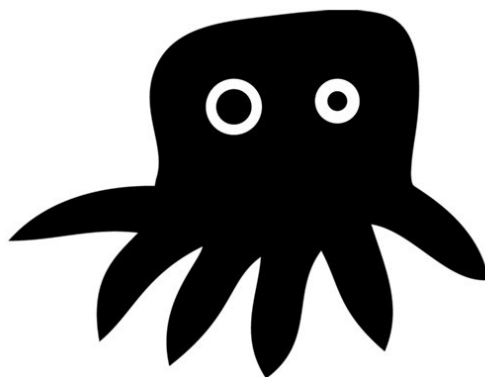

CHUMBY INDUSTRIES, INC. (DELAWARE CORPORATION)  
12264 EL CAMINO REAL, SUITE 203  
SAN DIEGO, CA 92130

FOR: COMPUTER SOFTWARE, NAMELY, SOFTWARE FOR DOWNLOADING AND PLAYING AUDIO, VIDEO AND DATA CONTENT VIA THE INTERNET AND GLOBAL COMPUTER NETWORKS; RADIOS INCORPORATING CLOCKS FEATURING COMPUTER HARDWARE FOR PLAYING AUDIO, VIDEO AND DATA CONTENT VIA THE INTERNET AND GLOBAL COMPUTER NETWORKS; COMPUTER HARDWARE AND WIRELESS RECEIVERS AND TRANSMITTERS FOR RECEIVING AND TRANSMITTING AUDIO/VIDEO AND RADIO DATA AND INFORMATION OVER WIRELESS BANDWIDTHS; COMPUTER HARD-

WARE AND PERIPHERALS IN THE NATURE OF SCREENS, WIRELESS COMMUNICATION CHIPS AND MICROPROCESSORS, AND SOFTWARE FOR GRAPHICS RENDERING, SOUND AND PORTING THAT PROVIDES ACCESS TO THE INTERNET AND GLOBAL COMPUTER NETWORKS, SOLD TOGETHER AS A UNIT, IN CLASS 9 (U.S. CLS. 21, 23, 26, 36 AND 38).

FIRST USE 8-25-2006; IN COMMERCE 7-31-2007.

THE MARK CONSISTS OF A DESIGN OF AN OCTOPUS.

SN 78-931,894, FILED 7-18-2006.

AISHA SALEM, EXAMINING ATTORNEY

**Int. Cl.: 40**

**Prior U.S. Cls.: 100, 103, and 106**

**United States Patent and Trademark Office**

**Reg. No. 3,396,412**

**Registered Mar. 11, 2008**

**SERVICE MARK  
PRINCIPAL REGISTER**

# TruColor

TRULUCK ENTERPRIZES, INC. (SOUTH CAROLINA CORPORATION)  
2107 LAURENS ROAD  
GREENVILLE, SC 29607

FOR: BINDERY SERVICES FOR OTHERS, NAME-  
LY, COLLATING, FOLDING, STAPLING, PERFOR-  
ATING, CUTTING AND BINDING OF PRINTED,  
PHOTOCOPIED AND TYPEWRITTEN MATERIALS;  
DIGITAL ON-DEMAND PRINTING SERVICES OF  
BOOKS AND OTHER DOCUMENTS; OFFSET  
PRINTING; PRINTING, IN CLASS 40 (U.S. CLS. 100,  
103 AND 106).

FIRST USE 11-1-2006; IN COMMERCE 11-1-2006.

THE MARK CONSISTS OF STANDARD CHAR-  
ACTERS WITHOUT CLAIM TO ANY PARTICULAR  
FONT, STYLE, SIZE, OR COLOR.

SN 78-932,136, FILED 7-18-2006.

CARYN GLASSER, EXAMINING ATTORNEY

**Int. Cl.: 11**

**Prior U.S. Cls.: 13, 21, 23, 31, and 34**

**United States Patent and Trademark Office**

**Reg. No. 3,396,413**

**Registered Mar. 11, 2008**

**TRADEMARK  
PRINCIPAL REGISTER**

**AK-MTG**

AMERIKOOLER, INC. (FLORIDA CORPORATION)  
575 EAST 10TH AVENUE  
HIALEAH, FL 33010

FOR: INSULATED AIR CONDITIONING PANELS FOR USE ON DOORS, WALLS, CEILING AND FLOORS FOR WALKIN COOLERS AND FREEZERS, REFRIGERATED WAREHOUSES, AND MOBILE WHEEL COOLERS/FREEZERS , IN CLASS 11 (U.S. CLS. 13, 21, 23, 31 AND 34).

FIRST USE 5-1-2005; IN COMMERCE 5-1-2005.

THE MARK CONSISTS OF STANDARD CHARACTERS WITHOUT CLAIM TO ANY PARTICULAR FONT, STYLE, SIZE, OR COLOR.

SN 78-932,824, FILED 7-19-2006.

DAVID TAYLOR, EXAMINING ATTORNEY



**Int. Cl.: 11**

**Prior U.S. Cls.: 13, 21, 23, 31, and 34**

**United States Patent and Trademark Office**

**Reg. No. 3,396,414**

**Registered Mar. 11, 2008**

**TRADEMARK  
PRINCIPAL REGISTER**

**AK-225**

AMERIKOOLER, INC. (FLORIDA CORPORATION)  
575 EAST 10TH AVENUE  
HIALEAH, FL 33010

FOR: INSULATED AIR CONDITIONING PANELS FOR USE ON DOORS, WALLS, CEILING AND FLOORS FOR WALKIN COOLERS AND FREEZERS, REFRIGERATED WAREHOUSES, AND MOBILE WHEEL COOLERS/FREEZERS , IN CLASS 11 (U.S. CLS. 13, 21, 23, 31 AND 34).

FIRST USE 5-1-2005; IN COMMERCE 5-1-2005.

THE MARK CONSISTS OF STANDARD CHARACTERS WITHOUT CLAIM TO ANY PARTICULAR FONT, STYLE, SIZE, OR COLOR.

SN 78-932,840, FILED 7-19-2006.

DAVID TAYLOR, EXAMINING ATTORNEY

Int. Cl.: 16

Prior U.S. Cls.: 2, 5, 22, 23, 29, 37, 38, and 50

United States Patent and Trademark Office

Reg. No. 3,396,415

Registered Mar. 11, 2008

TRADEMARK  
PRINCIPAL REGISTER



HOMES & LAND AFFILIATES, LLC (DELA-  
WARE LTD LIAB CO)  
1830 EAST PARK AVENUE  
TALLAHASSEE, FL 32301

FOR: REAL ESTATE LISTING MAGAZINES, IN  
CLASS 16 (U.S. CLS. 2, 5, 22, 23, 29, 37, 38 AND 50).

FIRST USE 1-0-2007; IN COMMERCE 1-0-2007.

OWNER OF U.S. REG. NOS. 1,256,835, 1,756,790,  
AND 2,743,516.

THE MARK CONSISTS OF THE WORDING "HO-  
GARES Y TERRENOS" IN A STYLIZED FORMAT

IN COMBINATION WITH A RECTANGULAR DE-  
SIGN.

THE FOREIGN WORDING IN THE MARK  
TRANSLATES INTO ENGLISH AS "HOMES" AND  
"LAND".

SEC. 2(F).

SN 78-933,590, FILED 7-20-2006.

CAROLYN CATALDO, EXAMINING ATTORNEY

**Int. Cl.: 38**

**Prior U.S. Cls.: 100, 101, and 104**

**United States Patent and Trademark Office**

**Reg. No. 3,396,416**

**Registered Mar. 11, 2008**

**SERVICE MARK  
PRINCIPAL REGISTER**

# Magellan

CORDIA CORPORATION (NEVADA CORPORATION)  
445 HAMILTON AVENUE, SUITE 408  
WHITE PLAINS, NY 10601

THE MARK CONSISTS OF STANDARD CHARACTERS WITHOUT CLAIM TO ANY PARTICULAR FONT, STYLE, SIZE, OR COLOR.

FOR: CALL FORWARDING SERVICES, IN CLASS 38 (U.S. CLS. 100, 101 AND 104).

SN 78-933,864, FILED 7-20-2006.

FIRST USE 5-1-2007; IN COMMERCE 5-1-2007.

HEATHER THOMPSON, EXAMINING ATTORNEY

**Int. Cls.: 41 and 42**

**Prior U.S. Cls.: 100, 101, and 107**

**United States Patent and Trademark Office**

**Reg. No. 3,396,417**

**Registered Mar. 11, 2008**

**SERVICE MARK  
PRINCIPAL REGISTER**

**SURGEON DRIVEN DESIGN**

K2M, INC. (DELAWARE CORPORATION)  
SUITE F-1  
751 MILLER DRIVE, SE  
LEESBURG, VA 20175

FOR: EDUCATIONAL SERVICES, NAMELY  
CONDUCTING CLASSES AND PROVIDING  
TRAINING SERVICES IN THE FIELD OF SURGERY  
AND IN THE FIELD OF MEDICAL AND SURGICAL  
APPARATUS, APPLIANCES, DEVICES AND IN-  
STRUMENTS, IN CLASS 41 (U.S. CLS. 100, 101 AND  
107).

FIRST USE 8-5-2006; IN COMMERCE 8-26-2006.

FOR: CONSULTING IN THE FIELD OF DESIGN-  
ING MEDICAL AND SURGICAL APPARATUS,

APPLIANCES, DEVICES AND INSTRUMENTS, IN  
CLASS 42 (U.S. CLS. 100 AND 101).

FIRST USE 3-16-2005; IN COMMERCE 3-16-2005.

THE MARK CONSISTS OF STANDARD CHAR-  
ACTERS WITHOUT CLAIM TO ANY PARTICULAR  
FONT, STYLE, SIZE, OR COLOR.

NO CLAIM IS MADE TO THE EXCLUSIVE  
RIGHT TO USE "SURGEON" OR "DESIGN", APART  
FROM THE MARK AS SHOWN.

SN 78-933,881, FILED 7-20-2006.

SEAN CROWLEY, EXAMINING ATTORNEY

**Int. Cls.: 25 and 35**

**Prior U.S. Cls.: 22, 39, 100, 101, and 102**

**United States Patent and Trademark Office**

**Reg. No. 3,396,418**

**Registered Mar. 11, 2008**

**TRADEMARK  
SERVICE MARK  
PRINCIPAL REGISTER**



JASPER, JAMIA C. (UNITED STATES INDIVIDUAL)  
SUITE PH  
128 E. 62ND STREET  
NEW YORK, NY 10021

FOR: INFANTWEAR AND TODDLER CLOTHING IN THE NATURE OF JUMPSUITS, HATS, MITTENS, BOOTIES, CARDIGAN, ONE PIECE CLOTHING, PANTS, DRESSES, SHORTS, SHIRTS, AND SOCKS ALL MADE OF ORGANIC COTTON, IN CLASS 25 (U.S. CLS. 22 AND 39).

FIRST USE 12-5-2007; IN COMMERCE 12-5-2007.

FOR: ON-LINE RETAIL STORE SERVICES IN THE FIELD OF INFANT AND TODDLER CLOTHING, IN CLASS 35 (U.S. CLS. 100, 101 AND 102).

FIRST USE 12-15-2005; IN COMMERCE 12-15-2005.

SN 78-934,472, FILED 7-21-2006.

B. PARADEWELAI, EXAMINING ATTORNEY

**Int. Cl.: 36**

**Prior U.S. Cls.: 100, 101, and 102**

**United States Patent and Trademark Office**

**Reg. No. 3,396,419**

**Registered Mar. 11, 2008**

**SERVICE MARK  
PRINCIPAL REGISTER**

**FNBI**

FIRST NATIONAL BANK OF IPSWICH (MASSACHUSETTS CORPORATION)  
31 MARKET STREET  
IPSWICH, MA 01938

FOR: BANKING; ADVICE RELATING TO INVESTMENTS; FINANCIAL SERVICES IN THE NATURE OF AN INVESTMENT SECURITY; FINANCIAL SERVICES, NAMELY, A TOTAL PORTFOLIO OFFERING FOR HIGH NET WORTH CLIENTS CONSISTING OF BOTH SEPARATE ACCOUNTS AND MUTUAL FUNDS FOR EQUITY AND FIXED INCOME INVESTMENTS; FINANCIAL SERVICES, NAMELY, INVESTMENT FUND TRANSFER AND TRANSACTION SERVICES; FUND INVESTMENT CONSULTATION; FUNDS INVESTMENT; INVESTMENT ADVICE; INVESTMENT ADVISORY SERVICES; INVESTMENT BROKERAGE; INVESTMENT CLUBS; INVEST-

MENT MANAGEMENT; INVESTMENT MANAGEMENT OF AND DISTRIBUTION OF VARIABLE ANNUITIES; INVESTMENT OF FUNDS FOR OTHERS; MUTUAL FUND INVESTMENT, IN CLASS 36 (U.S. CLS. 100, 101 AND 102).

FIRST USE 12-31-2001; IN COMMERCE 12-31-2001.

THE MARK CONSISTS OF STANDARD CHARACTERS WITHOUT CLAIM TO ANY PARTICULAR FONT, STYLE, SIZE, OR COLOR.

OWNER OF U.S. REG. NO. 2,510,457.

SN 78-934,563, FILED 7-21-2006.

JUSTINE D. PARKER, EXAMINING ATTORNEY

**Int. Cl.: 30**

**Prior U.S. Cl.: 46**

**United States Patent and Trademark Office**

**Reg. No. 3,396,420**

**Registered Mar. 11, 2008**

**TRADEMARK  
PRINCIPAL REGISTER**

**Sugar Sisters Bakery and  
Cafe**

SYKES, PATRICIA (UNITED STATES INDIVIDUAL)  
1012 LYNNRAE LN  
WICHITA, KS 67207

FOR: BAKED GOODS, NAMELY, BREADS, COOKIES, CAKES, PIES, TARTS, MUFFINS, SCONES, BAGELS; COFFEE, TEA, CANDY, PASTA SALAD, IN CLASS 30 (U.S. CL. 46).

FIRST USE 1-1-2008; IN COMMERCE 1-1-2008.

THE MARK CONSISTS OF STANDARD CHARACTERS WITHOUT CLAIM TO ANY PARTICULAR FONT, STYLE, SIZE, OR COLOR.

NO CLAIM IS MADE TO THE EXCLUSIVE RIGHT TO USE "BAKERY AND CAFE", APART FROM THE MARK AS SHOWN.

SN 78-935,411, FILED 7-22-2006.

JILL C. ALT, EXAMINING ATTORNEY

**Int. Cl.: 9**

**Prior U.S. Cls.: 21, 23, 26, 36, and 38**

**United States Patent and Trademark Office**

**Reg. No. 3,396,421**

**Registered Mar. 11, 2008**

**TRADEMARK  
PRINCIPAL REGISTER**

**JACK DANIEL'S**

JACK DANIEL'S PROPERTIES, INC. (DELA-  
WARE CORPORATION)  
4040 CIVIC CENTER DRIVE  
SUITE 528  
SAN RAFAEL, CA 94903

FOR: MUSICAL INSTRUMENT AMPLIFIERS, IN  
CLASS 9 (U.S. CLS. 21, 23, 26, 36 AND 38).

FIRST USE 11-5-2004; IN COMMERCE 11-5-2004.

THE MARK CONSISTS OF STANDARD CHAR-  
ACTERS WITHOUT CLAIM TO ANY PARTICULAR  
FONT, STYLE, SIZE, OR COLOR.

OWNER OF U.S. REG. NOS. 1,290,702, 2,898,085,  
AND OTHERS.

THE NAME(S), PORTRAIT(S), AND/OR SIGNA-  
TURE(S) SHOWN IN THE MARK DOES NOT IDEN-  
TIFY A PARTICULAR LIVING INDIVIDUAL.

SN 78-936,344, FILED 7-24-2006.

MICHAEL GAAFAR, EXAMINING ATTORNEY



**Int. Cl.: 15**

**Prior U.S. Cls.: 2, 21, and 36**

**United States Patent and Trademark Office**

**Reg. No. 3,396,422**

**Registered Mar. 11, 2008**

**TRADEMARK  
PRINCIPAL REGISTER**

**JACK DANIEL'S**

JACK DANIEL'S PROPERTIES, INC. (DELA-  
WARE CORPORATION)  
4040 CIVIC CENTER DRIVE  
SUITE 528  
SAN RAFAEL, CA 94903

FOR: GUITAR STRAPS, IN CLASS 15 (U.S. CLS. 2,  
21 AND 36).

FIRST USE 9-20-2004; IN COMMERCE 9-20-2004.

THE MARK CONSISTS OF STANDARD CHAR-  
ACTERS WITHOUT CLAIM TO ANY PARTICULAR  
FONT, STYLE, SIZE, OR COLOR.

OWNER OF U.S. REG. NOS. 1,290,702, 2,898,085,  
AND OTHERS.

THE NAME(S), PORTRAIT(S), AND/OR SIGNA-  
TURE(S) SHOWN IN THE MARK DOES NOT IDENT-  
TIFY A PARTICULAR LIVING INDIVIDUAL.

SN 78-936,364, FILED 7-24-2006.

MICHAEL GAAFAR, EXAMINING ATTORNEY

**Int. Cl.: 9**

**Prior U.S. Cls.: 21, 23, 26, 36, and 38**

**Reg. No. 3,396,423**

**United States Patent and Trademark Office**

**Registered Mar. 11, 2008**

**TRADEMARK  
PRINCIPAL REGISTER**



GREGORY ENTERPRISES, INC. (OKLAHOMA CORPORATION)  
3065 FOREST LANE  
GARLAND, TX 75042

NO CLAIM IS MADE TO THE EXCLUSIVE RIGHT TO USE "FOUNDATION SOLUTIONS", APART FROM THE MARK AS SHOWN.

FOR: COMPUTER SOFTWARE FOR USE IN FOUNDATION DESIGN AND DETERMINING PIER AND PILE CAPACITY, IN CLASS 9 (U.S. CLS. 21, 23, 26, 36 AND 38).

THE MARK CONSISTS OF THE WORDS "RAM JACK FOUNDATION SOLUTIONS" AND A REPRESENTATION OF A RAM'S HEAD.

FIRST USE 8-28-2007; IN COMMERCE 8-28-2007.

SN 78-937,021, FILED 7-25-2006.

OWNER OF U.S. REG. NOS. 1,539,595 AND 1,592,360.

THOMAS MANOR, EXAMINING ATTORNEY

**Int. Cl.: 5**

**Prior U.S. Cls.: 6, 18, 44, 46, 51, and 52**

**United States Patent and Trademark Office**

**Reg. No. 3,396,424**

**Registered Mar. 11, 2008**

**TRADEMARK  
PRINCIPAL REGISTER**



W. R. RAYSON CO., INC. (NORTH CAROLINA  
CORPORATION)  
720 SOUTH DICKERSON ST.  
BURGAW, NC 28425

FIRST USE 1-1-2007; IN COMMERCE 1-1-2007.

SN 78-937,030, FILED 7-25-2006.

FOR: ALL PURPOSE DISINFECTANT, IN CLASS  
5 (U.S. CLS. 6, 18, 44, 46, 51 AND 52).

MIDGE BUTLER, EXAMINING ATTORNEY

**Int. Cl.: 5**

**Prior U.S. Cls.: 6, 18, 44, 46, 51, and 52**

**United States Patent and Trademark Office**

**Reg. No. 3,396,425**

**Registered Mar. 11, 2008**

**TRADEMARK  
PRINCIPAL REGISTER**

**STA-THIN**

DENNISON, STAN (UNITED STATES INDIVIDUAL)  
1222 8TH STREET  
WOODWARD, OK 73801

THE MARK CONSISTS OF STANDARD CHARACTERS WITHOUT CLAIM TO ANY PARTICULAR FONT, STYLE, SIZE, OR COLOR.

FOR: NUTRITIONAL AND DIETARY SUPPLEMENTS, IN CLASS 5 (U.S. CLS. 6, 18, 44, 46, 51 AND 52).

SN 78-937,077, FILED 7-25-2006.

FIRST USE 1-12-2007; IN COMMERCE 1-12-2007.

MICHELLE DUBOIS, EXAMINING ATTORNEY

**Int. Cl.: 5**

**Prior U.S. Cls.: 6, 18, 44, 46, 51, and 52**

**United States Patent and Trademark Office**

**Reg. No. 3,396,426**

**Registered Mar. 11, 2008**

**TRADEMARK  
PRINCIPAL REGISTER**

**STA-RESTORED**

DENNISON, STAN (UNITED STATES INDIVIDUAL)  
1222 8TH STREET  
WOODWARD, OK 73801

THE MARK CONSISTS OF STANDARD CHARACTERS WITHOUT CLAIM TO ANY PARTICULAR FONT, STYLE, SIZE, OR COLOR.

FOR: NUTRITIONAL AND DIETARY SUPPLEMENTS, IN CLASS 5 (U.S. CLS. 6, 18, 44, 46, 51 AND 52).

SN 78-937,152, FILED 7-25-2006.

FIRST USE 1-12-2007; IN COMMERCE 1-12-2007.

MICHELLE DUBOIS, EXAMINING ATTORNEY

Int. Cl.: 45

Prior U.S. Cls.: 100 and 101

United States Patent and Trademark Office

Reg. No. 3,396,427

Registered Mar. 11, 2008

SERVICE MARK  
PRINCIPAL REGISTER



LIMEADE, INC. (WASHINGTON CORPORATION)  
SUITE 200  
2002 156TH AVE NE  
BELLEVUE, WA 98007

FOR: PROVIDING ONLINE HOLISTIC WELL-BEING AND PERSONALITY TYPING AND ASSESSMENT; PROVIDING ONLINE INFORMATION FOR SELF-HELP IN PERSONAL DEVELOPMENT, NAMELY, PROVIDING INFORMATION AND TOOLS FOR USE IN SETTING, TRACKING AND EVALUATING PERSONAL DEVELOPMENT GOALS, IN CLASS 45 (U.S. CLS. 100 AND 101).

FIRST USE 8-21-2006; IN COMMERCE 8-21-2006.

THE COLOR(S) DARK GREEN, LIGHT GREEN, YELLOW-GREEN, YELLOW AND WHITE IS/ARE CLAIMED AS A FEATURE OF THE MARK.

THE COLOR DARK GREEN APPEARS IN THE OUTERMOST OR FIRST RING OF THE LIME SLICE; THE COLOR LIGHT GREEN APPEARS IN THE SECOND RING OF THE LIME SLICE, IN THE LINES REPRESENTING SECTIONS OF THE SLICE, IN THE WORDING "LIMEADE" AND IN THE SHADING BENEATH THE LIME SLICE; THE COLOR YELLOW GREEN APPEARS IN THE THIRD RING OF THE LIME SLICE; THE COLOR YELLOW APPEARS IN THE DOT OF THE LETTER "I" IN LIMEADE AND IN THE INNERMOST OR FOURTH RING OF THE LIME SLICE; AND THE COLOR WHITE APPEARS IN THE CENTER OF THE DESIGN OF THE LIME SLICE.

SN 78-937,263, FILED 7-25-2006.

KAREN BRACEY, EXAMINING ATTORNEY

**Int. Cl.: 9**

**Prior U.S. Cls.: 21, 23, 26, 36, and 38**

**Reg. No. 3,396,428**

**United States Patent and Trademark Office**

**Registered Mar. 11, 2008**

---

**TRADEMARK  
PRINCIPAL REGISTER**

**OPENPATH**

HARLAND FINANCIAL SOLUTIONS, INC. (ORE-  
GON CORPORATION)  
400 SW SIXTH AVE  
SUITE 200  
PORTLAND, OR 97204

FOR: SOFTWARE FOR THE FINANCIAL SERVI-  
CES INDUSTRY, NAMELY, MIDDLEWARE USED  
TO AUTOMATICALLY MIGRATE FINANCIAL  
DATA BETWEEN APPLICATIONS , IN CLASS 9  
(U.S. CLS. 21, 23, 26, 36 AND 38).

FIRST USE 8-30-2006; IN COMMERCE 8-30-2006.

THE MARK CONSISTS OF STANDARD CHAR-  
ACTERS WITHOUT CLAIM TO ANY PARTICULAR  
FONT, STYLE, SIZE, OR COLOR.

SN 78-937,339, FILED 7-25-2006.

EDWARD NELSON, EXAMINING ATTORNEY

**Int. Cl.: 16**

**Prior U.S. Cls.: 2, 5, 22, 23, 29, 37, 38, and 50**

**United States Patent and Trademark Office**

**Reg. No. 3,396,429**

**Registered Mar. 11, 2008**

**TRADEMARK  
PRINCIPAL REGISTER**



SIMON, RACHEL (UNITED STATES INDIVIDUAL)  
658 LAKE PARK DRIVE  
COPPELL, TX 98019 AND  
SIMON, JASON (UNITED STATES INDIVIDUAL)  
441 PIMLICO DRIVE  
WALNUT CREEK, CA 94597

FIRST USE 11-1-2006; IN COMMERCE 11-1-2006.

THE MARK CONSISTS OF JEWISH STAR OF DAVID ON BOTTOM LEFT AND SCISSORS ON TOP RIGHT.

SN 78-937,346, FILED 7-25-2006.

FOR: CRAFT PAPER, IN CLASS 16 (U.S. CLS. 2, 5, 22, 23, 29, 37, 38 AND 50).

JOHN WILKE, EXAMINING ATTORNEY



**Int. Cl.: 21**

**Prior U.S. Cls.: 2, 13, 23, 29, 30, 33, 40, and 50**

**United States Patent and Trademark Office**

**Reg. No. 3,396,430**

**Registered Mar. 11, 2008**

**TRADEMARK  
PRINCIPAL REGISTER**

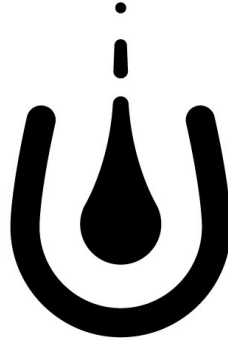

IGNITE USA, LLC (ILLINOIS LIMITED LIABILITY CORPORATION)  
MC 37  
954 W. WASHINGTON BLVD.  
CHICAGO, IL 60607

FOR: OPENING/CLOSING MECHANISM AS A COMPONENT PART OF A BEVERAGE CONTAIN-

ER, IN CLASS 21 (U.S. CLS. 2, 13, 23, 29, 30, 33, 40 AND 50).

FIRST USE 1-31-2007; IN COMMERCE 1-31-2007.

SN 78-937,520, FILED 7-26-2006.

HEATHER BIDDULPH, EXAMINING ATTORNEY

**Int. Cl.: 16**

**Prior U.S. Cls.: 2, 5, 22, 23, 29, 37, 38, and 50**

**United States Patent and Trademark Office**

**Reg. No. 3,396,431**

**Registered Mar. 11, 2008**

**TRADEMARK  
PRINCIPAL REGISTER**

**TEE JUICE**

RUPERT, GIBBONS & SPIDER, INC. (CALIFORNIA CORPORATION)  
P. O. BOX 425  
HEALDSBURG, CA 95448

THE MARK CONSISTS OF STANDARD CHARACTERS WITHOUT CLAIM TO ANY PARTICULAR FONT, STYLE, SIZE, OR COLOR.

FOR: MARKERS, IN CLASS 16 (U.S. CLS. 2, 5, 22, 23, 29, 37, 38 AND 50).

SN 78-937,723, FILED 7-26-2006.

FIRST USE 12-15-2006; IN COMMERCE 2-12-2007.

PAULA MAHONEY, EXAMINING ATTORNEY

**Int. Cl.: 35**

**Prior U.S. Cls.: 100, 101, and 102**

**United States Patent and Trademark Office**

**Reg. No. 3,396,432**

**Registered Mar. 11, 2008**

**SERVICE MARK  
PRINCIPAL REGISTER**

**ZEALTOR**

MURPHY, TODD (UNITED STATES INDIVIDUAL)  
2075-A COLUMBIANA ROAD  
BIRMINGHAM, AL 35216

FOR: ADVERTISING, MARKETING AND PROMOTION SERVICES; MARKETING SERVICES, NAMELY, PROVIDING INFORMATIONAL WEB PAGES DESIGNED TO GENERATE SALES TRAFFIC VIA HYPERLINKS TO OTHER WEB SITES; PROMOTING, ADVERTISING AND MARKETING OF THE ON-LINE WEBSITES OF OTHERS; PROMOTION, ADVERTISING AND MARKETING OF ON-

LINE WEBSITES, IN CLASS 35 (U.S. CLS. 100, 101 AND 102).

FIRST USE 8-22-2007; IN COMMERCE 8-22-2007.

THE MARK CONSISTS OF STANDARD CHARACTERS WITHOUT CLAIM TO ANY PARTICULAR FONT, STYLE, SIZE, OR COLOR.

SN 78-937,818, FILED 7-26-2006.

DORITT L. CARROLL, EXAMINING ATTORNEY

Int. Cl.: 3

Prior U.S. Cls.: 1, 4, 6, 50, 51, and 52

United States Patent and Trademark Office

Reg. No. 3,396,433

Registered Mar. 11, 2008

TRADEMARK  
PRINCIPAL REGISTER



CLIFT INDUSTRIES, INC. (NORTH CAROLINA CORPORATION)  
P.O. BOX 67153  
CHARLOTTE, NC 28226

FOR: CLEANING SUPPLIES, NAMELY, ALL-PURPOSE CLEANING PREPARATIONS; CANNED PRESSURIZED GAS FOR DUSTING AND CLEANING PURPOSES; CLEANING PREPARATIONS FOR HOUSEHOLD PURPOSES; FOAM CLEANING PREPARATIONS; GENERAL PURPOSE CLEANING, POLISHING AND ABRASIVE FLUIDS AND POWDERS; GLASS CLEANING PREPARATIONS; HOUSEHOLD CLEANING PREPARATIONS; SOAPS AND DETERGENTS; DEGREASING PREPARA-

TIONS FOR USE ON METAL, WOOD, CERAMIC, PLASTIC AND CONCRETE, IN CLASS 3 (U.S. CLS. 1, 4, 6, 50, 51 AND 52).

FIRST USE 9-27-2006; IN COMMERCE 9-27-2006.

NO CLAIM IS MADE TO THE EXCLUSIVE RIGHT TO USE "PURE", APART FROM THE MARK AS SHOWN.

SN 78-938,166, FILED 7-26-2006.

HEATHER THOMPSON, EXAMINING ATTORNEY

**Int. Cl.: 5**

**Prior U.S. Cls.: 6, 18, 44, 46, 51, and 52**

**United States Patent and Trademark Office**

**Reg. No. 3,396,434**

**Registered Mar. 11, 2008**

**TRADEMARK  
PRINCIPAL REGISTER**

**PHYTOMATRIX**

MANNATECH, INCORPORATED (TEXAS CORPORATION)  
SUITE 200  
600 SOUTH ROYAL LANE  
COPPELL, TX 75019

FOR: DIETARY SUPPLEMENTS, NUTRITIONAL SUPPLEMENTS; HERBAL AND MINERAL SUPPLEMENTS, IN CLASS 5 (U.S. CLS. 6, 18, 44, 46, 51 AND 52).

FIRST USE 11-10-2006; IN COMMERCE 11-10-2006.

THE MARK CONSISTS OF STANDARD CHARACTERS WITHOUT CLAIM TO ANY PARTICULAR FONT, STYLE, SIZE, OR COLOR.

SN 78-938,307, FILED 7-26-2006.

JAMES LOVELACE, EXAMINING ATTORNEY

**Int. Cls.: 35, 36, and 42**

**Prior U.S. Cls.: 100, 101, and 102**

**United States Patent and Trademark Office**

**Reg. No. 3,396,435**

**Registered Mar. 11, 2008**

**SERVICE MARK  
PRINCIPAL REGISTER**

**WE GET TO THE POINT.**

CLEARPOINT BUSINESS RESOURCES, INC. (DELAWARE CORPORATION)  
SUITE 110  
1600 MANOR DRIVE  
CHALFONT, PA 18914

FOR: HUMAN CAPITAL MANAGEMENT OUTSOURCING SERVICES; OUTSOURCING IN THE FIELD OF BUSINESS PROCESSES; PROVIDING OFFICE SUPPORT STAFF SERVICES AND STAFF AUGMENTATION SERVICES TO OTHERS, NAMELY, EMPLOYMENT STAFFING SERVICES; BUSINESS MANAGEMENT SERVICES FOR OTHERS IN THE FIELDS OF ENGINEERING, INFORMATION TECHNOLOGY, TRANSPORTATION AND HEALTHCARE; EXECUTIVE SEARCH AND PLACEMENT SERVICES; EMPLOYMENT HIRING, RECRUITING, PLACEMENT, AND STAFFING SERVICES; BUSINESS MANAGEMENT CONSULTATION IN THE DEVELOPMENT OF EMPLOYEE BENEFIT PLANS; BUSINESS MANAGEMENT AND CONSULTATION FOR OTHERS IN THE FIELDS OF VENDORS AND VENDOR SELECTION; PROVIDING ADMINISTRATIVE SUPPORT SERVICES TO OTHERS, NAMELY, PROVIDING OFFICE SUPPORT STAFF SERVICES, IN CLASS 35 (U.S. CLS. 100, 101 AND 102).

FIRST USE 6-1-2006; IN COMMERCE 6-1-2006.

FOR: FINANCIAL CONSULTATION FOR OTHERS IN THE FIELD OF WORKFORCE OPTIMIZATION, IN CLASS 36 (U.S. CLS. 100, 101 AND 102).

FIRST USE 6-1-2006; IN COMMERCE 6-1-2006.

FOR: COMPUTER CONSULTATION AND NEW TECHNOLOGY DEVELOPMENT FOR OTHERS IN THE FIELD OF WORKFORCE OPTIMIZATION; COMPUTER PROJECT MANAGEMENT SERVICES FOR OTHERS IN THE FIELDS OF ENGINEERING, INFORMATION TECHNOLOGY, TRANSPORTATION AND HEALTHCARE, IN CLASS 42 (U.S. CLS. 100 AND 101).

FIRST USE 6-1-2006; IN COMMERCE 6-1-2006.

THE MARK CONSISTS OF STANDARD CHARACTERS WITHOUT CLAIM TO ANY PARTICULAR FONT, STYLE, SIZE, OR COLOR.

SN 78-938,989, FILED 7-27-2006.

TANYA AMOS, EXAMINING ATTORNEY

**Int. Cl.: 16**

**Prior U.S. Cls.: 2, 5, 22, 23, 29, 37, 38, and 50**

**United States Patent and Trademark Office**

**Reg. No. 3,396,436**

**Registered Mar. 11, 2008**

**TRADEMARK  
PRINCIPAL REGISTER**

**SUZY SAYS**

TORONTO, SUSAN C. (UNITED STATES INDIVIDUAL)  
5400 LAKE STREET  
TANGERINE, FL 32777 AND  
TORONTO, ALLEN S. (UNITED STATES INDIVIDUAL)  
5400 LAKE STREET  
TANGERINE, FL 32777

FOR: ART PRINTS, ART REPRODUCTIONS, GREETING CARDS, NOTE CARDS, PRINTS, AND DRAWINGS, IN CLASS 16 (U.S. CLS. 2, 5, 22, 23, 29, 37, 38 AND 50).

FIRST USE 1-15-2004; IN COMMERCE 1-15-2004.

THE MARK CONSISTS OF STANDARD CHARACTERS WITHOUT CLAIM TO ANY PARTICULAR FONT, STYLE, SIZE, OR COLOR.

SN 78-939,071, FILED 7-27-2006.

GRETTA YAO, EXAMINING ATTORNEY

**Int. Cl.: 38**

**Prior U.S. Cls.: 100, 101, and 104**

**United States Patent and Trademark Office**

**Reg. No. 3,396,437**

**Registered Mar. 11, 2008**

**SERVICE MARK  
PRINCIPAL REGISTER**

**THE GROUPEY**

THE GROUPEY, INC. (CALIFORNIA CORPORATION)  
26030 ELENA ROAD  
LOS ALTOS, CA 94022

FOR: PROVIDING ONLINE BULLETIN BOARDS AND INTERACTIVE WEBPAGES FOR THE TRANSMISSION OF MESSAGES AND INFORMATION AMONG COMPUTER USERS CONCERNING EDUCATIONAL INSTITUTIONS AND COMMUNITY ORGANIZATIONS, IN CLASS 38 (U.S. CLS. 100, 101 AND 104).

FIRST USE 7-23-2007; IN COMMERCE 7-23-2007.

THE MARK CONSISTS OF STANDARD CHARACTERS WITHOUT CLAIM TO ANY PARTICULAR FONT, STYLE, SIZE, OR COLOR.

SN 78-940,179, FILED 7-28-2006.

JASON BLAIR, EXAMINING ATTORNEY



**Int. Cl.: 38**

**Prior U.S. Cls.: 100, 101, and 104**

**United States Patent and Trademark Office**

**Reg. No. 3,396,438**

**Registered Mar. 11, 2008**

**SERVICE MARK  
PRINCIPAL REGISTER**

**MYBUYS**

MYBUYS, INC. (DELAWARE CORPORATION)  
ONE LAGOON DRIVE, SUITE 120  
REDWOOD CITY, CA 94065

THE MARK CONSISTS OF STANDARD CHAR-  
ACTERS WITHOUT CLAIM TO ANY PARTICULAR  
FONT, STYLE, SIZE, OR COLOR.

FOR: INFORMATION TRANSMISSION VIA  
ELECTRONIC COMMUNICATION NETWORKS,  
IN CLASS 38 (U.S. CLS. 100, 101 AND 104).

SN 78-940,429, FILED 7-28-2006.

FIRST USE 8-8-2006; IN COMMERCE 8-8-2006.

JUSTINE D. PARKER, EXAMINING ATTORNEY

**Int. Cl.: 28**

**Prior U.S. Cls.: 22, 23, 38, and 50**

**United States Patent and Trademark Office**

**Reg. No. 3,396,439**

**Registered Mar. 11, 2008**

**TRADEMARK  
PRINCIPAL REGISTER**

**TOXATUNG**

MATTEL, INC. (DELAWARE CORPORATION)  
MAIL STOP M1-1518  
333 CONTINENTAL BOULEVARD  
EL SEGUNDO, CA 90245

THE MARK CONSISTS OF STANDARD CHAR-  
ACTERS WITHOUT CLAIM TO ANY PARTICULAR  
FONT, STYLE, SIZE, OR COLOR.

FOR: TOYS, GAMES AND PLAYTHINGS, NAME-  
LY, TOY VEHICLES AND ACCESSORIES THERE-  
FOR, IN CLASS 28 (U.S. CLS. 22, 23, 38 AND 50).

SN 78-940,562, FILED 7-29-2006.

FIRST USE 3-28-2007; IN COMMERCE 3-28-2007.

ELIZABETH BEYER, EXAMINING ATTORNEY

**Int. Cl.: 36**

**Prior U.S. Cls.: 100, 101, and 102**

**United States Patent and Trademark Office**

**Reg. No. 3,396,440**

**Registered Mar. 11, 2008**

**SERVICE MARK  
PRINCIPAL REGISTER**

**HELP ME TO BUY**

KORNMAN, MICHAEL (UNITED STATES INDIVIDUAL)  
6707 BROOKSHIRE DR.  
DALLAS, TX 75230

FOR: FINANCIAL SERVICES, NAMELY, CONSUMER LENDING SERVICES, LEASE-PURCHASE FINANCING, FINANCING OF THE PURCHASE AND RENTAL OF CONSUMER ELECTRONICS AND COMPUTER EQUIPMENT; ELECTRONIC COMMERCE SERVICES, NAMELY, ELECTRONIC DEBIT AND CREDIT CARD TRANSACTION PROCESSING SERVICES, FUNDS TRANSFERS, CREDIT TRANSFERS, ELECTRONIC DEBIT

TRANSACTIONS, IN CLASS 36 (U.S. CLS. 100, 101 AND 102).

FIRST USE 0-0-2007; IN COMMERCE 0-0-2007.

THE MARK CONSISTS OF STANDARD CHARACTERS WITHOUT CLAIM TO ANY PARTICULAR FONT, STYLE, SIZE, OR COLOR.

SN 78-940,715, FILED 7-30-2006.

STEPHEN AQUILA, EXAMINING ATTORNEY

**Int. Cl.: 36**

**Prior U.S. Cls.: 100, 101, and 102**

**United States Patent and Trademark Office**

**Reg. No. 3,396,441**

**Registered Mar. 11, 2008**

**SERVICE MARK  
PRINCIPAL REGISTER**



COASTWISE CAPITAL GROUP, LLC (CALIFORNIA LTD LIAB CO)  
7777 GIRARD AVENUE, SUITE 200  
LA JOLLA, CA 92037

FOR: FINANCIAL SERVICES, NAMELY, CAPITAL MANAGEMENT, IN CLASS 36 (U.S. CLS. 100, 101 AND 102).

FIRST USE 6-0-2006; IN COMMERCE 6-0-2006.

THE MARK CONSISTS OF A SAIL BOAT.

SN 78-940,857, FILED 7-31-2006.

MICHELLE DUBOIS, EXAMINING ATTORNEY

**Int. Cl.: 35**

**Prior U.S. Cls.: 100, 101, and 102**

**United States Patent and Trademark Office**

**Reg. No. 3,396,442**

**Registered Mar. 11, 2008**

**SERVICE MARK  
PRINCIPAL REGISTER**

**BUSINESS WORLD 411**

VIRTUAL DIRECTORIES INCORPORATED (CANADA CORPORATION)  
4093 HENRI JULIEN  
MONTREAL, CANADA H2W2K4

FOR: PROVIDING ON-LINE DIRECTORY INFORMATION SERVICES ALSO FEATURING HYPERLINKS TO OTHER WEB SITES, IN CLASS 35 (U.S. CLS. 100, 101 AND 102).

FIRST USE 10-4-2006; IN COMMERCE 10-4-2006.

THE MARK CONSISTS OF STANDARD CHARACTERS WITHOUT CLAIM TO ANY PARTICULAR FONT, STYLE, SIZE, OR COLOR.

NO CLAIM IS MADE TO THE EXCLUSIVE RIGHT TO USE "BUSINESS" AND "411", APART FROM THE MARK AS SHOWN.

SN 78-941,270, FILED 7-31-2006.

TAMARA FRAZIER, EXAMINING ATTORNEY

**Int. Cl.: 25**

**Prior U.S. Cls.: 22 and 39**

**United States Patent and Trademark Office**

**Reg. No. 3,396,443**

**Registered Mar. 11, 2008**

**TRADEMARK  
PRINCIPAL REGISTER**

**Twisted Tease**

TWISTED TEASE, LTD. (ILLINOIS CORPORATION)  
185 W. BRANDON COURT, UNIT F  
PALATINE, IL 60067

FIRST USE 7-15-2006; IN COMMERCE 7-15-2006.

SN 78-941,304, FILED 7-31-2006.

FOR: T-SHIRTS; SHORT-SLEEVED OR LONG-SLEEVED T-SHIRTS; SLEEVELESS SHIRTS; AND TANK TOPS, IN CLASS 25 (U.S. CLS. 22 AND 39).

JAMES A. RAUEN, EXAMINING ATTORNEY

**Int. Cls.: 6 and 19**

**Prior U.S. Cls.: 1, 2, 12, 13, 14, 23, 25, 33, and 50**

**United States Patent and Trademark Office**

**Reg. No. 3,396,444**

**Registered Mar. 11, 2008**

**TRADEMARK  
PRINCIPAL REGISTER**

**COUNTRY CRAFT BUILDINGS**

MORTON BUILDINGS, INC. (ILLINOIS CORPORATION)  
P.O. BOX 399  
MORTON, IL 615500399

THE MARK CONSISTS OF STANDARD CHARACTERS WITHOUT CLAIM TO ANY PARTICULAR FONT, STYLE, SIZE, OR COLOR.

FOR: PREFABRICATED METAL BUILDINGS, IN CLASS 6 (U.S. CLS. 2, 12, 13, 14, 23, 25 AND 50).

NO CLAIM IS MADE TO THE EXCLUSIVE RIGHT TO USE "BUILDINGS", APART FROM THE MARK AS SHOWN.

FIRST USE 5-0-2007; IN COMMERCE 5-0-2007.

FOR: PREFABRICATED NON-METAL BUILDINGS, IN CLASS 19 (U.S. CLS. 1, 12, 33 AND 50).

SN 78-941,748, FILED 7-31-2006.

FIRST USE 5-0-2007; IN COMMERCE 5-0-2007.

ELLEN BURNS, EXAMINING ATTORNEY

**Int. Cl.: 38**

**Prior U.S. Cls.: 100, 101, and 104**

**United States Patent and Trademark Office**

**Reg. No. 3,396,445**

**Registered Mar. 11, 2008**

**SERVICE MARK  
PRINCIPAL REGISTER**

**SUNCOM GOODCALL**

AFFILIATE LICENSE CO., L.L.C. (DELAWARE  
LTD LIAB CO)  
1100 CASSATT ROAD  
BERWYN, PA 19312

FOR: WIRELESS TELECOMMUNICATIONS SER-  
VICES, NAMELY, TRANSMISSION OF VOICE,  
DATA AND INFORMATION BY ELECTRONIC  
MEANS, IN CLASS 38 (U.S. CLS. 100, 101 AND 104).

FIRST USE 9-0-2006; IN COMMERCE 9-0-2006.

THE MARK CONSISTS OF STANDARD CHAR-  
ACTERS WITHOUT CLAIM TO ANY PARTICULAR  
FONT, STYLE, SIZE, OR COLOR.

OWNER OF U.S. REG. NOS. 2,367,621, 2,576,974,  
AND OTHERS.

SN 78-942,207, FILED 8-1-2006.

MARIAM MAHMOUDI, EXAMINING ATTORNEY



**Int. Cl.: 41**

**Prior U.S. Cls.: 100, 101, and 107**

**United States Patent and Trademark Office**

**Reg. No. 3,396,446**

**Registered Mar. 11, 2008**

**SERVICE MARK  
PRINCIPAL REGISTER**

**THE BAPTATIONS**

PORTER, CARL DARNELL (UNITED STATES  
INDIVIDUAL)  
855 LIDDESDALE, APT. #1  
DETROIT, MI 48217

THE MARK CONSISTS OF STANDARD CHAR-  
ACTERS WITHOUT CLAIM TO ANY PARTICULAR  
FONT, STYLE, SIZE, OR COLOR.

FOR: ENTERTAINMENT SERVICES IN THE  
NATURE OF LIVE PERFORMANCES BY A LIVE  
MUSICAL BAND, IN CLASS 41 (U.S. CLS. 100, 101  
AND 107).

SN 78-942,243, FILED 8-1-2006.

FIRST USE 9-30-2007; IN COMMERCE 9-30-2007.

MICHAEL LITZAU, EXAMINING ATTORNEY

**Int. Cl.: 7**

**Prior U.S. Cls.: 13, 19, 21, 23, 31, 34, and 35**

**Reg. No. 3,396,447**

**United States Patent and Trademark Office**

**Registered Mar. 11, 2008**

**TRADEMARK  
PRINCIPAL REGISTER**



VICTORY SWEEPERS, INC. (ALABAMA CORPORATION)  
9584 MADISON BOULEVARD  
MADISON, AL 35758

NO CLAIM IS MADE TO THE EXCLUSIVE RIGHT TO USE "SWEEPERS INC.", APART FROM THE MARK AS SHOWN.

FOR: LAND VEHICLES, NAMELY, INDUSTRIAL SIZE PAVEMENT, PARKING LOT, STREET AND ROAD SWEEPERS AND VACUUMS AND STRUCTURAL PARTS THEREFOR, IN CLASS 7 (U.S. CLS. 13, 19, 21, 23, 31, 34 AND 35).

THE MARK CONSISTS OF THE WORDS "VICTORY SWEEPERS INC." AND AN IMAGE OF AN INDIVIDUAL'S HEAD AND UPRAISED ARM.

SN 78-942,913, FILED 8-2-2006.

FIRST USE 11-0-2006; IN COMMERCE 11-0-2006.

DORITT L. CARROLL, EXAMINING ATTORNEY

**Int. Cl.: 35**

**Prior U.S. Cls.: 100, 101, and 102**

**United States Patent and Trademark Office**

**Reg. No. 3,396,448**

**Registered Mar. 11, 2008**

**SERVICE MARK  
PRINCIPAL REGISTER**

**BRANDS OVER TIME, SALES  
OVERNIGHT**

L2 GROUP, INC. (TEXAS CORPORATION)  
3809 PARRY AVENUE, SUITE 205  
DALLAS, TX 75226

THE MARK CONSISTS OF STANDARD CHAR-  
ACTERS WITHOUT CLAIM TO ANY PARTICULAR  
FONT, STYLE, SIZE, OR COLOR.

FOR: ADVERTISING AGENCIES, NAMELY,  
PROMOTING THE GOODS AND SERVICES OF  
OTHERS, IN CLASS 35 (U.S. CLS. 100, 101 AND 102).

SN 78-943,133, FILED 8-2-2006.

FIRST USE 8-3-2006; IN COMMERCE 8-3-2006.

KATHERINE STOIDES, EXAMINING ATTORNEY

**Int. Cl.: 25**

**Prior U.S. Cls.: 22 and 39**

**United States Patent and Trademark Office**

**Reg. No. 3,396,449**

**Registered Mar. 11, 2008**

**TRADEMARK  
PRINCIPAL REGISTER**

# Rebel H3arts

ROCK & ROYAL, INC. (CALIFORNIA CORPORATION)  
7357 WILLOUGHBY AVE  
LOS ANGELES, CA 90046

THE MARK CONSISTS OF STANDARD CHARACTERS WITHOUT CLAIM TO ANY PARTICULAR FONT, STYLE, SIZE, OR COLOR.

FOR: HATS; JACKETS; LEATHER BELTS; LEATHER JACKETS; PANTS; SHIRTS; SWEAT SHIRTS; T-SHIRTS; TOPS, IN CLASS 25 (U.S. CLS. 22 AND 39).

SN 78-943,712, FILED 8-3-2006.

FIRST USE 12-7-2007; IN COMMERCE 12-7-2007.

MATTHEW PAPPAS, EXAMINING ATTORNEY

**Int. Cl.: 31**

**Prior U.S. Cls.: 1 and 46**

**United States Patent and Trademark Office**

**Reg. No. 3,396,450**

**Registered Mar. 11, 2008**

**TRADEMARK  
PRINCIPAL REGISTER**

**SAMARA**

E.G. HILL COMPANY, INC. (INDIANA CORPORATION)  
446 NW 18TH STREET  
RICHMOND, IN 47374

THE MARK CONSISTS OF STANDARD CHARACTERS WITHOUT CLAIM TO ANY PARTICULAR FONT, STYLE, SIZE, OR COLOR.

FOR: ROSES; CUT ROSES; CUT FLOWER ROSES; ROSES FOR THE CUT FLOWER TRADE; AND LIVE FLOWERING PLANTS, IN CLASS 31 (U.S. CLS. 1 AND 46).

SN 78-943,818, FILED 8-3-2006.

FIRST USE 2-5-2007; IN COMMERCE 2-5-2007.

MATTHEW PAPPAS, EXAMINING ATTORNEY

**Int. Cl.: 1**

**Prior U.S. Cls.: 1, 5, 6, 10, 26, and 46**

**Reg. No. 3,396,451**

**United States Patent and Trademark Office**

**Registered Mar. 11, 2008**

---

**TRADEMARK  
PRINCIPAL REGISTER**

**FLEX-ALD**

THE BOC GROUP, INC. (DELAWARE CORPORATION)  
LEGAL SERVICES-IP DEPT.  
575 MOUNTAIN AVENUE  
MURRAY HILL, NJ 07974

FIRST USE 9-1-2007; IN COMMERCE 9-1-2007.

THE MARK CONSISTS OF STANDARD CHARACTERS WITHOUT CLAIM TO ANY PARTICULAR FONT, STYLE, SIZE, OR COLOR.

FOR: CHEMICAL SOURCE MATERIAL FOR THE DEPOSITION OF THIN FILMS UPON SEMICONDUCTOR WAFERS FOR THE MANUFACTURE OF SEMICONDUCTORS , IN CLASS 1 (U.S. CLS. 1, 5, 6, 10, 26 AND 46).

SN 78-944,369, FILED 8-3-2006.

ANGELA GAW, EXAMINING ATTORNEY

**Int. Cl.: 12**

**Prior U.S. Cls.: 19, 21, 23, 31, 35, and 44**

**United States Patent and Trademark Office**

**Reg. No. 3,396,452**

**Registered Mar. 11, 2008**

**TRADEMARK  
PRINCIPAL REGISTER**

**BLUE CORAL**

PENNZOIL-QUAKER STATE COMPANY (DELA-  
WARE CORPORATION)  
700 MILAM STREET  
HOUSTON, TX 77002

FOR: VEHICLE WINDSHIELD WIPERS AND  
BLADES THEREOF, IN CLASS 12 (U.S. CLS. 19, 21,  
23, 31, 35 AND 44).

FIRST USE 4-1-2007; IN COMMERCE 4-1-2007.

THE MARK CONSISTS OF STANDARD CHAR-  
ACTERS WITHOUT CLAIM TO ANY PARTICULAR  
FONT, STYLE, SIZE, OR COLOR.

OWNER OF U.S. REG. NOS. 562,745 AND 1,591,307.

SN 78-945,153, FILED 8-4-2006.

NAPOLEON SHARMA, EXAMINING ATTORNEY

Int. Cl.: 41

Prior U.S. Cls.: 100, 101, and 107

United States Patent and Trademark Office

Reg. No. 3,396,453

Registered Mar. 11, 2008

SERVICE MARK  
PRINCIPAL REGISTER

陳  
chanpoker.net

CHAN, JOHNNY (UNITED STATES INDIVIDUAL)  
13337 SOUTH STREET  
# 38  
CERRITOS, CA 90703

FOR: ARRANGING, ORGANIZING AND CONDUCTING ENTERTAINMENT SERVICES IN THE FORM OF ONLINE CONTESTS AND GAMES OF CHANCE, IN CLASS 41 (U.S. CLS. 100, 101 AND 107).

FIRST USE 3-1-2007; IN COMMERCE 3-1-2007.

THE MARK CONSISTS OF THE WORDING "CHANPOKER.NET" AND A CHINESE CHARACTER.

THE FOREIGN WORDING IN THE MARK TRANSLATES INTO ENGLISH AS "CHAN".

THE NON-LATIN CHARACTER(S) IN THE MARK TRANSLITERATES INTO CHAN, AND THIS MEANS CHAN IN ENGLISH.

SN 78-946,576, FILED 8-7-2006.

DARRYL SPRUILL, EXAMINING ATTORNEY



**Int. Cl.: 1**

**Prior U.S. Cls.: 1, 5, 6, 10, 26, and 46**

**United States Patent and Trademark Office**

**Reg. No. 3,396,454**

**Registered Mar. 11, 2008**

**TRADEMARK  
PRINCIPAL REGISTER**

**PAW PAL**

T AND N, INC. (MISSOURI CORPORATION)  
P.O. BOX 240  
815 HIGHWAY T  
FORISTELL, MO 63348

THE MARK CONSISTS OF STANDARD CHAR-  
ACTERS WITHOUT CLAIM TO ANY PARTICULAR  
FONT, STYLE, SIZE, OR COLOR.

FOR: CHEMICAL PREPARATIONS FOR MELT-  
ING SNOW AND ICE, IN CLASS 1 (U.S. CLS. 1, 5, 6,  
10, 26 AND 46).

SN 78-946,612, FILED 8-7-2006.

FIRST USE 9-0-2006; IN COMMERCE 9-0-2006.

PAULA MAHONEY, EXAMINING ATTORNEY

**Int. Cl.: 36**

**Prior U.S. Cls.: 100, 101, and 102**

**United States Patent and Trademark Office**

**Reg. No. 3,396,455**

**Registered Mar. 11, 2008**

**SERVICE MARK  
PRINCIPAL REGISTER**

**SKIP PAY**

KORNMAN, MICHAEL (UNITED STATES INDIVIDUAL)  
6707 BROOKSHIRE DR.  
DALLAS, TX 75230

FOR: DEBT MANAGEMENT CONSULTATION SERVICES FEATURING DEBT REPAYMENT, PLANNING, SCHEDULING AND PAYMENT SERVICES ON BEHALF OF DEBTORS, ALTERNATIVE DEBT REPAYMENT SERVICES FOR OTHERS, IN CLASS 36 (U.S. CLS. 100, 101 AND 102).

FIRST USE 0-0-2007; IN COMMERCE 0-0-2007.

THE MARK CONSISTS OF STANDARD CHARACTERS WITHOUT CLAIM TO ANY PARTICULAR FONT, STYLE, SIZE, OR COLOR.

SN 78-946,625, FILED 8-7-2006.

STEPHEN AQUILA, EXAMINING ATTORNEY

**Int. Cl.: 42**

**Prior U.S. Cls.: 100 and 101**

**United States Patent and Trademark Office**

**Reg. No. 3,396,456**

**Registered Mar. 11, 2008**

**SERVICE MARK  
PRINCIPAL REGISTER**

**GLOBALCARE**

GE FANUC INTELLIGENT PLATFORMS, INC.  
(DELAWARE CORPORATION)  
ROUTE 29 NORTH & ROUTE 606  
CHARLOTTESVILLE, VA 22911

FOR: TECHNICAL SUPPORT SERVICES, NAME-  
LY, TROUBLESHOOTING OF COMPUTER SOFT-  
WARE PROBLEMS; AND MAINTENANCE OF  
COMPUTER SOFTWARE, IN CLASS 42 (U.S. CLS.  
100 AND 101).

FIRST USE 9-30-2004; IN COMMERCE 9-30-2004.

THE MARK CONSISTS OF STANDARD CHAR-  
ACTERS WITHOUT CLAIM TO ANY PARTICULAR  
FONT, STYLE, SIZE, OR COLOR.

OWNER OF U.S. REG. NO. 2,537,183.

SN 78-946,764, FILED 8-7-2006.

DOMINICK J. SALEMI, EXAMINING ATTORNEY

**Int. Cl.: 41**

**Prior U.S. Cls.: 100, 101, and 107**

**United States Patent and Trademark Office**

**Reg. No. 3,396,457**

**Registered Mar. 11, 2008**

**SERVICE MARK  
PRINCIPAL REGISTER**

**M80**

FUEL TV, INC. (DELAWARE CORPORATION)  
10201 WEST PICO BOULEVARD  
LOS ANGELES, CA 90035

THE MARK CONSISTS OF STANDARD CHAR-  
ACTERS WITHOUT CLAIM TO ANY PARTICULAR  
FONT, STYLE, SIZE, OR COLOR.

FOR: ENTERTAINMENT SERVICES IN THE  
NATURE OF A TELEVISION SERIES FEATURING  
SPORTS, IN CLASS 41 (U.S. CLS. 100, 101 AND 107).

SN 78-946,773, FILED 8-7-2006.

FIRST USE 3-6-2005; IN COMMERCE 3-6-2005.

EMILY CARLSEN, EXAMINING ATTORNEY

**Int. Cl.: 38**

**Prior U.S. Cls.: 100, 101, and 104**

**United States Patent and Trademark Office**

**Reg. No. 3,396,458**

**Registered Mar. 11, 2008**

**SERVICE MARK  
PRINCIPAL REGISTER**

**EXTENET**

EXTENET SYSTEMS, INC. (DELAWARE CORPORATION)  
SUITE 190  
1901 S. MEYERS ROAD  
OAKBROOK TERRACE, IL 60181

FOR: TELECOMMUNICATIONS SERVICES, NAMELY, POINT TO POINT SIGNAL TRANSPORT SERVICES PROVIDED VIA DISTRIBUTED ANTENNA SYSTEMS OVER FIBER OPTIC AND OTHER CABLING AND COMMUNICATIONS LINKS TO WIRELESS COMMUNICATIONS SERVICE PROVIDERS AND WIRELESS COMMUNICATIONS SYSTEM OPERATORS FOR TRANSMISSION AND

RECEPTION OF VOICE, DATA, IMAGES AND SOUNDS, IN CLASS 38 (U.S. CLS. 100, 101 AND 104).

FIRST USE 12-21-2006; IN COMMERCE 12-21-2006.

THE MARK CONSISTS OF STANDARD CHARACTERS WITHOUT CLAIM TO ANY PARTICULAR FONT, STYLE, SIZE, OR COLOR.

SN 78-947,095, FILED 8-8-2006.

KELLY BOULTON, EXAMINING ATTORNEY

**Int. Cl.: 12**

**Prior U.S. Cls.: 19, 21, 23, 31, 35, and 44**

**United States Patent and Trademark Office**

**Reg. No. 3,396,459**

**Registered Mar. 11, 2008**

**TRADEMARK  
PRINCIPAL REGISTER**

# RACK RIDER

ALL RITE PRODUCTS, INC. (UTAH CORPORATION)  
9554 SOUTH WELLS CIRCLE, SUITE D  
WEST JORDAN, UT 84088

FOR: ATV RACK MOUNTED ACCESSORY ON  
MOTORIZED VEHICLES USED TO HOLD ELONGATED  
OBJECTS, FLASHLIGHTS, BUCKETS, FISHING  
RODS, LONG AND SHORT HANDLED HAND  
TOOLS, NAMELY, AXES, HATCHETS, HAMMERS  
AND TROWELS, IN CLASS 12 (U.S. CLS. 19, 21,  
23, 31, 35 AND 44).

FIRST USE 2-0-2007; IN COMMERCE 2-0-2007.

THE MARK CONSISTS OF STANDARD CHARACTERS  
WITHOUT CLAIM TO ANY PARTICULAR FONT,  
STYLE, SIZE, OR COLOR.

NO CLAIM IS MADE TO THE EXCLUSIVE  
RIGHT TO USE "RACK", APART FROM THE  
MARK AS SHOWN.

SN 78-947,578, FILED 8-8-2006.

BRENDAN REGAN, EXAMINING ATTORNEY

**Int. Cl.: 2**

**Prior U.S. Cls.: 6, 11, and 16**

**United States Patent and Trademark Office**

**Reg. No. 3,396,460**

**Registered Mar. 11, 2008**

**TRADEMARK  
PRINCIPAL REGISTER**

**ENVIRO-POX**

TNEMEC COMPANY, INC. (MISSOURI CORPORATION)  
6800 CORPORATE DRIVE  
KANSAS CITY, MO 64120

FOR: EPOXY PAINT-TYPE COATING FOR INTERIOR WALL AND FLOOR APPLICATIONS, IN CLASS 2 (U.S. CLS. 6, 11 AND 16).

FIRST USE 1-25-2001; IN COMMERCE 1-25-2001.

THE MARK CONSISTS OF STANDARD CHARACTERS WITHOUT CLAIM TO ANY PARTICULAR FONT, STYLE, SIZE, OR COLOR.

OWNER OF U.S. REG. NOS. 1,473,149, 3,107,948, AND OTHERS.

SN 78-947,744, FILED 8-8-2006.

ALICE BENMAMAN, EXAMINING ATTORNEY

**Int. Cl.: 12**

**Prior U.S. Cls.: 19, 21, 23, 31, 35, and 44**

**United States Patent and Trademark Office**

**Reg. No. 3,396,461**

**Registered Mar. 11, 2008**

**TRADEMARK  
PRINCIPAL REGISTER**

# Radix

VF ENTERPRISES, LLC (IDAHO LTD LIAB CO)  
4146 MARYLEBONE WAY  
BOISE, ID 83713

FOR: LAND VEHICLES IN THE NATURE OF A CROSS BETWEEN A SNOW MOBILE AND A MOTORCYCLE; AND CONVERSION KITS FOR ADAPTING MOTORCYCLES TO OVER-SNOW USE COMPRISED OF TRACK ASSEMBLIES, TRACK CARRIAGES, SWINGARM SUSPENSION UNITS, DRIVE TRAINS, AND SKI ASSEMBLIES CONSIST-

ING OF A SKI AND A MOUNTING FRAME, IN CLASS 12 (U.S. CLS. 19, 21, 23, 31, 35 AND 44).

FIRST USE 1-1-2007; IN COMMERCE 2-2-2007.

THE MARK CONSISTS OF STANDARD CHARACTERS WITHOUT CLAIM TO ANY PARTICULAR FONT, STYLE, SIZE, OR COLOR.

SN 78-947,939, FILED 8-8-2006.

RONALD MCMORROW, EXAMINING ATTORNEY



Int. Cl.: 30

Prior U.S. Cl.: 46

United States Patent and Trademark Office

Reg. No. 3,396,462

Registered Mar. 11, 2008

TRADEMARK  
PRINCIPAL REGISTER

The logo for 'Creme Savers' is rendered in a highly decorative, cursive script. The word 'Creme' is on the top line, and 'Savers' is on the bottom line. A large, ornate flourish connects the two words, starting from the end of 'Creme' and looping under 'Savers'. The letters are thick and have a hand-drawn, artistic quality.

WM. WRIGLEY JR. COMPANY (DELAWARE  
CORPORATION)  
410 NORTH MICHIGAN AVENUE  
CHICAGO, IL 60611

NO CLAIM IS MADE TO THE EXCLUSIVE  
RIGHT TO USE "CREME", APART FROM THE  
MARK AS SHOWN.

FOR: CONFECTIONERY, NAMELY, CANDY, IN  
CLASS 30 (U.S. CL. 46).

SN 78-948,244, FILED 8-9-2006.

FIRST USE 10-1-2006; IN COMMERCE 10-1-2006.

OWNER OF U.S. REG. NOS. 2,255,941, 2,649,618,  
AND 2,800,511.

WILLIAM P. SHANAHAN, EXAMINING ATTOR-  
NEY

**Int. Cl.: 35**

**Prior U.S. Cls.: 100, 101, and 102**

**United States Patent and Trademark Office**

**Reg. No. 3,396,463**

**Registered Mar. 11, 2008**

**SERVICE MARK  
PRINCIPAL REGISTER**

**PAY-ON-TIME BONUS**

DISCOVER FINANCIAL SERVICES (DELAWARE  
CORPORATION)  
2500 LAKE COOK ROAD  
RIVERWOODS, IL 60015

FOR: CONDUCTING A CREDIT CARD AND  
DEBIT CARD CUSTOMER INCENTIVE PROGRAM,  
IN CLASS 35 (U.S. CLS. 100, 101 AND 102).

FIRST USE 9-18-2006; IN COMMERCE 9-18-2006.

THE MARK CONSISTS OF STANDARD CHAR-  
ACTERS WITHOUT CLAIM TO ANY PARTICULAR  
FONT, STYLE, SIZE, OR COLOR.

NO CLAIM IS MADE TO THE EXCLUSIVE  
RIGHT TO USE "BONUS", APART FROM THE  
MARK AS SHOWN.

SN 78-948,517, FILED 8-9-2006.

DORITT L. CARROLL, EXAMINING ATTORNEY

**Int. Cl.: 33**

**Prior U.S. Cls.: 47 and 49**

**United States Patent and Trademark Office**

**Reg. No. 3,396,464**

**Registered Mar. 11, 2008**

**TRADEMARK  
PRINCIPAL REGISTER**

**FIRST CLASS**

PHILIPS, DANIEL (UNITED STATES INDIVIDUAL)  
P.O. BOX 5107  
OXNARD, CA 930315107

THE MARK CONSISTS OF STANDARD CHARACTERS WITHOUT CLAIM TO ANY PARTICULAR FONT, STYLE, SIZE, OR COLOR.

FOR: WINES, IN CLASS 33 (U.S. CLS. 47 AND 49).

SN 78-948,568, FILED 8-9-2006.

FIRST USE 8-27-2007; IN COMMERCE 8-27-2007.

KELLY BOULTON, EXAMINING ATTORNEY

**Int. Cl.: 38**

**Prior U.S. Cls.: 100, 101, and 104**

**United States Patent and Trademark Office**

**Reg. No. 3,396,465**

**Registered Mar. 11, 2008**

**SERVICE MARK  
PRINCIPAL REGISTER**

**N-PLUS**

BANDTEL, LLC (DELAWARE LTD LIAB CO)  
SUITE 200  
13 CORPORATE PLAZA  
NEWPORT BEACH, CA 92660

FIRST USE 7-24-2006; IN COMMERCE 7-24-2006.

FOR: TELECOMMUNICATIONS SERVICES,  
NAMELY, SESSION INITIATION PROTOCOL  
TRUNKING, VOICE OVER INTERNET PROTOCOL  
(VOIP) AND PROVIDING THIRD PARTY USERS  
WITH ACCESS TO VOICE OVER INTERNET PRO-  
TOCOL INFRASTRUCTURE, IN CLASS 38 (U.S. CLS.  
100, 101 AND 104).

THE MARK CONSISTS OF STANDARD CHAR-  
ACTERS WITHOUT CLAIM TO ANY PARTICULAR  
FONT, STYLE, SIZE, OR COLOR.

SN 78-948,750, FILED 8-9-2006.

KELLY BOULTON, EXAMINING ATTORNEY

**Int. Cls.: 6 and 20**

**Prior U.S. Cls.: 2, 12, 13, 14, 22, 23, 25, 32, and 50**

**United States Patent and Trademark Office**

**Reg. No. 3,396,466**

**Registered Mar. 11, 2008**

**TRADEMARK  
PRINCIPAL REGISTER**

**THE LUCKY TUB**

ROSS, RICHARD L. (UNITED STATES INDIVIDUAL)  
1079 SARAH STREET  
BETHEL PARK, PA 15102

FOR: METAL TUBS; METAL TUBS WITH STANDS, IN CLASS 6 (U.S. CLS. 2, 12, 13, 14, 23, 25 AND 50).

FIRST USE 6-0-2007; IN COMMERCE 6-0-2007.

FOR: PLASTIC TUBS; PLASTIC TUBS WITH STANDS; WOODEN TUBS; WOODEN TUBS WITH STANDS, IN CLASS 20 (U.S. CLS. 2, 13, 22, 25, 32 AND 50).

FIRST USE 6-0-2007; IN COMMERCE 6-0-2007.

THE MARK CONSISTS OF STANDARD CHARACTERS WITHOUT CLAIM TO ANY PARTICULAR FONT, STYLE, SIZE, OR COLOR.

NO CLAIM IS MADE TO THE EXCLUSIVE RIGHT TO USE "TUB", APART FROM THE MARK AS SHOWN.

SN 78-949,058, FILED 8-10-2006.

JASON BLAIR, EXAMINING ATTORNEY

**Int. Cl.: 36**

**Prior U.S. Cls.: 100, 101, and 102**

**United States Patent and Trademark Office**

**Reg. No. 3,396,467**

**Registered Mar. 11, 2008**

**SERVICE MARK  
PRINCIPAL REGISTER**

**CALTIUS EQUITY PARTNERS**

CALTIUS HOLDINGS LLC (DELAWARE LTD  
LIAB CO)  
SUITE 850  
11766 WILSHIRE BOULEVARD  
LOS ANGELES, CA 90025

FOR: INVESTMENT MANAGEMENT SERVICES,  
IN CLASS 36 (U.S. CLS. 100, 101 AND 102).

FIRST USE 5-10-2002; IN COMMERCE 5-10-2002.

THE MARK CONSISTS OF STANDARD CHAR-  
ACTERS WITHOUT CLAIM TO ANY PARTICULAR  
FONT, STYLE, SIZE, OR COLOR.

OWNER OF U.S. REG. NOS. 2,767,859, 2,998,575,  
AND OTHERS.

NO CLAIM IS MADE TO THE EXCLUSIVE  
RIGHT TO USE "EQUITY PARTNERS", APART  
FROM THE MARK AS SHOWN.

THE WORDING "CALTIUS" HAS NO MEANING  
OTHER THAN TRADEMARK SIGNIFICANCE.

SN 78-949,261, FILED 8-10-2006.

MARILYN IZZI, EXAMINING ATTORNEY

**Int. Cl.: 9**

**Prior U.S. Cls.: 21, 23, 26, 36, and 38**

**United States Patent and Trademark Office**

**Reg. No. 3,396,468**

**Registered Mar. 11, 2008**

**TRADEMARK  
PRINCIPAL REGISTER**

**NON-PREDICTIVE MUSIC**

HALPERN, STEVEN (UNITED STATES INDIVIDUAL)  
212 VAN TASSEL COURT  
SAN ANSELMO, CA 94960

FOR: SOUND RECORDINGS EMBODIED ON PHONORECORDS AND IN DIGITAL MEDIA, NAMELY VINYL DISCS, CASSETTE TAPES, DIGITAL COMPACT DISCS, MP3'S, ELECTRONIC FORMATS, ENHANCED CDS, CD-PLUS, CD-ROMS, DVDS, AND PRE-RECORDED VIDEO CASSETTES AND VIDEO DISCS, ALL FEATURING MUSIC ENTERTAINMENT, IN CLASS 9 (U.S. CLS. 21, 23, 26, 36 AND 38).

FIRST USE 9-4-2006; IN COMMERCE 9-4-2006.

THE MARK CONSISTS OF STANDARD CHARACTERS WITHOUT CLAIM TO ANY PARTICULAR FONT, STYLE, SIZE, OR COLOR.

NO CLAIM IS MADE TO THE EXCLUSIVE RIGHT TO USE "MUSIC", APART FROM THE MARK AS SHOWN.

SN 78-949,414, FILED 8-10-2006.

AMY HELLA, EXAMINING ATTORNEY

**Int. Cl.: 41**

**Prior U.S. Cls.: 100, 101, and 107**

**United States Patent and Trademark Office**

**Reg. No. 3,396,469**

**Registered Mar. 11, 2008**

**SERVICE MARK  
PRINCIPAL REGISTER**

**RUDY MAXA'S WORLD**

MAXA, RUDOLPH J., JR. (UNITED STATES  
INDIVIDUAL)  
300 WALL STREET, #505  
ST. PAUL, MN 55101

FOR: ENTERTAINMENT, NAMELY, A CONTINUING TRAVEL SHOW BROADCAST OVER TELEVISION, SATELLITE, AUDIO AND VIDEO MEDIA, IN CLASS 41 (U.S. CLS. 100, 101 AND 107).

FIRST USE 11-8-2007; IN COMMERCE 11-8-2007.

THE MARK CONSISTS OF STANDARD CHARACTERS WITHOUT CLAIM TO ANY PARTICULAR FONT, STYLE, SIZE, OR COLOR.

NO CLAIM IS MADE TO THE EXCLUSIVE RIGHT TO USE "WORLD", APART FROM THE MARK AS SHOWN.

THE NAME "RUDY MAXA" IDENTIFIES A LIVING INDIVIDUAL WHOSE CONSENT IS OF RECORD.

SN 78-949,729, FILED 8-10-2006.

GIANCARLO CASTRO, EXAMINING ATTORNEY



**Int. Cl.: 30**

**Prior U.S. Cl.: 46**

**United States Patent and Trademark Office**

**Reg. No. 3,396,470**

**Registered Mar. 11, 2008**

**TRADEMARK  
PRINCIPAL REGISTER**

**MELPI'S BODACIOUS BLISS**

MELPI & MICHELLE'S, LLC (NEW YORK LTD  
LIAB CO)  
99 NORTH 11TH STREET-SUITE 4  
BROOKLYN, NY 11211

THE MARK CONSISTS OF STANDARD CHAR-  
ACTERS WITHOUT CLAIM TO ANY PARTICULAR  
FONT, STYLE, SIZE, OR COLOR.

FOR: BAKERY PRODUCTS, IN CLASS 30 (U.S. CL.  
46).

SN 78-950,046, FILED 8-11-2006.

FIRST USE 10-1-2006; IN COMMERCE 10-1-2006.

G. MAYERSCHOFF, EXAMINING ATTORNEY

**Int. Cl.: 36**

**Prior U.S. Cls.: 100, 101, and 102**

**United States Patent and Trademark Office**

**Reg. No. 3,396,471**

**Registered Mar. 11, 2008**

**SERVICE MARK  
PRINCIPAL REGISTER**

**MAGAZINE DERBY**

MAGAZINE RETAIL ENTERPRISES INC. (DELA-  
WARE CORPORATION)  
1271 AVENUE OF THE AMERICAS  
NEW YORK, NY 10020

FOR: CHARITABLE FUND RAISING SERVICES,  
NAMELY, SHARING PROFITS FROM MAGAZINE  
SUBSCRIPTION SALES WITH NOT-FOR-PROFIT  
ORGANIZATIONS, IN CLASS 36 (U.S. CLS. 100, 101  
AND 102).

FIRST USE 7-31-2006; IN COMMERCE 7-31-2006.

THE MARK CONSISTS OF STANDARD CHAR-  
ACTERS WITHOUT CLAIM TO ANY PARTICULAR  
FONT, STYLE, SIZE, OR COLOR.

NO CLAIM IS MADE TO THE EXCLUSIVE  
RIGHT TO USE "MAGAZINE", APART FROM THE  
MARK AS SHOWN.

SN 78-950,185, FILED 8-11-2006.

ALICE BENMAMAN, EXAMINING ATTORNEY

**Int. Cl.: 16**

**Prior U.S. Cls.: 2, 5, 22, 23, 29, 37, 38, and 50**

**United States Patent and Trademark Office**

**Reg. No. 3,396,472**

**Registered Mar. 11, 2008**

**TRADEMARK  
PRINCIPAL REGISTER**

**M&M'S**

MARS, INCORPORATED (DELAWARE CORPORATION)  
6885 ELM STREET  
MCLEAN, VA 221013883

FOR: GREETING CARDS, IN CLASS 16 (U.S. CLS. 2, 5, 22, 23, 29, 37, 38 AND 50).

FIRST USE 2-0-2007; IN COMMERCE 2-0-2007.

THE MARK CONSISTS OF STANDARD CHARACTERS WITHOUT CLAIM TO ANY PARTICULAR FONT, STYLE, SIZE, OR COLOR.

OWNER OF U.S. REG. NOS. 2,473,762, 3,180,230, AND OTHERS.

SN 78-950,235, FILED 8-11-2006.

JOHN WILKE, EXAMINING ATTORNEY

**Int. Cl.: 39**

**Prior U.S. Cls.: 100 and 105**

**United States Patent and Trademark Office**

**Reg. No. 3,396,473**

**Registered Mar. 11, 2008**

**SERVICE MARK  
PRINCIPAL REGISTER**

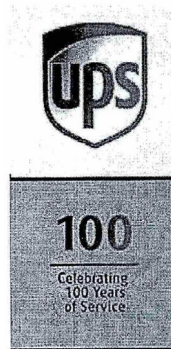

UNITED PARCEL SERVICE OF AMERICA, INC.  
(DELAWARE CORPORATION)  
55 GLENLAKE PARKWAY, NE  
ATLANTA, GA 30328

FOR: TRANSPORTATION AND DELIVERY OF  
PERSONAL PROPERTY BY AIR, RAIL, BOAT AND/  
OR MOTOR VEHICLE, IN CLASS 39 (U.S. CLS. 100  
AND 105).

FIRST USE 1-1-2007; IN COMMERCE 1-1-2007.

OWNER OF U.S. REG. NOS. 2,867,999, 2,981,794,  
AND OTHERS.

NO CLAIM IS MADE TO THE EXCLUSIVE  
RIGHT TO USE "CELEBRATING 100 YEARS OF  
SERVICE", APART FROM THE MARK AS SHOWN.

SN 78-950,685, FILED 8-11-2006.

TINA KUAN, EXAMINING ATTORNEY

**Int. Cl.: 28**

**Prior U.S. Cls.: 22, 23, 38, and 50**

**United States Patent and Trademark Office**

**Reg. No. 3,396,474**

**Registered Mar. 11, 2008**

**TRADEMARK  
PRINCIPAL REGISTER**

**VICTOR**

MATTEL, INC. (DELAWARE CORPORATION)  
MAIL STOP M1-1518  
333 CONTINENTAL BOULEVARD  
EL SEGUNDO, CA 90245

THE MARK CONSISTS OF STANDARD CHAR-  
ACTERS WITHOUT CLAIM TO ANY PARTICULAR  
FONT, STYLE, SIZE, OR COLOR.

FOR: TOYS, GAMES AND PLAYTHINGS, NAME-  
LY, TOY FIGURES AND ACCESSORIES THERE-  
FOR, IN CLASS 28 (U.S. CLS. 22, 23, 38 AND 50).

SN 78-950,749, FILED 8-11-2006.

FIRST USE 9-4-2007; IN COMMERCE 9-4-2007.

JUDITH HELFMAN, EXAMINING ATTORNEY

**Int. Cl.: 28**

**Prior U.S. Cls.: 22, 23, 38, and 50**

**United States Patent and Trademark Office**

**Reg. No. 3,396,475**

**Registered Mar. 11, 2008**

**TRADEMARK  
PRINCIPAL REGISTER**

**SIR JOHN**

MATTEL, INC. (DELAWARE CORPORATION)  
MAIL STOP M1-1518  
333 CONTINENTAL BOULEVARD  
EL SEGUNDO, CA 90245

THE MARK CONSISTS OF STANDARD CHAR-  
ACTERS WITHOUT CLAIM TO ANY PARTICULAR  
FONT, STYLE, SIZE, OR COLOR.

FOR: TOYS, GAMES AND PLAYTHINGS, NAME-  
LY, TOY VEHICLES AND ACCESSORIES THERE-  
FOR, IN CLASS 28 (U.S. CLS. 22, 23, 38 AND 50).

SN 78-950,752, FILED 8-11-2006.

FIRST USE 9-4-2007; IN COMMERCE 9-4-2007.

JUDITH HELFMAN, EXAMINING ATTORNEY

**Int. Cl.: 28**

**Prior U.S. Cls.: 22, 23, 38, and 50**

**United States Patent and Trademark Office**

**Reg. No. 3,396,476**

**Registered Mar. 11, 2008**

**TRADEMARK  
PRINCIPAL REGISTER**

**BEAUTY CUTIES**

MATTEL, INC. (DELAWARE CORPORATION)  
MAIL STOP M1-1518  
333 CONTINENTAL BOULEVARD  
EL SEGUNDO, CA 90245

FOR: TOYS, GAMES AND PLAYTHINGS, NAME-  
LY, DOLLS, DOLL CLOTHING AND DOLL ACCES-  
SORIES, TOY FIGURES AND ACCESSORIES  
THEREFOR, IN CLASS 28 (U.S. CLS. 22, 23, 38 AND  
50).

FIRST USE 5-4-2007; IN COMMERCE 5-4-2007.

THE MARK CONSISTS OF STANDARD CHAR-  
ACTERS WITHOUT CLAIM TO ANY PARTICULAR  
FONT, STYLE, SIZE, OR COLOR.

SN 78-950,777, FILED 8-11-2006.

ELIZABETH BEYER, EXAMINING ATTORNEY

**Int. Cls.: 16 and 39**

**Prior U.S. Cls.: 2, 5, 22, 23, 29, 37, 38, 50, 100, and 105**

**United States Patent and Trademark Office**

**Reg. No. 3,396,477**

**Registered Mar. 11, 2008**

**TRADEMARK  
SERVICE MARK  
PRINCIPAL REGISTER**

**SHOPARAZZI**

ERWIN, CHRISTINA (UNITED STATES INDIVIDUAL)

434 CATALINA DRIVE

NEWPORT BEACH, CA 92663 AND

PIASECKI, CASSIE (UNITED STATES INDIVIDUAL)

434 CATALINA DRIVE

NEWPORT BEACH, CA 92663

FOR: MAPS, NAMELY, MAPS OF HIGH-END FASHION RETAIL OUTLETS, IN CLASS 16 (U.S. CLS. 2, 5, 22, 23, 29, 37, 38 AND 50).

FIRST USE 7-1-2007; IN COMMERCE 7-1-2007.

FOR: TOUR CONDUCTING AND TOUR GUIDE SERVICES, NAMELY, THE ORGANIZATION OF EXCURSIONS AND TOURS OF HIGH-END FASHION RETAIL OUTLETS, IN CLASS 39 (U.S. CLS. 100 AND 105).

FIRST USE 7-1-2007; IN COMMERCE 7-1-2007.

THE MARK CONSISTS OF STANDARD CHARACTERS WITHOUT CLAIM TO ANY PARTICULAR FONT, STYLE, SIZE, OR COLOR.

SN 78-951,935, FILED 8-15-2006.

DAVID H. STINE, EXAMINING ATTORNEY



**Int. Cl.: 17**

**Prior U.S. Cls.: 1, 5, 12, 13, 35, and 50**

**United States Patent and Trademark Office**

**Reg. No. 3,396,478**

**Registered Mar. 11, 2008**

**TRADEMARK  
PRINCIPAL REGISTER**

The logo for TRIDENT-SEAL features the words "TRIDENT-SEAL" in a bold, black, sans-serif font. The word "SEAL" is partially enclosed by a red semi-circle above and below it, which is part of a larger circular design element.

NEPTUNE RESEARCH, INC. (FLORIDA CORPORATION)  
1683 LATHAM ROAD  
WEST PALM BEACH, FL 33409

FOR: KITS FOR THE REPAIR OF NATURAL GAS PIPES AND CONVEYANCES CONSISTING PRIMARILY OF RESIN-IMPREGNATED FIBERGLASS TAPE AND ALSO CONSISTING OF PUTTY AND RUBBER TAPE, IN CLASS 17 (U.S. CLS. 1, 5, 12, 13, 35 AND 50).

FIRST USE 10-1-2006; IN COMMERCE 10-1-2006.

THE COLOR(S) BLACK AND RED IS/ARE CLAIMED AS A FEATURE OF THE MARK.

THE COLOR BLACK APPEARS IN THE WORDING AND IN THE DESIGN OF THE OUTER SEMICIRCLES RUNNING ABOVE AND BELOW THE LETTERS "E" AND "A" IN "SEAL". THE COLOR RED APPEARS IN THE DESIGN OF THE INNER SEMICIRCLES RUNNING ABOVE AND BELOW THE LETTERS "E" AND "A" IN "SEAL".

SN 78-952,122, FILED 8-15-2006.

STEPHEN AQUILA, EXAMINING ATTORNEY

**Int. Cl.: 20**

**Prior U.S. Cls.: 2, 13, 22, 25, 32, and 50**

**United States Patent and Trademark Office**

**Reg. No. 3,396,479**

**Registered Mar. 11, 2008**

**TRADEMARK  
PRINCIPAL REGISTER**

**CURVISO**

BRAESIDE DISPLAYS (ILLINOIS CORPORATION)  
795 BARTLETT AVENUE  
ANTIOCH, IL 60002

THE MARK CONSISTS OF STANDARD CHARACTERS WITHOUT CLAIM TO ANY PARTICULAR FONT, STYLE, SIZE, OR COLOR.

FOR: ADVERTISING DISPLAY BOARDS, IN CLASS 20 (U.S. CLS. 2, 13, 22, 25, 32 AND 50).

SN 78-952,263, FILED 8-15-2006.

FIRST USE 3-0-2007; IN COMMERCE 3-0-2007.

TINA KUAN, EXAMINING ATTORNEY

**Int. Cl.: 3**

**Prior U.S. Cls.: 1, 4, 6, 50, 51, and 52**

**United States Patent and Trademark Office**

**Reg. No. 3,396,480**

**Registered Mar. 11, 2008**

**TRADEMARK  
PRINCIPAL REGISTER**

**PURE-FORMANCE**

AVEDA CORPORATION (DELAWARE CORPORATION)  
4000 PHEASANT RIDGE DRIVE  
MINNEAPOLIS, MN 55449

FOR: FRAGRANCES FOR PERSONAL USE; HAIR CARE PREPARATIONS, IN CLASS 3 (U.S. CLS. 1, 4, 6, 50, 51 AND 52).

FIRST USE 7-8-2007; IN COMMERCE 7-8-2007.

THE MARK CONSISTS OF STANDARD CHARACTERS WITHOUT CLAIM TO ANY PARTICULAR FONT, STYLE, SIZE, OR COLOR.

OWNER OF U.S. REG. NOS. 1,520,430, 2,012,839, AND OTHERS.

SN 78-952,386, FILED 8-15-2006.

DOMINICK J. SALEMI, EXAMINING ATTORNEY

**Int. Cl.: 10**

**Prior U.S. Cls.: 26, 39, and 44**

**United States Patent and Trademark Office**

**Reg. No. 3,396,481**

**Registered Mar. 11, 2008**

**TRADEMARK  
PRINCIPAL REGISTER**

# CAPTION

SMITH & NEPHEW, INC. (DELAWARE CORPORATION)  
1450 BROOKS ROAD  
MEMPHIS, TN 38116

FOR: MEDICAL DEVICE FOR USE IN ORTHOPAEDIC SURGERY; NAMELY, A DEVICE FOR MAKING PLATELET RICH CONCENTRATE, MIXING THE CONCENTRATE WITH SYNTHETIC OR AUTOGENOUS BONE GRAFTING MATERIAL, AND DELIVERY OF THE COMBINED CONCENTRATE AND BONE GRAFTING MATERIAL TO A SURGICAL SITE; MEDICAL DEVICE FOR USE IN THE DELIVERY OF BONE GRAFT MATERIAL TO

AN ORTHOPAEDIC SURGICAL SITE, IN CLASS 10 (U.S. CLS. 26, 39 AND 44).

FIRST USE 8-21-2007; IN COMMERCE 8-21-2007.

THE MARK CONSISTS OF STANDARD CHARACTERS WITHOUT CLAIM TO ANY PARTICULAR FONT, STYLE, SIZE, OR COLOR.

SN 78-952,622, FILED 8-15-2006.

ANTHONY RINKER, EXAMINING ATTORNEY

**Int. Cl.: 33**

**Prior U.S. Cls.: 47 and 49**

**United States Patent and Trademark Office**

**Reg. No. 3,396,482**

**Registered Mar. 11, 2008**

**TRADEMARK  
PRINCIPAL REGISTER**

**HULA GIRL BEVERAGES**

HULA GIRL BEVERAGES, LLC (CALIFORNIA  
LTD LIAB CO)  
4802 E. MORADA LANE  
STOCKTON, CA 95212

FOR: ALCOHOLIC BEVERAGES, NAMELY, RUM  
AND RUM BASED BEVERAGES, IN CLASS 33 (U.S.  
CLS. 47 AND 49).

FIRST USE 12-5-2007; IN COMMERCE 12-5-2007.

THE MARK CONSISTS OF STANDARD CHAR-  
ACTERS WITHOUT CLAIM TO ANY PARTICULAR  
FONT, STYLE, SIZE, OR COLOR.

NO CLAIM IS MADE TO THE EXCLUSIVE  
RIGHT TO USE "BEVERAGES", APART FROM  
THE MARK AS SHOWN.

SN 78-952,845, FILED 8-15-2006.

LINDA ORNDORFF, EXAMINING ATTORNEY

**Int. Cl.: 25**

**Prior U.S. Cls.: 22 and 39**

**United States Patent and Trademark Office**

**Reg. No. 3,396,483**

**Registered Mar. 11, 2008**

**TRADEMARK  
PRINCIPAL REGISTER**

**GREAT LENGTHS**

A. H. SCHREIBER COMPANY, INC. (NEW YORK  
CORPORATION)  
460 WEST 34TH STREET  
NEW YORK, NY 10001

THE MARK CONSISTS OF STANDARD CHAR-  
ACTERS WITHOUT CLAIM TO ANY PARTICULAR  
FONT, STYLE, SIZE, OR COLOR.

FOR: COVERUPS; SWIMSUITS, IN CLASS 25 (U.S.  
CLS. 22 AND 39).

SN 78-953,175, FILED 8-16-2006.

FIRST USE 8-0-2007; IN COMMERCE 8-0-2007.

EMILY CARLSEN, EXAMINING ATTORNEY

**Int. Cl.: 9**

**Prior U.S. Cls.: 21, 23, 26, 36, and 38**

**Reg. No. 3,396,484**

**United States Patent and Trademark Office**

**Registered Mar. 11, 2008**

---

**TRADEMARK  
PRINCIPAL REGISTER**

**ATRIO**

FUTURE SONICS, INC. (PENNSYLVANIA CORPORATION)  
1006 HOLICONG ROAD  
PINEVILLE, PA 18946

THE MARK CONSISTS OF STANDARD CHARACTERS WITHOUT CLAIM TO ANY PARTICULAR FONT, STYLE, SIZE, OR COLOR.

FOR: EARPHONES, IN CLASS 9 (U.S. CLS. 21, 23, 26, 36 AND 38).

SN 78-953,457, FILED 8-16-2006.

FIRST USE 7-6-2006; IN COMMERCE 7-6-2006.

KEVON CHISOLM, EXAMINING ATTORNEY

**Int. Cl.: 43**

**Prior U.S. Cls.: 100 and 101**

**United States Patent and Trademark Office**

**Reg. No. 3,396,485**

**Registered Mar. 11, 2008**

**SERVICE MARK  
PRINCIPAL REGISTER**

# Diva Dogs

DIVA DOGS INC. (CALIFORNIA CORPORATION)  
125 CONNEMARA WAY, UNIT 16  
SUNNYVALE, CA 94087

FOR: PET BOARDING SERVICES; PET DAY CARE SERVICES, IN CLASS 43 (U.S. CLS. 100 AND 101).

FIRST USE 2-16-2007; IN COMMERCE 7-3-2007.

THE MARK CONSISTS OF STANDARD CHARACTERS WITHOUT CLAIM TO ANY PARTICULAR FONT, STYLE, SIZE, OR COLOR.

NO CLAIM IS MADE TO THE EXCLUSIVE RIGHT TO USE "DOGS", APART FROM THE MARK AS SHOWN.

SN 78-953,968, FILED 8-17-2006.

GRETTA YAO, EXAMINING ATTORNEY



**Int. Cl.: 7**

**Prior U.S. Cls.: 13, 19, 21, 23, 31, 34, and 35**

**Reg. No. 3,396,486**

**United States Patent and Trademark Office**

**Registered Mar. 11, 2008**

**TRADEMARK  
PRINCIPAL REGISTER**

**PSR**

J.H. FENNER & CO. LIMITED (UNITED KING-  
DOM LTD LIAB CO)  
HESSLEWOOD COUNTRY OFFICE PARK  
FERRIBY ROAD, HESSLE  
EAST YORKSHIRE, ENGLAND HU13 OPW

FOR: CONVEYOR BELTING, IN CLASS 7 (U.S.  
CLS. 13, 19, 21, 23, 31, 34 AND 35).

FIRST USE 8-0-2006; IN COMMERCE 8-0-2006.

THE MARK CONSISTS OF STANDARD CHAR-  
ACTERS WITHOUT CLAIM TO ANY PARTICULAR  
FONT, STYLE, SIZE, OR COLOR.

SN 78-954,547, FILED 8-17-2006.

ALEXANDER L. POWERS, EXAMINING ATTOR-  
NEY

**Int. Cl.: 33**

**Prior U.S. Cls.: 47 and 49**

**United States Patent and Trademark Office**

**Reg. No. 3,396,487**

**Registered Mar. 11, 2008**

**TRADEMARK  
PRINCIPAL REGISTER**

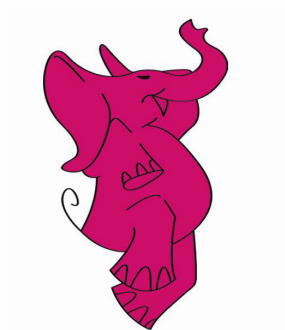

**PINK ELEPHANT**

P.E.G. ENTERTAINMENT GROUP, LLC (NEW YORK CORPORATION)  
281 COUNTY ROAD 39A  
SOUTHAMPTON, NY 11968

FOR: VODKA, IN CLASS 33 (U.S. CLS. 47 AND 49).

FIRST USE 5-1-2007; IN COMMERCE 5-1-2007.

OWNER OF U.S. REG. NO. 3,116,659.

THE COLOR(S) PINK IS/ARE CLAIMED AS A FEATURE OF THE MARK.

THE COLOR PINK APPEARS IN THE LETTERING AND IN THE ELEPHANT DESIGN.

SN 78-954,729, FILED 8-17-2006.

C. DIONNE CLYBURN, EXAMINING ATTORNEY

**Int. Cl.: 9**

**Prior U.S. Cls.: 21, 23, 26, 36, and 38**

**United States Patent and Trademark Office**

**Reg. No. 3,396,488**

**Registered Mar. 11, 2008**

**TRADEMARK  
PRINCIPAL REGISTER**

**TOUCH-IT**

WOHLER TECHNOLOGIES, INC. (CALIFORNIA  
CORPORATION)  
31055 HUNTWOOD AVENUE  
HAYWARD, CA 94544

THE MARK CONSISTS OF STANDARD CHAR-  
ACTERS WITHOUT CLAIM TO ANY PARTICULAR  
FONT, STYLE, SIZE, OR COLOR.

FOR: VIDEO AND AUDIO MONITORS, IN CLASS  
9 (U.S. CLS. 21, 23, 26, 36 AND 38).

SN 78-954,828, FILED 8-17-2006.

FIRST USE 9-29-2006; IN COMMERCE 9-29-2006.

PRISCILLA MILTON, EXAMINING ATTORNEY

**Int. Cl.: 9**

**Prior U.S. Cls.: 21, 23, 26, 36, and 38**

**United States Patent and Trademark Office**

**Reg. No. 3,396,489**

**Registered Mar. 11, 2008**

**TRADEMARK  
PRINCIPAL REGISTER**

**TOUCH-IT PLUS**

WOHLER TECHNOLOGIES, INC. (CALIFORNIA  
CORPORATION)  
31055 HUNTWOOD AVENUE  
HAYWARD, CA 94544

THE MARK CONSISTS OF STANDARD CHAR-  
ACTERS WITHOUT CLAIM TO ANY PARTICULAR  
FONT, STYLE, SIZE, OR COLOR.

FOR: VIDEO AND AUDIO MONITORS, IN CLASS  
9 (U.S. CLS. 21, 23, 26, 36 AND 38).

SN 78-954,834, FILED 8-17-2006.

FIRST USE 2-27-2007; IN COMMERCE 2-27-2007.

PRISCILLA MILTON, EXAMINING ATTORNEY

**Int. Cls.: 9 and 41**

**Prior U.S. Cls.: 21, 23, 26, 36, 38, 100, 101, and 107**

**United States Patent and Trademark Office**

**Reg. No. 3,396,490**

**Registered Mar. 11, 2008**

**TRADEMARK  
SERVICE MARK  
PRINCIPAL REGISTER**

**SURVIVE THE OFFROAD**

SONY COMPUTER ENTERTAINMENT AMERI-  
CA INC. (DELAWARE CORPORATION)  
919 E. HILLSDALE BLVD.  
FOSTER CITY, CA 94404

FOR: COMPUTER GAME SOFTWARE AND VI-  
DEO GAME SOFTWARE, IN CLASS 9 (U.S. CLS. 21,  
23, 26, 36 AND 38).

FIRST USE 3-6-2007; IN COMMERCE 3-6-2007.

FOR: OPERATING A REAL-TIME GAME FOR  
OTHERS OVER GLOBAL AND LOCAL AREA COM-

PUTER NETWORKS, IN CLASS 41 (U.S. CLS. 100, 101  
AND 107).

FIRST USE 3-6-2007; IN COMMERCE 3-6-2007.

THE MARK CONSISTS OF STANDARD CHAR-  
ACTERS WITHOUT CLAIM TO ANY PARTICULAR  
FONT, STYLE, SIZE, OR COLOR.

SN 78-955,720, FILED 8-18-2006.

SHAUNIA CARLYLE, EXAMINING ATTORNEY

**Int. Cl.: 41**

**Prior U.S. Cls.: 100, 101, and 107**

**United States Patent and Trademark Office**

**Reg. No. 3,396,491**

**Registered Mar. 11, 2008**

**SERVICE MARK  
PRINCIPAL REGISTER**

**LIGHTNING RAY PICTURES**

MARQUEZ, MARIANO III (UNITED STATES  
INDIVIDUAL)  
955 BAYSHORE BLVD  
SAN FRANCISCO, CA 941242206

FOR: PRODUCTION AND DISTRIBUTION OF  
MOTION PICTURES, IN CLASS 41 (U.S. CLS. 100, 101  
AND 107).

FIRST USE 11-1-2005; IN COMMERCE 12-1-2005.

THE MARK CONSISTS OF STANDARD CHAR-  
ACTERS WITHOUT CLAIM TO ANY PARTICULAR  
FONT, STYLE, SIZE, OR COLOR.

NO CLAIM IS MADE TO THE EXCLUSIVE  
RIGHT TO USE "PICTURES", APART FROM THE  
MARK AS SHOWN.

SN 78-955,800, FILED 8-18-2006.

MICHAEL WIENER, EXAMINING ATTORNEY

**Int. Cl.: 9**

**Prior U.S. Cls.: 21, 23, 26, 36, and 38**

**Reg. No. 3,396,492**

**United States Patent and Trademark Office**

**Registered Mar. 11, 2008**

**TRADEMARK  
PRINCIPAL REGISTER**

**5150<sup>III</sup>**

E.L.V.H., INC. (CALIFORNIA CORPORATION)  
C/O LORING WARD SUITE 1300  
10100 SANTA MONICA BLVD  
LOS ANGELES, CA 90067

OWNER OF U.S. REG. NOS. 1,405,761, 2,350,390,  
AND OTHERS.

FOR: AUDIO SPEAKERS; GUITAR AMPLIFIERS,  
IN CLASS 9 (U.S. CLS. 21, 23, 26, 36 AND 38).

THE MARK CONSISTS OF 5150 SUPERScript III.

SN 78-956,569, FILED 8-21-2006.

FIRST USE 6-28-2007; IN COMMERCE 6-28-2007.

TASHIA BUNCH, EXAMINING ATTORNEY

**Int. Cl.: 29**

**Prior U.S. Cl.: 46**

**United States Patent and Trademark Office**

**Reg. No. 3,396,493**

**Registered Mar. 11, 2008**

**TRADEMARK  
PRINCIPAL REGISTER**

**OIKOS**

STONYFIELD FARM (DELAWARE CORPORATION)  
10 BURTON DRIVE  
LONDONDERRY, NH 03053

FOR: DAIRY PRODUCTS EXCLUDING ICE CREAM, ICE MILK AND FROZEN YOGURT, IN CLASS 29 (U.S. CL. 46).

FIRST USE 5-1-2007; IN COMMERCE 5-1-2007.

THE MARK CONSISTS OF STANDARD CHARACTERS WITHOUT CLAIM TO ANY PARTICULAR FONT, STYLE, SIZE, OR COLOR.

THE FOREIGN WORDING IN THE MARK TRANSLATES INTO ENGLISH AS "HOUSE" OR "HOUSEHOLD".

SN 78-956,615, FILED 8-21-2006.

ADA HAN, EXAMINING ATTORNEY



**Int. Cl.: 43**

**Prior U.S. Cls.: 100 and 101**

**United States Patent and Trademark Office**

**Reg. No. 3,396,494**

**Registered Mar. 11, 2008**

**SERVICE MARK  
PRINCIPAL REGISTER**

**East LA Meets Napa**

ALTAMED HEALTH SERVICES CORPORATION  
(CALIFORNIA CORPORATION)  
SUITE 490  
500 CITADEL DRIVE  
LOS ANGELES, CA 90040

FOR: FOOD AND BEVERAGE SERVICES, NAME-  
LY, SERVING OF FOOD AND BEVERAGES, IN  
CLASS 43 (U.S. CLS. 100 AND 101).

FIRST USE 4-15-2006; IN COMMERCE 4-15-2006.

THE MARK CONSISTS OF STANDARD CHAR-  
ACTERS WITHOUT CLAIM TO ANY PARTICULAR  
FONT, STYLE, SIZE, OR COLOR.

NO CLAIM IS MADE TO THE EXCLUSIVE  
RIGHT TO USE "EAST LA" AND "NAPA", APART  
FROM THE MARK AS SHOWN.

SN 78-957,135, FILED 8-22-2006.

ROBIN MITTLER, EXAMINING ATTORNEY

**Int. Cl.: 9**

**Prior U.S. Cls.: 21, 23, 26, 36, and 38**

**United States Patent and Trademark Office**

**Reg. No. 3,396,495**

**Registered Mar. 11, 2008**

**TRADEMARK  
PRINCIPAL REGISTER**

**C-RAE**

COMPUTER PARTNERS, INC. (ALABAMA CORPORATION)  
670 U.S. HIGHWAY 278 EAST  
CULLMAN, AL 350550694

FOR: COMPUTER SOFTWARE FOR THE COLLECTION, EDITING, ORGANIZING, MODIFYING, BOOK MARKING, TRANSMISSION, STORAGE AND SHARING OF DATA AND INFORMATION IN THE FIELD OF WORTHLESS CHECK RECOVERY AND ENFORCEMENT FOR USE BY PROSECUTORS AND LAW ENFORCEMENT PERSONNEL, IN CLASS 9 (U.S. CLS. 21, 23, 26, 36 AND 38).

FIRST USE 9-26-2006; IN COMMERCE 9-26-2006.

THE MARK CONSISTS OF STANDARD CHARACTERS WITHOUT CLAIM TO ANY PARTICULAR FONT, STYLE, SIZE, OR COLOR.

SN 78-957,340, FILED 8-22-2006.

EMILY CHUO, EXAMINING ATTORNEY

**Int. Cl.: 20**

**Prior U.S. Cls.: 2, 13, 22, 25, 32, and 50**

**United States Patent and Trademark Office**

**Reg. No. 3,396,496**

**Registered Mar. 11, 2008**

**TRADEMARK  
PRINCIPAL REGISTER**



SHELF RELIANCE (UTAH LTD LIAB CO)  
810 N. 2800 W.  
LINDON, UT 84042

FOR: SHELVING AND COMPONENT PARTS  
THEREOF, NAMELY, SHELVES AND BRACKETS  
SOLD AS A UNIT, IN CLASS 20 (U.S. CLS. 2, 13, 22, 25,  
32 AND 50).

THE MARK CONSISTS OF THE WORD "CAN-  
DENSOR" WITH THE LETTER "C" OF THE WORD  
WRAPPING UNDERNEATH THE WORD AND  
FORMING AN ARROW.

SN 78-957,535, FILED 8-22-2006.

FIRST USE 3-1-2006; IN COMMERCE 3-1-2006.

JOHN DALIER, EXAMINING ATTORNEY

**Int. Cl.: 35**

**Prior U.S. Cls.: 100, 101, and 102**

**United States Patent and Trademark Office**

**Reg. No. 3,396,497**

**Registered Mar. 11, 2008**

**SERVICE MARK  
PRINCIPAL REGISTER**

**ceres**   
purchasing solutions

GOLDEN GATE ANCILLARY LLC (DELAWARE  
LTD LIAB CO)  
1000 BEVERLY WAY  
FORT SMITH, AR 72919

FOR: PROCUREMENT SERVICES NAMELY,  
PURCHASING OFFICE DEVICES AND HEALTH  
CARE MATERAILS FOR HEALTHCARE FACIL-  
ITIES, IN CLASS 35 (U.S. CLS. 100, 101 AND 102).

FIRST USE 4-13-2004; IN COMMERCE 4-13-2004.

OWNER OF U.S. REG. NOS. 2,706,710, 2,748,809,  
AND OTHERS.

NO CLAIM IS MADE TO THE EXCLUSIVE  
RIGHT TO USE "PURCHASING SOLUTIONS",  
APART FROM THE MARK AS SHOWN.

THE MARK CONSISTS OF LITERAL ELEMENT  
CERES WITH AN ABSTRACT CIRCULAR DESIGN  
THEN LITERAL ELEMENTS PURCHASING SOLU-  
TIONS BELOW WITH NO CLAIM TO COLOR.

SN 78-957,835, FILED 8-22-2006.

RICHARD A. STRASER, EXAMINING ATTORNEY

**Int. Cl.: 35**

**Prior U.S. Cls.: 100, 101, and 102**

**United States Patent and Trademark Office**

**Reg. No. 3,396,498**

**Registered Mar. 11, 2008**

**SERVICE MARK  
PRINCIPAL REGISTER**

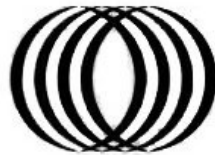

GOLDEN GATE ANCILLARY LLC (DELAWARE  
LTD LIAB CO)  
1000 BEVERLY WAY  
FORT SMITH, AR 72919

FOR: PROCUREMENT SERVICES, NAMELY,  
PURCHASING OFFICE DEVICES AND HEALTH  
CARE MATERIALS FOR HEALTHCARE FACIL-  
ITIES, IN CLASS 35 (U.S. CLS. 100, 101 AND 102).

FIRST USE 4-13-2004; IN COMMERCE 4-13-2004.

THE MARK CONSISTS OF ABSTRACT CIRCULAR DESIGN NO CLAIM TO COLOR.

SN 78-957,844, FILED 8-22-2006.

RICHARD A. STRASER, EXAMINING ATTORNEY

**Int. Cl.: 28**

**Prior U.S. Cls.: 22, 23, 38, and 50**

**United States Patent and Trademark Office**

**Reg. No. 3,396,499**

**Registered Mar. 11, 2008**

**TRADEMARK  
PRINCIPAL REGISTER**

**OCEAN CHIC**

MATTEL, INC. (DELAWARE CORPORATION)  
MAIL STOP M1-1518  
333 CONTINENTAL BOULEVARD  
EL SEGUNDO, CA 90245

THE MARK CONSISTS OF STANDARD CHAR-  
ACTERS WITHOUT CLAIM TO ANY PARTICULAR  
FONT, STYLE, SIZE, OR COLOR.

FOR: TOYS, GAMES AND PLAYTHINGS, NAME-  
LY, JIGSAW PUZZLES, IN CLASS 28 (U.S. CLS. 22, 23,  
38 AND 50).

SN 78-958,126, FILED 8-22-2006.

FIRST USE 3-2-2007; IN COMMERCE 3-2-2007.

ELIZABETH BEYER, EXAMINING ATTORNEY

Int. Cl.: 16

Prior U.S. Cls.: 2, 5, 22, 23, 29, 37, 38, and 50

United States Patent and Trademark Office

Reg. No. 3,396,500

Registered Mar. 11, 2008

TRADEMARK  
PRINCIPAL REGISTER

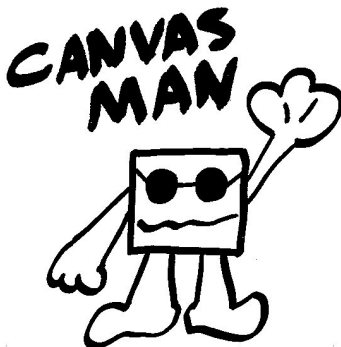

CONNOLLY, PAULA BODGER (UNITED STATES INDIVIDUAL)  
300 FREMONT ST.  
PEEKSKILL, NY 10566

FOR: COMIC BOOKS; COMIC STRIPS, IN CLASS 16 (U.S. CLS. 2, 5, 22, 23, 29, 37, 38 AND 50).

FIRST USE 1-15-1998; IN COMMERCE 7-10-2007.

THE MARK CONSISTS OF A CARTOON LIKE IMAGE OF A PERSON THAT HAS A SQUARE

ARTIST CANVAS AS HIS BODY AND ABOVE THAT THE STYLIZED TEXT OF THE WORDING "CANVAS MAN". A CARTOON CHARACTER THAT DEALS WITH LIFE AS AN ARTIST, ART SITUATIONS AND ART HUMOR.

SN 78-958,408, FILED 8-23-2006.

TEJBIR SINGH, EXAMINING ATTORNEY

**Int. Cl.: 44**

**Prior U.S. Cls.: 100 and 101**

**United States Patent and Trademark Office**

**Reg. No. 3,396,501**

**Registered Mar. 11, 2008**

**SERVICE MARK  
PRINCIPAL REGISTER**



BEVERLY ENTERPRISES, INC. (DELAWARE  
CORPORATION)  
1000 BEVERLY WAY  
FORT SMITH, AR 72919

FOR: HEALTH CARE SERVICES, IN CLASS 44  
(U.S. CLS. 100 AND 101).

FIRST USE 9-1-2006; IN COMMERCE 9-1-2006.

OWNER OF U.S. REG. NOS. 2,352,492, 2,388,256,  
AND OTHERS.

NO CLAIM IS MADE TO THE EXCLUSIVE  
RIGHT TO USE "LIVING COMMUNITIES", APART  
FROM THE MARK AS SHOWN.

THE MARK CONSISTS OF A FIVE LEAF  
BRANCH WITH THE LITERAL ELEMENTS BEV-  
ERLY LIVING COMMUNITIES.

SN 78-959,762, FILED 8-24-2006.

CHARISMA HAMPTON, EXAMINING ATTORNEY



**Int. Cl.: 42**

**Prior U.S. Cls.: 100 and 101**

**United States Patent and Trademark Office**

**Reg. No. 3,396,502**

**Registered Mar. 11, 2008**

**SERVICE MARK  
PRINCIPAL REGISTER**

# Lawyers Who Care

VERRILL DANA, LLP (MAINE LIMITED PART-  
NERSHIP)  
P.O. BOX 586  
ONE PORTLAND SQUARE  
PORTLAND, ME 041120586

THE MARK CONSISTS OF STANDARD CHAR-  
ACTERS WITHOUT CLAIM TO ANY PARTICULAR  
FONT, STYLE, SIZE, OR COLOR.

FOR: LEGAL SERVICES, IN CLASS 42 (U.S. CLS.  
100 AND 101).

SN 78-959,764, FILED 8-24-2006.

FIRST USE 2-2-2007; IN COMMERCE 10-24-2007.

KHANH LE, EXAMINING ATTORNEY

**Int. Cl.: 44**

**Prior U.S. Cls.: 100 and 101**

**United States Patent and Trademark Office**

**Reg. No. 3,396,503**

**Registered Mar. 11, 2008**

**SERVICE MARK  
PRINCIPAL REGISTER**



BEVERLY ENTERPRISES, INC. (DELAWARE  
CORPORATION)  
1000 BEVERLY WAY  
FORT SMITH, AR 72919

FOR: HEALTH CARE SERVICES, IN CLASS 44  
(U.S. CLS. 100 AND 101).

FIRST USE 9-1-2006; IN COMMERCE 9-1-2006.

OWNER OF U.S. REG. NOS. 2,352,492, 2,388,256,  
AND OTHERS.

NO CLAIM IS MADE TO THE EXCLUSIVE  
RIGHT TO USE "LIVING CENTERS", APART FROM  
THE MARK AS SHOWN.

THE MARK CONSISTS OF A FIVE LEAF  
BRANCH WITH THE LITERAL ELEMENTS "BEV-  
ERLY LIVING CENTERS".

SN 78-959,769, FILED 8-24-2006.

CHARISMA HAMPTON, EXAMINING ATTORNEY

**Int. Cl.: 35**

**Prior U.S. Cls.: 100, 101, and 102**

**United States Patent and Trademark Office**

**Reg. No. 3,396,504**

**Registered Mar. 11, 2008**

**SERVICE MARK  
PRINCIPAL REGISTER**



BEVERLY ENTERPRISES, INC. (DELAWARE CORPORATION)  
1000 BEVERLY WAY  
FORT SMITH, AR 72919

FOR: TEMPORARY STAFFING, NAMELY, TEMPORARY EMPLOYMENT AGENCIES, IN CLASS 35 (U.S. CLS. 100, 101 AND 102).

FIRST USE 4-22-2004; IN COMMERCE 4-22-2004.

THE MARK CONSISTS OF FOUR GEOMETRIC SHAPES REPRESENTING A MAN AND A RIBBON. THE GEOMETRIC SHAPES CONSIST OF A CIRCLE REPRESENTING THE HEAD OF THE MAN, AN

UPTURNED CRESCENT REPRESENTING THE UPPER BODY OF THE MAN, A DOWN-TURNED CRESCENT REPRESENTING THE LOWER HALF OF THE MAN, AND A CRESCENT WITH THE POINTS FACING THE LEFT REPRESENTING THE RIBBON. THE RIGHT TIPS OF THE CRESCENT REPRESENTING THE MAN'S UPPER AND LOWER HALF ARE TOUCHING THE TOP AND BOTTOM OF THE CRESCENT REPRESENTING THE RIBBON.

SN 78-959,776, FILED 8-24-2006.

CHARISMA HAMPTON, EXAMINING ATTORNEY

Int. Cl.: 42

Prior U.S. Cls.: 100 and 101

United States Patent and Trademark Office

Reg. No. 3,396,505

Registered Mar. 11, 2008

SERVICE MARK  
PRINCIPAL REGISTER

# Entaris

GAJADHAR, RON M. (UNITED STATES INDIVIDUAL)  
6443 37TH LANE NW  
OLYMPIA, WA 98502

FOR: CHARITABLE SERVICES, NAMELY, PROVIDING WEB SITE DESIGN FOR OTHERS; COMPUTER SECURITY SERVICE, NAMELY, RESTRICTING ACCESS TO AND BY COMPUTER NETWORKS TO AND OF UNDESIREED WEB SITES, MEDIA AND INDIVIDUALS AND FACILITIES; COMPUTER SERVICES IN THE NATURE OF CUSTOMIZED WEB PAGES FEATURING USER-DEFINED INFORMATION, PERSONAL PROFILES AND INFORMATION; COMPUTER SERVICES, NAMELY, CREATING AND MAINTAINING WEB SITES FOR OTHERS; COMPUTER SERVICES, NAMELY, DESIGNING AND IMPLEMENTING NETWORK WEB PAGES FOR OTHERS; COMPUTER SERVICES, NAMELY, DESIGNING AND IMPLEMENTING WEB SITES FOR OTHERS; COMPUTER SERVICES, NAMELY, HOSTING ON-LINE WEB FACILITIES FOR OTHERS FOR ORGANIZING AND CONDUCTING ONLINE MEETINGS, GATHERINGS, AND INTERACTIVE DISCUSSIONS; COMPUTER SERVICES, NAMELY, MANAGING WEB SITES FOR OTHERS; CREATING OR MAINTAINING WEB SITES FOR OTHERS; CREATION

AND MAINTENANCE OF WEB SITES FOR OTHERS; CREATION AND PROVISION OF WEB PAGES TO AND FOR THIRD PARTIES; DESIGN OF HOME PAGES, COMPUTER SOFTWARE AND WEB SITES; DESIGN OF HOMEPAGES AND WEB-SITES; DISPLAYING THE WEB SITES AND IMAGES OF OTHERS ON A COMPUTER SERVER; ELABORATION AND MAINTENANCE OF WEB SITES FOR THIRD PARTIES; HOSTING THE WEB SITES OF OTHERS ON A COMPUTER SERVER FOR A GLOBAL COMPUTER NETWORK; PROVIDING CUSTOMIZED ON-LINE WEB PAGES FEATURING USER-DEFINED INFORMATION, WHICH INCLUDES SEARCH ENGINES AND ON-LINE WEB LINKS TO OTHER WEB SITES; WEB SITE HOSTING SERVICES, IN CLASS 42 (U.S. CLS. 100 AND 101).

FIRST USE 9-15-2007; IN COMMERCE 9-15-2007.

THE MARK CONSISTS OF STANDARD CHARACTERS WITHOUT CLAIM TO ANY PARTICULAR FONT, STYLE, SIZE, OR COLOR.

SN 78-960,009, FILED 8-24-2006.

ALYSSA PALADINO, EXAMINING ATTORNEY

**Int. Cl.: 24**

**Prior U.S. Cls.: 42 and 50**

**United States Patent and Trademark Office**

**Reg. No. 3,396,506**

**Registered Mar. 11, 2008**

**TRADEMARK  
PRINCIPAL REGISTER**

**HEADLINE IT!**

PLISZKA'S ADVENTURES, LLC (UNITED STATES LTD LIAB CO)  
S.81 W. 17620 BRENNAN DRIVE  
MUSKEGO, WI 53150

FOR: DISPOSABLE, LIGHTWEIGHT, ABSORBABLE UNFITTED CLOTH LINER THAT AFFIXES INSIDE ANY WIG, HAT, HELMET, HEADWEAR OR PROSTHESIS, USED TO ABSORB PERSPIRATION THAT WOULD OTHERWISE SATURATE THE WIG, HAT, HELMET, HEADWEAR OR PROSTHESIS, IN CLASS 24 (U.S. CLS. 42 AND 50).

FIRST USE 8-1-2007; IN COMMERCE 8-1-2007.

THE MARK CONSISTS OF STANDARD CHARACTERS WITHOUT CLAIM TO ANY PARTICULAR FONT, STYLE, SIZE, OR COLOR.

SN 78-960,273, FILED 8-25-2006.

MATTHEW PAPPAS, EXAMINING ATTORNEY

**Int. Cl.: 38**

**Prior U.S. Cls.: 100, 101, and 104**

**United States Patent and Trademark Office**

**Reg. No. 3,396,507**

**Registered Mar. 11, 2008**

**SERVICE MARK  
PRINCIPAL REGISTER**



TURNER SPORTS, INC. (GEORGIA CORPORATION)  
C/O TURNER BROADCASTING SYSTEM, INC.  
ONE CNN CENTER, 13 NORTH  
ATLANTA, GA 30303

FIRST USE 2-17-2007; IN COMMERCE 2-17-2007.

THE MARK CONSISTS OF THE LETTERS TS IN A  
STYLIZED FORM.

FOR: TELECOMMUNICATION SERVICES,  
NAMELY, ELECTRONIC TRANSMISSION OF  
DATA, DOCUMENTS, MUSIC, VIDEOS, IMAGES,  
TEXT AND OTHER DATA VIA A GLOBAL COM-  
PUTER NETWORK, IN CLASS 38 (U.S. CLS. 100, 101  
AND 104).

SN 78-960,550, FILED 8-25-2006.

KELLY MCCOY, EXAMINING ATTORNEY

**Int. Cl.: 41**

**Prior U.S. Cls.: 100, 101, and 107**

**United States Patent and Trademark Office**

**Reg. No. 3,396,508**

**Registered Mar. 11, 2008**

**SERVICE MARK  
PRINCIPAL REGISTER**



TURNER SPORTS, INC. (GEORGIA CORPORATION)  
C/O TURNER BROADCASTING SYSTEM, INC.  
ONE CNN CENTER, 13 NORTH  
ATLANTA, GA 30303

FOR: ENTERTAINMENT SERVICES, NAMELY  
THE PRODUCTION AND EXHIBITION OF SPORTING  
EVENTS BOTH LIVE AND VIA TELEVISION,  
CABLE TELEVISION AND RADIO; AND PROVIDING  
INFORMATION IN THE FIELD OF SPORTING

EVENTS OVER A GLOBAL COMPUTER NETWORK,  
IN CLASS 41 (U.S. CLS. 100, 101 AND 107).

FIRST USE 1-4-2007; IN COMMERCE 1-4-2007.

THE MARK CONSISTS OF THE LETTERS TS IN A  
STYLIZED FORM.

SN 78-960,559, FILED 8-25-2006.

KELLY MCCOY, EXAMINING ATTORNEY

**Int. Cl.: 43**

**Prior U.S. Cls.: 100 and 101**

**United States Patent and Trademark Office**

**Reg. No. 3,396,509**

**Registered Mar. 11, 2008**

**SERVICE MARK  
PRINCIPAL REGISTER**

**MISSION OAK GRILL**

SECOND MICHAELA CORP. (MASSACHUSETTS  
CORPORATION)

26 GREEN STREET

NEWBURYPORT, MA 01950

FOR: RESTAURANT AND BAR SERVICES, IN  
CLASS 43 (U.S. CLS. 100 AND 101).

FIRST USE 10-4-2006; IN COMMERCE 10-4-2006.

THE MARK CONSISTS OF STANDARD CHAR-  
ACTERS WITHOUT CLAIM TO ANY PARTICULAR  
FONT, STYLE, SIZE, OR COLOR.

NO CLAIM IS MADE TO THE EXCLUSIVE  
RIGHT TO USE "GRILL", APART FROM THE  
MARK AS SHOWN.

SN 78-960,768, FILED 8-25-2006.

ELLEN PERKINS, EXAMINING ATTORNEY



**Int. Cl.: 1**

**Prior U.S. Cls.: 1, 5, 6, 10, 26, and 46**

**United States Patent and Trademark Office**

**Reg. No. 3,396,510**

**Registered Mar. 11, 2008**

**TRADEMARK  
PRINCIPAL REGISTER**

**PIPETRON**

CHAMPION TECHNOLOGIES, INC. (TEXAS  
CORPORATION)  
SUITE 2700  
3200 S.W. FREEWAY  
HOUSTON, TX 77027

FOR: CHEMICALS FOR INDUSTRIAL USE,  
NAMELY, CLEANING, CORROSION PREVEN-  
TION, CORROSION PROTECTION, PARAFFIN RE-  
MOVAL, BIOCIDES APPLICATIONS, BLACK  
POWDER REMOVAL, AND OTHER SCALE RE-  
MOVAL CHEMICALS FOR PIPELINE MAINTEN-  
ANCE, CLEANING, CORROSION PROTECTION

AND REMEDIATION, IN CLASS 1 (U.S. CLS. 1, 5, 6,  
10, 26 AND 46).

FIRST USE 9-9-2006; IN COMMERCE 9-9-2006.

THE MARK CONSISTS OF STANDARD CHAR-  
ACTERS WITHOUT CLAIM TO ANY PARTICULAR  
FONT, STYLE, SIZE, OR COLOR.

SN 78-960,891, FILED 8-25-2006.

GIANCARLO CASTRO, EXAMINING ATTORNEY

**Int. Cl.: 9**

**Prior U.S. Cls.: 21, 23, 26, 36, and 38**

**United States Patent and Trademark Office**

**Reg. No. 3,396,511**

**Registered Mar. 11, 2008**

**TRADEMARK  
PRINCIPAL REGISTER**

**THE STANDARD**

TRI-TRONICS, INC. (ARIZONA CORPORATION)  
1705 S. RESEARCH LOOP  
TUCSON, AZ 85710

FIRST USE 8-17-2006; IN COMMERCE 8-17-2006.

FOR: REMOTE ELECTRONIC DOG TRAINING DEVICES, NAMELY, COLLAR-MOUNTED ELECTRICAL RECEIVERS AND REMOTE HAND-HELD ELECTRICAL TRANSMITTERS AND TRAINING GUIDES AND USER MANUALS SOLD AS A UNIT, AND PARTS AND FITTINGS THEREFOR, NAMELY, CHARGERS AND HOLSTERS, IN CLASS 9 (U.S. CLS. 21, 23, 26, 36 AND 38).

THE MARK CONSISTS OF STANDARD CHARACTERS WITHOUT CLAIM TO ANY PARTICULAR FONT, STYLE, SIZE, OR COLOR.

SN 78-960,932, FILED 8-25-2006.

ELLEN BURNS, EXAMINING ATTORNEY

**Int. Cl.: 8**

**Prior U.S. Cls.: 23, 28, and 44**

**United States Patent and Trademark Office**

**Reg. No. 3,396,512**

**Registered Mar. 11, 2008**

**TRADEMARK  
PRINCIPAL REGISTER**

**MOLLI**

MAZUR, ROBERT (UNITED STATES INDIVIDUAL)  
43311 JOY RD.  
CANTON, MI 48187

THE MARK CONSISTS OF STANDARD CHARACTERS WITHOUT CLAIM TO ANY PARTICULAR FONT, STYLE, SIZE, OR COLOR.

FOR: MANUALLY OPERATED CONTAINER OPENER FOR HOUSEHOLD OR DOMESTIC USE, IN CLASS 8 (U.S. CLS. 23, 28 AND 44).

SN 78-961,152, FILED 8-26-2006.

FIRST USE 10-15-2006; IN COMMERCE 10-15-2006.

EDWARD NELSON, EXAMINING ATTORNEY

**Int. Cl.: 5**

**Prior U.S. Cls.: 6, 18, 44, 46, 51, and 52**

**United States Patent and Trademark Office**

**Reg. No. 3,396,513**

**Registered Mar. 11, 2008**

**TRADEMARK  
PRINCIPAL REGISTER**

**MySleep**

NUTRI88, INC. (CALIFORNIA CORPORATION)  
1061 MEADS AVE  
ORANGE, CA 92869

THE MARK CONSISTS OF STANDARD CHAR-  
ACTERS WITHOUT CLAIM TO ANY PARTICULAR  
FONT, STYLE, SIZE, OR COLOR.

FOR: DIETARY AND NUTRITIONAL SUPPLE-  
MENTS, IN CLASS 5 (U.S. CLS. 6, 18, 44, 46, 51 AND  
52).

SN 78-961,175, FILED 8-26-2006.

FIRST USE 3-1-2007; IN COMMERCE 3-1-2007.

KEVIN CORWIN, EXAMINING ATTORNEY

**Int. Cl.: 9**

**Prior U.S. Cls.: 21, 23, 26, 36, and 38**

**United States Patent and Trademark Office**

**Reg. No. 3,396,514**

**Registered Mar. 11, 2008**

**TRADEMARK  
PRINCIPAL REGISTER**

**EMERALD BUTTERFLY**

KONAMI GAMING, INC. (NEVADA CORPORATION)  
585 TRADE CENTER DRIVE  
LAS VEGAS, NV 89119

FOR: ELECTRONIC GAME PROGRAMS; GAMING EQUIPMENT, NAMELY, SLOT MACHINES WITH OR WITHOUT VIDEO OUTPUT; GAMING MACHINES; MACHINES FOR PLAYING GAMES OF CHANCE; SLOT MACHINES, IN CLASS 9 (U.S. CLS. 21, 23, 26, 36 AND 38).

FIRST USE 11-12-2006; IN COMMERCE 11-12-2006.

THE MARK CONSISTS OF STANDARD CHARACTERS WITHOUT CLAIM TO ANY PARTICULAR FONT, STYLE, SIZE, OR COLOR.

SN 78-961,595, FILED 8-28-2006.

MATTHEW EINSTEIN, EXAMINING ATTORNEY

**Int. Cl.: 44**

**Prior U.S. Cls.: 100 and 101**

**United States Patent and Trademark Office**

**Reg. No. 3,396,515**

**Registered Mar. 11, 2008**

**SERVICE MARK  
PRINCIPAL REGISTER**

**BYU-TI**

SUNSHINE, NATASHA (UNITED STATES INDIVIDUAL)  
1513 BERKELEY ST #5  
SANTA MONICA, CA 90404

FOR: HAIR CUTTING; HAIR SALON SERVICES, NAMELY, TREATMENTS TO PROTECT HAIR FROM AFFECTS OF EXPOSURE TO SUNLIGHT, HEAT, HUMIDITY AND CHLORINATED WATER; HAIR STYLING; HEALTH SPA SERVICES, NAMELY, COSMETIC BODY CARE SERVICES; MASSAGE, IN CLASS 44 (U.S. CLS. 100 AND 101).

FIRST USE 4-1-2005; IN COMMERCE 4-1-2005.

THE MARK CONSISTS OF STANDARD CHARACTERS WITHOUT CLAIM TO ANY PARTICULAR FONT, STYLE, SIZE, OR COLOR.

NO CLAIM IS MADE TO THE EXCLUSIVE RIGHT TO USE "BEAUTY", APART FROM THE MARK AS SHOWN.

SN 78-962,355, FILED 8-28-2006.

ALEXANDER L. POWERS, EXAMINING ATTORNEY

**Int. Cls.: 14, 20, and 24**

**Prior U.S. Cls.: 2, 13, 22, 25, 27, 28, 32, 42, and 50**

**United States Patent and Trademark Office**

**Reg. No. 3,396,516**

**Registered Mar. 11, 2008**

**TRADEMARK  
PRINCIPAL REGISTER**

# Symbology

L.A.W.LIMITED,L.C. (NEW MEXICO LTD LIAB  
CO)  
7629 EAGLE ROCK AVE NE  
ALBUQUERQUE, NM 87122

FOR: JEWELRY, IN CLASS 14 (U.S. CLS. 2, 27, 28  
AND 50).

FIRST USE 9-2-2007; IN COMMERCE 9-2-2007.

FOR: HOME ACCESSORIES, NAMELY, PIL-  
LOWS, POLYRESIN TABLETS WHICH LOOK LIKE  
STONE AND HAVE QUOTATIONS ENGRAVED ON  
THEM, RESIN SCULPTURES, RESIN FIGURINES,  
SOFT SCULPTURE WALL DECORATIONS, WOOD  
BOXES, DISPLAY CASES, IN CLASS 20 (U.S. CLS. 2,  
13, 22, 25, 32 AND 50).

FIRST USE 10-1-2007; IN COMMERCE 10-1-2007.

FOR: TEXTILE FABRICS FOR HOME AND COM-  
MERCIAL INTERIORS, IN CLASS 24 (U.S. CLS. 42  
AND 50).

FIRST USE 10-1-2007; IN COMMERCE 10-1-2007.

THE MARK CONSISTS OF STANDARD CHAR-  
ACTERS WITHOUT CLAIM TO ANY PARTICULAR  
FONT, STYLE, SIZE, OR COLOR.

SN 78-962,399, FILED 8-29-2006.

GEOFFREY FOSDICK, EXAMINING ATTORNEY

**Int. Cl.: 20**

**Prior U.S. Cls.: 2, 13, 22, 25, 32, and 50**

**United States Patent and Trademark Office**

**Reg. No. 3,396,517**

**Registered Mar. 11, 2008**

**TRADEMARK  
PRINCIPAL REGISTER**

**GUARD-N-EDGE**

REN CONCEPTS, LLC (COLORADO LTD LIAB  
CO)  
7700 MILLER DRIVE  
FREDERICK, CO 80504

THE MARK CONSISTS OF STANDARD CHAR-  
ACTERS WITHOUT CLAIM TO ANY PARTICULAR  
FONT, STYLE, SIZE, OR COLOR.

FOR: PLASTIC COVER FOR LANDSCAPE ED-  
GING, NAMELY, SAFETY COVERS FOR SHARP-  
EDGED LANDSCAPE EDGING TO PREVENT IN-  
JURY, IN CLASS 20 (U.S. CLS. 2, 13, 22, 25, 32 AND 50).

SN 78-963,074, FILED 8-29-2006.

FIRST USE 10-31-2006; IN COMMERCE 10-31-2006.

JORDAN BAKER, EXAMINING ATTORNEY



**Int. Cl.: 10**

**Prior U.S. Cls.: 26, 39, and 44**

**United States Patent and Trademark Office**

**Reg. No. 3,396,518**

**Registered Mar. 11, 2008**

**TRADEMARK  
PRINCIPAL REGISTER**

**DR.FUJI**

AMERICAN CROCODILE INTERNATIONAL  
GROUP, INC. (CALIFORNIA CORPORATION)  
762 BARBER LANE  
MILPITAS, CA 95035

FOR: PERSONAL HEALTH PRODUCTS, NAME-  
LY, MESSAGE APPARATUS FOR MEDICAL PUR-  
POSES; MESSAGE CHAIR; ELECTRIC MASSAGING  
APPARATUS FOR PERSONAL USE , IN CLASS 10  
(U.S. CLS. 26, 39 AND 44).

FIRST USE 9-19-2007; IN COMMERCE 9-19-2007.

THE MARK CONSISTS OF STANDARD CHAR-  
ACTERS WITHOUT CLAIM TO ANY PARTICULAR  
FONT, STYLE, SIZE, OR COLOR.

OWNER OF U.S. REG. NO. 3,201,055.

THE NAME DR. FUJI DOES NOT IDENTIFY A  
LIVING INDIVIDUAL.

SN 78-963,077, FILED 8-29-2006.

DAYNA BROWNE, EXAMINING ATTORNEY

**Int. Cl.: 44**

**Prior U.S. Cls.: 100 and 101**

**United States Patent and Trademark Office**

**Reg. No. 3,396,519**

**Registered Mar. 11, 2008**

**SERVICE MARK  
PRINCIPAL REGISTER**



MMMM RANCH, LTD. (TEXAS PARTNERSHIP),  
DBA 4M WHITETAILES,  
2308 WINTON TERRACE E.  
FORT WORTH, TX 76109

FOR: BREEDING OF DEER, IN CLASS 44 (U.S.  
CLS. 100 AND 101).

FIRST USE 10-6-2005; IN COMMERCE 2-3-2006.

NO CLAIM IS MADE TO THE EXCLUSIVE  
RIGHT TO USE "WHITETAILES", APART FROM  
THE MARK AS SHOWN.

THE COLOR(S) RED WHITE BLUE AND BLACK  
IS/ARE CLAIMED AS A FEATURE OF THE MARK.

THE MARK CONSISTS OF AN EIGHT-POINT  
STAR FILLED WITH A RED, WHITE AND BLUE  
TEXAS FLAG. THE LEFT PORTION OF THE FLAG  
IS BLUE, THE TOP RIGHT IS WHITE, THE BOTTOM  
RIGHT IS RED, AND THE FIVE-POINT STAR IS  
WHITE. THE EIGHT-POINT STAR IS OUTLINED IN  
BLACK. BLACK SOLID DEER ANTLERS COME  
OUT OF THE TOP OF THE EIGHT-POINT STAR.  
THE WORDS "4M WHITETAILES" ARE IN SOLID  
BLACK ABOVE THE STAR, AND ARE SUPERIM-  
POSED OVER THE ANTLERS.

SN 78-963,096, FILED 8-29-2006.

ROBIN MITTLER, EXAMINING ATTORNEY

**Int. Cl.: 9**

**Prior U.S. Cls.: 21, 23, 26, 36, and 38**

**United States Patent and Trademark Office**

**Reg. No. 3,396,520**

**Registered Mar. 11, 2008**

**TRADEMARK  
PRINCIPAL REGISTER**

**SOFTAGON**

SOFTAGON CORPORATION (CALIFORNIA CORPORATION)  
315 PACIFIC AVENUE  
SAN FRANCISCO, CA 94111

FOR: COMPUTER PROGRAMMES FOR DOCUMENT MANAGEMENT; COMPUTER SOFTWARE FOR THE COLLECTION, EDITING, ORGANIZING, MODIFYING, BOOK MARKING, TRANSMISSION, STORAGE AND SHARING OF DATA AND INFORMATION; COMPUTER SOFTWARE FOR USE IN CUSTOMER RELATIONSHIP MANAGEMENT (CRM); AND COMPUTER SOFTWARE FOR TRADING, PORTFOLIO MANAGEMENT, ORDER MANAGEMENT, PORTFOLIO MODELING, RESEARCH APPLICATIONS RELATED TO RISK ANALYSIS, BUSINESS INTELLIGENCE AND CAPITAL MAR-

KET PERFORMANCE, ALL FOR USE BY HEDGE FUNDS, INVESTMENT MANAGEMENT FIRMS, AND REAL ESTATE INVESTMENT TRUSTS (REITS), IN CLASS 9 (U.S. CLS. 21, 23, 26, 36 AND 38).

FIRST USE 11-0-2004; IN COMMERCE 11-0-2004.

THE MARK CONSISTS OF STANDARD CHARACTERS WITHOUT CLAIM TO ANY PARTICULAR FONT, STYLE, SIZE, OR COLOR.

OWNER OF U.S. REG. NO. 2,360,668.

SN 78-963,304, FILED 8-29-2006.

SHAILA SETTLES, EXAMINING ATTORNEY

**Int. Cl.: 28**

**Prior U.S. Cls.: 22, 23, 38, and 50**

**United States Patent and Trademark Office**

**Reg. No. 3,396,521**

**Registered Mar. 11, 2008**

**TRADEMARK  
PRINCIPAL REGISTER**

**THE HELICOPTER**

SDF GOLF, INC. (FLORIDA CORPORATION)  
260 SOMERSET WAY  
WESTON, FL 33326

FOR: GOLF SWING TRAINING AIDS, NAMELY,  
A DIRECTIONAL DEVICE ATTACHED TO A GOLF  
CLUB TO PERFECT THE POSITION OF THE  
HANDS DURING THE GOLF SWING, IN CLASS 28  
(U.S. CLS. 22, 23, 38 AND 50).

FIRST USE 12-21-2006; IN COMMERCE 12-21-2006.

THE MARK CONSISTS OF STANDARD CHAR-  
ACTERS WITHOUT CLAIM TO ANY PARTICULAR  
FONT, STYLE, SIZE, OR COLOR.

SN 78-963,385, FILED 8-29-2006.

LINDA M. KING, EXAMINING ATTORNEY

**Int. Cl.: 21**

**Prior U.S. Cls.: 2, 13, 23, 29, 30, 33, 40, and 50**

**United States Patent and Trademark Office**

**Reg. No. 3,396,522**

**Registered Mar. 11, 2008**

**TRADEMARK  
PRINCIPAL REGISTER**

**SWAMP DONKEY**

GRUBBS OUTDOOR, LLC (TEXAS LTD LIAB  
CO)  
P.O. BOX 85  
TARPLEY, TX 78883

THE MARK CONSISTS OF STANDARD CHAR-  
ACTERS WITHOUT CLAIM TO ANY PARTICULAR  
FONT, STYLE, SIZE, OR COLOR.

FOR: THERMAL INSULATED CONTAINERS  
FOR FOOD OR BEVERAGES, IN CLASS 21 (U.S.  
CLS. 2, 13, 23, 29, 30, 33, 40 AND 50).

SN 78-963,692, FILED 8-30-2006.

FIRST USE 9-30-2007; IN COMMERCE 9-30-2007.

JILL C. ALT, EXAMINING ATTORNEY

**Int. Cl.: 25**

**Prior U.S. Cls.: 22 and 39**

**United States Patent and Trademark Office**

**Reg. No. 3,396,523**

**Registered Mar. 11, 2008**

**TRADEMARK  
PRINCIPAL REGISTER**

**BULLFROGS**

SHOE SHOW, INC. (NORTH CAROLINA COR-  
PORATION)  
2201 TRINITY CHURCH ROAD  
CONCORD, NC 28027

THE MARK CONSISTS OF STANDARD CHAR-  
ACTERS WITHOUT CLAIM TO ANY PARTICULAR  
FONT, STYLE, SIZE, OR COLOR.

FOR: FOOTWEAR, IN CLASS 25 (U.S. CLS. 22 AND  
39).

SN 78-963,695, FILED 8-30-2006.

FIRST USE 8-20-2007; IN COMMERCE 8-20-2007.

JOHN HWANG, EXAMINING ATTORNEY

**Int. Cl.: 21**

**Prior U.S. Cls.: 2, 13, 23, 29, 30, 33, 40, and 50**

**United States Patent and Trademark Office**

**Reg. No. 3,396,524**

**Registered Mar. 11, 2008**

**TRADEMARK  
PRINCIPAL REGISTER**

**IT'S EASY TO BE THIS COOL**

GRUBBS OUTDOOR, LLC (TEXAS LTD LIAB  
CO)  
P.O. BOX 85  
TARPLEY, TX 78883

THE MARK CONSISTS OF STANDARD CHAR-  
ACTERS WITHOUT CLAIM TO ANY PARTICULAR  
FONT, STYLE, SIZE, OR COLOR.

FOR: THERMAL INSULATED CONTAINERS  
FOR FOOD OR BEVERAGES, IN CLASS 21 (U.S.  
CLS. 2, 13, 23, 29, 30, 33, 40 AND 50).

SN 78-963,702, FILED 8-30-2006.

FIRST USE 9-30-2007; IN COMMERCE 9-30-2007.

JILL C. ALT, EXAMINING ATTORNEY

**Int. Cl.: 44**

**Prior U.S. Cls.: 100 and 101**

**United States Patent and Trademark Office**

**Reg. No. 3,396,525**

**Registered Mar. 11, 2008**

**SERVICE MARK  
PRINCIPAL REGISTER**

**KIDS TIME PEDIATRICS**

KIDS TIME PEDIATRICS, LLC (GEORGIA LTD  
LIAB CO)

696 BILLUPS AVENUE

MADISON, GA 30650

FOR: MEDICAL SERVICES, IN CLASS 44 (U.S.  
CLS. 100 AND 101).

FIRST USE 6-1-2007; IN COMMERCE 6-1-2007.

THE MARK CONSISTS OF STANDARD CHAR-  
ACTERS WITHOUT CLAIM TO ANY PARTICULAR  
FONT, STYLE, SIZE, OR COLOR.

NO CLAIM IS MADE TO THE EXCLUSIVE  
RIGHT TO USE "KIDS" AND "PEDIATRICS",  
APART FROM THE MARK AS SHOWN.

SN 78-963,770, FILED 8-30-2006.

ROBERT LAVACHE, EXAMINING ATTORNEY



**Int. Cl.: 16**

**Prior U.S. Cls.: 2, 5, 22, 23, 29, 37, 38, and 50**

**Reg. No. 3,396,526**

**United States Patent and Trademark Office**

**Registered Mar. 11, 2008**

**TRADEMARK  
PRINCIPAL REGISTER**

**CLIMA SERIES**

WEYERHAEUSER COMPANY (WASHINGTON CORPORATION)  
33663 WEYERHAEUSER WAY SOUTH  
FEDERAL WAY, WA 98003

FOR: CORRUGATED CONTAINERS, CORRUGATED BOXES, PAPERBOARD CONTAINERS, PAPERBOARD BOXES, CORRUGATED FIBERBOARD CONTAINERS AND CORRUGATED FIBERBOARD BOXES, IN CLASS 16 (U.S. CLS. 2, 5, 22, 23, 29, 37, 38 AND 50).

FIRST USE 5-8-2007; IN COMMERCE 5-8-2007.

THE MARK CONSISTS OF STANDARD CHARACTERS WITHOUT CLAIM TO ANY PARTICULAR FONT, STYLE, SIZE, OR COLOR.

OWNER OF U.S. REG. NO. 2,668,893.

NO CLAIM IS MADE TO THE EXCLUSIVE RIGHT TO USE "SERIES", APART FROM THE MARK AS SHOWN.

SN 78-963,809, FILED 8-30-2006.

TEJBIR SINGH, EXAMINING ATTORNEY

**Int. Cl.: 30**

**Prior U.S. Cl.: 46**

**United States Patent and Trademark Office**

**Reg. No. 3,396,527**

**Registered Mar. 11, 2008**

**TRADEMARK  
PRINCIPAL REGISTER**

**CRUNCH ATTACK**

MEIJER, INC. (MICHIGAN CORPORATION)  
2929 WALKER AVE., N.W.  
GRAND RAPIDS, MI 49544

FOR: BREAKFAST CEREALS, IN CLASS 30 (U.S.  
CL. 46).

FIRST USE 1-20-2007; IN COMMERCE 1-20-2007.

THE MARK CONSISTS OF STANDARD CHAR-  
ACTERS WITHOUT CLAIM TO ANY PARTICULAR  
FONT, STYLE, SIZE, OR COLOR.

SN 78-963,979, FILED 8-30-2006.

MATTHEW MCDOWELL, EXAMINING ATTOR-  
NEY

**Int. Cl.: 12**

**Prior U.S. Cls.: 19, 21, 23, 31, 35, and 44**

**United States Patent and Trademark Office**

**Reg. No. 3,396,528**

**Registered Mar. 11, 2008**

**TRADEMARK  
PRINCIPAL REGISTER**



JR TRADING GROUP, INC. (FLORIDA CORPORATION)  
9101 S.W. 122 AVENUE, APT. 208  
MIAMI, FL 33186

FOR: ALL-TERRAIN VEHICLES, 3-WHEELED MOTORCYCLES, MOTORCYCLES, AND SCOOTERS, IN CLASS 12 (U.S. CLS. 19, 21, 23, 31, 35 AND 44).

FIRST USE 7-7-2007; IN COMMERCE 7-7-2007.

THE MARK CONSISTS OF THE STYLIZED LETTERS RTM ABOVE A DESIGN OF A CONVEX TRIANGLE INTERNALLY DIVIDED BY THREE LINES WITH SAID TRIANGLE OVERLAPPING A RING ELEMENT.

SN 78-964,048, FILED 8-30-2006.

MELISSA VALLILLO, EXAMINING ATTORNEY

**Int. Cl.: 43**

**Prior U.S. Cls.: 100 and 101**

**United States Patent and Trademark Office**

**Reg. No. 3,396,529**

**Registered Mar. 11, 2008**

**SERVICE MARK  
PRINCIPAL REGISTER**

**MAI HOUSE**

MYRIAD RESTAURANT GROUP, INC. (NEW  
YORK CORPORATION)  
180 FRANKLIN STREET  
NEW YORK, NY 10013

FOR: RESTAURANT, COCKTAIL LOUNGE, AND  
BAR SERVICES, IN CLASS 43 (U.S. CLS. 100 AND  
101).

FIRST USE 11-2-2006; IN COMMERCE 11-2-2006.

THE MARK CONSISTS OF STANDARD CHAR-  
ACTERS WITHOUT CLAIM TO ANY PARTICULAR  
FONT, STYLE, SIZE, OR COLOR.

NO CLAIM IS MADE TO THE EXCLUSIVE  
RIGHT TO USE "HOUSE", APART FROM THE  
MARK AS SHOWN.

THE ENGLISH TRANSLATION OF THE WORD  
"MAI" IN THE MARK IS "TURTLE SHELL".

SN 78-964,140, FILED 8-30-2006.

CYNTHIA SLOAN, EXAMINING ATTORNEY

**Int. Cl.: 5**

**Prior U.S. Cls.: 6, 18, 44, 46, 51, and 52**

**United States Patent and Trademark Office**

**Reg. No. 3,396,530**

**Registered Mar. 11, 2008**

**TRADEMARK  
PRINCIPAL REGISTER**

# Bag-R-Buck

GRANT, DONOVAN W. (UNITED STATES INDIVIDUAL)  
360 SOLITUDE CIRCLE  
GOODLETTSVILLE, TN 37072

FOR: MINERAL FEED SUPPLEMENT FOR DEER, NAMELY, MINERAL FEED SUPPLEMENT FOR DEER HERDS TO ASSIST IN BUCK DEVELOPMENT AND FOR A HEALTHIER DEER HERD, IN CLASS 5 (U.S. CLS. 6, 18, 44, 46, 51 AND 52).

FIRST USE 8-30-2006; IN COMMERCE 8-30-2006.

THE MARK CONSISTS OF STANDARD CHARACTERS WITHOUT CLAIM TO ANY PARTICULAR FONT, STYLE, SIZE, OR COLOR.

SN 78-964,393, FILED 8-30-2006.

JAY BESCH, EXAMINING ATTORNEY

**Int. Cl.: 25**

**Prior U.S. Cls.: 22 and 39**

**United States Patent and Trademark Office**

**Reg. No. 3,396,531**

**Registered Mar. 11, 2008**

**TRADEMARK  
PRINCIPAL REGISTER**

**SURVIVAL CITY**

PATIRE, TOM (UNITED STATES INDIVIDUAL)  
24 WAMPUM ROAD, UNIT A  
PARK RIDGE, NJ 07656

FIRST USE 5-1-2006; IN COMMERCE 5-1-2006.

FOR: CLOTHING, NAMELY, SHIRTS, GOLF SHIRTS, COLLARED SHIRTS, T-SHIRTS, SWEAT SHIRTS, TURTLENECK SWEATERS, MOCKNECK TURTLENECK SWEATERS, AND SWEATERS; FOOTWEAR, NAMELY BOOTS; AND HEADWEAR, NAMELY, HATS AND CAPS, IN CLASS 25 (U.S. CLS. 22 AND 39).

THE MARK CONSISTS OF STANDARD CHARACTERS WITHOUT CLAIM TO ANY PARTICULAR FONT, STYLE, SIZE, OR COLOR.

SN 78-964,892, FILED 8-31-2006.

MIDGE BUTLER, EXAMINING ATTORNEY

**Int. Cl.: 31**

**Prior U.S. Cls.: 1 and 46**

**United States Patent and Trademark Office**

**Reg. No. 3,396,532**

**Registered Mar. 11, 2008**

**TRADEMARK  
PRINCIPAL REGISTER**

**BAYSIDE PLUS**

WEST COAST TURF (CALIFORNIA CORPORATION)  
P.O. BOX 4563  
PALM DESERT, CA 92261

THE MARK CONSISTS OF STANDARD CHARACTERS WITHOUT CLAIM TO ANY PARTICULAR FONT, STYLE, SIZE, OR COLOR.

FOR: GRASS SEED, GRASS STOLONS, AND SOD,  
IN CLASS 31 (U.S. CLS. 1 AND 46).

SN 78-965,120, FILED 8-31-2006.

FIRST USE 8-11-2006; IN COMMERCE 8-11-2006.

ELLEN PERKINS, EXAMINING ATTORNEY

Int. Cl.: 25

Prior U.S. Cls.: 22 and 39

United States Patent and Trademark Office

Reg. No. 3,396,533

Registered Mar. 11, 2008

TRADEMARK  
PRINCIPAL REGISTER



TAYLOR, JEFFREY C. (UNITED STATES INDIVIDUAL)  
56745 MOUNTAIN VIEW  
LA QUINTA, CA 92253

FOR: BATH SLIPPERS; BATHING CAPS; BATHING COSTUMES; BATHING COSTUMES FOR WOMEN; BATHING SUITS; BATHING SUITS FOR MEN; BATHING TRUNKS; BERMUDA SHORTS; BOARD SHORTS; BODY SUITS; BOXER SHORTS; CAMP SHIRTS; CHEF'S HATS; DRESS SHIRTS; DRESS SUITS; DRY SUITS; FISHING VESTS; FITTED SWIMMING COSTUMES WITH BRA CUPS; FLEECE SHORTS; FLIGHT SUITS; FUR HATS; GOLF SHIRTS; GYM SHORTS; GYM SUITS; HAT BANDS; HATS; HEAD SCARVES; HUNTING VESTS; JOGGING SUITS; JUDO SUITS; KARATE SUITS; KNIT SHIRTS; LADIES' SUITS; LONG SLEEVED VESTS; MEN AND WOMEN JACKETS, COATS, TROUSERS, VESTS; MEN'S SUITS; MEN'S SUITS, WOMEN'S SUITS; NECK BANDS; NIGHT SHIRTS; OPEN-NECKED SHIRTS; PANTIES, SHORTS AND BRIEFS; PARTS OF CLOTHING, NAMELY, GUSSETS FOR TIGHTS, GUSSETS FOR STOCKINGS, GUSSETS FOR BATHING SUITS, GUSSETS FOR UNDERWEAR, GUSSETS FOR LEOTARDS AND GUSSETS FOR FOOTLETS; PIQUE SHIRTS; PLAY SUITS; POLO SHIRTS; RAIN SUITS; RUGBY SHORTS; SCARVES; SEDGE HATS (SUGE-GASA); SHIRT FRONTS; SHIRT YOKES; SHIRTS; SHIRTS FOR SUITS; SHORT OVERCOAT FOR KIMONO (HAORI); SHORT PETTICOATS; SHORT SETS; SHORT TROUSERS; SHORT-SLEEVED OR LONG-

SLEEVED T-SHIRTS; SHORT-SLEEVED SHIRTS; SHORTS; SHOULDER SCARVES; SILK SCARVES; SKI SUITS; SKI SUITS FOR COMPETITION; SKIRT SUITS; SLEEP SHIRTS; SLIDING SHORTS; SMALL HATS; SNOW BOARDING SUITS; SNOW SUITS; SPORT SHIRTS; SPORTS SHIRTS; SPORTS SHIRTS WITH SHORT SLEEVES; SUIT COATS; SUITS; SWEAT BANDS; SWEAT SHIRTS; SWEAT SHORTS; SWEAT SUITS; SWIM CAPS; SWIM TRUNKS; SWIM WEAR; SWIM WEAR FOR GENTLEMEN AND LADIES; SWIMMING CAPS; SWIMMING CAPS; SWIMMING COSTUMES; SWIMMING TRUNKS; T-SHIRTS; TOBOGGAN HATS, PANTS AND CAPS; TRACK SUITS; TRAINING SUITS; TRUNKS; VESTED SUITS; VESTS; WALKING SHORTS; WARM UP SUITS; WET SUIT GLOVES; WET SUITS; WET SUITS FOR WATER-SKIING AND SUB-AQUA; WIND SHIRTS; WIND VESTS; WOOLLY HATS; WRIST BANDS; WRISTBANDS; WRISTBANDS CONTAINING A COOLING SUBSTANCE TO COOL THE WEARER, IN CLASS 25 (U.S. CLS. 22 AND 39).

FIRST USE 1-6-2007; IN COMMERCE 1-6-2007.

THE MARK CONSISTS OF A SKELETON FISH DRAWN WITHIN A ROUND CIRCLE. THE WORD "FISHGILLZ" SURROUNDS THE OUTER PART OF THE CIRCLE.

SN 78-965,295, FILED 8-31-2006.

KATHERINE M. DUBRAY, EXAMINING ATTORNEY



**Int. Cl.: 29**

**Prior U.S. Cl.: 46**

**United States Patent and Trademark Office**

**Reg. No. 3,396,534**

**Registered Mar. 11, 2008**

**TRADEMARK  
PRINCIPAL REGISTER**

**Goop Dog**

CLARKE, PATRICK (UNITED STATES INDIVIDUAL)  
176 SPRING CHASE CIRCLE  
ALTAMONTE SPRINGS, FL 32714

THE MARK CONSISTS OF STANDARD CHARACTERS WITHOUT CLAIM TO ANY PARTICULAR FONT, STYLE, SIZE, OR COLOR.

FOR: SPECIALLY-SEASONED GROUND BEEF AND BAKED BEAN MIXTURE IN A SWEET/SPICY SAUCE SERVED ON A WARM POTATO ROLL WITH MELTED CHEESE, IN CLASS 29 (U.S. CL. 46).

SN 78-965,578, FILED 8-31-2006.

FIRST USE 10-4-2006; IN COMMERCE 10-4-2006.

HENRY S. ZAK, EXAMINING ATTORNEY

Int. Cl.: 13

Prior U.S. Cls.: 2 and 9

United States Patent and Trademark Office

Reg. No. 3,396,535

Registered Mar. 11, 2008

TRADEMARK  
PRINCIPAL REGISTER



BYNATURE LLC (ILLINOIS LTD LIAB CO)  
3901 DEER RIDGE ROAD  
QUINCY, IL 62305

FOR: FIRE IGNITERS, IN CLASS 13 (U.S. CLS. 2  
AND 9).

FIRST USE 12-1-2007; IN COMMERCE 12-1-2007.

NO CLAIM IS MADE TO THE EXCLUSIVE  
RIGHT TO USE "COB BRAND", APART FROM  
THE MARK AS SHOWN.

THE LIKENESS (OR, "PORTRAIT") IN THE  
MARK DOES NOT IDENTIFY A LIVING INDIVI-  
DUAL.

THE MARK CONSISTS OF THE FACE OF A  
COWBOY AND THE STYLIZED TEXT OF THE  
WORDING "COWBOY COB BRAND".

SN 78-965,887, FILED 9-1-2006.

HOWARD SMIGA, EXAMINING ATTORNEY

**Int. Cl.: 31**

**Prior U.S. Cls.: 1 and 46**

**United States Patent and Trademark Office**

**Reg. No. 3,396,536**

**Registered Mar. 11, 2008**

**TRADEMARK  
PRINCIPAL REGISTER**

**HILLS' AMBER**

E.G. HILL COMPANY, INC. (INDIANA CORPORATION)  
446 NW 18TH STREET  
RICHMOND, IN 47374

FOR: CUT FLOWER ROSES; AND ROSES FOR THE CUT FLOWER TRADE, IN CLASS 31 (U.S. CLS. 1 AND 46).

FIRST USE 2-6-2006; IN COMMERCE 2-6-2006.

THE MARK CONSISTS OF STANDARD CHARACTERS WITHOUT CLAIM TO ANY PARTICULAR FONT, STYLE, SIZE, OR COLOR.

NO CLAIM IS MADE TO THE EXCLUSIVE RIGHT TO USE "AMBER", APART FROM THE MARK AS SHOWN.

SN 78-966,993, FILED 9-5-2006.

MATTHEW PAPPAS, EXAMINING ATTORNEY

**Int. Cls.: 16 and 41**

**Prior U.S. Cls.: 2, 5, 22, 23, 29, 37, 38, 50, 100, 101, and 107**

**Reg. No. 3,396,537**

**United States Patent and Trademark Office**

**Registered Mar. 11, 2008**

**TRADEMARK  
SERVICE MARK  
PRINCIPAL REGISTER**

**MARINE WEALTH**

GLOBALONE LTD (ENGLAND CORPORATION)  
44 UPPER BELGRAVE ROAD  
CLIFTON, BRISTOL, ENGLAND BS8 2XN

FOR: NON-FICTION BOOKS ON A VARIETY OF TOPICS; SERIES OF FICTION AND NON-FICTION BOOKS ON A VARIETY OF TOPICS; EDUCATIONAL BOOKS FEATURING COMMERCIAL FISHING AND FISHERIES MANAGEMENT; SCHOLARLY BOOKS ON VARIOUS TOPICS, NAMELY, COMMERCIAL FISHING AND FISHERIES MANAGEMENT; AND PICTURE BOOKS, IN CLASS 16 (U.S. CLS. 2, 5, 22, 23, 29, 37, 38 AND 50).

FIRST USE 11-30-2006; IN COMMERCE 12-15-2006.

FOR: ENTERTAINMENT SERVICES, NAMELY, PROVIDING A WEBSITE FEATURING, PHOTOGRAPHIC, AUDIO, VIDEO AND PROSE PRESEN-

TATIONS FEATURING COMMERCIAL FISHING AND FISHERIES MANAGEMENT; AND PUBLISHING OF ELECTRONIC PUBLICATIONS, IN CLASS 41 (U.S. CLS. 100, 101 AND 107).

FIRST USE 11-30-2006; IN COMMERCE 12-15-2006.

THE MARK CONSISTS OF STANDARD CHARACTERS WITHOUT CLAIM TO ANY PARTICULAR FONT, STYLE, SIZE, OR COLOR.

NO CLAIM IS MADE TO THE EXCLUSIVE RIGHT TO USE "MARINE", APART FROM THE MARK AS SHOWN.

SN 78-967,020, FILED 9-5-2006.

HENRY S. ZAK, EXAMINING ATTORNEY

**Int. Cl.: 36**

**Prior U.S. Cls.: 100, 101, and 102**

**United States Patent and Trademark Office**

**Reg. No. 3,396,538**

**Registered Mar. 11, 2008**

**SERVICE MARK  
PRINCIPAL REGISTER**

**SCHWAB INDUSTRY RATINGS**

CHARLES SCHWAB & CO., INC. (CALIFORNIA CORPORATION)  
101 MONTGOMERY STREET  
SAN FRANCISCO, CA 94104

FOR: PROVIDING FINANCIAL INFORMATION AND ANALYSIS IN THE FIELD OF INVESTMENTS, IN CLASS 36 (U.S. CLS. 100, 101 AND 102).

FIRST USE 9-18-2006; IN COMMERCE 9-18-2006.

THE MARK CONSISTS OF STANDARD CHARACTERS WITHOUT CLAIM TO ANY PARTICULAR FONT, STYLE, SIZE, OR COLOR.

NO CLAIM IS MADE TO THE EXCLUSIVE RIGHT TO USE "INDUSTRY RATINGS", APART FROM THE MARK AS SHOWN.

SN 78-967,499, FILED 9-5-2006.

ANTHONY RINKER, EXAMINING ATTORNEY

**Int. Cl.: 42**

**Prior U.S. Cls.: 100 and 101**

**United States Patent and Trademark Office**

**Reg. No. 3,396,539**

**Registered Mar. 11, 2008**

**SERVICE MARK  
PRINCIPAL REGISTER**

**KAPÜTZ**

SHIELDS, GERALD (UNITED STATES INDIVIDUAL)  
8737 ORCHARD AVENUE  
OMAHA, NE 68127

FOR: TECHNOLOGY CONSULTATION IN THE FIELD OF AEROSPACE ENGINEERING, IN CLASS 42 (U.S. CLS. 100 AND 101).

FIRST USE 12-21-2007; IN COMMERCE 12-21-2007.

THE MARK CONSISTS OF STANDARD CHARACTERS WITHOUT CLAIM TO ANY PARTICULAR FONT, STYLE, SIZE, OR COLOR.

THE WORDING "KAPÜTZ" HAS NO MEANING IN A FOREIGN LANGUAGE.

SN 78-967,892, FILED 9-6-2006.

THOMAS MANOR, EXAMINING ATTORNEY

**Int. Cl.: 9**

**Prior U.S. Cls.: 21, 23, 26, 36, and 38**

**United States Patent and Trademark Office**

**Reg. No. 3,396,540**

**Registered Mar. 11, 2008**

**TRADEMARK  
PRINCIPAL REGISTER**

**SERVANTUS**

SERVANTUS CORPORATION (UTAH CORPORATION)  
9728 NORTH 6630 WEST  
HIGHLAND, UT 84003

FOR: COMPUTER SOFTWARE AND HARDWARE FOR USE IN BACKING-UP AND CONTROLLING DATA IN A COMPUTER NETWORK, IN CLASS 9 (U.S. CLS. 21, 23, 26, 36 AND 38).

FIRST USE 1-11-2007; IN COMMERCE 12-10-2007.

THE MARK CONSISTS OF STANDARD CHARACTERS WITHOUT CLAIM TO ANY PARTICULAR FONT, STYLE, SIZE, OR COLOR.

SN 78-967,956, FILED 9-6-2006.

PAUL CROWLEY, EXAMINING ATTORNEY

**Int. Cl.: 28**

**Prior U.S. Cls.: 22, 23, 38, and 50**

**United States Patent and Trademark Office**

**Reg. No. 3,396,541**

**Registered Mar. 11, 2008**

**TRADEMARK  
PRINCIPAL REGISTER**

**JUNGLE JUMPER**

MATTEL, INC. (DELAWARE CORPORATION)  
MAIL STOP M1-1518  
333 CONTINENTAL BOULEVARD  
EL SEGUNDO, CA 90245

FOR: TOYS, GAMES AND PLAYTHINGS, NAME-  
LY, TOY VEHICLES AND ACCESSORIES THERE-  
FOR, IN CLASS 28 (U.S. CLS. 22, 23, 38 AND 50).

FIRST USE 4-18-2007; IN COMMERCE 4-18-2007.

THE MARK CONSISTS OF STANDARD CHAR-  
ACTERS WITHOUT CLAIM TO ANY PARTICULAR  
FONT, STYLE, SIZE, OR COLOR.

OWNER OF U.S. REG. NOS. 2,427,556, 2,739,042,  
AND OTHERS.

SN 78-968,020, FILED 9-6-2006.

TRACY WHITTAKER-BROWN, EXAMINING AT-  
TORNEY



**Int. Cl.: 30**

**Prior U.S. Cl.: 46**

**United States Patent and Trademark Office**

**Reg. No. 3,396,542**

**Registered Mar. 11, 2008**

**TRADEMARK  
PRINCIPAL REGISTER**

# CHARGE

THE CONSOLIDATION GROUP, INC. (ILLINOIS CORPORATION)  
W7820 CONSERVATION ROAD  
LAKE MILLS, WI 535519564

FOR: BAKERY PRODUCTS; COFFEE, NAMELY, WHOLE AND GROUND COFFEE BEANS; POWDERED DRINK MIXES CONTAINING COFFEE; COFFEE-BASED BEVERAGES CONTAINING MILK; BEVERAGES MADE OF COFFEE; COFFEE-FLAVORED SYRUP USED IN MAKING BEVERAGES; AND PREPARED COFFEE AND COFFEE-BASED BEVERAGES, IN CLASS 30 (U.S. CL. 46).

FIRST USE 1-1-2007; IN COMMERCE 1-1-2007.

THE MARK CONSISTS OF STANDARD CHARACTERS WITHOUT CLAIM TO ANY PARTICULAR FONT, STYLE, SIZE, OR COLOR.

SN 78-968,091, FILED 9-6-2006.

JORDAN BAKER, EXAMINING ATTORNEY

**Int. Cl.: 9**

**Prior U.S. Cls.: 21, 23, 26, 36, and 38**

**United States Patent and Trademark Office**

**Reg. No. 3,396,543**

**Registered Mar. 11, 2008**

**TRADEMARK  
PRINCIPAL REGISTER**

**MASKED MONEY**

KONAMI GAMING, INC. (NEVADA CORPORATION)  
585 TRADE CENTER DRIVE  
LAS VEGAS, NV 89119

FOR: ELECTRONIC GAME PROGRAMS; GAMING EQUIPMENT, NAMELY, SLOT MACHINES WITH OR WITHOUT VIDEO OUTPUT; GAMING MACHINES; MACHINES FOR PLAYING GAMES OF CHANCE; SLOT MACHINES, IN CLASS 9 (U.S. CLS. 21, 23, 26, 36 AND 38).

FIRST USE 3-9-2007; IN COMMERCE 3-9-2007.

THE MARK CONSISTS OF STANDARD CHARACTERS WITHOUT CLAIM TO ANY PARTICULAR FONT, STYLE, SIZE, OR COLOR.

SN 78-968,306, FILED 9-6-2006.

MATTHEW EINSTEIN, EXAMINING ATTORNEY

**Int. Cl.: 5**

**Prior U.S. Cls.: 6, 18, 44, 46, 51, and 52**

**United States Patent and Trademark Office**

**Reg. No. 3,396,544**

**Registered Mar. 11, 2008**

**TRADEMARK  
PRINCIPAL REGISTER**

**GOT MICROBIALS?**

PERFORMANCE PRODUCTS, INC. (TEXAS CORPORATION)

737 ISOM RD.

SAN ANTONIO, TX 782164027

FOR: ANIMAL FEED SUPPLEMENTS, IN CLASS 5 (U.S. CLS. 6, 18, 44, 46, 51 AND 52).

FIRST USE 12-1-2006; IN COMMERCE 12-1-2006.

THE MARK CONSISTS OF STANDARD CHARACTERS WITHOUT CLAIM TO ANY PARTICULAR FONT, STYLE, SIZE, OR COLOR.

NO CLAIM IS MADE TO THE EXCLUSIVE RIGHT TO USE "MICROBIALS", APART FROM THE MARK AS SHOWN.

SN 78-968,812, FILED 9-7-2006.

BARBARA RUTLAND, EXAMINING ATTORNEY

**Int. Cl.: 9**

**Prior U.S. Cls.: 21, 23, 26, 36, and 38**

**United States Patent and Trademark Office**

**Reg. No. 3,396,545**

**Registered Mar. 11, 2008**

**TRADEMARK  
PRINCIPAL REGISTER**

# InfraTrac

INFRATRAC INC. (DELAWARE CORPORATION)  
8070 GEORGIA AVE. STE. 415  
SILVER SPRING INNOVATION CENTER  
SILVER SPRING, MD 20910

FOR: COMPUTER SOFTWARE FOR CHEMICAL ANALYSIS, IN THE FIELD OF TRACKING AND TAGGING A WIDE VARIETY OF SUBSTANCES SO AS TO DISTINGUISH BETWEEN COUNTERFEIT AND AUTHENTIC SUBSTANCES, AND TO DISTINGUISH BETWEEN PROPERLY-HANDLED AND IMPROPERLY-HANDLED SUBSTANCES, OR EX-

PIRED AND UNEXPIRED SUBSTANCES, IN CLASS 9 (U.S. CLS. 21, 23, 26, 36 AND 38).

FIRST USE 3-22-2006; IN COMMERCE 11-2-2007.

THE MARK CONSISTS OF STANDARD CHARACTERS WITHOUT CLAIM TO ANY PARTICULAR FONT, STYLE, SIZE, OR COLOR.

SN 78-969,056, FILED 9-7-2006.

KEVIN CORWIN, EXAMINING ATTORNEY

**Int. Cl.: 36**

**Prior U.S. Cls.: 100, 101, and 102**

**United States Patent and Trademark Office**

**Reg. No. 3,396,546**

**Registered Mar. 11, 2008**

**SERVICE MARK  
PRINCIPAL REGISTER**

# 333 ADVISORS

NUVEEN INVESTMENTS, INC. (DELAWARE CORPORATION)  
333 WEST WACKER DRIVE  
CHICAGO, IL 60606

FOR: INVESTMENT ADVISORY AND FINANCIAL PORTFOLIO MANAGEMENT SERVICES, IN CLASS 36 (U.S. CLS. 100, 101 AND 102).

FIRST USE 8-16-2006; IN COMMERCE 8-16-2006.

THE MARK CONSISTS OF STANDARD CHARACTERS WITHOUT CLAIM TO ANY PARTICULAR FONT, STYLE, SIZE, OR COLOR.

NO CLAIM IS MADE TO THE EXCLUSIVE RIGHT TO USE "ADVISORS", APART FROM THE MARK AS SHOWN.

SN 78-969,684, FILED 9-8-2006.

MICHAEL WEBSTER, EXAMINING ATTORNEY

**Int. Cl.: 9**

**Prior U.S. Cls.: 21, 23, 26, 36, and 38**

**United States Patent and Trademark Office**

**Reg. No. 3,396,547**

**Registered Mar. 11, 2008**

**TRADEMARK  
PRINCIPAL REGISTER**

**WILD & WILDER**

WMS GAMING INC. (DELAWARE CORPORATION)  
800 SOUTH NORTHPOINT BOULEVARD  
WAUKEGAN, IL 60085

FOR: GAMING MACHINES THAT GENERATE OR DISPLAY WAGER OUTCOMES; GAMING SOFTWARE THAT GENERATES OR DISPLAYS WAGER OUTCOMES OF GAMING MACHINES, IN CLASS 9 (U.S. CLS. 21, 23, 26, 36 AND 38).

FIRST USE 6-4-2007; IN COMMERCE 6-4-2007.

THE MARK CONSISTS OF STANDARD CHARACTERS WITHOUT CLAIM TO ANY PARTICULAR FONT, STYLE, SIZE, OR COLOR.

SN 78-969,696, FILED 9-8-2006.

MIDGE BUTLER, EXAMINING ATTORNEY

**Int. Cl.: 9**

**Prior U.S. Cls.: 21, 23, 26, 36, and 38**

**United States Patent and Trademark Office**

**Reg. No. 3,396,548**

**Registered Mar. 11, 2008**

**TRADEMARK  
PRINCIPAL REGISTER**

**LUCKY MEERKATS**

WMS GAMING INC. (DELAWARE CORPORATION)  
800 SOUTH NORTHPOINT BOULEVARD  
WAUKEGAN, IL 60085

FOR: GAMING MACHINES THAT GENERATE OR DISPLAY WAGER OUTCOMES; GAMING SOFTWARE THAT GENERATES OR DISPLAYS WAGER OUTCOMES OF GAMING MACHINES, IN CLASS 9 (U.S. CLS. 21, 23, 26, 36 AND 38).

FIRST USE 11-2-2007; IN COMMERCE 11-2-2007.

THE MARK CONSISTS OF STANDARD CHARACTERS WITHOUT CLAIM TO ANY PARTICULAR FONT, STYLE, SIZE, OR COLOR.

SN 78-969,697, FILED 9-8-2006.

MIDGE BUTLER, EXAMINING ATTORNEY

**Int. Cl.: 35**

**Prior U.S. Cls.: 100, 101, and 102**

**United States Patent and Trademark Office**

**Reg. No. 3,396,549**

**Registered Mar. 11, 2008**

**SERVICE MARK  
PRINCIPAL REGISTER**



MULLAHEY ENTERPRISES, INC. (NORTH CAROLINA CORPORATION)  
8274 WILLIAM WALLACE DR.  
SUMMERFIELD, NC 27358

FOR: ADVERTISING, MARKETING AND PROMOTION SERVICES, IN CLASS 35 (U.S. CLS. 100, 101 AND 102).

FIRST USE 9-15-2006; IN COMMERCE 9-15-2006.

NO CLAIM IS MADE TO THE EXCLUSIVE RIGHT TO USE "BRAND", APART FROM THE MARK AS SHOWN.

THE MARK CONSISTS OF A RIGHT-FACING PROFILE OF A GROTESQUE HEAD WITH THREE TRIANGLE LIKE FIGURES EMANATING AWAY FROM THE TOP PORTION OF THE HEAD WITH THE WORD "BRAND" TO THE BOTTOM LEFT OF THE HEAD AND THE WORD "FLARE" TO THE BOTTOM RIGHT OF THE HEAD AND THE TAGLINE "DELIVERING BRAND INNOVATION" AT THE BOTTOM PORTION OF THE MARK.

SN 78-970,000, FILED 9-8-2006.

MICHAEL LITZAU, EXAMINING ATTORNEY



**Int. Cl.: 28**

**Prior U.S. Cls.: 22, 23, 38, and 50**

**United States Patent and Trademark Office**

**Reg. No. 3,396,550**

**Registered Mar. 11, 2008**

**TRADEMARK  
PRINCIPAL REGISTER**

**SOFT CATCH COASTER**

WHAM-O, INC. (DELAWARE CORPORATION)  
5903 CHRISTIE AVENUE  
EMERYVILLE, CA 94608

FOR: GAMES AND PLAYTHINGS, NAMELY,  
TOY FLYING DISCS AND SAUCERS USED IN  
SPORT AND RECREATIONAL ACTIVITIES AND  
GAMES, IN CLASS 28 (U.S. CLS. 22, 23, 38 AND 50).

FIRST USE 5-0-2007; IN COMMERCE 5-0-2007.

THE MARK CONSISTS OF STANDARD CHAR-  
ACTERS WITHOUT CLAIM TO ANY PARTICULAR  
FONT, STYLE, SIZE, OR COLOR.

NO CLAIM IS MADE TO THE EXCLUSIVE  
RIGHT TO USE "SOFT CATCH", APART FROM  
THE MARK AS SHOWN.

SN 78-970,023, FILED 9-8-2006.

NELSON SNYDER, EXAMINING ATTORNEY

Int. Cls.: 35 and 43

Prior U.S. Cls.: 100, 101, and 102

United States Patent and Trademark Office

Reg. No. 3,396,551

Registered Mar. 11, 2008

SERVICE MARK  
PRINCIPAL REGISTER



REALLY NICE RESTAURANTS, LLC (DELA-  
WARE LTD LIAB CO)  
180 NORTH STETSON, SUITE 5300  
CHICAGO, IL 60601

FOR: OFFERING TECHNICAL ASSISTANCE IN  
THE ESTABLISHMENT AND/OR OPERATION OF  
RESTAURANTS; RESTAURANT MANAGEMENT  
FOR OTHERS, IN CLASS 35 (U.S. CLS. 100, 101  
AND 102).

FIRST USE 10-31-2006; IN COMMERCE 10-31-2006.

FOR: CATERING; CATERING FOR THE PROVI-  
SION OF FOOD AND BEVERAGES; CATERING OF  
FOOD AND DRINKS; RESERVATION OF RESTAU-  
RANTS; RESTAURANT AND BAR SERVICES; RES-  
TAURANT SERVICES; RESTAURANTS; TAKE-OUT

RESTAURANT SERVICES, IN CLASS 43 (U.S. CLS.  
100 AND 101).

FIRST USE 10-31-2006; IN COMMERCE 10-31-2006.

THE MARK CONSISTS OF A SILHOUETTE OF A  
CHEF HEAD AND TORSO WITH OUTSTRETCHED  
ARMS WITH TWO STARS TO THE LEFT AND  
THREE STARS TO THE RIGHT OF THE CHEF'S  
ARMS WITH THE AFOREMENTIONED DESIGN  
UNDERScoreD, WITH THE PHRASE "REALLY-  
NICERESTAURANTS" BELOW THE DESIGN.

SN 78-970,242, FILED 9-8-2006.

LEE-ANNE BERNS, EXAMINING ATTORNEY

**Int. Cl.: 4**

**Prior U.S. Cls.: 1, 6, and 15**

**United States Patent and Trademark Office**

**Reg. No. 3,396,552**

**Registered Mar. 11, 2008**

**TRADEMARK  
PRINCIPAL REGISTER**

**nuvara**

EVEY, DAVID (UNITED STATES INDIVIDUAL)  
SUITE 421  
9190 WEST OLYMPIC BLVD.  
BEVERLY HILLS, CA 90212

THE MARK CONSISTS OF STANDARD CHAR-  
ACTERS WITHOUT CLAIM TO ANY PARTICULAR  
FONT, STYLE, SIZE, OR COLOR.

FOR: CANDLES, IN CLASS 4 (U.S. CLS. 1, 6 AND  
15).

SN 78-970,954, FILED 9-11-2006.

FIRST USE 1-14-2007; IN COMMERCE 1-14-2007.

MARILYN IZZI, EXAMINING ATTORNEY

**Int. Cl.: 9**

**Prior U.S. Cls.: 21, 23, 26, 36, and 38**

**United States Patent and Trademark Office**

**Reg. No. 3,396,553**

**Registered Mar. 11, 2008**

**TRADEMARK  
PRINCIPAL REGISTER**

**JEWELS OF THE NIGHT**

WMS GAMING INC. (DELAWARE CORPORATION)  
800 SOUTH NORTHPOINT BOULEVARD  
WAUKEGAN, IL 60085

FOR: GAMING MACHINES THAT GENERATE OR DISPLAY WAGER OUTCOMES; GAMING SOFTWARE THAT GENERATES OR DISPLAYS WAGER OUTCOMES OF GAMING MACHINES, IN CLASS 9 (U.S. CLS. 21, 23, 26, 36 AND 38).

FIRST USE 11-14-2006; IN COMMERCE 11-14-2006.

THE MARK CONSISTS OF STANDARD CHARACTERS WITHOUT CLAIM TO ANY PARTICULAR FONT, STYLE, SIZE, OR COLOR.

SN 78-970,977, FILED 9-11-2006.

KIMBERLY FRYE, EXAMINING ATTORNEY

**Int. Cl.: 3**

**Prior U.S. Cls.: 1, 4, 6, 50, 51, and 52**

**United States Patent and Trademark Office**

**Reg. No. 3,396,554**

**Registered Mar. 11, 2008**

**TRADEMARK  
PRINCIPAL REGISTER**

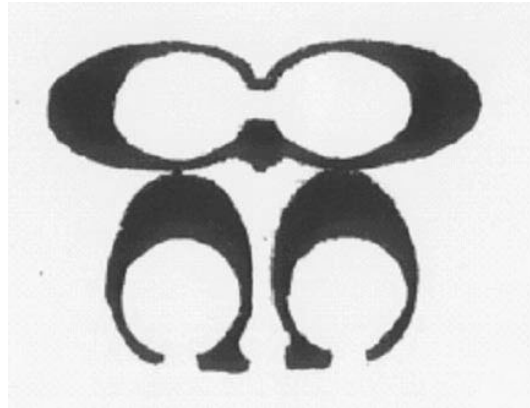

COACH SERVICES, INC. (MARYLAND CORPORATION)  
516 WEST 34TH STREET  
NEW YORK, NY 10001

FOR: FRAGRANCES FOR PERSONAL USE; LIP-STICKS, IN CLASS 3 (U.S. CLS. 1, 4, 6, 50, 51 AND 52).

FIRST USE 4-1-2007; IN COMMERCE 4-1-2007.

OWNER OF U.S. REG. NOS. 2,592,963, 2,626,565, AND 2,832,589.

THE MARK CONSISTS OF A REPEATING PATTERN FEATURING A STYLIZED LETTER "C" IN DIFFERENT ORIENTATIONS.

SN 78-972,141, FILED 9-12-2006.

JENNIFER MARTIN, EXAMINING ATTORNEY

**Int. Cl.: 3**

**Prior U.S. Cls.: 1, 4, 6, 50, 51, and 52**

**United States Patent and Trademark Office**

**Reg. No. 3,396,555**

**Registered Mar. 11, 2008**

**TRADEMARK  
PRINCIPAL REGISTER**

**Basic H<sup>2</sup>**

SHAKLEE CORPORATION (DELAWARE CORPORATION)  
4747 WILLOW ROAD  
PLEASANTON, CA 945882740

OWNER OF U.S. REG. NOS. 772,022, 1,006,847,  
AND OTHERS.

FOR: MOIST CLEANING WIPES IMPREGNATED  
WITH CHEMICALS OR COMPOUNDS FOR HOUSE-  
HOLD USE; ALL-PURPOSE HOUSEHOLD AND  
INDUSTRIAL CLEANING PREPARATIONS, IN  
CLASS 3 (U.S. CLS. 1, 4, 6, 50, 51 AND 52).

THE MARK CONSISTS OF "BASIC H2" WITH  
THE "2" AS A SUPERSCRIPT.

SN 78-972,149, FILED 9-12-2006.

FIRST USE 8-31-2006; IN COMMERCE 8-31-2006.

MATTHEW EINSTEIN, EXAMINING ATTORNEY

**Int. Cl.: 28**

**Prior U.S. Cls.: 22, 23, 38, and 50**

**United States Patent and Trademark Office**

**Reg. No. 3,396,556**

**Registered Mar. 11, 2008**

**TRADEMARK  
PRINCIPAL REGISTER**

**ANCIENT WISDOM, INSTANT  
INSIGHTS**

NEA MATIA, INC. (INDIANA CORPORATION)  
14233 SUGAR CREEK ROAD  
FORT WAYNE, IN 46814

THE MARK CONSISTS OF STANDARD CHAR-  
ACTERS WITHOUT CLAIM TO ANY PARTICULAR  
FONT, STYLE, SIZE, OR COLOR.

FOR: DOLLS AND ACCESSORIES THEREFOR,  
IN CLASS 28 (U.S. CLS. 22, 23, 38 AND 50).

SN 78-972,351, FILED 9-12-2006.

FIRST USE 12-19-2007; IN COMMERCE 12-19-2007.

BARBARA GAYNOR, EXAMINING ATTORNEY

**Int. Cl.: 11**

**Prior U.S. Cls.: 13, 21, 23, 31, and 34**

**United States Patent and Trademark Office**

**Reg. No. 3,396,557**

**Registered Mar. 11, 2008**

**TRADEMARK  
PRINCIPAL REGISTER**

**HULA SKIRT**

SHADOW MANAGEMENT, L.L.C. (ILLINOIS  
LTD LIAB CO)  
413 JUNE TERRACE  
BARRINGTON, IL 60010

THE MARK CONSISTS OF STANDARD CHAR-  
ACTERS WITHOUT CLAIM TO ANY PARTICULAR  
FONT, STYLE, SIZE, OR COLOR.

FOR: REMOVABLE SHADES FOR HIGH-BAY  
LIGHTING FIXTURES, IN CLASS 11 (U.S. CLS. 13,  
21, 23, 31 AND 34).

SN 78-972,398, FILED 9-12-2006.

FIRST USE 10-1-2006; IN COMMERCE 1-12-2007.

INGRID C. EULIN, EXAMINING ATTORNEY



**Int. Cl.: 9**

**Prior U.S. Cls.: 21, 23, 26, 36, and 38**

**Reg. No. 3,396,558**

**United States Patent and Trademark Office**

**Registered Mar. 11, 2008**

**TRADEMARK  
PRINCIPAL REGISTER**

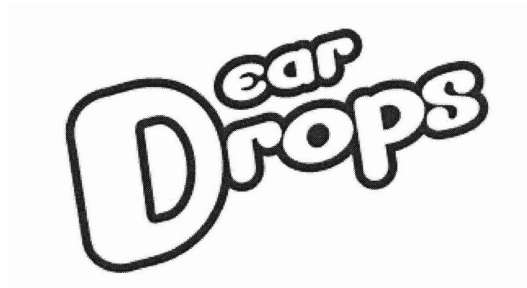

MATSUSHITA ELECTRIC INDUSTRIAL CO.,  
LTD. (JAPAN CORPORATION)  
1006, OAZA KADOMA, KADOMA-SHI  
OSAKA, JAPAN 571-8501

FIRST USE 10-1-2006; IN COMMERCE 10-1-2006.

SN 78-972,782, FILED 9-12-2006.

FOR: EARPHONES, IN CLASS 9 (U.S. CLS. 21, 23,  
26, 36 AND 38).

ROBIN CHOSID, EXAMINING ATTORNEY

**Int. Cl.: 10**

**Prior U.S. Cls.: 26, 39, and 44**

**United States Patent and Trademark Office**

**Reg. No. 3,396,559**

**Registered Mar. 11, 2008**

**TRADEMARK  
PRINCIPAL REGISTER**

**MESOONE**

RICARDO VIEIRA REGO ME (BRAZIL LTD  
LIAB CO)  
RUA XAVIER DE OLIVEIRA 287 PARQUELANDIA  
FORTALEZA, BRAZIL 60455

THE MARK CONSISTS OF STANDARD CHAR-  
ACTERS WITHOUT CLAIM TO ANY PARTICULAR  
FONT, STYLE, SIZE, OR COLOR.

FOR: INJECTION GUN DEVICE WITH A NEE-  
DLE FOR MEDICAL USE, IN CLASS 10 (U.S. CLS. 26,  
39 AND 44).

SN 78-974,039, FILED 9-14-2006.

FIRST USE 6-10-2006; IN COMMERCE 6-10-2006.

LAURIE MAYES, EXAMINING ATTORNEY

**Int. Cl.: 10**

**Prior U.S. Cls.: 26, 39, and 44**

**United States Patent and Trademark Office**

**Reg. No. 3,396,560**

**Registered Mar. 11, 2008**

**TRADEMARK  
PRINCIPAL REGISTER**



RICARDO VIEIRA REGO ME (BRAZIL LTD  
LIAB CO)  
RUA XAVIER DE OLIVEIRA 287 PARQUELANDIA  
FORTALEZA, BRAZIL 60455

FOR: INJECTION GUN DEVICE WITH A NEE-  
DLE FOR MEDICAL USE, IN CLASS 10 (U.S. CLS. 26,  
39 AND 44).

FIRST USE 6-10-2006; IN COMMERCE 6-10-2006.

THE COLOR(S) PURPLE IS/ARE CLAIMED AS A  
FEATURE OF THE MARK.

THE MARK CONSISTS OF THE COLOR PURPLE  
APPEARING IN THE LANGUAGE "MESOONE"  
AND IN THE DESIGN ELEMENT.

SN 78-974,041, FILED 9-14-2006.

LAURIE MAYES, EXAMINING ATTORNEY

**Int. Cl.: 6**

**Prior U.S. Cls.: 2, 12, 13, 14, 23, 25, and 50**

**Reg. No. 3,396,561**

**United States Patent and Trademark Office**

**Registered Mar. 11, 2008**

---

**TRADEMARK  
PRINCIPAL REGISTER**

**KLAW**

NATIONWIDE INDUSTRIES, INC. (FLORIDA  
CORPORATION)  
10333 WINDHORST RD.  
TAMPA, FL 33619

THE MARK CONSISTS OF STANDARD CHAR-  
ACTERS WITHOUT CLAIM TO ANY PARTICULAR  
FONT, STYLE, SIZE, OR COLOR.

FOR: METAL LOCKS FOR SLIDING DOORS, IN  
CLASS 6 (U.S. CLS. 2, 12, 13, 14, 23, 25 AND 50).

SN 78-974,734, FILED 9-14-2006.

FIRST USE 8-21-2006; IN COMMERCE 8-21-2006.

EMILY CHUO, EXAMINING ATTORNEY

**Int. Cl.: 3**

**Prior U.S. Cls.: 1, 4, 6, 50, 51, and 52**

**United States Patent and Trademark Office**

**Reg. No. 3,396,562**

**Registered Mar. 11, 2008**

**TRADEMARK  
PRINCIPAL REGISTER**

**JILL STUART**

THE TRUSTEE(S) OF THE STUART-CURTIS FAMILY TRUST, COMPRISING RON CURTIS, A U.S. CITIZEN (NEW YORK TRUST)

550 SEVENTH AVENUE  
NEW YORK, NY 10018

FOR: PERFUMES, IN CLASS 3 (U.S. CLS. 1, 4, 6, 50, 51 AND 52).

FIRST USE 12-31-2005; IN COMMERCE 12-31-2005.

THE MARK CONSISTS OF STANDARD CHARACTERS WITHOUT CLAIM TO ANY PARTICULAR FONT, STYLE, SIZE, OR COLOR.

THE NAME JILL STUART IDENTIFIES A LIVING INDIVIDUAL WHOSE CONSENT IS OF RECORD.

SN 78-977,828, FILED 1-11-2005.

KARANENDRA S. CHHINA, EXAMINING ATTORNEY

**Int. Cls.: 18 and 25**

**Prior U.S. Cls.: 1, 2, 3, 22, 39, and 41**

**United States Patent and Trademark Office**

**Reg. No. 3,396,563**

**Registered Mar. 11, 2008**

**TRADEMARK  
PRINCIPAL REGISTER**

**COUTURE. KICK.  
SOUL.**

BEYOND PRODUCTIONS LLC (DELAWARE  
LTD LIAB CO)  
31 WEST 34TH STREET  
NEW YORK, NY 10001

FOR: BAGS, NAMELY, BEACH BAGS, TOTE  
BAGS, BACKPACKS, HANDBAGS, KNAPSACKS;  
LEATHER AND IMITATION LEATHER GOODS,  
NAMELY, BAGS, NAMELY, BEACH BAGS, TOTE  
BAGS, BACKPACKS, HANDBAGS, KNAPSACKS, IN  
CLASS 18 (U.S. CLS. 1, 2, 3, 22 AND 41).

FIRST USE 8-0-2006; IN COMMERCE 8-0-2006.

FOR: CLOTHING, NAMELY, SHIRTS, SHORTS,  
PANTS, JACKETS, BLOUSES, SKIRTS, DRESSES,  
SHAWLS, SCARVES, OVERALLS, T-SHIRTS, JEANS,

SWEATSHIRTS, VESTS, RAINWEAR, BASEBALL  
CAPS, HATS, SWEATERS, JOG SETS COMPRISED  
OF SHIRTS, SWEATSHIRTS, AND SWEATPANTS,  
FOOTWEAR, TANK TOPS, SWIMWEAR, COATS,  
FUR COATS, JACKET COATS, IN CLASS 25 (U.S.  
CLS. 22 AND 39).

FIRST USE 12-0-2005; IN COMMERCE 12-0-2005.

THE MARK CONSISTS OF STANDARD CHAR-  
ACTERS WITHOUT CLAIM TO ANY PARTICULAR  
FONT, STYLE, SIZE, OR COLOR.

SN 78-978,443, FILED 9-8-2004.

MICHAEL TANNER, EXAMINING ATTORNEY

**Int. Cls.: 18 and 25**

**Prior U.S. Cls.: 1, 2, 3, 22, 39, and 41**

**United States Patent and Trademark Office**

**Reg. No. 3,396,564**

**Registered Mar. 11, 2008**

**TRADEMARK  
PRINCIPAL REGISTER**

**DERÉON**

BEYOND PRODUCTIONS LLC (DELAWARE  
LIMITED LIABILITY COMPANY)  
31 WEST 34TH STREET  
NEW YORK, NY 10001

FOR: BAGS, NAMELY, BEACH BAGS, TOTE  
BAGS, BACKPACKS, HANDBAGS, KNAPSACKS;  
LEATHER AND IMITATION LEATHER GOODS,  
NAMELY, BAGS, NAMELY, BEACH BAGS, TOTE  
BAGS, BACKPACKS, HANDBAGS, KNAPSACKS, IN  
CLASS 18 (U.S. CLS. 1, 2, 3, 22 AND 41).

FIRST USE 8-0-2006; IN COMMERCE 8-0-2006.

FOR: CLOTHING, NAMELY, SHIRTS, SHORTS,  
PANTS, JACKETS, BLOUSES, SKIRTS, DRESSES,  
SHAWLS, SCARVES, OVERALLS, T-SHIRTS, JEANS,

SWEATSHIRTS, VESTS, RAINWEAR, BASEBALL  
CAPS, HATS, SWEATERS, JOG SETS COMPRISED  
OF SHIRTS, SWEATSHIRTS, AND SWEATPANTS,  
FOOTWEAR, TANK TOPS, SWIMWEAR, COATS,  
FUR COATS, JACKET COATS, IN CLASS 25 (U.S.  
CLS. 22 AND 39).

FIRST USE 12-0-2005; IN COMMERCE 12-0-2005.

THE MARK CONSISTS OF STANDARD CHAR-  
ACTERS WITHOUT CLAIM TO ANY PARTICULAR  
FONT, STYLE, SIZE, OR COLOR.

SN 78-978,444, FILED 11-17-2004.

MICHAEL TANNER, EXAMINING ATTORNEY

**Int. Cl.: 14**

**Prior U.S. Cls.: 2, 27, 28, and 50**

**United States Patent and Trademark Office**

**Reg. No. 3,396,565**

**Registered Mar. 11, 2008**

**TRADEMARK  
PRINCIPAL REGISTER**

**ANDY GÖTZ**

JEWELMAK, INC. (NEW YORK CORPORATION)  
344 EAST 59TH STREET  
NEW YORK, NY 10022

FOR: JEWELRY, IN CLASS 14 (U.S. CLS. 2, 27, 28  
AND 50).

FIRST USE 8-0-2005; IN COMMERCE 8-0-2005.

THE MARK CONSISTS OF STANDARD CHAR-  
ACTERS WITHOUT CLAIM TO ANY PARTICULAR  
FONT, STYLE, SIZE, OR COLOR.

ANDY GOTZ IDENTIFIES A LIVING INDIVI-  
DUAL WHOSE CONSENT IS OF RECORD.

SN 78-978,496, FILED 12-23-2005.

RICHARD WHITE, EXAMINING ATTORNEY



**Int. Cl.: 41**

**Prior U.S. Cls.: 100, 101, and 107**

**United States Patent and Trademark Office**

**Reg. No. 3,396,566**

**Registered Mar. 11, 2008**

**SERVICE MARK  
PRINCIPAL REGISTER**



SYDA FOUNDATION (NEW YORK NON-PROFIT CORPORATION)  
LEGAL ADMINISTRATION  
371 BRICKMAN ROAD  
SOUTH FALLSBURG, NY 12779

THE NON-LATIN CHARACTERS IN THE MARK TRANSLITERATE TO SRI (DOT UNDER THE 'R'), PRONOUNCED "SHREE" AND THIS MEANS GLORIOUS, AUSPICIOUS, PROSPERITY IN ENGLISH.

FOR: EDUCATIONAL SERVICES, NAMELY, CONDUCTING COURSES, WORKSHOPS, AND OTHER PROGRAMS IN THE FIELD OF SPIRITUAL AND RELIGIOUS DEVELOPMENT , IN CLASS 41 (U.S. CLS. 100, 101 AND 107).

SN 78-978,501, FILED 9-3-2004.

FIRST USE 2-25-2007; IN COMMERCE 2-25-2007.

MICHELLE DUBOIS, EXAMINING ATTORNEY

**Int. Cls.: 41 and 43**

**Prior U.S. Cls.: 100, 101, and 107**

**United States Patent and Trademark Office**

**Reg. No. 3,396,567**

**Registered Mar. 11, 2008**

**SERVICE MARK  
PRINCIPAL REGISTER**

**LUXE VEGAS**

STATION CASINOS, INC. (NEVADA CORPORATION)  
1505 S. PAVILION CENTER DRIVE  
LAS VEGAS, NV 89135

FOR: CASINO SERVICES, AND LIVE ENTERTAINMENT SERVICES, NAMELY, MUSIC, DANCE AND COMIC PERFORMANCES, IN CLASS 41 (U.S. CLS. 100, 101 AND 107).

FIRST USE 2-1-2007; IN COMMERCE 2-1-2007.

FOR: RESORT HOTELS, HOTEL SERVICES, RESTAURANTS, BAR SERVICES, AND COCKTAIL LOUNGES, IN CLASS 43 (U.S. CLS. 100 AND 101).

FIRST USE 2-1-2007; IN COMMERCE 2-1-2007.

THE MARK CONSISTS OF STANDARD CHARACTERS WITHOUT CLAIM TO ANY PARTICULAR FONT, STYLE, SIZE, OR COLOR.

NO CLAIM IS MADE TO THE EXCLUSIVE RIGHT TO USE "VEGAS", APART FROM THE MARK AS SHOWN.

SN 78-978,728, FILED 2-11-2005.

ESTHER BELENKER, EXAMINING ATTORNEY

**Int. Cls.: 21, 25, 28, 35, 41, and 42**

**Prior U.S. Cls.: 2, 13, 22, 23, 29, 30, 33, 38, 39, 40, 50,  
100, 101, 102, and 107**

**Reg. No. 3,396,568**

**United States Patent and Trademark Office**

**Registered Mar. 11, 2008**

**TRADEMARK  
SERVICE MARK  
PRINCIPAL REGISTER**

**MAGIQUEST**

NEW KINGDOMS, LLC (SOUTH CAROLINA  
LTD LIAB CO)  
2411 OAK STREET, SUITE 402  
MYRTLE BEACH, SC 29577

FOR: MUGS, IN CLASS 21 (U.S. CLS. 2, 13, 23, 29,  
30, 33, 40 AND 50).

FIRST USE 8-0-2006; IN COMMERCE 8-0-2006.

FOR: CLOTHING, NAMELY, TOPS, SHIRTS, T-  
SHIRTS, CAPES, PULLOVERS, BELTS, COSTUMES  
FOR HALLOWEEN, MASQUERADE AND FOR USE  
IN ROLE-PLAYING; AND HEADWEAR, IN CLASS  
25 (U.S. CLS. 22 AND 39).

FIRST USE 6-0-2005; IN COMMERCE 6-0-2005.

FOR: TOYS AND PLAYTHINGS, NAMELY,  
WANDS AND DECORATIVE TOPPERS FOR  
WANDS, PLUSH TOY ANIMALS AND ACCESSOR-  
IES THEREFOR; CHRISTMAS TREE ORNAMENTS;  
GAME PIECES, NAMELY, TOY WANDS, TOY  
COMPASSES, TOY KEYS AND DECORATIVE TOP-  
PERS FOR WANDS, AND OTHER FANTASY OR  
ADVENTURE ITEMS THAT INTERFACE WITH  
LIVE, INTERACTIVE GAMES, NAMELY, HAND-  
HELD TOY WEAPONS; GAME PIECES, NAMELY,  
CHIPS FEATURING RUNES, IN CLASS 28 (U.S. CLS.  
22, 23, 38 AND 50).

FIRST USE 6-0-2005; IN COMMERCE 6-0-2005.

FOR: RETAIL STORE SERVICES, CATALOG SER-  
VICES AND ON-LINE RETAIL SERVICES ALL  
FEATURING FANTASY OR ADVENTURE ITEMS  
FOR USE IN LIVE, INTERACTIVE ELECTRONIC  
GAMES; BUSINESS DEVELOPMENT SERVICES,  
NAMELY, PROVIDING START-UP SUPPORT FOR  
RETAIL ENTERTAINMENT FACILITIES FOR OTH-  
ERS, IN CLASS 35 (U.S. CLS. 100, 101 AND 102).

FIRST USE 6-0-2005; IN COMMERCE 6-0-2005.

FOR: CHILDREN'S ENTERTAINMENT AND  
AMUSEMENT CENTERS, NAMELY, INTERACTIVE  
PLAY AREAS, AMUSEMENT AND THEME PARK  
SERVICES, ARCADE SERVICE, IN CLASS 41 (U.S.  
CLS. 100, 101 AND 107).

FIRST USE 6-0-2005; IN COMMERCE 6-0-2005.

FOR: DESIGN OF RETAIL ENTERTAINMENT  
FACILITIES FOR OTHERS, IN CLASS 42 (U.S. CLS.  
100 AND 101).

FIRST USE 7-0-2005; IN COMMERCE 7-0-2005.

THE MARK CONSISTS OF STANDARD CHAR-  
ACTERS WITHOUT CLAIM TO ANY PARTICULAR  
FONT, STYLE, SIZE, OR COLOR.

SN 78-978,851, FILED 10-20-2004.

JENNIFER MARTIN, EXAMINING ATTORNEY

**Int. Cl.: 28**

**Prior U.S. Cls.: 22, 23, 38, and 50**

**United States Patent and Trademark Office**

**Reg. No. 3,396,569**

**Registered Mar. 11, 2008**

**TRADEMARK  
PRINCIPAL REGISTER**



GIDDY GOOSE 'N GANDER GAMES, LLC (NEW JERSEY LTD LIAB CO)  
4 SPRING HILL ROAD  
ANNANDALE, NJ 08801

FOR: BOARD GAMES, IN CLASS 28 (U.S. CLS. 22, 23, 38 AND 50).

FIRST USE 2-12-2006; IN COMMERCE 2-12-2006.

THE COLOR(S) BLACK, RED AND GRAY IS/ARE CLAIMED AS A FEATURE OF THE MARK.

THE MARK CONSISTS OF THE STYLIZED LETTERS PIRATAACK WITH THE LETTER "T" IN THE

FORM OF A DAGGER AND AN OCEAN WAVE. THE COLOR BLACK APPEARS IN THE UPPER PART OF THE LETTERS, THE HILT AND UPPER BLADE OF THE DAGGER AND IN THE OCEAN WAVE BACKGROUND BEHIND THE LOWER PART OF THE LETTERS AND DAGGER BLADE. THE COLOR RED APPEARS IN THE LOWER PART OF THE LETTERS. THE COLOR GRAY APPEARS IN THE LOWER PART OF THE DAGGER BLADE.

SN 78-979,132, FILED 2-7-2006.

GIANCARLO CASTRO, EXAMINING ATTORNEY

**Int. Cl.: 1**

**Prior U.S. Cls.: 1, 5, 6, 10, 26, and 46**

**Reg. No. 3,396,570**

**United States Patent and Trademark Office**

**Registered Mar. 11, 2008**

---

**TRADEMARK  
PRINCIPAL REGISTER**

**ZOOM**

HOWARD JOHNSON'S ENTERPRISES, INC.  
(MISSOURI CORPORATION)  
700 WEST VIRGINIA STREET SUITE 222  
MILWAUKEE, WI 53204

FOR: FERTILIZERS, IN CLASS 1 (U.S. CLS. 1, 5, 6,  
10, 26 AND 46).

FIRST USE 4-13-2005; IN COMMERCE 4-13-2005.

THE MARK CONSISTS OF STANDARD CHAR-  
ACTERS WITHOUT CLAIM TO ANY PARTICULAR  
FONT, STYLE, SIZE, OR COLOR.

SN 78-979,303, FILED 12-23-2004.

KARANENDRA S. CHHINA, EXAMINING ATTOR-  
NEY

**Int. Cls.: 16, 25, and 30**

**Prior U.S. Cls.: 2, 5, 22, 23, 29, 37, 38, 39, 46, and 50**

**United States Patent and Trademark Office**

**Reg. No. 3,396,571**

**Registered Mar. 11, 2008**

**TRADEMARK  
PRINCIPAL REGISTER**



CEC ENTERTAINMENT CONCEPTS, L.P.  
(TEXAS LIMITED PARTNERSHIP)  
4441 WEST AIRPORT FREEWAY  
IRVING, TX 75062

FOR: PAPER GOODS AND PRINTED MATTER,  
NAMELY, CHILDREN'S ACTIVITY BOOKS, PEN  
AND PENCIL CASES, COMIC BOOKS, CRAYONS,  
PAPER PARTY DECORATIONS, IN CLASS 16 (U.S.  
CLS. 2, 5, 22, 23, 29, 37, 38 AND 50).

FIRST USE 12-13-2004; IN COMMERCE 12-13-2004.

FOR: CLOTHING, NAMELY, HATS, IN CLASS 25  
(U.S. CLS. 22 AND 39).

FIRST USE 12-13-2004; IN COMMERCE 12-13-2004.

FOR: PIZZA, SANDWICHES, COMBINATION  
MEALS CONSISTING PRIMARILY OF PIZZA  
AND/OR SANDWICHES WITH SALAD AND/OR  
SOFT DRINKS FOR CONSUMPTION ON THE PRE-  
MISES AND CANDY, IN CLASS 30 (U.S. CL. 46).

FIRST USE 12-13-2004; IN COMMERCE 12-13-2004.

OWNER OF U.S. REG. NOS. 1,203,974, 2,426,647,  
AND OTHERS.

SN 78-979,485, FILED 12-13-2004.

JASON BLAIR, EXAMINING ATTORNEY

**Int. Cl.: 41**

**Prior U.S. Cls.: 100, 101, and 107**

**United States Patent and Trademark Office**

**Reg. No. 3,396,572**

**Registered Mar. 11, 2008**

**SERVICE MARK  
PRINCIPAL REGISTER**

**GAMEDAY**

GAMEDAY BASEBALL, LLC (TENNESSEE LTD  
LIAB CO)  
7800 FISCHER STEEL ROAD  
CORDOVA, TN 38018

FOR: INSTRUCTION IN THE FIELD OF SPORTS;  
OPERATION OF SPORTS CAMPS; ORGANIZING  
COMMUNITY SPORTING AND CULTURAL  
EVENTS; PROVIDING FACILITIES FOR SPORTS  
TOURNAMENTS; PROVIDING VARIOUS FACIL-  
ITIES FOR AN ARRAY OF SPORTING EVENTS,  
SPORTS AND ATHLETIC COMPETITIONS AND

AWARDS PROGRAMMES; SPORT CAMPS, IN  
CLASS 41 (U.S. CLS. 100, 101 AND 107).

FIRST USE 10-14-2006; IN COMMERCE 10-14-2006.

THE MARK CONSISTS OF STANDARD CHAR-  
ACTERS WITHOUT CLAIM TO ANY PARTICULAR  
FONT, STYLE, SIZE, OR COLOR.

SN 78-979,503, FILED 12-21-2005.

DEZMONA MIZELLE, EXAMINING ATTORNEY

**Int. Cl.: 9**

**Prior U.S. Cls.: 21, 23, 26, 36, and 38**

**Reg. No. 3,396,573**

**United States Patent and Trademark Office**

**Registered Mar. 11, 2008**

**TRADEMARK  
PRINCIPAL REGISTER**

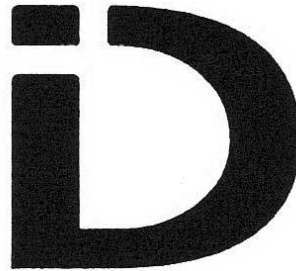

**DIGISCOPING**

NIKON CORPORATION (JAPAN CORPORATION)  
2-3, MARUNOUCHI 3-CHOME, CHIYODA-KU  
TOKYO, JAPAN 100

FOR: OPTICAL APPARATUS AND INSTRUMENTS, NAMELY, EYEPIECES FOR TELESCOPES, MICROSCOPES AND ATTACHMENTS CONNECTED TO A DIGITAL CAMERA, NAMELY, CAMERA LENS MOUNTS AND ADAPTORS, IN CLASS 9 (U.S. CLS. 21, 23, 26, 36 AND 38).

FIRST USE 6-25-2006; IN COMMERCE 6-25-2006.

NO CLAIM IS MADE TO THE EXCLUSIVE RIGHT TO USE "DIGISCOPING", APART FROM THE MARK AS SHOWN.

THE MARK CONSISTS OF A STYLIZED VERSION OF "ID DIGISCOPING".

SN 78-979,518, FILED 10-22-2004.

STEVEN PEREZ, EXAMINING ATTORNEY



**Int. Cl.: 35**

**Prior U.S. Cls.: 100, 101, and 102**

**United States Patent and Trademark Office**

**Reg. No. 3,396,574**

**Registered Mar. 11, 2008**

**SERVICE MARK  
PRINCIPAL REGISTER**

**TETRIS**

TETRIS HOLDING LLC (DELAWARE LTD LIAB  
CO)  
1209 ORANGE STREET  
WILMINGTON, DE 19801

FOR: COMPUTERIZED ON-LINE RETAIL STORE  
SERVICES IN THE FIELD OF COMPUTER AND  
VIDEO GAMES; PROMOTING THE GOODS AND  
SERVICES OF OTHERS BY MEANS OF OPERAT-  
ING AN ON-LINE SHOPPING MALL WITH LINKS  
TO THE RETAIL WEB SITES OF OTHERS; PRO-  
MOTING THE GOODS AND SERVICES OF OTHERS  
THROUGH ON-LINE ORDERING AND CATALO-  
GING OF THOSE GOODS AND SERVICES; PRO-  
VIDING AN ON-LINE COMPUTER DATABASE  
FEATURING TRADE INFORMATION IN THE

FIELD OF COMPUTER AND VIDEO GAMES, IN  
CLASS 35 (U.S. CLS. 100, 101 AND 102).

FIRST USE 6-2-1989; IN COMMERCE 2-22-2007.

THE MARK CONSISTS OF STANDARD CHAR-  
ACTERS WITHOUT CLAIM TO ANY PARTICULAR  
FONT, STYLE, SIZE, OR COLOR.

OWNER OF U.S. REG. NOS. 1,657,499, 2,362,238,  
AND 2,362,250.

SN 78-979,550, FILED 2-10-2006.

MATTHEW PAPPAS, EXAMINING ATTORNEY

**Int. Cl.: 16**

**Prior U.S. Cls.: 2, 5, 22, 23, 29, 37, 38, and 50**

**United States Patent and Trademark Office**

**Reg. No. 3,396,575**

**Registered Mar. 11, 2008**

**TRADEMARK  
PRINCIPAL REGISTER**

**MEMORY BOUTIQUE**

COLORBÖK INC. (MICHIGAN CORPORATION)  
2716 BAKER ROAD  
DEXTER, MI 48130

FOR: SCRAPBOOK ALBUMS; CHIPBOARD PAPER, CARDSTOCK, PAPER SHEETS FOR NOTE TAKING, USE IN SCRAPBOOK ALBUMS AND USE IN PHOTOGRAPH ALBUMS; VELLUM, TEXTURED, CARDSTOCK, PRINTED PAPERS FOR USE IN CREATING PHOTO ALBUMS AND SCRAPBOOKS ALBUMS; PAPER DIE CUTS IN VARIOUS SHAPES, SIZES AND COLORS FOR USE IN THE ARTS AND CRAFTS INDUSTRY; PAPER STICKERS; PHOTO AND SCRAPBOOK ALBUM THEME KITS CONSISTING OF NAMELY, CRAFT PAPER, VELLUM PAPER, TEXTURED PAPER, DRAWING PAPER, BORDER TRIM IN THE NATURE OF CRAFT PAPER, VELLUM PAPER, TEXTURED PAPER, DRAWING PAPER, PAPER DIE CUTS IN VARIOUS SHAPES, SIZES AND COLORS FOR USE IN THE ARTS AND CRAFTS INDUSTRY; PAPER STICKERS, PAPER PRINTED WITH DESIGNS, VEL-

LUM PAPER, TEXTURED PAPER, DRAWING PAPER, SHEET PROTECTORS IN THE NATURE OF PROTECTIVE COVERS FOR SHEETS OF PAPER, STICKERS, PAPER AND PRINTED EMBLEMS; PAPER TAGS; DECORATIVE PAPER BORDERS IN THE NATURE OF MATS; PHOTO MOUNTING CORNERS; PHOTOGRAPH AND SCRAP BOOK ALBUM REFILL PAGES; AND ALBUM PAGE PROTECTION SLEEVES IN THE NATURE OF COVERS FOR PAGES, STORAGE POCKETS IN THE NATURE OF FOLDERS, IN CLASS 16 (U.S. CLS. 2, 5, 22, 23, 29, 37, 38 AND 50).

FIRST USE 9-30-2005; IN COMMERCE 3-5-2006.

THE MARK CONSISTS OF STANDARD CHARACTERS WITHOUT CLAIM TO ANY PARTICULAR FONT, STYLE, SIZE, OR COLOR.

SN 78-979,551, FILED 10-10-2005.

LAURA HAMMEL, EXAMINING ATTORNEY

**Int. Cls.: 4, 37, 39, 40, and 42**

**Prior U.S. Cls.: 1, 6, 15, 100, 101, 103, 105, and 106**

**United States Patent and Trademark Office**

**Reg. No. 3,396,576**

**Registered Mar. 11, 2008**

**TRADEMARK  
SERVICE MARK  
PRINCIPAL REGISTER**

**RIO TINTO ENERGY AMERICA**

RIO TINTO PLC (UNITED KINGDOM CORPORATION)  
6 ST. JAMES'S SQUARE  
LONDON, ENGLAND SW1Y 4LD

FOR: FUELS, NAMELY, COAL, IN CLASS 4 (U.S. CLS. 1, 6 AND 15).

FIRST USE 6-0-2006; IN COMMERCE 6-0-2006.

FOR: MINING EXTRACTION, IN CLASS 37 (U.S. CLS. 100, 103 AND 106).

FIRST USE 6-0-2006; IN COMMERCE 6-0-2006.

FOR: TRANSPORTATION, STORAGE AND DELIVERY OF COAL AND COAL BLENDS, IN CLASS 39 (U.S. CLS. 100 AND 105).

FIRST USE 6-0-2006; IN COMMERCE 6-0-2006.

FOR: BLENDING OF COAL; PRODUCTION OF COAL AND COAL BY-PRODUCTS, IN CLASS 40 (U.S. CLS. 100, 103 AND 106).

FIRST USE 6-0-2006; IN COMMERCE 6-0-2006.

FOR: MINING AND MINERAL EXPLORATION SERVICES, IN CLASS 42 (U.S. CLS. 100 AND 101).

FIRST USE 6-0-2006; IN COMMERCE 6-0-2006.

THE MARK CONSISTS OF STANDARD CHARACTERS WITHOUT CLAIM TO ANY PARTICULAR FONT, STYLE, SIZE, OR COLOR.

NO CLAIM IS MADE TO THE EXCLUSIVE RIGHT TO USE "ENERGY AMERICA", APART FROM THE MARK AS SHOWN.

THE ENGLISH TRANSLATION OF THE WORD "RIO TINTO" IN THE MARK IS "RED RIVER".

SN 78-979,552, FILED 4-11-2006.

MICHAEL LEWIS, EXAMINING ATTORNEY

**Int. Cl.: 44**

**Prior U.S. Cls.: 100 and 101**

**United States Patent and Trademark Office**

**Reg. No. 3,396,577**

**Registered Mar. 11, 2008**

**SERVICE MARK  
PRINCIPAL REGISTER**

**INSIGHT TO IMPACT**

NVENTA BIOPHARMACEUTICALS CORPORATION  
(CANADA CORPORATION)  
120-4243 GLANFORD AVENUE  
VICTORIA, CANADA V8Z 4B9

FOR: PROVIDING MEDICAL INFORMATION  
ABOUT CANCER, INFECTIOUS DISEASES AND  
PHARMACEUTICAL PREPARATIONS AND SUB-  
STANCES FOR THE TREATMENT THEREOF , IN  
CLASS 44 (U.S. CLS. 100 AND 101).

FIRST USE 6-1-2006; IN COMMERCE 6-1-2006.

THE MARK CONSISTS OF STANDARD CHAR-  
ACTERS WITHOUT CLAIM TO ANY PARTICULAR  
FONT, STYLE, SIZE, OR COLOR.

SN 78-979,557, FILED 4-25-2006.

DAVID TAYLOR, EXAMINING ATTORNEY

**Int. Cl.: 36**

**Prior U.S. Cls.: 100, 101, and 102**

**United States Patent and Trademark Office**

**Reg. No. 3,396,578**

**Registered Mar. 11, 2008**

**SERVICE MARK  
PRINCIPAL REGISTER**



WYNDHAM TM CORP. (DELAWARE CORPORATION)  
10750 WEST CHARLESTON BLVD., SUITE 130  
LAS VEGAS, NV 89135

FOR: VACATION REAL ESTATE TIME SHARE SERVICES, IN CLASS 36 (U.S. CLS. 100, 101 AND 102).

FIRST USE 12-19-2006; IN COMMERCE 12-19-2006.

OWNER OF U.S. REG. NOS. 2,096,650, 3,043,521, AND OTHERS.

NO CLAIM IS MADE TO THE EXCLUSIVE RIGHT TO USE "VACATION OWNERSHIP", APART FROM THE MARK AS SHOWN.

THE COLOR(S) BLUE, GRAY AND WHITE IS/ ARE CLAIMED AS A FEATURE OF THE MARK.

THE MARK CONSISTS OF A "W" LOGO IN WHITE AGAINST A BLUE BACKGROUND, WITH SHADING ON THE UPPER LEFT HAND CORNER, APPEARING TO THE LEFT OF THE WORD "WYNDHAM" IN THE COLOR BLUE, AND THE WORDS "VACATION OWNERSHIP" IN THE COLOR GRAY.

SN 78-979,565, FILED 8-28-2006.

DARRYL SPRUILL, EXAMINING ATTORNEY

**Int. Cls.: 9 and 41**

**Prior U.S. Cls.: 21, 23, 26, 36, 38, 100, 101, and 107**

**United States Patent and Trademark Office**

**Reg. No. 3,396,579**

**Registered Mar. 11, 2008**

**TRADEMARK  
SERVICE MARK  
PRINCIPAL REGISTER**

**PAPA JOE RECORDS**

JT RECORDS, C/O DAVID LEVIN CPA, ESQ.  
DAVID LEVIN BUSINESS MANAGEMENT &  
ACCOUNTING (CALIFORNIA CORPORATION)  
200 WEST 57TH STREET, SUITE 308  
NEW YORK, NY 10019

FOR: AUDIO RECORDINGS FEATURING MUSIC; PHONOGRAPH RECORDS FEATURING MUSIC; PRE-RECORDED AUDIO CASSETTES AND COMPACT DISC FEATURING MUSIC; DIGITAL VERSATILE DISCS FEATURING MUSIC; PRE-RECORDED VIDEO TAPES FEATURING MUSICAL PERFORMANCES; MUSICAL SOUND RECORDINGS, IN CLASS 9 (U.S. CLS. 21, 23, 26, 36 AND 38).

FIRST USE 8-0-2005; IN COMMERCE 8-0-2005.

FOR: AUDIO RECORDING AND PRODUCTION; DUBBING SERVICES; ENTERTAINMENT IN THE NATURE OF LIVE PERFORMANCES BY A MUSICAL ARTIST, MUSICAL BAND AND MUSICAL GROUP; ENTERTAINMENT IN THE NATURE OF LIVE VISUAL AND AUDIO PERFORMANCES BY A MUSICAL ARTIST, MUSICAL BAND AND MUSICAL GROUP; ENTERTAINMENT, NAMELY, LIVE MUSIC CONCERTS; ENTERTAINMENT, NAMELY, PERSONAL APPEARANCES BY A MUSICAL ARTIST, MUSICAL BAND AND MUSICAL GROUP; ENTERTAINMENT SERVICES, NAMELY, PROVIDING A WEB SITE FEATURING MUSICAL PERFORMANCES, MUSICAL VIDEOS, RELATED FILM CLIPS, PHOTOGRAPHS, AND OTHER MULTIMEDIA MATERIALS; ENTERTAINMENT SERVICES, NAMELY, PROVIDING PRE-RECORDED MUSIC,

INFORMATION IN THE FIELD OF MUSIC, COMMENTARY AND ARTICLES ABOUT MUSIC, ALL ONLINE VIA A GLOBAL COMPUTER NETWORK FAN CLUBS; MUSIC COMPOSITION FOR OTHERS; MUSIC PRODUCTION SERVICES; MUSIC PUBLISHING SERVICES; PRESENTATION OF LIVE SHOW PERFORMANCES; PRESENTATION OF MUSICAL PERFORMANCES; PRODUCTION OF MUSICAL AUDIO AND VIDEO RECORDINGS; PRODUCTION OF RADIO AND TELEVISION PROGRAMS; PROVIDING AUDIO OR VIDEO STUDIOS; PUBLICATION OF MUSICAL TEXTS; RADIO ENTERTAINMENT PRODUCTION; RECORD PRODUCTION; RECORDING STUDIOS; SOUND RECORDING STUDIOS, IN CLASS 41 (U.S. CLS. 100, 101 AND 107).

FIRST USE 8-0-2005; IN COMMERCE 8-0-2005.

THE MARK CONSISTS OF STANDARD CHARACTERS WITHOUT CLAIM TO ANY PARTICULAR FONT, STYLE, SIZE, OR COLOR.

NO CLAIM IS MADE TO THE EXCLUSIVE RIGHT TO USE "RECORDS", APART FROM THE MARK AS SHOWN.

THE NAME PAPA JOE IDENTIFIES A LIVING INDIVIDUAL WHOSE CONSENT IS OF RECORD.

SN 78-979,567, FILED 8-18-2005.

SAMUEL E. SHARPER JR., EXAMINING ATTORNEY

**Int. Cls.: 20, 35, and 40**

**Prior U.S. Cls.: 2, 13, 22, 25, 32, 50, 100, 101, 102, 103,  
and 106**

**Reg. No. 3,396,580**

**United States Patent and Trademark Office**

**Registered Mar. 11, 2008**

**TRADEMARK  
SERVICE MARK  
PRINCIPAL REGISTER**

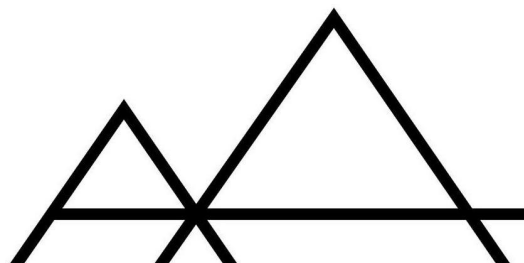

WILLIAM SWITZER & ASSOCIATES LTD. (CANADA CORPORATION)  
#6 - 611 ALEXANDER STREET  
VANCOUVER, CANADA V6E 1A1

FOR: FURNITURE, NAMELY, BEDROOM FURNITURE, DINING ROOM FURNITURE, LIVING ROOM FURNITURE, OFFICE FURNITURE, OUTDOOR FURNITURE, FURNITURE HARDWARE AND PARTS, IN CLASS 20 (U.S. CLS. 2, 13, 22, 25, 32 AND 50).

FIRST USE 2-28-2006; IN COMMERCE 2-28-2006.

FOR: WHOLESALE DISTRIBUTORSHIP FEATURING FURNITURE, FURNITURE HARDWARE

AND PARTS, LIGHTING, LIGHTING FIXTURES AND ACCESSORIES AND CARPETS, IN CLASS 35 (U.S. CLS. 100, 101 AND 102).

FIRST USE 3-31-2005; IN COMMERCE 3-31-2005.

FOR: CUSTOM MANUFACTURE OF FURNITURE, IN CLASS 40 (U.S. CLS. 100, 103 AND 106).

FIRST USE 3-31-2005; IN COMMERCE 3-31-2005.

SN 78-979,574, FILED 11-4-2005.

GIANCARLO CASTRO, EXAMINING ATTORNEY

Int. Cls.: 9, 18, and 24

Prior U.S. Cls.: 1, 2, 3, 21, 22, 23, 26, 36, 38, 41, 42, and 50

Reg. No. 3,396,581

United States Patent and Trademark Office

Registered Mar. 11, 2008

TRADEMARK  
PRINCIPAL REGISTER



BURCH, LAUREL A. (UNITED STATES INDIVIDUAL)  
122 HAMILTON DRIVE, SUITE F1  
NOVATO, CA 94949

FOR: COMPUTER SOFTWARE FEATURING EMBROIDERY DESIGN PATTERN INFORMATION STORED IN DIGITAL FORMAT FOR ENABLING EMBROIDERY MACHINES TO REPRODUCE EMBROIDERY DESIGNS, IN CLASS 9 (U.S. CLS. 21, 23, 26, 36 AND 38).

FIRST USE 12-0-2002; IN COMMERCE 12-0-2002.

FOR: WALLET, PURSES, HANDBAGS, MAKE-UP BAGS SOLD EMPTY, TOTE BAGS, COSMETIC

BAGS SOLD EMPTY, SHOULDER BAGS, IN CLASS 18 (U.S. CLS. 1, 2, 3, 22 AND 41).

FIRST USE 12-0-1998; IN COMMERCE 12-0-1998.

FOR: PATTERNED FABRICS MADE OF COTTON, IN CLASS 24 (U.S. CLS. 42 AND 50).

FIRST USE 12-0-2003; IN COMMERCE 12-0-2003.

OWNER OF U.S. REG. NO. 1,401,123.

SN 78-979,581, FILED 5-20-2005.

CHRISTOPHER BUONGIORNO, EXAMINING ATTORNEY



**Int. Cl.: 20**

**Prior U.S. Cls.: 2, 13, 22, 25, 32, and 50**

**Reg. No. 3,396,582**

**United States Patent and Trademark Office**

**Registered Mar. 11, 2008**

---

**TRADEMARK  
PRINCIPAL REGISTER**

**DISNEY PRINCESS**

DISNEY ENTERPRISES, INC. (DELAWARE CORPORATION)  
500 SOUTH BUENA VISTA STREET  
BURBANK, CA 91521

FOR: BEDS; CHAIRS; FURNITURE; MIRRORS;  
PILLOWS; SLEEPING BAGS, IN CLASS 20 (U.S. CLS.  
2, 13, 22, 25, 32 AND 50).

FIRST USE 9-0-2007; IN COMMERCE 9-0-2007.

THE MARK CONSISTS OF STANDARD CHARACTERS WITHOUT CLAIM TO ANY PARTICULAR FONT, STYLE, SIZE, OR COLOR.

OWNER OF U.S. REG. NOS. 1,037,788, 3,045,495,  
AND OTHERS.

SN 78-979,584, FILED 10-31-2005.

BRIDGETT SMITH, EXAMINING ATTORNEY

**Int. Cl.: 24**

**Prior U.S. Cls.: 42 and 50**

**United States Patent and Trademark Office**

**Reg. No. 3,396,583**

**Registered Mar. 11, 2008**

**TRADEMARK  
PRINCIPAL REGISTER**

**MicroMink**

WP IP, LLC (NEVADA LTD LIAB CO)  
28 EAST 28TH STREET  
8TH FLOOR  
NEW YORK, NY 10016

THE MARK CONSISTS OF STANDARD CHAR-  
ACTERS WITHOUT CLAIM TO ANY PARTICULAR  
FONT, STYLE, SIZE, OR COLOR.

FOR: BED BLANKETS AND THROW BLANKETS,  
IN CLASS 24 (U.S. CLS. 42 AND 50).

SN 78-979,589, FILED 12-12-2005.

FIRST USE 5-0-2006; IN COMMERCE 5-0-2006.

REBECCA SMITH, EXAMINING ATTORNEY

**Int. Cl.: 25**

**Prior U.S. Cls.: 22 and 39**

**United States Patent and Trademark Office**

**Reg. No. 3,396,584**

**Registered Mar. 11, 2008**

**TRADEMARK  
PRINCIPAL REGISTER**

**LIFETIME NETWORKS**

LIFETIME ENTERTAINMENT SERVICES (NEW  
YORK JOINT VENTURE)  
309 WEST 49TH STREET 16TH FLOOR  
NEW YORK, NY 10019

FOR: CLOTHING, NAMELY, SHIRTS, T-SHIRTS,  
IN CLASS 25 (U.S. CLS. 22 AND 39).

FIRST USE 10-31-2006; IN COMMERCE 10-31-2006.

THE MARK CONSISTS OF STANDARD CHAR-  
ACTERS WITHOUT CLAIM TO ANY PARTICULAR  
FONT, STYLE, SIZE, OR COLOR.

OWNER OF U.S. REG. NOS. 1,450,063, 2,830,659,  
AND OTHERS.

SN 78-979,612, FILED 12-9-2005.

STEVEN PEREZ, EXAMINING ATTORNEY

Int. Cls.: 16, 20, 21, and 25

Prior U.S. Cls.: 2, 5, 13, 22, 23, 25, 29, 30, 32, 33, 37,  
38, 39, 40, and 50

Reg. No. 3,396,585

United States Patent and Trademark Office

Registered Mar. 11, 2008

TRADEMARK  
PRINCIPAL REGISTER

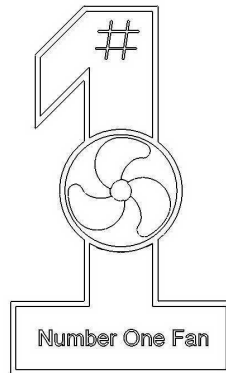

UPSHIFT DESIGN, LLC (NORTH CAROLINA  
LTD LIAB CO)  
2909 BELLS POINTE CT.  
APEX, NC 27539

FOR: PEN OR PENCIL HOLDERS, IN CLASS 16  
(U.S. CLS. 2, 5, 22, 23, 29, 37, 38 AND 50).

FIRST USE 10-25-2007; IN COMMERCE 10-25-2007.

FOR: PLASTIC KEY FOBS; PLASTIC NOVELTY  
LICENSE PLATES; PICTURE FRAMES NOT OF  
PRECIOUS METAL, IN CLASS 20 (U.S. CLS. 2, 13,  
22, 25, 32 AND 50).

FIRST USE 10-25-2007; IN COMMERCE 10-25-2007.

FOR: MUGS; CUPS; INSULATING SLEEVE  
HOLDERS FOR BEVERAGE CANS, IN CLASS 21  
(U.S. CLS. 2, 13, 23, 29, 30, 33, 40 AND 50).

FIRST USE 10-25-2007; IN COMMERCE 10-25-2007.

FOR: CLOTHING, NAMELY, T-SHIRTS, SHIRTS,  
SWEAT SHIRTS, BALL CAPS, IN CLASS 25 (U.S. CLS.  
22 AND 39).

FIRST USE 10-25-2007; IN COMMERCE 10-25-2007.

SN 78-979,613, FILED 9-23-2004.

JANICE L. MCMORROW, EXAMINING ATTOR-  
NEY

Int. Cl.: 10

Prior U.S. Cls.: 26, 39, and 44

United States Patent and Trademark Office

Reg. No. 3,396,586

Registered Mar. 11, 2008

**TRADEMARK  
PRINCIPAL REGISTER**

**MOVING REHABILITATION  
FORWARD**

ENCORE MEDICAL ASSET CORPORATION (NE-  
VADA CORPORATION)  
PO BOX 530759  
HENDERSON, NV 890530759

FOR: MEDICAL, REHABILITATION AND CHIRO-  
PRACTIC EQUIPMENT, NAMELY, THERAPEU-  
TIC DIATHERMY AND MULTIPLE FREQUENCY  
STIMULATORS USED TO STIMULATE NERVES,  
MUSCLE AND SKIN, NEUROMUSCULAR ELEC-  
TRICAL STIMULATORS, TRANSCUTANEOUS  
ELECTRICAL STIMULATORS, ULTRASONIC STI-  
MULATORS USED TO STIMULATE NERVES, MUS-  
CLE AND SKIN, ELECTROMYOGRAPHS FOR  
MEDICAL ELECTRODIAGNOSIS OF MUSCULAR  
ACTIVITY, BIOFEEDBACK MONITORS FOR MEA-  
SURING MUSCLE STRENGTH, PERFORMANCE  
AND RANGE OF MOTION, FLUID BED THERA-  
PEUTIC TREATMENT DEVICES USED TO TREAT

PAIN ARISING OUT OF INJURY OR ARTHRITIS,  
TABLES USED FOR MASSAGE THERAPY, TRAC-  
TION AND OTHER MEDICAL AND REHABILITA-  
TIVE USES, TRACTION APPLYING DEVICES,  
LASER THERAPY DEVICES, TILT TABLES, DEVI-  
CES FOR TREATING DYSPHAGIA, IN CLASS 10  
(U.S. CLS. 26, 39 AND 44).

FIRST USE 10-23-2006; IN COMMERCE 11-20-2006.

THE MARK CONSISTS OF STANDARD CHAR-  
ACTERS WITHOUT CLAIM TO ANY PARTICULAR  
FONT, STYLE, SIZE, OR COLOR.

SN 78-979,614, FILED 11-12-2005.

KELLY BOULTON, EXAMINING ATTORNEY

**Int. Cls.: 5, 29, and 30**

**Prior U.S. Cls.: 6, 18, 44, 46, 51, and 52**

**United States Patent and Trademark Office**

**Reg. No. 3,396,587**

**Registered Mar. 11, 2008**

**TRADEMARK  
PRINCIPAL REGISTER**

**STEADY NUTRITION FOR A  
WOBBLY WORLD**

SOCIETE DES PRODUITS NESTLE, S.A. (SWITZERLAND CORPORATION)  
CASE POSTALE 353  
1800 VEVEY, SWITZERLAND

FOR: BABY FOOD, IN CLASS 5 (U.S. CLS. 6, 18, 44, 46, 51 AND 52).

FIRST USE 2-0-2007; IN COMMERCE 2-0-2007.

FOR: PREPARED ENTREES CONSISTING OF MEAT, POULTRY, VEGETABLES, CHEESE, AND FRUIT; FREEZE-DRIED FRUITS AND VEGETABLES; YOGURT, IN CLASS 29 (U.S. CL. 46).

FIRST USE 2-0-2007; IN COMMERCE 2-0-2007.

FOR: PREPARED ENTREES CONSISTING PRIMARILY OF PASTA WITH MEAT SAUCE, PASTA AND SAUCE; PROCESSED CEREAL; BAKERY PRODUCTS, IN CLASS 30 (U.S. CL. 46).

FIRST USE 2-0-2007; IN COMMERCE 2-0-2007.

THE MARK CONSISTS OF STANDARD CHARACTERS WITHOUT CLAIM TO ANY PARTICULAR FONT, STYLE, SIZE, OR COLOR.

SN 78-979,617, FILED 7-18-2006.

MARY CRAWFORD, EXAMINING ATTORNEY

**Int. Cl.: 30**

**Prior U.S. Cl.: 46**

**United States Patent and Trademark Office**

**Reg. No. 3,396,588**

**Registered Mar. 11, 2008**

**TRADEMARK  
PRINCIPAL REGISTER**

**TODAY'S CHOICE**

GIORGIFRED COMPANY (DELAWARE COR-  
PORATION)  
SUITE 1414  
NEMOURS BUILDING 1007 ORANGE STREET  
WILMINGTON, DE 19801

FOR: PIZZA PRODUCTS, NAMELY, PIZZA, IN  
CLASS 30 (U.S. CL. 46).

FIRST USE 2-2-2006; IN COMMERCE 2-2-2006.

THE MARK CONSISTS OF STANDARD CHAR-  
ACTERS WITHOUT CLAIM TO ANY PARTICULAR  
FONT, STYLE, SIZE, OR COLOR.

OWNER OF U.S. REG. NO. 2,406,524.

SN 78-979,633, FILED 2-21-2006.

DAVID H. STINE, EXAMINING ATTORNEY

**Int. Cl.: 29**

**Prior U.S. Cl.: 46**

**United States Patent and Trademark Office**

**Reg. No. 3,396,589**

**Registered Mar. 11, 2008**

**TRADEMARK  
PRINCIPAL REGISTER**

**CHOBANI**

AGRO-FARMA, INC. (NEW YORK CORPORATION)  
230 ENTERPRISE ROAD  
JOHNSTOWN, NY 12095

FOR: DAIRY PRODUCTS, NAMELY, GREEK YOGURT, AND YOGURT, IN CLASS 29 (U.S. CL. 46).

FIRST USE 8-0-2007; IN COMMERCE 8-0-2007.

THE MARK CONSISTS OF STANDARD CHARACTERS WITHOUT CLAIM TO ANY PARTICULAR FONT, STYLE, SIZE, OR COLOR.

THE FOREIGN WORDING IN THE MARK TRANSLATES INTO ENGLISH AS SHEPHERD.

SN 78-979,645, FILED 6-15-2006.

AMY HELLA, EXAMINING ATTORNEY



**Int. Cl.: 41**

**Prior U.S. Cls.: 100, 101, and 107**

**United States Patent and Trademark Office**

**Reg. No. 3,396,590**

**Registered Mar. 11, 2008**

**SERVICE MARK  
PRINCIPAL REGISTER**

**BECAUSE CHANGE IS NOT AN  
OPTION**

HUTHWAITE, INC. (DELAWARE CORPORATION)  
SUITE 100  
22630 DAVIS DRIVE  
STERLING, VA 20164

FOR: EDUCATIONAL SERVICES, NAMELY, PROVIDING WORKSHOPS AND SEMINARS IN THE FIELD OF SALES TECHNIQUES AND STRATEGIES; PROVIDING ON-LINE PUBLICATIONS IN THE NATURE OF NEWSLETTERS, WHITE PAPERS AND ARTICLES IN THE FIELDS OF SALES TRAINING SKILLS DEVELOPMENT AND SALES AND

CHANGE MANAGEMENT CONSULTING, IN CLASS 41 (U.S. CLS. 100, 101 AND 107).

FIRST USE 7-2-2006; IN COMMERCE 7-2-2006.

THE MARK CONSISTS OF STANDARD CHARACTERS WITHOUT CLAIM TO ANY PARTICULAR FONT, STYLE, SIZE, OR COLOR.

SN 78-979,652, FILED 5-30-2006.

SHAILA SETTLES, EXAMINING ATTORNEY

Int. Cl.: 16

Prior U.S. Cls.: 2, 5, 22, 23, 29, 37, 38, and 50

United States Patent and Trademark Office

Reg. No. 3,396,591

Registered Mar. 11, 2008

TRADEMARK  
SUPPLEMENTAL REGISTER

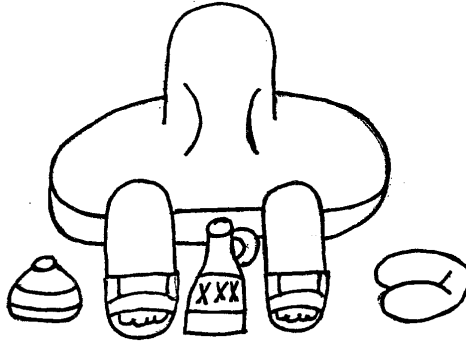

JOHNSON, LORRAINE M. (UNITED STATES  
INDIVIDUAL)  
707 WHITLOCK AVENUE, SW SUITE C-27  
MARIETTA, GA 30064

FIRST USE 2-6-2007; IN COMMERCE 2-6-2007.

SER. NO. 76-536,781, FILED P.R. 7-22-2003; AM. S.R.  
12-21-2007.

FOR: ART PICTURES AND ART PRINTS, IN  
CLASS 16 (U.S. CLS. 2, 5, 22, 23, 29, 37, 38 AND 50).

MICHAEL SOUDERS, EXAMINING ATTORNEY

**Int. Cl.: 9**

**Prior U.S. Cls.: 21, 23, 26, 36, and 38**

**United States Patent and Trademark Office**

**Reg. No. 3,396,592**

**Registered Mar. 11, 2008**

**TRADEMARK  
SUPPLEMENTAL REGISTER**

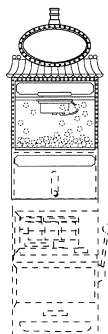

ATLANTIC CITY COIN & SLOT SERVICE COMPANY, INC. (NEW JERSEY CORPORATION)  
201 WEST DECATUR AVENUE  
PLEASANTVILLE, NJ 08232

FOR: GAMING MACHINES, NAMELY, SLOT MACHINES WITH OR WITHOUT A VIDEO OUTPUT AND CONVERSION KITS COMPRISED OF REPLACEMENT GLASS AND REEL STRIPS FOR SLOT MACHINES, IN CLASS 9 (U.S. CLS. 21, 23, 26, 36 AND 38).

FIRST USE 9-0-2003; IN COMMERCE 9-0-2003.

THE MARK COMPRISES A THREE-DIMENSIONAL CLEAR CONTAINER IN THE SHAPE OF A POPCORN MACHINE AFFIXED TO THE TOP OF A SLOT MACHINE. THE DOTTED LINES ARE NOT PART OF THE MARK BUT MERELY INDICATE THE ABOVE-MENTIONED SLOT MACHINE AND THE BALLS INSIDE THE CONTAINER.

SER. NO. 76-568,755, FILED P.R. 12-29-2003; AM. S.R. 12-3-2007.

PAULA MAYS, EXAMINING ATTORNEY

Int. Cl.: 9

Prior U.S. Cls.: 21, 23, 26, 36, and 38

United States Patent and Trademark Office

Reg. No. 3,396,593

Registered Mar. 11, 2008

**TRADEMARK  
SUPPLEMENTAL REGISTER**

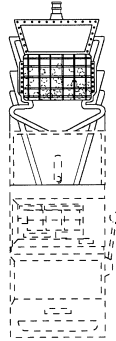

ATLANTIC CITY COIN & SLOT SERVICE COMPANY, INC. (NEW JERSEY CORPORATION)  
201 WEST DECATUR AVENUE  
PLEASANTVILLE, NJ 08232

FOR: GAMING MACHINES, NAMELY, SLOT MACHINES WITH OR WITHOUT A VIDEO OUTPUT AND CONVERSION KITS COMPRISED OF REPLACEMENT GLASS AND REEL STRIPS FOR SLOT MACHINES, IN CLASS 9 (U.S. CLS. 21, 23, 26, 36 AND 38).

FIRST USE 9-0-2003; IN COMMERCE 9-0-2003.

THE MARK COMPRISES A THREE-DIMENSIONAL CLEAR CONTAINER IN THE SHAPE OF A BINGO TUMBLER AFFIXED TO THE TOP OF A SLOT MACHINE. THE DOTTED LINES ARE NOT PART OF THE MARK BUT MERELY INDICATE THE ABOVE-MENTIONED SLOT MACHINE AND THE BALLS INSIDE THE CONTAINER.

SER. NO. 76-568,756, FILED P.R. 12-29-2003; AM. S.R. 12-3-2007.

PAULA MAYS, EXAMINING ATTORNEY

Int. Cl.: 9

Prior U.S. Cls.: 21, 23, 26, 36, and 38

United States Patent and Trademark Office

Reg. No. 3,396,594

Registered Mar. 11, 2008

TRADEMARK  
SUPPLEMENTAL REGISTER

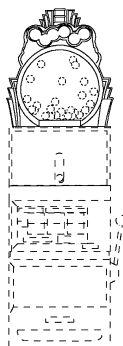

ATLANTIC CITY COIN & SLOT SERVICE COMPANY, INC. (NEW JERSEY CORPORATION)  
201 WEST DECATUR AVENUE  
PLEASANTVILLE, NJ 08232

FOR: GAMING MACHINES, NAMELY, SLOT MACHINES WITH OR WITHOUT A VIDEO OUTPUT AND CONVERSION KITS COMPRISED OF REPLACEMENT GLASS AND REEL STRIPS FOR SLOT MACHINES, IN CLASS 9 (U.S. CLS. 21, 23, 26, 36 AND 38).

FIRST USE 9-0-1999; IN COMMERCE 9-0-1999.

THE MARK COMPRISES A THREE-DIMENSIONAL CLEAR CONTAINER IN THE SHAPE OF A LOTTERY TUMBLER AFFIXED TO THE TOP OF A SLOT MACHINE. THE DOTTED LINES ARE NOT PART OF THE MARK BUT MERELY INDICATE THE ABOVE- MENTIONED SLOT MACHINE AND THE BONUS BALLS INSIDE THE CONTAINER.

SER. NO. 76-568,760, FILED P.R. 12-29-2003; AM. S.R. 12-3-2007.

PAULA MAYS, EXAMINING ATTORNEY

**Int. Cl.: 29**

**Prior U.S. Cl.: 46**

**United States Patent and Trademark Office**

**Reg. No. 3,396,595**

**Registered Mar. 11, 2008**

**TRADEMARK  
SUPPLEMENTAL REGISTER**

**HAND PULLED STYLE**

CAPITOL WHOLESALE MEATS, INC. (ILLINOIS  
CORPORATION)  
911 W. 37TH PLACE  
CHICAGO, IL 60609

FOR: SAUSAGES, IN CLASS 29 (U.S. CL. 46).

FIRST USE 6-0-2006; IN COMMERCE 6-0-2006.

THE MARK CONSISTS OF STANDARD CHAR-  
ACTERS WITHOUT CLAIM TO ANY PARTICULAR  
FONT, STYLE, SIZE, OR COLOR.

SER. NO. 76-657,503, FILED P.R. 3-29-2006; AM. S.R.  
12-26-2007.

TARAH HARDY, EXAMINING ATTORNEY

**Int. Cls.: 25 and 41**

**Prior U.S. Cls.: 22, 39, 100, 101, and 107**

**United States Patent and Trademark Office**

**Reg. No. 3,396,596**

**Registered Mar. 11, 2008**

**TRADEMARK  
SERVICE MARK  
SUPPLEMENTAL REGISTER**

**THE WORLDWIDE OFFICIAL BABY BOOMER EXPO**

MOSS, MARY INEZ BETHEL (UNITED STATES  
INDIVIDUAL)  
5804 JUSTINA DRIVE  
LANHAM, MD 20706

FOR: CLOTHING, NAMELY, T-SHIRTS; CLOTH-  
ING, NAMELY, HATS, IN CLASS 25 (U.S. CLS. 22  
AND 39).

FIRST USE 2-28-2006; IN COMMERCE 2-28-2006.

FOR: ARRANGING OF EXHIBITIONS, SEMI-  
NARS AND CONFERENCES FOR BABY BOOMERS

FROM OVER THE WORLD, IN CLASS 41 (U.S. CLS.  
100, 101 AND 107).

FIRST USE 2-28-2006; IN COMMERCE 2-28-2006.

THE MARK CONSISTS OF STANDARD CHAR-  
ACTERS WITHOUT CLAIM TO ANY PARTICULAR  
FONT, STYLE, SIZE, OR COLOR.

SER. NO. 76-662,369, FILED P.R. 6-29-2006; AM. S.R.  
12-17-2007.

GINA FINK, EXAMINING ATTORNEY

**Int. Cl.: 43**

**Prior U.S. Cls.: 100 and 101**

**United States Patent and Trademark Office**

**Reg. No. 3,396,597**

**Registered Mar. 11, 2008**

**SERVICE MARK  
SUPPLEMENTAL REGISTER**

**VILLA HOTEL**

LANGER, LARRY (UNITED STATES INDIVIDUAL)  
163 BAYBERRY LANE  
WESTPORT, CT 06880

FOR: PRIVATE RESIDENCE CLUB SERVICES, NAMELY, PROVISION TO CLUB MEMBERS OF TEMPORARY ACCOMMODATIONS IN COMPANY OWNED OR LEASED PRIVATE RESIDENCES, NAMELY, LUXURY VACATION PROPERTIES LOCATED WORLDWIDE, IN CLASS 43 (U.S. CLS. 100 AND 101).

FIRST USE 11-1-2004; IN COMMERCE 11-1-2004.

THE MARK CONSISTS OF STANDARD CHARACTERS WITHOUT CLAIM TO ANY PARTICULAR FONT, STYLE, SIZE, OR COLOR.

SER. NO. 76-663,561, FILED P.R. 7-24-2006; AM. S.R. 1-2-2008.

TRACY CROSS, EXAMINING ATTORNEY



**Int. Cl.: 43**

**Prior U.S. Cls.: 100 and 101**

**United States Patent and Trademark Office**

**Reg. No. 3,396,598**

**Registered Mar. 11, 2008**

**SERVICE MARK  
SUPPLEMENTAL REGISTER**

**VILLA RESORT**

LANGER, LARRY (UNITED STATES INDIVIDUAL)  
163 BAYBERRY LANE  
WESTPORT, CT 06880

FOR: PRIVATE RESIDENCE CLUB SERVICES, NAMELY, PROVISION TO CLUB MEMBERS OF TEMPORARY ACCOMMODATIONS IN COMPANY OWNED OR LEASED PRIVATE RESIDENCES, NAMELY, LUXURY VACATION PROPERTIES LOCATED WORLDWIDE, IN CLASS 43 (U.S. CLS. 100 AND 101).

FIRST USE 11-1-2004; IN COMMERCE 11-1-2004.

THE MARK CONSISTS OF STANDARD CHARACTERS WITHOUT CLAIM TO ANY PARTICULAR FONT, STYLE, SIZE, OR COLOR.

SER. NO. 76-663,562, FILED P.R. 7-24-2006; AM. S.R. 1-2-2008.

TRACY CROSS, EXAMINING ATTORNEY

**Int. Cl.: 14**

**Prior U.S. Cls.: 2, 27, 28, and 50**

**United States Patent and Trademark Office**

**Reg. No. 3,396,599**

**Registered Mar. 11, 2008**

**TRADEMARK  
SUPPLEMENTAL REGISTER**

**LOS ANGELES MINT**

HASKIN, TIM (UNITED STATES INDIVIDUAL)  
2900 BUENA VISTA  
BURBANK, CA 91504

THE MARK CONSISTS OF STANDARD CHAR-  
ACTERS WITHOUT CLAIM TO ANY PARTICULAR  
FONT, STYLE, SIZE, OR COLOR.

FOR: COMMERATIVE AND COLLECTIBLE CO-  
INS, IN CLASS 14 (U.S. CLS. 2, 27, 28 AND 50).

SER. NO. 76-665,008, FILED P.R. 8-23-2006; AM. S.R.  
8-17-2007.

FIRST USE 12-3-2000; IN COMMERCE 12-3-2000.

JULIE GUTTADAURO, EXAMINING ATTORNEY

**Int. Cl.: 35**

**Prior U.S. Cls.: 100, 101, and 102**

**United States Patent and Trademark Office**

**Reg. No. 3,396,600**

**Registered Mar. 11, 2008**

**SERVICE MARK  
SUPPLEMENTAL REGISTER**

**VIRTUAL JOB AUDITION**

SELECT INTELLECTUAL, LLC (PENNSYLVANIA LTD LIAB CO)  
5700 CORPORATE DRIVE, SUITE 250  
PITTSBURGH, PA 15237

FOR: BUSINESS SERVICES PROVIDED TO OTHERS, NAMELY, ONLINE TESTING TO DETERMINE EMPLOYMENT SKILLS OF JOB CANDIDATES, IN CLASS 35 (U.S. CLS. 100, 101 AND 102).

FIRST USE 11-0-2004; IN COMMERCE 11-1-2005.

THE MARK CONSISTS OF STANDARD CHARACTERS WITHOUT CLAIM TO ANY PARTICULAR FONT, STYLE, SIZE, OR COLOR.

SER. NO. 76-666,341, FILED P.R. 9-18-2006; AM. S.R. 6-25-2007.

JOHN GARTNER, EXAMINING ATTORNEY

**Int. Cl.: 45**

**Prior U.S. Cls.: 100 and 101**

**United States Patent and Trademark Office**

**Reg. No. 3,396,601**

**Registered Mar. 11, 2008**

**SERVICE MARK  
SUPPLEMENTAL REGISTER**

**KIDS IN DISCIPLESHIP**

GENERAL CONFERENCE CORPORATION OF  
SEVENTH-DAY ADVENTISTS (D.C. COR-  
PORATION)  
12501 OLD COLUMBIA PIKE  
SILVER SPRING, MD 20904

FOR: SPIRITUAL AND MINISTERIAL MENTOR-  
ING OF CHILDREN AND TEENS THROUGH  
WHOLE-CHURCH MENTORING MINISTRY IN-  
VOLVING PARENTS, PASTORS, LEADERS AND  
MENTORS TOWARD CREATION OF CHILDREN  
AND TEENS AS EMPOWERED DISCIPLES OF  
JESUS CHRIST, IN CLASS 45 (U.S. CLS. 100 AND 101).

FIRST USE 3-0-2002; IN COMMERCE 3-0-2002.

THE MARK CONSISTS OF STANDARD CHAR-  
ACTERS WITHOUT CLAIM TO ANY PARTICULAR  
FONT, STYLE, SIZE, OR COLOR.

SER. NO. 76-667,928, FILED P.R. 10-23-2006; AM.  
S.R. 1-4-2008.

ANNE MADDEN, EXAMINING ATTORNEY

**Int. Cl.: 28**

**Prior U.S. Cls.: 22, 23, 38, and 50**

**United States Patent and Trademark Office**

**Reg. No. 3,396,602**

**Registered Mar. 11, 2008**

**TRADEMARK  
SUPPLEMENTAL REGISTER**

**PISTON POINT**

BEAR ARCHERY, INC. (FLORIDA CORPORATION)  
817 MAXWELL AVENUE  
P.O. BOX 889  
EVANSVILLE, IN 47706

FOR: BROADHEAD, NAMELY, AN ARROW BROADHEAD USED IN BOW AND ARROW GAME HUNTING, IN CLASS 28 (U.S. CLS. 22, 23, 38 AND 50).

FIRST USE 12-1-2006; IN COMMERCE 12-1-2006.

THE MARK CONSISTS OF STANDARD CHARACTERS WITHOUT CLAIM TO ANY PARTICULAR FONT, STYLE, SIZE, OR COLOR.

NO CLAIM IS MADE TO THE EXCLUSIVE RIGHT TO USE "POINT", APART FROM THE MARK AS SHOWN.

SER. NO. 76-671,349, FILED P.R. 1-16-2007; AM. S.R. 1-25-2008.

KEVIN CORWIN, EXAMINING ATTORNEY

**Int. Cl.: 38**

**Prior U.S. Cls.: 100, 101, and 104**

**United States Patent and Trademark Office**

**Reg. No. 3,396,603**

**Registered Mar. 11, 2008**

**SERVICE MARK  
SUPPLEMENTAL REGISTER**

**THE VIRTUAL PHONE SYSTEM  
DESIGNED FOR ENTREPRENEURS**

GOTVMAIL COMMUNICATIONS, LLC (MASSACHUSETTS DOMESTIC LIMITED LIABILITY COMPANY)  
9 RIVERSIDE DRIVE  
WESTON, MA 02493

FOR: TELECOMMUNICATION SERVICES, NAMELY, VOICE MAIL SERVICES, TOLL FREE TELEPHONE SERVICES, AND WIRELESS PBX SERVICES, IN CLASS 38 (U.S. CLS. 100, 101 AND 104).

FIRST USE 12-10-2007; IN COMMERCE 12-10-2007.

THE MARK CONSISTS OF STANDARD CHARACTERS WITHOUT CLAIM TO ANY PARTICULAR FONT, STYLE, SIZE, OR COLOR.

OWNER OF U.S. REG. NO. 3,050,741.

SER. NO. 76-673,550, FILED P.R. 3-2-2007; AM. S.R. 12-13-2007.

JOHN E. MICHOS, EXAMINING ATTORNEY

**Int. Cl.: 35**

**Prior U.S. Cls.: 100, 101, and 102**

**United States Patent and Trademark Office**

**Reg. No. 3,396,604**

**Registered Mar. 11, 2008**

**SERVICE MARK  
SUPPLEMENTAL REGISTER**

**FINANCIAL RISK MITIGATION**

FINANCIAL RISK MITIGATION, INC. (MISSISSIPPI CORPORATION)  
2332 NORTH ARNOULT ROAD  
METAIRIE, LA 70001

FOR: BUSINESS INVESTIGATION SERVICES RELATED TO THE PROVIDING OF FINANCIAL INFORMATION FOR EVALUATING BUSINESS RELATIONSHIPS, IN CLASS 35 (U.S. CLS. 100, 101 AND 102).

FIRST USE 3-5-2004; IN COMMERCE 3-5-2004.

THE MARK CONSISTS OF STANDARD CHARACTERS WITHOUT CLAIM TO ANY PARTICULAR FONT, STYLE, SIZE, OR COLOR.

SER. NO. 76-674,044, FILED P.R. 3-13-2007; AM. S.R. 7-16-2007.

TASNEEM HUSSAIN, EXAMINING ATTORNEY

**Int. Cl.: 20**

**Prior U.S. Cls.: 2, 13, 22, 25, 32, and 50**

**United States Patent and Trademark Office**

**Reg. No. 3,396,605**

**Registered Mar. 11, 2008**

**TRADEMARK  
SUPPLEMENTAL REGISTER**

**SLIDE-LOCK**

DOUBLE TEAM INC. (CALIFORNIA CORPORATION)  
882 BUSH STREET  
SAN FRANCISCO, CA 94108

THE MARK CONSISTS OF STANDARD CHARACTERS WITHOUT CLAIM TO ANY PARTICULAR FONT, STYLE, SIZE, OR COLOR.

FOR: PLASTIC LIDS FOR CLOSING PAPER AND PLASTIC CUPS, IN CLASS 20 (U.S. CLS. 2, 13, 22, 25, 32 AND 50).

SER. NO. 76-675,805, FILED P.R. 4-20-2007; AM. S.R. 12-17-2007.

FIRST USE 11-8-2007; IN COMMERCE 11-8-2007.

STEVEN PEREZ, EXAMINING ATTORNEY



**Int. Cl.: 5**

**Prior U.S. Cls.: 6, 18, 44, 46, 51, and 52**

**United States Patent and Trademark Office**

**Reg. No. 3,396,606**

**Registered Mar. 11, 2008**

**TRADEMARK  
SUPPLEMENTAL REGISTER**

**STERILE CHECK**

AUTOCLAVE TESTING SERVICE, INC. (CONNECTICUT CORPORATION)  
30 NURNEY STREET  
STAMFORD, CT 06902

FOR: BIOLOGICAL MONITORING KITS FOR SPORE TESTING, NAMELY, RESISTANT SPORE TESTING STRIPS FOR DETERMINING THE EFFECTIVENESS OF ANTIBACTERIAL AGENTS FOR MEDICAL, SURGICAL, VETERINARY, CLINICAL, PHARMACEUTICAL, DENTAL, PODIATRY, AND TATTOOING USE, IN CLASS 5 (U.S. CLS. 6, 18, 44, 46, 51 AND 52).

FIRST USE 1-5-2007; IN COMMERCE 1-5-2007.

THE MARK CONSISTS OF STANDARD CHARACTERS WITHOUT CLAIM TO ANY PARTICULAR FONT, STYLE, SIZE, OR COLOR.

SER. NO. 76-675,848, FILED P.R. 4-23-2007; AM. S.R. 11-5-2007.

JAMES STEIN, EXAMINING ATTORNEY

**Int. Cl.: 7**

**Prior U.S. Cls.: 13, 19, 21, 23, 31, 34, and 35**

**United States Patent and Trademark Office**

**Reg. No. 3,396,607**

**Registered Mar. 11, 2008**

**TRADEMARK  
SUPPLEMENTAL REGISTER**

**FLEX SEAT**

EXCEL INDUSTRIES, INC. (KANSAS CORPORATION)

P.O. BOX 7000

HESSTON, KS 670622986

FOR: SEATS FOR LAWNMOWERS, IN CLASS 7  
(U.S. CLS. 13, 19, 21, 23, 31, 34 AND 35).

FIRST USE 1-31-2007; IN COMMERCE 1-31-2007.

THE MARK CONSISTS OF STANDARD CHARACTERS WITHOUT CLAIM TO ANY PARTICULAR FONT, STYLE, SIZE, OR COLOR.

NO CLAIM IS MADE TO THE EXCLUSIVE RIGHT TO USE "SEAT", APART FROM THE MARK AS SHOWN.

SER. NO. 76-676,490, FILED P.R. 5-7-2007; AM. S.R. 12-20-2007.

AMEETA JORDAN, EXAMINING ATTORNEY

**Int. Cl.: 42**

**Prior U.S. Cls.: 100 and 101**

**United States Patent and Trademark Office**

**Reg. No. 3,396,608**

**Registered Mar. 11, 2008**

**SERVICE MARK  
SUPPLEMENTAL REGISTER**

**Spinal Arthroscopy Center of N.Y. & N.J.**

PFLUM, FRANCIS (UNITED STATES INDIVIDUAL)  
20 WEST 13TH ST.  
NEW YORK CITY, NY 100117902

FOR: HEALTH AND MEDICAL SERVICES, IN CLASS 42 (U.S. CLS. 100 AND 101).

FIRST USE 7-14-2007; IN COMMERCE 7-14-2007.

THE MARK CONSISTS OF STANDARD CHARACTERS WITHOUT CLAIM TO ANY PARTICULAR FONT, STYLE, SIZE, OR COLOR.

SER. NO. 76-677,148, FILED P.R. 5-21-2007; AM. S.R. 12-20-2007.

JACQUELINE A. LAVINE, EXAMINING ATTORNEY

**Int. Cl.: 9**

**Prior U.S. Cls.: 21, 23, 26, 36, and 38**

**United States Patent and Trademark Office**

**Reg. No. 3,396,609**

**Registered Mar. 11, 2008**

**TRADEMARK  
SUPPLEMENTAL REGISTER**

**THE TAX CO-OP, INC.**

THE TAX CO-OP, INC. (CALIFORNIA CORPORATION)  
5610 SCOTTS VALLEY DRIVE, SUITE C  
SCOTTS VALLEY, CA 95066

FOR: DOWNLOADABLE APPLICATION SOFTWARE PROGRAM FEATURING TAX INFORMATION, PLANNING, AND STRATEGY FOR TAXPAYERS AND TAX PREPARERS, IN CLASS 9 (U.S. CLS. 21, 23, 26, 36 AND 38).

FIRST USE 5-25-2007; IN COMMERCE 5-25-2007.

THE MARK CONSISTS OF STANDARD CHARACTERS WITHOUT CLAIM TO ANY PARTICULAR FONT, STYLE, SIZE, OR COLOR.

NO CLAIM IS MADE TO THE EXCLUSIVE RIGHT TO USE "INC.", APART FROM THE MARK AS SHOWN.

SER. NO. 76-679,038, FILED P.R. 7-2-2007; AM. S.R. 12-19-2007.

DORITT L. CARROLL, EXAMINING ATTORNEY

**Int. Cl.: 37**

**Prior U.S. Cls.: 100, 103, and 106**

**United States Patent and Trademark Office**

**Reg. No. 3,396,610**

**Registered Mar. 11, 2008**

**SERVICE MARK  
SUPPLEMENTAL REGISTER**

**PROFESSIONAL CARPET  
CLEANING**

SPADARO, GEORGE (UNITED STATES INDIVIDUAL)

104 SNYDER ROAD

CROPSEYVILLE, NY 12052

FOR: CARPET AND UPHOLSTERY CLEANING,  
IN CLASS 37 (U.S. CLS. 100, 103 AND 106).

FIRST USE 4-1-2004; IN COMMERCE 4-1-2004.

THE MARK CONSISTS OF STANDARD CHARACTERS WITHOUT CLAIM TO ANY PARTICULAR FONT, STYLE, SIZE, OR COLOR.

NO CLAIM IS MADE TO THE EXCLUSIVE RIGHT TO USE "CARPET CLEANING", APART FROM THE MARK AS SHOWN.

SER. NO. 76-680,513, FILED P.R. 8-9-2007; AM. S.R. 2-4-2008.

KATHY DE JONGE, EXAMINING ATTORNEY

**Int. Cl.: 35**

**Prior U.S. Cls.: 100, 101, and 102**

**United States Patent and Trademark Office**

**Reg. No. 3,396,611**

**Registered Mar. 11, 2008**

**SERVICE MARK  
SUPPLEMENTAL REGISTER**

**AsiaComp**

WMG, INCORPORATED (CALIFORNIA CORPORATION), DBA WESTERN MANAGEMENT GROUP,  
16615 LARK AVENUE, SUITE 201  
LOS GATOS, CA 95032

FIRST USE 1-1-2007; IN COMMERCE 1-1-2007.

SER. NO. 76-681,295, FILED P.R. 8-29-2007; AM. S.R. 12-6-2007.

FOR: CONDUCTING MARKETING RESEARCH SURVEYS OF EMPLOYEE COMPENSATION LEVELS AND PRACTICES, IN CLASS 35 (U.S. CLS. 100, 101 AND 102).

EVELYN BRADLEY, EXAMINING ATTORNEY

**Int. Cl.: 42**

**Prior U.S. Cls.: 100 and 101**

**United States Patent and Trademark Office**

**Reg. No. 3,396,612**

**Registered Mar. 11, 2008**

**SERVICE MARK  
SUPPLEMENTAL REGISTER**

**Hurricane Law Group**

BERGER LAW, DBA HURRICANE LAW GROUP  
(FLORIDA LTD LIAB CO)  
12214 KENTON WAY  
BOCA RATON, FL 33428

FOR: LEGAL SERVICES PERTAINING TO ADJUSTING, MEDIATION, APPRAISAL AND LITIGATION OF INSURANCE CLAIMS FOR DAMAGES THAT WERE CAUSED BY HURRICANES, WINDSTORMS OR OTHER NATURAL CAUSES, IN CLASS 42 (U.S. CLS. 100 AND 101).

FIRST USE 9-18-2006; IN COMMERCE 9-18-2006.

THE MARK CONSISTS OF STANDARD CHARACTERS WITHOUT CLAIM TO ANY PARTICULAR FONT, STYLE, SIZE, OR COLOR.

NO CLAIM IS MADE TO THE EXCLUSIVE RIGHT TO USE "LAW GROUP", APART FROM THE MARK AS SHOWN.

SER. NO. 77-001,850, FILED P.R. 9-18-2006; AM. S.R. 1-7-2008.

JESSICA A. POWERS, EXAMINING ATTORNEY

**Int. Cl.: 28**

**Prior U.S. Cls.: 22, 23, 38, and 50**

**United States Patent and Trademark Office**

**Reg. No. 3,396,613**

**Registered Mar. 11, 2008**

**TRADEMARK  
SUPPLEMENTAL REGISTER**

**CARDIO BOUNCER**

STAMINA PRODUCTS, INC. (MISSOURI CORPORATION)  
2040 NORTH ALLIANCE  
SPRINGFIELD, MO 65803

THE MARK CONSISTS OF STANDARD CHARACTERS WITHOUT CLAIM TO ANY PARTICULAR FONT, STYLE, SIZE, OR COLOR.

FOR: A REBOUNTING PLATFORM SOLD AS AN INTEGRAL COMPONENT OF MANUALLY OPERATED EXERCISE EQUIPMENT, IN CLASS 28 (U.S. CLS. 22, 23, 38 AND 50).

SER. NO. 77-005,187, FILED P.R. 9-22-2006; AM. S.R. 8-14-2007.

FIRST USE 12-0-2006; IN COMMERCE 12-0-2006.

DAVID HOFFMAN, EXAMINING ATTORNEY



**Int. Cl.: 38**

**Prior U.S. Cls.: 100, 101, and 104**

**United States Patent and Trademark Office**

**Reg. No. 3,396,614**

**Registered Mar. 11, 2008**

**SERVICE MARK  
SUPPLEMENTAL REGISTER**

# Senior Newswire

MILLER, JAMES TIMOTHY (UNITED STATES  
INDIVIDUAL)

PO BOX 5443

NORMAN, OK 73070

FOR: TRANSMISSION OF NEWS, IN CLASS 38  
(U.S. CLS. 100, 101 AND 104).

FIRST USE 7-31-2006; IN COMMERCE 7-31-2006.

THE MARK CONSISTS OF STANDARD CHAR-  
ACTERS WITHOUT CLAIM TO ANY PARTICULAR  
FONT, STYLE, SIZE, OR COLOR.

NO CLAIM IS MADE TO THE EXCLUSIVE  
RIGHT TO USE "NEWSWIRE", APART FROM THE  
MARK AS SHOWN.

SER. NO. 77-005,764, FILED P.R. 9-22-2006; AM. S.R.  
2-16-2007.

ADA HAN, EXAMINING ATTORNEY

**Int. Cl.: 9**

**Prior U.S. Cls.: 21, 23, 26, 36, and 38**

**United States Patent and Trademark Office**

**Reg. No. 3,396,615**

**Registered Mar. 11, 2008**

**TRADEMARK  
SUPPLEMENTAL REGISTER**

**CORE**

DESIGN ENGINE (UTAH CORPORATION)  
9515 SOUTH 560 WEST  
SANDY, UT 84070

THE MARK CONSISTS OF STANDARD CHAR-  
ACTERS WITHOUT CLAIM TO ANY PARTICULAR  
FONT, STYLE, SIZE, OR COLOR.

FOR: WIRE AND CABLE SPOOLS FOR USE WITH  
HEADPHONES, AV CABLES, ELECTRICAL WIRES,  
LINE, STRING AND CORDS, IN CLASS 9 (U.S. CLS.  
21, 23, 26, 36 AND 38).

SER. NO. 77-008,177, FILED P.R. 9-26-2006; AM. S.R.  
4-27-2007.

FIRST USE 4-27-2007; IN COMMERCE 4-27-2007.

STEVEN R. FINE, EXAMINING ATTORNEY

**Int. Cl.: 36**

**Prior U.S. Cls.: 100, 101, and 102**

**United States Patent and Trademark Office**

**Reg. No. 3,396,616**

**Registered Mar. 11, 2008**

**SERVICE MARK  
SUPPLEMENTAL REGISTER**

**MERCHANT EQUITY PARTNERS**

MERCHANT EQUITY PARTNERS LLP (UNITED KINGDOM LIMITED LIABILITY PARTNERSHIP)  
10 BRUTON STREET  
LONDON W1J 6PX, UNITED KINGDOM

FOR: INVESTMENT MANAGEMENT; FINANCIAL INVESTMENT IN THE FIELD OF RETAIL, CONSUMER AND LEISURE BUSINESSES; FINANCIAL INVESTMENT IN THE FIELD OF DISTRESSED RETAIL BUSINESSES; FINANCIAL ADVICE RELATING TO INVESTMENTS; INVESTMENT SERVICES, NAMELY, ASSET ACQUISITION, CONSULTATION, DEVELOPMENT AND MANAGEMENT SERVICES; MANAGEMENT OF A CAPITAL INVESTMENT FUND; INVESTMENT MANAGEMENT SERVICES; INVESTMENT MANAGEMENT OF FUNDS; MONITORING OF INVESTMENT FUNDS, NAMELY, INVESTMENT FUND TRANSFER AND TRANSACTION SERVICES; FINANCING SERVICES; FINANCING SERVICES FOR THE SECURING OF FUNDS IN RESPECT OF VENTURES; FINANCING SERVICES FOR THE SECURING OF FUNDS FOR BUSINESS; FUNDS INVESTMENTS; EQUITY CAPITAL INVESTMENT; TRUST SERVICES,

NAMELY, INVESTMENT AND TRUST COMPANY SERVICES; INVESTMENT CONSULTATION AND ADVISORY SERVICES; FINANCIAL INFORMATION PROVIDED BY ELECTRONIC MEANS, IN CLASS 36 (U.S. CLS. 100, 101 AND 102).

THE MARK CONSISTS OF STANDARD CHARACTERS WITHOUT CLAIM TO ANY PARTICULAR FONT, STYLE, SIZE, OR COLOR.

PRIORITY CLAIMED UNDER SEC. 44(D) ON ERPN CMNTY TM OFC APPLICATION NO. 5000302, FILED 4-5-2006, REG. NO. 005000302, DATED 4-5-2006, EXPIRES 4-5-2016.

NO CLAIM IS MADE TO THE EXCLUSIVE RIGHT TO USE "EQUITY PARTNERS", APART FROM THE MARK AS SHOWN.

SER. NO. 77-012,770, FILED P.R. 10-3-2006; AM. S.R. 2-4-2008.

LINDA M. KING, EXAMINING ATTORNEY

**Int. Cl.: 9**

**Prior U.S. Cls.: 21, 23, 26, 36, and 38**

**United States Patent and Trademark Office**

**Reg. No. 3,396,617**

**Registered Mar. 11, 2008**

**TRADEMARK  
SUPPLEMENTAL REGISTER**

**SMARTSWIPE**

QUADRAMED CORPORATION (DELAWARE  
CORPORATION)  
12110 SUNSET HILLS ROAD, SUITE 600  
RESTON, VA 20190

FOR: COMPUTER SOFTWARE FOR READING  
DATA FROM A DRIVER'S LICENSE, CREDIT  
CARD, MILITARY OR OTHER PERSONAL IDENTIFICATION  
CARD, IN CLASS 9 (U.S. CLS. 21, 23, 26,  
36 AND 38).

FIRST USE 12-17-2007; IN COMMERCE 12-17-2007.

THE MARK CONSISTS OF STANDARD CHARACTERS  
WITHOUT CLAIM TO ANY PARTICULAR  
FONT, STYLE, SIZE, OR COLOR.

SER. NO. 77-016,906, FILED P.R. 10-9-2006; AM. S.R.  
12-17-2007.

BRENDAN REGAN, EXAMINING ATTORNEY

**Int. Cl.: 42**

**Prior U.S. Cls.: 100 and 101**

**United States Patent and Trademark Office**

**Reg. No. 3,396,618**

**Registered Mar. 11, 2008**

**SERVICE MARK  
SUPPLEMENTAL REGISTER**

**GTMS**

GLD SOLUTIONS, INC (ALABAMA CORPORATION)  
SUITE 1  
4900 UNIVERSITY SQUARE  
HUNTSVILLE, AL 35816

FOR: PROVIDING TEMPORARY USE OF NON-DOWNLOADABLE COMPUTER SOFTWARE FOR PREPARING SHIPPING DOCUMENTS OVER COMPUTER NETWORKS, INTRANETS AND THE INTERNET; PROVIDING TEMPORARY USE OF NON-DOWNLOADABLE COMPUTER SOFTWARE FOR SHIPMENT PROCESSING OVER COMPUTER NETWORKS, INTRANETS AND THE INTERNET; PROVIDING TEMPORARY USE OF NON-DOWNLOADABLE COMPUTER SOFTWARE FOR TRACKING FREIGHT OVER COMPUTER NET-

WORKS, INTRANETS AND THE INTERNET; PROVIDING TEMPORARY USE OF NON-DOWNLOADABLE COMPUTER SOFTWARE FOR TRACKING PACKAGES OVER COMPUTER NETWORKS, INTRANETS AND THE INTERNET, IN CLASS 42 (U.S. CLS. 100 AND 101).

FIRST USE 9-28-2003; IN COMMERCE 9-28-2003.

THE MARK CONSISTS OF STANDARD CHARACTERS WITHOUT CLAIM TO ANY PARTICULAR FONT, STYLE, SIZE, OR COLOR.

SER. NO. 77-027,977, FILED P.R. 10-24-2006; AM. S.R. 1-16-2008.

MARK PILARO, EXAMINING ATTORNEY

**Int. Cls.: 9 and 42**

**Prior U.S. Cls.: 21, 23, 26, 36, 38, 100, and 101**

**United States Patent and Trademark Office**

**Reg. No. 3,396,619**

**Registered Mar. 11, 2008**

**TRADEMARK  
SERVICE MARK  
SUPPLEMENTAL REGISTER**

**A GROWABLE NETWORK  
INFORMATION SYSTEM**

THE NATIONAL MARROW DONOR PROGRAM  
(COLORADO CORPORATION)  
SUITE 500  
3001 BROADWAY STREET  
MINNEAPOLIS, MN 55413

FOR: COMPUTER PROGRAM FOR USE IN ORGANIZING, COLLATING, AND EXCHANGING OF CLINICAL RESEARCH DATA , IN CLASS 9 (U.S. CLS. 21, 23, 26, 36 AND 38).

FIRST USE 10-1-2007; IN COMMERCE 10-29-2007.

FOR: SCIENTIFIC AND TECHNOLOGICAL SERVICES, NAMELY, DESIGNING AND DEVELOPING COMPUTER SOFTWARE PROGRAMS AND SYSTEMS FOR USE IN THE EXCHANGE OF CLINICAL

RESEARCH DATA, IN CLASS 42 (U.S. CLS. 100 AND 101).

FIRST USE 10-0-2004; IN COMMERCE 12-0-2004.

THE MARK CONSISTS OF STANDARD CHARACTERS WITHOUT CLAIM TO ANY PARTICULAR FONT, STYLE, SIZE, OR COLOR.

NO CLAIM IS MADE TO THE EXCLUSIVE RIGHT TO USE "NETWORK INFORMATION SYSTEM", APART FROM THE MARK AS SHOWN.

SER. NO. 77-034,422, FILED P.R. 11-1-2006; AM. S.R. 9-10-2007.

LINDA ESTRADA, EXAMINING ATTORNEY

**Int. Cls.: 9, 35, 36, 38, 42, and 45**

**Prior U.S. Cls.: 21, 23, 26, 36, 38, 100, 101, 102, and 104**

**Reg. No. 3,396,620**

**United States Patent and Trademark Office**

**Registered Mar. 11, 2008**

**TRADEMARK  
SERVICE MARK  
SUPPLEMENTAL REGISTER**

# VOICE TRACK

BIOMETRIC SECURITY LIMITED (UNITED KINGDOM CORPORATION)

100 PALL MALL

LONDON, UNITED KINGDOM SW1Y5HP

FOR: COMPUTER HARDWARE; COMPUTER SOFTWARE FOR USE IN THE FIELDS OF DATABASE MANAGEMENT, VOICE VERIFICATION AND FOR TRACKING INDIVIDUALS; COMPUTER HARDWARE AND SOFTWARE AND MANUALS SUPPLIED THEREWITH, FOR USE IN PROVIDING COMMUNICATIONS VIA LOCAL, WIDE AREA AND GLOBAL COMPUTER NETWORKS; COMPUTER HARDWARE AND SOFTWARE, AND MANUALS SUPPLIED THEREWITH, FOR USE IN THE FIELDS OF DATABASE MANAGEMENT, VOICE VERIFICATION AND FOR TRACKING INDIVIDUALS FOR USE WITH MOBILE COMMUNICATIONS DEVICES; COMPUTER HARDWARE AND SOFTWARE, AND MANUALS SUPPLIED THEREWITH, FOR PROVIDING COMMUNICATIONS VIA WIRELESS DEVICES, COMMUNICATIONS VIA BROADBAND MEDIA, COMMUNICATIONS VIA FIXED LINE MEDIA AND INTERCOMPANY COMMUNICATIONS; COMPUTER NETWORK SECURITY SOFTWARE; COMPUTER HARDWARE AND SOFTWARE AND MANUALS SUPPLIED THEREWITH FOR USE IN THE TRACKING OF INDIVIDUALS; COMPUTER HARDWARE AND SOFTWARE AND MANUALS SUPPLIED THEREWITH FOR USE IN THE TRACKING OF INDIVIDUALS ON PAROLE; COMPUTER HARDWARE AND SOFTWARE AND MANUALS SUPPLIED THEREWITH FOR USE IN VERIFYING INDIVIDUAL'S VOICES FOR THE PURPOSES OF IDENTIFICATION COMPUTER HARDWARE AND SOFTWARE AND MANUALS SUPPLIED THEREWITH FOR THE PURPOSE OF TRACKING INDIVIDUALS, IN CLASS 9 (U.S. CLS. 21, 23, 26, 36 AND 38).

FIRST USE 12-0-2005; IN COMMERCE 12-0-2005.

FOR: BUSINESS MANAGEMENT AND OPERATIONAL BUSINESS SERVICES, NAMELY, PROVIDING THE OPERATION AND BUSINESS MANAGEMENT OF COMPUTERIZED VOICE VERIFICATION CALL CENTERS AND COMMUNICATION CENTERS OF OTHERS USED IN THE TRACKING OF INDIVIDUALS AND INDIVIDUALS ON PAROLE, IN CLASS 35 (U.S. CLS. 100, 101 AND 102).

FIRST USE 12-0-2005; IN COMMERCE 12-0-2005.

FOR: FINANCIAL SERVICES, NAMELY, ADMINISTRATION AND IDENTIFICATION OF AUTHORIZED USERS FOR FINANCIAL MANAGEMENT SYSTEMS, NAMELY, FUNDS TRANSFER SYSTEMS, BANK PAYMENT AND CREDIT TRANSFER SERVICES AND SERVICES PROVIDED BY EXCHANGE BROKERS, CLEARINGHOUSES, SHARE DEALERS AND INVESTMENT INSTITUTIONS USING VOICE RECOGNITION SYSTEMS, IN CLASS 36 (U.S. CLS. 100, 101 AND 102).

FIRST USE 12-0-2005; IN COMMERCE 12-0-2005.

FOR: TELECOMMUNICATIONS SERVICES, NAMELY, TRANSMITTING STREAMED SOUND AND TRANSMITTING STREAMED SOUND AND AUDIO-VISUAL RECORDINGS VIA LOCAL, WIDE AREA AND GLOBAL COMPUTER NETWORKS AND TO MOBILE COMMUNICATIONS DEVICES; COMMUNICATIONS VIA WIRELESS DEVICES, NAMELY MOBILE PHONES, COMMUNICATIONS VIA BROADBAND MEDIA, NAMELY COMPUTER TERMINALS, COMMUNICATIONS VIA FIXED LINE MEDIA NAMELY TELEPHONES, AND INTERCOMPANY COMMUNICATIONS VIA ELEC-

TRONIC AND COMPUTER TERMINALS; UNIFIED MESSAGING SERVICES VIA EMAIL AND TELEPHONE FOR OTHERS; THE ABOVE SERVICES PROVIDED FOR THE PURPOSES OF TRACKING OF INDIVIDUALS AND ALSO WITH PARTICULAR REFERENCE TO INDIVIDUALS ON PAROLE, IN CLASS 38 (U.S. CLS. 100, 101 AND 104).

FIRST USE 12-0-2005; IN COMMERCE 12-0-2005.

FOR: IDENTITY VERIFICATION SERVICES, NAMELY, PROVIDING ELECTRONIC VOICE VERIFICATION SERVICES IN ORDER TO TRACK INDIVIDUALS GENERALLY AND TO TRACK INDIVIDUALS ON PAROLE; IDENTIFY VERIFICATION SERVICES, NAMELY, PROVIDING ELECTRONIC VOICE VERIFICATION SERVICES TO IDENTIFY AUTHORIZED USES FOR FINANCIAL MANAGEMENT SYSTEMS FOR THE PURPOSES OF CONDUCTING ELECTRONIC FUNDS TRANSFERS, BANK PAYMENT TRANSACTIONS, CREDIT TRANSFERS AND SERVICES PROVIDED BY EXCHANGE BROKERS, CLEARINGHOUSES, SHARE DEALERS AND INVESTMENT INSTITUTIONS; COMPUTER SERVICES, NAMELY, COMPUTER SOFTWARE DEVELOPMENT FOR OTHERS, AND THE MAINTENANCE AND UPDATING OF COMPUTER SOFTWARE FOR OTHERS; COMPUTER SECURITY SERVICES, NAMELY, RESTRICTING ACCESS TO COMPUTER NETWORKS USING COMPUTERIZED VOICE VERIFICATION SYSTEMS, COMPUTER SECURITY SERVICE, NAMELY, RESTRICTING ACCESS TO AND BY COMPUTER NETWORKS TO AND OF UNDESIRE

MEDIA AND INDIVIDUALS AND FACILITIES; COMPUTER SYSTEM ADMINISTRATION FOR OTHERS IN THE FIELD OF FINANCIAL TRANSACTIONS, IN CLASS 42 (U.S. CLS. 100 AND 101).

FIRST USE 12-0-2005; IN COMMERCE 12-0-2005.

FOR: ELECTRONIC MONITORING SERVICES FOR SECURITY PURPOSES, NAMELY, TRACKING INDIVIDUALS IN GENERAL AND INDIVIDUALS ON PAROLE THROUGH THE USE OF VOICE VERIFICATION TECHNOLOGY; ELECTRONIC MONITORING SERVICES FOR SECURITY PURPOSES, NAMELY, THE TRACKING OF INDIVIDUALS IN GENERAL AND INDIVIDUALS ON PAROLE PROVIDED BY VOICE VERIFICATION TECHNOLOGY; MONITORING OF COMPUTER SYSTEMS FOR SECURITY PURPOSES, IN CLASS 45 (U.S. CLS. 100 AND 101).

FIRST USE 12-0-2005; IN COMMERCE 12-0-2005.

THE MARK CONSISTS OF STANDARD CHARACTERS WITHOUT CLAIM TO ANY PARTICULAR FONT, STYLE, SIZE, OR COLOR.

PRIORITY CLAIMED UNDER SEC. 44(D) ON UNITED KINGDOM APPLICATION NO. 2433593, FILED 9-26-2006.

SER. NO. 77-037,443, FILED P.R. 11-6-2006; AM. S.R. 9-12-2007.

ELLEN PERKINS, EXAMINING ATTORNEY



**Int. Cl.: 36**

**Prior U.S. Cls.: 100, 101, and 102**

**United States Patent and Trademark Office**

**Reg. No. 3,396,621**

**Registered Mar. 11, 2008**

**SERVICE MARK  
SUPPLEMENTAL REGISTER**

**PREMIER MARKETING GROUP**

REALTY EXECUTIVES, INC. (ARIZONA CORPORATION)  
SUITE 200  
4427 N. 36TH ST.  
PHOENIX, AZ 85018

FOR: REAL ESTATE BROKERAGE, IN CLASS 36  
(U.S. CLS. 100, 101 AND 102).

FIRST USE 9-18-2002; IN COMMERCE 9-18-2002.

THE MARK CONSISTS OF STANDARD CHARACTERS WITHOUT CLAIM TO ANY PARTICULAR FONT, STYLE, SIZE, OR COLOR.

NO CLAIM IS MADE TO THE EXCLUSIVE RIGHT TO USE "MARKETING GROUP", APART FROM THE MARK AS SHOWN.

SER. NO. 77-042,413, FILED P.R. 11-13-2006; AM. S.R. 12-21-2007.

PAUL E. FAHRENKOPF, EXAMINING ATTORNEY

**Int. Cl.: 25**

**Prior U.S. Cls.: 22 and 39**

**United States Patent and Trademark Office**

**Reg. No. 3,396,622**

**Registered Mar. 11, 2008**

**TRADEMARK  
SUPPLEMENTAL REGISTER**

**Drama. It follows me like  
a tail.**

RIGGS, JULIE C. (UNITED STATES INDIVIDUAL)  
1208 BICYCLE ROAD  
STOYSTOWN, PA 15563

FOR: T-SHIRTS, IN CLASS 25 (U.S. CLS. 22 AND 39).

FIRST USE 11-6-2006; IN COMMERCE 5-11-2007.

THE MARK CONSISTS OF STANDARD CHARACTERS WITHOUT CLAIM TO ANY PARTICULAR FONT, STYLE, SIZE, OR COLOR.

SER. NO. 77-045,300, FILED P.R. 11-16-2006; AM. S.R. 9-15-2007.

JOHN DWYER, EXAMINING ATTORNEY

**Int. Cl.: 35**

**Prior U.S. Cls.: 100, 101, and 102**

**United States Patent and Trademark Office**

**Reg. No. 3,396,623**

**Registered Mar. 11, 2008**

**SERVICE MARK  
SUPPLEMENTAL REGISTER**

**STRATEGIC ENGAGEMENT INDEX**

ROOT LEARNING INC. (OHIO CORPORATION)  
5470 MAIN STREET  
SYLVANIA, OH 43560

FOR: BUSINESS INFORMATION IN THE FIELD OF MEASURING EMPLOYEES' PERSONAL AND PRACTICAL COMMITMENT TO COMPANY STRATEGY AND MEASURING AN ORGANIZATION'S ABILITY TO ALIGN ITS PEOPLE TOWARD THE EXECUTION OF COMPANY STRATEGY, IN CLASS 35 (U.S. CLS. 100, 101 AND 102).

FIRST USE 2-0-2007; IN COMMERCE 2-0-2007.

THE MARK CONSISTS OF STANDARD CHARACTERS WITHOUT CLAIM TO ANY PARTICULAR FONT, STYLE, SIZE, OR COLOR.

NO CLAIM IS MADE TO THE EXCLUSIVE RIGHT TO USE "INDEX", APART FROM THE MARK AS SHOWN.

SER. NO. 77-045,930, FILED P.R. 11-16-2006; AM. S.R. 12-18-2007.

JILL C. ALT, EXAMINING ATTORNEY

**Int. Cl.: 9**

**Prior U.S. Cls.: 21, 23, 26, 36, and 38**

**United States Patent and Trademark Office**

**Reg. No. 3,396,624**

**Registered Mar. 11, 2008**

**TRADEMARK  
SUPPLEMENTAL REGISTER**

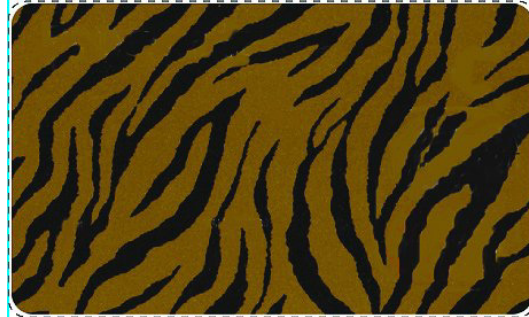

SOVEREIGN HOLDINGS, LLC (MICHIGAN LTD  
LIAB CO)

P.O. BOX 865

23 EAST FRONT STREET, SUITE 105

MONROE, MI 48161

FOR: MAGNETICALLY ENCODED CREDIT  
CARDS; MAGNETICALLY ENCODED DEBIT  
CARDS, IN CLASS 9 (U.S. CLS. 21, 23, 26, 36 AND 38).

FIRST USE 1-5-2007; IN COMMERCE 1-5-2007.

THE COLOR(S) GOLDISH TAN AND BLACK IS/  
ARE CLAIMED AS A FEATURE OF THE MARK.

THE MARK CONSISTS OF THE DESIGN OF A  
TIGER'S SKIN PLACED DIRECTLY ON THE  
GOODS AND ON PACKAGING FOR THE GOODS.  
THE COLOR GOLDISH TAN APPEARS IN THE  
BACKGROUND THAT COVERS THE GOODS AND  
THE COLOR BLACK APPEARS IN THE STRIPING  
THROUGHOUT THE DESIGN. THE MATTER  
SHOWN IN BROKEN LINES SERVES TO SHOW  
THE POSITIONING OF THE MARK ON THE  
GOODS OR ON PACKAGING FOR THE GOODS  
AND IS NOT PART OF THE MARK.

SER. NO. 77-046,830, FILED P.R. 11-17-2006; AM.  
S.R. 1-31-2008.

TERESA M. RUPP, EXAMINING ATTORNEY

**Int. Cls.: 19 and 27**

**Prior U.S. Cls.: 1, 12, 19, 20, 33, 37, 42, and 50**

**United States Patent and Trademark Office**

**Reg. No. 3,396,625**

**Registered Mar. 11, 2008**

**TRADEMARK  
SUPPLEMENTAL REGISTER**

**VENATI**

ANTONIO, IZZO (ITALY INDIVIDUAL)

VIA SAN MARTINO 87F

MONTESARCHIO (BN), ITALY 82016

FOR: GRANITE; NON-METAL CEILING PANELS; NON-METAL CLADDING FOR CONSTRUCTION AND BUILDING; NON-METAL FLOOR TILES; NON-METAL FLOORS; NON-METAL ROOFING PANELS; QUARTZ; SLABS OF STONE; STONE FOR BUILDING AND CONSTRUCTION; WALL PANELS NOT OF METAL, IN CLASS 19 (U.S. CLS. 1, 12, 33 AND 50).

FIRST USE 9-28-2007; IN COMMERCE 9-28-2007.

FOR: RESILIENT HARD SURFACE COVERING FOR FLOORS, WALLS AND OTHER SURFACES, IN CLASS 27 (U.S. CLS. 19, 20, 37, 42 AND 50).

FIRST USE 9-28-2007; IN COMMERCE 9-28-2007.

THE MARK CONSISTS OF STANDARD CHARACTERS WITHOUT CLAIM TO ANY PARTICULAR FONT, STYLE, SIZE, OR COLOR.

THE ENGLISH TRANSLATION OF THE WORD "VENATI" IN THE MARK IS "VEINED".

SER. NO. 77-049,850, FILED P.R. 11-22-2006; AM. S.R. 9-28-2007.

KHANH LE, EXAMINING ATTORNEY

**Int. Cl.: 9**

**Prior U.S. Cls.: 21, 23, 26, 36, and 38**

**United States Patent and Trademark Office**

**Reg. No. 3,396,626**

**Registered Mar. 11, 2008**

**TRADEMARK  
SUPPLEMENTAL REGISTER**

**SYSTEMSUITE**

AVANQUEST PUBLISHING USA, INC. (CALIFORNIA CORPORATION)  
7031 KOLL CENTER PARKWAY STE. 150  
PLEASANTON, CA 94566

FOR: COMPUTER UTILITY SOFTWARE; COMPUTER SOFTWARE FOR USE IN PARTITIONING, MANAGING AND OPTIMIZING COMPUTER HARD DISCS; COMPUTER FIREWALL SOFTWARE; COMPUTER ANTI-VIRUS SOFTWARE; MALICIOUS CODE AND MALICIOUS CONTENT SCREENING SOFTWARE; COMPUTER SECURITY SOFTWARE; COMPUTER SOFTWARE FOR OPTIMIZING PERFORMANCE OF COMPUTER HARDWARE AND SOFTWARE; COMPUTER SOFTWARE FOR USE IN DATA BACKUP, RECOVERY AND RESTORATION; COMPUTER SOFTWARE FOR USE IN COMPUTER SYSTEM BACKUP, RECOVERY AND RESTORATION; COMPUTER SOFTWARE FOR USE IN DISASTER RECOVERY; COMPUTER SOFTWARE FOR USE IN IDENTIFYING AND

DELETING PERSONAL OR CONFIDENTIAL DATA FROM PERSONAL COMPUTERS; COMPUTER SOFTWARE FOR IMAGING AND RESTORING COMPUTER DATA AND SYSTEMS; COMPUTER SOFTWARE FOR DIAGNOSING AND REPORTING ON COMPUTER HARDWARE AND SOFTWARE PROBLEMS AND FOR CORRECTING COMPUTER SOFTWARE PROBLEMS, IN CLASS 9 (U.S. CLS. 21, 23, 26, 36 AND 38).

FIRST USE 2-0-2000; IN COMMERCE 2-0-2000.

THE MARK CONSISTS OF STANDARD CHARACTERS WITHOUT CLAIM TO ANY PARTICULAR FONT, STYLE, SIZE, OR COLOR.

SER. NO. 77-052,294, FILED P.R. 11-28-2006; AM. S.R. 12-6-2007.

DOMINIC FATHY, EXAMINING ATTORNEY

**Int. Cl.: 9**

**Prior U.S. Cls.: 21, 23, 26, 36, and 38**

**United States Patent and Trademark Office**

**Reg. No. 3,396,627**

**Registered Mar. 11, 2008**

**TRADEMARK  
SUPPLEMENTAL REGISTER**

**FLYFISH MOBILE**

BARDOTEK SOFTWARE, INC. (ILLINOIS CORPORATION)  
711 FENVIEW CIRCLE  
ALGONQUIN, IL 60102

FOR: COMPUTER SOFTWARE TO PROVIDE INFORMATION AND INSTRUCTIONAL MATERIALS ACCESSED FROM STORED DATABASES AND THE INTERNET, ALL RELATING TO THE SPORT OF FLYFISHING, IN CLASS 9 (U.S. CLS. 21, 23, 26, 36 AND 38).

FIRST USE 1-11-2008; IN COMMERCE 1-11-2008.

THE MARK CONSISTS OF STANDARD CHARACTERS WITHOUT CLAIM TO ANY PARTICULAR FONT, STYLE, SIZE, OR COLOR.

NO CLAIM IS MADE TO THE EXCLUSIVE RIGHT TO USE "FLYFISH", APART FROM THE MARK AS SHOWN.

SER. NO. 77-055,874, FILED P.R. 12-2-2006; AM. S.R. 1-11-2008.

AMEETA JORDAN, EXAMINING ATTORNEY

**Int. Cl.: 41**

**Prior U.S. Cls.: 100, 101, and 107**

**United States Patent and Trademark Office**

**Reg. No. 3,396,628**

**Registered Mar. 11, 2008**

**SERVICE MARK  
SUPPLEMENTAL REGISTER**

**The Community College  
Conference on Legal Issues**

THE DISTRICT BOARD OF TRUSTEES OF VA-  
LENCIA COMMUNITY COLLEGE (FLORIDA  
POLITICAL SUB-DIVISION)  
190 S. ORANGE AVE.  
ORLANDO, FL 32801

FOR: EDUCATIONAL SERVICES, NAMELY,  
PROVIDING CLASSES, SEMINARS, CONFEREN-  
CES, WORKSHOPS, AND COURSES OF INSTRUC-  
TION AT THE CORPORATE, COMMUNITY, POST-  
SECONDARY, COLLEGE, AND POST-COLLEGE  
LEVELS IN THE FIELD OF LEGAL ISSUES IN  
EDUCATION, AND DISTRIBUTION OF COURSE  
MATERIALS IN CONNECTION THEREWITH; CON-  
DUCTING CORPORATE TRAINING CLASSES,  
SEMINARS, CONFERENCES, AND WORKSHOPS  
IN THE FIELD OF LEGAL ISSUES IN EDUCATION,  
AND DISTRIBUTION OF COURSE MATERIALS IN  
CONNECTION THEREWITH; DEVELOPING CUS-  
TOMIZED CURRICULA FOR CORPORATE TRAIN-

ING PROGRAMS IN THE FIELD OF LEGAL ISSUES  
IN EDUCATION FOR OTHERS, IN CLASS 41 (U.S.  
CLS. 100, 101 AND 107).

FIRST USE 6-10-2006; IN COMMERCE 6-10-2006.

THE MARK CONSISTS OF STANDARD CHAR-  
ACTERS WITHOUT CLAIM TO ANY PARTICULAR  
FONT, STYLE, SIZE, OR COLOR.

NO CLAIM IS MADE TO THE EXCLUSIVE  
RIGHT TO USE "COMMUNITY COLLEGE CON-  
FERENCE", APART FROM THE MARK AS SHOWN.

SER. NO. 77-056,286, FILED P.R. 12-4-2006; AM. S.R.  
10-1-2007.

LESLEY LAMOTHE, EXAMINING ATTORNEY



**Int. Cl.: 16**

**Prior U.S. Cls.: 2, 5, 22, 23, 29, 37, 38, and 50**

**United States Patent and Trademark Office**

**Reg. No. 3,396,629**

**Registered Mar. 11, 2008**

**TRADEMARK  
SUPPLEMENTAL REGISTER**

**CCN MEXICO REPORT**

CACHEAUX, CAVAZOS & NEWTON, L.L.P.  
(TEXAS LIMITED LIABILITY PARTNERSHIP)  
333 CONVENT STREET  
SAN ANTONIO, TX 78205

FOR: NEWSLETTERS IN THE FIELD OF MEXICAN LAW, BUSINESS AND POLITICAL ISSUES, IN CLASS 16 (U.S. CLS. 2, 5, 22, 23, 29, 37, 38 AND 50).

FIRST USE 1-1-2004; IN COMMERCE 1-1-2004.

NO CLAIM IS MADE TO THE EXCLUSIVE RIGHT TO USE "MEXICO REPORT", APART FROM THE MARK AS SHOWN.

THE COLOR(S) SILVER AND BLUE IS/ARE CLAIMED AS A FEATURE OF THE MARK.

THE MARK CONSISTS OF LOGO RUNNING HORIZONTALLY BEGINNING WITH A RECTANGULAR SHAPE ON THE LEFT HAND SIDE WITH A SILVER BORDER THAT IS THE SAME WIDTH AS

THE LETTERING IN THE SAME RECTANGLE ALSO BEING SILVER IN COLOR CONTAINED WITHIN THE RECTANGLE, WHICH IS "CCN" IN ALL CAPITAL, BLOCK LETTERS SET AGAINST A BLUE BACKGROUND. CENTERED BETWEEN THE TOP BORDER OF THE RECTANGLE AND BOTTOM BORDER IN THE SAME BLUE COLOR OF THE BACKGROUND SEEN IN THE RECTANGLE BEARING "CCN" ARE THE WORDS "MEXICO REPORT" IN SMALL CAPITAL LETTERS, LEAVING MINIMAL SPACE BETWEEN THE WORDING AND EDGES OF LOGO, WITH THE "M" OF "MEXICO" CAPITALIZED THEREFORE APPEARING SLIGHTLY LARGER THAN THE REMAINDER OF THE WORD AND THE "R" OF "REPORT" CAPITALIZED THEREFORE APPEARING SLIGHTLY LARGER THAN THE REMAINDER OF THE WORD.

SER. NO. 77-057,970, FILED P.R. 12-6-2006; AM. S.R. 12-11-2007.

CAROLYN GRAY, EXAMINING ATTORNEY

Int. Cl.: 33

Prior U.S. Cls.: 47 and 49

United States Patent and Trademark Office

Reg. No. 3,396,630

Registered Mar. 11, 2008

TRADEMARK  
SUPPLEMENTAL REGISTER

*Schulz*

SCHULZ CELLARS (CALIFORNIA PARTNER-  
SHIP)  
397 CALLE DEL MONTE  
SONOMA, CA 95476

FIRST USE 6-1-2007; IN COMMERCE 6-1-2007.

SER. NO. 77-058,477, FILED P.R. 12-6-2006; AM. S.R.  
12-20-2007.

FOR: WINE, IN CLASS 33 (U.S. CLS. 47 AND 49).

COLLEEN KEARNEY, EXAMINING ATTORNEY

**Int. Cl.: 36**

**Prior U.S. Cls.: 100, 101, and 102**

**United States Patent and Trademark Office**

**Reg. No. 3,396,631**

**Registered Mar. 11, 2008**

**SERVICE MARK  
SUPPLEMENTAL REGISTER**

**INTEGRATED ADVISORY  
SERVICES**

LINSKO/PRIVATE LEDGER CORP (CALIFORNIA CORPORATION)  
ONE BEACON STREET, 22ND FLOOR  
BOSTON, MA 02108

FOR: FINANCIAL ASSET MANAGEMENT SERVICES, INVESTMENT OF FUNDS FOR OTHERS, FINANCIAL RESEARCH SERVICES AND FINANCIAL PLANNING, IN CLASS 36 (U.S. CLS. 100, 101 AND 102).

FIRST USE 3-1-2005; IN COMMERCE 3-1-2005.

THE MARK CONSISTS OF STANDARD CHARACTERS WITHOUT CLAIM TO ANY PARTICULAR FONT, STYLE, SIZE, OR COLOR.

NO CLAIM IS MADE TO THE EXCLUSIVE RIGHT TO USE "ADVISORY SERVICES", APART FROM THE MARK AS SHOWN.

SER. NO. 77-062,787, FILED P.R. 12-12-2006; AM. S.R. 10-4-2007.

JIM RINGLE, EXAMINING ATTORNEY

**Int. Cl.: 35**

**Prior U.S. Cls.: 100, 101, and 102**

**United States Patent and Trademark Office**

**Reg. No. 3,396,632**

**Registered Mar. 11, 2008**

**SERVICE MARK  
SUPPLEMENTAL REGISTER**

**PEERQC**

BIONOSTICS INC. (MASSACHUSETTS CORPORATION)  
7 JACKSON ROAD  
DEVENS, MA 01434

FOR: COLLECTION, PREPARATION, COMPOSITION, STORAGE, PROCESSING, ACQUISITION AND PROVISION OF BUSINESS INFORMATION, DATA, STATISTICS AND INDICES RELATING TO LABORATORY QUALITY CONTROL, IN CLASS 35 (U.S. CLS. 100, 101 AND 102).

FIRST USE 3-0-2005; IN COMMERCE 3-0-2005.

THE MARK CONSISTS OF STANDARD CHARACTERS WITHOUT CLAIM TO ANY PARTICULAR FONT, STYLE, SIZE, OR COLOR.

SER. NO. 77-062,981, FILED P.R. 12-13-2006; AM. S.R. 1-4-2008.

SARA THOMAS, EXAMINING ATTORNEY

**Int. Cl.: 36**

**Prior U.S. Cls.: 100, 101, and 102**

**United States Patent and Trademark Office**

**Reg. No. 3,396,633**

**Registered Mar. 11, 2008**

**SERVICE MARK  
SUPPLEMENTAL REGISTER**

**home San Francisco**

GREG ANGILLY LLC (CALIFORNIA LTD LIAB  
CO)  
2442 38TH AVENUE  
SAN FRANCISCO, CA 94116

FOR: REAL ESTATE BROKERAGE SERVICES, IN  
CLASS 36 (U.S. CLS. 100, 101 AND 102).

FIRST USE 12-1-2006; IN COMMERCE 12-1-2006.

THE MARK CONSISTS OF STANDARD CHAR-  
ACTERS WITHOUT CLAIM TO ANY PARTICULAR  
FONT, STYLE, SIZE, OR COLOR.

SER. NO. 77-065,960, FILED P.R. 12-17-2006; AM.  
S.R. 1-31-2008.

BRIAN PINO, EXAMINING ATTORNEY

**Int. Cls.: 9 and 35**

**Prior U.S. Cls.: 21, 23, 26, 36, 38, 100, 101, and 102**

**United States Patent and Trademark Office**

**Reg. No. 3,396,634**

**Registered Mar. 11, 2008**

**TRADEMARK  
SERVICE MARK  
SUPPLEMENTAL REGISTER**

**FLATWIRE TV**

SOUTHWIRE COMPANY (DELAWARE CORPORATION)  
ONE SOUTHWIRE DRIVE  
CARROLLTON, GA 30119

FOR: ELECTRIC WIRES FOR AUDIO, VIDEO, AND DATA, IN CLASS 9 (U.S. CLS. 21, 23, 26, 36 AND 38).

FIRST USE 11-24-2006; IN COMMERCE 11-24-2006.

FOR: ON-LINE RETAIL STORE SERVICES FEATURING ELECTRONICS AND AUDIOVISUAL PRODUCTS, IN CLASS 35 (U.S. CLS. 100, 101 AND 102).

FIRST USE 11-24-2006; IN COMMERCE 11-24-2006.

THE MARK CONSISTS OF STANDARD CHARACTERS WITHOUT CLAIM TO ANY PARTICULAR FONT, STYLE, SIZE, OR COLOR.

OWNER OF U.S. REG. NO. 2,767,445.

SER. NO. 77-079,740, FILED P.R. 1-10-2007; AM. S.R. 11-2-2007.

VIVIAN MICZNIK FIRST, EXAMINING ATTORNEY

**Int. Cl.: 38**

**Prior U.S. Cls.: 100, 101, and 104**

**United States Patent and Trademark Office**

**Reg. No. 3,396,635**

**Registered Mar. 11, 2008**

**SERVICE MARK  
SUPPLEMENTAL REGISTER**

**Business Communication  
Analysts**

BUSINESS COMMUNICATION ANALYSTS, INC.  
(MICHIGAN CORPORATION)

23420 LORAIN ROAD, UNIT 200 #227

NORTH OLMSTED, OH 44070

FOR: TELECOMMUNICATION ACCESS SERVICES;  
TELECOMMUNICATIONS CONSULTATION,  
IN CLASS 38 (U.S. CLS. 100, 101 AND 104).

FIRST USE 5-1-2004; IN COMMERCE 5-1-2004.

THE MARK CONSISTS OF STANDARD CHARACTERS WITHOUT CLAIM TO ANY PARTICULAR FONT, STYLE, SIZE, OR COLOR.

NO CLAIM IS MADE TO THE EXCLUSIVE RIGHT TO USE "ANALYSTS", APART FROM THE MARK AS SHOWN.

SER. NO. 77-081,783, FILED P.R. 1-12-2007; AM. S.R. 11-5-2007.

ANGELA GAW, EXAMINING ATTORNEY

**Int. Cls.: 35 and 36**

**Prior U.S. Cls.: 100, 101, and 102**

**United States Patent and Trademark Office**

**Reg. No. 3,396,636**

**Registered Mar. 11, 2008**

**SERVICE MARK  
SUPPLEMENTAL REGISTER**

**SC LAUNCH!**

SC LAUNCH!, INC. (SOUTH CAROLINA CORPORATION)  
1330 LADY STREET, SUITE 505  
COLUMBIA, SC 29211

FOR: BUSINESS MANAGEMENT AND ADMINISTRATIVE SERVICES FOR ENTREPRENEURS, START-UP BUSINESSES AND EMERGING BUSINESSES, NAMELY, BUSINESS CONSULTING, BUSINESS RESEARCH, BUSINESS PLANNING, BUSINESS MANAGEMENT, IN CLASS 35 (U.S. CLS. 100, 101 AND 102).

FIRST USE 4-13-2006; IN COMMERCE 4-13-2006.

FOR: FINANCIAL SERVICES, NAMELY, EARLY STAGE CAPITAL FUNDING, EARLY STAGE EQUI-

TY INVESTMENTS AND PROVIDING LOANS TO BUSINESSES; BUSINESS INCUBATION SERVICES, NAMELY, RENTAL AND LEASING OF OFFICE SPACE, IN CLASS 36 (U.S. CLS. 100, 101 AND 102).

FIRST USE 4-13-2006; IN COMMERCE 4-13-2006.

THE MARK CONSISTS OF STANDARD CHARACTERS WITHOUT CLAIM TO ANY PARTICULAR FONT, STYLE, SIZE, OR COLOR.

SER. NO. 77-088,715, FILED P.R. 1-23-2007; AM. S.R. 12-26-2007.

RONALD MCMORROW, EXAMINING ATTORNEY



**Int. Cl.: 9**

**Prior U.S. Cls.: 21, 23, 26, 36, and 38**

**United States Patent and Trademark Office**

**Reg. No. 3,396,637**

**Registered Mar. 11, 2008**

**TRADEMARK  
SUPPLEMENTAL REGISTER**

**NANO SILVER ANTIBACTERIAL**

DUNA ENTERPRISES S.A. (PANAMA CORPORATION)  
EDIFICIO ARANGO-ORILLAC  
2ND FLOOR, CALLE 54 ESTE  
PANAMA, PANAMA

FOR: ELECTRIC APPARATUS FOR STRAIGHTENING HAIR, NAMELY, AN ELECTRIC HAIR STRAIGHTENER, IN CLASS 9 (U.S. CLS. 21, 23, 26, 36 AND 38).

FIRST USE 10-31-2007; IN COMMERCE 10-31-2007.

THE MARK CONSISTS OF STANDARD CHARACTERS WITHOUT CLAIM TO ANY PARTICULAR FONT, STYLE, SIZE, OR COLOR.

SER. NO. 77-091,042, FILED P.R. 1-25-2007; AM. S.R. 11-19-2007.

MATTHEW EINSTEIN, EXAMINING ATTORNEY

**Int. Cl.: 35**

**Prior U.S. Cls.: 100, 101, and 102**

**United States Patent and Trademark Office**

**Reg. No. 3,396,638**

**Registered Mar. 11, 2008**

**SERVICE MARK  
SUPPLEMENTAL REGISTER**

**NATIONAL TOURISM &  
HERITAGE ASSOCIATION**

NATIONAL TOURISM & HERITAGE ASSOCIATION (D.C. CORPORATION)  
2332 LAROSE ST.  
2332 LAROSE ST.  
MEMPHIS, TN 38114

FOR: BUSINESS DEVELOPMENT SERVICES, NAMELY, PROVIDING START-UP SUPPORT FOR BUSINESSES OF OTHERS; CHAMBER OF COMMERCE SERVICES, NAMELY, PROMOTING BUSINESS AND TOURISM IN URBAN AND RURAL COMMUNITIES NATIONWIDE, AND PROVIDING ASSOCIATED CONSULTING SERVICES CONCERNING HOW TO DEVELOP THESE TOURISM MARKETS, IN CLASS 35 (U.S. CLS. 100, 101 AND 102).

FIRST USE 12-6-2006; IN COMMERCE 12-6-2006.

THE MARK CONSISTS OF STANDARD CHARACTERS WITHOUT CLAIM TO ANY PARTICULAR FONT, STYLE, SIZE, OR COLOR.

NO CLAIM IS MADE TO THE EXCLUSIVE RIGHT TO USE "ASSOCIATION", APART FROM THE MARK AS SHOWN.

SER. NO. 77-091,660, FILED P.R. 1-25-2007; AM. S.R. 6-7-2007.

LYDIA BELZER, EXAMINING ATTORNEY

**Int. Cl.: 30**

**Prior U.S. Cl.: 46**

**United States Patent and Trademark Office**

**Reg. No. 3,396,639**

**Registered Mar. 11, 2008**

**TRADEMARK  
SUPPLEMENTAL REGISTER**

**AMERICA'S FRESHEST TEA**

CHA DAO TEA COMPANY, LLC (WASHINGTON  
LTD LIAB CO)  
PO BOX 31133  
SEATTLE, WA 98103

FOR: BEVERAGES MADE OF TEA; GREEN TEA;  
HERB TEA; HERBAL TEA; JAPANESE GREEN TEA;  
OOLONG TEA; TEA, IN CLASS 30 (U.S. CL. 46).

FIRST USE 2-1-2007; IN COMMERCE 2-1-2007.

THE MARK CONSISTS OF STANDARD CHAR-  
ACTERS WITHOUT CLAIM TO ANY PARTICULAR  
FONT, STYLE, SIZE, OR COLOR.

NO CLAIM IS MADE TO THE EXCLUSIVE  
RIGHT TO USE "TEA", APART FROM THE MARK  
AS SHOWN.

SER. NO. 77-097,296, FILED P.R. 2-1-2007; AM. S.R.  
11-29-2007.

DAWN HAN, EXAMINING ATTORNEY

**Int. Cls.: 35 and 44**

**Prior U.S. Cls.: 100, 101, and 102**

**United States Patent and Trademark Office**

**Reg. No. 3,396,640**

**Registered Mar. 11, 2008**

**SERVICE MARK  
SUPPLEMENTAL REGISTER**

**FOOT RX**

FOOT RX LICENSING LLC (VIRGINIA LTD  
LIAB CO)  
611 CAMPUS DRIVE  
SUITE 100  
ABINGDON, VA 24210

FOR: RETAIL STORE SERVICES FEATURING  
FOOTWEAR, APPAREL AND ACCESSORIES, IN  
CLASS 35 (U.S. CLS. 100, 101 AND 102).

FIRST USE 12-1-2003; IN COMMERCE 12-1-2003.

FOR: PEDORTHIC MEDICAL SERVICES, IN  
CLASS 44 (U.S. CLS. 100 AND 101).

FIRST USE 12-1-2003; IN COMMERCE 12-1-2003.

THE MARK CONSISTS OF STANDARD CHAR-  
ACTERS WITHOUT CLAIM TO ANY PARTICULAR  
FONT, STYLE, SIZE, OR COLOR.

OWNER OF U.S. REG. NO. 2,830,479.

SER. NO. 77-097,602, FILED P.R. 2-2-2007; AM. S.R.  
1-11-2008.

INGA ERVIN, EXAMINING ATTORNEY

Int. Cls.: 25 and 35

Prior U.S. Cls.: 22, 39, 100, 101, and 102

United States Patent and Trademark Office

Reg. No. 3,396,641

Registered Mar. 11, 2008

**TRADEMARK  
SERVICE MARK  
SUPPLEMENTAL REGISTER**



BABYSOY LLC (CALIFORNIA LTD LIAB CO)  
2550 WEST MAIN STREET SUITE 212  
ALHAMBRA, CA 91801

FOR: BATHING SUITS; BIBS NOT OF CLOTH OR PAPER; BLOUSES; BOOTIES; DRESSES; GLOVES; HATS; HEADWEAR; INFANT AND TODDLER ONE PIECE CLOTHING; INFANTS' TROUSERS; INFANTWEAR; JACKETS; JEANS; JUMPERS; KNIT SHIRTS; MATERNITY SLEEPWEAR; OVERALLS; PANTS; ROMPERS; SCARVES; SHIRTS; SHORTS; SKIRTS; SOCKS; STOCKINGS; SWEAT SHIRTS; SWEATERS; T-SHIRTS; TANK TOPS; TIES; TIGHTS; TOPS; TROUSERS, IN CLASS 25 (U.S. CLS. 22 AND 39).

FIRST USE 6-23-2005; IN COMMERCE 6-23-2005.

FOR: ON-LINE RETAIL STORE SERVICES FEATURING BABY AND INFANT CLOTHES, TODDLER AND CHILDREN CLOTHES, BABY ACCESSORIES, MATERNITY CLOTHES; WHOLESALE DISTRIBUTORSHIPS FEATURING BABY AND INFANT CLOTHES, TODDLER AND CHILDREN CLOTHES, BABY ACCESSORIES, MATERNITY CLOTHES, IN CLASS 35 (U.S. CLS. 100, 101 AND 102).

FIRST USE 6-23-2005; IN COMMERCE 6-23-2005.

SER. NO. 77-098,272, FILED P.R. 2-2-2007; AM. S.R. 1-29-2008.

LAURIE MAYES, EXAMINING ATTORNEY

**Int. Cl.: 16**

**Prior U.S. Cls.: 2, 5, 22, 23, 29, 37, 38, and 50**

**Reg. No. 3,396,642**

**United States Patent and Trademark Office**

**Registered Mar. 11, 2008**

**TRADEMARK  
SUPPLEMENTAL REGISTER**

**TOURING RIDER**

AFFINITY GROUP, INC. (DELAWARE CORPORATION)  
2575 VISTA DEL MAR DRIVE  
VENTURA, CA 93001

FOR: MAGAZINES, JOURNALS, NEWSPAPERS, AND NEWSLETTERS ALL IN THE FIELD OF MOTORCYCLES; MAGAZINE SECTIONS IN THE FIELD OF MOTORCYCLES; MAGAZINE COLUMNS ABOUT MOTORCYCLES, IN CLASS 16 (U.S. CLS. 2, 5, 22, 23, 29, 37, 38 AND 50).

FIRST USE 10-31-2006; IN COMMERCE 10-31-2006.

THE MARK CONSISTS OF STANDARD CHARACTERS WITHOUT CLAIM TO ANY PARTICULAR FONT, STYLE, SIZE, OR COLOR.

SER. NO. 77-101,745, FILED P.R. 2-7-2007; AM. S.R. 12-11-2007.

DARRYL SPRUILL, EXAMINING ATTORNEY

**Int. Cl.: 45**

**Prior U.S. Cls.: 100 and 101**

**United States Patent and Trademark Office**

**Reg. No. 3,396,643**

**Registered Mar. 11, 2008**

**SERVICE MARK  
SUPPLEMENTAL REGISTER**

**GARDA**

GARDA WORLD SECURITY CORPORATION  
(CANADA CORPORATION)  
1390 BARRE STREET  
MONTREAL, CANADA H3C1N4

FOR: PHYSICAL AND PERSONAL SECURITY SERVICES, NAMELY, DETECTIVE INVESTIGATIONS, SURVEILLANCE, BACKGROUND PROFILES, PRE-EMPLOYMENT BACKGROUND SCREENING, SECURITY RISK ANALYSIS AND PLANNING, CRISIS MANAGEMENT, ASSET PROTECTION, EXECUTIVE PROTECTION, GPS TRACKING OF VEHICLES, CASH IN TRANSIT SERVICES, CARGO SECURITY, KIDNAPPING AND RANSOM CRISIS MANAGEMENT SERVICES, BODYGUARD SERVICES, SECURITY GUARD SERVICES AND CONSULTING SERVICES IN THE

FIELD OF SECURITY NEEDS AND ASSESSMENT, IN CLASS 45 (U.S. CLS. 100 AND 101).

FIRST USE 7-0-2006; IN COMMERCE 7-0-2006.

THE MARK CONSISTS OF STANDARD CHARACTERS WITHOUT CLAIM TO ANY PARTICULAR FONT, STYLE, SIZE, OR COLOR.

THE FOREIGN WORDING IN THE MARK TRANSLATES INTO ENGLISH AS "TO LOOK AFTER OR PROTECT OR GUARD".

SER. NO. 77-102,854, FILED P.R. 2-8-2007; AM. S.R. 12-20-2007.

TINA KUAN, EXAMINING ATTORNEY

**Int. Cls.: 16 and 41**

**Prior U.S. Cls.: 2, 5, 22, 23, 29, 37, 38, 50, 100, 101, and 107**

**United States Patent and Trademark Office**

**Reg. No. 3,396,644**

**Registered Mar. 11, 2008**

**TRADEMARK  
SERVICE MARK  
SUPPLEMENTAL REGISTER**

# Little Green

HAIN PUBLISHING, INC. (NEBRASKA CORPORATION)  
2652 DAVEY ROAD  
BEE, NE 68314

FOR: MAGAZINES FEATURING TRACTORS, FARM EQUIPMENT AND RELATED COLLECTIBLES FOR CHILDREN, IN CLASS 16 (U.S. CLS. 2, 5, 22, 23, 29, 37, 38 AND 50).

FIRST USE 1-0-2007; IN COMMERCE 1-0-2007.

FOR: PROVIDING ON-LINE PUBLICATIONS IN THE NATURE OF CHILDREN-ORIENTED INFORMATION IN THE FIELD OF TRACTORS, FARM EQUIPMENT AND RELATED COLLECTIBLES, IN CLASS 41 (U.S. CLS. 100, 101 AND 107).

FIRST USE 10-12-2006; IN COMMERCE 10-12-2006.

THE MARK CONSISTS OF STANDARD CHARACTERS WITHOUT CLAIM TO ANY PARTICULAR FONT, STYLE, SIZE, OR COLOR.

NO CLAIM IS MADE TO THE EXCLUSIVE RIGHT TO USE "GREEN" , APART FROM THE MARK AS SHOWN.

SER. NO. 77-104,080, FILED P.R. 2-9-2007; AM. S.R. 10-19-2007.

K. MARGARET LE, EXAMINING ATTORNEY



**Int. Cl.: 35**

**Prior U.S. Cls.: 100, 101, and 102**

**United States Patent and Trademark Office**

**Reg. No. 3,396,645**

**Registered Mar. 11, 2008**

**SERVICE MARK  
SUPPLEMENTAL REGISTER**

**MONITOR TRACK MANAGE**

SABIOSO, INC. (UTAH CORPORATION)  
189 SOUTH STATE STREET, SUITE 250  
CLEARFIELD, UT 84015

FOR: PROVIDING A WEB-BASED PORTAL FOR MONITORING, TRACKING, AND MANAGEMENT OF ASSETS, NAMELY FREIGHT, PACKAGES, VEHICLES, AND CONTAINERS; COMPUTERIZED TRACKING AND TRACING OF FREIGHT, PACKAGES, VEHICLES AND CONTAINERS; LOGISTICS MANAGEMENT IN THE FIELD OF REMOTE MONITORING, TRACKING AND MANAGEMENT OF ASSETS, NAMELY, FREIGHT, PACKAGES, VEHI-

CLES, CONTAINERS AND INDIVIDUALS, IN CLASS 35 (U.S. CLS. 100, 101 AND 102).

FIRST USE 1-31-2004; IN COMMERCE 1-31-2004.

THE MARK CONSISTS OF STANDARD CHARACTERS WITHOUT CLAIM TO ANY PARTICULAR FONT, STYLE, SIZE, OR COLOR.

SER. NO. 77-104,215, FILED P.R. 2-9-2007; AM. S.R. 11-30-2007.

CORY BOONE, EXAMINING ATTORNEY

**Int. Cl.: 3**

**Prior U.S. Cls.: 1, 4, 6, 50, 51, and 52**

**United States Patent and Trademark Office**

**Reg. No. 3,396,646**

**Registered Mar. 11, 2008**

**TRADEMARK  
SUPPLEMENTAL REGISTER**

# Argan Body

ARGAN BODY LLC (NEW YORK LTD LIAB CO)  
41 MARBLE HILL AVENUE FLOOR 2  
NEW YORK, NY 10463

FOR: BODY AND BEAUTY CARE COSMETICS,  
IN CLASS 3 (U.S. CLS. 1, 4, 6, 50, 51 AND 52).

FIRST USE 1-5-2007; IN COMMERCE 1-5-2007.

THE MARK CONSISTS OF STANDARD CHAR-  
ACTERS WITHOUT CLAIM TO ANY PARTICULAR  
FONT, STYLE, SIZE, OR COLOR.

NO CLAIM IS MADE TO THE EXCLUSIVE  
RIGHT TO USE "ARGAN", APART FROM THE  
MARK AS SHOWN.

SER. NO. 77-104,469, FILED P.R. 2-10-2007; AM. S.R.  
1-31-2008.

ZHALEH DELANEY, EXAMINING ATTORNEY

**Int. Cl.: 43**

**Prior U.S. Cls.: 100 and 101**

**United States Patent and Trademark Office**

**Reg. No. 3,396,647**

**Registered Mar. 11, 2008**

**SERVICE MARK  
SUPPLEMENTAL REGISTER**

**THE LODGE AT PAINTED ROCK**

TEOFILO MANAGEMENT ENTERPRISES (CALIFORNIA CORPORATION)

P.O. BOX 3203

2908 PEARL HARBOR DRIVE

LAKE ISABELLA, CA 93240

FOR: PROVISION OF CONFERENCE FACILITIES; PROVISION OF MEETING FACILITIES; EXECUTIVE RETREAT SERVICES, NAMELY, PROVIDING MEETING AND CONFERENCE FACILITIES AND PROVIDING FOOD FOR BUSINESS GROUPS; PROVIDING BANQUET AND SOCIAL

FUNCTION FACILITIES FOR SPECIAL OCCASIONS, IN CLASS 43 (U.S. CLS. 100 AND 101).

FIRST USE 5-0-2007; IN COMMERCE 5-0-2007.

THE MARK CONSISTS OF STANDARD CHARACTERS WITHOUT CLAIM TO ANY PARTICULAR FONT, STYLE, SIZE, OR COLOR.

SER. NO. 77-105,638, FILED P.R. 2-12-2007; AM. S.R. 12-11-2007.

LINDA MICKLEBURGH, EXAMINING ATTORNEY

**Int. Cl.: 16**

**Prior U.S. Cls.: 2, 5, 22, 23, 29, 37, 38, and 50**

**United States Patent and Trademark Office**

**Reg. No. 3,396,648**

**Registered Mar. 11, 2008**

**TRADEMARK  
SUPPLEMENTAL REGISTER**

**YOURHEALTH MONTHLY  
AMERICA'S HEALTH BRAND**

GANNETT CO., INC. (DELAWARE CORPORATION)  
7950 JONES BRANCH DRIVE  
MCLEAN, VA 22201

FOR: MAGAZINES FEATURING TOPICS RELATED TO HEALTH, WELLNESS AND LIFESTYLE INFORMATION, IN CLASS 16 (U.S. CLS. 2, 5, 22, 23, 29, 37, 38 AND 50).

FIRST USE 6-6-2006; IN COMMERCE 6-6-2006.

THE MARK CONSISTS OF STANDARD CHARACTERS WITHOUT CLAIM TO ANY PARTICULAR FONT, STYLE, SIZE, OR COLOR.

SER. NO. 77-105,793, FILED P.R. 2-13-2007; AM. S.R. 12-4-2007.

LA TONIA FISHER, EXAMINING ATTORNEY

**Int. Cl.: 12**

**Prior U.S. Cls.: 19, 21, 23, 31, 35, and 44**

**United States Patent and Trademark Office**

**Reg. No. 3,396,649**

**Registered Mar. 11, 2008**

**TRADEMARK  
SUPPLEMENTAL REGISTER**

**UNIQUE FUNCTIONAL PRODUCTS**

UNIQUE FUNCTIONAL PRODUCTS, INC. (CALIFORNIA CORPORATION)  
135 SUNSHINE LANE  
SAN MARCOS, CA 92069

FOR: TRAILERS AND TRAILER PARTS, NAMELY, HYDRAULIC ACTUATORS, TRAILER COUPLERS, BRAKE SYSTEMS, AND SUSPENSION SYSTEMS, IN CLASS 12 (U.S. CLS. 19, 21, 23, 31, 35 AND 44).

FIRST USE 6-1-1989; IN COMMERCE 6-1-1989.

THE MARK CONSISTS OF STANDARD CHARACTERS WITHOUT CLAIM TO ANY PARTICULAR FONT, STYLE, SIZE, OR COLOR.

SER. NO. 77-105,799, FILED P.R. 2-13-2007; AM. S.R. 12-12-2007.

LA TONIA FISHER, EXAMINING ATTORNEY

**Int. Cl.: 35**

**Prior U.S. Cls.: 100, 101, and 102**

**United States Patent and Trademark Office**

**Reg. No. 3,396,650**

**Registered Mar. 11, 2008**

**SERVICE MARK  
SUPPLEMENTAL REGISTER**

**AUCTION NETWORK**

AUCTION NETWORK, LLC (DELAWARE LTD  
LIAB CO)  
7666 E. 61ST ST. SUITE 135  
TULSA, OK 74133

THE MARK CONSISTS OF STANDARD CHAR-  
ACTERS WITHOUT CLAIM TO ANY PARTICULAR  
FONT, STYLE, SIZE, OR COLOR.

FOR: ADVERTISING AND MARKETING OF  
AUCTIONS, IN CLASS 35 (U.S. CLS. 100, 101 AND  
102).

SER. NO. 77-105,930, FILED P.R. 2-13-2007; AM. S.R.  
11-30-2007.

FIRST USE 8-1-2006; IN COMMERCE 8-1-2006.

HEATHER THOMPSON, EXAMINING ATTORNEY

**Int. Cls.: 36 and 45**

**Prior U.S. Cls.: 100, 101, and 102**

**United States Patent and Trademark Office**

**Reg. No. 3,396,651**

**Registered Mar. 11, 2008**

**SERVICE MARK  
SUPPLEMENTAL REGISTER**

**THE VETERANS FUNERAL PLAN**

WATTS FUNERAL HOMES (FLORIDA CORPORATION)  
720 HWY. 17, S.  
SAN MATEO, FL 32187

FOR: PRE-PAID FUNERAL EXPENSE SERVICES,  
IN CLASS 36 (U.S. CLS. 100, 101 AND 102).

FIRST USE 1-3-2007; IN COMMERCE 1-3-2007.

FOR: CREMATION; FUNERAL ARRANGEMENT SERVICES; FUNERAL HOMES; FUNERAL SERVICE UNDERTAKING, IN CLASS 45 (U.S. CLS. 100 AND 101).

FIRST USE 1-3-2007; IN COMMERCE 1-3-2007.

THE MARK CONSISTS OF STANDARD CHARACTERS WITHOUT CLAIM TO ANY PARTICULAR FONT, STYLE, SIZE, OR COLOR.

NO CLAIM IS MADE TO THE EXCLUSIVE RIGHT TO USE "FUNERAL PLAN", APART FROM THE MARK AS SHOWN.

SER. NO. 77-107,150, FILED P.R. 2-14-2007; AM. S.R. 12-4-2007.

EVELYN BRADLEY, EXAMINING ATTORNEY

**Int. Cl.: 41**

**Prior U.S. Cls.: 100, 101, and 107**

**United States Patent and Trademark Office**

**Reg. No. 3,396,652**

**Registered Mar. 11, 2008**

**SERVICE MARK  
SUPPLEMENTAL REGISTER**

**ECOACH**

MEDECOACH.COM, INC. (TEXAS CORPORATION)  
710 NORTH POST OAK BOULEVARD, SUITE 150  
HOUSTON, TX 77024

FOR: PERSONAL COACHING SERVICES IN THE FIELD OF HEALTH AND WELLNESS; ONLINE INTERACTIVE PERSONAL COACHING SERVICES IN THE FIELD OF HEALTH AND WELLNESS , IN CLASS 41 (U.S. CLS. 100, 101 AND 107).

FIRST USE 8-28-2004; IN COMMERCE 8-28-2004.

THE MARK CONSISTS OF STANDARD CHARACTERS WITHOUT CLAIM TO ANY PARTICULAR FONT, STYLE, SIZE, OR COLOR.

OWNER OF U.S. REG. NO. 2,841,441.

SER. NO. 77-115,115, FILED P.R. 2-23-2007; AM. S.R. 12-26-2007.

TINA BROWN, EXAMINING ATTORNEY



**Int. Cl.: 30**

**Prior U.S. Cl.: 46**

**United States Patent and Trademark Office**

**Reg. No. 3,396,653**

**Registered Mar. 11, 2008**

**TRADEMARK  
SUPPLEMENTAL REGISTER**

**BROWNIE BISCOTTI**

SUGARDADDY'S SUMPTUOUS SWEETIES, LLC  
(OHIO LTD LIAB CO)  
1347 CAMERON AVE.  
LEWIS CENTER, OH 43035

NO CLAIM IS MADE TO THE EXCLUSIVE  
RIGHT TO USE "BISCOTTI", APART FROM THE  
MARK AS SHOWN.

FOR: BISCOTTI, IN CLASS 30 (U.S. CL. 46).

FIRST USE 5-0-2007; IN COMMERCE 5-0-2007.

THE MARK CONSISTS OF STANDARD CHAR-  
ACTERS WITHOUT CLAIM TO ANY PARTICULAR  
FONT, STYLE, SIZE, OR COLOR.

SER. NO. 77-116,855, FILED P.R. 2-27-2007; AM. S.R.  
2-4-2008.

SOPHIA S. KIM, EXAMINING ATTORNEY

**Int. Cl.: 9**

**Prior U.S. Cls.: 21, 23, 26, 36, and 38**

**United States Patent and Trademark Office**

**Reg. No. 3,396,654**

**Registered Mar. 11, 2008**

**TRADEMARK  
SUPPLEMENTAL REGISTER**

**MARKET DATA STUDIO**

CODESTREET, LLC (NEW YORK LTD LIAB CO)  
9TH FLOOR  
11 WEST 42ND STREET  
NEW YORK, NY 10036

FOR: COMPUTER SOFTWARE PROGRAM FOR  
GENERATING AND APPLYING MARKET DATA  
SCENARIOS TO BE USED IN TESTING APPLICA-  
TIONS THAT CONSUME REAL-TIME MARKET  
DATA , IN CLASS 9 (U.S. CLS. 21, 23, 26, 36 AND 38).

FIRST USE 9-1-2007; IN COMMERCE 9-1-2007.

THE MARK CONSISTS OF STANDARD CHAR-  
ACTERS WITHOUT CLAIM TO ANY PARTICULAR  
FONT, STYLE, SIZE, OR COLOR.

SER. NO. 77-117,995, FILED P.R. 2-28-2007; AM. S.R.  
12-17-2007.

NICHOLAS ALTREE, EXAMINING ATTORNEY

**Int. Cl.: 9**

**Prior U.S. Cls.: 21, 23, 26, 36, and 38**

**United States Patent and Trademark Office**

**Reg. No. 3,396,655**

**Registered Mar. 11, 2008**

**TRADEMARK  
SUPPLEMENTAL REGISTER**

**MARKET DATA WAREHOUSE**

CODESTREET, LLC (NEW YORK LTD LIAB CO)  
9TH FLOOR  
11 WEST 42ND STREET  
NEW YORK, NY 10036

FOR: COMPUTER SOFTWARE PROGRAM FOR  
CAPTURING, STORING, DISPLAYING, AND AR-  
CHIVING FINANCIAL MARKET DATA, IN CLASS 9  
(U.S. CLS. 21, 23, 26, 36 AND 38).

FIRST USE 9-1-2007; IN COMMERCE 9-1-2007.

THE MARK CONSISTS OF STANDARD CHAR-  
ACTERS WITHOUT CLAIM TO ANY PARTICULAR  
FONT, STYLE, SIZE, OR COLOR.

SER. NO. 77-118,011, FILED P.R. 2-28-2007; AM. S.R.  
12-17-2007.

NICHOLAS ALTREE, EXAMINING ATTORNEY

**Int. Cl.: 9**

**Prior U.S. Cls.: 21, 23, 26, 36, and 38**

**United States Patent and Trademark Office**

**Reg. No. 3,396,656**

**Registered Mar. 11, 2008**

**TRADEMARK  
SUPPLEMENTAL REGISTER**

**MARKET DATA METRICS**

CODESTREET, LLC (NEW YORK LTD LIAB CO)  
9TH FLOOR  
11 WEST 42ND STREET  
NEW YORK, NY 10036

FOR: COMPUTER SOFTWARE PROGRAM FOR  
PERFORMANCE TESTING OF MARKET DATA  
DISTRIBUTION INFRASTRUCTURE, IN CLASS 9  
(U.S. CLS. 21, 23, 26, 36 AND 38).

FIRST USE 9-1-2007; IN COMMERCE 9-1-2007.

THE MARK CONSISTS OF STANDARD CHAR-  
ACTERS WITHOUT CLAIM TO ANY PARTICULAR  
FONT, STYLE, SIZE, OR COLOR.

SER. NO. 77-118,025, FILED P.R. 2-28-2007; AM. S.R.  
12-17-2007.

NICHOLAS ALTREE, EXAMINING ATTORNEY

**Int. Cl.: 35**

**Prior U.S. Cls.: 100, 101, and 102**

**United States Patent and Trademark Office**

**Reg. No. 3,396,657**

**Registered Mar. 11, 2008**

**SERVICE MARK  
SUPPLEMENTAL REGISTER**

**CENTER FOR CAPITAL MARKETS  
COMPETITIVENESS**

THE CHAMBER OF COMMERCE OF THE UNITED STATES OF AMERICA (D.C. CORPORATION)  
1615 H STREET, N.W.  
WASHINGTON, DC 20062

FOR: PUBLIC ADVOCACY TO PROMOTE AWARENESS OF THE IMPORTANCE OF CAPITAL MARKETS; LEGISLATIVE AND REGULATORY ADVOCACY SERVICES, NAMELY, PROMOTING LEGISLATION, REGULATION, POLICIES, AND REFORMS THAT SUPPORT STABILITY, TRANSPARENCY, FAIRNESS, AND INNOVATION IN CAPITAL MARKETS, IN CLASS 35 (U.S. CLS. 100, 101 AND 102).

FIRST USE 3-14-2007; IN COMMERCE 3-14-2007.

THE MARK CONSISTS OF STANDARD CHARACTERS WITHOUT CLAIM TO ANY PARTICULAR FONT, STYLE, SIZE, OR COLOR.

NO CLAIM IS MADE TO THE EXCLUSIVE RIGHT TO USE "CENTER", APART FROM THE MARK AS SHOWN.

SER. NO. 77-120,052, FILED P.R. 3-1-2007; AM. S.R. 12-5-2007.

CHRISTOPHER BUONGIORNO, EXAMINING ATTORNEY

**Int. Cl.: 35**

**Prior U.S. Cls.: 100, 101, and 102**

**United States Patent and Trademark Office**

**Reg. No. 3,396,658**

**Registered Mar. 11, 2008**

**SERVICE MARK  
SUPPLEMENTAL REGISTER**

**US-BAHRAIN BUSINESS COUNCIL**

THE CHAMBER OF COMMERCE OF THE UNITED STATES OF AMERICA (D.C. CORPORATION)  
1615 H STREET, NW  
WASHINGTON, DC 20062

FOR: ASSOCIATION SERVICES, NAMELY, PROMOTING THE INTERESTS OF AND UNDERSTANDING BETWEEN BUSINESS SECTORS OF BAHRAIN AND THE UNITED STATES, IN CLASS 35 (U.S. CLS. 100, 101 AND 102).

FIRST USE 12-6-2006; IN COMMERCE 12-6-2006.

THE MARK CONSISTS OF STANDARD CHARACTERS WITHOUT CLAIM TO ANY PARTICULAR FONT, STYLE, SIZE, OR COLOR.

NO CLAIM IS MADE TO THE EXCLUSIVE RIGHT TO USE "BUSINESS COUNCIL", APART FROM THE MARK AS SHOWN.

SER. NO. 77-120,071, FILED P.R. 3-1-2007; AM. S.R. 12-5-2007.

CHRISTOPHER BUONGIORNO, EXAMINING ATTORNEY

**Int. Cl.: 44**

**Prior U.S. Cls.: 100 and 101**

**United States Patent and Trademark Office**

**Reg. No. 3,396,659**

**Registered Mar. 11, 2008**

**SERVICE MARK  
SUPPLEMENTAL REGISTER**

ARIZONA CANCER INSTITUTE

TROPPER, SCOTT (UNITED STATES INDIVIDUAL)  
7337 E. THOMAS ROAD  
SCOTTSDALE, AZ 85251

FOR: MEDICAL SERVICES, IN CLASS 44 (U.S. CLS. 100 AND 101).

FIRST USE 10-31-2006; IN COMMERCE 10-31-2006.

THE MARK CONSISTS OF STANDARD CHARACTERS WITHOUT CLAIM TO ANY PARTICULAR FONT, STYLE, SIZE, OR COLOR.

NO CLAIM IS MADE TO THE EXCLUSIVE RIGHT TO USE "CANCER INSTITUTE", APART FROM THE MARK AS SHOWN.

SER. NO. 77-121,493, FILED P.R. 3-2-2007; AM. S.R. 12-13-2007.

WILLIAM BRECKENFELD, EXAMINING ATTORNEY

**Int. Cl.: 16**

**Prior U.S. Cls.: 2, 5, 22, 23, 29, 37, 38, and 50**

**United States Patent and Trademark Office**

**Reg. No. 3,396,660**

**Registered Mar. 11, 2008**

**TRADEMARK  
SUPPLEMENTAL REGISTER**

**EC CHECKPOINT**

LAND CORP OF CINCINNATI, INC. (OHIO CORPORATION)  
P.O BOX 498  
LEBANON, OH 45036

FOR: MOUNTED DOCUMENT HOLDER POSTED AT OR NEAR AN ENTRANCE TO A CONSTRUCTION SITE, PARTICULARLY FOR RETAINING INFORMATION AND DOCUMENTATION REGARDING EROSION CONTROL COMPLIANCE AT THE CONSTRUCTION SITE, IN CLASS 16 (U.S. CLS. 2, 5, 22, 23, 29, 37, 38 AND 50).

FIRST USE 12-14-2007; IN COMMERCE 12-14-2007.

THE MARK CONSISTS OF STANDARD CHARACTERS WITHOUT CLAIM TO ANY PARTICULAR FONT, STYLE, SIZE, OR COLOR.

SER. NO. 77-122,573, FILED P.R. 3-5-2007; AM. S.R. 12-19-2007.

LINDA E. BLOHM, EXAMINING ATTORNEY



**Int. Cl.: 35**

**Prior U.S. Cls.: 100, 101, and 102**

**United States Patent and Trademark Office**

**Reg. No. 3,396,661**

**Registered Mar. 11, 2008**

---

**SERVICE MARK  
SUPPLEMENTAL REGISTER**

**PAID EMAIL**

COTTERWEB ENTERPRISES, INC. (DELAWARE  
CORPORATION)  
SUITE 155  
1210 NORTHLAND DRIVE  
MINNEAPOLIS, MN 55120

FOR: ADVERTISING SERVICES, NAMELY, FA-  
CILITATING THE DELIVERY OF ADVERTISING  
MESSAGES TO CONSUMERS, IN CLASS 35 (U.S.  
CLS. 100, 101 AND 102).

FIRST USE 12-31-2001; IN COMMERCE 12-31-2001.

THE MARK CONSISTS OF STANDARD CHAR-  
ACTERS WITHOUT CLAIM TO ANY PARTICULAR  
FONT, STYLE, SIZE, OR COLOR.

SER. NO. 77-123,236, FILED P.R. 3-6-2007; AM. S.R.  
12-20-2007.

JILL PRATER, EXAMINING ATTORNEY

**Int. Cl.: 41**

**Prior U.S. Cls.: 100, 101, and 107**

**United States Patent and Trademark Office**

**Reg. No. 3,396,662**

**Registered Mar. 11, 2008**

**SERVICE MARK  
SUPPLEMENTAL REGISTER**

MAYBACH FAMILY FOUNDATION

THE WILHELM KARL MAYBACH FOUNDATION (CALIFORNIA CORPORATION)  
1584 STIL WELL ROAD, SUITE D  
SAN FRANCISCO, CA 94129

FOR: CHARITABLE SERVICES, NAMELY, MENTORING OF YOUNG ADULTS IN THE FIELDS OF EDUCATION, BUSINESS AND THE ARTS, IN CLASS 41 (U.S. CLS. 100, 101 AND 107).

FIRST USE 11-1-2005; IN COMMERCE 11-1-2005.

THE MARK CONSISTS OF STANDARD CHARACTERS WITHOUT CLAIM TO ANY PARTICULAR FONT, STYLE, SIZE, OR COLOR.

NO CLAIM IS MADE TO THE EXCLUSIVE RIGHT TO USE FAMILY FOUNDATION, APART FROM THE MARK AS SHOWN.

SER. NO. 77-123,440, FILED P.R. 3-6-2007; AM. S.R. 12-20-2007.

CHERYL CLAYTON, EXAMINING ATTORNEY

**Int. Cl.: 17**

**Prior U.S. Cls.: 1, 5, 12, 13, 35, and 50**

**United States Patent and Trademark Office**

**Reg. No. 3,396,663**

**Registered Mar. 11, 2008**

**TRADEMARK  
SUPPLEMENTAL REGISTER**

**LAMINATING USA**

RITCHIE, CORINNE (UNITED STATES INDIVIDUAL)  
50 WILSON DRIVE  
CARMEL, IN 46032

THE MARK CONSISTS OF STANDARD CHARACTERS WITHOUT CLAIM TO ANY PARTICULAR FONT, STYLE, SIZE, OR COLOR.

FOR: PLASTIC FILM FOR USE IN LAMINATING PAPER, IN CLASS 17 (U.S. CLS. 1, 5, 12, 13, 35 AND 50).

SER. NO. 77-123,714, FILED P.R. 3-6-2007; AM. S.R. 12-20-2007.

FIRST USE 3-16-2007; IN COMMERCE 3-16-2007.

KEVIN CORWIN, EXAMINING ATTORNEY

**Int. Cl.: 25**

**Prior U.S. Cls.: 22 and 39**

**United States Patent and Trademark Office**

**Reg. No. 3,396,664**

**Registered Mar. 11, 2008**

**TRADEMARK  
SUPPLEMENTAL REGISTER**

# SHOE PORN

JEFF, DAVID (UNITED STATES INDIVIDUAL)  
721 E. 100TH STREET  
CHICAGO, IL 60628

FOR: CLOTHING, NAMELY, ATHLETIC SHOES, BELTS, BOOTS, BOXER SHORTS, COATS, DENIM JACKETS, DENIM JEANS, DENIM SHIRTS, FOOTWEAR, GLOVES, GOLF SHIRTS, HATS, HEADWEAR, HOSIERY, JACKETS, JEANS, JERSEYS, JOGGING SUITS, JUMP SUITS, LINGERIE, NECKTIES, NECKWEAR, OVERALLS, PANTS, POLO SHIRTS, PULLOVERS, RUGBY SHIRTS, SCARVES, SHIRTS, SHOES, SHORTS, SLEEPWEAR, SOCKS, SPORT SHIRTS, SWEAT PANTS, SWEAT SHIRTS, SWEAT SHORTS, SWEATERS, T-SHIRTS, TANK TOPS, TIES, TURTLENECKS, UNDERWEAR, VESTS, VISORS, WARM-UP SUITS, AND WIND

RESISTANT JACKETS, IN CLASS 25 (U.S. CLS. 22 AND 39).

FIRST USE 6-1-2003; IN COMMERCE 6-1-2003.

THE MARK CONSISTS OF STANDARD CHARACTERS WITHOUT CLAIM TO ANY PARTICULAR FONT, STYLE, SIZE, OR COLOR.

NO CLAIM IS MADE TO THE EXCLUSIVE RIGHT TO USE "SHOE", APART FROM THE MARK AS SHOWN.

SER. NO. 77-124,577, FILED P.R. 3-7-2007; AM. S.R. 12-20-2007.

JANICE L. MCMORROW, EXAMINING ATTORNEY

Int. Cl.: 25

Prior U.S. Cls.: 22 and 39

United States Patent and Trademark Office

Reg. No. 3,396,665

Registered Mar. 11, 2008

TRADEMARK  
SUPPLEMENTAL REGISTER

The logo features the word "Shoe" in a large, elegant, black cursive script. Below it, the word "PORN" is written in a bold, black, sans-serif font with a thick outline. The two words are centered and stacked vertically.

DAVID JEFF (UNITED STATES INDIVIDUAL)  
721 E. 100TH STREET  
CHICAGO, IL 60628

FIRST USE 6-1-2003; IN COMMERCE 6-1-2003.

FOR: CLOTHING, NAMELY, ATHLETIC SHOES, BELTS, BOOTS, BOXER SHORTS, COATS, DENIM JACKETS, DENIM JEANS, DENIM SHIRTS, FOOTWEAR, GLOVES, GOLF SHIRTS, HATS, HEADWEAR, HOSIERY, JACKETS, JEANS, JERSEYS, JOGGING SUITS, JUMP SUITS, LINGERIE, NECKTIES, NECKWEAR, OVERALLS, PANTS, POLO SHIRTS, PULLOVERS, RUGBY SHIRTS, SCARVES, SHIRTS, SHOES, SHORTS, SLEEPWEAR, SOCKS, SPORT SHIRTS, SWEAT PANTS, SWEAT SHIRTS, SWEAT SHORTS, SWEATERS, T-SHIRTS, TANK TOPS, TIES, TURTLENECKS, UNDERWEAR, VESTS, VISORS, WARM-UP SUITS, AND WIND RESISTANT JACKETS, IN CLASS 25 (U.S. CLS. 22 AND 39).

NO CLAIM IS MADE TO THE EXCLUSIVE RIGHT TO USE "SHOE", APART FROM THE MARK AS SHOWN.

THE MARK CONSISTS OF THE WORD SHOE SHOWN IN A STYLIZED FONT ON TOP OF THE WORD "PORN" SHOWN IN A DIFFERENT STYLIZED FONT.

SER. NO. 77-124,643, FILED P.R. 3-7-2007; AM. S.R. 12-20-2007.

JANICE L. MCMORROW, EXAMINING ATTORNEY

**Int. Cl.: 35**

**Prior U.S. Cls.: 100, 101, and 102**

**United States Patent and Trademark Office**

**Reg. No. 3,396,666**

**Registered Mar. 11, 2008**

**SERVICE MARK  
SUPPLEMENTAL REGISTER**

**ANGLICAN DISTRICT OF  
VIRGINIA**

ANGLICAN DISTRICT OF VIRGINIA, AN ASSO-  
CIATION OF CHURCHES (VIRGINIA NON-  
PROFIT CORPORATION)  
10523 MAIN STREET, 3RD FLOOR, SUITE 38  
FAIRFAX, VA 22030

FOR: ASSOCIATION SERVICES, NAMELY, PRO-  
MOTING THE INTERESTS OF CHURCHES, IN  
CLASS 35 (U.S. CLS. 100, 101 AND 102).

FIRST USE 12-5-2006; IN COMMERCE 12-5-2006.

THE MARK CONSISTS OF STANDARD CHAR-  
ACTERS WITHOUT CLAIM TO ANY PARTICULAR  
FONT, STYLE, SIZE, OR COLOR.

SER. NO. 77-125,259, FILED P.R. 3-8-2007; AM. S.R.  
12-12-2007.

JORDAN BAKER, EXAMINING ATTORNEY

**Int. Cl.: 45**

**Prior U.S. Cls.: 100 and 101**

**United States Patent and Trademark Office**

**Reg. No. 3,396,667**

**Registered Mar. 11, 2008**

**SERVICE MARK  
SUPPLEMENTAL REGISTER**

**ANGLICAN DISTRICT OF  
VIRGINIA**

ANGLICAN DISTRICT OF VIRGINIA, AN ASSO-  
CIATION OF CHURCHES (VIRGINIA NON-  
PROFIT CORPORATION)  
10523 MAIN STREET, 3RD FLOOR, SUITE 38  
FAIRFAX, VA 22030

FOR: RELIGIOUS SERVICES, NAMELY, MIS-  
SIONARY, EVANGELISTIC AND MINISTERIAL  
SERVICES, IN CLASS 45 (U.S. CLS. 100 AND 101).

FIRST USE 12-5-2006; IN COMMERCE 12-5-2006.

THE MARK CONSISTS OF STANDARD CHAR-  
ACTERS WITHOUT CLAIM TO ANY PARTICULAR  
FONT, STYLE, SIZE, OR COLOR.

SER. NO. 77-125,267, FILED P.R. 3-8-2007; AM. S.R.  
12-12-2007.

JORDAN BAKER, EXAMINING ATTORNEY

**Int. Cls.: 36, 41, and 44**

**Prior U.S. Cls.: 100, 101, 102, and 107**

**United States Patent and Trademark Office**

**Reg. No. 3,396,668**

**Registered Mar. 11, 2008**

**SERVICE MARK  
SUPPLEMENTAL REGISTER**

**THE BOWLING FOUNDATION**

THE BOWLING FOUNDATION (TEXAS NON-PROFIT ORGANIZATION)  
P.O. BOX 5802  
ARLINGTON, TX 76005

FOR: PROVIDING EDUCATION SCHOLARSHIPS; PROVIDING GRANTS TO SCHOOLS AND NON-PROFIT ASSOCIATIONS FOR PURCHASE OF BOWLING EQUIPMENT AND PROVISION OF INSTRUCTION, IN CLASS 36 (U.S. CLS. 100, 101 AND 102).

FIRST USE 1-11-2006; IN COMMERCE 1-11-2006.

FOR: EDUCATION SERVICES, NAMELY, PROVIDING IN-SCHOOL BOWLING INSTRUCTION AND MULTI-DISCIPLINARY ACTIVITIES, NAMELY, MATH, LANGUAGE ARTS, PROBLEM SOLVING, COMPUTERS, AND PHYSICAL EDUCATION; EDUCATIONAL SERVICES, NAMELY, PROVIDING AFTER-SCHOOL BOWLING INSTRUCTION; CHARACTER-BUILDING ACTIVITIES, NAMELY, EDUCATIONAL WORKSHOPS IN THE FIELD OF CHARACTER-BUILDING; BOWLING INSTRUCTION; EDUCATION

SERVICES, NAMELY, PROVIDING INSTRUCTION IN THE FIELD OF BOWLING CENTER MANAGEMENT AND OPERATION; BOWLING CAMPS, IN CLASS 41 (U.S. CLS. 100, 101 AND 107).

FIRST USE 1-11-2006; IN COMMERCE 1-11-2006.

FOR: PROVIDING HEALTH AND NUTRITION INFORMATION, IN CLASS 44 (U.S. CLS. 100 AND 101).

FIRST USE 1-11-2006; IN COMMERCE 1-11-2006.

THE MARK CONSISTS OF STANDARD CHARACTERS WITHOUT CLAIM TO ANY PARTICULAR FONT, STYLE, SIZE, OR COLOR.

NO CLAIM IS MADE TO THE EXCLUSIVE RIGHT TO USE FOUNDATION, APART FROM THE MARK AS SHOWN.

SER. NO. 77-125,806, FILED P.R. 3-8-2007; AM. S.R. 12-20-2007.

KATHY DE JONGE, EXAMINING ATTORNEY



**Int. Cl.: 43**

**Prior U.S. Cls.: 100 and 101**

**United States Patent and Trademark Office**

**Reg. No. 3,396,669**

**Registered Mar. 11, 2008**

**SERVICE MARK  
SUPPLEMENTAL REGISTER**

# Gourmet Pizza Bar

DELLOVO, MATTHEW J. (UNITED STATES IN-  
DIVIDUAL)  
SUITE 6-312  
290 TURNPIKE ROAD  
WESTBOROUGH, MA 01581

FOR: RESTAURANT SERVICES, NAMELY, RES-  
TAURANTS ENGAGED IN THE PROCURING AND  
PROCESSING OF FOOD AND DRINK, INCLUDING  
ALCOHOL AND NON-ALCOHOL DRINK, FOR  
CONSUMPTION ON THE PREMISES, SELF-SER-  
VICE RESTAURANTS, FAST FOOD RESTAU-  
RANTS, TAKE-OUT, EAT-IN, DELIVERY AND  
CATERING, IN CLASS 43 (U.S. CLS. 100 AND 101).

FIRST USE 5-1-2007; IN COMMERCE 5-1-2007.

THE MARK CONSISTS OF STANDARD CHAR-  
ACTERS WITHOUT CLAIM TO ANY PARTICULAR  
FONT, STYLE, SIZE, OR COLOR.

NO CLAIM IS MADE TO THE EXCLUSIVE  
RIGHT TO USE "PIZZA BAR", APART FROM THE  
MARK AS SHOWN.

SER. NO. 77-126,984, FILED P.R. 3-9-2007; AM. S.R.  
12-20-2007.

REBECCA SMITH, EXAMINING ATTORNEY

**Int. Cl.: 11**

**Prior U.S. Cls.: 13, 21, 23, 31, and 34**

**United States Patent and Trademark Office**

**Reg. No. 3,396,670**

**Registered Mar. 11, 2008**

**TRADEMARK  
SUPPLEMENTAL REGISTER**

**LED SPINE LITE**

ZELCO INDUSTRIES, INC. (NEW YORK CORPORATION)

65 HAVEN AVENUE

MOUNT VERNON, NY 10553

FOR: BOOK LIGHTS, IN CLASS 11 (U.S. CLS. 13, 21, 23, 31 AND 34).

FIRST USE 10-31-2006; IN COMMERCE 10-31-2006.

THE MARK CONSISTS OF STANDARD CHARACTERS WITHOUT CLAIM TO ANY PARTICULAR FONT, STYLE, SIZE, OR COLOR.

NO CLAIM IS MADE TO THE EXCLUSIVE RIGHT TO USE LED AND LITE, APART FROM THE MARK AS SHOWN.

SER. NO. 77-128,349, FILED P.R. 3-12-2007; AM. S.R. 12-17-2007.

TIMOTHY FINNEGAN, EXAMINING ATTORNEY

**Int. Cl.: 12**

**Prior U.S. Cls.: 19, 21, 23, 31, 35, and 44**

**United States Patent and Trademark Office**

**Reg. No. 3,396,671**

**Registered Mar. 11, 2008**

**TRADEMARK  
SUPPLEMENTAL REGISTER**

**THE NEWHAULER**

D D FARM PRODUCTS INC. (VIRGINIA COR-  
PORATION)  
4349 STUDLEY ROAD  
MECHANICSVILLE, VA 23116

FOR: CARTS, IN CLASS 12 (U.S. CLS. 19, 21, 23, 31,  
35 AND 44).

FIRST USE 6-15-2007; IN COMMERCE 6-15-2007.

THE MARK CONSISTS OF STANDARD CHAR-  
ACTERS WITHOUT CLAIM TO ANY PARTICULAR  
FONT, STYLE, SIZE, OR COLOR.

SER. NO. 77-129,374, FILED P.R. 3-13-2007; AM. S.R.  
12-6-2007.

MARY ROSSMAN, EXAMINING ATTORNEY

**Int. Cl.: 35**

**Prior U.S. Cls.: 100, 101, and 102**

**United States Patent and Trademark Office**

**Reg. No. 3,396,672**

**Registered Mar. 11, 2008**

**SERVICE MARK  
SUPPLEMENTAL REGISTER**

**UNITED STATES CENTER FOR  
ENTREPRENEURSHIP**

MEADOWS, DAVID H (UNITED STATES INDIVIDUAL)  
1815 DOUGLAS AVENUE  
DUNEDIN, FL 34698

FOR: INFORMATION, ADVISORY AND CONSULTANCY SERVICES RELATING TO BUSINESS AND MANAGEMENT OR BUSINESS ADMINISTRATION, INCLUDING SUCH SERVICES PROVIDED ON LINE OR VIA THE INTERNET; ASSISTANCE, ADVISORY SERVICES AND CONSULTANCY WITH REGARD TO BUSINESS PLANNING, BUSINESS ANALYSIS, BUSINESS MANAGEMENT, AND BUSINESS ORGANIZATION; BUSINESS DEVELOPMENT SERVICES, NAMELY, PROVIDING START-UP SUPPORT FOR BUSINESSES OF OTHERS; BUSINESS SERVICES,

NAMELY, MATCHING POTENTIAL PRIVATE INVESTORS WITH ENTREPRENEURS NEEDING FUNDING; ARRANGING AND CONDUCTING BUSINESS CONFERENCES, IN CLASS 35 (U.S. CLS. 100, 101 AND 102).

FIRST USE 9-6-2007; IN COMMERCE 9-6-2007.

THE MARK CONSISTS OF STANDARD CHARACTERS WITHOUT CLAIM TO ANY PARTICULAR FONT, STYLE, SIZE, OR COLOR.

SER. NO. 77-129,513, FILED P.R. 3-13-2007; AM. S.R. 12-22-2007.

HOWARD B. LEVINE, EXAMINING ATTORNEY

**Int. Cl.: 35**

**Prior U.S. Cls.: 100, 101, and 102**

**United States Patent and Trademark Office**

**Reg. No. 3,396,673**

**Registered Mar. 11, 2008**

**SERVICE MARK  
SUPPLEMENTAL REGISTER**

**XLNTADS**

XLNTADS, LLC (CALIFORNIA LTD LIAB CO)  
14 VISTA MAR  
LAGUNA NIGUEL, CA 92677

FIRST USE 2-2-2007; IN COMMERCE 2-2-2007.

FOR: ADVERTISING AND PUBLICITY SERVICES, NAMELY, PROMOTING THE GOODS, SERVICES, BRAND IDENTITY AND COMMERCIAL INFORMATION AND NEWS OF THIRD PARTIES THROUGH AUDIO, VIDEO, DIGITAL AND ONLINE MEDIA, IN CLASS 35 (U.S. CLS. 100, 101 AND 102).

THE MARK CONSISTS OF STANDARD CHARACTERS WITHOUT CLAIM TO ANY PARTICULAR FONT, STYLE, SIZE, OR COLOR.

SER. NO. 77-131,295, FILED P.R. 3-14-2007; AM. S.R. 12-20-2007.

MARK SPARACINO, EXAMINING ATTORNEY

Int. Cl.: 29

Prior U.S. Cl.: 46

United States Patent and Trademark Office

Reg. No. 3,396,674

Registered Mar. 11, 2008

TRADEMARK  
SUPPLEMENTAL REGISTER



BENT AND CAIN LLC (MARYLAND LTD LIAB  
CO)  
206 S 10TH ST  
CRISFIELD, MD 21817

FOR: SEAFOOD, NAMELY, LOBSTER AND  
CRAB, IN CLASS 29 (U.S. CL. 46).

FIRST USE 3-1-2007; IN COMMERCE 3-1-2007.

NO CLAIM IS MADE TO THE EXCLUSIVE  
RIGHT TO USE "LOBSTER" AND THE PICTORIAL  
REPRESENTATION OF A LOBSTER, APART FROM  
THE MARK AS SHOWN.

THE COLOR(S) ORANGE IS/ARE CLAIMED AS A  
FEATURE OF THE MARK.

THE MARK CONSISTS OF AN ORANGE LOB-  
STER AGAINST A WHITE BACKGROUND, WORDS  
"FINE LOBSTER" ARE IN ORANGE.

SER. NO. 77-131,510, FILED P.R. 3-15-2007; AM. S.R.  
12-21-2007.

JILL C. ALT, EXAMINING ATTORNEY

**Int. Cl.: 31**

**Prior U.S. Cls.: 1 and 46**

**United States Patent and Trademark Office**

**Reg. No. 3,396,675**

**Registered Mar. 11, 2008**

**TRADEMARK  
SUPPLEMENTAL REGISTER**

**FLAVORSWEET**

SHUMAN PRODUCE, INC. (GEORGIA CORPORATION)  
P.O. BOX 60  
COBBTOWN, GA 30420

THE MARK CONSISTS OF STANDARD CHARACTERS WITHOUT CLAIM TO ANY PARTICULAR FONT, STYLE, SIZE, OR COLOR.

FOR: FRESH ONIONS, IN CLASS 31 (U.S. CLS. 1 AND 46).

SER. NO. 77-133,244, FILED P.R. 3-16-2007; AM. S.R. 12-26-2007.

FIRST USE 6-16-2007; IN COMMERCE 6-16-2007.

STEVEN PEREZ, EXAMINING ATTORNEY

**Int. Cl.: 16**

**Prior U.S. Cls.: 2, 5, 22, 23, 29, 37, 38, and 50**

**United States Patent and Trademark Office**

**Reg. No. 3,396,676**

**Registered Mar. 11, 2008**

**TRADEMARK  
SUPPLEMENTAL REGISTER**

**NEW YORK HOUSING JOURNAL**

COMMUNITY HOUSING IMPROVEMENT PRO-  
GRAM, INC. (NEW YORK NON-PROFIT COR-  
PORATION)  
3RD FLOOR  
377 BROADWAY  
NEW YORK, NY 10013

FOR: NEWSLETTERS IN THE FIELD OF RENT  
AND APARTMENT BUILDING REGULATIONS, IN  
CLASS 16 (U.S. CLS. 2, 5, 22, 23, 29, 37, 38 AND 50).

FIRST USE 9-1-2007; IN COMMERCE 9-1-2007.

THE MARK CONSISTS OF STANDARD CHAR-  
ACTERS WITHOUT CLAIM TO ANY PARTICULAR  
FONT, STYLE, SIZE, OR COLOR.

NO CLAIM IS MADE TO THE EXCLUSIVE  
RIGHT TO USE "JOURNAL", APART FROM THE  
MARK AS SHOWN.

SER. NO. 77-133,297, FILED P.R. 3-16-2007; AM. S.R.  
12-6-2007.

GINA FINK, EXAMINING ATTORNEY



**Int. Cl.: 36**

**Prior U.S. Cls.: 100, 101, and 102**

**United States Patent and Trademark Office**

**Reg. No. 3,396,677**

**Registered Mar. 11, 2008**

**SERVICE MARK  
SUPPLEMENTAL REGISTER**

**NEW YORK HOUSING JOURNAL**

COMMUNITY HOUSING IMPROVEMENT PRO-  
GRAM, INC. (NEW YORK NON-PROFIT COR-  
PORATION)  
3RD FLOOR  
377 BROADWAY  
NEW YORK, NY 10013

FOR: PROVIDING ON-LINE INFORMATION  
AND NEWS IN THE FIELD OF RENTAL OF  
APARTMENTS, IN CLASS 36 (U.S. CLS. 100, 101  
AND 102).

FIRST USE 9-1-2007; IN COMMERCE 9-1-2007.

THE MARK CONSISTS OF STANDARD CHAR-  
ACTERS WITHOUT CLAIM TO ANY PARTICULAR  
FONT, STYLE, SIZE, OR COLOR.

NO CLAIM IS MADE TO THE EXCLUSIVE  
RIGHT TO USE "JOURNAL", APART FROM THE  
MARK AS SHOWN.

SER. NO. 77-133,310, FILED P.R. 3-16-2007; AM. S.R.  
12-6-2007.

GINA FINK, EXAMINING ATTORNEY

**Int. Cl.: 41**

**Prior U.S. Cls.: 100, 101, and 107**

**United States Patent and Trademark Office**

**Reg. No. 3,396,678**

**Registered Mar. 11, 2008**

**SERVICE MARK  
SUPPLEMENTAL REGISTER**

**Educational Architects**

THE FRANCE FOUNDATION, INC. (CONNECTI-  
CUT CORPORATION)

SUITE 202, 230 SHORE ROAD

OLD LYME, CT 06371

FOR: PROVIDING CONTINUING MEDICAL  
EDUCATION COURSES, IN CLASS 41 (U.S. CLS.  
100, 101 AND 107).

FIRST USE 11-1-2007; IN COMMERCE 11-1-2007.

THE MARK CONSISTS OF STANDARD CHAR-  
ACTERS WITHOUT CLAIM TO ANY PARTICULAR  
FONT, STYLE, SIZE, OR COLOR.

NO CLAIM IS MADE TO THE EXCLUSIVE  
RIGHT TO USE "EDUCATIONAL", APART FROM  
THE MARK AS SHOWN.

SER. NO. 77-134,472, FILED P.R. 3-19-2007; AM. S.R.  
12-21-2007.

MARK RADEMACHER, EXAMINING ATTORNEY

**Int. Cl.: 41**

**Prior U.S. Cls.: 100, 101, and 107**

**United States Patent and Trademark Office**

**Reg. No. 3,396,679**

**Registered Mar. 11, 2008**

**SERVICE MARK  
SUPPLEMENTAL REGISTER**

**WINES WOMEN WANT**

WOMEN FOR WINE SENSE (CALIFORNIA COR-  
PORATION)  
P.O. BOX 10549  
NAPA, CA 94581

FOR: ENTERTAINMENT SERVICES, NAMELY,  
WINE TASTINGS; CONDUCTING SEMINARS IN  
THE FIELD OF WINE APPRECIATION, IN CLASS 41  
(U.S. CLS. 100, 101 AND 107).

FIRST USE 3-12-2007; IN COMMERCE 3-12-2007.

THE MARK CONSISTS OF STANDARD CHAR-  
ACTERS WITHOUT CLAIM TO ANY PARTICULAR  
FONT, STYLE, SIZE, OR COLOR.

SER. NO. 77-135,870, FILED P.R. 3-20-2007; AM. S.R.  
12-28-2007.

ANDREA BUTLER, EXAMINING ATTORNEY

**Int. Cl.: 28**

**Prior U.S. Cls.: 22, 23, 38, and 50**

**United States Patent and Trademark Office**

**Reg. No. 3,396,680**

**Registered Mar. 11, 2008**

**TRADEMARK  
SUPPLEMENTAL REGISTER**

**OUT FISHES ALL OTHER BAIT!**

PURE FISHING, INC. (IOWA CORPORATION)  
1900 18TH STREET  
SPIRIT LAKE, IA 51360

FOR: ARTIFICIAL FISHING BAIT, IN CLASS 28  
(U.S. CLS. 22, 23, 38 AND 50).

FIRST USE 11-1-2006; IN COMMERCE 2-6-2007.

THE MARK CONSISTS OF STANDARD CHAR-  
ACTERS WITHOUT CLAIM TO ANY PARTICULAR  
FONT, STYLE, SIZE, OR COLOR.

OWNER OF U.S. REG. NO. 3,022,276.

SER. NO. 77-139,236, FILED P.R. 3-23-2007; AM. S.R.  
12-14-2007.

ELISSA GARBER KON, EXAMINING ATTORNEY

**Int. Cl.: 28**

**Prior U.S. Cls.: 22, 23, 38, and 50**

**United States Patent and Trademark Office**

**Reg. No. 3,396,681**

**Registered Mar. 11, 2008**

**TRADEMARK  
SUPPLEMENTAL REGISTER**

**OUT FISHES LIVE!**

PURE FISHING, INC. (IOWA CORPORATION)  
1900 18TH STREET  
SPIRIT LAKE, IA 51360

FOR: ARTIFICIAL FISHING BAIT, IN CLASS 28  
(U.S. CLS. 22, 23, 38 AND 50).

FIRST USE 11-1-2006; IN COMMERCE 6-15-2007.

THE MARK CONSISTS OF STANDARD CHAR-  
ACTERS WITHOUT CLAIM TO ANY PARTICULAR  
FONT, STYLE, SIZE, OR COLOR.

OWNER OF U.S. REG. NO. 3,022,276.

SER. NO. 77-139,308, FILED P.R. 3-23-2007; AM. S.R.  
12-14-2007.

ELISSA GARBER KON, EXAMINING ATTORNEY

**Int. Cl.: 28**

**Prior U.S. Cls.: 22, 23, 38, and 50**

**United States Patent and Trademark Office**

**Reg. No. 3,396,682**

**Registered Mar. 11, 2008**

**TRADEMARK  
SUPPLEMENTAL REGISTER**

**MICROFUSE**

PURE FISHING, INC. (IOWA CORPORATION)  
1900 18TH STREET  
SPIRIT LAKE, IA 51360

FOR: FISHING LINE, IN CLASS 28 (U.S. CLS. 22,  
23, 38 AND 50).

FIRST USE 3-5-2007; IN COMMERCE 5-31-2007.

THE MARK CONSISTS OF STANDARD CHAR-  
ACTERS WITHOUT CLAIM TO ANY PARTICULAR  
FONT, STYLE, SIZE, OR COLOR.

SER. NO. 77-139,365, FILED P.R. 3-23-2007; AM. S.R.  
12-14-2007.

ELISSA GARBER KON, EXAMINING ATTORNEY

**Int. Cl.: 11**

**Prior U.S. Cls.: 13, 21, 23, 31, and 34**

**United States Patent and Trademark Office**

**Reg. No. 3,396,683**

**Registered Mar. 11, 2008**

**TRADEMARK  
SUPPLEMENTAL REGISTER**

**SENSOR**

ZELCO INDUSTRIES, INC. (NEW YORK CORPORATION)  
65 HAVEN AVENUE  
NEW YORK, NY 10553

FOR: FLASH LIGHTS, IN CLASS 11 (U.S. CLS. 13, 21, 23, 31 AND 34).

FIRST USE 12-31-2005; IN COMMERCE 12-31-2005.

THE MARK CONSISTS OF STANDARD CHARACTERS WITHOUT CLAIM TO ANY PARTICULAR FONT, STYLE, SIZE, OR COLOR.

SER. NO. 77-140,692, FILED P.R. 3-26-2007; AM. S.R. 12-17-2007.

TIMOTHY FINNEGAN, EXAMINING ATTORNEY

**Int. Cl.: 41**

**Prior U.S. Cls.: 100, 101, and 107**

**United States Patent and Trademark Office**

**Reg. No. 3,396,684**

**Registered Mar. 11, 2008**

**SERVICE MARK  
SUPPLEMENTAL REGISTER**

**MR. KENNEDY**

WORLD WRESTLING ENTERTAINMENT, INC.  
(DELAWARE CORPORATION)  
1241 EAST MAIN STREET  
STAMFORD, CT 06902

FOR: ENTERTAINMENT SERVICES, NAMELY  
WRESTLING EXHIBITIONS AND PERFORMAN-  
CES BY A PROFESSIONAL WRESTLER AND EN-  
TERTAINER; PROVIDING WRESTLING NEWS  
AND INFORMATION VIA A GLOBAL COMPUTER  
NETWORK, IN CLASS 41 (U.S. CLS. 100, 101 AND  
107).

FIRST USE 8-25-2005; IN COMMERCE 8-25-2005.

THE MARK CONSISTS OF STANDARD CHAR-  
ACTERS WITHOUT CLAIM TO ANY PARTICULAR  
FONT, STYLE, SIZE, OR COLOR.

"THE NAME(S), PORTRAIT(S), AND/OR SIGNA-  
TURE(S) SHOWN IN THE MARK DOES NOT IDEN-  
TIFY A PARTICULAR LIVING INDIVIDUAL."

SER. NO. 77-141,719, FILED P.R. 3-27-2007; AM. S.R.  
12-26-2007.

TASHIA BUNCH, EXAMINING ATTORNEY



**Int. Cl.: 35**

**Prior U.S. Cls.: 100, 101, and 102**

**United States Patent and Trademark Office**

**Reg. No. 3,396,685**

**Registered Mar. 11, 2008**

**SERVICE MARK  
SUPPLEMENTAL REGISTER**

**CDR TRACKER**

WYATT MANAGEMENT CONSULTING INC.  
(CANADA CORPORATION)  
2387 DARLINGTON TRAIL  
OAKVILLE, CANADA L6H7J8

FOR: THE PROVISION OF INFORMATION IN  
RELATION TO PHARMACEUTICAL PRODUCTS  
THROUGH A GLOBAL COMPUTER NETWORK,  
IN CLASS 35 (U.S. CLS. 100, 101 AND 102).

THE MARK CONSISTS OF STANDARD CHAR-  
ACTERS WITHOUT CLAIM TO ANY PARTICULAR  
FONT, STYLE, SIZE, OR COLOR.

PRIORITY CLAIMED UNDER SEC. 44(D) ON  
CANADA APPLICATION NO. 1325978, FILED 11-28-  
2006, REG. NO. TMA698984, DATED 10-19-2007, EX-  
PIRES 10-19-2022.

SER. NO. 77-141,863, FILED P.R. 3-27-2007; AM. S.R.  
1-17-2008.

TIMOTHY FINNEGAN, EXAMINING ATTORNEY

**Int. Cl.: 41**

**Prior U.S. Cls.: 100, 101, and 107**

**United States Patent and Trademark Office**

**Reg. No. 3,396,686**

**Registered Mar. 11, 2008**

**SERVICE MARK  
SUPPLEMENTAL REGISTER**

**THE DETROIT SCHOOL OF ROCK  
AND POP MUSIC**

THE DETROIT SCHOOL OF ROCK LLC (MICHIGAN LTD LIAB CO)

11953 FARNUM AVE

WARREN, MI 48093

FOR: EDUCATIONAL SERVICES, NAMELY, CONDUCTING PROGRAMS IN THE FIELD OF MUSIC, IN CLASS 41 (U.S. CLS. 100, 101 AND 107).

FIRST USE 4-4-2007; IN COMMERCE 9-1-2007.

THE MARK CONSISTS OF STANDARD CHARACTERS WITHOUT CLAIM TO ANY PARTICULAR FONT, STYLE, SIZE, OR COLOR.

NO CLAIM IS MADE TO THE EXCLUSIVE RIGHT TO USE "SCHOOL OF ROCK AND POP MUSIC", APART FROM THE MARK AS SHOWN.

SER. NO. 77-147,361, FILED P.R. 4-3-2007; AM. S.R. 1-16-2008.

AISHA SALEM, EXAMINING ATTORNEY

**Int. Cl.: 17**

**Prior U.S. Cls.: 1, 5, 12, 13, 35, and 50**

**United States Patent and Trademark Office**

**Reg. No. 3,396,687**

**Registered Mar. 11, 2008**

**TRADEMARK  
SUPPLEMENTAL REGISTER**

**FASHION SNAPZ**

JOHN H. SCHOLL (UNITED STATES INDIVIDUAL)  
PO BOX 157  
THOMPSON RIDGE, NY 10985

FOR: SMALL DECORATIVE OBJECTS MADE OF RUBBER OR PLASTIC AS ORNAMENTS FOR ATTACHMENT TO WEARING APPAREL AND ACCESSORIES, NAMELY, HEAD WRAPS, HAIR BANDS, HAIR BARRETTES, HAIR CLIPS POCKETBOOKS, POCKETBOOK STRAPS, SHIRTS, SWEATSHIRTS, BELTS, HATS, AND SUN VISORS, IN CLASS 17 (U.S. CLS. 1, 5, 12, 13, 35 AND 50).

FIRST USE 6-28-2007; IN COMMERCE 6-28-2007.

THE MARK CONSISTS OF STANDARD CHARACTERS WITHOUT CLAIM TO ANY PARTICULAR FONT, STYLE, SIZE, OR COLOR.

NO CLAIM IS MADE TO THE EXCLUSIVE RIGHT TO USE "SNAPS", APART FROM THE MARK AS SHOWN.

SER. NO. 77-150,331, FILED P.R. 4-6-2007; AM. S.R. 12-21-2007.

TINA BROWN, EXAMINING ATTORNEY

**Int. Cl.: 35**

**Prior U.S. Cls.: 100, 101, and 102**

**United States Patent and Trademark Office**

**Reg. No. 3,396,688**

**Registered Mar. 11, 2008**

**SERVICE MARK  
SUPPLEMENTAL REGISTER**

**HOOF TRIMMING SPECIALTIES**

ROBISON, TRAVIS (UNITED STATES INDIVIDUAL)  
6727 TESSA LN.  
SILVERTON, OR 97381

FOR: MAIL ORDER SERVICES FEATURING  
HOOF TRIMMING SUPPLIES; ON-LINE RETAIL  
STORE SERVICES FEATURING HOOF TRIMMING  
SUPPLIES, IN CLASS 35 (U.S. CLS. 100, 101 AND 102).

FIRST USE 1-0-2006; IN COMMERCE 1-0-2007.

THE MARK CONSISTS OF STANDARD CHARACTERS WITHOUT CLAIM TO ANY PARTICULAR FONT, STYLE, SIZE, OR COLOR.

SER. NO. 77-150,699, FILED P.R. 4-6-2007; AM. S.R. 12-6-2007.

DEZMONA MIZELLE, EXAMINING ATTORNEY

**Int. Cl.: 3**

**Prior U.S. Cls.: 1, 4, 6, 50, 51, and 52**

**United States Patent and Trademark Office**

**Reg. No. 3,396,689**

**Registered Mar. 11, 2008**

**TRADEMARK  
SUPPLEMENTAL REGISTER**

**LA ISHÁ**

LA ISHÁ, INC. (COLORADO CORPORATION)  
4950 SOUTH YOSEMITE ST. - SQ361  
GREENWOOD VILLAGE, CO 80111

"THE FOREIGN WORDING IN THE MARK  
TRANSLATES INTO ENGLISH AS FOR THE WO-  
MAN."

FOR: NON-MEDICATED SKIN CARE PREPARA-  
TIONS, IN CLASS 3 (U.S. CLS. 1, 4, 6, 50, 51 AND 52).

FIRST USE 10-19-2007; IN COMMERCE 10-19-2007.

SER. NO. 77-150,868, FILED P.R. 4-6-2007; AM. S.R.  
10-26-2007.

THE MARK CONSISTS OF STANDARD CHAR-  
ACTERS WITHOUT CLAIM TO ANY PARTICULAR  
FONT, STYLE, SIZE, OR COLOR.

CAROL SPILS, EXAMINING ATTORNEY

**Int. Cl.: 41**

**Prior U.S. Cls.: 100, 101, and 107**

**United States Patent and Trademark Office**

**Reg. No. 3,396,690**

**Registered Mar. 11, 2008**

**SERVICE MARK  
SUPPLEMENTAL REGISTER**

# Wordflicks

MACCLURE,TERRENCE (UNITED STATES IN-  
DIVIDUAL)  
1434 GRANT STREET  
BERKELEY, CA 94703

FOR: EDUCATIONAL SERVICES, NAMELY, OF-  
FERING TRAINING IN THE FIELD OF VOCABU-  
LARY AND AN ONLINE EDUCATIONAL  
ACTIVITY FOR STUDENTS TO CREATE FILMS  
ILLUSTRATING VOCABULARY WORD USAGE  
AND PROVIDING A WEBSITE FOR POSTING  
THEIR VOCABULARY INSTRUCTIONAL VIDEOS,  
IN CLASS 41 (U.S. CLS. 100, 101 AND 107).

FIRST USE 6-1-2006; IN COMMERCE 6-1-2006.

THE MARK CONSISTS OF STANDARD CHAR-  
ACTERS WITHOUT CLAIM TO ANY PARTICULAR  
FONT, STYLE, SIZE, OR COLOR.

SER. NO. 77-151,416, FILED P.R. 4-8-2007; AM. S.R.  
1-24-2008.

MARLENE BELL, EXAMINING ATTORNEY

**Int. Cl.: 12**

**Prior U.S. Cls.: 19, 21, 23, 31, 35, and 44**

**United States Patent and Trademark Office**

**Reg. No. 3,396,691**

**Registered Mar. 11, 2008**

**TRADEMARK  
SUPPLEMENTAL REGISTER**

**FORGIATO**

FORGIATO, INC (CALIFORNIA CORPORATION)  
12720 WENTWORTH ST.  
ARLETA, CA 91331

FOR: WHEEL RIMS AND WHEELS FOR CARS,  
TRUCKS AND SPORT UTILITY VEHICLES, IN  
CLASS 12 (U.S. CLS. 19, 21, 23, 31, 35 AND 44).

FIRST USE 6-2-2006; IN COMMERCE 7-4-2006.

THE MARK CONSISTS OF STANDARD CHAR-  
ACTERS WITHOUT CLAIM TO ANY PARTICULAR  
FONT, STYLE, SIZE, OR COLOR.

THE FOREIGN WORDING IN THE MARK  
TRANSLATES INTO ENGLISH AS FORGED.

SER. NO. 77-153,574, FILED P.R. 4-10-2007; AM. S.R.  
12-20-2007.

DAVID MURRAY, EXAMINING ATTORNEY

**Int. Cl.: 41**

**Prior U.S. Cls.: 100, 101, and 107**

**United States Patent and Trademark Office**

**Reg. No. 3,396,692**

**Registered Mar. 11, 2008**

**SERVICE MARK  
SUPPLEMENTAL REGISTER**

**HealthImaging & IT**

TRIMED MEDIA GROUP, INC. (RHODE ISLAND CORPORATION)  
235 PROMENADE ST, STE 455  
PROVIDENCE, RI 02908

FOR: PUBLICATION OF BOOKS, MAGAZINES, ALMANACS AND JOURNALS, IN CLASS 41 (U.S. CLS. 100, 101 AND 107).

FIRST USE 1-6-2003; IN COMMERCE 1-6-2003.

THE COLOR(S) BLACK AND RED IS/ARE CLAIMED AS A FEATURE OF THE MARK.

THE MARK CONSISTS OF THE WORD "HEALTH" IN BLACK, THE WORD "IMAGING" IN RED, THE AMPERSAND IN BLACK, AND THE LETTERS "IT" IN RED.

SER. NO. 77-153,713, FILED P.R. 4-11-2007; AM. S.R. 12-20-2007.

NATALIE POLZER, EXAMINING ATTORNEY



**Int. Cl.: 35**

**Prior U.S. Cls.: 100, 101, and 102**

**United States Patent and Trademark Office**

**Reg. No. 3,396,693**

**Registered Mar. 11, 2008**

**SERVICE MARK  
SUPPLEMENTAL REGISTER**

**MISSISSIPPI FARMERS MARKET**

MISSISSIPPI CENTRAL MARKET BOARD (MISSISSIPPI STATE AGENCY)  
121 NORTH JEFFERSON  
JACKSON, MS 39201

FOR: FARMERS MARKET AND FLEA MARKET SERVICES, IN CLASS 35 (U.S. CLS. 100, 101 AND 102).

FIRST USE 0-0-2005; IN COMMERCE 0-0-2005.

THE MARK CONSISTS OF STANDARD CHARACTERS WITHOUT CLAIM TO ANY PARTICULAR FONT, STYLE, SIZE, OR COLOR.

SER. NO. 77-158,251, FILED P.R. 4-17-2007; AM. S.R. 12-20-2007.

MARGERY A. TIERNEY, EXAMINING ATTORNEY

**Int. Cl.: 9**

**Prior U.S. Cls.: 21, 23, 26, 36, and 38**

**United States Patent and Trademark Office**

**Reg. No. 3,396,694**

**Registered Mar. 11, 2008**

**TRADEMARK  
SUPPLEMENTAL REGISTER**

**SITE MIX-INS**

LEEPFROG TECHNOLOGIES, INC. (IOWA CORPORATION)  
2105 ACT CIRCLE  
IOWA CITY, IA 52245

FOR: WEB SITE DEVELOPMENT SOFTWARE, IN CLASS 9 (U.S. CLS. 21, 23, 26, 36 AND 38).

FIRST USE 12-10-2007; IN COMMERCE 12-10-2007.

THE MARK CONSISTS OF STANDARD CHARACTERS WITHOUT CLAIM TO ANY PARTICULAR FONT, STYLE, SIZE, OR COLOR.

SER. NO. 77-160,314, FILED P.R. 4-19-2007; AM. S.R. 12-12-2007.

AMY MCMENAMIN, EXAMINING ATTORNEY

**Int. Cl.: 44**

**Prior U.S. Cls.: 100 and 101**

**United States Patent and Trademark Office**

**Reg. No. 3,396,695**

**Registered Mar. 11, 2008**

**SERVICE MARK  
SUPPLEMENTAL REGISTER**

**EXPRESSPASS**

TENET PATIENT FINANCIAL SERVICES, INC.  
(CALIFORNIA CORPORATION)  
SUITE 100  
13737 NOEL ROAD  
DALLAS, TX 75240

FOR: PROVIDING MEDICAL, HEALTHCARE  
AND HOSPITAL SERVICES FEATURING A DESIGNATED  
ADMITTING AREA WITHIN HOSPITALS  
TO ENABLE FASTER PATIENT REGISTRATION ,  
IN CLASS 44 (U.S. CLS. 100 AND 101).

FIRST USE 5-31-2006; IN COMMERCE 5-31-2006.

THE MARK CONSISTS OF STANDARD CHARACTERS  
WITHOUT CLAIM TO ANY PARTICULAR FONT,  
STYLE, SIZE, OR COLOR.

SER. NO. 77-162,737, FILED P.R. 4-23-2007; AM. S.R.  
12-21-2007.

LANA PHAM, EXAMINING ATTORNEY

**Int. Cl.: 36**

**Prior U.S. Cls.: 100, 101, and 102**

**United States Patent and Trademark Office**

**Reg. No. 3,396,696**

**Registered Mar. 11, 2008**

**SERVICE MARK  
SUPPLEMENTAL REGISTER**

**INFOTECH ALLIANCE**

FIRST CITIZENS BANCSHARES, INC. (DELA-  
WARE CORPORATION)  
4300 SIX FORKS ROAD  
RALEIGH, NC 27609

FOR: BANKING SERVICES, IN CLASS 36 (U.S.  
CLS. 100, 101 AND 102).

FIRST USE 10-1-2007; IN COMMERCE 10-1-2007.

THE MARK CONSISTS OF STANDARD CHAR-  
ACTERS WITHOUT CLAIM TO ANY PARTICULAR  
FONT, STYLE, SIZE, OR COLOR.

SER. NO. 77-164,446, FILED P.R. 4-24-2007; AM. S.R.  
12-11-2007.

JAY BESCH, EXAMINING ATTORNEY

**Int. Cls.: 9 and 41**

**Prior U.S. Cls.: 21, 23, 26, 36, 38, 100, 101, and 107**

**United States Patent and Trademark Office**

**Reg. No. 3,396,697**

**Registered Mar. 11, 2008**

**TRADEMARK  
SERVICE MARK  
SUPPLEMENTAL REGISTER**

**SUPERSTAR STRIPPERS**

HAYEK, JAMES A. (UNITED STATES INDIVIDUAL)  
1813 GREENWOOD DRIVE  
OLDSMAR, FL 34677

FOR: PRERECORDED DVD'S FEATURING PERFORMANCES OF EXOTIC DANCING AND DANCE PERFORMANCES, AND MUSICAL, VARIETY, NEWS AND COMEDY SHOWS , IN CLASS 9 (U.S. CLS. 21, 23, 26, 36 AND 38).

FIRST USE 4-24-2007; IN COMMERCE 4-24-2007.

FOR: ENTERTAINMENT SERVICES, NAMELY, DANCE PERFORMANCES, PLANNING AND CONDUCTING LIVE THEATRICAL AND MUSICAL FLOOR SHOWS AT NIGHT CLUBS, ADULT NIGHT CLUBS, CASINOS AND THEATERS; ENTERTAINMENT IN THE NATURE OF AN ON-GOING SPECIAL VARIETY, NEWS OR MUSICAL TELEVISION SHOW FEATURING EXOTIC DANCING FOR MEN AND WOMEN, BROADCAST VIA TELEVISION, SATELLITE, AUDIO AND VIDEO; PROVIDING IN-

FORMATION IN THE FIELD OF PHOTOGRAPHIC, AUDIO, VISUAL AND PROSE PRESENTATIONS OF EXOTIC DANCING FOR MEN AND WOMEN IN THE NATURE OF VISUAL AND AUDIO PERFORMANCES, AND MUSICAL, VARIETY, NEWS AND COMEDY SHOWS VIA INTERNET WEBSITE, IN CLASS 41 (U.S. CLS. 100, 101 AND 107).

FIRST USE 4-6-2007; IN COMMERCE 4-6-2007.

THE MARK CONSISTS OF STANDARD CHARACTERS WITHOUT CLAIM TO ANY PARTICULAR FONT, STYLE, SIZE, OR COLOR.

NO CLAIM IS MADE TO THE EXCLUSIVE RIGHT TO USE "STRIPPERS", APART FROM THE MARK AS SHOWN.

SER. NO. 77-164,485, FILED P.R. 4-24-2007; AM. S.R. 1-18-2008.

HENRY S. ZAK, EXAMINING ATTORNEY

**Int. Cl.: 40**

**Prior U.S. Cls.: 100, 103, and 106**

**United States Patent and Trademark Office**

**Reg. No. 3,396,698**

**Registered Mar. 11, 2008**

**SERVICE MARK  
SUPPLEMENTAL REGISTER**

**ELECTRONIC RECYCLERS  
INTERNATIONAL**

ELECTRONIC RECYCLERS INTERNATIONAL  
INC. (DELAWARE CORPORATION)  
P.O. BOX 2428  
FRESNO, CA 93745

THE MARK CONSISTS OF STANDARD CHAR-  
ACTERS WITHOUT CLAIM TO ANY PARTICULAR  
FONT, STYLE, SIZE, OR COLOR.

FOR: ENVIRONMENTALLY SAFE SORTING  
AND DISPOSAL OF OBSOLETE ELECTRONIC  
GOODS, IN CLASS 40 (U.S. CLS. 100, 103 AND 106).

SER. NO. 77-167,662, FILED P.R. 4-27-2007; AM. S.R.  
1-23-2008.

FIRST USE 1-22-2008; IN COMMERCE 1-22-2008.

RICHARD A. STRASER, EXAMINING ATTORNEY

**Int. Cl.: 35**

**Prior U.S. Cls.: 100, 101, and 102**

**United States Patent and Trademark Office**

**Reg. No. 3,396,699**

**Registered Mar. 11, 2008**

**SERVICE MARK  
SUPPLEMENTAL REGISTER**

**CENTRAL OREGON SPORTSMEN'S  
SHOW & BOAT/RV SHOW**

TO-RO ENTERPRISES, INC. (OREGON CORPORATION)  
3600 S.W. MULTNOMAH BLVD.  
PORTLAND, OR 97219

OWNER OF U.S. REG. NOS. 2,560,586 AND 3,059,145.

FOR: ARRANGING AND CONDUCTING TRADE SHOWS IN THE FIELD OF RAFTING, CAMPING, BACKPACKING, FISHING, HUNTING, BOATING AND RECREATIONAL VEHICLES, IN CLASS 35 (U.S. CLS. 100, 101 AND 102).

NO CLAIM IS MADE TO THE EXCLUSIVE RIGHT TO USE "SPORTSMEN'S SHOW" & "BOAT/RV SHOW", APART FROM THE MARK AS SHOWN.

FIRST USE 3-1-2007; IN COMMERCE 3-1-2007.

SER. NO. 77-169,210, FILED P.R. 4-30-2007; AM. S.R. 12-27-2007.

THE MARK CONSISTS OF STANDARD CHARACTERS WITHOUT CLAIM TO ANY PARTICULAR FONT, STYLE, SIZE, OR COLOR.

MATTHEW MCDOWELL, EXAMINING ATTORNEY

**Int. Cl.: 35**

**Prior U.S. Cls.: 100, 101, and 102**

**United States Patent and Trademark Office**

**Reg. No. 3,396,700**

**Registered Mar. 11, 2008**

**SERVICE MARK  
SUPPLEMENTAL REGISTER**

**PORTLAND SPORTSHOW**

TO-RO ENTERPRISES, INC. (OREGON CORPORATION)

3600 S.W. MULTNOMAH BLVD.

PORTLAND, OR 97219

FOR: ARRANGING AND CONDUCTING TRADE SHOWS IN THE FIELD OF RAFTING, CAMPING, BACKPACKING, FISHING, HUNTING AND BOATING, IN CLASS 35 (U.S. CLS. 100, 101 AND 102).

FIRST USE 12-22-2007; IN COMMERCE 12-22-2007.

THE MARK CONSISTS OF STANDARD CHARACTERS WITHOUT CLAIM TO ANY PARTICULAR FONT, STYLE, SIZE, OR COLOR.

NO CLAIM IS MADE TO THE EXCLUSIVE RIGHT TO USE "SPORTSHOW", APART FROM THE MARK AS SHOWN.

SER. NO. 77-169,244, FILED P.R. 4-30-2007; AM. S.R. 12-27-2007.

MATTHEW MCDOWELL, EXAMINING ATTORNEY



**Int. Cl.: 3**

**Prior U.S. Cls.: 1, 4, 6, 50, 51, and 52**

**United States Patent and Trademark Office**

**Reg. No. 3,396,701**

**Registered Mar. 11, 2008**

**TRADEMARK  
SUPPLEMENTAL REGISTER**

**ANTIQUE CARE**

ANTIQUE EMPORIUM OF CARMEL (INDIANA  
SOLE PROPRIETORSHIP)  
1055 RANGE LINE ROAD  
CARMEL, IN 46032

FOR: FURNITURE POLISH; FURNITURE POL-  
ISHES; POLISH FOR MUSICAL INSTRUMENTS;  
POLISHING PREPARATIONS; WOOD CONDITION-  
ER, BRIGHTENER AND RENEWER; CLEANER  
FOR USE ON WOOD, LEATHER, METAL SURFA-  
CES, IN CLASS 3 (U.S. CLS. 1, 4, 6, 50, 51 AND 52).

FIRST USE 5-6-2007; IN COMMERCE 10-19-2007.

THE MARK CONSISTS OF STANDARD CHAR-  
ACTERS WITHOUT CLAIM TO ANY PARTICULAR  
FONT, STYLE, SIZE, OR COLOR.

SER. NO. 77-170,322, FILED P.R. 5-1-2007; AM. S.R.  
12-23-2007.

ESTHER A. BORSUK, EXAMINING ATTORNEY

**Int. Cls.: 29 and 30**

**Prior U.S. Cl.: 46**

**United States Patent and Trademark Office**

**Reg. No. 3,396,702**

**Registered Mar. 11, 2008**

**TRADEMARK  
SUPPLEMENTAL REGISTER**

**DIPPED FRUIT BOUQUET**

EDIBLE ARRANGEMENTS, LLC (CONNECTI-  
CUT LTD LIAB CO)  
95 BARNES ROAD  
WALLINGFORD, CT 064921800

FOR: FRESH FRUIT CUT INTO FLOWER  
SHAPES AND ARRANGED IN CONTAINERS AS  
FLORAL DESIGNS; PROCESSED FRUITS; AR-  
RANGEMENTS MADE OF FRESH PROCESSED  
FRUIT, IN CLASS 29 (U.S. CL. 46).

FIRST USE 3-10-2007; IN COMMERCE 3-10-2007.

FOR: FRESH FRUIT CUT INTO FLOWER  
SHAPES AND COATED WITH CHOCOLATE;  
FRESH FRUIT CUT INTO FLOWER SHAPES AND  
COATED WITH WITH CHOCOLATE AND ARRAN-  
GED IN CONTAINERS AS FLORAL DESIGNS; AR-

RANGEMENTS MADE OF PROCESSED FRUITS  
COATED WITH CHOCOLATE, IN CLASS 30 (U.S.  
CL. 46).

FIRST USE 3-10-2007; IN COMMERCE 3-10-2007.

THE MARK CONSISTS OF STANDARD CHAR-  
ACTERS WITHOUT CLAIM TO ANY PARTICULAR  
FONT, STYLE, SIZE, OR COLOR.

NO CLAIM IS MADE TO THE EXCLUSIVE  
RIGHT TO USE "DIPPED FRUIT", APART FROM  
THE MARK AS SHOWN.

SER. NO. 77-172,417, FILED P.R. 5-3-2007; AM. S.R.  
12-11-2007.

CAROLYN CATALDO, EXAMINING ATTORNEY

**Int. Cl.: 42**

**Prior U.S. Cls.: 100 and 101**

**United States Patent and Trademark Office**

**Reg. No. 3,396,703**

**Registered Mar. 11, 2008**

**SERVICE MARK  
SUPPLEMENTAL REGISTER**

**GREEN PEST MANAGEMENT**

NISUS CORPORATION (TENNESSEE CORPORATION)  
100 NISUS DRIVE  
ROCKFORD, TN 37853

FOR: CERTIFICATION SERVICES AND RELATED CONSULTING PROVIDED TO PEST CONTROL PROFESSIONALS FOR THE DEVELOPMENT, IMPLEMENTATION, CERTIFICATION, AND EVALUATION OF PEST CONTROL PROGRAMS AND PRODUCTS, IN CLASS 42 (U.S. CLS. 100 AND 101).

FIRST USE 12-19-2007; IN COMMERCE 12-19-2007.

THE MARK CONSISTS OF STANDARD CHARACTERS WITHOUT CLAIM TO ANY PARTICULAR FONT, STYLE, SIZE, OR COLOR.

SER. NO. 77-184,394, FILED P.R. 5-18-2007; AM. S.R. 12-21-2007.

BRIAN NEVILLE, EXAMINING ATTORNEY

**Int. Cl.: 37**

**Prior U.S. Cls.: 100, 103, and 106**

**United States Patent and Trademark Office**

**Reg. No. 3,396,704**

**Registered Mar. 11, 2008**

**SERVICE MARK  
SUPPLEMENTAL REGISTER**

**ULTIMATE AIRCRAFT  
MAINTENANCE CORPORATION**

ULTIMATE AIRCRAFT APPEARANCE COR-  
PORATION (NEW YORK CORPORATION)  
CARGO BUILDING 79 - JFK INTERNATIONAL  
AIRPORT  
JAMAICA, NY 11430

FOR: AIRCRAFT SERVICES, NAMELY, AIR-  
CRAFT MAINTENANCE AND REPAIR, IN CLASS  
37 (U.S. CLS. 100, 103 AND 106).

FIRST USE 6-30-2006; IN COMMERCE 6-30-2006.

THE MARK CONSISTS OF STANDARD CHAR-  
ACTERS WITHOUT CLAIM TO ANY PARTICULAR  
FONT, STYLE, SIZE, OR COLOR.

NO CLAIM IS MADE TO THE EXCLUSIVE  
RIGHT TO USE "AIRCRAFT MAINTENANCE COR-  
PORATION", APART FROM THE MARK AS  
SHOWN.

SER. NO. 77-188,681, FILED P.R. 5-23-2007; AM. S.R.  
12-18-2007.

PAUL E. FAHRENKOPF, EXAMINING ATTORNEY

**Int. Cl.: 41**

**Prior U.S. Cls.: 100, 101, and 107**

**United States Patent and Trademark Office**

**Reg. No. 3,396,705**

**Registered Mar. 11, 2008**

**SERVICE MARK  
SUPPLEMENTAL REGISTER**

**CALIFORNIA HOUSING HALL OF  
FAME**

CALIFORNIA HOUSING CONSORTIUM INSTI-  
TUTE (CALIFORNIA CORPORATION)  
369 PINE STREET, SUITE 310  
SAN FRANCISCO, CA 94104

FOR: EDUCATIONAL AND ADVOCACY SERVI-  
CES RELATED TO AFFORDABLE HOUSING,  
NAMELY, AN AWARDS PROGRAM TO RECOG-  
NIZE BUSINESSES AND INDIVIDUALS FOR THEIR  
LEADERSHIP AND ACHIEVEMENTS IN THE  
AREA OF PROMOTING AND SUPPORTING AF-  
FORDABLE HOUSING, IN CLASS 41 (U.S. CLS. 100,  
101 AND 107).

FIRST USE 4-27-2006; IN COMMERCE 4-27-2006.

THE MARK CONSISTS OF STANDARD CHAR-  
ACTERS WITHOUT CLAIM TO ANY PARTICULAR  
FONT, STYLE, SIZE, OR COLOR.

NO CLAIM IS MADE TO THE EXCLUSIVE  
RIGHT TO USE "HALL OF FAME", APART FROM  
THE MARK AS SHOWN.

SER. NO. 77-193,780, FILED 5-30-2007.

JEFFERY COWARD, EXAMINING ATTORNEY

**Int. Cl.: 16**

**Prior U.S. Cls.: 2, 5, 22, 23, 29, 37, 38, and 50**

**United States Patent and Trademark Office**

**Reg. No. 3,396,706**

**Registered Mar. 11, 2008**

**TRADEMARK  
SUPPLEMENTAL REGISTER**

**THE TRAVELER'S JOURNAL**

CHRISTIAN ART GIFTS, INC. (ILLINOIS CORPORATION)

1025 N. LOMBARD ROAD

LOMBARD, IL 60148

FOR: DIARIES DAILY AND PERIODIC TRAVEL RECORD BOOKS WITH RELIGIOUS AND/OR INSPIRATIONAL MESSAGES AND CONTENT, IN CLASS 16 (U.S. CLS. 2, 5, 22, 23, 29, 37, 38 AND 50).

FIRST USE 7-1-2006; IN COMMERCE 7-1-2006.

THE MARK CONSISTS OF STANDARD CHARACTERS WITHOUT CLAIM TO ANY PARTICULAR FONT, STYLE, SIZE, OR COLOR.

NO CLAIM IS MADE TO THE EXCLUSIVE RIGHT TO USE JOURNAL, APART FROM THE MARK AS SHOWN.

SER. NO. 77-194,481, FILED P.R. 5-31-2007; AM. S.R. 12-28-2007.

VIVIAN MICZNIK FIRST, EXAMINING ATTORNEY

**Int. Cl.: 35**

**Prior U.S. Cls.: 100, 101, and 102**

**United States Patent and Trademark Office**

**Reg. No. 3,396,707**

**Registered Mar. 11, 2008**

**SERVICE MARK  
SUPPLEMENTAL REGISTER**

**SHOPLOWVISION**

OPTELEC U.S., INC. (MASSACHUSETTS CORPORATION)  
321 BILLERICA ROAD  
CHELMSFORD, MA 01824

FOR: ELECTRONIC CATALOG SERVICES FEATURING VISION PRODUCTS; ELECTRONIC CATALOG ORDERING SERVICES FEATURING VISION PRODUCTS, IN CLASS 35 (U.S. CLS. 100, 101 AND 102).

FIRST USE 4-20-2007; IN COMMERCE 4-20-2007.

THE MARK CONSISTS OF STANDARD CHARACTERS WITHOUT CLAIM TO ANY PARTICULAR FONT, STYLE, SIZE, OR COLOR.

SER. NO. 77-197,531, FILED P.R. 6-5-2007; AM. S.R. 1-30-2008.

JAY FLOWERS, EXAMINING ATTORNEY

**Int. Cl.: 42**

**Prior U.S. Cls.: 100 and 101**

**United States Patent and Trademark Office**

**Reg. No. 3,396,708**

**Registered Mar. 11, 2008**

**SERVICE MARK  
SUPPLEMENTAL REGISTER**

**CARBON SCIENCES**

CARBON SCIENCES, INC. (NEVADA CORPORATION)  
50 CASTILIAN DRIVE, SUITE C  
SANTA BARBARA, CA 93117

FOR: SCIENTIFIC RESEARCH AND DEVELOPMENT, IN CLASS 42 (U.S. CLS. 100 AND 101).

FIRST USE 4-16-2007; IN COMMERCE 4-16-2007.

THE MARK CONSISTS OF STANDARD CHARACTERS WITHOUT CLAIM TO ANY PARTICULAR FONT, STYLE, SIZE, OR COLOR.

SER. NO. 77-198,401, FILED P.R. 6-5-2007; AM. S.R. 1-25-2008.

DANNEAN HETZEL, EXAMINING ATTORNEY



**Int. Cl.: 25**

**Prior U.S. Cls.: 22 and 39**

**United States Patent and Trademark Office**

**Reg. No. 3,396,709**

**Registered Mar. 11, 2008**

**TRADEMARK  
SUPPLEMENTAL REGISTER**

# Money Banks

LALUEZA, NICHOLAS (UNITED STATES INDIVIDUAL)  
9 FOREST DRIVE  
HIGHLAND LKS., NJ 07422

FOR: HATS; SWEATERS; T-SHIRTS, IN CLASS 25  
(U.S. CLS. 22 AND 39).

FIRST USE 3-10-2007; IN COMMERCE 3-10-2007.

THE MARK CONSISTS OF STANDARD CHARACTERS WITHOUT CLAIM TO ANY PARTICULAR FONT, STYLE, SIZE, OR COLOR.

SER. NO. 77-204,461, FILED P.R. 6-12-2007; AM. S.R. 9-19-2007.

ESTHER BELENKER, EXAMINING ATTORNEY

Int. Cl.: 37

Prior U.S. Cls.: 100, 103, and 106

**United States Patent and Trademark Office**

**Reg. No. 3,396,710**

Registered Mar. 11, 2008

**SERVICE MARK  
SUPPLEMENTAL REGISTER**

**FRYER PRO**

FRYER PRO, LLC (VIRGINIA LTD LIAB CO)  
932 EDWARDS FERRY ROAD, NO. 73  
LEESBURG, VA 20176

FOR: CLEANING OF COMMERCIAL DEEP FRYERS IN RESTAURANTS AND OTHER LARGE FOOD CATERERS, IN CLASS 37 (U.S. CLS. 100, 103 AND 106).

FIRST USE 1-15-2007; IN COMMERCE 1-15-2007.

THE MARK CONSISTS OF STANDARD CHARACTERS WITHOUT CLAIM TO ANY PARTICULAR FONT, STYLE, SIZE, OR COLOR.

NO CLAIM IS MADE TO THE EXCLUSIVE RIGHT TO USE "FRYER", APART FROM THE MARK AS SHOWN.

SER. NO. 77-207,223, FILED P.R. 6-15-2007; AM. S.R. 1-4-2008.

ROBERT C. CLARK JR., EXAMINING ATTORNEY

**Int. Cl.: 9**

**Prior U.S. Cls.: 21, 23, 26, 36, and 38**

**United States Patent and Trademark Office**

**Reg. No. 3,396,711**

**Registered Mar. 11, 2008**

**TRADEMARK  
SUPPLEMENTAL REGISTER**

# PC OVER IP

TERADICI CORPORATION (CANADA CORPORATION)  
4400 DOMINION STREET, SUITE 500  
BURNABY, CANADA

FOR: INTEGRATED CIRCUITS AND SOFTWARE FOR COMMUNICATION WITH AND REMOTE USE OF PERSONAL COMPUTER INTERFACES FOR COMMUNICATION OF GRAPHICS, VIDEO DISPLAYS, AUDIO, KEYBOARDS, PRINTERS, REMOVABLE MEDIA AND OTHER COMPUTER PERIPHERALS, IN CLASS 9 (U.S. CLS. 21, 23, 26, 36 AND 38).

FIRST USE 0-0-2006; IN COMMERCE 0-0-2006.

THE MARK CONSISTS OF STANDARD CHARACTERS WITHOUT CLAIM TO ANY PARTICULAR FONT, STYLE, SIZE, OR COLOR.

SER. NO. 77-208,571, FILED P.R. 6-18-2007; AM. S.R. 12-19-2007.

KYLE PEETE, EXAMINING ATTORNEY

**Int. Cl.: 28**

**Prior U.S. Cls.: 22, 23, 38, and 50**

**United States Patent and Trademark Office**

**Reg. No. 3,396,712**

**Registered Mar. 11, 2008**

**TRADEMARK  
SUPPLEMENTAL REGISTER**

**SUPERLIGHT**

BROWNING (UTAH CORPORATION)  
ONE BROWNING PLACE  
MORGAN, UT 84050

FOR: FISHING REELS; FISHING RODS, IN  
CLASS 28 (U.S. CLS. 22, 23, 38 AND 50).

FIRST USE 12-1-2004; IN COMMERCE 12-1-2004.

THE MARK CONSISTS OF STANDARD CHAR-  
ACTERS WITHOUT CLAIM TO ANY PARTICULAR  
FONT, STYLE, SIZE, OR COLOR.

SER. NO. 77-209,808, FILED P.R. 6-19-2007; AM. S.R.  
10-31-2007.

LAURIE KAUFMAN, EXAMINING ATTORNEY

**Int. Cl.: 8**

**Prior U.S. Cls.: 23, 28, and 44**

**United States Patent and Trademark Office**

**Reg. No. 3,396,713**

**Registered Mar. 11, 2008**

**TRADEMARK  
SUPPLEMENTAL REGISTER**

**PEDI BUFFER**

ARTEMIS WOMAN, LLC (CONNECTICUT LTD  
LIAB CO)

7 HOLLYHOCK ROAD

WILTON, CT 06897

FOR: BATTERY-OPERATED ELECTRIC PEDI-  
CURE SET, IN CLASS 8 (U.S. CLS. 23, 28 AND 44).

FIRST USE 10-25-2007; IN COMMERCE 10-25-2007.

THE MARK CONSISTS OF STANDARD CHAR-  
ACTERS WITHOUT CLAIM TO ANY PARTICULAR  
FONT, STYLE, SIZE, OR COLOR.

NO CLAIM IS MADE TO THE EXCLUSIVE  
RIGHT TO USE "BUFFER", APART FROM THE  
MARK AS SHOWN.

SER. NO. 77-212,114, FILED P.R. 6-21-2007; AM. S.R.  
12-7-2007.

ELLEN PERKINS, EXAMINING ATTORNEY

**Int. Cl.: 41**

**Prior U.S. Cls.: 100, 101, and 107**

**United States Patent and Trademark Office**

**Reg. No. 3,396,714**

**Registered Mar. 11, 2008**

**SERVICE MARK  
SUPPLEMENTAL REGISTER**

**Greensboro Bicentennial**

GREENSBORO BICENTENNIAL COMMISSION  
(NORTH CAROLINA CORPORATION)  
130 SUMMIT AVENUE  
GREENSBORO, NC 27401

FOR: ORGANIZING COMMUNITY FESTIVALS  
FEATURING A VARIETY OF ACTIVITIES, NAME-  
LY, ART EXHIBITIONS, HERITAGE MARKETS,  
ETHNIC DANCES, AND THE LIKE , IN CLASS 41  
(U.S. CLS. 100, 101 AND 107).

FIRST USE 5-1-2007; IN COMMERCE 5-1-2007.

THE MARK CONSISTS OF STANDARD CHAR-  
ACTERS WITHOUT CLAIM TO ANY PARTICULAR  
FONT, STYLE, SIZE, OR COLOR.

NO CLAIM IS MADE TO THE EXCLUSIVE  
RIGHT TO USE "BICENTENNIAL", APART FROM  
THE MARK AS SHOWN.

SER. NO. 77-214,723, FILED P.R. 6-25-2007; AM. S.R.  
10-3-2007.

MARIA-VICTORIA SUAREZ, EXAMINING ATTOR-  
NEY

**Int. Cl.: 44**

**Prior U.S. Cls.: 100 and 101**

**United States Patent and Trademark Office**

**Reg. No. 3,396,715**

**Registered Mar. 11, 2008**

**SERVICE MARK  
SUPPLEMENTAL REGISTER**

**SALON SPA SUITES**

OSWEGO SUITES, LLC (ILLINOIS LTD LIAB CO)  
SUITE 202  
123 WASHINGTON STREET  
OSWEGO, IL 60543

FIRST USE 9-16-2005; IN COMMERCE 6-1-2006.

SER. NO. 77-216,671, FILED P.R. 6-27-2007; AM. S.R.  
12-10-2007.

FOR: LEASING OF FULLY FURNISHED SALON  
SUITES, IN CLASS 44 (U.S. CLS. 100 AND 101).

SANI KHOURI, EXAMINING ATTORNEY

**Int. Cl.: 9**

**Prior U.S. Cls.: 21, 23, 26, 36, and 38**

**United States Patent and Trademark Office**

**Reg. No. 3,396,716**

**Registered Mar. 11, 2008**

**TRADEMARK  
SUPPLEMENTAL REGISTER**

**PARTY MIX**

MARTIN ROLAND INTERNATIONAL CORP.  
(CALIFORNIA CORPORATION)  
SUITE 113  
12368 E. VALLEY BLVD.  
EL MONTE, CA 91732

FOR: AUDIO EQUIPMENT, NAMELY, KAR-  
AOKE AMPLIFIER; COMBINATION SPEAKER  
AND MICROPHONE PA AMPLIFIER; MIXER;  
COMBINATION SPEAKER AND MICROPHONE ,  
IN CLASS 9 (U.S. CLS. 21, 23, 26, 36 AND 38).

FIRST USE 3-1-2006; IN COMMERCE 3-1-2006.

THE MARK CONSISTS OF STANDARD CHAR-  
ACTERS WITHOUT CLAIM TO ANY PARTICULAR  
FONT, STYLE, SIZE, OR COLOR.

SER. NO. 77-219,608, FILED P.R. 6-29-2007; AM. S.R.  
11-13-2007.

PAULA MAYS, EXAMINING ATTORNEY



**Int. Cl.: 42**

**Prior U.S. Cls.: 100 and 101**

**United States Patent and Trademark Office**

**Reg. No. 3,396,717**

**Registered Mar. 11, 2008**

**SERVICE MARK  
SUPPLEMENTAL REGISTER**

**Center for Improvement in  
Healthcare Quality**

CURTIS, RICHARD (UNITED STATES INDIVIDUAL)  
3101 BRIAR OAK LANE  
ROUND ROCK, TX 78681

FOR: ACCREDITATION CONSULTING SERVICES, NAMELY, DEVELOPING, EVALUATING, AND TESTING STANDARDS FOR HEALTHCARE SERVICES, FOR THE PURPOSE OF ACCREDITATION, IN CLASS 42 (U.S. CLS. 100 AND 101).

FIRST USE 11-0-1999; IN COMMERCE 11-0-1999.

THE MARK CONSISTS OF STANDARD CHARACTERS WITHOUT CLAIM TO ANY PARTICULAR FONT, STYLE, SIZE, OR COLOR.

SER. NO. 77-221,979, FILED P.R. 7-3-2007; AM. S.R. 11-8-2007.

ODESSA BIBBINS, EXAMINING ATTORNEY

**Int. Cl.: 9**

**Prior U.S. Cls.: 21, 23, 26, 36, and 38**

**Reg. No. 3,396,718**

**United States Patent and Trademark Office**

**Registered Mar. 11, 2008**

**TRADEMARK  
SUPPLEMENTAL REGISTER**

**D-Tech**  
**Digital Technologie**

K&H INT. INC. (CALIFORNIA CORPORATION)  
6209 GUS WAY  
ELK GROVE, CA 95757

FOR: ELECTRONICS, NAMELY, USB FLASH DISKS, MP3 PLAYERS, AND MP4 PLAYERS; COMPUTER ACCESSORIES, NAMELY, COMPUTER CARRYING CASES, COMPUTER MICE, KEYBOARDS, SPEAKERS, AND BLANK RECORDABLE DVD DISKS, CDR DISKS AND MINI DVDR DISKS, IN CLASS 9 (U.S. CLS. 21, 23, 26, 36 AND 38).

FIRST USE 7-11-2007; IN COMMERCE 7-11-2007.

NO CLAIM IS MADE TO THE EXCLUSIVE RIGHT TO USE "DIGITAL TECHNOLOGIE", APART FROM THE MARK AS SHOWN.

THE FOREIGN WORDING IN THE MARK TRANSLATES INTO ENGLISH AS "TECHNOLOGY".

SER. NO. 77-227,612, FILED 7-12-2007.

VIVIAN MICZNIK FIRST, EXAMINING ATTORNEY

**Int. Cl.: 41**

**Prior U.S. Cls.: 100, 101, and 107**

**United States Patent and Trademark Office**

**Reg. No. 3,396,719**

**Registered Mar. 11, 2008**

**SERVICE MARK  
SUPPLEMENTAL REGISTER**

**NUTCRACKER CIRQUE**

POET PRODUCTIONS, LLC (LOUISIANA LTD  
LIAB CO)  
1382 WEST MCNAB ROAD  
FT. LAUDERDALE, FL 33309

FOR: CONDUCTING ENTERTAINMENT EXHIBITIONS IN THE NATURE OF ACROBATICS COMBINED WITH ILLUSIONS AND MAGIC; ENTERTAINMENT IN THE NATURE OF THEATER PRODUCTIONS; ENTERTAINMENT, NAMELY, PRODUCTION OF THEATRICAL PERFORMANCES FEATURING ACROBATICS COMBINED WITH ILLUSIONS AND MAGIC; ENTERTAINMENT, NAMELY, PRODUCTION OF DVDS, COMPACT DISCS, AUDIO CASSETTES, AND VIDEO TAPES FEATURING EXHIBITIONS IN THE NATURE OF ACROBATICS COMBINED WITH ILLUSIONS AND MAGIC, IN CLASS 41 (U.S. CLS. 100, 101 AND 107).

FIRST USE 0-0-2004; IN COMMERCE 0-0-2004.

THE MARK CONSISTS OF STANDARD CHARACTERS WITHOUT CLAIM TO ANY PARTICULAR FONT, STYLE, SIZE, OR COLOR.

OWNER OF U.S. REG. NO. 3,126,292.

NO CLAIM IS MADE TO THE EXCLUSIVE RIGHT TO USE "CIRQUE", APART FROM THE MARK AS SHOWN.

THE FOREIGN WORDING IN THE MARK TRANSLATES INTO ENGLISH AS CIRCUS.

SER. NO. 77-239,559, FILED P.R. 7-26-2007; AM. S.R. 11-29-2007.

DAVID TAYLOR, EXAMINING ATTORNEY

**Int. Cl.: 35**

**Prior U.S. Cls.: 100, 101, and 102**

**United States Patent and Trademark Office**

**Reg. No. 3,396,720**

**Registered Mar. 11, 2008**

**SERVICE MARK  
SUPPLEMENTAL REGISTER**

**AMERICAN HOME CINEMAS**

BROADCAST TECHNICAL SERVICES, LLC (MISSISSIPPI LTD LIAB CO)  
905 ROCKFORD ROAD  
BIRMINGHAM, AL 35222

FOR: ON-LINE RETAIL STORE SERVICES FEATURING HOME ELECTRONICS SYSTEMS AND HOME THEATER SYSTEMS; WHOLESALE DISTRIBUTORSHIPS FEATURING HOME ELECTRONICS SYSTEMS AND HOME THEATER SYSTEMS; RETAIL STORE SERVICES FEATURING HOME ELECTRONICS SYSTEMS AND HOME THEATER SYSTEMS, IN CLASS 35 (U.S. CLS. 100, 101 AND 102).

FIRST USE 11-0-2007; IN COMMERCE 11-0-2007.

THE MARK CONSISTS OF STANDARD CHARACTERS WITHOUT CLAIM TO ANY PARTICULAR FONT, STYLE, SIZE, OR COLOR.

NO CLAIM IS MADE TO THE EXCLUSIVE RIGHT TO USE "HOME CINEMA", APART FROM THE MARK AS SHOWN.

SER. NO. 77-242,161, FILED P.R. 7-30-2007; AM. S.R. 1-31-2008.

PAUL F. GAST, EXAMINING ATTORNEY

**Int. Cl.: 6**

**Prior U.S. Cls.: 2, 12, 13, 14, 23, 25, and 50**

**United States Patent and Trademark Office**

**Reg. No. 3,396,721**

**Registered Mar. 11, 2008**

**TRADEMARK  
SUPPLEMENTAL REGISTER**

**COPPER**

BROWNING (UTAH CORPORATION)  
ONE BROWNING PLACE  
MORGAN, UT 84050

THE MARK CONSISTS OF STANDARD CHAR-  
ACTERS WITHOUT CLAIM TO ANY PARTICULAR  
FONT, STYLE, SIZE, OR COLOR.

FOR: METAL SAFES, IN CLASS 6 (U.S. CLS. 2, 12,  
13, 14, 23, 25 AND 50).

SER. NO. 77-242,248, FILED P.R. 7-30-2007; AM. S.R.  
10-31-2007.

FIRST USE 10-1-2005; IN COMMERCE 10-1-2005.

LAURIE KAUFMAN, EXAMINING ATTORNEY

**Int. Cl.: 9**

**Prior U.S. Cls.: 21, 23, 26, 36, and 38**

**United States Patent and Trademark Office**

**Reg. No. 3,396,722**

**Registered Mar. 11, 2008**

**TRADEMARK  
SUPPLEMENTAL REGISTER**

**ABS BrakeScan**

SPX CORPORATION (DELAWARE CORPORATION)  
13515 BALLANTYNE CORPORATE PLACE  
CHARLOTTE, NC 28277

FOR: ELECTRONIC DIAGNOSTIC SCAN TOOLS,  
NAMELY, VEHICLE OBD-II CODE READERS, IN  
CLASS 9 (U.S. CLS. 21, 23, 26, 36 AND 38).

FIRST USE 12-1-2007; IN COMMERCE 12-1-2007.

THE MARK CONSISTS OF STANDARD CHARACTERS WITHOUT CLAIM TO ANY PARTICULAR FONT, STYLE, SIZE, OR COLOR.

SER. NO. 77-248,115, FILED P.R. 8-6-2007; AM. S.R. 12-27-2007.

RONALD MCMORROW, EXAMINING ATTORNEY

**Int. Cl.: 42**

**Prior U.S. Cls.: 100 and 101**

**United States Patent and Trademark Office**

**Reg. No. 3,396,723**

**Registered Mar. 11, 2008**

**SERVICE MARK  
SUPPLEMENTAL REGISTER**

**CUSTOM CART SOLUTIONS**

CLASSIC CARTS CORPORATION (COLORADO CORPORATION), DBA CUSTOM CART SOLUTIONS,  
1828 85TH AVENUE COURT  
GREELEY, CO 80634

FOR: ENGINEERING AND DESIGN SERVICES FOR OTHERS OF INDUSTRY STANDARD CERTIFIED SELF CONTAINED, PERMANENT OR MOBILE FOOD UNITS AND KIOSKS , IN CLASS 42 (U.S. CLS. 100 AND 101).

FIRST USE 12-31-2004; IN COMMERCE 12-31-2004.

THE MARK CONSISTS OF STANDARD CHARACTERS WITHOUT CLAIM TO ANY PARTICULAR FONT, STYLE, SIZE, OR COLOR.

SER. NO. 77-253,744, FILED P.R. 8-13-2007; AM. S.R. 12-3-2007.

WARREN L. OLANDRIA, EXAMINING ATTORNEY

**Int. Cl.: 40**

**Prior U.S. Cls.: 100, 103, and 106**

**United States Patent and Trademark Office**

**Reg. No. 3,396,724**

**Registered Mar. 11, 2008**

**SERVICE MARK  
SUPPLEMENTAL REGISTER**

**Advanced Metal Processing**

CHINOOK SCIENCE GROUP CORPORATION  
(NEW JERSEY CORPORATION)

1150 RARITAN ROAD, SUITE 103

CRANFORD, NJ 07016

FOR: METAL RECLAMATION SERVICES;  
WASTE-TO-ENERGY GENERATION SERVICES, IN  
CLASS 40 (U.S. CLS. 100, 103 AND 106).

FIRST USE 4-27-2007; IN COMMERCE 4-27-2007.

THE MARK CONSISTS OF STANDARD CHAR-  
ACTERS WITHOUT CLAIM TO ANY PARTICULAR  
FONT, STYLE, SIZE, OR COLOR.

NO CLAIM IS MADE TO THE EXCLUSIVE  
RIGHT TO USE "METAL PROCESSING", APART  
FROM THE MARK AS SHOWN.

SER. NO. 77-257,545, FILED P.R. 8-16-2007; AM. S.R.  
12-13-2007.

COLLEEN KEARNEY, EXAMINING ATTORNEY



**Int. Cl.: 30**

**Prior U.S. Cl.: 46**

**United States Patent and Trademark Office**

**Reg. No. 3,396,725**

**Registered Mar. 11, 2008**

**TRADEMARK  
SUPPLEMENTAL REGISTER**

**DELICIOUS DESIGNS!**

CARRIGANS, INC (NORTH CAROLINA CORPORATION), DBA LOLLIPOP CREATIONS,  
PO BOX 11038  
CHARLOTTE, NC 28220

THE MARK CONSISTS OF STANDARD CHARACTERS WITHOUT CLAIM TO ANY PARTICULAR FONT, STYLE, SIZE, OR COLOR.

FOR: CANDY; CHOCOLATE CANDIES; GIFT BASKETS CONTAINING CANDY; LOLLIPOPS; MILK CHOCOLATE, IN CLASS 30 (U.S. CL. 46).

SER. NO. 77-259,610, FILED P.R. 8-20-2007; AM. S.R. 12-17-2007.

FIRST USE 1-1-2007; IN COMMERCE 3-1-2007.

JAY BESCH, EXAMINING ATTORNEY

**Int. Cl.: 41**

**Prior U.S. Cls.: 100, 101, and 107**

**United States Patent and Trademark Office**

**Reg. No. 3,396,726**

**Registered Mar. 11, 2008**

**SERVICE MARK  
SUPPLEMENTAL REGISTER**

**Free Try Traffic School**

FREE TRY TRAFFIC SCHOOL.COM INC (CALIFORNIA CORPORATION)

9903 SANTA MONICA BLVD. 736

BEVERLY HILLS, CA 90212

FOR: EDUCATIONAL SERVICES IN THE NATURE OF TRAFFIC SCHOOLS, IN CLASS 41 (U.S. CLS. 100, 101 AND 107).

FIRST USE 6-1-2007; IN COMMERCE 6-1-2007.

THE MARK CONSISTS OF STANDARD CHARACTERS WITHOUT CLAIM TO ANY PARTICULAR FONT, STYLE, SIZE, OR COLOR.

NO CLAIM IS MADE TO THE EXCLUSIVE RIGHT TO USE "TRAFFIC SCHOOL", APART FROM THE MARK AS SHOWN.

SER. NO. 77-261,392, FILED P.R. 8-22-2007; AM. S.R. 12-21-2007.

JOHN DWYER, EXAMINING ATTORNEY

**Int. Cl.: 25**

**Prior U.S. Cls.: 22 and 39**

**United States Patent and Trademark Office**

**Reg. No. 3,396,727**

**Registered Mar. 11, 2008**

**TRADEMARK  
SUPPLEMENTAL REGISTER**

**SAVE SOME FOR LATER**

TRUE CERTAINTY, INC. (CALIFORNIA CORPORATION)  
500 MOLINO STREET, SUITE 103  
LOS ANGELES, CA 90013

FOR: MEN'S AND WOMEN'S CLOTHING, NAMELY, SHIRTS, SHORTS, PANTS, JACKETS, HATS, BELTS AND FOOTWEAR, IN CLASS 25 (U.S. CLS. 22 AND 39).

FIRST USE 10-0-2006; IN COMMERCE 10-0-2006.

THE MARK CONSISTS OF STANDARD CHARACTERS WITHOUT CLAIM TO ANY PARTICULAR FONT, STYLE, SIZE, OR COLOR.

SER. NO. 77-263,020, FILED P.R. 8-23-2007; AM. S.R. 12-26-2007.

JORDAN BAKER, EXAMINING ATTORNEY

**Int. Cl.: 16**

**Prior U.S. Cls.: 2, 5, 22, 23, 29, 37, 38, and 50**

**United States Patent and Trademark Office**

**Reg. No. 3,396,728**

**Registered Mar. 11, 2008**

**TRADEMARK  
SUPPLEMENTAL REGISTER**

**Western Martial Arts  
WMA Illustrated**

PEREGRINUS PUBLISHING CO (ILLINOIS CORPORATION)  
5934 N. WASHTENAW AVE.  
CHICAGO, IL 60659

FOR: MAGAZINE COLUMNS ABOUT MARTIAL ARTS INFORMATION; MAGAZINE DEPARTMENTS IN THE FIELD OF MARTIAL ARTS INFORMATION; MAGAZINE SECTIONS IN THE FIELD OF MARTIAL ARTS INFORMATION; MAGAZINE SUPPLEMENTS TO NEWSPAPERS IN THE FIELD OF MARTIAL ARTS INFORMATION; MAGAZINES FEATURING MARTIAL ARTS INFORMATION, IN CLASS 16 (U.S. CLS. 2, 5, 22, 23, 29, 37, 38 AND 50).

FIRST USE 6-1-2007; IN COMMERCE 6-1-2007.

THE MARK CONSISTS OF STANDARD CHARACTERS WITHOUT CLAIM TO ANY PARTICULAR FONT, STYLE, SIZE, OR COLOR.

NO CLAIM IS MADE TO THE EXCLUSIVE RIGHT TO USE "ILLUSTRATED", APART FROM THE MARK AS SHOWN.

SER. NO. 77-263,341, FILED P.R. 8-24-2007; AM. S.R. 12-31-2007.

MICHELLE DUBOIS, EXAMINING ATTORNEY

**Int. Cl.: 41**

**Prior U.S. Cls.: 100, 101, and 107**

**United States Patent and Trademark Office**

**Reg. No. 3,396,729**

**Registered Mar. 11, 2008**

**SERVICE MARK  
SUPPLEMENTAL REGISTER**

# The HR Quarterly

BROOKENS, LARRY (CALIFORNIA SOLE PROPRIETORSHIP)  
P.O. BOX 91293  
CITY OF INDUSTRY, CA 91715

FOR: PUBLICATION OF BOOKS, OF MAGAZINES, OF JOURNALS, OF NEWSPAPERS, OF PERIODICALS, OF CATALOGS, OF BROCHURES, IN CLASS 41 (U.S. CLS. 100, 101 AND 107).

FIRST USE 3-2-2007; IN COMMERCE 7-1-2007.

THE MARK CONSISTS OF STANDARD CHARACTERS WITHOUT CLAIM TO ANY PARTICULAR FONT, STYLE, SIZE, OR COLOR.

SER. NO. 77-264,584, FILED P.R. 8-26-2007; AM. S.R. 1-2-2008.

BRENDAN REGAN, EXAMINING ATTORNEY

**Int. Cl.: 20**

**Prior U.S. Cls.: 2, 13, 22, 25, 32, and 50**

**United States Patent and Trademark Office**

**Reg. No. 3,396,730**

**Registered Mar. 11, 2008**

**TRADEMARK  
SUPPLEMENTAL REGISTER**

**worship chairs**

GABRIEL SERVICES, INC. (VIRGINIA CORPORATION)

PO BOX 513

1541 FRANKLIN STREET

ROCKY MOUNT, VA 24151

FOR: CHAIRS, IN CLASS 20 (U.S. CLS. 2, 13, 22, 25, 32 AND 50).

FIRST USE 11-26-2003; IN COMMERCE 1-5-2006.

THE MARK CONSISTS OF STANDARD CHARACTERS WITHOUT CLAIM TO ANY PARTICULAR FONT, STYLE, SIZE, OR COLOR.

NO CLAIM IS MADE TO THE EXCLUSIVE RIGHT TO USE "CHAIRS", APART FROM THE MARK AS SHOWN.

SER. NO. 77-267,980, FILED P.R. 8-30-2007; AM. S.R. 12-14-2007.

ATTIYA MALIK, EXAMINING ATTORNEY

**Int. Cl.: 44**

**Prior U.S. Cls.: 100 and 101**

**United States Patent and Trademark Office**

**Reg. No. 3,396,731**

**Registered Mar. 11, 2008**

**SERVICE MARK  
SUPPLEMENTAL REGISTER**

**THE FOOT TYPING CENTER**

SHAVELSON, DENNIS (UNITED STATES INDIVIDUAL)  
4 MILLBURY STREET  
SUFFERN, NY 10901

FOR: MEDICAL SERVICES, NAMELY, PODIATRY SERVICES IN THE NATURE OF DIAGNOSING AND TREATING MEDICAL ISSUES INVOLVING THE FEET; MEDICAL SERVICES, NAMELY, FITTING AND FABRICATING ORTHOTICS; MEDICAL SERVICES, NAMELY, FITTING AND ADJUSTING ORTHOTIC DEVICES; MEDICAL CONSULTATIONS; MEDICAL SERVICES, IN CLASS 44 (U.S. CLS. 100 AND 101).

FIRST USE 1-0-2007; IN COMMERCE 1-0-2007.

THE MARK CONSISTS OF STANDARD CHARACTERS WITHOUT CLAIM TO ANY PARTICULAR FONT, STYLE, SIZE, OR COLOR.

NO CLAIM IS MADE TO THE EXCLUSIVE RIGHT TO USE "THE FOOT AND CENTER", APART FROM THE MARK AS SHOWN.

SER. NO. 77-268,185, FILED P.R. 8-30-2007; AM. S.R. 12-18-2007.

TINA L. SNAPP, EXAMINING ATTORNEY

**Int. Cl.: 3**

**Prior U.S. Cls.: 1, 4, 6, 50, 51, and 52**

**United States Patent and Trademark Office**

**Reg. No. 3,396,732**

**Registered Mar. 11, 2008**

**TRADEMARK  
SUPPLEMENTAL REGISTER**

**MOLD MILDEW WIPES**

ERIC VON KNIPE (GREAT BRITAIN INDIVIDUAL)  
SUITE 620  
9601 WILSHIRE BLVD  
BEVERLY HILLS, CA 90210

FOR: DISPOSABLE WIPES IMPREGNATED WITH CLEANSING COMPOUNDS FOR HOUSEHOLD OR COMMERCIAL USE, IN CLASS 3 (U.S. CLS. 1, 4, 6, 50, 51 AND 52).

FIRST USE 2-9-2003; IN COMMERCE 2-9-2003.

THE MARK CONSISTS OF STANDARD CHARACTERS WITHOUT CLAIM TO ANY PARTICULAR FONT, STYLE, SIZE, OR COLOR.

NO CLAIM IS MADE TO THE EXCLUSIVE RIGHT TO USE "WIPES", APART FROM THE MARK AS SHOWN.

SER. NO. 77-273,472, FILED 9-6-2007.

KATINA MISTER, EXAMINING ATTORNEY



Int. Cl.: 31

Prior U.S. Cls.: 1 and 46

United States Patent and Trademark Office

Reg. No. 3,396,733

Registered Mar. 11, 2008

TRADEMARK  
SUPPLEMENTAL REGISTER

# Rotifer Diet

REED MARICULTURE INC. (CALIFORNIA  
CORPORATION)

511 PAMLAR AVE

SAN JOSE, CA 951284222

FOR: AQUACULTURE FEED, IN CLASS 31 (U.S.  
CLS. 1 AND 46).

FIRST USE 2-5-2003; IN COMMERCE 2-5-2003.

THE MARK CONSISTS OF STANDARD CHAR-  
ACTERS WITHOUT CLAIM TO ANY PARTICULAR  
FONT, STYLE, SIZE, OR COLOR.

NO CLAIM IS MADE TO THE EXCLUSIVE  
RIGHT TO USE "DIET", APART FROM THE MARK  
AS SHOWN.

SER. NO. 77-273,560, FILED P.R. 9-6-2007; AM. S.R.  
9-6-2007.

SIMON TENG, EXAMINING ATTORNEY

**Int. Cl.: 42**

**Prior U.S. Cls.: 100 and 101**

**United States Patent and Trademark Office**

**Reg. No. 3,396,734**

**Registered Mar. 11, 2008**

**SERVICE MARK  
SUPPLEMENTAL REGISTER**

**OFFICIAL CONEJO VALLEY  
WEBSITE**

MORSA, STEVE (UNITED STATES INDIVIDUAL)  
POB 1996  
THOUSAND OAKS, CA 91358

FOR: COMPUTER SERVICES, NAMELY, HOSTING AN ONLINE COMMUNITY WEBSITE FEATURING FACTS AND INFORMATION CONCERNING, AND OF VALUE TO, THE CURRENT EXISTING, FUTURE, AND VISITING RESIDENTS, BUSINESSES, AND OTHER ENTITIES OF THE CONEJO VALLEY AND NEIGHBORING COMMUNITIES, IN CLASS 42 (U.S. CLS. 100 AND 101).

FIRST USE 10-15-2007; IN COMMERCE 11-15-2007.

THE MARK CONSISTS OF STANDARD CHARACTERS WITHOUT CLAIM TO ANY PARTICULAR FONT, STYLE, SIZE, OR COLOR.

NO CLAIM IS MADE TO THE EXCLUSIVE RIGHT TO USE "WEBSITE", APART FROM THE MARK AS SHOWN.

SER. NO. 77-274,926, FILED P.R. 9-8-2007; AM. S.R. 12-19-2007.

TINA BROWN, EXAMINING ATTORNEY

**Int. Cl.: 9**

**Prior U.S. Cls.: 21, 23, 26, 36, and 38**

**United States Patent and Trademark Office**

**Reg. No. 3,396,735**

**Registered Mar. 11, 2008**

**TRADEMARK  
SUPPLEMENTAL REGISTER**

# American Video Art

ALARM ACCESSORY LTD. (DELAWARE CORPORATION), DBA WILMINGTON STUDIOS, 1509 BRANDYWINE BLVD WILMINGTON, DE 19809

FOR: AUDIO AND VIDEO RECORDINGS FEATURING PHOTOGRAPHS, ART, DRAMA, HUMOR, SATIRE, POLITICAL COMMENTARY, MUSIC, VIDEOS, ANIMATION; DIGITAL PHOTO FRAMES FOR DISPLAYING DIGITAL PICTURES, VIDEO CLIPS AND MUSIC; DOWNLOADABLE FILMS AND TV PROGRAMS FEATURING PHOTOGRAPHS, ART, DRAMA, HUMOR, SATIRE, POLITICAL COMMENTARY, MUSIC, VIDEOS, ANIMATION PROVIDED VIA A VIDEO-ON-DEMAND SERVICE; DOWNLOADABLE MULTIMEDIA FILE CONTAINING ARTWORK, TEXT, AUDIO, VIDEO, GAMES, AND INTERNET WEB LINKS RELATING TO PHOTOGRAPHS, ART, DRAMA, HUMOR, SATIRE, POLITICAL COMMENTARY, MUSIC, VIDEOS, ANIMATION; DOWNLOADABLE VIDEO RECORDINGS FEATURING PHOTOGRAPHS, ART, DRAMA, HUMOR, SATIRE, POLITICAL COMMENTARY, MUSIC, VIDEOS; PRERECORDED DIGITAL VIDEO DISKS FEATURING PHOTOGRAPHS, ART, DRAMA, HUMOR, SATIRE, POLITICAL COMMENTARY, MUSIC, VI-

DEOS, ANIMATION; PRERECORDED VIDEO CASSETTES FEATURING PHOTOGRAPHS, ART, DRAMA, HUMOR, SATIRE, POLITICAL COMMENTARY, MUSIC, VIDEOS, ANIMATION; PRERECORDED VIDEO TAPES FEATURING PHOTOGRAPHS, ART, DRAMA, HUMOR, SATIRE, POLITICAL COMMENTARY, MUSIC, VIDEOS, ANIMATION; VIDEO DISCS FEATURING PHOTOGRAPHS, ART, DRAMA, HUMOR, SATIRE, POLITICAL COMMENTARY, MUSIC, VIDEOS, ANIMATION; VIDEO RECORDINGS FEATURING PHOTOGRAPHS, ART, DRAMA, HUMOR, SATIRE, POLITICAL COMMENTARY, MUSIC, VIDEOS, ANIMATION; VIDEOTAPES AND VIDEO DISKS RECORDED WITH ANIMATION, IN CLASS 9 (U.S. CLS. 21, 23, 26, 36 AND 38).

FIRST USE 6-1-2007; IN COMMERCE 9-1-2007.

THE MARK CONSISTS OF STANDARD CHARACTERS WITHOUT CLAIM TO ANY PARTICULAR FONT, STYLE, SIZE, OR COLOR.

NO CLAIM IS MADE TO THE EXCLUSIVE RIGHT TO USE "VIDEO", APART FROM THE MARK AS SHOWN.

SER. NO. 77-275,016, FILED P.R. 9-9-2007; AM. S.R. 12-17-2007.

ANDREA BUTLER, EXAMINING ATTORNEY

**Int. Cls.: 35, 41, and 45**

**Prior U.S. Cls.: 100, 101, 102, and 107**

**United States Patent and Trademark Office**

**Reg. No. 3,396,736**

**Registered Mar. 11, 2008**

**SERVICE MARK  
SUPPLEMENTAL REGISTER**

**scout napa valley**

SPRINKEL, PATRICK (CALIFORNIA LTD LIAB CO), DBA SCOUT NAPA VALLEY, 6582 OAK LEAF COURT YOUNTVILLE, CA 94599

FOR: MEDIA PRODUCTION LOCATION SCOUTING SERVICES FOR ADVERTISING PURPOSES, IN CLASS 35 (U.S. CLS. 100, 101 AND 102).

FIRST USE 9-26-2006; IN COMMERCE 10-31-2006.

FOR: MEDIA PRODUCTION LOCATION SCOUTING SERVICES FOR ENTERTAINMENT PURPOSES, IN CLASS 41 (U.S. CLS. 100, 101 AND 107).

FIRST USE 9-26-2006; IN COMMERCE 10-31-2006.

FOR: PERSONAL CONCIERGE SERVICES FOR OTHERS COMPRISING MAKING REQUESTED PERSONAL ARRANGEMENTS AND RESERVATIONS, RUNNING ERRANDS AND PROVIDING

CUSTOMER SPECIFIC INFORMATION TO MEET INDIVIDUAL NEEDS, ALL RENDERED IN BUSINESS ESTABLISHMENTS, OFFICE BUILDINGS, HOTELS, RESIDENTIAL COMPLEXES AND HOMES, IN CLASS 45 (U.S. CLS. 100 AND 101).

FIRST USE 9-26-2006; IN COMMERCE 10-31-2006.

THE MARK CONSISTS OF STANDARD CHARACTERS WITHOUT CLAIM TO ANY PARTICULAR FONT, STYLE, SIZE, OR COLOR.

NO CLAIM IS MADE TO THE EXCLUSIVE RIGHT TO USE "SCOUT" IN CLASSES 035 AND 041, APART FROM THE MARK AS SHOWN.

SER. NO. 77-275,123, FILED P.R. 9-10-2007; AM. S.R. 12-20-2007.

ERNEST SHOSHO, EXAMINING ATTORNEY

**Int. Cl.: 41**

**Prior U.S. Cls.: 100, 101, and 107**

**United States Patent and Trademark Office**

**Reg. No. 3,396,737**

**Registered Mar. 11, 2008**

**SERVICE MARK  
SUPPLEMENTAL REGISTER**

**MORNING BRIEFING**

XM SATELLITE RADIO INC. (DELAWARE CORPORATION)  
1500 ECKINGTON PLACE, N.E.  
WASHINGTON, DC 20002

FOR: ENTERTAINMENT SERVICES, NAMELY, AN ONGOING RADIO PROGRAM IN THE FIELD OF POLITICS, IN CLASS 41 (U.S. CLS. 100, 101 AND 107).

FIRST USE 9-24-2007; IN COMMERCE 9-24-2007.

THE MARK CONSISTS OF STANDARD CHARACTERS WITHOUT CLAIM TO ANY PARTICULAR FONT, STYLE, SIZE, OR COLOR.

SER. NO. 77-276,197, FILED P.R. 9-11-2007; AM. S.R. 12-26-2007.

BRENDAN MCCAULEY, EXAMINING ATTORNEY

**Int. Cl.: 37**

**Prior U.S. Cls.: 100, 103, and 106**

**United States Patent and Trademark Office**

**Reg. No. 3,396,738**

**Registered Mar. 11, 2008**

**SERVICE MARK  
SUPPLEMENTAL REGISTER**

**Raleigh Fence Company**

RALEIGH FENCE COMPANY (NORTH CAROLINA LTD LIAB CO)

SUITE B

5020 DEPARTURE DRIVE

RALEIGH, NC 27616

FOR: INSTALLATION OF FENCES, IN CLASS 37  
(U.S. CLS. 100, 103 AND 106).

FIRST USE 3-1-2006; IN COMMERCE 3-20-2006.

THE MARK CONSISTS OF STANDARD CHARACTERS WITHOUT CLAIM TO ANY PARTICULAR FONT, STYLE, SIZE, OR COLOR.

NO CLAIM IS MADE TO THE EXCLUSIVE RIGHT TO USE "FENCE COMPANY", APART FROM THE MARK AS SHOWN.

SER. NO. 77-277,440, FILED P.R. 9-12-2007; AM. S.R. 12-20-2007.

JAY BESCH, EXAMINING ATTORNEY

**Int. Cl.: 41**

**Prior U.S. Cls.: 100, 101, and 107**

**United States Patent and Trademark Office**

**Reg. No. 3,396,739**

**Registered Mar. 11, 2008**

**SERVICE MARK  
SUPPLEMENTAL REGISTER**

**PRESS POOL**

XM SATELLITE RADIO INC. (DELAWARE CORPORATION)  
1500 ECKINGTON PLACE, N.E.  
WASHINGTON, DC 20002

FOR: ENTERTAINMENT SERVICES NAMELY AN ONGOING RADIO PROGRAM IN THE FIELD OF POLITICS, IN CLASS 41 (U.S. CLS. 100, 101 AND 107).

FIRST USE 9-27-2007; IN COMMERCE 9-24-2007.

THE MARK CONSISTS OF STANDARD CHARACTERS WITHOUT CLAIM TO ANY PARTICULAR FONT, STYLE, SIZE, OR COLOR.

SER. NO. 77-278,810, FILED P.R. 9-13-2007; AM. S.R. 12-26-2007.

BRENDAN MCCAULEY, EXAMINING ATTORNEY

**Int. Cl.: 36**

**Prior U.S. Cls.: 100, 101, and 102**

**United States Patent and Trademark Office**

**Reg. No. 3,396,740**

**Registered Mar. 11, 2008**

**SERVICE MARK  
SUPPLEMENTAL REGISTER**

**micro-loft**

THE AMERLAND GROUP, LLC (CALIFORNIA  
LTD LIAB CO)  
SUITE 240  
2878 CAMINO DEL RIO SOUTH  
SAN DIEGO, CA 92108

FIRST USE 8-18-2005; IN COMMERCE 8-11-2006.

THE MARK CONSISTS OF STANDARD CHAR-  
ACTERS WITHOUT CLAIM TO ANY PARTICULAR  
FONT, STYLE, SIZE, OR COLOR.

FOR: REAL ESTATE RENTAL SERVICES, NAME-  
LY, RENTAL OF RESIDENTIAL HOUSING APART-  
MENT UNITS THAT ARE LESS THAN FOUR  
HUNDRED AND FIFTY SQUARE FEET IN SIZE  
LOCATED IN BUILDINGS OVER TWO STORIES IN  
HEIGHT, IN CLASS 36 (U.S. CLS. 100, 101 AND 102).

SER. NO. 77-278,840, FILED P.R. 9-13-2007; AM. S.R.  
12-20-2007.

DAVID YONTEF, EXAMINING ATTORNEY



**Int. Cl.: 41**

**Prior U.S. Cls.: 100, 101, and 107**

**United States Patent and Trademark Office**

**Reg. No. 3,396,741**

**Registered Mar. 11, 2008**

**SERVICE MARK  
SUPPLEMENTAL REGISTER**

**POTUS LIVE**

XM SATELLITE RADIO INC. (DELAWARE CORPORATION)  
1500 ECKINGTON PLACE, N.E.  
WASHINGTON, DC 20002

FOR: ENTERTAINMENT SERVICES NAMELY AN ONGOING RADIO PROGRAM IN THE FIELD OF POLITICS, IN CLASS 41 (U.S. CLS. 100, 101 AND 107).

FIRST USE 9-24-2007; IN COMMERCE 9-24-2007.

THE MARK CONSISTS OF STANDARD CHARACTERS WITHOUT CLAIM TO ANY PARTICULAR FONT, STYLE, SIZE, OR COLOR.

NO CLAIM IS MADE TO THE EXCLUSIVE RIGHT TO USE "LIVE", APART FROM THE MARK AS SHOWN.

SER. NO. 77-279,589, FILED P.R. 9-14-2007; AM. S.R. 12-26-2007.

BRENDAN MCCAULEY, EXAMINING ATTORNEY

**Int. Cl.: 41**

**Prior U.S. Cls.: 100, 101, and 107**

**United States Patent and Trademark Office**

**Reg. No. 3,396,742**

**Registered Mar. 11, 2008**

**SERVICE MARK  
SUPPLEMENTAL REGISTER**

**AMERICA'S LEADING  
AUTHENTIC VOICE DOCTOR**

HOLLIS, NORMA (UNITED STATES INDIVIDUAL)

#10

630 W. QUEEN ST.

INGLEWOOD, CA 90301

FOR: PROFESSIONAL COACHING SERVICES IN THE FIELD OF PERSONAL AND PROFESSIONAL DEVELOPMENT FOR PUBLIC SPEAKERS, IN CLASS 41 (U.S. CLS. 100, 101 AND 107).

FIRST USE 7-9-2007; IN COMMERCE 7-9-2007.

THE MARK CONSISTS OF STANDARD CHARACTERS WITHOUT CLAIM TO ANY PARTICULAR FONT, STYLE, SIZE, OR COLOR.

SER. NO. 77-279,675, FILED P.R. 9-14-2007; AM. S.R. 12-18-2007.

MATTHEW MCDOWELL, EXAMINING ATTORNEY

**Int. Cl.: 41**

**Prior U.S. Cls.: 100, 101, and 107**

**United States Patent and Trademark Office**

**Reg. No. 3,396,743**

**Registered Mar. 11, 2008**

**SERVICE MARK  
SUPPLEMENTAL REGISTER**

**LOS ANGELES BRAZILIAN FILM  
FESTIVAL**

LOS ANGELES BRAZILIAN FILM FESTIVAL,  
INC. (CALIFORNIA CORPORATION)  
21515 HAWTHORNE BLVD., SUITE 200  
TORRANCE, CA 90503

FOR: ENTERTAINMENT SERVICES, NAMELY,  
PLANNING AND CONDUCTING A SERIES OF  
FILM FESTIVALS, IN CLASS 41 (U.S. CLS. 100, 101  
AND 107).

FIRST USE 2-1-2006; IN COMMERCE 5-1-2007.

THE MARK CONSISTS OF STANDARD CHAR-  
ACTERS WITHOUT CLAIM TO ANY PARTICULAR  
FONT, STYLE, SIZE, OR COLOR.

NO CLAIM IS MADE TO THE EXCLUSIVE  
RIGHT TO USE "FILM FESTIVAL", APART FROM  
THE MARK AS SHOWN.

SER. NO. 77-281,095, FILED P.R. 9-17-2007; AM. S.R.  
12-21-2007.

ELI HELLMAN, EXAMINING ATTORNEY

**Int. Cl.: 41**

**Prior U.S. Cls.: 100, 101, and 107**

**United States Patent and Trademark Office**

**Reg. No. 3,396,744**

**Registered Mar. 11, 2008**

**SERVICE MARK  
SUPPLEMENTAL REGISTER**

THE GLOBAL BUSINESS GAME

EXPERIENTIAL ADVENTURES LLC (OKLAHOMA LTD LIAB CO)

500 W. ROY STREET, W208

SEATTLE, WA 98119

FOR: ENTERTAINMENT SERVICES, NAMELY, PROVIDING AN ON-LINE COMPUTER GAME, IN CLASS 41 (U.S. CLS. 100, 101 AND 107).

FIRST USE 12-1-1999; IN COMMERCE 12-1-1999.

THE MARK CONSISTS OF STANDARD CHARACTERS WITHOUT CLAIM TO ANY PARTICULAR FONT, STYLE, SIZE, OR COLOR.

NO CLAIM IS MADE TO THE EXCLUSIVE RIGHT TO USE "GAME", APART FROM THE MARK AS SHOWN.

SER. NO. 77-281,991, FILED P.R. 9-18-2007; AM. S.R. 12-20-2007.

EMILY CHUO, EXAMINING ATTORNEY

**Int. Cl.: 35**

**Prior U.S. Cls.: 100, 101, and 102**

**United States Patent and Trademark Office**

**Reg. No. 3,396,745**

**Registered Mar. 11, 2008**

**SERVICE MARK  
SUPPLEMENTAL REGISTER**

**FLORIDA SCENTS**

DAYS, DOUGLAS (UNITED STATES INDIVIDUAL)  
1971 NE 148TH STREET  
NORTH MIAMI, FL 33181

FOR: ON-LINE RETAIL STORE SERVICES FEATURING AIR FRESHENERS, ROOM DEODORIZERS, INCENSE AND OILS, AND INCENSE BURNING AND OIL DISPENSING ACCESSORIES, IN CLASS 35 (U.S. CLS. 100, 101 AND 102).

FIRST USE 3-1-2007; IN COMMERCE 3-1-2007.

THE MARK CONSISTS OF STANDARD CHARACTERS WITHOUT CLAIM TO ANY PARTICULAR FONT, STYLE, SIZE, OR COLOR.

NO CLAIM IS MADE TO THE EXCLUSIVE RIGHT TO USE "SCENTS", APART FROM THE MARK AS SHOWN.

SER. NO. 77-284,177, FILED P.R. 9-20-2007; AM. S.R. 12-31-2007.

ESTHER BELENKER, EXAMINING ATTORNEY

**Int. Cls.: 39, 41, 42, and 43**

**Prior U.S. Cls.: 100, 101, 105, and 107**

**United States Patent and Trademark Office**

**Reg. No. 3,396,746**

**Registered Mar. 11, 2008**

**SERVICE MARK  
SUPPLEMENTAL REGISTER**

**We Rent for Less Always**

JAMES L COLE (UNITED STATES INDIVIDUAL)  
7340 W 21ST N, SUITE 102  
WICHITA, KS 67205

FOR: RENTAL OF REFRIGERATOR-FREEZERS  
FOR HOUSEHOLD PURPOSES, IN CLASS 39 (U.S.  
CLS. 100 AND 105).

FIRST USE 8-1-2007; IN COMMERCE 8-1-2007.

FOR: RENTAL OF TELEVISION SETS, IN CLASS  
41 (U.S. CLS. 100, 101 AND 107).

FIRST USE 8-1-2007; IN COMMERCE 8-1-2007.

FOR: RENTAL OF COMPUTERS, IN CLASS 42  
(U.S. CLS. 100 AND 101).

FIRST USE 8-1-2007; IN COMMERCE 8-1-2007.

FOR: RENTAL OF FURNITURE, IN CLASS 43  
(U.S. CLS. 100 AND 101).

FIRST USE 8-1-2007; IN COMMERCE 8-1-2007.

THE MARK CONSISTS OF STANDARD CHAR-  
ACTERS WITHOUT CLAIM TO ANY PARTICULAR  
FONT, STYLE, SIZE, OR COLOR.

SER. NO. 77-285,074, FILED 9-20-2007.

RONALD AIKENS, EXAMINING ATTORNEY

**Int. Cl.: 45**

**Prior U.S. Cls.: 100 and 101**

**United States Patent and Trademark Office**

**Reg. No. 3,396,747**

**Registered Mar. 11, 2008**

**SERVICE MARK  
SUPPLEMENTAL REGISTER**

**Legal Services for the  
Creation, Preservation and  
Transfer of Wealth**

KIRCHER, ALLEN D. (UNITED STATES INDIVIDUAL), DBA ALLEN D. KIRCHER, ATTORNEY AT LAW,

109 MEADOWLARK LANE

ST. CHARLES, MO 63301

FOR: LEGAL SERVICES, IN CLASS 45 (U.S. CLS. 100 AND 101).

FIRST USE 3-25-2004; IN COMMERCE 3-25-2004.

THE MARK CONSISTS OF STANDARD CHARACTERS WITHOUT CLAIM TO ANY PARTICULAR FONT, STYLE, SIZE, OR COLOR.

NO CLAIM IS MADE TO THE EXCLUSIVE RIGHT TO USE "LEGAL SERVICES", APART FROM THE MARK AS SHOWN.

SER. NO. 77-285,592, FILED P.R. 9-21-2007; AM. S.R. 12-27-2007.

ESTHER BELENKER, EXAMINING ATTORNEY

**Int. Cl.: 41**

**Prior U.S. Cls.: 100, 101, and 107**

**United States Patent and Trademark Office**

**Reg. No. 3,396,748**

**Registered Mar. 11, 2008**

**SERVICE MARK  
SUPPLEMENTAL REGISTER**

united america wound care  
group

NORENE THOMAS (UNITED STATES INDIVIDUAL)  
89-52 208 STREET  
QUEENS VILLAGE, NY 11427

FOR: MEDICAL TRAINING AND TEACHING; PROVIDING ON-LINE TRAINING COURSES IN THE FIELD OF HEALTH CARE; PUBLICATION OF DOCUMENTS IN THE FIELD OF TRAINING, SCIENCE, PUBLIC LAW AND SOCIAL AFFAIRS; TRAINING SERVICES IN THE FIELD OF HEALTH CARE, IN CLASS 41 (U.S. CLS. 100, 101 AND 107).

FIRST USE 7-1-2007; IN COMMERCE 7-1-2007.

THE MARK CONSISTS OF STANDARD CHARACTERS WITHOUT CLAIM TO ANY PARTICULAR FONT, STYLE, SIZE, OR COLOR.

NO CLAIM IS MADE TO THE EXCLUSIVE RIGHT TO USE "GROUP", APART FROM THE MARK AS SHOWN.

SER. NO. 77-286,566, FILED P.R. 9-23-2007; AM. S.R. 12-17-2007.

MICHAEL WIENER, EXAMINING ATTORNEY



**Int. Cl.: 30**

**Prior U.S. Cl.: 46**

**United States Patent and Trademark Office**

**Reg. No. 3,396,749**

**Registered Mar. 11, 2008**

**TRADEMARK  
SUPPLEMENTAL REGISTER**

**Maple Bacon Coffee Flavor**

FLAVOR DYNAMICS, INC. (NEW JERSEY CORPORATION)  
640 MONTROSE AVE.  
SOUTH PLAINFIELD, NJ 07080

FOR: FLAVORINGS FOR BEVERAGES, IN CLASS 30 (U.S. CL. 46).

FIRST USE 3-12-2007; IN COMMERCE 3-12-2007.

THE MARK CONSISTS OF STANDARD CHARACTERS WITHOUT CLAIM TO ANY PARTICULAR FONT, STYLE, SIZE, OR COLOR.

OWNER OF U.S. REG. NOS. 2,749,917 AND 2,959,169.

NO CLAIM IS MADE TO THE EXCLUSIVE RIGHT TO USE "COFFEE FLAVOR", APART FROM THE MARK AS SHOWN.

SER. NO. 77-292,679, FILED P.R. 10-1-2007; AM. S.R. 1-7-2008.

MELVIN AXILBUND, EXAMINING ATTORNEY

**Int. Cl.: 45**

**Prior U.S. Cls.: 100 and 101**

**United States Patent and Trademark Office**

**Reg. No. 3,396,750**

**Registered Mar. 11, 2008**

**SERVICE MARK  
SUPPLEMENTAL REGISTER**

# Spiritual Energetics

CASTELLANOS, MARYANN (CALIFORNIA  
SOLE PROPRIETORSHIP), DBA HEALTHY  
ENERGETICS,  
2106 SUMMERHILL DRIVE  
ENCINITAS, CA 92024

FOR: PROVIDING BOTH IN-PERSON AND ON-  
LINE HOLISTIC SPIRITUAL COUNSELING SERVI-  
CES; PROVIDING ON-LINE INFORMATION IN  
THE FIELD OF SPIRITUALITY, SELF-HELP, AND  
PERSONAL EMPOWERMENT SUBJECT MATTERS,  
IN CLASS 45 (U.S. CLS. 100 AND 101).

FIRST USE 4-0-2004; IN COMMERCE 8-0-2005.

THE MARK CONSISTS OF STANDARD CHAR-  
ACTERS WITHOUT CLAIM TO ANY PARTICULAR  
FONT, STYLE, SIZE, OR COLOR.

SER. NO. 77-304,756, FILED P.R. 10-15-2007; AM.  
S.R. 1-29-2008.

JASON LOTT, EXAMINING ATTORNEY

**Int. Cl.: 28**

**Prior U.S. Cls.: 22, 23, 38, and 50**

**United States Patent and Trademark Office**

**Reg. No. 3,396,751**

**Registered Mar. 11, 2008**

**TRADEMARK  
SUPPLEMENTAL REGISTER**

# Soaker Rides

SOAKER RIDES (NEVADA LTD LIAB CO)  
UNIT 115  
4333 SILVER STAR ROAD  
ORLANDO, FL 32808

FOR: AMUSEMENT PARK RIDES, IN CLASS 28  
(U.S. CLS. 22, 23, 38 AND 50).

FIRST USE 6-1-2007; IN COMMERCE 8-8-2007.

THE MARK CONSISTS OF STANDARD CHAR-  
ACTERS WITHOUT CLAIM TO ANY PARTICULAR  
FONT, STYLE, SIZE, OR COLOR.

NO CLAIM IS MADE TO THE EXCLUSIVE  
RIGHT TO USE "RIDES", APART FROM THE  
MARK AS SHOWN.

SER. NO. 77-305,417, FILED P.R. 10-16-2007; AM.  
S.R. 1-25-2008.

MATTHEW MCDOWELL, EXAMINING ATTOR-  
NEY

**Int. Cl.: 25**

**Prior U.S. Cls.: 22 and 39**

**United States Patent and Trademark Office**

**Reg. No. 3,396,752**

**Registered Mar. 11, 2008**

**TRADEMARK  
SUPPLEMENTAL REGISTER**

**USA STORES**

UNITED IP, LLC (TEXAS LTD LIAB CO)  
PO BOX 7640  
DALLAS, TX 75209

FOR: CLOTHING, NAMELY, SHIRTS, T-SHIRTS,  
SHORTS, PANTS, SKIRTS, SWEATERS, JACKETS,  
DRESSES, BELTS, HATS, SOCKS, GLOVES, VESTS,  
SCARVES, SLEEPWEAR, BATHING SUITS, TIGHTS,  
LEGGINGS, ROMPERS, OVERALLS, AND SHOES,  
IN CLASS 25 (U.S. CLS. 22 AND 39).

FIRST USE 8-8-2006; IN COMMERCE 8-8-2006.

THE MARK CONSISTS OF STANDARD CHAR-  
ACTERS WITHOUT CLAIM TO ANY PARTICULAR  
FONT, STYLE, SIZE, OR COLOR.

NO CLAIM IS MADE TO THE EXCLUSIVE  
RIGHT TO USE "STORES", APART FROM THE  
MARK AS SHOWN.

SER. NO. 77-310,160, FILED 10-22-2007.

MATTHEW EINSTEIN, EXAMINING ATTORNEY

**Int. Cl.: 16**

**Prior U.S. Cls.: 2, 5, 22, 23, 29, 37, 38, and 50**

**United States Patent and Trademark Office**

**Reg. No. 3,396,753**

**Registered Mar. 11, 2008**

**TRADEMARK  
SUPPLEMENTAL REGISTER**

**MOCKTAILS FOR MOMS-TO-BE**

ALYSSA D. GUSENOFF (UNITED STATES INDIVIDUAL)

269 DORSET ROAD

NEWTON, MA 02468

FOR: BOOKS, NAMELY, RECIPE BOOKS, RECIPE BOOKLETS AND RECIPE CARDS, IN CLASS 16 (U.S. CLS. 2, 5, 22, 23, 29, 37, 38 AND 50).

FIRST USE 12-0-2007; IN COMMERCE 12-0-2007.

THE MARK CONSISTS OF STANDARD CHARACTERS WITHOUT CLAIM TO ANY PARTICULAR FONT, STYLE, SIZE, OR COLOR.

NO CLAIM IS MADE TO THE EXCLUSIVE RIGHT TO USE "MOCKTAILS", APART FROM THE MARK AS SHOWN.

SER. NO. 77-312,131, FILED P.R. 10-24-2007; AM. S.R. 2-6-2008.

IRA J. GOODSaid, EXAMINING ATTORNEY

**Int. Cls.: 38 and 41**

**Prior U.S. Cls.: 100, 101, 104, and 107**

**United States Patent and Trademark Office**

**Reg. No. 3,396,754**

**Registered Mar. 11, 2008**

**SERVICE MARK  
SUPPLEMENTAL REGISTER**

**FASHIONWEEKLIVE**

INTERNATIONAL MERCHANDISING COR-  
PORATION (OHIO CORPORATION)  
IMG CENTER 1360 EAST NINTH STREET  
CLEVELAND, OH 44114

FOR: STREAMING OF AUDIO AND VIDEO  
MATERIAL ON THE INTERNET; TELEVISION  
PROGRAM BROADCASTING VIA CABLE AND  
SATELLITE, IN CLASS 38 (U.S. CLS. 100, 101 AND  
104).

FIRST USE 3-8-2007; IN COMMERCE 3-8-2007.

FOR: ENTERTAINMENT SERVICES, NAMELY,  
ORGANIZATION OF AND CONDUCTING FASH-

ION SHOWS; PUBLICATION OF ELECTRONIC MA-  
GAZINES AND EVENT PROGRAMS, IN CLASS 41  
(U.S. CLS. 100, 101 AND 107).

FIRST USE 1-0-2007; IN COMMERCE 1-0-2007.

THE MARK CONSISTS OF STANDARD CHAR-  
ACTERS WITHOUT CLAIM TO ANY PARTICULAR  
FONT, STYLE, SIZE, OR COLOR.

SER. NO. 77-975,154, FILED P.R. 10-23-2006; AM.  
S.R. 10-29-2007.

WENDY GOODMAN, EXAMINING ATTORNEY

**Int. Cl.: 21**

**Prior U.S. Cls.: 2, 13, 23, 29, 30, 33, 40, and 50**

**United States Patent and Trademark Office**

**Reg. No. 3,396,755**

**Registered Mar. 11, 2008**

**TRADEMARK  
SUPPLEMENTAL REGISTER**

**ICY PEPPERMINT**

JOHNSON & JOHNSON (NEW JERSEY CORPORATION)  
ONE JOHNSON & JOHNSON PLAZA  
NEW BRUNSWICK, NJ 089337001

FOR: DENTAL FLOSS, IN CLASS 21 (U.S. CLS. 2, 13, 23, 29, 30, 33, 40 AND 50).

FIRST USE 8-25-2003; IN COMMERCE 8-25-2003.

NO CLAIM IS MADE TO THE EXCLUSIVE RIGHT TO USE "PEPPERMINT", APART FROM THE MARK AS SHOWN.

SER. NO. 78-255,730, FILED P.R. 5-29-2003; AM. S.R. 12-20-2007.

BRIDGETT SMITH, EXAMINING ATTORNEY

**Int. Cls.: 24 and 25**

**Prior U.S. Cls.: 22, 39, 42, and 50**

**United States Patent and Trademark Office**

**Reg. No. 3,396,756**

**Registered Mar. 11, 2008**

**TRADEMARK  
SUPPLEMENTAL REGISTER**

**BLEACHSAFE**

BLU SAND, LLC (DELAWARE LTD LIAB CO)  
100 MIDDLESEX AVENUE SOUTH BUILDING  
CARTERET, NJ 07008

FOR: TEXTILE AND TEXTILE GOODS, NAME-  
LY, TOWELS, TABLECLOTHS NOT OF PAPER,  
CLOTH TABLE RUNNERS, NAPKINS, PLACE  
MATS, OVEN MITTS AND DISH CLOTHS; BED  
COVERS, NAMELY, SHEETS, DUVET COVERS  
AND BED BLANKETS; AND PILLOW CASES AND  
BED SKIRTS, IN CLASS 24 (U.S. CLS. 42 AND 50).

FIRST USE 0-0-2003; IN COMMERCE 0-0-2003.

FOR: CLOTHING, NAMELY, DRESSES, SHIRTS,  
JACKETS, UNDERWEAR, BRAS, SOCKS, TANK

TOPS, T-SHIRTS, MUSCLE SHIRTS, SWEATSHIRTS,  
SWEAT PANTS, PANTS, LEGGINGS, CAPRI PANTS,  
POLO SHIRTS, SWEATBANDS, SWIM SUITS,  
GLOVES, HATS, SCARVES, LOUNGEWEAR; BA-  
BIES' BOOTIES, JUMPSUITS, BUNTING AND  
CLOTH BIBS; SCHOOL AND INDUSTRIAL UNI-  
FORMS; AND APRONS , IN CLASS 25 (U.S. CLS. 22  
AND 39).

FIRST USE 0-0-2003; IN COMMERCE 0-0-2003.

SER. NO. 78-259,821, FILED P.R. 6-9-2003; AM. S.R.  
1-16-2007.

MARY ROSSMAN, EXAMINING ATTORNEY



**Int. Cl.: 9**

**Prior U.S. Cls.: 21, 23, 26, 36, and 38**

**Reg. No. 3,396,757**

**United States Patent and Trademark Office**

**Registered Mar. 11, 2008**

**TRADEMARK  
SUPPLEMENTAL REGISTER**

**MDAUDIT**

HAYES MANAGEMENT CONSULTING (MASSACHUSETTS CORPORATION)  
1320 CENTRE STREET; SUITE 402  
NEWTON CENTER, MA 02459

FOR: COMPUTER SOFTWARE PACKAGE THAT MANAGES THE AUDIT OF CLINICAL PRACTICE BILLING COMPLIANCE, INCLUDING MEDICAL DOCTORS, IN THE HEALTHCARE INDUSTRY, IN CLASS 9 (U.S. CLS. 21, 23, 26, 36 AND 38).

FIRST USE 11-1-2003; IN COMMERCE 11-1-2003.

THE MARK CONSISTS OF STANDARD CHARACTERS WITHOUT CLAIM TO ANY PARTICULAR FONT, STYLE, SIZE, OR COLOR.

SER. NO. 78-398,806, FILED P.R. 4-8-2004; AM. S.R. 11-7-2007.

AMY GEARIN, EXAMINING ATTORNEY

**Int. Cl.: 9**

**Prior U.S. Cls.: 21, 23, 26, 36, and 38**

**United States Patent and Trademark Office**

**Reg. No. 3,396,758**

**Registered Mar. 11, 2008**

**TRADEMARK  
SUPPLEMENTAL REGISTER**

**YOUR MINUTES CARRY  
FORWARD**

7-ELEVEN, INC. (TEXAS CORPORATION)  
2711 NORTH HASKELL AVENUE  
DALLAS, TX 75204

THE MARK CONSISTS OF STANDARD CHAR-  
ACTERS WITHOUT CLAIM TO ANY PARTICULAR  
FONT, STYLE, SIZE, OR COLOR.

FOR: TELECOMMUNICATION PRODUCTS,  
NAMELY CELLULAR TELEPHONES AND PRE-  
PAID TELECOMMUNICATION CALLING CARDS  
THAT ARE MAGNETICALLY ENCODED, IN  
CLASS 9 (U.S. CLS. 21, 23, 26, 36 AND 38).

SER. NO. 78-438,492, FILED P.R. 6-21-2004; AM. S.R.  
1-28-2008.

FIRST USE 4-1-2004; IN COMMERCE 4-1-2004.

JASON ROTH, EXAMINING ATTORNEY

**Int. Cl.: 3**

**Prior U.S. Cls.: 1, 4, 6, 50, 51, and 52**

**United States Patent and Trademark Office**

**Reg. No. 3,396,759**

**Registered Mar. 11, 2008**

**TRADEMARK  
SUPPLEMENTAL REGISTER**

**PARIGI BEVERLY  
HILLS**

ELYASSI, ELIE (UNITED STATES INDIVIDUAL)  
C/O HAYCO USA, INC. P.O. BOX 11718  
BEVERLY HILLS, CA 902134718

FOR: FACE CREAMS, EYE CREAMS, ANTI-AGING CREAMS, SKINCARE PRODUCTS, NAME-  
LY, MOISTURIZERS, LOTIONS AND CREMES FOR  
THE FACE, FACIAL CLEANSERS, SKIN MOISTUR-  
IZING CREAM, IN CLASS 3 (U.S. CLS. 1, 4, 6, 50, 51  
AND 52).

FIRST USE 8-20-2007; IN COMMERCE 8-20-2007.

THE MARK CONSISTS OF STANDARD CHAR-  
ACTERS WITHOUT CLAIM TO ANY PARTICULAR  
FONT, STYLE, SIZE, OR COLOR.

THE WORD "PARIGI" IS ITALIAN FOR "PARIS".

SER. NO. 78-515,995, FILED P.R. 11-12-2004; AM.  
S.R. 5-7-2007.

ZACHARY BELLO, EXAMINING ATTORNEY

Int. Cl.: 25

Prior U.S. Cls.: 22 and 39

United States Patent and Trademark Office

Reg. No. 3,396,760

Registered Mar. 11, 2008

TRADEMARK  
SUPPLEMENTAL REGISTER



BELL, GRACE W. (UNITED STATES INDIVIDUAL)  
315 E. ELM ST.  
MASON, MI 48854

FOR: SHIRTS, PANTS, HATS, IN CLASS 25 (U.S. CLS. 22 AND 39).

FIRST USE 9-1-2003; IN COMMERCE 2-1-2006.

NO CLAIM IS MADE TO THE EXCLUSIVE RIGHT TO USE "THE GEOGRAPHIC DESIGN OF THE STATE OF MICHIGAN", APART FROM THE MARK AS SHOWN.

SER. NO. 78-576,979, FILED P.R. 2-28-2005; AM. S.R. 11-30-2007.

WILLIAM P. SHANAHAN, EXAMINING ATTORNEY

**Int. Cl.: 36**

**Prior U.S. Cls.: 100, 101, and 102**

**United States Patent and Trademark Office**

**Reg. No. 3,396,761**

**Registered Mar. 11, 2008**

**SERVICE MARK  
SUPPLEMENTAL REGISTER**

**AMERICA'S LUXURY  
HOME LENDER**

TB PROPRIETARY CORP. (DELAWARE CORPORATION)

SUITE 612

1105 NORTH MARKET STREET

WILMINGTON, DE 19801

FOR: FINANCIAL SERVICES, NAMELY, MORTGAGE LENDING, IN CLASS 36 (U.S. CLS. 100, 101 AND 102).

FIRST USE 6-30-2005; IN COMMERCE 6-30-2005.

THE MARK CONSISTS OF STANDARD CHARACTERS WITHOUT CLAIM TO ANY PARTICULAR FONT, STYLE, SIZE, OR COLOR.

OWNER OF U.S. REG. NO. 3,246,359.

NO CLAIM IS MADE TO THE EXCLUSIVE RIGHT TO USE "LENDER", APART FROM THE MARK AS SHOWN.

SER. NO. 78-599,525, FILED P.R. 3-31-2005; AM. S.R. 1-31-2008.

KEVIN DINALLO, EXAMINING ATTORNEY

**Int. Cl.: 33**

**Prior U.S. Cls.: 47 and 49**

**United States Patent and Trademark Office**

**Reg. No. 3,396,762**

**Registered Mar. 11, 2008**

**TRADEMARK  
SUPPLEMENTAL REGISTER**

**SHAKE IT UP**

DIAGEO NORTH AMERICA, INC. (CONNECTI-  
CUT CORPORATION)  
801 MAIN AVENUE  
NORWALK, CT 06851

FOR: ALCOHOLIC BEVERAGES, NAMELY, LI-  
QUEURS, IN CLASS 33 (U.S. CLS. 47 AND 49).

FIRST USE 10-1-2005; IN COMMERCE 10-1-2005.

THE MARK CONSISTS OF STANDARD CHAR-  
ACTERS WITHOUT CLAIM TO ANY PARTICULAR  
FONT, STYLE, SIZE, OR COLOR.

SER. NO. 78-612,882, FILED P.R. 4-20-2005; AM. S.R.  
11-5-2007.

PAUL E. FAHRENKOPF, EXAMINING ATTORNEY

Int. Cl.: 33

Prior U.S. Cls.: 47 and 49

United States Patent and Trademark Office

Reg. No. 3,396,763

Registered Mar. 11, 2008

**TRADEMARK  
SUPPLEMENTAL REGISTER**



NAVARRO/FELIPE JESUS (MEXICO INDIVIDUAL)  
ALDAMA 75  
TEPATITLAN, MEXICO 47700

FOR: ALCOHOLIC BEVERAGES, NAMELY, TEQUILA, IN CLASS 33 (U.S. CLS. 47 AND 49).

FIRST USE 1-1-2007; IN COMMERCE 1-1-2007.

NO CLAIM IS MADE TO THE EXCLUSIVE RIGHT TO USE THE PRESENTATION OF THE CAP DESIGN, APART FROM THE MARK AS SHOWN.

THE MARK CONSISTS OF A THREE DIMENSIONAL BOTTLE SHAPED AS A FEMALE SILHOU-

ETTE SUCH THAT THE LOWER PORTION OF THE BOTTLE ABOUT A THIRD OF THE WAY UP FROM THE BOTTOM IS MORE NARROW THAN THE REMAINING BOTTLE AS IN A WAISTLINE OF A FEMALE, THE UPPER PORTION IN THE FRONT APPEARS PLEATED AND PROTRUDES OUTWARD SLIGHTLY AS IN A NECKLINE OF A FEMALE'S ATTIRE AND THE DISTINCTIVE INTERLACED SYMBOLS OF MAN AND WOMEN APPEARING IN THE BACK OF THE BOTTLE BELOW THE MOST NARROW PORTION.

SER. NO. 78-675,461, FILED P.R. 7-21-2005; AM. S.R. 10-26-2007.

GENE MACIOL, EXAMINING ATTORNEY

**Int. Cl.: 25**

**Prior U.S. Cls.: 22 and 39**

**United States Patent and Trademark Office**

**Reg. No. 3,396,764**

**Registered Mar. 11, 2008**

**TRADEMARK  
SUPPLEMENTAL REGISTER**

**WHAT WOULD JESUS RIDE?**

LOCKARD, BARRY (UNITED STATES INDIVIDUAL)  
20251 JENNY LANE  
EAGLE, NE 68347

THE MARK CONSISTS OF STANDARD CHARACTERS WITHOUT CLAIM TO ANY PARTICULAR FONT, STYLE, SIZE, OR COLOR.

FOR: CLOTHING, NAMELY, T-SHIRTS, HATS, JACKETS, WRISTBANDS, IN CLASS 25 (U.S. CLS. 22 AND 39).

SER. NO. 78-690,301, FILED P.R. 8-11-2005; AM. S.R. 12-21-2007.

FIRST USE 10-1-2006; IN COMMERCE 11-20-2006.

KATHERINE CHANG, EXAMINING ATTORNEY



**Int. Cl.: 35**

**Prior U.S. Cls.: 100, 101, and 102**

**United States Patent and Trademark Office**

**Reg. No. 3,396,765**

**Registered Mar. 11, 2008**

**SERVICE MARK  
SUPPLEMENTAL REGISTER**

**PUBLISHERS QUALITY LIBRARY  
SERVICE**

CHILDREN'S PLUS, INC. (ILLINOIS CORPORATION)  
3353 HOLEMAN AVENUE  
SOUTH CHICAGO HEIGHTS, IL 60411

FOR: MAIL ORDER AND ONLINE RETAIL STORE SERVICES FEATURING CHILDREN'S BOOKS; ONLINE WHOLESALE DISTRIBUTORSHIPS FEATURING CHILDREN'S BOOKS; ONLINE RETAIL ORDERING SERVICES FOR SCHOOLS AND LIBRARIES FEATURING CHILDREN'S BOOKS; DIRECT MAIL ADVERTISING OF CHILDREN'S BOOKS FOR OTHERS; CONDUCTING TRADE SHOWS IN THE FIELD OF CHILDREN'S BOOKS; AND MARKETING SERVICES, NAMELY, DIRECT MARKETING ADVERTISING OF CHILDREN'S BOOKS TO SCHOOLS AND LIBRARIES

FOR OTHERS, IN CLASS 35 (U.S. CLS. 100, 101 AND 102).

FIRST USE 12-31-1989; IN COMMERCE 12-31-1989.

THE MARK CONSISTS OF STANDARD CHARACTERS WITHOUT CLAIM TO ANY PARTICULAR FONT, STYLE, SIZE, OR COLOR.

NO CLAIM IS MADE TO THE EXCLUSIVE RIGHT TO USE "SERVICE", APART FROM THE MARK AS SHOWN.

SER. NO. 78-733,957, FILED 10-14-2005.

CHRISIE B. KING, EXAMINING ATTORNEY

Int. Cl.: 29

Prior U.S. Cl.: 46

United States Patent and Trademark Office

Reg. No. 3,396,766

Registered Mar. 11, 2008

**TRADEMARK  
SUPPLEMENTAL REGISTER**



HP HOOD LLC (DELAWARE LTD LIAB CO)  
6 KIMBALL LANE  
LYNNFIELD, MA 01940

FOR: DAIRY PRODUCTS, NAMELY, FLUID MILK, LOW FAT MILK AND SKIM MILK, IN CLASS 29 (U.S. CL. 46).

FIRST USE 10-3-2004; IN COMMERCE 10-3-2004.

THE COLOR(S) WHITE IS/ARE CLAIMED AS A FEATURE OF THE MARK.

THE MARK CONSISTS OF THE COLOR, SIZE AND SHAPE OF A PLASTIC JUG-TYPE ONE GALLON CONTAINER FOR MILK PRODUCTS, HAVING FOUR VERTICAL SIDES OF EQUAL WIDTH AND A ROUNDED, RATHER THAN PYRAMIDAL TOP. THE VERTICAL PANELS ARE PROPORTION-

ALLY TALLER THAN IN COMMONLY USED ONE GALLON MILK CONTAINERS. THE OVERALL DIMENSIONS OF THE CONTAINER ARE APPROXIMATELY 6 1/4 INCHES WIDE BY 6 1/4 INCHES DEEP BY 10 INCHES HIGH. THE JUG-HANDLE OF THE CONTAINER IS PLACED AT THE MIDDLE OF ONE SIDE RATHER THAN AT A CORNER. THERE ARE THREE HORIZONTAL RIBS INDENTED IN THE TWO SIDE PANELS WHICH ARE ADJACENT AND PERPENDICULAR TO THE HANDLE SIDE. THERE IS ONE VERTICAL RIB INDENTED INTO EACH CORNER OF THE CONTAINER WHERE THE VERTICAL PANELS ARE JOINED. THE CONTAINER IS WHITE.

SER. NO. 78-746,784, FILED P.R. 11-3-2005; AM. S.R. 11-4-2006.

KIMBERLY FRYE, EXAMINING ATTORNEY

**Int. Cl.: 3**

**Prior U.S. Cls.: 1, 4, 6, 50, 51, and 52**

**United States Patent and Trademark Office**

**Reg. No. 3,396,767**

**Registered Mar. 11, 2008**

**TRADEMARK  
SUPPLEMENTAL REGISTER**

**C'WATRE**

C'WATRE (VIRGINIA LTD LIAB CO)  
44050 ASHBURN PLAZA, SUITE 195  
ASHBURN, VA 20147

CARE PRODUCTS, NAMELY, SHAMPOOS AND  
CONDITIONERS, IN CLASS 3 (U.S. CLS. 1, 4, 6, 50,  
51 AND 52).

FOR: COSMETICS AND COSMETIC COMPOSI-  
TIONS, NAMELY, LIP BALMS AND GLOSSES,  
BRONZERS, CONCEALERS, MULTI-USE CREAMS,  
AND GELS FOR THE FACE; NON-MEDICATED  
SKIN CARE AND SKIN PROTECTION PRODUCTS,  
NAMELY, SKIN CARE PREPARATIONS, SKIN  
CLEANSERS, SKIN TONICS, MOISTURIZERS FOR  
THE FACE AND BODY, MASKS FOR THE FACE  
AND BODY; FACIAL AND BODY EXFOLIANTS,  
AFTER SUN SOOTHING AND REHYDRATING  
CREAMS, GELS, AND LOTIONS; AND PERSONAL

FIRST USE 2-1-2008; IN COMMERCE 2-1-2008.

THE MARK CONSISTS OF STANDARD CHAR-  
ACTERS WITHOUT CLAIM TO ANY PARTICULAR  
FONT, STYLE, SIZE, OR COLOR.

SER. NO. 78-754,179, FILED P.R. 11-15-2005; AM.  
S.R. 2-4-2008.

ELI HELLMAN, EXAMINING ATTORNEY

**Int. Cl.: 41**

**Prior U.S. Cls.: 100, 101, and 107**

**United States Patent and Trademark Office**

**Reg. No. 3,396,768**

**Registered Mar. 11, 2008**

---

**SERVICE MARK  
SUPPLEMENTAL REGISTER**

**STRATEGIC DISPENSING**

BDF, INC. (NEVADA CORPORATION)  
352 WEST 12300 SOUTH, #400  
DRAPER, UT 84020

FOR: TRAINING SERVICES IN THE FIELD OF  
AUDIOLOGY, IN CLASS 41 (U.S. CLS. 100, 101 AND  
107).

FIRST USE 6-23-2007; IN COMMERCE 6-23-2007.

THE MARK CONSISTS OF STANDARD CHAR-  
ACTERS WITHOUT CLAIM TO ANY PARTICULAR  
FONT, STYLE, SIZE, OR COLOR.

SER. NO. 78-756,149, FILED P.R. 11-17-2005; AM.  
S.R. 7-11-2007.

MARK RADEMACHER, EXAMINING ATTORNEY

**Int. Cl.: 16**

**Prior U.S. Cls.: 2, 5, 22, 23, 29, 37, 38, and 50**

**United States Patent and Trademark Office**

**Reg. No. 3,396,769**

**Registered Mar. 11, 2008**

**TRADEMARK  
SUPPLEMENTAL REGISTER**

# Late-Life Function & Disability Instrument

TRUSTEES OF BOSTON UNIVERSITY (MASSACHUSETTS CORPORATION)  
125 BAY STATE ROAD  
BOSTON, MA 02215

FOR: PUBLICATIONS, NAMELY, PRINTED DIAGNOSTIC TESTS, TEST BOOKLETS, MANUALS AND SCORE FORMS IN THE FIELD OF EVALUATION OF FUNCTION AND DISABILITY IN COMMUNITY-DWELLING OLDER ADULTS, IN CLASS 16 (U.S. CLS. 2, 5, 22, 23, 29, 37, 38 AND 50).

FIRST USE 4-30-2002; IN COMMERCE 4-30-2002.

THE MARK CONSISTS OF STANDARD CHARACTERS WITHOUT CLAIM TO ANY PARTICULAR FONT, STYLE, SIZE, OR COLOR.

SER. NO. 78-769,277, FILED P.R. 12-8-2005; AM. S.R. 9-20-2007.

EUGENIA MARTIN, EXAMINING ATTORNEY

**Int. Cl.: 20**

**Prior U.S. Cls.: 2, 13, 22, 25, 32, and 50**

**United States Patent and Trademark Office**

**Reg. No. 3,396,770**

**Registered Mar. 11, 2008**

**TRADEMARK  
SUPPLEMENTAL REGISTER**

**RUBBERMOUNT SUPERSTAKE**

TOUCHSTONE ACCENT LIGHTING (MINNESOTA CORPORATION)  
2425 W. INDUSTRIAL BOULEVARD  
LONG LAKE, MN 55356

FOR: FLEXIBLE DEVICE FOR MOUNTING ELECTRICAL PRODUCTS, NAMELY, LANDSCAPE LIGHTING AND ELECTRICAL BOXES, IN CLASS 20 (U.S. CLS. 2, 13, 22, 25, 32 AND 50).

FIRST USE 7-21-2005; IN COMMERCE 7-21-2005.

THE MARK CONSISTS OF STANDARD CHARACTERS WITHOUT CLAIM TO ANY PARTICULAR FONT, STYLE, SIZE, OR COLOR.

SER. NO. 78-780,098, FILED P.R. 12-23-2005; AM. S.R. 1-14-2008.

MICHELLE DUBOIS, EXAMINING ATTORNEY

**Int. Cl.: 9**

**Prior U.S. Cls.: 21, 23, 26, 36, and 38**

**United States Patent and Trademark Office**

**Reg. No. 3,396,771**

**Registered Mar. 11, 2008**

**TRADEMARK  
SUPPLEMENTAL REGISTER**

**HOME DECOR**

AUDIOVOX CORPORATION (DELAWARE CORPORATION)  
180 MARCUS BOULEVARD  
HAUPPAUGE, NY 11788

FOR: LOUDSPEAKERS; SUBWOOFERS; AMPLIFIERS; AND SPEAKER COVERS, ENCLOSURES AND CABINETS, IN CLASS 9 (U.S. CLS. 21, 23, 26, 36 AND 38).

FIRST USE 5-0-2006; IN COMMERCE 5-0-2006.

THE MARK CONSISTS OF STANDARD CHARACTERS WITHOUT CLAIM TO ANY PARTICULAR FONT, STYLE, SIZE, OR COLOR.

SER. NO. 78-785,085, FILED P.R. 1-4-2006; AM. S.R. 3-5-2007.

CAROLINE WOOD, EXAMINING ATTORNEY

**Int. Cl.: 42**

**Prior U.S. Cls.: 100 and 101**

**United States Patent and Trademark Office**

**Reg. No. 3,396,772**

**Registered Mar. 11, 2008**

**SERVICE MARK  
SUPPLEMENTAL REGISTER**

# eNotary Registry

NATIONAL NOTARY ASSOCIATION (CALIFORNIA CORPORATION)

9350 DE SOTO AVENUE

CHATSWORTH, CA 91311

FOR: PROVIDING AN ON-LINE DATABASE FEATURING INFORMATION ABOUT NOTARY PUBLICS, IN CLASS 42 (U.S. CLS. 100 AND 101).

FIRST USE 4-1-2006; IN COMMERCE 4-1-2006.

THE MARK CONSISTS OF STANDARD CHARACTERS WITHOUT CLAIM TO ANY PARTICULAR FONT, STYLE, SIZE, OR COLOR.

NO CLAIM IS MADE TO THE EXCLUSIVE RIGHT TO USE "REGISTRY", APART FROM THE MARK AS SHOWN.

SER. NO. 78-806,838, FILED P.R. 2-3-2006; AM. S.R. 2-4-2008.

RENEE MCCRAY, EXAMINING ATTORNEY



**Int. Cl.: 21**

**Prior U.S. Cls.: 2, 13, 23, 29, 30, 33, 40, and 50**

**United States Patent and Trademark Office**

**Reg. No. 3,396,773**

**Registered Mar. 11, 2008**

**TRADEMARK  
SUPPLEMENTAL REGISTER**

**TAKEDA BRUSH**

TAKEDA BRUSH INC. (JAPAN CORPORATION)  
3538-3, KUMANO-CHO, AKI-GUN  
HIROSHIMA, JAPAN 731-4214

2006, REG. NO. 5030802, DATED 3-9-2007, EXPIRES 3-9-2017.

FOR: TOILET BRUSHES, IN CLASS 21 (U.S. CLS. 2, 13, 23, 29, 30, 33, 40 AND 50).

NO CLAIM IS MADE TO THE EXCLUSIVE RIGHT TO USE "BRUSH", APART FROM THE MARK AS SHOWN.

THE MARK CONSISTS OF STANDARD CHARACTERS WITHOUT CLAIM TO ANY PARTICULAR FONT, STYLE, SIZE, OR COLOR.

SER. NO. 78-814,112, FILED P.R. 2-14-2006; AM. S.R. 3-20-2007.

PRIORITY CLAIMED UNDER SEC. 44(D) ON JAPAN APPLICATION NO. 2006-10290, FILED 2-8-

ANNE MADDEN, EXAMINING ATTORNEY

**Int. Cl.: 5**

**Prior U.S. Cls.: 6, 18, 44, 46, 51, and 52**

**United States Patent and Trademark Office**

**Reg. No. 3,396,774**

**Registered Mar. 11, 2008**

**TRADEMARK  
SUPPLEMENTAL REGISTER**

the golden pill

APPLIED MEDICAL RESEARCH (TEXAS CORPORATION)

3413 SPANISH OAK DR.

AUSTIN, TX 78731

FOR: PHARMACEUTICAL COMPOSITIONS FOR THE TREATMENT OF ENDOTHELIAL DYSFUNCTION, IN CLASS 5 (U.S. CLS. 6, 18, 44, 46, 51 AND 52).

FIRST USE 5-2-2006; IN COMMERCE 5-3-2007.

THE MARK CONSISTS OF STANDARD CHARACTERS WITHOUT CLAIM TO ANY PARTICULAR FONT, STYLE, SIZE, OR COLOR.

NO CLAIM IS MADE TO THE EXCLUSIVE RIGHT TO USE "PILL", APART FROM THE MARK AS SHOWN.

SER. NO. 78-815,372, FILED P.R. 2-15-2006; AM. S.R. 11-9-2007.

HENRY S. ZAK, EXAMINING ATTORNEY

**Int. Cl.: 36**

**Prior U.S. Cls.: 100, 101, and 102**

**United States Patent and Trademark Office**

**Reg. No. 3,396,775**

**Registered Mar. 11, 2008**

**SERVICE MARK  
SUPPLEMENTAL REGISTER**

**American REO**

AMERICAN REO (TEXAS CORPORATION)  
30638 BLUEBERRY RIDGE  
BULVERDE, TX 78163

FOR: REAL ESTATE BROKERAGE, IN CLASS 36  
(U.S. CLS. 100, 101 AND 102).

FIRST USE 2-28-2006; IN COMMERCE 2-28-2006.

THE MARK CONSISTS OF STANDARD CHAR-  
ACTERS WITHOUT CLAIM TO ANY PARTICULAR  
FONT, STYLE, SIZE, OR COLOR.

OWNER OF U.S. REG. NO. 3,299,843.

NO CLAIM IS MADE TO THE EXCLUSIVE  
RIGHT TO USE "REO", APART FROM THE MARK  
AS SHOWN.

SER. NO. 78-818,619, FILED P.R. 2-20-2006; AM. S.R.  
12-7-2007.

CAROL SPILS, EXAMINING ATTORNEY

**Int. Cl.: 38**

**Prior U.S. Cls.: 100, 101, and 104**

**United States Patent and Trademark Office**

**Reg. No. 3,396,776**

**Registered Mar. 11, 2008**

**SERVICE MARK  
SUPPLEMENTAL REGISTER**

VEGAS ENTERTAINMENT NETWORK

HORSE HEAD ENTERTAINMENT, INC. (DELA-  
WARE CORPORATION)  
4202 BARRINGER DRIVE  
CHARLOTTE, NC 28217

FOR: BROADCASTING SERVICES VIA TELEVI-  
SION, CABLE, SATELLITE, CELLULAR PHONE  
AND BROADBAND/INTERNET FEATURING EN-  
TERTAINMENT FROM LAS VEGAS, NEVADA , IN  
CLASS 38 (U.S. CLS. 100, 101 AND 104).

FIRST USE 1-1-2006; IN COMMERCE 1-1-2006.

THE MARK CONSISTS OF STANDARD CHAR-  
ACTERS WITHOUT CLAIM TO ANY PARTICULAR  
FONT, STYLE, SIZE, OR COLOR.

NO CLAIM IS MADE TO THE EXCLUSIVE  
RIGHT TO USE "ENTERTAINMENT NETWORK",  
APART FROM THE MARK AS SHOWN.

SER. NO. 78-827,014, FILED P.R. 3-2-2006; AM. S.R.  
12-14-2007.

PAUL E. FAHRENKOPF, EXAMINING ATTORNEY

**Int. Cl.: 38**

**Prior U.S. Cls.: 100, 101, and 104**

**United States Patent and Trademark Office**

**Reg. No. 3,396,777**

**Registered Mar. 11, 2008**

**SERVICE MARK  
SUPPLEMENTAL REGISTER**

**LAS VEGAS 24/7**

HORSE HEAD ENTERTAINMENT, INC. (DELA-  
WARE CORPORATION)  
4202 BARRINGER DRIVE  
CHARLOTTE, NC 28217

FOR: BROADCASTING SERVICES VIA TELEVI-  
SION, CABLE, SATELLITE, CELLULAR PHONE  
AND BROADBAND/INTERNET FEATURING EN-  
TERTAINMENT FROM LAS VEGAS, NEVADA , IN  
CLASS 38 (U.S. CLS. 100, 101 AND 104).

FIRST USE 12-7-2007; IN COMMERCE 12-7-2007.

THE MARK CONSISTS OF STANDARD CHAR-  
ACTERS WITHOUT CLAIM TO ANY PARTICULAR  
FONT, STYLE, SIZE, OR COLOR.

SER. NO. 78-827,020, FILED P.R. 3-2-2006; AM. S.R.  
12-14-2007.

PAUL E. FAHRENKOPF, EXAMINING ATTORNEY

**Int. Cl.: 5**

**Prior U.S. Cls.: 6, 18, 44, 46, 51, and 52**

**United States Patent and Trademark Office**

**Reg. No. 3,396,778**

**Registered Mar. 11, 2008**

**TRADEMARK  
SUPPLEMENTAL REGISTER**

# CARDIOMPO

THE CLEVELAND CLINIC FOUNDATION (OHIO CORPORATION)  
9500 EUCLID AVENUE  
CLEVELAND, OH 44195

FOR: MEDICAL TEST KITS COMPRISED PRINCIPALLY OF DIAGNOSTIC REAGENTS FOR MEDICINAL USE, DIAGNOSTIC CALIBRATORS IN THE NATURE OF MYELOPEROXIDASE IN A BUFFER MATRIX FOR THE MEASUREMENT OF MPO CONCENTRATION IN HUMAN PLASMA, AND DIAGNOSTIC REAGENTS FOR MEDICAL USE, SPECIFICALLY, FOR USE AS DIAGNOSTIC CONTROLS IN MEDICAL LABORATORIES, ALL OF THE FOREGOING FOR THE PURPOSE OF DIAG-

NOSIS AND EVALUATION OF PATIENTS AT RISK FOR ADVERSE CARDIAC EVENTS, IN CLASS 5 (U.S. CLS. 6, 18, 44, 46, 51 AND 52).

FIRST USE 9-1-2005; IN COMMERCE 9-1-2005.

THE MARK CONSISTS OF STANDARD CHARACTERS WITHOUT CLAIM TO ANY PARTICULAR FONT, STYLE, SIZE, OR COLOR.

SER. NO. 78-836,544, FILED P.R. 3-14-2006; AM. S.R. 2-28-2007.

ANDREA BUTLER, EXAMINING ATTORNEY

**Int. Cl.: 37**

**Prior U.S. Cls.: 100, 103, and 106**

**United States Patent and Trademark Office**

**Reg. No. 3,396,779**

**Registered Mar. 11, 2008**

**SERVICE MARK  
SUPPLEMENTAL REGISTER**

**NETWORK ELECTRICAL SERVICES**

TOWER CLEANING SYSTEMS, INC. (PENNSYLVANIA CORPORATION)  
1880 MARKLEY STREET,  
NORRISTOWN, PA 19401

FOR: ELECTRICIAN SERVICES, NAMELY, INSTALLATION; MAINTENANCE AND/OR REPAIR OF ELECTRICAL SYSTEMS, REPAIR, MAINTENANCE AND RETROFIT OF LIGHTING SYSTEMS, AND INSTALLATION, MAINTENANCE AND REPAIR OF SIGNS, IN CLASS 37 (U.S. CLS. 100, 103 AND 106).

FIRST USE 12-0-2005; IN COMMERCE 12-0-2005.

THE MARK CONSISTS OF STANDARD CHARACTERS WITHOUT CLAIM TO ANY PARTICULAR FONT, STYLE, SIZE, OR COLOR.

NO CLAIM IS MADE TO THE EXCLUSIVE RIGHT TO USE "ELECTRICAL SERVICES", APART FROM THE MARK AS SHOWN.

SER. NO. 78-843,292, FILED P.R. 3-22-2006; AM. S.R. 3-2-2007.

KAREN BRACEY, EXAMINING ATTORNEY

**Int. Cl.: 35**

**Prior U.S. Cls.: 100, 101, and 102**

**United States Patent and Trademark Office**

**Reg. No. 3,396,780**

**Registered Mar. 11, 2008**

**SERVICE MARK  
SUPPLEMENTAL REGISTER**

**Sleep Medicine Network**

MOORE, RICHARD R. (UNITED STATES INDIVIDUAL)  
SUITE 305  
7931 NE HALSEY  
PORTLAND, OR 97213

FOR: MEDICAL AND DENTAL BUSINESS RECORDS MANAGEMENT; MEDICAL AND DENTAL BUSINESS RISK MANAGEMENT; MEDICAL AND DENTAL BUSINESS RISK MANAGEMENT CONSULTATION; OFFICE MANAGEMENT AND CONSULTATION IN THE FIELD OF DENTAL AND MEDICAL CARE; CONSULTING SERVICES IN THE FIELD OF MEDICAL AND DENTAL PRACTICE MANAGEMENT; MEDICAL AND DENTAL FINANCIAL RECORDS MANAGEMENT; INFORMATION, ADVISORY AND CONSULTANCY SERVICES RELATING TO MEDICAL AND DENTAL BUSINESS AND MANAGEMENT OR MEDICAL AND DENTAL BUSINESS ADMINISTRATION, INCLUDING SUCH

SERVICES PROVIDED ON LINE OR VIA THE INTERNET; MEDICAL AND DENTAL REFERRALS; MEDICAL AND DENTAL BILLING SUPPORT SERVICES; MEDICAL AND DENTAL CLAIMS MANAGEMENT SERVICES, NAMELY, CLAIMS SUBMISSION AND TRACKING SERVICES, AND AUDIT SUPPORT SERVICES ALL OF THE ABOVE IN THE FIELD OF SLEEP DISORDERS, IN CLASS 35 (U.S. CLS. 100, 101 AND 102).

FIRST USE 4-23-2006; IN COMMERCE 4-23-2006.

THE MARK CONSISTS OF STANDARD CHARACTERS WITHOUT CLAIM TO ANY PARTICULAR FONT, STYLE, SIZE, OR COLOR.

SER. NO. 78-852,386, FILED P.R. 4-3-2006; AM. S.R. 11-7-2007.

SCOTT SISUN, EXAMINING ATTORNEY



**Int. Cls.: 35 and 41**

**Prior U.S. Cls.: 100, 101, 102, and 107**

**United States Patent and Trademark Office**

**Reg. No. 3,396,781**

**Registered Mar. 11, 2008**

**SERVICE MARK  
SUPPLEMENTAL REGISTER**

# Swim Safe

SWIMFARR SWIM SAFE, INC. (CALIFORNIA CORPORATION)  
3450 LINDBERGH STREET  
SAN DIEGO, CA 92154

FOR: RETAIL STORE SERVICES FEATURING TOWELS, HANDBAGS AND OTHER CLOTHING, NAMELY, SHIRTS, SHORTS AND SWIMMING SUITS, IN CLASS 35 (U.S. CLS. 100, 101 AND 102).

FIRST USE 2-0-2006; IN COMMERCE 2-0-2006.

FOR: EDUCATION AND TRAINING, NAMELY, INSTRUCTION RELATED TO SWIMMING, CPR AND FIRST AID; EDUCATION AND ENTERTAIN-

MENT FOR SWIMMING POOL RELATED SPORTS AND CULTURAL ACTIVITIES, NAMELY, AQUATIC EXERCISE AND WATER POLO, IN CLASS 41 (U.S. CLS. 100, 101 AND 107).

FIRST USE 2-0-2006; IN COMMERCE 2-0-2006.

THE MARK CONSISTS OF STANDARD CHARACTERS WITHOUT CLAIM TO ANY PARTICULAR FONT, STYLE, SIZE, OR COLOR.

SER. NO. 78-861,173, FILED P.R. 4-13-2006; AM. S.R. 11-15-2007.

GEORGIA CARTY, EXAMINING ATTORNEY

**Int. Cls.: 16, 18, 20, 21, and 35**

**Prior U.S. Cls.: 1, 2, 3, 5, 13, 22, 23, 25, 29, 30, 32, 33, 37, 38, 40, 41, 50, 100, 101, and 102**

**Reg. No. 3,396,782**

**United States Patent and Trademark Office**

**Registered Mar. 11, 2008**

**TRADEMARK  
SERVICE MARK  
SUPPLEMENTAL REGISTER**

**STORAGE DECOR**

THOMAS ST. JOHN (UNITED STATES INDIVIDUAL)  
672 ENTERPRISE COURT  
LIVERMORE, CA 94550

FOR: DECORATIVE STORAGE CONTAINERS, NAMELY, FABRIC COVERED PAPER BOXES USED FOR GARMENT STORAGE AND SHOE STORAGE, IN CLASS 16 (U.S. CLS. 2, 5, 22, 23, 29, 37, 38 AND 50).

FIRST USE 7-1-2004; IN COMMERCE 7-1-2004.

FOR: TOTE BAGS AND FABRIC COVERED TOTE BAGS, IN CLASS 18 (U.S. CLS. 1, 2, 3, 22 AND 41).

FIRST USE 7-1-2004; IN COMMERCE 7-1-2004.

FOR: FABRIC COVERED COAT HANGERS, IN CLASS 20 (U.S. CLS. 2, 13, 22, 25, 32 AND 50).

FIRST USE 7-1-2004; IN COMMERCE 7-1-2004.

FOR: DECORATIVE STORAGE CONTAINERS, NAMELY, FABRIC COVERED WICKER BASKETS USED FOR GARMENT STORAGE AND SHOE

STORAGE, IN CLASS 21 (U.S. CLS. 2, 13, 23, 29, 30, 33, 40 AND 50).

FIRST USE 7-1-2004; IN COMMERCE 7-1-2004.

FOR: RETAIL, WHOLESALE AND ONLINE STORE SERVICES FEATURING DECORATIVE STORAGE CONTAINERS AND FABRIC COVERED COAT HANGERS, IN CLASS 35 (U.S. CLS. 100, 101 AND 102).

FIRST USE 7-1-2004; IN COMMERCE 7-1-2004.

THE MARK CONSISTS OF STANDARD CHARACTERS WITHOUT CLAIM TO ANY PARTICULAR FONT, STYLE, SIZE, OR COLOR.

NO CLAIM IS MADE TO THE EXCLUSIVE RIGHT TO USE "STORAGE", APART FROM THE MARK AS SHOWN.

SER. NO. 78-868,610, FILED P.R. 4-25-2006; AM. S.R. 11-19-2007.

RENEE SERVANCE, EXAMINING ATTORNEY

Int. Cl.: 15

Prior U.S. Cls.: 2, 21, and 36

United States Patent and Trademark Office

Reg. No. 3,396,783

Registered Mar. 11, 2008

**TRADEMARK  
SUPPLEMENTAL REGISTER**

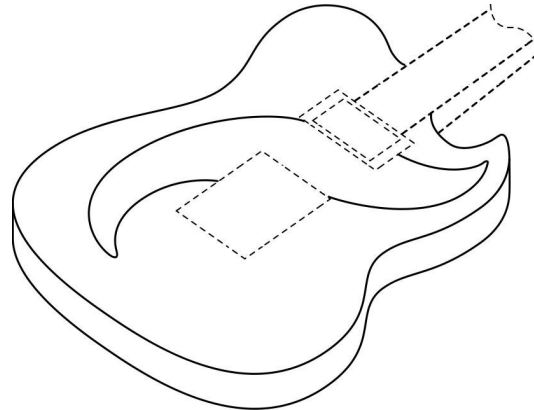

DAISY ROCK GUITARS, LLC (DELAWARE LTD  
LIAB CO)  
16320 ROSCOE BOULEVARD, SUITE 100  
VAN NUYS, CA 91406

FOR: STRINGED MUSICAL INSTRUMENTS, IN  
CLASS 15 (U.S. CLS. 2, 21 AND 36).

FIRST USE 1-20-2005; IN COMMERCE 1-20-2005.

"THE MARK CONSISTS OF A THREE-DIMEN-  
SIONAL VIEW OF THE CONFIGURATION OF THE

BODY OF A GUITAR, WITH AN INTEGRAL PICK-  
GUARD FEATURING A WAVE-LIKE DESIGN,  
WHICH ARE IN SOLID LINES. THE DOTTED LINES  
ARE NOT PART OF THE MARK AND ARE INCLU-  
DED TO SHOW PLACEMENT OF THE MARK."

SER. NO. 78-869,370, FILED P.R. 4-25-2006; AM. S.R.  
6-11-2007.

MICHAEL LEWIS, EXAMINING ATTORNEY

**Int. Cl.: 35**

**Prior U.S. Cls.: 100, 101, and 102**

**United States Patent and Trademark Office**

**Reg. No. 3,396,784**

**Registered Mar. 11, 2008**

**SERVICE MARK  
SUPPLEMENTAL REGISTER**

**COMPUTER FORENSIC  
SURVEILLANCE**

PM INVESTIGATIONS, INC. (GEORGIA CORPORATION)  
400 GALLERIA PARKWAY  
SUITE 1500  
ATLANTA, GA 30339

FOR: BUSINESS INVESTIGATION SERVICES, NAMELY, ELECTRONIC INVESTIGATIONS CONDUCTED ON PEOPLE, PLACES, OR THINGS WHICH RESULTED DIRECTLY FROM THE DISCOVERY OF PIECES OF DIGITAL EVIDENCE BEING OBTAINED BY USING COMMON TECHNIQUES AND METHODS PERFORMED IN THE USUAL CONDUCT OF EXAMINATIONS, IN CLASS 35 (U.S. CLS. 100, 101 AND 102).

FIRST USE 2-7-2006; IN COMMERCE 2-7-2006.

THE MARK CONSISTS OF STANDARD CHARACTERS WITHOUT CLAIM TO ANY PARTICULAR FONT, STYLE, SIZE, OR COLOR.

NO CLAIM IS MADE TO THE EXCLUSIVE RIGHT TO USE "SURVEILLANCE", APART FROM THE MARK AS SHOWN.

SER. NO. 78-881,090, FILED P.R. 5-11-2006; AM. S.R. 11-14-2007.

CARRIE GENOVESE, EXAMINING ATTORNEY

**Int. Cl.: 44**

**Prior U.S. Cls.: 100 and 101**

**United States Patent and Trademark Office**

**Reg. No. 3,396,785**

**Registered Mar. 11, 2008**

**SERVICE MARK  
SUPPLEMENTAL REGISTER**

**ADDICTION-FREE PAIN  
MANAGEMENT**

GRINSTEAD, STEVEN F. (UNITED STATES IN-  
DIVIDUAL)

83 VIA MERCATO

RANCHO MIRAGE, CA 92270

FOR: MEDICAL SERVICES, NAMELY, MANAGE-  
MENT OF CHRONIC PAIN SYNDROME, IN CLASS  
44 (U.S. CLS. 100 AND 101).

FIRST USE 12-31-1997; IN COMMERCE 12-31-1997.

THE MARK CONSISTS OF STANDARD CHAR-  
ACTERS WITHOUT CLAIM TO ANY PARTICULAR  
FONT, STYLE, SIZE, OR COLOR.

NO CLAIM IS MADE TO THE EXCLUSIVE  
RIGHT TO USE "PAIN MANAGEMENT", APART  
FROM THE MARK AS SHOWN.

SER. NO. 78-882,780, FILED P.R. 5-12-2006; AM. S.R.  
1-22-2008.

LINDA LAVACHE, EXAMINING ATTORNEY

**Int. Cl.: 20**

**Prior U.S. Cls.: 2, 13, 22, 25, 32, and 50**

**United States Patent and Trademark Office**

**Reg. No. 3,396,786**

**Registered Mar. 11, 2008**

**TRADEMARK  
SUPPLEMENTAL REGISTER**

**NEW ENGLAND CLOSET DESIGN,  
INC.**

COTA, MICHAEL (NEW HAMPSHIRE INDIVIDUAL)  
P.O. BOX 37  
492 PHILBRICK HILL RD.  
GRANTHAM, NH 03753

FOR: LAUNDRY CENTERS, NAMELY, CUSTOM SHELVES FOR LAUNDRY ROOMS; BUILT-INS, NAMELY, BUILT-IN BOOKCASES CONSISTING OF SHELVES, CUSTOM MOLDING AND BACKING; ENTERTAINMENT CENTERS; CUSTOM DESKS; FURNITURE; PANTRIES, NAMELY, CUSTOM SHELVES FOR PANTRIES, IN CLASS 20 (U.S. CLS. 2, 13, 22, 25, 32 AND 50).

FIRST USE 10-0-2004; IN COMMERCE 10-0-2004.

THE MARK CONSISTS OF STANDARD CHARACTERS WITHOUT CLAIM TO ANY PARTICULAR FONT, STYLE, SIZE, OR COLOR.

NO CLAIM IS MADE TO THE EXCLUSIVE RIGHT TO USE 'INC.', APART FROM THE MARK AS SHOWN.

SER. NO. 78-884,771, FILED P.R. 5-16-2006; AM. S.R. 1-30-2008.

JAMES STEIN, EXAMINING ATTORNEY

**Int. Cls.: 16, 35, and 41**

**Prior U.S. Cls.: 2, 5, 22, 23, 29, 37, 38, 50, 100, 101,  
102, and 107**

**Reg. No. 3,396,787**

**United States Patent and Trademark Office**

**Registered Mar. 11, 2008**

**TRADEMARK  
SERVICE MARK  
SUPPLEMENTAL REGISTER**

**AMERICAN ASSOCIATION FOR  
JUSTICE**

AMERICAN ASSOCIATION FOR JUSTICE (D.C.  
CORPORATION)  
1050 31ST STREET, NW  
WASHINGTON, DC 20007

FOR: PUBLICATIONS, NAMELY, BOOKS, MA-  
GAZINES, NEWSLETTERS, NEWS DIGESTS, PRIN-  
TED TEACHING MATERIALS, ABSTRACTS,  
MONOGRAPHS AND PAMPHLETS, IN THE FIELD  
OF LAW, IN CLASS 16 (U.S. CLS. 2, 5, 22, 23, 29, 37, 38  
AND 50).

FIRST USE 1-1-2007; IN COMMERCE 1-1-2007.

FOR: ASSOCIATION SERVICES, NAMELY, PRO-  
MOTING THE INTERESTS OF CONSUMERS, IN-  
JURED PERSONS AND ATTORNEYS, IN CLASS 35  
(U.S. CLS. 100, 101 AND 102).

FIRST USE 12-0-2006; IN COMMERCE 12-0-2006.

FOR: EDUCATION SERVICES, NAMELY, PRO-  
VIDING SEMINARS, WORKSHOPS AND CONFER-  
ENCES IN THE FIELD OF LAW, AND TRAINING  
SERVICES IN THE FIELD OF LAW, IN CLASS 41  
(U.S. CLS. 100, 101 AND 107).

FIRST USE 2-0-2007; IN COMMERCE 2-0-2007.

THE MARK CONSISTS OF STANDARD CHAR-  
ACTERS WITHOUT CLAIM TO ANY PARTICULAR  
FONT, STYLE, SIZE, OR COLOR.

NO CLAIM IS MADE TO THE EXCLUSIVE  
RIGHT TO USE "ASSOCIATION", APART FROM  
THE MARK AS SHOWN.

SER. NO. 78-912,409, FILED P.R. 6-20-2006; AM. S.R.  
2-1-2008.

JAY FLOWERS, EXAMINING ATTORNEY

**Int. Cls.: 35 and 45**

**Prior U.S. Cls.: 100, 101, and 102**

**United States Patent and Trademark Office**

**Reg. No. 3,396,788**

**Registered Mar. 11, 2008**

**SERVICE MARK  
SUPPLEMENTAL REGISTER**

**RPOworldwide**

MASTECH TRADEMARK SYSTEMS CORPORATION  
(DELAWARE CORPORATION)

SUITE 520

300 DELAWARE AVENUE

WILMINGTON, DE 19301

FOR: EMPLOYMENT AND JOB HIRING, PLACE-  
MENT AND RECRUITING SERVICES, IN CLASS 35  
(U.S. CLS. 100, 101 AND 102).

FIRST USE 6-7-2006; IN COMMERCE 6-7-2006.

FOR: PRE-EMPLOYMENT BACKGROUND  
SCREENING, IN CLASS 45 (U.S. CLS. 100 AND 101).

FIRST USE 6-7-2006; IN COMMERCE 6-7-2006.

THE MARK CONSISTS OF STANDARD CHAR-  
ACTERS WITHOUT CLAIM TO ANY PARTICULAR  
FONT, STYLE, SIZE, OR COLOR.

SER. NO. 78-915,532, FILED P.R. 6-23-2006; AM. S.R.  
1-14-2008.

NAKIA HENRY, EXAMINING ATTORNEY



**Int. Cl.: 41**

**Prior U.S. Cls.: 100, 101, and 107**

**United States Patent and Trademark Office**

**Reg. No. 3,396,789**

**Registered Mar. 11, 2008**

**SERVICE MARK  
SUPPLEMENTAL REGISTER**

# World Ocean Forum

OPEN SPACE INSTITUTE, INC. (NEW YORK  
NON-PROFIT CORPORATION)  
1350 BROADWAY, SUITE 201  
NEW YORK, PA 10018

FOR: EDUCATIONAL SERVICES, NAMELY, A  
FORUM FOR DISCUSSIONS RELATED TO THE  
OCEAN AND ITS RELATIONSHIP TO SUCH  
THEMES AS FRESH WATER, FOOD, ENERGY,  
HEALTH, TECHNOLOGY, FINANCE, GOVERN-  
ANCE, AND CULTURE, IN CLASS 41 (U.S. CLS.  
100, 101 AND 107).

FIRST USE 12-31-2004; IN COMMERCE 12-13-2005.

THE MARK CONSISTS OF STANDARD CHAR-  
ACTERS WITHOUT CLAIM TO ANY PARTICULAR  
FONT, STYLE, SIZE, OR COLOR.

NO CLAIM IS MADE TO THE EXCLUSIVE  
RIGHT TO USE "OCEAN FORUM", APART FROM  
THE MARK AS SHOWN.

SER. NO. 78-917,673, FILED P.R. 6-27-2006; AM. S.R.  
6-11-2007.

JENNY PARK, EXAMINING ATTORNEY

**Int. Cl.: 11**

**Prior U.S. Cls.: 13, 21, 23, 31, and 34**

**United States Patent and Trademark Office**

**Reg. No. 3,396,790**

**Registered Mar. 11, 2008**

**TRADEMARK  
SUPPLEMENTAL REGISTER**

**TORRINGTON**

HOMER TLC, INC. (DELAWARE CORPORATION)  
1404 SOCIETY DRIVE  
CLAYMONT, DE 19703

THE MARK CONSISTS OF STANDARD CHARACTERS WITHOUT CLAIM TO ANY PARTICULAR FONT, STYLE, SIZE, OR COLOR.

FOR: CEILING FANS; ELECTRIC LIGHTING FIXTURES, IN CLASS 11 (U.S. CLS. 13, 21, 23, 31 AND 34).

SER. NO. 78-918,560, FILED P.R. 6-28-2006; AM. S.R. 2-4-2008.

FIRST USE 5-9-2006; IN COMMERCE 5-9-2006.

JOHN KELLY, EXAMINING ATTORNEY

**Int. Cls.: 35 and 37**

**Prior U.S. Cls.: 100, 101, 102, 103, and 106**

**United States Patent and Trademark Office**

**Reg. No. 3,396,791**

**Registered Mar. 11, 2008**

**SERVICE MARK  
SUPPLEMENTAL REGISTER**

**UPFRONT PRICING GUARANTEE**

PATRICK O'BRIEN JR., CHEVROLET, INC.  
(OHIO CORPORATION)  
2810 BISHOP ROAD  
WILLOUGHBY HILLS, OH 44092

FOR: AUTOMOBILE DEALERSHIPS, IN CLASS 35  
(U.S. CLS. 100, 101 AND 102).

FIRST USE 5-1-2005; IN COMMERCE 5-1-2005.

FOR: AUTOMOBILE REPAIR AND MAINTENANCE,  
IN CLASS 37 (U.S. CLS. 100, 103 AND 106).

FIRST USE 5-1-2005; IN COMMERCE 5-1-2005.

THE MARK CONSISTS OF STANDARD CHARACTERS  
WITHOUT CLAIM TO ANY PARTICULAR FONT,  
STYLE, SIZE, OR COLOR.

SER. NO. 78-919,854, FILED P.R. 6-29-2006; AM. S.R.  
1-17-2008.

KATHLEEN LORENZO, EXAMINING ATTORNEY

**Int. Cl.: 16**

**Prior U.S. Cls.: 2, 5, 22, 23, 29, 37, 38, and 50**

**United States Patent and Trademark Office**

**Reg. No. 3,396,792**

**Registered Mar. 11, 2008**

**TRADEMARK  
SUPPLEMENTAL REGISTER**

**WEALTH MAGAZINE**

PERFORMANCE CAPITAL INTERNATIONAL  
LLC (FLORIDA LTD LIAB CO)  
1370 S. OCEAN BLVD.  
MANALAPAN, FL 33462

FOR: PUBLICATIONS, NAMELY, MAGAZINES  
IN THE FIELD OF BUILDING PERSONAL  
WEALTH, IN CLASS 16 (U.S. CLS. 2, 5, 22, 23, 29, 37,  
38 AND 50).

FIRST USE 12-0-2005; IN COMMERCE 12-0-2005.

THE MARK CONSISTS OF STANDARD CHAR-  
ACTERS WITHOUT CLAIM TO ANY PARTICULAR  
FONT, STYLE, SIZE, OR COLOR.

NO CLAIM IS MADE TO THE EXCLUSIVE  
RIGHT TO USE "MAGAZINE", APART FROM THE  
MARK AS SHOWN.

SER. NO. 78-922,284, FILED P.R. 7-5-2006; AM. S.R.  
1-9-2008.

LINDA ESTRADA, EXAMINING ATTORNEY

**Int. Cls.: 1, 16, 17, and 19**

**Prior U.S. Cls.: 1, 2, 5, 6, 10, 12, 13, 22, 23, 26, 29, 33, 35, 37, 38, 46, and 50**

**Reg. No. 3,396,793**

**United States Patent and Trademark Office**

**Registered Mar. 11, 2008**

**TRADEMARK  
SUPPLEMENTAL REGISTER**



SELLEYS PTY LIMITED (AUSTRALIA CORPORATION)  
1 GOW STREET, PADSTOW  
NEW SOUTH WALES, AUSTRALIA 2211

FOR: ADHESIVES, NAMELY, ADHESIVES FOR INDUSTRIAL PURPOSES AND CONSTRUCTION, ADHESIVES FOR WALL TILES; ADHESIVES OTHER THAN FOR STATIONERY OR HOUSEHOLD PURPOSES, IN CLASS 1 (U.S. CLS. 1, 5, 6, 10, 26 AND 46).

FOR: PRINTED MATTER, NAMELY, MAGAZINES, NEWSLETTERS, LEAFLETS, NOTEBOOKS AND POSTERS IN THE FIELDS OF PAINTS AND COATINGS, ADHESIVES, BUILDING AND CONSTRUCTION, HOME HANDYMAN BUILDING AND CONSTRUCTION, REPAIR AND MAINTENANCE; ADHESIVES FOR STATIONERY OR HOUSEHOLD PURPOSES; ADHESIVES FOR DO IT YOURSELF PURPOSES, NAMELY, ADHESIVES FOR MENDING BROKEN ARTICLES AND FOR PAPER HANGING; PAINT BRUSHES, PAINT ROLLERS; PAINTING ACCESSORIES, NAMELY, PAINT APPLICATORS, PAINT STIRRERS, AND PAINT ROLLER TRAYS; PAINT COLOR MATCHING SWATCHES, COLOR CARDS AND COLOR CHARTS FOR USE IN RELATION TO PAINTS AND COATINGS, ADHESIVES, BUILDING AND CONSTRUCTION, HOME HANDYMAN BUILDING AND CONSTRUCTION, REPAIR AND MAINTENANCE, IN CLASS 16 (U.S. CLS. 2, 5, 22, 23, 29, 37, 38 AND 50).

FOR: FILLERS, NAMELY, EXPANSION JOINT FILLERS FOR FILLING GAPS; ADHESIVE SEA-

LANTS FOR GENERAL USE; SEALANT COMPOUNDS FOR PIPE JOINTS; CHEMICAL COMPOSITIONS FOR REPAIRING LEAKS, NAMELY, ADHESIVE SEALANTS AND CAULKING COMPOUNDS; ADHESIVE SEALANTS, NAMELY, MASTICS AND CAULKING COMPOUNDS BEING MATERIAL FOR PACKING, STOPPING AND INSULATING; SILICONE BASED SEALANTS, NAMELY, PASTES THAT CURE TO FORM FLEXIBLE BONDS UTILIZED TO FILL GAPS OR JOINTS IN BUILDING STRUCTURES FOR THE PURPOSE OF PREVENTING WATER ENTRY; PUTTY, NAMELY, A FLEXIBLE COMPOUND WHICH CURES TO A CEMENT LIKE COMPOUND USED FOR THE PURPOSE OF SEALING WINDOWS AND SEALING AND FILLING CRACKS IN BUILDING STRUCTURES, IN CLASS 17 (U.S. CLS. 1, 5, 12, 13, 35 AND 50).

FOR: CEMENTITIOUS PREPARATIONS, NAMELY, FILLING CEMENT, ROOFING CEMENT, CEMENT USED FOR THE PURPOSE OF FILLING GAPS OR JOINTS IN BUILDING STRUCTURES, IN CLASS 19 (U.S. CLS. 1, 12, 33 AND 50).

PRIORITY CLAIMED UNDER SEC. 44(D) ON AUSTRALIA APPLICATION NO. 1119836, FILED 6-22-2006, REG. NO. 1119836, DATED 6-22-2006, EXPIRES 6-22-2016.

SER. NO. 78-922,688, FILED P.R. 7-5-2006; AM. S.R. 1-31-2008.

MELISSA VALLILLO, EXAMINING ATTORNEY

**Int. Cl.: 30**

**Prior U.S. Cl.: 46**

**United States Patent and Trademark Office**

**Reg. No. 3,396,794**

**Registered Mar. 11, 2008**

**TRADEMARK  
SUPPLEMENTAL REGISTER**

**HEALTHYROAST**

APPLIED FOODS SCIENCES, INC. (DELAWARE  
CORPORATION)  
1700 SOUTH LAMAR BLVD.  
SUITE 330  
AUSTIN, TX 78704

FOR: GROUND, BREWED AND WHOLE BEAN  
COFFEE, IN CLASS 30 (U.S. CL. 46).

FIRST USE 2-28-2005; IN COMMERCE 2-28-2005.

THE MARK CONSISTS OF STANDARD CHAR-  
ACTERS WITHOUT CLAIM TO ANY PARTICULAR  
FONT, STYLE, SIZE, OR COLOR.

SER. NO. 78-927,504, FILED P.R. 7-12-2006; AM. S.R.  
6-7-2007.

ELIZABETH BEYER, EXAMINING ATTORNEY

Int. Cl.: 43

Prior U.S. Cls.: 100 and 101

United States Patent and Trademark Office

Reg. No. 3,396,795

Registered Mar. 11, 2008

**SERVICE MARK  
SUPPLEMENTAL REGISTER**

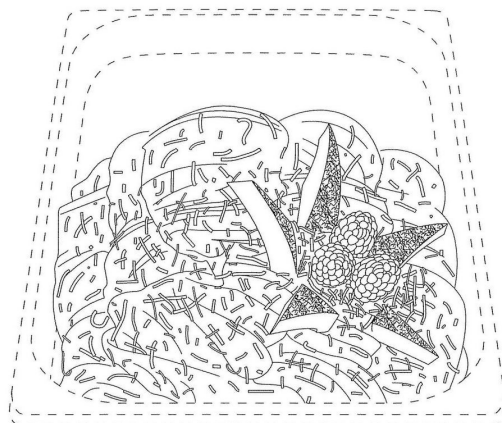

THE GELATERIA ICE CREAM. DESSERT.  
LOUNGE, INC. (ARIZONA CORPORATION)  
6934 EAST 5TH AVENUE  
SCOTTSDALE, AZ 85004

FOR: RESTAURANT SERVICES, IN CLASS 43  
(U.S. CLS. 100 AND 101).

FIRST USE 1-10-2005; IN COMMERCE 1-10-2005.

NO CLAIM IS MADE TO THE EXCLUSIVE  
RIGHT TO USE "THE CONFIGURATION OF THE  
RECTANGULAR TRAY THAT IS HOLDING THE  
GELATO AND THE PICTORIAL REPRESENTA-  
TION OF THE GELATO", APART FROM THE  
MARK AS SHOWN.

THE MARK CONSISTS OF A THREE-DIMEN-  
SIONAL RECTANGULAR TRAY OF GELATO. THE

GELATO IS IN THE FORM OF INDIVIDUAL BALLS  
THAT CONTAIN RIDGES PLACED AND SHAPED  
TO GIVE THE APPEARANCE OF ONE CONTINU-  
OUS MOUNTAIN-LIKE LAYER OF GELATO. A  
DECORATIVE GARNISH, NAMELY, TOASTED CO-  
CONUT, SPRINKLED ACROSS THE TOP OF THE  
GELATO, AND COCONUT WEDGES DISPLAYED  
AS FLOWER PETALS, WITH RASPBERRIES IN THE  
CENTER OF THE WEDGES TO REPRESENT THE  
BUD OF A FLOWER, IS PLACED TOWARDS THE  
FRONT OF THE GELATO LAYER. THE MATTER  
SHOWN BY THE DOTTED LINES IS NOT PART OF  
THE MARK AND SERVES TO SHOW THE POSI-  
TION OF THE MARK.

SER. NO. 78-928,122, FILED 7-12-2006.

WENDY GOODMAN, EXAMINING ATTORNEY

Int. Cl.: 43

Prior U.S. Cls.: 100 and 101

United States Patent and Trademark Office

Reg. No. 3,396,796

Registered Mar. 11, 2008

**SERVICE MARK  
SUPPLEMENTAL REGISTER**

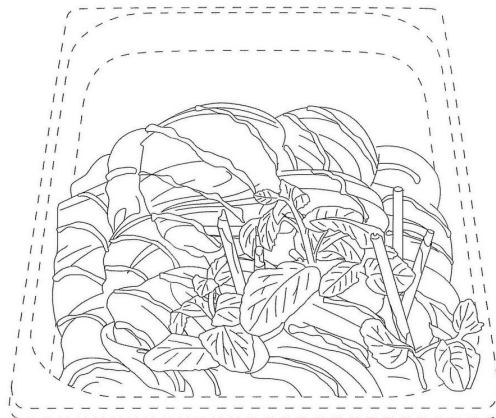

THE GELATERIA ICE CREAM, DESSERT,  
LOUNGE, INC. (ARIZONA CORPORATION)  
6934 EAST 5TH AVENUE  
SCOTTSDALE, AZ 85251

FOR: RESTAURANT SERVICES, IN CLASS 43  
(U.S. CLS. 100 AND 101).

FIRST USE 1-10-2005; IN COMMERCE 1-10-2005.

NO CLAIM IS MADE TO THE EXCLUSIVE  
RIGHT TO USE "THE CONFIGURATION OF THE  
RECTANGULAR TRAY THAT IS HOLDING THE  
GELATO AND THE PICTORIAL REPRESENTA-  
TION OF THE GELATO", APART FROM THE  
MARK AS SHOWN.

THE MARK CONSISTS OF A THREE-DIMEN-  
SIONAL RECTANGULAR TRAY OF GELATO. THE

GELATO IS IN THE FORM OF INDIVIDUAL BALLS  
THAT CONTAIN RIDGES PLACED AND SHAPED  
TO GIVE THE APPEARANCE OF ONE CONTINU-  
OUS MOUNTAIN-LIKE LAYER OF GELATO. A  
DECORATIVE GARNISH, NAMELY, CHOCOLATE  
SAUCE Poured ACROSS THE TOP OF THE GE-  
LATO IN A DIAGONAL PATTERN, MINT LEAVES  
AND CHOCOLATE STICKS, IS PLACED TOWARDS  
THE FRONT OF THE GELATO LAYER. THE MAT-  
TER SHOWN BY THE DOTTED LINES IS NOT PART  
OF THE MARK AND SERVES TO SHOW THE  
POSITION OF THE MARK.

SER. NO. 78-928,152, FILED 7-12-2006.

WENDY GOODMAN, EXAMINING ATTORNEY



Int. Cl.: 43

Prior U.S. Cls.: 100 and 101

United States Patent and Trademark Office

Reg. No. 3,396,797

Registered Mar. 11, 2008

**SERVICE MARK  
SUPPLEMENTAL REGISTER**

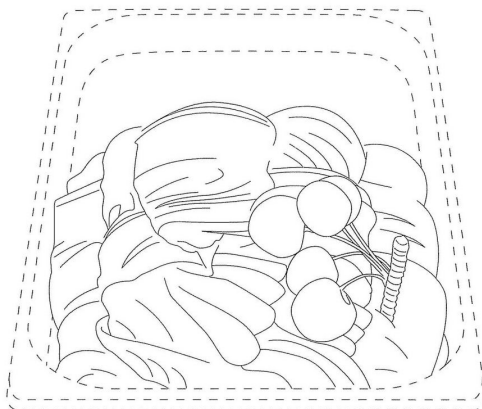

THE GELATERIA ICE CREAM. DESSERT.  
LOUNGE, INC. (ARIZONA CORPORATION)  
6934 EAST 5TH AVENUE  
SCOTTSDALE, AZ 85251

FOR: RESTAURANT SERVICES, IN CLASS 43  
(U.S. CLS. 100 AND 101).

FIRST USE 1-10-2005; IN COMMERCE 1-10-2005.

NO CLAIM IS MADE TO THE EXCLUSIVE  
RIGHT TO USE "THE CONFIGURATION OF THE  
RECTANGULAR TRAY THAT IS HOLDING THE  
SORBET AND THE PICTORIAL REPRESENTATION  
OF THE SORBET," APART FROM THE MARK AS  
SHOWN.

THE MARK CONSISTS OF A THREE-DIMEN-  
SIONAL RECTANGULAR TRAY OF SORBET. THE  
SORBET IS IN THE FORM OF INDIVIDUAL BALLS  
THAT CONTAIN RIDGES PLACED AND SHAPED  
TO GIVE THE APPEARANCE OF ONE CONTINU-  
OUS MOUNTAIN-LIKE LAYER OF SORBET. A  
DECORATIVE GARNISH, NAMELY, A BUNDLE  
OF CHERRIES, IS PLACED TOWARDS THE FRONT  
OF THE SORBET LAYER. THE MATTER SHOWN  
BY THE DOTTED LINES IS NOT PART OF THE  
MARK AND SERVES TO SHOW THE POSITION OF  
THE MARK.

SER. NO. 78-928,167, FILED 7-12-2006.

WENDY GOODMAN, EXAMINING ATTORNEY

Int. Cl.: 43

Prior U.S. Cls.: 100 and 101

United States Patent and Trademark Office

Reg. No. 3,396,798

Registered Mar. 11, 2008

**SERVICE MARK  
SUPPLEMENTAL REGISTER**

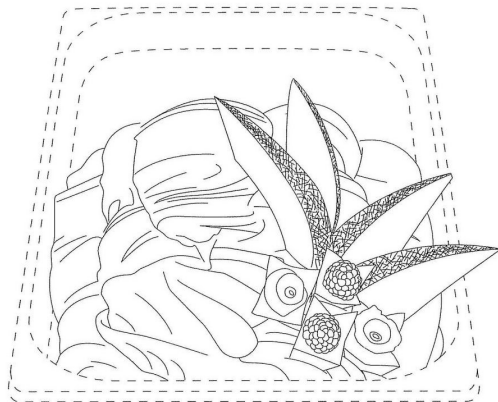

THE GELATERIA ICE CREAM. DESSERT.  
LOUNGE, INC. (ARIZONA CORPORATION)  
6934 EAST 5TH AVENUE  
SCOTTSDALE, AZ 85251

FOR: RESTAURANT SERVICES, IN CLASS 43  
(U.S. CLS. 100 AND 101).

FIRST USE 1-10-2005; IN COMMERCE 1-10-2005.

NO CLAIM IS MADE TO THE EXCLUSIVE  
RIGHT TO USE "THE CONFIGURATION OF THE  
RECTANGULAR TRAY THAT IS HOLDING THE  
SORBET AND THE PICTORIAL REPRESENTATION  
OF THE SORBET", APART FROM THE MARK AS  
SHOWN.

THE MARK CONSISTS OF A THREE-DIMEN-  
SIONAL RECTANGULAR TRAY OF SORBET. THE

SORBET IS IN THE FORM OF INDIVIDUAL BALLS  
THAT CONTAIN RIDGES PLACED AND SHAPED  
TO GIVE THE APPEARANCE OF ONE CONTINU-  
OUS MOUNTAIN-LIKE LAYER OF SORBET. A  
DECORATIVE GARNISH, NAMELY, CANTA-  
LOUPE, CUT IN A FLORAL SHAPE WITH RASP-  
BERRIES PLACED IN THE CENTER OF THE  
CANTALOUPE TO REPRESENT THE BUD OF A  
FLOWER, AND CANTALOUPE WEDGES ARRAN-  
GED BEHIND THE CUT CANTALOUPE, IS PLACED  
TOWARDS THE FRONT OF THE SORBET LAYER.  
THE MATTER SHOWN BY THE DOTTED LINES IS  
NOT PART OF THE MARK AND SERVES TO SHOW  
THE POSITION OF THE MARK.

SER. NO. 78-928,200, FILED 7-12-2006.

WENDY GOODMAN, EXAMINING ATTORNEY

Int. Cl.: 43

Prior U.S. Cls.: 100 and 101

United States Patent and Trademark Office

Reg. No. 3,396,799

Registered Mar. 11, 2008

**SERVICE MARK  
SUPPLEMENTAL REGISTER**

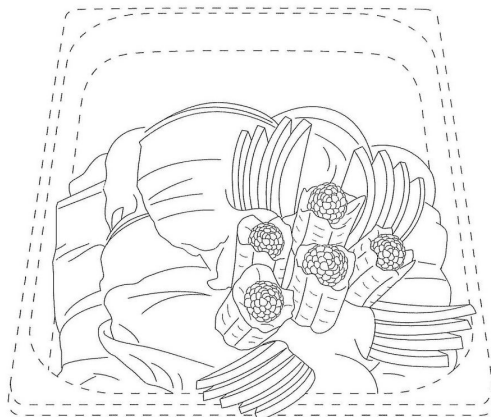

THE GELATERIA ICE CREAM, DESSERT,  
LOUNGE, INC. (ARIZONA CORPORATION)  
6934 EAST 5TH AVENUE  
SCOTTSDALE, AZ 85251

FOR: RESTAURANT SERVICES, IN CLASS 43  
(U.S. CLS. 100 AND 101).

FIRST USE 1-10-2005; IN COMMERCE 1-10-2005.

NO CLAIM IS MADE TO THE EXCLUSIVE  
RIGHT TO USE "THE CONFIGURATION OF THE  
RECTANGULAR TRAY THAT IS HOLDING THE  
SORBET AND THE PICTORIAL REPRESENTATION  
OF THE SORBET", APART FROM THE MARK AS  
SHOWN.

THE MARK CONSISTS OF A THREE-DIMEN-  
SIONAL RECTANGULAR TRAY OF SORBET. THE

SORBET IS IN THE FORM OF INDIVIDUAL BALLS  
THAT CONTAIN RIDGES PLACED AND SHAPED  
TO GIVE THE APPEARANCE OF ONE CONTINU-  
OUS MOUNTAIN-LIKE LAYER OF SORBET. A  
DECORATIVE GARNISH, NAMELY, BANANAS,  
CUT IN FLORAL SHAPES, WITH RASPBERRIES  
PLACED IN THE CENTER OF EACH BANANA TO  
REPRESENT THE BUD OF THE FLOWER, AND  
APPLES IN "FAN" SHAPES AND PLACED AROUND  
THE BANANAS, IS PLACED TOWARDS THE  
FRONT OF THE GELATO LAYER. THE MATTER  
SHOWN BY THE DOTTED LINES IS NOT PART OF  
THE MARK AND SERVES TO SHOW THE POSI-  
TION OF THE MARK.

SER. NO. 78-928,214, FILED 7-12-2006.

WENDY GOODMAN, EXAMINING ATTORNEY

**Int. Cl.: 1**

**Prior U.S. Cls.: 1, 5, 6, 10, 26, and 46**

**United States Patent and Trademark Office**

**Reg. No. 3,396,800**

**Registered Mar. 11, 2008**

**TRADEMARK  
SUPPLEMENTAL REGISTER**

**NANO-C**

NANO-C, INC. (DELAWARE CORPORATION)  
33 SOUTHWEST PARK  
WESTWOOD, MA 02090

FIRST USE 8-12-2003; IN COMMERCE 8-12-2003.

FOR: FULLERENES FOR USE IN ENERGY GENERATION AND CONSERVATION, MEDICAL THERAPY DEVELOPMENT, FILTRATION AND CATALYSIS APPLICATION AND GENERAL INDUSTRIAL USE, IN CLASS 1 (U.S. CLS. 1, 5, 6, 10, 26 AND 46).

THE MARK CONSISTS OF STANDARD CHARACTERS WITHOUT CLAIM TO ANY PARTICULAR FONT, STYLE, SIZE, OR COLOR.

SER. NO. 78-943,294, FILED P.R. 8-2-2006; AM. S.R. 1-31-2008.

ROBIN CHOSID, EXAMINING ATTORNEY

**Int. Cl.: 9**

**Prior U.S. Cls.: 21, 23, 26, 36, and 38**

**United States Patent and Trademark Office**

**Reg. No. 3,396,801**

**Registered Mar. 11, 2008**

**TRADEMARK  
SUPPLEMENTAL REGISTER**

**NOISE STOPPER**

THE QUEST GROUP (CALIFORNIA CORPORATION)  
2621 WHITE ROAD  
IRVINE, CA 92614

FOR: ELECTRONIC DEVICES THAT FILTER ELECTRO-MAGNETIC RADIO FREQUENCY INTERFERENCE IN AUDIO, VIDEO, AND COMPUTER CABLE PRODUCTS, IN CLASS 9 (U.S. CLS. 21, 23, 26, 36 AND 38).

FIRST USE 10-28-2005; IN COMMERCE 10-28-2005.

THE MARK CONSISTS OF STANDARD CHARACTERS WITHOUT CLAIM TO ANY PARTICULAR FONT, STYLE, SIZE, OR COLOR.

SER. NO. 78-945,576, FILED P.R. 8-4-2006; AM. S.R. 1-26-2008.

TINA KUAN, EXAMINING ATTORNEY

**Int. Cl.: 28**

**Prior U.S. Cls.: 22, 23, 38, and 50**

**United States Patent and Trademark Office**

**Reg. No. 3,396,802**

**Registered Mar. 11, 2008**

**TRADEMARK  
SUPPLEMENTAL REGISTER**

# Dosha Dolls

CHIODO ENTERPRISES SERIES Y, LLC (FLOR-  
IDA LTD LIAB CO)  
10045 IDLE PINELANE  
BONITA SPRINGS, FL 34135

FOR: DOLLS, NAMELY, DOLLS THAT ARE  
CUSTOMIZED TO ALIGN WITH THE 3 PHYSICAL  
CONSTITUTIONS ACCORDING TO THE ANCIENT  
SCIENCE OF AYURVEDA , IN CLASS 28 (U.S. CLS.  
22, 23, 38 AND 50).

FIRST USE 12-20-2007; IN COMMERCE 12-20-2007.

THE MARK CONSISTS OF STANDARD CHAR-  
ACTERS WITHOUT CLAIM TO ANY PARTICULAR  
FONT, STYLE, SIZE, OR COLOR.

NO CLAIM IS MADE TO THE EXCLUSIVE  
RIGHT TO USE "DOLLS", APART FROM THE  
MARK AS SHOWN.

SER. NO. 78-949,413, FILED P.R. 8-10-2006; AM. S.R.  
12-28-2007.

AMY HELLA, EXAMINING ATTORNEY

**Int. Cl.: 16**

**Prior U.S. Cls.: 2, 5, 22, 23, 29, 37, 38, and 50**

**United States Patent and Trademark Office**

**Reg. No. 3,396,803**

**Registered Mar. 11, 2008**

**TRADEMARK  
SUPPLEMENTAL REGISTER**

**MATTRESS MENU**

DIAL-A-MATTRESS OPERATING CORP. (NEW  
YORK CORPORATION)  
31-10 48TH AVE.  
LONG ISLAND CITY, NY 11101

FOR: MAGAZINE FEATURE IN THE FIELD OF  
MATTRESSES, BEDS, BEDDING, FURNITURE  
AND HOME FURNISHINGS, IN CLASS 16 (U.S.  
CLS. 2, 5, 22, 23, 29, 37, 38 AND 50).

FIRST USE 6-20-2006; IN COMMERCE 6-20-2006.

THE MARK CONSISTS OF STANDARD CHAR-  
ACTERS WITHOUT CLAIM TO ANY PARTICULAR  
FONT, STYLE, SIZE, OR COLOR.

SER. NO. 78-953,466, FILED P.R. 8-16-2006; AM. S.R.  
1-24-2008.

JOHN E. MICHOS, EXAMINING ATTORNEY

**Int. Cl.: 38**

**Prior U.S. Cls.: 100, 101, and 104**

**United States Patent and Trademark Office**

**Reg. No. 3,396,804**

**Registered Mar. 11, 2008**

**SERVICE MARK  
SUPPLEMENTAL REGISTER**

**CHAMPIONSHIP GAMING SERIES**

CHAMPIONSHIP GAMING SERIES, LLC (DELA-  
WARE LTD LIAB CO)  
2711 CENTERFILLE ROAD  
SUITE 400  
WILMINGTON, DE 19808

FOR: PROVIDING ON-LINE CHAT ROOMS AND  
ELECTRONIC BULLETIN BOARDS FOR TRANS-  
MISSION OF MESSAGES AMONG USERS IN THE  
FIELD OF GENERAL INTEREST , IN CLASS 38 (U.S.  
CLS. 100, 101 AND 104).

FIRST USE 7-0-2006; IN COMMERCE 7-0-2006.

THE MARK CONSISTS OF STANDARD CHAR-  
ACTERS WITHOUT CLAIM TO ANY PARTICULAR  
FONT, STYLE, SIZE, OR COLOR.

SER. NO. 78-954,912, FILED P.R. 8-17-2006; AM. S.R.  
1-31-2008.

MICHAEL ENGEL, EXAMINING ATTORNEY



Int. Cl.: 25

Prior U.S. Cls.: 22 and 39

United States Patent and Trademark Office

Reg. No. 3,396,805

Registered Mar. 11, 2008

TRADEMARK  
SUPPLEMENTAL REGISTER

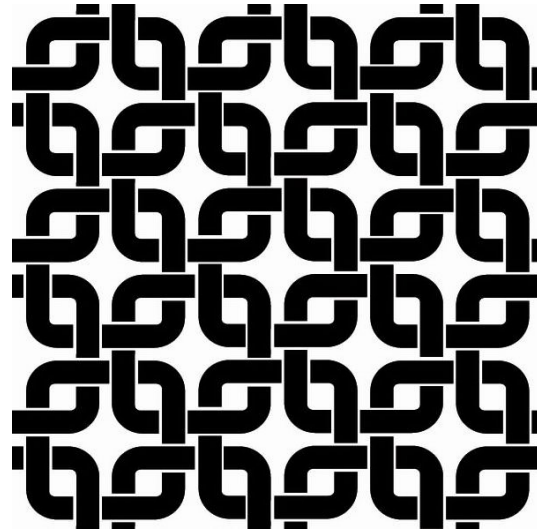

LA MARCA FINA, LTD (NEVADA LIMITED  
LIABILITY COMPANY)  
89-19 PONTIAC STREET  
QUEENS VILLAGE, NY 11427

FOR: SHIRTS, T-SHIRTS, PULLOVER SWEAT  
SHIRTS, ZIP-UP HOODED SWEATERS, BUTTON-  
UP HOODED SWEATERS, JACKETS, WAISTCOATS,  
KNITTED SWEATERS, PANTS, AND VESTS, IN  
CLASS 25 (U.S. CLS. 22 AND 39).

FIRST USE 1-0-2006; IN COMMERCE 1-0-2006.

THE MARK CONSISTS OF A REPEATING DE-  
SIGN OF INTERLOCKING AND STYLIZED  
SQUARES.

SER. NO. 78-956,216, FILED P.R. 8-21-2006; AM. S.R.  
1-30-2008.

FRANK LATTUCA, EXAMINING ATTORNEY

**Int. Cl.: 35**

**Prior U.S. Cls.: 100, 101, and 102**

**United States Patent and Trademark Office**

**Reg. No. 3,396,806**

**Registered Mar. 11, 2008**

**SERVICE MARK  
SUPPLEMENTAL REGISTER**

**MATTRESS MENU**

DIAL-A-MATTRESS OPERATING CORP. (NEW  
YORK CORPORATION)

31-10 48TH AVE.

LONG ISLAND CITY, NY 11101

FOR: RETAIL STORE SERVICES IN THE FIELD  
OF MATTRESSES, BEDS AND BEDDING, IN CLASS  
35 (U.S. CLS. 100, 101 AND 102).

FIRST USE 1-1-2004; IN COMMERCE 1-1-2004.

THE MARK CONSISTS OF STANDARD CHAR-  
ACTERS WITHOUT CLAIM TO ANY PARTICULAR  
FONT, STYLE, SIZE, OR COLOR.

NO CLAIM IS MADE TO THE EXCLUSIVE  
RIGHT TO USE "MATTRESS", APART FROM THE  
MARK AS SHOWN.

SER. NO. 78-957,421, FILED P.R. 8-22-2006; AM. S.R.  
1-24-2008.

JOHN E. MICHOS, EXAMINING ATTORNEY

**Int. Cls.: 5, 16, and 44**

**Prior U.S. Cls.: 2, 5, 6, 18, 22, 23, 29, 37, 38, 44, 46, 50,  
51, 52, 100, and 101**

**Reg. No. 3,396,807**

**United States Patent and Trademark Office**

**Registered Mar. 11, 2008**

**TRADEMARK  
SERVICE MARK  
SUPPLEMENTAL REGISTER**

**OREXIGEN**

OREXIGEN THERAPEUTICS, INC. (DELAWARE  
CORPORATION)  
SUITE 150  
12481 HIGH BLUFF DRIVE  
SAN DIEGO, CA 92130

FOR: PHARMACEUTICAL PREPARATIONS FOR  
THE TREATMENT OF DISORDERS OF THE CENTRAL  
NERVOUS SYSTEM, IN CLASS 5 (U.S. CLS. 6,  
18, 44, 46, 51 AND 52).

FIRST USE 10-2-2007; IN COMMERCE 10-2-2007.

FOR: PRINTED INSTRUCTIONAL, EDUCATIONAL  
AND TEACHING MATERIALS IN THE FIELD  
OF TREATMENT AND MANAGEMENT OF DIS-  
ORDERS OF THE CENTRAL NERVOUS SYSTEM,  
IN CLASS 16 (U.S. CLS. 2, 5, 22, 23, 29, 37, 38 AND 50).

FIRST USE 12-5-2007; IN COMMERCE 12-5-2007.

FOR: PROVIDING MEDICAL INFORMATION IN  
THE FIELD OF DISORDERS OF THE CENTRAL  
NERVOUS SYSTEM , IN CLASS 44 (U.S. CLS. 100  
AND 101).

FIRST USE 3-7-2006; IN COMMERCE 3-7-2006.

THE MARK CONSISTS OF STANDARD CHAR-  
ACTERS WITHOUT CLAIM TO ANY PARTICULAR  
FONT, STYLE, SIZE, OR COLOR.

SER. NO. 78-960,760, FILED P.R. 8-25-2006; AM. S.R.  
1-25-2008.

MATTHEW MCDOWELL, EXAMINING ATTOR-  
NEY

**Int. Cl.: 5**

**Prior U.S. Cls.: 6, 18, 44, 46, 51, and 52**

**United States Patent and Trademark Office**

**Reg. No. 3,396,808**

**Registered Mar. 11, 2008**

**TRADEMARK  
SUPPLEMENTAL REGISTER**

**Green SuperFood**

GRASS ADVANTAGE (CALIFORNIA CORPORATION)  
106 CERVANTES BLVD  
SAN FRANCISCO, CA 94123

THE MARK CONSISTS OF STANDARD CHARACTERS WITHOUT CLAIM TO ANY PARTICULAR FONT, STYLE, SIZE, OR COLOR.

FOR: DIETARY AND NUTRITIONAL SUPPLEMENTS, IN CLASS 5 (U.S. CLS. 6, 18, 44, 46, 51 AND 52).

SER. NO. 78-969,016, FILED P.R. 9-7-2006; AM. S.R. 12-28-2007.

FIRST USE 1-1-2004; IN COMMERCE 1-1-2004.

AISHA SALEM, EXAMINING ATTORNEY

**Int. Cls.: 35 and 41**

**Prior U.S. Cls.: 100, 101, 102, and 107**

**United States Patent and Trademark Office**

**Reg. No. 3,396,809**

**Registered Mar. 11, 2008**

**SERVICE MARK  
SUPPLEMENTAL REGISTER**

**GOURMET PIZZA CLASSIC**

PALM BAY IMPORTS, INC. (FLORIDA CORPORATION)

48 HARBOR PARK DRIVE

PORT WASHINGTON, NY 11050

FOR: CONTESTS AND INCENTIVE AWARD PROGRAMS TO PROMOTE THE SALE OF PRODUCTS AND SERVICES OF OTHERS, IN CLASS 35 (U.S. CLS. 100, 101 AND 102).

FIRST USE 1-1-2006; IN COMMERCE 1-1-2006.

FOR: ENTERTAINMENT SERVICES, NAMELY, CONDUCTING CONTESTS, IN CLASS 41 (U.S. CLS. 100, 101 AND 107).

FIRST USE 1-1-2006; IN COMMERCE 1-1-2006.

THE MARK CONSISTS OF STANDARD CHARACTERS WITHOUT CLAIM TO ANY PARTICULAR FONT, STYLE, SIZE, OR COLOR.

SER. NO. 78-972,190, FILED P.R. 9-12-2006; AM. S.R. 12-12-2007.

JOHN WILKE, EXAMINING ATTORNEY

**Int. Cl.: 35**

**Prior U.S. Cls.: 100, 101, and 102**

**United States Patent and Trademark Office**

**Reg. No. 3,396,810**

**Registered Mar. 11, 2008**

**SERVICE MARK  
SUPPLEMENTAL REGISTER**

# Time Banks

TIME DOLLAR INSTITUTE (MARYLAND CORPORATION)

5500 39TH ST NW

WASHINGTON, DC 20015

FOR: ADMINISTERING A TAX-EXEMPT TIME CREDIT EXCHANGE REWARDS PROGRAM WHEREBY PARTICIPANTS WHO PARTICIPATE IN VOLUNTEER AND COMMUNITY SERVICE INITIATIVES CAN ACCUMULATE CREDIT THAT CAN BE USED TO PURCHASE MERCHANDISE ITEMS AND SERVICES PROVIDED BY OTHER

MEMBERS, IN CLASS 35 (U.S. CLS. 100, 101 AND 102).

FIRST USE 1-3-2000; IN COMMERCE 1-3-2000.

THE MARK CONSISTS OF STANDARD CHARACTERS WITHOUT CLAIM TO ANY PARTICULAR FONT, STYLE, SIZE, OR COLOR.

SER. NO. 78-977,789, FILED P.R. 7-19-2004; AM. S.R. 2-5-2008.

JORDAN BAKER, EXAMINING ATTORNEY

**Int. Cl.: 25**

**Prior U.S. Cls.: 22 and 39**

**United States Patent and Trademark Office**

**Reg. No. 3,396,811**

**Registered Mar. 11, 2008**

**TRADEMARK  
SUPPLEMENTAL REGISTER**

**PIKE PLACE FISH MARKET**

PIKE PLACE FISH MARKET, INC. (WASHINGTON CORPORATION)  
86 PIKE PLACE  
SEATTLE, WA 98101

FOR: CLOTHING, NAMELY, T-SHIRTS, SWEATSHIRTS, AND APRONS; HEADGEAR, NAMELY, CAPS AND HATS, IN CLASS 25 (U.S. CLS. 22 AND 39).

FIRST USE 4-0-2004; IN COMMERCE 4-0-2004.

THE MARK CONSISTS OF STANDARD CHARACTERS WITHOUT CLAIM TO ANY PARTICULAR FONT, STYLE, SIZE, OR COLOR.

NO CLAIM IS MADE TO THE EXCLUSIVE RIGHT TO USE "FISH MARKET", APART FROM THE MARK AS SHOWN.

SER. NO. 78-979,522, FILED P.R. 4-27-2006; AM. S.R. 11-19-2007.

HOWARD B. LEVINE, EXAMINING ATTORNEY

**Int. Cl.: 9**

**Prior U.S. Cls.: 21, 23, 26, 36, and 38**

**United States Patent and Trademark Office**

**Reg. No. 3,396,812**

**Registered Mar. 11, 2008**

**TRADEMARK  
SUPPLEMENTAL REGISTER**

**THE FIGHTER COLLECTION**

THE FIGHTER COLLECTION LIMITED (ENGLAND CORPORATION)  
DUXFORD AIRFIELD  
IMPERIAL WAR MUSEUM  
DUXFORD, ENGLAND CB2 4QR

FOR: APPARATUS FOR TRANSMISSION OR REPRODUCTION OF SOUND OR IMAGES; MULTIMEDIA COMPUTER SOFTWARE RECORDED ON A CD-ROM FEATURING AVIATION SUBJECT MATTER; COMPUTER GAME PROGRAMS RECORDED ON CD-ROM; FLIGHT SIMULATOR COMPUTER GAME PROGRAMS; VIDEO GAME DISCS, AUDIO VIDEO DISCS, COMPACT DISCS, PARTS AND FITTINGS FOR ALL OF THE AFORE-

MENTIONED GOODS, IN CLASS 9 (U.S. CLS. 21, 23, 26, 36 AND 38).

FIRST USE 5-7-2006; IN COMMERCE 5-7-2006.

THE MARK CONSISTS OF STANDARD CHARACTERS WITHOUT CLAIM TO ANY PARTICULAR FONT, STYLE, SIZE, OR COLOR.

SER. NO. 78-979,826, FILED P.R. 5-18-2006; AM. S.R. 12-26-2007.

KELLEY WELLS, EXAMINING ATTORNEY