Overview of Energy Harvesting Systems (for low-power electronics)

Gyuhae Park

*Engineering Institute
Engineering Sciences & Applications
Los Alamos National Laboratory*

The First Engineering Institute Workshop:
Energy Harvesting

Outline

- Introduction to Energy Harvesting
- Limitations on Portable Electrical Energy
- Discussion of Previous Studies
 - Energy Conversion – Piezoelectric Materials
 - Energy Harvesting Circuitry
 - Energy Storage
 - Applications
 - Energy conversion – Thermoelectric, Radio-Frequency (RF)
- Future Research Issues

Which one do you want to have?



Battery-based



"Forever"-based

Energy Harvesting is an enabling technology

- Wireless technology allows electronics and sensors to be placed in remote locations
- Continuous advances in low-power electronics and MEMS
- Powering wireless sensors for years requires new advance in energy sources

- Energy harvesting can provide “endless energy” for the electronics lifespan.

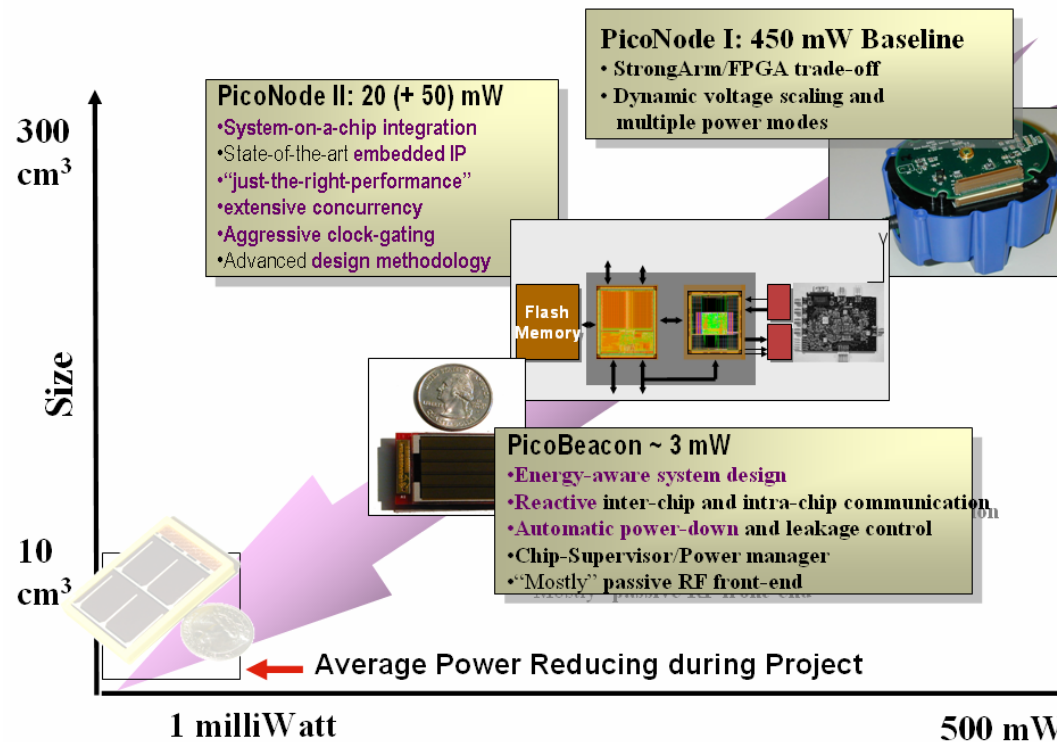

Figure from UC Berkley



Figure from University of Florida

Reduction in Energy Consumption and Size of Electric devices



Wright et al., 2005

- Makes energy harvesting more practical!!!

Portable Electric Energy Sources Available

■ Batteries

- Wide spread availability, high reliability
- Low-cost, mature technologies
- Replacement/recharging is an issue
 - Too numerous in the future
 - Location is unreachable
- Sensor size limited by battery size

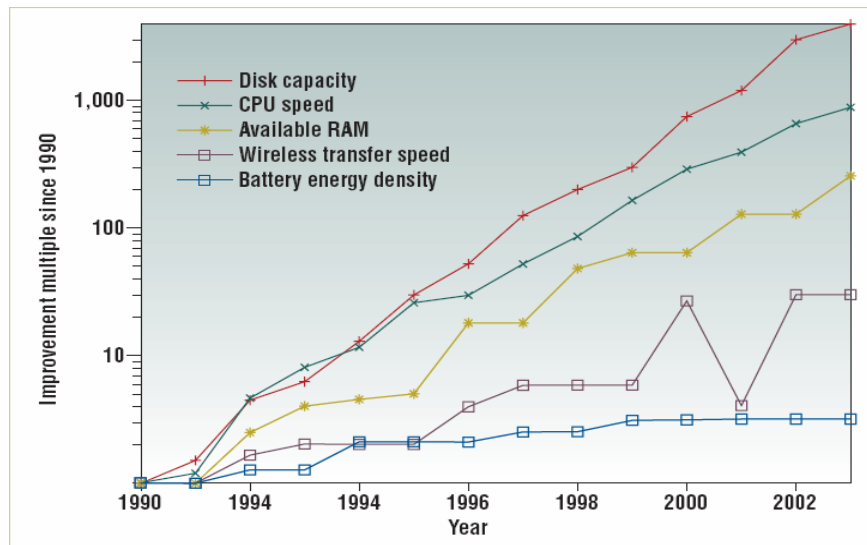
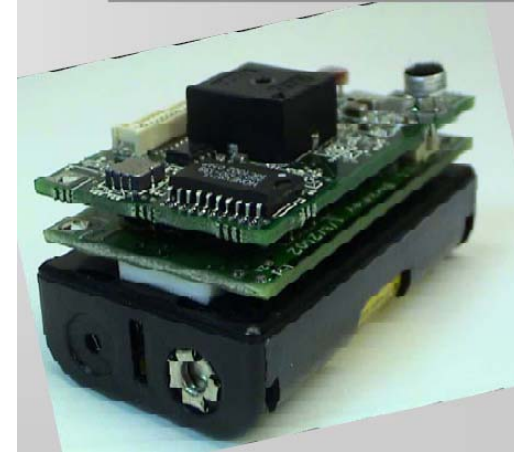

- Relative Improvement in Laptop Technology (Paradiso and Starner, 2005)
- Battery energy is the slowest trend

Portable Electric Energy Sources Available

- Solar Cells
 - COTS energy harvesting
 - 1cm x 1cm; 0.14 mW (much less inside)



Figure from Silicon Solar



Flexible solar cell

- Recent research trend to improve the efficiency, robustness, cost-down etc.
- Often limited by the availability of direct sunlight and size.

Important Aspects for Energy Harvesting

- Convert energy from ambient sources
- Ambient energy sources
 - mechanical, thermal, environmental
 - Biological
- Three components
 - Energy conversion
 - Harvesting and Conditioning Circuit
 - Energy Storage

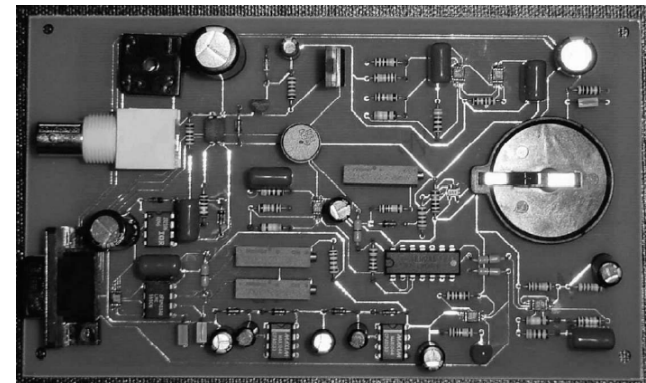

Lesieutre et al, 2004

Piezoelectric (PZT) Devices

- Materials can convert ambient vibration into electricity.

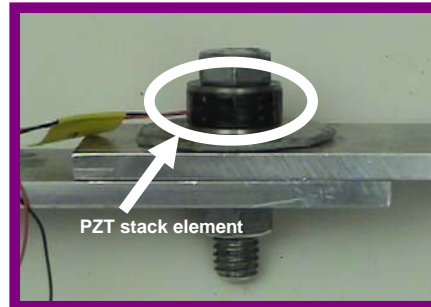
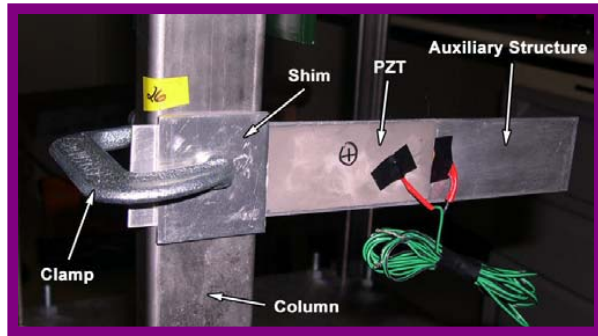

Energy harvesting eel, Ocean Technology, Inc

- Kymissis et al. (1998) investigated energy harvesting from piezoelectric devices located in shoes

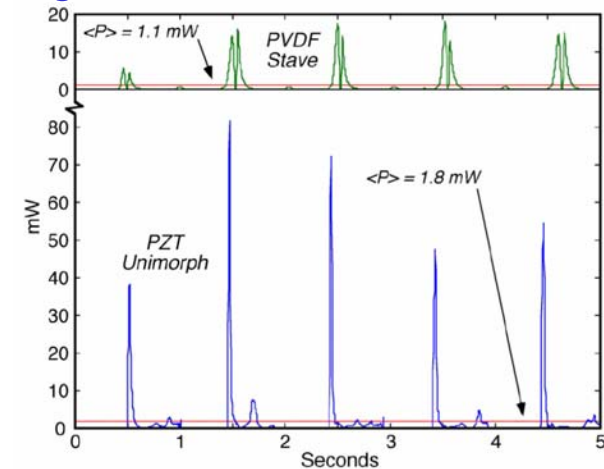
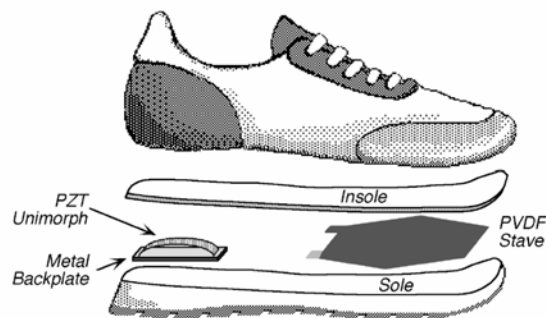

Sodano et al (2003) investigated the amount of energy that can be harvested w/o using any power conditioning circuits

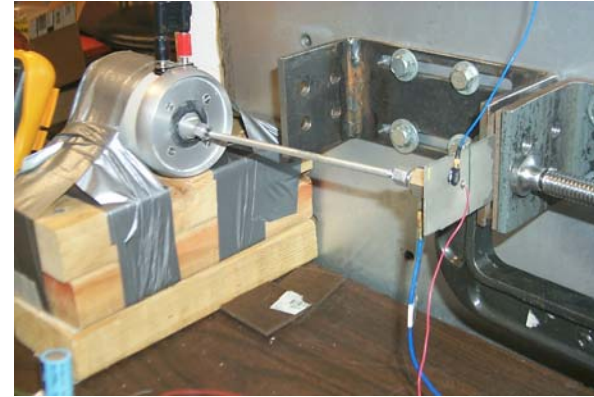
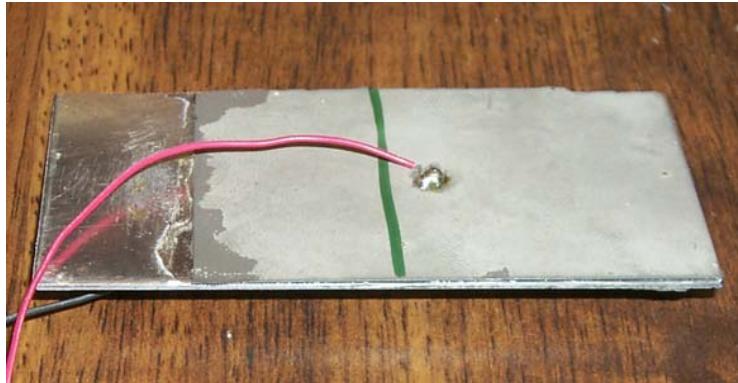

- PZT (40 x 60 mm) bonded to surface.
- Shaker used to apply a point input
- The various input signals were given (random- car compressor, Chirp, harmonic)
- Produced a maximum power of 1.9 mW, an average power of 0.12 mW

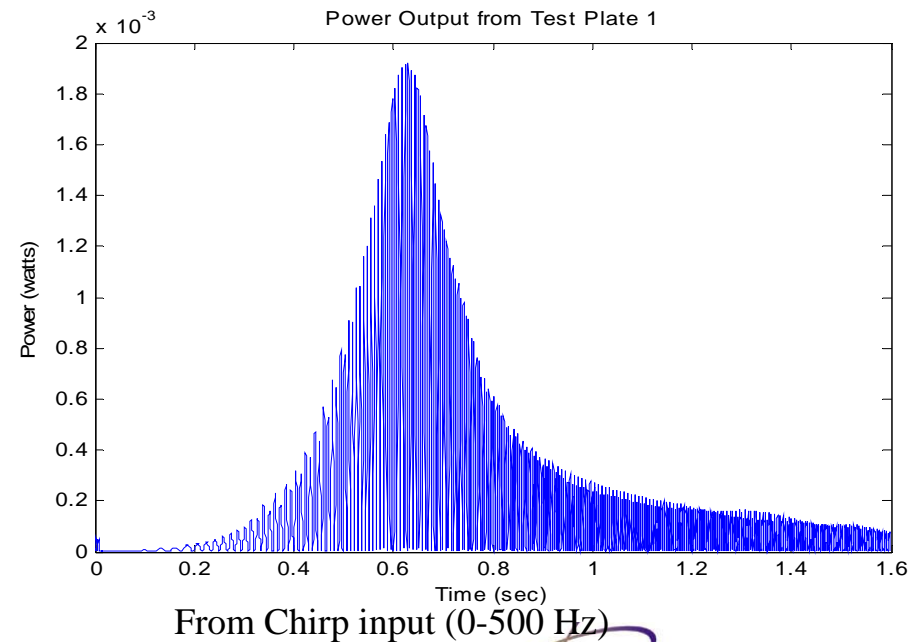

Mechanical tuning is important to maximize the power output (Cornwell et al 2003)

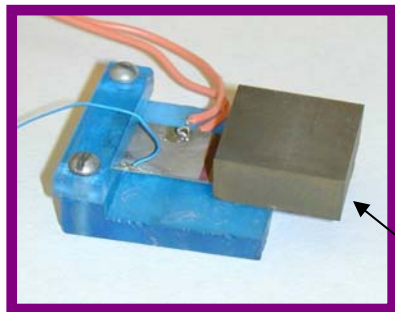
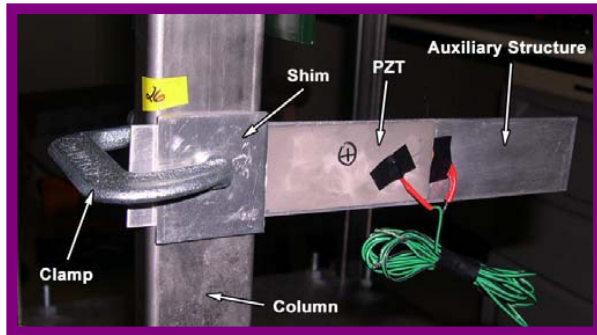

Proof mass

Figure from UC Berkley

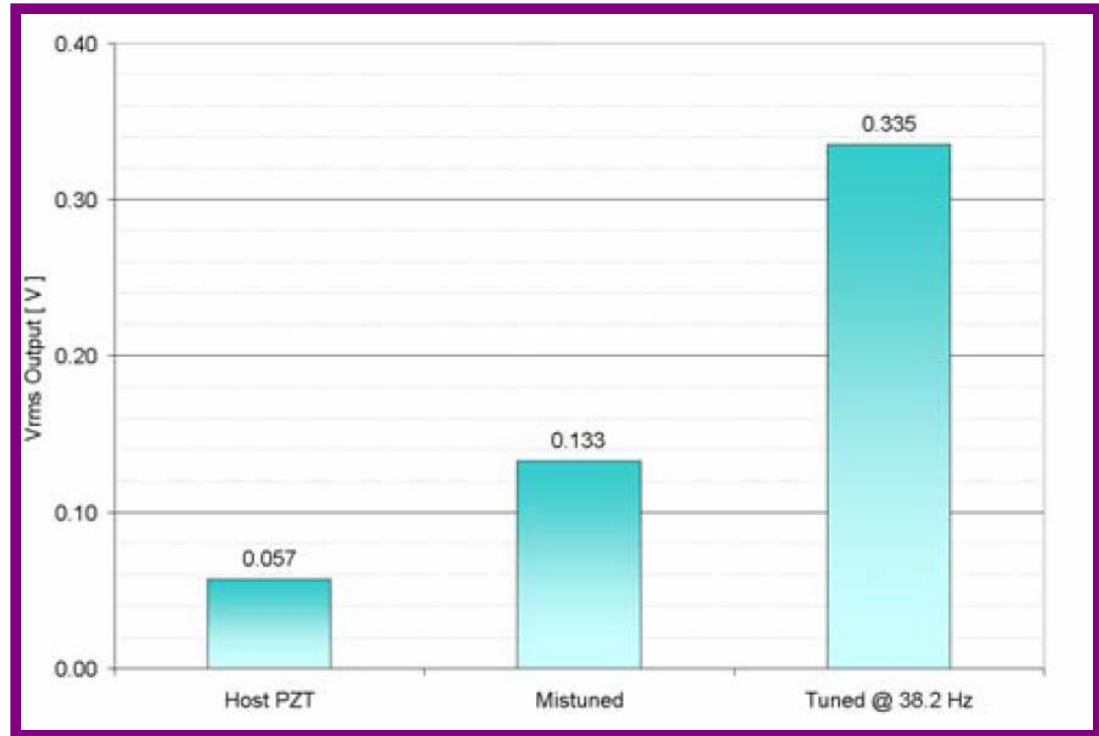

- A great improvement was observed when the resonance of the harvester matches that of the structure.

Broadband Energy Harvester (Boeing)

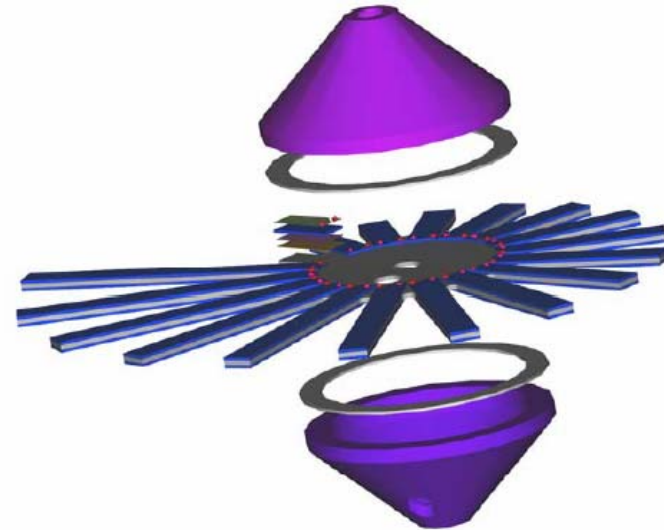
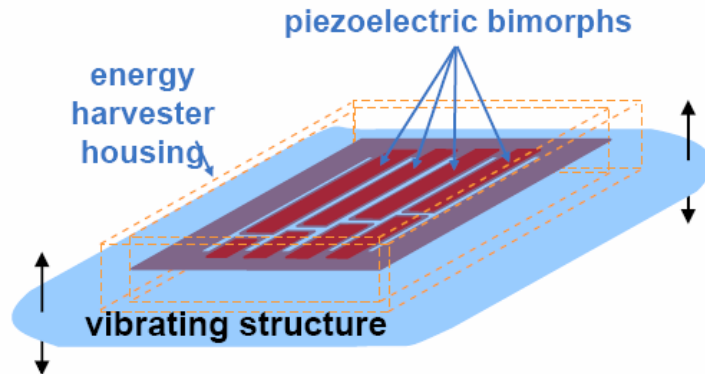

Figures from Boeing, (Malkin 2004)

- Precise mechanical tuning is not always possible.
- Vibrations excite multiple piezoelectric materials of varying lengths.
- Electrical signal from each bimorph is rectified and added.
- Total rectified voltage can be used.

Piezoelectric Devices

- The electro-mechanical coupling depends on the piezoelectric properties, the size and shape, frequency, and the direction of mechanical excitation and electrical response.
- Typical operating modes: d31 and d33

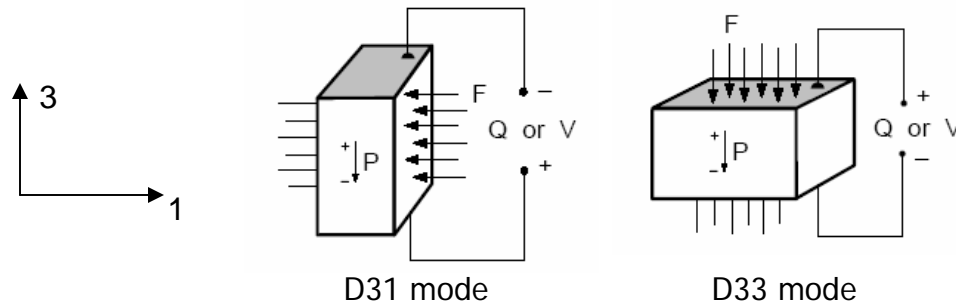

- Although the coupling coefficient of d33 is much higher than d31, the use of d33 mode does not always result in better performances because of
 - Mechanical reasons (Clark and Ramsay 2002)
 - Mechanical stress applied into 1 direction is much easily achieved at lower force
 - Electrical reasons (Sodano et al. 2004)

Sodano et al (2004) compared the performance of energy harvesting from three different piezoelectric devices

- Three Actuators used
 - Quick Pack IDE – Monolithic piezoceramic with interdigitated (IDE) electrodes
 - Quick pack – Monolithic Piezoceramic with traditional electrodes
 - Macro-Fiber Composite (MFC) – Piezofibers and IDE electrodes
- IDE patches utilize the d33 mode

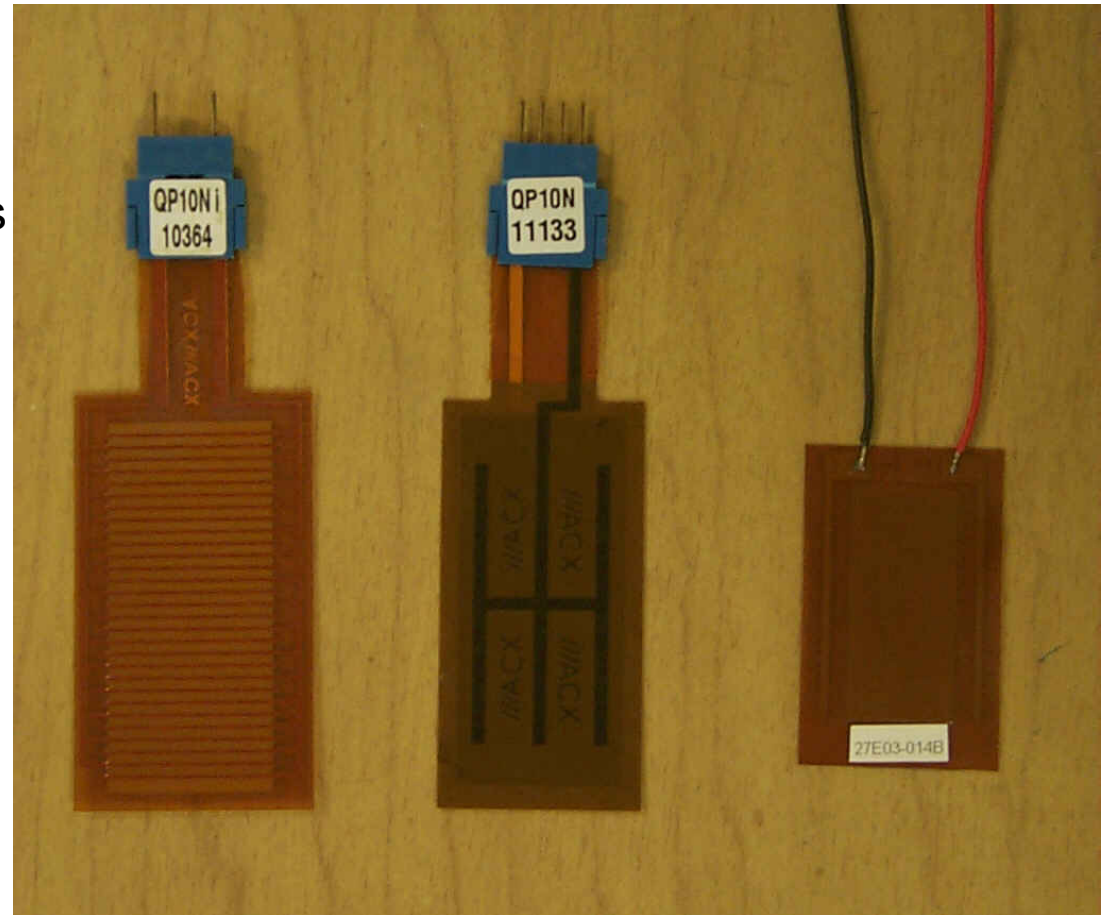

Quick Pack IDE

Quick Pack

MFC

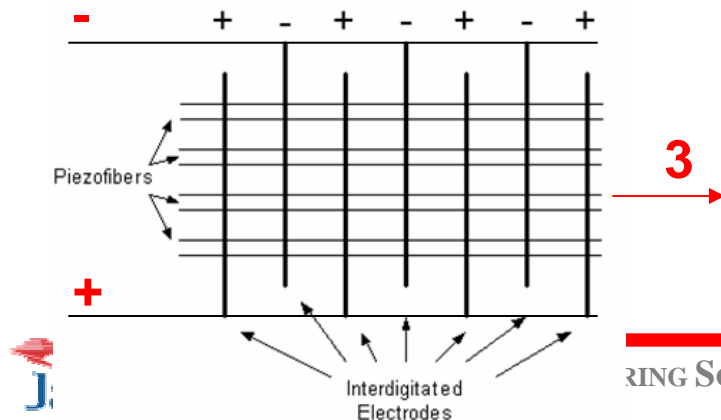

Results of Power Generation

- The generated energy was normalized to the volume of active material in each piezoelectric device
- The Quick Pack significantly outperformed the other devices
- Increased impedance due to lower capacitance of the IDE electrode pattern

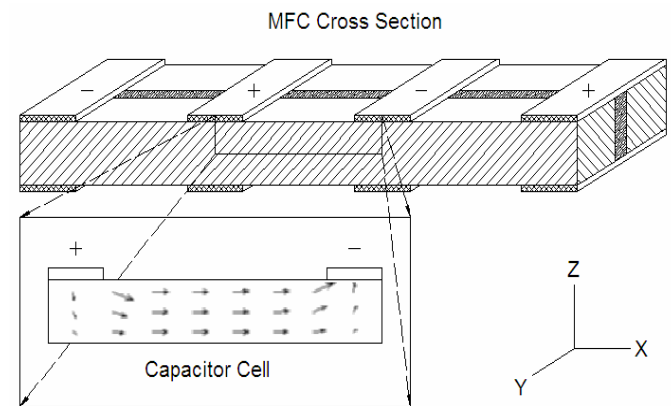
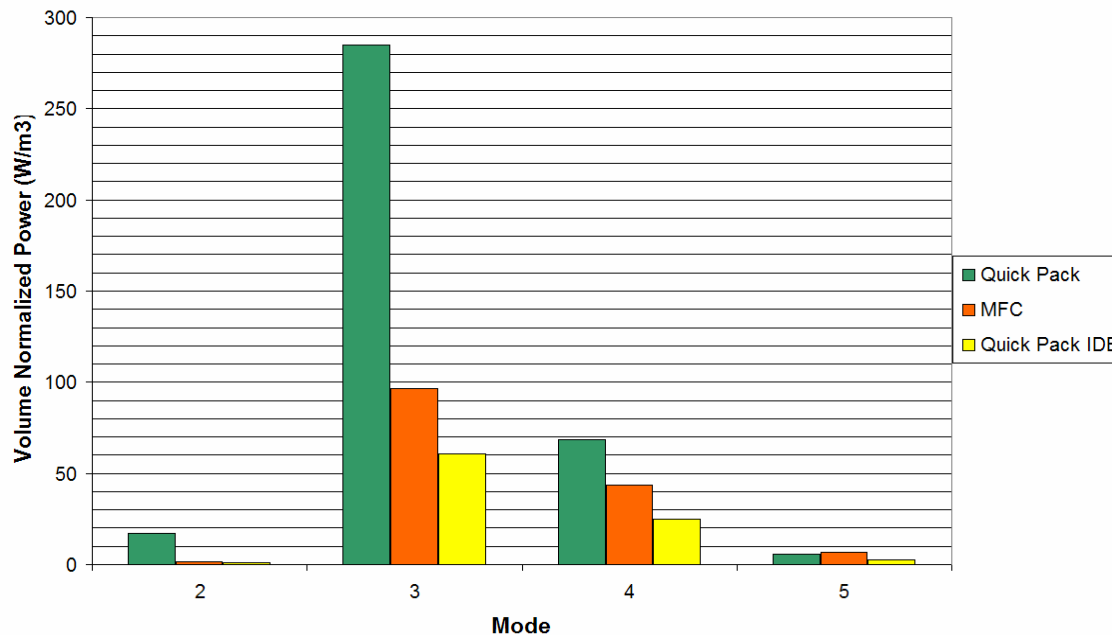

Jeon et al (2005) developed PZT-based MEMS power generating devices

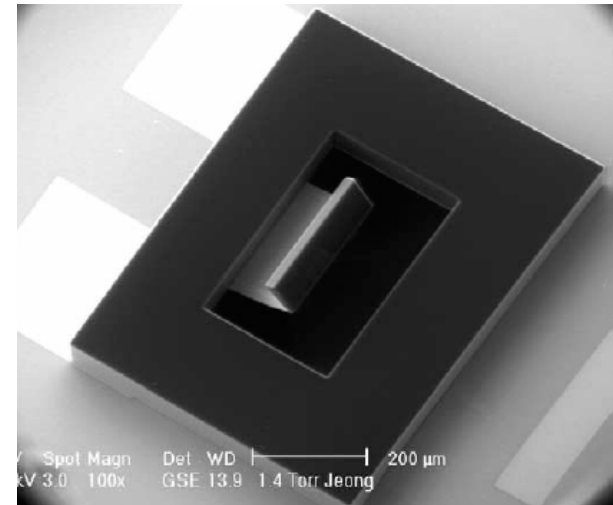
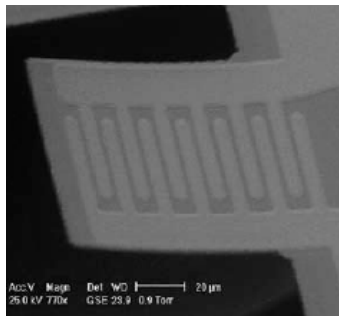
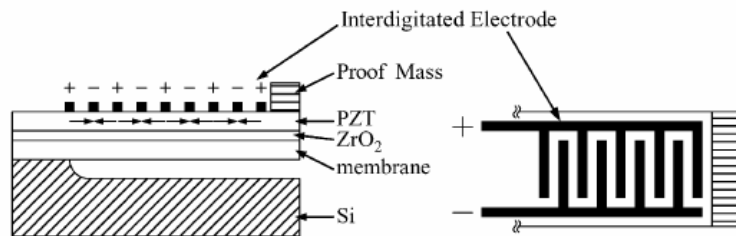

- The first resonance at 13.9 kHz.
- A maximum DC voltage of 3 V and a maximum continuous electric power of 1 micro W was produced under the resonant actuation.

Conceptual design of “pico-cube” (Wright et al 2004)

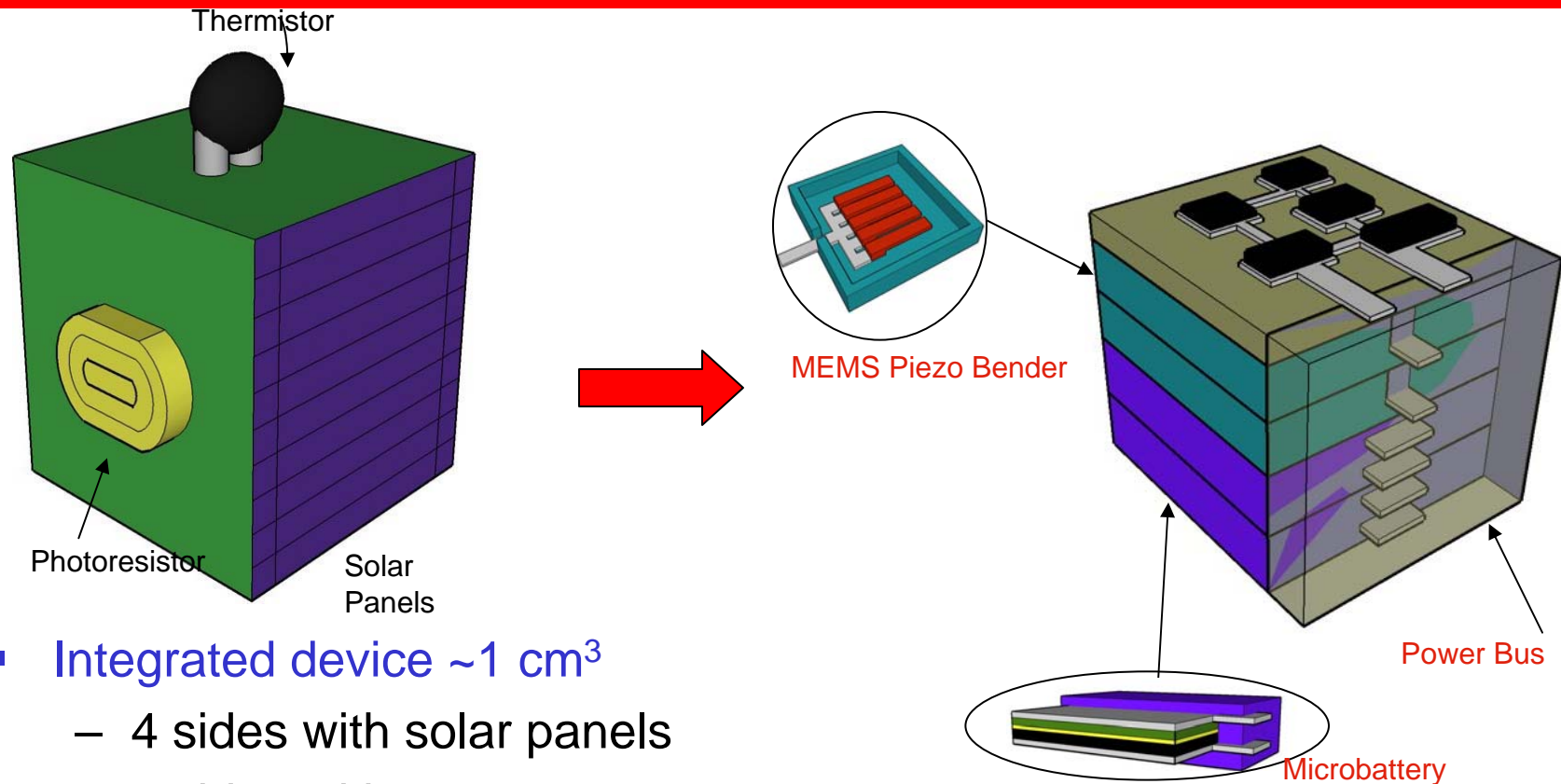

- Integrated device $\sim 1 \text{ cm}^3$
 - 4 sides with solar panels
 - 2 sides with sensors
 - On-board recharg. Battery and piezoelectric generation
 - 3-D wiring

Energy Harvesting Circuitry

- Typical circuit consists of voltage rectifier, converter, and storage.

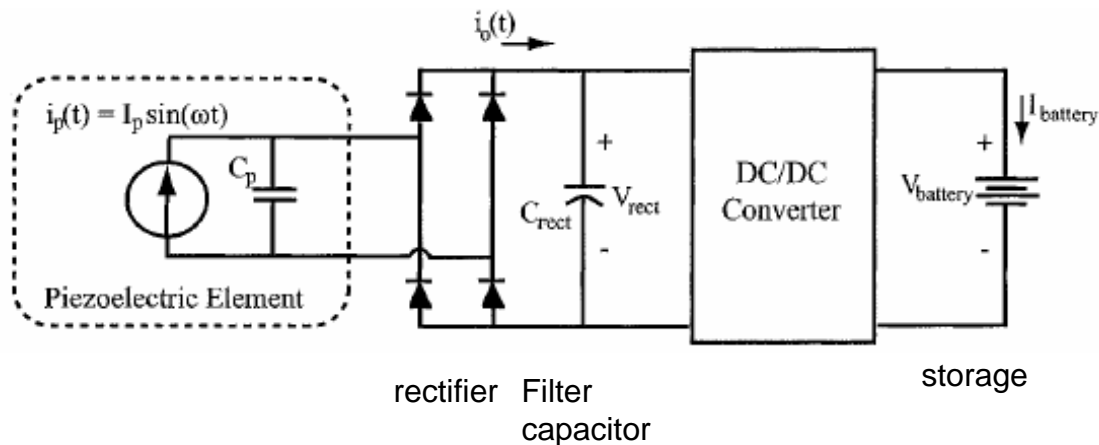

- Implementation of low-power electronics is critical to minimize the circuit loss
- Significant research efforts have been dedicated to improve the circuit efficiency.

Energy Harvesting Circuitry

- Kasyap et al. (2002) developed a flyback converter circuit
- The flyback converter allows the circuit's impedance to be tuned
- Maximum power output is obtained when the piezoelectric's impedance matches the load's
- A maximum of 20% efficiency was obtained

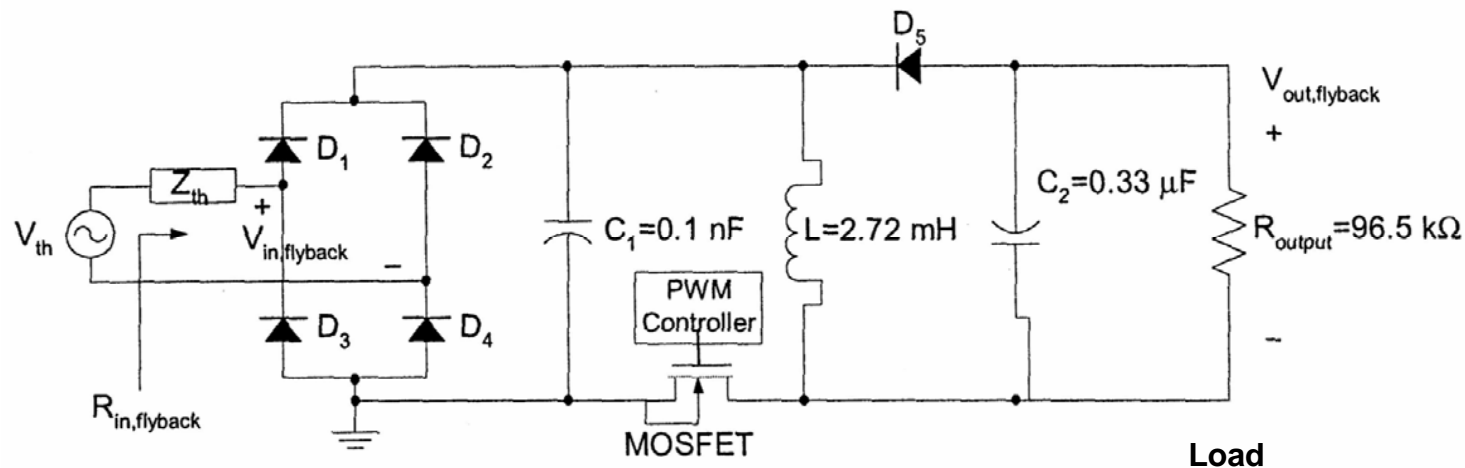

Energy Harvesting Circuitry

- Lesieutre (2004) proposed two-mode energy harvesting circuit.
- Their previous study showed that active control of converter duty cycle improves the power flow, only at higher voltage.
- At lower excitation → direct charge of batteries
- At higher excitation → Active control for optimal duty cycle of the step-down converter

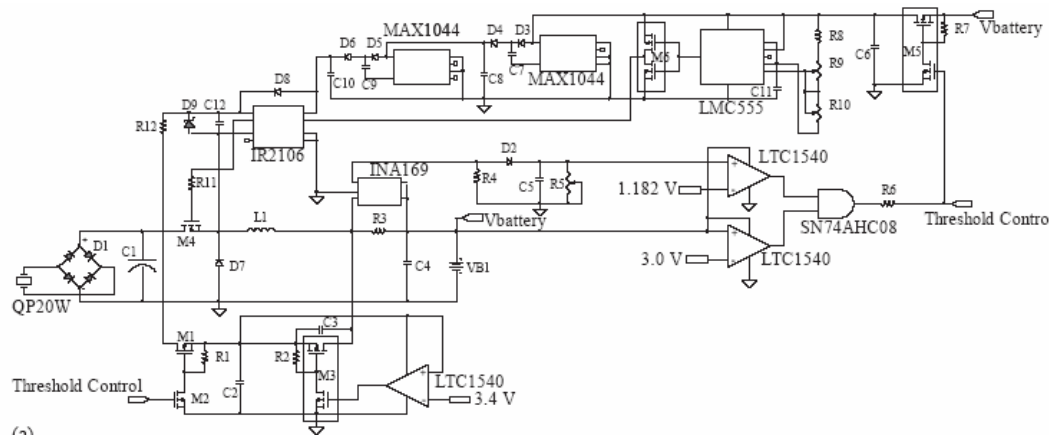
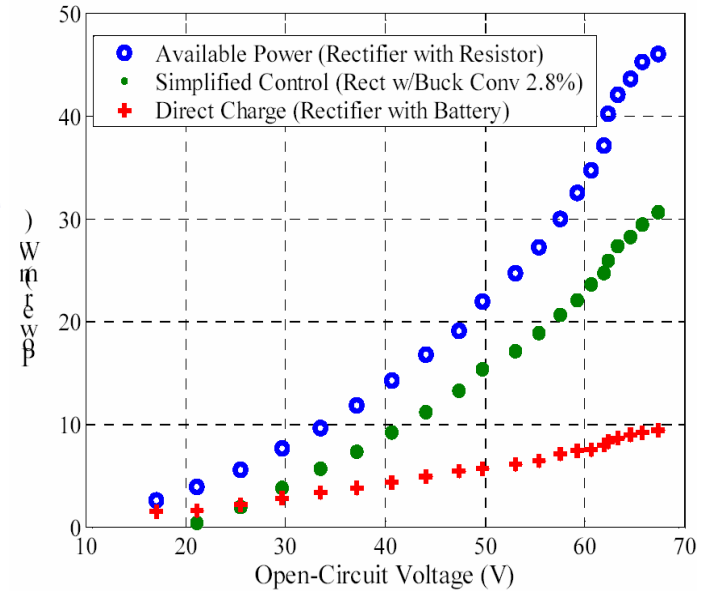

Energy Harvesting Circuitry

- Han et al (2004) proposed a novel power conditioning circuit.
- Synchronous rectification is employed to minimize the circuit loss from a simple diode bridge rectifier.

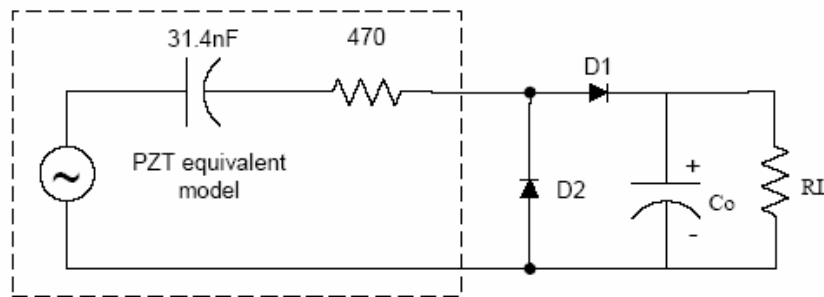

Diode-pair rectifier

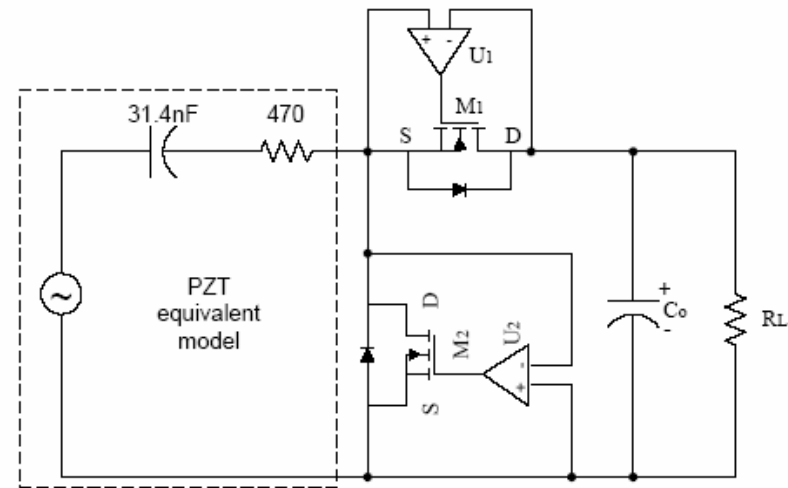

Synchronous rectifier

- The output extracted power with the use of synchronous rectifier is 150% of that with the diode-pair rectifier.

Energy Storage

- Energy storage is required to power larger devices.
- Two methods
 - Capacitors – immediate use
 - Rechargeable batteries – allows for controlled use, hold larger energy

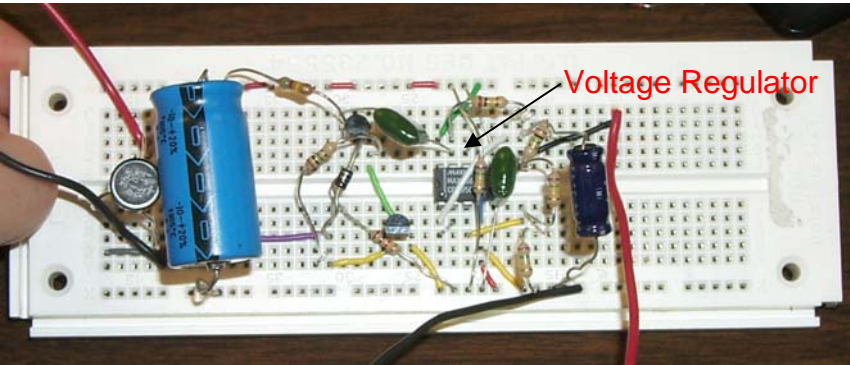

Sodano et al (2003)

Battery Size (mAh)	Time for Charge with Random Signal
40	1.6 Hours
80	2 Hours
200	1.2 Hours
300	5.8 Hours
750	8.6 Hours
1000	32 Hours

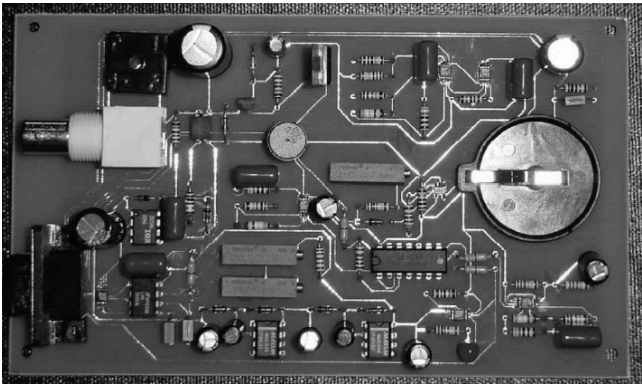

Two mode battery charging circuit, Lesieutre et al, 2004

Proof-of-Concept Applications

- A conceptual design of a self-powered damage detection sensor (Elvin et al. 2003)

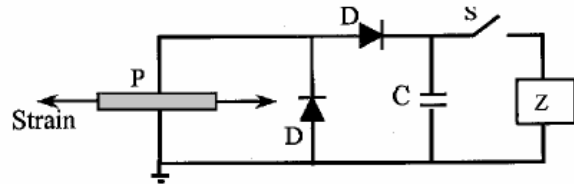

Self-powered strain energy sensor (SES)

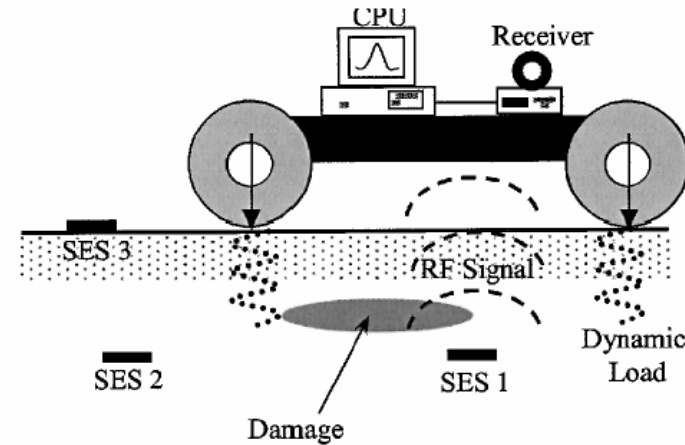
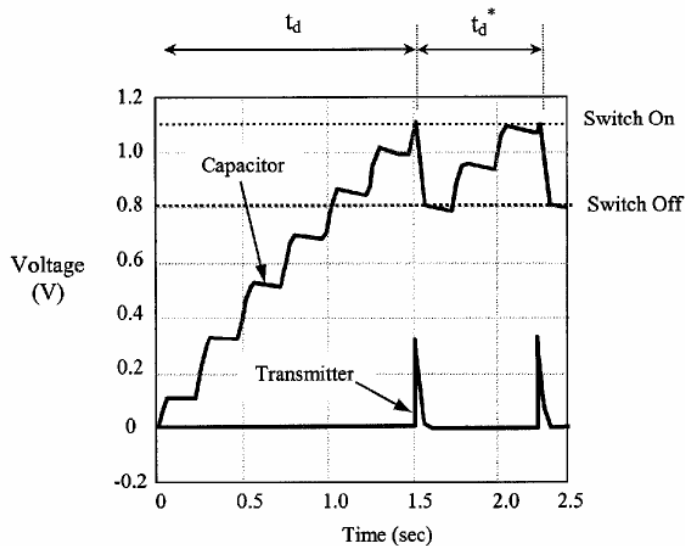

Proof-of-Concept Applications

- A conceptual design of self-powered microsensors with RFID tags (Pfeifer, 2003)
- The microcontroller operates at 40 micro W.
- The PZT (3 x 2 in) produces the power for 17 second operation under the laboratory environment.

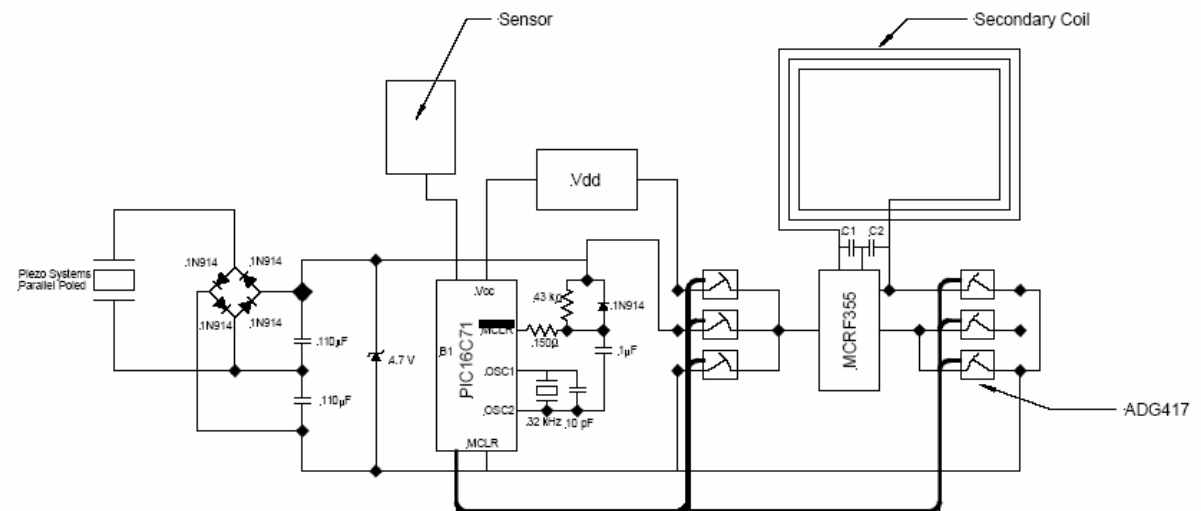
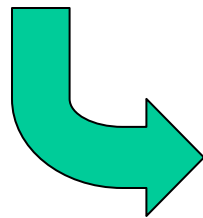
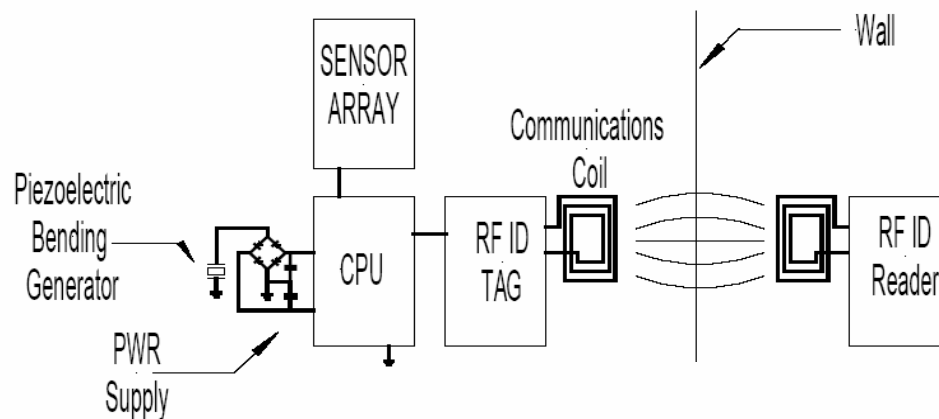

Commercial Products

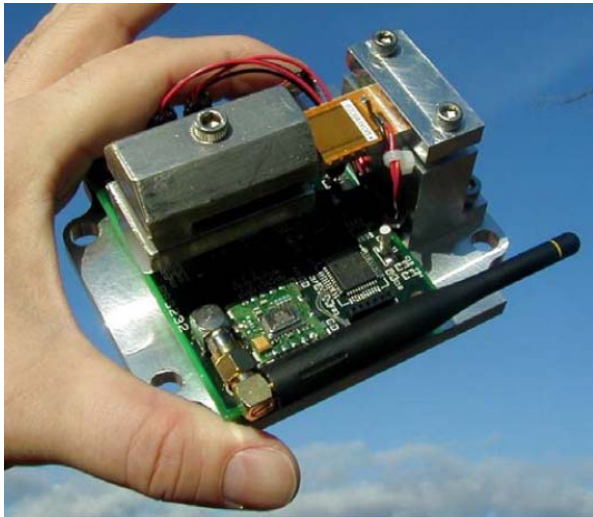

- Microstrain, Inc.,
- Integrated piezoelectric harvester and wireless temperature & humidity sensing node.
- 2.7 mW of power @57 Hz.

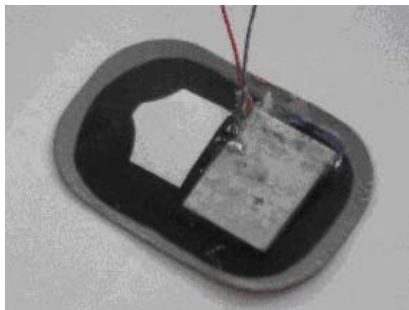

- KCF technology
- Dynamic power-harvesting demonstration for truck tires



- Continuum Inc, iPower
- Used as a backup energy source

Thermoelectric Devices

- Thermoelectric generators function through the Seebeck effect – production of a current when junctions composed of temperature gradient
- Source – body, soil, interior/exterior, exhaust pipe/muffler, engine
- It was reported that this device can generate up to 1 kW of peak power (Vazquez et al 2002)

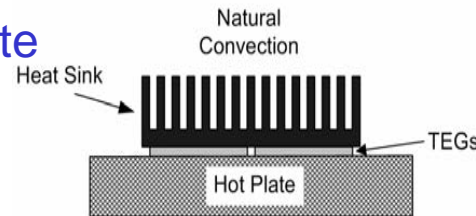
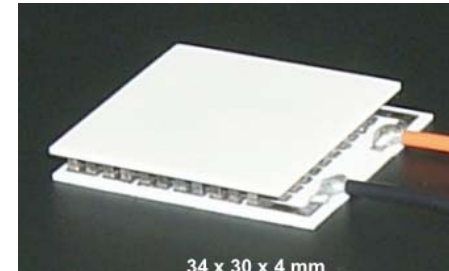

- AFRL: The harvested energy from compressor/turbine is worthwhile addition to the weight (Sanders, 2004)
- The application to low-power electronics has not been substantially investigated.
- New Materials: 0.5 cm² thin-film produces 1.5 micro W with 5 C temperature differences (Applied Digital Solution Corp)

Radio Frequency (RF) based Energy Harvesting

- Harrist et al (2004) attempted to charge mobile-phone batteries by capturing RF energy at 915 MHz.
- 4mV/second charging time was observed.

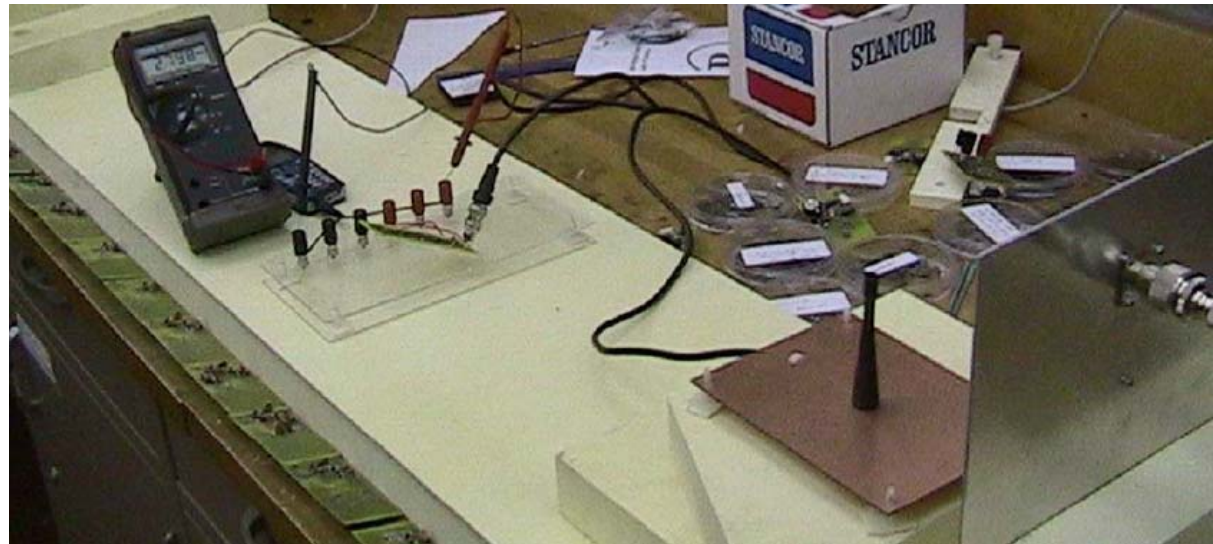
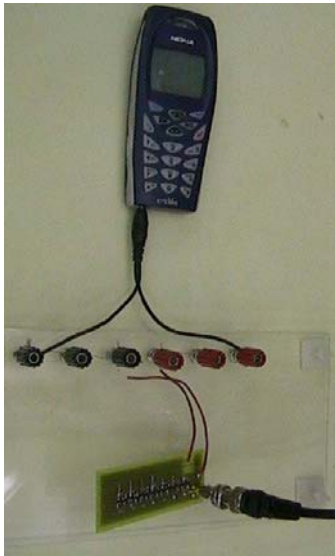

Radio Frequency based Energy Harvesting

- Briles (2004) investigated RF energy generation (delivery) systems.
- Provides energy to down-hole electrical equipment w/o wires.- using conductive pipes for radiating RF signals.

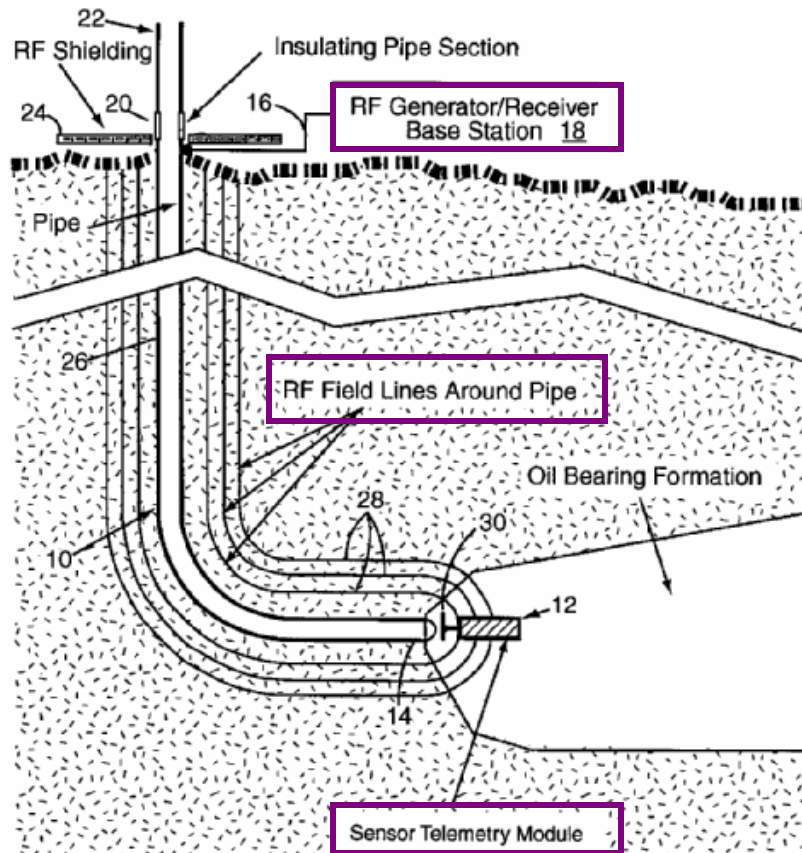

Received power for 8000-ft long pipe.

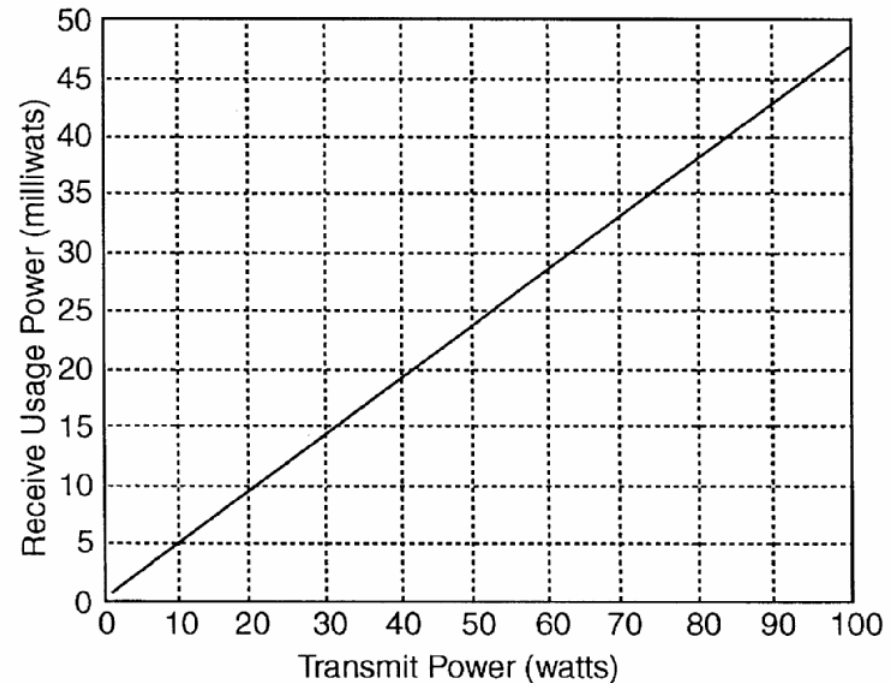

Current Limitations and Future Issues

- Efficient and innovative methods of storing the harvested energy are required (structural batteries, battery fibers, supercapacitors).



Figure from ITN energy systems



Figure from Cooper Industry

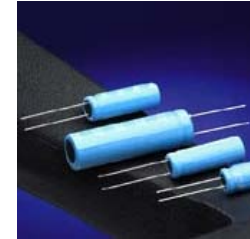

- Multidiscipline engineering approach is needed.
- The integrated use of energy harvesting techniques would be necessary.
- The performance of energy harvesting needs to be verified and validated in the real world environments.
- Advances in low-power electronics and new materials must continue.
- Application specific design guidelines need to be established.

Current Limitations and Future Issues

- ..and this workshop is designed to identify more ...

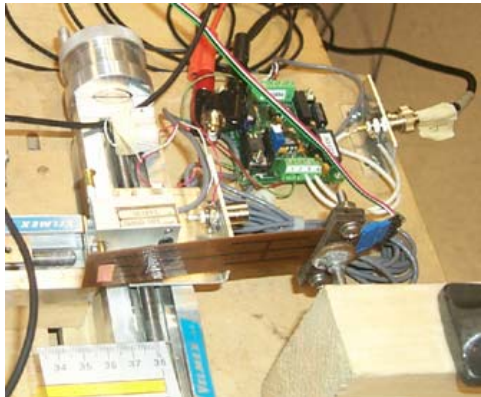
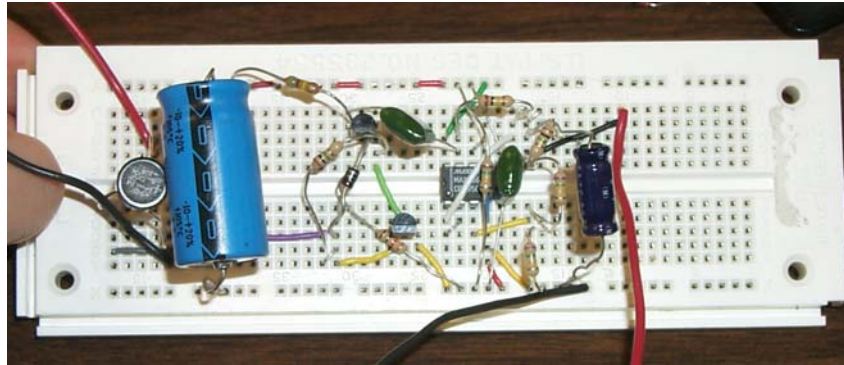
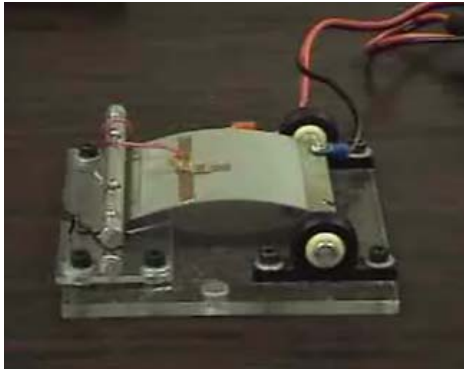

Questions??