



Risk Management Series

Incremental Protection for Existing Commercial Buildings from Terrorist Attack

Providing Protection to People and Buildings

FEMA 459 / April 2008



FEMA

RISK MANAGEMENT SERIES

Incremental Protection
for Existing Commercial
Buildings from Terrorist
Attack

PROVIDING PROTECTION TO PEOPLE AND BUILDINGS



FEMA

Any opinions, findings, conclusions, or recommendations expressed in this publication do not necessarily reflect the views of FEMA. Additionally, neither FEMA nor any of its employees makes any warranty, expressed or implied, or assumes any legal liability or responsibility for the accuracy, completeness, or usefulness of any information, product, or process included in this publication. Users of information from this publication assume all liability arising from such use.

BACKGROUND

The Federal Emergency Management Agency (FEMA) developed FEMA 459, *Incremental Protection for Existing Commercial Buildings from Terrorist Attack*, to provide guidance to owners of existing commercial buildings and their architects and engineers on security and operational enhancements to address vulnerabilities to explosive blasts and chemical, biological, and radiological hazards. It also addresses how to integrate these enhancements into the ongoing building maintenance and capital improvement programs. These enhancements are intended to mitigate or eliminate long-term risk to people and property.

FEMA's Risk Management Series publications addressing security risks are based on two core documents: FEMA 426, *Reference Manual to Mitigate Potential Terrorist Attacks Against Buildings*, and FEMA 452, *Risk Assessment: A How-To Guide to Mitigate Potential Terrorist Attacks Against Buildings*. FEMA 426 provides guidance to the building science community of architects and engineers on reducing physical damage caused by terrorist assaults to buildings, related infrastructure, and people. FEMA 452 outlines methods for identifying the critical assets and functions within buildings, determining the potential threats to those assets, and assessing the building's vulnerabilities to those threats. This assessment of risks facilitates hazard mitigation decision-making. Specifically, the document addresses methods for reducing physical damage to structural and non-structural components of buildings and related infrastructure and reducing resultant casualties during conventional bomb attacks, as well as attacks involving chemical, biological, and radiological agents.

FEMA 459 can be used in conjunction with FEMA 452. This manual presents an integrated, incremental rehabilitation approach to implementing the outcomes of a risk assessment completed in accordance with FEMA 452, *Risk Assessment: A How-To Guide to Mitigate Potential Terrorist Attacks Against Building*. This approach is intended to minimize disruption to building operations and control costs for existing commercial buildings.

The integrated incremental approach to risk reduction in buildings was initially developed in relation to seismic risk and was first articulated in

FEMA's Risk Management Series in the widely disseminated FEMA 395, *Incremental Seismic Rehabilitation of School Buildings (K–12)*, published in June 2003. In 2004 and 2005, FEMA also published *Incremental Seismic Rehabilitation* manuals (FEMA 396-400) for hospitals, office buildings, multifamily apartments, retail buildings, and hotels and motels.

OBJECTIVE AND SCOPE

This manual outlines an approach to incremental security enhancement in four types of existing commercial buildings: office buildings, retail buildings, multifamily apartment buildings, and hotel and motel buildings. It addresses both physical and operational enhancements that reduce building vulnerabilities to blasts and chemical, biological, and radiological attacks, within the constraints of the existing site conditions and building configurations.

The information contained in this document is:

- Not mandatory
- Not applicable to all buildings
- Not applicable when it interferes with other hazards such as fire

However, the manual presents incremental approaches that can be implemented over time to decrease the vulnerability of buildings to terrorist threats. Many of the recommendations can be implemented quickly and cost-effectively.

LIMITATIONS

This approach to incremental security enhancement applies to commercial buildings in urban or semi-urban areas. This approach **does not** apply to exceptionally high-risk iconic buildings of symbolic value. Examples of such buildings include the tallest buildings in a city, high rise buildings with a distinctive shape recognizable in the city skyline, and diplomatic buildings, such as embassies. Security enhancement in this class of buildings should be based on detailed engineering analysis and design.

INTENDED AUDIENCE

This manual addresses the specific needs and practices of commercial building owners, and guides building owners and managers through a process that will reduce the risks to their buildings from terrorist attacks. It is intended for use by both technical and non-technical audiences, including:

- Building Owners
- Facility Managers
- Risk Managers
- Security Consultants
- Design Professionals

CONTENT AND ORGANIZATION

This manual provides building owners and their design consultants with guidance on developing a program of incremental security enhancements that can be implemented over a period of time.

Chapter 1 provides an overview of integrated incremental rehabilitation of buildings, potential terrorist threats to buildings, the mitigation of the risks of terrorist attacks, special issues related to security in existing commercial buildings, a process for integrating incremental mitigation into the normal facility management process, and a step-by step approach to implementation of an incremental enhancement program. It is intended for building owners and their risk managers and facility managers.

Chapter 2 describes the relationship between this manual and FEMA 452 and includes a list of terrorism risk reduction measures. It also discusses the implementation of an integrated incremental program and links (in the form of matrices) specific physical and operational enhancement measures to normal maintenance and capital improvement programs associated with commercial buildings. It is intended for risk managers, facility managers, and design professionals.

Chapter 3 discusses blast threats to buildings and physical enhancements that reduce the vulnerability to blasts. It is intended for design professionals and their blast consultants.

Chapter 4 discusses chemical, biological, and radiological threats to buildings and physical and operational enhancements that reduce the vulnerability to these threats. It is intended for design professionals and their CBR consultants.

Chapter 5 discusses operational security measures that reduce commercial building vulnerabilities to terrorist threats. It is intended for design professionals and security personnel.

ACKNOWLEDGMENTS

This publication has been developed in collaboration with the Infrastructure and Geophysical Division of the Science and Technology Directorate of the Department of Homeland Security.

Principal Authors:

Frederick Krimgold, D.Tech., Virginia Tech
David Hattis, Building Technology Incorporated
Robert Smilowitz, Weidlinger Associates, Inc.
William Blewitt, Batelle
Terrence P. Ryan, Raytheon UTD

Contributors:

Pax Williams, Batelle

Expert Review Panel:

Eric Letvin, URS Corporation
Ken Mead, Centers for Disease Control and Prevention
John Sullivan, Portland Cement Association
Michael J. W. Kaminskis, Raytheon UTD
Mark M. Hankewycz, the Protection Engineering Group, PC
Mohamed Ettouney, Weidlinger Associates, Inc.

Project Officer:

Milagros Nanita Kennett
Infrastructure and Geophysical Division
Science and Technology Directorate
US Department of Homeland Security

TABLE OF CONTENTS

FOREWORD AND ACKNOWLEDGMENTS

Background..... i
Objective and Scope ii
Limitations ii
Intended Audience iii
Content and Organization iii
Acknowledgments..... iv

1 INTEGRATED INCREMENTAL BUILDING PROTECTION

1.1 What is Integrated Incremental Building Protection 1-1
1.1.1 Integration of Terrorism Risk Reduction in the Facility
Management Process..... 1-1
1.1.2 Incremental Approach Distributes Cost Over Time and Avoids Added
Disruption 1-2
1.1.3 Risk Reduction Decisions..... 1-3
1.2 Potential Threats 1-4
1.2.1 Explosive Threats..... 1-5
1.2.2 CBR Threats 1-7
1.2.2.1 Chemical Agents 1-7
1.2.2.2 Biological Agents 1-8
1.2.2.3 Radiological Threats..... 1-8
1.3 Terrorism Risk Reduction..... 1-9
1.3.1 Categories of Risk Reduction Increments 1-9
1.3.2 Implementation Considerations..... 1-10
1.4 Special Issues Related to Existing Commercial Buildings 1-11

1.5	Commercial Building Classifications	1-12
1.6	Facility Management Process for Existing Commercial Buildings	1-13
1.6.1	The Acquisition Phase of Commercial Building Facility Management.....	1-14
1.6.2	The Redevelopment Phase of Commercial Building Facility Management ...	1-15
1.6.3	The Current Building Use Phase of Commercial Building Facility Management	1-17
1.6.4	The Planning Phase of Commercial Building Facility Management.....	1-19
1.6.5	The Maintenance and Rehabilitation Budgeting Phase of Commercial Building Facility Management.....	1-22
1.6.6	The Maintenance and Rehabilitation Funding Phase of Commercial Building Facility Management.....	1-24
1.6.7	The Maintenance and Rehabilitation Implementation Phase of Commercial Building Facility Management.....	1-25
1.7	Planning and Managing Incremental Terrorism Risk Reduction	1-26
1.7.1	Step 1—Conduct a Due Diligence Terrorism Risk Assessment.....	1-27
1.7.2	Step 2—Identify and Implement Initial Increment Integration Opportunities.....	1-28
1.7.3	Step 3—Assess Terrorism Risk	1-29
1.7.4	Step 4—Develop a Security Master Plan	1-30
1.7.5	Step 5—Plan Incremental Rehabilitation for Specific Buildings.....	1-31
1.7.6	Step 6—Stage Rehabilitation Increments	1-32
1.7.7	Step 7—Coordinate with Tenant Work	1-33
1.7.8	Step 8—Define Budget Packaging	1-34
1.7.9	Step 9—Implement Integrated Incremental Rehabilitation Project Management	1-35
1.8	Terrorism Risk Assessment to Terrorism Risk Reduction	1-36
2	MOVING FROM RISK ASSESSMENT TO IMPLEMENTATION OF INCREMENTAL BUILDING PROTECTION	
2.1	Risk Assessment Process	2-1
2.1.1	Levels of Vulnerability Assessment	2-3

2.1.2	The Building Vulnerability Assessment Checklist	2-4
2.2	Scheduling Increments: Physical Protection and Strengthening Measures and Operational (Protective and Control) Measures	2-5
2.2.1	Physical Protection and Strengthening Measures	2-5
2.2.2	Operational Measures	2-5
2.3	Identifying Integration Opportunities for Incremental Building Protection	2-6
3	PRINCIPLES OF DESIGN FOR RISK REDUCTION RELATED TO BLASTS	
3.1	Selected Examples of Terrorist Attacks on Buildings	3-2
3.1.1	Baltic Exchange, City of London, April 1992	3-3
3.1.2	World Trade Center, New York City, February 1993	3-3
3.1.3	Bishopsgate, City of London, April 1993	3-4
3.1.4	Town Center, Manchester, England, June 1996	3-5
3.2	Performance Standards	3-6
3.3	Site Incremental Upgrades: Perimeter Protection	3-8
3.4	Incremental Building Rehabilitation Measures	3-10
3.4.1	Building Envelope	3-10
3.4.2	Fragment Retention Film	3-12
3.4.3	Laminated Glass	3-15
3.4.4	Blast Curtains	3-16
3.4.5	Glazing Catch Cable/Bar Retrofit	3-18
3.4.6	Energy-Absorbing Catch Cable Systems	3-19
3.4.7	Unreinforced Masonry Wall Debris Control	3-19
3.4.8	Other Facade Retrofits	3-22
3.5	Nonstructural Members	3-22
3.6	Structural Retrofits	3-23
3.6.1	Columns	3-24

3.6.2	Floor Systems.....	3-25
3.6.3	Load-Bearing Unreinforced Masonry Walls	3-28
3.6.4	Transfer Girders	3-29
3.7	Blast Protection Measures	3-29
3.8	Blast Protection Measure Cost Considerations	3-31
4	PRINCIPLES OF DESIGN FOR RISK REDUCTION RELATED TO CHEMICAL, BIOLOGICAL, AND RADIOLOGICAL THREATS	
4.1	Overview of CBR Threats.....	4-1
4.2	Principles of Design for Risk Reduction Related to CBR	4-2
4.3	Prioritization of CBR Vulnerabilities: Incremental Improvements.....	4-3
4.3.1	Level 1, Operational Measures and Expedient Protection.....	4-4
4.3.2	Level 2, Enhanced Physical Security	4-4
4.3.3	Level 3, Enhanced Sheltering in Place.....	4-5
4.3.4	Level 4, Aerosol Filtration, Medium Level.....	4-5
4.3.5	Level 5, Gas-Phase Filtration, Medium Level.....	4-6
4.3.6	Level 6, Aerosol Filtration, High Level	4-6
4.3.7	Level 7, Gas-Phase Filtration, High Level	4-7
4.4	Design Guidance for CBR Protective Levels	4-7
4.4.1	Level 1, Operational Measures and Expedient Protection.....	4-7
4.4.1.1	Scope and Capabilities	4-7
4.4.1.2	Methods and Requirements	4-8
4.4.1.3	Cost Considerations.....	4-13
4.4.2	Level 2, Physical Security.....	4-14
4.4.2.1	Scope and Capabilities	4-14
4.4.2.2	Methods and Requirements	4-14
4.4.2.3	Cost Considerations.....	4-17
4.4.3	Level 3, Enhanced Safe Rooms and Isolated Zones.....	4-17
4.4.3.1	Scope and Capabilities	4-17

4.4.3.2	Methods.....	4-17
4.4.3.3	Cost Considerations.....	4-20
4.4.4	Level 4, Aerosol Filtration, Medium Level.....	4-20
4.4.4.1	Scope and Capabilities	4-20
4.4.4.2	Methods and Requirements	4-21
4.4.4.3	Cost Considerations.....	4-21
4.4.5	Level 5, Gas-Phase Filtration, Medium Level.....	4-22
4.4.5.1	Scope and Capabilities	4-22
4.4.5.2	Methods and Requirements	4-23
4.4.5.3	Cost Considerations.....	4-24
4.4.6	Level 6, Aerosol Filtration, High Level	4-24
4.4.6.1	Scope and Capabilities	4-24
4.4.6.2	Methods and Requirements	4-24
4.4.6.3	Cost Considerations.....	4-25
4.4.7	Level 7, Gas-Phase Filtration, High Level	4-25
4.4.7.1	Scope and Capabilities	4-25
4.4.7.2	Methods and Requirements	4-26
4.4.7.3	Cost Considerations.....	4-28
4.5	Summary.....	4-28
4.6	CBR Protection Measures	4-30
5	PRINCIPLES OF DESIGN FOR RISK REDUCTION RELATED TO OPERATIONAL SECURITY MEASURES	
5.1	Overview of Operational Security Measures	5-1
5.2	Detection and Assessment Measures	5-2
5.2.1	Exterior Intrusion Detection Systems	5-2
5.2.2	Interior Intrusion Detection Systems	5-3
5.2.3	Video Assessment and Surveillance Systems.....	5-3
5.2.4	Access Control Systems.....	5-5

5.2.5	Vehicle Inspection Systems	5-6
5.2.6	Duress Alarms	5-7
5.2.7	Mail/Package Screening	5-7
5.3	Interdiction/Response Measures	5-9
5.3.1	Guard Force – Detection/Delay Role	5-9
5.3.2	Guard Force – Response/Interdiction Role	5-10
5.3.3	Response Force Contingency Planning	5-10
5.4	Procedural Measures	5-11
5.4.1	Restricted Areas	5-11
5.4.2	Parking and Traffic Controls.....	5-12
5.4.3	Restrict Access to Facility Information	5-13
5.4.4	Encourage Employee Support.....	5-13
5.5	Preparedness Measures	5-13
5.5.1	Develop a Disaster Preparedness Plan	5-14
5.5.2	Conduct Risk Assessments.....	5-14
5.5.3	Develop Mass Notification Systems	5-14
5.5.4	Evacuation Planning and Shelter In Place Preparation	5-14
5.5.5	Monitor Emergency Systems and Resources	5-15
5.5.6	Conduct Training Drills and Exercises	5-15
5.6	Security Master Planning	5-16
5.7	Additional Aspects of Operational Security Measures Related to Blast Events.....	5-17
5.7.1	Establish an Explosive Detection Program	5-18
5.7.2	Establish Bomb Threat Procedures.....	5-18
5.7.3	Establish Blast-Related Mail/Package Handling Procedures	5-18
5.8	Additional Aspects of Operational Security Measures Related to CBR Events	5-19
5.8.1	Prevent Access, and Secure and Monitor Outdoor Air Intakes	5-21
5.8.2	Establish CBR-Related Mail/Package Handling Procedures	5-21
5.8.3	Additional Measures.....	5-22

5.9	Prioritization of Operational Security Considerations	5-23
5.9.1	Retail Buildings	5-24
5.9.2	Office Buildings	5-24
5.9.3	Multi-Family Apartment Buildings	5-24
5.9.4	Hotel Security Measures.....	5-25
5.10	Incremental Integration of Operational and Physical Security Measures Into a Risk Reduction Program: Flexibility and Tradeoffs	5-25
5.11	Operational Security Protection Measures	5-27
5.11.1	Physical Protection and Strengthening Buildings.....	5-27
5.11.2	Operational Measures	5-28
5.11.3	Operational Measures Categorized into the Building Vulnerability Assessment Checklist	5-30
BIBLIOGRAPHY	I

1.1 WHAT IS INTEGRATED INCREMENTAL BUILDING PROTECTION

Integrated incremental building protection is a process for improving safety in existing buildings with minimum cost and disruption of building function. Integrated, incremental protection of existing commercial buildings from terrorist attacks applies the basic principles of security evaluation and design to the physical and operational demands of existing buildings. Rehabilitation of existing buildings poses special challenges not faced in the case of design and construction of new buildings. Site conditions are pre-defined. Configuration and structural system are given, and current building occupants must be accommodated during the rehabilitation process. Investments in rehabilitation of existing buildings may also not be justified in light of the expected remaining useful life of the building.

The term “building protection” or “protection,” as used in this chapter, refers to a specific category of building “rehabilitation” that addresses terrorism risk reduction. When the term “rehabilitation” is used it refers to general activities that may or may not include terrorism risk reduction.

1.1.1 INTEGRATION OF TERRORISM RISK REDUCTION IN THE FACILITY MANAGEMENT PROCESS

The integrated, incremental protection process is based on the identification of increments of security enhancement that may be integrated into the normal schedule of maintenance and capital improvement. For example, when window replacement is considered for energy conservation or modernization, blast resistance can be enhanced at the same time with relatively little added expense. The advantage of this approach to rehabilitation is that it reduces the cost of implementing security enhancements and it reduces the cost due to added business interruption related to a single purpose intervention in the building. The integration of terrorism risk reduction measures with normal maintenance and capital improvement takes advantage of regularly scheduled design, contracting, and staging to implement security enhancements at marginal added cost. The identification of specific increments of security enhancement allows these improvements

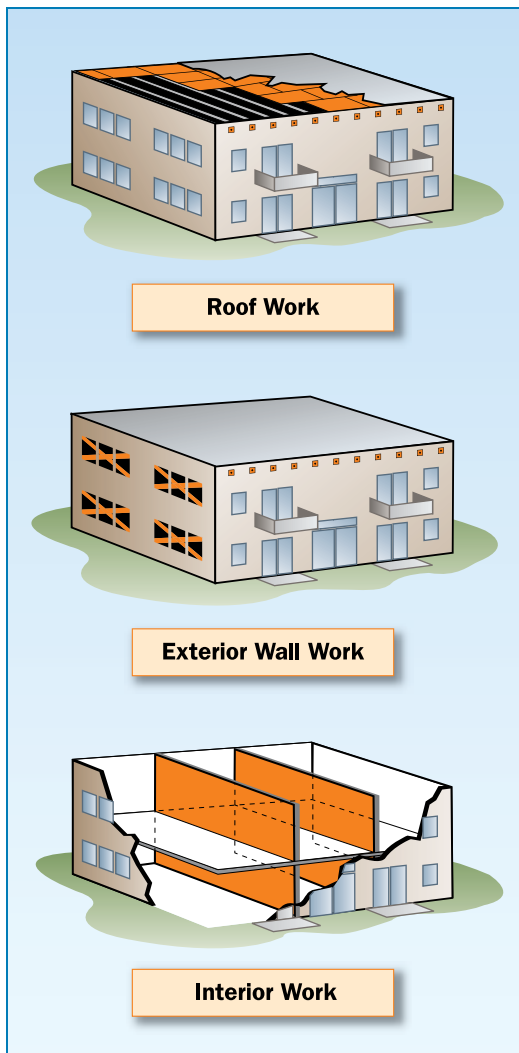

Figure 1-1: Schematic integration opportunities.

to be made opportunistically as normal work is carried out on various components of the building.

Integration of specific increments of terrorism risk reduction is illustrated in the three buildings of Figure 1-1. These examples show the opportunistic character of the incremental approach. By pre-identifying the increments of risk reduction, implementation can effectively “piggy-back” on work that arises in the normal course of building maintenance and capital improvement. For example, roofs are usually replaced on a schedule of 15 to 20 years. Strengthening the roof/wall connections and improving the blast resistance of the structure is relatively easy and inexpensive to do during a scheduled roof replacement. Provisions for opening up the roof and erecting scaffolding can serve both the purposes of roof renewal and terrorism risk reduction.

In a similar way, exterior wall maintenance and window replacement provide the opportunity for reducing outdoor air penetration into the building and improving the blast resistance of the windows. Work on interior walls provides the opportunity for strengthening of blast resistance and the creation of safe areas.

1.1.2 INCREMENTAL APPROACH DISTRIBUTES COST OVER TIME AND AVOIDS ADDED DISRUPTION

Over time, the accumulated effect of the incremental measures will be the same as a comprehensive one-stage building rehabilitation that would require closing the building and a major one-time investment. The incremental approach spreads the cost of security enhancement over a period of years, reducing the impact of rehabilitation costs.

Because the integrated incremental rehabilitation approach is designed to accommodate business continuity and a continued revenue stream from the commercial building, it is closely tied to the schedules and requirements of specific occupancies.

Investment in the rehabilitation of existing commercial buildings requires a strong business case. Sustainable costs must be justified and supported by future revenue generated by the building. Factors to consider in the justification of rehabilitation investment include: estimation of the remaining lifetime of the building, desirability for potential occupants, and the market value of security enhancements.

1.1.3 RISK REDUCTION DECISIONS

This manual is designed primarily for application in existing office, retail, multi-family residential, and hotel buildings. Owners of existing commercial buildings face a sequenced set of cost decisions diagrammed in Figure 1-2. On the basis of risk assessment methodologies, building owners can evaluate the terrorism risk for specific buildings. Based on the informed risk perception, the building owner may decide that building protection is not necessary. Alternatively, the building owner may decide to invest in terrorism risk reduction measures. If the decision is made to invest in terrorism risk reduction, the next decision is whether to replace the building, i.e., demolish or sell it and build a new one, or to rehabilitate the building to reduce terrorism risk.

Owners who decide to rehabilitate the building may initiate a single-stage intervention. Such an approach typically requires the evacuation of the building for a significant period of time and a major one-time

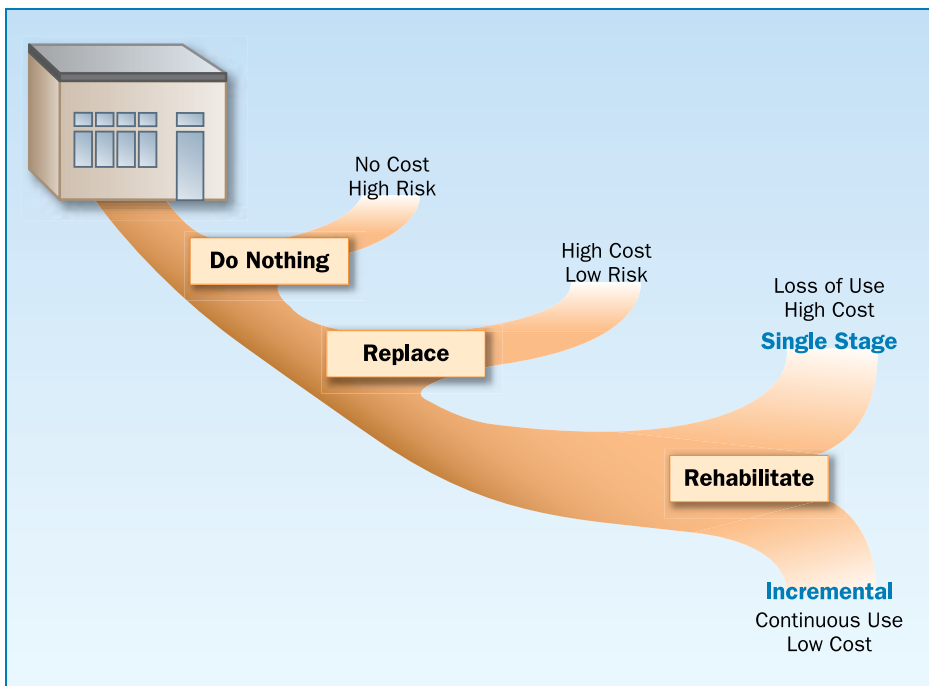

Figure 1-2: Cost decision scheme.

rehabilitation investment. Both these factors may be difficult to accept in the case of an existing commercial building with limited remaining asset life. An alternative approach is the incremental rehabilitation of the building.

The integrated incremental building protection approach has the advantage of reduced and distributed costs. While extending the time of implementation, an integrated incremental building protection program will eventually provide the same level of protection that can be supported by the revenue of an existing commercial building.

Careful planning and efficient use of opportunities for low cost risk reduction can make terrorism risk reduction feasible even for marginal existing commercial buildings.

1.2 POTENTIAL THREATS

Commercial building owners who want to implement measures that may save lives and property must understand the nature of the hazards that can affect their buildings and the impacts of those hazards on the buildings. The term “threat” is typically used to characterize manmade disasters (technological accidents) or terrorism hazards. Because there have been few terrorist attacks in the United States and data for manmade threats is scarce, predictions of the magnitude and recurrence of terrorist attacks are largely subjective.

Aggressor tactics may include: moving vehicle bombs, stationary vehicle bombs, bombs delivered by persons (suicide bombers), exterior attacks (thrown objects like rocks, Molotov cocktails, hand grenades, or hand-placed bombs), stand-off weapons attacks (rocket-propelled grenades, light antitank weapons, etc.), ballistic attacks (small arms and high-power rifles), covert entries (gaining entry by false credentials or circumventing security with or without weapons), mail bombs (delivered to individuals), supply bombs (larger bombs processed through shipping departments), airborne contamination (chemical, biological, and radiological [CBR] agents used to contaminate the air supply of a building), and waterborne contamination (CBR agents injected into the water supply). This section focuses on explosive threats, chemical agents, biological warfare agents, and radiological attacks.

1.2.1 EXPLOSIVE THREATS











The explosive threat is particularly significant, because all of the ingredients required to assemble an improvised explosive device are readily available at a variety of farm and hardware stores. The intensity of the explosive detonation is a function of the weight of the explosive. For explosive threats, the weight of the explosive depends on the means of transportation and delivery. Explosives weigh approximately 100 pounds per cubic foot and, as a result, the maximum credible threat corresponds to the weight of explosives that can be packaged in a variety of containers or vehicles. The U.S. Department of Defense (DoD) developed a chart indicating the weight of explosives and deflagrating materials that may reasonably fit within a variety of containers and vehicles (see Table 1-1). The table indicates the safe evacuation distances for occupants of conventional buildings, based on the ability of the buildings to withstand severe damage or resist collapse.

Operational security measures (see Chapter 5) define the areas within or around a building at which a device may be located, undetected by the building facility staff. These security procedures include screening of vehicles, inspection of delivered parcels, and vetting hand carried bags. The extent to which this inspection is carried out will determine the size of an explosive device that may evade detection. Despite the most vigilant attempts, however, it is unrealistic to expect complete success in preventing a small explosive threat from evading detection. While it is unlikely that a large explosive threat may be brought into a building, a parcel sized device may be introduced into publicly accessible lobbies, garages, loading docks, cafeterias, or retail spaces and a smaller explosive device may be brought anywhere into a building.

Only two domestic terrorist bombings involved the use of large quantities of High Energy explosive materials in the United States. (For more information on High Energy explosives, see FEMA 426, *Reference Manual to Mitigate Potential Terrorist Attacks Against Buildings*, Chapter 4.) Although these events represent the largest explosions that have occurred to date, they may not represent the current domestic explosive threat. The 1995 explosion that collapsed portions of the Murrah Federal Office Building in Oklahoma City contained 4,800 pounds of ammonium nitrate and fuel oil (ANFO) and the 1993 explosion within the parking garage beneath the World Trade Center complex contained 1,200 pounds of urea nitrate.

Every year, approximately 1,000 intentional explosive detonations are reported by the Federal Bureau of Investigation (FBI) Bomb Data Center. The FBI statistics indicate that the majority of the domestic events contain significantly smaller weights of Low Energy explosives. (For more information on Low Energy explosives, see FEMA 426, Chapter 4.)

Table 1-1: Safe Evacuation Distances from Explosive Threats

Threat Description		Explosives Mass* (TNT equivalent)	Building Evacuation Distance**	Outdoor Evacuation Distance***	
High Explosives (TNT Equivalent)		Pipe Bomb	5 lbs 2.3 kg	70 ft 21 m	850 ft 259 m
		Suicide Belt	10 lbs 4.5 kg	90 ft 27 m	1,080 ft 330 m
		Suicide Vest	20 lbs 9 kg	110 ft 34 m	1,360 ft 415 m
		Briefcase/ Suitcase Bomb	50 lbs 23 kg	150 ft 46 m	1,850 ft 564 m
		Compact Sedan	500 lbs 227 kg	320 ft 98 m	1,500 ft 457 m
		Sedan	1,000 lbs 454 kg	400 ft 122 m	1,750 ft 534 m
		Passenger/ Cargo Van	4,000 lbs 1,814 kg	640 ft 195 m	2,750 ft 838 m
		Small Moving Van/Delivery Truck	10,000 lbs 4,536 kg	860 ft 263 m	3,750 ft 1,143 m
		Moving Van/ Water Truck	30,000 lbs 13,608 kg	1,240 ft 375 m	6,500 ft 1,982 m
		Semi-Trailer	60,000 lbs 27,216 kg	1,570 ft 475 m	7,000 ft 2,134 m

* Based on the maximum amount of material that could reasonably fit into a container or vehicle. Variations are possible.

** Governed by the ability of an unreinforced building to withstand severe damage or collapse.

*** Governed by the greater of fragment throw distance or glass breakage/falling glass hazard distance. These distances can be reduced for personnel wearing ballistic protection. Note that the pipe bombs, suicide belts/vests, and briefcase/suitcase bombs are assumed to have a fragmentation characteristic that requires greater stand-off distances than an equal amount of explosives in a vehicle.

Although the majority of the explosions reported by the FBI targeted residential properties and vehicles, 63 took place in educational facilities, causing a total of \$68,500 in property damage. Other than the attack against the Murrah Federal Office Building, no explosive devices were detonated at a Federal government-owned facility, and only nine were detonated at local/state government facilities. Nearly 80 percent of the people known to be involved in bombing incidents were young offenders, and less than 0.5 percent of the perpetrators were identified as members of terrorist groups. Vandalism was the motivation in 53 percent of the known intentional and accidental bombing incidents, and the timing of the attacks was fairly uniformly distributed throughout the day.

1.2.2 CBR THREATS

Like explosive threats, CBR threats may be delivered externally or internally to a building. While there may not be official warning of a CBR event, the best defense may be to be alert to signs of a release.

There are three potential methods of CBR attack:

- A large exterior release originating some distance away from the building (includes delivery by aircraft)
- A small localized exterior release at an air intake or other opening in the exterior envelope of the building
- A small interior release in a publicly accessible area, a major egress route, or other vulnerable area (e.g., elevator lobby, mail room, delivery, receiving and shipping)

The following paragraphs provide summary information about each of the components of CBR attacks—chemical agents, biological agents, and radiological threats.

1.2.2.1 Chemical Agents

Toxic chemical agents can present airborne hazards when dispersed as gases, vapors, or solid or liquid aerosols. Unlike biological or radiological agents, chemical agents generally produce immediate effects. In most cases, toxic chemical agents can be detected by the senses, although a few are odorless. Their effects occur mainly through inhalation, although they can also cause injury to the eyes and skin.

1.2.2.2 Biological Agents

Biological agents are organisms or toxins that can kill or incapacitate people and livestock, and destroy crops. The three basic groups of biological agents that would likely be used as weapons are bacteria, viruses, and toxins.

- **Bacteria.** Bacteria are small free-living organisms that reproduce by simple division and are easy to grow. The diseases they produce often respond to treatment with antibiotics.
- **Viruses.** Viruses are organisms that require living cells in which to reproduce and are intimately dependent upon the body they infect. The diseases they produce generally do not respond to antibiotics; however, antiviral drugs are sometimes effective.
- **Toxins.** Toxins are poisonous substances found in, and extracted from, living plants, animals, or microorganisms; some toxins can be produced or altered by chemical means. Some toxins can be treated with specific antitoxins and selected drugs.

Most biological agents are difficult to grow and maintain. Many break down quickly when exposed to sunlight and other environmental factors, while others such as anthrax spores are very long lived. There are three methods for delivery of biological agents:

- **Aerosols.** Biological agents are dispersed into the air, forming a fine mist that may drift for miles. Inhaling the agent may cause disease in people or animals.
- **Animals.** Some diseases are spread by insects and animals, such as fleas, flies, mosquitoes, and mice. Deliberately spreading diseases through livestock is also referred to as agroterrorism. Person-to-person spread of a few infectious agents is also possible. Humans have been the source of infection for smallpox, plague, and the Lassa viruses.
- **Food and water contamination.** Some pathogenic organisms and toxins may persist in food and water supplies. Most microbes can be killed, and toxins deactivated, by cooking food and boiling water.

1.2.2.3 Radiological Threats

This manual does not address the severe and various effects generated by nuclear events, including blinding light, intense heat (thermal radiation),

initial nuclear radiation, blasts, fires started by the heat pulse, and secondary fires caused by the destruction.

Terrorist use of a radiological dispersion device (RDD), often called “dirty bomb,” is considered more likely than use of a nuclear device. These radiological weapons are a combination of conventional explosives and radioactive material designed to scatter dangerous and sublethal amounts of radioactive material over a general area. Very little technical knowledge is required to build and deploy such radiological weapons as compared to that of a nuclear device. Also, radioactive materials, used widely in medicine, agriculture, industry, and research, are more readily available and easy to obtain compared to the weapons-grade uranium or plutonium required for a nuclear device.

1.3 TERRORISM RISK REDUCTION

1.3.1 CATEGORIES OF RISK REDUCTION INCREMENTS

The adoption of risk reduction increments as part of enhancing, retrofitting, or rehabilitating a building can be an effective approach in reducing vulnerability to terrorist attacks. There is a range of risk reduction increments that can be used to enhance security in case of blasts and chemical, biological, and radiological hazards. For this manual, two categories are identified:

- **Physical Protection and Strengthening of Existing Buildings.** Physical protection and strengthening deals with structural and non-structural modifications of existing buildings. While new buildings may include protective measures to reduce the potential impact of terrorist attacks, existing buildings may be at larger risk because they were constructed without the appropriate safety measures to withstand potential attacks. Thus, improving the safety and structural integrity of existing buildings is often the best way to reduce the impact of terrorist attacks on such structures. When a terrorism threat occurs, it can directly damage a target building or indirectly cause secondary effects in adjacent buildings (collateral damage). Poorly engineered and constructed buildings cannot usually resist the forces generated by a blast event or serve as safe havens in case of CBR attacks.
- **Operational Measures.** Unlike other risk reduction increments that improve the resistance of buildings to disasters, protective and control measures focus on protecting structures by deflecting the destructive forces from vulnerable structures and people. Ideally, a potential terrorist attack is prevented or pre-empted through intelligence

measures. If the attack does occur, physical security measures combine with operational forces (e.g., surveillance, guards, and sensors) to provide layers of defense that can delay or thwart the attack. Deception may be used to make a facility appear to be more protected or lower risk than it actually is, making it a less attractive target. Deception can also be used to misdirect an attacker to a portion of the facility that is non-critical. Because of the interrelationship between physical and operational security measures, it is imperative for building owners and security professionals to define what extent of operational security is planned for various threat levels.

1.3.2 IMPLEMENTATION CONSIDERATIONS

The implementation of some risk reduction increments may create public inconvenience. For example, the placement of bollards, closure of public streets, and rehabilitation of buildings may affect people's access to public places or have a negative effect on community aesthetic. The implementation of mitigation enhancements involves the following considerations.

- **Costs and Benefits.** When implementing a risk reduction increment, the benefits (reduction of potential future losses) of implementing the option should outweigh the costs (capital cost of protection measure, operating cost of protection measure, and adverse effects on business).
- **Legal Authority.** A risk reduction increment should not be undertaken without the appropriate legal authority. Building owners should determine whether they have the legal authority to implement selected mitigation options. For example, creating standoff distances in urban areas can violate zoning ordinances and building set-back requirements.
- **Adverse Effects on the Built Environment.** Some risk reduction increments may have a negative effect on the built environment. When selecting mitigation measures, building owners should scrutinize the potential effects on:
 - Traffic/vehicular mobility
 - Pedestrian mobility
 - Ingress and egress to the building
 - Other building operations
 - Aesthetics

- Interference with first responders
- **Impact on the Natural Environment.** Considering whether the recommended risk reduction increments will have a negative effect on environmental assets, such as air quality, water quality, threatened and endangered species, and other protected natural resources is also important.

1.4 SPECIAL ISSUES RELATED TO EXISTING COMMERCIAL BUILDINGS

Certain features of existing buildings clearly distinguish them from newly designed and constructed buildings and may limit the range of security mitigation options available for consideration:

- The physical fabric of the existing building may be concealed or unknown. New buildings are designed and specified in terms of materials and systems whose characteristics are fully defined and that conform to known standards. By contrast, the design basis, materials, and standards that governed the design and construction of currently existing buildings are more ambiguous. Determining the inherent response of the building and its systems to blast forces, for example, may not be possible.
- Existing buildings are likely to have been designed to conform to older, and possibly archaic, building codes. Their performance under current physical conditions may be difficult to determine or control.
- The relationship of existing buildings to the surrounding site, roads, access, standoff, utilities, and adjacent buildings is fixed and not subject to significant alteration.
- The physical fabric of an existing building may constrain or prohibit the implementation of specific risk reduction measures that are considered in new building design as a matter of course.
- Existing buildings are usually occupied and perform a variety of business, cultural, and life support functions for their occupants. This may constrain or prohibit the implementation of specific risk reduction measures unless business or service interruption is acceptable.
- Compared to new buildings, existing buildings often have a limited useful remaining lifetime, which dictates a much shorter payback period for investments in security enhancement.

- Conditions of financing capital improvements in existing buildings may differ from those applicable to new buildings.

The commercial buildings addressed in this manual are office buildings, retail buildings, multifamily apartment buildings, and hotel buildings. All four categories have features that may limit the range of security mitigation options available for consideration:

- Commercial buildings are income-generating systems for their owners. Interruption of building operations interrupts the flow of income and is equivalent to an added cost when considering any capital improvement. This feature makes commercial buildings ideal candidates for integrated incremental enhancements, which better manage costs and disruption.
- Access control is a significant aspect of security enhancement for buildings. Commercial office, retail, hotel, and multifamily apartment buildings require public access. The extent to which that access can be controlled may be limited.

1.5 COMMERCIAL BUILDING CLASSIFICATIONS

Commercial buildings are often classified for real estate purposes into three classifications—Classes A, B, and C. The Urban Land Institute, a noted authority on commercial land uses, says the following about these classifications in its Office Development Handbook. Class A space can be characterized as buildings that have excellent location and access, attract high quality tenants, and are managed professionally. Building materials are high quality and rents are competitive with new buildings. Class B buildings have good locations, management, and construction, and tenant standards are high. Buildings should have very little functional obsolescence and deterioration. Class C buildings are typically 15 to 25 years old but are maintaining steady occupancy. Tenants filter from Class B to Class A and from Class C to Class B. In a normal market, Class A rents are higher than Class B, which are above Class C.

Facility management practices in commercial buildings vary as a function of this classification (Class A, B, or C) as well as the type and scale of ownership. The effectiveness of physical and operational security enhancements depends on the quality of the facility management.

1.6 FACILITY MANAGEMENT PROCESS FOR EXISTING COMMERCIAL BUILDINGS

Facility management processes for existing commercial buildings vary in detail by type of occupancy (office, retail, multifamily, hotels, etc.). The complexity and completeness of facility management practices may also vary by type of ownership (real estate investment trust [REIT], pension fund, insurance company, partnership, individual, etc.) and by scale of operation (dispersed portfolio, concentrated portfolio, individual building). Despite these variations, a generic facility management process consists of seven phases of activities:

1. Acquisition
2. Redevelopment
3. Current Building Use
4. Planning
5. Maintenance and Rehabilitation Budgeting
6. Maintenance and Rehabilitation Funding
7. Maintenance and Rehabilitation Implementation

Figure 1-3 depicts these seven distinctive phases in the overall facility management process and the activities associated with each phase, which are discussed in detail in the following sections. The facility

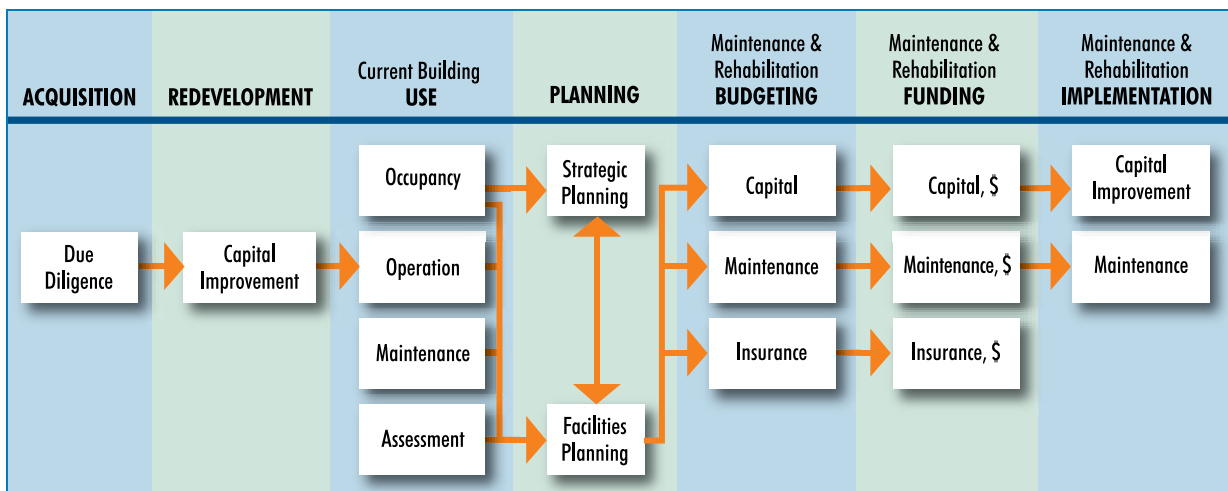

Figure 1-3: Typical facility management process.

management process is sequential, progressing from **acquisition** through **implementation** of rehabilitation in any given building. It begins with acquisition because commercial buildings normally change ownership every seven to 15 years, and this usually entails new financing and insurance, providing a unique opportunity for facility assessment and initial redevelopment. A current owner of an existing commercial building, as opposed to a prospective owner, begins the facility management process with the third phase, the **use** phase. An owner who has a large inventory of buildings is likely to have ongoing activities in all of these phases in different buildings.

This process is generic, and while there may be variations, commercial building owners generally follow it, either explicitly or implicitly.

The following sections briefly describe each phase, the activities therein, and some factors that influence those activities (indicated graphically by downward arrows for factors outside the owner organization and upward arrows for factors internal to the organization).

1.6.1 THE ACQUISITION PHASE OF COMMERCIAL BUILDING FACILITY MANAGEMENT

The acquisition phase of the typical commercial building facility management process consists of **due diligence** activities and is influenced by significant internal and external pressures, as depicted in Figure 1-4.

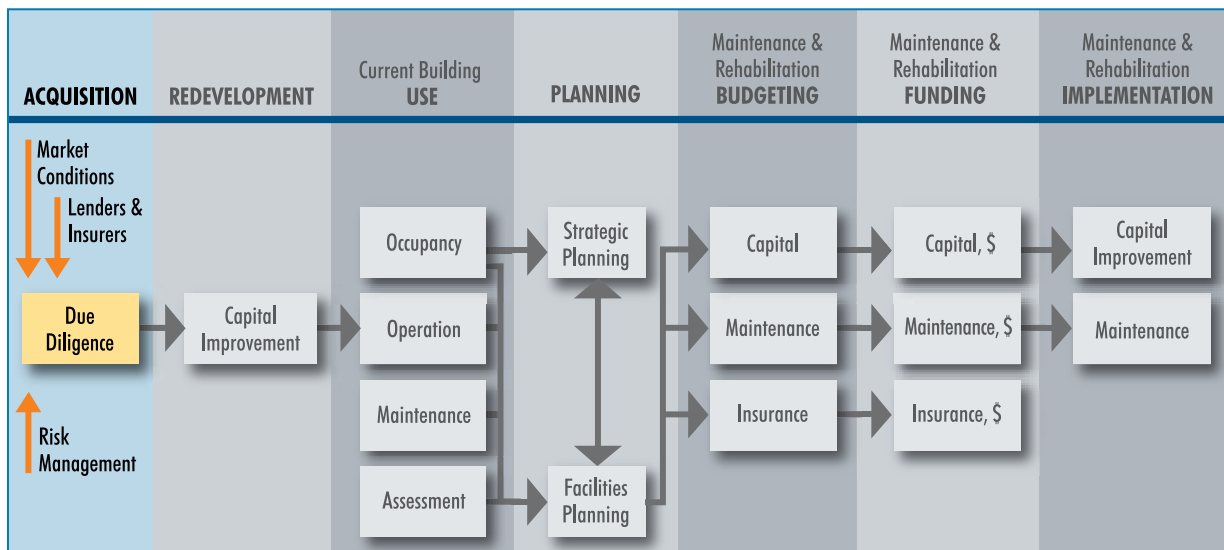

Figure 1-4: Acquisition phase.

Commercial building acquisitions initiate the facility management process for all owners who are not also developers or merchant builders. The **due diligence** process that precedes an acquisition is intended to identify, and quantify if possible, all the liabilities and risks or potential liabilities and risks related to the asset being acquired.

Acquisition phase decisions are influenced by three factors:

- **Market Conditions.** External local conditions of the commercial rental market are the principal factors governing commercial building acquisition, regardless of the short-term or long-term strategic objectives of the purchaser. This is true for all types of owners, be they REITs, pension funds or other fiduciary institutions, partnerships, or individuals.
- **Lenders and Insurers.** Lenders and insurers are important external participants in many commercial building acquisitions, and each carry out due diligence functions to determine the risks and potential liabilities in any given deal. By their nature, lenders and insurers spread their risks over a wider range of investments than that presented to an owner in a specific acquisition. The insurability of the acquired property is of great concern to commercial building owners, but the cost of insurance is of lesser concern because the cost may be passed on to tenants in many commercial properties.
- **Risk Management.** Many commercial building owners have formally established internal risk management functions within their organizations. These risk managers participate in the due diligence analyses carried out prior to acquisition. The rigor of internal due diligence varies from owner to owner.

1.6.2 THE REDEVELOPMENT PHASE OF COMMERCIAL BUILDING FACILITY MANAGEMENT

The redevelopment phase of the typical commercial building facility management process consists of various types of **capital improvements**, and is influenced by significant internal and external pressures, as depicted in Figure 1-5.

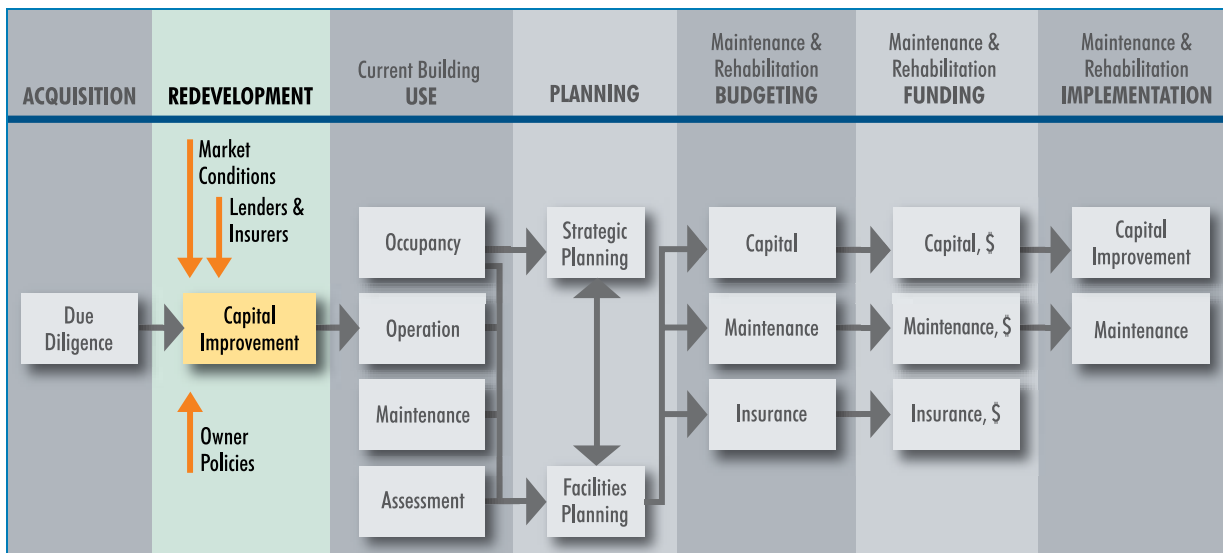

Figure 1-5: Redevelopment phase.

The types of redevelopment phase capital improvement projects vary as a function of the building's classification (A, B, or C). They generally consist of:

- Architectural upgrading of entrances, lobbies, and public areas
- Architectural upgrading of facades
- Upgrading of the heating, ventilation, and air-conditioning (HVAC) systems
- Environmental and other risk remediation work identified in the due diligence process
- Upgrading of life safety systems

Redevelopment phase decisions are influenced by three factors:

- **Market Conditions.** Commercial properties in a given classification must compete with neighboring, similarly classified properties. Local architectural traditions and fashions and historic preservation are significant factors determining the specific nature of various capital improvement projects.
- **Lenders and Insurers.** External lenders and insurers may require specific capital improvements as a condition of the deal. For example, they may require the replacement of a questionable roof or HVAC system. These are generally the direct result of the due diligence analyses.

- **Owner Policies.** Owners’ marketing and architectural policies are the principal internal factors governing capital improvement decisions in the redevelopment phase.

1.6.3 THE CURRENT BUILDING USE PHASE OF COMMERCIAL BUILDING FACILITY MANAGEMENT

The current building use phase of the typical commercial facility management process consists of four categories of activities and is influenced by significant internal and external pressures, as depicted in Figure 1-6.

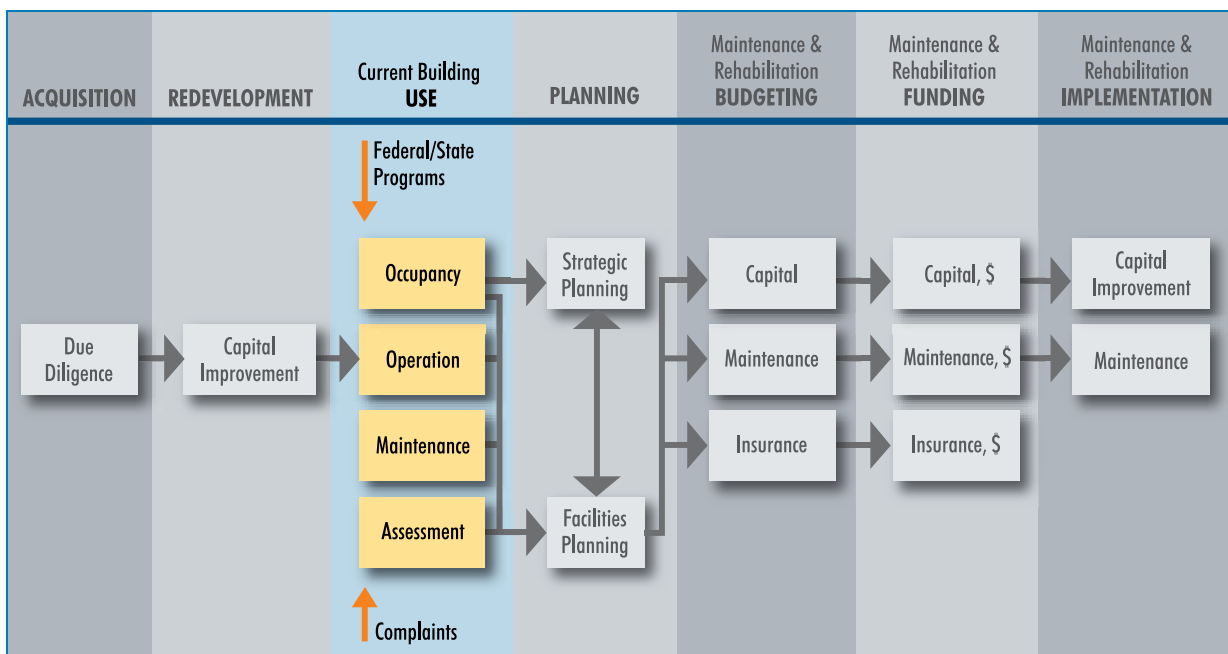

Figure 1-6: Use phase.

- **Occupancy.** The primary function of this category is occupancy of commercial space by tenants. Support functions are administrative, such as collecting rents and addressing tenants’ concerns. Ancillary functions may be recreational, such as operating a health club, pool, or spa, and social, such as operating a lecture room, restaurant, or similar facility. The specific functions may vary depending on the building classification (A, B, or C).

Occupancy functions are carried out in each building by the tenants and facility managers. Each of these functions is subject to security risk and can be disrupted by terrorist attacks.

- **Operation.** Facility operation consists of all the activities and functions that are required to support the occupancy. Examples of facility operation include mechanical functions (heating, cooling, and ventilation), electrical functions (lighting, communications, and alarm), and plumbing functions.

Operation functions may be carried out by custodial staff of the owner and/or by contractors. Each of these functions is subject to security risk and can be disrupted by terrorist attacks.

- **Maintenance.** Maintenance includes all the activities required to enable the occupancy and operation of the building continuously over time. They can be broken down into custodial maintenance, routine maintenance, and repair.

Maintenance functions may be carried out by custodial staff of the owner and/or by contractors. In some cases, tenants or their contractors may carry out some maintenance functions.

- **Scheduled Facility Assessment.** Facility assessment, which less sophisticated commercial building owners may not carry out systematically, consists of the survey or inspection of the buildings on a scheduled basis. It may also include a review of documents, such as archival building plans, for retrieving specific information. The purpose(s) of the surveys or inspections is to determine facility conditions in relation to one or more of the following categories:

- Specific environmental hazards
 - Asbestos
 - Lead paint
 - Lead
 - Radon
- Preventive maintenance needs
 - Structural hazards
 - Fire/life safety
 - Environmental quality
 - Energy use/conservation
- User complaints
- Accessibility
- Maintenance needs
- Other

These surveys may or may not be coordinated by schedule, content, personnel, etc. Facility managers may or may not use prepared inspection forms or checklists. Finally, the extent and specific nature of recordkeeping and reporting by facility managers may vary.

Current use phase decisions are influenced by two factors:

- **Federal and State Programs.** Various external programs may establish requirements affecting the use of commercial buildings that have facilities implications (e.g., Americans with Disabilities Act [ADA])

and Occupational Safety and Health Administration [OSHA] requirements).

Specific surveys or inspections may be mandated by State or local laws/programs. These surveys/inspections may be carried out by a variety of entities:

- Federal personnel (e.g., from OSHA or the Environmental Protection Agency)
 - State/city/county personnel (e.g., fire marshal, code enforcement, environmental, health)
 - Commercial building personnel (e.g., custodial or facility managers)
 - Commercial building contracted personnel (e.g., asbestos inspectors)
 - Consultants
- **Complaints by Occupants.** Complaints by tenants are a potentially significant internal pressure on the facility management process.

1.6.4 THE PLANNING PHASE OF COMMERCIAL BUILDING FACILITY MANAGEMENT

The planning phase consists of projecting and forecasting future needs. It can be carried out periodically or continuously, and the time period covered by the projections and forecasts may vary. The owner, with or without the assistance of consultants, may carry out planning functions. Planning consists of two separate but related activities—strategic planning and facility planning—and is affected by significant internal and external pressures, as depicted in Figure 1-7.

Strategic Planning. Strategic planning attempts to formulate future business strategy by analyzing and forecasting financial trends as well as national, regional, and local commercial space markets. Many owners acquire properties for a limited period of time, and many have an exit strategy in place at the time of acquisition. Strategic planning addresses such issues as:

- Should the property classification (A, B, or C) be upgraded or downgraded?
- Should the exit strategy be accelerated or prolonged?

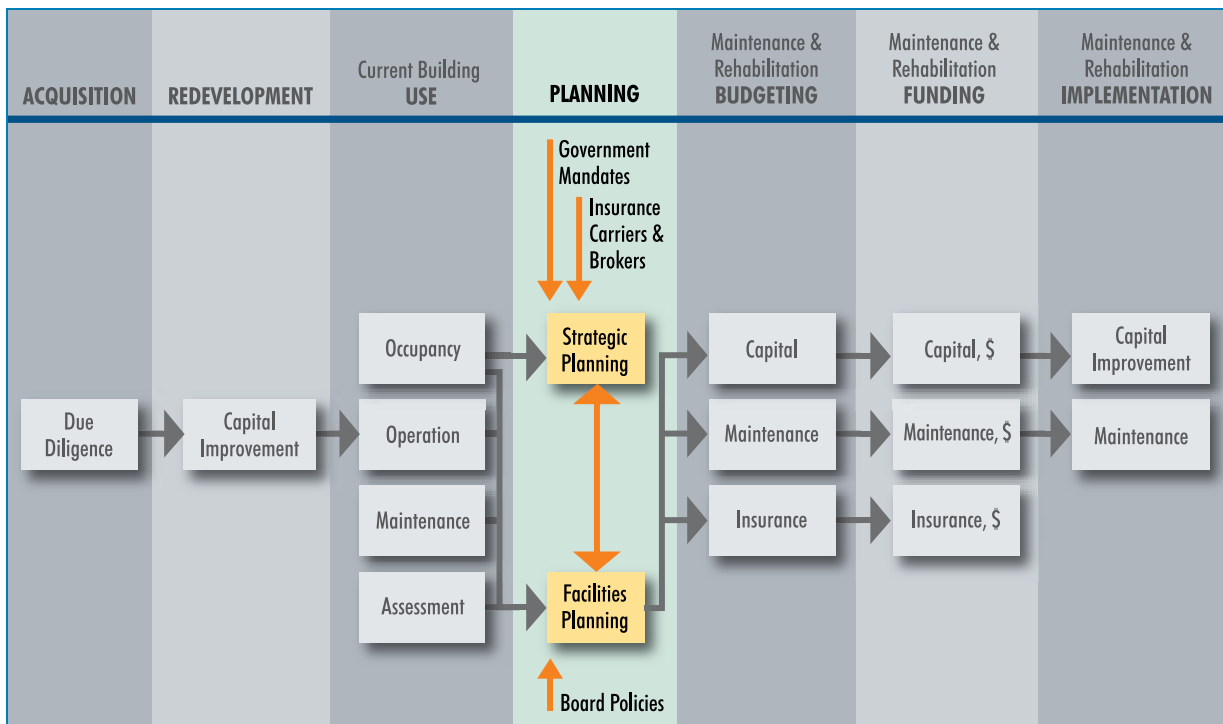

Figure 1-7: Planning phase.

- Should trends in the insurance market revise current investment programs?
- Should specific major capital investments be considered?

Strategic planning is usually carried out at the owner’s headquarters and addresses the owner’s entire commercial building portfolio or large segments of it.

Facility Planning. Facility planning consists of preparing short- and long-range facility plans. It combines the products of two distinct activities—the strategic plan and the facility assessment (see Figure 1-6)—into a detailed projection of facility requirements. The projection may cover a defined time frame, such as 5 years.

Different owners may use different classifications of projects in their facility plans, reflecting a variety of legal, administrative, jurisdictional, and other factors. However they may be classified, a comprehensive facility plan should include the following elements:

- New construction
- Additions to existing buildings
- Renovations of existing buildings

- Building systems replacements
- Building systems repairs
- Scheduled maintenance
- Preventive maintenance
- Building disposition (change of use, sale, demolition)

The plan identifies the time frames for accomplishing each project, and it may include cost estimates.

If effective, the facility plan is used as a budgeting tool and provides direct inputs into the budget process. It should be revised and updated on a routine basis to reflect:

- Changes in the strategic plan (including market conditions)
- Revised facility assessments
- Budgeting and funding realities

Facility planning usually begins at the individual building or project level and entails the flow of information up the management hierarchy for final capital decision-making and budgeting at the owner's headquarters in the case of large portfolios.

Planning phase decisions are influenced by three factors:

- **Government Mandates.** Federal, State, and local government agencies may establish external requirements affecting facility planning in the planning phase. These requirements may have facility rehabilitation implications.
- **Insurance Carriers and Brokers.** External private property and casualty insurance companies often require surveys or inspections of commercial buildings on an annual or other scheduled basis. Insurance carriers are more than willing, when asked, to provide building owners with Loss Control and Prevention Reports that include recommendations for loss prevention. Insurance brokers also employ loss/risk specialists.
- **Board Policies.** In terms of internal influences, boards of directors may occasionally adopt written policies on issues of business and social significance that can affect both strategic and facility planning. These policies guide the actions of the owner organization.

1.6.5 THE MAINTENANCE AND REHABILITATION BUDGETING PHASE OF COMMERCIAL BUILDING FACILITY MANAGEMENT

The budgeting phase consists of the projection of future financial resources required to meet future needs. It is carried out annually (covering a period of 1 or more years). Each local or regional facility manager initiates it with input from his or her staff. In the case of large portfolio owners, the facility budget process is initiated locally or regionally, and is overseen centrally. The facility budgeting is a process that can be thought of as percolating up through the organization. It is affected by external government fiscal regulations and lender requirements, and internal risk management policies and budget constraints, as depicted in Figure 1-8.

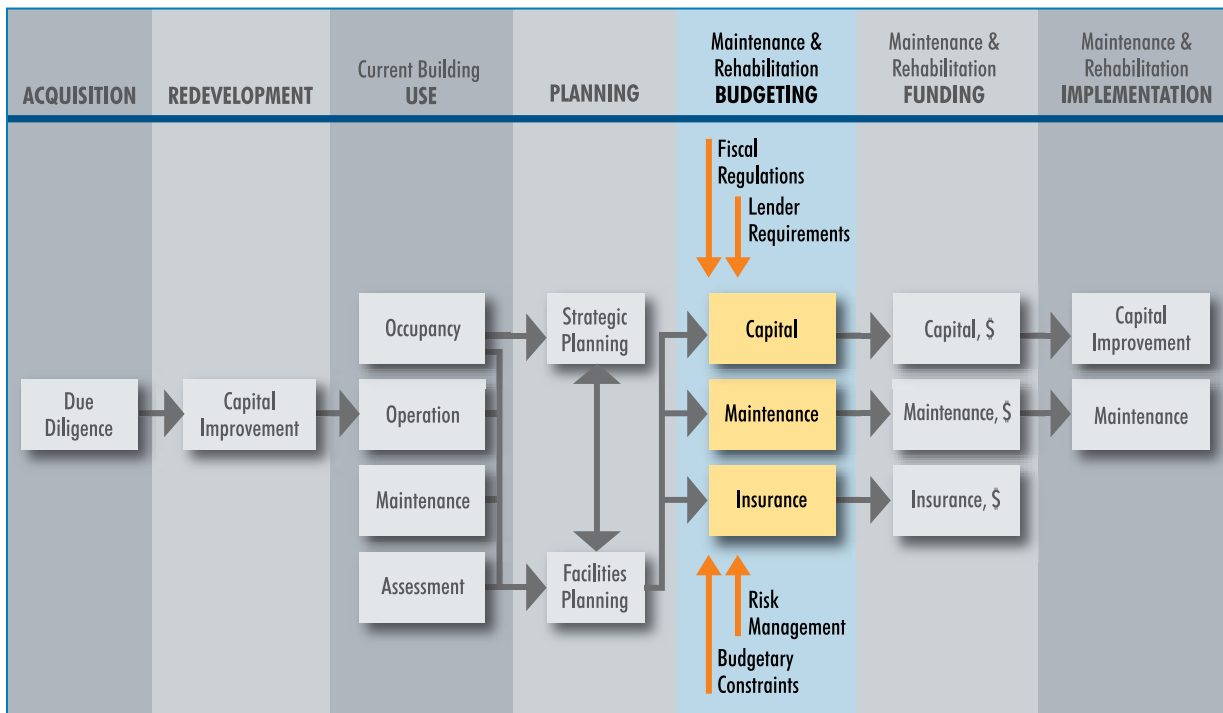

Figure 1-8: Budgeting phase.

Three elements of the budget are relevant to the discussion of facility management:

- Capital
- Maintenance
- Insurance

- **Capital Budgets.** Capital generally relates to the acquisition of buildings and major systems, which is not annual or repetitive, and which can therefore be amortized. The distinction between capital and maintenance budgets may vary among different commercial building owners. At one extreme is a total separation, mandated by law, labor jurisdiction, or other factor. At the other extreme is a rather unclear separation between the two funding mechanisms.
- **Maintenance Budgets.** Maintenance budgets generally relate to recurring annual expenditures and address existing inventories of buildings and systems without adding to the inventories.
- **Insurance Budgets.** Financial resources earmarked for insurance may be used in different ways, including the purchase of third-party insurance and/or the funding of a self-insurance reserve. Property and general liability insurance are relevant to facility management considerations.

Budgeting phase decisions are influenced by four factors:

- **Government Fiscal Regulations.** Federal, State, and local government agencies have historically established external requirements dealing with fiscal responsibility of commercial property owners. A variety of Security and Exchange Commission regulations apply to REITs. Pension funds are subject to a variety of fiduciary requirements. Partnerships are subject to a variety of State and Federal regulations. One important objective of these regulations is to ensure the responsible stewardship of third party resources. These requirements may have facility rehabilitation implications, if resources are expended in an irresponsible manner. Additionally, these regulations may determine, directly or indirectly, the length of time an acquired real estate asset must be held and, therefore, what the owner's planning horizon should be.
- **Lender Requirements.** Commercial lenders impose requirements on building owners who use mortgage financing for capital improvements. Often, the lender requires the purchase of a particular type of insurance coverage.
- **Budgetary Constraints.** Internally, political and economic conditions may place limits on commercial building capital and maintenance budgets. The problem is often exacerbated by unfunded mandates imposed on commercial buildings by Federal and State agencies.

- **Risk and Insurance Management.** Internally, the owner organization’s risk and insurance management may directly or indirectly affect insurance decisions in the budgeting phase of the process.

1.6.6 THE MAINTENANCE AND REHABILITATION FUNDING PHASE OF COMMERCIAL BUILDING FACILITY MANAGEMENT

The funding phase consists of those activities required to obtain the financial resources to meet the budgets. It is influenced externally by regional and local economic conditions and bond financing regulations, as depicted in Figure 1-9.

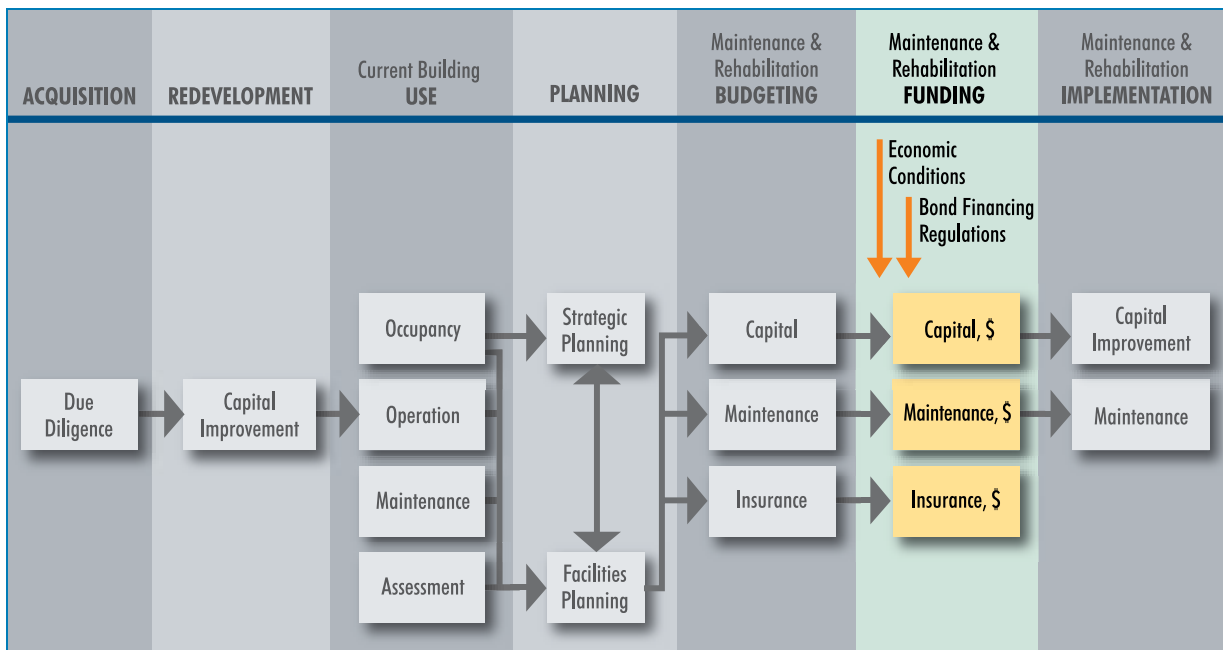

Figure 1-9: Funding phase.

The funding of commercial building budgets in general, and of the three budget elements of capital improvement, maintenance, and insurance, varies among owner organizations. Commercial building owners can fund their budgets by various combinations of equity and debt.

Funding phase decisions are influenced by two factors:

- **Regional and Local Economic Conditions.** Externally, the funding of commercial building construction is subject to local and national socioeconomic conditions well beyond the control of the building owner. Construction funding depends on interest rates, the owner’s bond rating, and similar parameters.

- **Bond Financing Regulations.** The local administrative procedures and structure in place to obtain bond financing will have a significant impact on the ability of commercial building owners to achieve their objectives, regardless of whether they include terrorism risk reduction or not. Certain types of expenditures out of the proceeds of a bond issue, such as operations or maintenance, may be prohibited by the conditions of the bond.

1.6.7 THE MAINTENANCE AND REHABILITATION IMPLEMENTATION PHASE OF COMMERCIAL BUILDING FACILITY MANAGEMENT

The implementation phase includes design and construction and can be broken into three categories of projects, all of which are relevant to existing buildings:

- Building acquisition projects
- Capital improvement projects
- Maintenance projects

The implementation phase is primarily affected by external Federal and State programs and building code requirements, as depicted in Figure 1-10.

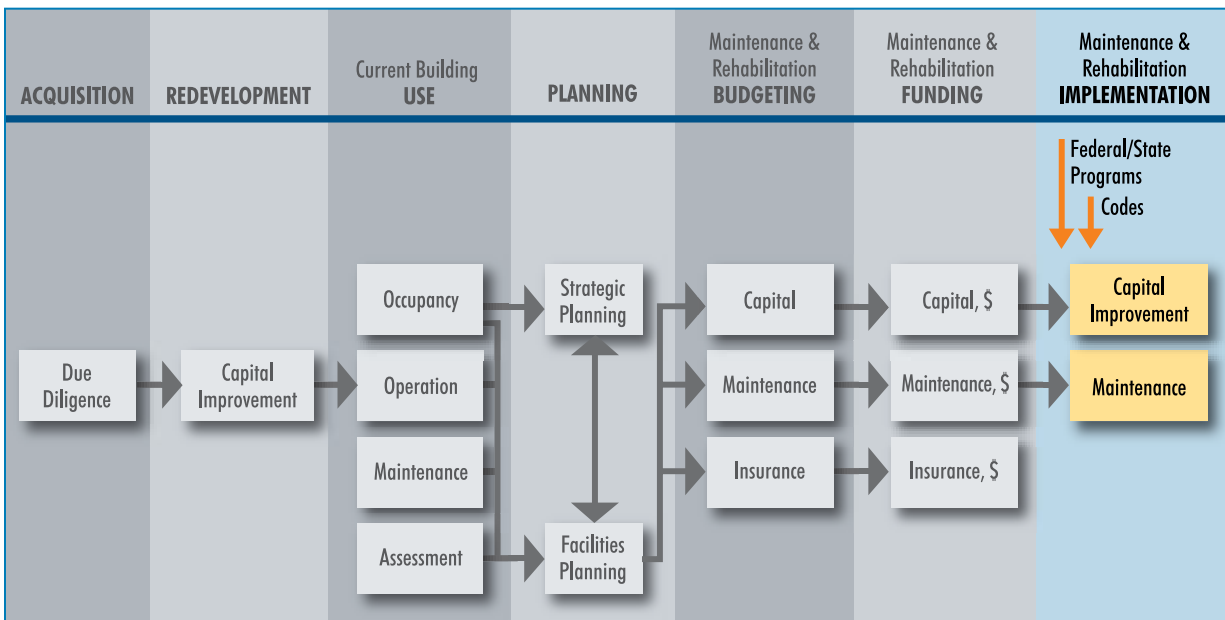

Figure 1-10: Implementation phase.

Acquisition includes new building construction and the acquisition of existing buildings. Acquisition of existing buildings is discussed above as the first phase of the facility management process.

Capital improvement and maintenance projects are managed by the commercial building owner's staff and carried out by the staff and contractors. The management of these two categories may be separated or combined, depending on issues of labor jurisdiction and legal authority.

Implementation phase decisions are influenced by two factors:

- **Federal and State Mandates and Programs.** Externally, Federal and State programs may establish requirements affecting the implementation phase (e.g., ADA and OSHA requirements).
- **Codes and Code Enforcement.** Also externally, building codes impose requirements on the implementation phase in cases of repair, alteration, or addition to existing buildings. These requirements may be enforced by a State or local agency. Such requirements can add costs to a project and jeopardize feasibility, unless done incrementally.

1.7 PLANNING AND MANAGING INCREMENTAL TERRORISM RISK REDUCTION

The implementation of an integrated incremental building protection program is supported by decisions and actions in each phase of the facility management process described in the preceding section.

There are nine steps of an incremental terrorism risk reduction program:

1. Conduct a Due Diligence Terrorism Risk Assessment
2. Identify and Implement Initial Increment Integration Opportunities
3. Assess Terrorism Risk
4. Develop a Security Master Plan
5. Plan Incremental Rehabilitation for Specific Buildings
6. Stage Rehabilitation Increments
7. Coordinate with Tenant Work
8. Define Budget Packaging
9. Implement Integrated Incremental Rehabilitation Project Management

Each of these steps relates to one (or more) of the facility management phases, as illustrated in the following table.

Table 1-2: Steps of an Incremental Terrorism Risk Reduction Program

Facility Management Process Phase	Steps of an Incremental Terrorism Risk Reduction Program
Acquisition	1. Conduct Due Diligence Terrorism Risk Assessment
Redevelopment	2. Identify and Implement Initial Increment Integration Opportunities
Use	3. Assess Terrorism Risk
Planning	4. Develop a Security Master Plan
	5. Plan Incremental Rehabilitation for Specific Buildings
	6. Stage Rehabilitation Increments
	7. Coordinate with Tenant Work
Budgeting	8. Define Budget Packaging
Funding	
Implementation	9. Implement Integrated Incremental Rehabilitation Project Management

1.7.1 STEP 1 – CONDUCT A DUE DILIGENCE TERRORISM RISK ASSESSMENT

Phase	Steps of an Incremental Terrorism Risk Reduction Program
Acquisition	1. Conduct Due Diligence Terrorism Risk Assessment
Redevelopment	2. Identify and Implement Initial Increment Integration Opportunities
Use	3. Assess Terrorism Risk
Planning	4. Develop a Security Master Plan
	5. Plan Incremental Rehabilitation for Specific Buildings
	6. Stage Rehabilitation Increments
	7. Coordinate with Tenant Work
Budgeting	8. Define Budget Packaging
Funding	
Implementation	9. Implement Integrated Incremental Rehabilitation Project Management

This step is implemented in the acquisition phase of the facility management process. It may be performed by the owner (buyer), lender, and insurer. Each may include a Tier 1 FEMA 452 assessment (discussed in more detail in Chapter 2) or equivalent terrorism risk assessment in their implementation of due diligence.

1.7.2 STEP 2—IDENTIFY AND IMPLEMENT INITIAL INCREMENT INTEGRATION OPPORTUNITIES

Phase	Steps of an Incremental Terrorism Risk Reduction Program
Acquisition	1. Conduct Due Diligence Terrorism Risk Assessment
Redevelopment	2. Identify and Implement Initial Increment Integration Opportunities
Use	3. Assess Terrorism Risk
Planning	4. Develop a Security Master Plan
	5. Plan Incremental Rehabilitation for Specific Buildings
	6. Stage Rehabilitation Increments
	7. Coordinate with Tenant Work
Budgeting	8. Define Budget Packaging
Funding	
Implementation	9. Implement Integrated Incremental Rehabilitation Project Management

This step is implemented in the initial redevelopment phase of the facility management process. As stated above, the types of redevelopment phase capital improvement projects vary, but generally consist of:

- Architectural upgrading of entrances, lobbies, and public areas
- Architectural upgrading of facades
- Upgrading of the HVAC systems
- Environmental and other risk remediation work identified in the due diligence process
- Upgrading of life safety systems

The owner should consider using the guidance provided in Chapter 2 of this manual to identify and implement specific terrorism risk reduction increments that can be integrated with these redevelopment capital improvements. Detailed information on specific risk reduction increments is presented in Chapters 3, 4, and 5.

1.7.3 STEP 3—ASSESS TERRORISM RISK

Phase	Steps of an Incremental Terrorism Risk Reduction Program
Acquisition	1. Conduct Due Diligence Terrorism Risk Assessment
Redevelopment	2. Identify and Implement Initial Increment Integration Opportunities
Use	3. Assess Terrorism Risk
Planning	4. Develop a Security Master Plan
	5. Plan Incremental Rehabilitation for Specific Buildings
	6. Stage Rehabilitation Increments
	7. Coordinate with Tenant Work
Budgeting	8. Define Budget Packaging
Funding	
Implementation	9. Implement Integrated Incremental Rehabilitation Project Management

This step is implemented as part of the scheduled and recurring assessment activities carried out in the use phase of the facility management process. As stated above, some of these assessment activities may address the following issues:

- Specific environmental hazards
 - Asbestos
 - Lead paint
 - Lead
 - Radon
- Preventive maintenance needs
 - Structural hazards
 - Fire/life safety
 - Environmental quality
 - Energy use/conservation
- User complaints
- Maintenance needs
- Accessibility
- Other

The owner should consider performing a Tier 1 FEMA 452 terrorism risk assessment (discussed in more detail in Chapter 2 of this manual) or equivalent as appropriate. Particular attention should be paid to the following factors:

- Government tenants, such as the U.S. General Services Administration or DoD, or government leased facilities that may have specific security requirements
- Tenant complaints about perceived security vulnerabilities

1.7.4 STEP 4—DEVELOP A SECURITY MASTER PLAN

Phase	Steps of an Incremental Terrorism Risk Reduction Program
Acquisition	1. Conduct Due Diligence Terrorism Risk Assessment
Redevelopment	2. Identify and Implement Initial Increment Integration Opportunities
Use	3. Assess Terrorism Risk
Planning	4. Develop a Security Master Plan
	5. Plan Incremental Rehabilitation for Specific Buildings
	6. Stage Rehabilitation Increments
	7. Coordinate with Tenant Work
Budgeting	8. Define Budget Packaging
Funding	
Implementation	9. Implement Integrated Incremental Rehabilitation Project Management

This step is implemented as part of the planning phase of the facility management process. A security master plan relates to both strategic plans and facility plans. A security master plan should be a 3- to 5-year plan, based on the goals of the overall organization. It should state the vision, goals, and objectives of the security program. The plan should also outline the operational security measures, the path for the security program to keep pace with the changing threat environment, and future initiatives. Further, it should be benchmarked against the security programs of similar facilities.

The security master plan provides the basis for all subsequent steps of the incremental terrorism risk reduction program.

A comprehensive Security Master Plan should:

- Be communicated and disseminated to all levels of management and building occupants as appropriate
- Be integrated into the facility construction or renovation planning
- Be benchmarked or compared to related facilities
- Be tested and evaluated
- Identify threats/hazards, assets, vulnerabilities, and risks

- Establish a security improvement implementation schedule
- Establish a security operating and capital budget
- Follow regulatory or industry guidelines/standards

The owner should consider requiring the development of a Security Master Plan in accordance with guidance provided in Chapter 5.

1.7.5 STEP 5—PLAN INCREMENTAL REHABILITATION FOR SPECIFIC BUILDINGS

Phase	Steps of an Incremental Terrorism Risk Reduction Program
Acquisition	1. Conduct Due Diligence Terrorism Risk Assessment
Redevelopment	2. Identify and Implement Initial Increment Integration Opportunities
Use	3. Assess Terrorism Risk
Planning	4. Develop a Security Master Plan
	5. Plan Incremental Rehabilitation for Specific Buildings
	6. Stage Rehabilitation Increments
	7. Coordinate with Tenant Work
Budgeting	8. Define Budget Packaging
Funding	
Implementation	9. Implement Integrated Incremental Rehabilitation Project Management

This step is implemented as part of the planning phase of the facility management process.

The owner should consider using the guidance provided in Chapter 2 of this manual to identify and implement specific terrorism risk reduction measures that can be integrated with planned maintenance and capital improvement projects.

The incremental rehabilitation plan combines information from the Security Master Plan (Step 4) and the strategic and facility plans discussed in Section 1.5.4, and provides a coherent sequencing of increments.

1.7.6 STEP 6—STAGE REHABILITATION INCREMENTS

Phase	Steps of an Incremental Terrorism Risk Reduction Program
Acquisition	1. Conduct Due Diligence Terrorism Risk Assessment
Redevelopment	2. Identify and Implement Initial Increment Integration Opportunities
Use	3. Assess Terrorism Risk
Planning	4. Develop a Security Master Plan
	5. Plan Incremental Rehabilitation for Specific Buildings
	6. Stage Rehabilitation Increments
	7. Coordinate with Tenant Work
Budgeting	8. Define Budget Packaging
Funding	
Implementation	9. Implement Integrated Incremental Rehabilitation Project Management

This step is implemented as part of the planning phase of the facility management process, and is closely related to Step 5.

Consider the staging of increments of terrorism risk reduction on the basis of a life-cycle benefit analysis. Figure 1-11 illustrates such a life-cycle benefit analysis. The three wide arrows represent the benefits of single-stage rehabilitation occurring at three points in time: now, in 10 years, and in 20 years. Clearly, the largest benefit derives from a single-stage rehabilitation done now, and is designated as 100 percent. The benefits of single-stage rehabilitation done in the future must be discounted and expressed as some percentage lower than 100 percent, as represented by the smaller arrows. The stepped portion of the diagram represents incremental rehabilitation starting soon and completed in four increments over 10 years. The benefits of the future increments must also be discounted, and the benefit of the completed incremental rehabilitation is therefore expressed as a percentage lower than 100 percent, but higher than the single-stage rehabilitation in year 10 or 20. Reducing the overall duration of the incremental rehabilitation will increase its benefit, and extending the duration will decrease it.

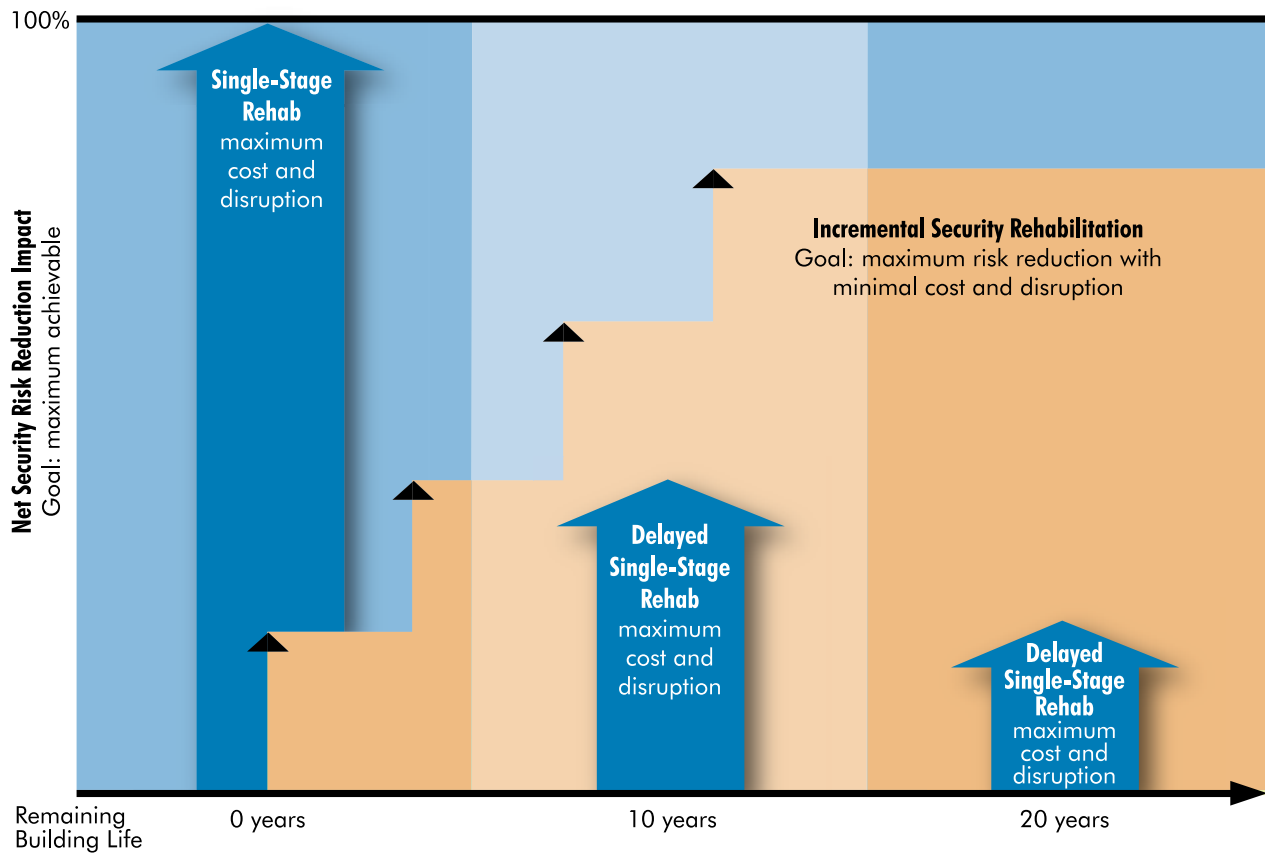

Figure 1-11: Life-cycle benefit analysis.

1.7.7 STEP 7—COORDINATE WITH TENANT WORK

Phase	Steps of an Incremental Terrorism Risk Reduction Program
Acquisition	1. Conduct Due Diligence Terrorism Risk Assessment
Redevelopment	2. Identify and Implement Initial Increment Integration Opportunities
Use	3. Assess Terrorism Risk
Planning	4. Develop a Security Master Plan
	5. Plan Incremental Rehabilitation for Specific Buildings
	6. Stage Rehabilitation Increments
	7. Coordinate with Tenant Work
Budgeting	8. Define Budget Packaging
Funding	
Implementation	9. Implement Integrated Incremental Rehabilitation Project Management

This step is implemented as part of the planning phase of the facility management process, and is closely related to Step 5.

In addition to the integration opportunities with maintenance and capital improvement work done in Step 5, the owner should consider integrating additional increments of terrorism risk reduction with tenant work in coordination with the tenants.

1.7.8 STEP 8—DEFINE BUDGET PACKAGING

Phase	Steps of an Incremental Terrorism Risk Reduction Program
Acquisition	1. Conduct Due Diligence Terrorism Risk Assessment
Redevelopment	2. Identify and Implement Initial Increment Integration Opportunities
Use	3. Assess Terrorism Risk
Planning	4. Develop a Security Master Plan
	5. Plan Incremental Rehabilitation for Specific Buildings
	6. Stage Rehabilitation Increments
	7. Coordinate with Tenant Work
Budgeting	8. Define Budget Packaging
Funding	
Implementation	9. Implement Integrated Incremental Rehabilitation Project Management

This step is implemented as part of the budgeting phase of the facility management process.

The owner’s facility, risk, and financial managers should determine:

- Potential losses due to terrorist attack (life, property, business interruption)
- The owner’s potential liability related to terrorist attacks
- The extent of security considerations attendant to government fiscal regulations applicable to the owner’s organization
- The extent of lender-imposed terrorism risk insurance requirements

The owner’s facility, risk, and financial managers should carefully plan the presentation of incremental security enhancement budgets to maximize the probability of their being approved, given the financial realities of the owner organization. A benefit-cost analysis as initiated in Step 6 can help. Concentrating on terrorism risk reduction measures that also reduce the risk of damage from natural disasters, and other causes may also be useful.

1.7.9 STEP 9—IMPLEMENT INTEGRATED INCREMENTAL REHABILITATION PROJECT MANAGEMENT

Phase	Steps of an Incremental Terrorism Risk Reduction Program
Acquisition	1. Conduct Due Diligence Terrorism Risk Assessment
Redevelopment	2. Identify and Implement Initial Increment Integration Opportunities
Use	3. Assess Terrorism Risk
Planning	4. Develop a Security Master Plan
	5. Plan Incremental Rehabilitation for Specific Buildings
	6. Stage Rehabilitation Increments
	7. Coordinate with Tenant Work
Budgeting	8. Define Budget Packaging
Funding	
Implementation	9. Implement Integrated Incremental Rehabilitation Project Management

The implementation of the plans developed in Step 5, consisting of selected incremental security rehabilitation measures in combination with other building work, may require added attention to project design and bid packaging.

- Fully brief or train in-house architects/engineers or outside consultants preparing the bid documents on the rationale behind the integration of physical protection and strengthening increments with the maintenance and capital improvement activities, as presented in Chapter 2 of this manual, to ensure that the terrorism risk reduction objectives are achieved.
- Ensure the continuity of building documentation from the analysis and design stages through construction and as-built drawings.
- Conduct a pre-bid conference to explain to all prospective bidders the terrorism risk reduction objectives and the rationale for their selection.
- In cases where security rehabilitation increments are to be implemented within tenant spaces, whether or not they are integrated with other items of tenant work, the tenant work and owner work should be well coordinated.

1.8 TERRORISM RISK ASSESSMENT TO TERRORISM RISK REDUCTION

These two activities, briefly discussed in this chapter as they relate to the phases of commercial building facility management, are discussed in detail in the Chapter 2.

The terrorism risk assessment process described in FEMA 452, *Risk Assessment: A How-To Guide to Mitigate Potential Terrorist Attacks Against Buildings*, helps building owners to assess major vulnerabilities in a building and identify mitigation measures to correct such vulnerabilities. The information generated by the application of FEMA 452 and by the methodology provided in this manual are fundamental for implementing an incremental security enhancement process for existing commercial buildings.

The mitigation measures generated by the application of FEMA 452 provide the starting point for the application of this document. This document then demonstrates how a building owner or facility manager categorizes those mitigation measures into increments of terrorism risk reduction, and integrates the increments into ongoing or planned facility maintenance or capital improvement projects.

A building owner or facility manager proceeding through the five steps of FEMA 452 described in Section 2.1 generates a series of physical protection and strengthening measures, as well as operational mitigation measures. In moving from a risk assessment to implementation, the building owner should check the compatibility of the former (physical protection and strengthening), as well as some of the latter (operational), with the maintenance and capital improvement plans. A matrix, as shown in Section 2.3, should be used to highlight opportunities for integration of specific mitigation options with specific maintenance or capital improvement activities.

2.1 RISK ASSESSMENT PROCESS

The risk assessment process described in FEMA 452 is based on five critical steps (Figure 2-1). These critical steps identify the best and most cost-effective terrorism mitigation measures for a building's unique security needs.

Conducting a threat assessment to identify, define, and quantify the threats or hazards is the first step of the risk assessment process. For terrorism, the threats are aggressors (people or groups) that are known to exist and that have the capability and a history of using hostile actions, or that have expressed intentions for using hostile actions against potential targets. Current credible information on targeting activity (surveillance of potential targets) or indications of preparation for terrorist acts may be available for these aggressors.

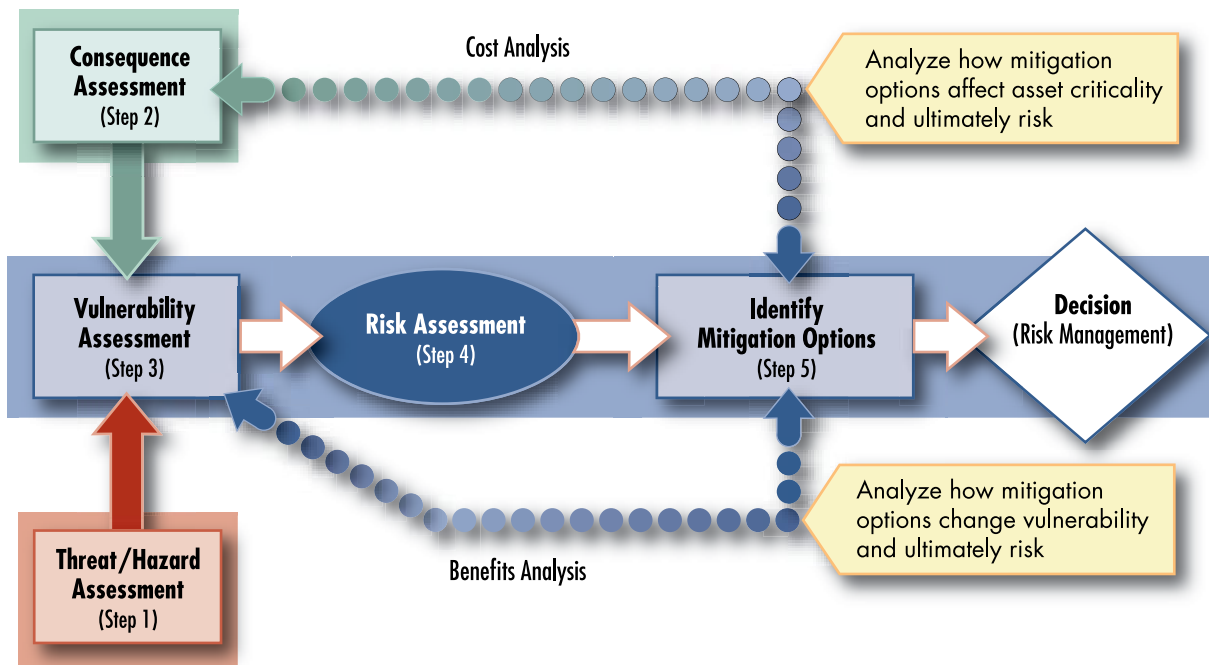

Figure 2-1: Risk assessment process model.

The second step of the risk assessment process is to identify the consequences of the loss of a building that needs to be protected from terrorist attack. Consequences relate to the criticality of the building in terms of the importance of the building operation to the owner and the locality, and can be defined as a degree of debilitation that would be caused by its destruction. This assessment of consequences can be applied to the entire building or significant portions of a very large building. It can also refer to a resource of value requiring protection. Consequences can be tangible (i.e., loss of buildings, facilities, equipment activities, operations, and information) or intangible (e.g., loss of processes or a company’s reputation).

As explained in FEMA 452, “after assessing consequences, the third step is to conduct a vulnerability assessment. A vulnerability assessment evaluates the potential vulnerability of the critical assets against a broad range of identified threats and natural hazards. By itself, the vulnerability assessment provides a basis for determining mitigation measures for protection of the building and its content. The assessment is a bridge in the methodology among threat/hazard, consequences, and the resultant level of risk.

“The fourth step of the process is the risk assessment. The risk assessment analyzes the likelihood or probability of the threat or natural hazard occurring and the consequences of the occurrence. Thus, a very high

likelihood of occurrence with very small consequences may require simple low cost mitigation measures, but a very low likelihood of occurrence with very serious consequences may require more costly and complex mitigation measures. The risk assessment should provide a relative risk profile. High-risk combinations of assets against associated threats, with the identified vulnerability, allow prioritization of resources to implement mitigation measures.

“The fifth and final step is to consider mitigation options that are directly associated with, and responsive to, the major risks identified during Step 4. From Step 5, decisions can be made as to where to minimize the risks and how to accomplish that over time.”

2.1.1 LEVELS OF VULNERABILITY ASSESSMENT

FEMA 452 provides guidance in conducting varied levels of assessments, ranging from screening level assessments to in-depth assessments. As stated in FEMA 452, “the level of assessment for a given building is dependent upon a number of factors such as potential threat, type of building, location, type of construction, number of occupants, economic life, and other owner specific concerns and available economic resources.” FEMA 452 defines a three-tier assessment process as follows:

“**Tier 1.** A Tier 1 assessment is a ‘70 percent’ assessment. It can typically be conducted by one or two experienced assessment professionals in approximately two days. A Tier 1 assessment will likely be sufficient for the majority of commercial buildings and other non-critical facilities and infrastructure.

“**Tier 2.** A Tier 2 assessment is a ‘90 percent’ assessment. It typically requires three to five assessment specialists, can be completed in 3 to 5 days, and requires key building staff participation. A Tier 2 assessment is likely to be sufficient for most high-risk buildings such as iconic commercial buildings, government facilities, schools, hospitals, and other high-value designated infrastructure assets.

“**Tier 3.** A Tier 3 assessment is a detailed evaluation of the building using blast, weapons of mass destruction (WMD), earthquake, flood, and high wind models to determine building response, survivability, and recovery, and the development of mitigation options. The assessment team is not defined for this tier; however, it could be composed of 8 to 12 people. Modeling and analysis can often take several days or weeks and is typically performed for high value and critical infrastructure assets.”

2.1.2 THE BUILDING VULNERABILITY ASSESSMENT CHECKLIST

FEMA 452 includes a Building Vulnerability Assessment Checklist, covering explosives, CBR, earthquakes, floods, and high-wind hazards. The checklist can be used to collect and report information related to the building. It compiles many best practices, based on the latest technologies and scientific research, to consider during the design of a new building or renovation of an existing building.

The vulnerability assessment step is supported by the Building Vulnerability Assessment Checklist (FEMA 452, Appendix A), which is organized into 13 sections corresponding to building subsystems:

1. Site
2. Architectural
3. Structural Systems
4. Building Envelope
5. Utility Systems
6. Mechanical Systems
7. Plumbing and Gas Systems
8. Electrical Systems
9. Fire Alarm Systems
10. Communications and IT Systems
11. Equipment Operations and Maintenance
12. Security Systems
13. Security Master Plan

To support the building assessment process, a Risk Assessment Database has been developed as a companion tool to FEMA 452. The database is a stand-alone application with several functions: import files and folders; display digital photos, emergency plans, and digital floor plans; and provide specific GIS tools. The database can be used to collect and report information related to the building.

The 13 sections of the Building Vulnerability Assessment Checklist provide a framework for the categorization of incremental measures of terrorism risk reduction discussed in the following sections.

2.2 SCHEDULING INCREMENTS: PHYSICAL PROTECTION AND STRENGTHENING MEASURES AND OPERATIONAL (PROTECTIVE AND CONTROL) MEASURES

 Once identified, the terrorism risk reduction improvements should be considered in relation to the owner's ongoing facility planning for maintenance and capital improvements (discussed in Section 2.3). Physical protection and strengthening measures and some operational measures can then be integrated with maintenance and capital improvements using this document, and can be scheduled for implementation.

2.2.1 PHYSICAL PROTECTION AND STRENGTHENING MEASURES

The increments of physical protections measures listed on the vertical axes of the integration matrices 1 and 2 in Section 2.3 are presented as an example of measures that might be generated by the FEMA 452 process or others and implemented using this manual. The specific measures included in the matrices were generated for this manual and are discussed in Chapters 3, 4, and 5. Where applicable, the references in parentheses following items in the list refer to the respective discussions in Chapters 3, 4, and 5. The protection measures are presented in the order of the 13 sections of the Building Vulnerability Assessment Checklist in Appendix A of FEMA 452.

2.2.2 OPERATIONAL MEASURES

The list of incremental operational measures is presented in Chapter 5, Section 5.11 as an example of measures that might be generated by the FEMA 452 process or others and implemented using this manual. The specific measures included in the matrices were generated for this manual and are discussed in Chapters 4 and 5. Some of these measures include physical elements and are also included in the list that comprises the vertical axes of the integration matrices in Section 2.3. Where applicable, the references in parentheses following items in both lists (Section 2.3 and Section 5.11) refer to the applicable discussions in Chapters 4 and 5. The measures are presented in the order of the 13 sections of the Building Vulnerability Assessment Checklist in Appendix A of FEMA 452.

2.3 IDENTIFYING INTEGRATION OPPORTUNITIES FOR INCREMENTAL BUILDING PROTECTION

Typical maintenance and capital improvement projects in commercial buildings fall into two categories:

- Maintenance and capital improvements that are common to all four types of commercial buildings—office, retail, and multifamily apartment buildings, and hotels.
- Maintenance and capital improvements specific and unique to each of the four types of commercial buildings.

These categories may also vary by building classification (A, B, or C). The following categorizations of maintenance and capital improvements are typical and reflect groupings of building elements, administrative and funding categories, tenant versus public spaces, or other parameters. Owners can substitute their own categories.

Common categories of maintenance and capital improvement projects:

1. Roofing maintenance and repair/reroofing
2. Exterior wall and window maintenance/façade modernization
3. Fire and life safety improvements
4. Public area modernization (Retail: mall public areas; Hotels: public and service areas)
5. Underfloor and basement maintenance and repair
6. HVAC upgrade and energy conservation
7. Hazardous materials abatement
8. Landscaping and site work

Occupancy-specific categories of maintenance and capital improvement projects:

Office Buildings:

1. New technology accommodations
2. Tenant alterations and improvements

Retail Buildings:

1. Retail area modernization

Multifamily Apartment Buildings:

1. Kitchen and bathroom modernization

Hotels and Motels:

1. Guestroom finishing, furniture, and equipment (FF&E)
2. Public area FF&E

Both of these respective categories are used as the horizontal axes of the integration matrices presented on the following pages.

How to Use the Matrices

In order to identify integration opportunities, a building owner should follow these three steps:

1. Identify the column of the planned maintenance or capital improvement.
2. Identify the physical increments of building protection with a corresponding check mark in the column.
3. Consider integration of the physical increments with the planned maintenance or capital improvement activities.

Matrix 1: Integration Opportunities for Common Categories of Maintenance and Capital Improvement Projects

		Maintenance and Capital Improvement Projects						
		Roofing maintenance & repair	Exterior wall & window work	Fire & life safety improvements	Public area modernization	Underfloor & basement work	HVAC upgrade & energy work	Hazardous material abatement
1. Site								
1.1	Increased standoff distance (3.3)							✓
1.2	Anti-ram vehicle barriers (3.3)							✓
1.3	Speed calming devices (3.3)							✓
1.4	Operable barriers (3.3)							✓
1.5	Security lighting (5.8)							✓
1.6	Detection & assessment measures	1.6.1	Exterior intrusion detection systems (5.2.1)					✓
		1.6.2	Access control systems (5.2.4)					✓
1.7	Interdiction/response measures	1.7.1	Guard force—detection/delay role (5.3.1)					✓
2. Architectural								
2.1	Bracing or reinforcing masonry walls at interior stairs (3.5)			✓	✓			
2.2	Restraint of hazardous materials containers (3.5)			✓	✓	✓	✓	
2.3	Architectural isolation of lobby, mailroom, cloakroom, & loading docks (4.3.2)				✓			
2.4	Architectural measures to isolate mechanical spaces that require large volumes of outside air (4.4.3.2)			✓	✓			
2.5	Vestibules or revolving doors for highly protected zones (4.3.5, 4.3.6)			✓	✓			
2.6	Vestibules or revolving doors for protected zones (4.3.7)			✓	✓			
2.7	Access control systems (5.2.4)			✓	✓			
3. Structural Systems (3.6)								
3.1	Upgrading the structure to make it more ductile		✓	✓	✓	✓	✓	
3.2	Upgrading spandrel beams to achieve catenary response		✓					
3.3	Upgrading slabs to achieve catenary response				✓	✓		
3.4	Standoff distance around vulnerable columns (3.6.1)		✓		✓			
3.5	Localized hardening of vulnerable columns (3.6.1)		✓		✓			
3.6	Floor slab upload resistance (3.6.2)				✓			

Note: The references in parentheses refer to the applicable discussions in Chapters 3, 4, and 5.

Matrix 1: Integration Opportunities for Common Categories of Maintenance and Capital Improvement Projects (continued)

		Maintenance and Capital Improvement Projects							
		Roofing maintenance & repair	Exterior wall & window work	Fire & life safety improvements	Public area modernization	Underfloor & basement work	HVAC upgrade & energy work	Hazardous material abatement	Landscaping
3.7 Load-bearing URM ¹ (3.6.3)	3.7.1 Shotcrete		✓	✓	✓	✓	✓	✓	
	3.7.2 Steel sections		✓	✓	✓	✓	✓	✓	
	3.7.3 Stiffened steel-plate wall system		✓	✓	✓	✓	✓	✓	
	3.7.4 Reinforcing		✓	✓	✓	✓	✓	✓	
3.8 Transfer girder retrofit (3.6.4)			✓						
4. Building Envelope									
4.1 Glazing	4.1.1 Fragment retention film (3.4.2)		✓	✓	✓		✓		
	4.1.2 Laminated glass (3.4.3)		✓	✓	✓		✓		
	4.1.3 Blast curtains (3.4.4)			✓	✓		✓		
	4.1.4 Glazing catch cable/bar (3.4.5)			✓	✓		✓		
	4.1.5 Energy absorbing cable systems (3.4.6)			✓	✓		✓		
4.2 URM (3.4.7)	4.2.1 Sprayed-on polymer		✓	✓	✓		✓		
	4.2.2 Geotextile fabric			✓	✓		✓		
	4.2.3 Steel stud and sheetmetal construction			✓	✓		✓		
4.3 Other building envelope retrofits	4.3.1 Bracing parapets, gables, ornamentation, & appendages (3.4.8)	✓	✓						
	4.3.2 Cladding anchorage (3.4.1)		✓						
	4.3.3 Anchorage of masonry veneer (3.4.8)		✓						
	4.3.4 Anchorage of steel stud backup (3.4.8)		✓	✓	✓		✓		
	4.3.5 Anchorage of exterior wythe in cavity walls (3.4.8)		✓						
	4.3.6 Debris catch systems for façade elements (3.4.8)		✓	✓	✓		✓		
	4.3.7 Increasing the roof's resistance to blast (3.6)	✓							
	4.3.8 Upgrading connections of light metal deck roofs to structure (3.6)	✓							
4.4 Sealing measures to tighten the envelope of the building and selected safe rooms (4.3.3)			✓		✓				

Note: The references in parentheses refer to the applicable discussions in Chapters 3, 4, and 5.

1. URM = unreinforced masonry

Matrix 1: Integration Opportunities for Common Categories of Maintenance and Capital Improvement Projects (continued)

		Maintenance and Capital Improvement Projects							
		Roofing maintenance & repair	Exterior wall & window work	Fire & life safety improvements	Public area modernization	Underfloor & basement work	HVAC upgrade & energy work	Hazardous material abatement	Landscaping
5. Utility Systems									
5.1	Light, secure, and monitor water service access points (5.8)				✓		✓	✓	
5.2	Intrusion detection sensors for all utility services to the building (5.8)		✓		✓		✓	✓	
5.3	Redundant utility systems to support security, life safety, and rescue functions				✓		✓		
5.4	Attachment and bracing of tanks (3.5)	✓			✓	✓	✓	✓	
6. Mechanical Systems (HVAC)									
6.1	Fastening and bracing of mechanical equipment above ceilings (3.5)			✓	✓		✓	✓	
6.2	Attachment and bracing of boilers and chillers (3.5)						✓		
6.3	Enhanced physical security (4.4.2.2)	✓	✓				✓	✓	
	6.3.1 Secure air intakes against unauthorized access (5.8.1)								
	6.3.2 Secure mechanical rooms & HVAC plenums against unauthorized access				✓		✓		
6.4	Enhanced sheltering in place (4.4.3.2)						✓		
	6.4.1 Single-switch control of fans for sheltering and purging						✓		
	6.4.2 Automatic dampers for outside air intakes and exhaust fans				✓			✓	
	6.4.3 Separate fans & air streams for ventilation and recirculation for conditioning safe rooms							✓	
	6.4.4 Recirculation filter units in safe rooms			✓	✓		✓		
6.5	Aerosol filtration, medium level (4.4.4.2)						✓		
	6.5.1 Sealing filter frames to minimize bypass						✓		
	6.5.2 Installation of filters of greater depth/surface area & higher MERV ² rating							✓	
	6.5.3 Operating at positive internal pressures						✓		
6.6	Gas-phase filtration, medium level (4.4.5.2)						✓		
	6.6.1 Indoor-air-quality type, low resistance adsorbers						✓		
	6.6.2 Operating at positive internal pressures						✓		
6.7	Aerosol filtration, high level (4.4.6.2)						✓		
	6.7.1 Installation of ventilation/makeup-air units with HEPA ³ filtration						✓		
	6.7.2 Operating at positive internal pressures						✓		

Note: The references in parentheses refer to the applicable discussions in Chapters 3, 4, and 5.

2. MERV = Minimum Efficiency Reporting Value

3. HEPA = High Efficiency Particulate Air

Matrix 1: Integration Opportunities for Common Categories of Maintenance and Capital Improvement Projects (continued)

		Maintenance and Capital Improvement Projects							
		Roofing maintenance & repair	Exterior wall & window work	Fire & life safety improvements	Public area modernization	Underfloor & basement work	HVAC upgrade & energy work	Hazardous material abatement	Landscaping
6.8 Gas-phase filtration, high level (4.4.7.2)	6.8.1 Ventilation/makeup-air units with high efficiency adsorbers & HEPA filtration						✓		
	6.8.2 Operating at positive internal pressures						✓		
6.9 Secure and monitor exterior mechanical spaces and equipment (5.8)			✓						✓
6.10 Secure and monitor interior HVAC access points (5.8)					✓		✓		
7. Plumbing & Gas Systems									
7.1 Attachment and bracing of sprinkler piping (3.5)				✓	✓		✓	✓	
8. Electrical Systems									
8.1 Attachment and bracing of emergency lighting (3.5)				✓	✓		✓	✓	
8.2 Fastening and bracing of electrical equipment above ceilings (3.5)				✓	✓		✓	✓	
8.3 Attachment and bracing of transformers (3.5)		✓			✓	✓			✓
8.4 Attachment and bracing of emergency generators (3.5)		✓			✓	✓			✓
9. Fire Alarm Systems									
10. Communications and IT Systems									
10.1 Public address system to achieve rapid implementation of emergency actions (4.4.3.2)				✓	✓		✓		
11. Equipment Operations & Maintenance									
12. Security Systems									
12.1 Exterior intrusion detection systems (5.2.1)			✓		✓				✓
12.2 Interior intrusion detection systems (5.2.2)				✓	✓	✓	✓		
12.3 CCTV ⁴ systems (5.2.3)		✓	✓	✓	✓	✓	✓	✓	✓
12.4 Duress alarms (5.2.6)				✓	✓	✓	✓		
13. Security Master Plan									

Note: The references in parentheses refer to the applicable discussions in Chapters 3, 4, and 5.

4. CCTV = closed circuit television

Matrix 2: Integration Opportunities for Occupancy-Specific Categories of Maintenance and Capital Improvement Projects

		Maintenance and Capital Improvement Projects					
		OFFICE		RETAIL	APARTMENT	HOTEL	
		New Technology	Tenant Alterations	Retail Area Modernization	Kitchen & Bath Modernization	Guestroom FF&E	Public Area FF&E
1. Site							
2. Architectural							
2.1 Bracing or reinforcing masonry walls at interior stairs (3.5)							
2.2 Restraint of hazardous materials containers (3.5)		✓	✓	✓			✓
2.3 Architectural isolation of lobby, mailroom, cloakroom, & loading docks (4.3.2)							
2.4 Architectural measures to isolate mechanical spaces that require large volumes of outside air (4.4.3.2)							
2.5 Vestibules or revolving doors for highly protected zones (4.3.5, 4.3.6)							✓
2.6 Vestibules or revolving doors for protected zones (4.3.7)							✓
2.7 Access control systems (5.2.4)							✓
3. Structural Systems							
3.1 Upgrading the structure to make it more ductile		✓	✓	✓	✓	✓	✓
3.2 Upgrading spandrel beams to achieve catenary response (3.6.2)							
3.3 Upgrading slabs to achieve catenary response (3.6.2)			✓	✓		✓	✓
3.4 Standoff distance around vulnerable columns (3.6.1)				✓			✓
3.5 Localized hardening of vulnerable columns (3.6.1)				✓			✓
3.6 Floor slab upload resistance (3.6.2)			✓	✓		✓	✓
3.7 Load-bearing URM (3.6.3)	3.7.1 Shotcrete	✓	✓	✓	✓	✓	✓
	3.7.2 Steel sections	✓	✓	✓	✓	✓	✓
	3.7.3 Stiffened steel-plate wall system	✓	✓	✓	✓	✓	✓
	3.7.4 Reinforcing	✓	✓	✓	✓	✓	✓
3.8 Transfer girder retrofit (3.6.4)							
4. Building Envelope							
4.1 Glazing	4.1.1 Fragment retention film (3.4.2)		✓	✓		✓	✓
	4.1.2 Laminated glass (3.4.3)		✓	✓		✓	✓
	4.1.3 Blast curtains (3.4.4)		✓	✓		✓	✓
	4.1.4 Glazing catch cable/bar (3.4.5)		✓	✓		✓	✓
	4.1.5 Energy absorbing cable systems (3.4.6)		✓	✓		✓	✓

Note: The references in parentheses refer to the applicable discussions in Chapters 3, 4, and 5.

Matrix 2: Integration Opportunities for Occupancy-Specific Categories of Maintenance and Capital Improvement Projects (continued)

		Maintenance and Capital Improvement Projects					
		OFFICE		RETAIL	APARTMENT	HOTEL	
		New Technology	Tenant Alterations	Retail Area Modernization	Kitchen & Bath Modernization	Guestroom FF&E	Public Area FF&E
4.2 URM (3.4.7)	4.2.1 Sprayed-on polymer		✓	✓		✓	✓
	4.2.2 Geotextile fabric		✓	✓		✓	✓
	4.2.3 Steel stud and sheetmetal construction		✓	✓		✓	✓
4.3 Other building envelope retrofits	4.3.1 Bracing parapets, gables, ornamentation and appendages (3.4.8)						
	4.3.2 Cladding anchorage (3.4.1)						
	4.3.3 Anchorage of masonry veneer (3.4.8)						
	4.3.4 Anchorage of steel stud backup (3.4.8)		✓	✓		✓	✓
	4.3.5 Anchorage of exterior wythe in cavity walls (3.4.8)						
	4.3.6 Debris catch systems for façade elements (3.4.8)		✓	✓		✓	✓
	4.3.7 Increasing the roof's resistance to blast (3.6)						
	4.3.8 Upgrading connections of light metal deck roofs to structure (3.6)						
4.5 Sealing measures to tighten the envelope of the building and selected safe rooms (4.3.3)		✓	✓	✓	✓	✓	
5. Utility Systems							
5.1 Light, secure, and monitor water service access points (5.8)							
5.2 Intrusion detection sensors for all utility services to the building (5.8)							
5.3 Redundant utility systems to support security, life safety, and rescue functions							✓
5.4 Attachment and bracing of tanks (3.5)							
6. Mechanical Systems (HVAC)							
6.1 Fastening and bracing of mechanical equipment above ceilings (3.5)	✓	✓	✓	✓	✓	✓	✓
6.2 Attachment and bracing of boilers and chillers (3.5)							
6.3 Enhanced physical security (4.4.2.2)	6.3.1 Secure air intakes against unauthorized access (5.8.1)						
	6.3.2 Secure mechanical rooms & HVAC plenums against unauthorized access.						✓

Note: The references in parentheses refer to the applicable discussions in Chapters 3, 4, and 5.

Matrix 2: Integration Opportunities for Occupancy-Specific Categories of Maintenance and Capital Improvement Projects (continued)

		Maintenance and Capital Improvement Projects					
		OFFICE		RETAIL	APARTMENT	HOTEL	
		New Technology	Tenant Alterations	Retail Area Modernization	Kitchen & Bath Modernization	Guestroom FF&E	Public Area FF&E
6.4 Enhanced sheltering in place (4.4.3.2)	6.4.1 Single-switch control of fans for sheltering and purging						
	6.4.2 Automatic dampers for outside air intakes and exhaust fans						
	6.4.3 Separate fans & air streams for ventilation and recirculation for conditioning safe rooms						
	6.4.4 Recirculation filter units in safe rooms		✓	✓	✓		✓
6.5 Aerosol filtration, medium level (4.4.4.2)	6.5.1 Sealing filter frames to minimize bypass						
	6.5.2 Installation of filters of greater depth/surface area & higher MERV rating						
	6.5.3 Operating at positive internal pressures						
6.6 Gas-phase filtration, medium level (4.4.5.2)	6.6.1 Indoor-air-quality type, low resistance adsorbers						
	6.6.2 Operating at positive internal pressures						
6.7 Aerosol filtration, high level (4.4.6.2)	6.7.1 Installation of ventilation/makeup-air units with HEPA filtration						
	6.7.2 Operating at positive internal pressures						
6.8 Gas-phase filtration, high level (4.4.7.2)	6.8.1 Ventilation/makeup-air units with high efficiency adsorbers & HEPA filtration						
	6.8.2 Operating at positive internal pressures						
6.9 Secure and monitor exterior mechanical spaces and equipment (5.8)							
6.10 Secure and monitor interior HVAC access points (5.8)			✓	✓		✓	
7. Plumbing & Gas Systems							
7.1 Attachment and bracing of sprinkler piping (3.5)		✓	✓	✓	✓	✓	✓
8. Electrical Systems							
8.1 Attachment and bracing of emergency lighting (3.5)		✓		✓			✓
8.2 Fastening and bracing of electrical equipment above ceilings (3.5)		✓	✓	✓	✓	✓	✓
8.3 Attachment and bracing of transformers							
8.4 Attachment and bracing of emergency generators							

Note: The references in parentheses refer to the applicable discussions in Chapters 3, 4, and 5.

Matrix 2: Integration Opportunities for Occupancy-Specific Categories of Maintenance and Capital Improvement Projects (continued)

	Maintenance and Capital Improvement Projects					
	OFFICE		RETAIL	APARTMENT	HOTEL	
	New Technology	Tenant Alterations	Retail Area Modernization	Kitchen & Bath Modernization	Guestroom FF&E	Public Area FF&E
9. Fire Alarm System						
10. Communications and IT Systems						
10.1 Public address system to achieve rapid implementation of emergency actions (4.4.3.2)	✓					✓
11. Equipment Operations & Maintenance						
12. Security Systems						
12.1 Exterior intrusion detection systems (5.2.1)						✓
12.2 Interior intrusion detection systems (5.2.2)	✓	✓	✓			✓
12.3 CCTV systems (5.2.3)	✓	✓	✓		✓	✓
12.4 Duress alarms (5.2.6)	✓	✓	✓			✓
13. Security Master Plan						

Note: The references in parentheses refer to the applicable discussions in Chapters 3, 4, and 5.

Most commercial buildings in the United States have not been designed and constructed to resist blasts. Therefore, the results of a FEMA 452 risk assessment may yield many high-risk scores to explosive blasts. New technologies and mitigation options are available to incrementally reduce the consequences of explosive blasts.¹

Some existing buildings may require retrofits for explosive threats if changes in purpose, occupancy, or world events make them more likely to be targets of a terrorist attack. Similarly, prudent facility managers should also consider whether nearby buildings are likely targets for terrorist attack. Conducting a risk assessment is the first step in determining the need to upgrade a conventionally designed building to protect its occupants and assets. The risk assessment identifies the maximum credible threats and the associated hazards based on the site conditions, neighboring properties, building layout, access control, structural framing, and facade components.

The effectiveness of the upgrades depends to a great extent on the structural details of the building and the acceptability of the aesthetic and functional impacts. For example, historic preservation requirements may limit secure design alternatives that would otherwise be considered appropriate. The cost of protective design and the impact of this protection on the property may be minimized using advanced analytical methods. These methods, developed over years of explosive testing and numerical simulation, enable the design team to focus resources on portions of the structure that are most likely to sustain damage and minimize materials required to mitigate these hazards. The protective measures that may offer the most benefits from these methods include

FEMA 452, *Risk Assessment: A How-To Guide to Mitigate Potential Terrorist Attacks Against Buildings*, January 2005, outlines methods for identifying the critical assets and functions within buildings, determining the threats to those assets, and assessing the vulnerabilities associated with those threats. The Guide provides a means to assess the risk and make risk-informed decisions to reduce vulnerability. The Guide also discusses methods to reduce physical damage to structural and non-structural components of buildings and related infrastructure and reducing resultant casualties that may occur during an explosive or CBR attack. Finally, the Guide leads the reader through a process for conducting a risk assessment and selecting mitigation options.

1. Much of the content for this chapter has been drawn from the articles "Designing to Resist Explosive Threats" and "Retrofits to Resist Explosive Threats" by Robert Smilowitz. These documents were originally prepared for the National Institute of Building Sciences in 2005 and later published on their Web-based portal, Whole Building Design Guide (www.wbdg.org), as a resource for building professionals.

the design of defensible perimeters, the design of protective facade systems, the hardening of structures to resist the effects of progressive collapse, the retrofit of existing structures, and the protection of non-structural components. The following sections describe retrofit upgrades that may be used to either reduce the hazard of debris impact or increase the load resistance of the structure.

This chapter identifies the protective measures that may be applied to the building perimeter, structure, and envelope, and non-structural systems within the incremental framework. Starting from the exterior of the building and working inward, these distinct protective upgrade projects may be combined with building maintenance and capital improvement projects. For buildings perceived as vulnerable to attack by virtue of their iconic nature or controversial occupancy, perimeter protection projects or column hardening may be beneficial. For other buildings, which may be in the vicinity of a likely target, perimeter protection and structural hardening will not reduce the risk of collateral damage. A protective facade upgrade makes more sense for these buildings. The incremental approach allows building owners to identify the best use of limited resources and combine these protective measures with other modernization projects that may increase the value of their property. Following a brief description of significant terrorist attacks against commercial properties, this chapter explores protective measures for:

- Building perimeters
- Building structures
- Building envelopes
- Non-structural systems

3.1 SELECTED EXAMPLES OF TERRORIST ATTACKS ON BUILDINGS

The following sections describe past terrorist attacks on buildings and the extent of collateral damage to neighboring structures.² The approximate dollar values for damages correspond to the time of the incident. These descriptions of blast damage inform the methods of assessing building vulnerabilities described in FEMA 452 and the physical and operational enhancements to address vulnerabilities to explosive blasts described in this document.

2. These descriptions were first published in 2007 as part of FEMA 430, *Site and Urban Design for Security*.

3.1.1 BALTIC EXCHANGE,³ CITY OF LONDON, APRIL 1992

Founded in the mid-eighteenth century, the Baltic Exchange is a United Kingdom company that operates the premier global marketplace for shipbrokers, ship owners, and charterers. It occupied a historic London building built in 1903.

In April 1992, at 9:20 p.m., the offices of the Baltic Exchange at 30 St. Mary Axe, London were virtually destroyed in an Irish Republican Army (IRA) bomb attack. A small truck carrying the explosives pulled up to the building on St. Mary Axe, a narrow street in the heart of London's financial district. The attack represents the first use of a large fertilizer-based homemade explosive device: the bomb's power was enhanced by a Semtex-based detonating cord wrapped around the explosives. Although most of the office workers had gone home, the bomb killed three people, all by flying glass, and injured 91. The damage was estimated at about \$1.2 billion.

3.1.2 WORLD TRADE CENTER,⁴ NEW YORK CITY, FEBRUARY 1993

On Friday, February 26, 1993, at 12:18 p.m. a large explosion ripped through the public parking garage of the World Trade Center. The explosion caused six deaths, more than 1,000 injuries, and \$300 million in property damage.

The explosive device, a 1,500-pound urea-nitrate bomb (equivalent to about 900 pounds of trinitrotoluene [TNT]), was detonated in a rented Ford van parked in the basement parking garage using a timer. The explosion created a 200-foot by 100-foot crater several stories deep (Figure 3-1). The power and emergency systems of the World Trade Center were destroyed. Most of the injuries were due to smoke inhalation.

3. SOURCES: Jonathan Bell, "The Morning News: Letters from London: Raising the Game"; Peter Dorsman, "Peak Talk, The Baltic Exchange Bomb," from www.peaktalk.com/archives/000143.php; "London Destruction: Baltic Exchange," from <http://us.geocities.com/londondestruction/baltic.html>; Leslie Hutchings, "Discussion Forum," from www.sapling.info/discussionforum/postings/1104.shtml.
4. SOURCES: ADL Law Enforcement Agency Resource Network; CNN, "WTC's owners found negligent in 1993 bombing"; "The 1993 Bombing: the First Attack on the World Trade Center," from <http://911research.wtc7.net>; John V. Parachini, "February 1993 Bombing of the World Trade Center in New York City," CNS Center for Nonproliferation Studies, from <http://cns.miiis.edu/pubs/reports/wtc93.htm>; J. Dwyer et al., *Two Seconds Under the World: Terror Comes to America—The Conspiracy Behind the World Trade Center Bombing*, Crown Publishers, New York, 1994.

Figure 3-1: Damage in WTC garage caused by the 1993 bomb attack.

SOURCE: CORBIS



3.1.3 BISHOPSGATE,⁵ CITY OF LONDON, APRIL 1993

A bomb hidden in the back of a large truck exploded in a narrow street, killing one person and injuring more than 40. The explosive was a homemade device using about 1 ton of fertilizer and was similar to the bomb that devastated the nearby Baltic Exchange (Section 3.1.1). The explosion shook buildings and shattered hundreds of windows, sending glass showering down into the streets below. A medieval church, St. Ethelburga's, collapsed. Another church and the Liverpool Street underground station were also destroyed.

The damage was estimated at more than \$1.5 billion. The Baltic Exchange, just having reopened following the completion of repairs from the 1992 bombing, was again damaged. Huge insurance payouts contributed to a crisis in the insurance industry, including the near financial collapse of the world's leading insurance market, Lloyds of London.

5. SOURCES: BBC On This Day, 1993, "IRA bomb devastates City of London"; Jonathan Liebenau, London School of Economics, "Information and Communications Disaster Recovery."

3.1.4 TOWN CENTER, MANCHESTER,⁶ ENGLAND, JUNE 1996

On June 15, 1996, at a peak shopping time on Father's Day, a 3,000-pound IRA bomb (equivalent to about 1,800 pounds of TNT) exploded in Manchester, the second largest city in the United Kingdom. The explosion injured more than 200 people and ripped into the fabric of the city's main shopping center (Figure 3-2).



Figure 3-2: Manchester shopping center damage.

SOURCE: CORBIS

Several telephone warnings about an hour before the blast and the subsequent police evacuations averted major casualties. Shoppers were evacuated from the Marks and Spencer Department Store at the center of the site, outside which the truck bomb was parked. An army bomb squad employing a robotic anti-bomb device was checking an illegally parked van, which had been recorded by several closed-circuit security cameras in the city, when the bomb exploded.

Most injuries were sustained from falling glass and building debris. The main railroad stations were closed for several hours, and the city center was sealed off.

An estimated 450,000 square feet of retail space and about 200,000 square feet of office space required reconstruction. A master plan for redevelopment of the city center was quickly developed. An international

6. SOURCES: John Moss, "Manchester 2004, The Manchester Bombing, June 1996," from www.manchester2002-uk.com/buildings/bombing.html; BBC On This Day, 1996, "Huge explosion rocks central Manchester."

urban design competition launched one month after the bombing provided a cohesive plan for rebuilding. After 4 years, the devastated zone was completely restored. Marks and Spencer rebuilt on its original site, with its largest store in the world (Figure 3-3).

Figure 3-3: New Marks and Spencer store, Manchester.

SOURCE: CHRIS ARNOLD



3.2 PERFORMANCE STANDARDS

Based on such recent experience of terrorism blast damage in commercial buildings, methods of analysis and design have been developed to reduce damage in existing buildings. These methods are discussed below.

A building's performance in response to blast loadings must be evaluated whether it is a likely target or close enough to a likely target to suffer collateral damage. The effects of a near contact detonation, such as a satchel threat placed in contact with a column or a vehicle-transported explosive near the structure, are significantly different from the effects of a distant detonation. Different analytical methods are required to evaluate the likely performance of building systems in response to varied intensities of blast loading.

Appropriate analytical methods are needed to demonstrate compliance with blast criteria or performance specifications established by agencies, such as the General Services Administration, the U.S. Department of

State, and others. Risk-based performance criteria must be established for each building in order to define the protective objectives. Continuity of services objectives require performance criteria that are significantly more severe than those for a life safety objective. Consequently, establishing the design objectives at the onset is important.

Furthermore, many of these performance criteria require that the building system be a balanced design. The objectives of balanced design are to fully utilize the load capacity of all the materials, maximize the potential energy dissipated due to deformation, and manage the failure mechanisms. These objectives

can be accomplished by ensuring a controlled sequence of failure. The expected performance of the building systems in response to either a targeted attack or collateral damage will determine the level of protection required, the sizing of the structural and nonstructural members, and the design of the connections between the different building components.

The behavior of structural materials, such as steel and aluminum, in response to explosive loading has been the subject of intensive investigation by the governments of the United Kingdom, Israel, and the United States of America. Some structural materials behave very differently when subjected to high strain rate loading than they do under static conditions. Furthermore, the inelastic deformation of structural members depends on their section properties, shape functions, and extent of deformation. For compound sections composed of different pieces and materials, transformed section properties may be used to characterize an equivalent material and a combined or composite section property may be used to represent its structural resistance. Care must be taken to calculate composite section properties when strain compatibility between components can be justified and combined section properties when deformation compatibility between components is achieved.

DYNAMIC ANALYSIS OF BUILDINGS

The performance of building systems and components in response to blast loading may be evaluated numerically using the principals of Structural Dynamics. These methods represent the inertia, the stiffness, and the strength of the dynamic system using a combination of nonlinear springs and masses. Simple Single Degree of Freedom (SDOF) models are appropriate for components on which the loading is uniform and the response is well characterized by the nonlinear spring. More complex material behavior, dynamic loading effects, and geometric nonlinearities require more complex Multi-Degree of Freedom (MDOF) models. The most complex structural systems must be analyzed using Finite Element Methods (FEM), which determines the nonlinear dynamic response using an explicit formulation of the equations of motion. Each level of analytical complexity requires successively more experience and expertise on the part of the blast response analyst.

The performance of building systems in response to explosive loading is highly dynamic, highly inelastic, and highly interactive. By controlling the flexibility and resulting deformations, the structural or facade component may be designed to dissipate considerable amounts of blast energy. The phasing of the different component responses and the energy that is dissipated through inelastic deformation must be carefully represented in order to accurately determine the behavior of the components. The 'SDOF model' approach commonly used to analyze individual components is likely to produce conservative designs. An accurate representation of the structural system requires a complex MDOF model. These MDOF models may be developed using appropriate inelastic Finite Element software in which an explicit formulation of the equations of motion is solved.

- Advanced analytical methods provide the most authentic representation of the system's ability to resist the dynamic blast loading and will produce the most cost-effective retrofits wherever the strength of the system is being evaluated.
- Simplified analytical methods and empirical relations are sufficient for debris mitigating upgrades, such as a daylight application of fragment retention film or blast resistant glazing fabricated with laminated glass.
- Approximate methods, such as the ASTM F 2248-03, *Standard Practice for Specifying an Equivalent 3-Second Duration Design Loading for Blast Resistant Glazing Fabricated with Laminated Glass*, do not require advanced analytical methods. Although this approximate approach does not quantify the improved behavior of glass in response to blast loading it "provides a design load suitable for sizing blast resistant glazing comprised of laminated glass or insulating glass fabricated with laminated glass" (ASTM, 2003).

3.3 SITE INCREMENTAL UPGRADES: PERIMETER PROTECTION

The risk analysis will help facility owners determine whether their building is a likely target or close enough to a likely target to suffer collateral damage. Perimeter protection only improves the performance of buildings that are targets of explosive attacks and provides no reduction in hazard if the building is vulnerable to collateral damage. However, characteristics of explosives, such as the charge weight, the efficiency of the chemical reaction, and the source location,

that would likely be used in such attacks cannot be reliably predicted. Given these uncertainties, the most effective means of protecting a structure is to keep the bomb as far away from the building as possible by maximizing the standoff distance. Facility managers often respond to world events by constructing a perimeter around their building even before they evaluate the risk to their building. This approach presumes the facility will be the target of a terrorist attack and is intended to either discourage the attacking vehicle or to prevent it from driving up against the structure. Although a temporary incremental rehabilitation measure may be an appropriate strategy until a risk assessment can be performed, a permanent perimeter protection installation requires an intensive study of traffic patterns and subgrade conditions.

To guarantee the maximum standoff distance between unscreened vehicles and the structure and to resist a moving vehicle attack, anti-ram barriers must be placed around the entire perimeter of the building. For urban buildings, the defensible perimeter is most effectively located as close to the curb as possible in order to maximize the available standoff distances. More standoff distance is typically available at suburban and rural sites and there may be more options for locating the defensible perimeter without diminishing effectiveness. The site conditions determine the maximum vehicle speeds attainable, and thus the kinetic energy that must be resisted. Both the impact-protective device (bollard or barrier) and its foundation must be designed to resist the maximum load (see Figure 3-4). Permanent barriers, especially ones rated for high impact levels, generally have very large, deep foundations. Placement of these foundations is difficult in urban areas because underground

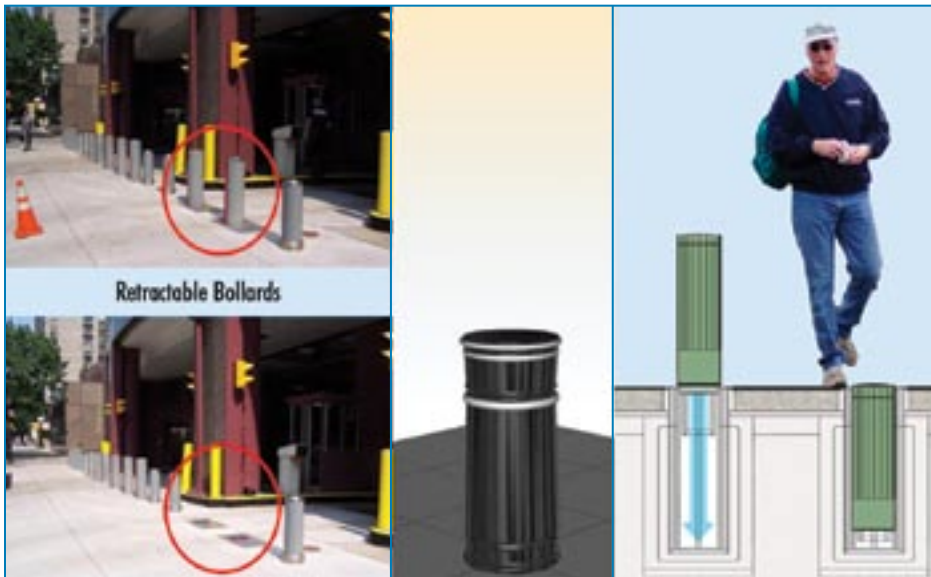

Figure 3-4: Barriers and bollards.

transportation facilities, building vaults, and utilities are often densely packed, and their locations may not be documented correctly or at all. Surveys and testing must be performed before construction begins to fully understand the feasibility and extent of these complications and to develop an appropriate design.

Conversely, if design restrictions limit the capacity of the impact-protective device or its foundation, then site restrictions will be required to limit the maximum speeds attainable. Speed calming devices may be installed to control the speed of oncoming vehicles. Furthermore, public parking abutting the building must be secured or eliminated, and street parking should not be permitted adjacent to the building. Removing one lane of traffic and turning it into an extended sidewalk or plaza can add additional standoff distance. However, the practical benefit of increasing the standoff depends on the charge weight. If the charge weight is small, this measure will significantly reduce the forces to a more manageable level. If the threat is a large charge weight, the blast forces may overwhelm the structure despite the addition of several feet to the standoff distance, and the measure may not significantly improve survivability of the occupants or the structure.

Entrances to parking garages and loading docks require operable barriers so that security personnel have the means to deny access to unauthorized vehicles following an inspection of their credentials or the contents of their cargo space. These operable barriers must be located to provide security personnel an effective means to inspect vehicles while minimizing the impact of queues on surrounding traffic patterns. Furthermore, the surrounding structure must be designed to accept the large dynamic forces that may be transferred upon impact.

3.4 INCREMENTAL BUILDING REHABILITATION MEASURES

3.4.1 BUILDING ENVELOPE

 One of the most formidable tasks facing property owners is the upgrade of an existing facade to resist blasts. Blast pressures engulf a structure, and glass damage can occur as far as a mile from a sizable vehicle detonation. Glass damage from the terrorist bombing in Oklahoma City was reported up to 4,000 feet away from the Murrah Building (see Figure 3-5). Because the intensity of blast loads vary as a function of height and exposure relative to the point of detonation, facility managers may be able to prioritize upgrades to take advantage of site-specific features. This is particularly true if another nearby building is

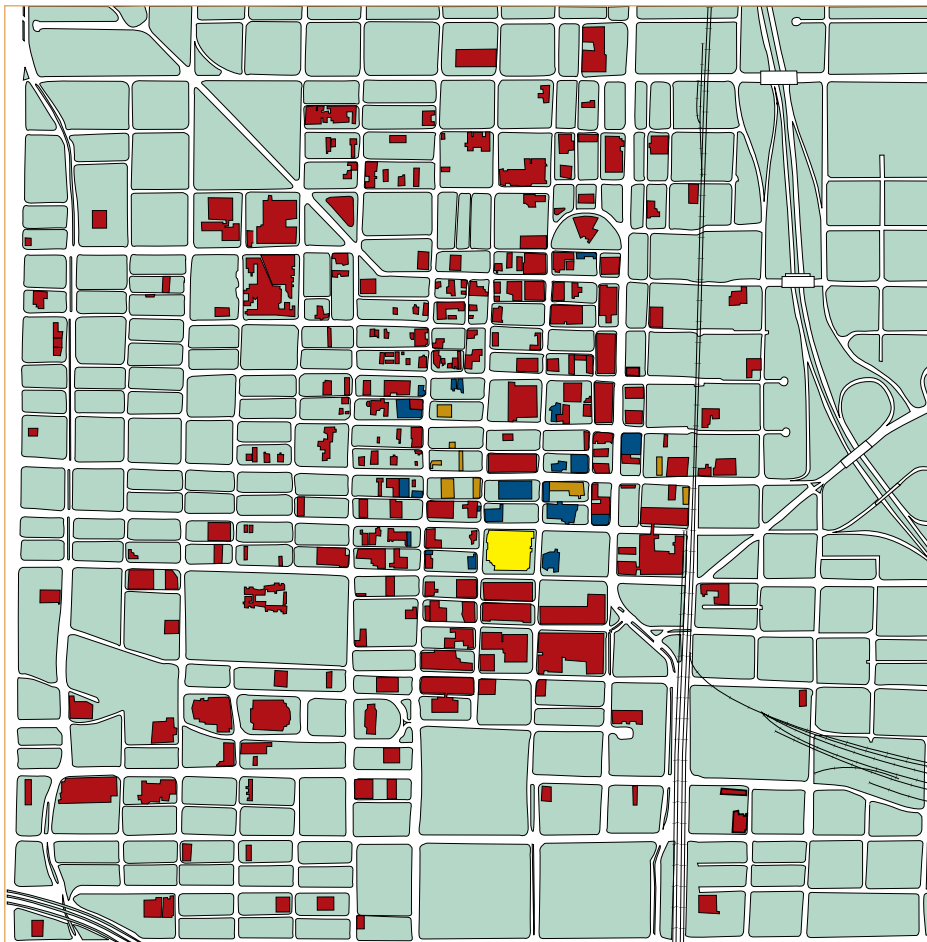
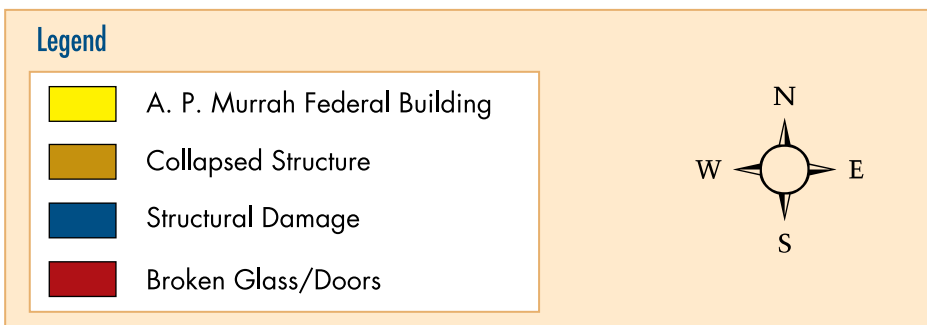

Figure 3-5: Locations of Murrah Building and other damaged structures.



identified to be the likely target of the attack and the directionality of the blast waves produce reflected pressures on some surfaces and not others. Similarly, results of a blast analysis may permit upper floors to be treated differently from lower floors.

Contractors rarely have access to the entire facade from within the building unless the building is undergoing a major modernization. But when these opportunities do arise, a significant level of protection can be introduced into the existing structure. This is particularly true when

the design team uses state-of-the-art technologies. With conventional approaches, all glazing is treated as if it were supported in rigid openings; however, the actual performance of flexible facade systems in response to blast loading may be far more forgiving. An accurate representation of the glazing response to blast loading requires proper understanding of the facade's flexibility. The full load-bearing capacity of all the components may then be realized through the appropriate detailing of the mullions, connections, and anchorages. Over-design of glass and its support structure can lead to wasted money and in some cases premature failure.

Since the retrofit of existing structures is often hampered by insufficient information about the structure and the presence of brittle materials, innovative energy-absorbing retrofit systems may provide the best protection for these aging structures. Although difficult to quantify by simplified analytical approaches, these energy absorbing systems have been demonstrated to transfer reduced forces to the surrounding structure. Once the decision to upgrade a facade is made, advanced analytical methods can be used to enhance blast resistance at a minimum cost.

The increased mass of precast panels and masonry walls make them more vulnerable to greater intensity blast pressures than glazed facades. The strength of unreinforced masonry (URM) or lightly reinforced precast panels may be increased with the adhesion of fiber reinforcement to the inner surface, and debris may be restrained with the application of an elastopolymer; however, the connection details typically present the greatest difficulty for new construction and for incremental rehabilitation measures. The anchorages of precast concrete panels must develop the panels' ultimate capacity, in response to direct loading and rebound, in order to develop the full blast resistance of the material. Similarly, the anchorage of grouted and reinforced masonry walls must be designed to take full advantage of the materials' strength. Debris catch systems, such as geotextile fabrics and steel stud walls, may be installed interior to the precast panels and masonry walls if the reinforcement is insufficient and the anchorages are inaccessible.

3.4.2 FRAGMENT RETENTION FILM

Fragment retention film, also commonly known as “shatter-resistant window film” or “security film,” is a laminate used to improve post-failure performance of existing windows. Applied to the interior face of glass, fragment retention film holds the fragments of broken glass together in one sheet, thus reducing the projectile hazard of flying glass fragments. A more appropriate name for fragment retention film would be “fragment reduction” film, since the methodology behind this hazard mitigation

technique focuses on retaining glass fragments resulting from blast overpressures.

Most fragment retention films are made from polyester-based materials and coated with adhesives. Clear and tinted fragment retention films are available. Clear film has minimal effects on the optical characteristics of the glass; tinted film can increase the effectiveness of existing heating/cooling systems, while also providing a variety of aesthetic and optical enhancements. Most films are designed with solar inhibitors to screen out ultraviolet (UV) rays, though over time the UV absorption damages the film's adhesive and degrades its effectiveness.

Film is packaged on rolls in widths as small as 24 inches and as large as 72 inches, depending on the manufacturer. Some manufacturers laminate multiple layers of film together to enhance performance. Whether one-ply or multi-ply, the overall film thickness can range from 2 to 15 mils. According to some government criteria (and verified by published test results), a 7-mil thick fragment retention security film, or specially manufactured 4-mil thick film, is considered to be the minimum thickness required to provide effective response to blast loads.

There are three types of fragment retention film installation methods. Each of the methods is capable of resisting different intensities of blast pressure, with the daylighting installation providing the lowest level of protection and the mechanically anchored installation providing the highest level of protection. Therefore, the selected installation method for incremental rehabilitation should be based on the required level of protection. For example, the reduction of fragment hazard in response to collateral damage may permit the use of the least invasive installations. The different installation methods are:

- Dry-Glazed Installation
- Wet-Glazed Installation
- Mechanically Anchored Installation

Dry-Glazed Installation. The application of security film must, at a minimum, cover the clear area of the window (i.e., the portion of the glass unobstructed by the frame). This minimum application to the exposed glass without any means of attachment or capture within the frame, termed “daylighting installation,” is commonly used for retrofitting windows. Application of the film to the edge of the glass panel where it would cover the glass within the bite is called an edge-to-edge installation. Other methods of application may improve film performance and further reduce hazards but are typically more expensive to install, especially in retrofits.

Energy absorbing catch systems, used in conjunction with a daylight application of fragment retention film, is another mechanism for retaining and reducing debris hazards. Cables spanning the window will impede the flight of filmed glass and absorb a considerable amount of energy upon impact. These cable catch systems are demonstrated, through explosive testing, to be more efficient and effective than the more rigid catch bar systems described below.

Wet-Glazed Installation. The wet-glazed installation is a method in which the film is positively attached to the frame using a high-strength, liquid sealant, such as silicone. Frequently used for field retrofits, the method allows the flexible frame to deform slightly, reducing glass fragments entering the building and offering more protection than the dry-glazed installation. The wet-glazed installation system is more costly than the dry-glazed installation method, but is less expensive than the mechanically anchored/attached installation method described below.

Mechanically Anchored/Attached Installation. Fragment retention film is most effective when it is used in conjunction with a blast-tested anchorage system. While a film may be effective in keeping glass fragments together, it may not be particularly effective in retaining the glass in the frame. Securing the film to the frame with a mechanically connected anchorage system further reduces the likelihood of the glazing system exiting the frame. Mechanical anchorage systems employ screws and/or batten strips to attach the film to the frame along 2 or 4 sides. Because additional framework is necessary, the mechanical attachment method can be less aesthetically pleasing than the wet-glazed installation system.

All application and attachment methods can be installed on site in either steel or aluminum frames. While some mechanically attached systems may be used for a wide variety of windows, others are designed for a particular type of window frame. Certain types of window frames may require a custom-fabricated anchorage system.

In addition to considering the various methods of installation, the designer must consider the thickness of the film and the task of positioning the film on the glass. A lighter weight or thinner film eases installation. Water used to aid in positioning the film during application must be thoroughly extruded, as the film is not very permeable and moisture that does not dry will prevent the development of the full adhesive bond strength. Fragment retention film should be carefully selected for its physical, optical, and thermal characteristics, with special consideration given to the adhesive used, the window thickness, and the window area. Window frame systems must also be capable of transferring the load collected by the glazing system. Corner-welded frames are

preferred over frames constructed of individual components. A schematic of this mitigation measure is shown in Figure 3-6.

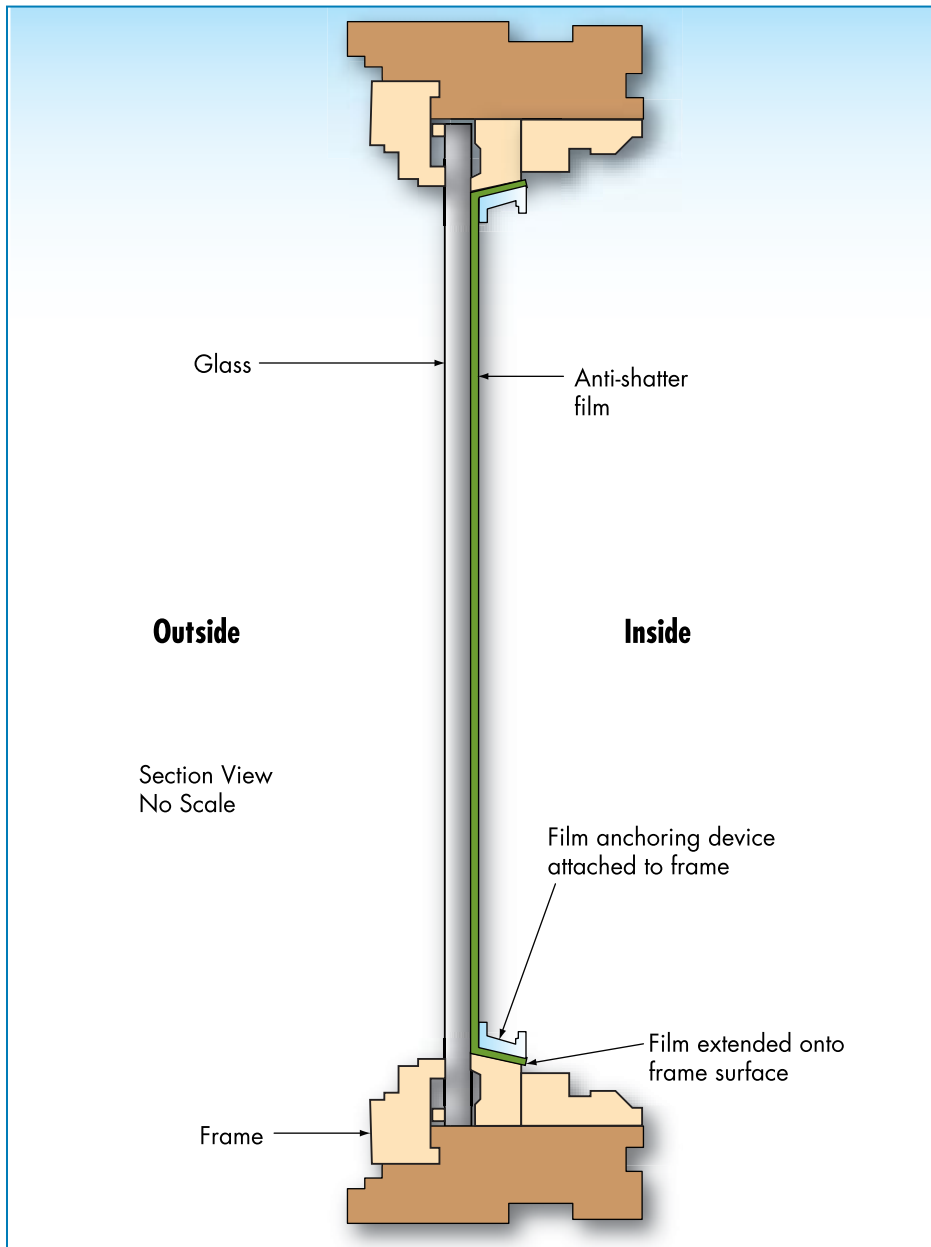

Figure 3-6: Mechanically attached fragment retention film.

3.4.3 LAMINATED GLASS

Laminated glass consists of two or more pieces of glass permanently bonded together by a tough plastic interlayer made of polyvinyl butyral (PVB) resin. Once sealed together, the glass “sandwich” behaves as a single unit. Annealed, heat strengthened, tempered glass or polycarbonate glazing can be mixed and matched between layers of laminated glass

in order to design the most effective lite for a given application. When fractured, fragments of laminated glass tend to adhere to the PVB interlayer instead of falling freely and potentially causing injury.

Laminated glass usually lasts as long as ordinary glass if it is not broken or damaged. The correct installation of laminated glass is very important to ensure long life. Manufacturers typically recommend installation of laminated glass on setting blocks that are at least 6 inches long and placed at the quarter points of the pane. Architectural details should incorporate a weep system for exterior glazing systems. Regardless of the degree of protection required, laminated glass needs to be installed with a proper sealant to ensure that no water comes in contact with the edges of the glass. The sealant supplier should verify that the sealant and PVB interlayer are compatible. Generic sealants shown to be compatible with PVB are the polysulfides, silicones, butyl or polybutene tapes, and polyurethanes. Minimum face and edge clearance should be provided as required by the manufacturer. Field cutting should be minimized in butt glazing installations to minimize edge defects. Glazing guidelines, such as those presented in the Glass Association of North America (formerly Flat Glass Marketing Association) Glazing Manual should be followed to avoid installation problems. Typical allowances for glass, metal, and erection tolerance, expansion, and contraction should be made.

3.4.4 BLAST CURTAINS

Blast curtains (see Figure 3-7) are attached to the interior frame of a window opening and essentially catch the glass fragments produced by a blast wave. The debris is then deposited on the floor at the base of the window. The use of these curtains does not eliminate the possibility of glass fragments penetrating the interior of the occupied space, but instead limits the travel distance of the airborne debris. Overall, the hazard level to occupants is significantly reduced by the installation of blast curtains. However, a person sitting directly adjacent to a window outfitted with a blast curtain may still be injured by shards of glass in the event of an explosion.

Figure 3-7: Blast curtains.



Blast curtains are made from a variety of materials, including a warp knit fabric or a polyethylene fiber. The fiber can be woven into a panel as thin as 0.029 inch that weighs less than 1.5 ounces per square foot. This fact dispels the myth that blast curtains are heavy sheets of lead that completely obstruct a window opening and eliminate all natural light from the interior of a protected building.

The main components of any blast curtain system are the curtains themselves, the mechanism by which the curtain is attached to the window frame, and either a trough or another retaining mechanism at the base of the window to hold the excess curtain material. Blast curtains, with curtain rod attachment and sill trough, differ largely from one manufacturer to the next. The curtain fabric, material properties, method of attachment, and manner in which they operate also vary, providing many options within the overall classification of blast curtains, which makes blast curtains applicable in many situations.

As shown in Figure 3-8, blast curtains differ from standard curtains in that they do not open and close in the typical manner. Blast curtains are designed to remain in a closed position at all times. The curtain may be pulled away from the window to allow for cleaning, blind or shade operation, or occupant egress in the case of fire. However, the curtains can be rendered ineffective if the building occupants do not use them

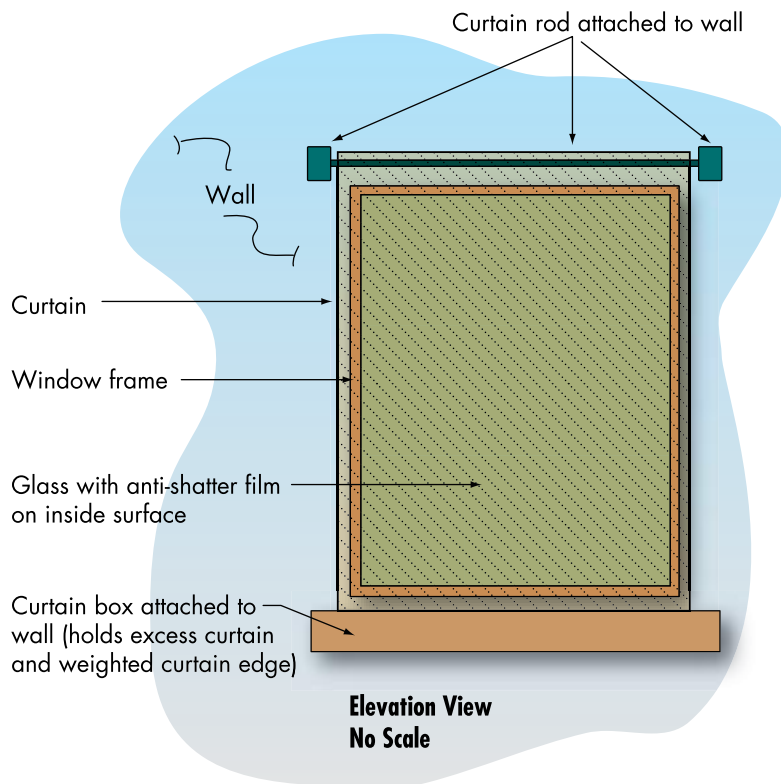

Figure 3-8: Blast curtain system.

correctly by pulling them away from the glazing. The color and openness factor of the fabric contributes to the amount of light that is transmitted through the curtains and their transparency. While the color and weave of these curtains may be varied to suit the aesthetics of the interior décor, the appearance of the windows is altered by the presence of the curtains.

The curtains may either be anchored at the top and bottom of the window frame or anchored at the top only and outfitted with a weighted hem. The curtain needs to be extra long relative to the window with the surplus either wound around a dynamic tension retainer or stored in a reservoir housing. When an explosion occurs, the curtain feeds out of the receptacle to absorb the force of the flying glass fragments.

3.4.5 GLAZING CATCH CABLE/BAR RETROFIT

As explained earlier, laminated and filmed glazing is designed to hold the glass shards together if the window is damaged. Unless the window frames and attachments are upgraded to withstand the capacity of the laminated glass, there is a high possibility that entire sheets of glass would fly free of the window frames in a blast environment. Rigid catch bar systems have been designed and tested as a means of increasing the effectiveness of laminated window upgrades. The rigid catch bars intercept the laminated glass and disrupt their flight (see Figure 3-9).

Figure 3-9: Glazing catch bar.

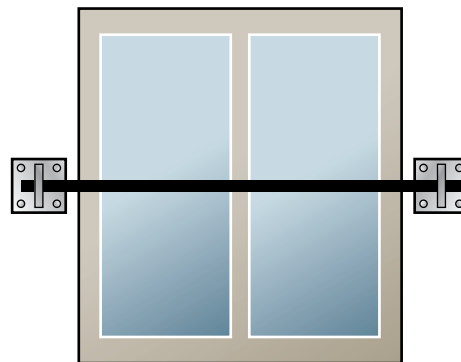

Rigid catch systems collect huge forces upon impact and require substantial anchorage into a very substantial structure to prevent failure. If either the attachments or the supporting structure are incapable of restraining the forces, the catch system will be dislodged and become part of the debris. Alternatively, the debris may be sliced by the rigid impact, severely limiting the effectiveness of the catch bars.

Flexible catch bars can be designed to absorb a significant amount of the energy upon impact, thereby keeping the debris intact and impeding

their flight into occupied spaces. They also may be designed to repel the debris from the failed glazing, as well as the walls in which the windows are mounted. The debris restraint system must be strong enough to withstand the momentum transferred upon impact, and the connections must be capable of transferring the forces to the supporting slabs and spandrel beams. Under no circumstances should the design of the restraint system add significant amounts of mass to the structure because it could be dislodged and present an even greater risk to the occupants of the building.

3.4.6 ENERGY-ABSORBING CATCH CABLE SYSTEMS

The use of cable systems has long been recognized as an effective means of stopping massive objects moving at high velocity. Cables are extensively used to absorb significant amounts of energy upon impact, and their flexibility makes them easily adaptable to many situations. The diameter of the cable, the spacing of the strands, and the means of attachment are all critical in designing an effective catch system. These catch cable concepts have been used by protective design window manufacturers as restraints for laminated lites. An analytical simulation or a physical test is required to confirm the adequacy of the cable catch system to restrain the debris resulting from an explosive event.

High-performance energy-absorbing cable catcher systems retain glass and frame fragments and limit the force transmitted to the supporting structure. These commercially available retrofit products consist of a series of ¼-inch diameter stainless steel cables connected with a shock-absorbing device to an aluminum box section, which is attached to the jambs, the underside of the header, and topside of the sill. The energy-absorbing characteristics allow the catch systems to be attached to relatively weakly constructed walls without the need for additional costly structural reinforcement. To reduce the possibility of slicing the laminated glass, the cable may either be sheathed in a tube or an aluminum strip may be affixed to the glass directly behind the cable.

3.4.7 UNREINFORCED MASONRY WALL DEBRIS CONTROL

URM facade provides limited protection against air blast due to explosions. When subjected to overload from air blast, brittle unreinforced concrete masonry unit (CMU) walls will fail and the debris will be propelled into the interior of the structure, possibly causing severe injury or death to the occupants. Masonry debris may result from a

100-pound TNT equivalent detonation within 300 feet or a 1,000-pound explosion within 1,000 feet and buildings may be subject to collateral damage due to an attack against a nearby building. Existing unreinforced CMU walls may be retrofitted with a sprayed-on polyurea coating to improve their air blast resistance. Polyurea materials are widely used as truck-bed liners and roof coatings; however, this innovative incremental rehabilitation technique takes advantage of their toughness and resiliency to effectively deform and dissipate the blast energy while containing the shattered wall fragments (see Figure 3-10). Although the sprayed walls may shatter in a blast event, the polyurea material remains intact and contains the debris.

Figure 3-10: Spray-on polyurea.

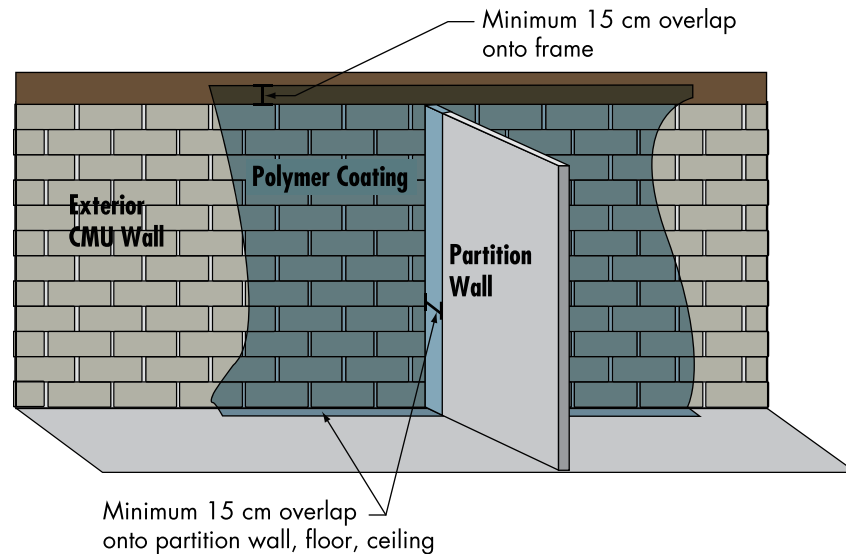

The blast mitigation retrofit for unreinforced CMU walls consists of an interior (and an optional exterior) layer of polyurea applied to exterior walls and lapped onto the adjacent floor and ceiling slabs. The polyurea provides a ductile and resilient membrane that catches and retains secondary fragments from the existing concrete block as it breaks apart in response to an air blast wave. The effectiveness of a spray-on polymer coating in controlling debris has been demonstrated through explosive testing at the Air Force Research Laboratory and by extensive numerical simulations. This retrofit is not applicable to load-bearing walls for which the preservation of structural integrity is required.

Instead of the spray-on polyurea, an aramid (geotextile) debris catching system may be attached to the structure by means of plates bolted through the floor and ceiling slabs (see Figure 3-11). Similar to the polyurea retrofit, the aramid layer does not strengthen the wall, but instead restrains the debris from being hurled into the occupied spaces in the case of an explosion.

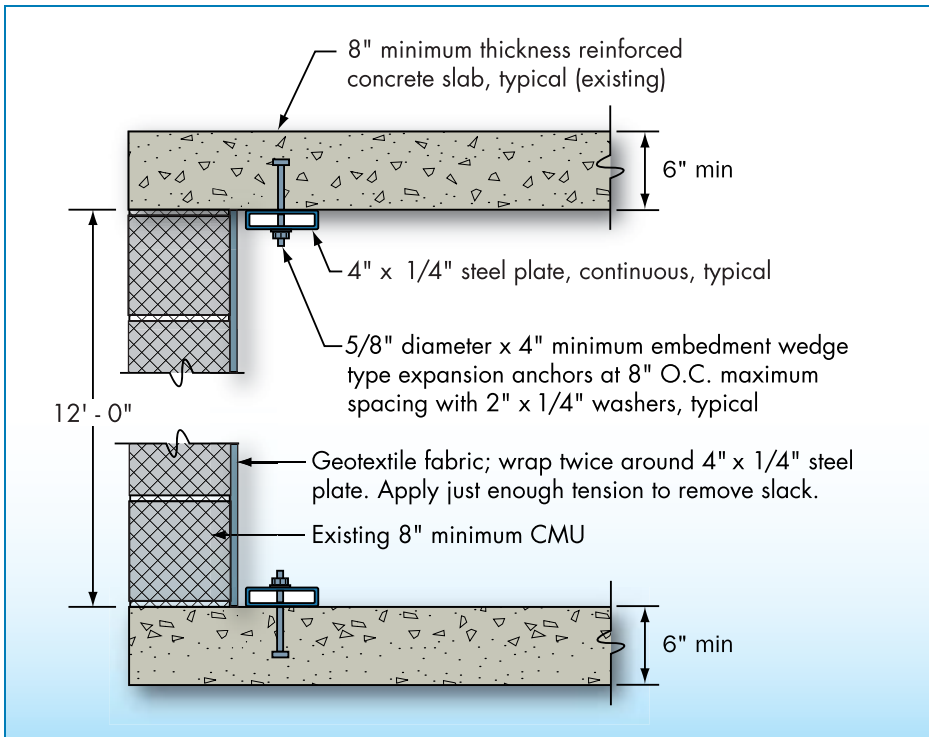

Figure 3-11: Geotextile debris catch system.

A steel stud wall construction may also be used to limit debris associated with masonry wall failure (see Figure 3-12). Commercially available 18 gauge steel studs may be attached web to web (back to back) and 16 gauge sheet metal may be installed outboard of the steel studs behind



Figure 3-12: Metal stud blast wall.

the cladding. While the wall absorbs a considerable amount of the blast energy through deformation, its connection to the surrounding structure must develop large tensile reaction forces. In order to prevent a premature failure, these connections should be able to develop the ultimate capacity of the stud in tension (FEMA, 2006a). The interior face of the stud should be finished with a steel-backed composite gypsum board product.

3.4.8 OTHER FACADE RETROFITS

In addition to upgrading the facade to minimize debris associated with failed glass, other retrofits might include the bracing of parapets, gables, ornamentation, and appendages that might be propelled into occupied space. Although these upgrades are more likely to be associated with increased resistance to seismic motions or hurricane force wind loads, they may also be warranted for buildings exposed to blast loading. Similarly, masonry veneer, steel stud back-up, and the exterior wythe of cavity walls may be upgraded to improve their resistance to extreme loads; however, these upgrades are relatively invasive and are rarely implemented to minimize the debris associated with blast loading. Due to the difficulty of improving the capacity of these building components, debris catch systems are typically installed instead of strengthening the components themselves. Although canopies at building entrances are vulnerable to an exterior explosion, they are outside of the building envelope and are rarely upgraded to improve their resistance to blast loading.

3.5 NONSTRUCTURAL MEMBERS

Because of the likelihood of glass damage and the associated infill pressures, significant damage to nonstructural members in the exterior bays is likely. This damage will produce additional debris that may cause injuries and disrupt emergency mechanical systems, such as sprinkler systems, emergency lighting, and smoke exhaust systems. Consequently, critical nonstructural systems should be protected by means of improved support and lateral bracing. While it may not be feasible to upgrade mechanical systems without conducting a comprehensive interior renovation, there may be an opportunity to perform incremental rehabilitation as systems are renovated. Some nonstructural systems that may be considered for upgrade are:

- Sprinkler piping
- Emergency lighting

- Mechanical and electrical equipment above ceilings
- Masonry walls at interior stairs
- Hazardous materials container
- Transformers
- Emergency generators
- Boilers
- Tanks
- Chillers

3.6 STRUCTURAL RETROFITS

Unlike seismic upgrades of structural systems, which generally address the global lateral load resisting system, upgrade to resist blast loads are more local. Generally, measures that tie the structure together, that increase the redundancy and ductility of individual members and upgrades, and that transfer the lateral loads into the diaphragms improve the structure's ability to resist blast loads. Since the capacity of members may be limited by the strength of the connections, upgrades must be comprehensive if they are to be effective.

The incremental rehabilitation of the structure to accept the threat independent removal of any load-bearing member, as required by the alternate path method, is generally invasive and expensive. This typically requires the development of beam-to-column moment connections for steel frame construction and the installation of tension reinforcement through beam/column connections. Steel frame connections are often difficult to access and connection upgrades may be infeasible unless the structure is fully exposed. Similarly, the inclusion of tension reinforcement through concrete frame connections may be accomplished by grooving the existing concrete and bonding supplemental reinforcement with epoxy or the adhesion of a composite fiber reinforcement to the exterior of the members.

In some cases, it may not be possible to retrofit an existing building to limit the extent of collapse to one floor on either side of a failed column. If the members are retrofitted to act as a catenary—the natural curve created by a flexible cord freely suspended between two fixed points—the adjoining bays must be upgraded to resist the large lateral forces associated with this mode of response. The catenary behavior may be achieved through the application of a glass or carbon fiber material to the top and underside of the spandrel beams and slabs. Alternatively,

steel plates may be through-bolted to the spandrel beams in order to develop continuity and axial capacity. However, developing the large lateral forces may require more extensive retrofit than is either feasible or desirable. In such a situation, it may be desirable to isolate the collapsed region rather than risk propagating the collapse to adjoining bays. This approach is best suited for arresting the horizontal progression of collapse in low structures with large floor plates. The creation of structural fuse planes prevents the lateral propagation of collapse. Vertical compartmentalization requires the structure resist the impact of debris from above without pancaking the floors below and this is more difficult to achieve.

The incremental rehabilitation of existing structures to protect against a potential progressive collapse resulting from the detonation of a terrorist explosive may best be achieved through the localized hardening of vulnerable columns. These columns need only be upgraded to a level of resistance that balances the capacities of all adjacent structural elements. At greater blast intensities, the resulting damage would be extensive and termed global collapse rather than progressive collapse.

Lightweight metal deck roof structures, without a concrete fill, are particularly susceptible to direct blast loading and suction associated with diffusion over the edge of the roof. Strengthening these roof systems may require extensive upgrades; however, the connections of the metal deck to the roof framing members and the roof framing members to the columns may also be upgraded to limit the extent of debris. While these systems may sustain significant damage in response to a sizeable vehicle-borne explosive threat, particularly for low buildings, improved connections protect occupants from falling debris hazards. Openings in walls and reentrant corners are not as critical for blasts as they are for multiple cycles of seismic base motions; however, they will create stress concentrations and must be developed with sufficient ductility to accept larger deformations.

3.6.1 COLUMNS

Conventionally designed columns may be vulnerable to the effects of explosives, particularly when placed in contact with their surface. Standoff elements such as partitions and enclosures may be designed to guarantee a minimum standoff distance; however, this alone may not be sufficient. A steel jacket or a carbon fiber wrap may be used to provide additional resistance to reinforced concrete structures (see Figure 3-13). These systems effectively confine the concrete core, increase the confined strength and shear capacity of the column, and hold the rubble together to permit it to continue carrying the axial loads. The capacity of steel flanged

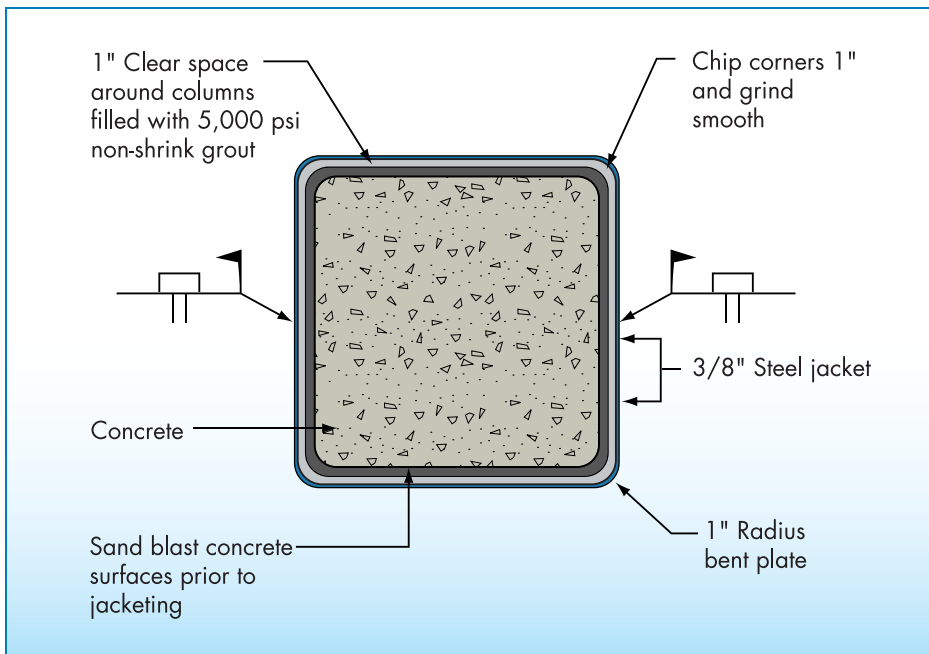

Figure 3-13: Steel jacket retrofit detail.

columns may be increased with a reinforced concrete encasement that adds mass to the steel section and protects the relatively thin flange sections. Alternatively, steel plate may be welded to flanged sections to create a box section that is more resistant to explosion. The details for these retrofits, and the corresponding connection upgrades, must be designed to resist the specific weight of the explosives and the standoff distance.

3.6.2 FLOOR SYSTEMS

Floor systems that span between column lines resist gravity loads and contribute to the lateral resistance of the building, either through frame action or as diaphragms that transfer lateral forces to braced frames or shear walls. Steel construction typically relies on concrete-filled metal decking that spans between closely spaced filler beams, which in turn span girders along the column lines. Steel beams and girders typically possess equal resistance to both upward and downward loading and are capable of developing large inelastic deformations; however, their ability to resist extreme loading is often limited by the capacity of their connections.

There is a greater variety of reinforced concrete floor systems, which may consist of beams and concrete slabs, beams and joists, waffle slabs, and flat slabs. Each of these systems optimizes the placement of reinforcement where they most efficiently resist the design loads; top reinforcement near the supports and bottom reinforcement at mid-span. Although the American Concrete Institute *Building Code Requirements for Structural*

Concrete (ACI, 2005) requires additional continuous reinforcement for enhanced structural integrity, these nominal quantities do not resist the effects of direct blast loading and rebound. Furthermore, the effectiveness of the concrete sections to develop large inelastic deformations is governed by the confinement of the concrete within the steel cages. This confinement enhances both the ductility of the members and the ability to transfer shear forces across the cracked sections. Beam-to-column connections are often congested with vertical column reinforcement and horizontal beam reinforcements and are particularly vulnerable to blast loading. Confinement of the connection details, such as those used in the design of structures to resist seismic loading, is more likely to resist the effects of blast loading than conventional concrete detailing; however, the effectiveness of critical connection details must be confirmed through dynamic analysis.

Flat slab structures do not rely on beams along edges to transfer loads to the columns; instead, they contain patterns of steel reinforcement within column strips and middle strips that develop the positive and negative moments that are imposed by the design loads. Because of the efficient use of materials, flat slab structures lack the redundancy of beam-slab systems and are vulnerable to punching shear failures around the columns (see Figure 3-14).

Floor slabs are typically designed to resist downward gravity loading and have limited capacity to resist uplift pressures or the upward deformations experienced during a load reversal (i.e., blast). Therefore, floor slabs that may be subjected to significant uplift pressures, which may overcome the gravity loads and subject the slabs to reversals in curvature, require tension reinforcement at the top fiber of the mid-span locations and bottom tension reinforcement at the underside near the supports (see Figure 3-15). The failure of floor slabs in response to explosive loading propels debris onto to the slab below and increases the unbraced length of the supporting columns. Both the pancaking of slabs and the destabilization of columns increases the potential for progressive collapse.

The incremental rehabilitation of steel floor systems typically involves the welding of plates at the connections to increase their capacity. Often, the inaccessibility of the connections makes these upgrades difficult to achieve. The incremental rehabilitation of conventional concrete construction in order to increase confinement, improve ductility, and provide for load reversals relies on techniques that were developed for the seismic upgrade of structures. If the slab does not contain this tension reinforcement, it must be supplemented with a lightweight carbon fiber application that may be bonded to the surface at critical locations. Carbon fiber reinforcing mats bonded to the top surface of slabs would strengthen the floors for upward loading and reduce the likelihood of

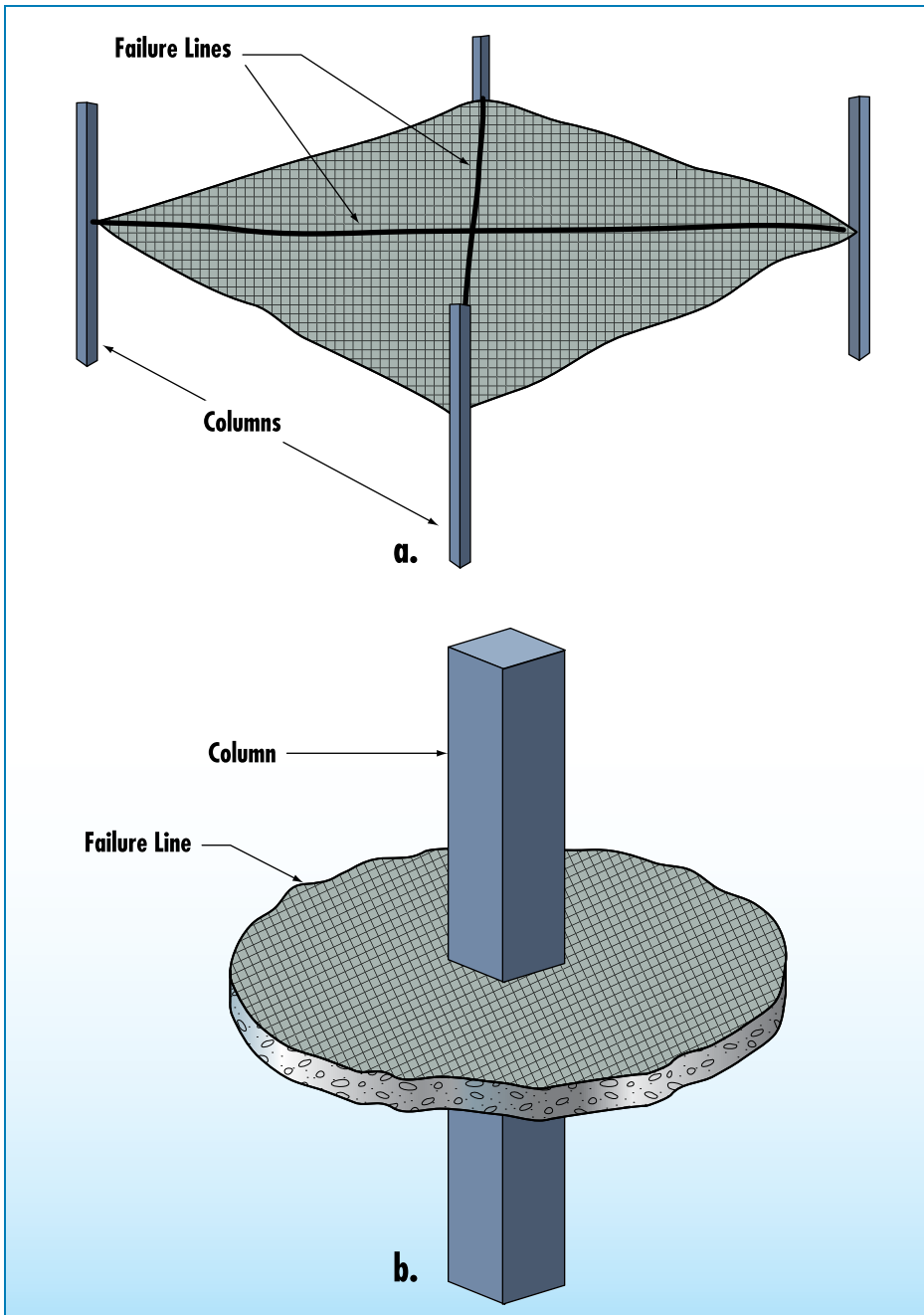
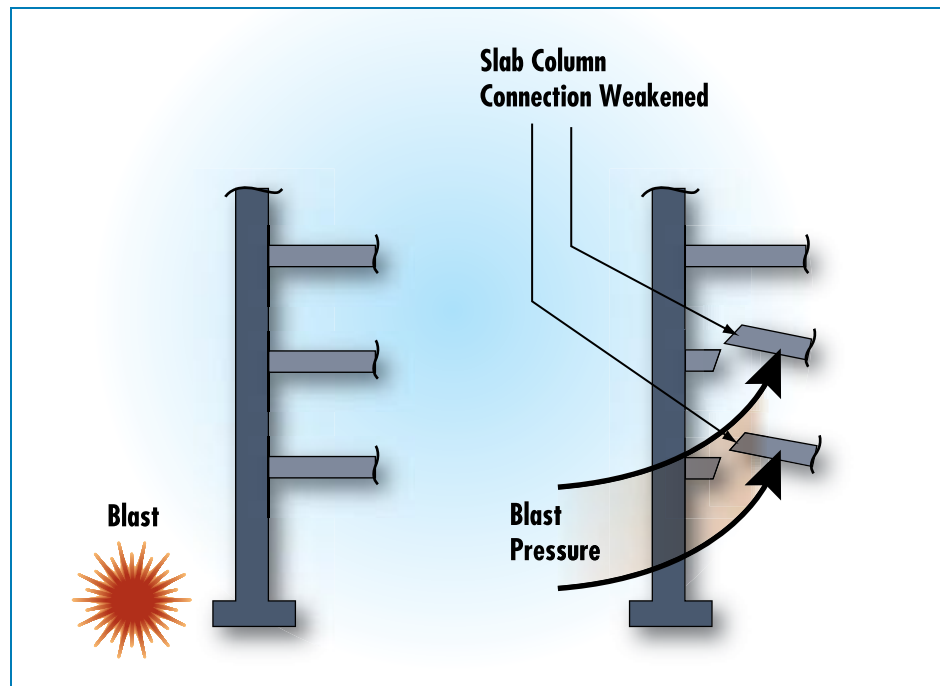

Figure 3-14: Flat slab failure mechanisms.

slab collapse from blast infill uplift pressures, as well as from internal explosions in mailrooms or other susceptible spaces. This lightweight high tensile strength material would supplement the limited capacity of the concrete to resist these unnatural loading conditions. Preliminary experience shows these retrofits to be effective. An alternative approach is to notch grooves into the top of the concrete slabs and then epoxy carbon fiber rods into those grooves. Although this approach may offer greater capacity, it is much more invasive and has not been evaluated with explosive testing.

Figure 3-15: Effects of uplift and load reversal.



3.6.3 LOAD-BEARING UNREINFORCED MASONRY WALLS

URM load-bearing-wall buildings are prohibited by the Department of Defense Unified Facilities Criteria where blast resistance is required. These buildings may sustain severe damage when subjected to 100 pounds of TNT-equivalent explosives at a standoff distance of 30 feet or 1,000 pounds of TNT-equivalent at a standoff distance of 150 feet. This makes the URM, load-bearing-wall buildings vulnerable to damage even when the structure is not the primary target of the attack. For this type of structure, it is not enough to just control the debris resulting from an explosive event; the structural integrity of the walls must be preserved to prevent structural collapse. Strengthening of the walls may be accomplished by means of a shotcrete sprayed onto the wall with a welded wire fabric. This method supplements the tensile capacity of the existing wall and limits the extent of debris that might be propelled into the protected space. Steel sections may also be installed against existing walls to reduce the span and provide an alternate load transfer to the floor diaphragms. Alternatively, stiffened steel-plate wall systems may be designed to withstand the effects of explosive loading by providing both redundancy and fragment protection. These load-bearing-wall retrofits require a more stringent design, capable of resisting lateral loads and the transfer of axial forces. Stiffened wall panels, consisting of a steel plate to catch the debris and welded tube sections spaced approximately 3 feet on center, supplement the gravity load-carrying capacity of the bearing walls and prevent the debris from entering the protected space. Finally,

internal strengthening of URM walls may be achieved using a system wherein cables are snaked through holes that are cored through the wall and anchored in place with an injected grout without disturbing the finishes.

3.6.4 TRANSFER GIRDERS

Key elements that may be exposed to the explosive threat, such as transfer girders and mega-columns, warrant the most immediate attention to incremental rehabilitation. The risk assessment will identify the most critical members and the priority for hardening. If structural upgrades such as concrete encasement or steel jacketing are not feasible, then vulnerability of key elements may be reduced by means of architectural enclosures that provide increased standoff distance. Small increases in standoff distance greatly reduce the intensity of the near-contact blast loading and increase the survivability of structural members. If the architecture permits, this approach is both inexpensive and highly effective; however, advanced analysis may be required to demonstrate the performance of the structural members in response to the reduced load intensity. These key components should also be upgraded to increase the resistance of fireproofing in response to blasts to account for a wider range of potential threats and hazards. If the connections of vulnerable steel-braced and moment-frame members are accessible, they may be upgraded to develop the plastic capacity.

3.7 BLAST PROTECTION MEASURES

The preceding discussions of blast threat mitigation measures (Sections 3.3–3.6) can be condensed into the following list.

It is presented here as an example of measures that might be generated by the FEMA 452 process and implemented using FEMA 459, as discussed in Chapter 2. These measures are all included in the list that comprises the vertical axes of the matrices in Section 2.3.

Site upgrades

- Increased standoff distance
- Anti-ram barriers
- Speed calming devices
- Operable barriers

Building envelope upgrades

- **Glazing**
 - Fragment retention film
 - Laminated glass
 - Blast curtains
 - Glazing catch cable/bar
 - Energy-absorbing cable systems
- **URM**
 - Sprayed-on polymer
 - Geotextile fabric
 - Steel stud and sheetmetal construction
- **Other building envelope retrofits**
 - Bracing parapets, gables, ornamentation, and appendages
 - Anchoring cladding
 - Anchoring masonry veneer
 - Anchoring steel stud backup
 - Anchoring exterior wythe in cavity walls
 - Installing debris catch systems for facade elements
 - Increasing the roof's resistance to blast
 - Upgrading connections of light metal deck roofs to the structure

Structural upgrades

- Upgrading the structure to make it more ductile
- Upgrading spandrel beams to achieve catenary response
- Upgrading slabs to achieve catenary response
- Increasing standoff distance around vulnerable columns
- Localized hardening of vulnerable columns
- Enhancing floor slab upload resistance
- Installing load-bearing URM retrofits
 - Shotcrete

- Steel sections
- Stiffened steel-plate wall system
- Reinforcing
- Retrofitting transfer girders

Nonstructural upgrades

- Sprinkler piping
- Emergency lighting
- Mechanical and electrical equipment above ceilings
- Masonry walls at interior stairs
- Restraint of hazardous materials containers
- Transformers
- Emergency generators
- Boilers
- Tanks
- Chillers

3.8 BLAST PROTECTION MEASURE COST CONSIDERATIONS

The major costs to consider in protection are those associated with standoff distance and building component costs. Cost reduction achieved by decreasing standoff and perimeter length must be evaluated against the comparative increased cost of other solutions, such as hardening the building, providing more guards, increasing camera surveillance, relocating the facility, or relocating key building occupants to interior locations. These costs must be evaluated with respect to achieving an acceptable level of risk.

Recent terrorist events have increased interest in the vulnerability of buildings to CBR threats. Of particular concern are building HVAC systems, because they can become an entry point and distribution system for airborne hazardous contaminants. Even without special protective systems, buildings can provide protection in varying degrees against airborne hazards that originate outdoors. Conversely, the hazards produced by a release inside a building can be much more severe than a similar release outdoors. Because buildings allow only a limited exchange of air between indoors and outdoors, not only can higher concentrations occur when there is a release inside, but hazards may persist longer indoors.

The results of the FEMA 452 risk assessment, including the vulnerability checklist, will likely yield many opportunities to reduce risk over time by upgrading the building's HVAC and other systems. This chapter describes the nature of the CBR threat and some of the opportunities for risk reduction.

4.1 OVERVIEW OF CBR THREATS

There are hundreds of toxic chemical, biological, and radiological agents that could be released in an accident or terrorist attack. Among them are chemical-warfare agents, industrial chemicals, radioactive materials, toxins, irritants, incapacitants, and biological agents, which are mainly bacteria, viruses, and rickettsiae. The potential hazard each agent presents is determined by its toxicity, persistence, and quantity.

Toxicity among these agents varies over several orders of magnitude. Toxicity and likely quantity of exposure determine the level of protection needed for protective systems. Toxic agents also vary widely in persistence. Gases such as chlorine are non-persistent and usually dissipate in minutes outdoors. Radiological agents and some of the biological agents are extremely persistent and may remain toxic in an indoor or outdoor environment for decades unless decontamination measures are undertaken.

Toxicity and persistence determine the extent and duration of a hazard, but the more important characteristics relative to protective strategies are

how readily the agents can be filtered and detected. Filtration involves the removal of a toxic agent from an air stream. The full spectrum of toxic agents includes gases, vapors, and aerosols (finely divided particles). With current technology, filtering the full spectrum of toxic agents requires three different processes—mechanical filtration for aerosols, physical adsorption for chemical agents of low vapor pressure, and chemisorption for chemical agents of high vapor pressure. The latter two are usually incorporated into a single filter called an adsorber.

With regard to detection, most of the toxic chemicals have warning properties; that is, they can be detected by the human senses—by smell, irritation of the eyes/respiratory tract, color, and in some cases by taste—before severe effects occur. There are no warning properties associated with airborne microbial pathogens or radioactive aerosols.

Most toxic chemicals produce immediate effects. Automatic detectors are available for the accurate detection of a few of the most toxic chemicals. Single-pass filtration systems of the high level of efficiency necessary for protection against toxic chemicals are generally expensive and cannot filter all toxic chemicals.

Biological agents are neither perceptible by the senses nor detectable in real time by automatic detectors. Their effects are delayed. The particle size range of concern for biological aerosols is 1 to 5 microns, and the very high filter efficiencies necessary for these aerosols can be achieved with HEPA filtration.

Similarly, radiological agents are not perceptible by human senses and their effects are delayed. However, they can be detected in real time and are easier to decontaminate from indoor spaces than biological agents. They can be filtered at very high efficiencies with HEPA filters.

4.2 PRINCIPLES OF DESIGN FOR RISK REDUCTION RELATED TO CBR

For a building owner or manager, reducing CBR risk means reducing the CBR vulnerability of the building. There are several options for doing so that vary in effectiveness and cost. The most effective measures are those that are preventive and protective.

Preventive measures are those intended to prevent the release of a toxic agent in or into a building. Protective measures are those that impose barriers and high-efficiency filter systems between people and spaces that

are or may become contaminated. A building may be considered as a system of barriers. Protective measures can be achieved by improving the building's filtration system, making the barrier system more complete, and applying pressures with fans to overcome the natural pressures of wind and buoyancy acting on air leakage paths.

There are two types of protective measures: passive (continuously protective) and active (initiated upon determining that a hazard exists or is imminent).

The nature of the CBR threat to a specific facility determines the strategy for applying preventive and protective measures. A building for which the threat, vulnerability, and asset value/consequence are considered high requires a high level of protection. If the combination of threat, vulnerability, and asset value/consequence is low, a low level of protection is appropriate. If the primary threat is an indoor or air-intake release, the greatest benefit is derived from physical security enhancements. Enhanced filtration of recirculated air is also beneficial. If the primary threat is an outdoor release, enhanced filtration of the ventilation air and/or enhanced safe rooms are most beneficial for reducing risk.

4.3 PRIORITIZATION OF CBR VULNERABILITIES: INCREMENTAL IMPROVEMENTS

There are several improvements that can protect building occupants from a CBR release or prevent a release from occurring inside or directly into a building. However, not all measures are effective against all types of agents and against all delivery methods. Systems involving air-filtration and pressurization are the most effective, and they provide secondary, but significant, benefits of better indoor air quality. They are also most expensive in terms of initial cost, operating cost, and maintenance cost.

There are seven distinct levels of CBR protection for buildings. These levels are listed below in general order of cost. Each succeeding level involves increased cost and provides greater protection for occupants and the building. Each level provides additional protection to the one preceding it, if the threat, vulnerability, and criticality so indicate. Seven options for CBR Protection include:

1. Operational measures and expedient protection
2. Enhanced physical security
3. Enhanced sheltering in place

4. Aerosol filtration, medium level
5. Gas-phase filtration, medium level
6. Aerosol filtration, high level
7. Gas-phase filtration, high level

4.3.1 LEVEL 1, OPERATIONAL MEASURES AND EXPEDIENT PROTECTION

Level 1 consists of basic, low-cost preparations for reducing the effects of a CBR attack. These are primarily operational measures and require no modifications to the building or special equipment. These operational measures involve developing procedures (active measures) for responding to a release of toxic agent, including:

- Expedient sheltering in place
 - Designating safe rooms: interior rooms with a low air exchange rate
 - Identifying switches for air handling units and fans for deactivation
 - Defining procedures and responsibilities for sheltering and for purging the building after plume passage
 - Establishing a building-wide notification system
 - Familiarizing building occupants with procedures and responsibilities
- Evacuation
- Purging
- Using escape respirators

4.3.2 LEVEL 2, ENHANCED PHYSICAL SECURITY

Level 2 measures focus on preventing the internal or air-intake release of agents. Incorporating building modifications or installing security equipment may include:

- Securing air intakes, mechanical rooms, and HVAC plenums against unauthorized access

- Performing entry inspections
- Installing and monitoring video surveillance equipment
- Instituting mail screening procedures
- Maintaining operational security to building plans and signage
- Applying mechanical and architectural isolation of lobby, mailroom, cloakroom, and loading docks

4.3.3 LEVEL 3, ENHANCED SHELTERING IN PLACE

Level 3 includes modifications to the building to make emergency protective actions more effective and to isolate zones in which indoor releases are most likely to occur. Modifications include:

- Installing single-switch control of fans for sheltering and purging
- Sealing the envelope of the building and selected safe room(s)
- Installing automatic dampers for outside air intakes and exhaust fans
- Implementing a public address system to achieve rapid implementation of emergency actions
- Isolating mechanical spaces that require large volumes of outside air by mechanical and architectural means
- Installing separate fans and air streams for ventilation and recirculation, as well as cooling and heating of safe rooms
- Installing recirculation filter units in safe rooms

4.3.4 LEVEL 4, AEROSOL FILTRATION, MEDIUM LEVEL

Level 4 is the first of four levels involving improved air filtration. It is the least costly of the four levels of filtration and includes only aerosol filtration and the use of existing air-handling units that filter mixed air (both ventilation air and return air) with the same filters. Aerosol filtration provides protection against biological agents, radiological agents, and most irritants. Level 4 may be applied to selected zones only or to the entire building (with the exception of mechanical spaces

requiring large volumes of outdoor air). It provides benefits against both outdoor and indoor releases and requires:

- Sealing filter frames to minimize bypass
- Installing filters of greater depth/surface area and higher Minimum Efficiency Rating Value (MERV) rating, such as MERV 14, 15, or 16 mini-pleats
- Operating at outdoor air fractions that produce positive internal pressures of approximately 0.1 to 0.2 inch, water gauge

4.3.5 LEVEL 5, GAS-PHASE FILTRATION, MEDIUM LEVEL

Level 5 expands filtration capability in air handling units to include gas adsorbers, which are the filters needed to remove chemical vapors and gases. Using indoor-air-quality type adsorption systems that have relatively low pressure drops produces initial removal efficiencies of about 99 percent for physically adsorbed (low vapor pressure) agents and provides about 1 year service life. Filtration of chemicals of high vapor pressure is poor. This type of filtration may be applied to the entire building (except for mechanical spaces requiring large volumes of outdoor air) or to selected zones. It provides protective benefits against both outdoor and indoor releases and requires:

- Indoor-air-quality type, low resistance adsorbers that may necessitate substantial modification to air handling units
- Operating at outdoor air fractions that produce positive internal pressures of approximately 0.1 to 0.2 inch, water gauge
- Vestibules or revolving doors for highly protected zones

4.3.6 LEVEL 6, AEROSOL FILTRATION, HIGH LEVEL

Level 6 increases the level of protection against an outdoor release of toxic aerosols substantially over Level 4, but it does not provide any benefits over Level 4 against an indoor release. Level 6 requires the installation of makeup-air/ventilation units with HEPA filters. This may be applied to the entire building or selected zones. It involves:

- Installing ventilation/makeup-air units with HEPA filtration for each zone to be protected
- Vestibules or revolving doors for highly protected zones
- Operating at outdoor air fractions that produce positive internal pressures of approximately 0.1 to 0.2 inch, water gauge

4.3.7 LEVEL 7, GAS-PHASE FILTRATION, HIGH LEVEL

Level 7 involves the installation of high-efficiency gas adsorbers in ventilation/makeup air units serving protected zones. It expands the protective capability to toxic gases and vapors in addition to the aerosol capability of Level 6. Its cost is relatively high, and costs vary with the tightness of the envelope being pressurized. It provides the highest, most complete level of protection against an outdoor release and may be applied to the entire building or selected zones. It involves:

- Installing ventilation/makeup air units with high efficiency gas adsorbers as well as HEPA filters for each zone protected
- Vestibules and revolving doors for the protected zones
- Operating at outdoor air fractions that produce positive internal pressures of approximately 0.1 to 0.2 inch, water gauge.

4.4 DESIGN GUIDANCE FOR CBR PROTECTIVE LEVELS

The following sections contain detailed descriptions and discussions of the seven levels summarized above.

4.4.1 LEVEL 1, OPERATIONAL MEASURES AND EXPEDIENT PROTECTION

4.4.1.1 Scope and Capabilities

This basic level of protection is achieved by preparing emergency plans and procedures, then familiarizing building occupants with these plans

SUMMARY OF CAPABILITIES FOR LEVEL 1

Sheltering in place provides a low level of protection from **chemical agents** released outdoors.

Evacuation and purging (when the nature of the release is known) provide low-level protection in response to indoor releases.

Operational measures and expedient protection are not generally practical for **biological agents** because biological agents cannot be detected in real time.

Operational measures and expedient protection also apply to **radiological agents**, but automatic detectors (e.g., radiac meters) are likely to be necessary.

and procedures for responding to a toxic-agent release. These plans and procedures cover:

- Expedient sheltering in place
- Purging
- Evacuating
- Using escape respirators

Each of these is an active measure; that is, it is initiated only when a hazard is present or known to be imminent. Active measures are most practical against chemical agents because chemical agents can be immediately detected, either by their

warning properties (particularly odor), automatic detectors, or visible/audible signs of a release. Biological agents are not detectable in real time; therefore, these measures are not expected to apply for biological agents unless there is forewarning of some kind provided by those who are releasing, transporting, or storing the agent.

Sheltering in place is employed mainly for outdoor releases, evacuation mainly for indoor releases, and escape respirators for either indoor or outdoor releases.

4.4.1.2 Methods and Requirements

Sheltering in Place

Some content addressing protective actions in this section was originally published in *Protecting Buildings and their Occupants from Airborne Hazards*, U.S. Army Corps of Engineers, October 2001.

For maximum protection, sheltering in place requires two actions to temporarily change a building's indoor-outdoor air exchange rate. The first is to reduce the air-exchange rate before contaminated air begins to enter the building. This involves shutting off all fans that promote the exchange of air between indoors and outdoors, closing all exterior doors and windows, and shutting off elevators.

The second action is to increase the air-exchange rate after the outdoor hazard has dissipated. This is necessary because even a tightly sealed building will not fully prevent contaminated air from entering. However, outdoor air will enter more slowly, and once the external hazard has passed, the building will release the contaminated air slowly

The advantage of sheltering in place is that it can be implemented rapidly. The disadvantage is that its protection is variable and diminishes with the duration of the hazard. The amount of protection varies with the building air exchange rate, the duration of exposure, and the period of occupancy after the hazardous condition has passed.

Sheltering can be employed as a precautionary measure if there is an impending release (e.g., a tanker truck crash involving a fire that releases toxic material, a non-windward release when winds shift, or a release at a great distance from the building). Sheltering is not appropriate for protecting people when the duration of exposure to an outdoor hazard is long and continuous, i.e., for several hours.

The need to shelter in place may be indicated by (1) visible or audible signs of release of agent, (2) information from authorities that there has been a release in the area, (3) observed symptoms of chemical-agent exposure in people outside the building, or (4) automatic detectors, if available, sampling air outside the building or outside air as it is drawn into the building.

One option for sheltering is to use designated rooms or safe rooms, if they are better sealed than the building as a whole and/or the location of the room is less subject to wind pressures or buoyancy pressures that induce infiltration. Safe rooms may also be located in the building on the side opposite a likely source (e.g., a nearby chemical storage facility or railroad line). The safe rooms must be of a number and capacity to accommodate all building occupants and visitors. Generally, safe rooms require a minimum of 5 square feet per person, with 10 square feet per person preferred.

Using a sealed interior room within a sealed building provides greater protection than a sealed building by itself. A sealed interior room has greater resistance to infiltration flow driven by wind and buoyancy. However, use of designated safe rooms is not essential. In many cases, office buildings do not have sufficient space in interior rooms for sheltering all building occupants.

To be effective in large commercial buildings, sheltering in place requires planning and preparation. All exterior doors must be secured and all

air handling units and exhaust fans must be turned off. Procedures for a sheltering plan, therefore, should include:

- Identifying all air handling units, fans, and the switches needed to deactivate them
- Identifying procedures for purging if an indoor release occurs, such as opening doors and windows; turning on smoke fans, air handlers, and exhaust fans that were turned off to shelter; and setting air-handlers on maximum outdoor air
- Designating safe rooms (see Figure 4-1), interior rooms having a lower air exchange rate that may provide a higher level of passive protection
- Establishing a building-wide notification system
- Familiarizing occupants with the procedures and responsibilities for sheltering in place



Figure 4-1: Signage designating safe room.

Although sheltering is for protection against an external release, sheltering in place on one or more floors of a multi-story building after an internal release has occurred on a single floor is also possible, though more complex. Under such conditions, stairwells must be isolated by closed fire doors, elevators must not be used, and clear evacuation routes must remain open in case evacuation becomes necessary. Escape respirators may be needed if the only evacuation routes are through contaminated areas.

Purging

Emergency actions for purging a building and reducing occupants' exposure include turning on a building's ventilation fans and smoke-purge fans and increasing air-handling units' outdoor air fraction to nominal 100 percent. Purging is useful primarily when the agent is known, the source of the agent is indoors, and as the final step in sheltering in place. The ventilation system and smoke purge fans can also be used to purge the building after an outdoor hazard has dissipated and it has been confirmed that the agent is no longer present near the building.

The location of the source and the time of the release should be carefully considered when purging. The source of agent must be inside the building; if not, purging should not be attempted. If the hazardous material has been identified before release or immediately upon release, purging should not be employed, as it may spread the hazardous material

throughout the building or zone. In this case, all air-handling units should be turned off to isolate the hazard while evacuating or temporarily sheltering in place.

Evacuating

Evacuating is the most common protective action when there is an airborne hazard in a building. In most cases, existing plans for fire evacuation apply. Though evacuating is the simplest and most reliable action, it may not be the best action for an outdoor release, particularly one that is widespread. Determining whether the source of the agent is indoors or outdoors is an important consideration in a non-fire evacuation.

If the source is outdoors, and the agent has infiltrated the building, evacuation is not the safest action (unless the source has dissipated), and the use of respirators is appropriate. Sheltering in place may also be employed, but generally should not be used once the hazardous material has entered the building. Evacuation routes may also be hazardous if they take people through contaminated areas as they leave the building.

Alternate routes that do not pass through the main lobby are best. For multi-story buildings, the elevators should be avoided because elevator movement promotes the exchange of air between and among floors. Assembly points should be designated outside the building so people can be accounted for or be given additional instructions.

Using Escape Respirators

Several models of universal-fit escape respirators have been developed for short-duration escape-only protection against chemical-warfare agents, aerosols (including biological agents), and some of the toxic industrial chemicals (see Figure 4-2). The National Institute for Occupational Safety and Health has a certification process for such respirators. Most of these respirators have their protective seals at the neck, rather than around the face, and consequently do not require special fitting techniques or multiple sizes to fit a large portion of the adult population. Training is required to use the masks properly. Depending on mask design, the wearer breathes through a mouth bit or uses straps to tighten a nose cup around the nose and mouth.

The protective capability and shelf life of these masks vary with the design. The filter units of the masks contain both HEPA filters and packed carbon adsorbers, so they will remove chemical and biological aerosols, as well

as chemical vapors and gases. Although the carbon filters are designed to filter a broad range of toxic chemicals, they cannot filter all chemicals. For example, the filters of escape masks are not effective against some chemicals of high vapor pressure. Unless they have a special filter, they provide no protection against the carbon monoxide that is produced in fires. Other escape hoods are available that employ compressed oxygen cylinders, rather than air filters, to provide eye and respiratory protection for short periods that vary with the intensity of the activity (i.e., walking, sitting, and climbing/descending stairs).

Plans for training, fitting, storing, and record retention procedures should be established for escape masks and respirators.

Figure 4-2: Escape respirators.



4.4.1.3 Cost Considerations

Costs of Expedient Sheltering In Place

The initial costs of establishing a basic sheltering-in-place capability are small where space is available. These costs are associated with:

- Conducting a survey to identify safe rooms
- Defining, printing, and distributing the sheltering procedures and familiarizing the building occupants with these procedures
- Assigning responsibilities for: closing doors, turning building fans off/on, and acting as safe room monitors in an emergency
- Creating signage designating the safe room and providing instructions for the occupants
- Keeping a supply of bottled drinking water in each safe room

Operating and maintenance costs are those associated with periodic training and exercises, such as an annual sheltering drill, and replenishing supplies in the safe rooms.

Costs of Escape Respirators

The initial costs of employing escape respirators that meet requirements developed by the U.S. Army and/or the National Institute of Occupational Safety and Health include:

- Purchasing respirators (approximate unit cost ranges from \$100 to \$300). This may include the purchase of respirators for visitors and new employees.
- Initial training in use of the respirators.
- Establishing an inventory system for the respirators that addresses serviceability checks and shelf life.

The operating and maintenance costs of escape respirators include:

- Replacement costs for respirators or respirator filters. Air-purifying type respirators require replacement every 4 to 5 years. Self-contained breathing apparatuses have a shelf life of 10 years.

- Maintaining an inventory system, conducting refresher training, reissuing serviceable unused respirators, and ordering and issuing replacement respirators or filters. Cost data from one Federal facility show this cost to be roughly 10 percent of the respirator costs per year.

4.4.2 LEVEL 2, PHYSICAL SECURITY

4.4.2.1 Scope and Capabilities

SUMMARY OF CAPABILITIES FOR LEVEL 2

Level 2 consists of physical security measures, preventive or deterrent measures that apply to indoor releases or outdoor releases close to the building.

These measures apply to all toxic agents—**chemical, biological, and radiological agents**—although detectability makes them most practical for chemical agents.

The purpose of the physical security measures applied in this level is to prevent the release of an agent from a point inside the building or through a penetration in the building shell from a point near the building.

These physical security measures, which also provide benefit against other criminal acts, include five measures as described in 4.4.2.2 below.

Physical security measures are preventive measures; they serve to deter potential attackers and to prevent the release of agent in or into the building. They are effective only within the building and/or its secure perimeter; they apply to indoor releases and outdoor releases near the building.

Among the security measures presented below, only the entry inspection requires the capability to detect toxic agents. Because of technical challenges in detecting and reliably identifying agents, entry inspection is most practical for chemical agents and least practical for biological agents.

4.4.2.2 Methods and Requirements

Securing Air Intakes

Securing air intakes is the highest priority physical security measure (see Figure 4-3). There are, however, several degrees of vulnerability for air intakes. Generally, the more difficult an intake is to access for surreptitious insertion of a toxic agent, the lower its vulnerability. Elevating intakes is the best approach to decreasing vulnerability. In retrofit, however, doing so can be expensive and require architectural



Figure 4-3: Typical air intakes.

changes that may not be aesthetically acceptable. There are less expensive, less effective measures that can be taken to reduce intake vulnerability, such as installation of security fencing and surveillance cameras. Whether an intake should be secured depends on its vulnerability and the level of threat to the building.

Securing Mechanical Rooms and HVAC Plenums

Securing mechanical rooms is a relatively inexpensive means of denying access to the HVAC system (except for the outside air intakes). Unsecured mechanical rooms present a vulnerability similar to but lower than unsecured outside air intakes. In most cases, mechanical rooms are accessed from inside the building; therefore, the routes of access are subject to the physical security of the building.

HVAC ceiling plenums present an accessible pathway to the air-handling units, in which a dissemination device could be concealed by lifting a drop-ceiling tile. Plenum return pathways are not present in buildings with ducted returns and cannot be secured in buildings with hallway returns. Securing the ceiling plenum is impractical in most applications because access to the ceiling plenum must be retained for maintenance purposes.

Performing Entry Inspections

Adding entry inspections to prevent containers of toxic agents from being brought into a building is practical only if security guards control access to the building. Entry inspections have varying degrees of effectiveness. They can be effective for both deterrence and detection. Detecting toxic agents in containers is difficult, however, as there is no practical technology for rapid, non-intrusive detection/identification of toxic agents. Current methods of detection are based on the type of container (e.g., pepper spray devices) or on quantities of specific chemicals detected on exposed surfaces.

Performing entry inspections in a lobby that is isolated architecturally and mechanically from the rest of the building is best. Such isolation should involve measures described in 4.4.3.2. In some cases, performing entry screening in a separate building (i.e., a visitors center) is more efficient and effective than modifying a lobby for isolation. Similarly, it may cost less to receive, inspect, and sort mail and packages in a separate building.

Employing Video Surveillance

The principles of deterrence and detection are also applied in the use of video surveillance equipment. For detection to be effective in preventing or mitigating the effects of a release, images from the cameras must be monitored continuously in real time. For deterrence, the surveillance must be overt rather than covert. Because of privacy concerns, overt surveillance is most commonly employed in office buildings.

Generally, surveillance cameras should be placed in common areas that are not within the normal view of security personnel. Indoors, these areas may include hallways, cloakrooms, and obscure parts of the lobby. Outdoors, suitable placement may include unsecured air intakes and areas where vehicles or pedestrians may release an agent that would be transported into the building.

Other Security Considerations

Building plans may contain information relevant to CBR vulnerabilities. For this reason, access to drawings and specifications should be restricted.

4.4.2.3 Cost Considerations

The cost of installing security equipment varies substantially with the number of surveillance cameras, resolution and features of cameras, and monitors and recording equipment.

4.4.3 LEVEL 3, ENHANCED SAFE ROOMS AND ISOLATED ZONES

4.4.3.1 Scope and Capabilities

Level 3 CBR protection involves increased protection against indoor releases. This level includes architectural and mechanical modifications to designated safe room(s) to increase the protection the safe room can provide, and to zones of concern, such as the mailroom and lobby, to isolate them from the rest of the building. The mailroom is a primary zone of concern, and the lobby is a zone of concern for access-controlled buildings. Isolating zones of concern is a passive measure that prevents the transport of airborne agents to other spaces of the building.

SUMMARY OF CAPABILITIES FOR LEVEL 3

Level 3 mitigates indoor releases. It applies to all types of agents: **chemical, biological, and radiological**.

These measures prevent an agent released in a lobby or mailroom from migrating to other parts of the building and require access control and some level of entry screening.

For enhanced sheltering in place, the protective capabilities described in level 1 apply.

4.4.3.2 Methods

Safe Room Enhancements

There are three classes of safe room, as defined by U.S. Army documents on CBR collective protection (USACE, 2001). These classes provide three levels of protection, with Class I being the most protective.

Class I safe rooms are ventilated and pressurized by air filtered at high efficiency.

Class II safe rooms have air filtration with either no ventilation or a ventilation rate that produces little or no overpressure.

Class III safe rooms are unventilated and have no air-filtration equipment. These safe rooms apply what is commonly referred to as sheltering in place.

The features listed below facilitate rapid transition to sheltering mode and improve the level of protection a CBR safe room provides. These apply mainly to Class II and III safe rooms, but some apply to Class I. The design of Class I (pressurized) safe rooms is covered under Level 7.

For commercial buildings, these enhancements are as follows:

- Single-switch, rapid-shutdown capability for all fans that induce indoor-outdoor air exchange (See Figure 4-4). This includes shutdown capability for ventilation fans, exhaust fans, and air-handling units that draw outside air.

Figure 4-4: A single switch for stopping HVAC fans.

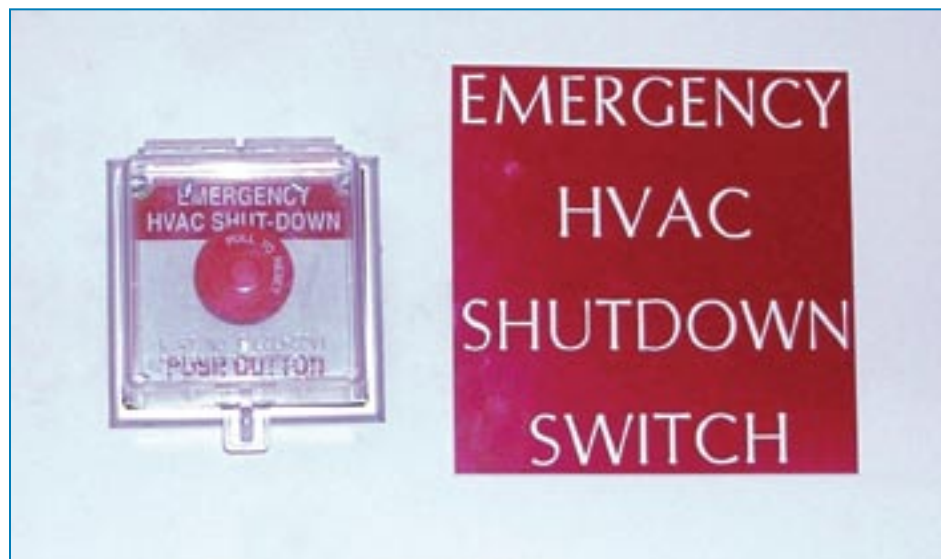

- Sealing measures. The level of protection varies with the tightness of the building in its sheltering configuration; the lower the air exchange rate, the higher the level of protection.
- A public-address system to rapidly instruct all people in the building to shelter in place (i.e., not to exit the building or open exterior doors). A broadcast voice system is preferable to a tone-alert, ring-down, or computer-screen message system because it is the most rapid and reliable.
- Dampers for outside air intakes and exhaust fans. Dampers should be automatic and interlocked with the fan operation and must be maintained in good working order.

Typical dampers are not effective enough to allow heating and air conditioning in the safe room while in the sheltering mode. Safe use of an air-handling unit serving a CBR safe room requires a recirculation fan separate from the makeup air fan. Cooling or heating in the safe room in the sheltering mode can be safely accomplished with separate ventilation and recirculation fans, when the damper for the ventilation fan is closed. A system with separate fans eliminates the potential for internally induced infiltration that typically occurs with an air-handling unit (single fan and damper) in the full recirculation mode.

Filtering recirculated air in a safe room increases the protection level of the safe room from Class III to Class II. Some recirculation filter units have substantial adsorbers as well as high-efficiency particulate air filters and are suitable for enhanced sheltering in place (See Figure 4-5). To improve the safe room's protection against chemical agents, the filter unit must have a substantial gas adsorber. The adsorber removes most chemical agents, while the high-efficiency particulate filter, found in most recirculation filter units, removes biological agents and other aerosols such as radioactive dust, tear gas, and pepper spray. While recirculation filters have the capability of removing biological agents, it is unlikely that the safe room would be used in the case of a biological release due to limitations in detection capability for biological agents.



Figure 4-5: Two recirculation filter units.

Isolating the Lobby and Mail Room

The lobby and mailroom are two spaces in an office building in which a toxic agent release would be most likely to occur. Isolating these spaces architecturally and mechanically reduces the probability that large portions of the building will become contaminated by an indoor release. The probability of a lobby release is higher if the building is access-controlled and the lobby is open to the public.

Isolating these spaces from the rest of the building may require both architectural and mechanical changes, including:

- Full-height walls
- A dedicated air handling unit (serving only the space) if an all-air HVAC system is used
- An exhaust fan or system balancing to maintaining the space at a negative pressure relative to the rest of the building
- Doors into and out of the lobby that are normally closed (The frequency of entries and exits determines whether vestibules or revolving doors are also required.)

4.4.3.3 Cost Considerations

Initial costs vary widely, as lobbies generally require architectural changes to place a barrier and doorway between the lobby and adjoining spaces. Mechanical changes would require a separate air-handling unit for the space.

4.4.4 LEVEL 4, AEROSOL FILTRATION, MEDIUM LEVEL

4.4.4.1 Scope and Capabilities

This is the first of four levels involving improved air filtration. Among the four, it is the simplest to apply and requires the least cost and space. Any improved air filtration requires a licensed mechanical contractor to ensure effective installation and prevent adverse effects on ventilation rates and HVAC system operation.

Level 4 involves aerosol filtration only in the existing air-handling units and provides a medium level of protection because the filters are less efficient than HEPA filters. Also, existing air-handling units typically allow substantial volumes of air to bypass the filters. This bypass occurs not only at the filter-holding frames but also at leakage paths in the air-handling unit cabinet under negative pressure.

4.4.4.2 Methods and Requirements

This increased level of protection for aerosols requires:

- Installing filters of higher MERV within available space and within resistance limitations of the air-handling unit fan. This is most easily accomplished by installing filters of mini-pleat configuration having greater filter depth and therefore, greater surface area.
- Sealing filters to their retaining frames to minimize bypass, and sealing leakage paths on the air-handling unit cabinet between the filter frames and the fan.
- Operating at outdoor air fractions that produce a positive internal pressure in the building.

The details of sealing frames vary from installation to installation. Generally, front-access filters provide much better potential for reducing bypass than do side-access filters, although there are side-access housings available with locking mechanisms to ensure a good filter seal. Pressurization levels are the same as those discussed for Levels 6 and 7.

4.4.4.3 Cost Considerations

The costs of modifications to the filter holding frames vary with the type and condition of the air-handling unit.

Additional resistance to flow in terms of pressure drop may result in increased operating costs, which are likely to be offset by additional service life resulting from greater surface area.

SUMMARY OF CAPABILITIES FOR LEVEL 4

Level 4 improves the protection against **biological and radiological agents** and certain irritants in aerosol form, such as tear gas and pepper spray.

For these agents, this provides a medium level of protection against outdoor releases and a low level of protection against indoor releases.

This level adds no capability to protect against **chemical agents**. At this level, sheltering in place provides capability for protecting against chemical warfare agents and toxic industrial chemicals (TICs).

Costs of replacement filters will increase, as will the labor to change filters, re-establish effective seals, and dispose of hazardous wastes that are characteristic for higher efficiency filters.

4.4.5 LEVEL 5, GAS-PHASE FILTRATION, MEDIUM LEVEL

4.4.5.1 Scope and Capabilities

SUMMARY OF CAPABILITIES FOR LEVEL 5

Level 5 applies a medium level of protection against **chemical warfare agents** and against some TICs released outdoors.

It provides a low level of protection against indoor releases of these chemical agents.

The filtering capability for chemicals of higher vapor pressure is less than that of Level 7.

This level provides no additional capability for **biological or radiological agents** beyond Level 4.

The second level of filtration involves the addition of adsorbers to the HVAC system to filter chemical agents from recirculated air and ventilation air. This level produces substantial protection against a chemical release either indoors or outdoors; however, it provides a lower level of protection against an outdoor release than Level 7.

Adsorbers for this application are commercially available and commonly used in buildings having special indoor-air-quality requirements. As such, the adsorbers have a relatively low resistance (pressure drop of around 0.5 to 1 inch,

water gauge) and consequently, a much lower efficiency (initially about 99 percent) and capacity than adsorbers made to the higher standards of military or Department of Energy specifications.

These adsorbers do not filter agents of higher vapor pressure as well as military adsorbers do. Typically, they have coarse granular carbon trays of 1-inch depth in a V-bed configuration. The units typically have an initial bypass of at least 1 percent. There are also adsorbers made of multiple layers of pleated, carbon-loaded, non-woven material (see Figure 4-6).

This capability is best attained with installation of adsorbers in an air-handling unit or ducted in line. A similar capability can be attained with free-standing, floor-mounted units or ceiling-mounted units; however, these are less practical in most large commercial buildings in that several units may be necessary in each room to provide performance equivalent to the units ducted in line or mounted in the air-handling unit.

Service life of these adsorbers is typically 12 to 18 months; however, efficiency diminishes with time in service, to relatively low values within a year, reducing the protection provided to low levels later in the service



Figure 4-6: 9,000-cfm filter unit incorporating pleated adsorbers.

life period. Manufacturers of the adsorbers provide surveillance testing to help determine the frequency of filter replacement.

4.4.5.2 Methods and Requirements

Adsorber units can be installed by adding an adsorber section (approximately 3 feet long) to an air-handling unit, or by adding an in-line filter unit in the supply duct. Upgrading the air-handling unit fan/motor may be necessary to accommodate the additional airflow resistance of the adsorbers.

There are two types of adsorbers, those with granular carbon beds and those with carbon pleats consisting of non-woven material loaded with fine-mesh carbon granules. Comparison of performance between these two types of adsorbers can be made on a carbon-per-cubic feet per minute (cfm) basis (usually this is in the range of 0.05 to 0.1 pound per cfm for substantial efficiency and capacity).

Multi-panel housings in which removable flat panels form V-bed configurations generally have greater bypass than V-bed cells or pleated cartridges.

4.4.5.3 Cost Considerations

The installation costs for adsorber units are about \$0.50 per cfm. With a one-year service life, filter replacement costs are about \$0.25 per cfm per year. Additional operating energy costs are about one fourth the maintenance costs due to the pressure drop of the adsorbers (0.75 inch of water gauge).

4.4.6 LEVEL 6, AEROSOL FILTRATION, HIGH LEVEL

4.4.6.1 Scope and Capabilities

SUMMARY OF CAPABILITIES FOR LEVEL 6

For **biological or radiological agents**, Level 6 provides the highest possible level of protection against outdoor releases.

Against an indoor release of **biological or radiological agents**, this level does not improve upon the protection Level 4 provides.

Except for irritant aerosols, this provides no additional capability for **chemical agents** beyond sheltering in place (Levels 2 and 3) or the adsorbers of Level 5.

This level is the first of two that involve very high efficiency filtering of ventilation air separately from recirculation air. This level is for aerosol filtration only and is to be applied in a continuously operating system, rather than activated upon detection, because biological agents are not detectable in real time.

4.4.6.2 Methods and Requirements

This level involves the installation of a makeup-air unit with HEPA filters and an effective sealing system to prevent filter bypass. The makeup-air unit requires heating and cooling coils to temper the air introduced into the building before it is further conditioned by the air-handling units.

An ultraviolet germicidal irradiation (UVGI) system of certified performance could be used in place of the HEPA filter for disinfection of air as it enters the building; however, such systems also require mechanical filtration for removal of other aerosols (and to keep lamp and reflector surfaces clean). Although there are several UVGI systems on the market for use in air-handling units, most do not have the capability for high-efficiency disinfection of biological threat agents in air. Some systems are intended for surface disinfection, killing mold, bacteria, and fungi on cooling coils or drain pans. There is currently no certification process for UVGI systems for protection against bio-agent attack.

Less space is required for Level 6 makeup-air units than Level 7, which requires both HEPA filters and high-efficiency adsorbers. Sizing of the filtration system in terms of airflow capacity is determined by the building's leakage rate and the square footage of the protected space. With normal building construction techniques, leakage is less than optimum for pressurization of the building. Desired pressure levels in low-rise buildings are 0.1 to 0.2 inch, water gauge, and greater in high-rise buildings. Pressurizing a building to these levels usually takes substantially more ventilation air than is supplied for health and comfort requirements. Table 4-1, below, shows the flow rate of air required per square foot of floor area for a 0.1-inch, water gauge pressure.

The airflow required for pressurization can be determined by fan-pressurization testing, American Society of Heating, Refrigerating and Air-Conditioning Engineers (ASHRAE) tables (ASHRAE, 2004), and tables based on previous fan-pressurization tests provided by the manufacturer.

Table 4-1: Estimated Makeup Airflow Rate per Square Foot (Floor Area) to Achieve an Overpressure of 0.1 Inch, Water Gage

Type of Construction	Airflow Rate (cfm per sq ft floor area)
Very Tight: 26-inch thick concrete walls and roof with no windows	0.04
Tight: 12-inch thick concrete or block walls and roof with tight windows and multiple sealed penetrations	0.20
Typical: 12-inch thick concrete or block walls with gypsum wall board ceilings or composition roof and multiple sealed penetrations	0.50
Loose: Wood-frame construction without special sealing measures	1.00

4.4.6.3 Cost Considerations

This level is relatively high in cost because it requires pressurization of the building or selected spaces to ensure that all exchange of indoor and outdoor air occurs through the filters. Pressurizing buildings typically requires substantial increases in the rate of ventilation air flow, which leads to increased heating and cooling costs.

4.4.7 LEVEL 7, GAS-PHASE FILTRATION, HIGH LEVEL

4.4.7.1 Scope and Capabilities

As with Level 6, this level also involves filtering the ventilation air separately from recirculation air at very high efficiency. Level 7 involves

SUMMARY OF CAPABILITIES FOR LEVEL 7

For chemical agents, Level 7 provides a very high level of protection for filterable chemicals released outdoors.

This level does not increase the protection against biological or radiological agents beyond that of Level 6.

Against an indoor release, this level does not provide benefit beyond that of Level 5.

the installation of high-efficiency gas adsorbers to filter makeup air for pressurizing the protected zones, and thereby expands the high-level protective capability to toxic gases and vapors.

Because this level includes HEPA filtration in series with the high-efficiency adsorber it provides the highest, most complete level of protection against an outdoor release of chemical, biological, or radiological agents. However, it is limited in the filtration of some chemical agents of higher vapor pressure.

Generally, chemicals of vapor pressure above 10 millimeters of mercury are filtered by chemisorption; that is, carbon is impregnated with salts of copper, silver, zinc, and molybdenum, and the gases react with these impregnants as they pass through the filter bed to form products that are innocuous or retained in the bed. However, the best broad-spectrum carbon will not filter all toxic chemicals. The addition of a special sorbent, mixed or layered in the bed, can add to the filter capability for specific gases, but increases the size and resistance of the adsorber.

Filtering only ventilation air is not effective against an indoor release. Protecting against an indoor release requires the internal filtration of Levels 4 and 5 or the physical security measures of level 2.

4.4.7.2 Methods and Requirements

Among the primary decisions in applying this level of protection is whether to protect the whole building or a relatively small selected space. This decision is usually based on cost and the need for a high level of protection.

Whole building. In pressurizing the whole building, mechanical rooms are generally excluded or divided to exclude furnaces or boilers from the protected space. In mechanical rooms containing both air-handling units and boilers, the mechanical room is partitioned so that the air-handling units are within a pressurized space and the boilers are not.

Selected space. Spaces usually selected for pressurized, high-level chemical protection are security operations centers, emergency operations centers, command and control centers, command suites, and safe rooms. A safe room with this level of protection is considered a Class I safe room (section 4.4.3).

A second decision regarding the application of Level 7 is whether to design a continuously operating system or a standby system. The latter may be applied because gas-phase filtration is for chemical agents, which can be detected in real time. Therefore, the system can be activated upon detecting a release or learning of a heightened threat level. Canister-type filter systems for use in safe rooms and home shelters are intended for standby use; these are hermetically sealed and can retain their full capability for at least 10 years. The high-efficiency filtration unit can be installed in a mechanical room, on the roof, or at grade inside secure fencing.

Three types of adsorbers commonly used are V-bed, radial-flow, and pleated, as shown in Figure 4-7. Installations of radial-flow and V-bed adsorbers are shown in Figures 4-8 and 4-9.



Figure 4-7: Three types of high-efficiency gas adsorbers commonly used (from left to right: radial-flow M98 military adsorber, V-bed adsorber, and multi-layer pleated adsorber).



Figure 4-8: Radial-flow adsorbers in multiple 1,000-cfm housings in a 16,000-cfm system serving a hospital.

Figure 4-9: A 6,000-cfm V-bed filter unit serving a 12,000 sq ft safe room.



4.4.7.3 Cost Considerations

Installing, operating, and maintaining systems for ultra-high efficiency gas adsorption is very expensive. Installing such a system costs approximately \$20 to \$100 per square foot.

The principal maintenance cost is the replacement of filters, the high-efficiency gas adsorbers, approximately every 3 years. This equates to a cost of \$2 per year per cfm, or about \$0.50 to \$1.00 per square foot per year. Energy costs for such units are about one-fourth the maintenance costs.

4.5 SUMMARY

Operational Risk-Reduction Measures for CBR

The following summarizes the operational measures for CBR risk reductions:

- Develop plans, procedures, and training for sheltering in place, evacuation, and purging

- Provide CBR threat awareness and response training to building occupants
- Purchase escape hood respirators for all occupants and provide training in their use
- Secure air intakes, mechanical rooms, and HVAC plenums against unauthorized access
- Perform entry inspections at the building lobby
- Institute mail-screening procedures
- Maintain operational security for building plans and building signage

Building Upgrades for CBR

- Install single-switch control of all building fans to facilitate sheltering in place and purging
- Install a public-address system to achieve rapid implementation of emergency actions
- Apply sealing measures to tighten selected safe room(s)
- Install automatic dampers for outside air intakes and exhaust fans to facilitate sheltering in place
- Place recirculation filter units having substantial adsorbers for use in safe rooms
- For safe rooms, install a separate, isolated recirculation system for cooling and heating
- Install and monitor video-surveillance cameras
- Isolate the lobby, mailroom, cloakroom, and loading dock architecturally and mechanically
- Install filters of greater depth/surface area and higher MERV rating, such as MERV 14, 15, or 16 mini-pleats, in air-handling units and seal filters and frames to minimize bypass
- Modify air-handling units to install indoor-air-quality type, low resistance adsorbers

- Install ventilation/makeup-air units with HEPA filtration for each zone to be protected
- Install ventilation/makeup-air units with high-efficiency gas adsorbers, as well as HEPA filters for each zone protected
- Install vestibules or revolving doors for highly protected zones
- With upgraded air filtration, operate air-handling units at outdoor air fractions that produce positive pressures of approximately 0.1 to 0.2 inch, water gauge, in the building

4.6 CBR PROTECTION MEASURES

The preceding discussions of CBR threat mitigation measures can be condensed into the following list. It is presented here as an example of measures that might be generated by the FEMA 452 process and implemented using this document (FEMA 459), as discussed in Chapter 2. These measures are all included in the list that comprises the vertical axes of the matrices in Section 2.3.

Level 1, Operational Measures and Expedient Protection

- Expedient sheltering in place
 - Designating safe rooms, interior rooms having a lower air exchange rate
 - Identifying switches for all air-handling units and fans for deactivation
 - Defining procedures for sheltering and for purging the building after plume passage
 - Establishing a building-wide notification system
 - Familiarizing occupants with procedures and responsibilities
- Evacuation
- Purging
- Using escape respirators

Level 2, Enhanced Physical Security

- Secure air intakes against unauthorized access
- Secure mechanical rooms and HVAC plenums against unauthorized access
- Perform entry inspections
- Employ video surveillance equipment
- Institute mail screening procedures
- Maintain operational security to building plans and signage
- Apply mechanical and architectural isolation of lobby, mailroom, cloakroom, and loading docks

Level 3, Enhanced Sheltering In Place

- Install single-switch control of fans for sheltering and purging
- Tighten the seal for the envelope of the building and selected safe room(s)
- Install automatic dampers for outside air intakes and exhaust fans
- Implement a public address system to achieve rapid implementation of emergency actions
- Isolate mechanical spaces that require large volumes of outside air
- Install separate fans and air streams for ventilation and recirculation, as well as cooling and heating, of safe rooms
- Use recirculation filter units in safe rooms

Level 4, Aerosol Filtration, Medium Level

- Seal filter frames to minimize bypass
- Install filters of greater depth/surface area and higher MERV rating
- Operate at positive internal pressures

Level 5, Gas-Phase Filtration, Medium Level

- Install indoor-air-quality type, low-resistance adsorbers
- Operate at positive internal pressures
- Install vestibules or revolving doors for highly protected zones

Level 6, Aerosol Filtration, High Level

- Install ventilation/makeup-air units with HEPA filtration
- Install vestibules or revolving doors for highly protected zones
- Operate at positive internal pressures

Level 7, Gas-Phase Filtration, High Level

- Install ventilation/makeup-air units with high-efficiency adsorbers and HEPA filtration
- Install vestibules or revolving doors for the protected zones
- Operate at positive internal pressures

All of these measures can be implemented independently with the exception of expedient sheltering in place (Level 1).

 Operational security measures for commercial buildings augment the blast and CBR physical protective measures by establishing the capability to deter, detect, delay, and respond to these threats, as well as other harmful acts. Operational security measures encompass the physical security systems, the security policies and procedures, and the personnel resources committed to protecting commercial buildings. This chapter reviews the range of operational security measures available to commercial facilities to counter blast and CBR threats and addresses considerations for applying these measures to retail, office, and multifamily residential facilities, and hotels. The chapter concludes with an examination of the integration of operational and physical protective measures, including the relative flexibility of operational measures and the resulting tradeoffs during implementation.

5.1 OVERVIEW OF OPERATIONAL SECURITY MEASURES

 Operational security measures work in conjunction with blast and CBR measures to protect personnel, equipment, and intellectual property. A baseline of protective measures established at commercial facilities might include locking doors, lighting parking lots, and controlling access to small expensive items. Beyond this baseline, additional security measures are commonly added to counter specific threats. These measures might include procedures as simple as checking the picture and date on an identification card. Additional security measures can also include sophisticated systems, such as biometric identification, metal detectors, video assessment and surveillance systems, armed security personnel, and even chemical and radiation detectors.

OPERATIONAL SECURITY MEASURES

- Detection and Assessment Measures
- Interdiction and Response Measures
- Procedural Measures
- Preparedness Measures
- Security Master Planning

Operational security measures can be divided into five basic components: detection and assessment measures, interdiction and response measures, procedural measures, preparedness measures, and security master planning.

5.2 DETECTION AND ASSESSMENT MEASURES

Detection and assessment measures for blast events and CBR threats include exterior intrusion detection, interior intrusion detection, CCTV systems, access control systems, vehicle inspections, duress alarms, and mail/package screening.

5.2.1 EXTERIOR INTRUSION DETECTION SYSTEMS

Exterior intrusion detection systems are used to detect an intruder crossing the boundary of a protected area. They can also be used in clear zones along fences or around buildings or for detecting unauthorized access to critical outdoor infrastructure (transformers, water tanks, etc.). Generally these systems use infrared, (see Figure 5-1) seismic, microwave, or video motion technologies to alert security personnel to an encroachment. Because of the nature of the outdoor environment, exterior sensors are more susceptible to nuisance and environmental alarms than interior sensors. The use of dual technology sensors and a proper assessment method is key to an effective system.

Figure 5-1: Doorway with balanced magnetic switch and passive infrared motion sensor.

SOURCE: TERRENCE RYAN



5.2.2 INTERIOR INTRUSION DETECTION SYSTEMS

Interior intrusion detection measures, like exterior systems, are designed to detect penetration or attempted penetration through perimeter barriers. Interior sensors can be deployed at a facility's perimeter or in an interior space. An interior asset is one contained within a cube with sensors protecting all six faces, such as walls, ceilings, and floors, to include duct openings, doors, and windows. Tamper protection and access/secure mode capabilities should be considered when planning interior systems. Interior sensors include:

- Structural vibration sensors
- Glass-breakage sensors
- Passive ultrasonic sensors
- Balanced magnetic switches
- Grid wire sensors
- Microwave motion sensors
- Passive infrared motion sensors
- Dual technology sensors
- Video motion sensors

DUAL TECHNOLOGY SENSORS

Dual technology sensors use two technologies in a logical combination to reduce false alarms. One example is a combination of a microwave sensor and a passive infrared sensor that must activate simultaneously to create an alarm.

5.2.3 VIDEO ASSESSMENT AND SURVEILLANCE SYSTEMS

Video assessment and surveillance systems may be used to conduct access control, surveillance, and video motion detection. Access control applications include monitoring building entrances, loading docks, and other access points. Surveillance applications include maintaining observation over large or concentrated areas, such as site access points, parking lots, building perimeters, key interior areas, or points of alarm. Video motion detection applications have sensors that generate an alarm when an intruder enters a selected portion of a camera's field of view. They can be programmed to activate alarms, initiate recording, or prompt other designated actions when motion is detected by a security camera.

- **Interior Applications.** Alarm assessment, card reader event assessment, emergency exit activation assessment, and surveillance of lobbies, corridors, and open areas.

- **Exterior Applications.** Alarm assessment, individual zones and portal assessment, specific paths and areas, exclusion areas, and surveillance of activities.
- **Video Motion Detection.** Video motion sensors are available on most digital video recorders (DVRs) used in security applications. The sensor processes and compares successive images against predefined alarm criteria. The system usually provides adjustable windows that can be positioned to monitor selected points of the video image. Some DVRs can be programmed to monitor very specific fields of view for specific types of motion in order to increase system effectiveness and minimize extraneous detections.

Video assessment and surveillance systems may be monitored in real time or recorded for later viewing (see Figure 5-2). Systems designed for one usage may not be optimized for the other.

ADDITIONAL VIDEO ASSESSMENT AND SURVEILLANCE SYSTEMS CONSIDERATIONS

- Plan camera placement to provide adequate coverage of vehicle and pedestrian movements along perimeter fence lines, site, roadway and parking lot access points, building exteriors, entrances, emergency exits, and utility systems.
- Use the integration features of modern Pan Tilt Zoom cameras systems to point and focus on cues from door contacts and switches, interior motion detection devices, or other sensors.
- Integrate landscaping efforts with camera placement initiatives. Control plantings and tree and shrubbery growth to avoid obstructing camera fields of view.
- Perform a lighting survey to ensure lighting levels are adequate and consistent with camera equipment manufacturer specifications.
- Train staff members on the use (and limitations) of the camera system.
- Video motion sensors can greatly improve the efficiency of security personnel monitoring security cameras by alerting them when motion is detected.



Figure 5-2: Video assessment and surveillance systems.
SOURCE: BOB CIZMADIA

5.2.4 ACCESS CONTROL SYSTEMS

The building layout, rate and flow of employees and visitors, threat level, personnel available, and types of technical equipment installed are considerations for establishing access control measures. A screening plan should be comprehensive to permit authorized personnel to conduct their business with minimum delay, but provide access to only those with a legitimate need. Access control measures normally consist of a public access control area, a walk-through metal detector and/or hand-held metal detector, and an entry control system.

- **Public Access Control Area.** This allows for identifying and screening of visitors before admitting them into restricted areas (see Figure 5-3).
- **Walk-Through Metal Detector and/or Hand-Held Metal Detector.** Metal detectors are intended to detect the presence of concealed firearms or other weapons while avoiding the intrusiveness of individual searches or frisking. Additionally, screening may detect the presence of concealed electronic devices (such as hidden transmitters) and explosive devices having metal components.
- **Entry Control Systems.** The function of an entry control system is to ensure that only authorized personnel are permitted into or out of a controlled area. Entry can be controlled by locked fence gates, locked doors to a building or rooms within a building, or specially designed portals. Entry control can be enforced physically with



Figure 5-3: Blast effects related to access control.

SOURCE: MICHAEL KAMINSKAS

guards or automatically using entry control devices. For a guard system, guards verify that a person is authorized to enter an area, usually by comparing the photograph and personal characteristics of the individual requesting entry. For an automated system, the entry control device verifies that a person is authorized to enter or exit. The automated system usually interfaces with locking mechanisms on doors or gates that open momentarily to permit passage. All entry control systems control passage using one or more of three basic techniques: a Personal Identification Number, a credential, or an identifying feature like a fingerprint. Automated entry control devices based on these techniques are grouped into three categories: code, credential, and biometric devices.

5.2.5 VEHICLE INSPECTION SYSTEMS

Vehicle inspection systems employ personnel to examine entering vehicles in accordance with predetermined guidelines (see Figure 5-4).



Figure 5-4: Entry control point.

SOURCE: TERENCE RYAN

Inspections may be appropriate at low and high threat locations. At low threat locations, guards may only inspect a vehicle driver's identification or a facility parking sticker. At higher threat locations, guards may inspect the vehicle and occupants' identification, vehicle interior, undercarriage, engine compartment, interior, trunk, and gas-fill cover area. Inspections should occur as far from critical site facilities as possible (preferably at the site perimeter). The inspection area may include vehicle arresting devices that prevent vehicles from tailgating or from leaving the inspection area without permission.

5.2.6 DURESS ALARMS

Duress alarms installed at fixed locations (see Figure 5-5) or carried as mobile devices alert security personnel to a potential threat or incident. If used outside a defined area, duress alarms should be programmed to transmit the precise location of the user.

5.2.7 MAIL/PACKAGE SCREENING

Mail and package screening involves controlling and screening the mail and packages for contraband, weapons, chemical, biological, radiological, or incendiary materials, and other items, whether brought into a facility by an individual or by mail/package delivery. Screening technologies may detect components of explosive devices or explosive compounds by radiographic analysis, by analyzing chemical emissions, or by other methods (see Figure 5-6). Radiological detectors, which are accurate,

reliable, and relatively inexpensive, may also be used. Package screening measures may include:

- Arranging for off-site inspection of mail/packages
- Centralizing mail/package delivery and screening into a standalone building or on the perimeter of the facility
- Providing explosive detection and response training to mail handlers
- Conducting X-ray screening of mail and packages
- Utilizing explosive and CBR detection equipment

Figure 5-5: Emergency phone in parking garage.

SOURCE: BOB CIZMADIA



Figure 5-6: Example of an air sampling system in a mailroom.

SOURCE: TERENCE RYAN



5.3 INTERDICTION/RESPONSE MEASURES

Response/interdiction forces provide a means to delay adversaries while protecting personnel and critical locations from blast and CBR events. Response force requirements are dependent on contingency planning and range from on-site or off-site security guards to local and State police forces. Response/interdiction measures include security guard forces with a deterrence or delay role, security guard forces with a response/interdiction role, and general contingency planning with local and State police.

Security guard services consist of proprietary or contract guards, or a combination of both depending on their purpose, the size of the facility, and other factors. Their effectiveness, however, is dependent on the quality of the individuals involved. Proper licensing, training, and background checks are critical for ensuring each individual response force member is qualified.

5.3.1 GUARD FORCE - DETECTION/DELAY ROLE

Guard forces with a detection or delay role generally monitor video surveillance equipment, check credentials, and patrol. They may be located in a lobby area, a patrol area, or in a security operations center connected to several entry points. These security guards perform access control functions and surveillance by either direct observation or through video surveillance. If an event occurs, they conduct an assessment and coordinate the response actions of employees and internal and external response forces. They may also respond directly to events if simple interdiction may limit the incident or to assist with evacuation and isolation.

For the largest facilities, the security guard may be afforded a protected booth with hardened walls, protected egress, pass tray, access denial system, CCTV monitors, controls of entrances and exits, radios, telephones, paging systems, intercoms, key boxes, indicator and alarm panels, the active vehicle barrier override control, security light controls, elevator controls, and controls for air-handling systems.

5.3.2 GUARD FORCE - RESPONSE/INTERDICTION ROLE

Guard forces with a response/interdiction role are more highly trained and responsible for conducting containment and denial actions. Guards may be trained and equipped for duties including: delaying at a distance, delaying to permit occupants at risk to escape, and finally delay–hold–counterattack. These guards protect personnel, goods, and services, but should not be expected to engage in law enforcement activities.

GUARD FORCE ROLES

- **Detection.** Monitor video surveillance equipment, control access, and patrol to detect threats.
- **Delay at a Distance.** Increase the time that elapses between the detection of an imminent terrorist attack and the actual onset of an attack to permit the arrival of response forces or the successful evacuation of personnel.
- **Delay to Permit Flight.** Increase the amount of time that elapses between the onset of an attack and terrorist access to executives to permit the arrival of response forces or the successful evacuation of executives under attack.
- **Delay, Hold, and Counterattack.** Increase the duration of an attack by allowing occupants to remain secure in a safe haven until a response force can arrive to repulse the attack, and apprehend the terrorists.

5.3.3 RESPONSE FORCE CONTINGENCY PLANNING

Conducting contingency planning and documenting procedures are critical to an effective response function. Contingency planning involves identifying potential intruders and developing response procedures for each likely threat. For example, facilities may specify a level of force that guards would be expected to use in different scenarios. Contingency planning also ensures the availability and redundancy of communication systems with both internal and external responders. This increases the ability of the guards to receive notification of an event, coordinate their internal response, and synchronize the response with outside agencies.

5.4 PROCEDURAL MEASURES

Procedural measures are the policies and procedures that limit vehicle and pedestrian movement around and within critical areas, limit the release of building information, such as plans and schematics, and encourage employee support of security programs. While most commercial buildings need to provide access for their tenants, customers, or the general public, each employee, maintenance person, and visitor does not need equal access to every space. Restricted areas may protect critical infrastructure or simply keep the public in easily observable spaces. Designating and enforcing parking controls are procedural measures of special note because of the possible use of vehicle bombs by terrorists.

5.4.1 RESTRICTED AREAS

Restricted areas are classified as controlled, limited, or exclusion areas, depending on the degree of security and control required (see Figure 5-7).



Figure 5-7: Electronic entry control device into restricted area.
SOURCE: BOB CIZMADIA

Controlled Area. A controlled area is that portion of a restricted area near or surrounding a limited or exclusion area. Entry to a controlled area is restricted to personnel with a need for access. Movement of authorized personnel within this area is not necessarily controlled because entry does not provide access to a security interest. The controlled area is provided for administrative control, for safety, or as a buffer zone to the in-depth security of the limited or exclusion area.

Limited Area. A limited area is a restricted area near a security interest. Uncontrolled movement may permit access to the security interest. Escorts and other internal restrictions may prevent access within limited areas.

Exclusion Area. An exclusion area is a restricted area containing a security interest. Uncontrolled movement permits direct access to the security interest.

5.4.2 PARKING AND TRAFFIC CONTROLS

In general, vehicle parking near buildings should be discouraged due to the threat of vehicle bombs. While pre-entry screening of vehicles at perimeter entrances will decrease the risk of penetration by vehicle-borne improvised explosive devices (IED), it does not eliminate this hazard. Restricting unscreened vehicles from parking under facilities, from parking within a predetermined distance from a building, or from traveling into a protected area will increase blast protection.

In summary, parking and traffic control activities include:

- Control on-site parking with ID checks, security personnel, and access systems (see Figure 5-8)
- Separate employee and visitor parking
- Eliminate internal building parking
- Ensure natural surveillance by concentrating pedestrian activity, limiting entrances/exits, and eliminating concealment opportunities
- Prevent pedestrian access to parking areas other than via established entrances

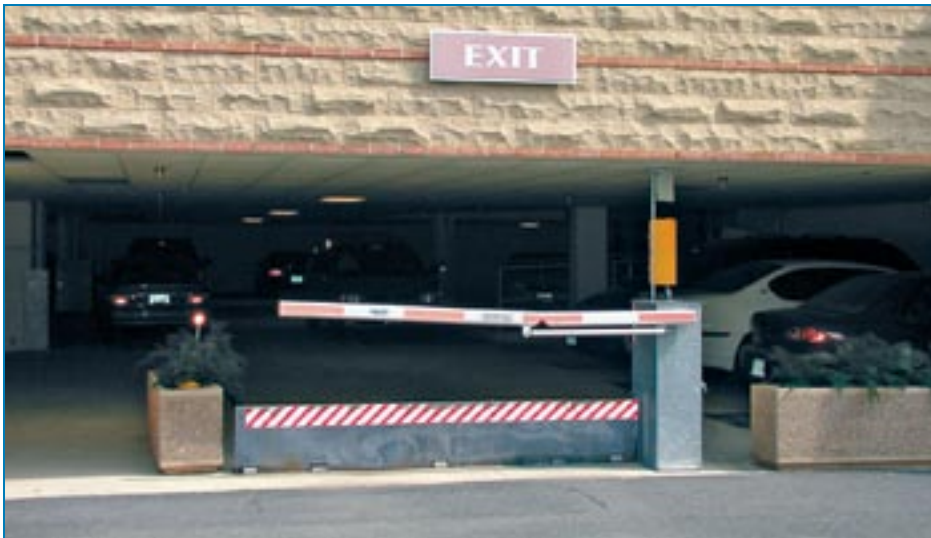

Figure 5-8: Parking control.

SOURCE: TERENCE RYAN

5.4.3 RESTRICT ACCESS TO FACILITY INFORMATION

Facility information, including drawings and operational procedures for mechanical, electrical, plumbing, structural, and security systems should be controlled, and its release should be restricted.

5.4.4 ENCOURAGE EMPLOYEE SUPPORT

Procedural measures require that employees be motivated to support the security program. Regardless of the security measures employed, if employees do not follow operational policies and procedures, vulnerabilities will persist. An appropriate corporate climate, adequate operational planning, and established management objectives will help encourage employees to support security measures.

5.5 PREPAREDNESS MEASURES

Preparedness measures are actions taken to increase readiness for a crisis, mitigate impacts, and respond to and recover from an incident. These include disaster preparedness planning, conducting risk assessments, developing mass notification warning systems, evacuation planning, preparing to shelter in place, monitoring systems and resources, and conducting training exercises.

PREPAREDNESS MEASURES

- Develop a Disaster Preparedness Plan
- Conduct Risk Assessments
- Develop Mass Notification Systems
- Conduct Evacuation Planning and Shelter in Place Preparation
- Monitor Systems and Resources
- Conduct Training Drills and Exercises

More information on disaster preparedness is available at the FEMA Web site: www.fema.gov/plan/index.shtm

5.5.1 DEVELOP A DISASTER PREPAREDNESS PLAN

Protecting facilities begins with developing a disaster preparedness plan. The FEMA Web site provides numerous links and examples of plans that can be tailored to fit your facility. The risk assessment, as well as identification of mitigation measures to minimize or prevent losses, provides the basis for developing the plan.

5.5.2 CONDUCT RISK ASSESSMENTS

Risk assessments are conducted to assess threat/hazards, impacts on assets, vulnerabilities to incidents, and subsequent risks. Security countermeasures should be defined and prioritized relative to their impact on risk.

5.5.3 DEVELOP MASS NOTIFICATION SYSTEMS

Mass notification systems, such as automatic messaging or public address systems, should be developed to reach all building occupants. These systems should provide warning and alert information, along with actions to

take before and after an incident. System and electric power redundancy should be ensured.

5.5.4 EVACUATION PLANNING AND SHELTER IN PLACE PREPARATION

The building occupants should be prepared for independent action prior to the arrival of emergency responders. This preparation involves evacuation planning and shelter in place preparation. The building occupants should also be trained on the Incident Command System in order to understand the chain of command, available integrated communications, and management of resources throughout the recovery.

5.5.5 MONITOR EMERGENCY SYSTEMS AND RESOURCES

Systems and resources intended to support the facility during a crisis should be monitored to ensure their availability and function. Examples of such systems and resources include, but are not limited to:

- Emergency equipment and critical utilities
- Fire alarms and detection and suppression systems
- Emergency resources and vendors (e.g., fuel for emergency generators)
- Alternate worksites
- Updated maps and floor plans
- System backups and off-site storage

5.5.6 CONDUCT TRAINING DRILLS AND EXERCISES

Training drills and exercises help to improve efficiency of emergency response teams and employees, clarify responsibilities, reveal weaknesses, and reduce stress. A commitment to testing also lends credibility and authority to the security program.

In summary, training involves:

- Rehearsing emergency plans with local law enforcement
- Conducting joint exercises with first responders

EMERGENCY MANAGEMENT

Complete information on the management of various emergency events and the Incident Command System is available from the FEMA Web site: www.fema.gov/emergency/nims/index.shtm

5.6 SECURITY MASTER PLANNING

All of these operational security measures should be guided by the final component, a Security Master Plan (see Figure 5-9). This 3- to 5-year plan, based on the goals of the overall organization, states the vision, goals, and objectives of the security program. The plan should also outline the operational security measures, the path for the security program to keep pace with the changing threat environment, and future initiatives. Further, it should be integrated into the organization's facility planning process as well as benchmarked against the security programs of similar facilities.

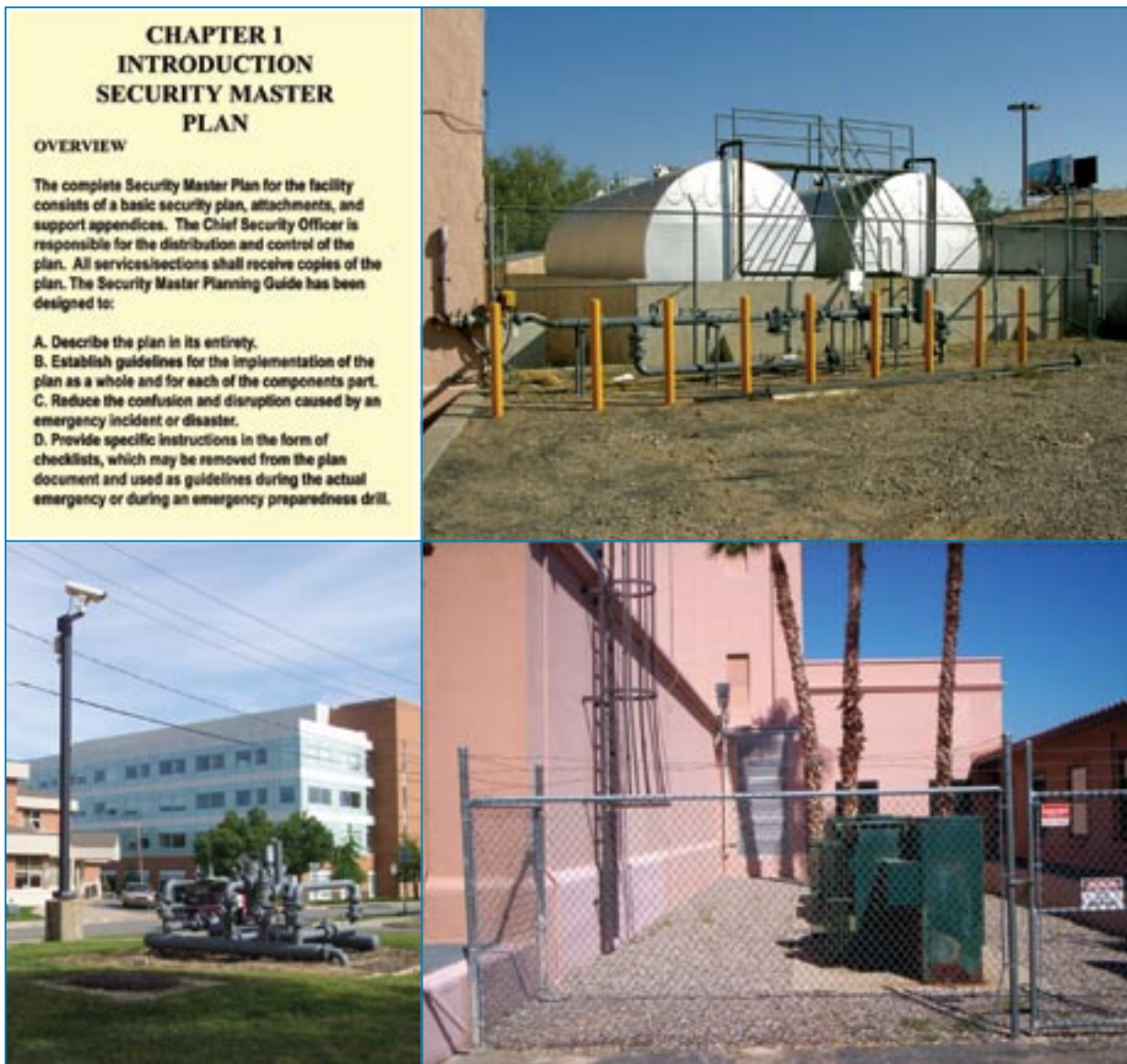

Figure 5-9: Security Master Planning integrates the operational security measures into the organization's facility planning process.

SOURCE: TERENCE RYAN

A comprehensive Security Master Plan should:

- Be communicated and disseminated to all levels of management and building occupants as appropriate
- Be integrated into the facility construction or renovation planning
- Be benchmarked or compared to related facilities
- Be tested and evaluated
- Identify threats/hazards, assets, vulnerabilities, and risks
- Establish a security improvement implementation schedule
- Establish a security operating and capital budget
- Follow regulatory or industry guidelines/standards

5.7 ADDITIONAL ASPECTS OF OPERATIONAL SECURITY MEASURES RELATED TO BLAST EVENTS

Tactics for developing and employing IEDs are continuing to evolve. Fortunately, responses to IED threats are also rapidly changing as technologies and procedures to detect and mitigate the terrorist leave-behind IED, human-carried IED, and vehicle-borne IED threats progress. Evolving countermeasure technologies are designed to provide time-sensitive information that security forces, critical asset managers, police/bomb squads, and incident commanders need to detect and counter IEDs away from critical infrastructure and personnel.

Additional operational security measures related to blast events include establishing an explosive detection program, establishing bomb threat procedures, and establishing blast-related mail/package handling procedures.

ADDITIONAL OPERATIONAL SECURITY MEASURES FOCUSED ON BLAST EVENTS

- Establish an explosive detection program
- Establish bomb threat procedures
- Establish blast-related mail/package handling procedures

5.7.1 ESTABLISH AN EXPLOSIVE DETECTION PROGRAM

The effectiveness of an explosive detection program is dependent on the level of sophistication of the detection measures. At the low end, bomb detection is conducted by inspection. Higher levels of protection are achieved using detection equipment, such as X-ray devices, metal detectors, and explosive detectors. Explosive detection dogs are an alternative to explosive detection technology.

5.7.2 ESTABLISH BOMB THREAT PROCEDURES

The following procedures should be followed when receiving a telephoned bomb threat:

- Get as much information from the caller as possible. Ask the following questions, if possible:

When is the bomb going to explode?

Where is it right now?

What does it look like?

What kind of bomb is it?

What will cause it to explode?

Did you place the bomb?

Why?

What is your address?

What is your name?

- Keep the caller on the line and record the conversation.
- Notify the police and building management.

5.7.3 ESTABLISH BLAST-RELATED MAIL/PACKAGE HANDLING PROCEDURES

Over the years, postal inspectors have identified typical characteristics of suspicious parcels. In many cases the packages:

- Are unexpected or from someone unfamiliar

- Have no return address or have one that cannot be verified as legitimate
- Have protruding wires or aluminum foil, strange odors, or stains
- Show a city or State in the postmark that doesn't match the return address
- Are of unusual weight given their size or are lopsided or oddly shaped
- Are marked with threatening language
- Have inappropriate or unusual labeling
- Have excessive postage or packaging material, such as masking tape and string
- Have misspellings of common words
- Are addressed to someone no longer with your organization or are otherwise outdated
- Have incorrect titles or titles without a name
- Are not addressed to a specific person
- Have hand-written or poorly typed addresses

5.8 ADDITIONAL ASPECTS OF OPERATIONAL SECURITY MEASURES RELATED TO CBR EVENTS

When protecting and responding to an accidental hazardous material release or an intentional CBR attack on a commercial building, focus operational security measures on personnel and vehicle access points, storage areas, the roof, mechanical areas, outdoor air intakes, and water utility feeds. The operational security needs of each building should be individually assessed, as the threat from a nearby hazardous material release or an actual CBR attack will vary considerably from building to building (Figure 5-10). Some operational security measures are low cost, such as locking doors to mechanical rooms or water utility pits, and can be implemented in retail, office, and multifamily residential buildings. Other operational security measures, such as personnel and package searches by X-ray or explosive detection

equipment, are expensive and may substantially inconvenience businesses. Measures should be implemented as warranted after careful consideration of the likelihood of an incident and the resulting consequences.

Figure 5-10: Projected plumes of CBR incident.

SOURCE: MICHAEL KAMINSKAS



ADDITIONAL OPERATIONAL SECURITY MEASURES FOCUSED ON CBR EVENTS

- Restrict access, and secure and monitor outdoor air intakes
- Light, secure, and monitor utility access points
- Secure and monitor exterior mechanical/electrical spaces
- Secure and monitor interior HVAC access points
- Provide internal first responders appropriate hazardous materials equipment
- Restrict access to facility and utility drawings
- Prevent unauthorized access and monitor roof areas
- Establish CBR related mail/package handling procedures

5.8.1 PREVENT ACCESS, AND SECURE AND MONITOR OUTDOOR AIR INTAKES

A contaminant could quickly spread throughout the building by the HVAC system. Air intakes that are publicly accessible and at or below ground level are at the most risk due to ease of approach, as well as characteristics of many CBR agents that cause them to remain close to the ground. Relocating or extending the air intakes upward can prevent access. Creating a restricted area to prevent public access, but allow access for authorized personnel can also improve security. Fencing or similar see-through barriers are preferred to allow visual detection of abnormal activity or a deposited CBR source. Security lighting should be provided for outdoor air intakes and other accessible points of the HVAC system, which should also be monitored with CCTV cameras. Intrusion detection sensors programmed to activate alarms, redirect surveillance cameras, and initiate recording should also be installed.

5.8.2 ESTABLISH CBR-RELATED MAIL/PACKAGE HANDLING PROCEDURES

Additional measures to mitigate the dangers from suspicious envelopes and packages with potential CBR agents include:

- Refraining from eating or drinking in a designated mail handling area
- Placing suspicious envelopes or packages in a plastic bag or some other type of container to prevent leakage of contents
- Avoiding sniffing or smelling suspect mail
- Covering the envelope or package with anything available (e.g., clothing, paper, or trash can)
- Leaving the room and closing the door and/or sectioning off the area to prevent others from entering
- Washing your hands with soap and water to prevent spreading any contaminants to your face
- Reporting the incident to your building security official or an available supervisor, who will notify authorities without delay
- Listing all people who were in the room or area when this suspicious letter or package was recognized to help local public health

authorities and law enforcement officials with follow-up investigations and advice

5.8.3 ADDITIONAL MEASURES

Additional measures to mitigate the potential spread of CBR agents through plumbing, mechanical, and electrical systems include:

- Hardening and locking incoming water service line junction points and service pits by installing intrusion detection sensors on the access points for all site utilities.
- Providing security lighting and monitoring on-site stored water and associated junction points with CCTV systems (Figure 5-11).

Figure 5-11: Exterior video camera for monitoring critical utilities.

SOURCE: BOB CIZMADIA



- Conducting perimeter surveys to identify mechanical, plumbing, and electrical rooms with exterior doors, windows, and utility openings. Hardening and locking the doors. Providing grills or louvers for all windows and man-passable openings in exterior walls below the second floor. (Openings greater than 96 square inches are considered man-passable.) Installing intrusion detection sensors on the access points.

- Securing exterior mechanical spaces and equipment. Identifying external mechanical spaces and equipment that are publicly accessible and establishing a means for direct surveillance, or monitoring with intrusion detection equipment and CCTV systems.
- Securing interior HVAC access points, such as return-air grills. Identifying the return-air grills that are publicly accessible and establishing a means for direct surveillance, or monitoring with intrusion detection equipment and CCTV systems. Removing or relocating furniture that obscures surveillance or provides access to the return air grills.
- Providing internal first responders access to appropriate hazardous materials response equipment. Required items, such as a hazardous material suit, gloves, boots, and a protective hood, may be packaged together for convenience.
- Restricting access to mechanical, plumbing, and electrical systems by outside maintenance personnel. Providing escorts for outside maintenance personnel that have not been pre-screened or are not from a trusted provider.
- Restricting access to facility and utility drawings and schematics.
- Preventing unauthorized access and monitoring facility roofs, which can provide access to HVAC systems, air intakes, and exhaust vents. Establishing fencing or barriers to restrict access from adjacent roofs. Locking and monitoring roof access doorways. Providing grills or louvers to man-accessible openings.

5.9 PRIORITIZATION OF OPERATIONAL SECURITY CONSIDERATIONS

Commercial buildings range in function from retail to office to multi-family facilities and hotels. They can be free-standing, strip mall, or multi-story structures, and have one occupant or thousands. These characteristics vary depending on whether building is located in a rural setting, a suburban setting, or a large urban area. The following general guidance is provided to protect retail, office, and multi-family apartment buildings, and hotels.

5.9.1 RETAIL BUILDINGS

Retail buildings are openly accessible to the public. This limits some of the operational physical security measures that can be applied. Physical hardening of the critical infrastructure may be implemented to address this limitation. However, even in these buildings, operational security measures can be applied:

- Restricted areas can be established for mechanical rooms, loading docks, roofs, and air vents.
- Interior and exterior CCTV systems may be established both for loss prevention and security detection.
- Anti-ram, landscaping, and other vehicle barriers may be established to mitigate the vehicle-borne IED threat.
- Certain detection and delay measures, such as visitor screening and access control, may not be practical during business hours. However, after business hours, all intrusion detection measures can be activated.
- Most procedural, preparedness, and master planning measures can be applied. Of these, rehearsing emergency plans with local law enforcement and conducting joint exercises with first responders are especially important because they contribute to a coordinated response in an incident.

5.9.2 OFFICE BUILDINGS

Office buildings usually have a circulation plan and procedures that permit greater control over visitors compared to retail facilities. This facilitates the use of the full range of the operational security measures to protect offices from blast and CBR attacks. Based on the risk assessment for an office building, effective physical security measures to deter, delay, detect, and interdict/respond may be established. All procedural, preparedness, and master planning measures, as appropriate, may also be applied.

5.9.3 MULTI-FAMILY APARTMENT BUILDINGS

A range of operational security measures is available for use in multi-family apartment buildings. Emergency preparedness plans and occupant

education may be the most important life savers in the event of an attack. Measures should include:

- Reviewing and updating emergency preparedness plans
- Providing education and training to occupants on evacuation procedures and identifying and reporting suspicious activity

Installing suitable hardware to lock doors and windows (delay measures) and using a remotely monitored alarm system (detection and interdiction/response measures) may also be useful in rented or leased spaces.

5.9.4 HOTEL SECURITY MEASURES

Operational security measures, similar to those for the other types of commercial buildings, may be established to protect a hotel from blast- and CBR-related events. Interior and exterior video surveillance systems may be established for loss prevention and security detection. Access to mechanical rooms, loading docks, roofs, and air vents should be restricted. Visitor screening and access control can be established during nighttime hours.

Most procedural, preparedness, and master planning measures can also be applied. Of these, rehearsing internal emergency plans and establishing a liaison with local law enforcement and other first responders are especially important because they contribute to a coordinated response in an incident.

5.10 INCREMENTAL INTEGRATION OF OPERATIONAL AND PHYSICAL SECURITY MEASURES INTO A RISK REDUCTION PROGRAM: FLEXIBILITY AND TRADEOFFS

Providing both an open, business-friendly environment and a safe and secure facility involves a delicate balance. Many diverse technologies are available to meet the security needs of a specific facility. The following flexibility and tradeoff considerations will help in the selection of incremental operational security measures.

Balance program improvements. Incremental increases in security should be implemented program-wide, with balanced deterrence, delay, detection and assessment, and interdiction/response measures.

Randomly implemented technology may only have a limited impact on risk reduction. For example, establishing electronic security systems on the doors and not the windows of a facility does not significantly improve security. Similarly, establishing a hardened, gated vehicle entrance that can be bypassed by driving across a lawn does not appreciably improve protection from vehicle bombs. Facility owners should plan incremental improvements that decrease the level of risk and increase the overall level of protection.

Use technology to improve detection effectiveness. Having a guard watching a bank of CCTV monitors without technology cueing systems usually limits detection. The integration of sensors with a CCTV system greatly increases the security effectiveness and the area that can be covered. Replacing or supplementing security guards with centralized monitoring station technology, rather than adding more personnel to monitor simple CCTV systems, may be a cost-effective incremental improvement.

Internet Protocol (IP)-based systems may provide flexibility and eliminate the need to integrate with other renovation projects. The rapid shift away from the classic, analog-only CCTV solutions to digital encoding and IP or network transport over open system connections presents existing building owners with new improvement opportunities. The installation of IP-based electronic security systems does not require the disruptive installation of long individual cable runs back to a central console. IP-based systems can generally be installed independent of major facility renovations.

Wireless systems may increase flexibility. In the past, installation of traditional wired external cameras or intrusion detection systems required thousands of dollars in installation costs and business disruptions from digging up roadways or parking lots to bury cables. This type of improvement had to be linked to other scheduled major renovations. Now, with IP-based systems and wireless links, installation may be less expensive and less disruptive, and can be completed independent of other scheduled renovations. However, wireless systems are more accessible to outsiders than wired systems and require appropriate protection, such as encryption, firewalls, and passwords to prevent hacking and tampering.

Not all hardware and software applications are compatible. Many proprietary systems cannot be integrated with other systems. They may also preclude future upgrades or the introduction of new capabilities. Facility managers should carefully project requirements and the necessary components of a complete system and plan for incremental improvements accordingly.

Plan the implementation of variable security measures. After establishing a baseline of protection, facility managers must be able to increase their protective posture in response to an increased threat. While many physical measures have long lead times (like applying fragment retention film on windows), many operational security measures do not require major capital improvement and can be quickly modified as needed. The practiced and proven capability to implement variable security measures, such as closing underground parking, screening visitors, or limiting access, may provide facilities with the alternative of continuing operations rather than doing nothing or closing during periods of increased threat.

Install a high profile security measure early in the improvement sequence to publicly highlight increased security. If a facility has several equally effective improvements, schedule the high profile items, such as gated entry into the loading dock area or a public access control system, early to increase the public perception of security.

5.11 OPERATIONAL SECURITY PROTECTION MEASURES

The operational security measures identified in the preceding discussions are listed below as an example of measures that might be generated by the FEMA 452 process and implemented using this document, as discussed in Chapter 2. The measures are categorized into those that include physical protection and strengthening measures (5.11.1), and those that are entirely operational (5.11.2). The former are all included in the list that comprises the vertical axes of the matrices in Section 2.3.

5.11.1 PHYSICAL PROTECTION AND STRENGTHENING BUILDINGS

1. Operational security measures related to blast and CBR events
 - Detection and assessment measures
 - Exterior intrusion detection systems
 - Interior intrusion detection systems
 - Video assessment and surveillance systems
 - Access control systems
 - Duress alarms

- Interdiction/response measures
 - Guard force: detection/delay role
- 2. Additional operational security measures related to blast events
 - None.
- 3. Additional operational security measures related to CBR Events
 - Restrict access and secure and monitor outdoor air intakes
 - Light, secure, and monitor water service access points
 - Install intrusion detection sensors for all utility services to the building
 - Secure and monitor exterior mechanical spaces and equipment
 - Secure and monitor interior HVAC access points

These measures can be implemented independently from one another.

5.1 1.2 OPERATIONAL MEASURES

1. Operational security measures related to blast and CBR events
 - Detection and assessment measures
 - Exterior intrusion detection systems
 - Interior intrusion detection systems
 - Video assessment and surveillance systems
 - Access control systems
 - Vehicle inspection systems
 - Duress alarms
 - Mail/package screening procedures
 - Interdiction/response measures
 - Guard force: detection/delay role
 - Guard force: response/interdiction role
 - Response force contingency planning
 - Procedural measures

- Restricted areas: controlled areas
 - Restricted areas: limited areas
 - Restricted areas: exclusion areas
 - Parking and traffic controls: separate employee and visitor parking
 - Parking and traffic controls: eliminate internal building parking
 - Parking and traffic controls: ensure natural surveillance
 - Parking and traffic controls: limit pedestrian access to parking areas
 - Restrict access to facility information
 - Encourage employee support
 - Preparedness measures
 - Develop a disaster preparedness plan
 - Conduct risk assessments
 - Develop mass notification systems
 - Conduct evacuation planning and shelter in place preparation
 - Monitor emergency systems and resources
 - Conduct training drills and exercises
 - Security master planning measures
 - Communicate and disseminate security master plan
 - Integrate into the facility construction or renovation planning
 - Benchmark or compare to related facilities
 - Test and evaluate the plan
 - Identify threats/hazards, assets, vulnerabilities, and risks
 - Establish security improvement implementation schedule
 - Establish security operating and capital budget
2. Additional operational security measures related to blast events
- Establish an explosive detection program
 - Establish bomb threat procedures

- Establish mail/package handling procedures
- 3. Additional operational security measures related to CBR events
 - Restrict access to, secure, and monitor outdoor air intakes
 - Light, secure, and monitor water service access points
 - Install intrusion detection sensors for all utility services to the building
 - Secure and monitor exterior mechanical spaces and equipment
 - Secure and monitor interior HVAC access points
 - Provide first responders appropriate hazardous materials equipment
 - Restrict access to critical utility drawings
 - Prevent unauthorized access to and monitor roof areas
 - Establish CBR-related mail/package handling procedures

All of these measures can be implemented independently from one another.

5.1 1.3 OPERATIONAL MEASURES CATEGORIZED INTO THE BUILDING VULNERABILITY ASSESSMENT CHECKLIST

The following list of operational mitigation measures reorganizes the preceding list (5.11.2) into the 13 sections of the Building Vulnerability Assessment Checklist in Appendix A of FEMA 452. Where applicable, the references in parentheses below refer to the respective sections in Chapters 4 and 5 where the item is discussed.

1. Site
 - 1.1 Vehicle inspections (5.2.5)
 - 1.2 Guard force, detection/delay role (5.3.1)
 - 1.3 Guard force, response/interdiction role (5.3.2)
 - 1.4 Parking and traffic controls (5.4.2)
 - 1.4.1 Control on-site parking

- 1.4.2 Separate employee and visitor parking
- 1.4.3 Eliminate internal building parking
- 1.4.4 Ensure natural surveillance
- 1.4.5 Limit pedestrian access to parking areas

2. Architectural

- 2.1 Expedient sheltering in place (4.4.1.2)
 - 2.1.1 Designating safe rooms, interior rooms having a lower air exchange rate
 - 2.1.2 Identifying switches for all air handling units and fans for deactivation
 - 2.1.3 Defining procedures for sheltering and for purging the building after plume passage
 - 2.1.4 Establishing a building-wide notification system
 - 2.1.5 Familiarizing occupants with the procedures and responsibilities
- 2.2 Evacuation (4.4.1.2)
- 2.3 Using escape respirators (4.4.1.2)
- 2.4 Enhanced physical security (4.4.2.2)
 - 2.4.1 Perform entry inspections
 - 2.4.2 Employ video surveillance equipment
 - 2.4.3 Institute mail screening procedures
 - 2.4.4 Maintain operational security to building plans and signage
- 2.5 Mail/package screening (5.7.3, 5.8.2)
- 2.6 Restricted areas (5.4.1)
 - 2.6.1 Controlled areas

- 2.6.2 Limited areas
- 2.6.3 Exclusion areas
- 2.7 Prevent unauthorized access to and monitor roof areas (5.8.4)
- 3. Structural Systems
- 4. Building Envelope
- 5. Utility Systems (water, sewer, fuel, electrical service, telephone, fire alarm)
- 6. Mechanical Systems (HVAC)
 - 6.1 Purging (expedient sheltering in place (4.4.1.2))
- 7. Plumbing and Gas Systems
- 8. Electrical Systems
- 9. Fire Alarm Systems
- 10. Communications and Information Technology Systems
 - 10.1 Expedient sheltering in place
 - 10.1.1 Defining building-wide notification system
 - 10.2 Develop mass notification systems (5.5.3)
- 11. Equipment Operations and Maintenance
 - 11.1 Provide first responders appropriate hazardous materials equipment (5.8.4)
- 12. Security Systems (perimeter security, interior security, security system documents)
- 13. Security Master Plan
 - 13.1 Detection and assessment measures
 - 13.1.1 Vehicle inspection systems (5.2.5)

- 13.1.2 Mail/package screening procedures (5.2.7)
- 13.2 Interdiction/response measures
 - 13.2.1 Response force contingency planning (5.3.3)
- 13.3 Procedural measures
 - 13.3.1 Restrict access to facility information (5.4.3)
 - 13.3.2 Encourage employee support (5.4.4)
- 13.4 Preparedness measures
 - 13.4.1 Develop disaster preparedness plan (5.5.1)
 - 13.4.2 Conduct risk assessments (5.5.2)
 - 13.4.3 Conduct evacuation planning and shelter in place preparation (5.5.4)
 - 13.4.4 Monitor emergency systems and resources (5.5.5)
 - 13.4.5 Conduct training drills and exercises (5.5.6)
- 13.5 Security master planning measures (5.6)
 - 13.5.1 Communicate and disseminate
 - 13.5.2 Integrate into the facility construction or renovation planning
 - 13.5.3 Benchmark or compare to related facilities
 - 13.5.4 Test and evaluate the plan
 - 13.5.5 Identify threats/hazards, assets, vulnerabilities, and risks
 - 13.5.6 Establish security improvement implementation schedule
 - 13.5.7 Establish security operating and capital budget
- 13.6 Additional operational security measures related to blast events

- 13.6.1 Establish an explosive detection program (5.7.1)
- 13.6.2 Establish bomb threat procedures (5.7.2)
- 13.6.3 Establish mail/package handling procedures (5.7.3)
- 13.7 Additional operational security measures related to CBR events
 - 13.7.1 Restrict access to critical utility drawings (5.8.4)

These security enhancement operational increments can be implemented at any time, as they do not entail physical work in the building.

American Concrete Institute (ACI), 2005. ACI 318-05, *Building Code Requirements for Structural Concrete and Commentary*, ACI Committee 318, 2005.

American Society of Heating, Refrigerating and Air-Conditioning Engineers (ASHRAE), 2004. *ASHRAE Handbook – HVAC Systems and Equipment*, ASHRAE, Inc., Atlanta, GA, January 2004.

ASHRAE, 2004. “Homeland Security for Buildings,” ASHRAE Satellite Broadcast, ASHRAE, Inc., Atlanta, GA, April 14, 2004.

American Society for Industrial Security (ASIS) International, 2000. *Protection of Assets Manual*, ASIS International, Alexandria, VA, www.protectionofassets.com.

ASIS International, 2005. *ASIS Business Continuity Guideline: A Practical Approach for Emergency Preparedness, Crisis Management, and Disaster Recovery*, ASIS International, Alexandria, VA, www.asisonline.org/guidelines/guidelinesbc.pdf.

American Society for Testing and Materials (ASTM), 2003. ASTM F 2248-03, *Standard Practice for Specifying an Equivalent 3-Second Design Loading for Blast Resistant Glazing Fabricated with Laminated Glass*, ASTM International, West Conchohocken, PA, August 10, 2003.

Blewett, W.K., and Arca, V.J., 1999. *Experiments in Sheltering in Place: How Filtering Affects Protection Against Sarin and Mustard Vapor*, AD A365348, U.S. Army Chemical Biological Center, Aberdeen Proving Ground, MD, June 1999.

Blewett, W.K., et al., 1996. *Sheltering in Place: An Evaluation for the Chemical Stockpile Emergency Preparedness Program*, AD A370441, U.S. Army Chemical Biological Center, Aberdeen Proving Ground, MD, May 1996.

Blewett, W.K., 2002. *Fail-Safe Application and Design of Air Conditioners for NBC Collective Protection Systems*, ECBC-TR-223, U.S. Army Chemical Biological Center, Aberdeen Proving Ground, MD, February 2002.

Centers for Disease Control and Prevention (CDC) and National Institute for Occupational Safety and Health (NIOSH), 2002. *Guidance for Protecting Building Environments from Airborne Chemical, Biological, or Radiological Attacks*, Atlanta, GA, www.cdc.gov/niosh/bldvent/2002-139.html.

Department of the Army, 1996. *Expedient Sheltering In Place: An Evaluation for the Chemical Stockpile Emergency Preparedness Program*, ERDEC-TR-336. U.S. Army Edgewood Research, Development and Engineering Center, Aberdeen Proving Grounds, MD, June 1996.

Department of the Army, 2001. *Field Manual 3-19.30, Physical Security*, www.army.mil/usapa/doctrine/Active_FM.html.

Department of Defense, 2003. *UFC 4-010-01 Unified Facilities Criteria (UFC) DoD Minimum Antiterrorism Standards for Buildings*, www.wbdg.org/references/pa_dod.php.

Department of Health and Human Services, National Institute for Occupational Safety and Health (NIOSH), 2002. *Guidance for Protecting Building Environments from Airborne Chemical, Biological, or Radiological Attacks*, Publication No. 2002-139, May 2002.

Department of Health and Human Services, NIOSH, 2003. *Guidance for Filtration and Air-Cleaning Systems to Protect Building Environments from Airborne Chemical, Biological, or Radiological Attacks*, Publication No. 2003-136, April 2003.

Department of State, 2003. *Specification for Vehicle Crash Test of Perimeter Barriers and Gates, Revision A*, SD-STD-02.01, Washington, DC, <https://pdc.usace.army.mil/library/BarrierCertification>.

Federal Emergency Management Agency (FEMA), 2003. *Reference Manual to Mitigate Potential Terrorist Attacks Against Buildings*, Publication 426, FEMA, Washington, DC, www.fema.gov/plan/prevent/rms/rmsp426.shtm.

FEMA, 2003. *Incremental Seismic Rehabilitation of School Buildings (K-12)*, Publication 395, FEMA, Washington, DC, www.fema.gov/plan/prevent/rms/rmsp395.shtm.

FEMA, 2005. *A How-To Guide to Mitigate Potential Terrorist Attacks Against Buildings*, Publication 452, FEMA, Washington, DC, www.fema.gov/plan/prevent/rms/rmsp452.shtm.

FEMA, 2006a. *Design Guidance for Safe Rooms and Shelters*, Publication 453, FEMA, Washington, DC, www.fema.gov/plan/prevent/rms/rmsp453.shtm.

FEMA, 2006b. *Bomb Threat*, FEMA, Washington, DC, www.fema.gov/hazard/terrorism/exp/exp_threat.shtm.

FEMA, 2006c. *Suspicious Packages and Letters*, FEMA, Washington, DC, www.fema.gov/hazard/terrorism/exp/exp_parcel.shtm.

FEMA, 2007. *Site Urban Design for Security: Guidance Against Potential Terrorist Attacks*, Publication 430, FEMA, Washington, DC, www.fema.gov/library/viewRecord.do?id=3135.

Fennelly, Lawrence J., 1999. *Handbook of Loss Prevention and Crime Prevention*, Stoneham, MA, Butterworth-Heinemann, ISBN: 0-7506-9703-2.

Fennelly, Lawrence J., 2004. *Effective Physical Security, Third Edition*, Burlington, MA, Elsevier Inc., ISBN: 0-7506-7767-8.

Garcia, Mary Lynn, 2001. *The Design and Evaluation of Physical Protection Systems*, Stoneham, MA, Butterworth-Heinemann, ISBN: 0-7506-7367-2.

General Services Administration, 2002. *Facilities Standards for Public Buildings Service, PBS-P100*, General Services Administration, Washington, DC, www.gsa.gov/Portal/gsa/ep/channelView.do?pageTypeId=8195&channelId=-15012.

General Services Administration, 2005. *Facilities Standards for the Public Buildings Service, PBS-P100-2005*, General Services Administration, Washington, DC, www.gsa.gov/Portal/gsa/ep/channelView.do?pageTypeId=8195&channelId=-14201.

Kovacich-Halizobek, 2003. *The Managers Handbook for Corporate Security*, Butterworth-Heinemann, Woburn, MA, pp. 186-206.

Lawrence Berkeley National Laboratory (LBNL), 2003. *Protecting Buildings from Biological or Chemical Attack: actions to be taken before or during a release*, Publication 51959, January 10, 2003.

Patterson, David G. III, CPP, CFE, CHS, 2004. *Implementing Physical Protection Systems: A Practical Guide*, USA, ASIS International, ISBN: 1-887056-58-0.

Purpura, Philip P., 2002. *Security and Loss Prevention, An Introduction, Fourth Edition*, Woburn, MA, Butterworth-Heinemann, ISBN: 0-7506-7437-7.

Smilowitz, Robert, 2005. *Designing to Resist Explosive Threats*, prepared for the National Institute of Building Sciences, 2005.

Smilowitz, Robert, 2005. *Retrofits to Resist Explosive Threats*, prepared for the National Institute of Building Sciences, 2005.

U.S. Air Force, 2003. *Entry Control Facilities Design Guide*, www.afcee.brooks.af.mil/dc/dcproducts/products.asp.

U.S. Army Corps of Engineers, 1999. "Design of Collective Protection Shelters to Resist Chemical, Biological, and Radiological (CBR) Agents," Engineer Technical Letter 1110-3-498, Washington, DC, 24 February 1999.

U.S. Army Corps of Engineers, 2001. *Protecting Buildings and Their Occupants from Airborne Hazards* (draft), Technical Instruction 853-01, October 2001.

U.S. Army Corps of Engineers, 2005. *Security Engineering: Procedures for Designing Airborne CBR Protection for Buildings* (draft), UFC 4-024-01, 4 February 2005.