

BBN Technologies

BBN Technical Memorandum No. 1270

ANIMIDA Phase I: Ambient and Industrial Noise Measurements Near the Northstar and Liberty Sites During April 2000

Final Report

August 2001

The opinions, findings, conclusions, or recommendations expressed in this report or product are those of the authors and do not necessarily reflect the views of the U.S. Department of the Interior, nor does mention of trade names or commercial products constitute endorsement or recommendation for use by the Federal Government.

G. W. Shepard, P.A. Krumhansl, M.L. Knack, C. I. Malme

Arctic Nearshore Impact Monitoring in the Development Area (ANIMIDA)

Prepared for:

This study was funded by the U.S. Department of the Interior, Minerals Management Service (MMS), Alaska Outer Continental Shelf Region, Anchorage, Alaska, under Contract No. 143501-99-CT-30998, as part of the MMS Alaska Environmental Studies Program.

Table of Contents

LIST OF TABLES III

LIST OF FIGURES..... III

LIST OF ACRONYMS AND ABBREVIATIONS V

EXECUTIVE SUMMARY 1

1.0 OVERVIEW 1

1.1 Introduction 1

1.2 Objectives 2

1.3 Field Measurement Summary 2

2.0 STUDY AREA DESCRIPTION AND METHODS..... 4

2.1 Study area 4

2.2 Acoustic and Vibration Measurements and Analysis Methods 7

 2.2.1 Measurement System 7

 2.2.2 Analysis Methods 10

3.0 RESULTS 11

3.1 Northstar Site 12

 3.1.1 Site NS-Trench1 12

 3.1.2 Site NA3 15

 3.1.3 Site NA2 23

 3.1.4 Site NA5 25

 3.1.5 Site NA6 36

 3.1.6 BSMP Site 5(5) 42

3.2 Liberty Site 46

 3.2.1 Site LA2 46

 3.2.2 Site LA3 48

4.0 DISCUSSION 53

4.1 Underwater Noise Environment 53

4.2 In-air Noise Environment 57

4.3 Ice Vibration Environment 60

5.0 SUMMARY AND CONCLUSIONS63

5.1 Noise and Vibration During Northstar Vibrahammer Operation63

5.2 Noise and Vibration without Northstar Vibrahammer Operation64

6.0 ACKNOWLEDGEMENTS65

7.0 LITERATURE CITED65

APPENDIX A: COMPLETE LISTING OF THE COLLECTED DATA SET66

APPENDIX B: THIRD OCTAVE BAND CENTER FREQUENCIES, HZ66

List of Tables

Table 1-1. Noise and vibration Measurement sites and environmental conditions.....2
 Table 2- 1. Measurement site locations and relative position re Northstar.4
 Table 2- 2. Amplifier gains for each data channel and measurement site.....8

List of Figures

Figure 2- 1. Map of ANIMIDA study area.....5
 Figure 2- 2 Photograph of Northstar Island showing sheet piling and the vibrahammer suspended from a crane.6
 Figure 2- 3. Photograph of site NA3 preparations.....7
 Figure 2- 4. Acoustic and vibration measurement system.....8
 Figure 2- 5. Hydrophone system characteristics.....9
 Figure 2- 6. Measured geophone and microphone electronic noise floors.....9
 Figure 3.1.1- 1. Near-bottom underwater Noise near Northstar ice road (2-2700).13
 Figure 3.1.1- 2. Mid depth underwater Noise near Northstar ice road (2-2700).13
 Figure 3.1.1- 3. Airborne noise near Northstar ice road (2-2700).14
 Figure 3.1.1- 4. Measured ice vibration levels near Northstar ice road (2-2700).15
 Figure 3.1.2- 1. Near-bottom underwater noise at Site NA3 (3-4610).16
 Figure 3.1.2- 2. Mid channel depth underwater noise at Site NA3 (3-4610).16
 Figure 3.1.2- 3. Near bottom underwater noise at Site NA3 (3-1315).17
 Figure 3.1.2- 4. Mid channel depth underwater noise at Site NA3 (3-1315).18
 Figure 3.1.2- 5. Airborne noise at Site NA3 (3-4610).18
 Figure 3.1.2- 6. Second example of airborne noise at Site NA3 (3-1315).19
 Figure 3.1.2- 7. Ice vibration levels from vibrahammer at Site NA3 (3-1315).19
 Figure 3.1.2- 8. Near bottom underwater noise at Site NA3, plowing noise (3-8100).20
 Figure 3.1.2- 9. Mid channel depth underwater noise at Site NA3, plowing (8-8100). ..21
 Figure 3.1.2- 10. Near bottom underwater noise at Site NA3; quiet (3-2500).21
 Figure 3.1.2- 11. Mid channel depth underwater noise at Site NA3; quiet (3-2500).22
 Figure 3.1.2- 12. Airborne noise at Site NA3; plowing (3-8100).22
 Figure 3.1.2- 13. Second example of airborne noise at Site NA3 (3-2500).23
 Figure 3.1.2- 14. Ice vibration noise spectra at Site NA3; plowing (3-8100).24
 Figure 3.1.2- 15. Second example of ice vibration noise at Site NA3 (3-2500).24
 Figure 3.1.3- 1. Near bottom underwater noise at site NA2. (4-4000).....25
 Figure 3.1.3- 2. Mid channel underwater noise at site NA2. (4-4000).....26
 Figure 3.1.3- 3. Measured in-air noise levels at site NA2. (4-4000)26
 Figure 3.1.3- 4. Measured ice vibration levels at site NA2. (4-4000)27
 Figure 3.1.4- 1. Near bottom underwater noise levels at site NA5; lunch break. (8-4400)28
 Figure 3.1.4- 2. Mid-channel underwater noise levels at site NA5; lunch break. (8-4400)29
 Figure 3.1.4- 3. Measured in-air noise levels at site NA5; lunch break. (8-4400)29

Figure 3.1.4- 4. Measured ice vibration levels at site NA5; lunch break. (8-4400)30

Figure 3.1.4- 5. Near bottom underwater noise levels at site NA5; vibrahammer. (8-1200)
.....31

Figure 3.1.4- 6. Mid channel underwater noise levels at site NA5; vibrahammer. (8-1200)
.....31

Figure 3.1.4- 7. Near bottom underwater noise levels at site NA5; strong vibrahammer.
(10-0000).....32

Figure 3.1.4- 8. Mid channel underwater noise levels at site NA5; strong vibrahammer.
(10-0000).....33

Figure 3.1.4- 9. In-air noise levels at site NA5; vibrahammer. (10-0000)33

Figure 3.1.4- 10. Second sample of in-air noise levels at site NA5; vibrahammer. (9-
6000).....34

Figure 3.1.4- 11. Measured in-air noise levels at site NA5; no vibrahammer. (8-1200)...35

Figure 3.1.4- 12. Second example of in-air noise levels at site NA5; no vibrahammer.
(10-1300).....35

Figure 3.1.4- 13. Ice vibration noise levels at site NA5; vibrahammer. (10-0000).....36

Figure 3.1.4- 14. Measured ice vibration levels at site NA5; vibrahammer. (10-1300)....37

Figure 3.1.5- 1. Near bottom underwater noise levels, site NA6; vibrahammer. (11-1300)
.....38

Figure 3.1.5- 2. Mid channel underwater noise levels, site NA6; vibrahammer. (11-1300)
.....38

Figure 3.1.5- 3. Near bottom underwater noise levels at site NA6; no vibrahammer. (11-
5330).....39

Figure 3.1.5- 4. Mid channel underwater noise levels at site NA6; no vibrahammer. (11-
5330).....39

Figure 3.1.5- 5. Measured in-air noise levels at site NA6; vibrahammer. (11-1300).....40

Figure 3.1.5- 6. Measured in-air noise levels at site NA6; no vibrahammer. (11-5330)...41

Figure 3.1.5- 7. Measured ice vibration levels at site NA6; vibrahammer. (11-1300).....41

Figure 3.1.5- 8. Measured ice vibration levels at site NA6; no vibrahammer. (11-5330).42

Figure 3.1.6- 1. Near bottom underwater noise levels at site 5(5); lower winds. (5-0400)
.....43

Figure 3.1.6- 2. Near bottom underwater noise levels at site 5(5); higher winds. (5-6050)
.....43

Figure 3.1.6- 3. Mid channel underwater noise levels at site 5(5); lower winds. (5-0400)
.....44

Figure 3.1.6- 4. Mid channel underwater noise levels at site 5(5); higher winds. (5-6050)
.....44

Figure 3.1.6- 5. Measured in-air noise levels at site 5(5). (5-0400)45

Figure 3.1.6- 6. Measured ice vibration levels at site 5(5). (5-0400)46

Figure 3.2.1- 1. Near bottom underwater noise level measured at site LA2 (6-1200).47

Figure 3.2.1- 2. Mid channel underwater noise level measured at site LA2 (6-1200).47

Figure 3.2.1- 3. Airborne noise level measured at site LA2 (6-1200).48

Figure 3.2.1- 4. Ice vibration noise level measured at site LA2 (6-1200).49

Figure 3.2.2- 1. Near bottom underwater noise level measured at site LA3 (7-5000).49

Figure 3.2.2- 2. Mid channel underwater noise level measured at site LA3 (7-5000).50

Figure 3.2.2- 3. Airborne noise level with flare measured at site LA3 (7-5000).51

Figure 3.2.2- 4. Airborne noise level with no audible flare measured at site LA3 (7-1200).51

Figure 3.2.2- 5. Ice vibration noise spectrum measured at site LA3 (7-5000).52

Figure 4.1- 1. Vibrahammer 23 Hz tonal spectrum level as a function of range as received on the near-bottom hydrophone (H1) and mid-channel depth hydrophone (H2).54

Figure 4.1- 2. Comparison of 1/3 OB spectra at multiple sites collected during vibrahammer operation using the hydrophone positioned near the bottom (H1).55

Figure 4.1- 3. Comparison of 1/3 OB spectra at multiple sites collected during vibrahammer operation using the hydrophone positioned in the middle of the water column (H2).56

Figure 4.1- 4. Comparison of 1/3 OB noise spectra at multiple sites without vibrahammer noise collected using the Hydrophone positioned near the bottom (H1).57

Figure 4.1- 5. Comparison of 1/3 OB noise spectra at multiple sites without vibrahammer noise collected using the Hydrophone positioned in the middle of the water column (H2)58

Figure 4.2- 1. Comparison of 1/3 OB airborne noise spectra at multiple sites with vibrahammer in operation at least at sites NA3, NA5, and NA6.59

Figure 4.2- 2. Comparison of 1/3 OB airborne noise spectra at multiple sites without vibrahammer excitation.59

Figure 4.3- 1. Comparison of 1/3 OB ice vibration noise spectra at multiple sites with vibrahammer in operation at least at sites NA3, NA5, and NA6.60

Figure 4.3- 2. Vibrahammer 23 Hz tonal received ice vibration spectrum level as a function of range.61

Figure 4.3- 3. Comparison of 1/3 OB ice vibration noise spectra at multiple sites without vibrahammer excitation.62

List of Acronyms and Abbreviations

ANIMIDA	Arctic Nearshore Impact Monitoring in the Development Area
BBN	Bolt Beranek and Newman
BSMP	Beaufort Sea Monitoring Posts
c	speed of sound in water (typically near 1500 m/s)
Cm	centimeter (1 cm = 0.39 inches)
CTD	Conductivity, Temperature, Depth profile measurement tool
d	water depth
DAT	Digital Audio Tape
dB re 1 μ Pa	decibels in relation to a reference pressure of 1 microPascal
dBV	decibel in relation to a reference of 1 volt
f_c	center frequency of a 1/3-octave band
F_c	acoustic cutoff frequency from normal mode theory
FFT	Fast Fourier Transform
ft	foot or feet (1 ft = 0.305 m)
Hz	Hertz (cycle per second)

ITC	International Transducer Corporation
kHz	kilo-Hertz (1000 cycle per second)
km	kilometer (1 km = 3281 feet or 0.54 nautical mile)
kt	knot (1 nautical mile per hour)
m	meter (1 m = 1.09 yards or 3.28 feet)
MATLAB™	Mathematical Software by The Mathworks Inc.
MLLW	mean lower low water
MMS	Minerals Management Service, U. S. Dept. of the Interior
nm	nautical mile (1 nm = 1.852 km)
OB	octave band
OCS	Outer Continental Shelf
SNR	Signal-to-Noise Ratio
SPL	Sound Pressure Level

Executive Summary

As part of the Minerals Management Service (MMS) program entitled "Arctic Nearshore Impact Monitoring in the Development Area," a winter field survey was conducted from 25 April to 30 April, 2000. Measurements of site-specific underwater noise, in-air noise, and ice vibrations were made at eight locations near and between the Northstar and Liberty prospects. Both prospects are located in the nearshore portion of the outer continental shelf in the Beaufort Sea near Prudhoe, Alaska.

The goal of this effort was to characterize noise and vibration conditions near the Northstar site which was under construction and near the Liberty site which is planned for development in the near future.

Analysis results are presented that document the underwater noise at two water depths, the airborne noise conditions, and the ice vibration levels at ranges varying from about 0.08 nm (0.15 km) to >2.2 nm (4 km) from Northstar. The results present measured levels caused by construction activities at Northstar including sheet pile driving using a vibrohammer, plowing operations, general truck movement on and near the island, island mounted machinery generated noise, and trench backfilling operations.

Similar measurements were made at and near the Liberty site which document the conditions with minimal, if any, man-made noise present.

1.0 Overview

1.1 Introduction

As onshore and offshore oil and gas exploration, development, and production activities increase across Alaska's North Slope, concern is also on the rise regarding the long-term effects of these activities.

This study is part of a multidisciplinary impact monitoring program of the first Federal oil development offshore of Alaska, in the nearshore Beaufort Sea. The overall goal is to verify the projected impacts from development and production and to provide information to support post-leasing decisions to minimize further impacts. Specifically, this study is the initial step of the ANIMIDA program to monitor impacts associated with the development activities and initial production of oil from Northstar and Liberty Units in the nearshore portion of the Outer Continental Shelf (OCS) in the Beaufort Sea near Prudhoe Bay.

During April of 2000, a team of scientists made several daily trips via snowmobile to various sites near and around both the Northstar and Liberty sites. The following physical environmental parameters were measured:

- Sediment samples to determine contaminant concentrations in local sediments and any residual mud and cuttings from earlier exploration activities,

- Suspended sediments to determine whether resuspension from construction activities will impact turbidity levels in the water or ice cover, and
- Acoustic and vibration noise levels to characterize the ambient and construction noise conditions.

This report documents the results of the third bullet, acoustic and vibration characterization.

1.2 Objectives

The goal of this study was to conduct a preliminary characterization of the site-specific noise and vibration environment at Northstar and Liberty sites. Specifically, the objectives were to measure and document both ambient and industrial noise in the air and underwater both in open water and ice-covered conditions, and, during the winter/spring, vibrations in the ice. The measurement of ambient noise levels was intended to address the basic question: Do the construction and operational activities at Northstar and Liberty result in noise levels and spectral shapes that differ from naturally occurring background conditions? These results will ultimately be used to examine the validity of the working hypothesis: Noise levels and related acoustic features in the study area differ from background levels as a result of Northstar and Liberty activities.

1.3 Field Measurement Summary

Two field measurement periods were chosen: an open water period from 16-26 August 1999, and an ice-covered period from 26-29 April 2000. Unfortunately, the data collected during August were severely contaminated with wave slap sounds (both in air and underwater) against the aluminum hull of MMS Launch 1273. Attempts were made in the field to separate the sensors from the vessel but these efforts proved unsuccessful. We also tried to identify “uncontaminated” snippets and statistically separate the wave slap characteristics from the underlying ambient noise also met with failure. Consequently, this data set was abandoned.

The data collection efforts in April were much more successful. Over the course of five days, acoustic and vibration measurements were collected at eight sites. The locations and their associated environmental conditions are provided in Table 1-1. Note: all latitudes and longitudes in NAD83 datum.

Station		Date	Time, Local	Latitude	Longitude	Wind Dir/ Speed, kts	Air Temp, deg C	Water Depth (m)	Ice Depth (m)
ID	Type								
S(5)	BSMP	04/27/2000	04/27/2000	70° 26.108	148° 18.090	N/9	-9	6.5	1.6
LA2	Liberty	04/28/2000	04/28/2000	70° 18.970	147° 37.928	Calm	-9	6	1.6
LA3	Liberty	04/28/2000	04/28/2000	70° 16.778	147° 33.529	SW/2	-9	6.1	1.6
NS-Trench1	Northstar	04/25/2000	04/25/2000	70° 28.806	148° 41.607	N/7	-13	9.7	1.6
NA2	Northstar	04/26/2000	04/26/2000	70° 30.817	148° 36.351	N/3	-11	10.8	1.7
NA3	Northstar	04/26/2000	04/26/2000	70° 29.569	148° 41.460	N/10	-14	11.5	2.4
NA5	Northstar	04/29/2000	04/29/2000	70° 29.889	148° 40.734	N/5	-11	11.8	1.8
NA6	Northstar	04/29/2000	04/29/2000	70° 30.372	148° 39.911	W/9	-6	12.4	1.8

Table 1-1. Noise and vibration Measurement sites and environmental conditions.

At each site, a suite of four sensors was deployed.

- Two ITC 6050C hydrophones to measure underwater noise both near the bottom and at mid-water depth.
- A 0.5 inch Electret-Condenser microphone to collect in-air acoustic noise.
- A Geo Space GS-30CT geophone which was frozen into the ice surface to measure ice vibrations.

Data from each sensor were amplified and recorded to a TEAC DAT recorder operating at double speed resulting in a measurement band from 2 Hz to 20 kHz. In addition, local environmental parameters were measured including air temperature, wind speed and direction, and CTD (conductivity, temperature, and depth) profiles of the water column.

2.0 Study Area Description and Methods

2.1 Study area

The study area is shown in Figure 2-1. The sampling protocol consisted of collecting data at two sites near the Liberty Prospect and a set of six sites at varying ranges from the Northstar Prospect. The Liberty sites are intended to establish a measurement basis prior to construction activities. The Northstar sites were selected at incremental ranges from the prospect to sample the range dependent aspects of noise and vibration excitation. Table 2-1 shows the location of the sites sampled near Northstar and the range and direction from Northstar to each site.

Site ID	Latitude	Longitude	Range to Northstar, km	Direction from Northstar to Site
NS-Trench	70° 28.806	148° 41.607	1.8	S
NA3	70° 29.569	148° 41.460	0.15	E
NA5	70° 29.889	148° 40.734	1	NNE
NA6	70° 30.372	148° 39.911	2	NNE
NA2	70° 30.817	148° 36.351	4	NNE
5(5)	70° 26.108	148° 18.090	15	SE

Table 2- 1. Measurement site locations and relative position re Northstar.

The Liberty site has yet to see any development activities so the measurements collected are primarily ambient conditions with the possible exception of noise/vibration radiating from a natural gas flare located at the end of the Endicott dock.

Two measurement sites were visited in April of 2000: LA2 and LA3, which are both marked in Figure 2-1. LA2 is located approximately 2.7 nm (5 km) NNW of the Liberty site over the Boulder Patch in 19.7 ft (6.0 m) water. The measured ice thickness was 5.2 ft (1.6 m). Site LA3 is at the center of the future Liberty artificial island where the water is 20.0 ft (6.1 m) deep and the ice thickness was also 5.2 ft (1.6m).

At Northstar, human activities were in nearly constant motion during our measurement periods. By the time of our measurements, the artificial island at Northstar was mostly complete. The main activities consisted of driving sheet piles into the island perimeter, backfilling the pipeline trench to shore, and truck movements plowing and moving earth on and about the island.

Figure 2-2 is a photograph taken on 26 April of Northstar. Suspended from the larger crane in the picture is a vibrahammer which is used to drive the sheet pilings around the perimeter of the island. Vibrahammer noise and vibration was a significant source during the measurement period and is described in Section 3.

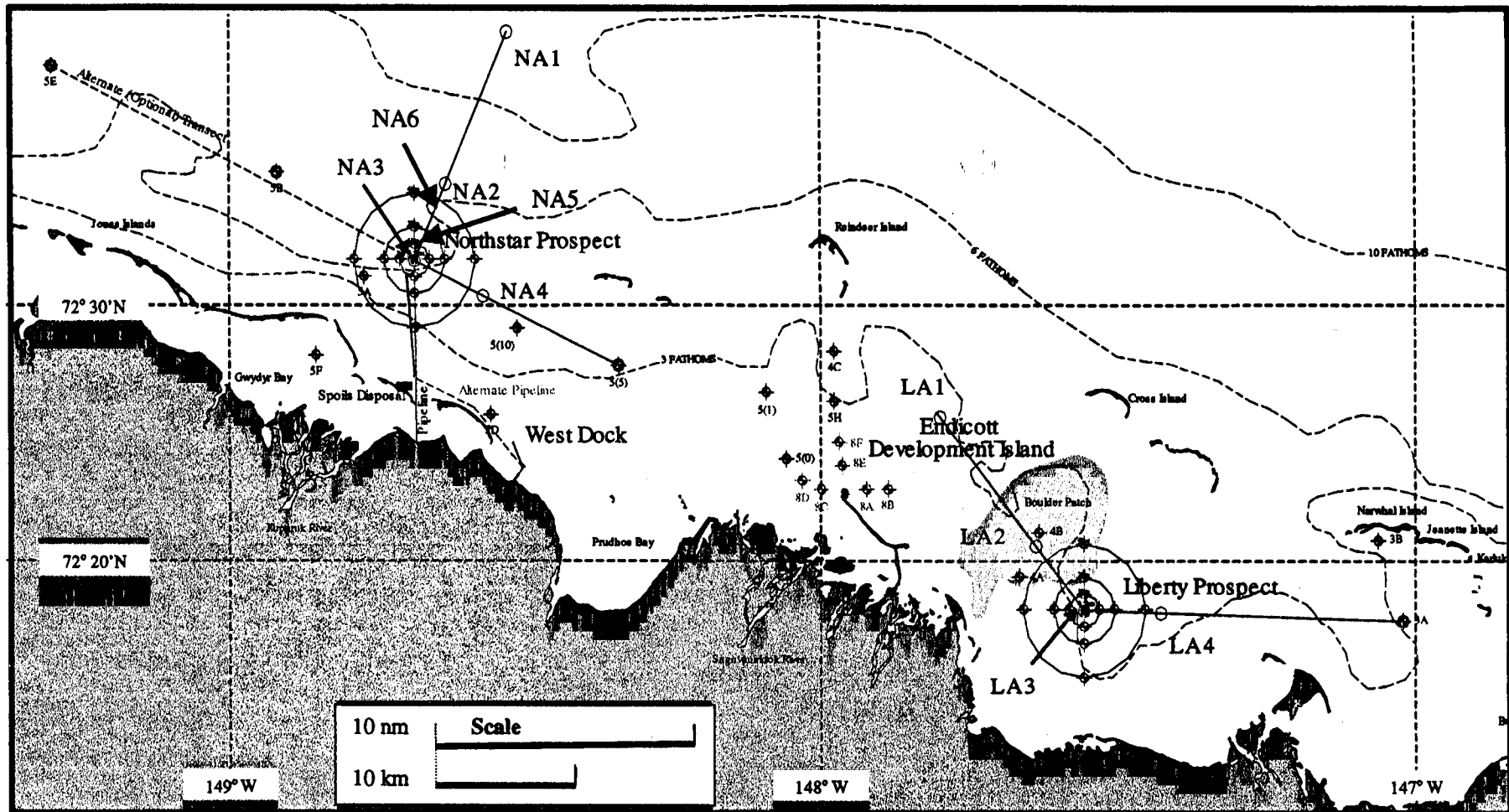

Figure 2- 1. Map of ANIMIDA study area.

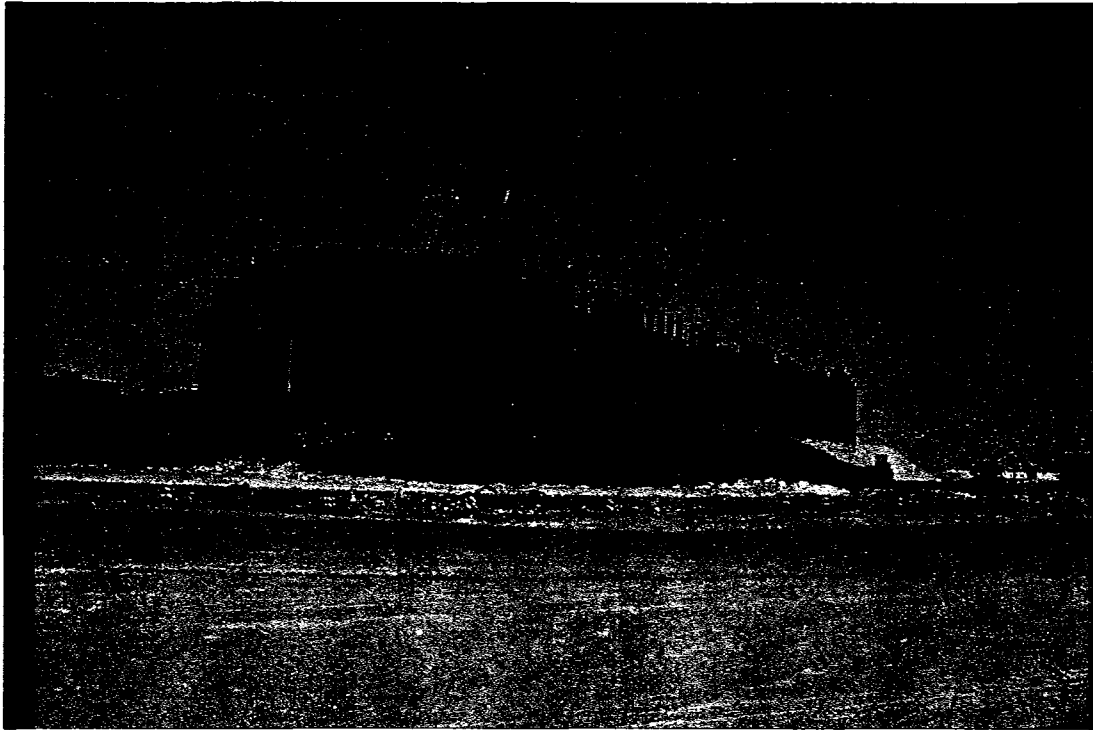

Figure 2- 2 Photograph of Northstar Island showing sheet piling and the vibrahammer suspended from a crane.

Six measurement sites near Northstar were visited. The first site, labeled as NS-Trench1 in Table 1-1, was near the ice road connecting the shore to the artificial island at a location roughly 1 nautical mile (nm) from the island. The sea ice was somewhat soft and slushy. The pipeline trench had already been opened and the pipe inserted. Backfilling of the trench was in progress. Truck movement and plowing noises were also present throughout the data set. Road graders were occasionally present working the ice road. During this period, sheet pile driving was not apparent to the scientific team.

The five other sites near Northstar include sites NA2, NA3, NA5, NA6, and BSMP site 5(5). The site positions varied in range from Northstar from 0.08 nm (150 m) (site NA3) to approximately 8.1 nm (15 km) (site 5(5)). Measurements were collected during daylight hours while activities continued on/near the island.

In general, the ice conditions at all sites consisted of shore-fast ice varying in depth from roughly 4.9 to 8.2 ft (1.5 to 2.5 m). The skies were overcast most of the time and light snow was in the air almost continuously. The ice was covered with light fluffy snow to a depth ranging from 2-6 inches (5-15 cm) which undoubtedly produced higher in-air propagation loss than would have been evident with bare pack ice. The photograph in Figure 2-3 was taken at site NA3 near the Northstar site and clearly shows the snow conditions.

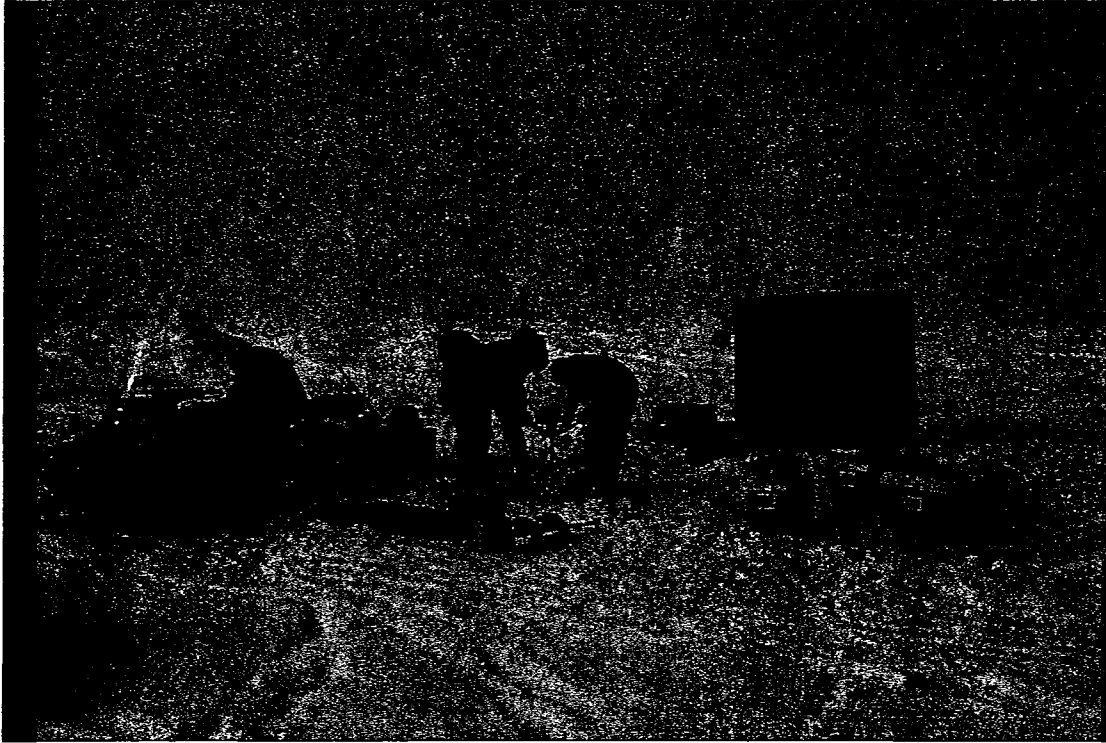

Figure 2- 3. Photograph of site NA3 preparations.

2.2 Acoustic and Vibration Measurements and Analysis Methods

2.2.1 Measurement System

The measurement system consisted two hydrophones, a microphone, and a geophone that was frozen into the ice surface. Figure 2-4 shows a block diagram of the system.

The hydrophones were both ITC Type 6050C calibrated sensors each with a nominal sensitivity of -161 dBV re $1 \mu\text{Pa}$. In the passband from 2 Hz to 20 kHz, the sensitivity ripple was ± 0.8 dB. System electronic noise was measured in the laboratory by shorting out the channel input and recording the resulting noise through the system and onto the DAT recorder which was subsequently analyzed to define the noise floor. Figure 2-5 compares the measured noise floor with historical Arctic and open water noise spectra.

The two hydrophones were deployed through a hole in the ice. Hydrophone #1 was installed at a depth within 6.5 ft (2 m) of the bottom. Hydrophone #2 was lowered to a mid water column depth. The signals from each hydrophone were passed through a signal conditioning amplifier with a gain of 0 dB for impedance matching and then amplified using a BBN manufactured (Model 392) low noise amplifier whose gain varied from site to site as the noise conditions warranted. Amplifier gains for all channels and measurement sites are documented in Table 2-2.

The microphone was a calibrated $\frac{1}{2}$ -inch Genrad Condenser microphone with a sensitivity of -134 dBV re $20\mu\text{Pa}$ over the frequency band from 15 Hz to 19 kHz. The

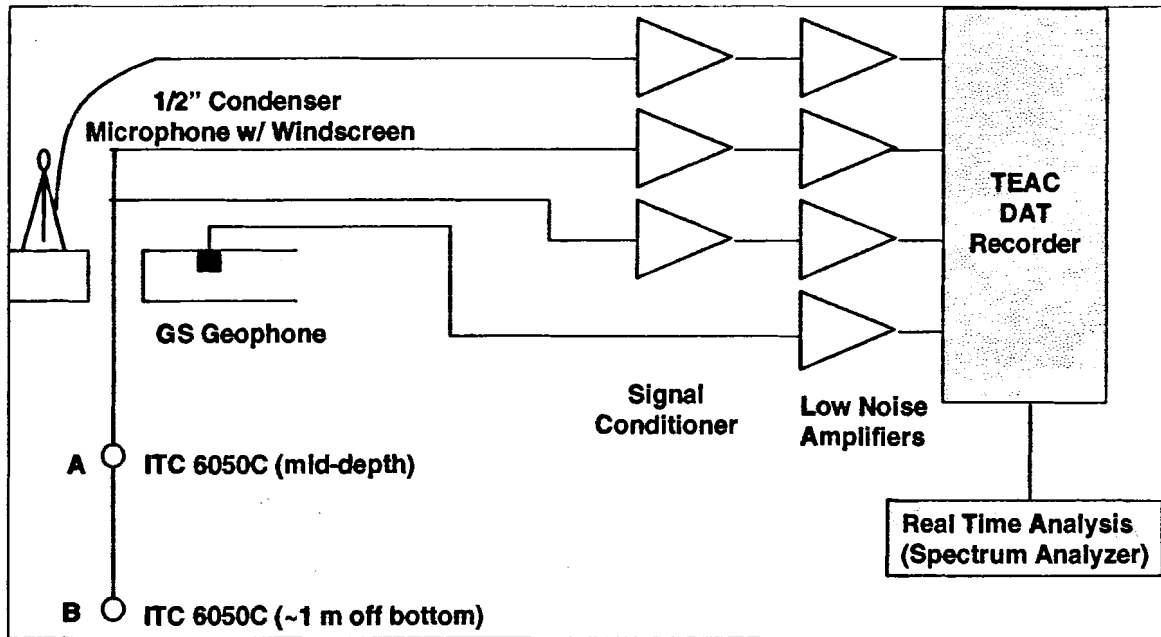

Figure 2- 4. Acoustic and vibration measurement system.

geophone was a Geo Space model GS-32CT close tolerance geophone. Its intrinsic voltage sensitivity was 0.698 V/in/sec and its sensitivity at 70% damping was 0.500 V/in/sec. The microphone signal was passed through a 0 dB gain signal conditioner and both sensors were amplified using BBN's 392 low noise amplifiers. As with the hydrophones, noise floors were measured in the laboratory and are presented in Figure 2-6.

All sensors were recorded on a 16-channel TEAC RD-145T DAT recorder set up to operate in a 4-channel mode. Recordings were made at "double speed" which digitally samples the data at 44.1 kHz producing an accurate measurement band out to 20 kHz. All equipment was battery powered during the data collection periods. At each site, data was recorded for a minimum of 30 minutes.

Site	H1 Gain, dB	H2 Gain, dB	Geophone Gain, dB	Microphone Gain, dB
NS Trench	30	30	30	30
NA3	30	30	30	30
NA2	40	40	40	40
5(5)	30	30	30	20
LA2	40	40	40	40
LA3	40	40	40	40
NA5	30	30	40	30
NA6	30	30	40	30

Table 2- 2. Amplifier gains for each data channel and measurement site.

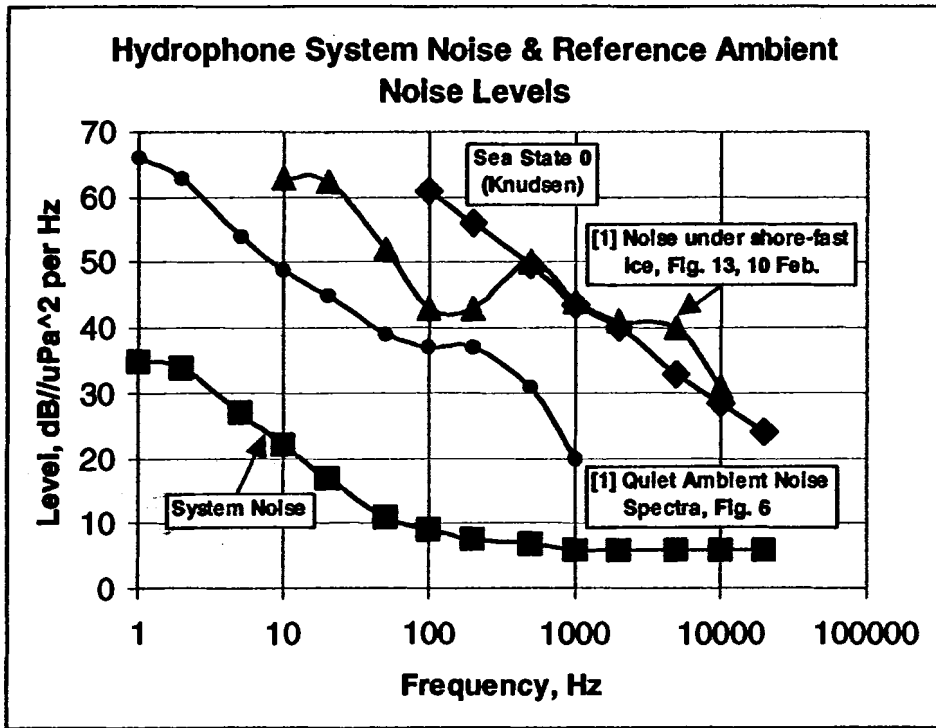

Figure 2- 5. Hydrophone system characteristics.

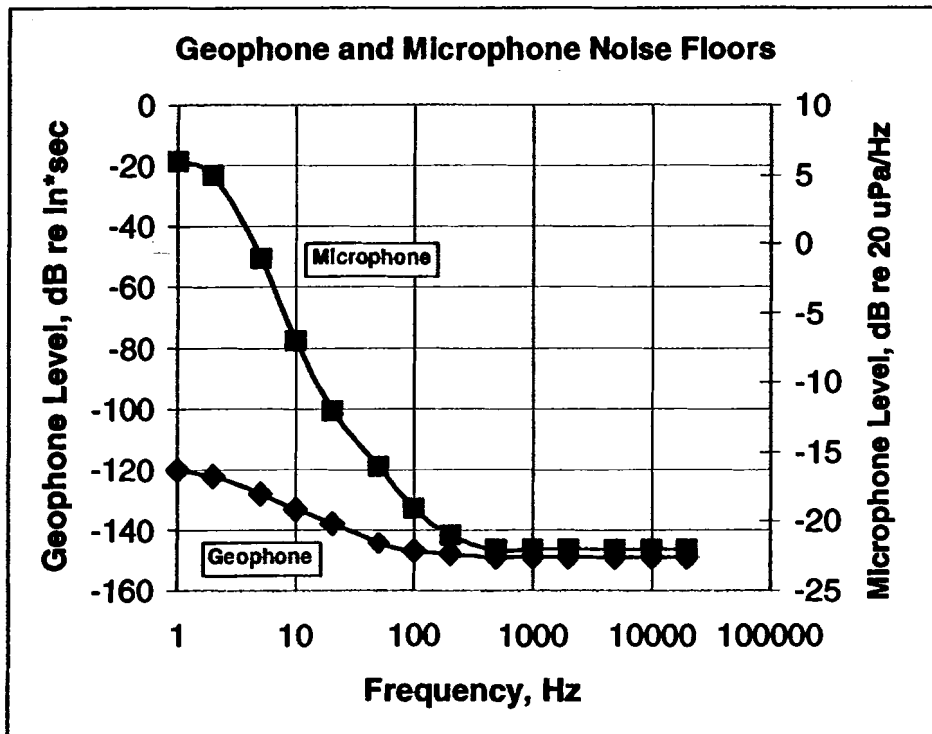

Figure 2- 6. Measured geophone and microphone electronic noise floors.

2.2.2 Analysis Methods

The first step in the analysis procedure was to qualitatively assess the recorded data to identify data segments for evaluation. For each site, a hydrophone and the microphone were played back through a headset and a log of the aurally observable activities was generated. Two minute segments were selected to highlight trucking noises, plowing activities, vibrahammer operation, the Endicott gas flare, and ambient noise without manmade contributions. As many as four data cuts were examined for each site.

Two minute data segments were selected because the man-made noises, such as the vibrahammer, were only present for short durations. For example, a typical vibrahammer operation lasted for 1 minute or less. Also, noise from plowing and truck movement was erratic and short in nature (typically 10 seconds or less). Longer analysis windows tended to obscure characteristics of the dominant noise source by averaging in more noise from other sources. For consistency, all analysis durations were set at 2 minutes.

Each identified data segment was then processed to estimate the 5th, 50th, and 95th percentile levels of the site-specific noise statistics. Results are reported in both narrowband spectra with a 1 Hz resolution and 1/3-octave bands from 2 to 20 kHz. The analysis parameters were as follows:

- Data sampling rate: 48 kHz,
- Fast Fourier Transform (FFT) size: 2^{17} (131,017),
- FFT overlap: 50%, and
- FFT time domain window: Hanning.

The process included downloading the DAT files to a personal computer in a format compatible with Matlab™ software system. Matlab scripts were then used to generate the narrowband and 1/3-octave band spectra. The 1/3-octave band spectra were then further processed to estimate the percentile levels.

3.0 Results

The recorded data were analyzed to develop a short-term statistical description of the variation of the underwater, in-air, and in ice noise conditions at each site for each identified noise source. In the following sections, results from six sites near Northstar and two sites near the future Liberty site are presented. No observers were stationed at Northstar to log activities so the conclusions and observations relating to the source of the measured noise provided in this section are inferred based on the measured spectral characteristics.

All results are presented as spectra in a consistent format. Each figure consists of five traces. The narrowband 1 Hz resolution power spectrum is an average over the selected two minute data segment. It provides insight into the tonal structure of the noise environment which is one part of overall acoustic environment; the other being the broadband component. Third octave band (OB) data are presented at the 5th, 50th, and 95th percentiles over the same two minute window with the 50th percentile trace marked with open circles. Finally, each figure includes a trace showing the 1/3 OB electronic noise floor of the measurement system for comparison to the 1/3 OB noise data. The noise floor is an average and as such includes some variability. This means that the 5th percentile noise estimate can dip below the average 1/3 OB curve. As an example, in Figure 3.1-4 below, the 50th percentile noise estimate above 50 Hz is only slightly above the noise floor; the difference primarily due to the tonals that appear in the narrowband spectra above the electronic noise floor. In this case, the 1/3 OB data represent an upper limit.

Third octave band data are reported three times per octave where an octave is a doubling of frequency. Each 1/3-octave sample is a sum of the energy over a range of frequencies. Thus in comparing 1/3-octave data and narrowband data, the 1/3-octave samples are the sum of the 1 Hz samples over a specified frequency band. And therefore, average or 50th percentile 1/3-octave data are equal to or higher than the averaged narrowband samples. This is also why the narrowband spectra can fall below the 1/3-octave band instrumentation noise floor. The bandwidth of each sample is proportional to the center frequency, in this case 23%. For example, starting at 2 Hz, 1/3 octave band data are reported at 2, 2.5, 3.15, 4, 5, and 6.3 Hz, and continue in this fashion to any desired upper frequency limit. Each sample covers the band from $0.891f_c$ to $1.122f_c$ where f_c is the band center frequency. Sound levels are often reported in 1/3-octave bands because in humans and some animals, hearing is roughly 1/3-octave.

At each site visited, data are typically is set of four: two hydrophones, the microphone, and the geophone. These sets were generated over the same 2 minute time interval. The reader will see that each figure has a label in its lower right-hand side which identifies the DAT tape number and the foot count at which the data analysis was begun. With this reference, we can easily re-examine any data segment accurately.

3.1 Northstar Site

The data collected near the Northstar site varied in range from the island from 0.08 to 8.1 nm (150 m to 15 km). The goal was to collect sample data versus range to qualitatively assess the extent of Northstar radiated noise with range. No attempt was made to estimate noise source levels or to derive transmission loss estimates since these were not project goals.

3.1.1 Site NS-Trench1

The first site visited was near the ice road about 1 nm from Northstar. Data were recorded between 7 and 8 PM local time. Backfilling operations were in progress to cover the trench carrying the pipeline to shore. The dominant audible sounds were generated by trucks and plows.

Underwater noise spectra from the near bottom hydrophone (labeled #1) is presented in Figure 3.1.1-1 and the mid water hydrophone (labeled #2) in Figure 3.1.1-2. The amplifier gains for both sensors were set at 30 dB. Hydrophone #1 (H1) was deployed at a depth of 26 ft (8 m) and hydrophone #2 (H2) at 16.5 ft (5 m). The water depth was 32 ft (9.7 m). Both sensors show a rich tonal structure above 25 Hz and below 600 Hz with H1, the deeper sensor, having higher level tonals. The source of the broad spectral peak near 700 Hz is unknown and was not observed at the other locations. However, it is also present in the microphone data discussed below. Field personnel noted “gurgling” water sounds at this site but it is not clear if this was the source of the spectral peak.

The noise at this site is dominated by the trucking and plowing operations which were nearly continuous during this data segment. Note that the 1/3 OB 50th percentile is approximately evenly spaced between the 5th and 95th percentiles indicating a reasonably stable noise environment. This is not always the case. For reference, the level difference between the 5th and 95th percentile is quite uniform across the analysis band at approximately 20 dB. As will be shown in the next section, the vibrahammer was not in operation during this period because its characteristic narrowband component at 23 Hz is not present.

The measured in-air noise level is shown in Figure 3.1.1-3. The amplifier gain was set at 30 dB. Here, the tonal content is significant from about 45 Hz up to roughly 2 kHz.

Above 5 kHz, the noise level is approaching the noise floor of our measurement system. Some of the same tonals seen underwater are present in the air such as near 44 Hz and at 350 and 400 Hz. But the dominant feature is the broadband low frequency noise. Compared to measurement made near Liberty in a very quiet environment (for example, see Section 3.2.1), the airborne noise here is 10 to 25 dB higher at frequencies below 200 Hz.

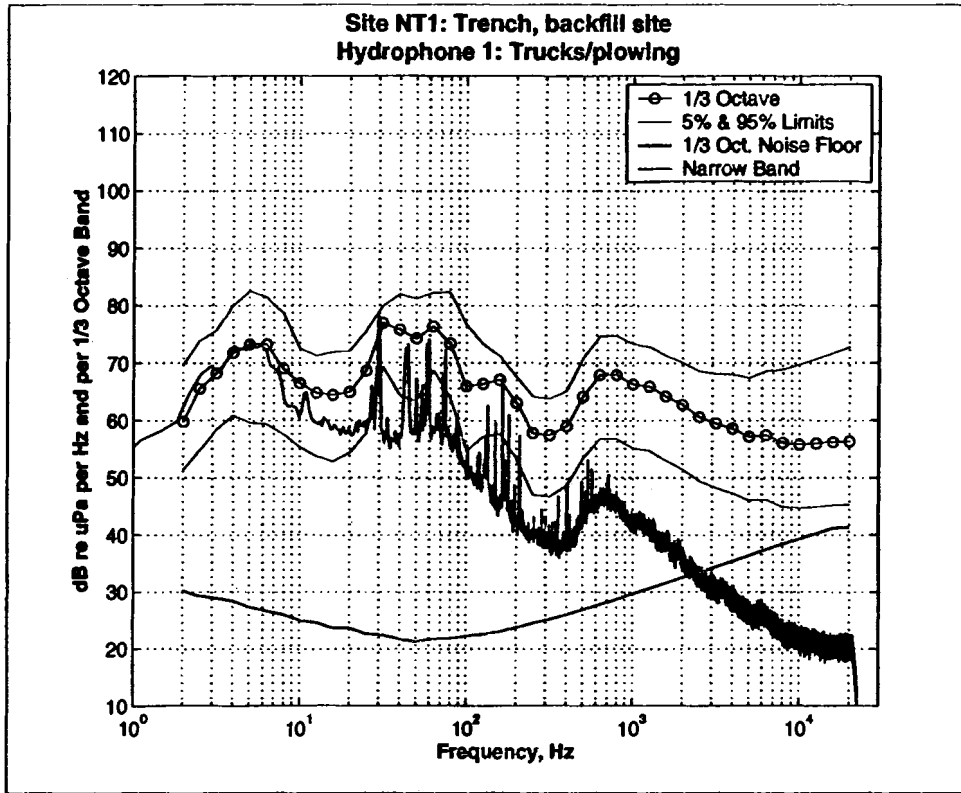

Figure 3.1.1- 1. Near-bottom underwater Noise near Northstar ice road (2-2700).

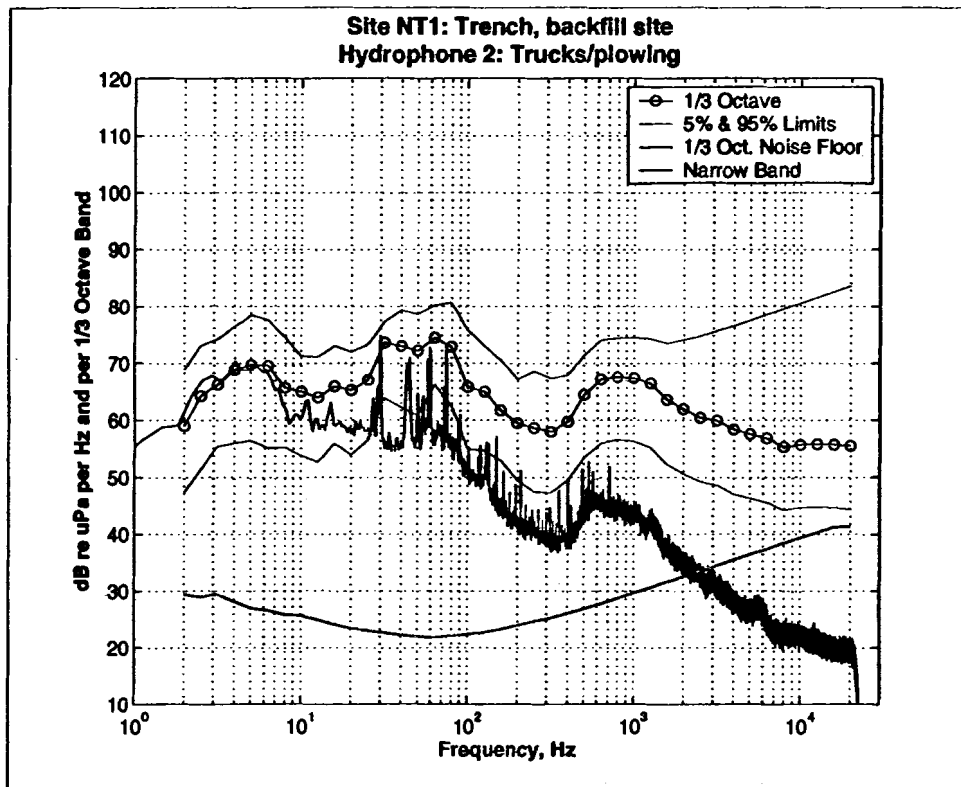

Figure 3.1.1- 2. Mid depth underwater Noise near Northstar ice road (2-2700).

In ice vibrations were measured using a geophone frozen into the ice surface and an amplifier gain of 30 dB. Vibrations can couple into the ice from four sources:

- vibrations that radiate from the bottom, through the water column and into the ice,
- excitation also from the bottom transmit into the ice through shore-fast ice pathways,
- vibrations that flow from ice floe to ice floe through the plate boundaries, and
- in-air noise that couples into the ice through the snow covered ice surface.

Figure 3.1.1-4 shows the measured ice vibrations at the NS-Trench1 site. In general, the levels are quite low with most of the energy in the band from 2 to 40 Hz. Some narrowband tonals can be seen above the noise up to a few kHz. The most significant feature is the high level of the 95th percentile noise. This indicates multiple short duration or bursts of high level vibrations in the data segment. Its broadband nature is consistent with impulsive noise most likely due to the bangs associated with plowing and dumping operations.

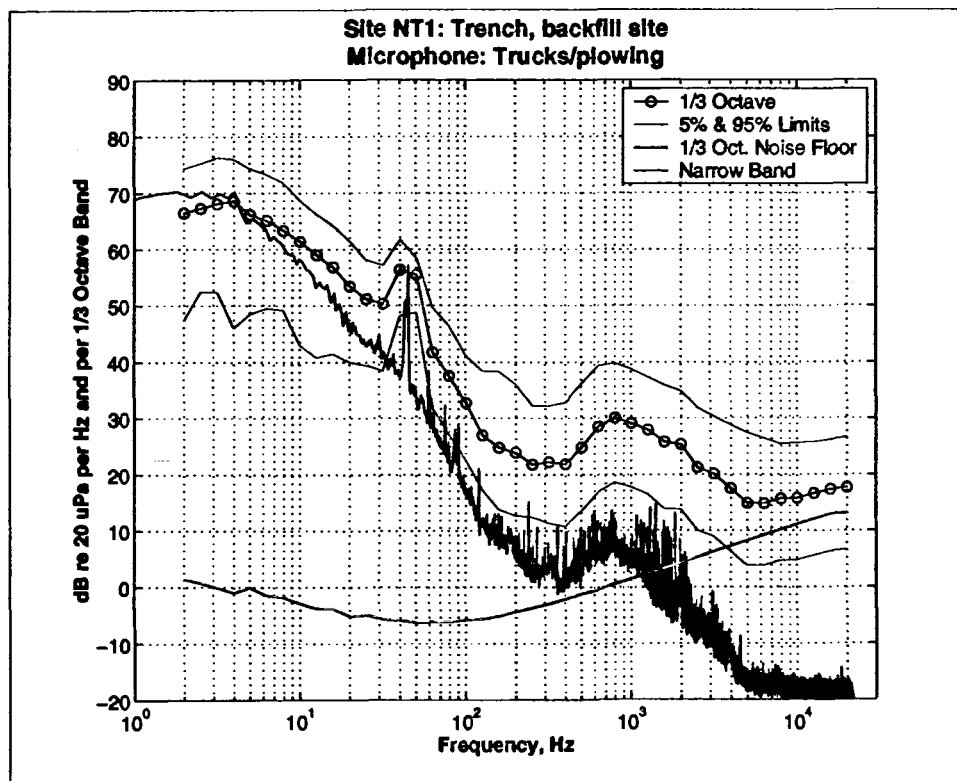

Figure 3.1.1- 3. Airborne noise near Northstar ice road (2-2700).

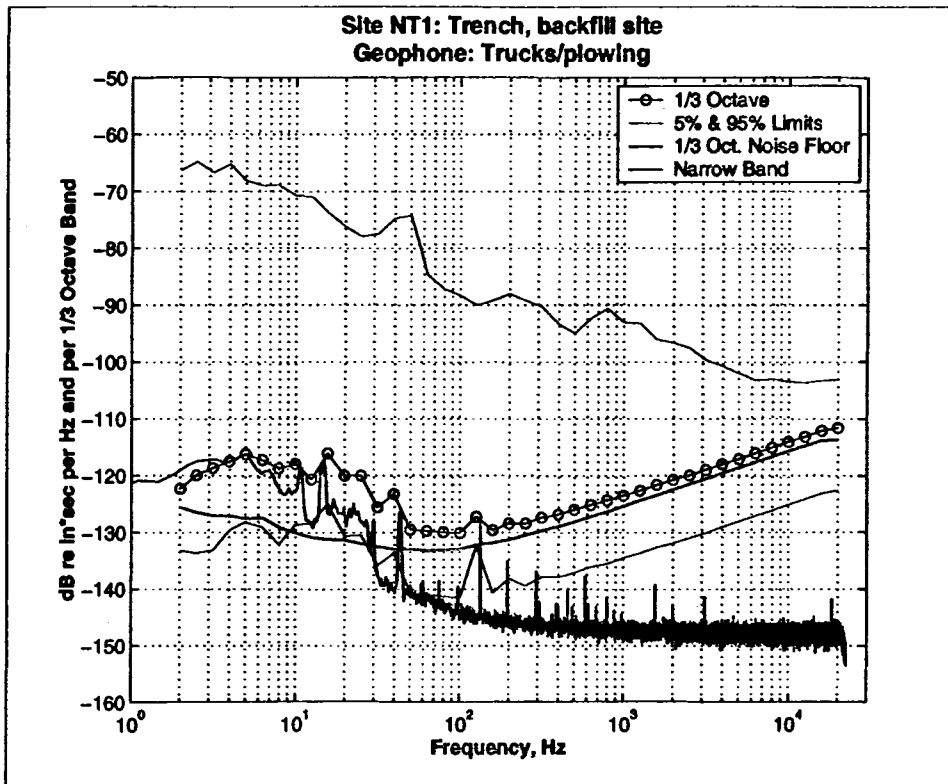

Figure 3.1.1- 4. Measured ice vibration levels near Northstar ice road (2-2700).

3.1.2 Site NA3

Site NA3 was located approximately 0.08 nm (150 m) from Northstar in a water depth of 38 ft (11.5 m). A little after 1 PM local time when the data were collected, the site was a hot bed of activity with periodic vibrahammer sheet pile driving, trucks moving about, and plowing operations. Four data segments were selected for analysis, two with the vibrahammer in operation, one with normal trucking and plowing, and a fourth collected during the quietest period observed.

Figures 3.1.2-1 and 3.1.2-2 present the strongest underwater noise levels collected during vibrahammer operation. Amplifier gains were set at 30 dB. With H1 suspended at a depth of 33 ft (10 m) and H2 at a mid channel depth of 20 ft (6 m), the near-bottom sensor exhibits higher level noise than the mid-channel hydrophone because of its proximity to the bottom from which we believe the noise is primarily radiating. The spectral characteristics of vibrahammer noise include a strong tonal at 23 Hz, a broad level peak in the 2 to 15 Hz band. A second broad peak centered at 30 Hz, and a steep roll-off of energy above about 80 Hz. Above 1 kHz, except for the few peaks, the noise is generally consistent with the quiet conditions measured near the Liberty site.

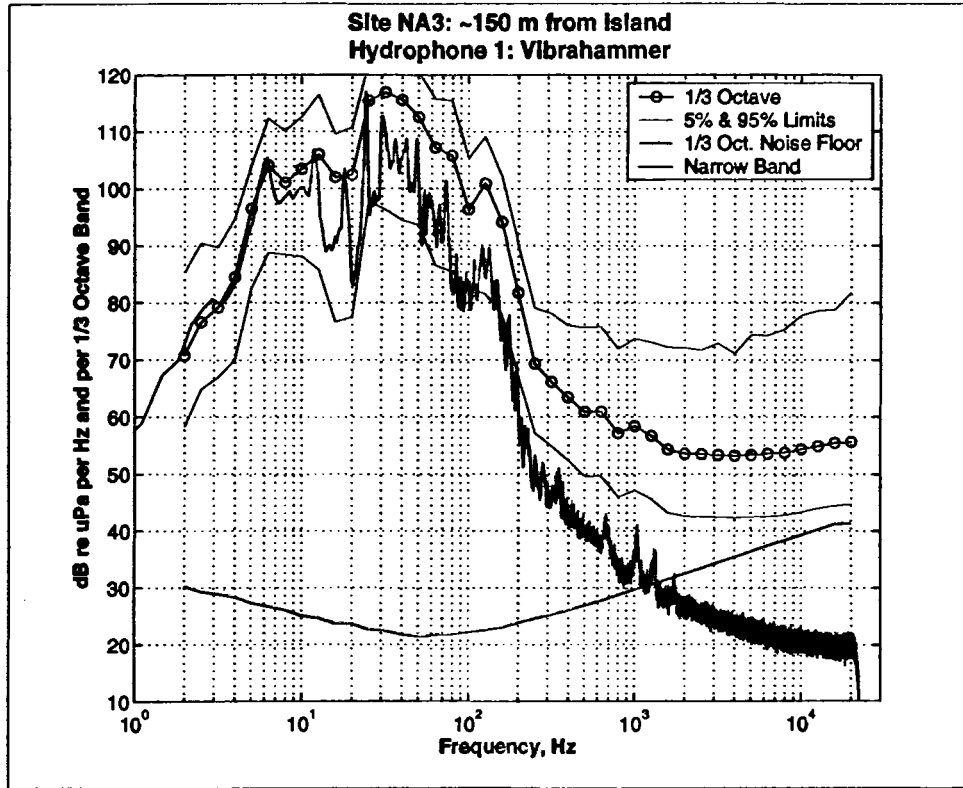

Figure 3.1.2- 1. Near-bottom underwater noise at Site NA3 (3-4610).

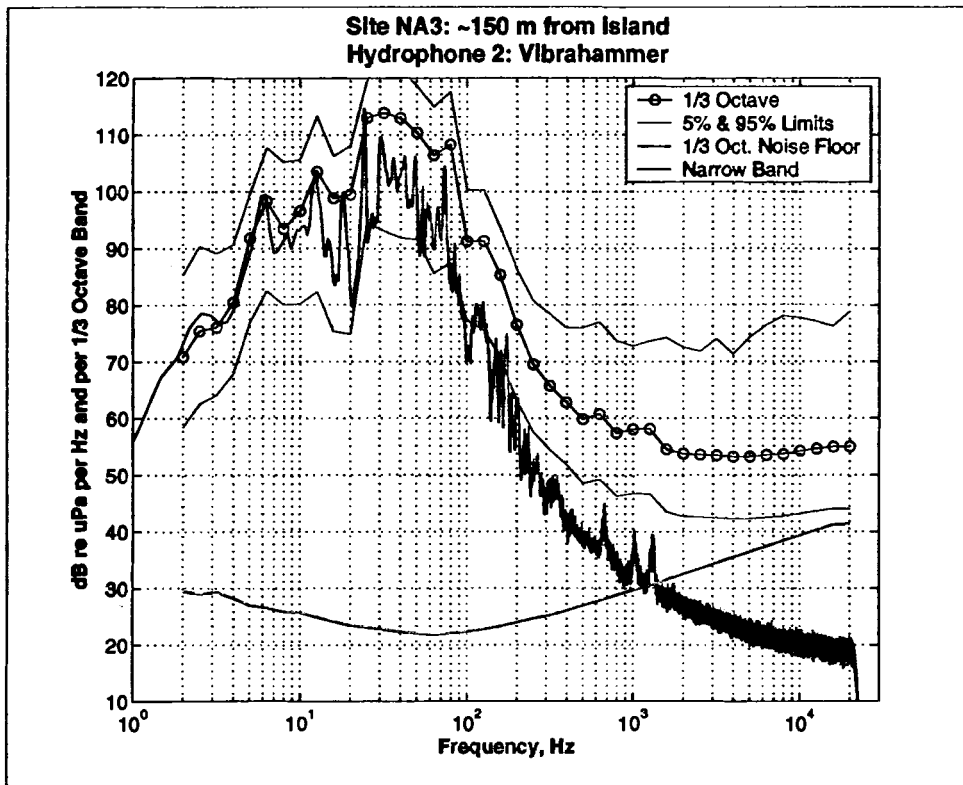

Figure 3.1.2- 2. Mid channel depth underwater noise at Site NA3 (3-4610).

A second set of vibrahammer underwater noise measurements is shown in Figures 3.1.2-3 (near bottom sensor) and 3.1.2-4 (mid depth sensor). The spectral characteristics are consistent with the previous set except the levels are roughly 2-5 dB lower. This variability should be expected as the coupling of energy into the ground (and thereafter into the water) depends on soil conditions at each sheet piling and how the vibrahammer is attached to the sheet piling. The higher frequency energy peaks at 700 Hz, 1 kHz, and 1.3 kHz in this example have generally higher levels and are due to the vibrahammer operation as they do not appear in any other data set.

Airborne radiated noise from the vibrahammer collected at the same two measurement times are presented in Figures 3.1.2-5 and 3.1.2-6. In the first example, strong peaks dominate the noise environment at 12 and 23 Hz, potentially an harmonically related pair. In the second sample, the 12 Hz contribution has disappeared and the 23 Hz energy is 10 dB lower. As noted above, the differences are thought to be due to the variability in sheet piling coupling to variable soil conditions on the island. In both cases, the vibrahammer dominates nearly the whole the spectrum from 2 Hz up to about 15 kHz.

Vibrahammer energy is also significant in the ice producing vibrations that can span the 2 Hz to 2 kHz band. Figure 3.1.2-7 provides an example. The characteristic vibrahammer spectral shape seen in the underwater environment is readily apparent. However, only energy below 200 Hz seems to couple well into the ice.

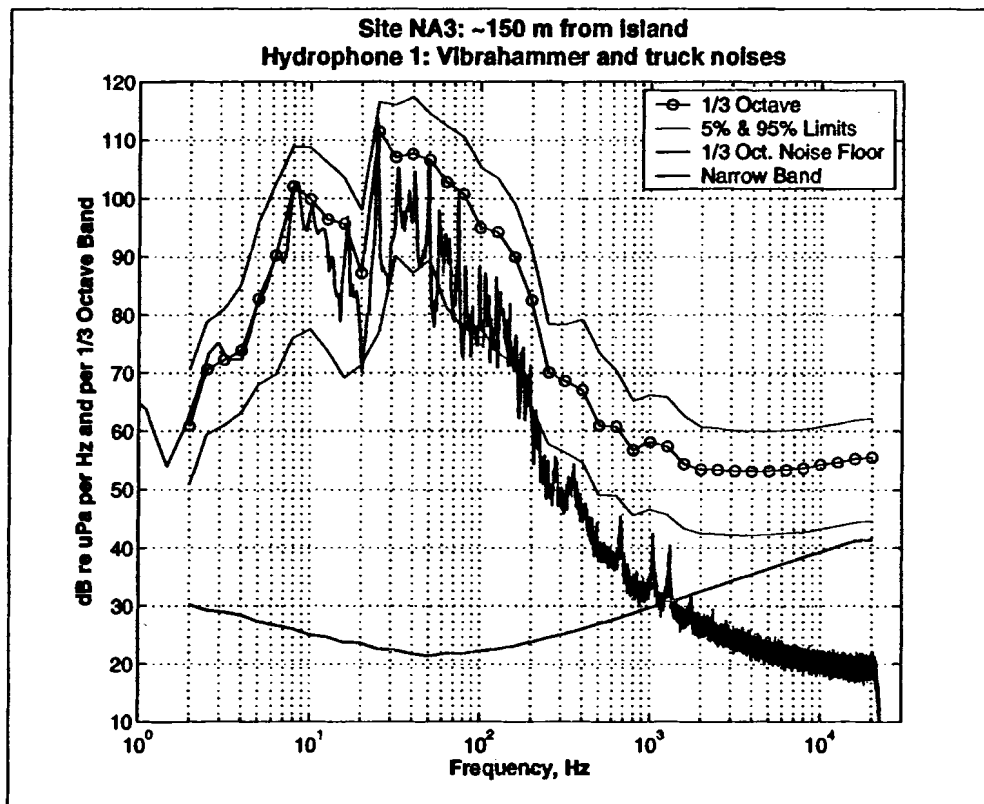

Figure 3.1.2- 3. Near bottom underwater noise at Site NA3 (3-1315).

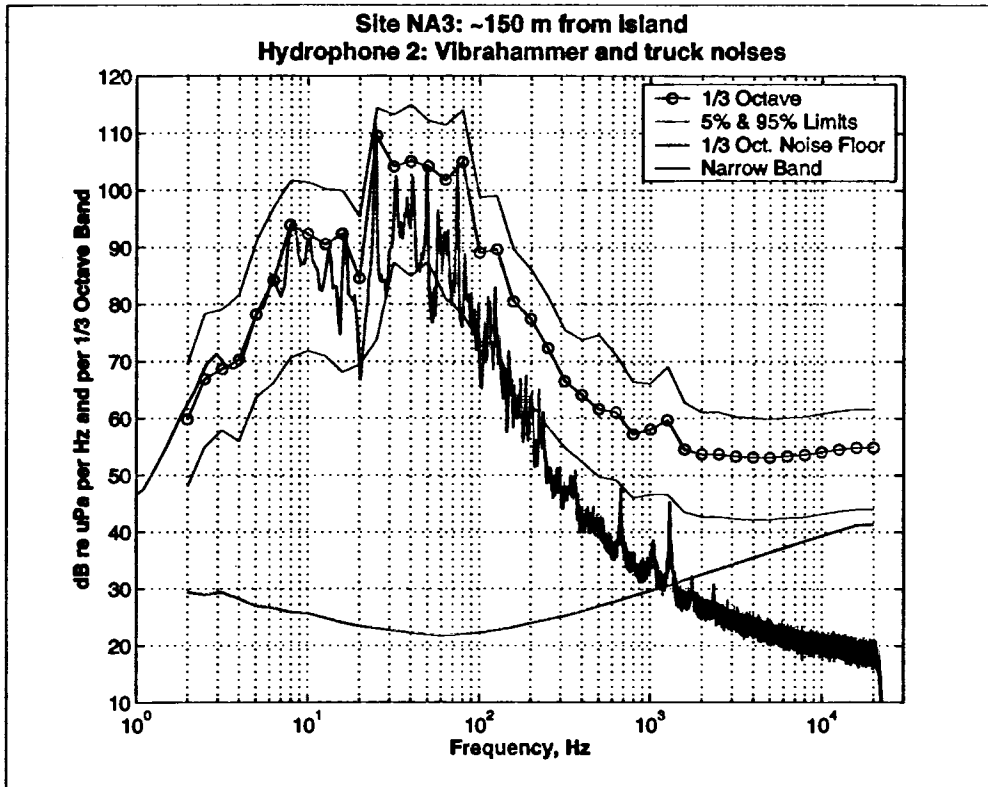

Figure 3.1.2- 4. Mid channel depth underwater noise at Site NA3 (3-1315).

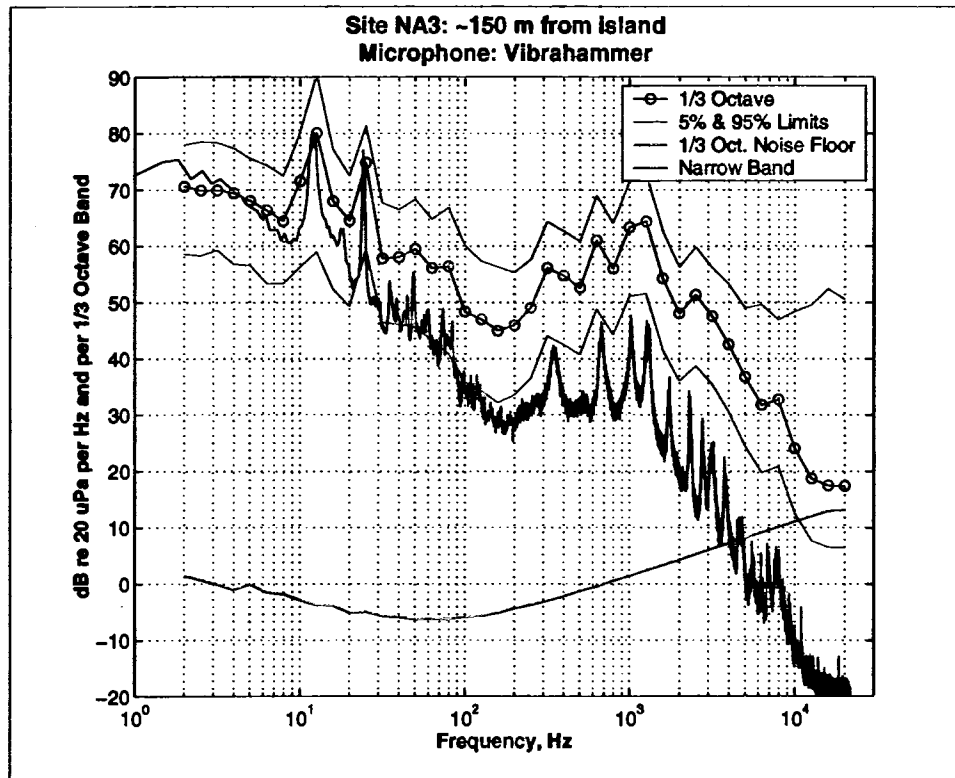

Figure 3.1.2- 5. Airborne noise at Site NA3 (3-4610).

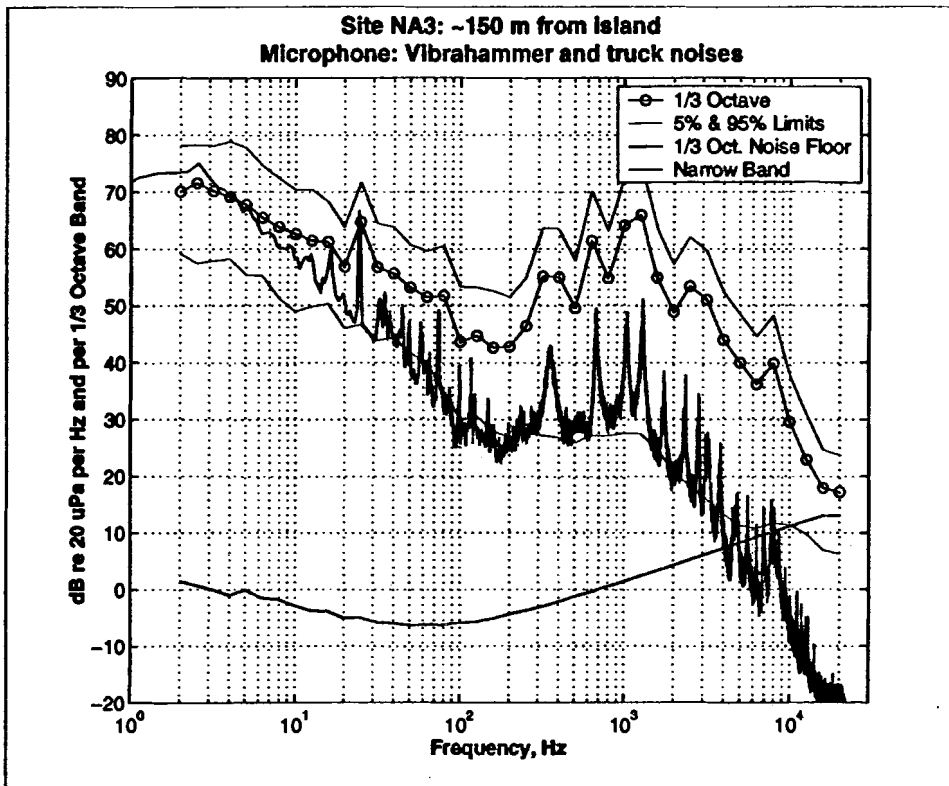

Figure 3.1.2- 6. Second example of airborne noise at Site NA3 (3-1315).

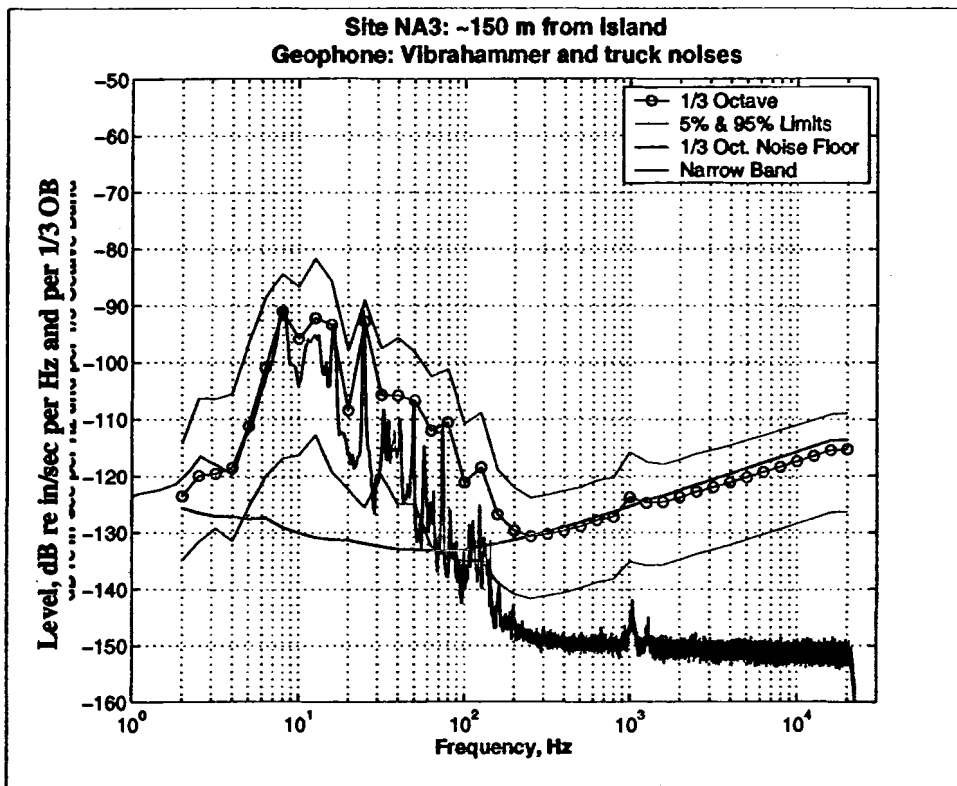

Figure 3.1.2- 7. Ice vibration levels from vibrahammer at Site NA3 (3-1315).

As was observed along the ice road in Section 3.1.1, plows and trucks operated generally continuously. Figures 3.1.2-8 and 3.1.2-9 show the measured underwater noise levels collected at site NA3 while these activities were underway around Northstar. The vibrahammer was not in operation at this time but undoubtedly generators and related equipment were in operation.

As has been noted before, the lower hydrophone (H1) exhibits a slightly higher noise environment. Both sensors show strong manmade noises in the sub-10 Hz region, strong tonal presence between 30 and 120 Hz, and significant energy all the way out to 20 kHz when compared to the noise measurements collected near the Liberty site. A second set of underwater measurements is presented in figures 3.1.2-10 (H1) and 3.1.2-11 (H2). These examples were collected during the quietest time period during our data recording effort at this site. In general, the broadband noise level is lower but the narrowband contribution to the noise field is much more evident.

Two examples of the in-air noise environment at NA3 when the vibrahammer is not operating are shown in figures 3.1.2-12 and 3.1.2-13. Manmade noise dominates the airborne noise environment at all frequencies below about 6 kHz. As in the water below, numerous narrowband tonals produced by nearby machinery are a significant feature.

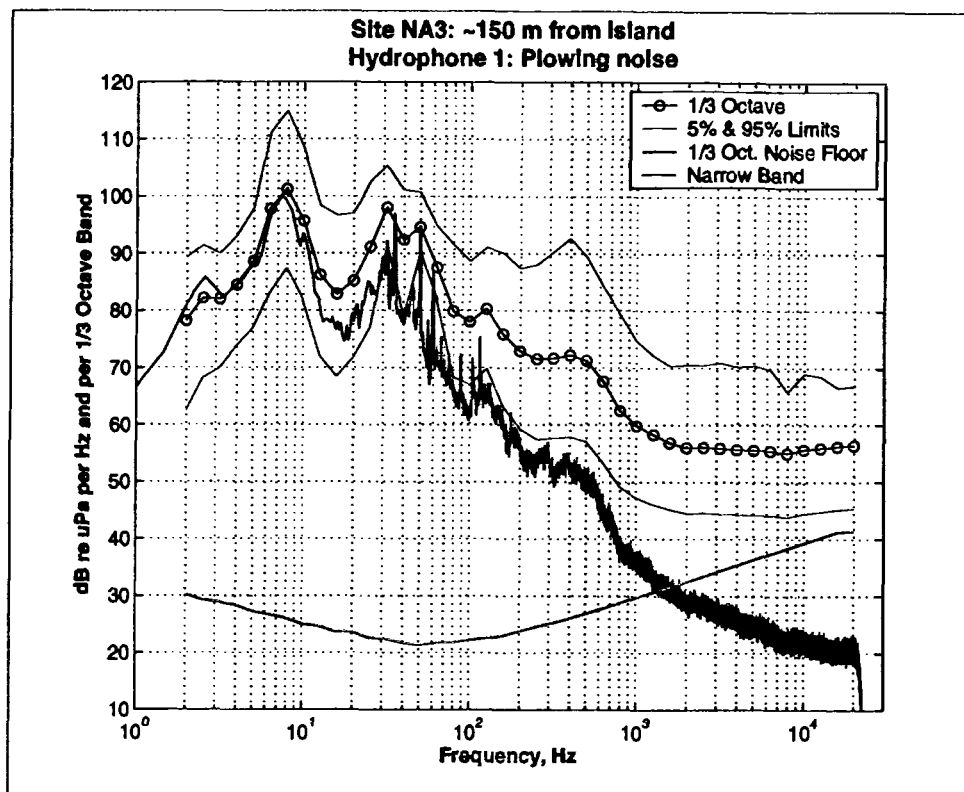

Figure 3.1.2- 8. Near bottom underwater noise at Site NA3, plowing noise (3-8100).

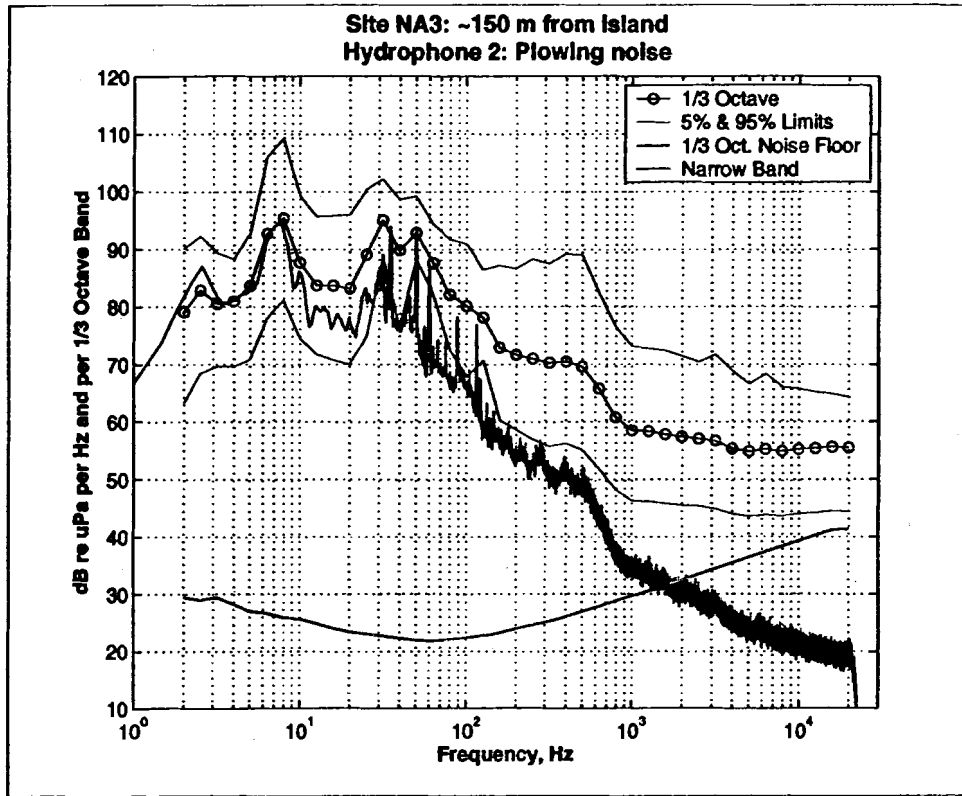

Figure 3.1.2- 9. Mid channel depth underwater noise at Site NA3, plowing (8-8100).

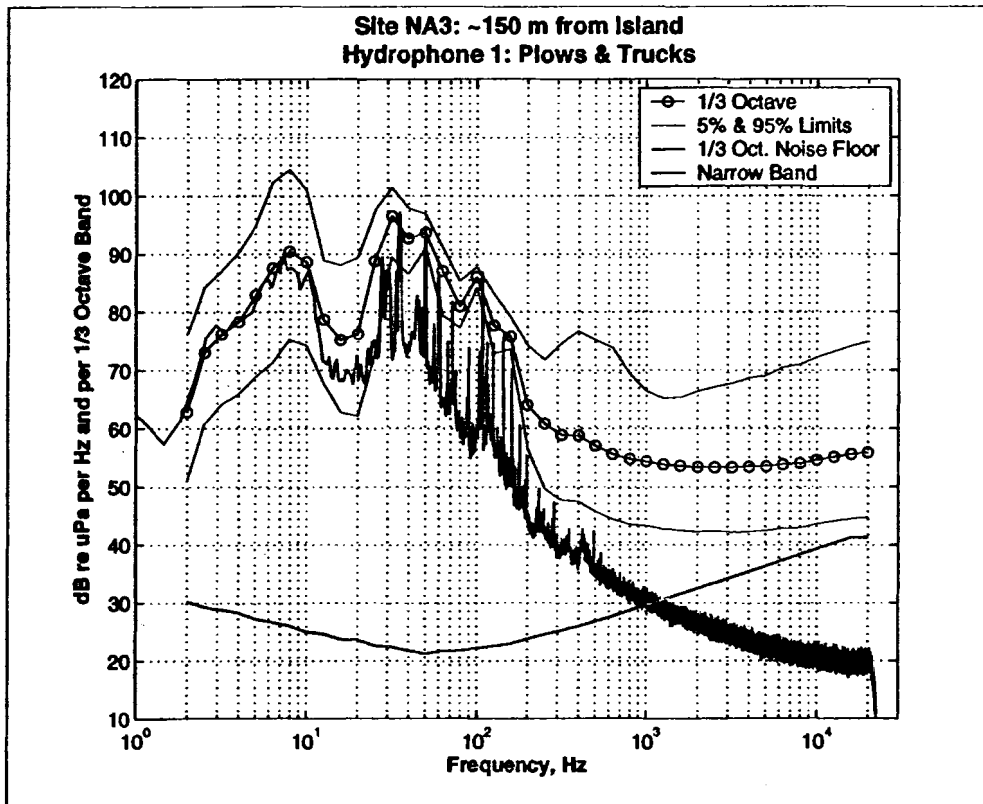

Figure 3.1.2- 10. Near bottom underwater noise at Site NA3; quiet (3-2500).

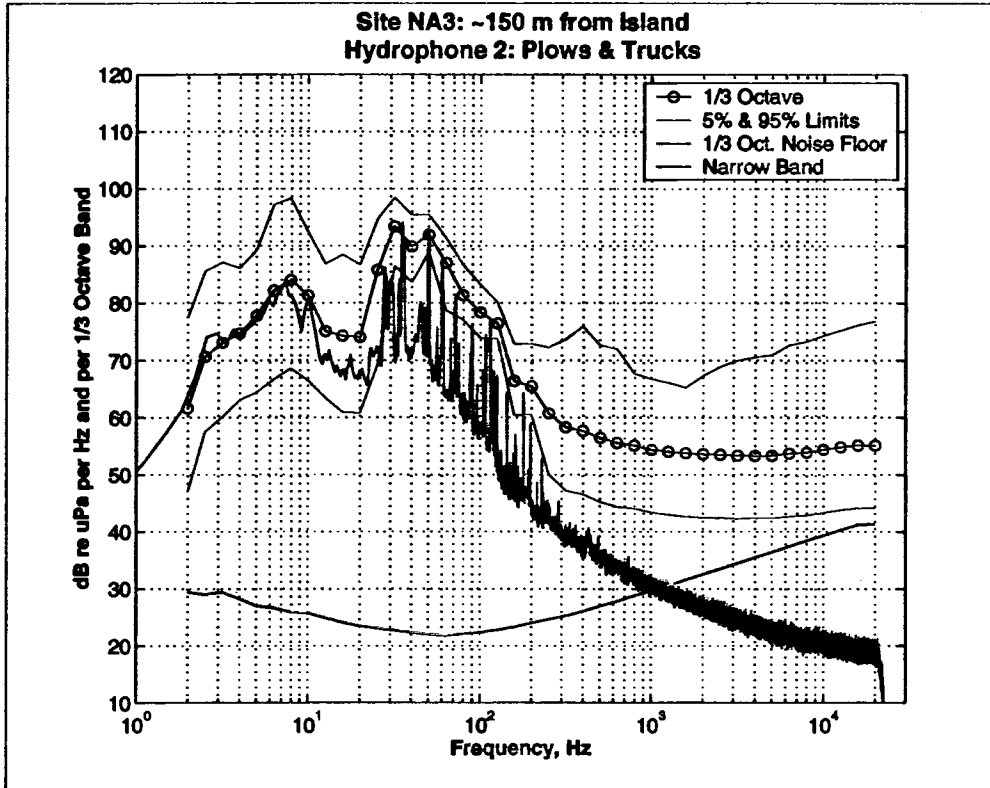

Figure 3.1.2- 11. Mid channel depth underwater noise at Site NA3; quiet (3-2500).

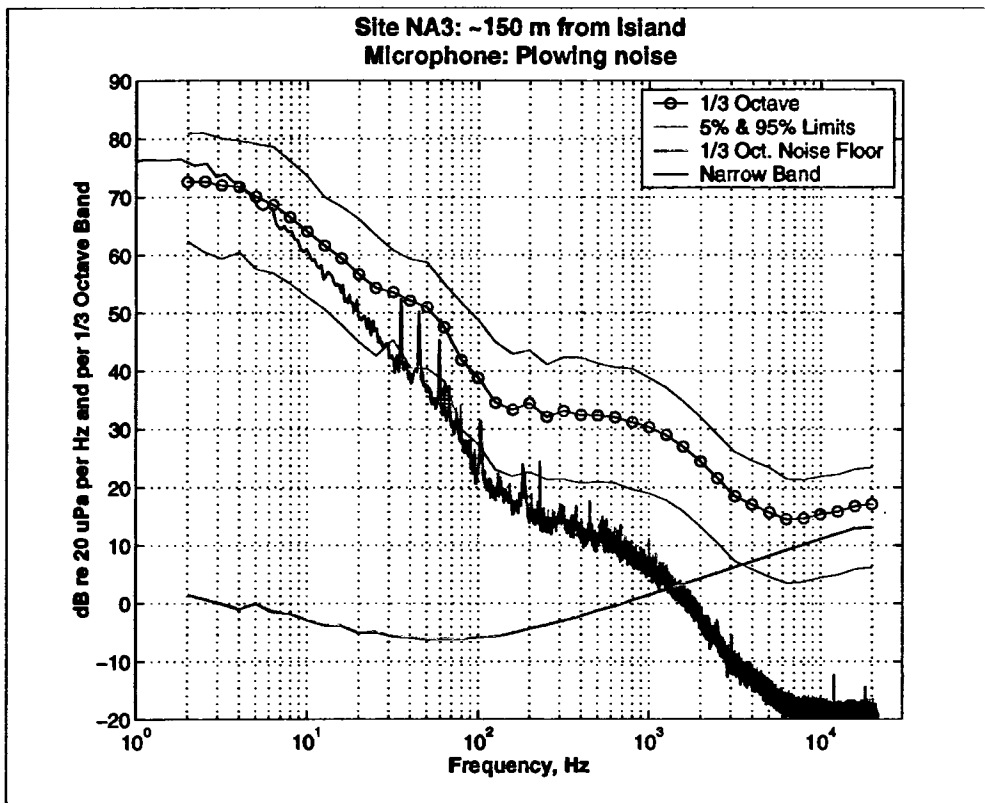

Figure 3.1.2- 12. Airborne noise at Site NA3; plowing (3-8100).

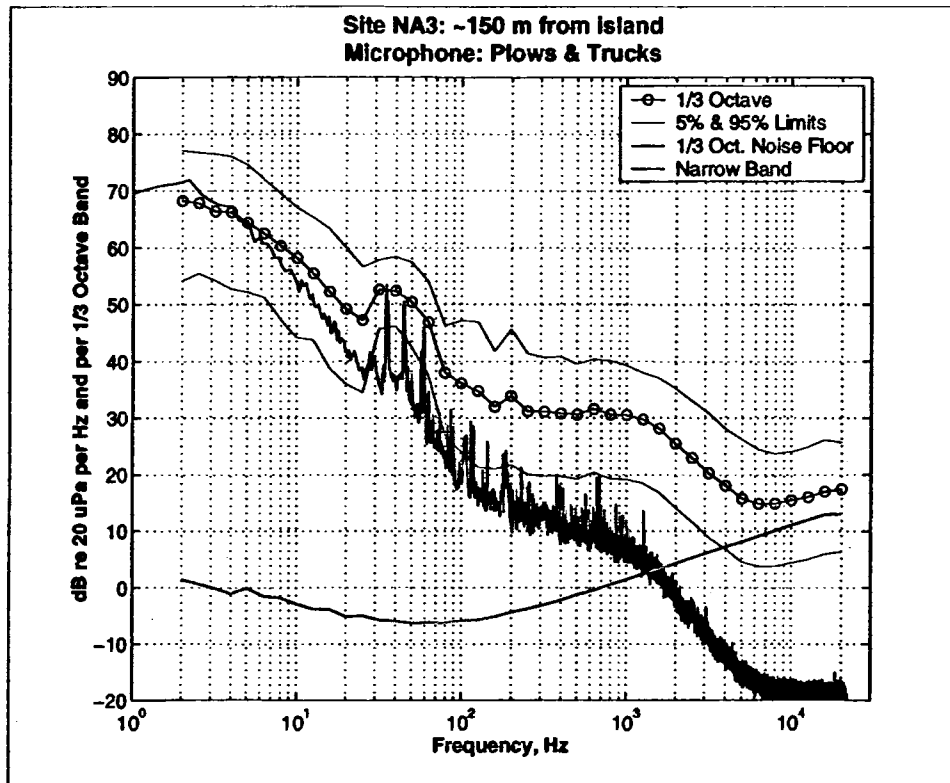

Figure 3.1.2-13. Second example of airborne noise at Site NA3 (3-2500).

Finally, figures 3.1.2-14 and 3.1.2-15 provide samples of ice vibration levels near Northstar when the vibrahammer is off. In these examples, only energy between about 3 and 140 Hz, both broadband and narrowband, couples well enough into the ice to be observable above our system electronic noise floor.

3.1.3 Site NA2

Site NA2 was located approximately 2.2 nm (4 km) NNE of the Northstar site. This site was specifically chosen to assess the Northstar noise radiation with range. The data were collected on 26 April starting at 6:30 PM local time. In a water of depth 35 ft (10.8 m), the lower hydrophone was deployed at a depth of 30 ft (9 m) while the mid water sensor was at a depth of 18 ft (5.5 m).

In general, the noise environment at site NA2 showed hardly any apparent manmade noise contamination. Two samples of underwater noise spectra, shown in Figures 3.1.3-1 and 3.1.3-2, are quite close to the conditions measured in [1] under quiet ambient conditions (see Figure 2-5) and is approximately 12 dB lower than Knudsen's sea state zero [2]. No narrowband tonals are present and the 1/3 OB levels at both water depths are nearly identical. There is a small energy peak in the mid channel hydrophone near 20 Hz whose source is unknown but may be produced by the ice; see the geophone data below.

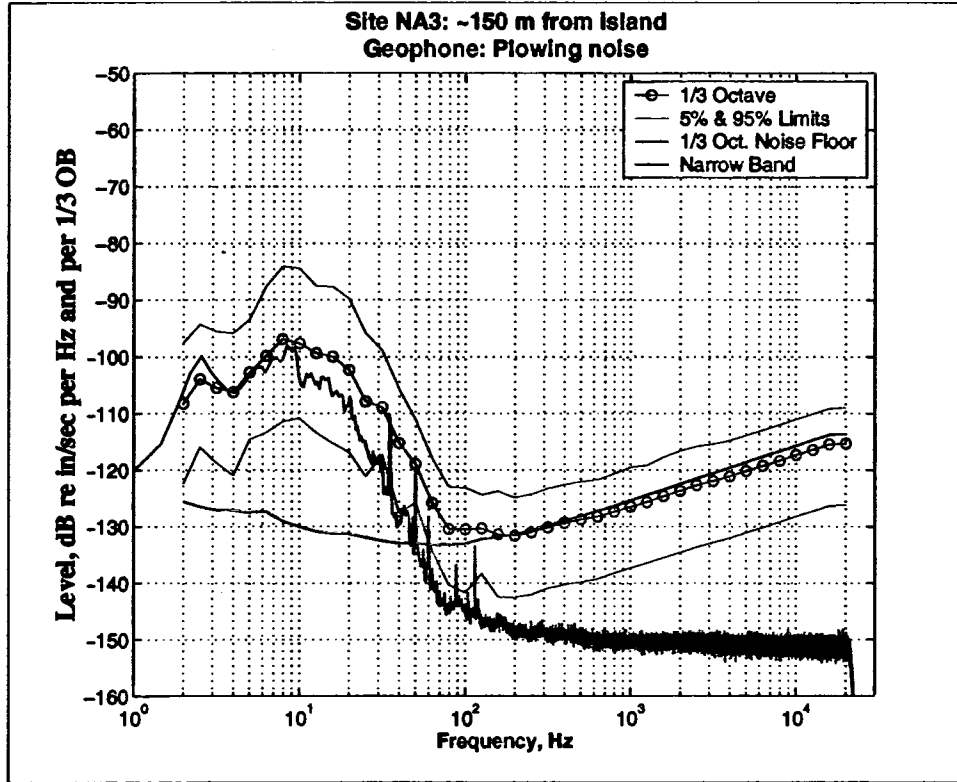

Figure 3.1.2- 14. Ice vibration noise spectra at Site NA3; plowing (3-8100).

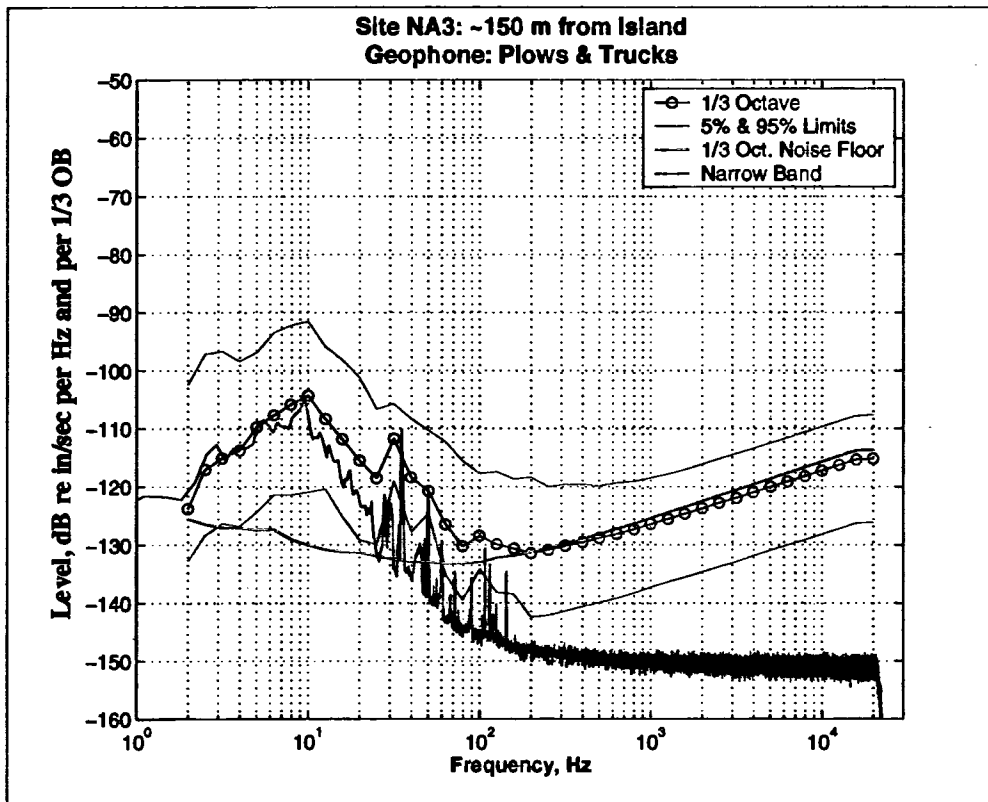

Figure 3.1.2- 15. Second example of ice vibration noise at Site NA3 (3-2500).

The in-air noise at site NA2 was very quiet. Winds were light and ice cracking noise was not detected aurally. Figure 3.1.3-3 shows a sample spectrum. While a few narrowband lines are present, the levels represent very quiet conditions.

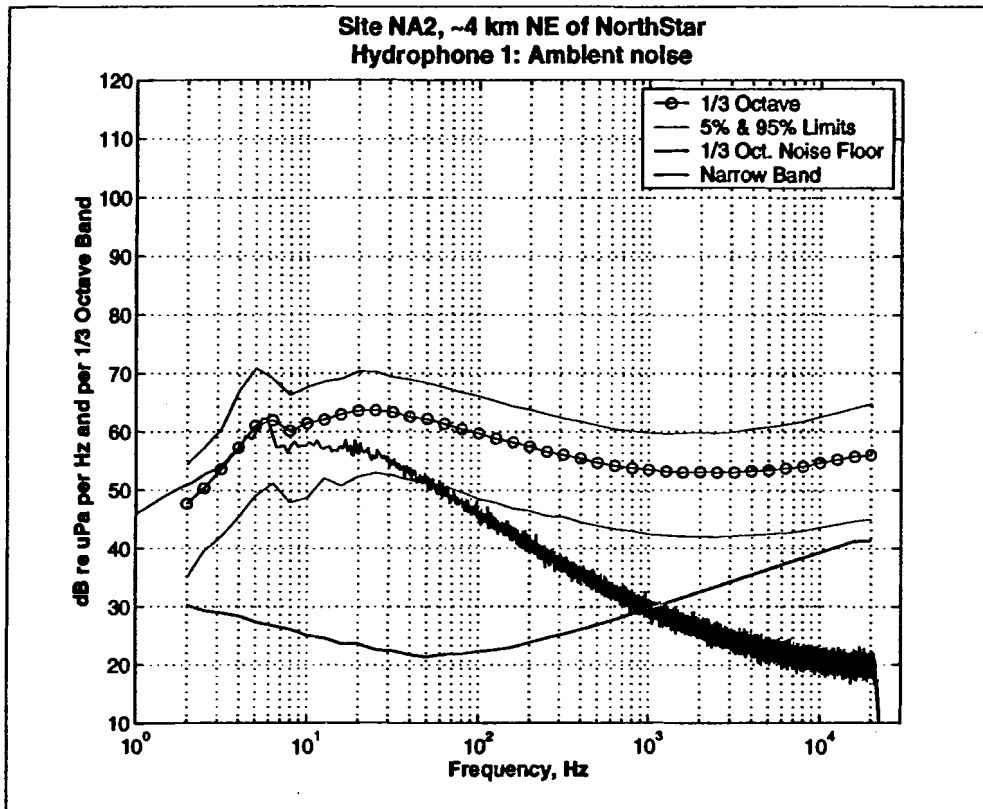

Figure 3.1.3- 1. Near bottom underwater noise at site NA2. (4-4000)

Ice vibration noise is shown in Figure 3.1.3-4. The only spectral region with valid data above system noise is in the band from 12 to 18 Hz. This appears to be the same peak observed with the mid water hydrophone and is probably generated in the ice.

3.1.4 Site NA5

Based on the measurements made close to the Northstar artificial island, we attempted to collect noise data at increasing ranges to assess the noise level versus range of the vibrahammer and other machinery sources at Northstar. Site NA5 was located roughly 0.54 nm (1 km) to the northeast of the artificial island. The water depth was 39 ft (11.8 m) and the ice thickness was 6 ft (1.8 m). On April 29th when our measurements were made, the winds were light at 5 kts (2.6 m/s) out of the north. Light snow had been falling over the last several days resulting in a fresh snow cover of from 2-6 inches (5-15 cm). The ice was quite rough with ridges rising to heights up to five feet (1.5 m).

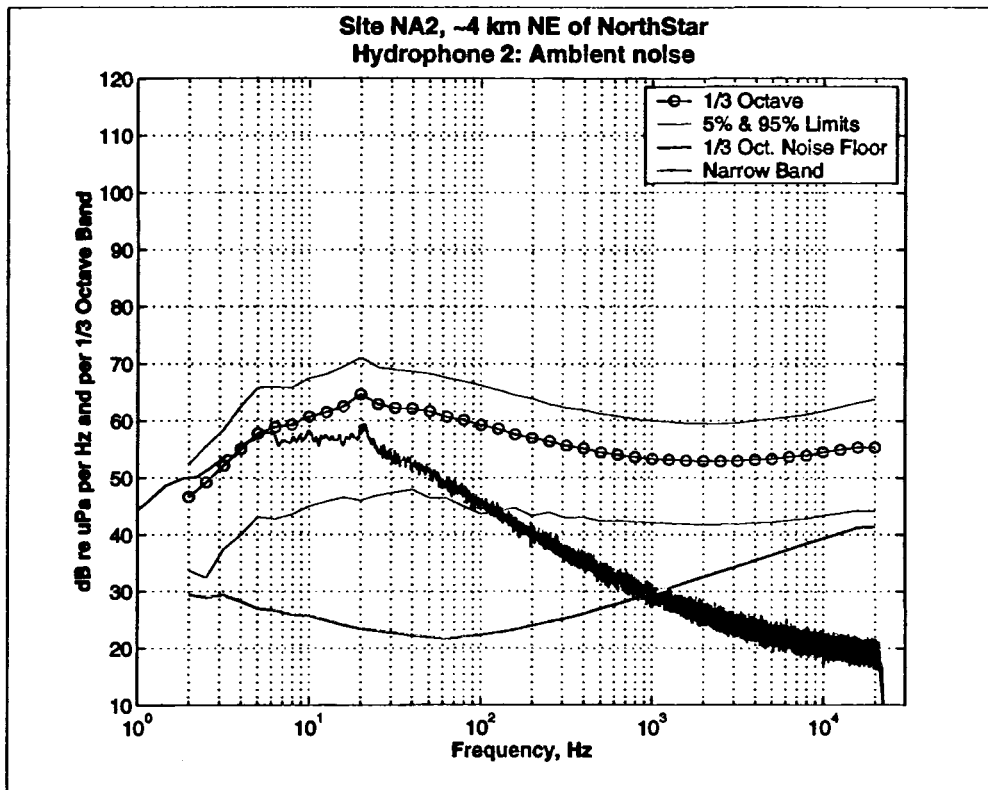

Figure 3.1.3- 2. Mid channel underwater noise at site NA2. (4-4000)

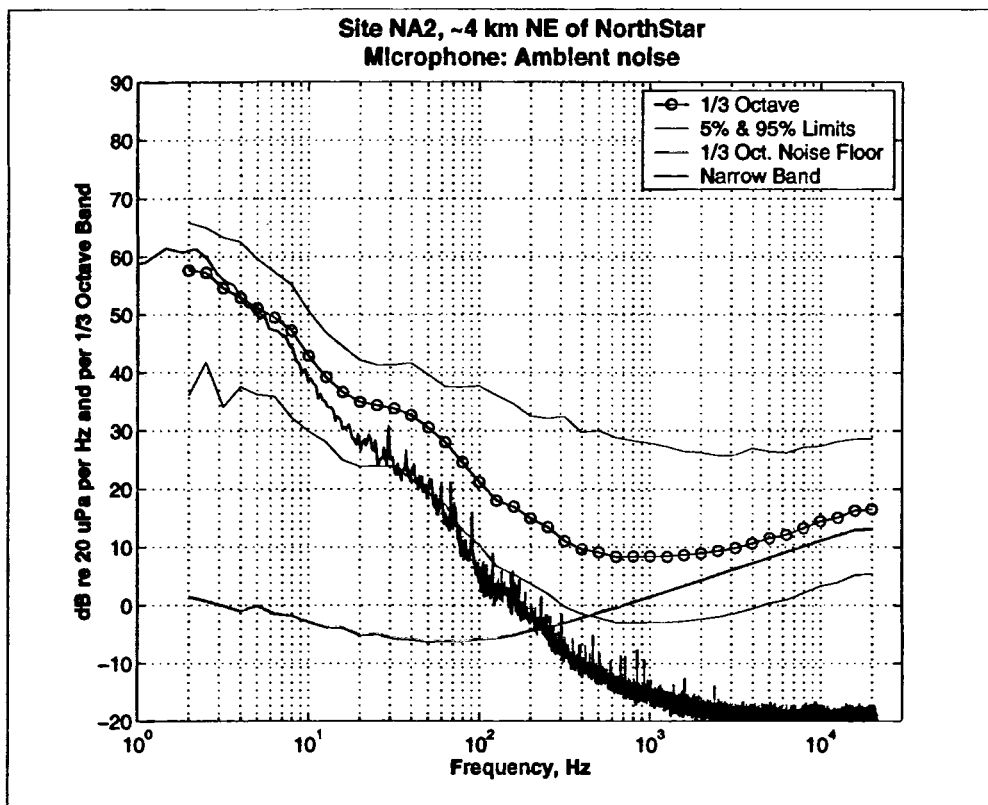

Figure 3.1.3- 3. Measured in-air noise levels at site NA2. (4-4000)

Data collection commenced at 11:45 local time and continued through the construction workers' lunch time and beyond. This provided a unique opportunity to capture the radiated noise without vibrahammer operation or the steady stream of trucks and plows that were typically operating in the area.

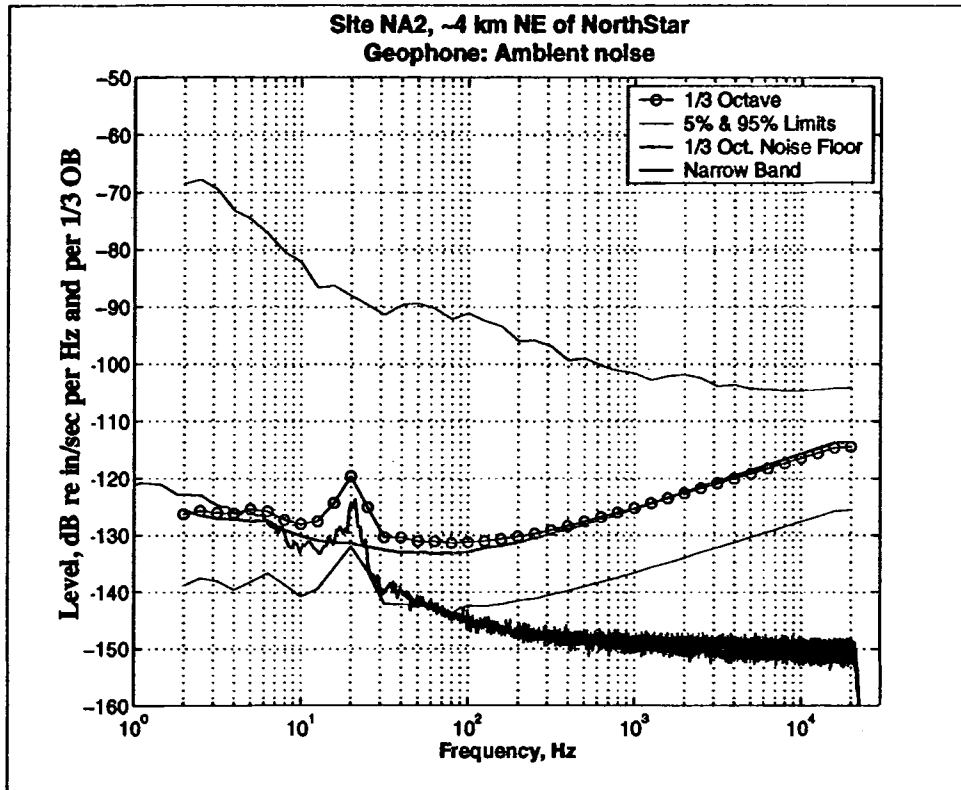

Figure 3.1.3- 4. Measured ice vibration levels at site NA2. (4-4000)

3.1.4.1 Site NA5 During Lunch Break

The measured underwater noise environment during the lunch time lull is represented in Figures 3.1.4-1 and 3.1.4-2. The first figure is from the near bottom hydrophone at a depth of 33 ft (10 m) and the second from the mid water hydrophone at 21 ft (6.4 m). The dominant noise source is most likely due to electrical generators and/or machinery left running. Significant features include the peak near 6-7 Hz and the tonal set from 30 to 60 Hz. Compared to site LA2 near Liberty reported below in Section 3.2.1 which was very quiet, the only spectral regions with manmade sounds are below 10 Hz and from 20 to 60 Hz. The hydrophone positioned near the bottom exhibits slightly higher levels indicating that the energy is likely propagating primarily through the bottom.

The airborne noise spectra recorded during the lunch break is shown in Figure 3.1.4-3. Again comparing these conditions to the quiet period at site LA2, the only manmade, i.e., machinery, sounds above ambient at this site are at frequencies below 80 Hz. At 80 Hz

the two sites had equal levels. The difference increases as frequency decreases so that at 2 Hz the site NA5 levels are nearly a 15 dB higher than measured at LA2. Also note that the microphone picked up a few tonals, notably at about 180 and 290 Hz. When work resumes, these tonals are masked by the site crew at work as discussed below.

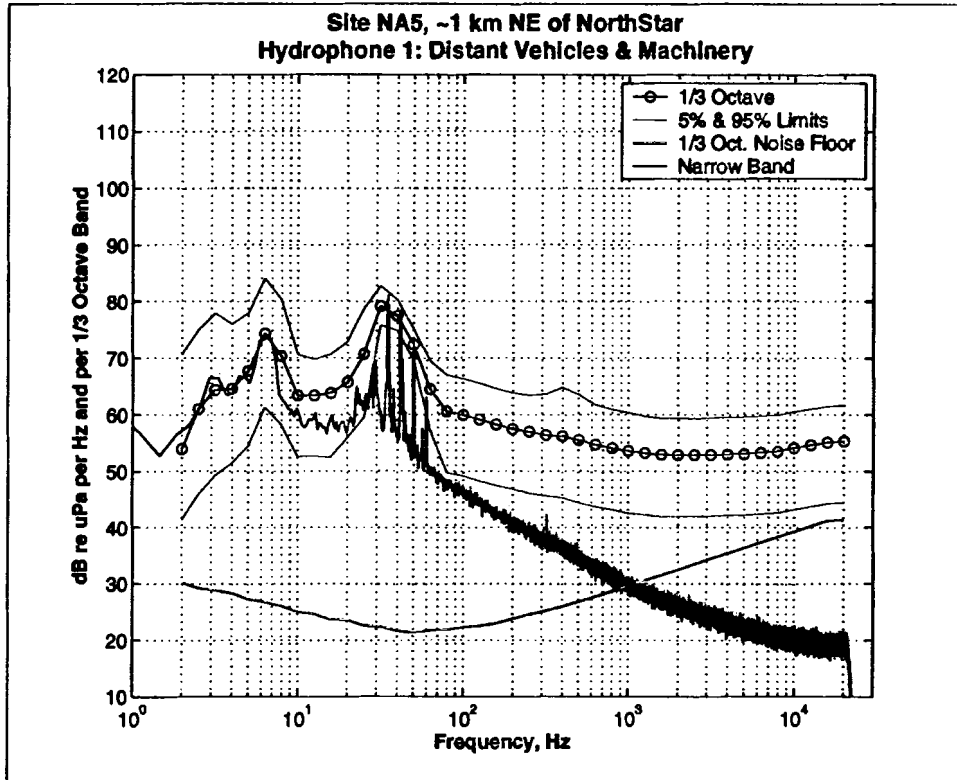

Figure 3.1.4- 1. Near bottom underwater noise levels at site NA5; lunch break. (8-4400)

Ice vibration levels 0.54 nm (1 km) away from Northstar at lunch time are shown in Figure 3.1.4-4. The only energy detectable above the measurement system noise floor is below about 30 Hz and includes three of the tonals observed in the underwater data set discussed above.

3.1.4.1 Site NA5 During Working Hours

With lunch time over, vibrahammer operations resumed and trucks and plows again were active. Multiple time cuts were examined both before and after lunch. They all fell into one of two categories: moderate or high level vibrahammer operation. The difference between the two is presumed to be due to the different soil conditions encountered as each sheet piling was driven into the island base.

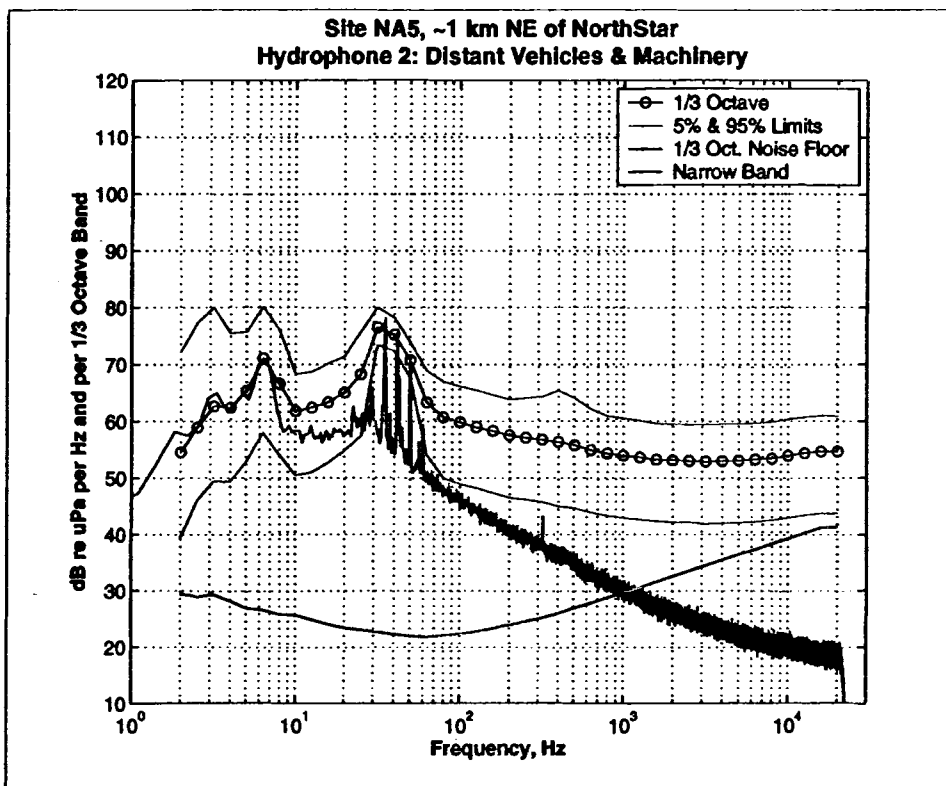

Figure 3.1.4- 2. Mid-channel underwater noise levels at site NA5; lunch break. (8-4400)

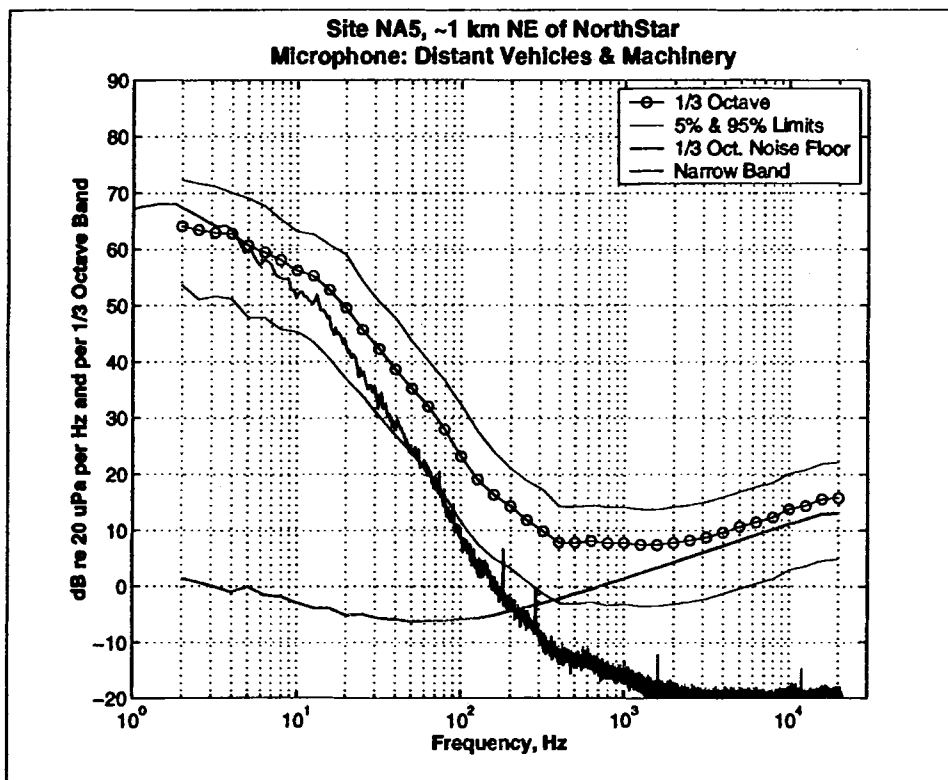

Figure 3.1.4- 3. Measured in-air noise levels at site NA5; lunch break. (8-4400)

Underwater noise from the two sensors during moderate vibrahammer excitation are shown in Figures 3.1.4-5 and 3.1.4-6 for the deep and mid channel hydrophones, respectively. The dominant features are the tonal near 23 Hz, the high energy below 10 Hz, and a few tonals above the strong 23 Hz peak. As before, the near bottom sensor has slightly more noise than the mid-channel sensor. Under moderate vibrahammer noise, the 1/3 OB containing the 23 Hz tonal was seen to vary in level from 96 to 106 dB re μPa on H1 and 92 to 102 dB re μPa on H2. Over the rest of the spectral band, the noise spectra levels remained quite consistent (± 2 dB).

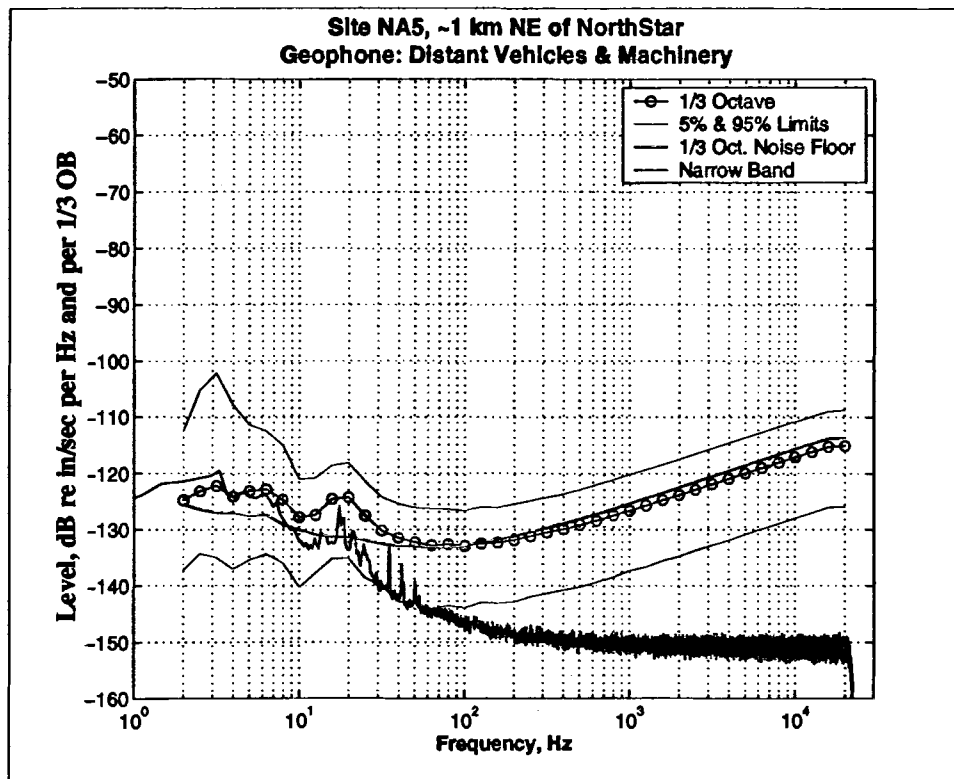

Figure 3.1.4- 4. Measured ice vibration levels at site NA5; lunch break. (8-4400)

High level vibrahammer induced underwater noise spectra are presented in Figures 3.1.4-7 and 3.1.4-8. The differences between this and the moderate operation levels are:

- much stronger, about 10 dB, noise levels around 7 Hz,
- higher level 23 Hz tonal sound levels, and
- richer narrowband structure from about 40 to 150 Hz.

Under these noisier conditions, the 23 Hz tonal was seen to vary from 102 to 112 dB μPa . There is also an energy peak centered near 500 Hz. This feature was sometimes observed under moderate vibrahammer operation although at a lower level.

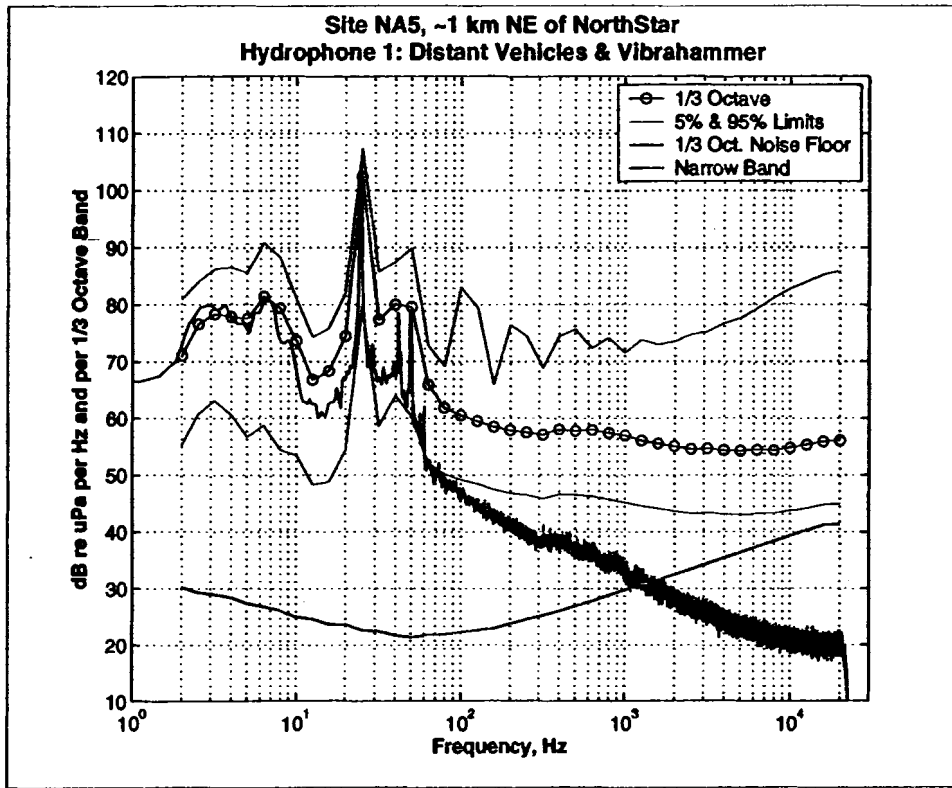

Figure 3.1.4- 5. Near bottom underwater noise levels at site NA5; vibrahammer. (8-1200)

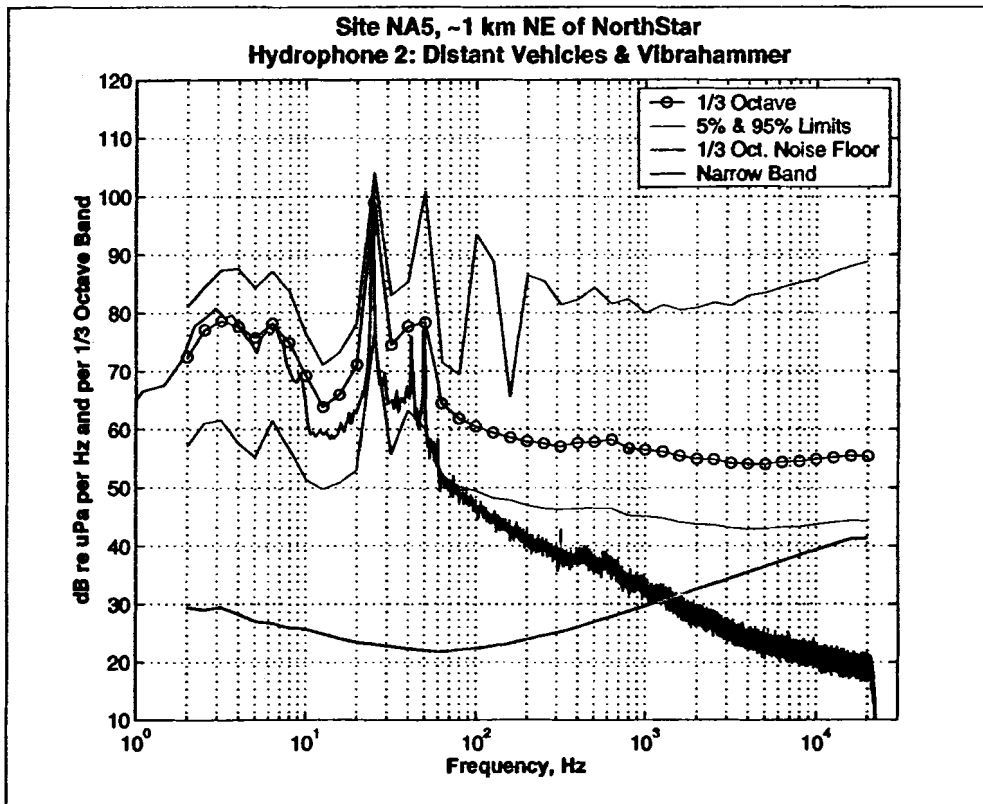

Figure 3.1.4- 6. Mid channel underwater noise levels at site NA5; vibrahammer. (8-1200)

At site NA5, the microphone data included times with the vibrahammer clearly in operation and times when the dominant noise was due to distant plowing and truck sounds. Two samples of airborne noise with vibrahammer excitation are shown in Figures 3.1.4-9 and 3.1.4-10. In the first case, the 23 Hz tonal is clearly evident with about a 12 dB signal-to-noise ratio (SNR). Additional tonals in the 350 to 1800 Hz band are also present. In the second case, the soil resistance around the sheet piling must have been less than the previous case resulting in a much lower level 23 Hz tonal and a considerably sparser narrowband tonal set. In general, the quieter example had lower 1/3 OB levels by from 6 to 10 dB out to 2 kHz. Above 2 kHz, the noise level is only a lower bound due to the measurement system noise floor.

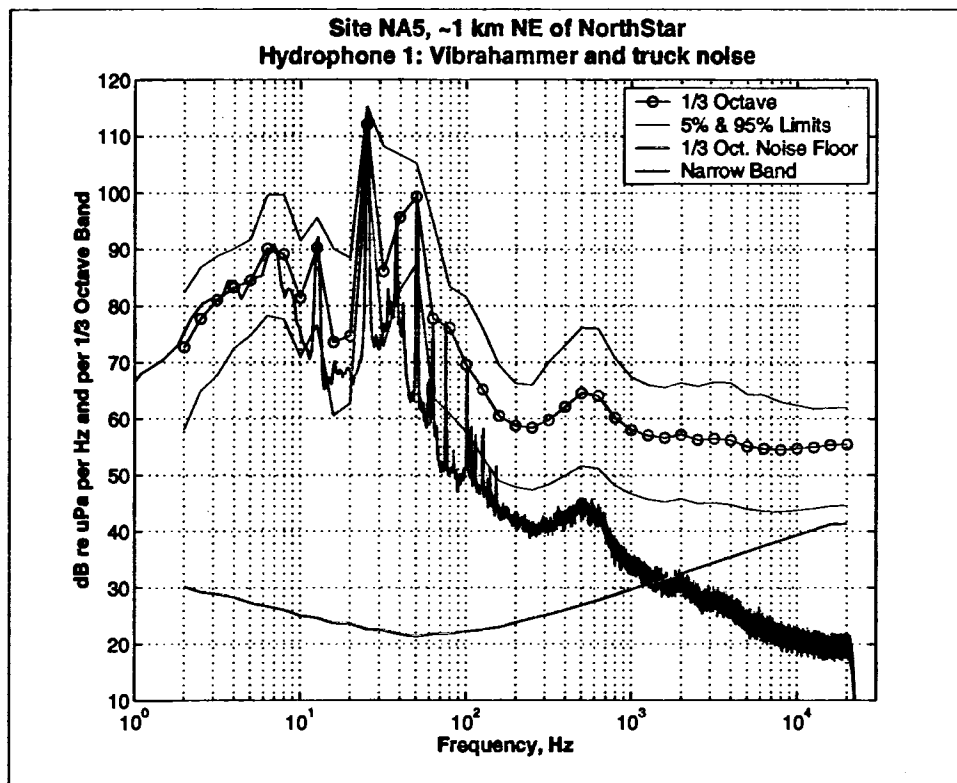

Figure 3.1.4- 7. Near bottom underwater noise levels at site NA5; strong vibrahammer. (10-0000)

When the vibrahammer 23 Hz tonal was not observable with the microphone at site NA5, the average 1/3 OB in-air noise levels showed considerable variability. The audible sounds were those of the plowing and trucking vehicles which were also present when the 23 Hz tonal was detectable. However, as will be seen in the ice vibration discussion immediately below, even though the 23 Hz tonal noise was not detectable, it was still present during these times. Other noise sources, most likely machinery and vehicle sounds, overrode the tonal level.

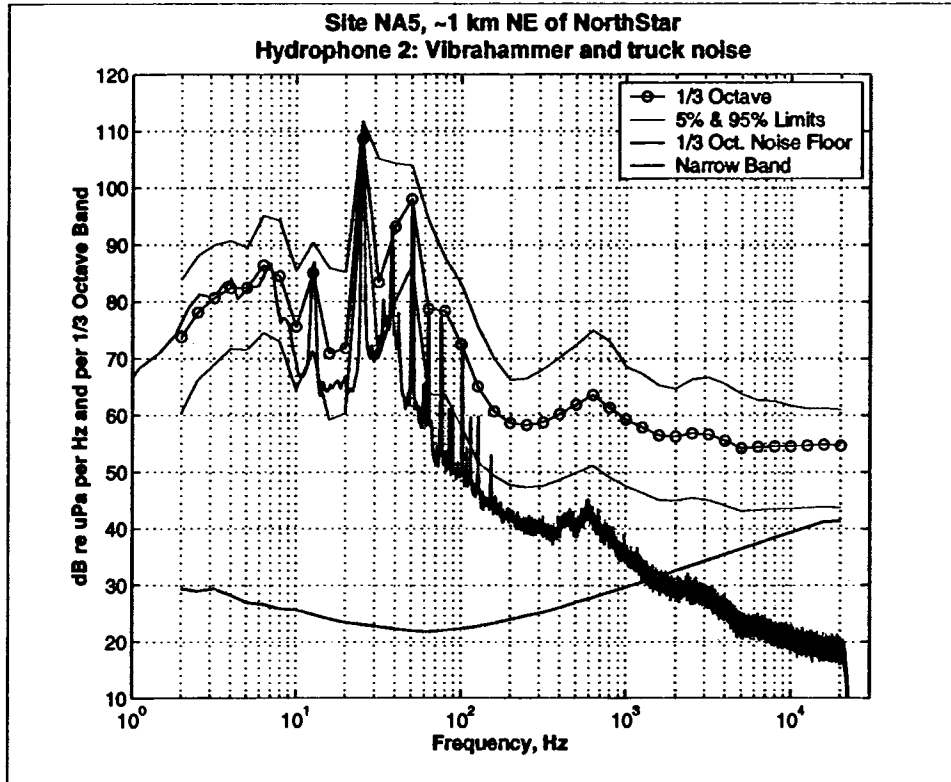

Figure 3.1.4- 8. Mid channel underwater noise levels at site NA5; strong vibrahammer. (10-0000)

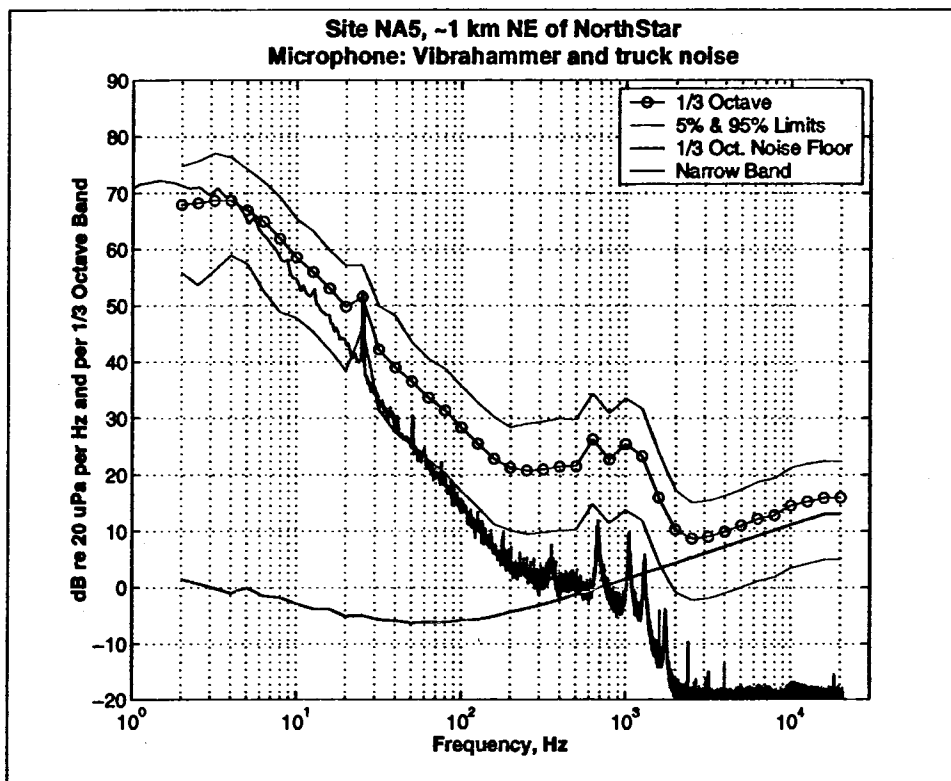

Figure 3.1.4- 9. In-air noise levels at site NA5; vibrahammer. (10-0000)

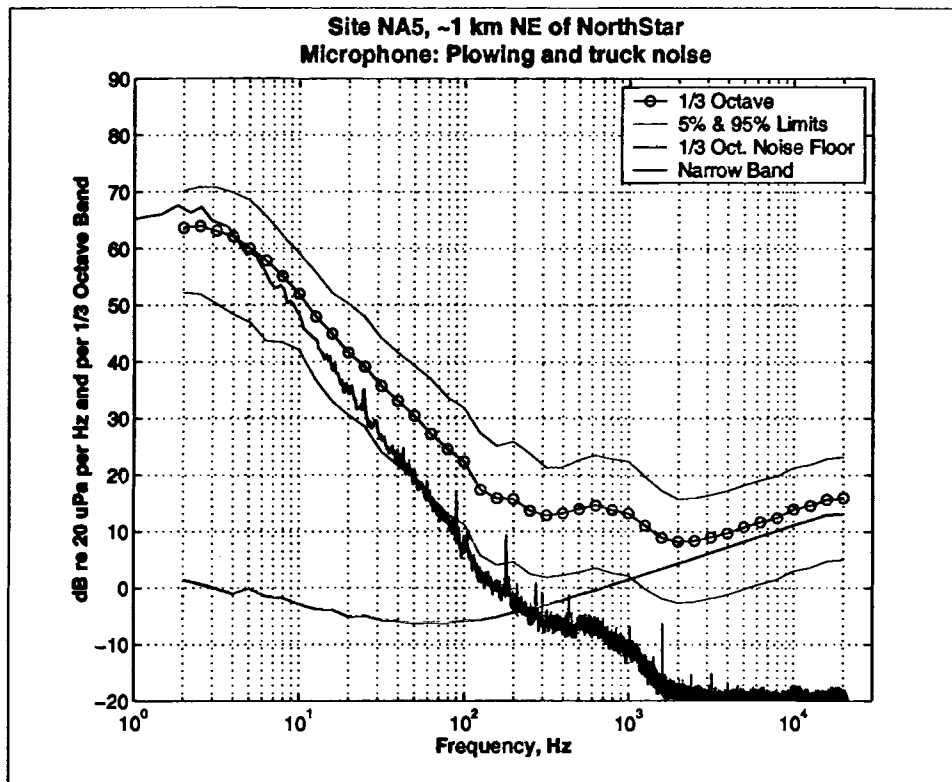

Figure 3.1.4- 10. Second sample of in-air noise levels at site NA5; vibrahammer. (9-6000)

Figures 3.1.4-11 and 3.1.4-12 are two examples when the 23 Hz is not detectable in the air. Comparing the two, the former shows 2 to 8 dB higher noise levels in the 8 to 150 Hz band but 2-3 dB lower noise in the 300 to 1200 Hz region. The 1/3 OB levels are nearly comparable to the levels measured with the 23 Hz tonal present. This implies that the primary airborne noise sources are the machinery and vehicle noises at Northstar and individual samples are dependent on the amount of this activity at the time of data collection.

Ice vibrations at site NA5 were only impacted by Northstar activities at frequencies below about 100 Hz. Two representative examples are provided in Figures 3.1.4-13 and 3.1.4-14. The most energetic measured vibration levels are shown in Figure 3.1.4-13. The dominant features are the narrowband tonals at 23, 39, 50, 61, 75 and 100 Hz plus

the broad low frequency noise hump below 20 Hz. In-air noise levels at this time were shown in Figure 3.1.4-9 while the underwater noise levels were presented in Figures 3.1.4-7 and 3.1.4-8. All four plots show a strong 23 Hz tonal.

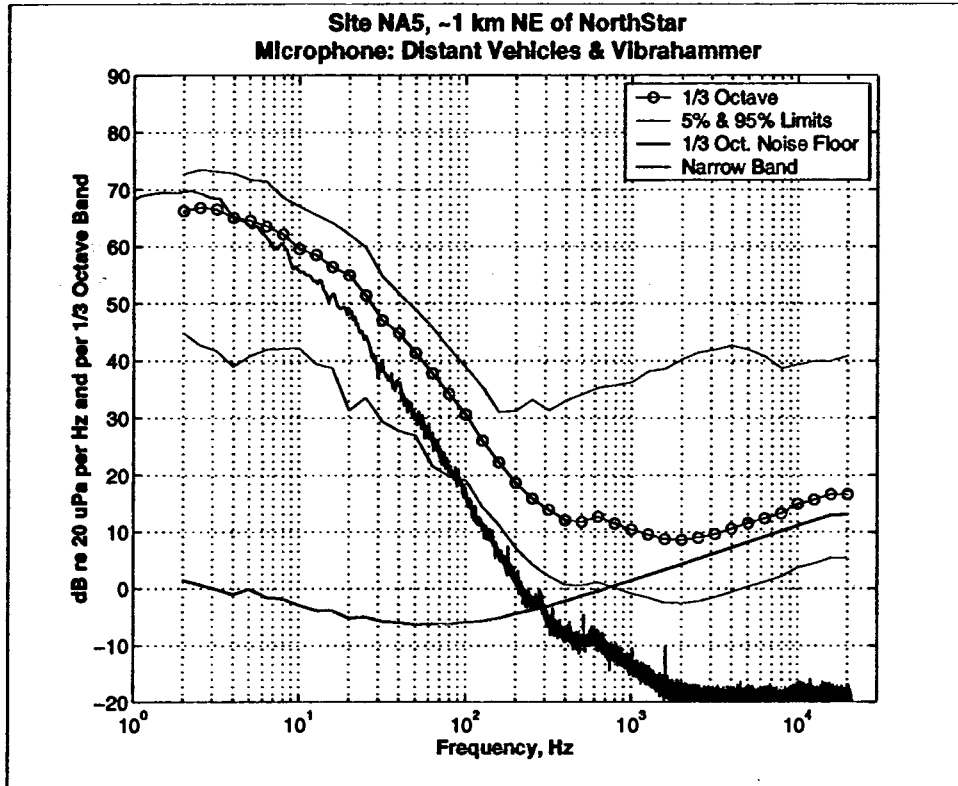

Figure 3.1.4- 11. Measured in-air noise levels at site NA5; no vibrahammer. (8-1200)

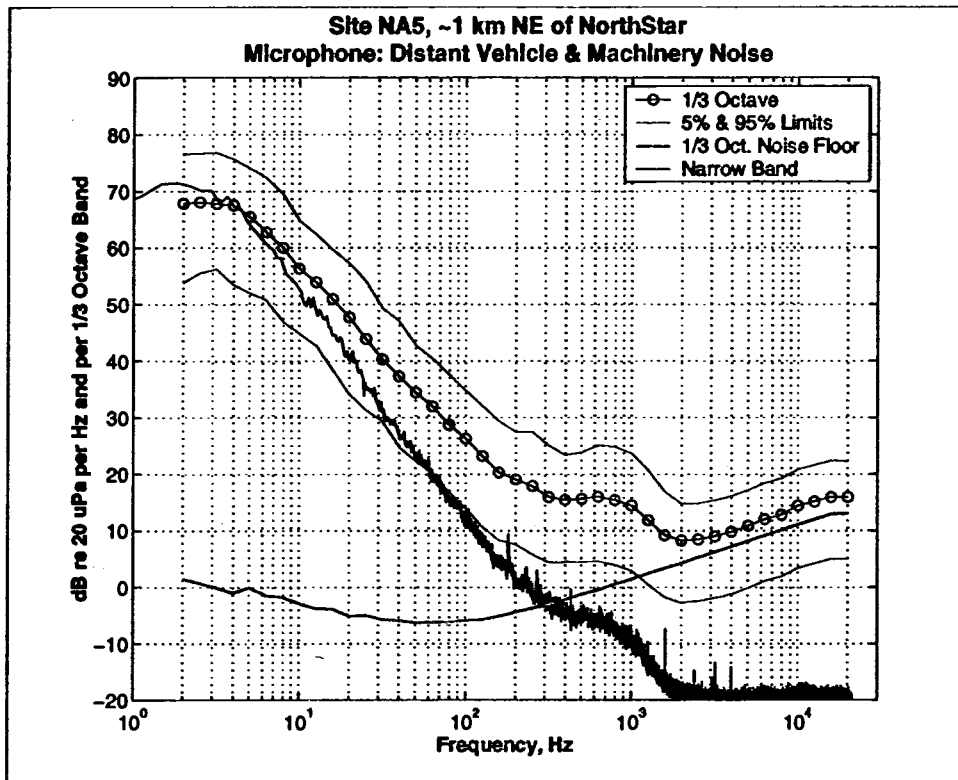

Figure 3.1.4- 12. Second example of in-air noise levels at site NA5; no vibrahammer. (10-1300)

In the second, quieter ice vibration example, the low frequency hump is still prominent but fewer significant tonals are present (23, 38, 50, and 73 Hz). Measured in-air noise shown in Figure 3.1.4-12 did not exhibit a strong 23 Hz tonal. However, both hydrophones (spectra not provided) had strong 23 Hz and other tonal components present. These observations lead to the conclusion that the vibrahammer noise propagates to the ice primarily through the ground and then briefly into the water. It is unclear whether the in-air vibrahammer noise is due to direct through-air propagation or is radiated from the ice into the air.

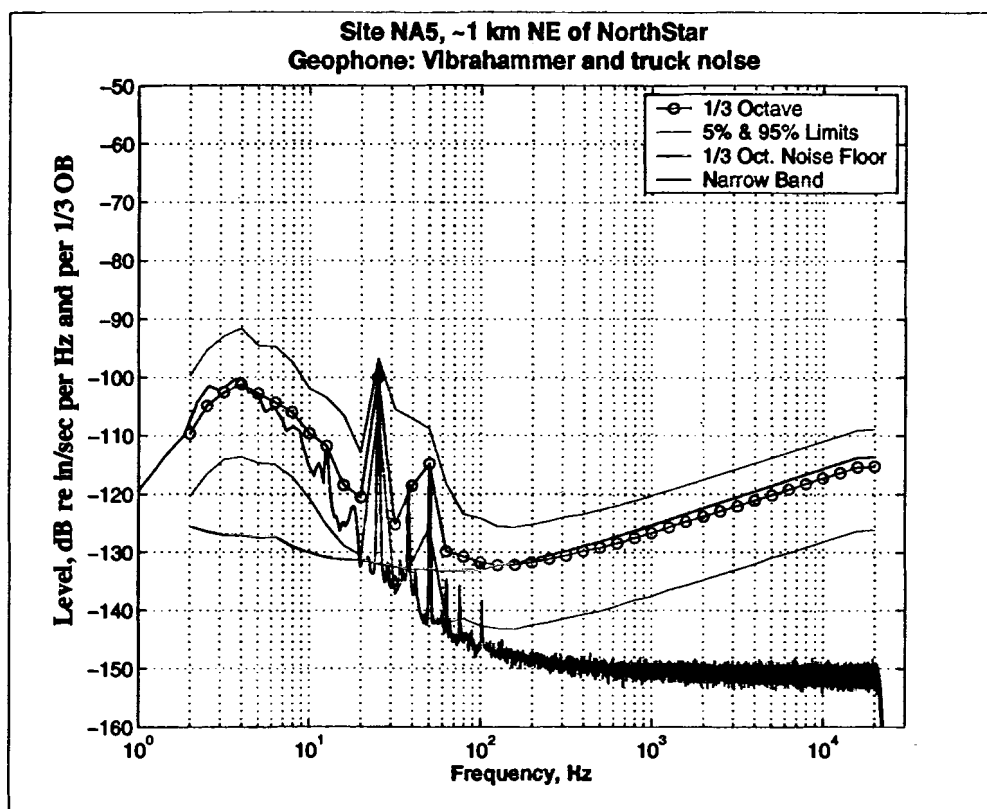

Figure 3.1.4- 13. Ice vibration noise levels at site NA5; vibrahammer. (10-0000)

3.1.5 Site NA6

Site NA 6 was occupied on 29 April 2000 with data collection starting at 4:23 PM local time. The location was about 1.1 nm (2 km) from the Northstar Prospect. Weather conditions were light snow with gusty winds around 10 kts (5.2 m/s) from the west. The water depth was 41 ft (12.4 m) with an ice thickness of 6 ft (1.8 m). The near bottom hydrophone was lowered to a depth of 33 ft (10 m) while the mid-channel sensor was at 21 ft (6.5 m). In general, the ambient noise conditions were very quiet with occasional ice clicks and pops.

Two examples of the conditions at NA6 are presented: one with strong vibrahammer noise and the other without. Figures 3.1.5-1 and 3.1.5-2 are spectra from the lower and mid-channel hydrophones respectively. Both exhibit the strong 23 Hz tonal, high low frequency noise levels below 10 Hz, and a tonal near 50 Hz. We hypothesize that the 50 Hz tonal is a machinery line and the low frequency energy is due to vehicle and machinery noise at Northstar.

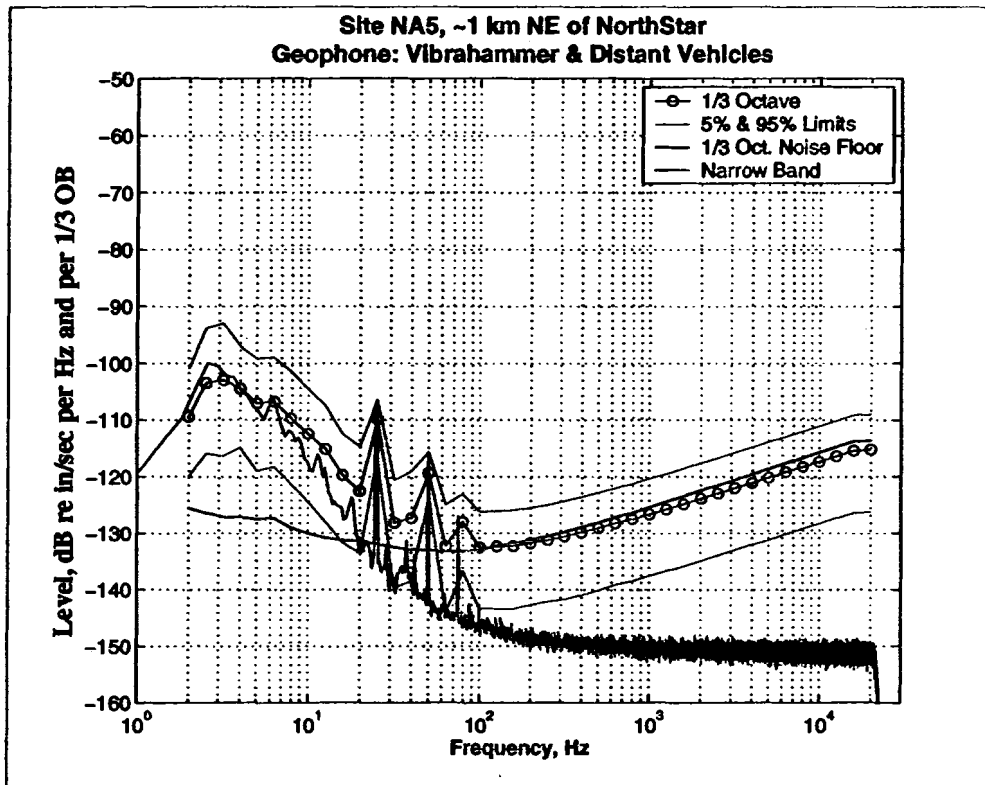

Figure 3.1.4- 14. Measured ice vibration levels at site NA5; vibrahammer. (10-1300)

Figures 3.1.5-3 and 3.1.5-4 show spectra for the same two sensors when the 23 Hz vibrahammer sound is not present. The other features, namely the 50 Hz tonal and the high low frequency energy below 10 Hz are still present, albeit somewhat reduced in level. Over the rest of the band, the levels are nearly identical to those observed with the vibrahammer in operation. In both pairs of spectra, the deeper sensor exhibits slightly higher noise levels indicating noise radiation from the bottom.

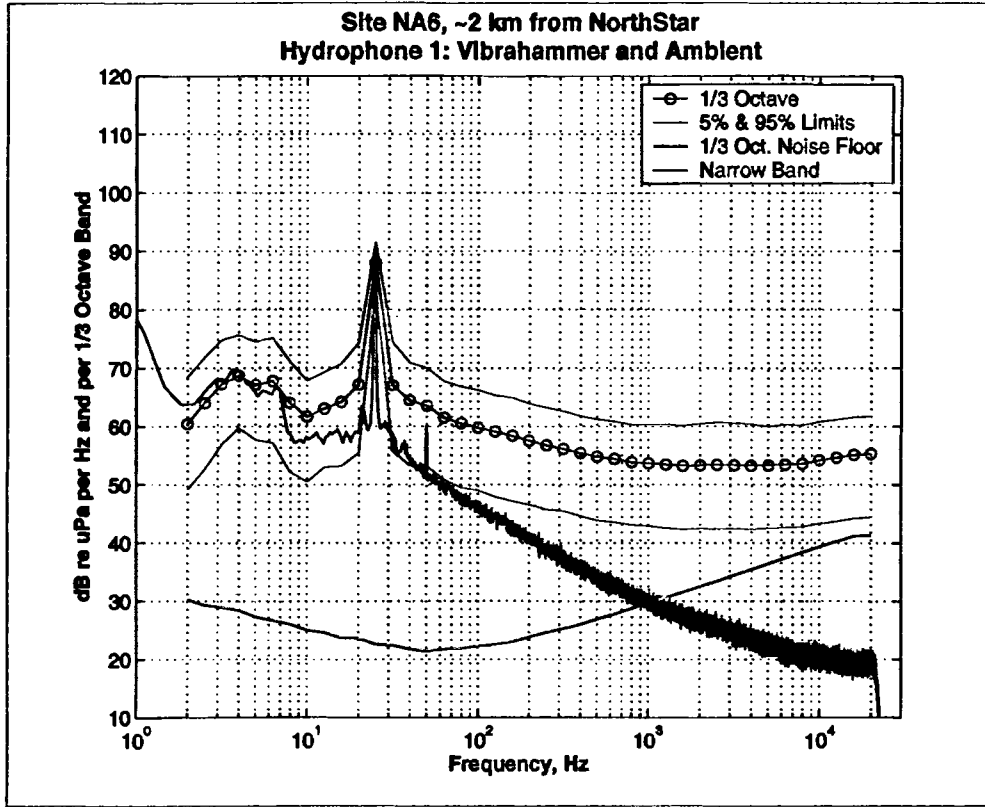

Figure 3.1.5- 1. Near bottom underwater noise levels, site NA6; vibrahammer. (11-1300)

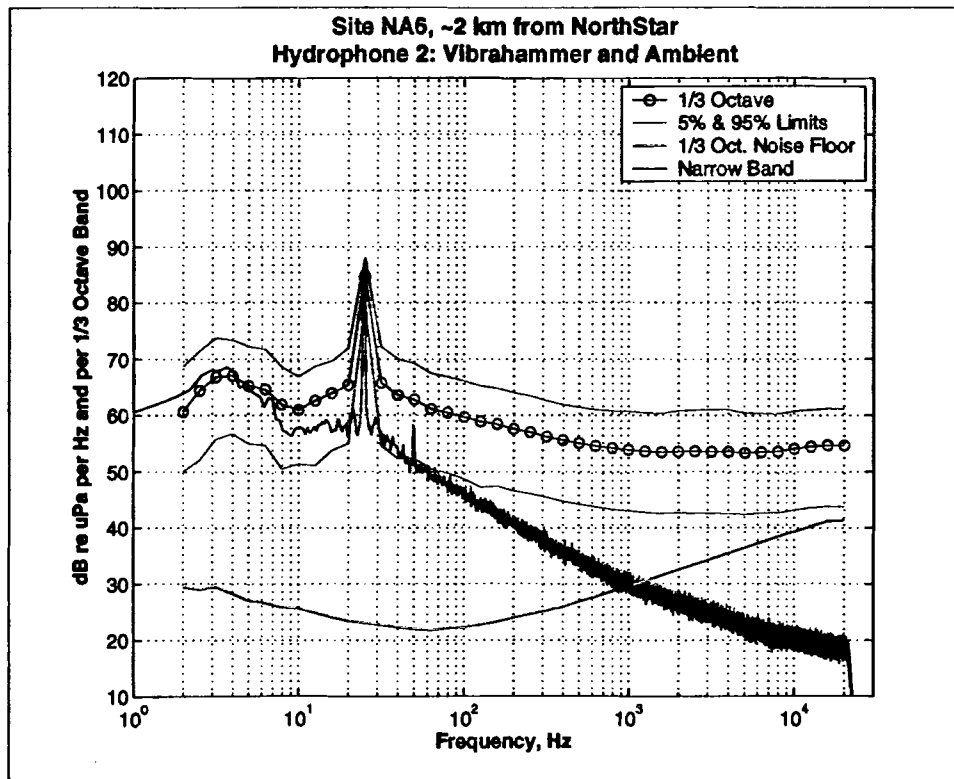

Figure 3.1.5- 2. Mid channel underwater noise levels, site NA6; vibrahammer. (11-1300)

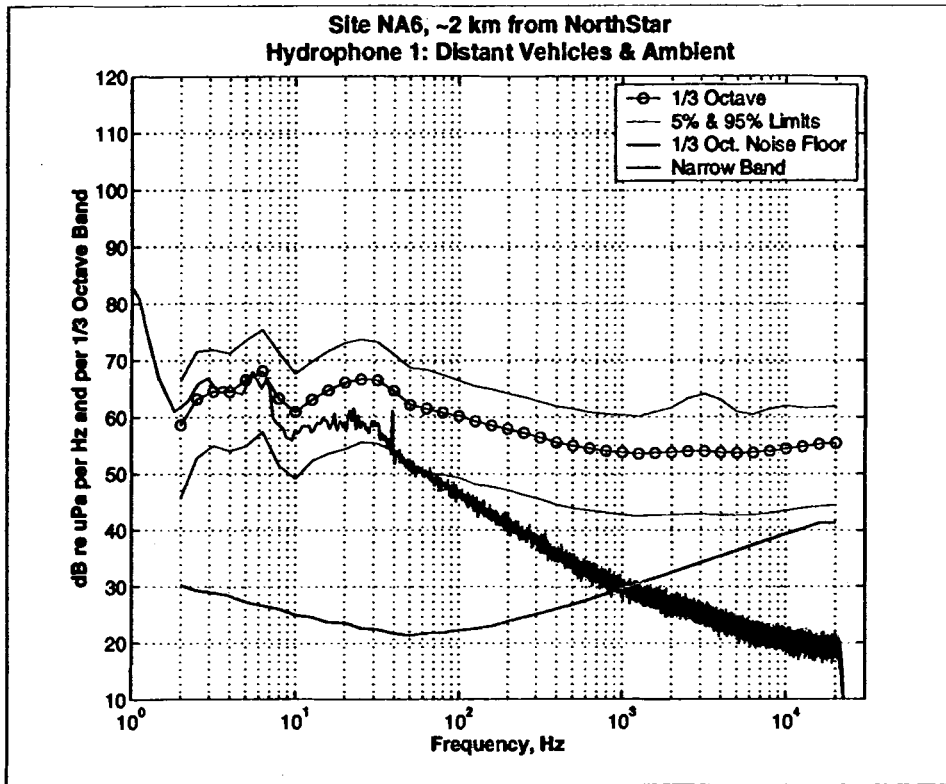

Figure 3.1.5- 3. Near bottom underwater noise levels at site NA6; no vibrahammer. (11-5330)

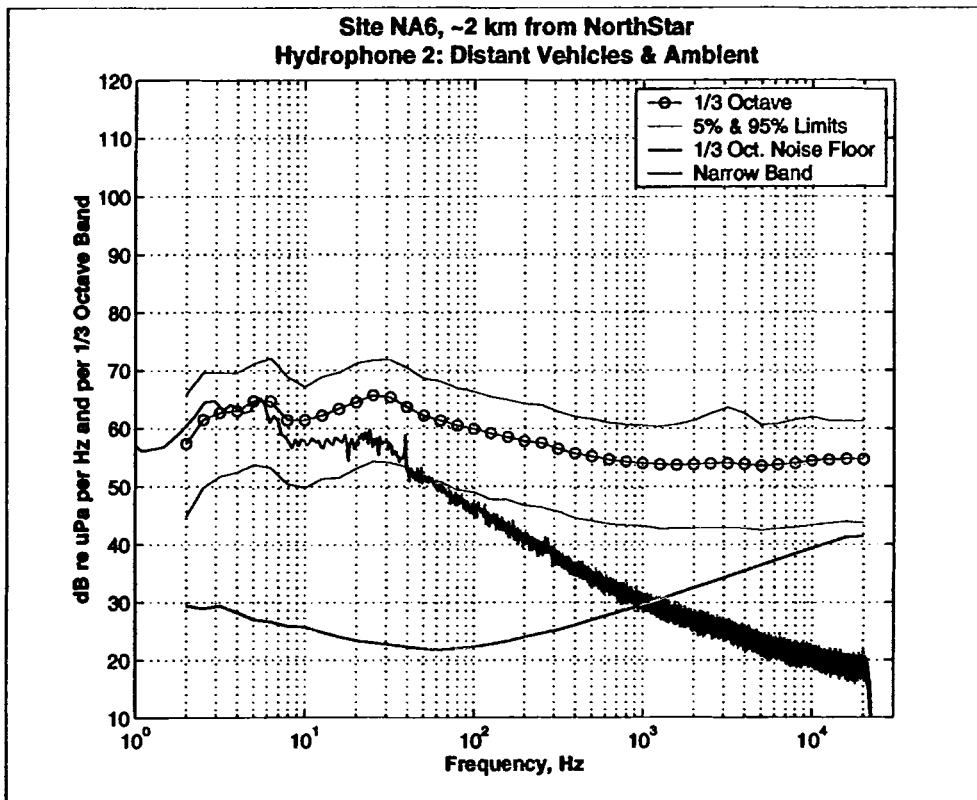

Figure 3.1.5- 4. Mid channel underwater noise levels at site NA6; no vibrahammer. (11-5330)

Measured in-air noise levels for the same two time periods are shown in Figures 3.1.5-5 and 3.1.5-6. Both exhibit no significant narrowband spectral features. In the first case, the vibrahammer is in operation and the 1/3 OB noise levels are 2-10 dB higher than the second case without the vibrahammer excitation. In the band from 4 to 800 Hz, the narrowband noise spectral noise falls at a rate of about 10 dB per octave and the 1/3 OB noise decreases at 7 dB per octave.

As seen at site NA5, even when the microphone can't detect the vibrahammer's 23 Hz tonal, the geophone can detect the tonal. Figure 3.1.5-7 presents measured ice vibration levels with the vibrahammer in operation. The 23 Hz tonal is clearly evident. Only energy at 23 Hz and below 10 Hz is above the measurement system noise. The very low frequency noise is most likely due to vehicle and machinery noise at Northstar. In Figure 3.1.5-8, the 23 Hz tonal has disappeared leaving only measurable low frequency energy between about 2 and 6 Hz.

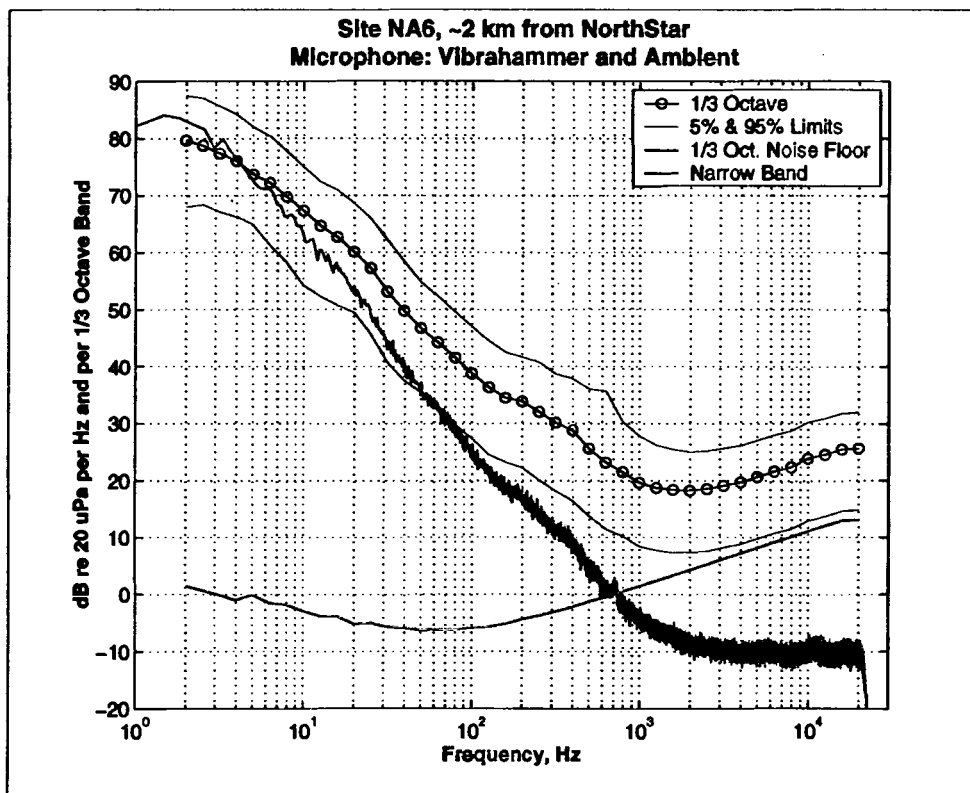

Figure 3.1.5- 5. Measured in-air noise levels at site NA6; vibrahammer. (11-1300)

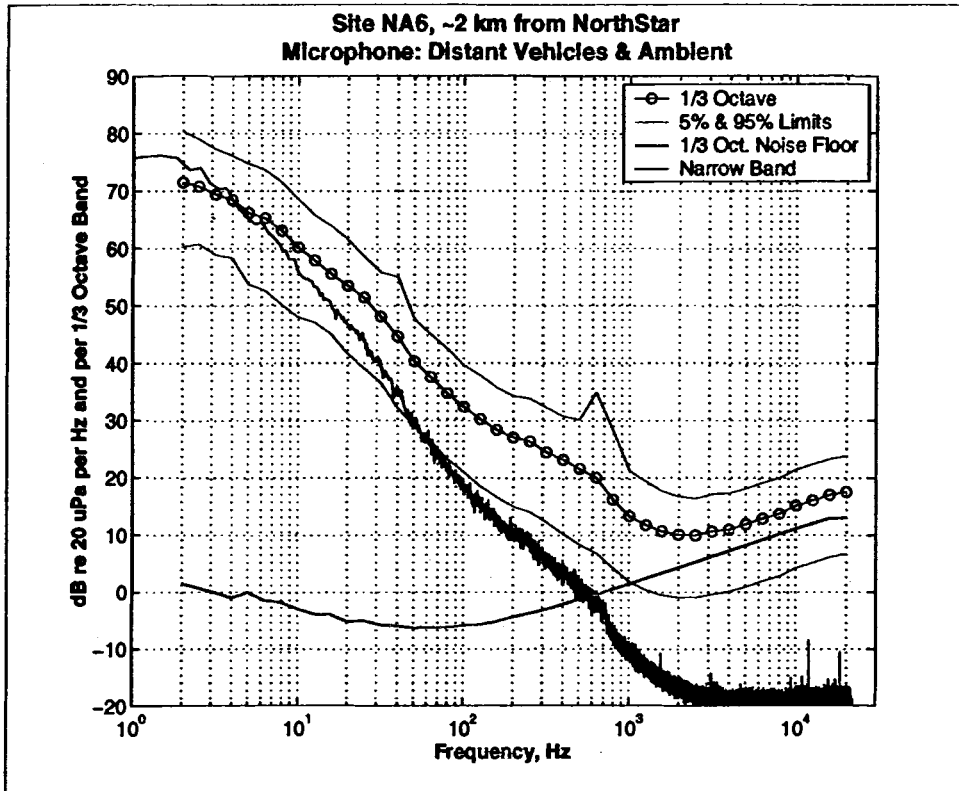

Figure 3.1.5- 6. Measured in-air noise levels at site NA6; no vibrahammer. (11-5330)

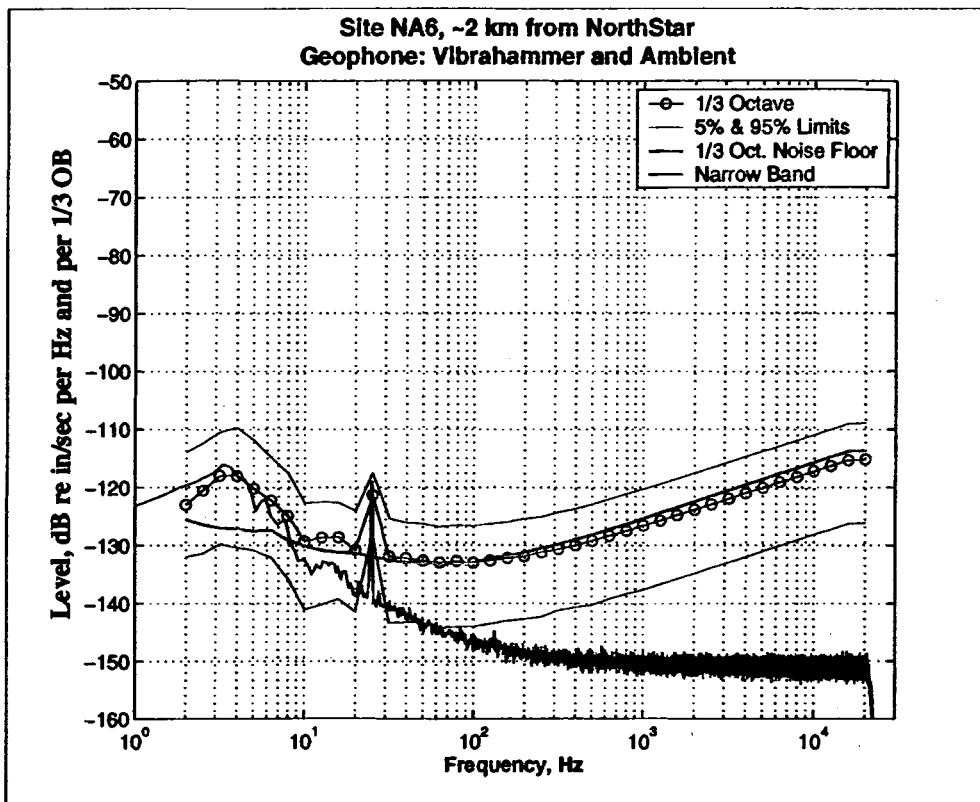

Figure 3.1.5- 7. Measured ice vibration levels at site NA6; vibrahammer. (11-1300)

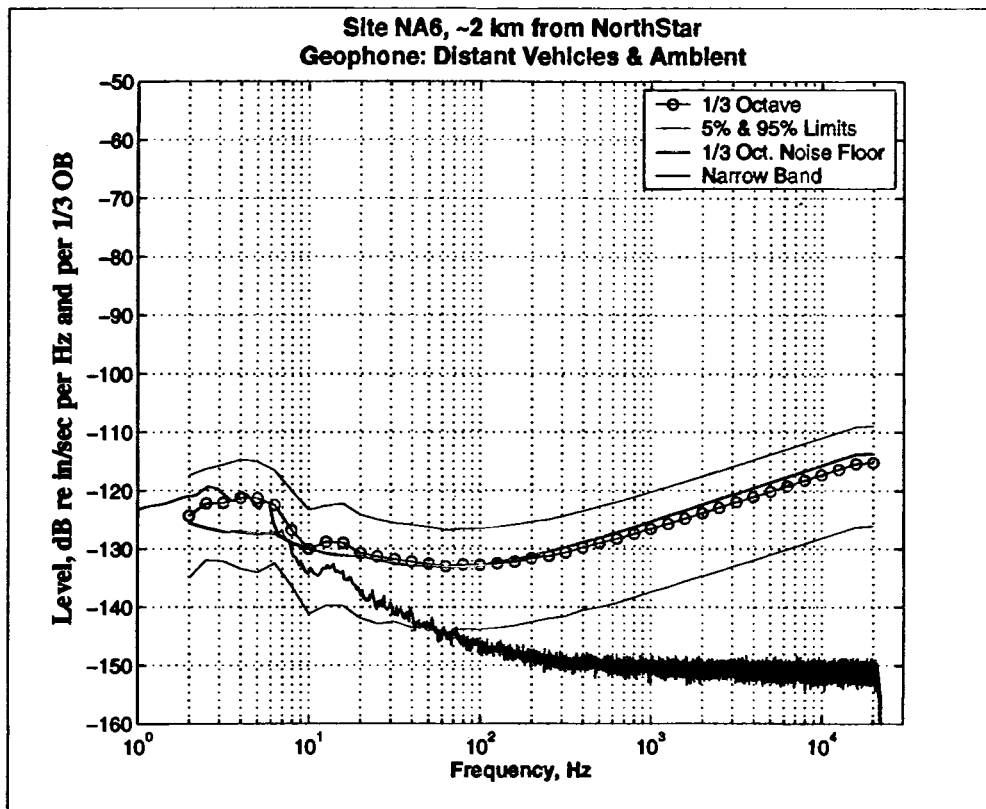

Figure 3.1.5- 8. Measured ice vibration levels at site NA6; no vibrahammer. (11-5330)

3.1.6 BSMP Site 5(5)

Site 5(5) is one of the Beaufort Sea Monitoring Posts located roughly 8.1 nm (15 km) from the Northstar prospect in 21 ft (6.5 m) of water. The site was occupied on 27 April with data collection beginning at 7:54 PM local time. Winds were from the north at 9 kts (4.6 m/s). In the distance to the northwest, a caravan of vehicles was observed which were thought to be a seismic crew. However, no evidence of seismic noise was detected.

The underwater noise field was sampled with H1 at a depth of 16 ft (5 m) and H2 at 10 ft (3 m). Two data segments are presented, one with low winds and the second with higher gusting winds.

Figures 3.1.6-1 and 3.1.6-2 show measured noise spectra for the deeper hydrophone under both wind conditions. The average 1/3 OB levels are nearly identical. However, the 95th percentile level is considerably higher over the band from 40 Hz to 2 kHz. The same is true of the noise field at mid depth as shown in Figures 3.1.6-3 and 3.1.6-4. The noise is quite similar to those measured at site NA2 2.2 nm (4 km) from Northstar except for a much more significant energy peak centered at 22 Hz and a broad increase in the noise level from 1 to 5 kHz.

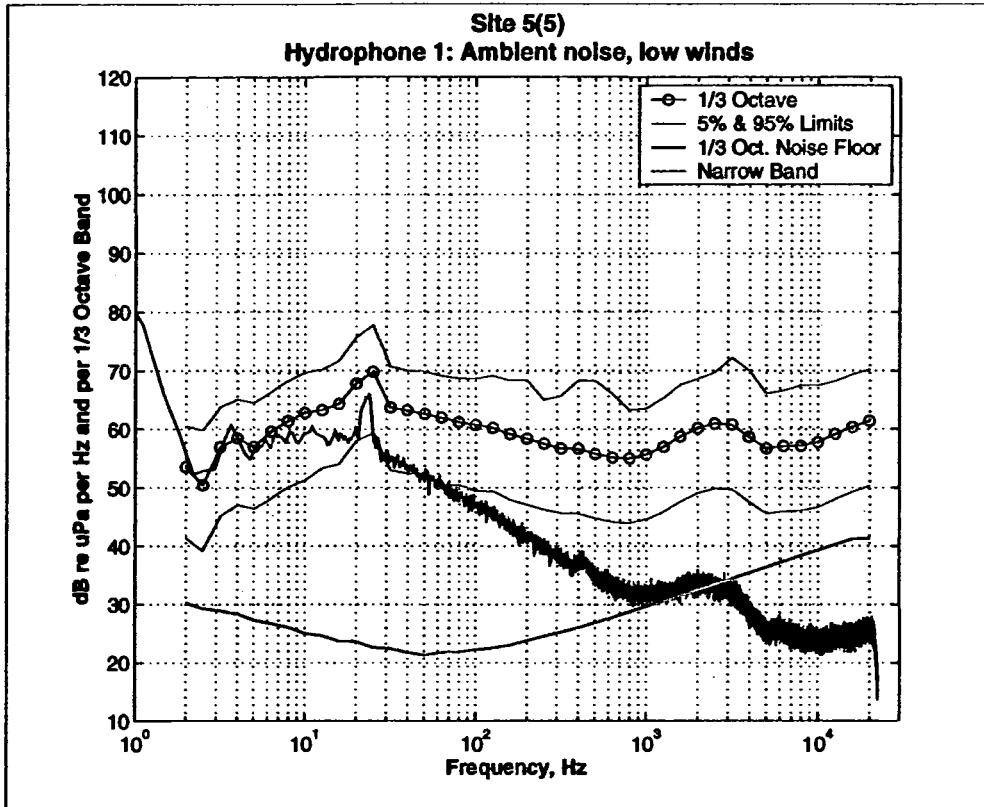

Figure 3.1.6- 1. Near bottom underwater noise levels at site 5(5); lower winds. (5-0400)

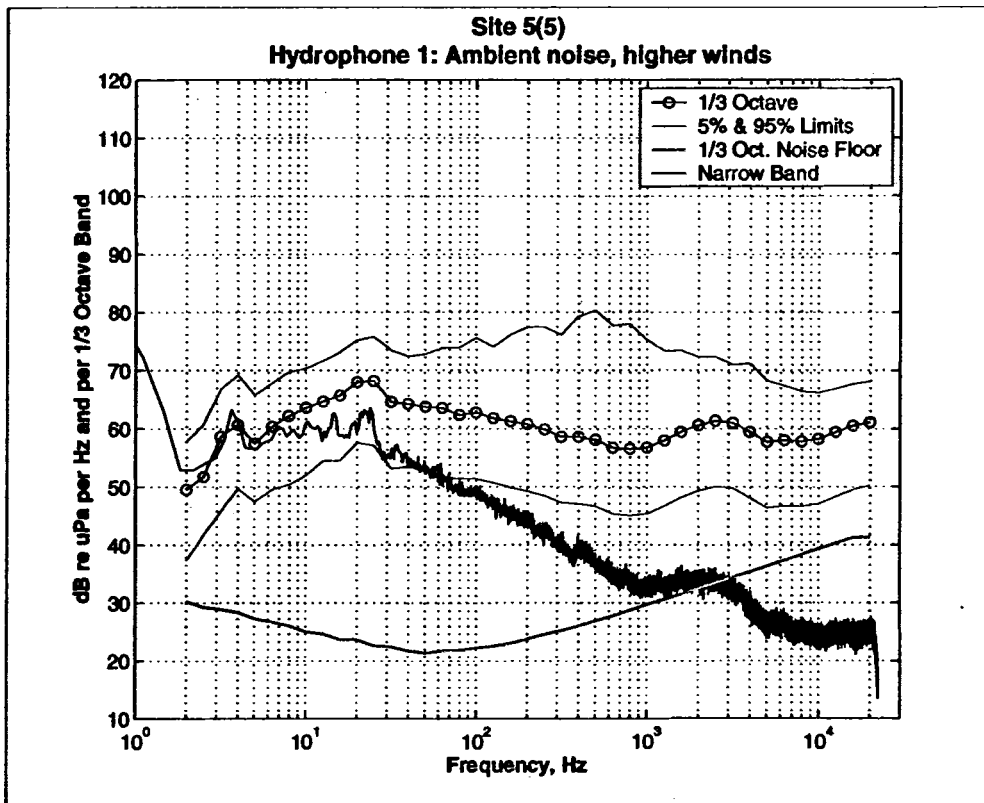

Figure 3.1.6- 2. Near bottom underwater noise levels at site 5(5); higher winds. (5-6050)

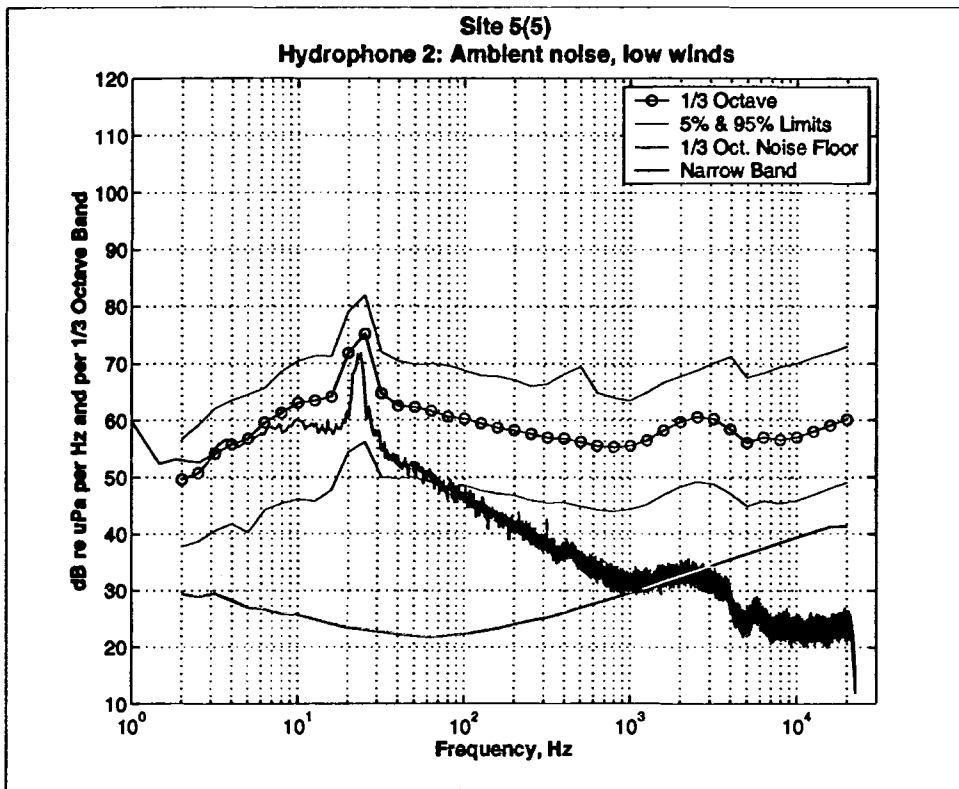

Figure 3.1.6- 3. Mid channel underwater noise levels at site 5(5); lower winds. (5-0400)

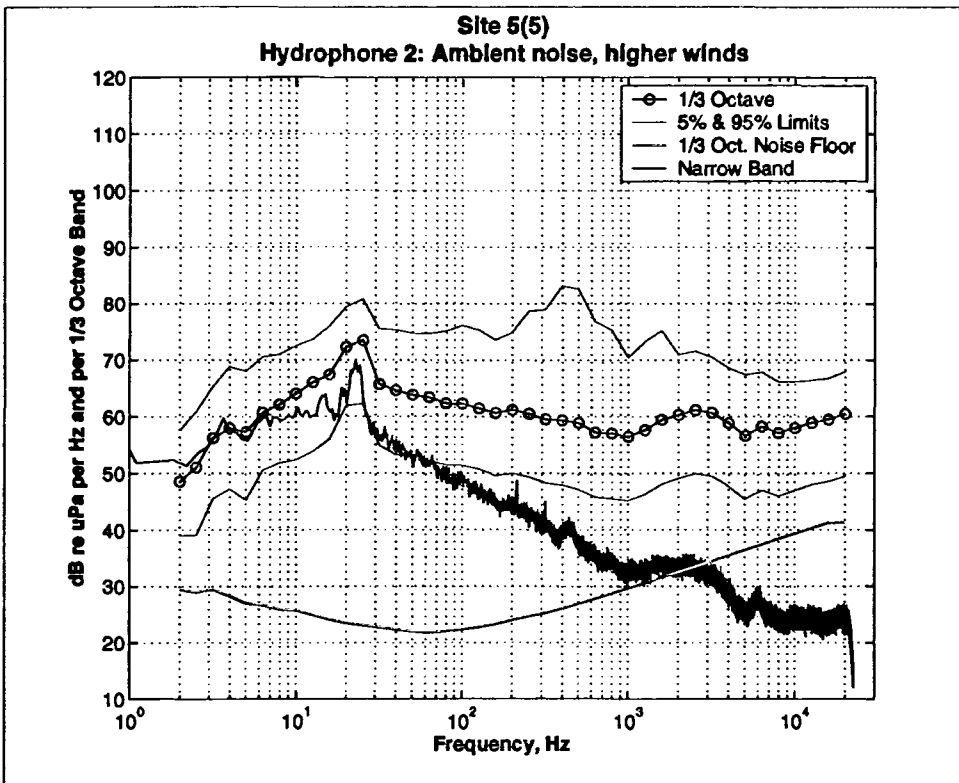

Figure 3.1.6- 4. Mid channel underwater noise levels at site 5(5); higher winds. (5-6050)

Airborne noise at site 5(5) was higher than that observed at site NA2 under lower wind conditions. Figure 3.1.6-5 is a typical example. Below about 2 kHz, the noise level here is approximately 10 dB higher than at NA2. The other significant feature is a peak near 200 Hz, possibly caused by the distant caravan noted above. Data above 2 kHz is approaching the system noise floor limit.

The ice vibration levels at 5(5) were, as at site NA2, generally at or below our system noise floor (figure 3.1.6-6). As at NA2, only the small band from 12 to 30 Hz shows any sign of excitation above the noise floor. Here, the energy centered at about 22 Hz has a higher level by roughly 10 dB than at NA2 based on the narrowband spectra. It is not clear whether this excitation is from the same source as observed at NA2. The 5(5) peak is slightly higher in frequency. It is unlikely that the source of this vibration is vibrahammer operation at Northstar. Vibrahammer data collected at sites NA3, NA5, and NA6 all show a stable narrowband tonal at a slightly higher frequency and with a much smaller bandwidth.

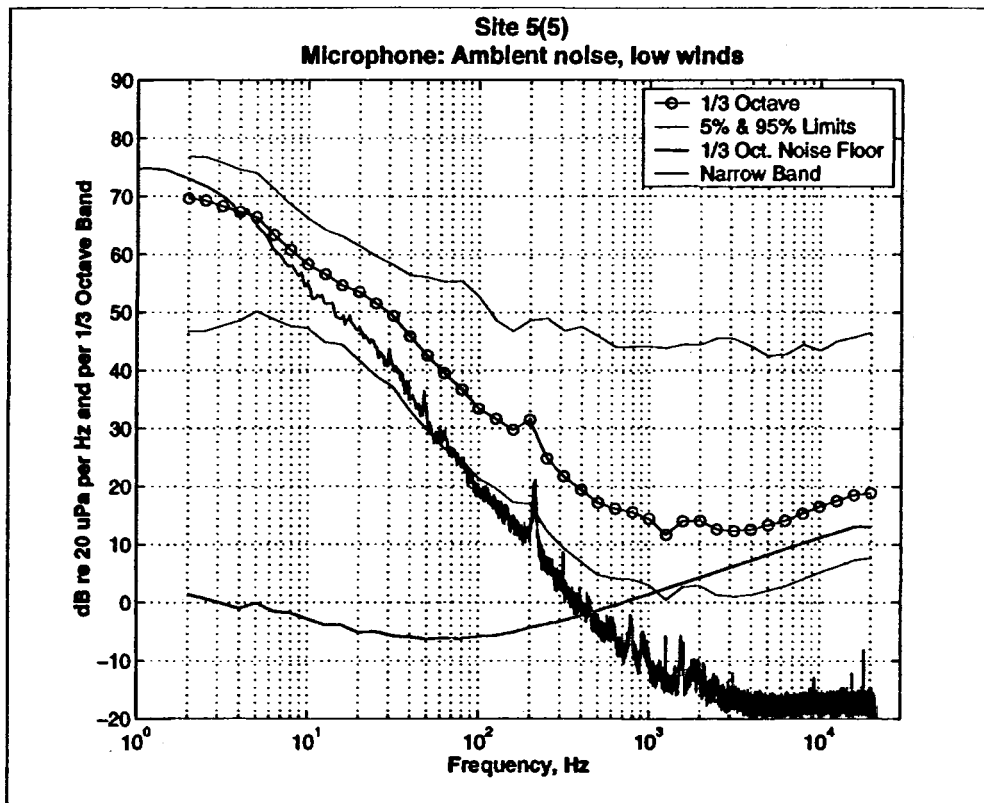

Figure 3.1.6- 5. Measured in-air noise levels at site 5(5). (5-0400)

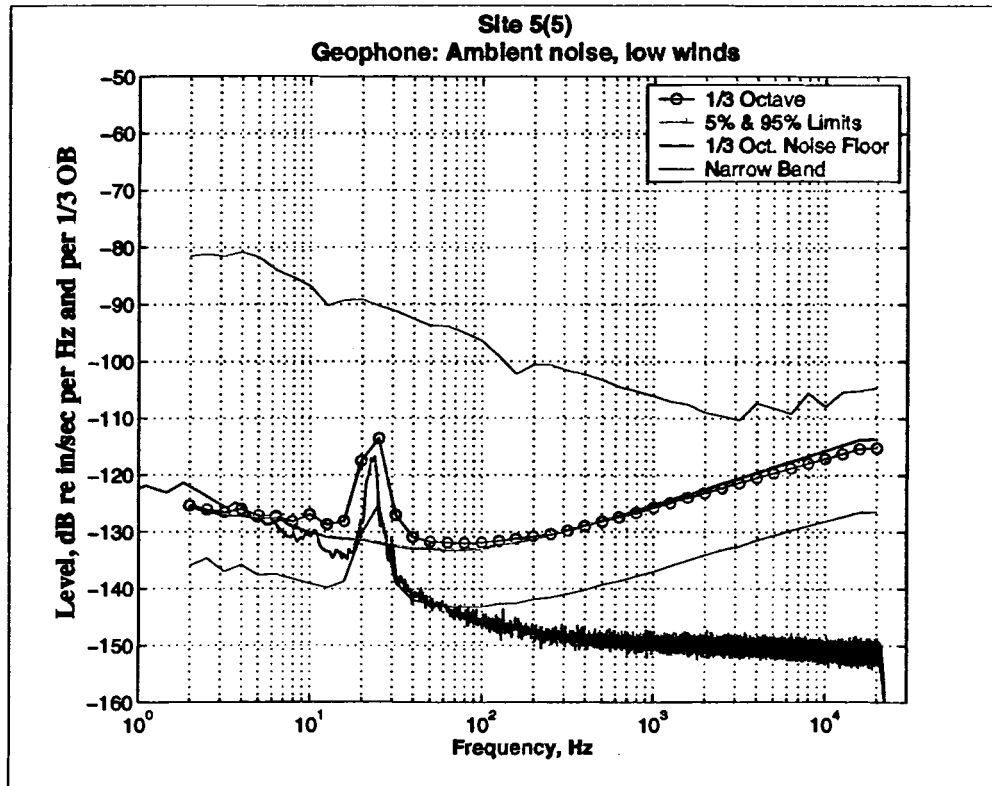

Figure 3.1.6- 6. Measured ice vibration levels at site 5(5). (5-0400)

3.2 Liberty Site

Data were collected at two sites at/near the future Liberty site. Aural examination of the data indicates that the only manmade noise was most likely the faint sounds from the Endicott flare. Otherwise, only natural ambient noises were present. The ice at both sites was quite smooth compared to the west and the snow was deeper, approaching 10 inches (25 cm) in places.

3.2.1 Site LA2

Site LA2 is located approximately 2.7 nm (5 km) NW of the future Liberty site. It is just about in the center of the Boulder Patch. The water depth was 20 ft (6 m) and the ice was 5 ft (1.6 m) thick. Winds were calm and the noise underwater and in the air were very quiet. Data collection started at 1 PM local time on 28 April.

Underwater noise spectra from the near bottom hydrophone at a 16 ft (5 m) depth and the mid depth sensor at 10 ft (3 m) are shown in Figures 3.2.1-1 and 3.2.1-2. Both plots have spectra nearly identical to those collected at site NA2. The only significant differences are a rise in noise level at high frequencies above about 7 kHz and higher levels of noise in the 20-30 Hz band. As before, the mid depth sensor measured a higher level of this 20-30 Hz energy than the near bottom hydrophone. As at NA2, this low frequency energy is also present in the ice vibration.

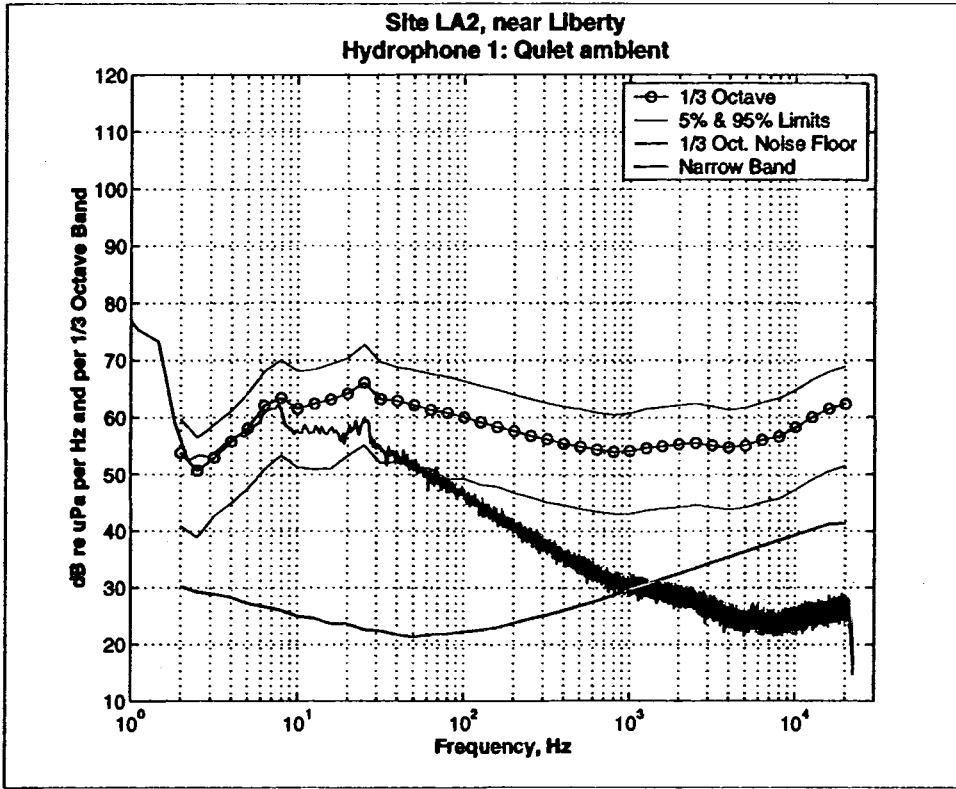

Figure 3.2.1- 1. Near bottom underwater noise level measured at site LA2 (6-1200).

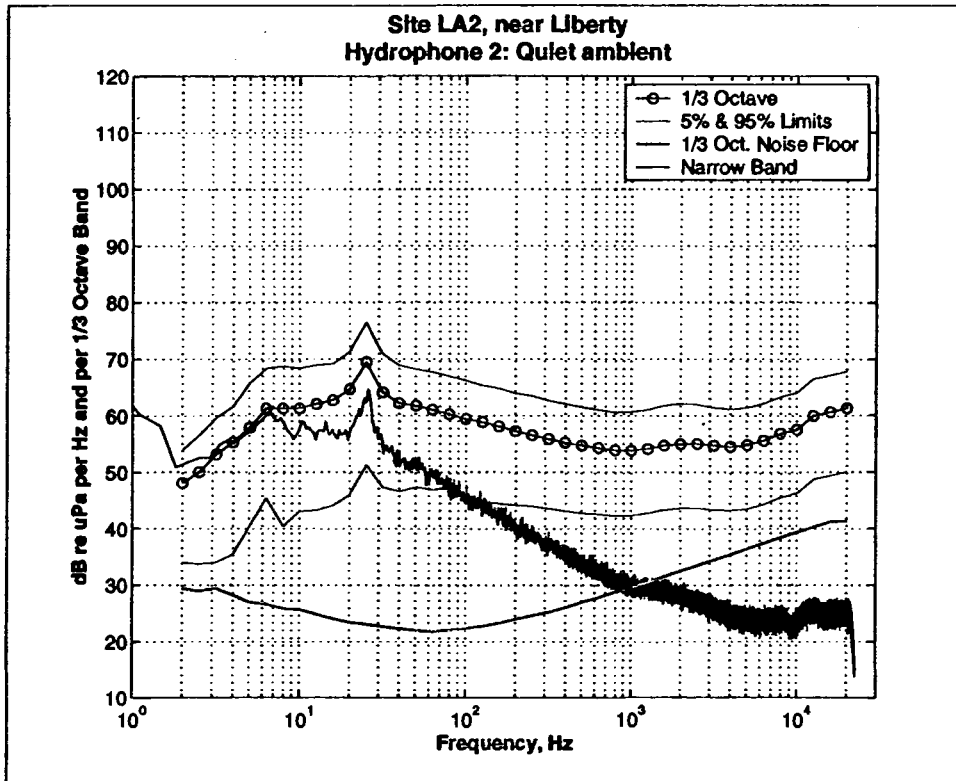

Figure 3.2.1- 2. Mid channel underwater noise level measured at site LA2 (6-1200).

In-air noise at LA2 is presented in Figure 3.2.1-3 while 3.2.1-4 displays the ice vibration spectrum collected using the geophone. The airborne noise level is also similar to those measured at NA2 except that the level approximately 5 dB quieter below 20 Hz. Energy in narrowband tonals is low with fewer lines present compared to NA2. As at NA2, the geophone detected very little energy except between 20 and 30 Hz.

3.2.2 Site LA3

Liberty site LA3 is located where Liberty Prospect development will take place. The scientific team collected data starting around 4:30 PM local time. Winds were light and the measured data are almost identical to the conditions encountered at LA2.

With a water depth of 20 ft (6.1 m), the two hydrophones were deployed to the same depths used at LA2, namely, 10 and 16 ft (3 and 5 m). The spectra in Figures 3.2.2-1 and 3.2.2-2 display the data from the near bottom and mid depth sensors, respectively. The noise levels are comparable to the data collected to LA2 except that the increase above 7 kHz is not present. As encountered before, the energy peak in the 20-30 Hz band is much more energetic at mid water column than near the bottom. These data represent quiet conditions with potentially some contribution from the Endicott flare to the west.

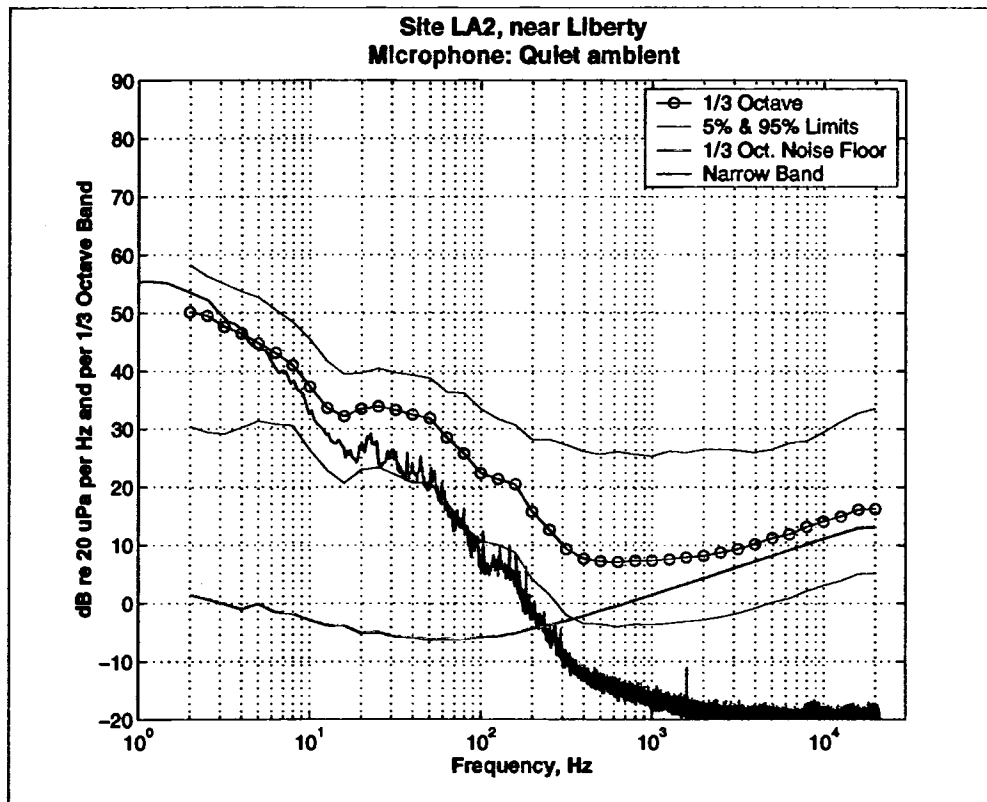

Figure 3.2.1- 3. Airborne noise level measured at site LA2 (6-1200).

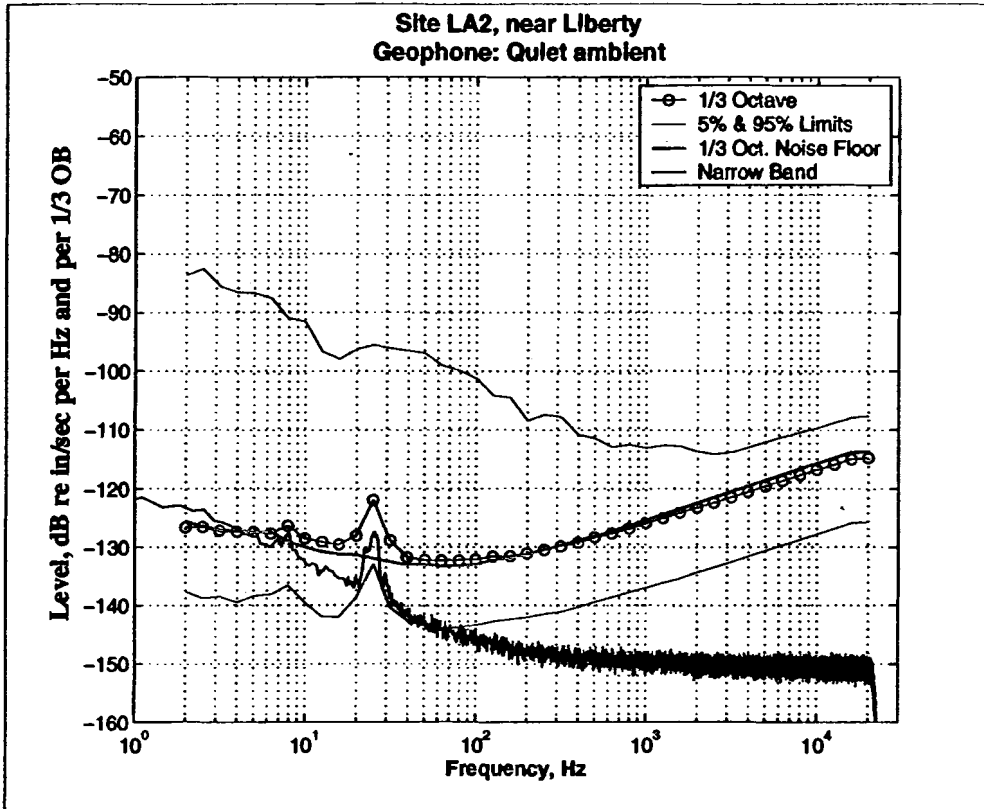

Figure 3.2.1- 4. Ice vibration noise level measured at site LA2 (6-1200).

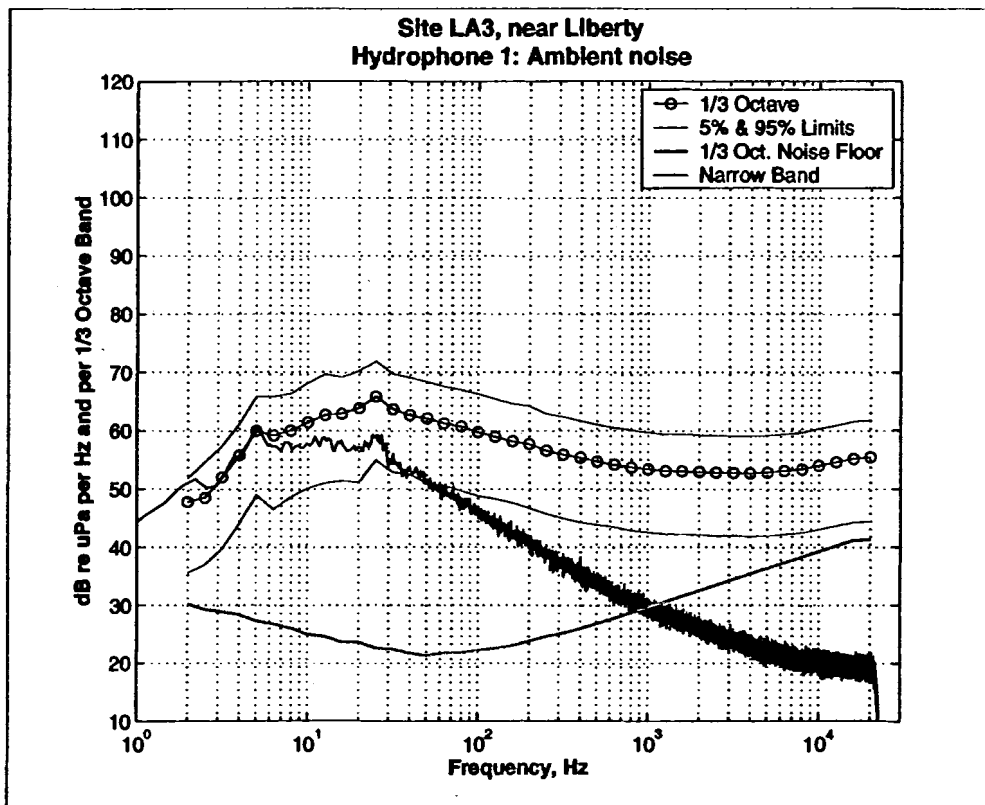

Figure 3.2.2- 1. Near bottom underwater noise level measured at site LA3 (7-5000).

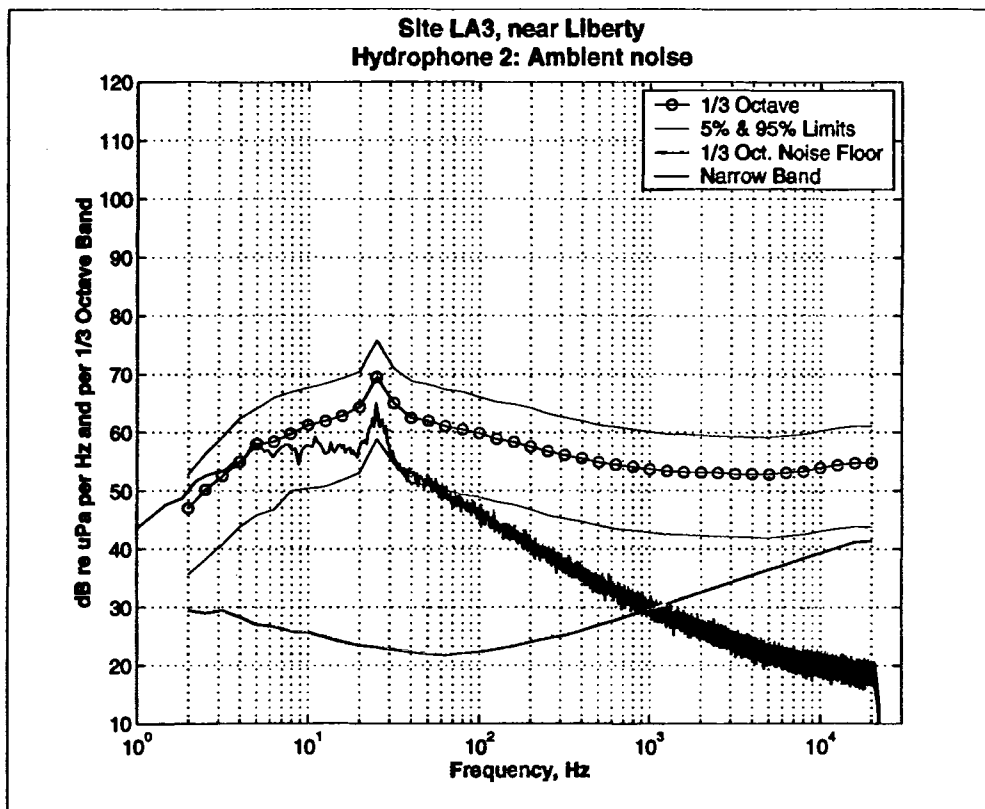

Figure 3.2.2- 2. Mid channel underwater noise level measured at site LA3 (7-5000).

The only sensor with which we could detect the Endicott flare was the microphone. It sounded like a low rumble which faded in and out. The data from LA3 contained a time period when the flare was faintly but consistently evident and a time when the flare was undetectable aurally. Spectra from these two periods are presented in Figures 3.2.2-3 and 3.2.2-4. The noise levels are practically identical except in the 70 to 500 Hz band where as much as a 10 dB increase is seen in Figure 3.2.2-3. With no other evidence, we conclude that this rise in energy is due to the flare located approximately 10.3 nm (19 km) to the west-north-west.

Measured ice vibration levels at LA3 are shown in Figure 3.2.3-5. As noted at LA2 and NA2, the only observable energy above the noise floor is in the 20-30 Hz band, the same spectral region that peaks in the mid depth hydrophone data. The source of this energy is unknown at this time.

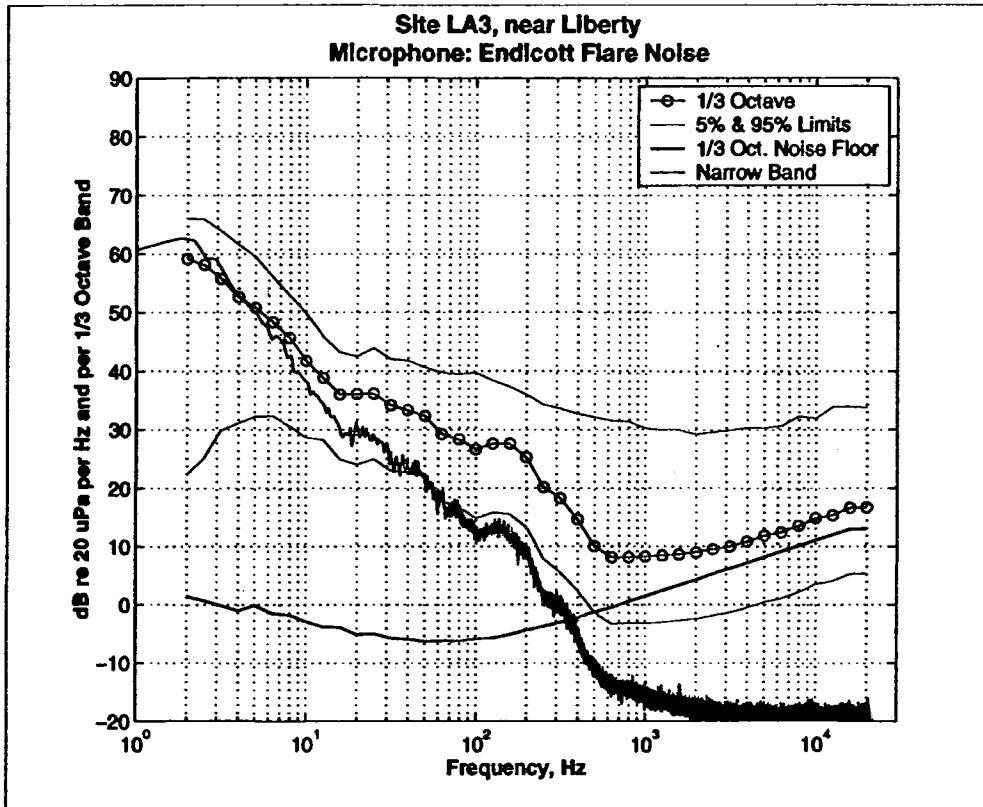

Figure 3.2.2- 3. Airborne noise level with flare measured at site LA3 (7-5000).

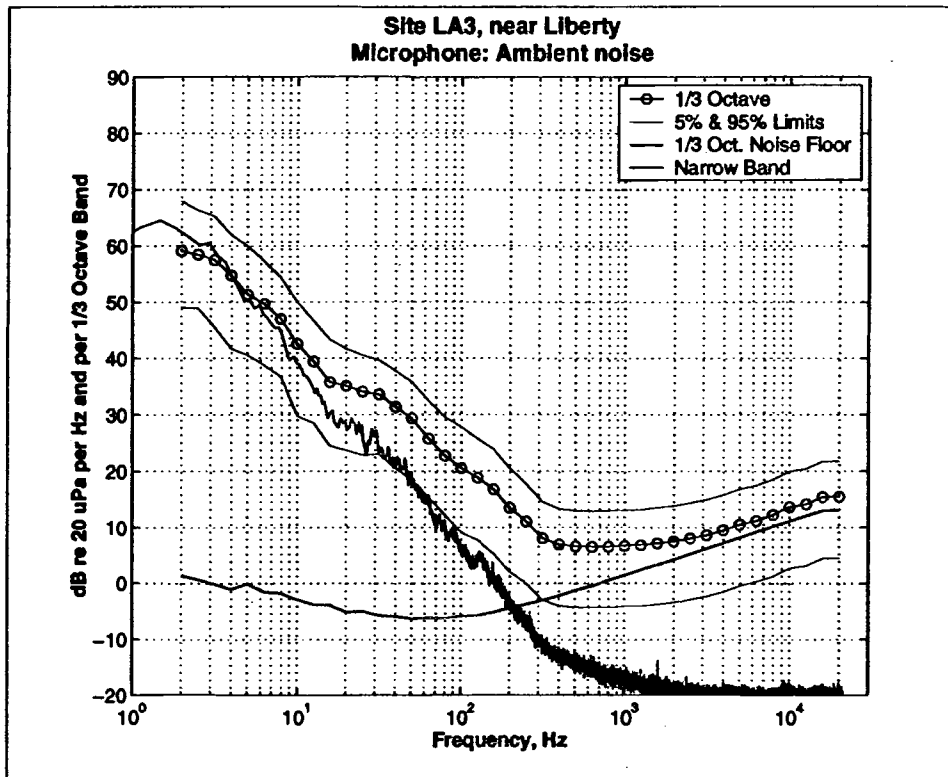

Figure 3.2.2- 4. Airborne noise level with no audible flare measured at site LA3 (7-1200).

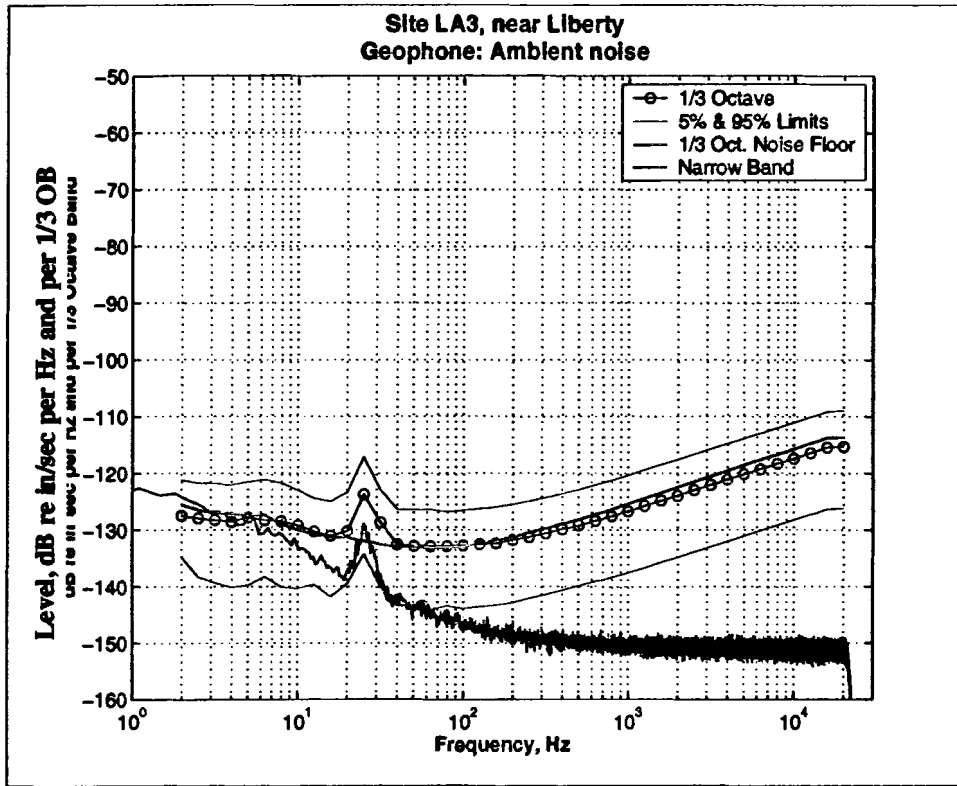

Figure 3.2.2- 5. Ice vibration noise spectrum measured at site LA3 (7-5000).

4.0 Discussion

4.1 Underwater Noise Environment

Underwater man-made noise emanating from Northstar island is primarily caused by three sources: vibrahammer operation, machinery noise such as diesel electric generators, and vehicle operations including plowing and truck movement. When driving sheet piles on the island, the vibrahammer produces the highest noise levels observed during our measurement period.

A vibrahammer is a heavy device that is attached to a standing sheet pile and caused to vibrate vertically driving the piling into the ground. The open-cell pilings are driven into the ground to a top elevation of about 7 ft (2 m) above mean lower low water (MLLW) along the south side of the island for a docking area [3]. Sheet piling are also installed to reduce potential contaminant releases into the marine environment by preventing damage to island facilities [3]. Energy is thought to be supplied by hydraulic motors which in turn are powered by diesel generators. Thus this suite of systems creates a rich noise environment. Depending on the soil conditions encountered by the sheet piling, the load on this suite can vary considerably and consequently the radiated noise levels, in the air and through the ground, fluctuate accordingly.

Vibrahammer noise is easily recognizable due to its strong, quite narrowband, tonal at 23 Hz. This tonal radiates out to at least a range of 1.1 nm (2 km) and probably further. Measured levels as a function of range are shown in figure 4.1-1. These data are 2 minute averages and were taken over several days. As noted above, the levels vary significantly from piling to piling; more than 15 dB at site NA5 0.54 nm (1 km) from Northstar. Because of this variability, the transmission loss as a function of range cannot be determined from this data set. However, spectra calculated over the same time period invariably resulted in higher levels measured near the sea bottom compared to the sensor located half way down the water column. This implies that the primary propagation path is through the earth and into the water column rather than directly into the water column at Northstar.

At ranges beyond 1.1 nm (2 km), no clear evidence of the vibrahammer's 23 Hz tonal was observed. This may have been due to data collection occurring at times when the vibrahammer was not operational. However, an interesting spectral peak spanning several Hertz in the 20-25 Hz region was observed at sites 5(5), LA2, and LA3; see, for example figure 3.1.6-1. It is possible that this energy is caused by the vibrahammer but without corroborating evidence, the association is not clear.

Similar measurements of tonal levels were made in the Prudhoe Bay area in March of 1979 [4]. Low frequency tonal levels (<50 Hz) versus range were recorded near the Reindeer Island Cost Well (on a natural barrier-beach island) and the Niakuk 3 Well (on a man-made gravel island). The trend in that data set showed a 30-40 dB per decade spreading loss plus an absorption loss of about 1 dB per mile. The data presented in figure 4.1-1 show a 25 dB/decade spreading loss which is less than observed in [4].

However, the earlier data were obtained in water depths of only 10-23 ft (3-7m) and transmission loss is expected to be higher in shallow water.

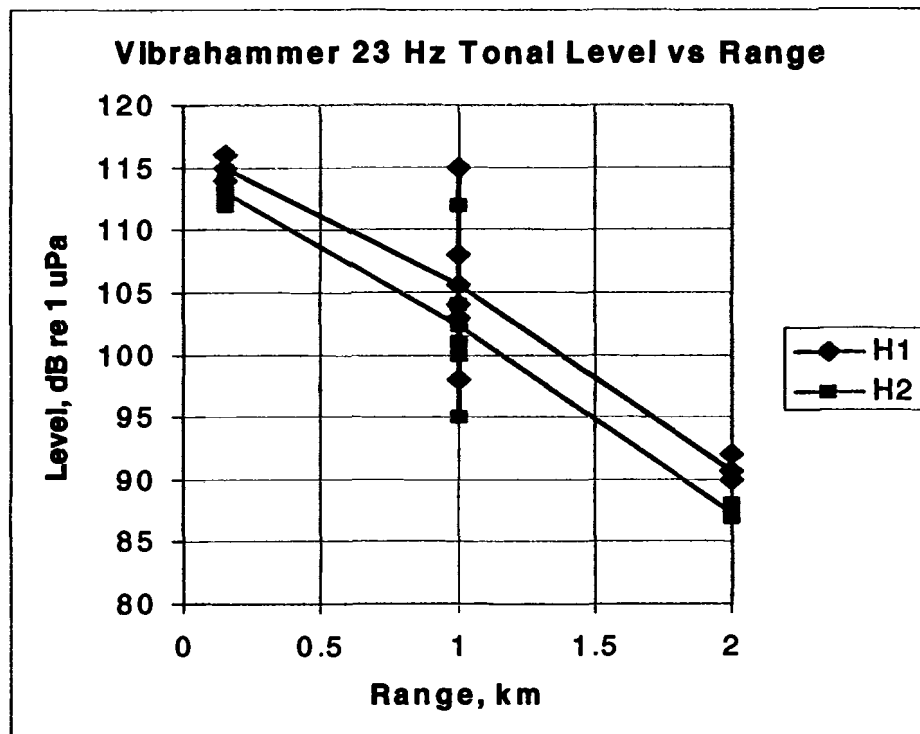

Figure 4.1- 1. Vibrahhammer 23 Hz tonal spectrum level as a function of range as received on the near-bottom hydrophone (H1) and mid-channel depth hydrophone (H2).

From normal mode theory, the acoustic cutoff frequency (F_c) for a 33 ft (10 m) water channel over a hard bottom is

$$F_c = c/4d = 37.5 \text{ Hz,}$$

where c is the speed of sound in water (approximately 4920 ft/s or 1500 m/s) and d is the water depth. Thus the vibrahhammer energy and low frequency sound measured must involve propagation through the bottom water-saturated sediment. This means that the bottom sediments are acoustically similar to the water column since there is no indication of a low frequency cutoff in propagation as also observed in [4] and therefore the effective propagation channel depth near Northstar is larger than 33 ft (10 m) and the cutoff frequency lower than predicted using this shallow water depth.

The other significant feature observed underwater during vibrahhammer operation is an increase in energy below 10 Hz. A comparison of figures 3.1.4-5 (with vibrahhammer noise) and 3.1.4-1 (without vibrahhammer excitation), both taken from hydrophone 1 at site NA5 0.54 nm (1 km) from Northstar shows that noise below 10 Hz is 5-15 dB higher in the former case. Above 60 Hz, the measured noise levels with and without vibrahhammer operation are nearly identical indicating that noise in this band is not coming from the vibrahhammer itself. The comparison also shows that the narrowband

lines seen in both are not specifically related to the vibrahammer and are more likely associated with machinery sources on Northstar.

When the vibrahammer is not driving sheet piles, the radiated noise is dominated by vehicle noise and machinery. These noise sources are primarily confined to frequencies below about 500 Hz. They consist of broadband noise and narrowband tonals which are most likely caused by machinery.

At a range of 0.08 nm (150 m) from Northstar (site NA3), the man-made noise consists of a broad band peak centered around 7 Hz and a large set of narrowband tonals spanning the frequency band from 25 to 500 Hz; for example, see figure 3.1.2-10. Moving out to a range of 0.54 nm (1 km) (site NA5), the low frequency peak has fallen by 10-15 dB and the only man-made sounds are relegated to the spectral region below 70 Hz (see figure 3.1.4-1).

Figure 4.1-2 presents the measured 1/3 OB noise spectra collected at four sites near Northstar plus site 5(5) and site LA2. All spectra from sites NA3, NA5, and NA6 were calculated while the vibrahammer was in operation. It is not known if the vibrahammer was operational during the other analyzed segments.

Close to Northstar at NA3 (range = 0.08 nm or 0.15 km), underwater noise is dominated by radiation from the island below 500 Hz, rising as much as 45 dB above quiet background noise as represented by the spectra taken at site NA2. Half a nautical mile (1

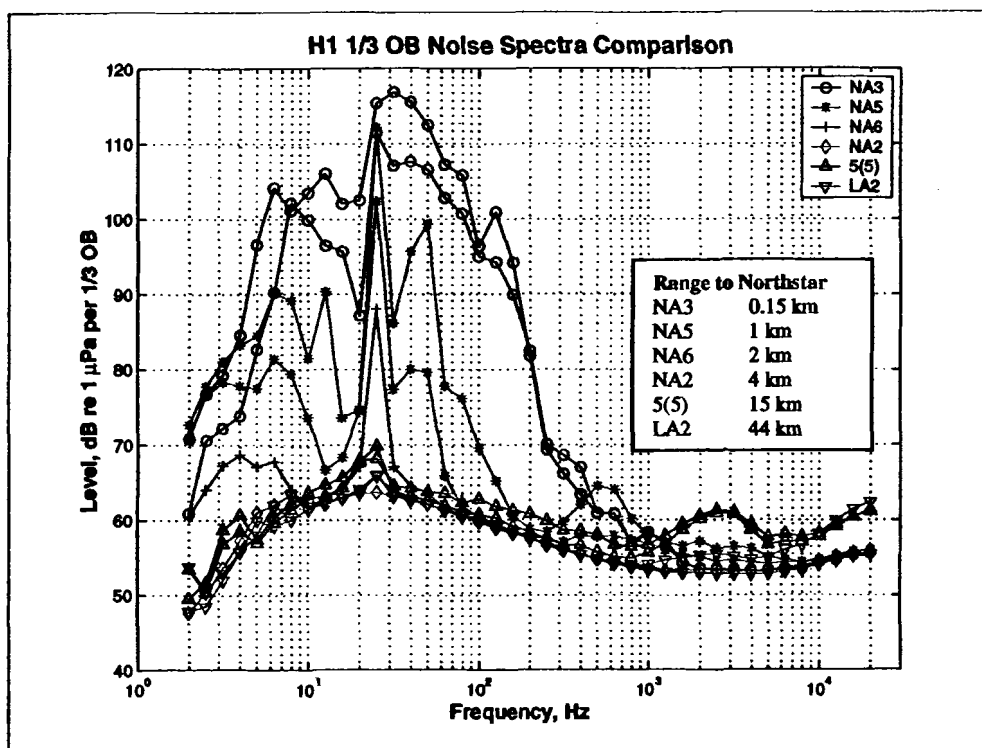

Figure 4.1- 2. Comparison of 1/3 OB spectra at multiple sites collected during vibrahammer operation using the hydrophone positioned near the bottom (H1).

km) from Northstar (site NA5), man-made noise dominates only in the spectral region below about 100 Hz. And at a range of 1.1 nm (2 km) (NA6), only energy in the 23 Hz tonal and at very low frequencies below about 7 Hz is detectable above ambient levels.

Figure 4.1-3 shows the measured 1/3 OB noise spectra for the mid-water column depth hydrophone (H2) collected at the same sites and times as shown in the previous figure with the vibrahammer in operation. As with H1, close to Northstar the underwater noise field is dominated by radiation from the island below 500 Hz, again rising as much as 45 dB above quiet background noise levels. One kilometer (.54 nm) from Northstar, man-made noise dominates only in the spectral region below about 100 Hz. And at a range of 1.1 nm (2 km) (NA6), again only energy in the 23 Hz tonal and at very low frequencies below about 7 Hz is detectable above normal ambient conditions. Unlike the 1/3 OB data from H1, both sites 5(5) and LA2 have a spectral peak near 23 Hz. While it is possible this energy is due to vibrahammer operation, it is unlikely because of the long range and the fact that H1 did not have the same characteristic. The cause, therefore, is unknown.

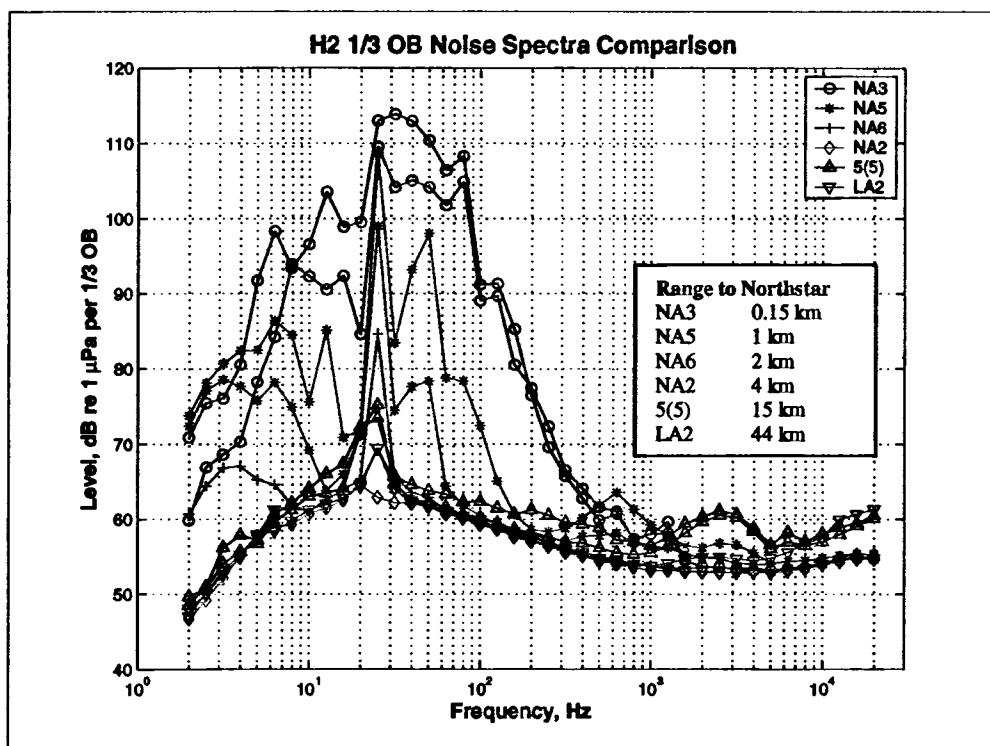

Figure 4.1- 3. Comparison of 1/3 OB spectra at multiple sites collected during vibrahammer operation using the hydrophone positioned in the middle of the water column (H2).

Figures 4.1-4 and 4.1-5 present comparisons of measured 1/3 OB spectral levels at the same sites when the vibrahammer was not in operation for H1 and H2, respectively. In both instances, the underwater sound energy at NA3 is dominated by island noise particularly in the band centered around about 8 Hz and in the band from 20 to 200 Hz. In general, the levels are roughly comparable with the near-bottom sensor receiving

slightly higher levels. At ranges beyond 1.1 nm (2 km), the man-made noise contribution to the ambient noise conditions is low to negligible across the measurement band.

The underwater data described above are consistent with the results obtained from other measurements of radiated noise radiated from activities on icebound islands. These are documented in [5], section 6.4.

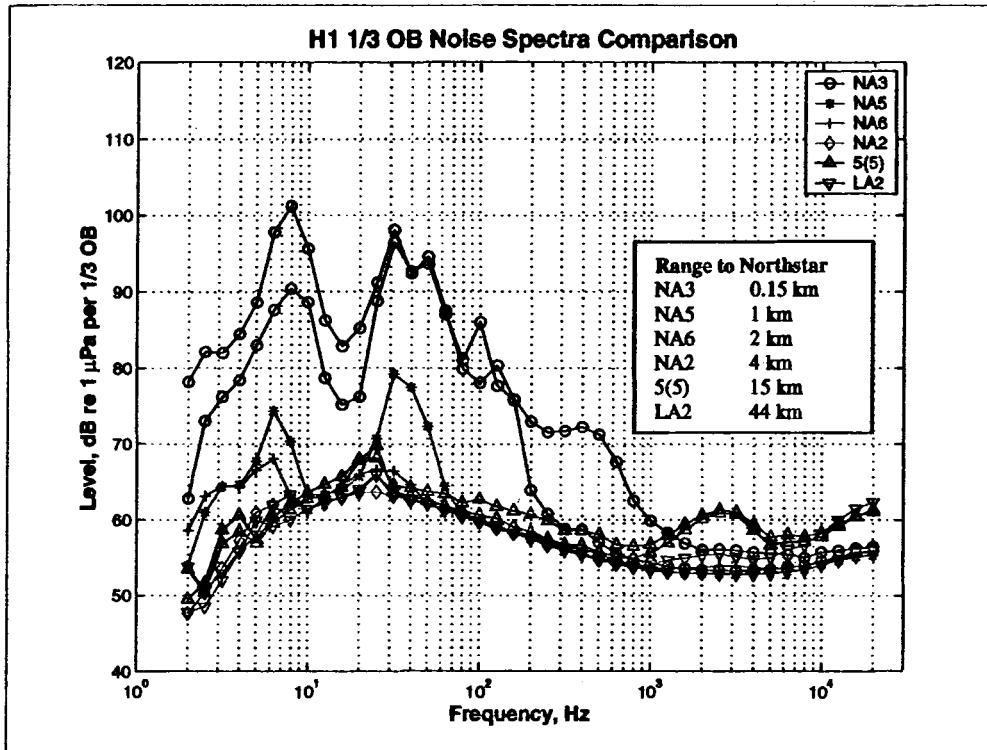

Figure 4.1- 4. Comparison of 1/3 OB noise spectra at multiple sites without vibrahammer noise collected using the Hydrophone positioned near the bottom (H1).

4.2 In-air Noise Environment

The impact of airborne noise radiating from Northstar has a smaller footprint (i.e., man-made sounds rising above naturally occurring ambient noise levels) than island generated noise impacts the underwater environment. Except for the 23 Hz tonal due to the vibrahammer and some moderately significant noise in the 500 Hz to 1.5 kHz band, at ranges 0.54 nm (1 km) and greater, no man-made sounds were detectable using the 1/3 OB data.

Figure 4.2-1 is a comparison of 1/3 OB measured in-air noise levels at 6 measurement sites. The vibrahammer was in operation during the data segments displayed for sites NA3, NA5, and NA6. As can be seen, at short ranges from Northstar, island noise dominates the airborne noise over almost the whole measurement band (10 Hz to about 12 kHz). But the measurements at site NA5, only 0.54 nm (1 km) from Northstar, the only apparent man-made energy above the background noise is due to the 23 Hz tonal and the .5-1.5 kHz energy. The variability in the broadband characteristics is thought to

be due to varying wind conditions. The lower noise levels measured at sites LA2 and NA2 encountered the lowest wind speeds (see Table 1-1).

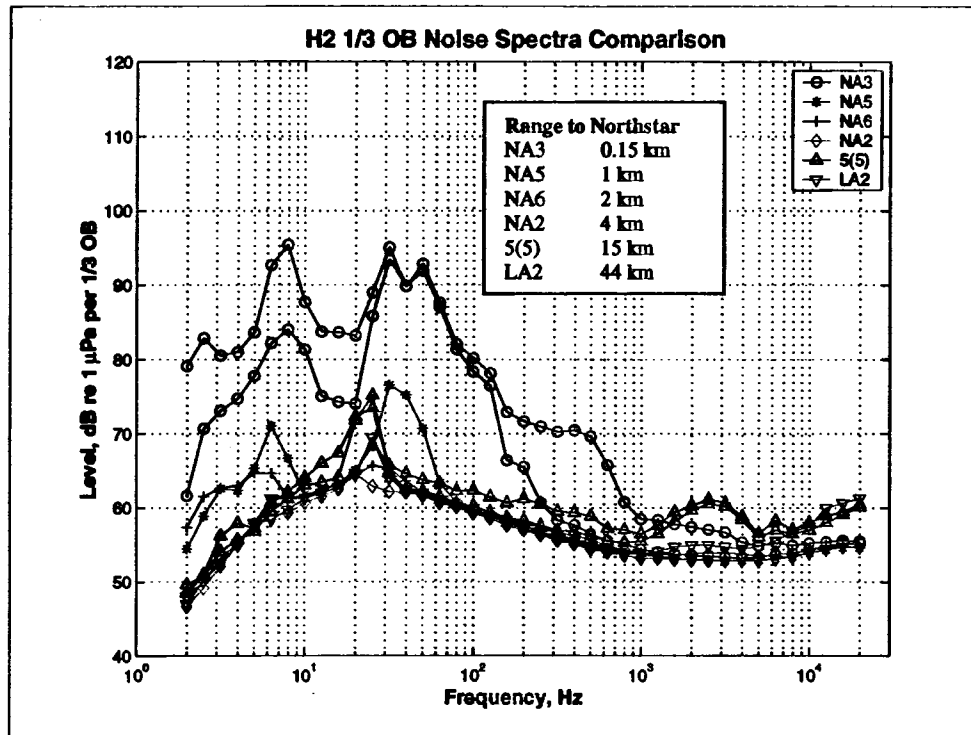

Figure 4.1- 5. Comparison of 1/3 OB noise spectra at multiple sites without vibrahammer noise collected using the Hydrophone positioned in the middle of the water column (H2)

The airborne man-made noise (radiated while driving sheet pilings) in the spectral region above a few hundred Hertz measured close to Northstar is driven by a rich set of reasonably narrow energy peaks as was shown in figures 3.1.2-5 and 3.1.2-6. At a range of 0.54 nm (1 km), these peaks have fallen by about 40 dB as can be seen by comparing the levels in figure 3.1.4-5 with those read from figure 3.1.2-5. The energy levels and spectral width of these peaks is significantly less when the vibrahammer is off as discussed next.

When the vibrahammer is not in operation, the airborne noise levels are considerably lower near Northstar. Figure 4.2-2 presents a comparison of measured 1/3 OB noise levels at 3 sites near Northstar. Vehicle and machinery noise drive the in-air noise levels at site NA3 but appear to have minimal impact at site NA5 located 0.54 nm (1km) from Northstar. The increased noise level at site NA6 from 100-500 Hz is unexplained.

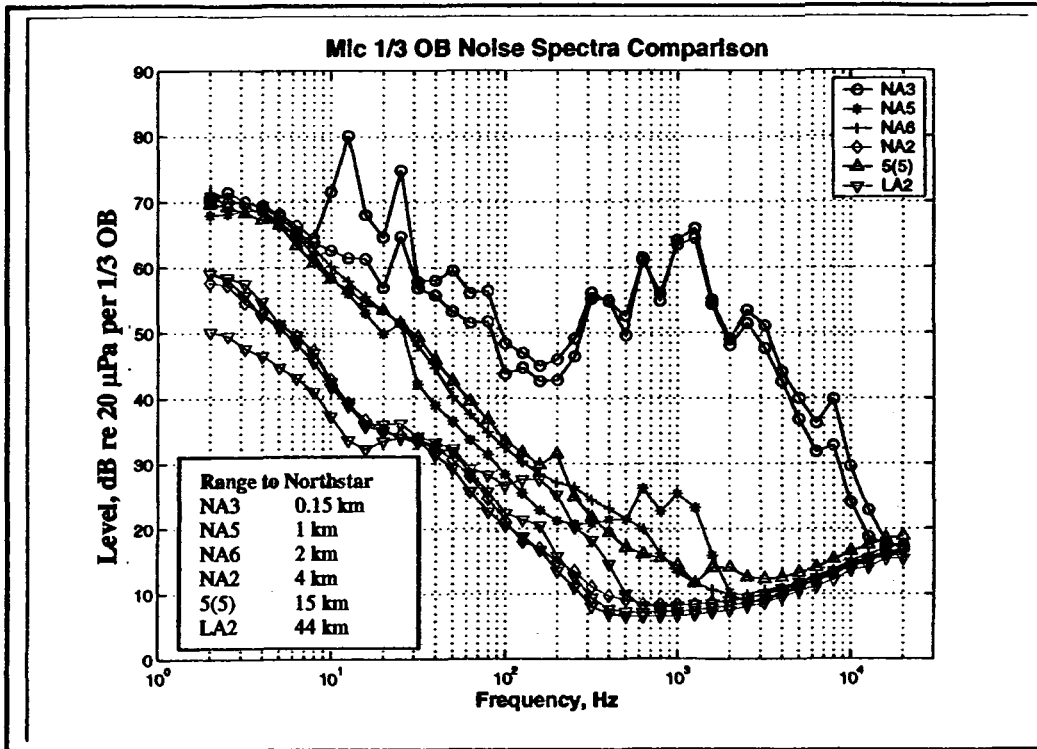

Figure 4.2- 1. Comparison of 1/3 OB airborne noise spectra at multiple sites with vibrahammer in operation at least at sites NA3, NA5, and NA6.

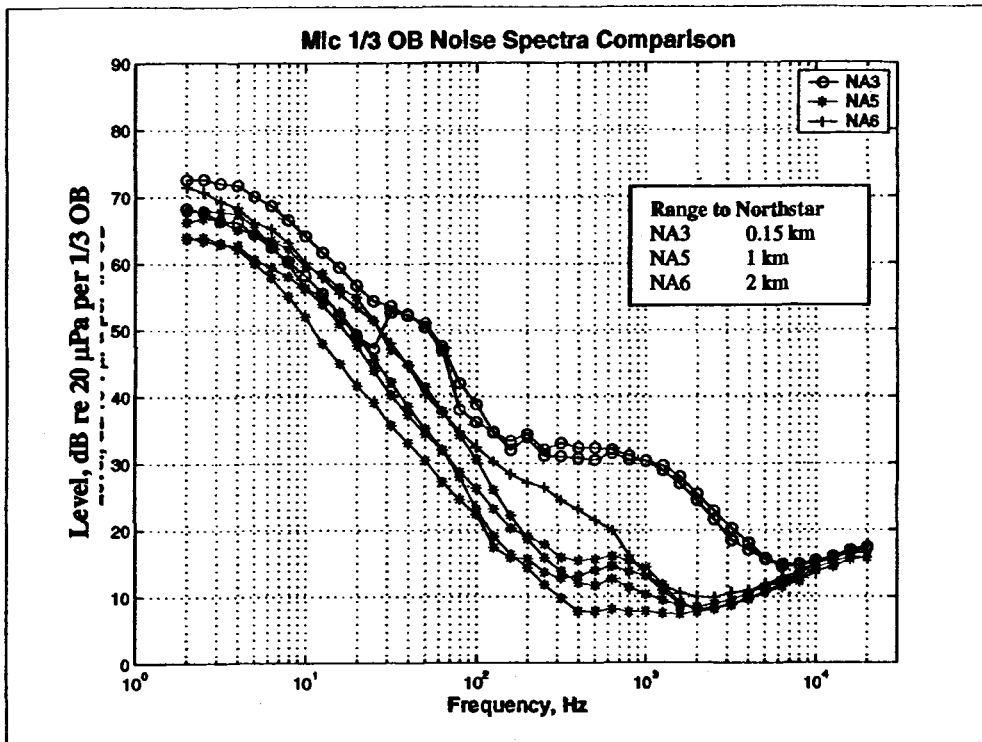

Figure 4.2- 2. Comparison of 1/3 OB airborne noise spectra at multiple sites without vibrahammer excitation.

4.3 Ice Vibration Environment

Ice vibrations at the sites located away from Northstar were in general at or below the noise floor of the measurement system. Thus the measured levels above 200 Hz represent an upper limit. Two factors contribute to the low vibration levels. First, the ice is shore-fast and not moving, and second, the stable and reasonably warm temperatures coupled with the snow cover that acts as an insulating layer between the air and the ice effectively stopped thermal ice cracking noise.

Near Northstar, man-made noise dominates the ambient noise in the frequency band below 200 Hz. Figure 4.3-1 displays measured 1/3 OB ice vibration spectra from 6 sites. The vibrahammer was in operation at sites NA3, NA5, and NA6 in this data sample. It is not known if the vibrahammer was working during the other data samples but the spectral peaks suggest that it was operating. However, the narrowband spectra at sites 5(5) and LA2 (see figures 3.1.6-6 and 3.2.1-4) show a broad peak in the 20-30 Hz band that is up to 10 Hz wide. This broadened peak is not consistent with the quite narrowband 23 Hz tonal observed at sites closer to Northstar (for example, figures 3.1.4-13 and 3.1.5-7). A mechanism that could expand a narrowband tonal to such an extent is not known. Therefore, the source of the 1/3 OB energy in the 24 Hz band cannot be defined and may possibly be due to some noise or vibration contamination caused by the measurement equipment.

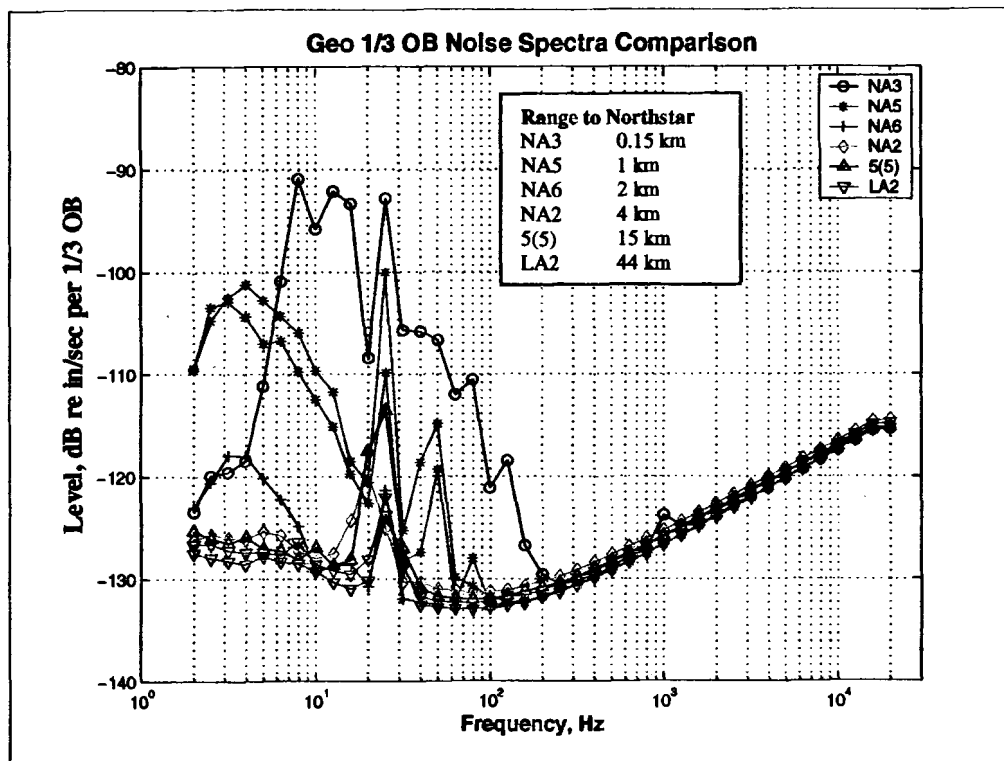

Figure 4.3- 1. Comparison of 1/3 OB ice vibration noise spectra at multiple sites with vibrahammer in operation at least at sites NA3, NA5, and NA6.

Measured ice vibration spectral shape varies considerably from one site to another. Close in at NA3, the vibrahammer and other island noises exhibit a broad peak from 8 to 20 Hz, the 23 Hz tonal, and decaying energy from 30 Hz up to 200Hz. At a range of 0.54 nm (1 km; site NA5), island induced ice vibrations are most significant in the 2-15 Hz band probably due to machinery excitation plus two narrow spectral regions centered on 23 and about 50 Hz. The higher frequency peak is most likely due to generator vibration.

At a 1.1 nm (2 km) range (site NA6), only Northstar energy below 8 Hz and in the 23 Hz tonal was detectable above the measurement equipment noise floor. And as noted above, the source of the energy in the 1/3 OB centered at 24 Hz for sites NA6, 5(5), and LA2 is not known. When the vibrahammer was known to be in operation, the level of the 23 Hz narrowband tonal versus range is shown in figure 4.3-2. A comparison of the measured vibrahammer 23 Hz tonal level versus range collected underwater in figure 4.1-1 with the range dependence of the ice vibration levels depicted in figure 4.3-2 shows that the fall-off is comparable. This indicates that the ice is being driven by water-borne energy rather than direct transmission from the island into the ice.

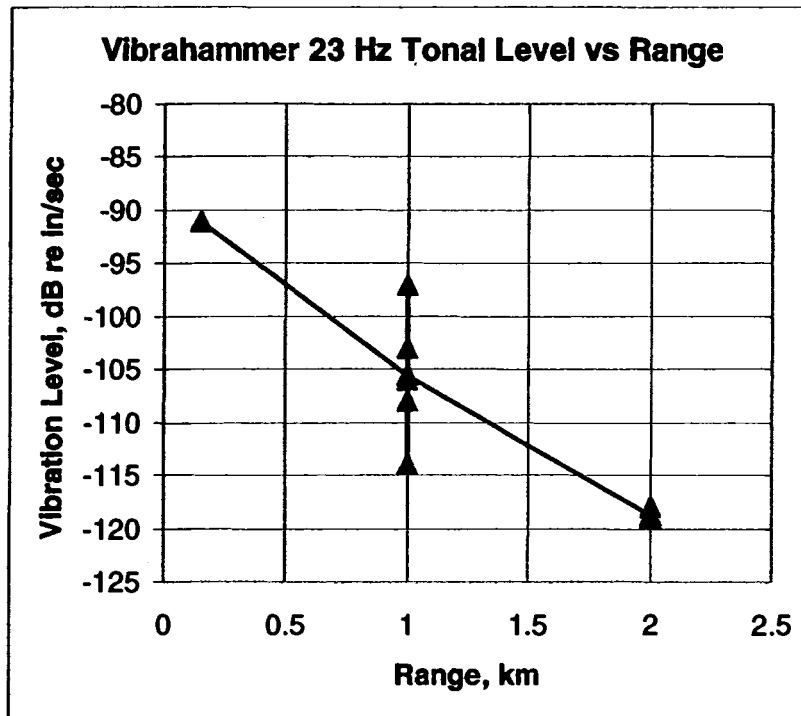

Figure 4.3- 2. Vibrahammer 23 Hz tonal received ice vibration spectrum level as a function of range.

Figure 4.3-3 presents 1/3 OB ice vibration levels for three sites while the vibrahammer was not in operation. Trucking and machinery are seen to be the dominant source of ice vibrations below about 150 Hz. The ice vibration levels fall off significantly at a 0.54 nm

(1 km) range (NA5) and except for the man-induced vibrations below 10 Hz, have disappeared at a range of 1.1 km (2 km) (site NA6).

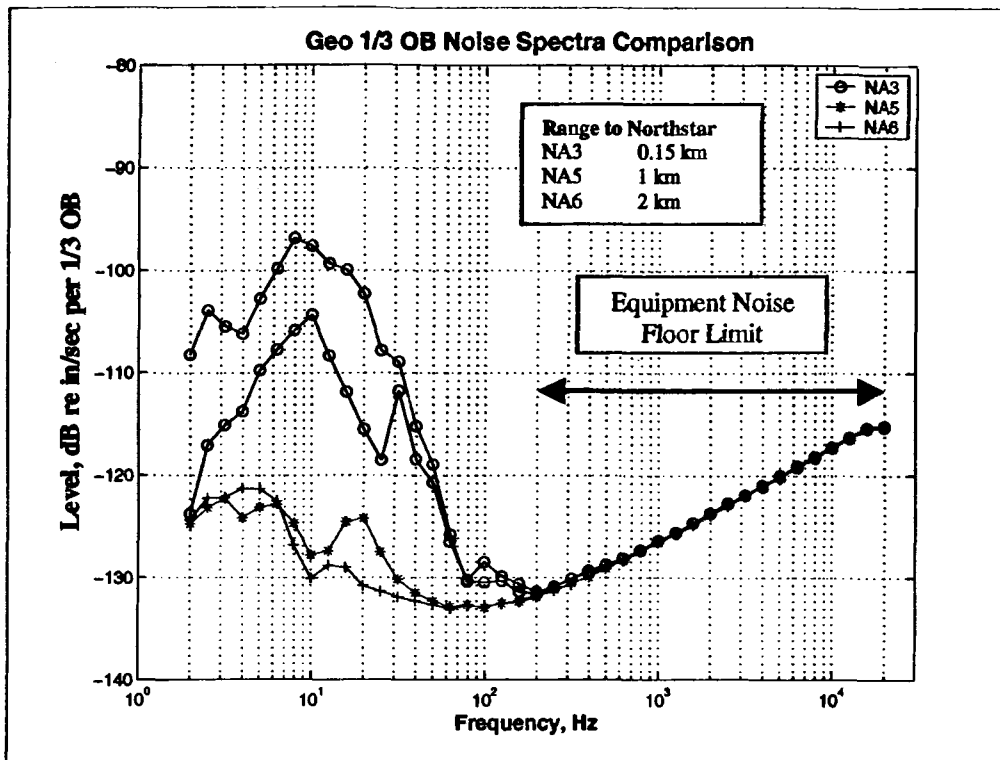

Figure 4.3- 3. Comparison of 1/3 OB ice vibration noise spectra at multiple sites without vibrahammer excitation.

5.0 Summary and Conclusions

In April of 1999, environmental noise and vibration levels were measured at eight sites near and between the Northstar and Liberty prospects in the nearshore portion of the outer continental shelf in the Beaufort Sea near Prudhoe Bay. The goal was to characterize the site-specific underwater and in-air noise and ice vibration environment. Data were collected using two hydrophones (one near the sea bottom and one in the middle of the water column), a microphone positioned roughly 5 ft (1.5 m) above the ice about 100 ft (30 m) from the hydrophone hole, and a geophone which was frozen into the ice surface near the hole.

The Northstar prospect was under construction including sheet pile driving, trench backfilling operations, plowing operations, and trucking activity. In addition, machinery on the artificial island was in operation to supply power and operate the vibrahammer used to drive the sheet piles. All of these noise sources contributed to a rich noise environment close to Northstar.

The Northstar noise environment was measured under two conditions: 1) high level noise conditions during vibrahammer operation with vehicle and machinery sound sources, and 2) moderate noise conditions with truck and plow activity with machinery in operation, but without vibrahammer noise.

5.1 Noise and Vibration During Northstar Vibrahammer Operation

The noisiest conditions were encountered near Northstar at site NA3 (located approximately 0.08 nm (150 m) from the island, see Table 1-1) while sheet piles were driven into the island soil using a vibrahammer. Vibrahammer and related machinery produced 1/3 OB noise levels as much as 50 dB above ambient noise conditions as derived from measurements at far removed sites such as 5(5) and LA2. The dominant radiated noise feature from the vibrahammer was a 23 Hz tonal which was easily detected in the underwater environment and within the ice at least out to a range of 1.1 nm (2 km). Our in-air microphone only detected the 23 Hz tonal out to a range of 0.54 nm (1 km).

During vibrahammer operation, the noise and vibration levels varied as a function of range from Northstar. At a distance of 0.08 nm (150 m), the 1/3 OB underwater noise environment was dominated by island noise in the spectral region below about 700 Hz. Third octave band levels varied from 10 to 50 dB above ambient levels. Often, the third OB noise was driven by one or a few narrowband tonals with the band. See for example, figure 3.1.2-3. At a range of 0.54 nm (1 km) from Northstar (site NA5), vibrahammer noise only impacted the underwater environment in the spectral region below about 120 Hz with 1/3 OB levels ranging from 5-45 dB above ambient. Finally, at a range of 1.1 nm (2 km) (site NA6), the underwater noise field is only impacted by vibrahammer induced noise in the 23 Hz tonal and at low frequencies below 8 Hz. At longer ranges, there was evidence of man-made noise near 23 Hz, but its narrowband spectral characteristics were not consistent with those observed at closer range and therefore it is not clear if this energy was due to vibrahammer operation.

In all cases, the underwater noise due to man-made sounds was higher near the bottom compared to measurements taken at mid water column depth. This implies that the dominant propagation mode for vibrahammer noise is through the earth and then locally into the water rather than into the water near the island and thence forth through the water channel.

The contribution of man-made sound to the airborne noise environment during vibrahammer operation is primarily a local effect. At a range of 0.08 nm (150 m) from Northstar, vibrahammer, vehicle and machinery can noise dominate the 1/3 OB spectral region from 8 Hz up to about 12 kHz. Measured levels varied 0-50 dB above ambient noise conditions with the highest levels above ambient in the 200 Hz to 8 kHz bands. And often the 1/3 OB levels were driven by narrowband tonals (e.g., figure 3.1.2-5). Further out in range at 0.54 nm (1 km), the only man-made airborne energy detectable above the ambient noise was in the 1/3 OB containing the 23 Hz tonal and a band from 500 to 2,000 Hz. The former was only about 5 dB above ambient while the latter peaked at a level 12 dB over ambient levels. At longer ranges, only naturally occurring in-air ambient noise consistent with the weather/snow conditions was observed.

Vibrahammer operation also impacted local ice vibration levels. Close to Northstar, island related sounds drove the ice vibration levels at frequencies from 2 to 200 Hz with levels rising as much as 35 dB above ambient conditions. Most of the energy is concentrated in the 1/3 OB from 5 to 100 Hz. Northstar construction noise with the vibrahammer in operation is still significant at a range of 0.54 nm (1 km) but only in the spectral region below about 80 Hz. And at a 1.1 nm (2 km) range, man-made sounds were only detectable in the spectral region at and below 8 Hz and in the 23 Hz vibrahammer tonal. At longer ranges (2.2 nm or 4 km and higher), only energy in the 10-30 Hz band rose above our equipment noise floor and as with the hydrophone data, it is not clear if this was due to vibrahammer related excitation or some other source.

5.2 Noise and Vibration without Northstar Vibrahammer Operation

When the vibrahammer was not in operation, the underwater environment was not as severely affected by man-made sounds. Vehicle and machinery noise was seen to dominate the noise field at close range (0.08 nm or 150 m) over the 1/3 OB spectral region from 2 Hz to about 1 kHz with levels rising as high as 40 dB above ambient conditions. The highest levels were seen in the 5-12 Hz and 20-100 Hz bands. The high levels in the latter band are due primarily to several narrowband tonals. See, for example, figures 3.1.2-10 and 3.1.2-11.

At a range of 0.54 nm (1 km) (site NA5), man-made noise under the ice was significantly less, rising above ambient only in the 2-8 Hz and 25-60 Hz bands with a 1/3 OB maximum peak only about 15 dB above ambient. And at 1.1 nm (2 km), only energy below about 7 Hz appears to be due to Northstar activity. Finally, the man-made noise levels were consistently higher near the sea bottom compared to levels measured at mid water column depth.

Airborne noise from Northstar when the vibrahammer was inactive generally produced man-made sounds only moderately above ambient levels at short range (0.08 nm or 150 m) but little appears to have been present at longer distances. See figure 4.2.2. At site NA3, measured 1/3 OB noise above ambient occurred generally across the band from 2 Hz to about 8 kHz but the majority was only 0-5 dB higher. Significant man-made noise was observed only in the 30-70 Hz (due to a limited set of narrowband tonals; figure 3.1.2-12) and 200 Hz to 4 kHz regions.

Ice vibration induced by construction activities when sheet piles were not being driven were quite localized. At a range of 0.08 nm (150 m), vibration levels above our measurement system noise floor only occurred in 1/3-octave bands below about 120 Hz (figure 4.3-2) with a maximum observed level of 30 dB above the lower limit. Narrowband tonals contributed the majority of the energy in the third octave bands 25-120 Hz; for example, see figure 3.1.2-5. At longer ranges, no significant man-made ice vibration levels were detected.

6.0 Acknowledgements

The authors wish to thank the contractor team headed by Paul Boehm and John Brown from Arthur D. Little Corporation. In addition, the work would not have been possible without the excellent logistics support provided by Kinnetic Labs headed by Mark Savoie. We also appreciated the in-field assistance provided by John Trefry from the Florida Institute of technology.

7.0 Literature Cited

- [1] Milne, A.R., and J.H. Ganton: Ambient Noise under Arctic Sea Ice, *J. Acoust. Soc. Am.*, **36**:855 (1964).
- [2] Knudsen, V.O., Alford, R.S. and Emling, J.W.: Underwater Ambient Noise, *J. Mar. Res.* **7**(3):410-429 (1948).
- [3] U.S. Army Corps of Engineers, Alaska: Final Environmental Impact Statement, Beaufort Sea Oil and Gas Development/Northstar Project, February 1999.
- [4] Malme, C.I., and Mlawski, R.: Measurements of Underwater Acoustic Noise in Prudhoe Bay, Alaska, BBN Technical Memorandum No. 513, April, 1979.
- [5] Richardson, W. J., et. al., *Marine Mammals and Noise*, Academic Press, San Diego, CA, 1995.

Appendix A: Complete Listing of the Collected Data Set

Site	Date	Latitude	Longitude	Start Time, Local	End Time, Local	Observations
NS-Trench	26 April	70° 28.806	148° 41.607	19:12	20:10	Plowing Trucks Moving Trench Backfilling
NA3	26 April	70° 29.569	148° 41.460	13:17	14:27	Vibrahammer Plowing Trucks Moving
NA2	26 April	70° 30.817	148° 36.351	18:30	19:07	Very Quiet
5(5)	27 April	70° 26.108	148° 18.090	19:47	20:42	Quite Quiet Wind Noise
LA2	28 April	70° 18.970	147° 37.928	12:55	13:42	Very Quiet Low Freq. Rumble
LA3	28 April	70° 16.778	147° 33.529	16:30	17:18	Very Quiet Low Freq. Rumble
NA5	29 April	70° 29.889	148° 40.734	11:45	12:46	Trucks Moving Plowing Lunch Break
				12:48	13:40	Plowing Trucks Moving
				13:49	14:05	Vibrahammer
NA6	29 April	70° 30.372	148° 39.911	16:23	17:12	Vibrahammer

Appendix B: Third Octave Band Center Frequencies, Hz

2.00	12.59	79.43	501.19	3981.07
2.51	15.85	100.00	630.96	5011.87
3.16	19.95	125.89	794.33	6309.57
3.98	25.12	158.49	1000.00	7943.28
5.01	31.62	199.53	1258.93	10000.00
6.31	39.81	251.19	1584.89	12589.25
7.94	50.12	316.23	2511.89	15848.93
10.00	63.10	398.11	3162.29	19952.62