

Chapter 2200 Citation of Prior Art and Ex Parte Reexamination of Patents

<p>2201 Introduction</p> <p>2202 Citation of Prior Art</p> <p>2203 Persons Who May Cite Prior Art</p> <p>2204 Time for Filing Prior Art Citation</p> <p>2205 Content of Prior Art Citation</p> <p>2206 Handling of Prior Art Citation</p> <p>2207 Entry of Court Decision in Patent File</p> <p>2208 Service of Citation on Patent Owner</p> <p>2209 <i>Ex Parte</i> Reexamination</p> <p>2210 Request for <i>Ex Parte</i> Reexamination</p> <p>2211 Time for Requesting <i>Ex Parte</i> Reexamination</p> <p>2212 Persons Who May File a Request for <i>Ex Parte</i> Reexamination</p> <p>2212.01 Inquiries from Persons Other Than the Patent Owner</p> <p>2213 Representative of Requester</p> <p>2214 Content of Request for <i>Ex Parte</i> Reexamination</p> <p>2215 Fee for Requesting <i>Ex Parte</i> Reexamination</p> <p>2216 Substantial New Question of Patentability</p> <p>2217 Statement in the Request Applying Prior Art</p> <p>2218 Copies of Prior Art</p> <p>2219 Copy of Printed Patent</p> <p>2220 Certificate of Service</p> <p>2221 Amendments Included in Request by Patent Owner</p> <p>2222 Address of Patent Owner</p> <p>2223 Withdrawal of Attorney or Agent</p> <p>2224 Correspondence</p> <p>2225 Untimely Paper Filed Prior to Order</p> <p>2226 Initial Processing of Request for <i>Ex Parte</i> Reexamination</p> <p>2227 Incomplete Request for <i>Ex Parte</i> Reexamination</p> <p>2229 Notice of Request for <i>Ex Parte</i> Reexamination in <i>Official Gazette</i></p> <p>2230 Constructive Notice to Patent Owner</p> <p>2231 Processing of Request Corrections</p> <p>2232 Public Access</p> <p>2232.01 Determining if a Reexamination >Request< Was Filed for a Patent</p> <p>2233 Processing in Central Reexamination Unit and Technology Center</p> <p>2234 Entry of Amendments</p> <p>2235 Record Systems</p> <p>2236 Assignment of Reexamination</p> <p>2237 Transfer Procedure</p> <p>2238 Time Reporting</p> <p>2239 Reexamination Ordered at the Director's Initiative</p> <p>2240 Decision on Request</p> <p>2241 Time for Deciding Request</p>	<p>2242 Criteria for Deciding Request</p> <p>2243 Claims Considered in Deciding Request</p> <p>2244 Prior Art on Which the Determination Is Based</p> <p>2245 Processing of Decision</p> <p>2246 Decision Ordering Reexamination</p> <p>2247 Decision on Request for Reexamination, Request Denied</p> <p>2247.01 Examples of Decisions on Request for Reexamination</p> <p>2248 Petition From Denial of Request</p> <p>2249 Patent Owner's Statement</p> <p>2250 Amendment by Patent Owner</p> <p>2250.01 Correction of Patent Drawings</p> <p>2250.02 Correction of Inventorship</p> <p>2250.03 Fees for Adding Claims</p> <p>2251 Reply by Third Party Requester</p> <p>2252 Consideration of Statement and Reply</p> <p>2253 Consideration by Examiner</p> <p>2254 Conduct of <i>Ex Parte</i> Reexamination Proceedings</p> <p>2255 Who Reexamines</p> <p>2256 Prior Art Patents and Printed Publications Reviewed by Examiner in Reexamination</p> <p>2257 Listing of Prior Art</p> <p>2258 Scope of <i>Ex Parte</i> Reexamination</p> <p>2258.01 Use of Previously Cited/Considered Art in Rejections</p> <p>2259 <i>Res Judicata</i> and Collateral Estoppel In Reexamination Proceedings</p> <p>2260 Office Actions</p> <p>2260.01 Dependent Claims</p> <p>2261 Special Status For Action</p> <p>2262 Form and Content of Office Action</p> <p>2263 Time for Response</p> <p>2264 Mailing of Office Action</p> <p>2265 Extension of Time</p> <p>2266 Responses</p> <p>2266.01 Submission Not Fully Responsive to Non-Final Office Action</p> <p>2266.02 Examiner Issues Notice of Defective Paper in <i>Ex Parte</i> Reexamination</p> <p>2266.03 Service of Papers</p> <p>2267 Handling of Inappropriate or Untimely Filed Papers</p> <p>2268 Petition for Entry of Late Papers for Revival of Reexamination Proceeding</p> <p>2269 Reconsideration</p> <p>2270 Clerical Handling</p> <p>2271 Final Action</p> <p>2271.01 Panel Review</p> <p>2272 After Final Practice</p>
---	--

- 2273 **Appeal in *Ex Parte* Reexamination**
- 2274 **Appeal Brief**
- 2275 **Examiner's Answer**
- 2276 **Oral Hearing**
- 2277 **Board of Patent Appeals and Interferences Decision**
- 2278 **Action Following Decision**
- 2279 **Appeal to Courts**
- 2280 **Information Material to Patentability in Reexamination Proceeding**
- 2281 **Interviews in *Ex Parte* Reexamination Proceedings**
- 2282 **Notification of Existence of Prior or Concurrent Proceedings and Decisions Thereon**
- 2283 **Multiple Copending *Ex Parte* Reexamination Proceedings**
- 2284 **Copending *Ex Parte* Reexamination and Interference Proceedings**
- 2285 **Copending *Ex Parte* Reexamination and Reissue Proceedings**
- 2286 ***Ex Parte* Reexamination and Litigation Proceedings**
- 2287 **Conclusion of *Ex Parte* Reexamination Proceeding**
- >2287.01 Examiner Consideration of Submissions After a NIRC<
- 2288 **Issuance of *Ex Parte* Reexamination Certificate**
- 2289 **Reexamination Review**
- 2290 **Format of *Ex Parte* Reexamination Certificate**
- 2291 **Notice of *Ex Parte* Reexamination Certificate Issuance in *Official Gazette***
- 2292 **Distribution of Certificate**
- 2293 **Intervening Rights**
- 2294 **Concluded Reexamination Proceedings**
- 2295 **Reexamination of a Reexamination**
- 2296 **USPTO Forms To Be Used in *Ex Parte* Reexamination**
- 2201 Introduction [R-5]**

Statutory basis for citation of prior art patents or printed publications in patent files and reexamination of patents became available on July 1, 1981, as a result of new sections 301-307 of title 35 United States Code which were added by Public Law 96-517 enacted on December 12, 1980. The rules of practice

in patent cases relating to reexamination were initially promulgated on April 30, 1981, at 46 FR 24179-24180 and on May 29, 1981, at 46 FR 29176-29187.

On November 29, 1999, Public Law 106-113 was enacted, and expanded reexamination by providing an “*inter partes*” option. Public Law 106-113 authorized the extension of reexamination proceedings via an optional *inter partes* reexamination procedure in addition to the present *ex parte* reexamination. 35 U.S.C. 311 - 318 are directed to the optional *inter partes* reexamination procedures. The final rules to implement the optional *inter partes* reexamination were published in the *Federal Register* on December 7, 2000 at 65 FR 76756 and in the *Official Gazette* on January 2, 2001 at 1242 OG 12.

See MPEP Chapter 2600 for guidance on the procedures for *inter partes* reexamination proceedings.

The reexamination statute was amended on November 2, 2002, by Public Law 107-273, 116 Stat. 1758, 1899-1906 (2002) to expand the scope of what qualifies for a substantial new question of patentability upon which a reexamination may be based (see MPEP § 2242, POLICY IN SPECIFIC SITUATIONS, part A), and made technical corrections to the statute. See the 21st Century Department of Justice Appropriations Authorization Act, TITLE III-INTELLECTUAL PROPERTY, Subtitle A - Patent and Trademark Office, Section 13105, of the “Patent and Trademark Office Authorization Act of 2002” - Enacted as part of Public Law 107-273 on November 2, 2002.

This chapter is intended to be primarily a guide for U.S. Patent and Trademark Office (Office) personnel on the processing of prior art citations and *ex parte* reexamination requests, as well as handling *ex parte* reexamination proceedings. Secondly, it is to also serve as a guide on the formal requirements for filing such documents in the Office.

The flowcharts show the general provisions of both the citation of prior art and *ex parte* reexamination proceedings, including reference to the pertinent rule sections.

**>

Ex Parte Reexamination - PROCEDURE PRIOR TO APPEAL
(applicable rule section)

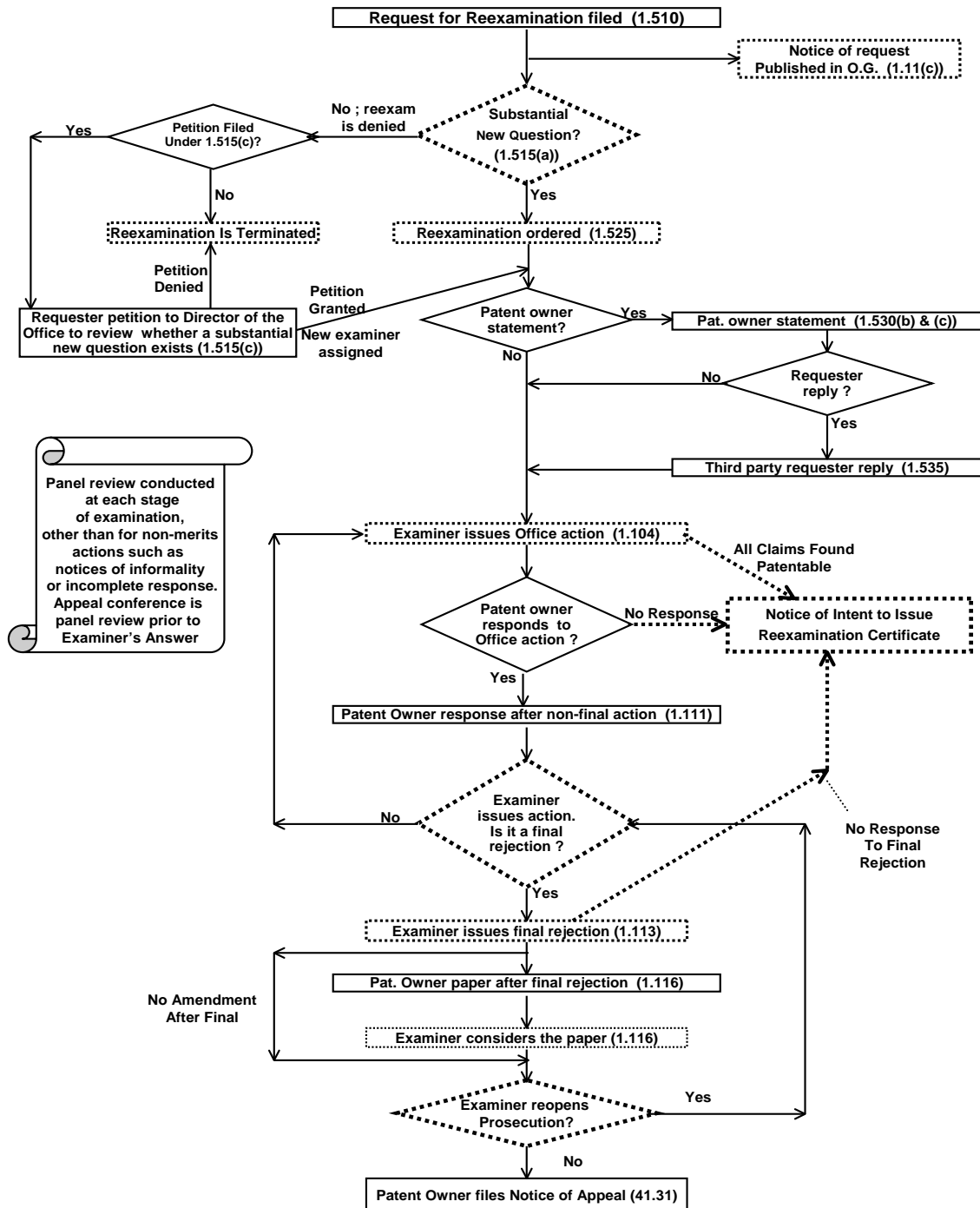

Ex Parte Reexamination – PROCEDURE FROM TIME OF APPEAL
(applicable rule section)

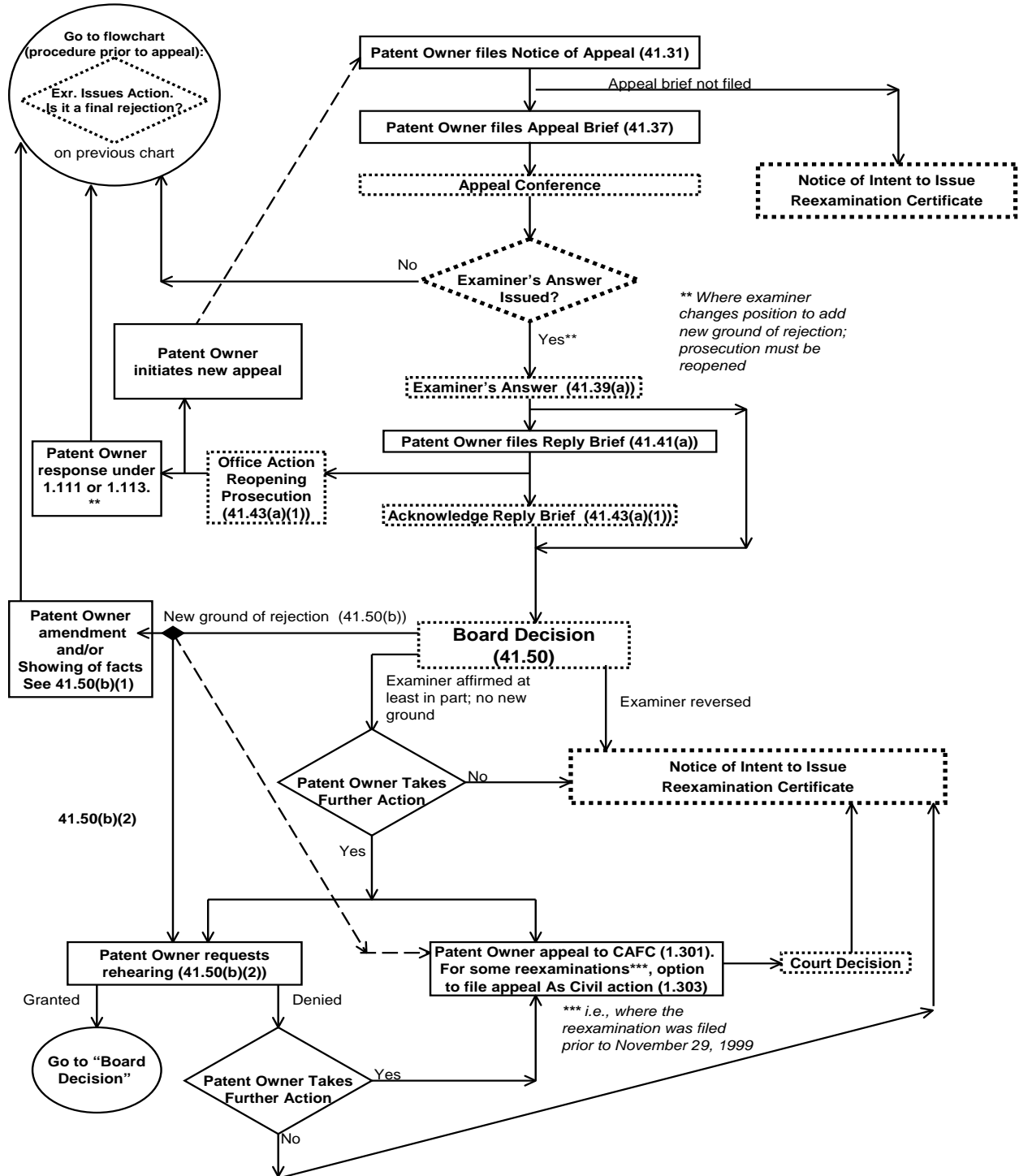

<

2202 Citation of Prior Art [R-2]

35 U.S.C. 301. Citation of prior art.

Any person at any time may cite to the Office in writing prior art consisting of patents or printed publications which that person believes to have a bearing on the patentability of any claim of a particular patent. If the person explains in writing the pertinency and manner of applying such prior art to at least one claim of the patent, the citation of such prior art and the explanation thereof will become a part of the official file of the patent. At the written request of the person citing the prior art, his or her identity will be excluded from the patent file and kept confidential.

37 CFR 1.501. Citation of prior art in patent files.

(a) At any time during the period of enforceability of a patent, any person may cite, to the Office in writing, prior art consisting of patents or printed publications which that person states to be pertinent and applicable to the patent and believes to have a bearing on the patentability of any claim of the patent. If the citation is made by the patent owner, the explanation of pertinency and applicability may include an explanation of how the claims differ from the prior art. Such citations shall be entered in the patent file except as set forth in §§ 1.502 and 1.902.

(b) If the person making the citation wishes his or her identity to be excluded from the patent file and kept confidential, the citation papers must be submitted without any identification of the person making the submission.

(c) Citation of patents or printed publications by the public in patent files should either: (1) Reflect that a copy of the same has been mailed to the patent owner at the address as provided for in § 1.33(c); or in the event service is not possible (2) Be filed with the Office in duplicate.

>

37 CFR 1.502. Processing of prior art citations during an *ex parte* reexamination proceeding.

Citations by the patent owner under § 1.555 and by an *ex parte* reexamination requester under either § 1.510 or § 1.535 will be entered in the reexamination file during a reexamination proceeding. The entry in the patent file of citations submitted after the date of an order to reexamine pursuant to § 1.525 by persons other than the patent owner, or an *ex parte* reexamination requester under either § 1.510 or § 1.535, will be delayed until the reexamination proceeding has been terminated. See § 1.902 for processing of prior art citations in patent and reexamination files during an *inter partes* reexamination proceeding filed under § 1.913.

37 CFR 1.902.

Citations by the patent owner in accordance with § 1.933 and by an *inter partes* reexamination third party requester under § 1.915 or § 1.948 will be entered in the *inter partes* reexamination file. The entry in the patent file of other citations submitted after the date of an order for reexamination pursuant to § 1.931 by persons other than the patent owner, or the third party requester under either § 1.915 or § 1.948, will be delayed until the *inter partes* reexamination proceeding has been terminated. See § 1.502 for processing of prior art citations in patent and reexamination files during an *ex parte* reexamination proceeding filed under § 1.510.<

Prior art in the form of patents or printed publications may be cited to the Office for placement into the patent files. Such citations may be made without payment of a fee. Citations of prior art may be made separate from and without a request for reexamination.

The basic purpose for citing prior art in patent files is to inform the patent owner and the public in general that such patents or printed publications are in existence and should be considered when evaluating the validity of the patent claims. Placement of citations in the patent file along with copies of the cited prior art will also ensure consideration thereof during any subsequent reissue or reexamination proceeding.

The citation of prior art provisions of 35 U.S.C. 301 and 37 CFR 1.501 do not apply to citations or protests filed in pending applications.

2203 Persons Who May Cite Prior Art [R-7]

The patent owner, or any member of the public, may submit prior art citations of patents or printed publications to the Office. 35 U.S.C. 301 states that “Any person at any time may cite to the Office. . . .”

“Any person” may be a corporate or governmental entity as well as an individual.

If a person citing prior art desires his or her identity to be kept confidential, such a person need not identify himself or herself.

“Any person” includes patentees, licensees, reexamination requesters, real parties in interest >to the patent owner or requester<, persons without a real interest, and persons acting for real parties in interest without a need to identify the real party of interest.

The statute indicates that “at the written request of the person citing the prior art, his or her identity will be excluded from the patent file and kept confidential”. Although an attempt will be made to exclude any such written request from the public files, since the review will be mainly clerical in nature, complete assurance of such exclusion cannot be given. Persons citing art who desire to remain confidential are therefore advised to not identify themselves anywhere in their papers.

Confidential citations should include at least an unsigned statement indicating that the patent owner has been sent a copy of the citation papers. In the event that it is not possible to serve a copy on the patent owner, a duplicate copy should accompany the

original of the prior art citation, when the original is filed with the Office.

Patent examiners should not, at their own initiative, place in a patent file or forward for placement in the patent file, any citations of prior art. Patent examiners are charged with the responsibility of making decisions as to patentability for the Director of the Office. Any activity by examiners which would appear to indicate that patent claims are not patentable, outside of those cases pending before them, is considered to be inappropriate.

2204 Time for Filing Prior Art Citation [R-7]

Citations of prior art may be filed “at any time” under 35 U.S.C. 301. However, this period has been defined by rule (37 CFR 1.501(a)) to be “any time during the period of enforceability of a patent.” The period of enforceability is the length of the term of the patent plus the 6 years under the statute of limitations for bringing an infringement action (35 U.S.C. 286). In addition, if litigation is instituted within the period of the statute of limitations, citations may be submitted after the statute of limitations has expired, as long as the patent is still enforceable against someone. While citations of prior art may be filed at any time during the period of enforceability of the patent, citations submitted after the date of any order to reexamine will not be entered into the patent file until the pending reexamination proceeding has been concluded (37 CFR 1.501(a)), unless the citations are submitted (A) by the patent owner, (B) by an *ex parte* reexamination requester who also submits the fee and other documents required under 37 CFR 1.510, (C) by an *inter partes* reexamination requester who also submits the fee and other documents required under 37 CFR 1.915, (D) in an *ex parte* third party requester’s reply under 37 CFR 1.535, or (E) as an enterable submission pursuant to 37 CFR 1.948 in an *inter partes* reexamination proceeding. To ensure that prior art cited by a third party is considered without the payment of another reexamination fee, it must be presented >(in compliance with 37 CFR 1.501)< before reexamination is ordered.

The purpose of this rule is to prevent harassment of the patent owner due to frequent submissions of prior art citations during reexamination proceedings.

2205 Content of Prior Art Citation [R-7]

The prior art which may be submitted under 35 U.S.C. 301 is limited to “written prior art consisting of patents or printed publications.”

*>Pursuant to 35 U.S.C. 301, an< explanation is required of how the person submitting the prior art considers it to be pertinent and applicable to the patent, as well as an explanation of why it is believed that the prior art has a bearing on the patentability of any claim of the patent. The prior art citation must, at a minimum, contain some broad statement of the pertinency and applicability of the art submitted to the patentability of the claims of the patent for which the prior art citation is made. *>The explanation of why it is believed that the prior art has a bearing on the patentability of any claim of the patent< would be met, for example, by a statement that the art submitted in the prior art citation under 37 CFR 1.501 was made of record in a foreign or domestic application having the same or related invention to that of the patent. >The explanation of how the person submitting the prior art considers it to be pertinent and applicable to the patent would set forth, for at least one of the patent claims, how each item cited shows or teaches at least one limitation of the claim.< Citations of prior art by patent owners may also include an explanation of how the claims of the patent differ from the prior art cited.

It is preferred that copies of all the cited prior art patents or printed publications and any necessary English translation be included so that the value of the citations may be readily determined by persons inspecting the patent files and by the examiner during any subsequent reissue or reexamination proceeding.

All prior art citations filed by persons other than the patent owner must either indicate that a copy of the citation has been mailed to, or otherwise served on, the patent owner at the correspondence address as defined under 37 CFR 1.33(c), or if for some reason service on the patent owner is not possible, a duplicate copy of the citation must be filed with the Office along with an explanation as to why the service was not possible. The most recent address of the attorney or agent of record may be obtained from the Office’s register of registered patent attorneys and agents maintained by the Office of Enrollment and Discipline pursuant to 37 CFR 10.5 and 10.11(a).

All prior art citations submitted should identify the patent in which the citation is to be placed by the patent number, issue date, and patentee.

A cover sheet with an identification of the patent should have firmly attached to it all other documents relating to the citation so that the documents will not become separated during processing. The documents themselves should also contain, or have placed thereon, an identification of the patent for which they are intended.

Affidavits or declarations or other written evidence relating to the prior art documents submitted may accompany the citation to explain the contents or pertinent dates in more detail. A commercial success affidavit tied in with a particular prior art document may also be acceptable. For example, the patent owner may wish to cite a patent or printed publication which raises the issue of obviousness of at least one patent claim. Together with the cited art, the patent owner may file (A) an affidavit of commercial success or other evidence of nonobviousness, or (B) an affidavit which questions the enablement of the teachings of the cited prior art.

No fee is required for the submission of citations under 37 CFR 1.501.

A prior art citation is limited to the citation of patents and printed publications and an explanation of the pertinency and applicability of the patents and printed publications. This may include an explanation by the patent owner as to how the claims differ from the prior art. It may also include affidavits and declarations. The prior art citation cannot include any issue which is not directed to patents and printed publications. Thus, for example, a prior art citation cannot include a statement as to the claims violating 35 U.S.C. 112, a statement as to the public use of the claimed invention, or a statement as to the conduct of the patent owner. A prior art citation must be directed to patents and printed publications and cannot discuss what the patent owner did, or failed to do, with respect to submitting and/or describing patents and printed publications, because that would be a statement as to the conduct of the patent owner. The citation also should not contain argument and discussion of references previously treated in the prosecution of the invention which matured into the patent or references previously treated in a reexamination proceeding as to the patent.

If the prior art citation contains any issue not directed to patents and printed publications, it should not be entered into the patent file, despite the fact that it may otherwise contain a complete submission of patents and printed publications with an explanation of the pertinency and applicability. Rather, the prior art citation should be returned to the sender as described in MPEP § 2206.

Examples of letters submitting prior art under 37 CFR 1.501 follow.

EXAMPLE I

Submission by a third party:

IN THE UNITED STATES
PATENT AND TRADEMARK OFFICE

In re patent of
Joseph Smith
Patent No. 9,999,999
Issued: July 7, 2000
For: Cutting Tool

Submission of Prior Art Under 37 CFR
1.501

Hon. Commissioner for Patents
P.O. Box 1450
Alexandria, VA 22313-1450

Sir:

The undersigned herewith submits in the above-identified patent the following prior art (including copies thereof) which is pertinent and applicable to the patent and is believed to have a bearing on the patentability of at least claims 1 – 3 thereof:

Weid et al U.S. 2,585,416 April 15, 1933
McGee U.S. 2,722,794 May 1, 1934
Paulk et al U.S. 3,625,291 June 16, 1936

Each of the references discloses a cutting tool strikingly similar to the device of Smith in having pivotal handles with cutting blades and a pair of dies. It is believed that each of the references has a bearing on the patentability of claims 1 – 3 of the Smith patent.

Insofar as claims 1 and 2 are concerned, each of the references clearly anticipates the claimed subject matter under 35 U.S.C. 102.

As to claim 3, the differences between the subject matter of this claim and the cutting tool of Weid et al are shown in the device of Paulk et al. Further, Weid et al suggests that different cutting blades can be used in their device. A person of ordinary skill in the art at the time the invention was made would have been led by the suggestion of Weid et al to the cutting blades of Paulk et al as obvious substitutes for the blades of Weid et al.

Respectfully submitted,
(Signed)

Certificate of Service

I hereby certify on this first day of June 1982, that a true and correct copy of the foregoing "Submission of Prior Art" was mailed by first-class mail, postage paid, to:

Ben Schor
555 Any Lane
Anytown, VA 22202

(Signed)

John Jones

EXAMPLE II

Submission by the patent owner:

IN THE UNITED STATES
PATENT AND TRADEMARK OFFICE

In re patent of
Joseph Smith
Patent No. 9,999,999
Issued: July 7, 2000
For: Cutting Tool

Submission of Prior Art Under 37 CFR
1.501

Hon. Commissioner for Patents
P.O. Box 1450
Alexandria, VA 22313-1450

Sir:

The undersigned herewith submits in the above identified patent the following prior art (including copies thereof) which is pertinent and applicable to the patent and is believed to have a bearing on the patentability of at least claims 1-3 thereof:

Weid et al U.S. 2,585,416 April 15, 1933
McGee U.S. 2,722,794 May 1, 1934
Paulk et al U.S. 3,625,291 June 16, 1936

Each of the references discloses a cutting tool strikingly similar to the device of Smith in having pivotal handles with cutting blades and a pair of dies. While it is believed that each of the references has a bearing on the patentability of claims 1 – 3 of the Smith patent, the subject matter claimed differs from the references and is believed patentable thereover.

Insofar as claims 1 and 2 are concerned, none of the references show the particular die claimed and the structure of these claimed dies would not have been obvious to a person of ordinary skill in the art at the time the invention was made.

As to claim 3, while the cutting blades required by this claim are shown in Paulk et al, the remainder of the claimed structure is found only in Weid et al. A person of ordinary skill in the art at the time the invention was made would not have found it obvious to substitute the cutting blades of Paulk et al for those of Weid et al. In fact, the disclosure of Weid et al would lead a person of ordinary skill in the art away from the use of cutting blades such as shown in Paulk et al.

The reference to McGee, while generally similar, lacks the particular cooperation between the elements which is specifically set forth in each of claims 1-3.

Respectfully submitted,

(Signed)

William Green
Attorney for Patent Owner
Reg. No. 29760

2206 Handling of Prior Art Citation [R-7]

Prior art citations received in the Office will be forwarded to the Technology Center (TC) that currently examines the class and subclass in which the patent to which the prior art citations are addressed is classified as an original.

It is the responsibility of the TC to immediately determine whether a citation meets the requirements of the statute and the rules and to enter it into the patent file at the appropriate time if it is proper.

If a proper citation is filed after the date of an order for reexamination but it is not entitled to entry pursuant to the reexamination rules, the citation is retained (stored) in the TC until the reexamination is concluded. Note 37 CFR 1.502 and 1.902 and MPEP § 2294. An e-tag should be placed in the reexamination file history as a reminder of the citation to be placed in the patent file after conclusion of the reexamination proceeding. The citation is then placed in the TC's citation storage file. After the reexamination proceeding is concluded, the citation is removed from the storage file and processed for placement in the patent file. Citations filed after the date of an order for reexamination which are not entitled to entry pursuant to the reexamination rules will not be considered by the examiner during the reexamination.

I. CITATION QUALIFIES FOR ENTRY UNDER 37 CFR 1.501

A. Citations by Third Party

1. Prior to Order in Any Pending Reexamination Proceeding

If the citation is proper (i.e., limited to patents and printed publications >and including the requisite citation description<) and is filed prior to an order in a reexamination proceeding, it should be immediately entered into the reexamination file. If no reexamination is pending for the patent, the citation should be placed in the patent file. If the citation includes an indication of service on the patent owner, the citation is merely timely entered and no notice of such entry is sent to any party. If the citation does not include an indication of service, the patent owner should be notified that a citation of prior art has been entered into the patent file. If a duplicate copy of the citation was filed, the duplicate copy should be sent to the patent owner along with the notification. If no duplicate copy is present, no copy will be sent with the notification. Wording similar to the following should be used:

“A citation of prior art under 35 U.S.C. 301 and 37 CFR 1.501 has been filed on ____ in your patent number ____ entitled_____.

This notification is being made to inform you that the citation of prior art has been placed in the file wrapper /file history of:

[] the above identified patent.

[] reexamination control # _____.

The person submitting the prior art:

1. [] was not identified
2. [] is confidential
3. [] is _____.”

2. After the Order in Any Pending Reexamination Proceeding

If the >37 CFR 1.501< citation is proper but is filed after an order for reexamination in a pending reexamination, the citation is not entered at >that< time because of the ongoing reexamination, but rather is stored until the conclusion of the reexamination proceeding, after which the citation is entered into the patent file. The patent owner and sender (if known) should be alerted of this by a letter providing notification. If there is a third party requester, the third party requester should also be sent a copy of the notification letter pursuant to 37 CFR 1.550(f). Such notification is important to enable the patent owner to consider submitting the prior art under 37 CFR 1.555 or 1.933 during the reexamination. Such notification will also enable the third party sender to consider the desirability of filing a separate request for reexamination. If the citation does not include service of a copy on the patent owner and a duplicate copy is submitted, the duplicate copy should be sent to the patent owner along with the notification. If a duplicate copy is not present, no copy will accompany the notification to the patent owner. In this situation, the original copy (in storage) should be made available for copying by the patent owner. If the citation includes service of a copy on the patent owner, the citation is placed in storage and not entered until the reexamination is concluded. The patent owner and third party sender (if known) should be given notice of this action.

An example of a letter (in a patent owner filed reexamination) giving notice to the patent owner and third party sender, where the citation was filed after the order for *ex parte* reexamination, is as follows.

John A. Jones (Citation Sender)
 Jones & Smith
 1020 United First Bldg.
 1033 Any Street
 U.S. Town, Washington 98121

Richard A. Davis (Patent Owner)
 The A.B. Good Co.
 Patent Law Dept.
 9921 Any Street
 Any City, Ohio 44141

In re Doe, et al :
 Examination Proceeding :
 Control No. 90/999,999 : NOTIFICATION RE
 Filed: February 7, 2000 : PRIOR ART CITATION
 For: U.S. Patent No. 9,999,999 :

The prior art citation filed May 19, 2000, is a proper citation under 37 CFR 1.501(a); however, it was filed after the May 2, 2000, date of the order for reexamination in reexamination control # 90/999,999.

Because the prior art citation was filed after the date of the order for reexamination, the citation is being retained in the Technology Center (TC1700) until the reexamination is concluded. Note 37 CFR 1.501 (a) and MPEP § 2294. At that time, the citation will be processed for placement in the patent file of patent # 9,999,999.

The prior art citation filed May 19, 2000, will not be considered in reexamination control # 90/999,999.

The patent owner and sender of the citation are being provided with a copy of this notification. If appropriate, the patent owner may wish to consider submitting prior art from the prior art citation pursuant to 37 CFR 1.555 during the reexamination proceeding (reexamination control # 90/999,999). In addition, if appropriate, the sender may file a request for reexamination to place the art of the prior art citation before the patent examiner.

Kenneth M. Schor
 **>Quality Assurance Specialist<
 Technology Center 3700

B. Citation Filed by Patent Owner

If a proper prior art citation is filed by the patent owner, it should be entered in the file. This is true whether the citation is filed prior to or after an order

for reexamination has been mailed. No notification to the patent owner is necessary.

The following diagram shows the various situations which can occur when a proper prior art citation is filed and the action to be taken for each alternative situation:

PROCESSING OF CITATIONS OF PRIOR ART WHICH QUALIFY FOR ENTRY UNDER 37 CFR 1.501

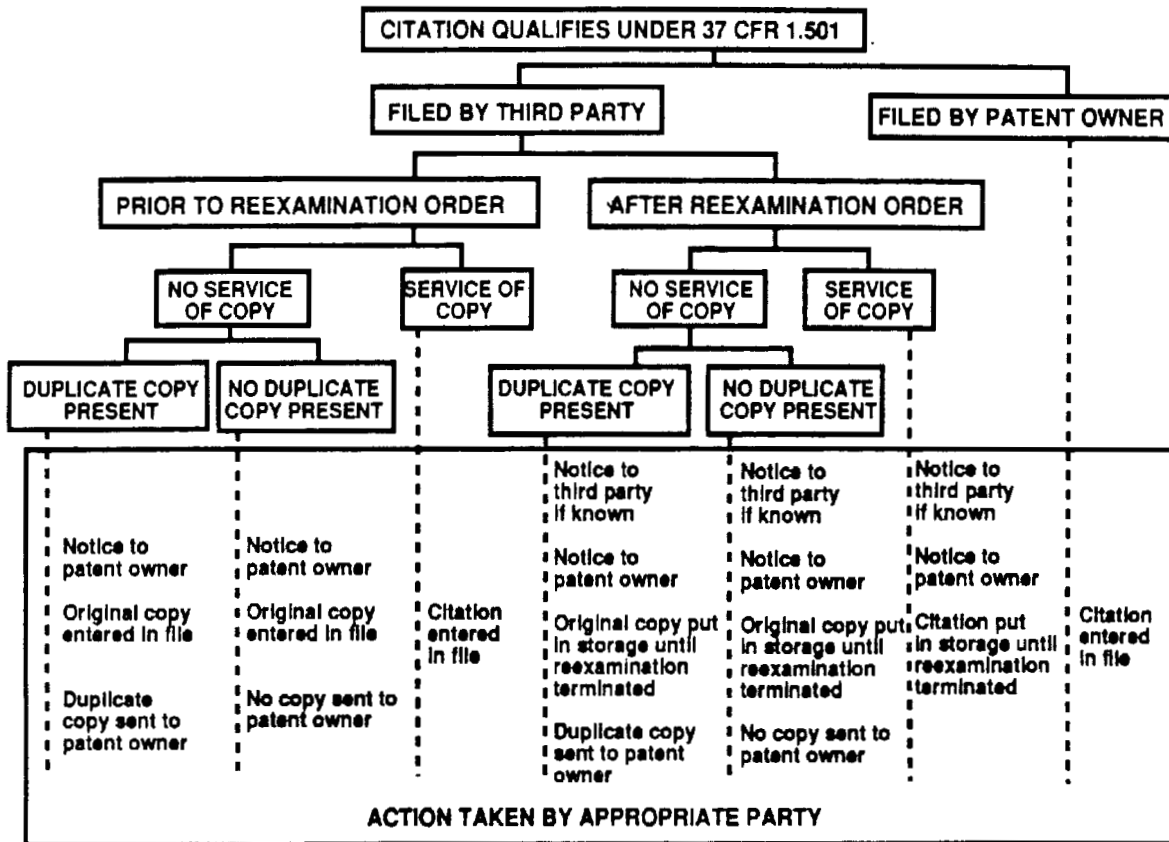

II. CITATION DOES NOT QUALIFY FOR ENTRY UNDER 37 CFR 1.501

A. *Citation by Third Party*

If the citation is not proper (i.e., it is not limited to patents or printed publications >or fails to include the requisite citation description<), it should not be entered in the patent file. The sender (if known) and the patent owner *in all cases* should be notified that the citation is improper and that it is not being entered in the patent file. The handling of the citation will vary depending on the particular following situation.

1. **Service of Copy Included**

Where the citation includes an indication of service of copy on the patent owner and the identity of the third party sender is known, the original citation paper should be returned to the third party sender along with the notification of nonentry. If the identity of the third party sender is not known, the original citation papers should be discarded.

2. **Service of Copy Not Included; Identity of Third Party Sender Known**

Where the citation does not include an indication of service on the patent owner, the identity of the third party sender is known, and a duplicate copy of the citation is present, the original citation papers should be returned to the third party sender and the duplicate copy should be sent to the patent owner along with the notification of nonentry. If the duplicate copy required in 37 CFR 1.501(c) is not present, the original citation papers should be sent to the PATENT OWNER along

with the notification of nonentry. The third party sender should be sent a notification that the citation was not entered and that the original citation papers were sent to the patent owner.

3. **Service of Copy Not Included; Identity of Third Party Sender Not Known**

Where the citation does not include an indication of service, the identity of the third party sender is not known, and a duplicate copy of the citation is or is not present, the duplicate copy (if present) should be discarded and the original citation papers should be sent to the patent owner along with the notification of nonentry.

B. *Citation Filed by the Patent Owner*

If an improper prior art citation under 37 CFR 1.501 is filed by the patent owner prior to an order for reexamination, it should not be entered in the file.

The patent owner should be notified of the nonentry, and the citation papers should be returned to the patent owner along with the notification. Prior art submission filed by the patent owner after an order for reexamination should be entered in the file under 37 CFR 1.555 (for *ex parte* reexamination) or under 37 CFR 1.933 (for *inter partes* reexamination).

The following diagram shows the various situations which can occur when an improper prior art citation is filed and the action to be taken for each alternative situation. Any unusual problems should be brought to the attention of the Office of Patent Legal Administration.

PROCESSING OF CITATIONS OF PRIOR ART WHICH DO NOT QUALIFY FOR ENTRY UNDER 37 CFR 1.501

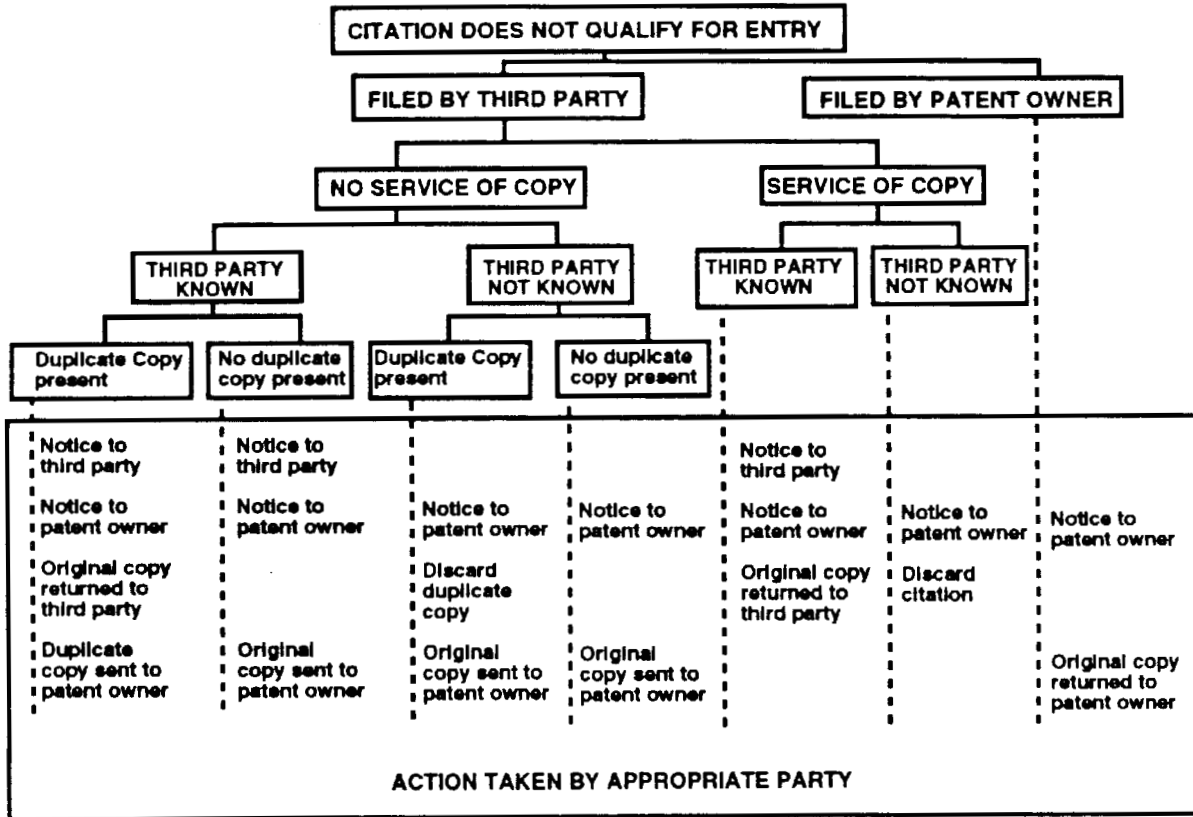

2207 Entry of Court Decision in Patent File [R-7]

The Solicitor's Office processes *notices* required by 35 U.S.C. 290, received from the clerks of the various courts >in the United States<, and has them entered in the patent file. However, it is considered desirable that the *entire court decision* be supplied to the Office for entry into the patent file. Accordingly, the Office will accept at *any time* from *any party* for placement in the patent file, submissions of the following: copies of notices of suits, copies of notices regarding other proceedings involving the patent and copies of decisions from litigations or other proceedings involving the patent. The Office will also accept for entry into the patent file other court papers, or papers filed in the court, from litigations or other proceedings involving the patent. >The decisions from litigations or other proceedings include final court decisions (even if the decision is still appealable), decisions to vacate, decisions to remand, and decisions as to the merits of the patent claims. Non-merit decisions on motions such as for a new venue, a new trial/discovery date, or sanctions will not be entered into the patent file, and will be expunged from the patent file by closing the appropriate paper if they were entered before discovery of their nature. Further, papers filed in the court from litigations or other proceedings involving the patent will not be entered into the patent file (and will be expunged if already entered) if they provide a party's arguments, such as a memorandum in support of summary judgment. If the argument has an entry right in the reexamination proceeding, it must be submitted via the vehicle (provision(s) of the rules) that provides for that entry right. It is not required nor is it permitted that parties submit copies of copending reexamination proceedings and applications (which copies can be mistaken for a new request/filing); rather, submitters may provide a notice identifying the application/proceeding number and its status. Any submission that is not permitted entry will be returned, expunged, or discarded, at the sole discretion of the Office.<

It is to be noted that if the Office, in its sole discretion, deems the volume of the papers filed from litigations or other proceedings to be too extensive/lengthy, the Office may return >, expunge, or discard, at its sole discretion,< all or part of the submission. In such

an instance, a party may limit the submission in accordance with what is deemed relevant, and resubmit the papers. Such submissions must be provided without additional comment. Persons making such submissions must *limit the submission to the notification* and not include further arguments or information. It is to be understood that highlighting of certain text by underlining, fluorescent marker, etc., goes beyond bare notice of the prior or concurrent proceedings. Any proper submission will be promptly placed on record (entered) in the patent file. Entry of these submissions is performed by the Files Repository personnel, unless a reexamination proceeding is pending, in which case, the Central Reexamination Unit, the Technology Center, or other area of the Office having responsibility for the reexamination enters the submission.

>It is to be further noted that 35 U.S.C. 290 is directed to "courts of the United States." Accordingly, any submission of papers from a court outside the United States (a foreign jurisdiction) will be returned, expunged or discarded, at the sole discretion of the Office.<

Where a request for reexamination has been filed, see MPEP § 2282 for *ex parte* reexamination and MPEP § 2686 for *inter partes* reexamination. See MPEP § 2240 and § 2242 for handling of requests for *ex parte* reexamination of patents involved in litigation. See MPEP § 2640 and § 2642 for handling of requests for *inter partes* reexamination of patents involved in litigation.

2208 Service of Citation on Patent Owner [R-2]

A copy of any submission of a citation of prior art patents or printed publications in a patent file should be served on the patent owner so that the patent owner is kept fully informed as to the content of his or her patent file wrapper >/file history<. See MPEP § 2206 for handling of prior art citations.

The service to the patent owner should be addressed to the correspondence address as set forth in 37 CFR 1.33(c). See MPEP § 2222 as to the correspondence address.

2209 Ex Parte Reexamination [R-7]

Procedures for reexamination of issued patents began on July 1, 1981, the date when the reexamina-

tion provisions of Public Law 96-517 came into effect.

The reexamination statute and rules permit any person to file a request for an *ex parte* reexamination containing certain elements and the fee required under 37 CFR 1.20(c)(1). The Office initially determines if “a substantial new question of patentability” (35 U.S.C. 303(a)) is presented. If such a new question has been presented, reexamination will be ordered. The reexamination proceedings which follow the order for reexamination are very similar to regular examination procedures in patent applications; however, there are notable differences. For example, there are certain limitations as to the kind of rejections which may be made, special reexamination forms to be used, and time periods set to provide “special dispatch.” When the prosecution of a reexamination proceeding is terminated, a reexamination certificate is issued which indicates the status of all claims following the reexamination. Unless prosecution is reopened by the Director, the reexamination proceeding is concluded by the issuance and publication of a reexamination certificate.

The following sections of this chapter explain the details of reexamination.

The intent of the reexamination procedures covered in this chapter include the following:

- (A) To provide procedures for reexamination of patents;
- (B) To implement reexamination in an essentially *ex parte* manner;
- (C) To minimize the processing costs and complexities of reexamination;
- (D) To maximize respect for the reexamined patent;
- (E) To provide procedures for prompt and timely determinations by the Office in accordance with the “special dispatch” requirements of 35 U.S.C. 305.

The basic characteristics of ex parte reexamination are as follows:

- (A) Anyone can request reexamination at any time during the period of enforceability of the patent;
- (B) Prior art considered during reexamination is limited to prior art patents or printed publications applied under the appropriate parts of 35 U.S.C. 102 and 103;

(C) A substantial new question of patentability must be present for reexamination to be ordered;

(D) If ordered, the actual reexamination proceeding is *ex parte* in nature;

(E) Decision on the request must be made no later than 3 months from its filing, and the remainder of proceedings must proceed with “special dispatch” within the Office;

(F) If ordered, a reexamination proceeding will normally be conducted to its conclusion and the issuance of a reexamination certificate;

(G) The scope of a claim cannot be enlarged by amendment;

(H) All reexamination and patent files are open to the public, but see paragraph (I) below;

(I) The reexamination file is scanned into IFW to provide an electronic format copy of the file. All public access to and copying of the reexamination file may be made from the electronic format copy available through PAIR. Any remaining paper files are not available to the public.

>Parties are cautioned that the reexamination statute, regulations, and published examining procedures do not countenance so-called “litigation tactics” in reexamination proceedings. The parties are expected to conduct themselves accordingly. For example, it is expected that submissions of papers that are not provided for in the reexamination regulations and/or appear to be excluded by the regulation will either be filed with an appropriate petition to accept the paper and/or waive the regulation(s), or not filed at all. Parties are advised that multiple submissions, such as a reply to a paper opposing a petition and a sur-reply directed to such a reply are not provided for in the reexamination regulations or examining procedures. It is expected that the parties will adhere to the provisions of 37 CFR 10.18(b) throughout the course of a reexamination proceeding.<

2210 Request for *Ex Parte* Reexamination [R-7]

35 U.S.C. 302. Request for reexamination.

Any person at any time may file a request for reexamination by the Office of any claim of a patent on the basis of any prior art cited under the provisions of section 301 of this title. The request must be in writing and must be accompanied by payment of a reexamination fee established by the Director pursuant to the provisions of section 41 of this title. The request must set forth the

pertinency and manner of applying cited prior art to every claim for which reexamination is requested. Unless the requesting person is the owner of the patent, the Director promptly will send a copy of the request to the owner of record of the patent.

37 CFR 1.510. Request for ex parte reexamination.

(a) Any person may, at any time during the period of enforceability of a patent, file a request for an *ex parte* reexamination by the Office of any claim of the patent on the basis of prior art patents or printed publications cited under § 1.501. The request must be accompanied by the fee for requesting reexamination set in § 1.20(c)(1).

(b) Any request for reexamination must include the following parts:

(1) A statement pointing out each substantial new question of patentability based on prior patents and printed publications.

(2) An identification of every claim for which reexamination is requested, and a detailed explanation of the pertinency and manner of applying the cited prior art to every claim for which reexamination is requested. If appropriate the party requesting reexamination may also point out how claims distinguish over cited prior art.

(3) A copy of every patent or printed publication relied upon or referred to in paragraph (b)(1) and (2) of this section accompanied by an English language translation of all the necessary and pertinent parts of any non-English language patent or printed publication.

(4) A copy of the entire patent including the front face, drawings, and specification/claims (in double column format) for which reexamination is requested, and a copy of any disclaimer, certificate of correction, or reexamination certificate issued in the patent. All copies must have each page plainly written on only one side of a sheet of paper.

(5) A certification that a copy of the request filed by a person other than the patent owner has been served in its entirety on the patent owner at the address as provided for in § 1.33(c). The name and address of the party served must be indicated. If service was not possible, a duplicate copy must be supplied to the Office.

(c) If the request does not include the fee for requesting *ex parte* reexamination required by paragraph (a) of this section and meet all the requirements by paragraph (b) of this section, then the person identified as requesting reexamination will be so notified and will generally be given an opportunity to complete the request within a specified time. Failure to comply with the notice will result in the *ex parte* reexamination request not being granted a filing date, and will result in placement of the request in the patent file as a citation if it complies with the requirements of § 1.501.

(d) The filing date of the request for *ex parte* reexamination is the date on which the request satisfies all the requirements of this section.

(e) A request filed by the patent owner may include a proposed amendment in accordance with § 1.530.

**>

(f) If a request is filed by an attorney or agent identifying another party on whose behalf the request is being filed, the attor-

ney or agent must have a power of attorney from that party or be acting in a representative capacity pursuant to § 1.34.<

Any person, at any time during the period of enforceability of a patent, may file a request for *ex parte* reexamination by the U.S. Patent and Trademark Office of any claim of the patent based on prior art patents or printed publications. The request must include the elements set forth in 37 CFR 1.510(b) (see MPEP § 2214) and must be accompanied by the fee as set forth in 37 CFR 1.20(c)(1). If a request filed by the patent owner includes a proposed amendment in accordance with 37 CFR 1.530, excess claims fees under 37 CFR 1.20(c)(3) and (c)(4) may also apply; see MPEP § 2250.03. No attempt will be made to maintain a requester's name in confidence.

After the request for reexamination, including the entire fee for requesting reexamination, is received in the Office, no abandonment, withdrawal, or striking of the request is possible, regardless of who requests the same. In some limited circumstances, such as after a final court decision where all of the claims are finally held invalid, a reexamination order may be vacated, see MPEP § 2286.

2211 Time for Requesting **>Ex Parte Reexamination<* [R-2]

Under 37 CFR 1.510(a), any person may, at any time during the period of enforceability of a patent, file a request for *>ex parte<* reexamination. This period was set by rule, since the Office considered that Congress could not have intended expending Office resources on deciding patent validity questions in patents which cannot be enforced. In this regard see *Patlex Corp. v. Mossinghoff*, 758 F.2d 594, 225 USPQ 243, 249 (Fed. Cir. **>1985<*). The period of enforceability is determined by adding 6 years to the date on which the patent expires. The patent expiration date for a utility patent, for example, is determined by taking into account the term of the patent, whether maintenance fees have been paid for the patent, *** whether any disclaimer was filed as to the patent to shorten its term>, any patent term extensions or adjustments for delays within the Office under 35 U.S.C. 154 (see MPEP § 2710, *et seq.*), and any patent term extensions available under 35 U.S.C. 156 for premarket regulatory review (see MPEP § 2750 *et seq.*)<. Any other relevant information should also be taken into account. In addition, if litigation is instituted within

the period of the statute of limitations, requests for reexamination may be filed after the statute of limitations has expired, as long as the patent is still enforceable against someone.

2212 Persons Who May File a Request >for *Ex Parte* Reexamination< [R-2]

37 CFR 1.510. Request for >ex parte< reexamination.

(a) Any person may, at any time during the period of enforceability of a patent, file a request for an *ex parte* reexamination by the Office of any claim of the patent on the basis of prior art patents or printed publications cited under § 1.501. The request must be accompanied by the fee for requesting reexamination set in § 1.20(c)(1).

35 U.S.C. 302 and 37 CFR 1.510(a) both indicate that “any person” may file a request for reexamination of a patent. Accordingly, there are no persons who are excluded from being able to seek reexamination. Corporations and/or governmental entities are included within the scope of the term “any person.” The patent owner can ask for reexamination which will be limited to an *ex parte* consideration of prior >art< patents or printed publications. If the patent owner wishes to have a wider consideration of issues by the Office, including matters such as prior public use or >on< sale, the patent owner may file a reissue application. It is also possible for the *>Director of the Office< to initiate reexamination on the *>Director’s< own initiative under 37 CFR 1.520. Reexamination will be initiated by the *>Director’s< on a very limited basis, such as where a general public policy question is at issue and there is no interest by “any other person.” Some of the persons likely to use reexamination are patentees, licensees, potential licensees, attorneys without identification of their real client in interest, infringers, potential exporters, patent litigants, interference applicants, and International Trade Commission respondents. The name of the person who files the request will not be maintained in confidence.

2212.01 Inquiries from Persons Other Than the Patent Owner [R-7]

Examiners should not discuss or answer inquiries from third parties (i.e., parties who are not the patent owner) in reexamination proceedings. A party who is

not the patent owner should be referred by the examiner to the Technology Center (TC) >Quality Assurance Specialist (QAS)< or Central Reexamination Unit (CRU) **>Supervisory Patent Examiner (SPE)< for the examiner’s art unit. The *>CRU SPE or TC QAS< will address any such questions. Only questions on strictly procedural matters, i.e., not directed to any specific reexamination proceeding, may be discussed by the *>CRU SPE or TC QAS< with that party.

Employees of the Office, particularly patent examiners who conducted a concluded reexamination proceeding, should not discuss or answer inquiries from any person outside the Office as to whether a certain reference or other particular evidence was considered during the proceeding and whether a claim would have been allowed over that reference or other evidence had it been considered during the proceeding.

Patent practitioners must not make improper inquiries of members of the patent examining corps and the Office as a whole. See 37 CFR 10.23. Inquiries from members of the public relating to the matters discussed above must, of necessity, be refused and such refusal should not be considered discourteous or an expression of opinion by the Office as to the validity, patentability, or enforceability of the patent.

The definitions set forth in 37 CFR 104.1 and the exceptions in 37 CFR 104.21 are applicable to this section.

2213 Representative of Requester [R-7]

37 CFR 1.510. Request for *ex parte* reexamination.

**>

(f) If a request is filed by an attorney or agent identifying another party on whose behalf the request is being filed, the attorney or agent must have a power of attorney from that party or be acting in a representative capacity pursuant to § 1.34.<

Where an attorney or agent files a request for an identified client (the requester), he or she may act under either a power of attorney from the client, or act in a representative capacity under 37 CFR 1.34*, see 37 CFR 1.510(f). While the filing of the power of attorney is desirable, processing of the reexamination request will not be delayed due to its absence.

>In order to act in a representative capacity under 37 CFR 1.34, an attorney or agent must set forth his or her registration number, his or her name and signa-

ture. In order to act under a power of attorney from a requester, an attorney or agent must be provided with a power of attorney. 37 CFR 1.32(c) provides that a “power of attorney may only name as representative” the inventors or registered patent practitioners. Thus, an attorney or agent representing a requester must be a registered patent practitioner.<

>If an attorney or agent files a request for reexamination for another entity (e.g., a corporation) that wishes to remain anonymous, then that attorney or agent is the third party requester.<

If any question of authority to act is raised, proof of authority may be required by the Office.

All correspondence for a requester that is not the patent owner **>is< addressed to the representative of the requester, unless a specific indication is made to forward correspondence to another address.

If the request is filed by a person on behalf of the patent owner, correspondence will be directed to the patent owner at the address as indicated in 37 CFR 1.33(c), regardless of the address of the person filing the request. See MPEP § 2222 for a discussion of who receives correspondence on behalf of a patent owner and how changes in the correspondence address are to be made.

A patent owner may not be represented during a reexamination proceeding by an attorney or other person who is not registered to practice before the Office, since those individuals are prohibited by 37 CFR 1.33(c) from signing amendments and other papers filed in a reexamination proceeding on behalf of the patent owner.

2214 Content of Request for *Ex Parte* Reexamination [R-7]

37 CFR 1.510. *Request for ex parte reexamination.*

(a) Any person may, at any time during the period of enforceability of a patent, file a request for an *ex parte* reexamination by the Office of any claim of the patent on the basis of prior art patents or printed publications cited under § 1.501. The request must be accompanied by the fee for requesting reexamination set in § 1.20(c)(1).

(b) Any request for reexamination must include the following parts:

(1) A statement pointing out each substantial new question of patentability based on prior patents and printed publications.

(2) An identification of every claim for which reexamination is requested, and a detailed explanation of the pertinency and manner of applying the cited prior art to every claim for which

reexamination is requested. If appropriate the party requesting reexamination may also point out how claims distinguish over cited prior art.

(3) A copy of every patent or printed publication relied upon or referred to in paragraph (b)(1) and (2) of this section accompanied by an English language translation of all the necessary and pertinent parts of any non-English language patent or printed publication.

(4) A copy of the entire patent including the front face, drawings, and specification/claims (in double column format) for which reexamination is requested, and a copy of any disclaimer, certificate of correction, or reexamination certificate issued in the patent. All copies must have each page plainly written on only one side of a sheet of paper.

(5) A certification that a copy of the request filed by a person other than the patent owner has been served in its entirety on the patent owner at the address as provided for in § 1.33(c). The name and address of the party served must be indicated. If service was not possible, a duplicate copy must be supplied to the Office.

37 CFR 1.510(a) requires the payment of the fee specified in 37 CFR 1.20(c)(1) for a request for reexamination. See MPEP § 2215. If a request filed by the patent owner includes a proposed amendment in accordance with 37 CFR 1.530, excess claims fees under 37 CFR 1.20(c)(3) and (c)(4) may also apply; see MPEP § 2250.03.

37 CFR 1.510(b) sets forth the required elements of a request for *ex parte* reexamination. The elements are as follows:

“(1) a statement pointing out each substantial new question of patentability based on prior patents and printed publications.”

This statement should clearly point out what the requester considers to be the substantial new question of patentability which would warrant a reexamination. The cited prior art should be listed on a form PTO/SB/08A or 08B, or PTO/SB/42 (or on a form having a format equivalent to one of these forms) by the requester. See also MPEP § 2217.

A request for reexamination must assert a substantial new question of patentability. > For each identified substantial new question of patentability and each identified proposed ground of rejection, the request must explain how the cited documents identified for that substantial new question of patentability/proposed ground of rejection raise a substantial new question of patentability.< See MPEP § 2216. A requester *>must< not, in a request for reexamination,

argue that the submitted references do not raise a substantial new question of patentability, and that no order for reexamination should be issued.

“(2) An identification of every claim for which reexamination is requested, and a detailed explanation of the pertinency and manner of applying the cited prior art to every claim for which reexamination is requested. If appropriate the party requesting reexamination may also point out how claims distinguish over cited prior art.”

>The request must identify **each** substantial new question of patentability raised and proposed ground of rejection separately.< The request *must* apply >all of< the cited prior art to **>the claims< for which reexamination is requested. > For each identified substantial new question of patentability and each identified proposed ground of rejection, the request must explain how the cited documents identified for that substantial new question of patentability/proposed ground of rejection are applied to meet or teach the patent claim limitations to thus establish the identified substantial new question of patentability or proposed ground of rejection.< See MPEP § 2217. If the request is filed by the patent owner, he or she may also indicate how the claims distinguish from the cited prior art patents and printed publications.

“(3) A copy of every patent or printed publication relied upon or referred to in paragraph (b)(1) and (2) of this section accompanied by an English language translation of all the necessary and pertinent parts of any non-English language patent or printed publication.”

A copy of each cited patent or printed publication, as well as a translation of each non-English document (or a translation of at least the portion(s) relied upon) is required so that all materials will be available to the examiner for full consideration. >A listing of the patents and printed publications as provided for in 37 CFR 1.98 must also be provided. A comprehensive listing is required, since the identification of the cited art in reexamination by the requester is no less important than that of a patent owner or applicant, and furthers the statutory mandate of 35 U.S.C. 305 that reexamination proceedings must be “conducted with special dispatch within the Office.”< See MPEP § 2218.

“(4) A copy of the entire patent including the front face, drawings, and specification/claims (in double column format) for which reexamination is requested, and a copy of any disclaimer, certificate of correction, or reex-

amination certificate issued in the patent. All copies must have each page plainly written on only one side of a sheet of paper.”

A copy of the patent, for which reexamination is requested, should be provided with the specification and claims submitted in a **double** column format. The drawing pages of the printed patent are presented as they appear in the printed patent; the same is true for the front page of the patent. Thus, a full copy of the printed patent (including the front page) can be used to provide the abstract, drawings, specification, and claims of the patent for the reexamination request. The printed patent is to be reproduced on only one side of the paper; a two sided copy of the patent is not proper. See MPEP § 2219.

Any disclaimer, certificate of correction, or reexamination certificate issued in the patent becomes a part of the patent. Thus, a copy of each must be supplied in order to provide the complete patent. The copy must have each page plainly written on only one side of a sheet of paper.

“(5) A certification that a copy of the request filed by a person other than the patent owner has been served in its entirety on the patent owner at the address as provided for in § 1.33(c). The name and address of the party served must be indicated. If service was not possible, a duplicate copy must be supplied to the Office.”

If the request is filed by a person other than the patent owner, a certification that a copy of the request papers has been served on the patent owner must be included. The certification must set forth the name and address employed in serving the patent owner. If service was not possible >after a reasonable effort to do so<, a duplicate copy of the request must be supplied to the Office together with >a **cover letter** including< an explanation of what effort was made to effect service, and why that effort was not successful. >To avoid the possibility of the Office erroneously charging a duplicate filing fee, requesters are strongly encouraged to clearly word the cover letter by stating, for example, in bold print in the heading “**Duplicate Copy of Request Filed under 37 CFR 1.510(b)(5) When Service on the Patent Owner Was Not Possible.**”< The request should be as complete as possible, since there is no guarantee that the examiner will consider other prior art when making the decision on the request. Also, >this may be the third party requester’s only opportunity to participate in the proceeding

since, < if no statement under 37 CFR 1.530(b) is filed by the patent owner, no later reply under 37 CFR 1.535 or other submission may be filed by the requester in the *ex parte* reexamination proceeding. See also MPEP § 2220.

In order to obtain a reexamination filing date, the request papers must include the fee for requesting *ex parte* reexamination required by 37 CFR 1.510(a) and all of the parts required by 37 CFR 1.510(b). Request papers that fail to satisfy all the requirements of 37 CFR 1.510(a) and (b) are incomplete and will not be granted a filing date. See MPEP § 2227.

>An application data sheet (ADS) under 37 CFR 1.76 cannot be submitted in a reexamination proceeding since a reexamination proceeding is not an “application.”<

Form PTO/SB/57 should be helpful to persons filing requests for reexamination. The use of this form as the transmittal form and cover sheet of a request for reexamination is encouraged, but its use is not a requirement of the law nor the rules. Immediately following is a form PTO/SB/57 and a sample of a request for reexamination that would be attached to the form PTO/SB/57 cover sheet.

**>

PTO/SB/57 (09-07)

Approved for use through 08/31/2010. OMB 0651-0033

U.S. Patent and Trademark Office; U.S. DEPARTMENT OF COMMERCE

Under the Paperwork Reduction Act of 1995, no persons are required to respond to a collection of information unless it displays a valid OMB control number.

(Also referred to as FORM PTO-1465)

REQUEST FOR *EX PARTE* REEXAMINATION TRANSMITTAL FORM

Address to:

**Mail Stop *Ex Parte* Reexam
Commissioner for Patents
P.O. Box 1450
Alexandria, VA 22313-1450**

Attorney Docket No.:

Date:

1. This is a request for *ex parte* reexamination pursuant to 37 CFR 1.510 of patent number _____ issued _____. The request is made by:
- patent owner. third party requester.
2. The name and address of the person requesting reexamination is:
- _____
- _____
- _____
3. a. A check in the amount of \$ _____ is enclosed to cover the reexamination fee, 37 CFR 1.20(c)(1);
- b. The Director is hereby authorized to charge the fee as set forth in 37 CFR 1.20(c)(1) to Deposit Account No. _____ (submit duplicative copy for fee processing); or
- c. Payment by credit card. Form PTO-2038 is attached.
4. Any refund should be made by check or credit to Deposit Account No. _____. 37 CFR 1.26(c). If payment is made by credit card, refund must be to credit card account.
5. A copy of the patent to be reexamined having a double column format on one side of a separate paper is enclosed. 37 CFR 1.510(b)(4)
6. CD-ROM or CD-R in duplicate, Computer Program (Appendix) or large table
 Landscape Table on CD
7. Nucleotide and/or Amino Acid Sequence Submission
If applicable, items a. – c. are required.
- a. Computer Readable Form (CRF)
- b. Specification Sequence Listing on:
- i. CD-ROM (2 copies) or CD-R (2 copies); or
- ii. paper
- c. Statements verifying identity of above copies
8. A copy of any disclaimer, certificate of correction or reexamination certificate issued in the patent is included.
9. Reexamination of claim(s) _____ is requested.
10. A copy of every patent or printed publication relied upon is submitted herewith including a listing thereof on Form PTO/SB/08, PTO-1449, or equivalent.
11. An English language translation of all necessary and pertinent non-English language patents and/or printed publications is included.

[Page 1 of 2]

This collection of information is required by 37 CFR 1.510. The information is required to obtain or retain a benefit by the public which is to file (and by the USPTO to process) an application. Confidentiality is governed by 35 U.S.C. 122 and 37 CFR 1.11 and 1.14. This collection is estimated to take 2 hours to complete, including gathering, preparing, and submitting the completed application form to the USPTO. Time will vary depending upon the individual case. Any comments on the amount of time you require to complete this form and/or suggestions for reducing this burden, should be sent to the Chief Information Officer, U.S. Patent and Trademark Office, U.S. Department of Commerce, P.O. Box 1450, Alexandria, VA 22313-1450. DO NOT SEND FEES OR COMPLETED FORMS TO THIS ADDRESS. **SEND TO: Mail Stop *Ex Parte* Reexam, Commissioner for Patents, P.O. Box 1450, Alexandria, VA 22313-1450.**

If you need assistance in completing the form, call 1-800-PTO-9199 and select option 2.

PTO/SB/57 (09-07)

Approved for use through 08/31/2010. OMB 0651-0033

U.S. Patent and Trademark Office; U.S. DEPARTMENT OF COMMERCE

Under the Paperwork Reduction Act of 1995, no persons are required to respond to a collection of information unless it displays a valid OMB control number.

12. The attached detailed request includes at least the following items:

a. A statement identifying each substantial new question of patentability based on prior patents and printed publications. 37 CFR 1.510(b)(1)

b. An identification of every claim for which reexamination is requested, and a detailed explanation of the pertinency and manner of applying the cited art to every claim for which reexamination is requested. 37 CFR 1.510(b)(2)

13. A proposed amendment is included (only where the patent owner is the requester). 37 CFR 1.510(e)

14. a. It is certified that a copy of this request (if filed by other than the patent owner) has been served in its entirety on the patent owner as provided in 37 CFR 1.33(c).
The name and address of the party served and the date of service are:

Date of Service: _____; or

b. A duplicate copy is enclosed since service on patent owner was not possible.

15. Correspondence Address: Direct all communication about the reexamination to:

The address associated with Customer Number:

OR

Firm or Individual Name

Address

City	State	Zip
Country		
Telephone	Email	

16. The patent is currently the subject of the following concurrent proceeding(s):

a. Copending reissue Application No. _____.

b. Copending reexamination Control No. _____.

c. Copending Interference No. _____.

d. Copending litigation styled: _____

WARNING: Information on this form may become public. Credit card information should not be included on this form. Provide credit card information and authorization on PTO-2038.

Authorized Signature

Date

Typed/Printed Name

Registration No.

For Patent Owner Requester

For Third Party Requester

Privacy Act Statement

The **Privacy Act of 1974 (P.L. 93-579)** requires that you be given certain information in connection with your submission of the attached form related to a patent application or patent. Accordingly, pursuant to the requirements of the Act, please be advised that: (1) the general authority for the collection of this information is 35 U.S.C. 2(b)(2); (2) furnishing of the information solicited is voluntary; and (3) the principal purpose for which the information is used by the U.S. Patent and Trademark Office is to process and/or examine your submission related to a patent application or patent. If you do not furnish the requested information, the U.S. Patent and Trademark Office may not be able to process and/or examine your submission, which may result in termination of proceedings or abandonment of the application or expiration of the patent.

The information provided by you in this form will be subject to the following routine uses:

1. The information on this form will be treated confidentially to the extent allowed under the Freedom of Information Act (5 U.S.C. 552) and the Privacy Act (5 U.S.C. 552a). Records from this system of records may be disclosed to the Department of Justice to determine whether disclosure of these records is required by the Freedom of Information Act.
2. A record from this system of records may be disclosed, as a routine use, in the course of presenting evidence to a court, magistrate, or administrative tribunal, including disclosures to opposing counsel in the course of settlement negotiations.
3. A record in this system of records may be disclosed, as a routine use, to a Member of Congress submitting a request involving an individual, to whom the record pertains, when the individual has requested assistance from the Member with respect to the subject matter of the record.
4. A record in this system of records may be disclosed, as a routine use, to a contractor of the Agency having need for the information in order to perform a contract. Recipients of information shall be required to comply with the requirements of the Privacy Act of 1974, as amended, pursuant to 5 U.S.C. 552a(m).
5. A record related to an International Application filed under the Patent Cooperation Treaty in this system of records may be disclosed, as a routine use, to the International Bureau of the World Intellectual Property Organization, pursuant to the Patent Cooperation Treaty.
6. A record in this system of records may be disclosed, as a routine use, to another federal agency for purposes of National Security review (35 U.S.C. 181) and for review pursuant to the Atomic Energy Act (42 U.S.C. 218(c)).
7. A record from this system of records may be disclosed, as a routine use, to the Administrator, General Services, or his/her designee, during an inspection of records conducted by GSA as part of that agency's responsibility to recommend improvements in records management practices and programs, under authority of 44 U.S.C. 2904 and 2906. Such disclosure shall be made in accordance with the GSA regulations governing inspection of records for this purpose, and any other relevant (*i.e.*, GSA or Commerce) directive. Such disclosure shall not be used to make determinations about individuals.
8. A record from this system of records may be disclosed, as a routine use, to the public after either publication of the application pursuant to 35 U.S.C. 122(b) or issuance of a patent pursuant to 35 U.S.C. 151. Further, a record may be disclosed, subject to the limitations of 37 CFR 1.14, as a routine use, to the public if the record was filed in an application which became abandoned or in which the proceedings were terminated and which application is referenced by either a published application, an application open to public inspection or an issued patent.
9. A record from this system of records may be disclosed, as a routine use, to a Federal, State, or local law enforcement agency, if the USPTO becomes aware of a violation or potential violation of law or regulation.

<

Attachment to Form PTO/SB/57

REQUEST FOR REEXAMINATION OF U.S. PATENT 9,999,999Identification of Claims for Which Reexamination Is Requested

In accordance with 37 CFR 1.510, reexamination of claims 1-5 of U.S. Patent 9,999,999 is requested, in view of the following references:

Smith, U.S. Patent 8,999,999

Jones, U.S. Patent 8,555,555

Cooper, U.S. Patent 8,333,333

Reexamination of claim 1 is requested in view of the Smith patent. Reexamination of claim 2 is requested in view of the combination of Smith in view of Jones. Reexamination of claims 3-5 is requested in view of the combination of Smith in view of Jones, and further in view of Cooper. U.S. Patent 9,999,999 is still enforceable.

Statement Pointing Out Each Substantial New Question of Patentability

The Smith and Jones references were not of record in the file of U.S. Patent 9,999,999. Smith discloses a filter comprising a housing containing activated carbon, where the housing has an outer wall, a closed end, an open end, and a lid attachable to the open end as recited in claim 1 (see col. 6, lines 2-3; Figure 3; col. 12, lines 1-3). Jones teaches the activated carbon and ion exchange resin mixture of claim 2 in lines 4-5 column 9. Because these teachings of Smith and Jones provide subject matter of the U.S. Patent 9,999,999 claims that was not taught in any prior art cited during the prosecution of U.S. Patent 9,999,999, the teachings of Smith and Jones each raise a substantial new question of patentability. The Cooper reference was cited in the prosecution of U.S. Patent 9,999,999, but was never relied upon in any rejection of the claims. Cooper discloses the iodinated exchange resin of claims 3-5 in lines 8-10 of column 5. Because this teaching of Cooper was not applied in any rejection of the claims during the prosecution of U.S. Patent 9,999,999, a substantial new question of patentability is raised by Cooper.

Detailed Explanation Under 37 CFR 1.510(b)

1. Claim 1 of U.S. Patent 9,999,999 is unpatentable under 35 U.S.C. 102(b) as being anticipated by Smith, as shown by the following claim chart:

U.S. Patent 9,999,999

Claim 1. A filter comprising a housing, the housing having an outer wall, a closed end, an open end, and a lid attachable to the open end. . .

. . . wherein the housing contains a filter material, the filter material comprising activated carbon. . . .

Smith

Smith teaches “the filter housing having an outer wall **1**, a closed end **2**, an open end **3**, and a hinged lid **4** that is securable to the open end **3** via clamp **5**.” (col. 6, lines 2-3; Figure 3). The hinged lid **4** of Smith is attachable to the outer rim of the open end **3** via clamp **5**.

Smith teaches activated carbon as a filter material: “the filter housing containing filter materials, wherein the filter materials include any mixture of known filter materials such as clay, activated carbon, and any other known filter materials.” (col. 12, lines 1-3).

2. Claim 2 of U.S. Patent 9,999,999 is unpatentable under 35 U.S.C. 103 as being obvious over Smith in view of Jones, as shown by the following claim chart:

U.S. Patent 9,999,999

Claim 2. The filter of claim 1, wherein the filter material further comprises a mixture of activated carbon and ion exchange resin.

Jones

Jones teaches “preferably, the filter material mixture includes activated carbon and ion exchange resin.” (col. 9, lines 4-5). Smith teaches that the filter materials include “any mixture of known filter materials”, including activated carbon (col. 12, lines 1-3). It would have been obvious to utilize the activated carbon and ion exchange mixture of Jones in the housing of Smith since the mixture of Jones is a “mixture of known filter materials” as taught by Smith.

3. Claims 3-5 of U.S. Patent 9,999,999 are unpatentable under 35 U.S.C. 103 as being obvious over Smith in view of Jones, and further in view of Cooper, as shown by the following claim chart:

U.S. Patent 9,999,999

Claim 3. The filter of claim 2, wherein the ion exchange resin is iodinated exchange resin.

Cooper

Cooper teaches “the use of iodinated exchange resin in filter material mixtures for its sterilization properties is preferred.” (col. 5, lines 8-10). The substitution of the iodinated exchange resin of Cooper for the ion exchange resin of the Smith/Jones combination would have been obvious to provide sterilization properties as taught by Cooper.

U.S. Patent 9,999,999

Claim 4. The filter of claim 3, wherein the housing is made of metal.

Smith

Smith teaches a metal housing (col. 7, line 8) and a red-colored housing (col. 11, line 3).

Claim 5. The filter of claim 3, wherein the housing is red.

Conclusion

For the reasons given above, reexamination of claims 1-5 of U.S. Patent 9,999,999 is requested.

Signed,

John Q. Attorney, Reg. No. 29760
Attorney for Requester

2215 Fee for Requesting *Ex Parte* Reexamination [R-7]

37 CFR 1.510. Request for *ex parte* reexamination.

(c) If the request does not include the fee for requesting *ex parte* reexamination required by paragraph (a) of this section and meet all the requirements by paragraph (b) of this section, then the person identified as requesting reexamination will be so notified and will generally be given an opportunity to complete the request within a specified time. Failure to comply with the notice will result in the *ex parte* reexamination request not being granted a filing date, and will result in placement of the request in the patent file as a citation if it complies with the requirements of § 1.501.

(d) The filing date of the request for *ex parte* reexamination is the date on which the request satisfies all the requirements of this section.

In order for a request to be accepted, be given a filing date, and be published in the *Official Gazette*, the request papers must satisfy all the requirements of 37 CFR 1.510(a) and (b)**>. The< entire fee required under 37 CFR 1.20(c)(1) for filing a request for reexamination must be paid. If the request was filed by the patent owner and includes a proposed amendment in accordance with 37 CFR 1.530, excess claims fees under 37 CFR 1.20(c)(3) and (c)(4) may also apply; see MPEP § 2250.03.

If the request for *ex parte* reexamination is subsequently denied (see MPEP § 2247 and § 2248), or vacated (see MPEP § 2227 and § 2246, subsection I), a refund in accordance with 37 CFR 1.26(c) will be made to the identified requester. If the request for *ex parte* reexamination is found to be incomplete and the defect is not cured (see MPEP § 2227), a refund in accordance with 37 CFR 1.26(a) will be made to the identified requester.

If the entire fee for *ex parte* reexamination is not paid or all the requirements of 37 CFR 1.510(a) and (b) are not satisfied, the request will be considered to be incomplete. See 37 CFR 1.510 (c) and (d) and MPEP § 2227.

Where the entire filing fee is not paid after the requester has been given an opportunity to do so, no determination on the request will be made. The request papers will ordinarily be placed in the patent file as a prior art citation, if they comply with the requirements for a citation of prior art under 37 CFR

1.501. See MPEP § 2206 for handling of prior art citations.

2216 Substantial New Question of Patentability [R-7]

Under 35 U.S.C. 304, the Office must determine whether “a substantial new question of patentability” affecting any claim of the patent has been raised. 37 CFR 1.510(b)(1) requires that a request for *ex parte* reexamination include “a statement pointing out each substantial new question of patentability based on prior patents and printed publications.” If such a new question is found, an order for *ex parte* reexamination of the patent is issued. It is therefore important that the request clearly set forth in detail what the requester considers the “substantial new question of patentability” to be in view of prior patents and printed publications. The request *>must< point out how any questions of patentability raised are substantially different from those raised in the previous examination of the patent before the Office. **

>It is not sufficient that a request for reexamination merely proposes one or more rejections of a patent claim or claims as a basis for reexamination. It must first be demonstrated that a patent or printed publication that is relied upon in a proposed rejection presents a new, non-cumulative technological teaching that was not previously considered and discussed on the record during the prosecution of the application that resulted in the patent for which reexamination is requested, and during the prosecution of any other prior proceeding involving the patent for which reexamination is requested. See also MPEP § 2242.

The legal standard for ordering *ex parte* reexamination, as set forth in 35 U.S.C. 303(a), requires a substantial new question of patentability. The substantial new question of patentability may be based on art previously considered by the Office if the reference is presented in a new light or a different way that escaped review during earlier examination. The clarification of the legal standard for determining obviousness under 35 U.S.C. 103 in *KSR International Co. v. Teleflex Inc.* (KSR), 550 U.S. ____, 82 USPQ2d 1385 (2007) does not alter the legal standard for determining whether a substantial new question of patentability exists. The requirement for a substantial new question of patentability remains in place even if it is clear from the record of a patent for which reexamina-

tion is requested that the patent was granted because the Office did not show “motivation” to combine, or otherwise satisfy the teaching, suggestion, or motivation (TSM) test. Thus, a reexamination request relying on previously applied prior art that asks the Office to look at the art again based solely on the Supreme Court’s clarification of the legal standard for determining obviousness under 35 U.S.C. 103 in *KSR*, without presenting the art in new light or different way, will not raise a substantial new question of patentability as to the patent claims, and reexamination will not be ordered.

After the enactment of the Patent and Trademark Office Authorization Act of 2002 (“the 2002 Act”), a substantial new question of patentability can be raised by patents and printed publications “previously cited by or to the Office or considered by the Office” (“old art”). The 2002 Act did not negate the statutory requirement for a substantial new question of patentability that requires raising new questions about pre-existing technology. In the implementation of the 2002 Act, MPEP § 2242, subsection II.A. was revised. The revision permits raising a substantial new question of patentability based solely on old art, but only if the old art is “presented/viewed in a new light, or in a different way, as compared with its use in the earlier concluded examination(s), in view of a material new argument or interpretation presented in the request.” Thus, a request may properly raise a substantial new question of patentability by raising a material new analysis of previously considered reference(s) under the rationales authorized by *KSR*. <

Questions relating to grounds of rejection other than those based on prior art patents or printed publications should **not** be included in the request and will not be considered by the examiner if included. Examples of such questions that will not be considered are public use, on sale, and *>conduct by parties<.

Affidavits or declarations or other written evidence which explain the contents or pertinent dates of prior art patents or printed publications in more detail may be considered in reexamination. See MPEP § 2258.

2217 Statement in the Request Applying Prior Art [R-7]

The third sentence of 35 U.S.C. 302 indicates that the “request must set forth the pertinency and manner of applying cited prior art to every claim for which

reexamination is requested.” 37 CFR 1.510(b)(2) requires that the request include “[a]n identification of every claim for which reexamination is requested, and a detailed explanation of the pertinency and manner of applying the cited prior art to every claim for which reexamination is requested.” If the request is filed by the patent owner, the request for reexamination may also point out how claims distinguish over cited prior art.

The prior art applied may only consist of prior art patents or printed publications. Substantial new questions of patentability may be based upon the following portions of 35 U.S.C. 102:

“(a)...patented or described in a printed publication in this or a foreign country, before the invention thereof by the applicant for patent, or”

“(b) the invention was patented or described in a printed publication in this or a foreign country... more than one year prior to the date of the application for patent in the United States, or”

“(d) the invention was first patented or caused to be patented, or was the subject of an inventor’s certificate, by the applicant or his legal representatives or assigns in a foreign country prior to the date of the application for patent in this country on an application for patent or inventor’s certificate filed more than twelve months before the filing of the application in the United States, or”

“(e) the invention was described in — (1) an application for patent, published under section 122(b), by another filed in the United States before the invention by the applicant for patent or (2) a patent granted on an application for patent by another filed in the United States before the invention by the applicant for patent, except that an international application filed under the treaty defined in section 351(a) shall have the effects for the purposes of this subsection of an application filed in the United States only if the international application designated the United States and was published under Article 21(2) of such treaty in the English language; or”

“(g)**>...<(2) before such person’s invention thereof, the invention was made in this country by another inventor who had not abandoned, suppressed, or concealed it. **>...<

Substantial new questions of patentability may also be presented under 35 U.S.C. 103 which are based on the above indicated portions of 35 U.S.C. 102. See MPEP § 706.02(1)(1) for information pertaining to

references which qualify as prior art under 35 U.S.C. 102(e)/103.

Substantial new questions of patentability must be based on patents or printed publications. Other matters, such as public use or on sale, inventorship, 35 U.S.C. 101, 35 U.S.C. 112, *conduct, etc., will not be considered when making the determination on the request and should not be presented in the request. Further, a prior art patent or printed publication cannot be properly applied as a ground for reexamination if it is merely used as evidence of alleged prior public use or on sale, insufficiency of disclosure, etc. The prior art patent or printed publication must be applied directly to claims under 35 U.S.C. 103 and/or an appropriate portion of 35 U.S.C. 102 or relate to the application of other prior art patents or printed publications to claims on such grounds.

The statement applying the prior art may, where appropriate, point out that claims in the patent for which reexamination is requested are entitled only to the filing date of the patent and are not supported by an earlier foreign or United States patent application whose filing date is claimed. For example, the effective

date of some of the claims in a patent which resulted from a continuing application under 35 U.S.C. 120 could be the filing date of the continuing application since those claims were not supported in the parent application. Therefore, intervening patents or printed publications are available as prior art. See *In re Ruscetta*, 255 F.2d 687, 118 USPQ 101 (CCPA 1958), *In re van Langenhoven*, 458 F.2d 132, 173 USPQ 426 (CCPA 1972). See also MPEP § 201.11.

**Typically, substantial new questions of patentability in a reexamination proceeding are based on “prior art” patents and publications. There are exceptions, however. For example, in *In re Lonardo*, 119 F.3d 960, 43 USPQ2d 1262 (Fed. Cir. 1997), the Federal Circuit upheld a nonstatutory double patenting rejection in which the patent upon which the rejection was based and the patent under reexamination shared the same effective filing date. See also the discussion as to double patenting in MPEP § 2258. Analogously, a 35 U.S.C. 102(g)(2) rejection may be asserted in a reexamination proceeding based on the examples illustrated in the chart below:<

>

Rejection of claims in patent with earlier filing date over claims of patent having later filing date- using 35 U.S.C. 102(g), in a manner analogous to double patenting

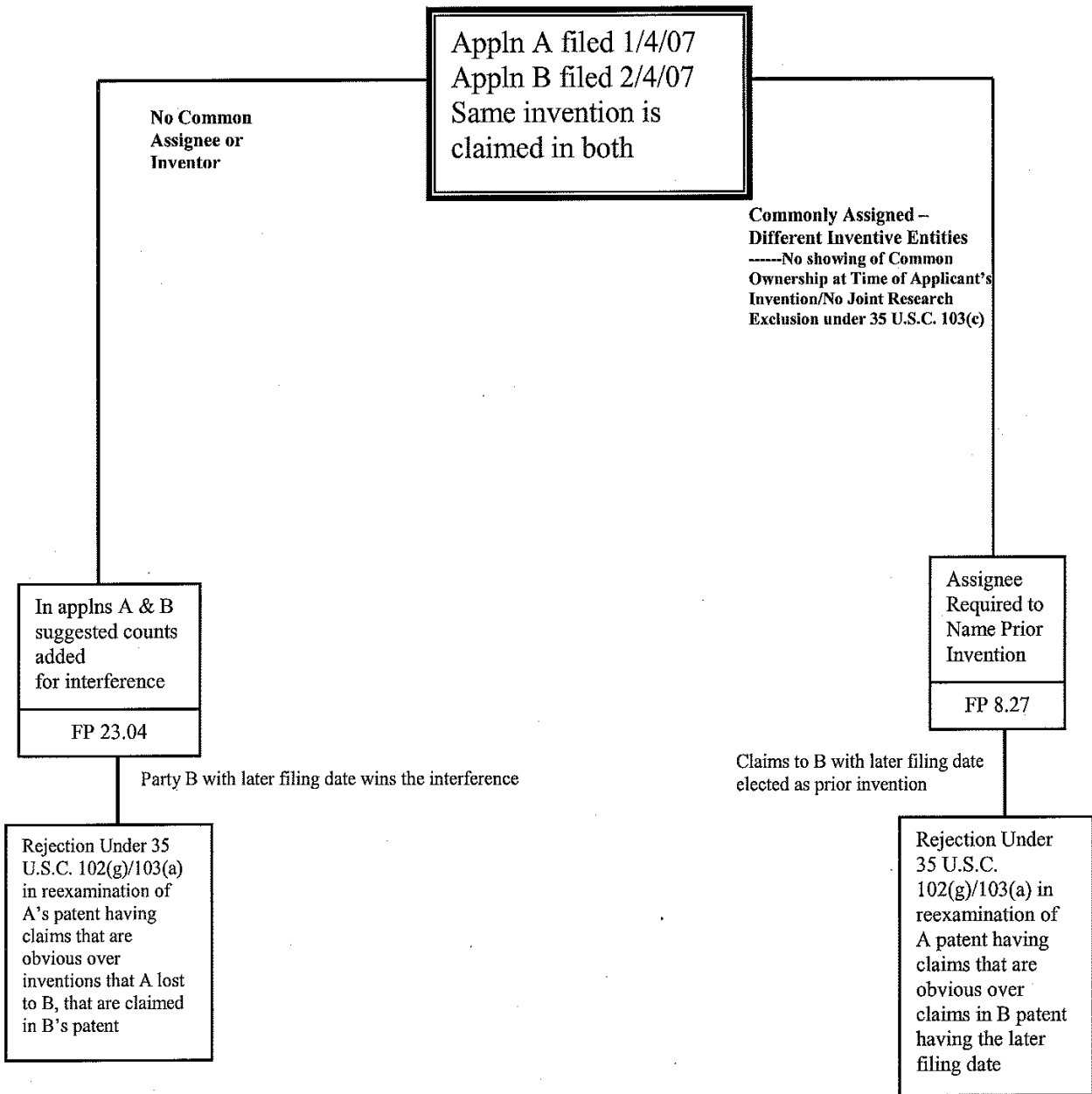

<

I. EXPLANATION MUST BE COMPLETE

The mere citation of new patents or printed publications without an explanation does not comply with 37 CFR 1.510(b)(2). Requester must present an explanation of how the cited patents or printed publications are applied to all claims which requester considers to merit reexamination. This not only sets forth the requester's position to the Office, but also to the patent owner (where the patent owner is not the requester).

Thus, for example, once the request has cited documents (patents and printed publications) and proposed combinations of the documents as to patent claims 1-10 (for example), the request must explain how each of the proposed combinations specifically applies to each claim that it is asserted against (i.e., claims 1 – 10), explaining how each document (reference) identified for the combination is used.<

Ideally, the required explanation can be provided using an appropriately detailed claim chart that compares, limitation by limitation, each claim for which reexamination is requested with the relevant teachings of each reference cited in the request. See the sample request for reexamination in MPEP § 2214.

For proposed obviousness rejections, requester **must provide** at least one basis for combining the cited references, and a statement of why the claim(s) under reexamination would have been obvious over the proposed reference combination. Preferably, the requester should quote the pertinent teachings in the reference, referencing each quote by page, column and line number and any relevant figure numbers. The explanation **must not** lump together the proposed rejections or proposed combinations of references.

Examples of inappropriate language:

- Claim 1 is unpatentable under 35 U.S.C. 102(b) as being anticipated by, **or in the alternative**, under 35 U.S.C. 103 as being obvious over the Smith reference.
- Claim 1 is unpatentable under 35 U.S.C. 103 as being obvious over Smith **and/or** Charles.
- Claim 2 is unpatentable under 35 U.S.C. 103 as being obvious over Smith in view of Jones **or** Harvey. (This could however be used if both Jones and Harvey provide a minor teaching which can be articulated in a sentence or two.)

- Claims 3 - 10 are unpatentable under 35 U.S.C. 103 as being obvious over Smith in view of either Jones **and** Cooper **or** Harvey **and** Cooper.
- Claims 3 - 10 are unpatentable under 35 U.S.C. 103 as being obvious over Smith in view of Harvey, **taken alone or further in view of** Cooper.

Examples of appropriate language:

- Claim 1 is unpatentable under 35 U.S.C. 102(b) as being anticipated by Smith.
- Claim 1 is unpatentable under 35 U.S.C. 103 as being obvious over Smith.
- Claim 1 is unpatentable under 35 U.S.C. 103 as being obvious over Charles.
- Claim 2 is unpatentable under 35 U.S.C. 103 as being obvious over Smith in view of Jones.
- Claim 2 is unpatentable under 35 U.S.C. 103 as being obvious over Smith in view of Harvey.
- Claims 3 - 10 are unpatentable under 35 U.S.C. 103 as being obvious over Smith in view of Jones, and further in view of Cooper.
- Claims 3 - 10 are unpatentable under 35 U.S.C. 103 as being obvious over Smith in view of Harvey, and further in view of Cooper.

Any failure to provide the required explanation for any document, combination, or claim will be identified in a "Notice of Failure to Comply with *Ex Parte* Reexamination Request Filing Requirements" (see MPEP § 2227). If a requester receives such a notice that identifies one or more documents, combinations, or claims for which an explanation was not given, the requester has the option to respond by either:

(A) providing a separate explanation for each combination, document, and claim identified in the notice as lacking explanation; or

(B) explicitly withdrawing any document, combination, or claim for which reexamination was requested for which there is no explanation. Obviously, once this is done, requester need not provide an explanation for the withdrawn document, combination, or claim. Thus, for example, if the requester's response to the notice explicitly withdraws the request as to claims 6-10, then the documents and their combinations need only be applied separately as to claims 1-5 of the patent. Likewise, if the requester's response to the notice explicitly withdraws the Jones patent from the request, then no explanation is required as to the Jones reference, and all combinations advanced in

the request that contained Jones are deemed to be withdrawn.

Even if the request fails to comply with one of the above-identified requirements, the request may be accepted if it is readily understood from the explanation provided in the request as to how the cited patents or printed publications are applied to all claims which requester considers to merit reexamination.

II. AFFIDAVITS/DECLARATIONS/OTHER WRITTEN EVIDENCE

Affidavits or declarations or other written evidence which explain the contents or pertinent dates of prior art patents or printed publications in more detail may be considered in reexamination. See MPEP § 2258.

III. ADMISSIONS

The consideration under 35 U.S.C. 303 of a request for *ex parte* reexamination is limited to prior art patents and printed publications. See *Ex parte McGaughey*, 6 USPQ2d 1334, 1337 (Bd. Pat. App. & Inter. 1988). Thus an admission, *per se*, may not be the basis for establishing a substantial new question of patentability. However, an admission by the patent owner of record in the file or in a court record may be utilized in combination with a patent or printed publication.

For handling of admissions during the examination stage of a proceeding (i.e., after reexamination has been ordered), see MPEP § 2258.

The admission can reside in the patent file (made of record during the prosecution of the patent application) or may be presented during the pendency of the reexamination proceeding or in litigation. Admissions by the patent owner as to any matter affecting patentability may be utilized to determine the scope and content of the prior art **in conjunction with patents and printed publications** in a prior art rejection, whether such admissions result from patents or printed publications or from some other source. An admission relating to *any* prior art established in the record or in court may be used by the examiner in combination with patents or printed publications in a reexamination proceeding. The admission must stand on its own. Information supplementing or further defining the admission would be improper.

Any admission submitted by the patent owner is proper. A third party, however, may not submit admissions of the patent owner made outside the record of the file or the court record >, unless such admissions were entered into a court record. If an admission made outside the record of the file or the court record is entered into a court record and a copy thereof is then filed in a reexamination (as a copy of a paper filed in the court), such paper could be admitted pursuant to MPEP § 2282; however, such would not be given weight as an admission with respect to use in establishing a substantial new question of patentability, or as a basis in rejecting claims.< Such a submission would be outside the scope of reexamination.

2218 Copies of Prior Art [R-7]

It is required that a copy of each patent or printed publication relied on or referred to in the request, be filed with the request (37 CFR 1.510(b)(3)). If the copy provided is not legible, or is such that its image scanned into the Image File Wrapper system (IFW) will not be legible, it is deemed to not have been provided.>The appropriate “Notice of Failure to Comply with *Ex Parte* Reexamination Request Filing Requirements” (see MPEP § 2227) will identify this defect.< An exception is color photographs and like color submissions, which, if legible as presented, will be retained in an “artifact” file and used as such. If any of the documents are not in the English language, an English language translation of all necessary and pertinent parts is also required. See MPEP § 609.04(a), subsection III. An English language summary or abstract of a non-English language document is usually not sufficient. There is no assurance that the Office will consider the non-English language patent or printed publication beyond the translation matter that is submitted.

It is also helpful to include copies of the prior art considered (via a 37 CFR 1.555 information disclosure statement – separate from the listing of the patents or printed publications relied upon as raising a substantial new question of patentability) during earlier prosecution of the patent for which reexamination is requested. The presence of both the old and the new prior art allows a comparison to be made to determine whether a substantial new question of patentability is indeed present. See MPEP § 2242.

**>As to the requirement for a copy of every patent or printed publication relied upon or referred to in the request, or submitted under 37 CFR 1.98, this requirement is not currently being enforced to require copies of U.S. patents and U.S. patent publications; and the requirement is deemed waived to that extent. In addition, it is not required nor is it permitted that parties submit copies of copending reexamination proceedings and applications (which copies can be mistaken for a new request/filing); rather, submitters may provide the application/proceeding number and its status (note that a submission that is not permitted entry will be returned, expunged or discarded, at the sole discretion of the Office). For example, where the patent for which reexamination is requested is a continuation in part of a parent application, the requester would notify the Office of the application number of the parent application and its status if the asserted substantial new question of patentability relates to a proposed rejection based on an intervening art and the question of whether the claimed subject matter in the patent has support in the parent application is relevant.<

2219 Copy of Printed Patent [R-3]

The U.S. Patent and Trademark Office will prepare a separate file * for each reexamination request, which will become part of the patent file. **>In< order to provide a format which can be amended and used for printing, requesters are required under 37 CFR 1.510(b)(4) to include a copy of the patent for which reexamination is requested, to serve as the specification for the reexamination proceeding. A copy of the patent for which reexamination is requested should be provided in a double column format. Thus, a full copy of the printed patent (including the front page) would be used to provide the abstract, drawings, specification, and claims of the patent for the reexamination request and the resulting reexamination proceeding. A copy of any disclaimer, certificate of correction, or reexamination certificate issued for the patent must also be included, so that a complete history of the patent is before the Office for consideration. A copy of any Federal Court decision, complaint in a pending civil action, or interference decision should also be submitted.

2220 Certificate of Service [R-7]

If the requester is a person other than the patent owner, the owner of the patent must be served with a copy of the request in its entirety. The service *>must< be made **>on the patent owner's< correspondence address as indicated in 37 CFR 1.33(c). The third party requester must set forth on the certificate of service the name and address of the party served and the method of service. The certificate of service must be attached to the request submitted to the Office. Further, the copy of the request served on the patent owner must also include a copy of the certificate of service. If service was not possible >after a reasonable effort to do so<, a duplicate copy of the request papers must be supplied to the Office together with >a **cover letter** including< an explanation of what effort was made to effect service, and why that effort was not successful. > To avoid the possibility of the Office erroneously charging a duplicate filing fee, requesters are strongly encouraged to clearly word the cover letter by stating, for example, in bold print in the heading “**Duplicate Copy of Request Filed under 37 CFR 1.510(b)(5) When Service on the Patent Owner Was Not Possible**.”<

**See MPEP § 2266.03 regarding service on the requester and on the patent owner.

2221 Amendments Included in Request by Patent Owner [R-3]

Under 37 CFR 1.510(e), a patent owner may include a proposed amendment with his or her request. Any such amendment must be in accordance with 37 CFR 1.530(d) through (j). See MPEP § 2250 >as to the format and requirements of an amendment in a reexamination proceeding. If an amendment is submitted to add claims to the patent being reexamined, then excess claims fees pursuant to 37 CFR 1.20(c)(3) and (c)(4) may be applicable to the presentation of the added claims. See the discussion of excess claim fees in MPEP § 2250.03<. Amendments may also be proposed by patent owners in a statement under 37 CFR 1.530(b) and (c) or during the actual *ex parte* reexamination prosecution (37 CFR 1.550(b)). See also MPEP § 2234 and § 2250.

The request should be decided on the wording of the patent claims in effect at that time (without any proposed amendments). The decision on the request

will be made on the basis of the patent claims as though the proposed amendment had not been presented. However, if the request for reexamination is granted, all subsequent reexamination prosecution and examination should be on the basis of the claims as amended.

2222 Address of Patent Owner [R-7]

37 CFR 1.33. *Correspondence respecting patent applications, reexamination proceedings, and other proceedings.*

(c) **>All notices, official letters, and other communications for the patent owner or owners in a reexamination proceeding will be directed to the correspondence address. Amendments and other papers filed in a reexamination proceeding on behalf of the patent owner must be signed by the patent owner, or if there is more than one owner by all the owners, or by an attorney or agent of record in the patent file, or by a registered attorney or agent not of record who acts in a representative capacity under the provisions of § 1.34. Double correspondence with the patent owner or owners and the patent owner's attorney or agent, or with more than one attorney or agent, will not be undertaken.<

**>Address of Patent Owner: The correspondence address for the patent to be reexamined, or being reexamined is the correct address for all notices, official letters, and other communications for patent owners in reexamination proceedings. See 37 CFR 1.33(c).

Representative of Patent Owner:< As a general rule, the attorney-client relationship terminates when the purpose for which the attorney was employed is accomplished; e.g., the issuance of a patent to the client. However, apart from the attorney-client relationship, the Office has, by regulation, 37 CFR 10.23(c)(8), made it the responsibility of every "practitioner," by virtue of his/her registration, "to inform a client or former client ... of correspondence received from the Office ... when the correspondence (i) could have a significant effect on a matter pending before the Office, (ii) is received by the practitioner on behalf of a client or former client, and (iii) is correspondence of which a reasonable practitioner would believe under the circumstances the client or former client should be notified." (Emphasis added.) This responsibility of a practitioner to a former client manifestly is not eliminated by withdrawing as an attorney or agent of record. The practitioner if he/she so desires, can minimize the need for forwarding corre-

spondence concerning issued patents by having the correspondence address changed after the patent issues if the correspondence address is the practitioner's address, which frequently is the case where the practitioner is the attorney or agent of record.

Further, 37 CFR 10.23(c)(8) requires a practitioner to "timely notify the Office of an inability to notify a client or former client of correspondence received from the Office" (Emphasis added.) As the language of this requirement clearly indicates, the duty to notify the Office is a consequence, not of any attorney-client relationship, but rather arises by virtue of the practitioner's status as a registered patent attorney or agent.

If the patent owner desires that a different attorney or agent receive correspondence, then a new power of attorney must be filed. **>See MPEP § 324 for establishing an assignee's right to take action when submitting a power of attorney.<

Submissions to the Office to change the correspondence address or power of attorney in the record of the patent should be addressed as follows:

Where a request for *ex parte* reexamination has been filed :

Mail Stop "Ex Parte Reexam"
Attn: Central Reexamination Unit
Commissioner for Patents
P.O. Box 1450
Alexandria, VA 22313-1450

Where a request for *inter partes* reexamination has been filed :

Mail Stop "Inter Partes Reexam"
Attn: Central Reexamination Unit
Commissioner for Patents
P.O. Box 1450
Alexandria, VA 22313-1450

Where no request for reexamination has been filed and the patent is in storage:

Mail Stop Document Services
Director of the U.S. Patent and Trademark Office
P.O. Box 1450
Alexandria, VA 22313-1450

It is strongly recommended that the Mail Stop information be placed in a prominent position on the

first page of each paper being filed utilizing a sufficiently large font size that will direct attention to it.

A sample form for changing correspondence address or power of attorney is set forth below.

**>

PTO/SB/81 (07-08)
Approved for use through 12/31/2008. OMB 0651-0035

U.S. Patent and Trademark Office; U.S. DEPARTMENT OF COMMERCE

Under the Paperwork Reduction Act of 1995, no persons are required to respond to a collection of information unless it displays a valid OMB control number.

POWER OF ATTORNEY OR REVOCATION OF POWER OF ATTORNEY WITH A NEW POWER OF ATTORNEY AND CHANGE OF CORRESPONDENCE ADDRESS	Application Number	
	Filing Date	
	First Named Inventor	
	Title	
	Art Unit	
	Examiner Name	
	Attorney Docket Number	

I hereby revoke all previous powers of attorney given in the above-identified application.

A Power of Attorney is submitted herewith.

OR

I hereby appoint Practitioner(s) associated with the following Customer Number as my/our attorney(s) or agent(s) to prosecute the application identified above, and to transact all business in the United States Patent and Trademark Office connected therewith:

OR

I hereby appoint Practitioner(s) named below as my/our attorney(s) or agent(s) to prosecute the application identified above, and to transact all business in the United States Patent and Trademark Office connected therewith:

Practitioner(s) Name	Registration Number

Please recognize or change the correspondence address for the above-identified application to:

The address associated with the above-mentioned Customer Number.

OR

The address associated with Customer Number:

OR

<input type="checkbox"/> Firm or Individual Name			
Address			
City	State	Zip	
Country			
Telephone	Email		

I am the:

Applicant/Inventor.

OR

Assignee of record of the entire interest. See 37 CFR 3.71. Statement under 37 CFR 3.73(b) (Form PTO/SB/96) submitted herewith or filed on _____.

SIGNATURE of Applicant or Assignee of Record

Signature	Date	
Name	Telephone	
Title and Company		

NOTE: Signatures of all the inventors or assignees of record of the entire interest or their representative(s) are required. Submit multiple forms if more than one signature is required, see below*.

*Total of _____ forms are submitted.

This collection of information is required by 37 CFR 1.31, 1.32 and 1.33. The information is required to obtain or retain a benefit by the public which is to file (and by the USPTO to process) an application. Confidentiality is governed by 35 U.S.C. 122 and 37 CFR 1.11 and 1.14. This collection is estimated to take 3 minutes to complete, including gathering, preparing, and submitting the completed application form to the USPTO. Time will vary depending upon the individual case. Any comments on the amount of time you require to complete this form and/or suggestions for reducing this burden, should be sent to the Chief Information Officer, U.S. Patent and Trademark Office, U.S. Department of Commerce, P.O. Box 1450, Alexandria, VA 22313-1450. DO NOT SEND FEES OR COMPLETED FORMS TO THIS ADDRESS. SEND TO: Commissioner for Patents, P.O. Box 1450, Alexandria, VA 22313-1450.

If you need assistance in completing the form, call 1-800-PTO-9199 and select option 2.

Privacy Act Statement

The **Privacy Act of 1974 (P.L. 93-579)** requires that you be given certain information in connection with your submission of the attached form related to a patent application or patent. Accordingly, pursuant to the requirements of the Act, please be advised that: (1) the general authority for the collection of this information is 35 U.S.C. 2(b)(2); (2) furnishing of the information solicited is voluntary; and (3) the principal purpose for which the information is used by the U.S. Patent and Trademark Office is to process and/or examine your submission related to a patent application or patent. If you do not furnish the requested information, the U.S. Patent and Trademark Office may not be able to process and/or examine your submission, which may result in termination of proceedings or abandonment of the application or expiration of the patent.

The information provided by you in this form will be subject to the following routine uses:

1. The information on this form will be treated confidentially to the extent allowed under the Freedom of Information Act (5 U.S.C. 552) and the Privacy Act (5 U.S.C. 552a). Records from this system of records may be disclosed to the Department of Justice to determine whether disclosure of these records is required by the Freedom of Information Act.
2. A record from this system of records may be disclosed, as a routine use, in the course of presenting evidence to a court, magistrate, or administrative tribunal, including disclosures to opposing counsel in the course of settlement negotiations.
3. A record in this system of records may be disclosed, as a routine use, to a Member of Congress submitting a request involving an individual, to whom the record pertains, when the individual has requested assistance from the Member with respect to the subject matter of the record.
4. A record in this system of records may be disclosed, as a routine use, to a contractor of the Agency having need for the information in order to perform a contract. Recipients of information shall be required to comply with the requirements of the Privacy Act of 1974, as amended, pursuant to 5 U.S.C. 552a(m).
5. A record related to an International Application filed under the Patent Cooperation Treaty in this system of records may be disclosed, as a routine use, to the International Bureau of the World Intellectual Property Organization, pursuant to the Patent Cooperation Treaty.
6. A record in this system of records may be disclosed, as a routine use, to another federal agency for purposes of National Security review (35 U.S.C. 181) and for review pursuant to the Atomic Energy Act (42 U.S.C. 218(c)).
7. A record from this system of records may be disclosed, as a routine use, to the Administrator, General Services, or his/her designee, during an inspection of records conducted by GSA as part of that agency's responsibility to recommend improvements in records management practices and programs, under authority of 44 U.S.C. 2904 and 2906. Such disclosure shall be made in accordance with the GSA regulations governing inspection of records for this purpose, and any other relevant (*i.e.*, GSA or Commerce) directive. Such disclosure shall not be used to make determinations about individuals.
8. A record from this system of records may be disclosed, as a routine use, to the public after either publication of the application pursuant to 35 U.S.C. 122(b) or issuance of a patent pursuant to 35 U.S.C. 151. Further, a record may be disclosed, subject to the limitations of 37 CFR 1.14, as a routine use, to the public if the record was filed in an application which became abandoned or in which the proceedings were terminated and which application is referenced by either a published application, an application open to public inspection or an issued patent.
9. A record from this system of records may be disclosed, as a routine use, to a Federal, State, or local law enforcement agency, if the USPTO becomes aware of a violation or potential violation of law or regulation.

<

**2223 Withdrawal of Attorney or Agent
[R-7]**

A request by an attorney or agent of record to withdraw from a patent will normally be approved only if

at least 30 days remain in any running period for response. See also MPEP § 402.06.

A sample form for a request by an attorney or agent of record to withdraw from a patent is set forth below.

**>

Doc Code: PET.POA.WDRW

Document Description: Petition to withdraw attorney or agent (SB83)

PTO/SB/83 (04-08)

Approved for use through 12/31/2008. OMB 0651-0035

U.S. Patent and Trademark Office, U.S. DEPARTMENT OF COMMERCE

Under the Paperwork Reduction Act of 1995, no persons are required to respond to a collection of information unless it displays a valid OMB control number.

REQUEST FOR WITHDRAWAL AS ATTORNEY OR AGENT AND CHANGE OF CORRESPONDENCE ADDRESS	Application Number	
	Filing Date	
	First Named Inventor	
	Art Unit	
	Examiner Name	
	Attorney Docket Number	

To: Commissioner for Patents
P.O. Box 1450
Alexandria, VA 22313-1450

Please withdraw me as attorney or agent for the above identified patent application, and

- all the practitioners of record;
- the practitioners (with registration numbers) of record listed on the attached paper(s); or
- the practitioners of record associated with Customer Number: _____

NOTE: The immediately preceding box should only be marked when the practitioners were appointed using the listed Customer Number.

The reason(s) for this request are those described in 37 CFR :

- | | | | |
|---|--|--|--|
| <input type="checkbox"/> 10.40(b)(1) | <input type="checkbox"/> 10.40(b)(2) | <input type="checkbox"/> 10.40(b)(3) | <input type="checkbox"/> 10.40(b)(4) |
| <input type="checkbox"/> 10.40(c)(1)(i) | <input type="checkbox"/> 10.40(c)(1)(ii) | <input type="checkbox"/> 10.40(c)(1)(iii) | <input type="checkbox"/> 10.40(c)(1)(iv) |
| <input type="checkbox"/> 10.40(c)(1)(v) | <input type="checkbox"/> 10.40(c)(1)(vi) | <input type="checkbox"/> 10.40(c)(2) | <input type="checkbox"/> 10.40(c)(3) |
| <input type="checkbox"/> 10.40(c)(4) | <input type="checkbox"/> 10.40(c)(5) | <input type="checkbox"/> 10.40(c)(6) Please explain below: | |

Certifications

Check each box below that is factually correct. WARNING: If a box is left unchecked, the request will likely not be approved.

1. I/We have given reasonable notice to the client, prior to the expiration of the response period, that the practitioner(s) intend to withdraw from employment.
2. I/We have delivered to the client or a duly authorized representative of the client all papers and property (including funds) to which the client is entitled.
3. I/We have notified the client of any responses that may be due and the time frame within which the client must respond.

Please provide an explanation, if necessary:

[Page 1 of 2]

This collection of information is required by 37 CFR 1.36. The information is required to obtain or retain a benefit by the public which is to file (and by the USPTO to process) an application. Confidentiality is governed by 35 U.S.C. 122 and 37 CFR 1.11 and 1.14. This collection is estimated to take 12 minutes to complete, including gathering, preparing, and submitting the completed application form to the USPTO. Time will vary depending upon the individual case. Any comments on the amount of time you require to complete this form and/or suggestions for reducing this burden, should be sent to the Chief Information Officer, U.S. Patent and Trademark Office, U.S. Department of Commerce, P.O. Box 1450, Alexandria, VA 22313-1450. DO NOT SEND FEES OR COMPLETED FORMS TO THIS ADDRESS. SEND TO: Commissioner for Patents, P.O. Box 1450, Alexandria, VA 22313-1450.

If you need assistance in completing the form, call 1-800-PTO-9199 and select option 2.

PTO/SB/83 (04-08)

Approved for use through 12/31/2008. OMB 0651-0035

U.S. Patent and Trademark Office, U.S. DEPARTMENT OF COMMERCE

Under the Paperwork Reduction Act of 1995, no persons are required to respond to a collection of information unless it displays a valid OMB control number.

REQUEST FOR WITHDRAWAL AS ATTORNEY OR AGENT AND CHANGE OF CORRESPONDENCE ADDRESS			
Complete the following section only when the correspondence address will change. Changes of address will only be accepted to an inventor or an assignee that has properly made itself of record pursuant to 37 CFR 3.71.			
Change the correspondence address and direct all future correspondence to:			
A. <input type="checkbox"/>	The address of the inventor or assignee associated with Customer Number: _____		
OR			
B. <input type="checkbox"/>	Inventor or Assignee name		
Address			
City	State	Zip	Country
Telephone			Email
I am authorized to sign on behalf of myself and all withdrawing practitioners.			
Signature			
Name			Registration No.
Address			
City	State	Zip	Country
Date			Telephone No.
NOTE: Withdrawal is effective when approved rather than when received.			

[Page 2 of 2]

This collection of information is required by 37 CFR 1.36. The information is required to obtain or retain a benefit by the public which is to file (and by the USPTO to process) an application. Confidentiality is governed by 35 U.S.C. 122 and 37 CFR 1.11 and 1.14. This collection is estimated to take 12 minutes to complete, including gathering, preparing, and submitting the completed application form to the USPTO. Time will vary depending upon the individual case. Any comments on the amount of time you require to complete this form and/or suggestions for reducing this burden, should be sent to the Chief Information Officer, U.S. Patent and Trademark Office, U.S. Department of Commerce, P.O. Box 1450, Alexandria, VA 22313-1450. DO NOT SEND FEES OR COMPLETED FORMS TO THIS ADDRESS. SEND TO: **Commissioner for Patents, P.O. Box 1450, Alexandria, VA 22313-1450.**

If you need assistance in completing the form, call 1-800-PTO-9199 and select option 2.

Privacy Act Statement

The **Privacy Act of 1974 (P.L. 93-579)** requires that you be given certain information in connection with your submission of the attached form related to a patent application or patent. Accordingly, pursuant to the requirements of the Act, please be advised that: (1) the general authority for the collection of this information is 35 U.S.C. 2(b)(2); (2) furnishing of the information solicited is voluntary; and (3) the principal purpose for which the information is used by the U.S. Patent and Trademark Office is to process and/or examine your submission related to a patent application or patent. If you do not furnish the requested information, the U.S. Patent and Trademark Office may not be able to process and/or examine your submission, which may result in termination of proceedings or abandonment of the application or expiration of the patent.

The information provided by you in this form will be subject to the following routine uses:

1. The information on this form will be treated confidentially to the extent allowed under the Freedom of Information Act (5 U.S.C. 552) and the Privacy Act (5 U.S.C. 552a). Records from this system of records may be disclosed to the Department of Justice to determine whether disclosure of these records is required by the Freedom of Information Act.
2. A record from this system of records may be disclosed, as a routine use, in the course of presenting evidence to a court, magistrate, or administrative tribunal, including disclosures to opposing counsel in the course of settlement negotiations.
3. A record in this system of records may be disclosed, as a routine use, to a Member of Congress submitting a request involving an individual, to whom the record pertains, when the individual has requested assistance from the Member with respect to the subject matter of the record.
4. A record in this system of records may be disclosed, as a routine use, to a contractor of the Agency having need for the information in order to perform a contract. Recipients of information shall be required to comply with the requirements of the Privacy Act of 1974, as amended, pursuant to 5 U.S.C. 552a(m).
5. A record related to an International Application filed under the Patent Cooperation Treaty in this system of records may be disclosed, as a routine use, to the International Bureau of the World Intellectual Property Organization, pursuant to the Patent Cooperation Treaty.
6. A record in this system of records may be disclosed, as a routine use, to another federal agency for purposes of National Security review (35 U.S.C. 181) and for review pursuant to the Atomic Energy Act (42 U.S.C. 218(c)).
7. A record from this system of records may be disclosed, as a routine use, to the Administrator, General Services, or his/her designee, during an inspection of records conducted by GSA as part of that agency's responsibility to recommend improvements in records management practices and programs, under authority of 44 U.S.C. 2904 and 2906. Such disclosure shall be made in accordance with the GSA regulations governing inspection of records for this purpose, and any other relevant (*i.e.*, GSA or Commerce) directive. Such disclosure shall not be used to make determinations about individuals.
8. A record from this system of records may be disclosed, as a routine use, to the public after either publication of the application pursuant to 35 U.S.C. 122(b) or issuance of a patent pursuant to 35 U.S.C. 151. Further, a record may be disclosed, subject to the limitations of 37 CFR 1.14, as a routine use, to the public if the record was filed in an application which became abandoned or in which the proceedings were terminated and which application is referenced by either a published application, an application open to public inspection or an issued patent.
9. A record from this system of records may be disclosed, as a routine use, to a Federal, State, or local law enforcement agency, if the USPTO becomes aware of a violation or potential violation of law or regulation.

<

2224 Correspondence [R-7]

All requests for *ex parte* reexamination (original request papers) and all subsequent *ex parte* reexamination correspondence mailed to the U.S. Patent and Trademark Office via the U.S. Postal Service Mail, other than correspondence to the Office of the General Counsel pursuant to 37 CFR 1.1(a)(3) and 1.302(e), should be addressed:

Mail Stop “*Ex Parte* Reexam”
Attn: Central Reexamination Unit
Commissioner for Patents
P.O. Box 1450
Alexandria, VA 22313-1450

All such correspondence hand carried to the Office, or submitted by delivery service (e.g., Federal Express, DHL, etc., which are commercial mail or delivery services) should be carried to:

Customer Service Window
Randolph Building
401 Dulany Street
Alexandria, VA 22314

Hand-carried correspondence and correspondence submitted by delivery service should also be marked “Mail Stop *Ex Parte* Reexam.” Whether the correspondence is mailed via the U.S. Postal Service mail or is hand-carried to the Office, it is strongly recommended that the Mail Stop information be placed in a prominent position on the first page of each paper being filed utilizing a sufficiently large font size that will direct attention to it.

A request for *ex parte* reexamination may not be sent by facsimile transmission (FAX). See 37 CFR 1.6(d)(5). >This is also true for a corrected/completed request sent in response to a notice that the original request was not filing date compliant, since the corrected/completed request stands in place of, or is a completion of, the original request papers.< All subsequent *ex parte* reexamination correspondence, however, may be FAXed to:

Central Reexamination Unit
(571) 273-9900.

>Effective July 9, 2007, the U.S. Patent and Trademark Office began accepting requests for reexamination, and “follow-on” papers (i.e., subsequent correspondence in reexamination proceedings) submitted via the Office’s Web-based electronic filing system (EFS-Web). The Office has updated the Legal Framework for EFS-Web to set forth that requests for reexamination, and reexamination “follow-on” papers are permitted to be submitted using EFS-Web. The current version of the Legal Framework for EFS-Web may be accessed at: <http://www.uspto.gov/ebc/portal/efs/legal.htm>.<

After the filing of the request for *ex parte* reexamination, any letters sent to the U.S. Patent and Trademark Office relating to the resulting *ex parte* reexamination proceeding should identify the proceeding by the number of the patent undergoing reexamination, the reexamination request control number assigned, the art unit, and the name of the examiner.**

>The certificate of mailing and transmission procedures (37 CFR 1.8) may be used to file any paper in an *ex parte* reexamination proceeding, except for a request for reexamination and a corrected/replacement request for reexamination. This includes the filing of a patent owner’s statement under 37 CFR 1.530, and a requester’s reply under 37 CFR 1.535. See MPEP § 512 as to the use of the certificate of mailing and transmission procedures. The “Express Mail” mailing procedure (37 CFR 1.10) may be used to file any paper in an *ex parte* reexamination proceeding. See MPEP § 513 as to the use of the “Express Mail” mailing procedure. Again, the filing of a patent owner’s statement under 37 CFR 1.530, and a requester’s reply under 37 CFR 1.535, are included.<

Communications from the U.S. Patent and Trademark Office to the patent owner will be directed to the ** >correspondence address for the patent being reexamined. See< 37 CFR 1.33(c).

Amendments and other papers filed on behalf of patent owners must be signed by the patent owners, or the registered attorney or agent of record in the patent file, or any registered attorney or agent acting in a representative capacity under 37 CFR 1.34(a). See MPEP § 2213.

Double correspondence with the patent owners and the attorney or agent normally will not be undertaken by the Office.

Where no correspondence address is otherwise specified, correspondence will be with the most recent attorney or agent made of record by the patent owner.

Note MPEP § 2220 on certificate of service.

See MPEP § 2624 for correspondence in *inter partes* reexamination proceedings.

2225 Untimely Paper Filed Prior to Order [R-7]

After filing of a request for *ex parte* reexamination, no papers directed to the merits of the reexamination other than (A) citations of patents or printed publications under 37 CFR 1.501 or 37 CFR 1.555, (B) another complete request under 37 CFR 1.510 or 37 CFR 1.915, or (C) notifications pursuant to MPEP § 2282, should be filed with the Office prior to the date of the decision on the request for reexamination. Any papers directed to the merits of the reexamination other than those under 37 CFR 1.501, 1.555 or 1.915, or MPEP § 2282, filed prior to the decision on the request will be returned to the sender by the Central Reexamination Unit or Technology Center Director without consideration. >If the papers are entered prior to discovery of the impropriety, such papers will be expunged from the record.< A copy of the letter *>providing notification of< the returned papers >or expungement< will be made of record in the patent file. However, no copy of the returned>/expunged< papers will be retained by the Office. If the submission of the returned>/expunged< papers is appropriate later in the proceedings, they **>may be filed and< accepted by the Office at that time. See *Patlex Corp. v. Mossinghoff*, 771 F.2d 480, 226 USPQ 985, 989 (Fed. Cir. 1985); *In re Knight*, 217 USPQ 294 (Comm'r Pat. 1982) and *In re Amp*, 212 USPQ 826 (Comm'r Pat. 1981).

2226 Initial Processing of Request >for Ex Parte Reexamination< [R-2]

The opening of all mail marked “*>Mail Stop Ex Parte< Reexam,” and all initial clerical processing of requests for reexamination, will be performed by the reexamination preprocessing staff in the Office of Patent Legal Administration, Central Reexamination Unit.

2227 Incomplete Request for Ex Parte Reexamination [R-7]

37 CFR 1.510. Request for *ex parte* reexamination.

(c) If the request does not include the fee for requesting *ex parte* reexamination required by paragraph (a) of this section and meet all the requirements by paragraph (b) of this section, then the person identified as requesting reexamination will be so notified and will generally be given an opportunity to complete the request within a specified time. Failure to comply with the notice will result in the *ex parte* reexamination request not being granted a filing date, and will result in placement of the request in the patent file as a citation if it complies with the requirements of § 1.501.

(d) The filing date of the request for *ex parte* reexamination is the date on which the request satisfies all the requirements of this section.

Request papers that fail to satisfy all the requirements of 37 CFR 1.510(a) and (b) are incomplete and will not be granted a filing date.

OFFICE PROCEDURE WHERE THE REQUEST FAILS TO COMPLY WITH REQUIREMENTS FOR A FILING DATE

A. Discovery of Non-Compliance with Filing Date Requirement(s) Prior to Assigning a Filing Date

1. Notice of Failure to Comply with Reexamination Request Filing Requirement

The Central Reexamination Unit (CRU) Legal Instrument Examiner (LIE) and CRU Paralegal check the request for compliance with the reexamination filing date requirements. If it is determined that the request fails to meet one or more of the filing date requirements (see MPEP § 2214), the person identified as requesting reexamination will be so notified and will be given an opportunity to complete the requirements of the request within a specified time (generally 30 days). Form PTOL-2077, “Notice of Failure to Comply with *Ex Parte* Reexamination Request Filing Requirements,” is used to provide the notification for *ex parte* reexamination. If explanation is needed as to a non-compliance item, the box at the bottom of the form will be checked. An attachment will then be completed to specifically explain why the request does not comply. If there is a filing fee defi-

ciency, a form, PTOL-2057, is completed and attached to form PTOL-2077.

2. Failure to Remedy Defect(s) in “Notice of Failure to Comply with *Ex Parte* Reexamination Request Filing Requirements”

If after receiving a “Notice of Failure to Comply with *Ex Parte* Reexamination Request Filing Requirements,” the requester does not remedy the defects in the request papers that are pointed out, then the request papers will not be given a filing date, but the assigned control number will be retained. Examples of a failure to remedy the defect(s) in the notice are (A) where the third party requester does not timely respond to the notice, and (B) where requester does respond, but the response does not cure the defect(s) identified to requester and/or introduces a new defect or deficiency.

If the third party requester timely responds to the “Notice of Failure to Comply with *Ex Parte* Reexamination Request Filing Requirements,” the CRU LIE and CRU Paralegal will check the request, as supplemented by the response, for correction of all non-compliance items identified in the notice. If any identified non-compliance item has not been corrected, a filing date will not be assigned to the request papers. It is to be noted that a single failure to comply with the “Notice of Failure to Comply with *Ex Parte* Reexamination Request Filing Requirements” will ordinarily result in the reexamination request not being granted a filing date. 37 CFR 1.510(c) provides that “[f]ailure to comply with the notice may result in the *ex parte* reexamination request not being granted a filing date.” Thus, absent extraordinary circumstances, requester will be given only one opportunity to correct the non-compliance. Similarly, if the response introduces a new defect or deficiency into the request papers, the *ex parte* reexamination request will not be granted a filing date absent extraordinary circumstances. **

If the request papers are not made filing-date-compliant in response to the Office’s “Notice of Failure to Comply with *Ex Parte* Reexamination Request Filing Requirements,” the CRU LIE will prepare a “Notice of Disposition of *Ex Parte* Reexamination Request,” form PTOL-2079, identifying what defects have not been corrected.

B. Non-Compliance with Filing Date Requirement(s) Discovered After Initial Issuance of Notice of Reexamination Request Filing Date

1. Decision Vacating Filing Date

After a filing date and control number are assigned to the request papers, the examiner reviews the request to decide whether to grant or deny reexamination. If, in the process of reviewing the request, the examiner notes a non-compliance item not earlier recognized, the examiner will forward a memo to his/her CRU Supervisory Patent Examiner (SPE) detailing any such non-compliance item(s); a “cc” of the e-mail is provided to the Director of the CRU and to a Senior Legal Advisor in the Office of Patent Legal Administration (OPLA) overseeing reexamination. The CRU SPE will screen the memo and discuss the case with an appropriate OPLA Legal Advisor. Upon confirmation of the existence of any such non-compliant item(s), OPLA will issue a decision vacating the assigned reexamination filing date. In OPLA’s decision, the requester will be notified of the non-compliant item(s) and given time to correct the non-compliance. As noted above, 37 CFR 1.510(c) provides that “[f]ailure to comply with the notice may result in the *ex parte* reexamination request not being granted a filing date.” Thus, absent extraordinary circumstances, requester will only be given one opportunity to correct the non-compliant item(s) identified in the Decision Vacating Filing Date. This category also includes instances where the Office becomes aware of a check returned for insufficient fund or a stopped payment of a check after a filing date has been assigned, and prior to the decision on the request for reexamination.

2. Failure to Remedy Defect in Decision Vacating Filing Date

If the third party requester does not timely respond to the Office’s notice, the CRU LIE will so inform a Senior Legal Advisor in the OPLA overseeing reexamination, and OPLA will issue a Decision Vacating the Proceeding.

If the requester timely responds to the Decision Vacating Filing Date, but the response fails to satisfy all the non-compliance items identified in the decision or introduces a new defect into the request papers, the examiner will prepare a memo to that effect. In the

memo, the examiner will point out why the defect(s) have not been appropriately dealt with, and whether the non-compliant request papers qualify as a 37 CFR 1.501 submission or not (and why). The examiner will forward the memo to his/her *>CRU SPE<; a “cc” of the memo is provided to the Director of the CRU and to a Senior Legal Advisor in the OPLA overseeing reexamination. The *>CRU SPE< will screen the memo and discuss the case with an appropriate OPLA Legal Advisor. Where the defects are not remedied or a new defect has been added, OPLA will issue a Decision Vacating the Proceeding.

The Decision Vacating the Proceeding will identify the items that do not comply with the filing date requirements which were not rectified, or are newly added, using the content of the examiner’s memo to explain why the defects are present. The decision will also point out the disposition of the request papers (treated as a 37 CFR 1.501 submission or discarded) and why.

2229 Notice of Request for *Ex Parte* Reexamination in *Official Gazette* [R-7]

Notice of filing of all complete *ex parte* reexamination requests will be published in the *Official Gazette*, approximately 4 - 5 weeks after filing.

Both reexamination requests that have been assigned a filing date and Director-initiated orders to reexamine made without a request will be announced in the *Official Gazette*. The reexamination preprocessing staff of the Central Reexamination Unit (CRU) will complete a form with the information needed to print the notice. The forms are forwarded at the end of each week to the Office of *>Data Management< for printing in the *Official Gazette*.

In addition, a record of requests filed will be located in the Patent Search Room and in the reexamination preprocessing area of the CRU. Office personnel may use the PALM system to determine if a request for reexamination has been filed in a particular patent. The *Official Gazette* notice will appear in the notice section of the *Official Gazette* under the heading of Requests for *Ex Parte* Reexamination Filed and will include the name of any requestor along with the other items set forth in 37 CFR 1.11(c).

2230 Constructive Notice to Patent Owner [R-2]

In some instances, it may not be possible to deliver mail to the patent owner because no current address is available. If all efforts to correspond with the patent owner fail, the reexamination proceeding will proceed without actual notice to the patent owner. The publication in the *Official Gazette* of (* >A<) the notice of the filing of a request for reexamination, or (* >B<) the >notice of the< ordering of reexamination at the initiative of the *>Director of the Office<, will serve as constructive notice to the patent owner in such an instance.

2231 Processing of Request Corrections [R-5]

**>All processing of submissions to cure an incomplete request for *ex parte* reexamination (see MPEP § 2227) is carried out in the preprocessing area of the Central Reexamination Unit (CRU). Any such submission should be marked “Mail Stop *Ex Parte* Reexam” in the manner discussed in MPEP § 2224 so that the submission may be promptly forwarded to the reexamination preprocessing staff of the CRU.<

2232 Public Access [R-7]

Reexamination files are open to inspection by the general public by way of the Public PAIR via the USPTO Internet site. In viewing the images of the reexamination proceedings, members of the public will be able to view the entire content of the reexamination file >with the exception of non-patent literature<. To access Public PAIR, a member of the public would (A) go to the USPTO web site at <http://www.uspto.gov>, (B) click on the “Site Index” link, (C) click on the letter “E” in the index, (D) click on the link to the Electronic Business Center, (E) in the “Patents” column, click on the “? Status & View Documents” link, (F) *>select< “Patent Application Information Retrieval” **>and select< “Control Number” >as the type of number,< (G) enter the control number of the reexamination proceeding in the “Enter Number” box, and (H) click on “*>Search<.”

If a copy of the reexamination file is requested, it may be ordered from the Document Services Division of the Office of Public Records (OPR). Orders for such copies must indicate the control number of the

reexamination proceeding. Orders should be addressed as follows:

Mail Stop Document Services
Director of the U.S. Patent & Trademark Office
P.O. Box 1450
Alexandria, VA 22313-1450

Requests for a copy of a request may also be sent via e-mail to: dsd@uspto.gov, and the cost of the copy may be charged to a credit card or deposit account. Alternatively, a copy may be obtained from IFW via PAIR.

To obtain a “certified copy” of a reexamination file, a CD-ROM may be purchased from Document Services Division of OPR.

2232.01 Determining if a Reexamination >Request< Was Filed for a Patent [R-7]

TO DETERMINE FROM PAIR OR PALM IF A REEXAMINATION REQUEST HAS BEEN FILED FOR A GIVEN PATENT NUMBER

Both the Internet and the USPTO Intranet can be accessed to determine if a reexamination request has been filed for a particular patent.

A. Using the Internet

- Log on to the Internet.
- Go to USPTO Website located at <http://www.uspto.gov>.
- Click on the “Site Index” link.
- Click on the letter “E” in the index.
- Click on the link to the Electronic Business Center.
- Click on the “? Status & View Documents” link.
- *>Select< “Patent Application Information Retrieval” **>and select< “Patent Number” >as the type of number< and enter the patent number (e.g., 5806063 – no commas are to be inserted) in the “Enter Number” box.
- Click on “*>Search<.”
- Click the “Continuity Data” button.
- Scroll to “Child Continuity Data” where any related reexamination will be listed. *Ex parte* reexaminations are identified by the unique “90” series code,

e.g., 90/005,727. *Inter partes* reexaminations are identified by the unique “95” series code, e.g., 95/000,001.

- Clicking on the underlined (hyperlinked) reexamination number will reveal the “Contents” for the reexamination file.

B. Using the USPTO Intranet

- From the USPTO Intranet site <http://ptoweb/ptointranet/index.htm>, Office personnel can click on “PALM” and then “General Information” which opens the PALM INTRANET General Information Display.

- From here, enter the patent number in the box labeled Patent #.

- Click on “Search” and when the “Patent Number Information” appears, click on “Continuity Data” to obtain the reexamination number.

Any reexamination for the patent number will be listed.

There will be about a ten (10) day lag between filing and data entry into the PALM database.

2233 Processing in Central Reexamination Unit and Technology Center [R-7]

The working groups in the Central Reexamination Unit (CRU) or Technology Centers (TCs) have designated the legal instrument examiners to act as reexamination clerks, as part of their assigned duties, and thus to perform those clerical duties and responsibilities in the groups which are unique to reexamination. The **>TC Quality Assurance Specialists (QASs) or CRU Supervisory Patent Examiners (SPEs) and CRU< Paralegal Specialists have the responsibility to oversee clerical processing and serve as a resource for questions.

I. FEES

Under reexamination, there are fees for the request (37 CFR 1.20(c)(1)), for addition of claims (excess claims fees under 37 CFR 1.20(c)(3) and (c)(4)), for an extension of time under 37 CFR 1.550(c), and for any appeal, brief, and oral hearing fees under 37 CFR 41.20(b). No fee is required for issue of the reexamination certificate.

Any petitions filed under 37 CFR 1.137 or 37 CFR 1.182 or 1.183 relating to a reexamination proceeding require fees (37 CFR 1.17(f), (l) and (m)).

Small entity reductions are available to the patent owner for the 37 CFR 1.137 petition fee, excess claim fees, appeal, brief, and oral hearing fees. Small entity reductions in fees are not available for the reexamination filing fee, extension of time fees, nor for petition fees for petitions filed under 37 CFR 1.182 and 1.183.

When a fee is required in a merged proceeding (see MPEP § 2283 and § 2285), only a single fee is needed even though multiple copies of the submissions (one for each file) are required.

II. MAILING

A transmittal form with the requester's address will be used to forward copies of Office actions (and any references cited in the Office actions) to the requester. Whenever an Office action is issued, a copy of this form will be made and attached to a copy of the Office action. The use of this form removes the need to retype the requester's address each time a mailing is required. When the patent owner is the requester, no such form is needed.

2234 Entry of Amendments [R-7]

37 CFR 1.121. Manner of making amendments in applications.

(j) *Amendments in reexamination proceedings.* Any proposed amendment to the description and claims in patents involved in reexamination proceedings must be made in accordance with § 1.530.

37 CFR 1.530. Statement by patent owner in ex parte reexamination; amendment by patent owner in ex parte or inter partes reexamination; inventorship change in ex parte or inter partes reexamination.

(d) *Making amendments in a reexamination proceeding.* A proposed amendment in an *ex parte* or an *inter partes* reexamination proceeding is made by filing a paper directing that proposed specified changes be made to the patent specification, including the claims, or to the drawings. An amendment paper directing that proposed specified changes be made in a reexamination proceeding may be submitted as an accompaniment to a request filed by the patent owner in accordance with § 1.510(e), as part of a patent

owner statement in accordance with paragraph (b) of this section, or, where permitted, during the prosecution of the reexamination proceeding pursuant to § 1.550(a) or § 1.937.

(1) *Specification other than the claims.* Changes to the specification, other than to the claims, must be made by submission of the entire text of an added or rewritten paragraph including markings pursuant to paragraph (f) of this section, except that an entire paragraph may be deleted by a statement deleting the paragraph, without presentation of the text of the paragraph. The precise point in the specification must be identified where any added or rewritten paragraph is located. This paragraph applies whether the amendment is submitted on paper or compact disc (*see* §§ 1.96 and 1.825).

(2) *Claims.* An amendment paper must include the entire text of each patent claim which is being proposed to be changed by such amendment paper and of each new claim being proposed to be added by such amendment paper. For any claim changed by the amendment paper, a parenthetical expression "amended," "twice amended," *etc.*, should follow the claim number. Each patent claim proposed to be changed and each proposed added claim must include markings pursuant to paragraph (f) of this section, except that a patent claim or proposed added claim should be canceled by a statement canceling the claim, without presentation of the text of the claim.

(3) *Drawings.* Any change to the patent drawings must be submitted as a sketch on a separate paper showing the proposed changes in red for approval by the examiner. Upon approval of the changes by the examiner, only new sheets of drawings including the changes and in compliance with § 1.84 must be filed. Amended figures must be identified as "Amended," and any added figure must be identified as "New." In the event a figure is canceled, the figure must be surrounded by brackets and identified as "Canceled."

(4) The formal requirements for papers making up the reexamination proceeding other than those set forth in this section are set out in § 1.52.

(e) *Status of claims and support for claim changes.* Whenever there is an amendment to the claims pursuant to paragraph (d) of this section, there must also be supplied, on pages separate from the pages containing the changes, the status (*i.e.*, pending or canceled), as of the date of the amendment, of all patent claims and of all added claims, and an explanation of the support in the disclosure of the patent for the changes to the claims made by the amendment paper.

(f) *Changes shown by markings.* Any changes relative to the patent being reexamined which are made to the specification, including the claims, must include the following markings:

(1) The matter to be omitted by the reexamination proceeding must be enclosed in brackets; and

(2) The matter to be added by the reexamination proceeding must be underlined.

(g) *Numbering of patent claims preserved.* Patent claims may not be renumbered. The numbering of any claims added in the reexamination proceeding must follow the number of the highest numbered patent claim.

(h) *Amendment of disclosure may be required.* The disclosure must be amended, when required by the Office, to correct

inaccuracies of description and definition, and to secure substantial correspondence between the claims, the remainder of the specification, and the drawings.

(i) *Amendments made relative to patent.* All amendments must be made relative to the patent specification, including the claims, and drawings, which are in effect as of the date of filing the request for reexamination.

(j) *No enlargement of claim scope.* No amendment may enlarge the scope of the claims of the patent or introduce new matter. No amendment may be proposed for entry in an expired patent. Moreover, no amendment, other than the cancellation of claims, will be incorporated into the patent by a certificate issued after the expiration of the patent.

(k) *Amendments not effective until certificate.* Although the Office actions will treat proposed amendments as though they have been entered, the proposed amendments will not be effective until the reexamination certificate is issued and published.<

Amendments which comply with 37 CFR 1.530(d) through (j) (and are formally presented pursuant to 37 CFR 1.52(a) and (b), and contain all fees required by 37 CFR 1.20(c)) are entered in the reexamination file.

For an IFW reexamination file, the amendment will be entered as follows:

(A) The amendment paper is designated by consecutive letters of the alphabet (A, B, C, etc.);

(B) Each entry in the amendment paper will be blocked by two lines, and given a successive number (for amendment A, the numbers would be A1, A2, A3, etc.);

(C) A copy of the claims filed with the request (which should be the copy in the printed patent) and the patent pages containing paragraphs being revised will be printed from the IFW file history;

(D) A line will be drawn through any claim(s) or paragraph(s) amended with the substituted copy being indicated by the reference letter and number (e.g., A1, A2, A3) of the amendment paper;

(E) Canceled claim(s) or paragraph(s) which are part of the patent are surrounded by brackets (i.e., a bracket placed at the beginning and end of each canceled claim or paragraph of the patent). They are not lined through;

(F) The marked up copy of the claims filed with the request and the patent pages containing paragraphs being revised are scanned into the IFW file history;

(G) The marked up amendment document is scanned into the IFW file history.

** Patent claims must not be renumbered, and the numbering of the claims added during reexamination must follow the number of the highest numbered patent claim.

ALL amendments in reexamination proceedings, including examiner's amendments made at the time when the Notice of Intent to Issue *Ex Parte* Reexamination Certificate (NIRC) is prepared (37 CFR 1.121(g) does not apply in reexamination proceedings), must be presented in the form of a full copy of the text of each claim which is amended and each paragraph of the description which is amended. In other words, the entire claim or paragraph must be presented for any amendment of the claim or paragraph.

If a portion of the text is amended more than once, each amendment should indicate *ALL* of the changes (insertions and deletions) in relation to the current text of the patent under reexamination.

Although amendments will be entered for purposes of examination, the amendments are not legally effective until the reexamination certificate is issued >and published<.

See MPEP § 2250 for manner of making amendments by patent owner and for examples of proper claim amendment format. For clerical handling of amendments, see MPEP § 2270. See also MPEP § 2221 for amendments included in the request by the patent owner. For entry of amendments in a merged proceeding, see MPEP § 2283 and § 2285.

2235 Record Systems [R-7]

PALM — MONITORING SYSTEMS

The Patent Application Locating and Monitoring (PALM) system is used to support the reexamination process. The sections below delineate PALM related activities.

(A) *Reexamination File Data on PALM* — The routine PALM retrieval transactions are used to obtain data on reexamination files. From the USPTO Intranet site <http://ptoweb/ptointranet/index.htm>, Office staff can click on "PALM" and then "General Information" which opens the PALM INTRANET General Information Display. From here, enter the patent number in the box labeled Patent #. Then click on "Search" and when the "Patent Number Information" appears, click

on “Continuity Data” to obtain the reexamination number.

(B) *Reexamination e-File* — The papers of a reexamination proceeding may be viewed on IFW. PALM provides information for the reexamination proceeding as to the patent owner and requester, contents, status, and related Office proceedings (applications, patents and reexamination proceedings). Some of the data entry for reexamination in PALM is different from that of a regular patent application. There are also differences in the status codes – all reexamination proceedings have status codes in the “400” range (there are some in the “800” range for some *inter partes* documents and actions), while patent applications have status codes ranging from “020” to over “100.”

(C) *Patent File Location Control for Patents Not Available on IFW, i.e., Available Only in Paper File* — The movement of paper patent files related to requests for reexamination throughout the Office is monitored by the PALM system in the normal fashion. The patent file will be charged to the examiner assigned the reexamination file and will be kept in the examiner’s office until the proceeding is concluded. After the reexamination proceeding has been concluded, the patent file should be forwarded with the reexamination file to the Office of Patent Legal Administration for review (see MPEP § 2289) and then to the Office of *>Data Management<*. The Office of *>Data Management<* will forward the patent file to the Record Room after printing of the certificate.

(D) *Reporting Events to PALM* — The PALM system is used to monitor major events that take place in processing reexamination proceedings. During initial processing all major pre-*ex parte* examination events are reported. During the *ex parte* phase, the mailing of examiner’s actions are reported as well as owner’s responses thereto. The reexamination clerk is responsible for reporting these events using the reexamination icon and window initiated in the PALM EXPO program. The events that will be reported are as follows:

(1) Determination Mailed — Denial of request for reexamination.

(2) Determination Mailed — Grant of request for reexamination.

(3) Petition for reconsideration of determination received.

(4) Decision on petition mailed — Denied.

(5) Decision on petition mailed — Granted.

(6) Owner response to determination (owner’s statement) received.

(7) Requester response to determination (requester’s reply) received.

(8) The mailing of all examiner actions.

(9) The receipt of owner’s responses to examiner’s actions and Office receipt date.

Each of these events, as well as additional events reported by the Reexamination Preprocessing Unit will be permanently recorded and displayed in the “Contents” portion of PALM. In addition, status representative of these events will also be displayed.

(E) *Status Reports* — Various weekly “tickler” reports can be generated for each area given the event reporting discussed above. The primary purpose of these computer outputs is to assure that reexaminations are, in fact, processed with “special dispatch.”

(1) *PALM Reports* — A number of automated reports generated from the PALM system are provided to the TCs at the beginning of each week. These reports serve to indicate to the TCs when certain deadlines are approaching. Each report is subdivided by working group and lists the requests in control number sequence. The following reports have been identified.

(2) *Requests Not Yet Received in CRU* — This report serves to indicate to the CRU those requests assigned to it for which preprocessing has not been completed and which have not yet been received in the TC. This report provides an indicator of future workload as well as identifying potential, problem stragglers.

(3) *Requests Not Yet Assigned to an Examiner* — This report serves to highlight those requests which have not been assigned to an examiner by the 6th week since their filing. Requests appearing on this report should be located and docketed immediately.

(4) *Requests Which Should Be Taken Up for Determination* — This report lists those requests which have been assigned to an examiner and in which no determination has been mailed and the 6th week since their filing is past. Requests on this report should be taken up for determination by the examiner.

(5) *Requests for Which Determinations Should be Prepared* — This report lists those requests which have been assigned to an examiner and in which no determination has been mailed and the 2nd month since their filing is past. Determinations for requests on this report should be in the final stages of preparation.

(6) **Requests for Which Determinations Should Have Been Mailed* — This report lists those requests which have been assigned to an examiner and in which no determination has been mailed and the 10th week since their filing is past. Determinations for requests on this report should be mailed immediately.

(7) **Overdue Determinations* — This report lists those requests in which no determination has been mailed and the 3rd month since their filing is past. This report should always be zero.

(8) *Overdue Petitions for Reconsideration of a Denial* — This report lists those requests in which the determination denied reexamination and no petition has been received and 6 weeks have passed since the determination was mailed. Reexamination proceedings on this report should be concluded.

(9) *Overdue Owner Responses to Determinations* — This report lists those requests in which the determination ordered reexamination and the owner has not filed a response and 10 weeks have passed since the mailing of the determination. These requests should be taken up for immediate *ex parte* action by the examiner.

(10) *Overdue Requester Responses to Statements* — This report lists those requests in which a proper OWNER statement was received and NO requester reply has been received and 10 weeks have passed since the receipt of the owner response. These requests should be taken up for immediate action.

(11) **Overdue First Ex Parte Actions* — This report lists those requests in which reexamination has been ordered and a first action has not been mailed and 6 weeks have passed since the request became available for *ex parte* prosecution. These requests should be taken up for immediate action by the examiner.

(12) **Overdue Action or Examiner's Answer* — This report lists those reexaminations which are up for second or subsequent action by the examiner and no such action has been mailed and 2 months have

passed since the filing of an owner response to a previous action.

(13) **Overdue Advisory Action* — This report lists those reexaminations which are up for action by the examiner and no such action has been mailed and 1 month has passed since the filing of an owner response to a previous final action.

(14) **Overdue Owner Response* — This report lists those requests in which there has been an action rendered and 4 months have passed without an owner response.

(15) **Overdue Certificates* — This report lists those requests in which a Notice of Intent to Issue *Ex Parte* Reexamination Certificate has been mailed and 3 months have passed since its mailing and no issue date has been assigned.

(16) **Requests With Prolonged Prosecution* — This report lists pending requests which have not matured into a certificate and 15 months have passed since the date of filing.

*Asterisk items require immediate action and follow-up, if appropriate.

2236 Assignment of Reexamination [R-7]

Reexamination requests should normally be assigned to the Central Reexamination Unit (CRU) art unit which examines the technology (Chemical, Electrical, Mechanical, etc.) in which the patent to be reexamined is currently classified as an original. In that art unit, the **>CRU Supervisory Patent Examiner (SPE)< will assign the reexamination request to a primary examiner, other than the examiner who originally examined the patent application (see "Examiner Assignment Policy" below), who is most familiar with the claimed subject matter of the patent. **>In an extremely rare situation, where a proceeding is still in a Technology Center (TC) rather than the CRU<, the reexamination may be assigned to an assistant examiner >if no knowledgeable primary examiner is available<. In such an instance a primary examiner must sign all actions and take responsibility for all actions taken.

I. EXAMINER ASSIGNMENT POLICY

It is the policy of the Office that the * CRU **>SPE< will assign the reexamination request to an examiner different from the examiner(s) who examined the patent application. Thus, under normal cir-

cumstances, the reexamination request will not be assigned to a primary examiner or assistant examiner who was involved in any part of the examination of the patent for which reexamination is requested (e.g., by preparing/signing an action), or was so involved in the examination of the parent of the patent. This would preclude assignment of the request to an examiner who was a conferee in an appeal conference or panel review conference in an earlier concluded examination of the patent (e.g., the application for patent, a reissue, or a prior concluded reexamination proceeding). The conferee is considered to have participated in preparing the Office action which is preceded by the conference.

Exceptions to this general policy include cases where the original examiner is the only examiner with adequate knowledge of the relevant technology to examine the case. In the unusual case where there is a need to assign the request to the original examiner, the assignment must be approved by the CRU Director, and the fact that such approval was given by the CRU Director must be stated by the examiner in the decision on the request for reexamination.

It should be noted that while an examiner who examined an earlier concluded reexamination proceeding is generally excluded from assignment of a newly filed reexamination, if the earlier reexamination is still ongoing, the same examiner will be assigned the new reexamination.

Copending reissue and reexamination proceedings:

(A) When a reissue application is pending for a patent, and a reexamination request is filed for the same patent, the reexamination request is generally assigned to an examiner who did not examine the original patent application even though the examiner who examined the patent application is handling the reissue application. If the reexamination request is granted and the reissue and reexamination proceedings are later merged (see MPEP § 2285), the merged proceeding will be handled (upon return of the files from the Office of Patent Legal Administration (OPLA)) by the TC examiner who is handling the reissue application. However, if that examiner was involved in any part of the examination of the patent for which reexamination is requested (e.g., by preparing/signing an action), or was so involved in the examination of the parent application of the patent, a

different TC examiner will be assigned. *>In this instance<, the reissue application would be transferred (reassigned) from the originally assigned examiner.

(B) When a reexamination proceeding is pending for a patent, and a reissue application is filed for the same patent:

(1) Where reexamination has already been ordered (granted) in the reexamination proceeding, OPLA should be notified as promptly as possible after the reissue application reaches the TC, that the proceedings are ready for consideration of merger. If any of the reexamination file, the reissue application, and the patent file are paper files, they should be hand delivered to OPLA at the time of the notification to OPLA. If the reissue and reexamination proceedings are merged by OPLA, the reissue application will generally be assigned in the TC having the reissue (upon return of the files from OPLA) to the TC examiner who would ordinarily handle the reissue application. However, if that examiner was involved in any part of the examination of patent for which reexamination is requested (e.g., by preparing/signing an action), or was so involved in the examination of the parent application of the patent, a different TC examiner will be assigned. If the reissue and reexamination proceedings are not merged by OPLA, the decision will provide guidance as to assignment of the reissue proceeding depending on the individual fact situation.

(2) If reexamination has not yet been ordered (granted) in the reexamination proceeding, the **>TC Quality Assurance Specialist (QAS)< will ensure that the reissue application is not assigned nor acted on, and the decision on the reexamination request will be made. If reexamination is denied, the reexamination proceeding will be concluded pursuant to MPEP § 2294, and the reissue application assigned in accordance with MPEP § 1440. If reexamination is granted, the **>TC QAS< will await the filing of any statement under 37 CFR 1.530 and any reply under 37 CFR 1.535, or the expiration of the time for same (see MPEP § 2249 – § 2251), and then the OPLA should be promptly notified that the proceedings are ready for consideration of merger. If any of the reexamination file, the reissue application, and the patent file are paper files, they should be hand delivered to OPLA at the time of the notification to OPLA. If the reissue and reexamination proceedings are merged by OPLA,

the reissue application will generally be assigned in the TC having the reissue (upon return of the files from OPLA) to the TC examiner who ordinarily handle the reissue application. However, if that examiner was involved in any part of the examination of the patent for which reexamination is requested (e.g., by preparing/signing an action), or was so involved in the examination of the parent application of the patent, a different TC examiner will be assigned. If the reissue and reexamination proceedings are not merged by OPLA, the decision will provide guidance as to assignment of the reissue proceeding depending on the individual fact situation.

II. CONSEQUENCES OF INADVERTENT ASSIGNMENT TO AN “ORIGINAL EXAMINER”

Should a reexamination be inadvertently assigned to an “original examiner” (in a situation where the TC or CRU Director’s approval is not stated in the decision on the request), the patent owner or the third party requester who objects must promptly file a paper alerting the Office of this fact. Any request challenging the assignment of an examiner to the case must be made within two months of the first Office action or other Office communication indicating the examiner assignment, or reassignment will not be considered. Reassignment of the reexamination to a different examiner will be addressed on a case-by-case basis. In no event will the assignment to the original examiner, by itself, be grounds for vacating any Office decision(s) or action(s) and “restarting” the reexamination.

A situation may arise where a party timely (i.e., within the two months noted above) files a paper alerting the Office to the assignment of a reexamination to the “original examiner,” but that paper does not have a right of entry under the rules. An example of this is where a third party requester becomes aware of the assignment to the “original examiner” via that examiner signing the order for reexamination, and the patent owner does not file a statement under 37 CFR 1.530. In that situation, the third party requester cannot file a reply under 37 CFR 1.535, and thus has no way to present the paper directed to the examiner assignment (no right of entry under the rules). In situations where a paper directed to the examiner assignment has no right of entry under the rules, the Office

may waive the rules to the extent that the paper directed to the examiner assignment will be entered and considered.

2237 Transfer Procedure [R-7]

Although the number of reexamination requests which must be transferred should be very small, the following procedures have been established for an expeditious resolution of any such problems.

A reexamination request is normally assigned to a Central Reexamination Unit (CRU) art unit which examines the technology (Chemical, Electrical, Mechanical, etc.) in which the patent to be reexamined is currently classified as an original. If the CRU Supervisory Patent Examiner (SPE) (to whose art unit the reexamination has been assigned) believes that the reexamination should be assigned to another art unit, he or she must obtain the consent of the CRU SPE of the art unit to which a transfer is desired. Pursuant to 35 U.S.C. 305, all *ex parte* reexamination proceedings must be conducted with special dispatch within the Office. This applies to the transfer of reexamination proceedings. Accordingly, the CRU SPE to whose art unit the reexamination has been assigned should expeditiously make any request for transfer of a reexamination proceeding to the CRU SPE of the art unit to which a transfer is desired (the “new” art unit). Further, the SPE to whose art unit the reexamination has been assigned should hand-carry any paper patent file for the reexamination proceeding to the CRU SPE of the art unit to which a transfer is desired. Any conflict which cannot be resolved by the SPEs will be resolved by the CRU Director.

If the “new” art unit accepts assignment of the reexamination request, the “new” CRU SPE assigns the request to an examiner in that unit.

2238 Time Reporting [R-7]

Reexamination fees are based on full cost recovery, and it is essential that all time expended on reexamination activities be reported accurately. Thus, all USPTO personnel should report all time spent on reexamination on their individual Time and Attendance Reports. Even activities such as supervision, copying, typing, and docketing should be included.

2239 Reexamination Ordered at the Director's Initiative [R-7]

37 CFR 1.520. *Ex parte reexamination at the initiative of the Director.*

The Director, at any time during the period of enforceability of a patent, may determine whether or not a substantial new question of patentability is raised by patents or printed publications which have been discovered by the Director or which have been brought to the Director's attention, even though no request for reexamination has been filed in accordance with § 1.510 or § 1.913. The Director may initiate *ex parte* reexamination without a request for reexamination pursuant to § 1.510 or § 1.913. Normally requests from outside the Office that the Director undertake reexamination on his own initiative will not be considered. Any determination to initiate *ex parte* reexamination under this section will become a part of the official file of the patent and will be mailed to the patent owner at the address as provided for in § 1.33(c).

The Director of the USPTO may initiate reexamination without a request being filed and without a fee being paid. Such reexamination may be ordered at any time during the period of enforceability of the patent.

A decision to order reexamination at the Director's initiative is, however, rare. Only in compelling circumstances, after a review of all the facts concerning the patent, would such a decision be made. Authority to order reexamination at the Director's initiative has been delegated to the Deputy Commissioner for Patent Examination Policy. A decision to order reexamination at the Director's initiative may also be made by the Director of the USPTO, the Deputy Director or the Commissioner for Patents.

If an Office employee becomes aware of an unusual fact situation in a patent which he or she considers to clearly warrant reexamination, a memorandum setting forth these facts (including a proposed rejection of all appropriate claims) along with the patent file (paper or electronic) and any prior art patents or printed publications should be forwarded to the Office of Patent Legal Administration (OPLA) through the Central Reexamination Unit (CRU) or Technology Center (TC) supervisory chain of command. A disk having the memorandum in electronic format should be included with a paper copy of the memorandum.

If an order to reexamine is to be issued, the decision is prepared in the OPLA. The decision is signed by the Deputy Commissioner for Patent Examination Policy and mailed by the **>CRU<**. The patent file is then forwarded to the CRU reexamination preprocessing staff for preparation of a reexamination file and

Official Gazette notice. Examination and prosecution will then proceed without further communication with anyone but the patent owner.

If the Deputy Commissioner for Patent Examination Policy refuses to issue an order for reexamination, no record of any consideration of the matter will be maintained in the patent file or anywhere else in the Office, and the patent owner will not be notified.

The Director of the USPTO will not normally consider requests to order reexamination at the Director's initiative received from members of the public. If a member of the public desires reexamination of a patent, a request and fee should be filed in accordance with 37 CFR 1.510 or 37 CFR 1.915.

2240 Decision on Request [R-7]

35 U.S.C. 303. *Determination of issue by Director.*

(a) Within three months following the filing of a request for reexamination under the provisions of section 302 of this title, the Director will determine whether a substantial new question of patentability affecting any claim of the patent concerned is raised by the request, with or without consideration of other patents or printed publications. On his own initiative, and any time, the Director may determine whether a substantial new question of patentability is raised by patents and publications discovered by him or cited under the provisions of section 301 of this title. The existence of a substantial new question of patentability is not precluded by the fact that a patent or printed publication was previously cited by or to the Office or considered by the Office.

(b) A record of the Director's determination under subsection (a) of this section will be placed in the official file of the patent, and a copy promptly will be given or mailed to the owner of record of the patent and to the person requesting reexamination, if any.

(c) A determination by the Director pursuant to subsection (a) of this section that no substantial new question of patentability has been raised will be final and nonappealable. Upon such a determination, the Director may refund a portion of the reexamination fee required under section 302 of this title.

37 CFR 1.515. *Determination of the request for ex parte reexamination.*

(a) Within three months following the filing date of a request for an *ex parte* reexamination, an examiner will consider the request and determine whether or not a substantial new question of patentability affecting any claim of the patent is raised by the request and the prior art cited therein, with or without consideration of other patents or printed publications. The examiner's determination will be based on the claims in effect at the time of the determination, will become a part of the official file of the patent, and will be mailed to the patent owner at the address as provided for in § 1.33(c) and to the person requesting reexamination.

(b) Where no substantial new question of patentability has been found, a refund of a portion of the fee for requesting *ex parte* reexamination will be made to the requester in accordance with § 1.26(c).

(c) The requester may seek review by a petition to the Director under § 1.181 within one month of the mailing date of the examiner's determination refusing *ex parte* reexamination. Any such petition must comply with § 1.181(b). If no petition is timely filed or if the decision on petition affirms that no substantial new question of patentability has been raised, the determination shall be final and nonappealable.

Before making a determination on the request for reexamination, the examiner must request a litigation * search by the Scientific and Technical Information Center (STIC) to check if the patent has been, or is, involved in litigation. The "Litigation Review" box on the reexamination IFW file jacket form should be completed to indicate that the review was conducted and the results thereof. A copy of the STIC search and the reexamination file jacket form are scanned into the IFW reexamination file history. In the rare instance where the record of the reexamination proceeding or the STIC search indicates that additional information is desirable, guidance as to making an additional litigation search may be obtained from the library of the Office of the Solicitor. If the patent is or was involved in litigation, and a paper referring to the court proceeding has been filed, reference to the paper by number should be made in the "Litigation Review" box on the reexamination IFW file jacket form as, for example, "litigation; see paper filed 7-14-2005. If a litigation records search is already noted on the file, the examiner need not repeat or update it.

If litigation has concluded or is taking place in the patent on which a request for reexamination has been filed, the request must be promptly brought to the attention of the Central Reexamination Unit (CRU) **>Supervisory Patent Examiner (SPE)<, who should review the decision on the request and any examiner's action to ensure that it conforms to the current Office litigation policy and guidelines. See MPEP § 2286.

35 U.S.C. 303 requires that within 3 months following the filing of a request for reexamination, the Director of the USPTO will determine whether or not the request raises a "substantial new question of patentability" affecting any claim of the patent of which reexamination is desired. See also MPEP § 2241. Such a determination may be made with or without consideration of other patents or printed publications in addition to those cited in the request. No input from

the patent owner is considered prior to the determination, unless the patent owner filed the request. See *Patlex Corp. v. Mossinghoff*, 771 F.2d 480, 226 USPQ 985 (Fed. Cir. 1985).

The patent claims in effect at the time of the determination will be the basis for deciding whether a substantial new question of patentability has been raised. 37 CFR 1.515(a). Amendments which (1) have been presented with the request if by the patent owner, (2) have been filed in a pending reexamination proceeding in which the certificate has not been issued, or (3) have been submitted in a reissue application on which no reissue patent has been issued, will not be considered or commented upon when deciding requests.

The decision on the request for reexamination has as its object either the granting or denial of an order for reexamination. This decision is based on whether or not "a substantial new question of patentability" is found. A * determination as to >patentability/<unpatentability of the claims is not made in the decision >on the request<; >rather,< this determination will be made during the examination stage of the reexamination proceedings >if reexamination is ordered<. Accordingly, no *prima facie* case of unpatentability need be found to grant an order for reexamination. If a decision to deny an order for reexamination is made, the requester may seek review by a petition under CFR 1.181. See 37 CFR 1.515(c). >It should be noted that a decision to deny the request for reexamination is equivalent to a final holding (subject only to a petition pursuant to 37 CFR 1.515(c) for review of the denial) that the request failed to raise a substantial new question of patentability based on the cited art (patents and printed publications).<

It is only necessary to establish that a substantial new question of patentability exists as to one of the patent claims in order to grant reexamination. The Office's determination in both the order for reexamination and the examination stage of the reexamination will generally be limited solely to a review of the claim(s) for which reexamination was requested. If the requester was interested in having all of the claims reexamined, requester had the opportunity to include them in its request for reexamination. However, if the requester chose not to do so, those claim(s) for which reexamination was not requested will generally not be reexamined by the Office. It is further noted that 35

U.S.C. 302 requires that “[t]he request must set forth the pertinency and manner of applying cited prior art to every claim for which reexamination is requested.” If the requester fails to apply the art to certain claims, then the requester is not statutorily entitled to reexamination of such claims. If a requester chooses not to request reexamination for a claim, and thus fails to set forth the pertinency and manner of applying the cited art to that claim as required by 37 CFR 1.510(b), that claim will generally not be reexamined. The decision to reexamine any claim for which reexamination has not been requested lies within the sole discretion of the Office, to be exercised based on the individual facts and situation of each individual case. If the Office chooses to reexamine any claim for which reexamination has not been requested, it is permitted to do so. In addition, the Office may always initiate a reexamination on its own initiative of the non-requested claim (35 U.S.C. 303(a)). See *Sony Computer Entertainment America Inc. v. Dudas*, 85 USPQ2d 1594 (E.D. Va 2006). It is to be noted that if a request fails to set forth the pertinency and manner of applying the cited art to any claim for which reexamination is requested as required by 37 CFR 1.510(b), a filing date will not be awarded to the request. See MPEP § 2217 and § 2227.<

One instance where reexamination was carried out only for the claims requested occurred in reexamination control numbers 95/000,093 and 95/000,094, where reexamination was requested for patent claims which were being litigated, but not for claims which were not being litigated. In that instance, the entirety of the reexamination was limited to the claims which were being litigated, for which reexamination was requested. The Office’s authority to carry out reexamination only for the claims for which reexamination was requested in reexamination control numbers 95/000,093 and 95/000,094 was confirmed by the court in *Sony, supra*. See also MPEP § 2242 for the situation where there was a prior final federal court decision as to the invalidity/unenforceability of some of the claims, as another example of non-examination of some of the patent claims in a reexamination proceeding.

The decision on the request for reexamination should discuss all of the patent claims requested for reexamination. The examiner should limit the discussion of those claims in the order for reexamination as

to whether a substantial new question of patentability has been raised. The examiner SHOULD NOT reject claims in the order for reexamination. Rather, any rejection of the claims will be made in the first Office action (on the patentability of the claims) that is issued after the expiration of the time for submitting any patent owner statement and requester reply that follow the examiner’s order.

The examiner should indicate, insofar as possible, his or her initial position on all the issues identified in the request or by the requester so that comment thereon may be received in the patent owner’s statement and in the requester’s reply.

The Director of the USPTO has the authority to order reexamination only for a request which raise a substantial new question of patentability. The substantial new question of patentability requirement protects patentees from having to respond to, or participate in unjustified reexaminations. *Patlex Corp. v. Mossinghoff*, 771 F.2d 480, 226 USPQ 985 (Fed. Cir. 1985).

I. REQUEST FOR REEXAMINATION OF THE PATENT AFTER REISSUE OF THE PATENT

Where a request for reexamination is filed on a patent after a reissue patent for that patent has already issued, reexamination will be denied, because the patent on which the request for reexamination is based has been surrendered. Should reexamination of the reissued patent be desired, a new request for reexamination, including and based on the specification and the claims of the reissue patent, must be filed. Where the reissue patent issues after the filing of a request for reexamination, see MPEP § 2285.

II. SECOND OR SUBSEQUENT REQUEST FILED DURING REEXAMINATION

If a second or subsequent request for *ex parte* reexamination is filed (by any party) while a first *ex parte* reexamination is pending, the presence of a substantial new question of patentability depends on the prior art (patents and printed publications) cited by the second or subsequent requester. If the requester includes in the second or subsequent request prior art which raised a substantial new question in the pending reexamination, reexamination should be ordered only if the prior art cited raises a substantial new question of patentability which is different from that raised in the

pending reexamination proceeding. If the prior art cited raises the same substantial new question of patentability as that raised in the pending reexamination proceedings, the second or subsequent request should be denied.

Where the request raises a different substantial new question of patentability as to some patent claims, but not as to others, the request would be granted in part; see the order issued in reexamination control number 90/007,843 and 90/007,844.

The second or subsequent request for reexamination may provide information raising a substantial new question of patentability with respect to any new or amended claim which has been proposed under 37 CFR 1.530(d) in the first (or prior) pending reexamination proceeding. However, in order for the second or subsequent request for reexamination to be granted, the second or subsequent requester must independently provide a substantial new question of patentability which is **different from** that raised in the pending reexamination for **the claims in effect at the time of the determination**. The decision on the second or subsequent request is thus based on the claims in effect at the time of the determination (37 CFR 1.515(a)). If a “different” substantial new question of patentability is not provided by the second or subsequent request for the claims in effect at the time of the determination, the second or subsequent request for reexamination must be denied since the Office is only authorized by statute to grant a reexamination proceeding based on a substantial new question of patentability “affecting any claim of the patent.” See 35 U.S.C. 303. Accordingly, there must be at least one substantial new question of patentability established for the existing claims in the patent in order to grant reexamination.

Once the second or subsequent request has provided a “different” substantial new question of patentability based on the claims in effect at the time of the determination, the second or subsequent request for reexamination may also provide information directed to any proposed new or amended claim in the pending reexamination, to permit examination of the entire patent package. The information directed to a proposed new or amended claim in the pending reexamination is addressed during the later filed reexamination (where a substantial new question of

patentability is raised in the later filed request for reexamination for the existing claims in the patent), in order to permit examination of the entire patent package. When a proper basis for the second or subsequent request for reexamination is established, it would be a waste of resources to prevent addressing the proposed new or amended claims, by requiring parties to wait until the certificate issues for the proposed new or amended claims, and only then to file a new reexamination request challenging the claims as revised via the certificate. This also prevents a patent owner from simply amending all the claims in some nominal fashion to preclude a subsequent reexamination request during the pendency of the reexamination proceeding.

In certain situations, after a grant of a second or subsequent request for *ex parte* reexamination, where (A) the patent owner files a petition under 37 CFR 1.182 as part of the statement or as the statement, and (B) it appears clear that the second or subsequent request was filed for purposes of harassment of the patent owner, if the petition is granted, prosecution on the second or subsequent reexamination would be suspended. Merger of such a second or subsequent request with the already pending reexamination proceeding(s) would unduly prolong the conclusion of the pending reexamination and be inconsistent with the requirement that reexamination proceeding be conducted with special dispatch.

If the second or subsequent requester does not include the prior art which raised a substantial new question of patentability in the pending reexamination, reexamination may or may not be ordered depending on whether the different prior art raises a substantial new question of patentability. The second or subsequent request should be determined on its own merits without reference to the pending reexamination.

For additional treatment of cases in which a first *ex parte* reexamination is pending at the time a second or subsequent request for *ex parte* reexamination is to be decided, see MPEP § 2283.

For additional treatment of cases in which either the first or subsequent request for reexamination, or both, is/are an *inter partes* reexamination proceeding, see MPEP § 2640 and § 2686.01.

2241 Time for Deciding Request [R-2]

The determination of whether or not to reexamine must be made within 3 months following the filing date of a request. See 35 U.S.C. 303(a) and 37 CFR 1.515(a). If the 3-month period ends on a Saturday, Sunday, or Federal holiday within the District of Columbia, then the determination must be mailed by the **preceding** business day. The examiner should take up a request for decision about 6 weeks after the request was filed. The decision should be mailed within 10 weeks of the filing date of the request. When reexamination for the same patent has already been ordered based on an earlier request and that reexamination is pending, the examiner should immediately take up the new request for decision, i.e., there should be no delay of 6 weeks. See the last portion of MPEP § 2240 and also see MPEP § 2283 for multiple copending reexamination proceedings. A determination to reexamine may be made at any time during the period of enforceability of a patent.

2242 Criteria for Deciding Request [R-7]

I. SUBSTANTIAL NEW QUESTION OF PATENTABILITY

The presence or absence of “a substantial new question of patentability” determines whether or not reexamination is ordered. The meaning and scope of the term “a substantial new question of patentability” is not defined in the statute and must be developed to some extent on a case-by-case basis, using the case law to provide guidance as will be discussed in this section.

If the prior art patents and printed publications raise a substantial question of patentability of at least one claim of the patent, then a substantial new question of patentability is present, unless the same question of patentability has already been decided by (A) a final holding of invalidity, after all appeals, or (B) by the Office in a previous examination or pending reexamination of the patent. A “previous examination” of the patent is: (A) the original examination of the application which matured into the patent; (B) the examination of the patent in a reissue application that has resulted in a reissue of the patent; or (C) the examination of the patent in an earlier pending or concluded

reexamination. The answer to the question of whether a “substantial new question of patentability” exists, and therefore whether reexamination may be had, is decided by the Director of the USPTO, and, as 35 U.S.C. 303 provides, that determination is final, i.e., not subject to appeal on the merits of the decision. See *In re Etter*, 756 F.2d 852, 225 USPQ 1 (Fed. Cir. 1985). But see *Heinl v. Godici*, 143 F.Supp.2d 593, 596-98 (E.D.Va. 2001) (35 U.S.C. 303 addresses only USPTO decisions to deny a request for reexamination and does not bar review of *ultra vires* USPTO decisions to grant reexamination requests. However, a decision to grant a reexamination request is not a final agency decision and is not ordinarily subject to judicial review.).

A prior art patent or printed publication raises a substantial question of patentability where there is a substantial likelihood that a reasonable examiner would consider the prior art patent or printed publication important in deciding whether or not the claim is patentable. If the prior art patents and/or publications would be considered important, then the examiner should find “a substantial new question of patentability” unless the same question of patentability has already been decided as to the claim in a final holding of invalidity by the Federal court system or by the Office in a previous examination. For example, the same question of patentability may have already been decided by the Office where the examiner finds the additional (newly provided) prior art patents or printed publications are merely cumulative to similar prior art already fully considered by the Office in a previous examination of the claim.

For “a substantial new question of patentability” to be present, it is only necessary that: (A) the prior art patents and/or printed publications raise a substantial question of patentability regarding at least one claim, i.e., the teaching of the (prior art) patents and printed publications is such that a reasonable examiner would consider the teaching to be important in deciding whether or not the claim is patentable; and (B) the same question of patentability as to the claim has not been decided by the Office in a previous examination or pending reexamination of the patent or in a final holding of invalidity by the Federal Courts in a decision on the merits involving the claim. It is not necessary that a “*prima facie*” case of unpatentability exist as to the claim in order for “a substantial new question

of patentability” to be present as to the claim. Thus, “a substantial new question of patentability” as to a patent claim could be present even if the examiner would not necessarily reject the claim as either fully anticipated by, or obvious in view of, the prior art patents or printed publications. As to the importance of the difference between “a substantial new question of patentability” and a “*prima facie*” case of unpatentability see generally *In re Etter*, 756 F.2d 852, 857 n.5, 225 USPQ 1, 4 n.5 (Fed. Cir. 1985).

>Note that the clarification of the legal standard for determining obviousness under 35 U.S.C. 103 in *KSR International Co. v. Teleflex Inc.* (KSR), 550 U.S. ____, 82 USPQ2d 1385 (2007) does not alter the legal standard for determining whether a substantial new question of patentability exists. See the discussion in MPEP § 2216.<

Where a >second or subsequent< request for reexamination of a patent is made before the conclusion of an earlier filed reexamination proceeding pending (ongoing) for that patent, **>the second or subsequent request for reexamination may provide information raising a substantial new question of patentability with respect to any new or amended claim which has been proposed under 37 CFR 1.530(d) in the ongoing pending reexamination proceeding. However, in order for the second or subsequent request for reexamination to be granted, the second or subsequent requester must independently provide a substantial new question of patentability which is **different from** that raised in the pending reexamination for **the claims in effect at the time of the determination** The decision on the second or subsequent request is thus based on the claims in effect at the time of the determination (37 CFR 1.515(a)). If a “different” substantial new question of patentability is not provided by the second or subsequent request for the claims in effect at the time of the determination, the second or subsequent request for reexamination must be denied since the Office is only authorized by statute to grant a reexamination proceeding based on a substantial new question of patentability “affecting any claim of the patent.” See 35 U.S.C. 303. Accordingly, there must be at least one substantial new question of patentability established for the existing claims in the patent in order to grant reexamination.

Once the second or subsequent request has provided a “different” substantial new question of patentability based on the claims in effect at the time of the determination, the second or subsequent request for reexamination may also provide information directed to any proposed new or amended claim in the pending reexamination, to permit examination of the entire patent package. The information directed to a proposed new or amended claim in the pending reexamination is addressed during the later filed reexamination (where a substantial new question is raised in the later reexamination for the existing claims in the patent), in order to permit examination of the entire patent package. When a proper basis for the subsequent reexamination is established, it would be a waste of resources to prevent addressing the proposed new or amended claims, by requiring parties to wait until the certificate issues for the proposed new or amended claims, and only then to file a new reexamination request challenging the claims as revised via the certificate. This also prevents a patent owner from simply amending all the claims in some nominal fashion to preclude a subsequent reexamination request during the pendency of the reexamination proceeding.<

II. POLICY IN SPECIFIC SITUATIONS

In order to further clarify the meaning of “a substantial new question of patentability” certain situations are outlined below which, if present, should be considered when making a decision as to whether or not “a substantial new question of patentability” is present.

A. *Prior Favorable Decisions by the U.S. Patent and Trademark Office (Office) on the Same or Substantially Identical Prior Art in Relation to the Same Patent.*

A “substantial new question of patentability” is not raised by prior art presented in a reexamination request if the Office has previously considered (in an earlier examination of the patent) the same question of patentability as to a patent claim favorable to the patent owner based on the same prior art patents or printed publications. *In re Recreative Technologies*, 83 F.3d 1394, 38 USPQ2d 1776 (Fed. Cir. 1996).

In deciding whether to grant a request for reexamination of a patent, the examiner should check the

patent's file history to ascertain whether any of the prior art now advanced by requester was previously cited/considered in an earlier Office examination of the patent (e.g., in the examination of the application for the patent, or in a concluded or pending reexamination proceeding). For the sake of expediency, such art is referred to as "old art" throughout, since the term "old art" was coined by the Federal Circuit in its decision of *In re Hiniker*, 150 F.3d 1362,1365-66, 47 USPQ2d 1523, 1526 (Fed. Cir. 1998).

In a decision to order reexamination made on or after November 2, 2002, reliance on old art does not necessarily preclude the existence of a substantial new question of patentability * that is based exclusively on that old art. See Public Law 107-273, 116 Stat. 1758, 1899-1906 (2002), which expanded the scope of what qualifies for a substantial new question of patentability upon which a reexamination may be based. Determinations on whether a * >substantial new question of patentability < exists in such an instance shall be based upon a fact-specific inquiry done on a case-by-case basis. For example, a * >substantial new question of patentability < may be based solely on old art where the old art is being presented/viewed in a new light, or in a different way, as compared with its use in the earlier * examination(s), in view of a material new argument or interpretation presented in the request.

When it is determined that a * >substantial new question of patentability < based solely on old art is raised, form paragraph 22.01.01 should be included in the order for reexamination.

¶ 22.01.01 *Criteria for Applying "Old Art" as Sole Basis for Reexamination*

The above [1] is based solely on patents and/or printed publications already cited/considered in an earlier concluded examination of the patent being reexamined. On November 2, 2002, Public Law 107-273 was enacted. Title III, Subtitle A, Section 13105, part (a) of the Act revised the reexamination statute by adding the following new last sentence to 35 U.S.C. 303(a) and 312(a):

"The existence of a substantial new question of patentability is not precluded by the fact that a patent or printed publication was previously cited by or to the Office or considered by the Office."

For any reexamination ordered on or after November 2, 2002, the effective date of the statutory revision, reliance on previously cited/considered art, i.e., "old art," does not necessarily preclude the existence of a substantial new question of patentability (SNQ) that is based exclusively on that old art. Rather, determinations on whether a SNQ exists in such an instance shall be based upon a fact-specific inquiry done on a case-by-case basis.

In the present instance, there exists a SNQ based solely on [2]. A discussion of the specifics now follows:

[3]

Examiner Note:

1. In bracket 1, insert "substantial new question of patentability" if the present form paragraph is used in an order granting reexamination (or a TC Director's decision on petition of the denial of reexamination). If this form paragraph is used in an Office action, insert "ground of rejection".
2. In bracket 2, insert the old art that is being applied as the sole basis of the SNQ. For example, "the patent to Schor" or "the patent to Schor when taken with the Jones publication" or "the combination of the patent to Schor and the Smith publication" could be inserted. Where more than one SNQ is presented based solely on old art, the examiner would insert all such bases for SNQ.
3. In bracket 3, for each basis identified in bracket 2, explain how and why that fact situation applies in the proceeding being acted on. The explanation could be for example that the old art is being presented/viewed in a new light, or in a different way, as compared with its use in the earlier concluded examination(s), in view of a material new argument or interpretation presented in the request. See *Ex parte Chicago Rawhide Mfg. Co.*, 223 USPQ 351 (Bd. Pat. App. & Inter. 1984).
4. This form paragraph is only used the first time the "already cited/considered" art is applied, and is not repeated for the same art in subsequent Office actions.

See MPEP § 2258.01 for a discussion of the use of "old art" in the examination stage of an ordered reexamination (as a basis for rejecting the patent claims).

B. *Prior Adverse Decisions by the Office on the Same or Substantially Identical Prior Art in the Same Patent.*

A prior decision adverse to the patentability of a claim of a patent by the Office based upon prior art patents or printed publications would usually mean that "a substantially new question of patentability" is present. Such an adverse decision by the Office could, for example, arise from a reissue application which was abandoned after rejection of the claim and without disclaiming the patent claim.

C. *Prior Adverse Reissue Application Final Decision by the Director of the USPTO or the Board of Patent Appeals and Interferences Based Upon Grounds Other Than Patents or Printed Publications.*

Any prior adverse final decision by the Director of the USPTO or the Board of Patent Appeals and Interferences, on an application seeking to reissue the

same patent on which reexamination is requested will be considered by the examiner when determining whether or not a “substantial new question of patentability” is present. *>However, to< the extent that such prior adverse final decision was based upon grounds other than patents or printed publications, the prior adverse final decision will not be a basis for determining whether or not a “substantial new question of patentability” is present.

D. *Prior Favorable or Adverse Decisions on the Same or Substantially Identical Prior Art Patents or Printed Publications in Other Cases not Involving the Patent.*

While the Office would consider decisions involving substantially identical patents or printed publications in determining whether a “substantial new question of patentability” is raised, the weight to be given such decisions will depend upon the circumstances.

III. POLICY WHERE A FEDERAL COURT DECISION HAS BEEN ISSUED ON THE PATENT

A. *Final Holding of Validity by the Courts.*

When the initial question as to whether the prior art raises a substantial new question of patentability as to a patent claim is under consideration, the existence of a final court decision of claim *validity* in view of the same or different prior art does not necessarily mean that no new question is present, because of the different standards of proof employed by the Federal District Courts and the Office. While the Office may accord deference to factual findings made by the district court, the determination of whether a substantial new question of patentability exists will be made independently of the court’s decision on validity, because it is not controlling on the Office.

B. *Nonfinal Holding of Invalidity or Unenforceability by the Courts.*

A *nonfinal* holding of claim *invalidity* or *unenforceability* will not be controlling on the question of whether a substantial new question of patentability is present.

C. *Final Holding of Invalidity or Unenforceability by the Courts.*

A *final* holding of claim *invalidity* or *unenforceability*, after all appeals, is controlling on the Office. In such cases, a substantial new question of patentability would *not* be present as to the claims finally held invalid or unenforceable.

As to A. - C. above, see *Ethicon v. Quigg*, 849 F.2d 1422, 7 USPQ2d 1152 (Fed. Cir. 1988).

Any situations requiring clarification should be brought to the attention of the Office of Patent Legal Administration.

2243 Claims Considered in Deciding Request [R-7]

The claims >of the patent< in effect at the time of the determination will be the basis for deciding whether “a substantial new question of patentability” is present. 37 CFR 1.515(a). The Office’s determination in both the order for reexamination and the examination stage of the reexamination will generally be limited solely to a review of the claim(s) for which reexamination was requested. If the requester was interested in having all of the claims reexamined, requester had the opportunity to include them in its request for reexamination. However, if the requester chose not to do so, those claim(s) for which reexamination was not requested will generally not be reexamined by the Office. It is further noted that 35 U.S.C. 302 requires that “[t]he request must set forth the pertinency and manner of applying cited prior art to every claim for which reexamination is requested.” If the requester fails to apply the art to certain claims, then the requester is not statutorily entitled to reexamination of such claims. If a request fails to set forth the pertinency and manner of applying the cited art to any claim for which reexamination is requested as required by 37 CFR 1.510(b), that claim will generally not be reexamined. The decision to reexamine any claim for which reexamination has not been requested lies within the sole discretion of the Office, to be exercised based on the individual facts and situation of each individual case. If the Office chooses to reexamine any claim for which reexamination has not been requested, it is permitted to do so. In addition, the Office may always initiate a reexamination on its own initiative of the non-requested claim (35 U.S.C.

303(a)). Thus, while the examiner will ordinarily concentrate on those claims for which reexamination is requested, the finding of “a substantial new question of patentability” can be based upon a claim of the patent other than the ones for which reexamination is requested. For example, the request might seek reexamination of particular claims, but the examiner is not limited to those claims and can make a determination that “a substantial new question of patentability” is present as to other claims in the patent without necessarily finding “a substantial new question” with regard to the claims for which reexamination was requested.

The decision on the request for reexamination should discuss all of the patent claims requested for reexamination. The examiner should limit the discussion of those claims in the order for reexamination as to whether a substantial new question of patentability has been raised.

See MPEP § 2242 for a discussion of patent claims which have been the subject of a prior decision.

Amendments and/or new claims presented in any copending reexamination or reissue proceeding for the patent to be reexamined will not (see MPEP § 2240, subsection II.) be considered nor commented upon when deciding a request for reexamination. Where a request for reexamination is granted and reexamination is ordered, the first Office action and any subsequent reexamination prosecution should be on the basis of the claims as amended by any copending reexamination or reissue proceeding.

2244 Prior Art on Which the Determination Is Based [R-2]

The determination whether or not “a substantial new question of patentability” is present can be based upon any prior art patents or printed publications. 35 U.S.C. 303(a) and 37 CFR 1.515(a) provide that the determination on a request will be made “with or without consideration of other patents or printed publications,” i.e., other than those relied upon in the request. The examiner is not limited in making the determination based on the patents and printed publications relied on in the request. The examiner can find “a substantial new question of patentability” based upon the prior art patents or printed publications relied on in the request, a combination of the prior art relied on in the request and other prior art

found elsewhere, or based entirely on different patents or printed publications. The primary source of patents and printed publications used in making the determination are those relied on in the request. For reexamination ordered on or after November 2, 2002, see MPEP § 2242, subsection II.A. for a discussion of “old art.” The examiner can also consider any patents and printed publications of record in the patent file from submissions under 37 CFR 1.501 which are in compliance with 37 CFR 1.98 in making the determination. If the examiner believes that additional prior art patents and publications can be readily obtained by searching to supply any deficiencies in the prior art cited in the request, the examiner can perform such an additional search. Such a search should be limited to that area most likely to contain the deficiency of the prior art previously considered and should be made only where there is a reasonable likelihood that prior art can be found to supply any deficiency necessary to “a substantial new question of patentability.”

The determination should be made on the claims in effect at the time the decision is made (37 CFR 1.515(a)).

The Director of the USPTO has the authority to order reexamination only in those cases which raise a substantial new question of patentability. The substantial new question of patentability requirement protects patentees from having to respond to, or participate in unjustified reexaminations. See, e.g., *Patlex Corp. v. Mossinghoff*, 771 F.2d 480, 226 USPQ 985 (Fed. Cir. 1985).

2245 Processing of Decision [R-5]

After the examiner has prepared the decision and proofread and signed the typed version, the reexamination file and decision are given to the Central Reexamination Unit (CRU) Legal Instrument Examiner (LIE) for coordinating the clerical processing carried out by the technical support staff.

The technical support staff then prints the heading on the decision by using the computer terminal. If the request was made by a third party, the technical support staff makes copies for both the patent owner and the requester of any prior art documents not already supplied by or to the patent owner or requester. If the patent owner filed the request, only a patent owner copy is required.

A copy of the decision is then mailed to the patent owner and to any third party, along with any required copies of prior art documents. The original signed copy of the decision and a copy of any prior art enclosed is made of record in the reexamination electronic file (file history).

2246 Decision Ordering Reexamination [R-7]

35 U.S.C. 304. Reexamination order by Director.

If, in a determination made under the provisions of subsection 303(a) of this title, the Director finds that a substantial new question of patentability affecting any claim of a patent is raised, the determination will include an order for reexamination of the patent for resolution of the question. The patent owner will be given a reasonable period, not less than two months from the date a copy of the determination is given or mailed to him, within which he may file a statement on such question, including any amendment to his patent and new claim or claims he may wish to propose, for consideration in the reexamination. If the patent owner files such a statement, he promptly will serve a copy of it on the person who has requested reexamination under the provisions of section 302 of this title. Within a period of two months from the date of service, that person may file and have considered in the reexamination a reply to any statement filed by the patent owner. That person promptly will serve on the patent owner a copy of any reply filed.

37 CFR 1.525. Order for *ex parte* reexamination.

(a) If a substantial new question of patentability is found pursuant to § 1.515 or § 1.520, the determination will include an order for *ex parte* reexamination of the patent for resolution of the question. If the order for *ex parte* reexamination resulted from a petition pursuant to § 1.515(c), the *ex parte* reexamination will ordinarily be conducted by an examiner other than the examiner responsible for the initial determination under § 1.515(a).

(b) The notice published in the *Official Gazette* under § 1.11(c) will be considered to be constructive notice and *ex parte* reexamination will proceed.

If a request for reexamination is granted, the examiner's decision granting the request will conclude that a substantial new question of patentability has been raised by (A) identifying all claims and issues, (B) identifying the patents and/or printed publications relied on, and (C) providing a brief statement of the rationale supporting each new question.

In the examiner's decision, the examiner must identify at least one substantial new question of patentability and explain how the prior art patents and/or printed publications raise such a question. The examiner should indicate, insofar as possible, his or her initial position on all the issues identified in the request

or by the requester (without rejecting claims) so that comment thereon may be received in the patent owner's statement and in the requester's reply. The prior art relied on should be listed on a form PTO-892 if it is not already listed on a form PTO/SB/08A or 08B, or PTO/SB/42 (or on a form having a format equivalent to one of these forms) by the requester. A copy of a reference should be supplied only where it has not been previously supplied to the patent owner and requester.

As to each substantial new question of patentability identified in the decision, the decision should point out:

- (A) The prior art patents and printed publications which add some new teaching as to at least one claim;
- (B) What that new teaching is;
- (C) The claims that the new teaching is directed to;
- (D) That the new teaching was not previously considered nor addressed in the prior examination of the patent or a final holding of invalidity by the Federal Courts;
- (E) That the new teaching is such that a reasonable examiner would consider the new teaching to be important in deciding to allow the claim being considered; and
- (F) Where the question is raised, or where it is not clear that a patent or printed publication pre-dates the patent claims, a discussion should be provided as to why the patent or printed publication is deemed to be available against the patent claims.

See MPEP § 2247.01 for an example of a decision granting a request for reexamination.

In a simple case, the examiner may adopt the reasons provided by the requester in the discussion of the substantial new question of patentability.

The example in MPEP § 2247.01 is drafted for the case where the "request indicates that Requester considers that Claims 1-3 are unpatentable over Smith taken with Jones." There may, however, be a request **that does not indicate the claims to be unpatentable over the art**, but rather that a substantial new question of patentability is raised by the art. This may occur, for example, in a patent owner request filed to address prior art that raises a substantial new question of patentability but the claims are still patentable over the art. **In such an instance**, the decision on the

request should not state that the “request indicates that Requester considers that Claims 1-3 are unpatentable over Smith taken with Jones.” Rather, it should state that the “request indicates that Requester considers that a substantial new question of patentability is raised as to Claims 1-3 based on Smith taken with Jones.”

In the decision on the request, the examiner will not decide, and no statement should be made as to, whether the claims are rejected over the patents and printed publications. The examiner does not decide * the question of patentability of the claims in the decision on the request. The examiner only decides whether there is a substantial new question of patentability to grant the request to order reexamination.

If arguments are raised by a requester (third party or patent owner) as to grounds not based on the patents or printed publications, such as those based on public use or sale, or abandonment under 35 U.S.C. 102(c), the examiner should note that such grounds are improper for reexamination and are not considered or commented upon. See 37 CFR 1.552(c).

The decision granting the request is made on a decision form and must set forth the time periods for the patent owner and requester to file their statement and any reply thereto.

Form paragraph 22.01 should be used at the beginning of each decision letter.

¶ 22.01 *New Question of Patentability*

A substantial new question of patentability affecting claim [1] of United States Patent Number [2] is raised by the request for *ex parte* reexamination.

Extensions of time under 37 CFR 1.136(a) will not be permitted in these proceedings because the provisions of 37 CFR 1.136 apply only to “an applicant” and not to parties in a reexamination proceeding. Additionally, 35 U.S.C. 305 requires that *ex parte* reexamination proceedings “will be conducted with special dispatch” (37 CFR 1.550(a)). Extensions of time in *ex parte* reexamination proceedings are provided for in 37 CFR 1.550(c).

Form paragraph 22.73 should be used at the end of each decision letter.

¶ 22.73 *Correspondence and Inquiry as to Office Actions*

All correspondence relating to this *ex parte* reexamination proceeding should be directed:

By Mail to: Mail Stop *Ex Parte* Reexam
Central Reexamination Unit
Commissioner for Patents
United States Patent & Trademark Office
P.O. Box 1450
Alexandria, VA 22313-1450

By FAX to: (571) 273-9900
Central Reexamination Unit

By hand: Customer Service Window
Randolph Building
401 Dulany Street
Alexandria, VA 22314

Any inquiry concerning this communication should be directed to [1] at telephone number [2].

Examiner Note:

1. This form paragraph is used at the end of *ex parte* reexamination communications.
2. In bracket 1, insert the name of the examiner having charge of the proceeding.
3. In bracket 2, insert the examiner’s telephone number.

I. PANEL REVIEW CONFERENCE

After an examiner has determined that the reexamination proceeding is ready for granting reexamination, the examiner will formulate a draft preliminary order granting reexamination. The examiner will then inform his/her **>Central Reexamination Unit (CRU) Supervisory Patent Examiner (SPE)< of his/her intent to issue an order granting reexamination. The *>CRU SPE< will convene a panel review conference, and the conference members will review the matter. See MPEP § 2271.01 for the make-up of the panel. If the conference confirms the examiner’s preliminary decision to grant reexamination, the proposed order granting reexamination shall be issued and signed by the examiner, with the two other conferees initialing the action (as “conferee”) to indicate their presence in the conference. If the conference does not confirm the examiner’s preliminary decision, the examiner will reevaluate and issue an appropriate communication.

II. PETITION TO VACATE THE ORDER GRANTING REEXAMINATION

A substantive determination by the Director of the USPTO to institute reexamination pursuant to a finding that the prior art patents or printed publications raise a substantial new question of patentability is not subject to review by the courts until a final agency decision in the reexamination proceeding has issued. See *Joy Mfg. Co. v. Nat’l Mine Serv. Co., Inc.*, 810 F.2d 1127, 1 USPQ2d 1627 (Fed. Cir. 1987); *Heinl v. Godici*, 143 F. Supp.2d 593 (E.D.Va. 2001). Note further the decision of *Patlex Corp. v. Quigg*,

680 F. Supp. 33, 35, 6 USPQ2d 1296, 1298 (D.D.C. 1988) (the legislative scheme leaves the Director's 35 U.S.C. 303 determination entirely to his or her discretion and not subject to judicial review until a final agency decision on the reexamination proceeding has issued). Accordingly, neither the patent owner nor the requester has a right to petition, or request reconsideration of, a finding that prior art patents or printed publications raise a substantial new question after a request for reexamination is granted. There is no right to petition such a finding after a request for reexamination is granted even if the finding of a substantial new question is based on reasons other than those urged by the requester (or based on less than all the grounds urged by the requester). Where the examiner determines that a date of a reference is early enough such that the reference constitutes prior art, that determination is not petitionable (with respect to vacating the examiner's finding of a substantial new question). Where the examiner determines that a reference is a printed publication (i.e., that the criteria for publication has been satisfied), that determination is also not petitionable. These matters cannot be questioned with respect to vacating the order granting reexamination until a final agency decision on the reexamination proceeding has issued. Rather, these matters can be argued by the patent owner and appealed during the examination phase of the reexamination proceeding.

A petition under 37 CFR 1.181 may, however, be filed to vacate an *ultra vires* reexamination order, such as where the order for reexamination is not based on prior art patents and printed publications. In cases where no discretion to grant a request for reexamination exists, a petition to vacate the decision to grant, or a request for reconsideration, will be entertained. "Appropriate circumstances" under 37 CFR 1.181(a)(3) exist to vacate the order granting reexamination where, for example:

(A) the reexamination order is not based on prior art patents or printed publications;

(B) all claims of the patent were held to be invalid by a final decision of a Federal Court after all appeals;

(C) reexamination was ordered for the wrong patent;

(D) reexamination was ordered based on a duplicate copy of the request; or

(E) the reexamination order is based wholly on the same question of patentability raised by the prior art previously considered in an earlier concluded examination of the patent by the Office (e.g., the application which matured into the patent, a prior reexamination, an interference proceeding).

As to (E) above, the decision of *In re Recreative Technologies Corp.*, 83 F.3d 1394, 38 USPQ2d 1776 (Fed. Cir. 1996) is to be noted. See the discussion in MPEP § 2242 subsection II.A. as to the criteria for vacating a reexamination order in view of the decision.

When a petition under 37 CFR 1.181 is filed to vacate a reexamination order, the third party requester (where one is present in the reexamination proceeding) may file a single submission in opposition to the petition. Because reexamination proceedings are conducted with special dispatch, 35 U.S.C. 305, any such opposition by the third party requester must be filed within two weeks of the date upon which a copy of the original 37 CFR 1.181 petition was served on the third party requester to ensure consideration. It is advisable that, upon receipt and review of the served copy of such a 37 CFR 1.181 petition which the third party requester intends to oppose, the requester should immediately place a courtesy telephone call to both the **>CRU< support staff and the **>CRU SPE< to notify the Office that an opposition to the 37 CFR 1.181 petition will be filed. Whenever possible, filing of the opposition should be submitted by facsimile transmission.

The filing of a 37 CFR 1.181 petition to vacate an *ultra vires* reexamination order is limited to a single submission, even if an opposition thereto is filed by a third party requester.

II. PRIOR ART SUBMITTED AFTER THE ORDER

Any prior art citations under 37 CFR 1.501 submitted after the date of the decision on the order should be retained in a separate file by the CRU or **>Technology Center (TC) (usually the CRU SPE or the TC Quality Assurance Specialist (QAS))< and stored until the reexamination proceeding is concluded, at which time the prior art citation is then entered of record on the patent file. See MPEP § 2206.

2247 Decision on Request for Reexamination, Request Denied [R-7]

The request for reexamination will be denied if a substantial new question of patentability is not found based on patents or printed publications.

If the examiner concludes that no substantial new question of patentability has been raised, the examiner should prepare a decision denying the reexamination request. Form paragraph 22.02 should be used as the introductory paragraph in a decision denying reexamination.

¶ 22.02 No New Question of Patentability

No substantial new question of patentability is raised by the request for reexamination and prior art cited therein for the reasons set forth below.

The decision denying the request will then indicate, for each patent and printed publication cited in the request, why the citation is:

(A) Cumulative to the teachings of the art cited in the earlier concluded examination of the patent;

(B) Not available against the claims (e.g., the reference is not available as prior art because of its date or the reference is not a publication);

(C) Not important to a reasonable examiner in deciding whether any claim of the patent for which reexamination is requested is patentable, even though the citation is not cumulative and the citation is available against the claim; or

(D) One which was cited in the record of the patent and is barred by the guidelines set forth in MPEP § 2242 subsection II. A.

The examiner should also, in the decision respond to the substance of each argument raised by the requester which is based on patents or printed publications. If arguments are presented as to grounds not based on prior art patents or printed publications, such as those based on public use or on sale under 35 U.S.C. 102(b), or abandonment under 35 U.S.C. 102(c), the examiner should note that such grounds are improper for reexamination and are not considered or commented upon. See 37 CFR 1.552(c).

See MPEP § 2247.01 for an example of a decision denying a request for reexamination. The example in MPEP § 2247.01 is drafted for the case where the “request indicates that Requester considers that Claims 1-2 are unpatentable over Smith taken with

Jones.” There may, however, be a request **that does not indicate the claims to be unpatentable over the art**, but rather that a substantial new question of patentability is raised by the art. This may occur, for example, in a patent owner request filed to address prior art that raises a substantial new question of patentability but the claims are still patentable over the art. **In such an instance**, the decision on the request should not state that the “request indicates that Requester considers that Claims 1-2 are unpatentable over Smith taken with Jones.” Rather, it should state that the “request indicates that Requester considers that a substantial new question of patentability is raised as to Claims 1-2 based on Smith taken with Jones.”

The decision denying a request for reexamination is mailed, and jurisdiction over the reexamination proceeding is retained by the Central Reexamination Unit (CRU) to await any petition seeking review of the examiner’s determination refusing reexamination. If such a petition is not filed within one (1) month of the examiner’s determination denying reexamination, the CRU then processes the reexamination file to provide the partial refund set forth in 37 CFR 1.26(c) (the Office of Finance no longer processes reexamination proceedings for a refund). The reexamination proceeding is then given a 420 status. A copy of the PALM “Application Number Information” screen and the “Contents” screen is printed, the printed copy is annotated by adding the comment “PROCEEDING CONCLUDED,” and the annotated copy is then scanned into IFW using the miscellaneous letter document code.

The concluded reexamination file (electronic or paper) containing the request and the decision denying the request becomes part of the patent’s record.

PANEL REVIEW CONFERENCE

After an examiner has determined that the reexamination proceeding is ready for denying reexamination, the examiner will formulate a draft preliminary order denying reexamination. The examiner will then inform his/her **>CRU Supervisory Patent Examiner (SPE)** of his/her intent to issue an order denying reexamination. The **>CRU SPE** will convene a panel review conference, and the conference members will review the matter. See MPEP § 2271.01 for the make-up of the panel. If the conference confirms the

examiner's preliminary decision to deny reexamination, the proposed order denying reexamination shall be issued and signed by the examiner, with the two other conferees initialing the action (as "conferee") to indicate their presence in the conference. If the conference does not confirm the examiner's preliminary decision, the examiner will reevaluate and issue an appropriate communication.

2247.01 Examples of Decisions on Request for Reexamination [R-7]

Examples of decisions on requests for *ex parte* reexamination are provided below. The first example is a grant of an *ex parte* reexamination. The second example is a denial of an *ex parte* reexamination. The examiner should leave the paper number blank since IFW files do not have a paper number.

Example (1): Decision Granting Request for Reexamination.



**UNITED STATES DEPARTMENT OF COMMERCE
Patent and Trademark Office**

Address: COMMISSIONER OF PATENTS AND TRADEMARKS
Washington, D.C. 20231

CONTROL NUMBER	FILING DATE	PATENT UNDER REEXAMINATION	ATTORNEY DOCKET NO.
----------------	-------------	----------------------------	---------------------

90/999,999 09/09/99 9,999,999

999
EXAMINER

William Dyre
2400 Any Street Road
Anytown, VA 22202

Kenneth Schor
ART UNIT PAPER NUMBER

3725 3
DATE MAILED
09/14/99

ORDER GRANTING/DENYING REQUEST FOR REEXAMINATION

The request for reexamination has been considered. Identification of the claims, the references relied on, and the rationale supporting the determination are attached.

Attachment(s) PTO-892 PTO-1449 Other: _____

1. The request for reexamination is GRANTED.

RESPONSE TIMES ARE SET TO EXPIRE AS FOLLOWS:

For Patent Owner's Statement (optional): TWO MONTHS from the mailing date hereof. 37 CFR 1.530(b). EXTENSIONS OF TIME ARE GOVERNED BY 37 CFR 1.550(c).

For Requester's reply (optional): TWO MONTHS from the date of service of any patent owner's statement. 37 CFR 1.535. NO EXTENSION OF TIME IS PERMITTED. If patent owner does not file a timely statement under 37 CFR 1.530(b), no reply by requester is permitted.

2. The request for reexamination is DENIED.

This decision is not appealable. 35 U.S.C. 303(c). Requester may seek review by petition to the Commissioner within ONE MONTH from the mailing date hereof. 37 CFR 1.515(c). EXTENSIONS OF TIME ONLY UNDER 37 CFR 1.183.

In due course, a refund under 37 CFR 1.26(c) will be made to requester (listed below if not patent owner)
 by Treasury check by credit to Deposit Account No. _____
unless notified otherwise. 35 U.S.C. 303(c).

(Third party requester's correspondence address)

John Doe
12 Seemore Street
Any City, New York 10001

DECISION

A substantial new question of patentability affecting Claims 1 - 3 of United States Patent Number 9,999,999 to Key is raised by the request for reexamination.

Extensions of time under 37 CFR 1.136(a) will not be permitted in these proceedings because the provisions of 37 CFR 1.136 apply only to “an applicant” and not to parties in a reexamination proceeding. Additionally, Office policy requires that reexamination proceedings “will be conducted with special dispatch” (37 CFR 1.550(a)) and provides for extensions of time in reexamination proceedings as set forth in 37 CFR 1.550(c).

The patent owner is reminded of the continuing responsibility under 37 CFR 1.565(a), to apprise the Office of any litigation activity, or other prior or concurrent proceeding, involving Patent No. 9,999,999 throughout the course of this reexamination proceeding.

The request *>sets forth< that Requester considers that Claims 1 - 3 are unpatentable over Smith taken with Jones.

The request further *>sets forth< that Requester considers that Claim 4 is unpatentable over the Horn publication.

It is agreed that the consideration of Smith raises a substantial new question of patentability as to Claims 1 - 3 of the Key patent. As pointed out on pages 2 - 3 of the request, Smith teaches using an extruder supported on springs at a 30 degree angle to the horizontal but does not teach the specific polymer of Claims 1 - 3 which is extruded. The teaching as to spring-supporting the extruder at 30 degrees was not present in the prosecution of the application which became the Key patent. Further, there is a substantial likelihood that a reasonable examiner would consider this teaching important in deciding whether or not the claim is patentable. Accordingly, Smith raises a substantial new question of patentability as to Claims 1 - 3, which question has not been decided in a previous examination of the Key patent.

The Horn publication does not raise a new question of patentability as to Claim 4 because its teaching as to the extrusion die is a substantial equivalent of the teaching of the die by the Dorn patent which was considered in the prosecution of the application which became the Key patent. **>Accordingly, claim 4 will not be reexamined.

Finally, reexamination has not been requested for claims 5 – 20 of the Key patent. Accordingly, claims 5 – 20 will not be reexamined.

Claims 1 – 3 of the Key patent will be reexamined.<

All correspondence relating to this *ex parte* reexamination proceeding should be directed:

By Mail to: Mail Stop *Ex Parte* Reexam
 Attn: Central Reexamination Unit
 Commissioner for Patents
 United States Patent & Trademark Office
 P.O. Box 1450
 Alexandria, VA 22313-1450

By FAX to: (571) 273-9900
Central Reexamination Unit

By hand: Customer Service Window
Randolph Building
401 Dulany Street
Alexandria, VA 22314

Any inquiry concerning this communication should be directed to Kenneth Schor at telephone number (571) 272-0000.

Kenneth M. Schor
Kenneth M. Schor
Primary Examiner
>CRU< Art Unit *>3998<

ARI
Conferee

BZ
Conferee

Example (2): Decision Denying Request for Reexamination



**UNITED STATES DEPARTMENT OF COMMERCE
Patent and Trademark Office**

Address: COMMISSIONER OF PATENTS AND TRADEMARKS
Washington, D.C. 20231

CONTROL NUMBER	FILING DATE	PATENT UNDER REEXAMINATION	ATTORNEY DOCKET NO.
-----------------------	--------------------	-----------------------------------	----------------------------

90/999,999 09/09/99 9,999,999

999
EXAMINER

William Dyre
2400 Any Street Road
Anytown, VA 22202

Kenneth Schor
ART UNIT PAPER NUMBER

3725 3
DATE MAILED
09/14/99

ORDER GRANTING/DENYING REQUEST FOR REEXAMINATION

The request for reexamination has been considered. Identification of the claims, the references relied on, and the rationale supporting the determination are attached.

Attachment(s) PTO-892. PTO-1449. Other: _____

1. The request for reexamination is GRANTED.

RESPONSE TIMES ARE SET TO EXPIRE AS FOLLOWS:

For Patent Owner's Statement (optional): TWO MONTHS from the mailing date hereof. 37 CFR 1.530(b).
EXTENSIONS OF TIME ARE GOVERNED BY 37 CFR 1.550(c).

For Requester's reply (optional): TWO MONTHS from the date of service of any patent owner's statement.
37 CFR 1.535. **NO EXTENSION OF TIME IS PERMITTED.** If patent owner does not file a timely statement
under 37 CFR 1.530(b), no reply by requester is permitted.

2. The request for reexamination is DENIED.

This decision is not appealable. 35 U.S.C. 303(c). Requester may seek review by petition to the Commissioner
within ONE MONTH from the mailing date hereof. 37 CFR 1.515(c). **EXTENSIONS OF TIME ONLY
UNDER 37 CFR 1.183.**

In due course, a refund under 37 CFR 1.26(c) will be made to requester (listed below if not patent owner)

by Treasury check by credit to Deposit Account No. _____
unless notified otherwise. 35 U.S.C. 303(e).

(Third party requester's correspondence address)

John Doe
12 Seemore Street
Any City, New York 10001

DECISION

No substantial new question of patentability is raised by the request for reexamination and prior art cited therein for the reasons set forth below.

The request indicates that Requester considers that a substantial new question of patentability is raised as to Claims 1 - 2 based on Smith taken with Jones.

The request further indicates that Requester considers that a substantial new question of patentability is raised as to Claim 3 based on Smith taken with Jones and when further taken with the Horn publication.

The claims of the Key patent, for which reexamination is requested, require that an extruder be supported on springs at an angle of 30 degrees to the horizontal, while a specific chlorinated polymer is extruded through a specific extrusion die.

The Smith patent does not raise a substantial new question of patentability as to the Key claims. Smith's teaching as to the extruder being spring-supported at 30 degrees is a substantial equivalent of the teaching of same by the Dorn patent which was considered in the prosecution of the application which became the Key patent.

In the request for reexamination, it is argued that Jones teaches the extrusion die. However, Jones was also used in the prosecution of the Key application to teach the extrusion die.

The request argued that the Horn publication shows the connection of the support means to the extruder via bolts, as recited in Claim 3 of the Key patent. Although this teaching was not provided in the prosecution of the Key application, the teaching would not be considered to be important to a reasonable examiner in deciding whether or not the Key claims are patentable. The use of a bolt instead of a screw (which was taught by the art of record in the Key application) to provide the connection has not been shown in the request to be important in the context of attaching the support means to the extruder.

The references set forth in the request have been considered both alone and in combination. They fail to raise a substantial new question of patentability as to any one of the Key patent claims. Accordingly, the request for reexamination is DENIED.

All correspondence relating to this *ex parte* reexamination proceeding should be directed:

By Mail to: Mail Stop *Ex Parte* Reexam
Attn: Central Reexamination Unit
Commissioner for Patents
United States Patent & Trademark Office
P.O. Box 1450
Alexandria, VA 22313-1450

By FAX to: (571) 273-9900
Central Reexamination Unit

By hand: Customer Service Window
Randolph Building
401 Dulany Street
Alexandria, VA 22314

Any inquiry concerning this communication should be directed to Kenneth Schor at telephone number (571) 272-0000.

Kenneth M. Schor
Kenneth M. Schor
Primary Examiner
>CRU< Art Unit *>3998<

ARI
Conferee

BZ
Conferee

2248 Petition From Denial of Request [R-7]

37 CFR 1.515. Determination of the request for *ex parte* reexamination.

(c) The requester may seek review by a petition to the Director under § 1.181 within one month of the mailing date of the examiner's determination refusing *ex parte* reexamination. Any such petition must comply with § 1.181(b). If no petition is timely filed or if the decision on petition affirms that no substantial new question of patentability has been raised, the determination shall be final and nonappealable.

PROCESSING OF PETITION UNDER 37 CFR 1.515(c)

After a request for reexamination has been denied, jurisdiction over the reexamination proceeding is retained by the Central Reexamination Unit (CRU), to await the possibility of a petition seeking review of the examiner's determination refusing reexamination. If a petition seeking review of the examiner's determination refusing reexamination is not filed within one (1) month of the examiner's determination, the CRU will then process the reexamination file as a concluded reexamination file. See MPEP § 2247 and § 2294.

If a petition seeking review of the examiner's determination refusing reexamination is filed, it is forwarded (together with the reexamination file) to the Office of the CRU Director for decision. Where a petition is filed, the CRU Director will review the examiner's determination that a substantial new question of patentability has not been raised. The CRU Director's review will be *de novo*. Each decision by the CRU Director will conclude with the paragraph:

This decision is final and nonappealable. See 35 U.S.C. 303(c) and 37 CFR 1.515(c). No further communication on this matter will be acknowledged or considered.

If the petition is granted, the decision of the CRU Director should include a sentence setting a 2-month period for filing a statement under 37 CFR 1.530; the reexamination file will then be returned to the **>CRU Supervisory Patent Examiner (SPE)< of the art unit that will handle the reexamination for consideration of reassignment to another examiner.

Reassignment will be the general rule. Only in exceptional circumstances where no other examiner is

available and capable to give a proper examination, will the case remain with the examiner who denied the request.

Under normal circumstances, the reexamination proceeding will not be reassigned to a primary examiner or assistant examiner who was involved in any part of the examination of the patent for which reexamination is requested. Only where unusual circumstances are found to exist may the CRU Director make an exception to this practice and reassign the reexamination proceeding to an examiner involved with the examination of the patent. For example, if the original examiner of the patent and the examiner who issued the denial are the only examiners with adequate knowledge of the relevant technology, the CRU Director may permit reassignment of the reexamination proceeding to the examiner that originally examined the patent.

The requester may seek review of a *denial* of a request for reexamination only by petitioning the Director of the USPTO under 37 CFR 1.515(c) and 1.181 within 1 month of the mailing date of the decision denying the request for reexamination. Additionally, any request for an extension of the time period to file such a petition from the >examiner's< denial of a request for reexamination can only be entertained by filing a petition under 37 CFR 1.183 with appropriate fee to waive the time provisions of 37 CFR 1.515(c).

After the time for petition has expired without a petition having been filed, or a petition has been filed and the decision thereon affirms the denial of the request, a partial refund of the filing fee for requesting reexamination will be made to the requester. (35 U.S.C. 303(c) and 37 CFR 1.26(c)). A decision on a petition under 37 CFR 1.515(c) is final and is not appealable.

37 CFR 1.515(c) applies only where reexamination is denied; it does not apply to a grant of reexamination where either the patent owner or the requester is not satisfied with one or more findings made in a decision granting reexamination. Except for the limited exception described in MPEP § 2246, no petition may be filed requesting review of a decision *granting* a request for reexamination, even if the decision grants the request as to a specific claim for reasons other than those advanced by the requester. No right to review exists as to that claim, because it will be reex-

amined in view of all prior art during the reexamination under 37 CFR 1.550.

2249 Patent Owner's Statement [R-7]

37 CFR 1.530. *Statement by patent owner in ex parte reexamination; amendment by patent owner in ex parte or inter partes reexamination; inventorship change in ex parte or inter partes reexamination.*

(a) **>Except as provided in § 1.510(e), no statement or other response by the patent owner in an *ex parte* reexamination proceeding shall be filed prior to the determinations made in accordance with § 1.515 or § 1.520. If a premature statement or other response is filed by the patent owner, it will not be acknowledged or considered in making the determination, and it will be returned or discarded (at the Office's option).<

(b) The order for *ex parte* reexamination will set a period of not less than two months from the date of the order within which the patent owner may file a statement on the new question of patentability, including any proposed amendments the patent owner wishes to make.

(c) Any statement filed by the patent owner shall clearly point out why the subject matter as claimed is not anticipated or rendered obvious by the prior art patents or printed publications, either alone or in any reasonable combinations. Where the reexamination request was filed by a third party requester, any statement filed by the patent owner must be served upon the *ex parte* reexamination requester in accordance with § 1.248.

The patent owner has no right to file a statement subsequent to the filing of the request but prior to the order for reexamination. Any such premature statement will not be acknowledged nor considered by the Office when making the decision on the request >and will be returned or discarded at the option of the Office<. See MPEP § 2225 and *Patlex Corp. v. Mossinghoff*, 771 F.2d 480, 226 USPQ 985 (Fed. Cir. 1985).

If reexamination is ordered, the decision will set a period of not less than 2 months within which period the patent owner may file a statement and any narrowing amendments to the patent claims. If necessary, an extension of time beyond the 2 months may be requested under 37 CFR 1.550(c) by the patent owner. Such request is decided by the Technology Center (TC) or Central Reexamination Unit (CRU) Director.

Any statement filed must clearly point out why the patent claims are believed to be patentable, considering the cited prior art patents or printed publications alone or in any reasonable combination.

A copy of the statement must be served by the patent owner on the requester, unless the request was filed by the patent owner.

In the event the decision is made to reexamine, 35 U.S.C. 304 provides that the owner will have a period, not less than 2 months, to file a statement directed to the issue of patentability. Since the 2-month period is the minimum provided by statute, first extensions may be granted up to one (1) month based upon good and sufficient reasons. Further extensions should be granted only in the most extraordinary situations; e.g., death or incapacitation of the representative or owner.

Lack of proof of service especially poses a problem where the patent owner fails to indicate that he or she has served the requester in the statement subsequent to the order for reexamination (37 CFR 1.530(c)). In this situation, the Reexamination Clerk should immediately contact the patent owner by telephone to see whether the indication of proof of service was inadvertently omitted from the patent owner's response. If it was, the patent owner should be advised to submit a supplemental paper indicating the manner and date of service on requester. If the patent owner cannot be contacted, the Reexamination Clerk will then contact the requester to verify that service has in fact been made by the patent owner and indicate that acknowledgment of proof of service should accompany requester's reply (37 CFR 1.248(b)(1)). If the 2-month period for response under 37 CFR 1.530 has expired and requester has not been served, the patent owner's statement is considered inappropriate (37 CFR 1.248) and may be denied consideration; see MPEP § 2267.

See also MPEP § 2266.03 for further discussion as to the patent owner providing service on the third party requester.

It should be noted that the period for response by requester for a reply under 37 CFR 1.535 is 2 months from the owner's service date and not 2 months from the date the patent owner's statement was received in the Office.

Where the patent owner has determined that a statement under 37 CFR 1.530 will not be filed, the patent owner may expedite the reexamination proceeding by filing a paper that indicates that the patent owner waives the filing of a statement under 37 CFR 1.530 and serving the waiver on the requester, if any. This

will permit reexamination of the proceeding to proceed pursuant to 37 CFR 1.550(a).

2250 Amendment by Patent Owner [R-7]

37 CFR 1.121. *Manner of making amendments in application.*

(j) *Amendments in reexamination proceedings.* Any proposed amendment to the description and claims in patents involved in reexamination proceedings must be made in accordance with § 1.530.

37 CFR 1.530. *Statement by patent owner in ex parte reexamination; amendment by patent owner in ex parte or inter partes reexamination; inventorship change in ex parte or inter partes reexamination.*

(d) *Making amendments in a reexamination proceeding.* A proposed amendment in an *ex parte* or an *inter partes* reexamination proceeding is made by filing a paper directing that proposed specified changes be made to the patent specification, including the claims, or to the drawings. An amendment paper directing that proposed specified changes be made in a reexamination proceeding may be submitted as an accompaniment to a request filed by the patent owner in accordance with § 1.510(e), as part of a patent owner statement in accordance with paragraph (b) of this section, or, where permitted, during the prosecution of the reexamination proceeding pursuant to § 1.550(a) or § 1.937.

(1) *Specification other than the claims.* Changes to the specification, other than to the claims, must be made by submission of the entire text of an added or rewritten paragraph including markings pursuant to paragraph (f) of this section, except that an entire paragraph may be deleted by a statement deleting the paragraph, without presentation of the text of the paragraph. The precise point in the specification must be identified where any added or rewritten paragraph is located. This paragraph applies whether the amendment is submitted on paper or compact disc (*see* §§ 1.96 and 1.825).

(2) *Claims.* An amendment paper must include the entire text of each patent claim which is being proposed to be changed by such amendment paper and of each new claim being proposed to be added by such amendment paper. For any claim changed by the amendment paper, a parenthetical expression “amended,” “twice amended,” *etc.*, should follow the claim number. Each patent claim proposed to be changed and each proposed added claim must include markings pursuant to paragraph (f) of this section, except that a patent claim or proposed added claim should be canceled by a statement canceling the claim, without presentation of the text of the claim.

(3) *Drawings.* Any change to the patent drawings must be submitted as a sketch on a separate paper showing the proposed changes in red for approval by the examiner. Upon approval of the changes by the examiner, only new sheets of drawings including the changes and in compliance with § 1.84 must be filed.

Amended figures must be identified as “Amended,” and any added figure must be identified as “New.” In the event a figure is canceled, the figure must be surrounded by brackets and identified as “Canceled.”

(4) The formal requirements for papers making up the reexamination proceeding other than those set forth in this section are set out in § 1.52.

(e) *Status of claims and support for claim changes.* Whenever there is an amendment to the claims pursuant to paragraph (d) of this section, there must also be supplied, on pages separate from the pages containing the changes, the status (*i.e.*, pending or canceled), as of the date of the amendment, of all patent claims and of all added claims, and an explanation of the support in the disclosure of the patent for the changes to the claims made by the amendment paper.

(f) *Changes shown by markings.* Any changes relative to the patent being reexamined which are made to the specification, including the claims, must include the following markings:

(1) The matter to be omitted by the reexamination proceeding must be enclosed in brackets; and

(2) The matter to be added by the reexamination proceeding must be underlined.

(g) *Numbering of patent claims preserved.* Patent claims may not be renumbered. The numbering of any claims added in the reexamination proceeding must follow the number of the highest numbered patent claim.

(h) *Amendment of disclosure may be required.* The disclosure must be amended, when required by the Office, to correct inaccuracies of description and definition, and to secure substantial correspondence between the claims, the remainder of the specification, and the drawings.

(i) *Amendments made relative to patent.* All amendments must be made relative to the patent specification, including the claims, and drawings, which are in effect as of the date of filing the request for reexamination.

(j) *No enlargement of claim scope.* No amendment may enlarge the scope of the claims of the patent or introduce new matter. No amendment may be proposed for entry in an expired patent. Moreover, no amendment, other than the cancellation of claims, will be incorporated into the patent by a certificate issued after the expiration of the patent.

(k) *Amendments not effective until certificate.* Although the Office actions will treat proposed amendments as though they have been entered, the proposed amendments will not be effective until the reexamination certificate is issued and published.<

37 CFR 1.52. *Language, paper, writing, margins, compact disc specifications.*

(a) *Papers that are to become a part of the permanent United States Patent and Trademark Office records in the file of a patent application or a reexamination proceeding.*

(1) All papers, other than drawings, that are submitted on paper or by facsimile transmission, and are to become a part of the permanent United States Patent and Trademark Office records in the file of a patent application or reexamination proceeding, must

be on sheets of paper that are the same size, not permanently bound together, and:

- (i) Flexible, strong, smooth, non-shiny, durable, and white;
- (ii) Either 21.0 cm by 29.7 cm (DIN size A4) or 21.6 cm by 27.9 cm (8 1/2 by 11 inches), with each sheet including a top margin of at least 2.0 cm (3/4 inch), a left side margin of at least 2.5 cm (1 inch), a right side margin of at least 2.0 cm (3/4 inch), and a bottom margin of at least 2.0 cm (3/4 inch);
- (iii) Written on only one side in portrait orientation;
- (iv) Plainly and legibly written either by a typewriter or machine printer in permanent dark ink or its equivalent; and
- (v) Presented in a form having sufficient clarity and contrast between the paper and the writing thereon to permit the direct reproduction of readily legible copies in any number by use of photographic, electrostatic, photo-offset, and microfilming processes and electronic capture by use of digital imaging and optical character recognition.

(2) All papers that are submitted on paper or by facsimile transmission and are to become a part of the permanent records of the United States Patent and Trademark Office should have no holes in the sheets as submitted.

(3) The provisions of this paragraph and paragraph (b) of this section do not apply to the pre-printed information on paper forms provided by the Office, or to the copy of the patent submitted on paper in double column format as the specification in a reissue application or request for reexamination.

(4) See § 1.58 for chemical and mathematical formulae and tables, and § 1.84 for drawings.

(5) Papers that are submitted electronically to the Office must be formatted and transmitted in compliance with the Office's electronic filing system requirements.

(b) *The application (specification, including the claims, drawings, and oath or declaration) or reexamination proceeding and any amendments or corrections to the application or reexamination proceeding.*

(1) The application or proceeding and any amendments or corrections to the application (including any translation submitted pursuant to paragraph (d) of this section) or proceeding, except as provided for in § 1.69 and paragraph (d) of this section, must:

- (i) Comply with the requirements of paragraph (a) of this section; and
- (ii) Be in the English language or be accompanied by a translation of the application and a translation of any corrections or amendments into the English language together with a statement that the translation is accurate.

(2) The specification (including the abstract and claims) for other than reissue applications and reexamination proceedings, and any amendments for applications (including reissue applications) and reexamination proceedings to the specification, except as provided for in §§ 1.821 through 1.825, must have:

- (i) Lines that are 1 1/2 or double spaced;
- (ii) Text written in a nonscript type font (e.g., Arial, Times Roman, or Courier, preferably a font size of 12) lettering style having capital letters which should be at least 0.3175 cm. (0.125 inch) high, but may be no smaller than 0.21 cm. (0.08 inch) high (e.g., a font size of 6); and

(iii) Only a single column of text.

(3) The claim or claims must commence on a separate physical sheet or electronic page (§ 1.75(h)).

(4) The abstract must commence on a separate physical sheet or electronic page or be submitted as the first page of the patent in a reissue application or reexamination proceeding (§ 1.72(b)).

Amendments to the patent (one which has not expired) may be filed by the patent owner with his or her request. See MPEP § 2221. Such amendments, however, may not enlarge the scope of a claim of the patent or introduce new matter. Amended or new claims which broaden or enlarge the scope of a claim of the patent should be rejected under 35 U.S.C. 305. The test for when an amended or "new claim enlarges the scope of an original claim under 35 U.S.C. 305 is the same as that under the 2-year limitation for reissue applications adding enlarging claims under 35 U.S.C. 251, last paragraph." *In re Freeman*, 30 F.3d 1459, 1464, 31 USPQ2d 1444, 1447 (Fed. Cir. 1994). See MPEP § 2258 for a discussion of enlargement of claim scope. For handling of new matter, see MPEP § 2270. Amendments proposed in a reexamination will normally be entered and be considered to be entered for purposes of prosecution before the Office (if they are timely and comply with the rules); however, the amendments do not become effective in the patent until the reexamination certificate under 35 U.S.C. 307 is issued >and published<.

No amendment will be permitted where the certificate issues after expiration of the patent. See 37 CFR 1.530(d)(3). The patent expiration date for a utility patent, for example, is determined by taking into account the term of the patent, whether maintenance fees have been paid for the patent, whether any disclaimer was filed as to the patent to shorten its term, any patent term extensions or adjustments for delays within the USPTO under 35 U.S.C. 154 (see MPEP § 2710 *et seq.*), and any patent term extensions available under 35 U.S.C. 156 for premarket regulatory review (see MPEP § 2750 *et seq.*). Any other relevant information should also be taken into account.

Amendment Entry — Amendments which comply with 37 CFR 1.530(d)-(j) (and are formally presented pursuant to 37 CFR 1.52(a) and (b), and contain all fees required by 37 CFR 1.20(c)) will be entered in

the reexamination file pursuant to the guidelines set forth in MPEP § 2234.

I. MANNER OF MAKING AMENDMENTS IN REEXAMINATION PROCEEDINGS

Amendments made in a reexamination proceeding must comply with the formal requirements of 37 CFR 1.52(a) and (b), as do all papers that are to become a part of the permanent USPTO file records in a patent application or proceeding. If an amendment is submitted to add claims to the patent being reexamined (i.e., to provide new claims), then excess claim fees pursuant to 37 CFR 1.20(c)(3) and (4) may be applicable to the presentation of the added claims. See MPEP § 2250.03. In addition, the provisions of 37 CFR 1.530(d)-(k) uniquely apply to amendments in both *ex parte* and *inter partes* reexamination proceedings, as follows.

A. *The Specification*

37 CFR 1.530(d)(1) relates to the manner of making amendments to the reexamination “specification” (other than the claims). It is not to be used for making amendments to the claims or the drawings.

37 CFR 1.530(d)(1) requires that all amendments, which include any deletions or additions, must be made by submission of the full text of any paragraph to be changed in any manner, with markings (brackets and underlining) showing the changes. It should be noted that examiner’s amendments made at the time when the Notice of Intent to Issue Reexamination Certificate (NIRC) is prepared also require the full text of any paragraph to be changed, with markings. The exception for examiner’s amendment set forth in 37 CFR 1.121(g) does **not** apply to examiner’s amendments in reexamination proceedings. It should further be noted that the requirement of 37 CFR 1.530(d)(1) applies regardless of whether the amendment is submitted on paper or on compact disc (pursuant to 37 CFR 1.96 or 1.825). The only exception to this requirement is that an entire paragraph of specification text may be deleted from the specification by a statement deleting the paragraph without the presentation of the text of the paragraph.

In accordance with 37 CFR 1.530(d)(1), all paragraphs which are added to the specification must be submitted as completely underlined.

37 CFR 1.530(d)(1) requires that the precise point where each amendment is to be made must be indicated.

37 CFR 1.530(d)(1) defines the “markings” by reference to 37 CFR 1.530(f) as being brackets for deletion and underlining for addition. All bracketing and underlining is made in comparison to the original patent; not in comparison with the prior amendment.

Where a change is made in one sentence, paragraph or page of the patent, and the change increases or decreases the size of the sentence, paragraph or page, this will have no effect on the body of the reexamination “specification” (the copy of the patent). This is because all insertions are made as blocked additions of paragraphs, which are not physically inserted within the specification papers. Rather, each blocked paragraph is assigned a letter and number, and a caret written in the specification papers indicates where the blocked paragraph is to be incorporated. Therefore, a reexamination patent owner need not be concerned with page formatting considerations when presenting amendments to the Office.

B. *The Claims*

37 CFR 1.530(d)(2) relates to the manner of making amendments to the claims in a reexamination proceeding. It is not to be used for making amendments to the remainder of the specification or to the drawings.

37 CFR 1.530(d)(2) requires that:

(A) for each claim that is proposed to be amended by the amendment paper being submitted (the current amendment paper), the entire text of the claim must be presented with appropriate markings showing the changes to the claim;

(B) for each proposed new claim which is added in the reexamination by the amendment paper being submitted (the current amendment paper), the entire text of the proposed new claim must be presented and it must be underlined throughout;

(C) a patent claim is canceled by a direction to cancel that claim, there is no need to present the text of the patent claim surrounded by brackets; and

(D) a proposed new claim (previously added in the reexamination) is canceled by a direction to cancel that claim.

It should be noted that examiner's amendments made at the time when the Notice of Intent to Issue Reexamination Certificate (NIRC) is prepared also require the full text of any claim to be changed, with markings. The exception for examiner's amendment set forth in 37 CFR 1.121(g) does **not** apply to examiner's amendments in reexamination proceedings. It should further be noted that the requirements of 37 CFR 1.530(d)(2) apply regardless of whether the amendment is submitted on paper or on compact disc (pursuant to 37 CFR 1.96 or 1.825).

In accordance with 37 CFR 1.530(e), each amendment submitted must set forth the status of all patent claims and all added claims as of the date of the submission. The status to be set forth is whether the claim is pending, or canceled. The failure to submit the claim status will generally result in a notification to the patent owner of an informal response (see MPEP § 2266.02) prior to final rejection. Such an amendment submitted after final rejection will not be entered.

Also in accordance with 37 CFR 1.530(e), each claim amendment must be accompanied by an explanation of the support in the disclosure of the patent for the amendment (i.e., support for the changes made in the claim(s), support for any insertions and deletions). The failure to submit an explanation will generally result in a notification to the patent owner that the amendment prior to final rejection is not completely responsive since the failure to set forth the support in the disclosure goes to the merits of the case (see MPEP § 2266.01). Such an amendment submitted after final rejection will not be entered.

37 CFR 1.530(f) identifies the type of markings required in the claim to be amended as underlining for added material and single brackets for material deleted.

37 CFR 1.530(g) states that original patent claims may not be renumbered. A patent claim retains its number even if it is canceled in the reexamination proceeding, and the numbering of any added claims must begin after the last original patent claim.

C. The Drawings

With respect to amendment of the drawings in a reexamination proceeding, see MPEP § 2250.01.

Form paragraph 22.12 may be used to advise patent owner of the proper manner of making amendments in an *ex parte* reexamination proceeding.

D. Form Paragraphs - Ex Parte Reexamination

¶ 22.12 Amendments Proposed in a Reexamination - 37 CFR 1.530(d)-(j)

Patent owner is notified that any proposed amendment to the specification and/or claims in this reexamination proceeding must comply with 37 CFR 1.530(d)-(j), must be formally presented pursuant to 37 CFR 1.52(a) and (b), and must contain any fees required by 37 CFR 1.20(c).

Examiner Note:

This paragraph may be used in the order granting reexamination and/or in the first Office action to advise patent owner of the proper manner of making amendments in a reexamination proceeding.

¶ 22.13 Improper Amendment in an Ex Parte Reexamination - 37 CFR 1.530(d)-(j)

The amendment filed [1] proposes amendments to [2] that do not comply with 37 CFR 1.530(d)-(j), which sets forth the manner of making amendments in reexamination proceedings. A supplemental paper correctly proposing amendments in the present *ex parte* reexamination proceeding is required.

A shortened statutory period for response to this letter is set to expire ONE MONTH or THIRTY DAYS, whichever is longer, from the mailing date of this letter. If patent owner fails to timely correct this informality, the amendment will be held not to be an appropriate response, prosecution of the present *ex parte* reexamination proceeding will be terminated, and a reexamination certificate will issue. 37 CFR 1.550(d).

Examiner Note:

This paragraph may be used for any 37 CFR 1.530(d)-(j) informality as to a proposed amendment submitted in a reexamination proceeding prior to final rejection. After final rejection, the amendment should not be entered and patent owner informed of such in an advisory Office action using Form PTOL 467.

The cover sheet to be used for mailing the notification to the patent owner will be PTOL-473.

As an alternative to using form paragraph 22.13, it would also be appropriate to use form PTOL-475.

Note that if the informal amendment is submitted after final rejection, form paragraph 22.13 and form PTOL-475 should not be used. Rather an advisory Office action (using form PTOL-467) should be issued indicating that the amendment was not entered. In the "Other" section, it should be explained that the amendment was not entered because it does not comply with 37 CFR 1.530(d)-(j), which sets forth the

manner of making amendments in reexamination proceedings.

E. Form Paragraphs - Inter Partes Reexamination

See MPEP § 2666.01 for the form paragraphs to use in *inter partes* reexamination proceedings, in advising the patent owner as to the manner of making amendments.

II. ALL CHANGES ARE MADE VIS-A-VIS THE PATENT BEING REEXAMINED

When a reexamination certificate is printed, all underlined matter is printed in italics and all brackets are printed as they were inserted in the proceeding in order to thereby show exactly which additions and deletions have been made in the patent via the reexamination proceeding. In accordance with 37 CFR 1.530(i), all amendments to the patent being reexamined must be made relative to the patent specification in effect as of the date of the filing of the request for reexamination. The patent specification includes the claims and drawings. If there was a prior change to the patent (made via a >concluded post-patent proceeding, e.g., < prior reexamination certificate, reissue of the patent, certificate of correction, etc.), the first amendment must be made relative to the patent specification as changed by the prior proceeding or other mechanism for changing the patent. All amendments subsequent to the first amendment must also be made relative to the patent specification in effect as of the date of the filing of the request for reexamination, and not relative to the prior amendment. >In those rare instances where a concluded post-patent proceeding changes the patent while the reexamination proceeding is pending, amendments will be made relative to the patent, as revised by the concluded proceeding, and 37 CFR 1.530(i) is waived to that extent.<

III. AMENDMENT AFTER THE PATENT HAS EXPIRED

Pursuant to 37 CFR 1.530(j), “[n]o amendment may be proposed for entry in an expired patent.” Thus, if a patent expires during the pendency of a reexamination proceeding for a patent, all amendments to the patent claims and all claims added during the proceeding are withdrawn. This is carried out by placing a diagonal line across all amended and new

claims (and text added to the specification) residing in the amendment papers. The patent owner should be notified of this in the next Office action. The Office action will hold the amendments to be improper, and state that all subsequent reexamination will be on the basis of the unamended patent claims. This procedure is necessary since no amendments will be incorporated into the patent by a certificate after the expiration of the patent.

37 CFR 1.530(j) further states that “[m]oreover, no amendment, other than the cancellation of claims, will be incorporated into the patent by a certificate issued after the expiration of the patent.”

Thus, at the time the NIRC is to be issued, the examiner should ensure that all rejected and objected to claims are canceled. The examiner should issue an examiner’s amendment canceling any such claims not already canceled.

The cancellation of the original patent claims is the only “amendatory” change permitted in an expired patent.

IV. EXAMPLES

A substantial number of problems arise in the Office because of improper submission of proposed amendments in reexamination proceedings. The following examples are provided to assist in the preparation of proper proposed amendments in reexamination proceedings.

(A) Original Patent Description or Patent Claim Amended

(1) Specification - submit a copy of the entire paragraph (of the specification of the patent) being amended with underlining and bracketing. Thus, the amendment would be presented as follows:

Replace the paragraph beginning at column 4, line 23 with the following:

Scanning [is] are controlled by clocks which are, in turn, controlled from the display tube line synchronization. The signals resulting from scanning the scope of the character are delivered in parallel, then converted into serial mode through a shift register, wherein the shift signal frequency is controlled by a clock that is controlled from the display tube line synchronization.

(2) Claims - for changes to the patent claims, one must submit a copy of the entire patent claim with the amendments shown by underlining and bracket-

ing. Thus, the amendment would be presented as follows:

Amend claim 6 as follows:

Claim 6. (amended), The apparatus of claim [5] 1 wherein the [first] second piezoelectric element is parallel to the [second] third piezoelectric element.

If the dependency of any original patent claim is to be changed by amendment, it is proper to make that original patent claim dependent upon a later filed higher numbered claim.

(B) Cancellation of Entire Claim(s)

(1) Original patent claim canceled - in writing, direct cancellation of the entire patent claim.

Cancel claim 6.

(2) Proposed new claim (previously added in the reexamination) canceled - in writing, direct cancellation of the entire claim.

Cancel claim 15.

(C) >Re-presentation of Original Patent Claims (no underlining or bracketing)

Amend claim 4 to read as original patent claim 4

Claim 4. The apparatus of claim 1 wherein the first piezoelectric element is perpendicular to the second piezoelectric element.

(D) < Presentation of New Claims

Each proposed new claim (i.e., a claim not found in the patent, that is newly presented in the reexamination proceeding) should be presented with underlining throughout the claim.

>Insert new claim 7 as follows:<

Claim 7. The apparatus of claim 5 further comprising electrodes attaching to said opposite faces of the second and third piezoelectric elements.

Even though an original claim may have been canceled, the numbering of the original claims does not change. Accordingly, any added claims are numbered beginning with the next higher number than the number of claims in the original patent. If new claims have been added to the reexamination proceeding which are later canceled prior to the issuance of the reexamination certificate, the examiner will renum-

ber, at the time of preparing the NIRC for subsequent issuance of the certificate, any remaining new claims in numerical order to follow the highest number of the claims in the original patent.

A claim number previously assigned to a new claim that has been canceled should not be reassigned to a different new claim during the reexamination proceeding. For example, if new claim 5 added in a prior amendment is canceled in a later amendment, a different new claim added in a later amendment during the reexamination proceeding would be claim 6. Of course, at the time of preparing the NIRC, claim 6 would be renumbered for issue of the reexamination certificate as claim 5.

*>

(E) < Amendment of New Claims

An amendment of a new claim (i.e., a claim not found in the patent, that was previously presented in the reexamination proceeding) must present the entire text of the new claim containing the amendatory material, and it must be underlined throughout the claim. The presentation cannot contain any bracketing or other indication of what was in the previous version of the claim. This is because all changes in the reexamination are made *vis-a-vis* the original patent, and not in comparison with any prior amendment. Although the presentation of the amended claim does not contain any indication of what is changed from a previous version of the claim, patent owner must point out what is changed, in the "Remarks" portion of the amendment. Also, as per 37 CFR 1.530(e), each change made in the claim must be accompanied by an explanation of the support in the disclosure of the patent (i.e., the reexamination specification) for the change.

*>

(F) < Amendment of Original Patent Claims More Than Once

The following example illustrates proper claim amendment of original patent claims in reexamination proceedings, where more than one amendment to a claim is made:

(1) Patent claim.

Claim 1. A cutting means having a handle portion and a blade portion.

(2) Proper first amendment format.

Claim 1. (amended), A [cutting means] knife having a bone handle portion and a notched blade portion.

(3) Proper second amendment format.

Claim 1. (twice amended), A [cutting means] knife having a handle portion and a serrated blade portion.

Note that the second amendment must include

(1) the changes previously presented in the first amendment; i.e., [cutting means] knife, as well as (2) the new changes presented in the second amendment; i.e., serrated.

The word bone was presented in the first amendment and is now to be deleted in the second amendment. Thus, “bone” is NOT to be shown in brackets in the second amendment. Rather, the word “bone” is simply omitted from the claim, since “bone” never appeared in the patent.

The word notched which was presented in the first amendment is replaced by the word serrated in the second amendment. The word notched is being deleted in the second amendment and did not appear in the patent; accordingly, “notched” is not shown in any form in the claim. The word serrated is being added in the second amendment, and accordingly, “serrated” is added to the claim and is underlined.

It should be understood that in the second amendment, the deletions of “notched” and “bone” are not changes from the original patent claim text and therefore, are not shown in the second amendment. In both the first and the second amendments, the entire claim is presented only with the changes from the original patent text.

If the patent expires during an *ex parte* or *inter partes* reexamination proceeding and the patent claims have been amended in that *ex parte* reexamination proceeding, the Office will hold the amendments as being improper, and all subsequent reexamination will be on the basis of the unamended patent claims. This procedure is necessary since no amendments will be incorporated into the patent by certificate after the expiration of the patent.

V. CROSS REFERENCES TO OTHER AREAS

(A) For clerical handling of amendments, see MPEP § 2270 for *ex parte* reexamination proceedings, and see MPEP § 2670 for *inter partes* reexamination proceedings.

(B) As to amendments in a merged proceeding, see MPEP § 2283 for an *ex parte* reexamination merged with another *ex parte* reexamination and MPEP § 2285 for an *ex parte* reexamination merged with a reissue application. If an *inter partes* reexamination proceeding is included in the merger, see MPEP § 2686.01 and § 2686.03.

(C) As to amendments in a pending reexamination proceeding where a reexamination certificate has issued for the patent based on a prior concluded reexamination, pursuant to MPEP § 2295, any amendment made in the pending reexamination proceeding must be presented as if the changes made to the patent text via the reexamination certificate (for the prior concluded reexamination) are a part of the original patent. All italicized text of the certificate is considered as if the text was present without italics in the original patent. Further, any text of the reexamination certificate found in brackets is considered as if it were never present in the patent at all. Thus, for making an amendment in the pending reexamination, all italicized text of the reexamination certificate is presented in the amendment without italics. Further, any text found in brackets in the reexamination certificate is omitted in the amendment.

(D) As to amendments in a pending reexamination proceeding where a reissue patent has been granted, pursuant to MPEP § 2285, subsection II.A., an amendment in a reexamination of a reissued patent is made the same way as in a reexamination of a reexamined patent (i.e., as per MPEP § 2295). Thus, all italicized text of the reissue patent is presented in the amendment (made in the pending reexamination proceeding) without italics. Further, any text found in brackets in the reissue patent is omitted in the amendment (made in the pending reexamination proceeding).

(E) For handling a dependent claim in reexamination proceedings, see MPEP § 2260.01.

2250.01 Correction of Patent Drawings [R-3]

37 CFR 1.530. Statement by patent owner in *ex parte* reexamination; amendment by patent owner in *ex parte* or *inter partes* reexamination; inventorship change in *ex parte* or *inter partes* reexamination.

(d) *Making amendments in a reexamination proceeding.* A proposed amendment in an *ex parte* or an *inter partes* reexamination proceeding is made by filing a paper directing that proposed specified changes be made to the patent specification, including the claims, or to the drawings. An amendment paper directing that proposed specified changes be made in a reexamination proceeding may be submitted as an accompaniment to a request filed by the patent owner in accordance with § 1.510(e), as part of a patent owner statement in accordance with paragraph (b) of this section, or, where permitted, during the prosecution of the reexamination proceeding pursuant to § 1.550(a) or § 1.937.

(3) *Drawings.* Any change to the patent drawings must be submitted as a sketch on a separate paper showing the proposed changes in red for approval by the examiner. Upon approval of the changes by the examiner, only new sheets of drawings including the changes and in compliance with § 1.84 must be filed. Amended figures must be identified as “Amended,” and any added figure must be identified as “New.” In the event a figure is canceled, the figure must be surrounded by brackets and identified as “Canceled.”

In the reexamination proceeding, the copy of the patent drawings submitted pursuant to 37 CFR 1.510(b)(4) will be used for reexamination purposes, provided no change whatsoever is made to the drawings. If there is to be ANY change in the drawings, a new sheet of drawings for each sheet changed must be submitted. The change may NOT be made on the original patent drawings.

37 CFR 1.530(d)(3) sets forth the manner of making amendments to the drawings. Amendments to the original patent drawing sheets are not permitted, and any change to the patent drawings must be in the form of a new sheet of drawings for each drawing sheet that is changed. Any amended figure(s) must be identified as “Amended” and any added figure(s) must be identified as “New.” In the event a figure is canceled, the figure must be surrounded by brackets and identified as “Canceled.”

Where the patent owner wishes to change/amend the drawings, the patent owner should submit a sketch in permanent ink showing proposed change(s)/amendment(s) in red, for approval by the examiner. The submitted sketch should be presented as a separate paper, and it will be made part of the record. Once the sketch is approved, sheets of substitute formal drawings must be submitted for each drawing sheet that is to be changed/amended. After receiving the new sheets of drawings from the patent owner, the

examiner may have the draftsman review the new sheets of drawings if the examiner would like the draftsman’s assistance in identifying errors in the drawings. If a draftsman reviews the drawings and finds the drawings to be unacceptable, the draftsman should complete a PTO-948 for the examiner to include with the next Office action. A draftsman’s “stamp” to indicate approval is no longer required on patent drawings, and these stamps are no longer to be used by draftsmen. The new sheets of drawings must be entered into the record in the reexamination file prior to the preparation of a Notice of Intent to Issue *Ex Parte* Reexamination Certificate (NIRC). If a proposed drawing correction has been approved but the new sheets of drawings have not been filed, and the proceeding is otherwise in condition for termination of the prosecution by means of a NIRC, an *ex parte Quayle* Office action should be prepared - setting a one month SSP for the filing of the new sheets of drawing. If the new sheets of drawings are not timely filed, the Reexamination Certificate will be issued with drawings that do not reflect the changes/amendments which were proposed by the patent owner.

2250.02 Correction of Inventorship [R-7]

37 CFR 1.530. *Statement by patent owner in ex parte reexamination; amendment by patent owner in ex parte or inter partes reexamination; inventorship change in ex parte or inter partes reexamination.*

(1) *Correction of inventorship in an ex parte or inter partes reexamination proceeding.*

(1) **>When it appears in a patent being reexamined that the correct inventor or inventors were not named through error without deceptive intention on the part of the actual inventor or inventors, the Director may, on petition of all the parties set forth in § 1.324(b)(1)-(3), including the assignees, and satisfactory proof of the facts and payment of the fee set forth in § 1.20(b), or on order of a court before which such matter is called in question, include in the reexamination certificate to be issued under § 1.570 or § 1.997 an amendment naming only the actual inventor or inventors. The petition must be submitted as part of the reexamination proceeding and must satisfy the requirements of § 1.324.

(2) Notwithstanding paragraph (1)(1) of this section, if a petition to correct inventorship satisfying the requirements of § 1.324 is filed in a reexamination proceeding, and the reexamination proceeding is concluded other than by a reexamination certificate under § 1.570 or § 1.997, a certificate of correction indicating the change of inventorship stated in the petition will be issued upon request by the patentee.<

Where the inventorship of a patent being reexamined is to be corrected, a petition for correction of inventorship which complies with 37 CFR 1.324 must be submitted during the prosecution of the reexamination proceeding. See 37 CFR 1.530(l)(1). If the petition under 37 CFR 1.324 is granted, a certificate of correction indicating the change of inventorship will **not** be issued, because the reexamination certificate that will ultimately issue will contain the appropriate change of inventorship information. The certificate of correction is in effect merged with the reexamination certificate.

In some instances, the reexamination proceeding concludes but does not result in a reexamination certificate under 37 CFR 1.570 or 1.997, e.g., reexamination is vacated, or the order for reexamination is denied. In those instances, patent owner may, after the conclusion of the reexamination proceeding, request that the inventorship be corrected by a certificate of correction indicating the change of inventorship. See 37 CFR 1.530(l)(2). Alternatively, the failure to name the correct inventive entity is an error in the patent which is correctable by reissue under 35 U.S.C. 251. See MPEP § 1412.04 for a discussion of when correction of inventorship by reissue is appropriate.

2250.03 Fees for Adding Claims [R-7]

37 CFR 1.20. Post issuance fees.

- (c) In reexamination proceedings
 - (1) For filing a request for *ex parte* reexamination (§ 1.510(a)).....\$2,520.00
 - (2) For filing a request for *inter partes* reexamination (§ 1.915(a)).....\$8,800.00
 - (3) ~~**>~~For filing with a request for reexamination or later presentation at any other time of each claim in independent form in excess of 3 and also in excess of the number of claims in independent form in the patent under reexamination:
 - By a small entity (§ 1.27(a)).....\$105.00
 - By other than a small entity\$210.00<
 - (4) For filing with a request for reexamination or later presentation at any other time of each claim (whether dependent or independent) in excess of 20 and also in excess of the number of claims in the patent under reexamination (note that § 1.75(c) indicates how multiple dependent claims are considered for fee calculation purposes):
 - By a small entity (§ 1.27(a)).....\$25.00
 - By other than a small entity\$50.00
 - (5) If the excess claims fees required by paragraphs (c)(3) and (c)(4) are not paid with the request for reexamination or on

later presentation of the claims for which the excess claims fees are due, the fees required by paragraphs (c)(3) and (c)(4) must be paid or the claims canceled by amendment prior to the expiration of the time period set for reply by the Office in any notice of fee deficiency in order to avoid abandonment.

Excess claims fees as specified in 35 U.S.C. 41(a)(2) as amended by the Consolidated Appropriations Act of 2005 are applicable to excess claims proposed to be added to a patent by their presentation during a reexamination proceeding. Under “former” 35 U.S.C. 41, excess claims fees were included as part of the “application” filing fee under 35 U.S.C. 41(a)(1), and thus did not apply during reexamination proceedings. The Consolidated Appropriations Act does not include the excess claims as part of the “application” filing fee under 35 U.S.C. 41(a)(1), but separately provides for excess claims fees in 35 U.S.C. 41(a)(2) (as being in addition to the filing fee in 35 U.S.C. 41(a)(1)). 35 U.S.C. 41(a)(2) provides that an excess claims fee is due “on filing or on presentation at any other time” (e.g., during a reexamination proceeding) of an independent claim in excess of three or of a claim (whether independent or dependent) in excess of twenty.

37 CFR 1.20 was amended, effective December 8, 2004, to provide for excess claims fees in a reexamination proceeding. The excess claims fees specified in 37 CFR 1.20(c) apply to all patents, whenever granted. The fees must be submitted for any excess claims presented in a reexamination proceeding on or after December 8, 2004 (no excess claims fee was due under 35 U.S.C. 41 for any claim presented during a reexamination proceeding before December 8, 2004). Even though a reexamination proceeding was commenced prior to December 8, 2004, the excess claims fees are due for any amendment filed on or after December 8, 2004.

When a patent owner presents an amendment to the claims (on or after December 8, 2004) during an *ex parte* reexamination proceeding, or upon filing of an *ex parte* reexamination request (on or after December 8, 2004), excess claims fees may be applicable. If the amendment is limited to revising the existing claims, i.e., it does not provide any new claim, there is no claim fee. The excess claims fees apply only to the submission of new, i.e., “excess” claims.

The excess claims fees specified in 37 CFR 1.20(c) apply to excess claims that result from an amendment as follows:

(A) The fee designated in 37 CFR 1.20(c)(3) as the independent claims fee must be paid for each independent claim in excess of three and also in excess of the number of independent claims in the patent being reexamined. The amendment must increase the number of independent claims to be more than both of these limits, in order for the “independent excess claims fee” to apply;

(B) The fee designated in 37 CFR 1.20(c)(4) as the total claims fee must be paid for each claim (whether independent or dependent) in excess of twenty and also in excess of the number of claims in the patent being reexamined. The amendment must increase the total number of claims to be more than both of these limits, in order for the “total excess claims fee” to apply.

The following examples illustrate the application of the excess claims fees in a patent (non-small entity) to be reexamined containing six independent claims and thirty total claims:

(A) No excess claims fee is due if the patent owner cancels ten claims, two of which are independent, and adds ten claims, two of which are independent.

(B) The 37 CFR 1.20(c)(3) excess independent claims fee for a seventh independent claim is due if the patent owner cancels ten claims, two of which are independent, and adds ten claims, three of which are independent.

(C) The 37 CFR 1.20(c)(4) excess total claims fee for a thirty-first claim is due if the patent owner cancels ten claims, two of which are independent, and adds eleven claims, two of which are independent.

(D) The 37 CFR 1.20(c)(3) excess independent claims fee for a seventh independent claim and the 37 CFR 1.20(c)(4) excess total claims fee for a thirty-first claim are due if the patent owner cancels ten claims, two of which are independent, and adds eleven claims, three of which are independent.

A claim that has been disclaimed under 35 U.S.C. 253 and 37 CFR 1.321(a) as of the date of filing of the request for reexamination is not considered to be a claim in the patent under reexamination for purposes

of excess claims fee calculations. The same applies to a claim canceled via a prior Reexamination Certificate, reissue patent, or Certificate of Correction.

If the excess claims fees required by 37 CFR 1.20(c)(3) and (c)(4) are not paid with the presentation of the excess claims, a notice of fee deficiency will be issued as a Notice of Defective Paper In *Ex Parte* Reexamination, PTOL-475. A one-month time period will be set in the form PTOL-475 for correction of the defect, i.e., the fee deficiency. An extension of time to correct the fee deficiency may be requested under 37 CFR 1.550(c). If the unpaid excess claims fees required by 37 CFR 1.20(c)(3) and (c)(4) are not paid within the time period set for response to the Notice, the prosecution of the reexamination proceeding will be terminated under 37 CFR 1.550(e), to effect the “abandonment” set forth in 37 CFR 1.20(c)(5).

2251 Reply by Third Party Requester

37 CFR 1.535. Reply by third party requester in ex parte reexamination.

A reply to the patent owner’s statement under § 1.530 may be filed by the *ex parte* reexamination requester within two months from the date of service of the patent owner’s statement. Any reply by the *ex parte* requester must be served upon the patent owner in accordance with § 1.248. If the patent owner does not file a statement under § 1.530, no reply or other submission from the *ex parte* reexamination requester will be considered.

If the patent owner files a statement in a timely manner, the third party requester is given a period of 2 months from the date of service to reply. Since the statute, 35 U.S.C. 304, provides this time period, there will be no extensions of time granted.

The reply need not be limited to the issues raised in the statement. The reply may include additional prior art patents and printed publications and may raise any issue appropriate for reexamination.

If no statement is filed by the patent owner, no reply is permitted from the third party requester.

The third party requester must serve a copy of the reply on the patent owner. See MPEP § 2266.03 for further discussion as to the third party requester providing service on the patent owner.

The third party requester is not permitted to file any further papers after his or her reply to the patent owner’s statement. Any further papers will not be considered and will be returned to the requester. The

patent owner cannot file papers on behalf of the third party requester and thereby circumvent the rules.

2252 Consideration of Statement and Reply [R-5]

37 CFR 1.540. Consideration of responses in ex parte reexamination.

The failure to timely file or serve the documents set forth in § 1.530 or in § 1.535 may result in their being refused consideration. No submissions other than the statement pursuant to § 1.530 and the reply by the *ex parte* reexamination requester pursuant to § 1.535 will be considered prior to examination.

Although 37 CFR 1.540 would appear to be discretionary in stating that late responses “may result in their being refused consideration,” patent owners and requesters can expect consideration to be refused if the statement and/or reply is not timely filed. 37 CFR 1.540 restricts the number and kind of submissions to be considered prior to examination to those expressly provided for in 37 CFR 1.530 and 37 CFR 1.535. Untimely submissions will ordinarily not be considered. Untimely submissions, other than untimely papers filed by the patent owner after the period set for response, will not be placed of record in the reexamination file but will be returned to the sender.

Any paper for which proof of service is required, which is filed without proof of service, may be denied consideration. Where no proof of service is included, inquiry should be made of the sender by the reexamination clerk as to whether service was in fact made. If no service was made, the paper is placed in the reexamination file but is not considered. See MPEP § 2266.03 and § 2267.

2253 Consideration by Examiner [R-2]

Once reexamination is ordered, any submissions properly filed and served in accordance with 37 CFR 1.530 and 37 CFR 1.535 will be considered by the examiner when preparing the first Office action.

With respect to consideration of any proposed amendments to the specification, including claims, made by the patent owner, the examiner will be guided by the provisions of 37 CFR 1.530(d)-(j). With respect to consideration of the patent owner’s statement, the examiner will be guided by 37 CFR 1.530(c).

As to consideration of a reply by a third party requester, the examiner will be guided by 37 CFR

1.535. If the requester’s reply to the patent owner’s statement raises issues not previously presented, such issues will be treated by the examiner in the Office action if they are within the scope of reexamination. However, if an issue raised by the third party requester in the reply is not within the scope of reexamination, it should be treated pursuant to 37 CFR 1.552(c).

For handling of new matter, see MPEP § 2270.

2254 Conduct of Ex Parte Reexamination Proceedings [R-7]

35 U.S.C. 305. Conduct of reexamination proceedings.

After the times for filing the statement and reply provided for by section 304 of this title have expired, reexamination will be conducted according to the procedures established for initial examination under the provisions of sections 132 and 133 of this title. In any reexamination proceeding under this chapter, the patent owner will be permitted to propose any amendment to his patent and a new claim or claims thereto, in order to distinguish the invention as claimed from the prior art cited under the provisions of section 301 of this title, or in response to a decision adverse to the patentability of a claim of a patent. No proposed amended or new claim enlarging the scope of a claim of the patent will be permitted in a reexamination proceeding under this chapter. All reexamination proceedings under this section, including any appeal to the Board of Patent Appeals and Interferences, will be conducted with special dispatch within the Office.

37 CFR 1.550. Conduct of ex parte reexamination proceedings.

(a) All *ex parte* reexamination proceedings, including any appeals to the Board of Patent Appeals and Interferences, will be conducted with special dispatch within the Office. After issuance of the *ex parte* reexamination order and expiration of the time for submitting any responses, the examination will be conducted in accordance with §§ 1.104 through 1.116 and will result in the issuance of an *ex parte* reexamination certificate under § 1.570.

(b) The patent owner in an *ex parte* reexamination proceeding will be given at least thirty days to respond to any Office action. In response to any rejection, such response may include further statements and/or proposed amendments or new claims to place the patent in a condition where all claims, if amended as proposed, would be patentable.

(c) The time for taking any action by a patent owner in an *ex parte* reexamination proceeding will be extended only for sufficient cause and for a reasonable time specified. Any request for such extension must be filed on or before the day on which action by the patent owner is due, but in no case will the mere filing of a request effect any extension. Any request for such extension must be accompanied by the petition fee set forth in § 1.17(g). See § 1.304(a) for extensions of time for filing a notice of appeal to the U.S. Court of Appeals for the Federal Circuit or for commencing a civil action.

(d) ****>**If the patent owner fails to file a timely and appropriate response to any Office action or any written statement of an interview required under § 1.560(b), the prosecution in the *ex parte* reexamination proceeding will be a terminated prosecution, and the Director will proceed to issue and publish a certificate concluding the reexamination proceeding under § 1.570 in accordance with the last action of the Office.<

(e) If a response by the patent owner is not timely filed in the Office,

(1) The delay in filing such response may be excused if it is shown to the satisfaction of the Director that the delay was unavoidable; a petition to accept an unavoidably delayed response must be filed in compliance with § 1.137(a); or

(2) The response may nevertheless be accepted if the delay was unintentional; a petition to accept an unintentionally delayed response must be filed in compliance with § 1.137(b).

(f) The reexamination requester will be sent copies of Office actions issued during the *ex parte* reexamination proceeding. After filing of a request for *ex parte* reexamination by a third party requester, any document filed by either the patent owner or the third party requester must be served on the other party in the reexamination proceeding in the manner provided by § 1.248. The document must reflect service or the document may be refused consideration by the Office.

(g) The active participation of the *ex parte* reexamination requester ends with the reply pursuant to § 1.535, and no further submissions on behalf of the reexamination requester will be acknowledged or considered. Further, no submissions on behalf of any third parties will be acknowledged or considered unless such submissions are:

(1) in accordance with § 1.510 or § 1.535; or

(2) entered in the patent file prior to the date of the order for *ex parte* reexamination pursuant to § 1.525.

(h) Submissions by third parties, filed after the date of the order for *ex parte* reexamination pursuant to § 1.525, must meet the requirements of and will be treated in accordance with § 1.501(a).

Once *ex parte* reexamination is ordered pursuant to 35 U.S.C. 304 and the times for submitting any responses to the order have expired, no further active participation by a third party reexamination requester is allowed, and no third party submissions will be acknowledged or considered unless they are in accordance with 37 CFR 1.510. The reexamination proceedings will be *ex parte*, even if ordered based on a request filed by a third party, because this was the intention of the legislation. *Ex parte* proceedings preclude the introduction of arguments and issues by the third party requester which are not within the intent of 35 U.S.C. 305 (“reexamination will be conducted

according to the procedures established for initial examination under the provisions of sections 132 and 133 of this title”).

The patent owner may not file papers on behalf of the requester and thereby circumvent the intent of the *ex parte* reexamination legislation and the rules. The Court of Appeals for the Federal Circuit held in *Emerson Elec. Co. v. Davoil, Inc.*, 88 F.3d 1051, 39 USPQ2d 1474 (Fed. Cir. 1996) that a federal district court does not have the authority to order a patent owner to file papers prepared by a third party in addition to the patent owner’s own submission in a patent reexamination proceeding. Such papers prepared by the third party and filed by the patent owner will not be entered, and the entire submission will be returned to the patent owner as an inappropriate response. See MPEP § 2266 and § 2267.

The examination will be conducted in accordance with 37 CFR 1.104, 1.105, 1.110-1.113, and 1.116 (35 U.S.C. 132 and 133) and will result in the issuance of a reexamination certificate under 37 CFR 1.570. The proceeding shall be conducted with special dispatch within the Office pursuant to 35 U.S.C. 305, last sentence. A full search will not routinely be made by the examiner. The third party reexamination requester will be sent copies of Office actions and the patent owner must serve responses on the requester. Citations submitted in the patent file prior to issuance of an order for reexamination will be considered by the examiner during the reexamination. Reexamination will proceed even if the copy of the order sent to the patent owner is returned undelivered. The notice under 37 CFR 1.11(c) is constructive notice to the patent owner and lack of response from the patent owner will not delay reexamination. See MPEP § 2230.

2255 Who Reexamines [R-5]

The examination will ordinarily be conducted by the same patent examiner ****** who made the decision on whether the reexamination request should be granted. See MPEP § 2236.

However, if a petition under 37 CFR 1.515(c) is granted, the reexamination will normally be conducted by another examiner. See MPEP § 2248.

2256 Prior Art Patents and Printed Publications Reviewed by Examiner in Reexamination [R-7]

Typically, the primary source of prior art will be the patents and printed publications cited in the request for *ex parte* reexamination.

Subject to the discussion provided below in this section, the examiner must also consider patents and printed publications:

(A) cited by another reexamination requester under 37 CFR 1.510 or 37 CFR 1.915;

(B) cited in a patent owner's statement under 37 CFR 1.530 or a requester's reply under 37 CFR 1.535 if they comply with 37 CFR 1.98;

(C) cited by the patent owner under a duty of disclosure (37 CFR 1.555) in compliance with 37 CFR 1.98;

(D) discovered by the examiner in searching;

(E) of record in the patent file from earlier examination; and

(F) of record in the patent file from any 37 CFR 1.501 submission prior to date of an order if it complies with 37 CFR 1.98.

**

Where patents, publications, and other such items of information are submitted by a party (patent owner or requester) in compliance with the requirements of the rules, the requisite degree of consideration to be given to such information will be normally limited by the degree to which the party filing the information citation has explained the content and relevance of the information. The initials of the examiner placed adjacent to the citations on the form PTO/SB/08A and 08B or its equivalent, without an indication to the contrary in the record, do not signify that the information has been considered by the examiner any further than to the extent noted above.

As to (E) above, it is pointed out that ** the degree of consideration of information from the patent file and its parent files is dependent on the availability of the information. Thus, for example, *>as to< a reference other than a U.S. *>patent< and U.S. patent publication **>that is< not scanned into the Image File Wrapper (IFW) * what was said about *>that< reference in the patent's record is the full extent of consideration, unless otherwise indicated >, or unless parties appropriately supplied a copy<.

As to **>(C) and (F) above, 37 CFR 1.98(a)(2) requires a legible copy of:

(1) each foreign patent;

(2) each publication or that portion which caused it to be listed, other than U.S. patents and U.S. patent application publications unless required by the Office;

(3) for each cited pending unpublished U.S. application, the application specification including the claims, and any drawing of the application, or that portion of the application which caused it to be listed including any claims directed to that portion;

(4) all other information or that portion which caused it to be listed.

It is not required nor is it permitted that parties submit copies of copending reexamination proceedings and applications (which copies can be mistaken for a new request/filing) ; rather, submitters may provide the application/proceeding number and its status. A submission that is not permitted entry will be returned, expunged, or discarded at the soled discretion of the Office. <

The exception to the requirement for reference copies note 37 CFR 1.98(d)(1) does not apply to reexamination proceedings since a reexamination proceeding does not receive 35 U.S.C. 120 benefit from the patent.

AFTER THE NOTICE OF INTENT TO ISSUE EX PARTE REEXAMINATION CERTIFICATE (NIRC):

Once the NIRC has been mailed, the reexamination proceeding must proceed to publication of the Reexamination Certificate as soon as possible. Thus, when the patent owner provides a submission of patents and printed publications, or other information described in 37 CFR 1.98(a), after the NIRC has been mailed, the submission must be accompanied by (A) a factual accounting providing a sufficient explanation of why the information submitted could not have been submitted earlier, and (B) an explanation of the relevance of the information submitted with respect to the claimed invention in the reexamination proceeding. This is provided via a petition under 37 CFR 1.182 (with petition fee) for entry and consideration of the information submitted after NIRC. The requirement in item (B) above is for the purpose of facilitating the Office's compliance with the statutory requirement

for “special dispatch,” when the requirement in item (A) above is satisfied to provide a basis for interrupting the proceeding after the NIRC.

Once the reexamination has entered the Reexamination Certificate ****>printing cycle (452 status)<**, pulling the proceeding from that process provides an even greater measure of delay. 37 CFR 1.313 states for an application (emphasis added):

“(c) Once the issue fee has been paid, **the application will not be withdrawn from issue upon petition by the applicant for any reason except:**

(1) Unpatentability of one or more claims, which petition must be accompanied by an unequivocal statement that one or more claims are unpatentable, an amendment to such claim or claims, and an explanation as to how the amendment causes such claim or claims to be patentable;”

The ****>printing cycle<** for an application occurs after the payment of the issue fee (there is no issue fee in reexamination), and thus 37 CFR 1.313(c) applies during the ***>printing<** cycle for an application. Based on the statutory requirement for “special dispatch,” the requirements for withdrawal of a reexamination proceeding from its ***>printing<** cycle are at least as burdensome as those set forth in 37 CFR 1.313(b) and (c). Accordingly, where a submission of patents and printed publications, or other information described in 37 CFR 1.98(a), is made while a proceeding is in its ***>printing<** cycle, the patent owner must provide an unequivocal statement as to why the art submitted makes at least one claim unpatentable, an amendment to such claim or claims, and an explanation as to how the amendment causes such claim or claims to be patentable. This is in addition to the above-discussed ****>(see item (A) above)<** factual accounting providing a sufficient explanation of why the information submitted could not have been submitted earlier. The submission of patents and printed publications must be accompanied by a petition under 37 CFR 1.182 (with petition fee) for withdrawal of the reexamination proceeding from the ****>printing cycle<** for entry and consideration of the information submitted by patent owner. A grantable petition must provide the requisite showing discussed in this paragraph.

No consideration will be given to a third party requester submission of patents and printed publication, or other information, that is filed in the reexami-

nation proceeding unless it is part of the request for reexamination or the requester’s reply under 37 CFR 1.540.

2257 Listing of Prior Art [R-7]

>The reexamination request must provide a listing of the patents and printed publications (discussed in the request) as provided for in 37 CFR 1.98. See MPEP § 2214.< The examiner must *** list** on a form PTO-892, if not already listed on a form PTO/SB/08A or 08B, or PTO/SB/42 (or on a form having a format equivalent to one of these forms), all prior art patents or printed publications which have been cited in the decision on the request, applied in making rejections or cited as being pertinent during the reexamination proceedings. Such prior art patents or printed publications may have come to the examiner’s attention because:

(A) they were of record in the patent file due to a prior art submission under 37 CFR 1.501 which was received prior to the date of the order;

(B) they were of record in the patent file as result of earlier examination proceedings; or

(C) they were discovered by the examiner during a prior art search.

All citations listed on form PTO-892, and all citations not lined-through on any form PTO/SB/08A or 08B, or PTO/SB/42 (or on a form having a format equivalent to one of these forms), will be printed on the reexamination certificate under “References Cited.”

A submission of patents and/or publications is entitled to entry and citation in the reexamination certificate (that will be issued) when it complies with 37 CFR 1.98 and is submitted:

(A) by the patent owner in the statement under 37 CFR 1.530;

(B) by the reexamination requester in the reply under 37 CFR 1.535;

(C) prior to the order of reexamination under 37 CFR 1.501 by any party; and/or

(D) by the patent owner under the duty of disclosure requirements of 37 CFR 1.555.

2258 Scope of *Ex Parte* Reexamination [R-7]

37 CFR 1.552. *Scope of reexamination in ex parte reexamination proceedings.*

(a) Claims in an *ex parte* reexamination proceeding will be examined on the basis of patents or printed publications and, with respect to subject matter added or deleted in the reexamination proceeding, on the basis of the requirements of 35 U.S.C. 112.

(b) Claims in an *ex parte* reexamination proceeding will not be permitted to enlarge the scope of the claims of the patent.

(c) Issues other than those indicated in paragraphs (a) and (b) of this section will not be resolved in a reexamination proceeding. If such issues are raised by the patent owner or third party requester during a reexamination proceeding, the existence of such issues will be noted by the examiner in the next Office action, in which case the patent owner may consider the advisability of filing a reissue application to have such issues considered and resolved.

The reexamination proceeding provides a complete reexamination of the patent claims on the basis of prior art patents and printed publications. Issues relating to 35 U.S.C. 112 are addressed only with respect to new claims or amendatory subject matter in the specification, claims or drawings. Any new or amended claims are examined to ensure that the scope of the original patent claims is not enlarged, i.e., broadened. See 35 U.S.C. 305.

I. PRIOR ART PATENTS OR PRINTED PUBLICATIONS, AND DOUBLE PATENTING

Rejections on prior art in reexamination proceedings may only be made on the basis of prior art patents or printed publications. Prior art rejections may be based upon the following portions of 35 U.S.C. 102:

“(a) . . . patented or described in a printed publication in this or a foreign country, before the invention thereof by the applicant for patent, or”

“(b) the invention was patented or described in a printed publication in this or a foreign country . . . more than one year prior to the date of the application for patent in the United States, or”

“(d) the invention was first patented or caused to be patented, or was the subject of an inventor’s certificate, by the applicant or his legal representatives or assigns in a foreign country prior to the date of the application for patent in this country on an application for patent or inventor’s certificate filed more than twelve months before the filing of the application in the United States, or”

(e) the invention was described in — (1) an application for patent, published under section 122(b), by another filed in the United States before the invention by the applicant for patent or (2) a patent granted on an application for patent by another filed in the United States before the invention by the applicant for patent, except that an international application filed under the treaty defined in section 351(a) shall have the effects for the purposes of this subsection of an application filed in the United States only if the international application designated the United States and was published under Article 21(2) of such treaty in the English language; or”

“(g) . . . (2) before such person’s invention thereof, the invention was made in this country by another inventor who had not abandoned, suppressed, or concealed it. In determining priority of invention under this subsection, there shall be considered not only the respective dates of conception and reduction to practice of the invention, but also the reasonable diligence of one who was first to conceive and last to reduce to practice, from a time prior to conception by the other.”

**>Typically, substantial new questions of patentability and rejections in a reexamination proceeding are based on “prior art” patents and publications. There are exceptions, however. For example, in *In re Lonardo*, 119 F.3d 960, 43 USPQ2d 1262 (Fed. Cir. 1997), the Federal Circuit upheld a nonstatutory double patenting rejection in which the patent upon which the rejection was based and the patent under reexamination shared the same effective filing date. See also the discussion as to double patenting in subsection I.D. below. Analogously, a 35 U.S.C. 102(g)(2) rejection may be asserted in a reexamination proceeding based on the examples illustrated in the chart below:<

>

Rejection of claims in patent with earlier filing date over claims of patent having later filing date- using 35 U.S.C. 102(g), in a manner analogous to double patenting

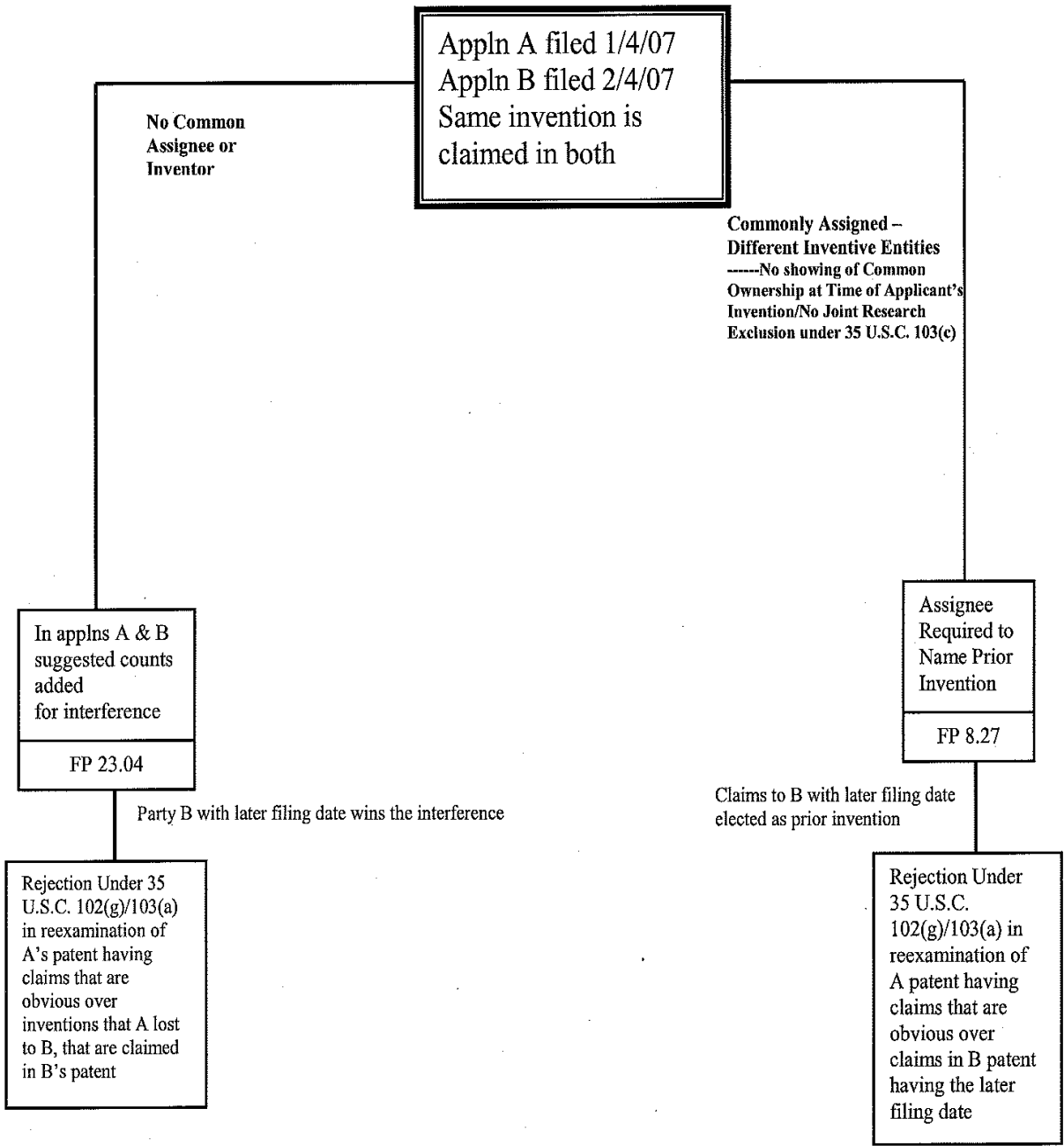

<

A. *Previously Considered Prior Art Patents or Printed Publications*

After reexamination is ordered based on a proper substantial new question of patentability, the propriety of making a ground of rejection based on prior art previously considered by the Office (in an earlier examination of the patent) is governed by the guidance set forth in MPEP § 2258.01. Note also *In re Hiniker Co.*, 150 F.3d 1362, 1367, 47 USPQ2d 1523,1527 (Fed. Cir. 1998)(court held the reexamination proceeding was supported by a substantial new question of patentability where the rejection before the court was based on a combination of art that had been before the examiner during the original prosecution, and art newly cited during the reexamination proceeding. The court further stated that any error in the Commissioner's authority to institute a reexamination was "washed clean" during the reexamination procedure.)

B. *Matters Other Than Patents or Printed Publications*

Rejections will not be based on matters other than patents or printed publications, such as public use or sale, inventorship, 35 U.S.C. 101, *conduct issues<, etc. In this regard, see *In re Lanham*, 1 USPQ2d 1877 (Comm'r Pat. 1986), and *Stewart Systems v. Comm'r of Patents and Trademarks*, 1 USPQ2d 1879 (E.D. Va. 1986). A rejection on prior public use or sale, insufficiency of disclosure, etc., cannot be made even if it relies on a prior art patent or printed publication. Prior art patents or printed publications must be applied under an appropriate portion of 35 U.S.C. 102 and/or 103 when making a rejection.

C. *Intervening Patents or Printed Publications*

Rejections may be made in reexamination proceedings based on intervening patents or printed publications where the patent claims under reexamination are entitled only to the filing date of the patent and are not supported by an earlier foreign or United States patent application whose filing date is claimed. For example, under 35 U.S.C. 120, the effective date of these claims would be the filing date of the application which resulted in the patent. Intervening patents or printed publications are available as prior art under *In re Rus-*

cetta, 255 F.2d 687, 118 USPQ 101 (CCPA 1958), and *In re van Langenhoven*, 458 F.2d 132, 173 USPQ 426 (CCPA 1972). See also MPEP § 201.11.

D. *Double Patenting*

1. *General Considerations*

Double patenting is normally proper for consideration in reexamination. See *In re Lonardo*, 119 F.3d 960, 43 USPQ2d 1262 (Fed. Cir. 1997). In *Lonardo*, the Federal Circuit reviewed and interpreted the language of 35 U.S.C. 303 and stated that:

Since the statute in other places refers to prior art in relation to reexamination, *see id.*, it seems apparent that Congress intended that the phrases 'patents and publications' and 'other patents or printed publications' in section 303(a) not be limited to prior art patents or printed publications... . Finally, it is reasonable to conclude that Congress intended to include double patenting over a prior patent as a basis for reexamination because maintenance of a patent that creates double patenting is as much of an imposition on the public as maintenance of patent that is unpatentable over prior art. Thus, we conclude that the PTO was authorized during reexamination to consider the question of double patenting based upon the '762 patent.

In re Lonardo, 119 F.3d at 966, 43 USPQ2d at 1266. Accordingly, the issue of double patenting is appropriate for consideration in reexamination, both as a basis for ordering reexamination and during subsequent examination on the merits. The issue of double patenting is to be considered by the examiner when making the decision on the request for reexamination. The examiner should determine whether the issue of double patenting raises a substantial new question of patentability. The issue of double patenting is also to be considered during the examination stage of reexamination proceeding. In the examination stage, the examiner should determine whether a rejection based on double patenting is appropriate.

See also *Ex parte Obiaya*, 227 USPQ 58, 60 (Bd. Pat. App. & Inter. 1985) ("Double patenting rejections are analogous to rejections under 35 U.S.C. 103 and depend on the presence of a prior patent as the basis for the rejection").

See MPEP § 804 to § 804.03 for discussion on double patenting.

2. Where Double Patenting May Be Present

Double patenting may exist where the patent being reexamined and a patent or application contain conflicting claims and:

(A) are filed by the same inventive entity;

(B) are filed by different inventive entities having a common inventor; and/or

(C) are filed by a common assignee (common ownership); and/or

(D) result from activities undertaken within the scope of a joint research agreement as defined in 35 U.S.C. 103(c)(3).

A double patenting rejection based on common ownership may be applied if the earlier invention would qualify as prior art for purposes of obviousness under 35 U.S.C. 103(a) only under 35 U.S.C. 102(g), or under 35 U.S.C. 102(e) in a reexamination proceeding in which the patent under reexamination was granted on or after December 10, 2004; or in a reexamination proceeding in which the application which issued as a patent undergoing reexamination was filed on or after November 29, 1999.

As is the case for an application, a judicially created double patenting rejection (made in a reexamination) can be overcome by the filing of a terminal disclaimer in accordance with 37 CFR 1.321(c). Where a terminal disclaimer is submitted in a reexamination proceeding, form paragraph 14.23.01 should be used if the terminal disclaimer is proper. If the terminal disclaimer is not proper, form paragraph 14.25 should be used, and one or more of the appropriate form paragraphs 14.26 to 14.32 must follow form paragraph 14.25 to indicate why the terminal disclaimer is not accepted. See also MPEP § 1490.

3. Joint Research Agreement

Where the patent under reexamination issued on or after December 10, 2004, a double patenting rejection may be applied (assuming that the patent owner has not already filed the appropriate terminal disclaimer) if:

(A) the patent under reexamination claims an invention that is not patentably distinct from an invention claimed in a non-commonly owned pending application or issued patent (i.e., not patentably dis-

tinct from an invention claimed in a “reference application or patent”);

(B) the patent being reexamined and the non-commonly owned reference application or patent are by, or on behalf of, parties to a joint research agreement; and

(C) a statement has been filed under 37 CFR 1.104(c)(4)(iii) to disqualify the non-commonly owned reference application or patent from being prior art under 35 U.S.C. 103(c)(2).

Thus, the patent being reexamined and the subject matter disqualified under 35 U.S.C. 103(c), as amended by the CREATE Act, will be treated as commonly owned for purposes of double patenting analysis. Such a double patenting rejection will be made regardless of whether the patent being reexamined and the non-commonly owned reference patent or application have the same or a different inventive entity. This double patenting rejection may be obviated by filing a terminal disclaimer in accordance with 37 CFR 1.321(d). A double patenting rejection may **NOT** be made on this basis if the patent under reexamination issued before December 10, 2004.<

E. Affidavits or Declarations or Other Written Evidence

Affidavits or declarations or other written evidence which explain the contents or pertinent dates of prior art patents or printed publications in more detail may be considered in reexamination, but any rejection must be based upon the prior art patents or printed publications as explained by the affidavits or declarations or other written evidence. The rejection in such circumstances cannot be based on the affidavits or declarations or other written evidence as such, but must be based on the prior art patents or printed publications.

F. Admissions; Use of Admissions

1. Initial Reexamination Determination and Order

The consideration under 35 U.S.C. 303 of a request for reexamination is limited to prior art patents and printed publications. See *Ex parte McGaughey*, 6 USPQ2d 1334, 1337 (Bd. Pat. App. & Inter. 1988). Thus an admission, *per se*, may not be the basis for establishing a substantial new question of patentabil-

ity. However, an admission by the patent owner of record in the file or in a court record may be utilized in combination with a patent or printed publication.

2. Reexamination Ordered, Examination on the Merits

After reexamination has been ordered, the examination on the merits is dictated by 35 U.S.C. 305, see *Ex parte McGaughey*, 6 USPQ2d 1334, 1337 (Bd. Pat. App. & Inter. 1988).

Admissions by the patent owner in the record as to matters affecting patentability may be utilized in a reexamination proceeding; see 37 CFR 1.104(c)(3).

37 CFR 1.104(c)(3) provides that admissions by the patent owners as to matters affecting patentability may be utilized in a reexamination proceeding. The Supreme Court when discussing 35 U.S.C. 103 in *Graham v. John Deere Co.*, 383 U.S. 6, 148 USPQ 459 (1966) stated, *inter alia*, “the scope and content of the prior art are to be determined.” Accordingly, a proper evaluation of the scope and content of the prior art in determining obviousness would require a utilization of any “admission” by the patent owner which can be used to interpret or modify a patent or printed publication applied in a reexamination proceeding. This is true whether such admission results from a patent or printed publication or from some other source. An admission as to what is in the prior art is simply that, an admission, and requires no independent proof. It is an acknowledged, declared, conceded, or recognized fact or truth, *Ex parte McGaughey*, 6 USPQ2d 1334, 1337 (Bd. Pat. App. & Inter. 1988). While the scope and content of the admission may sometimes have to be determined, this can be done from the record and from the paper file or IFW file history in the same manner as with patents and printed publications. To ignore an admission by the patent owner, from any source, and not use the admission as part of the prior art *in conjunction with patents and printed publications* in reexamination would make it impossible for the examiner to properly determine the scope and content of the prior art as required by *Graham*, supra.

The Board of Appeals upheld the use of an admission in a reexamination proceeding in *Ex parte Seiko Koko Kabushiki Kaisha*, 225 USPQ 1260 (Bd. Pat. App. & Inter. 1984), *Ex parte Kimbell*, 226 USPQ 688 (Bd. Pat. App. & Inter. 1985) and in *Ex parte*

McGaughey, 6 USPQ2d 1334 (Bd. Pat. App. & Inter. 1988). In *Seiko*, the Board relied on *In re Nomiya*, 509 F.2d 566, 184 USPQ 607 (CCPA 1975) holding an admission of prior art in the specification of the parent undergoing reexamination is considered prior art which may be considered as evidence of obviousness under 35 U.S.C. 103. In *Kimbell*, the Board referred to the patent specification and noted the admission by appellant that an explosion-proof housing was well known at the time of the invention. In *Ex parte McGaughey*, 6 USPQ2d 1334, 1337 (Bd. Pat. App. & Int. 1988), the Board held that any *>unequivocal<* admission relating to prior art is a fact which is part of the scope and content of the prior art and that prior art admissions established in the record are to be considered in reexamination. An admission from any source can be used with respect to interpreting or modifying a prior art patent or printed publication, in a reexamination proceeding. The Board expressly overruled the prior Board decision in *Ex parte Horton*, 226 USPQ 697 (Bd. Pat. App. & Inter. 1985) which held that admissions which are used as a basis for a rejection in reexamination must relate to patents and printed publications.

The admission can reside in the patent file (made of record during the prosecution of the patent application) or may be presented during the pendency of the reexamination proceeding or in litigation. Admissions by the patent owner as to any matter affecting patentability may be utilized to determine the scope and content of the prior art in conjunction with patents and printed publications in a prior art rejection, whether such admissions result from patents or printed publications or from some other source. An admission relating to *any* prior art (e.g., on sale, public use) established in the record or in court may be used by the examiner in combination with patents or printed publications in a reexamination proceeding. Any admission submitted by the patent owner is proper. A third party, however, may not submit admissions of the patent owner made outside the record *>of the file or the court record<*. Such a submission would be outside the scope of reexamination.

G Claim Interpretation and Treatment

Original patent claims will be examined *only* on the basis of prior art patents or printed publications applied under the appropriate parts of 35 U.S.C. 102

and 103. See MPEP § 2217. During reexamination, claims are given the broadest reasonable interpretation consistent with the specification and limitations in the specification are not read into the claims (*In re Yamamoto*, 740 F.2d 1569, 222 USPQ 934 (Fed. Cir. 1984)). In a reexamination proceeding involving claims of an expired patent, claim construction pursuant to the principle set forth by the court in *Phillips v. AWH Corp.*, 415 F.3d 1303, 1316, 75 USPQ2d 1321, 1329 (Fed. Cir. 2005) (words of a claim “are generally given their ordinary and customary meaning” as understood by a person of ordinary skill in the art in question at the time of the invention) should be applied since the expired claim are not subject to amendment. The statutory presumption of validity, 35 U.S.C. 282, has no application in reexamination (*In re Etter*, 756 F.2d 852, 225 USPQ 1 (Fed. Cir. 1985)).

II. COMPLIANCE WITH 35 U.S.C. 112

Where new claims are presented or where any part of the disclosure is amended, the claims of the reexamination proceeding, are to be examined for compliance with 35 U.S.C. 112. Consideration of 35 U.S.C. 112 issues should, however, be limited to the amendatory (e.g., new language) matter. For example, a claim which is amended or a new claim which is presented containing a limitation not found in the original patent claim should be considered for compliance under 35 U.S.C. 112 only with respect to that limitation. To go further would be inconsistent with the statute to the extent that 35 U.S.C. 112 issues would be raised as to matter in the original patent claim. Thus, a term in a patent claim which the examiner might deem to be too broad cannot be considered as too broad in a new or amended claim *unless* the amendatory matter in the new or amended claim creates the issue. >If a limitation that appears in an existing patent claim also appears in a claim newly presented in a reexamination proceeding, that limitation cannot be examined as to 35 U.S.C. 112. If a dependent claim is rewritten as an independent claim in a reexamination proceeding, that independent claim cannot be examined as to 35 U.S.C. 112, unless the nature of the rewriting raises a new question (e.g., by newly providing a lack of claim antecedent for a term in the claim). <

A. 35 U.S.C. 112 Issues To Be Considered

Compliance of new or amended claims with the enablement and/or description requirements of the first paragraph of 35 U.S.C. 112 should be considered as to the amendatory and new text in the reexamination proceeding. Likewise, the examiner should determine whether the new or amended claims comply with the second paragraph of 35 U.S.C. 112. MPEP § 2163 - § 2173.05(v) provide extensive guidance as to these matters.

B. New Matter

35 U.S.C. 305 provides for examination under 35 U.S.C. 132, which prohibits the introduction of new matter into the disclosure. Thus, the question of new matter should be considered in a reexamination proceeding. See MPEP § 2163.06 as to the relationship of the written description requirement of the first paragraph of 35 U.S.C. 112 and the new matter prohibition under 35 U.S.C. 132. Where the new matter is added to the claims or affects claim limitations, the claims should be rejected under 35 U.S.C. 112, first paragraph, for failing to meet the written description requirement.

C. Amendment of the Specification

Where the specification is amended in a reexamination proceeding, the examiner should make certain that the requirements of 35 U.S.C. 112 are met. An amendment to the specification can redefine the scope of the terms in a claim such that the claim is no longer clear or is not supported by the specification. Thus, an amendment to the specification can result in the failure of the claims to comply with 35 U.S.C. 112, even where the claims are not amended in any respect.

III. CLAIMS IN PROCEEDING MUST NOT ENLARGE SCOPE OF THE CLAIMS OF THE PATENT

Where new or amended claims are presented or where any part of the disclosure is amended, the claims of the reexamination proceeding should be examined under 35 U.S.C. 305, to determine whether they enlarge the scope of the original claims. 35 U.S.C. 305 states that “no proposed amended or new claim enlarging the scope of the claims of the

patent will be permitted in a reexamination proceeding...”.

A. *Criteria for Enlargement of the Scope of the Claims*

A claim presented in a reexamination proceeding “enlarges the scope” of the claims of the patent being reexamined where the claim is broader than each and every claim of the patent. See MPEP § 1412.03 for guidance as to when the presented claim is considered to be a broadening claim as compared with the claims of the patent, i.e., what is broadening and what is not. If a claim is considered to be a broadening claim for purposes of reissue, it is likewise considered to be a broadening claim in reexamination.

B. *Amendment of the Specification*

Where the specification is amended in a reexamination proceeding, the examiner should make certain that the amendment to the specification does not enlarge the scope of the claims of the patent. An amendment to the specification can enlarge the scope of the claims by redefining the scope of the terms in a claim, even where the claims are not amended in any respect.

C. *Rejection of Claims Where There Is Enlargement*

Any claim in a reexamination proceeding which enlarges the scope of the claims of the patent should be rejected under 35 U.S.C. 305. Form paragraph 22.11 is to be employed in making the rejection.

¶ 22.11 *Rejection, 35 U.S.C. 305, Claim Enlarges Scope of Patent - Ex Parte Reexamination*

Claim [1] rejected under 35 U.S.C. 305 as enlarging the scope of the claim(s) of the patent being reexamined. In 35 U.S.C. 305, it is stated that “[n]o proposed amended or new claim enlarging the scope of a claim of the patent will be permitted in a reexamination proceeding...” A claim presented in a reexamination “enlarges the scope” of the patent claim(s) where the claim is broader than any claim of the patent. A claim is broader in scope than the original claims if it contains within its scope any conceivable product or process which would not have infringed the original patent. A claim is broadened if it is broader in any one respect, even though it may be narrower in other respects.

[2]

Examiner Note:

The claim limitations which are considered to broaden the scope should be identified and explained in bracket 2. See MPEP § 2258.

IV. OTHER MATTERS

A. *Patent Under Reexamination Subject of a Prior Office or Court Decision*

Where some of the patent claims in a patent being reexamined have been the subject of a prior Office or court decision, see MPEP § 2242. Where other proceedings involving the patent are copending with the reexamination proceeding, see MPEP § 2282 - § 2286.

Patent claims not subject to reexamination because of their prior adjudication by a court should be identified. See MPEP § 2242. For handling a “live” claim dependent on a patent claim not subject to reexamination, see MPEP § 2260.01. All added claims will be examined.

Where grounds are set forth in a prior Office decision or Federal Court decision, which are not based on patents or printed publications and which clearly raise questions as to the validity of the claims, the examiner’s Office action should clearly state that the claims have not been examined as to those grounds not based on patents or printed publications that were stated in the prior decision. See 37 CFR 1.552(c). See *In re Knight*, 217 USPQ 294 (Comm’r Pat. 1982).

B. *“Live” Claims That Are Reexamined During Reexamination*

The Office’s determination in both the order for reexamination and the examination stage of the reexamination will generally be limited solely to a review of the “live” claims (i.e., existing claims not held invalid by a final decision, after all appeals) for which reexamination has been requested. If the requester was interested in having all of the claims reexamined, requester had the opportunity to include them in its request for reexamination. However, if the requester chose not to do so, those claim(s) for which reexamination was not requested will generally not be reexamined by the Office. It is further noted that 35 U.S.C. 302 requires that “[t]he request must set forth the pertinency and manner of applying cited prior art to every claim for which reexamination is requested.” If requester fails to apply the art to certain claims, requester is not statutorily entitled to reexamination of

such claims. If a request fails to set forth the pertinency and manner of applying the cited art to any claim for which reexamination is requested as required by 37 CFR 1.510(b), that claim will generally not be reexamined.

The decision to reexamine any claim for which reexamination has not been requested lies within the sole discretion of the Office, to be exercised based on the individual facts and situation of each individual case. If the Office chooses to reexamine any claim for which reexamination has not been requested, it is permitted to do so. In addition, the Office may always initiate a reexamination on its own initiative of the non-requested claim (35 U.S.C. 303(a)).

Similarly, if prior art patents or printed publications are discovered during reexamination which raise a substantial new question of patentability as to one or more patent claims for which reexamination has not been ordered (while reexamination has been ordered for other claims in the patent), then such claims may be added, within the sole discretion of the Office, during the examination phase of the proceeding.

C. Restriction Not Proper in Reexamination

Restriction requirements cannot be made in a reexamination proceeding since no statutory basis exists for restriction in a reexamination proceeding. Note also that the addition of claims to a “separate and distinct” invention to the patent would be considered as being an enlargement of the scope of the patent claims. See *Ex parte Wikdahl*, 10 USPQ2d 1546 (Bd. Pat. App. & Inter. 1989). See MPEP § 1412.03.

D. Ancillary Matters

There are matters ancillary to reexamination which are necessary and incident to patentability which will be considered. Amendments may be made to the specification to correct, for example, an inadvertent failure to claim foreign priority or the continuing status of the patent relative to a parent application if such correction is necessary to overcome a reference applied against a claim of the patent.

E. Claiming Foreign and Domestic Priority in Reexamination

The patent owner may obtain the right of foreign priority under 35 U.S.C. 119 (a)-(d) where a claim for priority had been made before the patent was granted,

and it is only necessary for submission of the certified copy in the reexamination proceeding to perfect priority. Likewise, patent owner may obtain the right of foreign priority under 35 U.S.C. 119 (a)-(d) where it is necessary to submit for the first time both the claim for priority and the certified copy. However, where it is necessary to submit for the first time both the claim for priority and the certified copy, and the patent to be reexamined matured from a utility or plant application filed on or after November 29, 2000, then the patent owner must also file a grantable petition for an unintentionally delayed priority claim under 37 CFR 1.55(c). See MPEP § 201.14(a).

Also, patent owner may correct the failure to adequately claim (in the application for the patent reexamined) benefit under 35 U.S.C. 120 of an earlier filed copending U.S. patent application. For a patent to be reexamined which matured from a utility or plant application filed on or after November 29, 2000, the patent owner must file a grantable petition for an unintentionally delayed priority claim under 37 CFR 1.78(a)(3). See MPEP § 201.11.

For a patent to be reexamined which matured from a utility or plant application filed before November 29, 2000, the patent owner can correct via reexamination the failure to adequately claim benefit under 35 U.S.C. 119(e) of an earlier filed provisional application. Under no circumstances can a reexamination proceeding be employed to add or correct a benefit claim under 35 U.S.C. 119(e) for a patent matured from a utility or plant application filed on or after November 29, 2000.

Section 4503 of the American Inventor’s Protection Act of 1999 (AIPA) amended 35 U.S.C. 119(e)(1) to state that:

No application shall be entitled to the benefit of an earlier filed provisional application under this subsection unless an amendment containing the specific reference to the earlier filed provisional application is submitted at such time during the pendency of the application as required by the Director. The Director may consider the failure to submit such an amendment within that time period as a waiver of any benefit under this subsection. The Director may establish procedures, including the payment of a surcharge, to accept an unintentionally delayed submission of an amendment under this section during the pendency of the application.

35 U.S.C. 119(e)(1), as amended by the AIPA, clearly prohibits the addition or correction of benefit

claims under 35 U.S.C. 119(e) when the application is no longer pending, e.g., an issued patent. Therefore, a reexamination is not a valid mechanism for adding or correcting a benefit claim under 35 U.S.C. 119(e) after a patent has been granted (for a patent matured from a utility or plant application filed on or after November 29, 2000).

No renewal of previously made claims for foreign priority under 35 U.S.C. 119 or domestic benefit under 35 U.S.C. 119(e) or 120, is necessary during reexamination.

F. Correction of Inventorship

Correction of inventorship may also be made during reexamination. See 37 CFR 1.324 and MPEP § 1481 for petition for correction of inventorship in a patent. If a petition filed under 37 CFR 1.324 is granted, a Certificate of Correction indicating the change of inventorship will not be issued, because the reexamination certificate that will ultimately issue will contain the appropriate change-of-inventorship information (i.e., the Certificate of Correction is in effect merged with the reexamination certificate).

G. Affidavits in Reexamination

Affidavits under 37 CFR 1.131 and 1.132 may be utilized in a reexamination proceeding. Note, however, that an affidavit under 37 CFR 1.131 may not be used to “swear back” of a reference patent if the reference patent is claiming the “same invention” as the patent undergoing reexamination. In such a situation, the patent owner may, if appropriate, seek to raise this issue via an affidavit under 37 CFR 1.130 (see MPEP § 718) or in an interference proceeding via an appropriate reissue application if such a reissue application may be filed (see MPEP § 1449.02).

H. Issues Not Considered in Reexamination

If questions other than those indicated above (for example, questions of patentability based on public use or on sale, *>conduct issues<, abandonment under 35 U.S.C. 102(c), etc.) are raised by the third party requester or the patent owner during a reexamination proceeding, the existence of such questions will be noted by the examiner in an Office action, in which case the patent owner may desire to consider the advisability of filing a reissue application to have such questions considered and resolved. Such ques-

tions could arise in a reexamination requester’s 37 CFR 1.510 request or in a 37 CFR 1.535 reply by the requester. Note form paragraph 22.03.

**>

¶ 22.03 Issue Not Within Scope of Ex Parte Reexamination

It is noted that an issue not within the scope of reexamination proceedings has been raised. [1]. The issue will not be considered in a reexamination proceeding. 37 CFR 1.552(c). While this issue is not within the scope of reexamination, the patentee is advised that it may be desirable to consider filing a reissue application provided that the patentee believes one or more claims to be partially or wholly inoperative or invalid based upon the issue.

Examiner Note:

1. In bracket 1, identify the issues.
2. This paragraph may be used either when the patent owner or third party requester raises issues such as public use or on sale, conduct, or abandonment of the invention. Such issues should not be raised independently by the patent examiner.

<

If questions of patentability based on public use or on sale, *>conduct issues<, abandonment under 35 U.S.C. 102(c), etc. are independently discovered by the examiner during a reexamination proceeding but were not raised by the third party requester or the patent owner, the existence of such questions will not be noted by the examiner in an Office action, because 37 CFR 1.552(c) is only directed to such questions “raised by the patent owner or the third party requester.”

I. Request for Reexamination Filed on Patent After It Has Been Reissued

Where a request for reexamination is filed on a patent after it has been reissued, reexamination will be denied because the patent on which the request for reexamination is based has been surrendered. Should reexamination of the reissued patent be desired, a new request for reexamination including, and based on, the specification and claims of the reissue patent must be filed.

Any amendment made by the patent owner to accompany the initial reexamination request, or in later prosecution of the reexamination proceeding, should treat the changes made by the granted reissue patent as the text of the patent, and all bracketing and underlining made with respect to the patent **as changed by the reissue**.

Where the reissue patent issues after the filing of a request for reexamination, see MPEP § 2285.

2258.01 Use of Previously Cited/Considered Art in Rejections [R-7]

In the examining stage of a reexamination proceeding, the examiner will consider whether the claims are subject to rejection based on art. Before making such a rejection, the examiner should check the patent's file history to ascertain whether the art that will provide the basis for the rejection was previously cited/considered in an earlier concluded Office examination of the patent (e.g., in the examination of the application for the patent). For the sake of expediency, such art is referred to as "old art" throughout, since the term "old art" was coined by the Federal Circuit in its decision of *In re Hiniker*, 150 F.3d 1362, 1365-66, 47 USPQ2d 1523, 1526 (Fed. Cir. 1998).

If the rejection to be made by the examiner will be based on a combination of "old art" and art newly cited during the reexamination proceeding, the rejection is proper, and should be made. See *In re Hiniker*, 150 F.3d at 1367, 47 USPQ2d at 1527. (Court held the reexamination proceeding was supported by a substantial new question of patentability where the rejection before the court was based on a combination of art that had been before the examiner during the original prosecution, and art newly cited during the reexamination proceeding.)

If the "old art" provides the **sole basis** for a rejection, the following applies:

(A) Reexamination was ordered **on or after November 2, 2002**:

For a reexamination that was ordered on or after November 2, 2002 (the date of enactment of Public Law 107-273; see Section 13105, of the Patent and Trademark Office Authorization Act of 2002), reliance solely on old art (as the basis for a rejection) does not necessarily preclude the existence of a substantial new question of patentability (SNQ) that is based exclusively on that old art. Determinations on whether a SNQ exists in such an instance shall be based upon a fact-specific inquiry done on a case-by-case basis. For example, a SNQ may be based solely on old art where the old art is being presented/viewed in a new light, or in a different way, as compared with its use in the earlier concluded examination(s), in view of a material new argument or interpretation presented in the request.

When an Office action is being considered, and it is newly determined that a SNQ based solely on old art is raised by a request in a reexamination that was ordered on or after November 2, 2002, form paragraph 22.01.01 should be included in the Office action. Form paragraph 22.01.01 should be included in any Office action in which a SNQ based solely on the old art is first set forth (i.e., it was not set forth in the order granting reexamination or a prior Office action in the proceeding).

¶ 22.01.01 Criteria for Applying "Old Art" as Sole Basis for Reexamination

The above [1] is based solely on patents and/or printed publications already cited/considered in an earlier concluded examination of the patent being reexamined. On November 2, 2002, Public Law 107-273 was enacted. Title III, Subtitle A, Section 13105, part (a) of the Act revised the reexamination statute by adding the following new last sentence to 35 U.S.C. 303(a) and 312(a):

"The existence of a substantial new question of patentability is not precluded by the fact that a patent or printed publication was previously cited by or to the Office or considered by the Office."

For any reexamination ordered on or after November 2, 2002, the effective date of the statutory revision, reliance on previously cited/considered art, i.e., "old art," does not necessarily preclude the existence of a substantial new question of patentability (SNQ) that is based exclusively on that old art. Rather, determinations on whether a SNQ exists in such an instance shall be based upon a fact-specific inquiry done on a case-by-case basis.

In the present instance, there exists a SNQ based solely on [2]. A discussion of the specifics now follows:

[3]

Examiner Note:

1. In bracket 1, insert "substantial new question of patentability" if the present form paragraph is used in an order granting reexamination (or a TC or CRU Director's decision on petition of the denial of reexamination). If this form paragraph is used in an Office action, insert "ground of rejection".
2. In bracket 2, insert the old art that is being applied as the sole basis of the SNQ. For example, "the patent to Schor" or "the patent to Schor when taken with the Jones publication" or "the combination of the patent to Schor and the Smith publication" could be inserted. Where more than one SNQ is presented based solely on old art, the examiner would insert all such bases for SNQ.
3. In bracket 3, for each basis identified in bracket 2, explain how and why that fact situation applies in the proceeding being acted on. The explanation could be for example that the old art is being presented/viewed in a new light, or in a different way, as compared with its use in the earlier concluded examination(s), in view of a material new argument or interpretation presented in the request. See *Ex parte Chicago Rawhide Mfg. Co.*, 223 USPQ 351 (Bd. Pat. App. & Inter. 1984).

4. This form paragraph is only used the first time the “already cited/considered” art is applied, and is not repeated for the same art in subsequent Office actions.

(B) Reexamination was ordered prior to November 2, 2002:

For a reexamination that was ordered prior to November 2, 2002, old art **cannot** (subject to the exceptions set forth below) be used as the **sole basis** for a rejection.

In determining the presence or absence of “a substantial new question of patentability” on which to base a rejection, the use of “old art” in a reexamination that was ordered prior to November 2, 2002, is controlled by *In re Portola Packaging Inc.*, 110 F.3d 786, 42 USPQ2d 1295 (Fed. Cir. 1997). (Note that *Portola Packaging* was decided based on the reexamination statute as it existed prior to the amendment by Public Law 107-273, Section 13105 of the Patent and Trademark Office Authorization Act of 2002). The amendment by Public Law 107-273, Section 13105, overruled the *Portola Packaging* decision for any reexamination that was ordered on or after November 2, 2002. See *In re Bass*, 314 F.3d 575, 576-77, 65 USPQ2d 1156, 1157 (Fed. Cir. 2002) where the Court stated in the sole footnote:

The following guidelines are provided for reviewing ongoing reexaminations ordered **prior to November 2, 2002**, for compliance with the *Portola Packaging* decision.

On November 2, 2002, 35 U.S.C. 303(a) was amended by the passage of Pub. L. No. 107-273, 13105, (116 Stat.) 1758, 1900, to add “[t]he existence of a substantial new question of patentability is not precluded by the fact that a patent or printed publication was previously cited by or to the Office or considered by the Office,” thereby overruling *Portola Packaging*. The following guidelines are provided for reviewing ongoing reexaminations ordered **prior to November 2, 2002**, for compliance with the *Portola Packaging* decision.

(1) General principles governing compliance with *Portola Packaging* for ongoing reexaminations ordered prior to November 2, 2002.

If prior art was previously relied upon to reject a claim in a concluded prior related Office proceeding, the Office will not conduct reexamination based only on such prior art. “Prior related Office proceedings”

include the application which matured into the patent that is being reexamined, any reissue application for the patent, and any reexamination proceeding for the patent.

If prior art was not relied upon to reject a claim, but was cited in the record of a concluded prior related Office proceeding, and its relevance to the patentability of any claim was actually discussed on the record, the Office will not conduct reexamination based only on such prior art. The relevance of the prior art to patentability may have been discussed by either the applicant, patentee, examiner, or any third party. However, 37 CFR 1.2 requires that all Office business be transacted in writing. Thus, the Office cannot presume that a prior art reference was previously relied upon or discussed in a prior Office proceeding if there is no basis in the written record to so conclude other than the examiner’s initials or a check mark on a form PTO/SB/08A or 08B, or PTO/SB/42 (or on a form having a format equivalent to one of these forms) submitted with an information disclosure statement. Thus, any specific discussion of prior art must appear on the record of a prior related Office proceeding. Generalized statements such as the prior art is “cited to show the state of the art,” “cited to show the background of the invention,” or “cited of interest” would not preclude reexamination.

The Office may conduct reexamination based on prior art that was cited but whose relevance to patentability of the claims was not discussed in any prior related Office proceeding.

(2) Procedures for determining whether the prosecution of an ongoing reexamination must be terminated in compliance with *Portola Packaging*.

Office personnel must adhere to the following procedures when determining whether the prosecution of an ongoing reexamination should be terminated in compliance with the Federal Circuit’s decision in *Portola Packaging*.

(a) Ascertain that the order granting reexamination was mailed prior to November 2, 2002. If the order granting reexamination was not mailed prior to November 2, 2002, see above “Reexamination was ordered on or after November 2, 2002” for guidance.

(b) Prior to making any rejection in the ongoing reexamination, determine for any prior related Office proceeding what prior art was (i) relied upon to reject any claim, or (ii) cited and discussed.

(c) Base any and all rejections of the patent claims under reexamination at least in part on prior art that was, in any prior related Office proceeding, neither (i) relied upon to reject any claim, nor (ii) cited and its relevance to patentability of any claim discussed.

(d) Withdraw any rejections based only on prior art that was, in any prior related Office proceeding, previously either (i) relied upon to reject any claim, or (ii) cited and its relevance to patentability of any claim discussed.

(e) Terminate the prosecution of any reexamination in which the only remaining rejections are entirely based on prior art that was, in any prior related Office proceeding, previously (i) relied upon to reject any claim, and/or (ii) cited and its relevance to patentability of a claim discussed.

The Director of the USPTO may conduct a search for new art to determine whether a substantial new question of patentability exists prior to terminating the prosecution of any ongoing reexamination proceeding. See 35 U.S.C. 303. See also 35 U.S.C. 305 (indicating that “reexamination will be conducted according to the procedures established for initial examination,” thereby suggesting that the Director of the USPTO may conduct a search during an ongoing reexamination proceeding).

(3) Application of *Portola Packaging* to unusual fact patterns.

The Office recognizes that each case must be decided on its particular facts and that cases with unusual fact patterns will occur. In such a case, the reexamination should be brought to the attention of the Central Reexamination Unit (CRU) or Technology Center (TC) Director who will then determine the appropriate action to be taken.

Unusual fact patterns may appear in cases in which prior art was relied upon to reject any claim or cited and discussed with respect to the patentability of a claim in a prior related Office proceeding, but other evidence clearly shows that the examiner did not appreciate the issues raised in the reexamination request or the ongoing reexamination with respect to that art. Such other evidence may appear in the reexamination request, in the nature of the prior art, in the prosecution history of the prior examination, or in an admission by the patent owner, applicant, or inventor. See 37 CFR 1.104(c)(3).

The following examples are intended to be illustrative and not inclusive.

For example, if a textbook was cited during prosecution of the application which matured into the patent, the record of that examination may show that only select information from the textbook was discussed with respect to the patentability of the claims. The file history of the prior Office proceeding should indicate which portion of the textbook was previously considered. See 37 CFR 1.98(a)(2)(ii) (an information disclosure statement must include a copy of each “publication or that portion which caused it to be listed”). If a subsequent reexamination request relied upon other information in the textbook that actually teaches what is required by the claims, it may be appropriate to rely on this other information in the textbook to order and/or conduct reexamination. However, a reexamination request that merely provides a new interpretation of a reference already previously relied upon or actually discussed by the Office does not create a substantial new question of patentability.

Another example involves the situation where an examiner discussed a reference in a prior Office proceeding, but did not either reject a claim based upon the reference or maintain the rejection based on the mistaken belief that the reference did not qualify as prior art. For example, the examiner may not have believed that the reference qualified as prior art because: (i) the reference was undated or was believed to have a bad date; (ii) the applicant submitted a declaration believed to be sufficient to antedate the reference under 37 CFR 1.131; or (iii) the examiner attributed an incorrect filing date to the claimed invention. If the reexamination request were to explain how and why the reference actually does qualify as prior art, it may be appropriate to rely on the reference to order and/or conduct reexamination. For example, the request could: (i) verify the date of the reference; (ii) undermine the sufficiency of the declaration filed under 37 CFR 1.131 >(by a showing of an inaccuracy/mistake of fact in the declaration)<; or (iii) explain the correct filing date accorded a claim >where the issue was not previously addressed in an earlier examination of the patent<. See e.g., *Heinl v. Godici*, 143 F. Supp.2d 593 (E.D.Va. 2001) (reexamination on the basis of art previously presented without

adequate proof of date may proceed if prior art status is now established).

Another example involves foreign language prior art references. If a foreign language prior art reference was cited and discussed in any prior Office proceeding but the foreign language prior art reference was never completely and accurately translated into English during the original prosecution, *Portola Packaging* may not prohibit reexamination over a complete and accurate translation of that foreign language prior art reference. Specifically, if a reexamination request were to explain why a more complete and accurate translation of that same foreign language prior art reference actually teaches what is required by the patent claims, it may be appropriate to rely on the foreign language prior art reference to order and/or conduct reexamination.

Another example of an unusual fact pattern involves cumulative references. To the extent that a cumulative reference is repetitive of a prior art reference that was previously applied or discussed, *Portola Packaging* may prohibit reexamination of the patent claims based only on the repetitive reference. For purposes of reexamination, a cumulative reference that is repetitive is one that substantially reiterates verbatim the teachings of a reference that was either previously relied upon or discussed in a prior Office proceeding even though the title or the citation of the reference may be different. However, it is expected that a repetitive reference which cannot be considered by the Office during reexamination will be a rare occurrence since most references teach additional information or present information in a different way than other references, even though the references might address the same general subject matter.

(4) Notices regarding compliance with *Portola Packaging*.

(a) If the prosecution of an ongoing reexamination is terminated under (2)(e) above in order to comply with the Federal Circuit's decision in *Portola Packaging*, the Notice of Intent to Issue *Ex Parte* Reexamination Certificate should state:

"The prosecution of this reexamination is terminated based on *In re Portola Packaging, Inc.*, 110 F.3d 786, 42 USPQ2d 1295 (Fed. Cir. 1997). No patentability determination has been made in this reexamination proceeding."

(b) If a rejection in the reexamination has previously been issued and that rejection is withdrawn under (2)(d) above in order to comply with the Federal Circuit's decision in *Portola Packaging*, the Office action withdrawing such rejection should state:

"The rejection(s) based upon _____ is/are withdrawn in view of *In re Portola Packaging, Inc.*, 110 F.3d 786, 42 USPQ2d 1295 (Fed. Cir. 1997). No patentability determination of the claims of the patent in view of such prior art has been made in this reexamination proceeding."

2259 >Res Judicata and< Collateral Estoppel in Reexamination Proceedings [R-2]

MPEP § 2242 and § 2286 relate to the Office policy controlling the determination on a request for reexamination and the subsequent examination phase of the reexamination where there has been a Federal Court decision on the merits as to the patent for which reexamination is requested.

Since claims finally held invalid by a Federal Court>, after all appeals,< will be withdrawn from consideration and not reexamined during a reexamination proceeding, **>a **rejection** on the grounds of *res judicata* will not be appropriate in reexamination. In situations, where the issue decided in Court did not invalidate claims, but applies in one or more respects to the claims being reexamined, the doctrine of collateral estoppel may be applied in reexamination to resolve the issue.<

2260 Office Actions [R-5]

37 CFR 1.104. Nature of examination.

(a) Examiner's action.

(1) On taking up an application for examination or a patent in a reexamination proceeding, the examiner shall make a thorough study thereof and shall make a thorough investigation of the available prior art relating to the subject matter of the claimed invention. The examination shall be complete with respect both to compliance of the application or patent under reexamination with the applicable statutes and rules and to the patentability of the invention as claimed, as well as with respect to matters of form, unless otherwise indicated.

(2) The applicant, or in the case of a reexamination proceeding, both the patent owner and the requester, will be notified of the examiner's action. The reasons for any adverse action or any objection or requirement will be stated in an Office action and such information or references will be given as may be useful in aiding the applicant, or in the case of a reexamination proceeding

the patent owner, to judge the propriety of continuing the prosecution.

(3) An international-type search will be made in all national applications filed on and after June 1, 1978.

(4) Any national application may also have an international-type search report prepared thereon at the time of the national examination on the merits, upon specific written request therefor and payment of the international-type search report fee set forth in § 1.21(e). The Patent and Trademark Office does not require that a formal report of an international-type search be prepared in order to obtain a search fee refund in a later filed international application.

(b) *Completeness of examiner's action.* The examiner's action will be complete as to all matters, except that in appropriate circumstances, such as misjoinder of invention, fundamental defects in the application, and the like, the action of the examiner may be limited to such matters before further action is made. However, matters of form need not be raised by the examiner until a claim is found allowable.

(c) *Rejection of claims.*

(1) If the invention is not considered patentable, or not considered patentable as claimed, the claims, or those considered unpatentable will be rejected.

(2) In rejecting claims for want of novelty or for obviousness, the examiner must cite the best references at his or her command. When a reference is complex or shows or describes inventions other than that claimed by the applicant, the particular part relied on must be designated as nearly as practicable. The pertinence of each reference, if not apparent, must be clearly explained and each rejected claim specified.

(3) In rejecting claims the examiner may rely upon admissions by the applicant, or the patent owner in a reexamination proceeding, as to any matter affecting patentability and, insofar as rejections in applications are concerned, may also rely upon facts within his or her knowledge pursuant to paragraph (d)(2) of this section.

(4) **>Subject matter which is developed by another person which qualifies as prior art only under 35 U.S.C. 102(e), (f) or (g) may be used as prior art under 35 U.S.C. 103 against a claimed invention unless the entire rights to the subject matter and the claimed invention were commonly owned by the same person or subject to an obligation of assignment to the same person at the time the claimed invention was made.<

(5) The claims in any original application naming an inventor will be rejected as being precluded by a waiver in a published statutory invention registration naming that inventor if the same subject matter is claimed in the application and the statutory invention registration. The claims in any reissue application naming an inventor will be rejected as being precluded by a waiver in a published statutory invention registration naming that inventor if the reissue application seeks to claim subject matter:

(i) Which was not covered by claims issued in the patent prior to the date of publication of the statutory invention registration; and

(ii) Which was the same subject matter waived in the statutory invention registration.

(d) *Citation of references.*

(1) If domestic patents are cited by the examiner, their numbers and dates, and the names of the patentees will be stated. If domestic patent application publications are cited by the examiner, their publication number, publication date, and the names of the applicants will be stated. If foreign published applications or patents are cited, their nationality or country, numbers and dates, and the names of the patentees will be stated, and such other data will be furnished as may be necessary to enable the applicant, or in the case of a reexamination proceeding, the patent owner, to identify the published applications or patents cited. In citing foreign published applications or patents, in case only a part of the document is involved, the particular pages and sheets containing the parts relied upon will be identified. If printed publications are cited, the author (if any), title, date, pages or plates, and place of publication, or place where a copy can be found, will be given.

(2) When a rejection in an application is based on facts within the personal knowledge of an employee of the Office, the data shall be as specific as possible, and the reference must be supported, when called for by the applicant, by the affidavit of such employee, and such affidavit shall be subject to contradiction or explanation by the affidavits of the applicant and other persons.

(e) *Reasons for allowance.* If the examiner believes that the record of the prosecution as a whole does not make clear his or her reasons for allowing a claim or claims, the examiner may set forth such reasoning. The reasons shall be incorporated into an Office action rejecting other claims of the application or patent under reexamination or be the subject of a separate communication to the applicant or patent owner. The applicant or patent owner may file a statement commenting on the reasons for allowance within such time as may be specified by the examiner. Failure by the examiner to respond to any statement commenting on reasons for allowance does not give rise to any implication.

It is intended that the examiner's first *ex parte* action on the merits be the primary action to establish the issues which exist between the examiner and the patent owner insofar as the patent is concerned. At the time the first action is issued, the patent owner has already been permitted to file a statement and an amendment pursuant to 37 CFR 1.530; and the reexamination requester, if the requester is not the patent owner, has been permitted to reply thereto pursuant to 37 CFR 1.535. Thus, at this point, the issues should be sufficiently focused to enable the examiner to make a definitive first *ex parte* action on the merits which should clearly establish the issues which exist between the examiner and the patent owner insofar as the patent is concerned. In view of the fact that the examiner's first action will clearly establish the issues, the first action should include a statement cautioning the patent owner that a complete response should be made to the action since the next action is expected to be a final action. The first action should further caution the patent owner that the requirements

of 37 CFR 1.116(b) will be strictly enforced after final action and that any amendment after a final action must include “a showing of good and sufficient reasons why the amendment is necessary and was not earlier presented” in order to be considered. The language of form paragraph 22.04 is appropriate for inclusion in the first Office action:

¶ 22.04 Papers To Be Submitted in Response to Action - Ex Parte Reexamination

In order to ensure full consideration of any amendments, affidavits or declarations, or other documents as evidence of patentability, such documents must be submitted in response to this Office action. Submissions after the next Office action, which is intended to be a final action, will be governed by the requirements of 37 CFR 1.116 after final rejection and 37 CFR 41.33 after appeal, which will be strictly enforced.

2260.01 Dependent Claims [R-2]

If ** >an unamended base patent claim (i.e., a claim appearing in the reexamination as it appears in the patent)< has been rejected or canceled, any claim which is directly or indirectly dependent thereon should be confirmed or allowed if the dependent claim is otherwise allowable. The dependent claim should *not* be objected to or rejected merely because it depends on a rejected or canceled patent claim. No requirement should be made for rewriting the dependent claim in independent form. As the original patent claim numbers are not changed in a reexamination proceeding, the content of the canceled base claim would remain in the printed patent and would be available to be read as a part of the confirmed or allowed dependent claim.

If a new base claim (a base claim other than a base claim appearing in the patent) has been canceled in a reexamination proceeding, a claim which depends thereon should be rejected as *>indefinite<*. If a new base claim >or an amended patent claim< is rejected, a claim dependent thereon should be objected to if it is otherwise patentable and a requirement made for rewriting the dependent claim in independent form.

2261 Special Status for Action

35 U.S.C. 305. Conduct of reexamination proceedings.

All reexamination proceedings under this section, including any appeal to the Board of Patent Appeals and Interferences, will be conducted with special dispatch within the Office.

In view of the requirement for “special dispatch,” reexamination proceedings will be “special” throughout their pendency in the Office. The examiner’s first action on the merits should be completed within *1 month* of the filing date of the requester’s reply (37 CFR 1.535), or within *1 month* of the filing date of the patent owner’s statement (37 CFR 1.530) if there is no requester other than the patent owner. If no submissions are made under either 37 CFR 1.530 or 37 CFR 1.535, the first action on the merits should be completed within *1 month* of any due date for such submission. Mailing of the first action should occur within 6 WEEKS after the appropriate filing or due date of any statement and any reply thereto.

Any cases involved in litigation, whether they are reexamination proceedings or reissue applications, will have priority over all other cases. Reexamination proceedings not involved in litigation will have priority over all other cases except reexaminations or reissues involved in litigation.

2262 Form and Content of Office Action [R-7]

The examiner’s first Office action will be a statement of the examiner’s position and should be so complete that the second Office action can properly be made a final action. See MPEP § 2271.

All Office actions are to be typed. The first Office action must be sufficiently detailed that the pertinency and manner of applying the cited prior art to the claims is clearly set forth therein. Where the request for reexamination includes material such as a claim chart to explain a proposed rejection in order to establish the existence of a substantial new question of patentability, the examiner may cut and paste the claim chart (or other material) to incorporate it within the body of the Office action. The examiner must, however, carefully review the claim chart (or other material) to ensure that any items incorporated in a statement of the rejection clearly and completely address the patentability of the claims. For actions subsequent to the first Office action, the examiner must be careful to additionally address all patent owner responses to previous actions. If the examiner concludes in any Office action that one or more of the claims are patentable over the cited patents or printed publications, the examiner should indicate why the claim(s) is clearly patentable in a manner similar to

that used to indicate reasons for allowance (MPEP § 1302.14). If the record is clear why the claim(s) is/are clearly patentable, the examiner may refer to the particular portions of the record which clearly establish the patentability of the claim(s). The first action should also respond to the substance of each argument raised by the patent owner and requester pursuant to 37 CFR 1.510, 1.530, and 1.535. If arguments are presented which are inappropriate in reexamination, they should be treated in accordance with 37 CFR 1.552(c). It is especially important that the examiner's action in reexamination be thorough and complete in view of the finality of a reexamination proceeding and the patent owner's inability to file a continuation proceeding.

Normally, the title will not need to be changed during reexamination. If a change of the title is necessary, patent owner should be notified of the need to provide an amendment changing the title as early as possible in the prosecution as a part of an Office Action. If all of the claims are found to be patentable and a Notice of Intent to Issue *Ex Parte* Reexamination Certificate has been or is to be mailed, a change to the title of the invention by the examiner may only be done by a formal Examiner's Amendment. Changing the title and merely initialing the change is NOT permitted in reexamination.

>Current procedure permits the examiner, in the exercise of his or her professional judgment to indicate that a discussion with the patent owner's representative may result in agreement whereby the reexamination proceeding may be placed in condition for issuing a Notice of Intent to Issue a Reexamination Certificate (NIRC) and that the examiner will telephone the patent owner's representative within about 2 weeks. Under this practice the patent owner's representative can be adequately prepared to conduct

such a discussion. Any resulting amendment may be made either by the patent owner's attorney or agent, or by the examiner in an examiner's amendment. It should be recognized that when extensive amendments are necessary, it would be preferable if the amendments were filed by the patent owner's attorney or agent of record since this will provide the file wrapper with a better record because the amendments would include the patent owner's arguments for patentability as required by 37 CFR 1.111.<

I. PANEL REVIEW CONFERENCE

After an examiner has determined that the reexamination proceeding is ready for an Office action, the examiner will formulate a draft preliminary Office action. The examiner will then inform his/her >Central Reexamination Unit (CRU) Supervisory Patent Examiner (SPE) or Technology Center (TC) Quality Assurance Specialist (QAS)< of his/her intent to issue the Office action. The >CRU SPE/TC QAS< will convene a panel review conference, and the conference members will review the patentability of the claim(s) pursuant to MPEP § 2271.01. If the conference confirms the examiner's preliminary decision to reject and/or allow the claims, the proposed Office action shall be issued and signed by the examiner, with the two other conferees initialing the action (as "conferee") to indicate their presence in the conference. If the conference does not confirm the examiner's treatment of the claims, the examiner will reevaluate and issue an appropriate Office action.

II. SAMPLE OFFICE ACTION

A sample of a first Office action in a reexamination proceeding is set forth below.



UNITED STATES PATENT AND TRADEMARK OFFICE

COMMISSIONER FOR PATENTS
UNITED STATES PATENT AND TRADEMARK OFFICE
P.O. BOX 1450
ALEXANDRIA, VA 22313-1450
WWW.USPTO.GOV

DO NOT USE IN PALM PRINTER

(THIRD PARTY REQUESTER'S CORRESPONDENCE ADDRESS)

Requester
12345 Anystreet Road
Anytown, VA 22222

EX PARTE REEXAMINATION COMMUNICATION TRANSMITTAL FORM

REEXAMINATION CONTROL NO. 90/999,999.

PATENT NO. 9,999,999.

ART UNIT 3725.

Enclosed is a copy of the latest communication from the United States Patent and Trademark Office in the above identified *ex parte* reexamination proceeding (37 CFR 1.550(f)).

Where this copy is supplied after the reply by requester, 37 CFR 1.535, or the time for filing a reply has passed, no submission on behalf of the *ex parte* reexamination requester will be acknowledged or considered (37 CFR 1.550(g)).

PTOL-465

Office Action in Ex Parte Reexamination	Control No. 90/999,999	Patent Under Reexamination 9,999,999	
	Examiner Kenneth Schor	Art Unit 3725	

-- The MAILING DATE of this communication appears on the cover sheet with the correspondence address --

a Responsive to the communication(s) filed on 19 September 1999. b This action is made FINAL.
c A statement under 37 CFR 1.530 has not been received from the patent owner.

A shortened statutory period for response to this action is set to expire _____ month(s) from the mailing date of this letter. Failure to respond within the period for response will result in termination of the proceeding and issuance of an *ex parte* reexamination certificate in accordance with this action. 37 CFR 1.550(d). **EXTENSIONS OF TIME ARE GOVERNED BY 37 CFR 1.550(c)**. If the period for response specified above is less than thirty (30) days, a response within the statutory minimum of thirty (30) days will be considered timely.

Part I THE FOLLOWING ATTACHMENT(S) ARE PART OF THIS ACTION:

1. <input checked="" type="checkbox"/> Notice of References Cited by Examiner, PTO-892.	3. <input type="checkbox"/> Interview Summary, PTO-474.
2. <input checked="" type="checkbox"/> Information Disclosure Statement, PTO-1449.	4. <input type="checkbox"/> _____.

Part II SUMMARY OF ACTION

- 1a. Claims 4-6 are subject to reexamination.
- 1b. Claims 1-3 are not subject to reexamination.
2. Claims _____ have been canceled in the present reexamination proceeding.
3. Claims 5 are patentable and/or confirmed.
4. Claims 4 and 6 are rejected.
5. Claims _____ are objected to.
6. The drawings, filed on _____ are acceptable.
7. The proposed drawing correction, filed on _____ has been (7a) approved (7b) disapproved.
8. Acknowledgment is made of the priority claim under 35 U.S.C. § 119(a)-(d) or (f).
a) All b) Some* c) None of the certified copies have
1 been received.
2 not been received.
3 been filed in Application No. _____.
4 been filed in reexamination Control No. _____.
5 been received by the International Bureau in PCT application No. _____.

* See the attached detailed Office action for a list of the certified copies not received.

9. Since the proceeding appears to be in condition for issuance of an *ex parte* reexamination certificate except for formal matters, prosecution as to the merits is closed in accordance with the practice under *Ex parte* Quayle, 1935 C.D. 11, 453 O.G. 213.
10. Other:

cc: Requester (if third party requester)

Claims 1 - 3 of the Smith patent are not being reexamined in view of the final decision in the *ABC Corp. v. Smith*, 999 USPQ2d 99 (Fed. Cir. 1999). Claims 1 - 3 were held not valid by the Court.

The following is a quotation of 35 U.S.C. 103 which forms the basis for all obviousness rejections set forth in this Office action:

A patent may not be obtained though the invention is not identically disclosed or described as set forth in section 102 of this title, if the differences between the subject matter sought to be patented and the prior art are such that the subject matter as a whole would have been obvious at the time the invention was made to a person having ordinary skill in the art to which said subject matter pertains. Patentability shall not be negated by the manner in which the invention was made.

Subject matter developed by another person, which qualifies as prior art only under one or more of subsections (f) or (g) of section 102 of this title, shall not preclude patentability under this section where the subject matter and the claimed invention were, at the time the invention was made, owned by the same person, or subject to an obligation of assignment to the same person.

Claims 4 and 6 are rejected under 35 U.S.C. 103 as being unpatentable over Berridge in view of McGee.

Berridge teaches extruding a chlorinated polymer using the same extrusion structure recited in Claims 4 and 6 of the Smith patent. However, Berridge does not show supporting the extrusion barrel at 30 degrees to the horizontal, using spring supports. McGee teaches spring supporting an extrusion barrel at an angle of 25 - 35 degrees, in order to decrease imperfections in extruded chlorinated polymers. It would have been obvious to one of ordinary skill in the polymer extrusion art to support the extrusion barrel of Berridge on springs and at an angle of 30 degrees because McGee teaches this to be known in the polymer extrusion art for decreasing imperfections in extruded chlorinated polymers.

Claim 5 is patentable over the prior art patents and printed publications because of the specific extrusion die used with the Claim 4 spring-supported barrel. This serves to even further reduce imperfections in the extruded chlorinated polymers and is not taught by the art of record, alone or in combination.

It is noted that an issue not within the scope of reexamination proceedings has been raised. In the above-cited final Court decision, a question is raised as to the possible public use of the invention of Claim 6. This question was also raised by the requester in the reply to the owner's statement. The issue will not be considered in a reexamination proceeding (37 CFR 1.552(c)). While this issue is not within the scope of the reexamination, the patentee is advised that it may be desirable to consider filing a reissue application provided that the patentee believes one or more claims to be partially or wholly inoperative or invalid based upon the issue.

Swiss Patent 80555 and the American Machinist article are cited to show cutting and forming extruder apparatus somewhat similar to that claimed in the Smith patent.

In order to ensure full consideration of any amendments, affidavits, or declarations, or other documents as evidence of patentability, such documents must be submitted in response to this Office action. Submissions after the next Office action, which is intended to be a final action, will be governed by the requirements of 37 CFR 1.116 after final rejection and 37 CFR 41.33 after appeal which will be strictly enforced.

All correspondence relating to this *ex parte* reexamination proceeding should be directed:

By Mail to: Mail Stop *Ex Parte* Reexam
Attn: Central Reexamination Unit
Commissioner for Patents
United States Patent & Trademark Office
P.O. Box 1450
Alexandria, VA 22313-1450

By FAX to: (571) 273-9900
Central Reexamination Unit

By hand: Customer Service Window
Randolph Building
401 Dulany Street
Alexandria, VA 22314

Any inquiry concerning this communication should be directed to Kenneth Schor at telephone number (571) 272-0000.

Kenneth M. Schor
Kenneth M. Schor
Primary Examiner
>CRU< Art Unit *>3998<

ARI
Conferee

BZ
Conferee

2263 Time for Response [R-5]

A shortened statutory period of 2 months will be set for response to Office actions in reexaminations, except *as follows. Where the reexamination results from a court order or litigation is stayed for purposes of reexamination, ** the shortened statutory period will be set at 1 month. >In addition, if (A) there is litigation concurrent with an *ex parte* reexamination proceeding and (B) the reexamination proceeding has been pending for more than one year, the Director or Deputy Director of the Office of Patent Legal Administration (OPLA), Director of the Central Reexamination Unit (CRU), Director of the Technology Center (TC) in which the reexamination is being conducted, or a Senior Legal Advisor of the OPLA, may approve Office actions in such reexamination proceeding setting a one-month or thirty days, whichever is longer, shortened statutory period for response rather than the two months usually set in reexamination proceedings. A statement at the end of the Office action – “One month or thirty days, whichever is longer, shortened statutory period approved,” followed by the signature of one of these officials, will designate such approval.< See MPEP § 2286. Note, however, that this 1-month policy does NOT apply to the 2-month period for the filing of a statement under 37 CFR 1.530, which 2-month period is set by 35 U.S.C. 304.

Where a reexamination proceeding has been stayed because of a copending reissue application, and the reissue application is abandoned, all actions in the reexamination after the stay has been removed will set a 1-month shortened statutory period unless a longer period for response is clearly warranted by nature of the examiner’s action; see MPEP § 2285.

2264 Mailing of Office Action [R-3]

Ex Parte reexamination forms are structured so that the PALM printer can be used to print the identifying information for the reexamination file and the mailing address — usually the address of the patent owner’s legal representative. Where there is no legal representative, the patent owner’s address is printed. Only the first patent owner’s address is printed where there are multiple patent owners. A transmittal form PTOL-465 is also provided for each partial patent owner in addition to the one named on the top of the Office action.

All actions in a third party requester *ex parte* reexamination will have a copy mailed to the third party requester. A transmittal form PTOL-465 must be used in providing the third party requester with a copy of each Office action.

A completed transmittal form PTOL-465 will be provided as needed for any third party requester and additional partial patent owner (discussed above), and the appropriate address will be entered on it. The number of transmittal forms provides a ready reference for the number of copies of each Office action to be made, and the transmittal form permits use of the window envelopes in mailing the copies of the action to parties other than the patent owner.

**

2265 Extension of Time [R-7]

37 CFR 1.550. *Conduct of ex parte reexamination proceedings.*

(c) The time for taking any action by a patent owner in an *ex parte* reexamination proceeding will be extended only for sufficient cause and for a reasonable time specified. Any request for such extension must be filed on or before the day on which action by the patent owner is due, but in no case will the mere filing of a request effect any extension. Any request for such extension must be accompanied by the petition fee set forth in § 1.17(g). See § 1.304(a) for extensions of time for filing a notice of appeal to the U.S. Court of Appeals for the Federal Circuit or for commencing a civil action.

The provisions of 37 CFR 1.136 (a) and (b) are *NOT* applicable to *ex parte* reexamination proceedings under any circumstances. Public Law 97-247 amended 35 U.S.C. 41 to authorize the Director to provide for extensions of time to take action which do not require a reason for the extension in an “application.” An *ex parte* reexamination proceeding does not involve an “application.” 37 CFR 1.136 authorizes extensions of the time period only in an application in which an applicant must respond or take action. There is neither an “application,” nor an “applicant” involved in a reexamination proceeding.

An extension of time in an *ex parte* reexamination proceeding is requested pursuant to 37 CFR 1.550(c). Accordingly, a request for an extension (A) must be filed on or before the day on which action by the patent owner is due and (B) must set forth sufficient

reason for the extension, and (C) must be accompanied by the petition fee set forth in 37 CFR 1.17(g). Requests for an extension of time in an *ex parte* reexamination proceeding will be considered only after the decision to grant or deny reexamination is mailed. Any request filed before that decision will be denied.

The certificate of mailing and the certificate of transmission procedures (37 CFR 1.8) and the “Express Mail” mailing procedure (37 CFR 1.10) may be used to file a request for extension of time, as well as any other paper in a pending *ex parte* reexamination proceeding (see MPEP § 2266).

With the exception of an automatic 1-month extension of time to take further action which will be granted upon filing a first timely response to a final Office action (see MPEP § 2272), *all* requests for extensions of time to file a patent owner statement under 37 CFR 1.530 or respond to any subsequent Office action in an *ex parte* reexamination proceeding must be filed under 37 CFR 1.550(c) and will be decided by the Director of the Central Reexamination Unit (CRU) or Technology Center (TC) conducting the reexamination proceeding. These requests for an extension of time will be granted only for sufficient cause and must be filed on or before the day on which action by the patent owner is due. In no case, other than the “after final” practice set forth immediately above, will mere filing of a request for extension of time automatically effect any extension. Evaluation of whether sufficient cause has been shown for an extension must be made in the context of providing the patent owner with a fair opportunity to present an argument against any attack on the patent, and the requirement of the statute (35 U.S.C. 305) that the proceedings be conducted with special dispatch.

Any request for an extension of time in a reexamination proceeding must fully state the reasons therefor. The reasons must include (A) a statement of what action the patent owner has taken to provide a response, to date as of the date the request for extension is submitted, and (B) why, in spite of the action taken thus far, the requested additional time is needed. The statement of (A) must provide a factual accounting of reasonably diligent behavior by all those responsible for preparing a response to the outstanding Office action within the statutory time period. All requests must be submitted in a separate paper which will be forwarded to the CRU or TC Director for

action. A request for an extension of the time period to file a petition from the denial of a request for reexamination can only be entertained by filing a petition under 37 CFR 1.183 with appropriate fee to waive the time provisions of 37 CFR 1.515(c). Since the reexamination examination process (for a reexamination request filed under 35 U.S.C. 302 and 37 CFR 1.510) is intended to be essentially *ex parte*, the party requesting reexamination can anticipate that requests for an extension of time to file a petition under 37 CFR 1.515(c) will be granted only in extraordinary situations.

The time period for filing a third party requester reply under 37 CFR 1.535 to the patent owner’s statement (i.e., 2 months from the date of service of the statement on the third party requester) cannot be extended under any circumstances. No extensions will be permitted to the time for filing a reply under 37 CFR 1.535 by the requester because the 2-month period for filing the reply is a statutory period. 35 U.S.C. 304. It should be noted that a statutory period for response cannot be waived. See MPEP § 2251.

Ex parte prosecution will be conducted by initially setting either a 1-month or a 2-month shortened period for response, see MPEP § 2263. The patent owner also will be given a 2-month * period after the order for reexamination to file a statement >(by statute (35 U.S.C. 304), this period cannot be less than 2-months, even in a proceeding where the patent is being litigated)<. See 37 CFR 1.530(b). First requests for extensions of these statutory time periods will be granted for sufficient cause, and for a reasonable time specified — usually 1 month. The reasons stated in the request will be evaluated by the CRU or TC Director, and the requests will be favorably considered where there is a factual accounting of reasonably diligent behavior by all those responsible for preparing a response within the statutory time period. Second or subsequent requests for extensions of time or requests for more than 1 month will be granted only in extraordinary situations. Any request for an extension of time in a reexamination proceeding to file a notice of appeal to the Board of Patent Appeals and Interferences, a brief or reply brief, or a request for reconsideration or rehearing will be considered under the provisions of 37 CFR 1.550(c). The time for filing the notice and reasons of appeal to the U.S. Court of Appeals for the Federal Circuit or for commencing a

civil action will be considered under the provisions of 37 CFR 1.304.

Form paragraph 22.04.01 may be used to notify the parties in a reexamination proceeding the extension of time practice in reexamination.

¶ 22.04.01 *Extension of Time in Reexamination*

Extensions of time under 37 CFR 1.136(a) will not be permitted in these proceedings because the provisions of 37 CFR 1.136 apply only to “an applicant” and not to parties in a reexamination proceeding. Additionally, 35 U.S.C. 305 requires that reexamination proceedings “will be conducted with special dispatch” (37 CFR 1.550(a)). Extensions of time in *ex parte* reexamination proceedings are provided for in 37 CFR 1.550(c).

I. FINAL ACTION — TIME FOR RESPONSE

The after-final practice in reexamination proceedings did not change on October 1, 1982 (at which time a change in practice was made for applications), and the automatic extension of time policy for response to a final rejection and associated practice are still in effect in reexamination proceedings.

The filing of a timely first response to a final rejection having a shortened statutory period for response is construed as including a request to extend the shortened statutory period for an additional month, which will be granted even if previous extensions have been granted, but in no case may the period for response exceed 6 months from the date of the final action. Even if previous extensions have been granted, the primary examiner is authorized to grant the request for extension of time which is implicit in the filing of a timely first response to a final rejection. It should be noted that the filing of any timely first response to a final rejection will be construed as including a request to extend the shortened statutory period for an additional month, even an informal response and even a response that is not signed. An object of this practice is to obviate the necessity for appeal merely to gain time to consider the examiner’s position in reply to an amendment timely filed after final rejection. Accordingly, the shortened statutory period for response to a final rejection to which a proposed first response has been received will be extended 1 month. Note that the Office policy of construing a response after final as inherently including a request for a 1-month extension of time applies only to the first response to the final rejection. This automatic 1-month extension of time does not apply once the Notice of Appeal has been

filed. In that instance, the patent owner will be notified that an appeal brief is due two months from the date of the notice of appeal to avoid dismissal of the appeal, and extensions of time are governed by 37 CFR 1.550(c).

It should be noted that the patent owner is entitled to know the examiner’s ruling on a timely response filed after final rejection before being required to file a notice of appeal. Notification of the examiner’s ruling should reach the patent owner with sufficient time for the patent owner to consider the ruling and act on it.

Normally, examiners will complete a response to an amendment after final rejection within 5 days after receipt thereof. In those situations where the advisory action cannot be mailed in sufficient time for the patent owner to consider the examiner’s position with respect to the amendment after final rejection (or other patent owner paper) and act on it before termination of the prosecution of the proceeding, the granting of additional time to complete the response to the final rejection or to take other appropriate action would be appropriate. See *Theodore Groz & Sohne & Ernst Bechert Nadelfabrik KG v. Quigg*, 10 USPQ2d 1787 (D.D.C. 1988). The additional time should be granted by the examiner, and the time granted should be set forth in the advisory Office action. The advisory action form, *Ex Parte* Reexamination Advisory Action Before the Filing of an Appeal Brief (PTOL-467), states that “THE PERIOD FOR RESPONSE IS EXTENDED TO RUN ___ MONTHS FROM THE MAILING DATE OF THE FINAL REJECTION.” The blank before “MONTHS” should be filled in with an integer (2, 3, 4, 5, or 6); fractional months should not be indicated. In no case can the period for reply to the final rejection be extended to exceed 6 months from the mailing date of the final rejection. An appropriate response (e.g., a second or subsequent amendment or a notice of appeal) must be filed within the extended period for response. If patent owner elects to file a second or subsequent amendment, it must place the reexamination in condition for allowance. If the amendment does not place the reexamination in condition for allowance, the prosecution of the reexamination proceeding will stand terminated under 37 CFR 1.550(d) unless an appropriate notice of appeal was filed before the expiration of the response period.

II. EXTENSIONS OF TIME TO SUBMIT AFFIDAVITS AFTER FINAL REJECTION

Frequently, patent owners request an extension of time, stating as a reason therefor that more time is needed in which to submit an affidavit. When such a request is filed after final rejection, the granting of the request for extension of time is without prejudice to the right of the examiner to question why the affidavit is now necessary and why it was not earlier presented. If the patent owner's showing is insufficient, the examiner may deny entry of the affidavit, notwithstanding the previous grant of an extension of time to submit it. The grant of an extension of time in these circumstances serves merely to keep the prosecution of the proceeding from becoming terminated while allowing the patent owner the opportunity to present the affidavit or to take other appropriate action. Moreover, prosecution of the reexamination to save it from termination must include such timely, complete and proper action as required by 37 CFR 1.113. The admission of the affidavit for purposes other than allowance of the claims, or the refusal to admit the affidavit, and any proceedings relative, thereto, shall not operate to save the prosecution of the proceeding from termination.

Implicit in the above practice is the fact that affidavits submitted after final rejection are subject to the same treatment as amendments submitted after final rejection. See *In re Affidavit Filed After Final Rejection*, 152 USPQ 292, 1966 C.D. 53 (Comm'r Pat. 1966).

2266 Responses [R-7]

37 CFR 1.111. *Reply by applicant or patent owner to a non-final Office action.*

(a)(1) If the Office action after the first examination (§ 1.104) is adverse in any respect, the applicant or patent owner, if he or she persists in his or her application for a patent or reexamination proceeding, must reply and request reconsideration or further examination, with or without amendment. See §§ 1.135 and 1.136 for time for reply to avoid abandonment.

(2) *Supplemental replies.* (i) A reply that is supplemental to a reply that is in compliance with § 1.111(b) will not be entered as a matter of right except as provided in paragraph (a)(2)(ii) of this section. The Office may enter a supplemental reply if the supplemental reply is clearly limited to:

- (A) Cancellation of a claim(s);
- (B) Adoption of the examiner suggestion(s);
- (C) Placement of the application in condition for

allowance;

(D) Reply to an Office requirement made after the first reply was filed;

(E) Correction of informalities (e.g., typographical errors); or

(F) Simplification of issues for appeal.

(ii) A supplemental reply will be entered if the supplemental reply is filed within the period during which action by the Office is suspended under § 1.103(a) or (c).

(b) In order to be entitled to reconsideration or further examination, the applicant or patent owner must reply to the Office action. The reply by the applicant or patent owner must be reduced to a writing which distinctly and specifically points out the supposed errors in the examiner's action and must reply to every ground of objection and rejection in the prior Office action. The reply must present arguments pointing out the specific distinctions believed to render the claims, including any newly presented claims, patentable over any applied references. If the reply is with respect to an application, a request may be made that objections or requirements as to form not necessary to further consideration of the claims be held in abeyance until allowable subject matter is indicated. The applicant's or patent owner's reply must appear throughout to be a *bona fide* attempt to advance the application or the reexamination proceeding to final action. A general allegation that the claims define a patentable invention without specifically pointing out how the language of the claims patentably distinguishes them from the references does not comply with the requirements of this section.

(c) In amending in reply to a rejection of claims in an application or patent under reexamination, the applicant or patent owner must clearly point out the patentable novelty which he or she thinks the claims present in view of the state of the art disclosed by the references cited or the objections made. The applicant or patent owner must also show how the amendments avoid such references or objections.

37 CFR 1.550. *Conduct of ex parte reexamination proceedings.*

(a) All *ex parte* reexamination proceedings, including any appeals to the Board of Patent Appeals and Interferences, will be conducted with special dispatch within the Office. After issuance of the *ex parte* reexamination order and expiration of the time for submitting any responses, the examination will be conducted in accordance with §§ 1.104 through 1.116 and will result in the issuance of an *ex parte* reexamination certificate under § 1.570.

(b) The patent owner in an *ex parte* reexamination proceeding will be given at least thirty days to respond to any Office action. In response to any rejection, such response may include further statements and/or proposed amendments or new claims to place the patent in a condition where all claims, if amended as proposed, would be patentable.

(c) The time for taking any action by a patent owner in an *ex parte* reexamination proceeding will be extended only for sufficient cause and for a reasonable time specified. Any request for such extension must be filed on or before the day on which action by the patent owner is due, but in no case will the mere filing of a request effect any extension. Any request for such extension must be accompanied by the petition fee set forth in § 1.17(g). See §

1.304(a) for extensions of time for filing a notice of appeal to the U.S. Court of Appeals for the Federal Circuit or for commencing a civil action.

(d) **>If the patent owner fails to file a timely and appropriate response to any Office action or any written statement of an interview required under § 1.560(b), the prosecution in the *ex parte* reexamination proceeding will be a terminated prosecution, and the Director will proceed to issue and publish a certificate concluding the reexamination proceeding under § 1.570 in accordance with the last action of the Office.<

(e) If a response by the patent owner is not timely filed in the Office,

(1) The delay in filing such response may be excused if it is shown to the satisfaction of the Director that the delay was unavoidable; a petition to accept an unavoidably delayed response must be filed in compliance with § 1.137(a); or

(2) The response may nevertheless be accepted if the delay was unintentional; a petition to accept an unintentionally delayed response must be filed in compliance with § 1.137(b).

(f) The reexamination requester will be sent copies of Office actions issued during the *ex parte* reexamination proceeding. After filing of a request for *ex parte* reexamination by a third party requester, any document filed by either the patent owner or the third party requester must be served on the other party in the reexamination proceeding in the manner provided by § 1.248. The document must reflect service or the document may be refused consideration by the Office.

(g) The active participation of the *ex parte* reexamination requester ends with the reply pursuant to § 1.535, and no further submissions on behalf of the reexamination requester will be acknowledged or considered. Further, no submissions on behalf of any third parties will be acknowledged or considered unless such submissions are:

(1) in accordance with § 1.510 or § 1.535; or

(2) entered in the patent file prior to the date of the order for *ex parte* reexamination pursuant to § 1.525.

(h) Submissions by third parties, filed after the date of the order for *ex parte* reexamination pursuant to § 1.525, must meet the requirements of and will be treated in accordance with § 1.501(a).

Pursuant to 37 CFR 1.550(a):

“After issuance of the *ex parte* reexamination order and expiration of the time for submitting any response, the examination will be conducted in accordance with §§ 1.104 through 1.116...”

Accordingly, the provisions of 37 CFR 1.111 apply to the response by a patent owner in a reexamination proceeding.

The certificate of mailing and certificate of transmission procedures (37 CFR 1.8), and the “Express Mail” mailing procedure (37 CFR 1.10), may be used to file any response in a pending *ex parte* reexamination proceeding.

The patent owner is required to serve a copy of any response made in the reexamination proceeding on the third party requester. 37 CFR 1.550(f). See MPEP § 2266.03 as to service of patent owner responses to an Office action.

The patent owner will normally be given a period of 2 months to respond to the Office action. An extension of time can be obtained only in accordance with 37 CFR 1.550(c). Note that 37 CFR 1.136 does not apply in reexamination proceedings.

If the patent owner fails to file a timely and appropriate response to any Office action, the prosecution of the reexamination proceeding will be terminated, unless the response is “not fully responsive” as defined in MPEP § 2266.01 or is an “informal submission” as defined in MPEP § 2266.02. After the prosecution of the proceeding is terminated, the Director will proceed to issue >and publish< a reexamination certificate.

Pursuant to 37 CFR 1.111(a)(2), a response that is supplemental to a response that is in compliance with 37 CFR 1.111(b) will not be entered as a matter of right. The Office may enter a supplemental response if the supplemental response is clearly limited to: (A) cancellation of a claim(s); (B) adoption of the examiner suggestion(s); (C) placement of the proceeding in condition for Notice of Intent to Issue Reexamination Certificate (NIRC); (D) a response to an Office requirement made after the first response was filed; (E) correction of informalities (e.g., typographical errors); or (F) simplification of issues for appeal. When a supplemental response is filed in sufficient time to be entered into the reexamination proceeding before the examiner considers the prior response, the examiner may approve the entry of a supplemental response if, after a cursory review, the examiner determines that the supplemental response is limited to meeting one or more of the conditions set forth in 37 CFR 1.111(a)(2)(i).

A supplemental response, which has not been approved for entry, will not be entered when a response to a subsequent Office action is filed, even if there is a specific request for its entry in the subsequent response. If a patent owner wishes to have the unentered supplemental response considered by the examiner, the patent owner must include the contents of the unentered supplemental response in a proper response to a subsequent Office action.

The patent owner in an *ex parte* reexamination proceeding must not file papers on behalf of a third party. 37 CFR 1.550(g). If a third party paper accompanies, or is submitted as part of a timely filed response, the response and the third party paper are considered to be an improper submission under 37 CFR 1.550(g), and the entire submission shall be returned to the patent owner, since the Office will not determine which portion of the submission is the third party paper. The third party paper will not be considered. The decision returning the improper response and the third party paper should provide an appropriate extension of time under 37 CFR 1.550(c) to refile the patent owner response without the third party paper. See MPEP § 2254 and § 2267.

>Patent owner cannot submit an application data sheet (ADS) in a reexamination proceeding since a reexamination proceeding is not an “application” (see 37 CFR 1.76). An ADS is an improper paper in a reexamination proceeding.<

2266.01 Submission Not Fully Responsive to Non-Final Office Action [R-7]

A response by the patent owner will be considered not fully responsive to a non-final Office action where:

(A) a *bona fide* response to an examiner’s non-final action is filed;

(B) before the expiration of the permissible response period;

(C) but through an apparent oversight or inadvertence, some point necessary to a full response has been omitted (i.e., appropriate consideration of a matter that the action raised, or compliance with a requirement made by the examiner, has been omitted).

Where patent owner’s amendment or response **prior to final rejection** is not fully responsive to an Office action in a reexamination and meets all of (A) through (C) above, the prosecution of the reexamination proceeding should not be terminated; but, rather, a practice similar to that of 37 CFR 1.135(c) (which is directed to applications) may be followed. The examiner may treat a patent owner submission which is not fully responsive to a non-final Office action by:

(A) waiving the deficiencies (if not serious) in the response and acting on the patent owner submission;

(B) accepting the amendment as a response to the non-final Office action but notifying the patent owner (via a new Office action setting a new time period for response) that the omission must be supplied; or

(C) notifying the patent owner that the response must be completed within the remaining period for response to the non-final Office action (or within any extension pursuant to 37 CFR 1.550(c)) to avoid termination of the prosecution of the proceeding under 37 CFR 1.550(d). This third alternative should only be used in the *very unusual situation* where there is sufficient time remaining in the period for response (including extensions under 37 CFR 1.550(c)), as is discussed below.

Where a patent owner submission responds to the rejections, objections, or requirements in a non-final Office action and is a *bona fide* attempt to advance the reexamination proceeding to final action, but contains a minor deficiency (e.g., fails to treat every rejection, objection, or requirement), the examiner may simply act on the amendment and issue a new (non-final or final) Office action. The new Office action may simply reiterate the rejection, objection, or requirement not addressed by the patent owner submission, or the action may indicate that such rejection, objection, or requirement is no longer applicable. In the new Office action, the examiner will identify the part of the previous Office action which was not responded to and make it clear what is needed. Obviously, this course of action would not be appropriate in instances in which a patent owner submission contains a serious deficiency (e.g., the patent owner submission does not appear to have been filed in response to the non-final Office action).

Where patent owner’s submission contains a serious deficiency (i.e., omission) to be dealt with prior to issuing an action on the merits and the period for response has expired, or there is insufficient time remaining to take corrective action before the expiration of the period for response, the patent owner should be notified of the deficiency and what is needed to correct the deficiency, and given a new time period for response (usually 1 month). The patent owner must supply the omission within the new time period for response (or any extensions under 37 CFR 1.550(c) thereof) to avoid termination of the prosecu-

tion of the proceeding under 37 CFR 1.550(d). The patent owner may also file a further response as permitted under 37 CFR 1.111. This is analogous to 37 CFR 1.135(c) for an application.

Form paragraph 22.14 may be used where a *bona fide* response is not entirely responsive to a non-final Office action.

¶ 22.14 *Submission Not Fully Responsive to Non-Final Office Action - Ex Parte Reexamination*

The communication filed on [1] is not fully responsive to the prior Office action. [2]. The response appears to be *bona fide*, but through an apparent oversight or inadvertence, consideration of some matter or compliance with some requirement has been omitted. Patent owner is required to deal with the omission to thereby provide a full response to the prior Office action.

A shortened statutory period for response to this letter is set to expire ONE MONTH, or THIRTY DAYS, whichever is longer, from the mailing date of this letter. If patent owner fails to timely deal with the omission and thereby provide a full response to the prior Office action, prosecution of the present reexamination proceeding will be terminated. 37 CFR 1.550(d).

Examiner Note:

1. In bracket 2, the examiner should explain the nature of the omitted point necessary to complete the response, i.e., what part of the Office action was not responded to. The examiner should also make it clear what is needed to deal with the omitted point.
2. This paragraph may be used for a patent owner communication that is not completely responsive to the outstanding (i.e., prior) Office action. See MPEP § 2266.01.
3. This practice does not apply where there has been a deliberate omission of some necessary part of a complete response.
4. This paragraph is only used for a response made prior to final rejection. After final rejection, an advisory Office action and Form PTOL 467 should be used, and the patent owner informed of any non-entry of the amendment.

In the very unusual situation where there is sufficient time remaining in the period for response (including extensions under 37 CFR 1.550(c)), the patent owner may simply be notified that the omission must be supplied within the remaining time period for response. This notification should be made, by telephone, and an interview summary record (see MPEP § 2281) must be completed and entered into the file of the reexamination proceeding to provide a record of such notification. When notification by telephone is not possible, the procedure set forth above should be followed.

The practice of giving the patent owner a time period to supply an omission in a *bona fide* response (which is analogous to that set forth in 37 CFR 1.135(c) for an application) does not apply where there has been a deliberate omission of some necessary part of a complete response; rather, it is applicable **only** when the missing matter or lack of compliance is considered by the examiner as being “inadvertently omitted.” Once an inadvertent omission is brought to the attention of the patent owner, the question of inadvertence no longer exists. Therefore, a second Office action giving another new (1 month) time period to supply the omission would not be appropriate. However, if patent owner’s response to the notification of the omission raises a different issue of a different inadvertently omitted matter, a second Office action may be given.

This practice authorizes, but does not require, an examiner to give the patent owner a new time period to supply an omission. Thus, where the examiner concludes that the patent owner is attempting to abuse the practice to obtain additional time for filing a response, the practice should not be followed. If time still remains for response, the examiner may telephone the patent owner and inform the patent owner that the response must be completed within the period for response to the non-final Office action or within any extension pursuant to 37 CFR 1.550(c) to avoid termination of the prosecution of the reexamination proceeding.

The practice of giving the patent owner a time period to supply an omission in a *bona fide* response does **not** apply after a final Office action. If a *bona fide* response to an examiner’s action is filed **after final rejection** (before the expiration of the permissible response period), but through an apparent oversight or inadvertence, some point necessary to fully respond has been omitted, the examiner should **not** issue (to the patent owner) a notice of failure to fully respond. Rather, an advisory Office action (form PTOL-467) should be issued with an explanation of the omission. The time period set in the final rejection continues to run and is extended by 1 month if the response is the first response after the final rejection in accordance with the guidelines set forth in MPEP § 2265. See also MPEP § 2272.

Amendments after final rejection are approved for entry only if they place the proceeding in condition

for issuance of a reexamination certificate or in better form for appeal. Otherwise, they are not approved for entry. See MPEP § 714.12 and § 714.13. Thus, an amendment after final rejection should be denied entry if some point necessary for a complete response under 37 CFR 1.113 was omitted, even where the omission was through an apparent oversight or inadvertence. Where a submission after final Office action (e.g., an amendment filed under 37 CFR 1.116) does not place the proceeding in condition for issuance of a reexamination certificate, the period for response continues to run until a response under 37 CFR 1.113 (i.e., a Notice of Appeal or an amendment that places the proceeding in condition for issuance of a reexamination certificate) is filed. Where a submission after appeal (e.g., an amendment filed under 37 CFR 41.33) does not place the proceeding in condition for issuance of a reexamination certificate, the period for filing an appeal brief continues to run until an appeal brief or an amendment that places the proceeding in condition for issuance of a reexamination certificate is filed. The nature of the omission is immaterial. The examiner cannot give the patent owner a time period to supply the omission.

The examiner has the authority to enter the response, withdraw the final Office action, and issue a new Office action, which may be a final Office action, if appropriate, or an action closing prosecution in an otherwise allowable application under *Ex parte Quayle*, 25 USPQ 74, 1935 C.D. 11 (Comm'r Pat. 1935), if appropriate. This course of action is within the discretion of the examiner. However, the examiner should recognize that substantial patent rights will be at issue with no opportunity for the patent owner to refile under 37 CFR 1.53(b) or 1.53(d) in order to continue prosecution nor to file a request for continued examination under 37 CFR 1.114. Thus, where the time has expired for response and the amendment submitted would place the proceeding in condition for issuance of a reexamination certificate except for an omission through apparent oversight or inadvertence, the examiner should follow this course of action.

2266.02 Examiner Issues Notice of Defective Paper in *Ex Parte* Reexamination [R-5]

Even if the substance of a submission is complete, the submission can still be defective, i.e., an “informal

submission.” Defects in the submission can be, for example:

- (A) The paper filed does not include proof of service;
- (B) The paper filed is unsigned;
- (C) The paper filed is signed by a person who is not of record;
- (D) The amendment filed by the patent owner does not comply with 37 CFR 1.530(d)-(j);
- (E) The amendment filed by the patent owner does not comply with 37 CFR 1.20(c)(3) and/or (c)(4).

Where a submission made **prior to final rejection** is defective (informal), form PTOL-475 is used to provide notification of the defects present in the submission. In many cases, it is only necessary to check the appropriate box on the form and fill in the blanks. However, if the defect denoted by one of the entries on form PTOL-475 needs further clarification (such as the specifics of why the amendment does not comply with 37 CFR 1.530(d)-(j)), the additional information should be set forth on a separate sheet of paper which is then attached to the form.

The defects identified above as (A) through (E) are specifically included in form PTOL-475. If the submission contains a defect other than those specifically included on the form, the “other” box on the form is to be checked and the defect explained in the space provided for the explanation. For example, a response might be presented on easily erasable paper, and thus, a new submission would be needed.

A time period of one month or thirty days, whichever is longer, from the mailing date of the PTOL-475 letter will be set in form PTOL-475 for correction of the defect(s). Extension of time to correct the defect(s) may be requested under 37 CFR 1.550(c). >If, in response to the notice, the defect still is not corrected, the submission will not be entered. If the failure to comply with the notice results in a patent owner failure to file a timely and appropriate response to any Office action, the prosecution of the reexamination proceeding generally will be terminated under 37 CFR 1.550(d).<

If a defective (informal) response to an examiner’s action is filed **after final rejection** (before the expiration of the permissible response period), the examiner should **not** issue a form PTOL-475 notification to the

patent owner. Rather, an advisory Office action (form PTOL-467) should be issued with an explanation of the defect (informality). The time period set in the final rejection continues to run and is extended by

1 month if the response is the first response after the final rejection in accordance with the guidelines set forth in MPEP § 2265. See also MPEP § 2272.

Notice Of Defective Paper In Ex Parte Reexamination	Control Number	Patent Under Reexamination	
	Examiner	Art Unit	

--The MAILING DATE of this communication appears on the cover sheet with the correspondence address--

1. Since no proof of service was included with the paper filed on _____, it fails to comply with 37 CFR 1.248 and 1.540. Proof of service is required within ONE (1) MONTH or THIRTY (30) DAYS from the mailing date of this letter, whichever is longer. Failure to provide proof of service may result in a refusal to consider the paper. If the failure to comply with this requirement results in a patent owner failure to file a timely and appropriate response to any Office action or any written statement of an interview required under 37 CFR 1.560(b), the prosecution of the reexamination proceeding will be terminated under 37 CFR 1.550(d).
2. The paper filed on _____ is unsigned. A duplicate paper or ratification, properly signed, is required within ONE (1) MONTH or THIRTY (30) DAYS from the mailing date of this letter, whichever is longer. Failure to comply with this requirement will result in the paper not being considered. If the failure to comply results in a patent owner failure to file a timely and appropriate response to any Office action or any written statement of an interview required under 37 CFR 1.560(b), the prosecution of the reexamination proceeding will be terminated under 37 CFR 1.550(d).
3. The paper filed on _____ is signed by _____, who is not of record. A duplicate paper or ratification signed by a person of record, or by a person made of record by way of a new power of attorney, is required within ONE (1) MONTH or THIRTY (30) DAYS from the mailing date of this letter, whichever is longer. Failure to comply with this requirement will result in the paper not being considered. If the failure to comply results in a patent owner failure to file a timely and appropriate response to any Office action or any written statement of an interview required under § 1.560(b), the prosecution of the reexamination proceeding will be terminated under 37 CFR 1.550(d).
4. The Amendment filed on _____ does not comply with 37 CFR 1.530(d)-(j). Patent owner is given ONE (1) MONTH or THIRTY (30) DAYS from the mailing date of this letter, whichever is longer, to correct this informality; otherwise, the prosecution of the reexamination proceeding will be terminated under 37 CFR 1.550(d).
5. The amendment filed by patent owner on _____, does not comply with 37 CFR 1.20(c)(3) and/or 1.20(c)(4), as to excess claim fees. Patent owner is given a time period of ONE (1) MONTH or THIRTY (30) DAYS from the mailing date of this letter, whichever is longer, to correct this fee deficiency, or the prosecution of the reexamination proceeding will be terminated under 37 CFR 1.550(d), to effect the "abandonment" set forth in 37 CFR 1.20(c)(5).
6. Other: _____

NOTE: EXTENSION OF TIME ARE GOVERNED BY 37 CFR 1.550(c). If the period for response specified above is less than thirty (30) days, a response within the statutory minimum of thirty (30) days will be considered timely.

cc: Requester (if third party requester)

2266.03 Service of Papers [R-5]

37 CFR 1.510. Request for ex parte reexamination.

(b) Any request for reexamination must include the following parts:

(5) A certification that a copy of the request filed by a person other than the patent owner has been served in its entirety on the patent owner at the address as provided for in § 1.33(c). The name and address of the party served must be indicated. If service was not possible, a duplicate copy must be supplied to the Office

37 CFR 1.550. Conduct of ex parte reexamination proceedings.

(f) The reexamination requester will be sent copies of Office actions issued during the *ex parte* reexamination proceeding. After filing of a request for *ex parte* reexamination by a third party requester, any document filed by either the patent owner or the third party requester must be served on the other party in the reexamination proceeding in the manner provided by § 1.248. The document must reflect service or the document may be refused consideration by the Office.

Any paper filed with the Office, i.e., any submission made, in a third party requested reexamination by either the patent owner or the third party requester, must be served on every other party in the reexamination proceeding.

As proof of service, the party submitting the paper to the Office must attach a certificate of service to the paper. It is required that the name and address of the party served, and the method of service be set forth in the certificate of service. Further, a copy of the certificate of service must be attached with the copy of the paper that is served on the other party.

**>Any paper for which proof of service is required, which is filed without proof of service,< may be denied consideration. Where no proof of service is included, the reexamination clerk should immediately contact the party making the submission by telephone to see whether the indication of proof of service was inadvertently omitted from the submission but there was actual service.

If service was in fact made, the party making the submission should be advised to submit a supplemental paper indicating the manner and date of service. The reexamination clerk should enter the submission for consideration, and annotate the submission with:

“Service confirmed by [name of person] on [date]”

If no service was made, or the party making the submission cannot be contacted >where an effort to do so was made<, the submission is placed in the reexamination file and normally is not considered. *>Where the submission is not considered because of a service defect, the< submission is added to the IFW file history as an unentered paper with a “N/E” notation, along with a brief annotation as to why the paper is not entered. The submission itself shall be annotated with “no service,” which also can be crossed through if the appropriate service is later made.

If the party making the submission cannot be contacted, a Notice of Defective Paper (PTOL-475), giving 1 month or 30 days, whichever is longer, to complete the paper, with a supplemental paper indicating the manner and date of service, will be mailed to the party.

If it is known that service of a submission was not made, notice of the requirement for service of copy is given (to the party that made the submission), and a 1-month or 30 days, whichever is longer, time period is set. Form paragraph 22.15 may be used to give notice.

¶ 22.15 Lack of Service - 37 CFR 1.550(f)

The submission filed on [1] is defective because it appears that the submission was not served on the [2]. After the filing of a request for reexamination by a third party requester, any document filed by either the patent owner or the third party requester must be served on the other party (or parties where two or more third party requester proceedings are merged) in the reexamination proceeding in the manner provided in 37 CFR 1.248. See 37 CFR 1.550(f).

It is required that service of the submission be made, and a certificate of service be provided to the Office within a shortened statutory period of ONE MONTH or THIRTY DAYS, whichever is longer, from the mailing date of this letter. If service of the submission is not timely made, the submission may be denied consideration.

Examiner Note:

1. This paragraph may be used where a submission to the Office was not served as required in a third party requester reexamination proceeding.
2. In bracket 2, insert --patent owner-- or --third party requester--, whichever is appropriate.

The cover sheet to be used for mailing the notice will be form PTOL-473.

The failure of a party to serve the submission in response to the notice will have the following consequences:

(A) For a patent owner statement or a third party reply, the submission may be refused consideration by the Office. Where consideration is refused, the submission will not be addressed in the reexamination proceeding other than to inform parties of the lack of consideration thereof;

(B) For a patent owner response to an Office action, the response may be refused consideration by the Office. Where consideration of a response is refused, the prosecution of the proceeding will be terminated in accordance with 37 CFR 1.550(d), unless the patent owner has otherwise completely responded to the Office action.

See MPEP § 2220 as to the initial third party request.

See MPEP § 2249 as to the patent owner statement.

See MPEP § 2251 as to third party reply.

See MPEP § 2266 as to patent owner responses to an Office action.

2267 Handling of Inappropriate or Untimely Filed Papers [R-7]

The applicable regulations (37 CFR 1.501(a), 1.550(e)) provide that certain types of correspondence will not be considered or acknowledged unless timely received. Whenever reexamination correspondence is received, a decision is required of the Office as to the action to be taken on the correspondence based on what type of paper it is and whether it is timely.

The return of inappropriate submissions complies with the regulations that certain papers will not be considered and also reduces the amount of paper which would ultimately have to be scanned into the record. >Where an inappropriate (unauthorized, improper) paper has already been scanned into the Image File Wrapper (IFW) of the reexamination proceeding before discovery of the inappropriate nature of the paper, the paper cannot be physically returned to the party that submitted it. Instead, the paper will be “returned” by expunging it, i.e., by marking the

paper as “non-public” and “closed” so that it does not appear in the active IFW record with the other active papers that comprise the public record of the reexamination proceeding.<

I. DISPOSITION OF PAPERS

Where papers are filed during reexamination proceedings which are inappropriate because of some defect, such papers will either be returned to the sender or forwarded to one of three files, the “Reexamination File” (paper file or IFW file history), the “Patent File” (paper file or IFW file history), or the “Storage File” (paper file). Any papers returned to the sender from the Central Reexamination Unit (CRU) or a Technology Center (TC) must be accompanied by a letter indicating signature and approval of the CRU or TC Director.

The “Storage Files” will be maintained separate and apart from the other two files at a location selected by the CRU or TC Director. For example, the CRU or TC Director may want to locate the “Storage File” in a central area in the CRU or TC as with the reexamination clerk or in his or her room.

II. TYPES OF PAPERS RETURNED WITH DIRECTOR OF THE USPTO OR CRU/TC DIRECTOR’S APPROVAL REQUIRED

Filed by Owner

A. Premature Response by Owner-

§ 1.530(a),
§ 1.540

Where the patent owner is NOT the requester, any response or amendment filed by owner prior to an order to reexamine is premature and will be returned and will not be considered.

§ 1.550(g)

B. Paper Submitted on Behalf of Third Party -

Submission filed on behalf of a third party will be returned and will not be considered. Where third party paper is submitted as part of a patent owner response, see MPEP § 2254 and § 2266.

>In those rare instances where an opposition to a patent owner petition is filed, after such opposition is filed by a third party requester (regardless of whether such opposition has an entry right or not), any further paper in opposition/rebuttal/response to the third party opposition paper will not be considered and will be returned. There must be a limitation on party iterations of input, especially given the statutory mandate for special dispatch in reexamination.<

>In those rare instances where an opposition to a requester petition is filed, after such opposition is filed by the patent owner (regardless of whether such opposition has an entry right or not), any further paper in opposition/rebuttal/response to the patent owner opposition paper will not be considered and will be returned. There must be a limitation on party iterations of input, especially given the statutory mandate for special dispatch in reexamination. Further, any petition requesting that an extension of time be denied will be returned, since a requester does not have a participation right in the reexamination proceeding. <

**Filed by
Requester**

A. No Statement Filed by Owner -

§ 1.535 If a patent owner fails to file a statement within the prescribed limit, any reply by the requester is inappropriate and will be returned and will not be considered.

B. Late Response by Requester -

§ 1.535,
§ 1.540 Any response subsequent to 2 months from the date of service of the patent owner's statement will be returned and will not be considered.

C. Additional Response by Requester-

§ 1.550(g) The active participation of the reexamination requester ends with the reply pursuant to § 1.535. Any further submission on behalf of requester will be returned and will not be considered.

**Filed by
Third Party**

§ 1.501,
§ 1.565(a) Unless a paper submitted by a third party raises only issues appropriate under 37 CFR 1.501, or consists solely of a prior decision on the patent by another forum, e.g., a court (see MPEP § 2207 and § 2286 or presentation of a paper of record in a litigation (see MPEP § 2282)), it will be returned to an identified third party or destroyed if the submitter is unidentified.

Where a paper is to be returned based on the above criteria, or other appropriate reasons, and the paper is not accompanied by a petition under 37 CFR 1.182 or 1.183, the CRU or TC Director will return the paper. Where a petition under 37 CFR 1.182 or 1.183 has been filed, the reexamination proceeding should be forwarded to the Office of Patent Legal Administration for decision.

III. TYPES OF DEFECTIVE PAPERS TO BE LOCATED IN THE “REEXAMINATION FILE”

- Filed by Owner**
- A. Unsigned Papers -
 - § 1.33 Papers filed by owner which are unsigned or signed by less than all of the owners (no attorney of record or acting in representative capacity).
 - B. No Proof of Service -
 - § 1.248 Papers filed by the patent owner in which no proof of service on requester is included and proof of service is required may be denied consideration.
 - C. Untimely Papers -
 - § 1.530(b), § 1.540 Where owner has filed a paper which is untimely, that is, it was filed after the period set for response, the paper will not be considered.

- Filed by Requester**
- A. Unsigned Papers -
 - Papers filed by requester which are unsigned will not be considered.
 - B. No Proof of Service -
 - § 1.510(b)(5), § 1.33, § 1.248 Papers filed by requester in which no proof of service on owner is included and where proof of service is required may be denied consideration.

>In those limited instances where there is a right to file an opposition to a petition, any such opposition

must be filed within two weeks of the date upon which a copy of the original petition was served on the opposing party, to ensure consideration. Any such opposition which is filed after the two-week period will remain in the record, even though it is not considered.<

IV. PAPERS LOCATED IN THE “STORAGE FILE”

§ 1.501	Citations by Third Parties
§ 1.550(h)	Submissions by third parties based solely on prior art patents or publications filed after the date of the order to reexamine are not entered into the patent file but delayed until the reexamination proceedings have been concluded. See MPEP § 2206.

Proper timely filed citations by third parties (i.e., filed prior to the order) are placed in the reexamination file.

2268 Petition for Entry of Late Papers for Revival of Reexamination Proceeding [R-7]

35 U.S.C. 41. Patent fees; patent and trademark search systems.

(a) GENERAL FEES. — The Director shall charge the following fees:

(7) REVIVAL FEES. — On filing each petition for the revival of an unintentionally abandoned application for a patent, for the unintentionally delayed payment of the fee for issuing each patent, or for an unintentionally delayed response by the patent owner in any reexamination proceeding, \$1,500, unless the petition is filed under section 133 or 151 of this title, in which case the fee shall be \$500.

35 U.S.C. 133. Time for prosecuting application.

Upon failure of the applicant to prosecute the application within six months after any action therein, of which notice has been given or mailed to the applicant, or within such shorter time, not less than thirty days, as fixed by the Director in such action, the application shall be regarded as abandoned by the parties

thereto, unless it be shown to the satisfaction of the Director that such delay was unavoidable.

*37 CFR 1.137. **>Revival of abandoned application, terminated or limited reexamination prosecution, or lapsed patent.*

(a) *Unavoidable.* If the delay in reply by applicant or patent owner was unavoidable, a petition may be filed pursuant to this paragraph to revive an abandoned application, a reexamination prosecution terminated under §§ 1.550(d) or 1.957(b) or limited under § 1.957(c), or a lapsed patent. A grantable petition pursuant to this paragraph must be accompanied by:<

(1) The reply required to the outstanding Office action or notice, unless previously filed;

(2) The petition fee as set forth in § 1.17(l);

(3) A showing to the satisfaction of the Director that the entire delay in filing the required reply from the due date for the reply until the filing of a grantable petition pursuant to this paragraph was unavoidable; and

(4) Any terminal disclaimer (and fee as set forth in § 1.20(d)) required pursuant to paragraph (d) of this section.

(b) ***>Unintentional.* If the delay in reply by applicant or patent owner was unintentional, a petition may be filed pursuant to this paragraph to revive an abandoned application, a reexamination prosecution terminated under §§ 1.550(d) or 1.957(b) or limited under § 1.957(c), or a lapsed patent. A grantable petition pursuant to this paragraph must be accompanied by:<

(1) The reply required to the outstanding Office action or notice, unless previously filed;

(2) The petition fee as set forth in § 1.17(m);

(3) A statement that the entire delay in filing the required reply from the due date for the reply until the filing of a grantable petition pursuant to this paragraph was unintentional. The Director may require additional information where there is a question whether the delay was unintentional; and

(4) Any terminal disclaimer (and fee as set forth in § 1.20(d)) required pursuant to paragraph (d) of this section.

**>

(e) *Request for reconsideration.* Any request for reconsideration or review of a decision refusing to revive an abandoned application, a terminated or limited reexamination prosecution, or lapsed patent upon petition filed pursuant to this section, to be considered timely, must be filed within two months of the decision refusing to revive or within such time as set in the decision. Unless a decision indicates otherwise, this time period may be extended under:

(1) The provisions of § 1.136 for an abandoned application or lapsed patent;

(2) The provisions of § 1.550(c) for a terminated *ex parte* reexamination prosecution, where the *ex parte* reexamination was filed under § 1.510; or

(3) The provisions of § 1.956 for a terminated *inter partes* reexamination prosecution or an *inter partes* reexamination lim-

ited as to further prosecution, where the *inter partes* reexamination was filed under § 1.913.<

Pursuant to 37 CFR 1.550(d), the prosecution of an *ex parte* reexamination proceeding is terminated if the patent owner fails to file a timely and appropriate response to any Office action or any written statement of an interview required under 37 CFR 1.560(b). An *ex parte* reexamination prosecution terminated under 37 CFR 1.550(d) can be revived if the delay in response by the patent owner (or the failure to timely file the interview statement) was unavoidable in accordance with 37 CFR 1.137(a), or unintentional in accordance with 37 CFR 1.137(b).

The failure to timely file a statement pursuant to 37 CFR 1.530 or a reply pursuant to 37 CFR 1.535, however, would not (under ordinary circumstances) constitute adequate basis to justify a showing of unavoidable/unintentional delay regardless of the reasons for the failure, since failure to file a statement or reply does not result in a “termination” of the reexamination prosecution, to which 37 CFR 1.137 is directed.

All petitions in reexamination proceedings to accept late papers and to revive the proceedings will be decided in the Office of Patent Legal Administration.

I. PETITION BASED ON UNAVOIDABLE DELAY

The unavoidable delay provisions of 35 U.S.C. 133 are imported into, and are applicable to, *ex parte* reexamination proceedings by 35 U.S.C. 305. See *In re Katrapat*, 6 USPQ2d 1863 (Comm’r Pat. 1988). Accordingly, the Office will consider, in appropriate circumstances, a petition showing unavoidable delay under 37 CFR 1.137(a) where untimely papers are filed subsequent to the order for reexamination. Any such petition must provide an adequate showing of the cause of unavoidable delay, including the details of the circumstances surrounding the unavoidable delay and evidence to support the showing. Additionally, the petition must be accompanied by the petition fee set forth in 37 CFR 1.17(l) and a proposed response to continue prosecution (unless it has been previously filed).

II. PETITION BASED ON UNINTENTIONAL DELAY

The unintentional delay fee provisions of 35 U.S.C. 41(a)(7) are imported into, and are applicable to, all *ex parte* reexamination proceedings by section 4605 of the American Inventors Protection Act of 1999. The unintentional delay provisions of 35 U.S.C. 41(a)(7) became effective in reexamination proceedings on November 29, 2000. Accordingly, the Office will consider, in appropriate circumstances, a petition showing unintentional delay under 37 CFR 1.137(b) where untimely papers are filed subsequent to the order for reexamination. Any such petition must provide a verified statement that the delay was unintentional, a proposed response to continue prosecution (unless it has been previously filed), and the petition fee set forth in 37 CFR 1.17(m).

III. RENEWED PETITION

Reconsideration may be requested of a decision dismissing or denying a petition under 37 CFR 1.137(a) or (b) to revive a terminated reexamination prosecution. The request for reconsideration must be submitted within one (1) month from the mail date of the decision for which reconsideration is requested. An extension of time may be requested only under 37 CFR 1.550(c); extensions of time under 37 CFR 1.136 are not available in reexamination proceedings. Any reconsideration request which is submitted should include a cover letter entitled "Renewed Petition under 37 CFR 1.137(a)" (for a petition based on unavoidable delay) or "Renewed Petition under 37 CFR 1.137(b)" (for a petition based on unintentional delay).

IV. FURTHER DISCUSSION OF THE PETITION REQUIREMENTS

See also MPEP § 711.03(c), subsection III, for a detailed discussion of the requirements of petitions filed under 37 CFR 1.137(a) and (b).

2269 Reconsideration

In order to be entitled to reconsideration, the patent owner must respond to the Office action. 37 CFR 1.111(b). The patent owner may respond to such Office action with or without amendment and the patent under reexamination will be reconsidered, and

so on repeatedly unless the examiner has indicated that the action is final. See 37 CFR 1.112. Any amendment after the second Office action, which will normally be final as provided for in MPEP § 2271, must ordinarily be restricted to the rejection or to the objection or requirement made.

2270 Clerical Handling [R-7]

The person designated as the reexamination clerk will handle most of the initial clerical processing of the reexamination file. The Central Reexamination >(CRU) Supervisory Patent Examiner (SPE)< Unit or Technology Center ** >(TC) Quality Assurance Specialist (QAS)< provides oversight as to clerical processing.

Amendments which comply with 37 CFR 1.530(d)-(j) will be entered for purposes of reexamination in the reexamination file. See MPEP § 2234 and § 2250 for the manner of entering amendments.

For entry of amendments in a merged reissue-reexamination proceeding, see MPEP § 2283 and § 2285.

Where an amendment is submitted in proper form and it is otherwise appropriate to enter the amendment, the amendment will be entered for purposes of the reexamination proceeding, even though the amendment does not have legal effect until the certificate is issued. Any "new matter" amendment to the disclosure (35 U.S.C. 132) will be required to be canceled, and claims containing new matter will be rejected under 35 U.S.C. 112. A "new matter" amendment to the drawing is ordinarily not entered. See MPEP § 608.04, § 608.04(a) and (c). Where an amendment enlarges the scope of the claims of the patent, the amendment will be entered; however the appropriate claims will be rejected under 35 U.S.C. 305.

2271 Final Action [R-7]

Before a final action is in order, a clear issue should be developed between the examiner and the patent owner. To bring the prosecution to a speedy conclusion and at the same time deal justly with the patent owner and the public, the examiner will twice provide the patent owner with such information and references as may be useful in defining the position of the Office as to unpatentability before the action is made final. Initially, the decision ordering reexamination of the patent will contain an identification of the new ques-

tions of patentability that the examiner considers to be raised by the prior art considered. In addition, the first Office action will reflect the consideration of any arguments and/or amendments contained in the request, the owner's statement filed pursuant to 37 CFR 1.530, and any reply thereto by the requester, and should fully apply all relevant grounds of rejection to the claims.

The statement which the patent owner may file under 37 CFR 1.530 and the response to the first Office action should completely respond to and/or amend with a view to avoiding all outstanding grounds of rejection.

It is intended that the second Office action in the reexamination proceeding following the decision ordering reexamination will generally be made final. The criteria for making a rejection final in an *ex parte* reexamination proceeding is analogous to that set forth in MPEP § 706.07(a) for making a rejection final in an application. Both the patent owner and the examiner should recognize that a reexamination proceeding may result in the final cancellation of claims from the patent and that the patent owner does not have the right to renew or continue the proceedings by refiling under 37 CFR 1.53(b) or 1.53(d) or former 37 CFR 1.60 or 1.62, nor by filing a request for continued examination under 37 CFR 1.114. Complete and thorough actions by the examiner coupled with complete responses by the patent owner, including early presentation of evidence under 37 CFR 1.131 or 1.132, will go far in avoiding such problems and reaching a desirable early termination of the reexamination prosecution.

In making the final rejection, all outstanding grounds of rejection of record should be carefully reviewed and any grounds of rejection relied on should be reiterated. The grounds of rejection must (in the final rejection) be clearly developed to such an extent that the patent owner may readily judge the advisability of an appeal. However, where a single previous Office action contains a complete statement of a ground of rejection, the final rejection may refer to such a statement and also should include a rebuttal of any arguments raised in the patent owner's response.

I. PANEL REVIEW CONFERENCE

After an examiner has determined that the reexamination proceeding is ready for final rejection, the examiner will formulate a draft preliminary decision to issue a final rejection, the preliminary decision setting forth which claims to reject, the grounds of rejection, which claims to allow/confirm and reasons for allowance/confirmation. The examiner will then inform his/her Central Reexamination Unit (CRU) Supervisory Patent Examiner (SPE) or Technology Center (TC) Quality Assurance Specialist (QAS) of his/her intent to issue the final rejection. The CRU SPE/TC QAS will convene a panel review conference, and the conference members will review the patentability of the claim(s) pursuant to MPEP § 2271.01. If the conference confirms the examiner's preliminary decision to reject and/or allow the claims, the proposed final rejection shall be issued and signed by the examiner, with the two other conferees initialing the action (as "conferee") to indicate their presence in the conference. If the conference does not confirm the examiner's preliminary decision, the examiner will reevaluate and issue an appropriate Office action.

II. FORM PARAGRAPHS

The final rejection letter should conclude with one of form paragraphs 22.09 or 22.10.

¶ 22.09 *Ex Parte Reexamination - Action Is Final*

THIS ACTION IS MADE FINAL.

A shortened statutory period for response to this action is set to expire [1] from the mailing date of this action.

Extensions of time under 37 CFR 1.136(a) do not apply in reexamination proceedings. The provisions of 37 CFR 1.136 apply only to "an applicant" and not to parties in a reexamination proceeding. Further, in 35 U.S.C. 305 and in 37 CFR 1.550(a), it is required that reexamination proceedings "will be conducted with special dispatch within the Office."

Extensions of time in reexamination proceedings are provided for in 37 CFR 1.550(c). A request for extension of time must be filed on or before the day on which a response to this action is due, and it must be accompanied by the petition fee set forth in 37 CFR 1.17(g). The mere filing of a request will not effect any extension of time. An extension of time will be granted only for sufficient cause, and for a reasonable time specified.

The filing of a timely first response to this final rejection will be construed as including a request to extend the shortened statutory period for an additional month, which will be granted even if previous extensions have been granted. In no event, however, will the statutory period for response expire later than SIX MONTHS from the mailing date of the final action. See MPEP § 2265.

Examiner Note:

1. This form paragraph may be used only in reexamination proceedings.
2. In bracket 1, insert the appropriate period for response, which is normally TWO (2) MONTHS. In court sanctioned or stayed litigation situations a ONE (1) MONTH period should be set.

¶ *22.10 Ex Parte Reexamination - Action Is Final, Necessitated by Amendment*

Patent owner's amendment filed [1] necessitated the new grounds of rejection presented in this Office action. Accordingly, **THIS ACTION IS MADE FINAL**. See MPEP § 706.07(a).

A shortened statutory period for response to this action is set to expire [2] from the mailing date of this action.

Extensions of time under 37 CFR 1.136(a) do not apply in reexamination proceedings. The provisions of 37 CFR 1.136 apply only to "an applicant" and not to parties in a reexamination proceeding. Further, in 35 U.S.C. 305 and in 37 CFR 1.550(a), it is required that reexamination proceedings "will be conducted with special dispatch within the Office."

Extensions of time in reexamination proceedings are provided for in 37 CFR 1.550(e). A request for extension of time must be filed on or before the day on which a response to this action is due, and it must be accompanied by the petition fee set forth in 37 CFR 1.17(g). The mere filing of a request will not effect any extension of time. An extension of time will be granted only for sufficient cause, and for a reasonable time specified.

The filing of a timely first response to this final rejection will be construed as including a request to extend the shortened statutory period for an additional month, which will be granted even if previous extensions have been granted. In no event, however, will the statutory period for response expire later than SIX MONTHS from the mailing date of the final action. See MPEP § 2265.

Examiner Note:

1. This form paragraph may be used only in reexamination proceedings.
2. In bracket 1, insert filing date of amendment.
3. In bracket 2, insert the appropriate period for response, which is normally TWO (2) MONTHS. In court sanctioned or stayed litigation situations a ONE (1) MONTH period should be set.
4. As with all other Office correspondence on the merits in a reexamination proceeding, the final Office action must be signed by a primary examiner.

III. ART CITED BY PATENT OWNER DURING PROSECUTION

Where art is submitted in a prior art citation under 37 CFR 1.501 and/or 37 CFR 1.555 (an IDS filed in a reexamination is construed as a prior art citation) and the submission is not accompanied by a statement similar to that of 37 CFR 1.97(e), the examiner may use the art submitted and make the next Office action

final whether or not the claims have been amended, provided that no other new ground of rejection is introduced by the examiner based on the new art not cited in the prior art citation. See MPEP § 706.07(a).

IV. SIGNATORY AUTHORITY

As with all other Office correspondence on the merits in a reexamination proceeding, the final Office action must be signed by a primary examiner.

2271.01 *>Panel< Review * [R-5]

**>A panel review will be conducted at each stage of the examiner's examination in an *ex parte* reexamination proceeding, other than for actions such as notices of informality or incomplete response. Matters requiring decision outside of the examiner's jurisdiction (e.g., decisions on petitions or extensions of time, or Central Reexamination Unit (CRU) support staff notices) will not be reviewed by a panel.

The panel review is carried out for each Office action. The panel reviews the examiner's preliminary decision to reject and/or allow the claims in the reexamination proceeding, prior to the issuance of each Office action.

I. MAKE-UP OF THE PANEL

The panel will consist of three members, one of whom will be a manager. The second member will be the examiner in charge of the proceeding. The manager will select the third member. The examiner-conferees will be primary examiners, or examiners who are knowledgeable in the technology of the invention claimed in the patent being reexamined and/or who are experienced in reexamination practice. The majority of those present at the conference will be examiners who were not involved in the examination or issuance of the patent. An "original" examiner (see MPEP § 2236) should be chosen as a conferee only if that examiner is the most knowledgeable in the art, or there is some other specific and justifiable reason to choose an original examiner as a participant in the conference.<

II. **>PANEL< PROCESS

The examiner must inform his/her *>manager< of his/her intent to issue **>an Office action. The manager< will then convene a **>panel and the members

will confer and review the patentability of the claim(s). If the conference confirms the examiner's preliminary decision to reject and/or allow the claims, the Office action ** shall be issued and signed by the examiner, with the two other conferees initialing the action (as "conferee") to indicate their participation in the conference. Both conferees will initial, even though one of them may have dissented from the 3-party conference decision as to the patentability of claims. If the conference does not confirm the examiner's preliminary decision, **>examiner will reevaluate and issue an appropriate Office action **.

Where the examiner in charge of the proceeding is not in agreement with the conference decision, the >manager< will generally assign the proceeding to another examiner**.

III. WHAT THE CONFERENCE IS TO ACCOMPLISH

Each conference will provide a forum to consider all issues of patentability as well as procedural issues having an impact on patentability. Review of the patentability of the claims by more than one primary examiner should diminish the perception that the patent owner can disproportionately influence the examiner in charge of the proceeding. The conferences will also provide greater assurance that all matters will be addressed appropriately. All issues in the proceeding will be viewed from the perspectives of three examiners. What the examiner in charge of the proceeding might have missed, the other two conference members would likely detect. The conference will provide for a comprehensive discussion of, and finding for, each issue.

IV. CONSEQUENCES OF FAILURE TO HOLD CONFERENCE

Should the examiner issue **>an Office action without panel review<, the patent owner or the third party requester who wishes to object must promptly file a paper alerting the Office of this fact. (The failure to **>provide panel review< would be noted by the parties where there are no conferees' initials at the end of the ** Office action.) Any challenge of the failure to hold a >panel< review conference must be made within two *>weeks of receipt< of the Office action issued, or the challenge will not be considered. ** In no event will the failure to hold a >panel<

review conference, by itself, be grounds for vacating any Office decision(s) or action(s) and "restarting" the reexamination proceeding.

2272 After Final Practice [R-7]

It is intended that prosecution before the examiner in a reexamination proceeding will be concluded with the final action. Once a final rejection that is not premature has been entered in a reexamination proceeding, the patent owner no longer has any right to unrestricted further prosecution. Consideration of amendments submitted after final rejection and prior to, or with, the appeal will be governed by the strict standards of 37 CFR 1.116. Further, consideration of amendments submitted after appeal will be governed by the strict standards of 37 CFR 41.33. Both the examiner and the patent owner should recognize that substantial patent rights will be at issue with no opportunity for the patent owner to refile under 37 CFR 1.53(b), or 1.53(d), and with no opportunity to file a request for continued examination under 37 CFR 1.114. Accordingly, both the examiner and the patent owner should identify and develop all issues prior to the final Office action, including the presentation of evidence under 37 CFR 1.131 and 1.132.

>In the event that the patent owner is of the opinion that (A) a final rejection is improper or premature, or (B) that an amendment submitted after final rejection complies with 37 CFR 1.116 but the examiner improperly refused entry of such an amendment, the patent owner may file a petition under 37 CFR 1.181 requesting that the final rejection be withdrawn and that prosecution be reopened, or file a petition under 37 CFR 1.181 requesting entry of the amendment, where appropriate. The petition under 37 CFR 1.181 must be filed within the time period for filing a notice of appeal. Note that the filing of a petition under 37 CFR 1.181 does **not** toll the time period for filing a notice of appeal.<

I. FINAL REJECTION — TIME FOR RESPONSE

The statutory period for response to a final rejection in a reexamination proceeding will normally be two (2) months. If a response to the final rejection is filed, the time period set in the final rejection continues to run. The time period is automatically extended by 1 month (in accordance with the guidelines set forth

in MPEP § 2265) if the response is the first response after the final rejection and a notice of appeal has not yet been filed. Any advisory Office action using form PTOL-467, *Ex Parte* Reexamination Advisory Action Before the Filing of an Appeal Brief, which is issued in reply to patent owner's response after final rejection (and prior to the filing of the notice of appeal) will inform the patent owner of the automatic 1 month extension of time. It should be noted that the filing of any timely first response to a final rejection (even an informal response or even a response that is not signed) will automatically result in the extension of the shortened statutory period for an additional month. Note further that the patent owner is entitled to know the examiner's ruling on a timely response filed after final rejection before being required to file a notice of appeal. Notification of the examiner's ruling should reach the patent owner with sufficient time for the patent owner to consider the ruling and act on it. Accordingly, the period for response to the final rejection should be appropriately extended in the examiner's advisory action. See *Theodore Groz & Sohne & Ernst Bechert Nadelfabrik KG v. Quigg*, 10 USPQ2d 1787 (D.D.C. 1988). The period for response may not, however, be extended to run past 6 months from the date of the final rejection.

II. ACTION BY EXAMINER

It should be kept in mind that a patent owner cannot, as a matter of right, amend any finally rejected claims, add new claims after a final rejection, or reinstate previously canceled claims. For an amendment filed after final rejection and prior to the appeal brief, a showing under 37 CFR 1.116(b) is required and will be evaluated by the examiner for all proposed amendments after final rejection except where an amendment merely cancels claims, adopts examiner's suggestions, removes issues for appeal, or in some other way requires only a cursory review by the examiner. An amendment filed at any time after final rejection but before an appeal brief is filed, may be entered upon or after filing of an appeal provided:

(A) the total effect of the amendment is to cancel claims or comply with any requirement of form expressly set forth in a previous Office action, or present rejected claims in better form for consideration on appeal;

(B) for an amendment touching the merits of the patent under reexamination, the patent owner provides a showing of good and sufficient reasons why the amendment is necessary and was not earlier presented.

The first proposed amendment after final action in a reexamination proceeding will be given sufficient consideration to determine whether it places all the claims in condition where they are patentable and/or whether the issues on appeal are reduced or simplified. Unless the proposed amendment is entered in its entirety, the examiner will briefly explain the reasons for not entering a proposed amendment. For example, if the claims as amended present a new issue requiring further consideration or search, the new issue should be identified and a brief explanation provided as to why a new search or consideration is necessary. The patent owner should be notified if certain portions of the amendment would be entered if a separate paper was filed containing only such amendment.

Any second or subsequent amendment after final will be considered only to the extent that it removes issues for appeal or puts a claim in obvious patentable condition.

Since patents undergoing reexamination cannot become abandoned and cannot be refiled, and since the holding of claims unpatentable and canceled in a certificate is absolutely final, it is appropriate that the examiner consider the feasibility of entering amendments touching the merits after final rejection or after appeal has been taken, where there is a showing why the amendments are necessary and a suitable reason is given why they were not earlier presented.

The practice of giving the patent owner a time period to supply an omission in a *bona fide* response (as set forth in MPEP § 2266.01) does **not** apply after a final Office action. If a *bona fide* response to an examiner's action is filed **after final rejection** (before the expiration of the permissible response period), but through an apparent oversight or inadvertence, some point necessary to fully respond has been omitted, the examiner should **not** issue (to the patent owner) a notice of failure to fully respond. Rather, an advisory Office action (form PTOL-467) should be issued with an explanation of the omission.

Likewise, the practice of notifying the patent owner of the defects present in a submission via form PTOL-475 and setting a time period for correction of

the defect(s) (as set forth in MPEP § 2266.02) does **not** apply after a final Office action. If a defective (informal) response to an examiner's action is filed **after final rejection** (before the expiration of the permissible response period), the examiner should **not** issue a form PTOL-475 notification to the patent owner. Rather, an advisory Office action (form PTOL-467) should be issued with an explanation of the defect (informality) being provided in the advisory action.

2273 Appeal in *Ex Parte* Reexamination [R-7]

35 U.S.C. 306. Appeal.

The patent owner involved in a reexamination proceeding under this chapter may appeal under the provisions of section 134 of this title, and may seek court review under the provisions of sections 141 to 145 of this title, with respect to any decision adverse to the patentability of any original or proposed amended or new claim of the patent.

A patent owner who is dissatisfied with the primary examiner's decision to reject claims in an *ex parte* reexamination proceeding may appeal to the Board of Patent Appeals and Interferences for review of the examiner's rejection by filing a notice of appeal within the required time. A third party requester may not appeal, and may not participate in the patent owner's appeal.

In an *ex parte* reexamination filed before November 29, 1999, the patent owner may appeal to the Board after the second rejection of the claims (which is either final or non-final). This is based on the version of 35 U.S.C. 134 in existence prior to the amendment of the reexamination statute on November 29, 1999, by Public Law 106-113. This "prior version" of 35 U.S.C. 134 applies to appeals in reexamination where the reexamination was filed in the Office ~~**>~~before< November 29, 1999. See Section 13202(d) of Public Law 107-273.

In an *ex parte* reexamination filed on or after November 29, 1999, the patent owner may appeal to the Board only after the final rejection of the claims. This is based on the current version of 35 U.S.C. 134 as amended by Public Law 106-113. This "current version" of 35 U.S.C. 134 applies to appeals in reexamination, where the reexamination was filed in the Office on or after November 29, 1999. See Section 13202(d) of Public Law 107-273.

The notice of appeal need not be signed by the patent owner or his or her attorney or agent. See 37 CFR 41.31(b). The fee required by 37 CFR 41.20(b)(1) must accompany the notice of appeal. See 37 CFR 41.31(a)(2) and (a)(3).

The period for filing the notice of appeal is the period set for response in the last Office action which is normally 2 months. The timely filing of a first response to a final rejection having a shortened statutory period for response is construed as including a request to extend the period for response an additional month, even if an extension has been previously granted, as long as the period for response does not exceed 6 months from the date of the final rejection. The normal *ex parte* appeal procedures set forth at 37 CFR 41.31 through 37 CFR 41.54 apply in *ex parte* reexamination, except as pointed out in this Chapter. A third party requester may not appeal or otherwise participate in the appeal.

The reexamination statute does not provide for review of a patentability decision favoring the patentee. *Greenwood v. Seiko Instruments*, 8 USPQ2d 1455 (D.D.C. 1988).

See MPEP § 1204 for a discussion of the requirements for a proper appeal. However, note that in the unusual circumstances where an appeal is defective (e.g., no proof of service is included, it was filed for the wrong proceeding), patent owner should **not** be advised by the examiner to obtain an extension of time under 37 CFR 1.136(a), because an extension of time under 37 CFR 1.136 cannot be obtained in a reexamination proceeding.

Where a notice of appeal is defective, the patent owner will be so notified. Form PTOL-475 will be used to provide the notification. The "other" box on the PTOL-475 will be checked where it is appropriate with an explanation as to why the notice of appeal is defective. A 1-month or 30 days, whichever is longer, time period will be provided for the patent owner to cure the defect(s) in the appeal.

If the patent owner does not timely file a notice of appeal and/or does not timely file the appropriate appeal fee, the patent owner will be notified that the appeal is dismissed. Form PTOL-468 will be used to provide the notification. The reexamination prosecution is then terminated, and a Notice of Intent to Issue *Ex Parte* Reexamination Certificate (NIRC) will subsequently be issued indicating the status of the claims

at the time of final rejection (or after the second rejection of the claims, where an appeal was taken from that action without waiting for a final rejection). See MPEP § 2287.

2274 Appeal Brief [R-5]

I. AMENDMENT

Where the appeal brief is not filed, but within the period allowed for filing the brief an amendment is presented which places the claims of the patent under reexamination in a patentable condition, the amendment may be entered. Amendments should not be included in the appeal brief.

As to separate amendments, i.e., amendments not included with the appeal brief, filed with or after the appeal, see MPEP § 1207.

II. TIME FOR FILING APPEAL BRIEF

The time for filing the appeal brief is 2 months from the date of the appeal.

III. EXTENSION OF TIME FOR FILING APPEAL BRIEF

In the event that the patent owner finds that he or she is unable to file a brief within the time allowed by the rules, he or she may file a petition with the appropriate extension of time fee, to the >Central Reexamination Unit (CRU) or< Technology Center (TC), requesting additional time (usually 1 month), and give reasons for the request. The petition should contain the address to which the response is to be sent. If sufficient cause is shown and the petition is filed prior to the expiration of the period sought to be extended (37 CFR 1.550(c)), the >CRU or< TC Director is authorized to grant the extension for up to 1 month. Requests for extensions of time for more than 1 month will also be decided by the >CRU or< TC Director, but will not be granted unless extraordinary circumstances are involved; e.g., death or incapacitation of the patent owner. The time extended is added to the last calendar day of the original period, as opposed to being added to the day it would have been due when said last day is a Saturday, Sunday, or Federal holiday.

IV. FAILURE TO TIMELY FILE APPEAL BRIEF

Failure to file the brief and/or the appeal brief fee within the permissible time will result in dismissal of the appeal. Form PTOL-468 is used to notify the patent owner that the appeal is dismissed. The reexamination prosecution is then terminated, and a Notice of Intent to Issue *Ex Parte* Reexamination Certificate (NIRC) (see MPEP § 2287) will subsequently be issued indicating the status of the claims at the time of appeal.

V. REQUIREMENTS FOR THE APPEAL BRIEF

A fee as set forth in 37 CFR 41.20(b)(2) is required when the appeal brief is filed for the first time in a particular reexamination proceeding, 35 U.S.C. 41(a). 37 CFR 41.37 provides that the appellant shall file a brief of the authorities and arguments on which he or she will rely to maintain his or her appeal, including a summary of claimed subject matter which must refer to the specification by page and line number, and to the drawing, if any, by reference characters, and a copy of the claims involved. Only one copy of the appeal brief is required. Where the request for reexamination was filed by a third party requester, a copy of the brief must be served on that third party requester.

In the case of a merged proceeding (see MPEP § 2283 and § 2285), one original copy of the brief should be provided for each reexamination proceeding and reissue application in the merged proceeding. In addition, a copy of the brief must be served on any third party requesters who are part of the merged proceeding.

For the sake of convenience, the copy of the claims involved should be double spaced and should start on a new page. Note that >the copy of the< claims on appeal in reexamination proceedings *>must< include all underlining and bracketing *>, as required by 37 CFR 1.530(f),< to reflect the changes made to the original patent claims throughout the prosecution of the reexamination. In addition, any new claims added in the reexamination should be completely underlined. This represents a departure from the procedure set forth in MPEP § 1205.02 for applications.

The brief, as well as every other paper relating to an appeal, should indicate the number of the *>art unit<

to which the reexamination is assigned and the reexamination control number. When the brief is received, it is forwarded to the *>CRU or TC (depending which is examining the proceeding)< where it is entered in the file and referred to the examiner.

Patent owners are reminded that their briefs in appeal cases must be responsive to every ground of rejection stated by the examiner. A reply brief, if filed, shall be entered, except that amendments or affidavits or other evidence are subject to 37 CFR 1.116 and 41.33. See 37 CFR 41.41(a)(2).

It is essential that the Board of Patent Appeals and Interferences should be provided with a brief fully stating the position of the appellant with respect to each issue involved in the appeal so that no search of the record is required in order to determine that position. The fact that appellant may consider a ground to be clearly improper does not justify a failure on the part of the appellant to point out to the Board the reasons for that view in the brief.

See MPEP § 1205.02 for further discussion of the requirements for an appeal brief.

VI. DEFECTIVE APPEAL BRIEF

Where an appeal brief is defective, the examiner will notify the patent owner that the brief is defective, using PTOL-462R. A 1-month period is provided for the patent owner to cure the defect(s). Where items 1-9 in the form do not provide the defect which has been found in the brief, or where more explanation is needed as to one of items 1-9, box 10 should be checked and the nature of the defect(s) explained by the examiner in an attachment to form PTOL-462R. An example of this is where an appellant patent owner inadvertently fails to respond by way of brief to any ground of rejection under a separate heading, and it is clear from the record which ground has not been responded to. In such a case, appellant should be notified by the examiner that he or she is given 1 month to correct the defect by filing a supplemental brief.

It is important for the examiner to identify any defects in the brief and give the patent owner 1 month in which to cure the defects. Where this procedure has not been followed, the Board of Patent Appeals and Interferences (Board) may return the reexamination file to the examiner for compliance (i.e., for corrective action).

When the record clearly indicates *intentional failure* to respond by brief, to any ground of rejection, for example, the examiner should inform the Board of this fact in his or her answer and merely specify the claim(s) affected. Where the failure to respond by brief appears to be intentional, the Board may summarily sustain the rejection. Oral argument at the hearing will not remedy such deficiency of a brief.

The mere filing of any paper whatsoever entitled as a brief cannot necessarily be considered as compliance with 37 CFR 41.37. The rule requires that the brief must set forth the authorities and arguments relied on, and to the extent that it fails to do so with respect to any ground of rejection, that ground may be summarily sustained. A distinction must be made between the lack of any argument and the presentation of arguments that carry no conviction. In the former case summarily sustaining the rejection is in order, while in the latter case a decision on the merits is made, although it may well be merely an affirmance based on the grounds relied on by the examiner.

Appellant must traverse *every* ground of rejection set forth in the final rejection that appellant is presenting for review in the appeal. Oral argument at the hearing will not remedy a deficiency of failure to traverse a ground of rejection in the brief. Ignoring or acquiescing in any rejection, even one based upon formal matters which could be cured by subsequent amendment, will invite summarily affirmance of the rejection.

The reexamination prosecution is considered terminated as of the date of the dismissal of the appeal. After the appeal is dismissed, the examiner will proceed to issue a Notice of Intent to Issue *Ex Parte* Reexamination Certificate for the proceeding; see MPEP § 2287.

2275 Examiner's Answer [R-3]

**>

37 CFR 41.39. *Examiner's answer.*

(a)(1)The primary examiner may, within such time as may be directed by the Director, furnish a written answer to the appeal brief including such explanation of the invention claimed and of the references relied upon and grounds of rejection as may be necessary, supplying a copy to appellant. If the primary examiner determines that the appeal does not comply with the provisions of §§ 41.31 and 41.37 or does not relate to an appealable action, the primary examiner shall make such determination of record.

(b) If an examiner's answer contains a rejection designated as a new ground of rejection, appellant must within two months from the date of the examiner's answer exercise one of the following two options to avoid sua sponte dismissal of the appeal as to the claims subject to the new ground of rejection:

(1) Reopen prosecution. Request that prosecution be reopened before the primary examiner by filing a reply under § 1.111 of this title with or without amendment or submission of affidavits (§§ 1.130, 1.131 or 1.132 of this title) or other evidence. Any amendment or submission of affidavits or other evidence must be relevant to the new ground of rejection. A request that complies with this paragraph will be entered and the application or the patent under *ex parte* reexamination will be reconsidered by the examiner under the provisions of § 1.112 of this title. Any request that prosecution be reopened under this paragraph will be treated as a request to withdraw the appeal.

(2) Maintain appeal. Request that the appeal be maintained by filing a reply brief as set forth in § 41.41. Such a reply brief must address each new ground of rejection as set forth in § 41.37(c)(1)(vii) and should follow the other requirements of a brief as set forth in § 41.37(c). A reply brief may not be accompanied by any amendment, affidavit (§§ 1.130, 1.131 or 1.132 of this title) or other evidence. If a reply brief filed pursuant to this section is accompanied by any amendment, affidavit or other evidence, it shall be treated as a request that prosecution be reopened before the primary examiner under paragraph (b)(1) of this section.

(c) Extensions of time under § 1.136 (a) of this title for patent applications are not applicable to the time period set forth in this section. See § 1.136 (b) of this title for extensions of time to reply for patent applications and § 1.550 (c) of this title for extensions of time to reply for *ex parte* reexamination proceedings.<

MPEP § >1207< through § >1207.05< relate to preparation of examiner's answers in appeals. The procedures covered in these sections apply to appeals in both patent applications and patents undergoing *ex parte* reexamination proceedings, except as provided for in this Chapter.

Where appellant files a timely reply brief to an examiner's answer or a supplemental examiner's answer, the examiner may * (A) acknowledge receipt and entry of the reply brief, * (B) ** reopen prosecution to respond to the reply brief>, or (C) furnish a supplemental examiner's answer responding to any new issue raised in the reply brief (see MPEP § 1207.05 for information on supplemental examiner's answer). See 37 CFR 41.43(a)<. A supplemental examiner's answer **>responding to a reply brief may not include a new ground of rejection. See 37 CFR 41.43(a)(2). A supplemental examiner's answer, other than to respond to any new issue raised in the reply brief, is not permitted unless the reexamination

proceeding< has been remanded by the Board of Patent Appeals and Interferences for such purposes.

2276 Oral Hearing [R-3]

If appellant (patent owner) desires an oral hearing, appellant must file a written request for such hearing accompanied by the fee set forth in 37 CFR >41.20(b)(3)< within 2 months after the date of the examiner's answer >or supplemental examiner's answer. The time for requesting an oral hearing may not be extended. 37 CFR 41.73(b). No appellant will be permitted to participate in an oral hearing unless he or she has requested an oral hearing and submitted the fee set forth in 37 CFR 41.20(b)(3)<.

Where the appeal involves reexamination proceedings, oral hearings are open to the public as observers (subject to the admittance procedures established by the Board), unless the appellant (A) >petitions under 37 CFR 41.3< that the hearing not be open to the public>,< * (B) presents >sufficient< reasons for such a request>, (C) pays the petition fee set forth in 37 CFR 41.20(a), and (D) the petition is granted<.

MPEP § 1209 relates to oral hearings in appeals in both patent applications and *ex parte* reexamination proceedings.

2277 Board of Patent Appeals and Interferences Decision [R-2]

MPEP § 1213 through § 1213.03 relate to decisions of the Board of Patent Appeals and Interferences for both applications and >*ex parte*< reexamination proceedings.

2278 Action Following Decision [R-2]

MPEP § 1214 through § 1214.07 provide the procedures to be followed after the conclusion of the appeal to the Board of Patent Appeals and Interferences, for both patent applications and >*ex parte*< reexamination proceedings, except as provided for in this Chapter.

2279 Appeal to Courts [R-3]

A patent owner >who is< not satisfied with the decision of the Board of Patent Appeals and Interferences may seek judicial review.

In an *ex parte* reexamination filed before November 29, 1999, the patent owner may appeal the deci-

sion of the Board of Patent Appeals and Interferences to either (A) the United States Court of Appeals for the Federal Circuit pursuant to 35 U.S.C. 141, or (B) the United States District Court for the District of Columbia pursuant to 35 U.S.C. 145. This is based on the version of 35 U.S.C. 141 and 35 U.S.C. 145 in existence prior to the amendment of the reexamination statute on November 29, 1999 by Public Law 106-113. This “prior version” of 35 U.S.C. 141 and 35 U.S.C. 145 applies to appeals in reexamination, where the reexamination was filed in the Office before November 29, 1999. See Section 13202(d) of Public Law 107-273.

In an *ex parte* reexamination filed on or after November 29, 1999, the patent owner may appeal the decision of the Board of Patent Appeals and Interferences only to the United States Court of Appeals for the Federal Circuit pursuant to 35 U.S.C. 141. This is based on the current version of 35 U.S.C. 141 and 35 U.S.C. 145 as they were amended by Public Law 106-113. This “current version” of 35 U.S.C. 141 and 35 U.S.C. 145 applies to appeals in reexamination, where the reexamination was filed in the Office on or after November 29, 1999. See Section 13202(d) of Public Law 107-273.

A third party requester of an *ex parte* reexamination may not seek judicial review. *Yuasa Battery v. Comm’r*, 3 USPQ2d 1143 (D.D.C. 1987).

While the reexamination statutory provisions do not provide for participation by any third party requester during any court review, the courts have permitted intervention by a third party requester in appropriate circumstances. See *In re Etter*, 756 F.2d 852, 225 USPQ 1 (Fed. Cir. 1985) and *Reed v. Quigg*, 230 USPQ 62 (D.D.C. 1986). See also MPEP § 1216, § 1216.01, and § 1216.02. A third party requester who is permitted to intervene in a civil action has no standing to appeal the court’s decision, *Boeing Co. v. Comm’r*, 853 F.2d 878, 7 USPQ2d 1487 (Fed. Cir. 1988).

2280 Information Material to Patentability in Reexamination Proceeding [R-7]

37 CFR 1.555. *Information material to patentability in ex parte reexamination and inter partes reexamination proceedings.*

(a) A patent by its very nature is affected with a public interest. The public interest is best served, and the most effective reexamination occurs when, at the time a reexamination proceeding is being conducted, the Office is aware of and evaluates the teachings of all information material to patentability in a reexamination proceeding. Each individual associated with the patent owner in a reexamination proceeding has a duty of candor and good faith in dealing with the Office, which includes a duty to disclose to the Office all information known to that individual to be material to patentability in a reexamination proceeding. The individuals who have a duty to disclose to the Office all information known to them to be material to patentability in a reexamination proceeding are the patent owner, each attorney or agent who represents the patent owner, and every other individual who is substantively involved on behalf of the patent owner in a reexamination proceeding. The duty to disclose the information exists with respect to each claim pending in the reexamination proceeding until the claim is cancelled. Information material to the patentability of a cancelled claim need not be submitted if the information is not material to patentability of any claim remaining under consideration in the reexamination proceeding. The duty to disclose all information known to be material to patentability in a reexamination proceeding is deemed to be satisfied if all information known to be material to patentability of any claim in the patent after issuance of the reexamination certificate was cited by the Office or submitted to the Office in an information disclosure statement. However, the duties of candor, good faith, and disclosure have not been complied with if any fraud on the Office was practiced or attempted or the duty of disclosure was violated through bad faith or intentional misconduct by, or on behalf of, the patent owner in the reexamination proceeding. Any information disclosure statement must be filed with the items listed in § 1.98(a) as applied to individuals associated with the patent owner in a reexamination proceeding, and should be filed within two months of the date of the order for reexamination, or as soon thereafter as possible.

(b) Under this section, information is material to patentability in a reexamination proceeding when it is not cumulative to information of record or being made of record in the reexamination proceeding, and

(1) It is a patent or printed publication that establishes, by itself or in combination with other patents or printed publications, a *prima facie* case of unpatentability of a claim; or

(2) It refutes, or is inconsistent with, a position the patent owner takes in:

(i) Opposing an argument of unpatentability relied on by the Office, or

(ii) Asserting an argument of patentability.

A *prima facie* case of unpatentability of a claim pending in a reexamination proceeding is established when the information

compels a conclusion that a claim is unpatentable under the preponderance of evidence, burden-of-proof standard, giving each term in the claim its broadest reasonable construction consistent with the specification, and before any consideration is given to evidence which may be submitted in an attempt to establish a contrary conclusion of patentability.

(c) The responsibility for compliance with this section rests upon the individuals designated in paragraph (a) of this section and no evaluation will be made by the Office in the reexamination proceeding as to compliance with this section. If questions of compliance with this section are raised by the patent owner or the third party requester during a reexamination proceeding, they will be noted as unresolved questions in accordance with § 1.552(c).

The duty of disclosure in reexamination proceedings applies to the patent owner; to each attorney or agent who represents the patent owner, and to every other individual who is substantively involved on behalf of the patent owner. That duty is a continuing obligation on all such individuals throughout the proceeding. The continuing obligation during the reexamination proceeding is that any such individual to whom the duty applies who is aware of, or becomes aware of, patents or printed publications which (A) are material to patentability in a reexamination proceeding, and (B) which have not previously been made of record in the patent file, must bring such patents or printed publications to the attention of the Office.

Such individuals are strongly encouraged to file information disclosure statements in accordance with 37 CFR 1.98, within two months of the date of the order to reexamine, or as soon thereafter as possible, in order to bring the patents or printed publications to the attention of the Office. An information disclosure statement filed under 37 CFR 1.555 by the patent owner after the order for reexamination and before the first action on the merits may be submitted as part of the statement under 37 CFR 1.530, or it may be filed as a separate paper. If the information disclosure statement is filed as part of a statement under 37 CFR 1.530, the submission may include a discussion of the patentability issues in the reexamination. If, however, the submission is filed as a separate paper, not part of a statement under 37 CFR 1.530, the submission must be limited to a listing of the information disclosed and an explanation of its relevance. See 37 CFR 1.98. Any discussion of the information disclosed relating to patentability issues in the reexamination would be improper.

It is to be noted that, to comply with 37 CFR 1.98(a) as to documents cited in the patent or its parent applications that a party wishes to submit, the party must supply copies of the information. >37 CFR 1.98(a)(2) requires a legible copy of:

- (1) each foreign patent;
- (2) each publication or that portion which caused it to be listed, other than U.S. patents and U.S. patent application publications unless required by the Office;
- (3) for each cited pending unpublished U.S. application, the application specification including the claims, and any drawing of the application, or that portion of the application which caused it to be listed including any claims directed to that portion;
- (4) all other information or that portion which caused it to be listed.<

The exception to the requirement for copies noted in 37 CFR 1.98(d) does not apply to *ex parte* and *inter partes* reexamination proceedings, since a reexamination proceeding does not rely on the patent for an earlier effective filing date.

Any individual substantively involved in the reexamination proceeding may satisfy his or her duty by disclosing the information to the attorney or agent having responsibility for the reexamination proceeding or to a patent owner acting in his or her own behalf. A patent owner may satisfy his or her duty by disclosing the information to the attorney or agent having responsibility for the reexamination proceeding. An attorney, agent, or patent owner who receives information has no duty to submit such information if it is not material to patentability in the reexamination proceeding. See 37 CFR 1.555(b) for the definition of "material to patentability."

The responsibility of compliance with 37 CFR 1.555 rests on all such individuals. Any fraud practiced or attempted on the Office or any violation of the duty of disclosure through bad faith or intentional misconduct by any such individual results in noncompliance with 37 CFR 1.555(a). This duty of disclosure is consistent with the duty placed on patent applicants by 37 CFR 1.56. Any such issues raised by the patent owner or the third party requester during a reexamination proceeding will merely be noted as unresolved questions under 37 CFR 1.552(c).

All such individuals who fail to comply with 37 CFR 1.555(a) do so at the risk of diminishing the

quality and reliability of the reexamination certificate issuing from the proceeding.

See MPEP § 2282 (*ex parte* reexamination) and MPEP § 2686 (*inter partes* reexamination) for the patent owner's duty to disclose prior or concurrent proceedings in which the patent is or was involved.

2281 Interviews in *Ex Parte* Reexamination Proceedings [R-7]

37 CFR 1.560. *Interviews in ex parte reexamination proceedings.*

(a) Interviews in *ex parte* reexamination proceedings pending before the Office between examiners and the owners of such patents or their attorneys or agents of record must be conducted in the Office at such times, within Office hours, as the respective examiners may designate. Interviews will not be permitted at any other time or place without the authority of the Director. Interviews for the discussion of the patentability of claims in patents involved in *ex parte* reexamination proceedings will not be conducted prior to the first official action. Interviews should be arranged in advance. Requests that reexamination requesters participate in interviews with examiners will not be granted.

(b) In every instance of an interview with an examiner in an *ex parte* reexamination proceeding, a complete written statement of the reasons presented at the interview as warranting favorable action must be filed by the patent owner. An interview does not remove the necessity for response to Office actions as specified in § 1.111. Patent owner's response to an outstanding Office action after the interview does not remove the necessity for filing the written statement. The written statement must be filed as a separate part of a response to an Office action outstanding at the time of the interview, or as a separate paper within one month from the date of the interview, whichever is later.

Interviews are permitted in an *ex parte* reexamination proceeding. In the *ex parte* proceeding, only *ex parte* interviews between the examiner and patent owner and/or the patent owner's representative are permitted. Requests by third party requesters to participate in interviews or to attend interviews will not be granted. >However, it is permitted for a Paralegal or Legal Instruments Examiner (or support staff in general) to telephone a requester to discuss a request that fails to comply with the filing date requirements for filing a reexamination request, because there is no reexamination proceeding yet.<

Unless the Office of Patent Legal Administration authorizes otherwise, interviews between examiner and the owners of patents undergoing *ex parte* reexamination or their attorneys or agents must be had in the Office at such times, within Office hours, as the respective examiners may designate.

Where a panel review has been conducted for an action in a reexamination proceeding, every effort will be made to have the panel members present at an interview requested by the patent owner to discuss that action. An interview such as a telephone interview initiated by the examiner to obtain an amendment to allow the case will not have the panel member participating in the telephone interview.

Interviews for the discussion of the patentability of claims in patents involved in reexamination proceedings will ordinarily not be had prior to the first Office action following the order for reexamination and any submissions pursuant to 37 CFR 1.530 and 1.535. Such interviews will be permitted prior to the first Office action *only* where the examiner initiates the interview for the purpose of providing an amendment which will make the claims patentable and the patent owner's role is passive. The patent owner's role (or patent owner's attorney or agent) is limited to agreeing to the change or not. The patent owner should not otherwise discuss the case on the merits during this interview.

The patent owner's questions on purely procedural matters may be answered by the examiner at any time during the proceeding.

Where any party who is not the patent owner requests information as to the merits of a reexamination proceeding, the examiner will not conduct a personal or telephone interview with that party to provide the information. Only questions on strictly procedural matters, i.e., not directed to any specific reexamination proceeding, may be discussed with that party. The party who is not the patent owner should be referred by the examiner to the ** Central Reexamination Unit (CRU) **>Supervisory Patent Examiner (SPE) or Technology Center (TC) Quality Assurance Specialist (QAS)< to address any such questions on strictly procedural matters. See MPEP § 2212.01. The following guidelines are to be followed in determining whether a question is strictly directed to a procedural matter: (A) any information which a person could obtain by reading the file (which is open to the public) is procedural, and it may be discussed; (B) a matter not available from a reading of the file is considered as relating to the merits of the proceeding, and may not be discussed. Thus, for example, a question relating to when the next Office action will be rendered is improper as it relates to the merits of the proceeding (because this

information cannot be obtained from a reading of the file). Such a question by a party who is not the patent owner should not be responded to by the examiner or any other official.

The examiner must complete an *Ex Parte* Interview Summary form PTOL-474 for each interview held where a matter of substance has been discussed (see MPEP § 713.04). A copy of the form should be given to the patent owner at the conclusion of the interview. The original should be made of record in the reexamination file, and a copy should be mailed to any third party requester.

The general procedure for conducting interviews and recording same is described at MPEP § 713.01 - § 713.04.

Pursuant to 35 U.S.C. 305, however, “[a]ll reexamination proceedings ... will be conducted with special dispatch within the Office.” Accordingly, there are additional procedural requirements to facilitate the statutory mandate for “special dispatch.”

In the case where the patent owner desires to initiate an interview, the patent owner should initially contact the examiner in charge of the proceeding to indicate what issues are sought to be discussed, and to determine if an interview will be granted. If the examiner agrees to grant the interview, the patent owner must file, at least three (3) working days prior to the interview, *>an informal< written statement of the issues to be discussed at the interview, and *>an informal< copy of any proposed claims to be discussed, unless examiner waives this requirement. **>The copy of these materials is to be submitted by facsimile transmission (FAX) directly to the examiner or hand-carried to the examiner so as to avoid the possibility of delay in matching the materials with the file. The informal copies that are considered by the examiner will be made of record in the reexamination proceeding as an attachment to the Interview Summary form PTOL-474 completed by the examiner after the interview. These preliminary steps are for the purpose of providing< structure to the interview so as to facilitate the statutory mandate for special dispatch.

The duration of the interview will not exceed one hour, unless the patent owner files a petition under 37 CFR 1.182 showing sufficient cause where more time is needed. In a reexamination proceeding, the invention should be well defined after the patent has issued, and it is simply a matter of defining the claims

over art applied, to the extent such is deemed necessary. An hour of time in a structured planned interview should be sufficient to accomplish this, and in those rare instances where it is not, a patent owner may show cause to extend the time. During the interview, the examiner is always free to extend the duration of the interview to discuss issues that the examiner deems appropriate for (further) discussion. Such an extension of the duration of the interview is permitted at the examiner’s sole discretion.

Only one interview may be requested after an Office action and prior to filing the response to that action, absent a showing of good cause to conduct a second interview during this period.

PATENT OWNER’S STATEMENT OF THE INTERVIEW

In every instance of an interview with the examiner, a patent owner’s statement of the interview, including a complete written statement of the reasons presented at the interview as warranting favorable action, **must** be filed by the patent owner. 37 CFR 1.560(b). The written statement must be filed either as a separate paper within one month after the date of the interview, or as a separate part of a response to an outstanding Office action, whichever is later.

The requirement for a patent owner’s statement of the interview cannot be waived by the examiner. It should be noted that, pursuant to 37 CFR 1.550(d), the failure to file a written statement of an interview as required under 37 CFR 1.560(b) will result in the termination of the reexamination prosecution (in the same way that failure to timely respond to an Office action results in the termination of the reexamination prosecution).

2282 Notification of Existence of Prior or Concurrent Proceedings and Decisions Thereon [R-7]

37 CFR 1.565. Concurrent office proceedings which include an ex parte reexamination proceeding.

(a) In an *ex parte* reexamination proceeding before the Office, the patent owner must inform the Office of any prior or concurrent proceedings in which the patent is or was involved such as interferences, reissues, *ex parte* reexaminations, *inter partes* reexaminations, or litigation and the results of such proceedings. See § 1.985 for notification of prior or concurrent proceedings in an *inter partes* reexamination proceeding.

It is important for the Office to be aware of any prior or concurrent proceedings in which a patent undergoing *ex parte* reexamination is or was involved, such as interferences, reissues, *inter partes* reexaminations, other *ex parte* reexaminations or litigations, and any results of such proceedings. In accordance with 37 CFR 1.565(a), the patent owner is required to provide the Office with information regarding the existence of any such proceedings, and the results thereof, if known. Ordinarily, no submissions of any kind by third parties filed after the date of the order are entered into the reexamination or patent file while the reexamination proceeding is pending. However, in order to ensure a complete file, with updated status information regarding prior or concurrent proceedings regarding the patent under reexamination, the Office will, at any time, accept from any parties, for entry into the reexamination file, copies of notices of suits and other proceedings involving the patent and copies of decisions or papers filed in the court from litigations or other proceedings involving the patent. >Such decisions include final court decisions (even if the decision is still appealable), decisions to vacate, decisions to remand, and decisions as to the merits of the patent claims. Non-merit decisions on motions such as for a new venue, a new trial/discovery date, or sanctions will not be entered into the patent file, and will be expunged from the patent file by closing the appropriate paper if they were entered before discovery of their nature. Further, papers filed in the court from litigations or other proceedings involving the patent will not be entered into the record (and will be expunged if already entered) if they provide a party's arguments, such as a memorandum in support of summary judgment. If the argument has an entry right in the reexamination proceeding, it must be submitted via the vehicle (provision(s) of the rules) that provides for that entry right. It is not required nor is it permitted that parties submit copies of copending reexamination proceedings and applications (which copies can be mistaken for a new request/filing); rather, submitters may provide a notice identifying the application/proceeding number and its status. Any submission that is not permitted entry will be returned, expunged, or discarded, at the sole discretion of the Office.< It is to be noted that if the Office, in its sole discretion, deems the volume of the papers

filed from litigations or other proceedings to be too extensive/lengthy, the Office may return >, expunge or discard, at its sole discretion,< all or part of the submission. In such an instance, a party may limit the submission in accordance with what is deemed relevant, and resubmit the papers. Persons making such submissions must limit the submissions to the notification, and must not include further arguments or information. Where a submission is not limited to bare notice of the prior or concurrent proceedings (in which a patent undergoing reexamination is or was involved), the submission will be returned by the Office. It is to be understood that highlighting of certain text by underlining, fluorescent marker, etc., goes beyond bare notice of the prior or concurrent proceedings.

Any proper submission pursuant to 37 CFR 1.565(a) will be promptly entered into the record of the reexamination file, and will be considered by the examiner as to its content, when the proceeding comes up for action on the merits. Thus, for example, if the patent owner properly files in a reexamination proceeding, pursuant to 37 CFR 1.565(a), an Information Disclosure Statement (IDS) that was submitted by a third party in the discovery stage of litigation of the patent being reexamined, the IDS would be entered into the reexamination file and considered by the examiner, the next time the proceeding comes up for action on the merits. See MPEP § 2286 for Office investigation for prior or concurrent litigation.

Form paragraph 22.07 or 22.08, if appropriate, may be used to remind the patent owner of the continuing duty under 37 CFR 1.565(a) to apprise the Office of any litigation activity.

¶ 22.07 *Litigation Reminder (Patent Owner Request or Director Ordered Reexamination)*

The patent owner is reminded of the continuing responsibility under 37 CFR 1.565(a), to apprise the Office of any litigation activity, or other prior or concurrent proceeding, involving Patent No. [1] throughout the course of this reexamination proceeding. See MPEP §§ 2207, 2282 and 2286.

Examiner Note:

This form paragraph is to be used when granting an *ex parte* reexamination request filed by a patent owner and in the first action in a Director Ordered reexamination.

¶ 22.08 *Litigation Reminder (Third Party Requester)*

The patent owner is reminded of the continuing responsibility under 37 CFR 1.565(a), to apprise the Office of any litigation activity, or other prior or concurrent proceeding, involving Patent

No. [1] throughout the course of this reexamination proceeding. The third party requester is also reminded of the ability to similarly apprise the Office of any such activity or proceeding throughout the course of this reexamination proceeding. See MPEP §§ 2207, 2282 and 2286.

Examiner Note:

This form paragraph is to be used when granting an *ex parte* reexamination request filed by a third party requester.

2283 Multiple Copending *Ex Parte* Reexamination Proceedings [R-7]

37 CFR 1.565. *Concurrent Office proceedings which include an ex parte reexamination proceeding.*

(c) **>If *ex parte* reexamination is ordered while a prior *ex parte* reexamination proceeding is pending and prosecution in the prior *ex parte* reexamination proceeding has not been terminated, the *ex parte* reexamination proceedings will usually be merged and result in the issuance and publication of a single certificate under § 1.570. For merger of *inter partes* reexamination proceedings, see § 1.989(a). For merger of *ex parte* reexamination and *inter partes* reexamination proceedings, see § 1.989(b).<

This section discusses multiple copending reexamination requests which are filed on the same patent, where none of the requests is an *inter partes* request. If one of the multiple copending reexamination requests is an *inter partes* request, see MPEP § 2686.01.

In order for a second or subsequent request for *ex parte* reexamination to be granted, a substantial new question of patentability must be raised by the art (patents and/or printed publications) cited in the second or subsequent request for reexamination. MPEP § 2240 provides a discussion as to whether a substantial new question of patentability is raised by the prior art cited in a second or subsequent request for reexamination filed while a reexamination proceeding is pending.

If the second or subsequent request is granted, the decision on whether or not to combine the proceedings will be made by the Central Reexamination Unit (CRU) Director where the reexamination is pending. The CRU Director may delegate this to the **>CRU Supervisory Patent Examiner (SPE)<. No decision on combining the reexaminations should be made until reexamination is actually ordered in the later filed request for reexamination.

I. PROCEEDINGS MERGED

**>

Where a second request for reexamination is filed and reexamination is ordered, and a first reexamination proceeding is pending, 37 CFR 1.565(c) provides that the proceedings will usually be merged. However, a decision not to merge is within the sole discretion of the Office to facilitate/carry out the statutory mandate of 35 U.S.C. 305 to conduct reexamination proceedings with “special dispatch.”

Where a second request for reexamination is filed while a first reexamination proceeding is pending, the second request is decided based on the claims in effect at the time of the determination (see 37 CFR 1.515(a)), and if reexamination is ordered, the patent owner and the second requester are given an opportunity to file a statement and reply, respectively. It is then considered whether the proceedings will, or will not, be merged. If the proceedings are merged, the prosecution will then continue at the most advanced point possible for the first proceeding. It should be noted that if a final rejection has been issued in the first proceeding, prosecution will be ordinarily be reopened where any of the new patents or printed publications presented in the second request are applied to the merged proceeding in a new ground of rejection.

The patent owner will be provided with an opportunity to respond to any new rejection in a merged reexamination proceeding prior to the action being made final. See MPEP § 2271. If the reexamination proceedings are merged, a single certificate will be issued based upon the merged proceedings, 37 CFR 1.565(c).

II. WHEN PROCEEDING IS SUSPENDED

It may also be desirable in certain situations to suspend a proceeding for a short and specified period of time. For example, a suspension of a first reexamination proceeding may be issued to allow time for the patent owner’s statement and the requester’s reply in a second proceeding prior to merging. Further, after the second proceeding *has been ordered*, it may be desirable to suspend the second proceeding where the first proceeding is presently on appeal before a Federal court to await the court’s decision prior to merging. A suspension will only be granted in extraordinary instances, because of the statutory requirements that

examination proceed with “special dispatch.” The express written approval of the CRU or Technology Center (TC) Director must be obtained. Suspension will not be granted when there is an outstanding Office action.

III. MERGER OF REEXAMINATIONS

The following guidelines should be observed when two requests for reexamination directed to a single patent have been filed.

The second request (i.e., Request 2) should be processed as quickly as possible and assigned to the same examiner to whom the first request (i.e., Request 1) is assigned. Request 2 should be decided immediately without waiting the usual period (e.g., for submission of art). If Request 2 is denied, *ex parte* prosecution of Request 1 should continue. If Request 2 is granted, the order in the second proceeding should be mailed immediately. The two requests should be held in storage until the patent owner’s statement and any reply by the requester have been received in Request 2, or until the time for filing same expires. Then, the CRU Director or the CRU Director’s delegate will prepare a decision whether to merge the two proceedings.

A decision by the CRU Director to merge the reexamination proceedings should include a requirement that the patent owner maintain identical claims in both files. It will further require that responses by the patent owner, and any other paper filed in the merged proceeding, must consist of a single response, addressed to both files, filed in duplicate, each bearing a signature and containing identifying data for both files, for entry in both files. The decision will point out that both files will be maintained as separate complete files. Where the claims are not the same in both files, the decision of merger will indicate at its conclusion that the patent owner is given 1 month to provide an amendment to make the claims the same in each file. Where the claims are already the same in both files, the decision will indicate at its conclusion that an Office action will be mailed in due course, and that the patent owner need not take any action at present. The decision of merger will be mailed immediately.

Where the merger decision indicates that an Office action will follow, the merged proceeding is returned to the examiner immediately after the decision to issue an Office action. Where the merger decision

indicates that the patent owner is given 1 month to provide an amendment to make the claims the same in each file (identical amendments to be placed in all files), the *CRU* will await submission of the amendment or the expiration of the time to submit the amendment. After the amendment is received and processed by the technical support staff or the time for submitting the amendment expires, the merged proceeding will be returned to the examiner to issue an Office action.

Once the merged proceeding is returned to the examiner for issuance of an Office action, the examiner should prepare an Office action at the most advanced point possible for the first proceeding. Thus, if the first proceeding is ready for a final rejection and the second proceeding does not provide any new information which would call for a new ground of rejection, the examiner should issue a final rejection for the merged proceeding using the guidelines for the prosecution stage set forth below.

If the *ex parte* prosecution stage has not yet begun in Request 1 when Request 2 is received, Request 1 should be processed to the point where it is ready for *ex parte* prosecution. Then, Request 1 is normally held until Request 2 is granted and is ready for *ex parte* action following the statement and reply. Thereafter, the two proceedings would be merged. However, if Request 2 is denied, there would be no merger and prosecution will be carried out solely on Request 1. Note that Request 2 should be determined on its own merits and should not rely on nor refer to the decision issued in Request 1.

In the event that an amendment to make the claims the same in each file is required by the merger decision (identical amendments to be placed in all files) but is not timely submitted, any claim that does not contain identical text in all of the merged proceedings should be rejected under 35 U.S.C. 112, second paragraph, as being indefinite as to the content of the claim, and thus failing to particularly point out the invention.

IV. THE PROSECUTION STAGE, AFTER MERGER

Where merger is ordered, the patent owner is required to maintain identical amendments in the merged reexamination files for purposes of the merged proceeding. The maintenance of identical

amendments in the files is required as long as the reexamination proceedings remain merged. Where identical amendments are not present in the reexamination files at the time merger is ordered, the patent owner will be required to submit an appropriate “housekeeping” amendment placing the same amendments in the proceedings. This may be accomplished by amending one or more of the proceedings, as appropriate. The patent owner must not address any issue of patentability in the housekeeping amendment. In the event that an amendment to make the claims the same in each file is required by the merger decision (identical amendments to be placed in all files) but is not timely submitted, any claim that does not contain identical text in all of the merged proceedings should be rejected under 35 U.S.C. 112, paragraph 2, as being indefinite as to the content of the claim, and thus failing to particularly point out the invention.<

When prosecution is appropriate in merged proceedings, a single combined examiner’s action will be prepared. Each action will contain the control number of the two proceedings on every page. A single action cover form (having both control numbers penned in at the top) will be provided by the examiner to the clerical staff. The clerical staff will copy the action cover form, and then use the PALM printer to print the appropriate data (A) on the original for the first request and (B) on the copy for the second request. Each requester will receive a copy of the action and both action cover forms, with the transmission form PTOL-465 placed on top of the package. The patent owner will get a copy of both action cover forms and the action itself.

When a “Notice Of Intent To Issue *Ex Parte* Reexamination Certificate” (NIRC) is appropriate, plural notices will be printed. Both reexamination files will then be processed. The TC or the CRU should prepare the file of the concurrent proceedings in the manner specified in MPEP § 2287 before release to Office of *>Data Management<.

The above guidelines should be extended to those situations where more than two requests for reexamination are filed for a single patent.

V. PROCEEDINGS NOT MERGED

Pursuant to 35 U.S.C. 305, “[a]ll reexamination proceedings under this section...will be conducted with special dispatch within the Office.” This statu-

tory provision is grounded on the need for certainty and finality as to the question of patentability raised by the request for reexamination. Thus, if a second request for reexamination **>will unduly delay< the first reexamination proceeding, the two proceedings generally will not be merged. If the Office were to merge the two *>proceedings<, the first reexamination proceeding would need to be withdrawn from its **>place in the process,< thus delaying, instead of advancing, prosecution. This would run contrary to the statutory “special dispatch” requirement of 35 U.S.C. 305 and its intent. On the other hand, if the Office does not merge, the first reexamination proceeding can be concluded, and any substantial new question of patentability raised by the second reexamination request can be resolved in the second proceeding, with no delay resulting. The second request is then considered based on the claims in the patent as indicated in the issued reexamination certificate, rather than the original claims of the patent. However, the Office always retains the authority to merge because in some instances, it may be more efficient to merge the two proceedings, which would foster “special dispatch.”>The instances where the Office may, or may not, merge an ongoing reexamination proceeding with a subsequent reexamination proceeding, are addressed on a case-by-case basis.<

**

For processing of the second reexamination proceeding, see MPEP § 2295.

VI. FEES IN MERGED PROCEEDINGS

Where the proceedings have been merged and a paper is filed which requires payment of a fee (e.g., excess claim fee, fee for request for extension of time, petition fee, appeal fee, brief fee, oral hearing fee), only a single fee need be paid. For example, only one fee need be paid for an appeal brief even though the brief relates to merged multiple proceedings and copies must be filed for each file in the merged proceeding.

VII. PETITION TO MERGE MULTIPLE COPENING REEXAMINATION PROCEEDINGS

No petition to merge multiple reexamination proceedings is necessary since the Office will generally, *sua sponte*, make a decision as to whether or not it is

appropriate to merge the multiple reexamination proceedings. If any petition to merge the proceedings is filed prior to the determination (37 CFR 1.515) and order to reexamine (37 CFR 1.525) on the second request, it will not be considered but will be returned to the party submitting the same by the CRU Director. The decision returning such a premature petition will be made of record in both reexamination files, but no copy of the petition will be retained by the Office. See MPEP § 2267.

While the patent owner can file a petition to merge the proceedings at any time after the order to reexamine (37 CFR 1.525) on the second request, the better practice is to include any such petition with the patent owner's statement under 37 CFR 1.530, in the event the CRU Director has not acted prior to that date to merge the multiple reexamination proceedings. If the requester of any of the multiple reexamination proceedings is not the patent owner, that party may petition to merge the proceedings as a part of a reply pursuant to 37 CFR 1.535 in the event the CRU Director has not acted prior to that date to merge the multiple proceedings. A petition to merge the multiple proceedings which is filed by a party other than the patent owner or one of the requesters of the reexamination will not be considered but will be returned to that party by the CRU Director as being improper under 37 CFR 1.550(g).

All decisions on the merits of petitions to merge multiple reexamination proceedings will be made by the CRU Director (or to the CRU **>SPE<, if the CRU Director delegates it to him or her).

2284 Copending *Ex Parte* Reexamination and Interference Proceedings [R-5]

37 CFR 1.565. *Concurrent office proceedings which include an ex parte reexamination proceeding.*

(a) In an *ex parte* reexamination proceeding before the Office, the patent owner must inform the Office of any prior or concurrent proceedings in which the patent is or was involved such as interferences, reissues, *ex parte* reexaminations, *inter partes* reexaminations, or litigation and the results of such proceedings. See § 1.985 for notification of prior or concurrent proceedings in an *inter partes* reexamination proceeding.

(e) If a patent in the process of *ex parte* reexamination is or becomes involved in an interference, the Director may suspend the reexamination or the interference. The Director will not consider a request to suspend an interference unless a motion

(§ 41.121(a)(3) of this title) to suspend the interference has been presented to, and denied by, an administrative patent judge, and the request is filed within ten (10) days of a decision by an administrative patent judge denying the motion for suspension or such other time as the administrative patent judge may set. For concurrent *inter partes* reexamination and interference of a patent, see § 1.993.

37 CFR 41.8. *Mandatory notices.*

(a) In an appeal brief (§§ 41.37, 41.67, or 41.68) or at the initiation of a contested case (§ 41.101), and within 20 days of any change during the proceeding, a party must identify:

- (1) Its real party-in-interest, and
- (2) Each judicial or administrative proceeding that could affect, or be affected by, the Board proceeding.

(b) For contested cases, a party seeking judicial review of a Board proceeding must file a notice with the Board of the judicial review within 20 days of the filing of the complaint or the notice of appeal. The notice to the Board must include a copy of the complaint or notice of appeal. See also §§ 1.301 to 1.304 of this title.

37 CFR 41.102. *Completion of examination.*

Before a contested case is initiated, except as the Board may otherwise authorize, for each involved application and patent:

- (a) Examination or reexamination must be completed, and
- (b) There must be at least one claim that:
 - (1) Is patentable but for a judgment in the contested case, and
 - (2) Would be involved in the contested case.

37 CFR 41.103. *Jurisdiction over involved files.*

The Board acquires jurisdiction over any involved file when the Board initiates a contested case. Other proceedings for the involved file within the Office are suspended except as the Board may order.

A patent being reexamined in an *ex parte* reexamination proceeding may be involved in an interference proceeding with at least one application, where the patent and the application are claiming the same patentable invention, and at least one of the application's claims to that invention are patentable to the applicant. See MPEP Chapter 2300.

The general policy of the Office is that a reexamination proceeding will not be delayed, or stayed, because of an interference or the possibility of an interference. The reason for this policy is the requirement of 35 U.S.C. 305 that all reexamination proceedings be conducted with "special dispatch" within the Office. In general, the Office will follow the practice of making the required and necessary decisions in the reexamination proceeding and, at the same time, going forward with the interference to the extent desirable. It is noted that 37 CFR 41.103 provides the

Board with the flexibility to tailor a specific solution to occurrences where reexamination and interference proceedings for the same patent are copending, as such occurrences may arise. Decisions in the interference will take into consideration the status of the reexamination proceeding and what is occurring therein. The decision as to what actions are taken in the interference will, in general, be taken in accordance with normal interference practice.

Although a *patent* being reexamined via a reexamination proceeding may become involved in an interference proceeding, the reexamination proceeding itself can never be involved in an interference proceeding. See 35 U.S.C. 135 subsection (a) which states that “[w]henever an application is made for a patent which, in the opinion of the Director, would interfere with any pending *application*, or with any unexpired *patent*, an interference may be declared” (emphasis added). The reexamination proceeding is neither an application nor a patent.

I. ATTEMPTING TO PROVOKE AN INTERFERENCE WITH A PATENT INVOLVED IN A REEXAMINATION PROCEEDING

When an amendment is filed in a pending application seeking to provoke an interference with a patent involved in a reexamination proceeding, the applicant must comply with 37 CFR 41.202(a), including identifying the patent under reexamination with which interference is sought. The corresponding application claims may be rejected on any applicable ground including, if appropriate, the prior art cited in the reexamination proceeding. See MPEP Chapter 2300. Prosecution of the application should continue as far as possible. If the application is placed in condition for allowance and still contains claims which interfere with claims of the patent under reexamination, then an interference should ordinarily be proposed between the application and the patent. The examiner must notify the Office of Patent Legal Administration (OPLA) before proposing the interference, and such an interference may not be proposed unless authorized by OPLA.

If the interference is not authorized (e.g., resolution of an issue in the reexamination proceeding is necessary to the interference), further action on the application should be suspended until the certificate on the reexamination proceeding has been issued and pub-

lished. Form paragraph 23.16 may be used to notify applicant of the suspension.

Once the reexamination certificate has issued and published, the examiner should review the certificate to see if it makes any changes in the patent claims and then evaluate whether the patent still contains claims which interfere with claims of the application. If the claims do interfere, then the examiner should propose an interference. See MPEP Chapter 2300.

II. MOTION/REQUEST TO SUSPEND INTERFERENCE PENDING THE OUTCOME OF A REEXAMINATION PROCEEDING

A miscellaneous motion under 37 CFR 41.121(a)(3) to suspend an interference pending the outcome of a reexamination proceeding may be made at any time during the interference by any party thereto. See 37 CFR 41.123(b) for the procedure. The motion must be presented to the administrative patent judge who will decide the motion based on the particular fact situation. However, suspension is not favored. Normally, no consideration will be given such a motion unless and until a reexamination order is issued, nor will suspension of the interference normally be permitted until after any motions have been disposed of in the interference proceeding. If the motion under 37 CFR 41.121(a)(3) is denied by the administrative patent judge, a request to stay the interference may be made to the Director of the USPTO under 37 CFR 1.565(e).

A request to stay an interference under 37 CFR 1.565(e) will be decided by the Chief Administrative Patent Judge of the Board of Patent Appeals and Interferences.

III. REQUEST FOR REEXAMINATION FILED DURING INTERFERENCE

In view of the provisions of 37 CFR 1.510(a), “[a]ny person may, at any time during the period of enforceability of a patent” file a request for reexamination. Under 37 CFR 41.8(a), the patent owner must notify the Board of Patent Appeals and Interferences that a request for reexamination was filed, within 20 days of receiving notice of the request having been filed. Where it is the patent owner that files the request for reexamination, the 20 days run from the filing date of the request, since that is when the patent owner “received the notice” of filing the request. Such

requests for reexamination will be processed in the normal manner. No delay, or stay, of the reexamination will occur because the requester is not a party to the interference. If the examiner orders reexamination pursuant to 37 CFR 1.525 and subsequently rejects a patent claim corresponding to a count in the interference, the attention of the Board shall be called thereto.

IV. INTERFERENCE DECLARED WHILE REEXAMINATION PROCEEDING IS ONGOING

Under 37 CFR 1.565, the patent owner in a reexamination proceeding before the Office is required to notify the Office when the patent being reexamined becomes involved in an interference. To do so, the patent owner must file in the reexamination proceeding a paper giving notice of the interference proceeding. The requirements of 37 CFR 1.565, and of 37 CFR 41.8(a) (see the preceding paragraph), are designed to keep the Office and the appropriate parties informed of activity which is relevant to reexamination and interference proceedings and, to the extent possible, to eliminate procedural surprise.

V. PETITION TO STAY REEXAMINATION PROCEEDING BECAUSE OF INTERFERENCE

Any petition to stay a reexamination proceeding, because of an interference, which is filed prior to the determination (37 CFR 1.515) and order to reexamine (37 CFR 1.525) will not be considered, but will be returned to the party submitting the same. The decision returning such a premature petition will be made of record in the reexamination file, but no copy of the petition will be retained by the Office. A petition to stay the reexamination proceeding because of the interference may be filed by the patent owner as a part of the patent owner's statement under 37 CFR 1.530 or subsequent thereto. If a party to the interference, other than the patent owner, is a requester of the reexamination, that party may petition to stay the reexamination proceeding as a part of a reply pursuant to 37 CFR 1.535. If the other party to the interference is not the requester, any petition by that party is improper under 37 CFR 1.550(g) and will not be considered. Any such improper petitions will be returned to the party submitting the same. Premature petitions to stay the reexamination proceedings, i.e., those filed

prior to the determination (37 CFR 1.515) and order to reexamine (37 CFR 1.525), will be returned by the >Central Reexamination Unit (CRU) or< Technology Center (TC) Director as premature. Petitions to stay filed subsequent to the date of the order for reexamination will be referred to the OPLA for decision. All decisions on the merits of petitions to stay a reexamination proceeding because of an interference will be made in the OPLA.

VI. ACTION IN INTERFERENCE FOLLOWING REEXAMINATION

If one or more claims of a patent which is involved in an interference are canceled or amended by the issuance and publication of a reexamination certificate, the Board must be promptly notified.

Upon issuance and publication of the reexamination certificate, the patent owner must notify the administrative patent judge thereof.

2285 Copending *Ex Parte* Reexamination and Reissue Proceedings [R-7]

37 CFR 1.565. *Concurrent office proceedings which include an ex parte reexamination proceeding.*

(d) **>If a reissue application and an *ex parte* reexamination proceeding on which an order pursuant to § 1.525 has been mailed are pending concurrently on a patent, a decision will usually be made to merge the two proceedings or to suspend one of the two proceedings. Where merger of a reissue application and an *ex parte* reexamination proceeding is ordered, the merged examination will be conducted in accordance with §§ 1.171 through 1.179, and the patent owner will be required to place and maintain the same claims in the reissue application and the *ex parte* reexamination proceeding during the pendency of the merged proceeding. The examiner's actions and responses by the patent owner in a merged proceeding will apply to both the reissue application and the *ex parte* reexamination proceeding and will be physically entered into both files. Any *ex parte* reexamination proceeding merged with a reissue application shall be concluded by the grant of the reissued patent. For merger of a reissue application and an *inter partes* reexamination, see § 1.991.<

The general policy of the Office is that a reissue application examination and an *ex parte* reexamination proceeding will not be conducted separately at the same time as to a particular patent. The reason for this policy is to permit timely resolution of both proceedings to the extent possible and to prevent incon-

sistent, and possibly conflicting, amendments from being introduced into the two proceedings on behalf of the patent owner. Accordingly, if both a reissue application and an *ex parte* reexamination proceeding are pending concurrently on a patent, a decision will normally be made (A) to merge the two proceedings or (B) to stay one of the two proceedings. See *In re Onda*, 229 USPQ 235 (Comm'r Pat. 1985). The decision as to whether the proceedings are to be merged, or which proceeding (if any) is to be stayed is made in the Office of Patent Legal Administration (OPLA).

Where a reissue application and a reexamination proceeding are pending concurrently on a patent, the patent owner, i.e., the reissue applicant, has a responsibility to notify the Office of such. 37 CFR 1.178(b), 1.565(a), and 1.985. The patent owner should file in the reissue application, as early as possible, a Notification of Concurrent Proceedings pursuant to 37 CFR 1.178(b) in order to notify the Office in the reissue application of the existence of the reexamination proceeding on the same patent. See MPEP § 1418. In addition, the patent owner should file in the reexamination proceeding, as early as possible, a Notification of Concurrent Proceedings pursuant to 37 CFR 1.565(a) or 1.985 (depending on whether the reexamination proceeding is an *ex parte* reexamination proceeding or an *inter partes* reexamination proceeding) to notify the Office in the reexamination proceeding of the existence of the two concurrent proceedings.

I. TIME FOR MAKING DECISION ON MERGING OR STAYING THE PROCEEDINGS

A decision whether or not to merge the reissue application examination and the *ex parte* reexamination proceeding, or to stay one of the two proceedings, will not be made prior to the mailing of an order to reexamine the patent pursuant to 37 CFR 1.525 >, and the expiration of the statement-reply period following the order to reexamine<. Until such time **, the examination of the reissue application will proceed. A determination on the request must not be delayed because of the existence of a copending reissue application, since 35 U.S.C. 304 and 37 CFR 1.515 *require a determination within 3 months* following the filing date of the request. See MPEP § 2241. If the decision on the request denies reexamination (MPEP § 2247), the examination of the reissue application should be

continued. If reexamination is ordered (MPEP § 2246), the ** Central Reexamination Unit (CRU) >Supervisory Patent Examiner (SPE)< or Technology Center **>Quality Assurance Specialist (QAS)< will await the filing of any statement under 37 CFR 1.530 and any reply under 37 CFR 1.535, or the expiration of the time for same (see MPEP § 2249 to § 2251). Thereafter, **>CRU SPE or TC QAS< should promptly notify the OPLA that the proceedings are ready for consideration of merger. If any of the reexamination file, the reissue application, and the patent file are paper files, they should be hand delivered to the OPLA at the time of the notification to OPLA.

If a reissue application is filed during the pendency of a reexamination proceeding, the OPLA should be notified as promptly as possible after the reissue application reaches the TC, that the proceedings are ready for consideration of merger. If any of the reexamination file, the reissue application, and the patent file are paper files, they should be hand delivered to the OPLA at the time of the notification to OPLA.

The decision on whether or not the proceedings are to be merged, or which proceeding (if any) is to be stayed, will generally be made as promptly as possible after receipt of the notification to OPLA and delivery of all the paper files to the OPLA. Until a decision is mailed merging the proceedings or staying one of the proceedings, the two proceedings will continue and be conducted simultaneously, but separately.

The Office may in certain situations issue a certificate at the termination of a reexamination prosecution, even if a copending reissue application or another reexamination request has already been filed.

II. CONSIDERATIONS IN DECIDING WHETHER TO MERGE THE PROCEEDINGS OR WHETHER TO STAY A PROCEEDING

The decision on whether to merge the proceedings or stay a proceeding will be made on a case-by-case basis based upon the status of the various proceedings. **>The decision to merge, or not to merge, is within the sole discretion of the Office to facilitate/carry out the orderly operation of the Office in addressing the proceedings. The status of the reissue application and the reexamination proceeding will be taken into account in the decision as to whether

merger will be ordered, or one of the two proceedings stayed.<

A. *Reissue About To Issue, Reexamination Requested.*

If the reissue patent will issue before the determination on the reexamination request must be made, the determination on the request should normally be delayed until after the granting of the reissue patent; and then the determination should be made on the basis of the claims *in the reissue patent*. The reexamination, if ordered, would then be on the reissue patent claims rather than the original patent claims. Since the reissue application would no longer be pending, the reexamination would be processed in a normal manner.

Where a reissue patent has been issued, the determination on the request for reexamination should specifically point out that the determination has been made on the claims of the reissue patent and not on the claims of the original patent. Any amendment made in the reexamination proceeding should treat the changes made by the reissue as the text of the patent, and all bracketing and underlining made with respect to the patent **as changed by the reissue**. Note that the reissue claims used as the starting point in the reexamination proceeding must be presented in the reexamination proceeding as a “clean copy.” Thus, words bracketed in the reissue patent claim(s) would not appear at all in the reexamination clean copy of the claim(s). Also, words that were added via the reissue patent will appear in italics in the reissue patent, but must appear in plain format in the reexamination clean copy of the claim(s).

If a reissue patent issues on the patent under reexamination after reexamination is ordered, the next action from the examiner in the reexamination should point out that further proceedings in the reexamination will be based on the claims of the reissue patent and not on the patent surrendered. Form paragraph 22.05 may be used in the Office action.

¶ *22.05 Reexamination (Ex Parte or Inter Partes) Based on Reissue Claims*

In view of the surrender of original Patent No. [1] and the granting of Reissue Patent No. [2] which issued on [3], all subsequent proceedings in this reexamination will be based on the reissue patent claims.

Where the reissue patent has issued prior to the filing of a request for reexamination of the parent patent, see MPEP § 2258.

B. *Reissue Pending, Reexamination Request Filed.*

Where a reissue patent will not be granted prior to the expiration of the 3-month period for making the determination on the reexamination request, a decision will be made as to whether the reissue application and the reexamination proceeding are to be merged, or which of the two (if any) is to be stayed, after an order to reexamine has been issued.

The general policy of the Office is to merge the more narrow reexamination proceeding with the broader reissue application examination whenever it is desirable to do so in the interests of expediting the conduct of both proceedings. In making a decision on whether or not to merge the reissue application and the reexamination proceeding, consideration will be given to the status of the reissue application examination at the time the order to reexamination the patent pursuant to 37 CFR 1.525 is mailed. For example, if examination of the reissue application has not begun, or if a rejection by the primary examiner has not been appealed to the Board of Patent Appeals and Interferences (Board) pursuant to 37 CFR 41.31, it is likely that the OPLA will order a merger of the reissue application examination and the reexamination proceeding. If, however, the reissue application is on appeal to the Board or the courts, that fact would be considered in making a decision whether to merge the reissue application and the reexamination proceeding or stay one of them. See *In re Stoddard*, 213 USPQ 386 (Comm’r Pat. 1982); and *In re Scragg*, 215 USPQ 715 (Comm’r Pat. 1982).

If such a merger of the reissue application and the reexamination proceeding is ordered, the order merging them will also require that the patent owner place the same claims in the reissue application and in the reexamination proceeding for purposes of the merged proceedings. An amendment may be required to be filed to do this within a specified time set in the order merging the proceedings.

If the reissue application examination has progressed to a point where a merger of the two proceedings is not desirable at that time, then the reexamination proceeding will generally be stayed

until the reissue application examination is complete on the issues then pending. After completion of the examination on the issues then pending in the reissue application examination, the stay of the reexamination proceeding will be removed and the proceedings will be merged if the reissue application is pending, or the reexamination proceeding will be conducted separately if the reissue application has become abandoned. The reissue application examination will be reopened, if necessary, for merger of the reexamination proceeding therewith.

If a stay of a reexamination proceeding has been removed following a reissue application examination, the first Office action will set a shortened statutory period for response of 1 month unless a longer period for response clearly is warranted by the nature of the examiner's action. The second Office action will normally be final and also have a 1-month period for response. These shortened periods are considered necessary to prevent undue delay in concluding the proceedings and also to proceed with "special dispatch" in view of the earlier stay.

If the reissue application examination and the reexamination proceeding are merged, the issuance of the reissue patent will also serve as the certificate under 37 CFR 1.570 and the reissue patent will so indicate.

C. Reexamination Proceedings Underway, Reissue Application Filed.

When a reissue application is filed after an *ex parte* reexamination request has been filed, the OPLA should be notified as promptly as possible after the reissue application reaches the TC. A determination will be made as to whether reexamination should be ordered. If reexamination is ordered, no first Office action will accompany the decision ordering reexamination. The order and any of the files that are paper files should then be hand delivered to the OPLA.

Where reexamination has already been ordered prior to the filing of a reissue application, the OPLA should be notified as promptly as possible after the reissue application reaches the TC, that the proceedings are ready for consideration of merger. If any of the reexamination file, the reissue application, and the patent file are paper files, they should be hand delivered to the OPLA at the time of the notification to OPLA.

In making a decision on whether or not to merge the reissue application examination and the reexamination proceeding, consideration will be given as to whether issues are raised in the reissue application that would not be proper for consideration in reexamination. In addition, consideration will also be given to the status of the reexamination proceeding. For example, if the reexamination proceeding is on appeal to the Board or to the Court of Appeals for the Federal Circuit, or a Notice of Intent to Issue a Reexamination Certificate was issued for the reexamination, that fact would be considered in making a decision whether to merge the reissue application examination and the reexamination proceeding or stay one of them.

III. EXAMINER ASSIGNMENT

With respect to the appropriate examiner assignment of the merged reexamination/reissue proceeding, see MPEP § 2236.

IV. CONDUCT OF MERGED REISSUE APPLICATION AND REEXAMINATION PROCEEDING

>Where merger is ordered, the patent owner is required to maintain identical amendments in the reissue application and the reexamination file for purposes of the merged proceeding. The maintenance of identical amendments in both files is required as long as the reissue and reexamination proceedings remain merged. See 37 CFR 1.565(d). Where identical amendments are not present in both files at the time merger is ordered, the patent owner will be required to submit an appropriate "housekeeping" amendment placing the same amendments in both proceedings. This may be accomplished by amending either of the two proceedings (the reissue application or the reexamination) or both of them, as appropriate. The patent owner must not address any issue of patentability in the housekeeping amendment. Amendments in a merged reexamination/reissue proceeding are submitted under 37 CFR 1.173, in accordance with reissue practice.<

Where the merger decision indicates that an Office action will follow, the merged proceeding is returned to the examiner immediately after the decision to issue an Office action. Where the merger decision indicates that the patent owner is given 1 month to provide an amendment to make the claims the same in

each file (identical amendments to be placed in all files), the **>CRU SPE or TC QAS< will retain jurisdiction over the merged reexamination proceeding to await submission of the amendment or the expiration of the time to submit the amendment. After the amendment is received and processed by the technical support staff or the time for submitting the amendment expires, the merged proceeding will be returned to the examiner to issue an Office action.

Once the proceeding is returned to the examiner for issuance of an Office action, the examiner should prepare an Office action at the most advanced point possible for the first proceeding. Thus, if the first proceeding is ready for a final rejection and the second proceeding does not provide any new information which would call for a new ground of rejection, the examiner should issue a final rejection for the merged proceeding.

In the event that *>a “housekeeping”< amendment to make the claims the same in each file is required by the merger decision (identical amendments to be placed in all files) but is not timely submitted, any claim that does not contain identical text in all of the merged proceedings should be rejected under 35 U.S.C. 112, paragraph 2, as being indefinite as to the content of the claim, and thus failing to particularly point out the invention.

If a reissue application examination and a reexamination proceeding are merged, the merged examination will be conducted on the basis of the rules relating to the broader reissue application examination. Amendments should be submitted in accordance with the reissue practice under 37 CFR 1.121(i) and 37 CFR 1.173; see MPEP § 1453. The examiner, in examining the merged proceeding, will apply the reissue statute, rules, and case law to the merged proceeding. This is appropriate in view of the fact that the statutory provisions for reissue applications and reissue application examination include provisions equivalent to 35 U.S.C. 305 relating to the conduct of reexamination proceedings.

In any merged reissue application and reexamination proceeding, each Office action issued by the examiner will take the form of a single action which jointly applies to both the reissue application and the reexamination proceeding. Each action will contain identifying data for both the reissue application and the reexamination proceeding, and each action will be

physically entered into both files, which will be maintained as separate files.

Any response by the applicant/patent owner in such a merged proceeding must consist of a single response, filed in duplicate for entry in both files (or provide multiple copies if there are multiple reexamination proceedings being merged with a reissue application), and service of copy must be made on any third party reexamination requester. A copy of all Office actions will be mailed to the third party reexamination requester but not to any other third party.

If the applicant/patent owner in such a merged proceeding fails to file a timely and appropriate response to any Office action, the merged proceeding will be terminated. The reissue application will be held abandoned. A NIRC will be issued (see MPEP § 2287), and the Director will proceed to issue a reexamination certificate under 37 CFR 1.570 in accordance with the last action of the Office, unless further action is clearly needed in view of the difference in rules relating to reexamination and reissue proceedings.

If the applicant/patent owner in a merged proceeding files an express abandonment of the reissue application pursuant to 37 CFR 1.138, the next Office action of the examiner will accept the express abandonment, dissolve the merged proceeding, and continue the reexamination proceeding. If the applicant/patent owner files a continued prosecution reissue application (a CPA) of a reissue design application under 37 CFR 1.53(d), whereby the existing reissue design application is considered to be expressly abandoned, this will most likely result in the dissolution of the merged proceeding, a stay of the CPA reissue application, and separate, continued prosecution of the reexamination proceeding.

Where the merged proceeding is dissolved based on abandonment of the reissue application and the reexamination proceeding continues, any grounds of rejection which are not applicable under reexamination should be withdrawn (e.g., based on public use or on sale) and any new grounds of rejection which are applicable under reexamination (e.g., improper broadened claims) should be made by the examiner. The existence of any questions remaining which cannot be considered under reexamination following dissolution of the merged proceeding would be noted by the examiner as not being proper under reexamination pursuant to 37 CFR 1.552(c).

Where the merged proceeding is dissolved based on abandonment of the reissue application and the reexamination proceeding continues, there is no guarantee that any continuation reissue application will be merged with the reexamination proceeding (the continuation reissue application might be stayed pending conclusion of the reexamination). This policy is necessary to prevent the patent owner from filing reissue continuation applications to delay a decision by the Board on rejected claims.

If applicant/patent owner files a request for continued examination (RCE) of the reissue application under 37 CFR 1.114 (which may be filed on or after May 29, 2000 for an application filed on or after June 8, 1995), the reissue application is not considered to be expressly abandoned; rather the finality of the Office action is withdrawn, and the merged proceeding will continue. This is so, because an RCE is not an abandonment of any application, whether it be a reissue application or a non-reissue application.

V. PETITION TO MERGE REISSUE APPLICATION AND REEXAMINATION PROCEEDING OR TO STAY EITHER OF THE TWO BECAUSE OF THE EXISTENCE OF THE OTHER

No petition to merge the reissue application and the reexamination proceeding, or stay one of them, should be filed before an order directing reexamination is issued because the Office will generally, *sua sponte*, make a decision to merge the reissue application and the reexamination proceeding or stay one of them. If any petition to merge the reissue application and the reexamination proceeding, or to stay one of them because of the other, is filed prior to the determination (37 CFR 1.515) and order to reexamine (37 CFR 1.525), it will not be considered, but will be returned to the party submitting the same by the CRU or TC Director, regardless of whether the petition is filed in the reexamination proceeding, the reissue application, or both. This is necessary to prevent premature papers relating to the reexamination proceeding from being filed. The decision returning such a premature petition will be made of record in both the reexamination file and the reissue application file, but no copy of the petition will be retained by the Office. See MPEP § 2267.

The patent owner may file a petition under 37 CFR 1.182 to merge the reissue application and the reexamination proceeding, or stay one of them because of the other, at the time the patent owner's statement under 37 CFR 1.530 is filed or subsequent thereto in the event the Office has not acted prior to that date to merge or stay. If the requester of the reexamination is not the patent owner, that party may petition to merge the reissue application and the reexamination proceeding, or stay **>the reexamination proceeding< because of the *> reissue proceeding<, as a part of a reply pursuant to 37 CFR 1.535, in the event the Office has not acted prior to that date to merge or stay. A petition to merge the reissue application and the reexamination proceeding, or stay one of them because of the other, which is filed by a party other than the patent owner or the requester of the reexamination will not be considered, but will be returned to that party by the CRU or TC Director as being improper under 37 CFR 1.550(g).

**>All petitions to merge or stay which are filed by the patent owner or the third party requester subsequent to the date of the order for reexamination will be referred to the OPLA for decision.<

VI. FEES IN MERGED PROCEEDINGS

Where the proceedings have been merged and a paper is filed which requires payment of a fee (e.g., excess claim fee, extension of time fee, petition fee, appeal fee, brief fee, oral hearing fee), only a single fee need be paid. For example, only one fee need be paid for an appeal brief even though the brief relates to merged multiple proceedings and copies must be filed for each file in the merged proceeding. As to excess claim fees, reissue practice will control.

2286 *Ex Parte* Reexamination and Litigation Proceedings [R-7]

37 CFR 1.565. *Concurrent office proceedings which include an ex parte reexamination proceeding.*

(b) If a patent in the process of *ex parte* reexamination is or becomes involved in litigation, the Director shall determine whether or not to suspend the reexamination. See § 1.987 for *inter partes* reexamination proceedings.

35 U.S.C. 302 permits a request for *ex parte* reexamination to be filed “at any time.” Requests for *ex parte* reexamination are frequently filed where the patent for which reexamination is requested is involved in concurrent litigation. The guidelines set forth below will generally govern Office handling of *ex parte* reexamination requests where there is concurrent litigation in the Federal courts.

I. COURT-ORDERED/ SANCTIONED RE-EXAMINATION PROCEEDING, LITIGATION STAYED FOR REEXAMINATION, OR EXTENDED PENDENCY OF REEXAMINATION PROCEEDING CONCURRENT WITH LITIGATION

*Where a request for *ex parte* reexamination * indicates (A) that it is filed as a result of an order by a court or an agreement by parties to litigation which agreement is sanctioned by a court, or (B) that litigation is stayed for the filing of a reexamination request, the request will be taken up by the examiner for decision 6 weeks after the request was filed, and all aspects of the proceeding will be expedited to the extent possible. See MPEP § 2241. If reexamination is ordered, the examination following the statement by the patent owner under 37 CFR 1.530 and the reply by the requester under 37 CFR 1.535 will be expedited to the extent possible. Office actions in these reexamination proceedings will normally set a 1-month shortened statutory period for response rather than the 2 months usually set in reexamination proceedings. See MPEP § 2263. **Response periods may be extended only upon a strong showing of sufficient cause. See MPEP § 2265. Action on such a proceeding will generally take precedence to any other action taken by the examiner. See generally *In re Vamco Machine and Tool, Inc.*, 752 F.2d 1564, 224 USPQ 617 (Fed. Cir. 1985); *Gould v. Control Laser Corp.*, 705 F.2d 1340, 217 USPQ 985 (Fed. Cir. 1983); *Loffland Bros. Co. v. Mid-Western Energy Corp.*, 225 USPQ 886 (W.D. Okla. 1985); *The Toro Co. v. L.R. Nelson Corp.*, 223 USPQ 636 (C.D. Ill. 1984); *Digital Magnetic Systems, Inc. v. Ansley*, 213 USPQ 290 (W.D. Okla. 1982); *Raytek, Inc. v. Solfan Systems Inc.*, 211 USPQ 405 (N.D. Cal. 1981); and *Dresser Industries, Inc. v. Ford Motor Co.*, 211 USPQ 1114 (N.D. Texas 1981).

In addition, if (A) there is litigation concurrent with an *ex parte* reexamination proceeding and (B) the reexamination proceeding has been pending for more than one year, the Director or Deputy Director of the Office of Patent Legal Administration (OPLA), Director of the Central Reexamination Unit (CRU), Director of the Technology Center (TC) in which the reexamination is being conducted, or a Senior Legal Advisor of the OPLA, may approve Office actions in such reexamination proceeding setting a one-month or thirty days, whichever is longer, shortened statutory period for response rather than the two months usually set in reexamination proceedings. A statement at the end of the Office action – “One month or thirty days, whichever is longer, shortened statutory period approved,” followed by the signature of one of these officials, will designate such approval. It is to be noted that the statutory requirement for “special dispatch” in reexamination often becomes important, and sometimes critical, in coordinating the concurrent litigation and reexamination proceedings.

II. FEDERAL COURT DECISION KNOWN TO EXAMINER AT THE TIME THE DETERMINATION ON THE REQUEST FOR REEXAMINATION IS MADE

If a Federal Court decision *on the merits* of a patent is known to the examiner at the time the determination on the request for *ex parte* reexamination is made, the following guidelines will be followed by the examiner, whether or not the person who filed the request was a party to the litigation. When the initial question as to whether the prior art raises a substantial new question of patentability as to a patent claim is under consideration, the existence of a final court decision of claim *validity* in view of the same or different prior art does not necessarily mean that no new question is present. This is true because of the different standards of proof and claim interpretation employed by the District Courts and the Office. See for example *In re Zletz*, 893 F.2d 319, 322, 13 USPQ2d 1320, 1322 (Fed. Cir. 1989) (manner of claim interpretation that is used by courts in litigation is not the manner of claim interpretation that is applicable during prosecution of a pending application before the PTO) and *In re Etter*, 756 F.2d 852, 225 USPQ 1 (Fed. Cir. 1985) (the 35 U.S.C. 282 presumption of patent validity has no application in reex-

amination proceedings). Thus, while the Office may accord deference to factual findings made by the court, the determination of whether a substantial new question of patentability exists will be made independently of the court's decision on validity as it is not controlling on the Office. A *non-final* holding of claim *invalidity* or unenforceability will not be controlling on the question of whether a substantial new question of patentability is present. A final holding of claim invalidity or unenforceability (after all appeals), however, is controlling on the Office. In such cases, a substantial new question of patentability would *not* be present as to the claims held invalid or unenforceable. See *Ethicon v. Quigg*, 849 F.2d 1422, 7 USPQ2d 1152 (Fed. Cir. 1988).

>Note the following two Federal Circuit decisions involving reexamination proceedings where the court affirmed the Office's rejections even though parallel district court proceeding upheld the claims as valid and infringed. *In re Trans Texas Holdings Corp.*, 498 F.3d 1290, 83 USPQ2d 1835 (Fed. Cir. 2007) and *In re Translogic Technology, Inc.*, 504 F.3d 1249, 84 USPQ2d 1929 (Fed. Cir. 2007).

In *Trans Texas*, the patent being reexamined was subject to an infringement suit, in which the district court had issued its claim construction ruling (in a district court opinion) as to the definition of a term. The parties ultimately reached a settlement before trial, and the district court issued an "Order of Dismissal with Prejudice." The patent owner relied on that district court claim construction ruling in a reexamination proceeding, and argued that the Office was bound by that district court claim construction ruling, under the doctrine of issue preclusion. The Federal Circuit stated that issue preclusion could not be applied against the Office based on a district court holding in an infringement proceeding, since the Office was not a party to that earlier infringement proceeding.

In *Translogic*, a district court infringement suit proceeded in parallel with a reexamination proceeding. The district court upheld the validity of the patent in the infringement suit, while the reexamination examiner found the claim combination to be obvious. The examiner's rejection was affirmed by the Board of Patent Appeals and Interferences (Board). The defendant (the alleged infringer) of the infringement suit appealed the district court decision to the Federal Circuit, while the patent owner appealed the Board's

decision to the Federal Circuit. The Federal Circuit consolidated the appeals, and then addressed only the patent owner's reexamination appeal from the Board. The Federal Circuit affirmed the examiner's conclusion of obviousness by relying upon and providing an extensive discussion of *KSR International Co. v. Teleflex Inc.*, 550 U.S.____, 82 USPQ2d 1385 (2007).<

Any determination on a request for reexamination which the examiner makes after a Federal Court decision must be reviewed by the Central Reexamination Unit (CRU) **>Supervisory Patent Examiner (SPE)< to ensure that it conforms to the current Office litigation policy and guidelines. See MPEP § 2240.

For a discussion of the policy in specific situations where a Federal Court decision has been issued, see MPEP § 2242.

III. REEXAMINATION WITH CONCURRENT LITIGATION BUT ORDERED PRIOR TO FEDERAL COURT DECISION

In view of the statutory mandate to make the determination on the request within 3 months, the determination on the request based on the record before the examiner will be made without awaiting a decision by the Federal Court. It is not realistic to attempt to determine what issues will be treated by the Federal Court prior to the court decision. Accordingly, the determination on the request will be made without considering the issues allegedly before the court. If an *ex parte* reexamination is ordered, the reexamination will continue until the Office becomes aware that a court decision has issued. At such time, the request will be reviewed in accordance with the guidelines set forth below. The patent owner is required by 37 CFR 1.565(a) to call the attention of the Office to any prior or concurrent proceeding in which the patent is involved or was involved. Thus, the patent owner has an obligation to promptly notify the Office that a decision has been issued in the Federal Court.

IV. FEDERAL COURT DECISION ISSUES AFTER EX PARTE REEXAMINATION ORDERED

Pursuant to 37 CFR 1.565(a), the patent owner in an *ex parte* reexamination proceeding must promptly notify the Office of any Federal court decision involving the patent. Where the reexamination proceeding is currently pending and the court decision issues, or

the Office becomes aware of a court decision relating to a pending reexamination proceeding, the order to reexamine is reviewed to see if a substantial new question of patentability is still present. If no substantial new question of patentability is still present, the order to reexamine is vacated by the CRU or TC Director and reexamination is concluded.

A *non-final* Federal Court decision concerning a patent under reexamination shall have no binding effect on a reexamination proceeding.

The issuance of a *final* Federal Court decision upholding validity during an *ex parte* reexamination also will have no binding effect on the examination of the reexamination. This is because the court states in *Ethicon v. Quigg*, 849 F.2d 1422, 1428, 7 USPQ2d 1152, 1157 (Fed. Cir. 1988) that the Office is *not* bound by a court's holding of patent *validity* and should continue the reexamination. The court notes that district courts and the Office use different standards of proof in determining invalidity, and thus, on the same evidence, could quite correctly come to different conclusions. Specifically, invalidity in a district court must be shown by "clear and convincing" evidence, whereas in the Office, it is sufficient to show nonpatentability by a "preponderance of evidence." Since the "clear and convincing" standard is harder to satisfy than the "preponderance" standard, deference will ordinarily be accorded to the factual findings of the court where the evidence before the Office and the court is the same. If sufficient reasons are present, claims held valid by the court may be rejected in reexamination.

On the other hand, a *final* Federal Court holding of invalidity or unenforceability (after all appeals), is binding on the Office. Upon the issuance of a final holding of invalidity or unenforceability, the claims being examined which are held invalid or unenforceable will be withdrawn from consideration in the reexamination. The reexamination will continue as to any remaining claims being examined. Thus, the reexamination will continue if any original, new, or amended claim being examined that was not found invalid or unenforceable by the Court. If all of the claims being examined in the reexamination proceeding are finally held invalid or unenforceable, the reexamination will be vacated by the CRU or TC Director as no longer containing a substantial new question of patentability and the reexamination will be concluded.

If not all claims being examined were held invalid (or unenforceable), a substantial new question of patentability may still exist as to the remaining claims. In such a situation, the remaining claims would be examined; and, as to the claims held invalid/unenforceable, form paragraph 22.20 should be used at the beginning of the Office action.

¶ 22.20 *Claims Held Invalid By Court, No Longer Being Reexamined*

Claims [1] of the [2] patent are not being reexamined in view of the final decision of [3]. Claim(s) [1] was/were held invalid/unenforceable by the [4].

Examiner Note:

1. In bracket 1, insert the claim(s) held invalid.
2. In bracket 2, insert the patentee (e.g., Rosenthal, Schor et al).
3. In bracket 3, insert the decision (e.g., *ABC Corp. v. Smith*, 888 F. 3d 88, 999 USPQ2d 99 (Fed. Cir. 1999) or *XYZ Corp. v. Jones*, 888 F. Supp. 2d 88, 999 USPQ2d 1024 (N.D. Cal. 1999)).
4. In bracket 4, insert the name of the court (e.g., the Court of Appeals for the Federal Circuit, or the Federal District Court).

V. LITIGATION REVIEW AND *APPROVAL

In order to ensure that the Office is aware of prior or concurrent litigation, the examiner is responsible for conducting a reasonable investigation for evidence as to whether the patent for which *ex parte* reexamination is requested has been or is involved in litigation. The investigation will include a review of the reexamination file, the patent file, and the results of the litigation computer search by the STIC.

If the examiner discovers, *at any time* during the reexamination proceeding, that there is litigation or that there has been a federal court decision on the patent, the fact will be brought to the attention of the CRU **>**SPE or Technology Center (TC) Quality Assurance Specialist (QAS)**<** prior to any further action by the examiner. The **>**CRU SPE or TC QAS**<** must review any action taken by the examiner in such circumstances to ensure current Office litigation policy is being followed.

VI. FEDERAL COURT DECISION CONTROLLING IN REEXAMINATION PROCEEDING

Once a federal court has ruled upon the merits of a patent and an *ex parte* reexamination is still appropriate under the guidelines set forth above, the federal court decision will be considered controlling and will

be followed as to claims finally held to be invalid by the court.

2287 Conclusion of *Ex Parte* Reexamination Proceeding [R-7]

Upon conclusion of the *ex parte* reexamination proceeding, the examiner must prepare a “Notice of Intent to Issue *Ex Parte* Reexamination Certificate” (NIRC) by completing form PTOL-469. If appropriate, an examiner’s amendment will also be prepared. Where claims are found patentable, reasons must be given for each claim found patentable. See the discussion as to preparation of an examiner’s amendment and reasons for allowance at the end of this section. In addition, the examiner must prepare the reexamination file so that the Office of *>Data Management< can prepare and issue a certificate in accordance with 35 U.S.C. 307 and 37 CFR 1.570 setting forth the results of the reexamination proceeding and the content of the patent following the proceeding. See MPEP § 2288.

**>The examiner will so inform his/her Central Reexamination Unit (CRU) Supervisory Patent Examiner (SPE) or Technology Center (TC) Quality Assurance Specialist (QAS) of the conclusion of the reexamination proceeding. The CRU SPE/TC QAS< will convene a panel review conference (see MPEP § 2271.01), and the conference members will review the patentability of the claim(s). If the conference confirms the **>examiner’s decision<, a NIRC shall be issued and signed by the examiner, with the two other conferees initialing the NIRC (as “conferee”) to indicate their participation in the conference. Both conferees will initial, even though one of them may have dissented from the 3-party conference decision on the patentability of the claim(s). If the conference does not confirm the patentability of the claim(s), the examiner will reevaluate and issue an appropriate Office action rejecting the claim(s), not confirmed as patentable.

A panel review conference is not to be held as to any claim that was in the case (proceeding) at the time the case was reviewed by the Board of Patent Appeals and Interferences (Board) or a federal court. The following example will serve to illustrate this point. In a reexamination proceeding, claims 5-10 are allowed by the examiner, and claims 1-4 are rejected. The rejection of claims 1-4 is then appealed to the Board. The

Board reverses the rejection of claims 1-4 and imposes a new ground of rejection of claims 1-4 under 37 CFR 41.50(b). The patent owner then elects further prosecution before the examiner pursuant to 37 CFR 41.50(b)(1) and submits an amended set of claims 1-4. The examiner finds amended claims 1-4 to be allowable and wishes to “allow” the entire case by issuing a NIRC. A panel review conference must be held at this stage of the proceeding. The conferees will review the allowance of amended claims 1-4. The conferees will not, however, review the allowance of claims 5-10, because claims 5-10 were in the case, and before the Board at the time the Board decided the appeal.

A panel review conference is not to be held where the proceeding is to be concluded by the cancellation of all claims. No panel review conference is needed in this instance, as the issuance of the NIRC is essentially ministerial.

Thus, a panel review conference **must** be held in each instance where a NIRC is about to be issued, unless the NIRC is being issued: (A) following and consistent with a decision by the Board of Patent Appeals and Interferences (or court) on the merits of the proceeding; or (B) as a consequence of the patent owner’s failure to respond or take other action where such a response or action is necessary to maintain pendency of the proceeding and, as a result of which failure to respond, all of the claims will be canceled.

A NIRC informs the patent owner and any third party requester that the reexamination prosecution has been terminated. The rules do not provide for an amendment to be filed in a reexamination proceeding after prosecution has been terminated. The provisions of 37 CFR 1.312 do *not* apply in reexamination. Any amendment, information disclosure statement, or other paper related to the merits of the reexamination proceeding filed after prosecution has been terminated must be accompanied by a petition under 37 CFR 1.182 to have the amendment considered.

Normally the title of the invention will not need to be changed during reexamination. If a change of the title is necessary, the patent owner should be notified of the need to provide an amendment changing the title as early as possible in the prosecution as a part of an Office action. If all of the claims are found to be patentable and a NIRC has been or is to be mailed, the examiner may change to the title of the invention

only by an examiner's amendment. Changing the title and merely initialing the change is *not* permitted in reexamination.

An examiner's amendment can be made to change the abstract, where the patent owner's narrowing amendments during the prosecution of the reexamination have changed the focus of the invention. An example of this would be where a claim is made more specific during reexamination, and the abstract does not at all focus on the specific limitation that is now required for all the patent claims.

If all of the claims are disclaimed in a patent under reexamination, a certificate under 37 CFR 1.570 will be issued indicating that fact.

I. PREPARATION OF THE CASE FOR PUBLICATION

In preparing the reexamination file for publication of the certificate, the examiner must review the reexamination and patent files (IFW and paper files) to be sure that all the appropriate parts are completed. The review should include completion of the following items:

(A) The IFW file wrapper Search Notes form — The "SEARCHED" and the "SEARCH NOTES" boxes are to be filled in with the classes and subclasses that were actually searched and other areas consulted. See MPEP § 719.05.

(B) The IFW file jacket form — Check to be sure that the necessary data is included thereon. The "Litigation Review" and "Copending Office Proceedings" boxes should be completed to ensure that the Office is aware of prior or concurrent litigation and Office proceedings.

(C) The Bibliographic Data Sheet — Check to be sure that the data included thereon is correct and the blank spaces have been initialed.

(D) The Issue Classification IFW form — The form must be completed to set forth the status of each claim and the final claim numbers. The appropriate information must be included in the "Issue Classification" box. The current international classification and U.S. classification must be inserted for both the original classification and all cross-references. Completion of the Issue Classification box is required, even if all of the claims are canceled.

An appropriate drawing figure is to be indicated for printing on the certificate cover sheet and in the

Official Gazette. In addition, a representative claim which has been reexamined is to be indicated for publication in the *Official Gazette*. The claim or claims for the *Official Gazette* should be selected in accordance with the following instructions:

(A) The broadest claim should be selected;

(B) Examiners should ordinarily designate but one claim on each invention, although when a plurality of inventions are claimed in one application, additional claims up to a maximum of five may be designated for publication. In the case of reexamination, the examiner must select only one claim;

(C) A dependent claim should not be selected unless the independent claim from which it depends is also printed. In the case where a multiple dependent claim is selected, the entire chain of claims for one embodiment should be listed. In the case of reexamination, a dependent patent claim may be selected where the independent original patent claim has been canceled; in such a case, the dependent claim would be printed while the independent claim would not be printed; and

(D) In reissue applications, the broadest claim with changes or the broadest additional reissue claim should be selected for printing.

When recording this information in the box provided, the following items should be kept in mind:

(A) Write the claim number clearly in black ink;

(B) If multiple claims are selected, the claim numbers should be separated by commas; and

(C) The claim designated must be referred to by using the renumbered patent claim number rather than the original application claim number.

If the patent owner desires the names of the attorneys or agents, or law firm, to be printed on the certificate, a separate paper limited to this issue which lists the names and positively states that they should be printed on the certificate must be filed. A mere power of attorney or change of address is not a request that the name appear on the certificate.

The examiner must also complete a checklist, form PTO-1516, for the reexamination file which will be forwarded to the Office of *>Data Management< identifying information used in printing the reexamination certificate. A copy of this form may be

obtained from the **>CRU SPE or TC QAS or their support staff<.

The examiner should inspect the title report, or patent abstract of title, in the file. If the title report, or patent abstract of title, indicates a title in the inventors, but the patent copy shows an assignment to an assignee, a telephone call can be made to the patent owner, and the patent owner can be asked to submit a statement under 37 CFR 3.73(b) indicating that title is in the assignee (i.e., it has not reverted back to the inventors). See MPEP § 320.

After the examiner has prepared the NIRC and attachments for mailing, completed the review and preparation of the case as discussed above, and completed the Examiner Checklist form PTOL-1516, the reexamination and patent files will be given to the reexamination clerk. The reexamination clerk will complete the Reexamination Clerk Checklist form PTO-1517. The reexamination clerk will revise and update the files. The clerk should check to see if any changes in especially:

- (A) the title;
- (B) the inventor;
- (C) the assignee;
- (D) the continuing data;
- (E) the foreign priority;
- (F) the address of the owner's attorney; and
- (G) the requester's address

have been properly entered in the reexamination and patent files (in the file history of an IFW file and on the face of a paper file) and properly entered in the PALM data base. After the clerk has finished his/her processing, he or she will forward the reexamination proceeding to the **>CRU SPE or TC QAS< for review. After approval by the **>CRU SPE or TC QAS<, the reexamination clerk will mail the NIRC with attachments and forward the reexamination proceeding to the OPLA (see MPEP § 2289), which will ultimately forward same to the Office of *>Data Management< for printing.

II. REEXAMINATION PROCEEDINGS IN WHICH ALL THE CLAIMS ARE CANCELED

There will be instances where all claims in the reexamination proceeding are to be canceled, and a NIRC will be issued indicating that fact. This would occur

where the patent owner fails to timely respond to an Office action, and all live claims in the reexamination proceeding are under rejection. It would also occur where all live claims in the reexamination proceeding are to be canceled as a result of a Board decision affirming the examiner, and the time for appeal to the court and for requesting reconsideration or modification has expired.

Prior to canceling the claims and issuing the NIRC, the examiner should telephone the patent owner to inquire if a timely response, timely appeal, etc., was filed with the Office so as to make certain that a timely response has not been misdirected within the Office. Where the patent owner indicates that no such filing was made, or where the patent owner cannot be reached, the examiner will proceed to issue a NIRC terminating prosecution.

A panel review conference is not to be held, because the proceeding is to be concluded by the cancellation of all claims. Rather, the examiner will issue a NIRC action, and as an attachment to the NIRC, the examiner will draft an examiner's amendment canceling all live claims in the reexamination proceeding. In the examiner's amendment, the examiner should point out why the claims have been canceled. For example, the examiner might make one of the two following statements, as appropriate:

"Claims 1-5 and 6-8 (all live claims in the proceeding) were subject to rejection in the last Office action mailed 9/9/99. Patent owner failed to timely respond to that Office action. Accordingly claims 1-5 and 6-8 have been canceled. See 37 CFR 1.550(d) and MPEP § 2266."

"The rejection of claims 1-5 and 6-8 (all live claims in the proceeding) has been affirmed in the Board decision of 9/9/99, and no timely appeal to the court has been filed. Accordingly claims 1-5 and 6-8 have been canceled."

If the patent owner was reached by telephone and indicated that there was no timely filing (as discussed above), the attachment to the NIRC will make the telephone interview of record.

In order to physically cancel the live claims in the file history, brackets should be placed around all the live claims on a copy of the claims printed from the file history, and the copy then scanned into the IFW file history. All other claims in the proceeding should have previously been either replaced or canceled.

The examiner will designate a cancelled original patent claim, to be printed in the *Official Gazette*, on

the Issue Classification IFW form in the appropriate place for the claim chosen.

III. HANDLING OF MULTIPLE DEPENDENT CLAIMS

The following discussion provides guidance on how to treat multiple dependent claims when preparing a reexamination proceeding for publication of the reexamination certificate.

Assume Patent X issues with the following claims:
Patent claims:

1. A method of sintering a particulate ceramic preform, comprising heating it above 500 degrees F, cooling it to 100 degrees F, and repeating the heating and cooling steps six times.
2. The method of **claim 1**, where a pressure of 300 - 400 psi is applied during the heating steps.
3. The method of **claim 1 or claim 2**, where the pressure applied during the heating steps is 350 - 375 psi.
4. The method of **claim 3**, where the pressure applied during the heating steps is 360 - 365 psi.
5. The method of **claim 1**, where the preform contains lithium and magnesium oxides.
6. The method of **claim 5**, where the preform contains sodium fluoride.
7. The method of **claim 1 or claim 5**, where the sintered preform is machined into a lens.

A reexamination request is then filed for Patent X, and at the point when the claims are ready for issuance of the certificate, the following claims are present in the reexamination file.

In reexamination:

1. (Text Unchanged) A method of sintering a particulate ceramic preform, comprising heating it above 500 degrees F, cooling it to 100 degrees F, and repeating the heating and cooling steps six times.
2. (Amended) The method of **claim 1 or claim 8**, where the sintered preform is machined into a lens.
3. (Amended) The method of [**claim 1 or**] **claim 2**, where the pressure applied during the heating steps is 350 - 375 psi.
4. (Amended) The method of **claim 3 or claim 8**, where the pressure applied during the heating steps is 355 [360] - 365 psi.

5. (Text Unchanged) The method of **claim 1**, where the preform contains lithium and magnesium oxides.

6. (Amended) The method of **claim 8[5]**, where the preform contains sodium fluoride.

7. (Text Unchanged) The method of **claim 1 or claim 5**, where the sintered preform is machined into a lens.

8. (New) A method of sintering a particulate fluoride ceramic preform comprising heating it above 500 degrees F, cooling it to 100 degrees F, and repeating the heating and cooling steps six times.

The status of the claims would be set forth as follows:

Part 1(h) of the Notice of Intent to Issue *Ex Parte* Reexamination Certificate Form PTOL-469 (NIRC) would be completed as follows.

Patent claims confirmed: 1, 2/1, 5, 7

Patent claims amended: 3, 4/3,

Patent claims canceled: 3/1, 6/5

New claims patentable: 2/8, 4/8, 6/8, 8

The parts of the Examiner's checklist (Form PTO-1516) directed to the status of the claims would be completed as follows.

7. Patent claims confirmed: 1, 5, 7

11. Patent claims canceled: None

12. Patent claims amended: 2, 3, 4 and 6

13. Patent claims dependent on amended: None

14. New claims patentable: 8

Looking at claim 2:

For the purpose of the NIRC, the addition of a claim of the multiple dependency is viewed as adding a new claim for which protection is now to be provided. Thus, prior to reexamination, only the subject matter of claim 2/1 was protected. As a result of reexamination, claim 2/8 has been added, and its subject matter is now protected. Thus, claim 2/8 is designated as a new claim. Claim 2/1 has not changed as to its content and its scope of protection, and is designated as a confirmed claim.

For the purpose of the Examiner's checklist, the addition or deletion of a claim of the multiple dependency is viewed simply as amending the claim,

because of the way claims are printed on the certificate. Thus, claim 2 is designated as an amended claim and is simply printed on the certificate in its amended form as:

2. The method of claim 1 or claim 8, where the sintered preform is machined into a lens.

Looking at claim 3:

For the purpose of the NIRC, the deletion of a claim of the multiple dependency is viewed as canceling the claim deleted, and protection is no longer provided for the claim as dependent from the deleted claim. Thus, prior to reexamination, the subject matter of claims 3/1 and 3/2 was protected. As a result of reexamination, claim 3/1 has been deleted, and its subject matter is no longer protected. Thus, claim 3/1 is designated as a canceled claim. Claim 3/2 has not changed as to its content and its scope of protection, and is designated as a confirmed claim.

For the purpose of the Examiner's checklist, the addition or deletion of a claim of the multiple dependency is viewed simply as amending the claim, because of the way claims are printed on the certificate. Thus, claim 3 is designated as an amended claim and is simply printed on the certificate in its amended form as:

3. The method of [claim 1 or] claim 2, where the pressure applied during the heating steps is 350 - 375 psi.

Looking at claim 4:

For the purpose of the NIRC, the addition of a claim of the multiple dependency is viewed as adding a new claim for which protection is now to be provided. Thus, prior to reexamination, only the subject matter of claim 4/3 was protected. As a result of reexamination, claim 4/8 has been added, and its subject matter is now protected. Thus, claim 4/8 is designated as a new claim. Claim 4/3 has changed as to its content and its scope of protection due to the expanding of the pressure range from 360 - 365 psi to 355 - 365 psi, and claim 4/3 is designated as an amended claim.

For the purpose of the Examiner's checklist, the addition or deletion of a claim of the multiple dependency is viewed simply as amending the claim, because of the way claims are printed on the

certificate. Thus, claim 4 is designated as an amended claim and simply printed on the certificate in its amended form as:

4. (Amended) The method of claim 3 or claim 8, where the pressure applied during the heating steps is 355 [360] - 365 psi.

Looking at claim 6:

For the purpose of the NIRC, prior to reexamination, the subject matter of claim 6/5 was protected and claim 6/8 did not exist. As a result of reexamination, claim 6/5 has been deleted and claim 6/8 has been added. Thus, claim 6/5 is designated as a canceled claim, and claim 6/8 is designated as a new claim.

For the Examiner's checklist, claim 6 is designated as an amended claim and is simply printed on the certificate in its amended form as:

6. (Amended) The method of claim 8 [5], where the preform contains sodium fluoride.

Looking at claim 7:

It is unchanged as to its text. Claim 7 remains dependent on claim 1 or claim 5, as it did prior to reexamination. Thus, both claims 7/1 and 7/5 are confirmed. Claims 7/1 and 7/5 are listed in the "Confirmed" part of the NIRC. They are not listed separately, but rather simply as "7." This is because the entirety of claim 7 has been confirmed.

As to the Examiner's checklist, claim 7, being unchanged as to its text and not being dependent on an amended claim, is simply listed in the "Confirmed" part of the checklist. Claim 7 will not be printed on the certificate, but will simply be listed as one of the confirmed claims.

IV. REEXAMINATION REMINDERS

The following items deserve special attention. The examiner should ensure they have been correctly completed or followed before forwarding the case to the Legal Instrument Examiner (LIE).

(A) All patent claims for which a substantial new question of patentability has been found must have been examined. See MPEP § 2243.

(B) No renumbering of patent claims is permitted. New claims may require renumbering. See MPEP § 2250.

(C) All amendments to the description and claims must conform to requirements of 37 CFR 1.530(d)-(j). This includes any changes made by Examiner's Amendment. If a portion of the text is amended more than once, each amendment should indicate all of the changes (insertions and deletions) in relation to the current text in the patent under reexamination. See MPEP § 2250.

(D) The prior art must be listed on a form PTO 892, PTO/SB/08A or 08B, or PTO/SB/42 (or on a form having a format equivalent to one of these forms). These forms must be properly completed. See MPEP § 2257.

(E) The examiner and reexamination clerk checklists PTO-1516 and PTO-1517 must be *entirely* and *properly* completed. A careful reading of the instructions contained in these checklists is essential. The clerical checklist is designed as a check and review of the examiner's responses on the examiner checklist. Accordingly, the reexamination clerk should personally review the file before completing an item. The reexamination clerk should check to make certain that the responses to all related items on both checklists are in agreement.

(F) Multiple pending reexamination proceedings are often merged. See MPEP § 2283.

(G) Where the reexamination proceeding is copending with an application for reissue of the patent being reexamined, the files must have been forwarded to the Office of Patent Legal Administration (OPLA) for a consideration of potential merger, with a decision (by a Senior Legal Advisor or Special Projects Examiner) on the question being present in the reexamination file. See MPEP § 2285.

(H) Reasons for patentability and/or confirmation are required for each claim found patentable. See below.

(I) There is no issue fee in reexamination. See MPEP § 2233.

(J) The patent claims may not be amended nor new claims added after expiration of the patent. See MPEP § 2250.

(K) Original drawings cannot be physically changed. All drawing amendments must be presented on new sheets. The examiner may have the draftsman review the new sheets of drawings if the examiner would like the draftsman's assistance in identifying errors in the drawings. A draftsman's "stamp" to

indicate approval is no longer required on patent drawings, and these stamps are no longer to be used by draftspersons. See MPEP § 2250.01.

(L) An amended or new claim may not enlarge the scope of the patent claims. See MPEP § 2250.

(M) If the patent has expired, all amendments to the patent claims and all claims added during the proceeding must be withdrawn. Further, all presently rejected and objected-to claims are canceled by examiner's amendment. See MPEP § 2250, subsection III, Amendment after the Patent Has Expired.

V. EXAMINER'S AMENDMENT

Where it is necessary to amend the patent in order to place the proceeding in condition to issuance of a reexamination certificate, the examiner may request that the patent owner provide the amendment(s), or the examiner may make the amendments, with the patent owner's approval, by a formal examiner's amendment. If the changes are made by an examiner's amendment, the examiner's amendment must comply with the requirements of 37 CFR 1.530(d)-(j) in amending the patent. Thus, the examiner's amendment requires presentation of the full text of any paragraph or claim to be changed, with the 37 CFR 1.530(f) markings. The exception for examiner's amendments set forth in 37 CFR 1.121(g) does not apply to examiner's amendments in reexamination proceedings. See MPEP § 2250. The only **exception** to the full text presentation requirement is that an entire claim or an entire paragraph of specification may be deleted from the patent by a statement deleting the claim or paragraph without the presentation of the text of the claim or paragraph.

>If a patent expires during the pendency of a reexamination proceeding for that patent, all amendments to the patent claims and all claims added during the proceeding must be withdrawn. The examiner's amendment is to include a statement such as:

"As the patent being reexamined has expired during the pendency of the present reexamination proceeding, all amendments made during the proceeding are improper, and are hereby expressly withdrawn."

If it has not previously been done in the proceeding, a diagonal line should be drawn across a copy of all amended and new claims (and text added to the specification) residing in the amendment papers, and scanned into the IFW. <

Where an examiner's amendment is prepared, Box 7 of form PTOL-469 (Notice of Intent to Issue *Ex Parte* Reexamination Certificate) is checked, and form paragraph 22.06 is used to provide the appropriate attachments.

¶ 22.06 *Examiner's Amendment Accompanying Notice of Intent To Issue Ex Parte Reexamination Certificate*

An examiner's amendment to the record appears below. The changes made by this examiner's amendment will be reflected in the reexamination certificate to issue in due course.

[1]

VI. REASONS FOR PATENTABILITY AND/OR CONFIRMATION

Reasons for patentability must be provided, unless all claims are canceled in the proceeding. Box 2 of form PTOL-469 is checked, and the reasons are provided as an attachment. In the attachment to the NIRC, the examiner should indicate why the claims found patentable in the reexamination proceeding are clearly patentable over the cited patents or printed publications. This is done in a manner similar to that used to indicate reasons for allowance in an application. See MPEP § 1302.14. Where the record is clear as to why a claim is patentable, the examiner may refer to the particular portions of the record which clearly establish the patentability of that claim.

The reasons for patentability may be set forth on form PTOL-476, entitled "REASONS FOR PATENTABILITY AND/OR CONFIRMATION." However, as a preferred alternative to using form PTOL-476, the examiner may instead use form paragraph 22.16.

¶ 22.16 *Reasons For Patentability and/or Confirmation*

STATEMENT OF REASONS FOR PATENTABILITY AND/OR CONFIRMATION

The following is an examiner's statement of reasons for patentability and/or confirmation of the claims found patentable in this reexamination proceeding: [1]

Any comments considered necessary by PATENT OWNER regarding the above statement must be submitted promptly to avoid processing delays. Such submission by the patent owner should be labeled: "Comments on Statement of Reasons for Patentability and/or Confirmation" and will be placed in the reexamination file.

Examiner Note:

This form paragraph may be used as an attachment to the Notice of Intent to Issue *Ex Parte* Reexamination Certificate, PTOL-469 (item number 2).

Original patent claims that are found patentable in a reexamination proceeding are generally to be designated as "confirmed" claims, while new claims and amended patent claims are generally to be designated as "patentable" claims. However, for purposes of the examiner setting forth reasons for patentability or confirmation, the examiner may use "patentable" to refer to any claim that defines over the cited patents or printed publications. There is no need to separate the claims into "confirmed" and "patentable" categories when setting forth the reasons.

Obviously, where all claims are canceled in the proceeding, no reasons for patentability are provided.

Any "Comments on Statement of Reasons for Patentability and/or Confirmation" which are received will be placed in the reexamination file, without comment. This will be done even where the reexamination certificate has already issued.

>

2287.01 Examiner Consideration of Submissions After a NIRC [R-7]

The rules do not provide for an amendment to be filed in a reexamination proceeding after a Notice of Intent to Issue *Ex Parte* Reexamination Certificate (NIRC) has been issued. Note that 37 CFR 1.312 does not apply in a reexamination proceeding. Any amendment, information disclosure statement, or other paper related to the merits of the reexamination proceeding filed after the NIRC must be accompanied by a petition under 37 CFR 1.182. The petition must be granted, in order to have the amendment, information disclosure statement, or other paper related to the merits considered. Where an amendment, information disclosure statement, or other paper related to the merits of the reexamination proceeding is filed after the NIRC, and the accompanying petition under 37 CFR 1.182 is granted, the examiner will reconsider the case in view of the new information, and if appropriate, will reopen prosecution. See MPEP § 2256 for a detailed discussion of the criteria for obtaining entry and consideration of an information disclosure statement filed after a NIRC.

Any "Comments on Statement of Reasons for Patentability and/or Confirmation" which are received will be placed in the reexamination file, without comment. This will be done even where the reexamination certificate has already issued.<

2288 Issuance of *Ex Parte* Reexamination Certificate [R-7]

35 U.S.C. 307. *Certificate of patentability, unpatentability, and claim cancellation.*

(a) In a reexamination proceeding under this chapter, when the time for appeal has expired or any appeal proceeding has terminated, the Director will issue and publish a certificate canceling any claim of the patent finally determined to be unpatentable, confirming any claim of the patent determined to be patentable, and incorporating in the patent any proposed amended or new claim determined to be patentable.

37 CFR 1.570. ***>Issuance and publication of ex parte reexamination certificate concludes ex parte reexamination proceeding.*

(a) To conclude an *ex parte* reexamination proceeding, the Director will issue and publish an *ex parte* reexamination certificate in accordance with 35 U.S.C. 307 setting forth the results of the *ex parte* reexamination proceeding and the content of the patent following the *ex parte* reexamination proceeding.

(b) An *ex parte* reexamination certificate will be issued and published in each patent in which an *ex parte* reexamination proceeding has been ordered under § 1.525 and has not been merged with any *inter partes* reexamination proceeding pursuant to § 1.989(a). Any statutory disclaimer filed by the patent owner will be made part of the *ex parte* reexamination certificate.<

(c) The *ex parte* reexamination certificate will be mailed on the day of its date to the patent owner at the address as provided for in § 1.33(c). A copy of the *ex parte* reexamination certificate will also be mailed to the requester of the *ex parte* reexamination proceeding.

(d) ***>If an ex parte reexamination certificate has been issued and published which cancels all of the claims of the patent, no further Office proceedings will be conducted with that patent or any reissue applications or any reexamination requests relating thereto.<*

(e) If the *ex parte* reexamination proceeding is terminated by the grant of a reissued patent as provided in § 1.565(d), the reissued patent will constitute the *ex parte* reexamination certificate required by this section and 35 U.S.C. 307.

(f) A notice of the issuance of each *ex parte* reexamination certificate under this section will be published in the *Official Gazette* on its date of issuance.

Since abandonment is not possible in a reexamination proceeding, a reexamination certificate will be issued >and published< at the conclusion of the proceeding in each patent in which a reexamination proceeding has been ordered under 37 CFR 1.525 except where the reexamination has been concluded by vacating the reexamination proceeding or by the grant of a reissue patent on the same patent in which case

the reissue patent also serves as the reexamination certificate.

Where the reexamination is to be concluded for a failure to timely respond to an Office action, see MPEP § 2266.

The reexamination certificate will set forth the results of the proceeding and the content of the patent following the reexamination proceeding. The certificate will:

(A) cancel any patent claims determined to be unpatentable;

(B) confirm any patent claims determined to be patentable;

(C) incorporate into the patent any amended or new claims determined to be patentable;

(D) make any changes in the description approved during reexamination;

(E) include any statutory disclaimer or terminal disclaimer filed by the patent owner;

(F) identify unamended claims which were held invalid on final holding by another forum on any grounds;

(G) identify any patent claims not reexamined;

(H) be mailed on the day it is dated to the patent owner at the address provided for in 37 CFR 1.33(c) and a copy will be mailed to the third party requester; and

(I) identify patent claims, dependent on amended claims, determined to be patentable.

If a certificate issues >and publishes< which cancels all of the claims of the patent, no further Office proceedings will be conducted with regard to that patent or any reissue application or reexamination request directed thereto. >However, in an extremely rare situation in which a reissue application is copending with a reexamination proceeding in which a reexamination certificate subsequently issues cancelling all claims of the patent, the patent owner may file a petition under 37 CFR 1.183 requesting waiver of the provisions of 37 CFR 1.570(d), to address claims that were pending in the reissue application prior to the issuance of the certificate. Any such petition must be accompanied by a paper cancelling any claim within the scope of the claims canceled by the certificate and pointing out why the claims remaining in the reissue application can be patentable, despite the cancellation of all the patent claims by certificate, i.e., why the

remaining claims are patentable over the cancelled claims. Such a paper will be available to the examiner, should the petition be granted. See 37 CFR 1.570(d).

If a reexamination proceeding is concluded by the grant of a reissued patent as provided for in 37 CFR 1.565(b), the reissued patent will constitute the reexamination certificate required by 35 U.S.C. 307 and this section. See 37 CFR 1.570(e).

A notice of the issuance of each reexamination certificate will be published in the *Official Gazette* on its date of issuance in a format similar to that used for reissue patents. See 37 CFR 1.570(f) and MPEP § 2291.

2289 Reexamination Review [R-7]

All reexamination cases are monitored and reviewed in the Central Reexamination Unit (CRU) or Technology Center (TC) by the CRU Supervisory Patent Examiner (SPE) or TC Quality Assurance Specialist (QAS), paralegal or other technical support who might be assigned as backup at several stages during the prosecution. This is done to ensure that practice and procedure unique to reexamination has been carried out for the reexamination proceeding. In addition to the CRU SPE or TC QAS review of the reexamination cases, a panel review is made prior to issuing Office actions as set forth in MPEP § 2271.01.

After a Notice of Intent to Issue *Ex Parte* Reexamination Certification (NIRC) has been issued and prosecution has been terminated, all reexamination cases go through a screening process currently performed in the Office of Patent Legal Administration (OPLA) for obvious errors and proper preparation in order to issue a reexamination certificate.

The above identified review processes are appropriate vehicles for correcting errors, identifying problem areas and recognizing trends, providing information on the uniformity of practice, and providing feedback to the Office personnel that process and examine reexamination cases.

2290 Format of *Ex Parte* Reexamination Certificate [R-5]

An *ex parte* reexamination certificate is issued at the close of each *ex parte* reexamination proceeding

in which reexamination has been ordered under 37 CFR 1.525, except for the following two cases:

(A) The *ex parte* reexamination proceeding is merged with a reissue application pursuant to 37 CFR 1.565(d). If the *ex parte* reexamination proceeding is concluded by the grant of a reissue patent, the reissue patent will constitute the reexamination certificate;

(B) The *ex parte* reexamination proceeding is merged with an *inter partes* reexamination proceeding pursuant to 37 CFR 1.989(a). If the *ex parte* reexamination proceeding is to be concluded as part of a merged proceeding containing an *inter partes* reexamination proceeding, a single reexamination certificate will issue for both proceedings; see MPEP § 2690.

The *ex parte* reexamination certificate is formatted much the same as the title page of current U.S. patents.

The certificate is titled “*Ex Parte* Reexamination Certificate.” The title is followed by an “ordinal” number in parentheses, such as “(235th),” which indicates that it is the two hundred and thirty fifth *ex parte* reexamination certificate that has issued. *Inter partes* reexamination certificates are numbered in a separate and new ordinal sequence, beginning with “(1st).” *Ex parte* reexamination certificates continue the ordinal numbering sequence that has already been established for *ex parte* reexamination certificates.

The *ex parte* reexamination certificate number will always be the patent number of the original patent followed by a two-character “kind code” suffix. The first letter of the “kind code” suffix is “B” for reexamination certificates published prior to January 2, 2001, and “C” for reexamination certificates published on or after January 2, 2001. The second letter of the “kind code” suffix is the number of the reexamination proceeding of that patent, and thus shows how many times that patent has been reexamined.

Note that where the first reexamination certificate was a “B1” certificate and a second reexamination certificate then issues, the second reexamination certificate will be designated “C2” and NOT “C1.” Thus, by looking at the number following the “C,” one will be able to ascertain the number of reexamination certificates that preceded the certificate being viewed, i.e., how many prior reexamination certificates have been issued for the patent. (If this were not the practice and C1 were used, one would not be able to ascer-

tain from the number on the certificate how many B certificates came before.)

It should also be noted that the next higher number will be given to the reexamination proceeding for which the reexamination certificate is issued, regardless of whether the proceeding is an *ex parte* reexamination or an *inter partes* reexamination proceeding.

See MPEP § 901.04(a) for a complete list of the kind codes used by the United States Patent and Trademark Office.

The certificate denotes the date the certificate was issued at INID code [45] (see MPEP § 901.04). The title, name of inventor, international and U.S. classification, the abstract, and the list of prior art documents appear at their respective INID code designations, much the same as is presently done in utility patents.

The primary differences, other than as indicated above, are:

(A) the filing date and number of the request is preceded by “Reexamination Request;”

(B) the patent for which the certification is now issued is identified under the heading “Reexamination Certificate for”; and

(C) the prior art documents cited at INID code [56] will be only those which are part of the reexamination file and cited on forms ** PTO/SB/08A or 08B, or PTO/SB/42 (or on a form having a format equivalent to one of these forms) (and the documents have not been crossed out because they were not considered) and PTO-892.

Finally, the certificate will identify the patent claims which were confirmed as patentable, canceled, disclaimed, and those claims not examined. Only the status of the confirmed, canceled, disclaimed, and not examined claims will be indicated in the certificate. The text of the new and amended claims will be printed in the certificate. Any new claims will be printed in the certificate completely in italics, and any amended claims will be printed in the certificate with italics and bracketing indicating the amendments thereto. Any prior court decisions will be identified, as well as the citation of the court decisions.

REEXAMINATION CERTIFICATE (24th)

United States Patent [19]

[11] **B1 4,182,460**

Holk, Jr. et al.

[45] **Certificate Issued Oct. 19, 1982**

[54] **LEVER ACTION TAB SYSTEM FOR EASY OPENING ENDS**

[56] **References Cited**

[75] **Inventors:** Albert J. Holk, Jr., Frankfort;
Arnold R. Boik, Chicago, both
of Ill.

U.S. PATENT DOCUMENTS

2,772,808 12/1956 Fried.
3,089,609 5/1963 D'Andrea.
3,416,699 12/1968 Bozek.

[73] **Assignee:** The Continental Group, Inc., New
York, N.Y.

Primary Examiner—George T. Hall

[57] **ABSTRACT**

Reexamination Request

No. 90/000,076, Sep. 28, 1981

This disclosure has to do with an easy opening container end wherein substantially the entire end panel is removed. The removable panel portion has rigidly attached thereto a pull tab which is first utilized as a lever to obtain the initial rupture of the end panel and then as a handle to tear out the removable panel portion. The removable panel portion is provided with a weakening line immediately adjacent the connection between the pull tab and the removable panel portion for the purpose of first venting the interior of a container and then forming a hinge which will permit the necessary pivoting of the pull tab relative to the end panel.

Reexamination Certificate for:

Patent No.: 4,182,460
Issued: Jan. 8, 1980
Appl. No.: 656,388
Filed: Jul. 27, 1967

- [51] Int. Cl.³.....B65D 41/32
- [52] U.S. Cl.....220/271; 220/273
- [58] Field of Search.....220/265-273

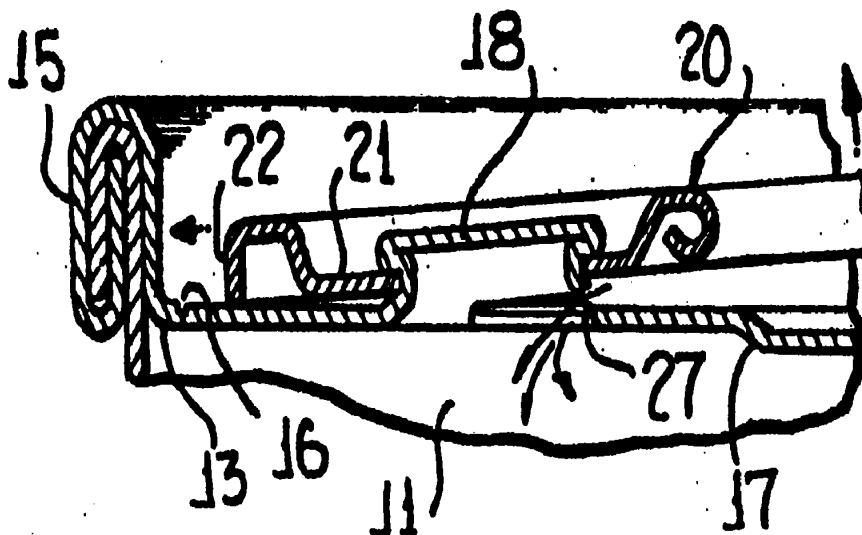

B1 4,182,460

1

**REEXAMINATION CERTIFICATE
ISSUED UNDER 35 U.S.C. 307.**

**THE PATENT IS HEREBY AMENDED AS
INDICATED BELOW.**

Matter enclosed in heavy brackets appeared in the patent, but has been deleted and is no longer a part of the patent; matter printed in italics indicates additions made to the patent.

**AS A RESULT OF REEXAMINATION, IT HAS
BEEN DETERMINED THAT:**

The patentability of claims 1-10, 16, 18, 19 and 21-54 is confirmed.

Claims 11-15, 17 and 20 are determined to be patentable as amended:

11. In a container end including an end panel defined by an upstanding chuck wall, a [weakening] score line formed in said end panel and defining a removable panel portion, said [weakening] score line including a starting portion disposed closely adjacent said chuck wall, a pull tab having a nose for engaging said panel along said [weakening] score line starting portion for effecting the rupture of said panel in the removal of said panel portion, and securing means securing said pull tab to said panel; the improvement comprising said securing means rigidly securing said pull tab to said panel portion and including hinge forming means in said removable panel portion for facilitating the hinging of said pull tab relative to said end panel to rupture said end panel along said [weakening] score line starting portion.

12. The container end of claim 11 wherein said hinge forming means includes a generally U-shaped [weakening] score line opening towards said [weakening] score line starting portion.

13. The container end of claim 11 wherein said hinge forming means includes a generally U-shaped [weakening] score line opening towards said [weakening] score line starting portion and having terminal

2

ends directed away from said [weakening] score line starting portion for preventing the accidental tearing out of a narrow portion only of said removable panel portion between said [weakening] score lines.

14. The container end of claim 11 wherein said score line [of weakening] includes a generally U-shaped central portion and diverging adjacent portions.

15. The assembly of claim 1 wherein said removable panel portion is defined by a second score line [of weakening] formed separate and apart from the first-mentioned score line [of weakening], and said score lines [of weakening] define an intermediate strap-like hinge strip.

17. In a container, the combination of:

a container wall of sheet material;

a first score line [of weakness] in said container wall defining a tear strip manually removable therefrom;

a second score line [of weakness] in said container wall adjacent said first score line [of weakness] and defining a hinge, said hinge being spaced from said first score line [of weakness] by a portion of said tear strip;

a separate tab lying at least partially within the area of said tear strip, said tab having a handle end and a force applying end with the force applying end lying at a preselected location closely adjacent said first score line [of weakness]; and

means integral with said tear strip for securing said tab to said tear strip, movement of said handle end of said tab urging said force applying end firmly against said container wall to cause hinged movement of said portion of said container wall about said hinge to initiate severance of the tear strip along said first score line [of weakness].

20. A combination as defined in claim 18 wherein said hinge lies intermediate said last mentioned means and said first score line [of weakness] and said preselected location is on said tear strip.

* * * * *

45



US005506049C1

(12) **REEXAMINATION CERTIFICATE** (4368th)

United States Patent
Swei et al.

(10) Number: **US 5,506,049 C1**
(45) Certificate Issued: **May 29, 2001**

(54) **PARTICULATE FILLED COMPOSITE FILM AND METHOD OF MAKING SAME**

2,945,831 7/1960 Evans et al. .
2,980,965 4/1961 Infantino et al. .
3,290,165 12/1966 Iannicelli .

(75) Inventors: **Gwo S. Swei, Northboro; David J. Arthur, Norwood, both of MA (US)**

(List continued on next page.)

(73) Assignee: **World Properties, Inc., Lincolnwood, IL (US)**

FOREIGN PATENT DOCUMENTS

Reexamination Request:
No. 90/005,295, Mar. 16, 1999

0198375 5/1987 (EP) .
0 598 464 5/1994 (EP) .
1119260 7/1968 (GB) .
2071112 4/1984 (GB) .
6-263464 9/1994 (JP) .
WO 90/02102 3/1990 (WO) .
WO 95/07177 3/1995 (WO) .

Reexamination Certificate for:
Patent No.: **5,506,049**
Issued: **Apr. 9, 1996**
Appl. No.: **08/177,198**
Filed: **Dec. 30, 1993**

OTHER PUBLICATIONS

(*) Notice: This patent is subject to a terminal disclaimer.

"Production Refinement of Very Thin Teflon Film", American Machine and Foundry Co, Stamford, CT, Mar., 1963.
"Silane Coupling Agents", Edwin P. Plueddemann, Dow Corning Corporation, Midland, Michigan, Plenum Press, New York, 1982.

Related U.S. Application Data

(List continued on next page.)

(62) Division of application No. 07/705,624, filed on May 24, 1991, now abandoned.

Primary Examiner—H. Thi Le

(51) Int. Cl.⁷ **B32B 5/16**
(52) U.S. Cl. **428/323; 428/325; 428/335; 428/901**

(57) **ABSTRACT**

(58) Field of Search **428/323, 325, 428/335, 403, 404, 901, 405, 406, 421, 422, 457**

A particulate filled fluoropolymeric matrix composite article and method of making the same is presented. Preferably, the article comprises an electrical substrate material. The method for making the particulate filled polymeric matrix composite film includes mixing a polymeric matrix material with a dispersion of particulate filler in a carrier liquid to form a casting composition and adjusting the viscosity of the casting composition to retard separation of the particulate filler from the composition. A layer of the viscosity-adjusted casting composition is cast on a substrate and the layer is consolidated to form the particulate filled polymer matrix composite film. Films made by the method include very thin, e.g. less than 1.0 mil, fluoropolymeric matrix films highly filled with very small diameter, preferably spherical, particles for use as, e.g. dielectric substrate materials in laminar electrical circuits.

(56) **References Cited**

U.S. PATENT DOCUMENTS

Re. 30,450 12/1980 Iannicelli .
2,539,329 1/1951 Sanders .
2,739,073 3/1956 Bertorelli .
2,832,754 4/1958 Jex et al. .
2,843,502 7/1958 Fay, Jr. .
2,848,346 8/1958 Bertorelli .
2,930,809 3/1960 Jex et al. .



US 5,506,049 C1

Page 2

U.S. PATENT DOCUMENTS

3,340,222	9/1967	Fang .	5,069,702	12/1991	Block et al. .	
3,489,595	1/1970	Brown, Jr. .	5,071,635	12/1991	Yamanaka et al.	423/592
3,518,332	6/1970	Sklarchuk et al. .	5,075,065	12/1991	Effenberger et al. .	
3,556,161	1/1971	Roberts .	5,126,192	6/1992	Chellis .	
3,655,604	4/1972	Strolle .	5,256,180	10/1993	Garnier et al. .	
3,780,156	12/1973	Cameron .	5,280,414	1/1994	Davis et al. .	
3,801,427	4/1974	Morishita et al. .	5,421,507	6/1995	Davis et al. .	
3,830,770	8/1974	Ribbans, III .	5,496,403	3/1996	Gaedcke et al. .	
3,838,998	10/1974	Matthews et al. .	5,534,348	7/1996	Miller et al.	65/21.4
3,886,103	5/1975	Koizumi et al. .				
3,896,071	7/1975	Poirier .				
3,928,703	12/1975	Cook .				
3,929,721	12/1975	Leverett .				
3,970,627	7/1976	Seymus .				
4,036,807	7/1977	Atherton .				
4,038,244	7/1977	Ogden et al. .				
4,039,713	8/1977	Vassiliou .				
4,118,537	10/1978	Vary et al. .				
4,123,401	10/1978	Berghmans et al. .				
4,128,519	12/1978	Bartoszek et al. .				
4,134,848	1/1979	Adicoff .				
4,141,873	2/1979	Dohany .				
4,143,110	3/1979	Morozumi et al. .				
4,151,154	4/1979	Berger .				
4,169,087	9/1979	Richter .				
4,179,542	12/1979	Christofas et al. .				
4,183,991	1/1980	Smiley et al. .				
4,194,040	3/1980	Breton et al. .				
4,214,914	7/1980	Ivanchev et al. .				
4,216,024	8/1980	Ivanchev et al. .				
4,233,366	11/1980	Sample, Jr. et al. .				
4,309,328	1/1982	Carson et al. .				
4,333,857	6/1982	Lim et al. .				
4,335,180	6/1982	Traut .				
4,352,717	10/1982	Watanabe et al. .				
4,391,930	7/1983	Olson .				
4,440,879	4/1984	Kawachi et al. .				
4,469,747	9/1984	Sasaki et al. .				
4,495,247	1/1985	Vasta .				
4,529,774	7/1985	Evans et al. .				
4,546,144	10/1985	Knight .				
4,556,603	12/1985	Thorsrud .				
4,587,286	5/1986	Wilkinson .				
4,623,390	11/1986	Delmonico .				
4,649,037	3/1987	Marsh et al. .				
4,654,235	3/1987	Effenberger et al. .				
4,661,137	4/1987	Garnier et al.	65/21.4			
4,665,113	5/1987	Eberl .				
4,715,878	12/1987	Kopatz et al.	65/21.1			
4,756,980	7/1988	Niksa et al. .				
4,772,322	9/1988	Bellis et al. .				
4,788,764	12/1988	Niksa et al. .				
4,824,511	4/1989	Hartman et al. .				
4,868,350	9/1989	Hoffarth et al. .				
4,879,345	11/1989	Connelly et al. .				
4,923,520	5/1990	Anzai et al. .				
4,985,190	1/1991	Ishikawa et al. .				
5,055,342	10/1991	Markovich .				

OTHER PUBLICATIONS

"A Guide to Dow Corning Silane Coupling Agents", Dow Corning Corporation, 1985.

"Silane Coupling Agents in Mineral-Filled Composites", Union Carbide Corporation, 1973, 1979.

"Silane Adhesion Promoters in Mineral-Filled Composites", Union Carbide Corporation, 1973.

"Handbook of Fillers and Reinforcements for Plastics", Van Nostrand Reinhold Company, 1978.

"The Use of Mixed Silane Coupling Agents", Edwin P. Plueddemann and Peter G. Pape, 40th Annual Conference, Reinforced Plastics/Composites Institute, The Society of the Plastics Industry, Inc. Jan. 28-Feb. 1, 1985, Session 17-F, pp. 1-4.

"Microwave Substrates—Present and Future", Thomas E. Nowicki, *New Electronics*, May 27, 1980, pp. 85-88.

MIL-P 13949F, Military Specification, Plastic Sheet, Laminated, Metal Clad (For Printed Wiring Boards), General Specification For (Mar. 10, 1981)(superseding MIL-P 13949E (Jul. 15, 1971), MIL-P-55636B (Sep. 10, 1976), and MIL-P-55617B (Sep. 10, 1976).

Murray Olyphant, Jr. & Thomas E. Nowicki, "Microwave Substrates Support MIC Technology", in *Microwave Tech Topics*, also published in *Microwaves Magazine*, Nov./Dec. 1980.

Ex. 1—World Properties, Inc. & Rogers Corp. v. Tonoga Limited D/B/A Taconic Plastics—3:98CV1218 (JBA), Ruling On Defendant's Motion To Compel Return Of Inadvertently Produced Privileged Documents dated May 30, 2000.

Ex. 2—Letter dated Aug. 25, 1998 from John C. Hilton at McCormick, Paulding & Huber LLP to Mr. Andrew Russell.

Ex. 3—World Properties et al v. Tonoga, et al—3:98cv1218 (JBA), Endorsement Order [Doc. #76, #80] dated Jul. 5, 2000.

Ex. 4—World Properties, et al v. Tonoga, et al—3:98cv1218 (JBA), portion of Deposition of Malcolm Green transcript on Nov. 19, 1998.

Ex. 5—World Properties, et al v. Tonoga, et al—3:98cv1218 (JBA), Declaration of Thomas McCarthy dated May 10, 2000.

Ex. 6—World Properties, et al v. Tonoga, et al—3:98cv1218 (JBA), Order Returning Pleading dated Jul. 7, 2000.

Ex. 7—World Properties et al v. Tonoga, et al—3:98cv1218 (JBA), Amended Answer And Counterclaim dated Jun. 1, 2000.

US 5,506,049 C1

1

**REEXAMINATION CERTIFICATE
ISSUED UNDER 35 U.S.C. 307**

THE PATENT IS HEREBY AMENDED AS
INDICATED BELOW.

Matter enclosed in heavy brackets [] appeared in the patent, but has been deleted and is no longer a part of the patent; matter printed in *italics* indicates additions made to the patent.

AS A RESULT OF REEXAMINATION, IT HAS BEEN DETERMINED THAT:

Claims 1-40 are cancelled.

New claims 41-53 are added and determined to be patentable.

41. A particulate filled fluoropolymeric matrix composite circuit material, comprising:

- (1) an electric substrate including a nonfibrillated fluoropolymer matrix and about 15 to about 95 volume percent filler particles distributed throughout the matrix, said particles having a maximum equivalent spherical diameter of less than about 10 μm , said filler particles comprising inorganic filler particles treated with a coating selected from the group consisting of silane coatings, zirconate coatings, and titanate coatings;
- (2) a layer of metal being disposed on at least one surface of said substrate; and
- (3) said substrate being formed by a casting composition, wherein the viscosity of said casting composition is adjusted by a polymeric viscosity modifier to adjust the viscosity of the casting composition to retard separation of the particulate filler from the composition to provide a stabilized, homogeneous casting composition, said polymeric viscosity modifier being substantially removed after the completion of

2

processing, and wherein a surfactant is added to said casting composition to modify the surface tension of the carrier liquid so that the carrier liquid wets the filler particles.

42. The circuit material of claim 41, wherein the fluoropolymer comprises polytetrafluoroethylene.

43. The circuit material of claim 41, wherein the fluoropolymer comprises polychlorotrifluoroethylene.

44. The circuit material of claim 41, wherein the fluoropolymer comprises a copolymer of tetrafluoroethylene and a monomer selected from the group consisting of hexafluoropropylene and perfluoroalkylvinylethers.

45. The circuit material of claim 41, wherein the fluoropolymer comprises a copolymer of tetrafluoroethylene and a monomer selected from the group consisting of vinylidene fluoride, vinyl fluoride and ethylene.

46. The circuit material of claim 41, wherein the fluoropolymer comprises a copolymer of chlorotrifluoroethylene and a monomer selected from the group consisting of hexafluoropropylene, perfluoroalkylvinylethers, vinylidene fluoride, vinyl fluoride, and ethylene.

47. The circuit material of claim 41, wherein the substrate comprises a film having a thickness of less than about 2 mil.

48. The circuit material of claim 41, wherein the substrate comprises a film having a thickness of less than about 1 mil.

49. The circuit material of claim 41 wherein said metal comprises copper.

50. The circuit material of claim 41, wherein each of the filler particles has an equivalent spherical diameter of less than 5 μm .

51. The circuit material of claim 41, wherein none of the filler particles has a single linear dimension greater than 10 μm .

52. The circuit material of claim 41, wherein none of the filler particles has a single linear dimension greater than 5 μm .

53. The circuit material of claim 41, wherein all of the filler particles are of substantially the same particle size.

* * * * *

2291 Notice of *Ex Parte* Reexamination Certificate Issuance in *Official Gazette* [R-3]

The *Official Gazette* notice will include bibliographic information, and an indication of the status of each claim after the *>conclusion< of the reexamination proceeding. Additionally, a representative claim will be published along with an indication of any changes to the specification or drawing.

The notice of *ex parte* reexamination certificate will clearly indicate that it is a certificate for a concluded *ex parte* reexamination proceeding, as opposed to an *inter partes* reexamination proceeding.

2292 Distribution of Certificate [R-3]

**>An e-copy< of the reexamination certificate **>will be associated with the e-copy< of the patent in the search files. A copy of the certificate will also be made a part of any patent copies prepared by the Office subsequent to the issuance of the certificate.

A copy of the certificate will also be forwarded to all depository libraries and to those foreign offices which have an exchange agreement with the U.S. Patent and Trademark Office.

2293 Intervening Rights

35 U.S.C. 307. *Certificate of patentability, unpatentability, and claim cancellation.*

(b) Any proposed amended or new claim determined to be patentable and incorporated into a patent following a reexamination proceeding will have the same effect as that specified in section 252 of this title for reissued patents on the right of any person who made, purchased, or used within the United States, or imported into the United States, anything patented by such proposed amended or new claim, or who made substantial preparation for the same, prior to issuance of a certificate under the provisions of subsection (a) of this section.

The situation of intervening rights resulting from reexamination proceedings parallels the intervening rights situation resulting from reissue proceedings, and the rights detailed in 35 U.S.C. 252 apply equally in reexamination and reissue situations. See *Fortel Corp. v. Phone-Mate, Inc.*, 825 F.2d 1577, 3 USPQ2d 1771 (Fed. Cir. 1987); *Kaufman Co., Inc. v. Lantech, Inc.*, 807 F.2d 970, 1 USPQ2d 1202 (Fed. Cir. 1986); *Tennant Co. v. Hako Minuteman, Inc.*, 4 USPQ2d

1167 (N.D. Ill. 1987); *Key Mfg. Group, Inc. v. Microdot, Inc.*, 679 F. Supp. 648, 4 USPQ2d 1687 (E.D. Mich. 1987).

2294 Concluded Reexamination Proceedings [R-7]

Ex parte reexamination proceedings may be concluded in one of four ways:

(A) The prosecution of the proceeding may be *>brought to an end<, and the proceeding itself concluded, by a denial of reexamination>< or vacating the reexamination proceeding**>, or terminating the reexamination proceeding. (In these instances<, no Reexamination Certificate is issued).

**>

(1) A reexamination file< (IFW or paper) in which reexamination has been denied or vacated *>is< processed by the Central Reexamination Unit (CRU) or Technology Center (TC) to provide the partial refund set forth in 37 CFR 1.26(c). The reexamination file will then be given a 420 status (reexamination denied) or a 422 status (reexamination vacated). A copy of the PALM “Application Number Information” screen and the “Contents” screen is printed. The printed copy is annotated by adding the comment “PROCEEDING CONCLUDED,” and the annotated copy is then scanned into IFW using the miscellaneous letter document code.

>

(2) A reexamination file (IFW or paper) in which the reexamination proceeding has been terminated should be forwarded to the Central Reexamination Unit (CRU) if the file is not already there. The reexamination file will then be given a 420 status. A copy of the PALM “Application Number Information” screen and the “Contents” screen is printed, the printed copy is annotated by adding the comment “PROCEEDING CONCLUDED,” and the annotated copy is then scanned into IFW using the miscellaneous letter document code. A partial refund is not made in this instance, since the reexamination was properly commenced and addressed, and was terminated later based upon a court decision, or the like.<

(B) The proceeding may be concluded under 37 CFR 1.570(b) with the issuance of a Reexamination Certificate.

A reexamination proceeding that is to be concluded in this manner should be processed as set forth in MPEP § 2287, reviewed by the **>CRU Supervisory Patent Examiner (SPE) or TC Quality Assurance Specialist (QAS)<, and then forwarded to the Office of Patent Legal Administration (OPLA).

(C) The proceeding may be concluded under 37 CFR 1.570(e) where the reexamination proceeding has been merged with a reissue proceeding and a reissue patent is granted; an individual reexamination certificate is not issued, but rather the reissue patent serves as the certificate.

A reexamination proceeding that is to be concluded in this manner should be processed, together with the reissue proceeding, as set forth in MPEP § 1455 and forwarded to the OPLA in accordance with MPEP § 1456.

(D) The proceeding may be concluded under 37 CFR 1.997(b) where the *ex parte* reexamination proceeding has been merged with an *inter partes* reexamination proceeding and a single reexamination certificate is issued.

A reexamination proceeding that is to be concluded in this manner should be processed, together with the *inter partes* reexamination, into a merged certificate of the nature set forth in MPEP § 2690 and MPEP § 2694.

2295 Reexamination of a Reexamination [R-7]

This section provides guidance for the processing and examination of a reexamination request filed on a patent for which a reexamination certificate has already issued, or a reexamination certificate issues on a prior reexamination, while the new reexamination is pending. This reexamination request is generally referred to as a “Reexamination of a reexamination.”

The reexamination request is to be considered based on the claims in the patent *as modified by the previously issued reexamination certificate*, and not based on the original claims of the patent. Accordingly, when the file for the new reexamination proceeding (reexamination of a reexamination) is first received by the Central Reexamination Unit (CRU) or

Technology Center (TC), the reexamination clerk will promptly incorporate into the reexamination specification all of the changes to the patent made by the issued reexamination certificate. Such incorporation must be done prior to forwarding the proceeding to the examiner for action.

The examiner should review the reexamination clerk’s entry of the reexamination certificate to ensure that all certificate changes are properly entered so that (A) the reexamination will be given on an accurate specification and claims, and (B) the appropriate version of the patent will be printed in any future reexamination certificate that will ultimately issue. The examiner will issue a decision on the reexamination request **based on the patent claims (and specification) with the certificate changes entered.**

Once reexamination is ordered, the reexamination proceeding is conducted in accordance with 35 U.S.C. 305, 37 CFR 1.550 and MPEP § 2254 - § 2294.

I. PRIOR REEXAMINATION MATURES TO CERTIFICATE WHILE LATER REEXAMINATION IS PENDING

If a second request for reexamination of a patent is filed where the certificate for the first reexamination of the patent will issue within 3 months from the filing of the second request, the proceedings normally will not be merged. If the certificate for the first reexamination proceeding will issue before the decision on the second request must be decided, the reexamination certificate is allowed to issue. The second request is then considered based upon the claims in the patent as indicated in the issued reexamination certificate rather than the original claims of the patent. The Legal Instrument Examiner (LIE) will print out a copy of the issued reexamination certificate and make it of record in the second reexamination file wrapper as a preliminary amendment.

In the order/denial decision on the second request, it should be noted that this preliminary amendment (the certificate) was entered into the reexamination file, and that the determination (order/denial) was based upon the new patent claims in the certificate.

A copy of the reexamination certificate should be included as an attachment to the order/denial decision to ensure that any third party requester of the second reexamination has a copy of the certificate claims.

II. PATENT OWNER'S SUBMISSION OF AMENDMENTS

Any amendment to the claims (or specification) of the reexamination proceeding must be presented as if the changes made to the patent text via the reexamination certificate are a part of the original patent. Thus, all italicized text in the certificate is considered as if the text was present without italics in the original patent. Further, any certificate text placed in brackets is considered as if it were never present in the patent at all.

For example, an amendment in a "reexamination of a reexamination" might include italicized text of claim 1 of the reexamination certificate as underlined (or italicized) in the copy of claim 1 submitted in the amendment. This would indicate that text already present in the patent (via the reexamination certificate) is again being added. This would be an improper amendment, and as such, an "informal submission." Accordingly, the examiner would notify the patent owner that the amendment does not comply with 37 CFR 1.530. Form PTOL-475 would be used to provide the notification of the defect in the amendment, and a 1-month time period would be set for correction of the defect. See also MPEP § 2266.02.

III. COMPLETION OF THE CHECKLISTS

Upon conclusion of the reexamination proceeding, the reexamination file will be processed by the CRU or the TC so that the Office of Data Management can prepare and issue a certificate in accordance with 35 U.S.C. 307 and 37 CFR 1.570. The certificate will set forth the results of the reexamination proceeding and the content of the patent following the proceeding. See MPEP § 2287. The examiner will complete a checklist, Form PTO-1516, and the reexamination clerk will complete the reexamination clerk checklist Form PTO-1517. In completing the checklists, the examiner and reexamination clerk should keep in mind that the "patent" is the *original patent as modified by the reexamination certificate*. For example, claims canceled by the prior reexamination certificate should be listed in Item 8 - "Claim(s) _____ (and) _____ was (were) previously canceled." Likewise, in Item 12 of the examiner checklist - "Claim(s) _____ (and) _____ is (are) determined to be patentable as amended."; any claims amended **only** by the prior

reexamination certificate (i.e., not further amended in the present reexamination) **should not be listed**.

Each "reexamination of a reexamination" must be reviewed by a CRU Supervisory Patent Examiner (SPE) or TC Quality Assurance Specialist (QAS) and a paralegal to ensure compliance with the above guidelines.

2296 USPTO Forms To Be Used In *Ex Parte* Reexamination [R-3]

The following forms must be used in *ex parte* reexamination actions and processing (these forms are not reproduced below):

**>

(A) Granting/Denying Request For *Ex Parte* Reexamination – PTOL-471

(B) Office Action in *Ex Parte* Reexamination – PTOL-466

(C) *Ex Parte* Reexamination Advisory Action – PTOL-467

(D) *Ex Parte* Reexamination Notification re Appeal – PTOL-468

(E) Notification of Non-Compliant Appeal Brief (37 CFR 41.37) in *Ex Parte* Reexamination – PTOL-462R

(F) *Ex Parte* Reexamination Advisory Action After the Filing of an Appeal Brief – PTOL-304R

(G) Notice of Intent to Issue *Ex Parte* Reexamination Certificate – PTOL-469

(H) *Ex Parte* Reexamination Communication Transmittal Form – PTOL-465

(I) *Ex Parte* Reexamination Interview Summary-PTOL-474

(J) Notice of Defective Paper In *Ex Parte* Reexamination – PTOL-475

(K) *Ex Parte* Reexamination Communication – PTOL-473

(L) Reexamination Clerk Checklist – PTOL-1517

(M) Examiner Checklist – Reexamination – PTOL-1516<

A Request for *Ex Parte* Reexamination Transmittal Form, PTO/SB/57, is available on the USPTO web site at <http://www.uspto.gov> for use in the filing of a request for reexamination; its use, however, is not mandatory.