



Coastal Marine Institute

# Examination of the Development of Liquefied Natural Gas on the Gulf of Mexico



**Coastal Marine Institute**

# **Examination of the Development of Liquefied Natural Gas on the Gulf of Mexico**

Authors

David E. Dismukes

July 2008

Prepared under MMS Contract  
1435-01-04-CA-32806-36435 (M08AX12688)  
by  
Louisiana State University  
Center for Energy Studies  
Baton Rouge, Louisiana 70803

Published by

**U.S. Department of the Interior  
Minerals Management Service  
Gulf of Mexico OCS Region**

**Cooperative Agreement  
Coastal Marine Institute  
Louisiana State University**

## **DISCLAIMER**

This report was prepared under contract between the Minerals Management Service (MMS) and Louisiana State University's Center for Energy Studies. This report has been technically reviewed by MMS. Approval does not signify that the contents necessarily reflect the view and policies of the Service, nor does mention of trade names or commercial products constitute endorsement or recommendation for use. It is, however, exempt from review and compliance with MMS editorial standards.

## **REPORT AVAILABILITY**

Extra copies of the report may be obtained from the Public Information Office (Mail Stop 5034) at the following address:

U.S. Department of the Interior  
Minerals Management Service  
Gulf of Mexico OCS Region  
Public Information Office (MS 5034)  
1201 Elmwood Park Boulevard  
New Orleans, Louisiana 70123-2394  
Telephone Number: 1-800-200-GULF  
1-504-736-2519

## **CITATION**

Suggested citation:

Dismukes, D.E. 2008. Examination of the development of liquefied natural gas on the Gulf of Mexico. U.S. Dept. of the Interior, Minerals Management Service, Gulf of Mexico OCS Region, New Orleans, LA. OCS Study MMS 2008-017. 106 pp.

## ABSTRACT

This research examines the role, importance, and development of liquefied natural gas (LNG) regasification facilities along the Gulf of Mexico (GOM). The central conclusion of the research is that the GOM is perhaps the best situated location for the development of LNG regasification facilities given the region's proximity to a wide range of energy infrastructure assets that can help support, and serve as a market to, these new LNG investments.

The research provides historic context on LNG development in the U.S. and the factors that are making the current spate of LNG development different than what occurred during the late 1970s and early 1980s. Changes in natural gas markets have been examined and the role that new environmental pressures are placing on natural gas-fired power generation and industrial applications discussed. The LNG "value chain" is examined at length, as well as the respective costs, and estimated break-even prices needed to import natural gas into the U.S.

The interaction of these new LNG facilities with existing GOM energy infrastructure is examined in considerable depth. The research notes that GOM pipeline and storage infrastructure in the region is perhaps one of the most important sets of energy assets that will help facilitate the movement of imported gas across the region, and into other regions of the U.S. Gas processing and other supporting gas infrastructure is also examined.

Perhaps the biggest area of concern for many policy makers along the GOM is the ability of imported natural gas to help dampen both the increases and volatility of natural gas prices to all end users in the region, particularly those end users in the petrochemical sector. The research examines the challenges that high natural gas prices are having on these large energy using sectors, and the regional job losses that have occurred in the aftermath of the large natural gas price run up of 2000-2001.

The conclusion of the research is that the development of LNG regasification facilities along the GOM will be supplemental, and even complementary, to the existing set of energy infrastructure in the region. These facilities will provide new sources of revenue for pipelines, storage, and gas processing facilities, which in turn, can be used to service existing and ongoing domestic natural gas production. As a result, currently anticipated expansions of existing infrastructure (i.e., storage, pipelines, processing) in certain areas are anticipated to be more complementary, as opposed to competitive, with existing domestic natural gas production.

# TABLE OF CONTENTS

	<u>Page</u>
LIST OF FIGURES .....	ix
LIST OF TABLES .....	xi
EXECUTIVE SUMMARY .....	1
1. INTRODUCTION .....	5
1.1. Purpose of the Proposed Research.....	5
1.2. Organization of the Report.....	7
2. BACKGROUND ON U.S. AND REGIONAL GAS MARKETS, REGULATIONS, AND INSTITUTIONS.....	9
2.1. Energy Crisis of the 1970s and Initial LNG Development.....	9
2.2. LNG Development during the Period of Crisis .....	11
2.3. The Evolution of Competition .....	14
2.4. LNG and Regional Natural Gas Production .....	15
2.5. LNG and Regional Natural Gas Consumption .....	20
2.6. Implications of Natural Gas Price Changes and U.S. Industrial Activity.....	26
2.7. Implications of Natural Gas Price Changes on GOM Industrial Activity .....	31
3. PRIMER ON LNG FACILITIES AND THEIR PROPOSED DEVELOPMENT IN THE U.S. AND GULF OF MEXICO REGION .....	39
3.1. Introduction to LNG .....	39
3.2. Current and Proposed LNG Facilities.....	45
3.3. Importance of LNG on Future U.S. Supply Disposition .....	52
4. GULF OF MEXICO REGION IS WELL SUITED FOR LNG INVESTMENT .....	57
4.1. Transportation, Processing, and Storage Infrastructure .....	58
4.1.1. Transportation .....	58
4.1.2. Processing .....	63
4.1.3. Storage .....	64
5. REGULATORY ISSUES ASSOCIATED WITH LNG SITING AND DEVELOPMENT .....	69
5.1. Onshore Permitting Process.....	72
5.1.1. Pre-Filing Technical Consultation .....	73
5.1.2. Pre-Decision Review .....	73
5.1.3. Post-Decision Inspection and Monitoring .....	74
5.2. Offshore Permitting Process .....	74
5.3. State Input into the Permitting Process.....	75

**TABLE OF CONTENTS**  
**(continued)**

	<u>Page</u>
6. SAFETY ISSUES ARISING IN THE LNG PERMITTING PROCESS .....	77
6.1. Public Perception of LNG.....	77
6.2. Background: LNG Safety Record.....	77
6.3. LNG Tanker Safety Record .....	78
6.4. Tanker Incidents: LNG, LPG, and Crude Oil.....	82
6.4.1. <i>El Paso Paul Kayser</i> Grounding.....	83
6.4.2. <i>Yuyo Maru No. 10</i> .....	83
6.4.3. Terrorist Attack on the <i>Limburg</i> Crude Oil Tanker .....	83
6.5. Onshore Facility Safety Record.....	84
6.6. Storage Facilities and Safety.....	84
6.7. Physical Properties and Associated Potential Hazards .....	85
6.8. Potential Vulnerabilities.....	87
6.8.1. Terrorism.....	87
6.8.2. Earthquakes.....	87
6.8.3. Hurricanes .....	87
6.9. Review of Previous LNG Safety Issues.....	89
7. ENVIRONMENTAL ISSUES ARISING FROM THE LNG PERMITTING PROCESS .....	91
7.1. Description of Offshore LNG Regasification Configurations .....	91
7.1.1. Open Loop (Open Rack Vaporization).....	91
7.1.2. Other Technologies.....	93
7.2. Public Opposition and Positions in the Open Loop LNG Debate .....	94
7.3. Industry Response to Public Opposition and Permitting Changes .....	95
8. CONCLUSIONS.....	97
REFERENCES .....	101

## LIST OF FIGURES

<u>Figure</u>	<u>Page</u>
ES1	The LNG Value Chain.....1
ES2	Daily Henry Hub Prices, 1998 to Present.....3
1	Existing and Proposed North American LNG Terminals.....6
2	U.S. LNG Terminals and Original Capacity.....12
3	U.S. Natural Gas Production by State, 2005.....16
4	GOM Natural Gas Production, Onshore and Offshore, 1980-2005.....16
5	Active GOM Drilling Rigs and Crude Oil Prices, 1959-2006.....17
6	GOM Oil and Gas Production, 1992-2005.....17
7	U.S. Drilling Activity and Production, 1997-2006.....18
8	GOM Drilling Activity and Production, 1998-2006.....19
9	All Deepwater Wells Drilled in the Gulf of Mexico, by Water Depth.....19
10	U.S. Proved Oil and Natural Gas Reserves, 1990-2005.....20
11	Changes in Natural Gas Demand.....21
12	Industrial Natural Gas Usage.....22
13	GOM Region Petrochemical Facilities.....23
14	Natural Gas Components and Petrochemical Products.....24
15	Industrial Consumption of Natural Gas, 2005.....24
16	Per Customer Natural Gas Consumption by Sector, 2005.....25
17	Natural Gas Consumption, Texas, Louisiana and World Comparison, 2004.....25
18	Daily Henry Hub Prices, 1998 to Present.....26
19	Comparison of Consumer Product Price to Natural Gas.....27
20	Historic U.S. Average Wellhead Price and Chemical Industry Employment, 1940-2005.....28
21	Natural Gas Costs Around the World, 2005, \$/MMBtu.....28
22	Average Monthly Expenditures by Industrial Customers in U.S. for Natural Gas and Electric, 1999-2003.....29
23	Employment in Chemical, Fertilizer and Petrochemical Industry in the U.S.....30
24	Value of Net Exports of Chemicals (NAICS 325), 1989-2005.....31
25	Chemical Industry Portion of State GDP, 2004.....32
26	Chemical Industry Employment as a Percent of Total Manufacturing Employment, 2005.....32
27	Henry Hub Spot Price and Louisiana Chemical Industry Employment, 1994-2005.....34
28	GOM Chemical Industry Job Losses Since 2000.....34
29	Louisiana Refinery Employment and Natural Gas Spot Price.....35
30	GOM Refinery Job Losses Since 2000.....36
31	Louisiana Paper Manufacturing Employment and Natural Gas Spot Price.....37
32	GOM Paper and Pulp Industry Job Losses Since 2000.....37
33	Natural Gas Reserves by Country, as of January 1, 2005.....39
34	World Importers of LNG: Imports as Percent of Total Natural Gas Consumption, 2004.....40
35	LNG Schematic, Production to End-User.....41

**LIST OF FIGURES**  
(continued)

<b><u>Figure</u></b>	<b><u>Page</u></b>
36	Receiving Terminal – LNG Gas Flow .....42
37	The LNG Value Chain .....43
38	Types of Offshore LNG Receiving Terminals.....44
39	Types and Locations of Typical Regasification Facilities .....45
40	U.S. LNG Facilities.....46
41	Current U.S. LNG Import Terminals .....47
42	Existing and Proposed North American LNG Terminals .....48
43	Planned LNG Capacity Additions and Expansions, 2007-2011 .....52
44	U.S. Natural Gas Imports as a Percent of Total Consumption, 1990-2006 .....53
45	LNG Imports and Natural Gas Price.....54
46	Natural Gas Production, Consumption and Imports, 1970-2030.....55
47	U.S. and Canadian Natural Gas Supply .....55
48	GOM Gas Supply Schematic .....57
49	Region-to-Region Natural Gas Pipeline Capacity, 2004 .....58
50	Principle Interstate Natural Gas Flow Summary .....59
51	Natural Gas Processing Facilities .....64
52	Working Gas in Underground Storage .....65
53	Natural Gas Storage Facilities .....66
54	Natural Gas Storage Facilities in the Lower 48 States .....66
55	Timeline for LNG Review Process.....70
56	EPA’s Role in the LNG Permitting Process .....71
57	LNG Tanker Design with Spherical Tanks.....79
58	Spherical Tank Design.....79
59	LNG Tanker with Prismatic Tanks .....80
60	LNG Tanker Design with Prismatic Tanks.....80
61	Prismatic Tank Design.....81
62	LNG Tanker Design with Double Membrane Tanks.....81
63	Membrane Tank Design.....82
64	Global LNG Fleet Containment Design .....82
65	Damage to the <i>Limburg</i> Following Terrorist Attack .....83
66	Types of LNG Storage Tanks .....85
67	Gulf Gateway LNG Facility and Surrounding Pipelines .....88
68	Lake Charles LNG Facility and Surrounding Pipelines .....89
69	Primary Methods to Vaporize LNG.....91
70	Mustang LNG Smart™ Ambient Air Vaporization Process .....94



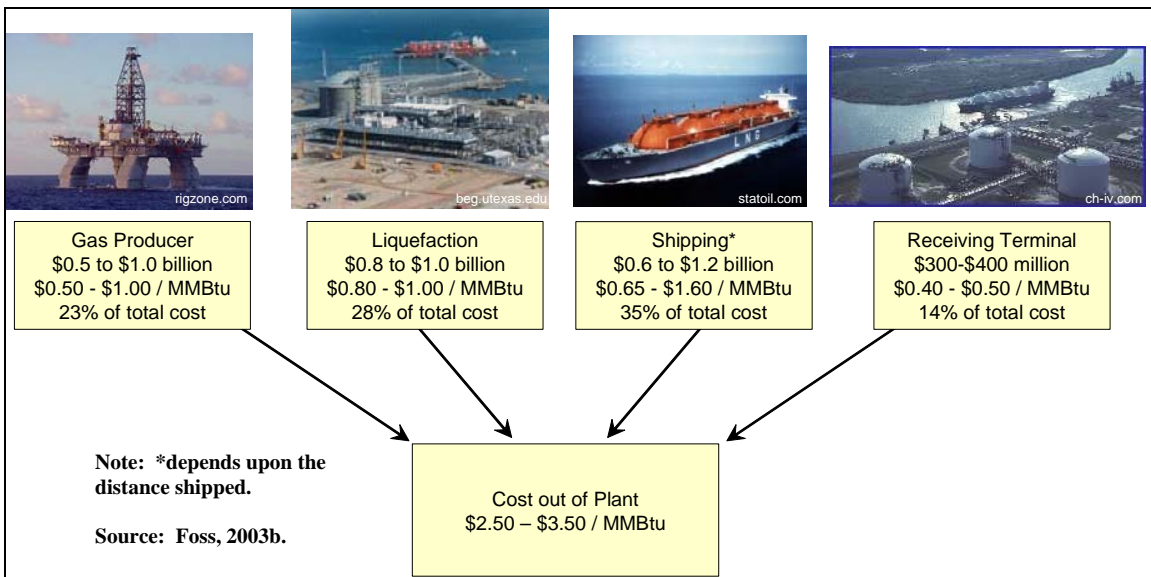
## LIST OF TABLES

<b><u>Table</u></b>		<b><u>Page</u></b>
1	Louisiana Industrial Natural Gas and Electricity Usage and Expenditures, 2002.....	33
2	Proposed North American LNG Terminals .....	49
3	Proposed LNG Terminals in GOM Region, 2007 .....	50
4	GOM Pipeline Capacity Utilization, 2003-2007 .....	60
5	Investment Costs for Proposed LNG Facilities .....	62
6	GOM Natural Gas Storage Fields by Type, 2005.....	67
7	New and Proposed Storage Projects, as of January 2007 .....	68
8	Environmental Impact Statement for Onshore LNG Terminals .....	70

## EXECUTIVE SUMMARY

This research examines the role, importance, and development of liquefied natural gas (LNG) regasification facilities along the Gulf of Mexico (GOM). LNG represents a growing, important, and almost necessary source of natural gas supply for the U.S. economy. The central issue in the development of LNG regasification facilities in the U.S. is not whether these facilities will in fact be developed but where and to what extent. The central conclusion of the research is that the GOM is perhaps the best situated location for the development of LNG regasification facilities given the region’s proximity to a wide range of energy infrastructure assets that can help support, and serve as a market to, these new LNG investments.

An important consideration in the economic, environmental, and policy analysis of LNG development is the recognition that only one component of the LNG “value chain,” the “regasification” component, will actually be constructed and operated in the U.S. Regasification, as shown in Figure ES.1, is the last component of the entire process associated with producing, liquefying, and shipping natural gas over extremely long distances. Considerations about the development of LNG, therefore, involve a wide range of issues influencing each and every component, not just the regasification investment which typically represents about 14% percent of the overall total project investment.



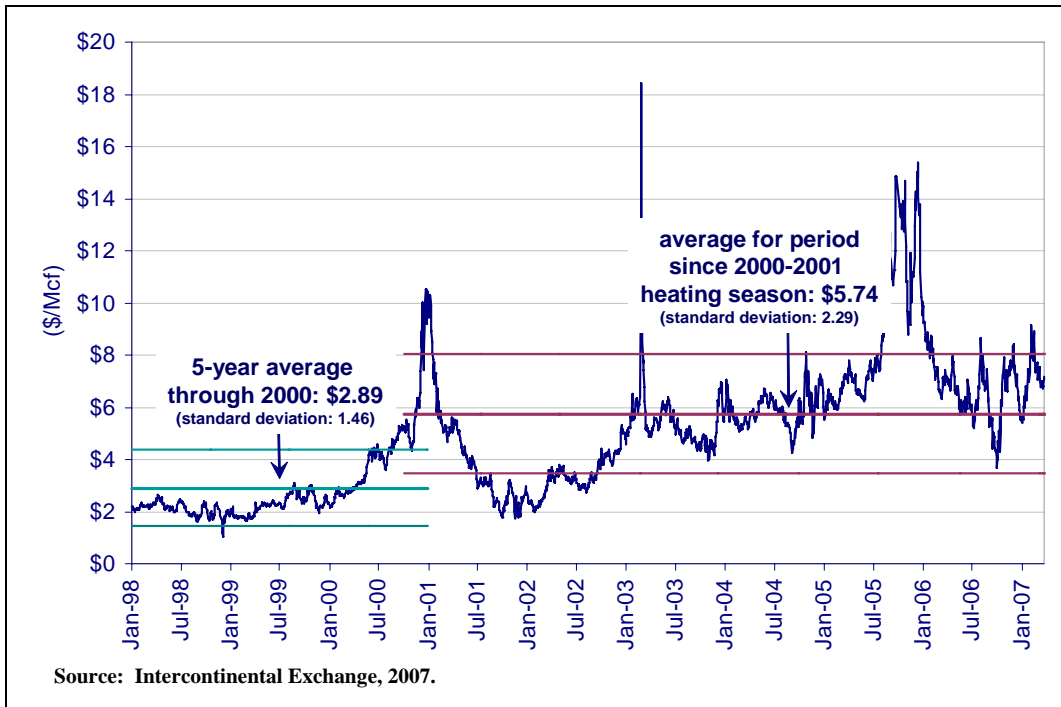
**Figure ES.1. The LNG Value Chain.**

Liquefying natural gas is not a new technology, nor are recent proposals the first attempts to develop LNG facilities in the U.S. The use of LNG dates back to as early as the 19<sup>th</sup> century as a means of distributing natural gas to locations that did not have local energy resources or the pipeline investments needed to transport natural gas. LNG developments comparable in scale to the current proposals date back to the late 1950s and early 1960s when Western Europe and Asia began importing LNG in large quantities.

The energy crisis of the 1970s stimulated interest in the use of LNG in the U.S. Four different large-scale facilities were developed during this period, include one along the GOM in Lake Charles, Louisiana. The crash of natural gas prices during the natural gas “bubble” of the 1980s called into question the longer-run economics of these investments. As a result, many of these initially developed LNG regasification facilities were shut-down or mothballed at some point in their operational history. It took close to two decades, and a number of fundamental changes in U.S. natural gas markets, to revive interest in imported liquid natural gas.

The period between 1978 to 2000 saw a number of fundamental changes in natural gas markets and their regulation. Prior to 1978, natural gas markets were tightly governed by utility-style price regulation. Deregulation and competition, policy initiatives which were gaining widespread attention during this period, were soon injected into natural gas markets creating fundamental shifts in both supply and demand that would be felt for several decades.

One of the more prominent changes in natural gas markets post-1978 restructuring was the collapse in prices which was maintained for a period of close to twenty years. Those trends reversed dramatically starting with the winter of 2000-2001 when natural gas prices spiked to unprecedentedly high levels as seen in Figure ES.2. After a brief reprieve in 2002, prices began a steady increase from 2003 onwards in both absolute levels and volatility.



**Figure ES.2. Daily Henry Hub Prices, 1998 to Present.**

High natural gas prices over the past several years has called into question the ability of existing domestic supply resources to meet demand. These market trends have also created a favorable pricing environment for the large multi-billion dollar investment needed to develop the entire value chain for any given LNG project (i.e., production, liquefaction, transportation and regasification). As a result, the number of announced LNG regasification projects in the U.S. virtually exploded starting in 2003.

Siting and permitting new LNG facilities, like any type of new major energy infrastructure, is an involved process that engages many federal and state regulations and regulators. The siting and permitting process is even further complicated since it can vary and change depending upon whether the proposed LNG regasification facility is designed to be located onshore or offshore. To date, federal regulations have set considerable precedent and primacy on the overall LNG siting process although several projects have been confounded, and eventually cancelled, due to state objections during the course of the siting and permitting process.

The two fundamental “hot button” issues associated with siting and permitting new LNG regasification facilities have been related to safety and environmental concerns over the technology. Interestingly, safety concerns have dominated the debate associated with proposed LNG facilities along the Atlantic seaboard and Pacific coast while environmental concerns have dominated the debate along the Gulf Coast, primarily for facilities that are proposed to be located offshore.

Along the East Coast, LNG regasification terminals are usually proposed to be built onshore near populated areas which can raise concerns about potential safety and security hazards. In considering the adequacy of safety provisions in the LNG permitting process, the federal government is faced with balancing the need for increased natural gas supplies against the public's concerns about LNG safety. Public perception of safety and risk can be, and has been a major inhibitor of facility development particularly for projects on the eastern seaboard. It is therefore vital for both industry and government to educate the public regarding the real versus perceived hazards of LNG facilities.

In order for LNG to enter the U.S. pipeline network as natural gas, it must be returned to a gaseous state. LNG offshore terminals typically use one of two processes for vaporization, commonly referred to as open or closed-loop systems. There is an on-going debate within the industry and environmental advocacy groups over the use of open loop (also called Open Rack Vaporization, or ORV) vs. closed loop (also called Submerged Combustion Vaporization, or SCV) systems.

For offshore LNG projects, both systems can use ocean water to warm the LNG, thus returning it to a vapor status. The primary environmental issue associated with LNG terminals is the potential impact the open-loop systems can have on fish populations when LNG is vaporized. This concern has resulted in an intense opposition campaign by many environmental groups in South Louisiana. To date, several projects have been cancelled as a result of this opposition, and one project was forced to change its design specifications to the SCV system in order to obtain state approval.

The conclusion of the research is that the development of LNG regasification facilities along the GOM will be supplemental, and even complementary, to the existing set of energy infrastructure in the region. These facilities will provide new sources of revenue for pipelines, storage, and gas processing facilities, which in turn, can be used to service existing and ongoing domestic natural gas production. As a result, currently anticipated expansions of existing infrastructure (i.e., storage, pipelines, processing) in certain areas are anticipated to be more complementary, as opposed to competitive, with existing domestic natural gas production.

# 1. INTRODUCTION

## 1.1. Purpose of the Proposed Research

Liquefied Natural Gas (LNG) is natural gas converted to liquid form. Natural gas is converted to LNG by cooling it to a temperature of -256°F, at which point it becomes a liquid. This simple process allows natural gas to be transported from an area of abundance to an area where it is needed. Once the LNG arrives at its destination, it is either stored as a liquid, or converted back to natural gas and delivered to end-users. This is not a new technology or new approach for delivering natural gas to commercial markets. It is simply a process by which the physical properties of natural gas, primarily methane, are altered in order to transport the commodity from markets where it is abundant to those more limited in supply.

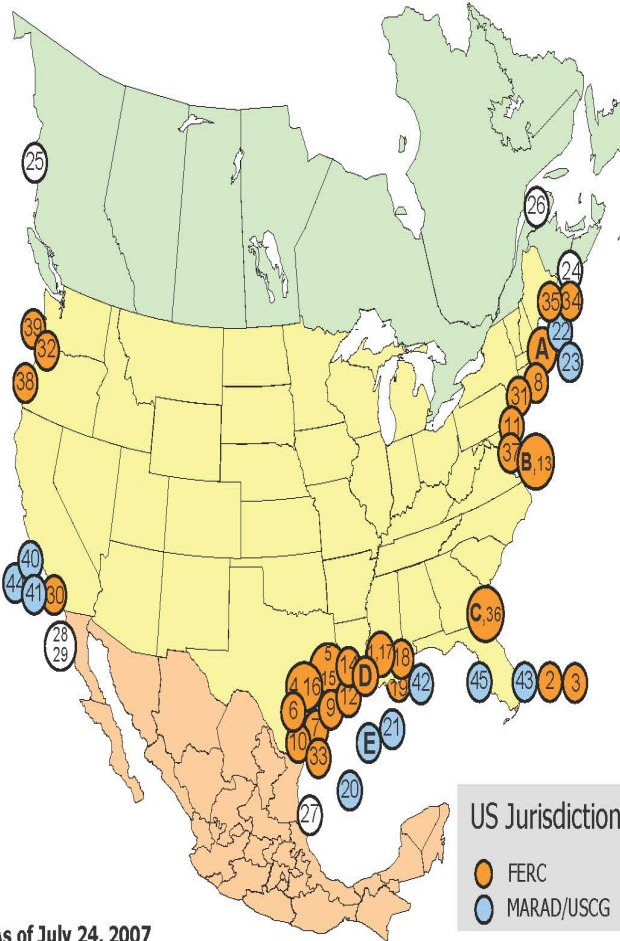
The use of LNG in the U.S. dates back to almost the turn of the last century when the first commercial LNG regasification facility was developed in West Virginia in 1912. The Gulf Coast has played a unique role in this historic development. In January 1959, the world's first LNG tanker, the Methane Pioneer carried LNG from Lake Charles, Louisiana to Canveg, United Kingdom. Two decades later, Lake Charles would serve as the location for the last major LNG regasification terminal developed during the energy crises of the early 1980s. Another 20 years would pass before the Gulf Coast would see any other significant LNG infrastructure development.

As discussed later in this report, a number of fundamental changes in natural gas supply and demand have come together over the past seven years to dramatically change the opportunities for LNG development in the U.S. Recent increases in prices, created by structural changes in natural gas markets, now make LNG an economical means for supplementing existing gas supplies. Figure 1, for instance, shows the significant current and proposed LNG facility development in North America.



# FERC

## Existing and Proposed North American LNG Terminals



US Jurisdiction

- FERC
- MARAD/USCG

As of July 24, 2007

\* US pipeline approved; LNG terminal pending in Bahamas Visit [FERC.gov LNG website](http://www.ferc.gov/lng_website)  
 \*\* Construction suspended <http://www.ferc.gov/industries/lng.asp>

Office of Energy Projects

Source: FERC, 2007a.

- CONSTRUCTED**
- A. Everett, MA : 1.035 Bcfd (DOMAC - SUEZ LNG)
  - B. Cove Point, MD : 1.0 Bcfd (Dominion - Cove Point LNG)
  - C. Elba Island, GA : 1.2 Bcfd (El Paso - Southern LNG)
  - D. Lake Charles, LA : 2.1 Bcfd (Southern Union - Trunkline LNG)
  - E. Gulf of Mexico: 0.5 Bcfd (Gulf Gateway Energy Bridge - Excelerate Energy)
- APPROVED BY FERC**
- 1. Hackberry, LA : 1.8 Bcfd (Cameron LNG - Sempra Energy)
  - 2. Bahamas : 0.84 Bcfd (AES Ocean Express)\*
  - 3. Bahamas : 0.83 Bcfd (Calypso Tractebel)\*
  - 4. Freeport, TX : 1.5 Bcfd (Cheniere/Freeport LNG Dev.)
  - 5. Sabine, LA : 2.6 Bcfd (Sabine Pass Cheniere LNG)
  - 6. Corpus Christi, TX : 2.6 Bcfd (Cheniere LNG)
  - 7. Corpus Christi, TX : 1.1 Bcfd (Vista Del Sol - ExxonMobil)
  - 8. Fall River, MA : 0.8 Bcfd (Weaver's Cove Energy/Hess LNG)
  - 9. Sabine, TX : 2.0 Bcfd (Golden Pass - ExxonMobil)
  - 10. Corpus Christi, TX : 1.0 Bcfd (Ingleside Energy - Occidental Energy Ventures)
  - 11. Logan Township, NJ : 1.2 Bcfd (Crown Landing LNG - BP)
  - 12. Port Arthur, TX : 3.0 Bcfd (Sempra Energy)
  - 13. Cove Point, MD : 0.8 Bcfd (Dominion)
  - 14. Cameron, LA : 3.3 Bcfd (Creole Trail LNG - Cheniere LNG)
  - 15. Sabine, LA : 1.4 Bcfd (Sabine Pass Cheniere LNG - Expansion)
  - 16. Freeport, TX : 2.5 Bcfd (Cheniere/Freeport LNG Dev. - Expansion)
  - 17. Hackberry, LA : 0.85 Bcfd (Cameron LNG - Sempra Energy - Expansion)
  - 18. Pascagoula, MS : 1.5 Bcfd (Gulf LNG Energy LLC)
  - 19. Pascagoula, MS : 1.3 Bcfd (Bayou Casotte Energy LLC - ChevronTexaco)
- APPROVED BY MARAD/COAST GUARD**
- 20. Port Pelican: 1.6 Bcfd (Chevron Texaco)
  - 21. Offshore Louisiana : 1.0 Bcfd (Main Pass McMoRan Exp.)
  - 22. Offshore Boston: 0.4 Bcfd (Neptune LNG - SUEZ LNG)
  - 23. Offshore Boston: 0.8 Bcfd (Northeast Gateway - Excelerate Energy)
- CANADIAN APPROVED TERMINALS**
- 24. St. John, NB : 1.0 Bcfd (Canaport - Irving Oil/Repsol)
  - 25. Kitimat, BC : 1.0 Bcfd (Kitimat LNG - Galveston LNG)
  - 26. Rivière-du- Loup, QC : 0.5 Bcfd (Cacouna Energy - TransCanada/PetroCanada)
- MEXICAN APPROVED TERMINALS**
- 27. Altamira, Tamulipas : 0.7 Bcfd (Shell/Total/Mitsui)
  - 28. Baja California, MX : 1.0 Bcfd (Energia Costa Azul - Sempra Energy)
  - 29. Baja California, MX : 1.5 Bcfd (Energia Costa Azul - Sempra Energy - Expansion)
- PROPOSED TO FERC**
- 30. Long Beach, CA : 0.7 Bcfd, (Mitsubishi/ConocoPhillips - Sound Energy Solution)
  - 31. LI Sound, NY : 1.0 Bcfd (Broadwater Energy - TransCanada/Shell)
  - 32. Bradwood, OR : 1.0 Bcfd (Northern Star LNG - Northern Star Natural Gas LLC)
  - 33. Port Lavaca, TX : 1.0 Bcfd (Calhoun LNG - Gulf Coast LNG Partners)
  - 34. Pleasant Point, ME : 2.0 Bcfd (Quoddy Bay, LLC)
  - 35. Robbinston, ME : 0.5 Bcfd (Downeast LNG - Kestrel Energy)
  - 36. Elba Island, GA : 0.9 Bcfd (El Paso - Southern LNG)
  - 37. Baltimore, MD : 1.5 Bcfd (AES Sparrows Point - AES Corp.)
  - 38. Coos Bay, OR : 1.0 Bcfd (Jordan Cove Energy Project)
  - 39. Astoria, OR : 1.5 Bcfd (Oregon LNG)
- PROPOSED TO MARAD/COAST GUARD**
- 40. Offshore California : 1.5 Bcfd (Cabrillo Port - BHP Billiton)
  - 41. Offshore California : 1.4 Bcfd, (Clearwater Port LLC - NorthernStar NG LLC)
  - 42. Gulf of Mexico: 1.4 Bcfd (Bienville Offshore Energy Terminal - TORP)
  - 43. Offshore Florida: 1.9 Bcfd (SUEZ Calypso - SUEZ LNG)
  - 44. Offshore California: 1.2 Bcfd (OceanWay - Woodside Natural Gas)
  - 45. Offshore Florida: 1.2 Bcfd (Hoëgh LNG - Port Dolphin Energy)

Figure 1. Existing and Proposed North American LNG Terminals.

The large number of facilities listed in the figure, as compiled by the Federal Energy Regulatory Commission (FERC), has garnered the attention of a wide range of stakeholders potentially impacted by this significant scale of infrastructure development. Some of the stakeholders impacted, and their areas of interest, include:

LNG Development/Energy Companies: interested in the market for importing LNG as well as the status and activity of competing facilities.

Exploration and Development Companies: interested in the number and location of regasification facilities in order to determine how these facilities may interact with existing offshore oil and gas operations (drilling, production) as well as how these facilities may impact future natural gas supplies and prices.

Midstream Companies: interested in the potential business development opportunities these new sources of natural gas may have on gathering, transportation, processing, storage and fractionation.

Downstream Companies: Large energy users along the GOM are exceptionally interested in the potential new natural gas and natural gas liquids supplies these new LNG facilities may provide. This is particularly true for the region's very large petrochemical companies that rely heavily on low-cost feedstocks.

Local/State Government: interested in these major capital investments and the economic development implications these facilities may have for their communities.

Environmental Groups: interested in the potential impacts these facilities could have on the surrounding physical environment.

The purpose of this report is to examine the implications and potential impacts that LNG has for the GOM. This includes an examination of the impacts that LNG could have on existing production in the region, as well as the extensive infrastructure that has the potential to support, and be supported by, these new LNG regasification facilities.

## **1.2. Organization of the Report**

This report is organized into eight different sections including the introduction. Section 2 examines recent changes in natural gas markets that have facilitated the increase in LNG development in North America. This includes an examination of the recent pressures placed on both natural gas supply and demand in the U.S., as well as the impact these changes are having on industry and economies of the GOM Region.

The goals of Section 2 are to provide some context on LNG development for the U.S. and the GOM Region. This section shows that LNG liquefaction and regasification are not new technologies and that they have served important, albeit small roles in the U.S. natural gas market. Perhaps the most important topic addressed in this section is the growing importance that natural gas consumption has in the U.S. economy and how critically important low cost



supplies of natural gas are to some industrial sectors, like refining and petrochemicals, along the GOM.

Section 3 provides a primer on LNG facilities. This chapter discusses the nature of LNG, the historic experiences with LNG in the U.S., and the forecasted importance of LNG to the U.S. natural gas disposition.

A discussion on the physical nature of LNG, its properties, and how it compares to traditional, domestically produced natural gas has been provided. As will be shown in this section, LNG once gasified, differs very little from gas produced in the U.S. The imported gas however, will serve important needs and will be an important and necessary supplement to domestic supplies of natural gas.

Section 4 concentrates on LNG issues specific to the GOM. The GOM is home to some of the largest producers, as well as users, of natural gas in the U.S. While most Americans can easily identify Texas and Louisiana as the largest natural gas producers in the country, it is doubtful that they can identify the magnitude of their natural gas usage. Both states have large concentrations of refineries and petrochemical facilities that are considerable users of natural gas. This chapter will also highlight the considerable supporting energy infrastructure that is located in the region – including pipelines, gas processing and natural gas storage.

Section 5 examines a number of important regulatory and siting issues associated with LNG facilities. This section provides an overview of the important roles various federal and state agencies play in the permitting process.

The siting, permitting and licensing for a new LNG regasification facility is a multi-layered process that differs depending on where the facility is to be located. Offshore permitting processes will be described and compared to the process for facilities located onshore.

Section 6 concentrates on the one specific regulatory issue that has raised a number of early concerns about LNG: that is, safety. Being that LNG is transported via ships, albeit reinforced and safe ships, there is still concern for accidents, particularly close to shore. Fire is the biggest concern, regardless of source. However, since September 11 the concern for terror attacks has grown as well, which has resulted in many calls for extra protection around ships and LNG facilities. This is, indeed, one of the primary reasons for building offshore facilities.

Section 7 examines some of the more recent regulatory issues associated with the environmental concerns of different LNG configurations. This discussion surveys the range of positions on the open versus close-loop vaporization methods used to re-gasify LNG.

Lastly, Section 8 presents report conclusions, including the potential impact of increased LNG facilities in the GOM, as well as its competitive position versus GOM oil and gas production.

## **2. BACKGROUND ON U.S. AND REGIONAL GAS MARKETS, REGULATIONS, AND INSTITUTIONS**

### **2.1. Energy Crisis of the 1970s and Initial LNG Development**

Quite often, oil and gas are co-produced in various hydrocarbon basins in the U.S. and around the world. In some instances, wells can be primarily oil producing, in others primarily gas producing. Energy companies can and do drill wells that are expected to focus on primarily one of these hydrocarbons. Yet from a geological and engineering perspective, the close link between the production of these two hydrocarbons is well recognized.

While the development of crude oil and natural gas may be closely related, the pricing and regulation of these two energy commodities was unrelated until recently. Crude oil, since its early inception, was not “regulated” in the traditional sense, particularly as a public utility, or in association with one.<sup>1</sup> Natural gas, on the other hand, has experienced considerable regulatory oversight and was controlled and priced much differently from crude oil over the past 50 years. Natural gas has experienced price regulation since the 1950s.

Price regulation in the natural gas industry began with the U.S. Supreme Court decision of 1954 commonly referred to as the “Phillips Decision.” This decision ruled that natural gas producers that sold natural gas into interstate pipelines fell under the classification of “natural gas companies” as defined by The Natural Gas Act of 1938 and were subject to regulatory oversight by the Federal Power Commission (FPC), the main federal energy regulator at the time.<sup>2</sup> This meant that wellhead prices, defined as the rate at which producers sold natural gas into the interstate market, would be regulated in much the same manner as natural gas sold by interstate pipelines to local distribution companies (utilities), often referred to as “LDCs.”

The Supreme Court’s decision was based upon the finding that natural gas production was part of an overall integrated natural gas supply chain, which, as a public utility, was regulated. The Court found that it would be inconsistent to regulate the downstream portion of this supply chain (i.e., transportation and distribution) without appropriate prices controls on the upstream portion (i.e., production).

Historically, natural gas pipelines purchased natural gas supplies from producers. In turn, these pipelines sold the natural gas to either affiliated or unaffiliated LDCs. The prices charged to all parties in these transactions (pipelines to LDCs) were regulated by either federal or state utility regulators, depending upon whether the transaction involved interstate or intrastate commerce, respectively. Interstate commerce was governed by FPC regulation, and intrastate commerce was regulated by the state. This left no part of the industry, from wellhead to burner tip, unregulated.

---

<sup>1</sup>This is not to suggest that no form of regulation of crude oil prices occurred during much of the twentieth century. Some form of price regulation, through the regulation of output, did occur by the Texas Railroad Commission. However, this regulation was maintained to keep prices from falling, thereby protecting producers, not consumers. This is different from traditional regulation, typically practiced in the oversight of utilities, which attempts to keep prices from rising too high, thereby protecting consumers.

<sup>2</sup>The FPC is the predecessor agency to the Federal Energy Regulatory Commission or FERC.

During the period 1954 to 1973, natural gas demand rose considerably as LDCs expanded their retail operations of what was considered at that time to be a very economically-priced, reliable and widely available energy resource. LDCs significantly expanded their service territories during this period to provide natural gas space and water heating, as well as increased appliance uses for natural gas at the residential and commercial levels. Industrial and power generation customers also increased their natural gas usage during this period, though in many instances, they had considerable fuel flexibility to switch back and forth from crude oil fuels (like distillates) to natural gas. Natural gas was a popular fuel for large users given its affordable pricing, flexibility, and availability.

By the early 1970s, strong demand for a low-cost energy resource and strict price regulation, combined with a sudden crude oil shortage, led to a classic economic mismatch between supply and demand. Since prices were regulated during this period, producers had little incentive to expand natural gas-specific production, particularly when such production came at the expense of developing crude oil resources priced at globally competitive levels. Regulation of natural gas wellhead prices further reduced producer incentives to drill gas-specific wells and expand their natural gas production. As a result, the demand for this low-cost fuel quickly outpaced price-regulated production.

Basic economic principles would suggest that when prices are not allowed to clear markets for any basic good or service some other form of rationing must fill the void. In the case of regulated natural gas markets, this rationing came in the form of service interruptions and curtailments. From 1973 to 1978, there were a considerable number of natural gas interruptions. The curtailment during the winter of 1976-77 coupled with increasing regulations restricting usage resulted in a decreased interest in natural gas.

In 1978, Congress passed the National Energy Act (NEA) which was composed of five different statutes: the Public Utilities Regulatory Policy Act (PURPA); the Powerplant and Industrial Fuel Use Act (FUA); the Natural Gas Policies Act (NGPA); the National Energy Tax Act; and the National Energy Conservation Policy Act. The general purpose of the NEA was to ensure sustained economic growth during a period in which the availability and price of future energy resources was becoming increasingly uncertain. The two major themes of the legislation were to: (1) promote conservation and the use of renewable/alternative energy, and (2) reduce the country's dependence on foreign oil. The first two statutes associated with this legislation (PURPA and FUA) would have considerable implications for natural gas use for the next decade, while the third (NGPA) would start a process of gradual price decontrols that would result in a dramatic movement towards the complete restructuring of the natural gas industry.

PURPA began the process of establishing regulatory policies favorable to energy efficiency in residential, commercial, and industrial uses through what has eventually come to be referred to as “demand-side management” or “DSM.” PURPA outlined regulatory considerations for cost recovery of energy efficiency programs and other rate design applications (like time-of-use pricing) that would result in more efficient, or even reduced usage of energy (including natural gas) either directly or indirectly through lower power generation requirements. PURPA also stimulated industrial use of natural gas-fired generation through a more efficient energy use process referred to as cogeneration. The FUA, on the other hand, created restrictions that

reduced utility development of new natural gas fired-steam generation. This legislation also placed some new restrictions on industrial natural gas usage for boilers.<sup>3</sup>

The NGPA significantly impacted natural gas supply by providing phased decontrol of natural gas wellhead prices to stimulate greater domestic natural gas production. Most importantly, the NGPA attempted to stimulate new natural gas production by removing price regulations and setting a schedule for decontrol of most newly drilled wells by 1985. This new production was needed to meet the nation's growing need for low-cost and available energy. The NGPA had three main goals (NGSA, 2004):

- Create a single national natural gas market;
- Equalize supply with demand;
- Allow market forces to establish the wellhead price of natural gas.

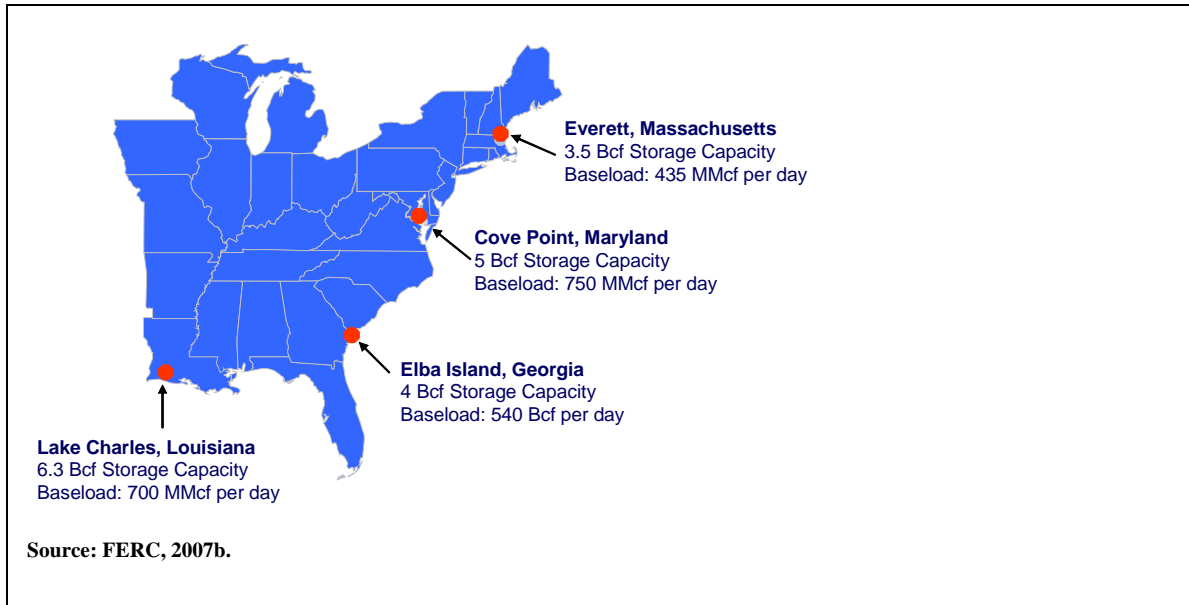
The deregulation of wellhead prices was completed with the Wellhead Decontrol Act of 1989. In addition, beginning in 1985, the Federal Energy Regulatory Commission (FERC) developed new regulations for interstate pipelines, which changed their role in the delivery of natural gas. At the same time, many state public utility commissions (PUCs) began to allow new competition for local distribution companies (LDCs) in supplying end users in local markets (U.S. Dept. of Energy, EIA, 2001).

## **2.2. LNG Development during the Period of Crisis**

The price controls and production shortages of the late 1960s led energy planners to look at alternative sources of natural gas to meet domestic needs. The crisis of the early 1970s provided the impetus for the first generation of LNG regasification facilities in the U.S. During this period, four different LNG facilities were developed in various locations in the eastern U.S., as shown in Figure 2.

---

<sup>3</sup>Many of these restrictions on power generation and industrial use of natural gas were repealed in 1987.



**Figure 2. U.S. LNG Terminals and Original Capacity.**

The first major LNG facility to import natural gas to the U.S. from foreign countries was constructed by Cabot LNG in Everett, Massachusetts in 1971.<sup>4</sup> The Everett facility had a storage capacity of 3.5 Bcf and a peak sendout capacity of 435 MMcf per day. The LNG imported at Everett helped to supply most of the gas utilities in New England as well as power producers and industrial users in the region.<sup>5</sup>

The construction of two more LNG regasification terminals, at Cove Point, Maryland and Elba Island, Georgia, followed in 1978. Consolidated Natural Gas Company partnered with the Columbia Gas System to build the Cove Point terminal. It was the largest of the four terminals with a storage capacity of 5 Bcf and peak send out capacity of 750 MMcf per day. Elba Island was built by Southern LNG, a part of the El Paso Corporation to supply natural gas to the growing population and industrial base of the southeastern U.S. The terminal had a storage capacity of 4 Bcf and peak send out capacity of 540 MMcf per day. Initially, all LNG deliveries to the U.S. came from Algeria. For Cove Point and Elba Island, the LNG was purchased from El Paso Corporation, which bought the LNG from Algeria's Sonatrach and delivered it in its own ships (Taylor, 2001).<sup>6</sup>

By 1979, U.S. LNG imports had peaked at around 250 Bcf, but soon fell precipitously as the deregulation of gas prices in 1978 stimulated domestic drilling, encouraged conservation, and

<sup>4</sup> Everett is located on the Mystic River and is part of the greater Boston metropolitan area.

<sup>5</sup> In September 2000, Tractebel acquired Cabot LNG and Cabot changed its name to Tractebel LNG North America LLC. Tractebel is the energy division of the French-based Suez Group. Tractebel is also the parent company of Distrigas of Massachusetts.

<sup>6</sup> In 1988 Consolidated sold its interest in Cove Point to Columbia who in turn sold the terminal to Williams in 2000. Dominion purchased Cove Point from Williams in 2002 for \$217 million. The Elba Island terminal is still owned and operated by El Paso Corporation.

reduced the need for alternative supply sources (Taylor, 2001). In addition, skyrocketing LNG costs after the 1978 Iranian revolution made LNG noncompetitive and deliveries from Algeria halted. The virtual overnight change in the economics of LNG regasification resulted in ceasing operations soon after opening in 1980. The Cove Point facility did not reopen until 1995, and Elba Island reopened in late 2001 after being mothballed for over 20 years. Cabot LNG (Everett) eventually renegotiated its contract and was able to import LNG at prices more competitive with local markets. The facility remained in operation due to its unique position in a heavily concentrated market center where demand was high. The facility did, however, suffer from chronic low utilization for close to two decades.

Despite the decline in LNG cost-effectiveness, the construction of the fourth terminal in Lake Charles, Louisiana was completed in 1982. This terminal had a storage capacity of 6.3 Bcf and a peak sendout capacity of 700 MMcf per day. Developed and owned by CMS Trunkline LNG, the facility closed within one year after its opening, and it did not return to commercial operation until 1989.

The development of the original four regasification facilities during the past energy crisis highlights a number of important challenges for these capital-intensive investments. All of the projects were developed during a period in which natural gas supplies were anticipated to be constrained and expensive. Further, many of the projects were developed on a spot market basis without considerable cost-recovery certainty that would secure the assets through long-term contracts. Policies, markets and the underlying economics of LNG importation changed relatively quickly, and left these facilities stranded in the marketplace for almost 20 years.

One of the larger, more unexpected changes which occurred during this period was the considerable economic contraction of natural gas demand, which prior to that point in time, appeared to be growing without bounds. The period between 1979 and 1983 represented the first example of the now commonly used euphemism of “demand destruction” in the U.S. During this period, natural gas demand fell by 3.4 Tcf, or over 17 percent. The decline in natural gas demand was most pervasive for industrial customers who saw their loads contract by over 18 percent (1.3 Tcf). Much of this contraction was created by industrial facilities shutting down and moving plant operations to places of the world where labor and energy were less expensive. The remaining share of this contraction was associated with residential and small commercial decreases in usage.

The overall increase in supply – created primarily through new government policies deregulating natural gas prices and the overall decrease in demand, created by price elasticity impacts and economic contractions, led to what has commonly been referred to as the natural gas supply “bubble”. This bubble would exist for virtually twenty years and would ensure adequate amount of low cost reliable supplies of domestically produced natural gas.

This bubble would prevent any significant utilization of existing LNG import facilities much less the development of any new facilities. It would take twenty years, and a long-term policy agenda of further deregulating natural gas markets, in order for these facilities to resume their economic usefulness and contribution to U.S. natural gas supplies.

### **2.3. The Evolution of Competition**

Since 1978, natural gas markets began to reflect an ever-increasing degree of competition as initiated by the NGPA. After 1978, the FERC began the process of promulgating a series of rules based upon the authority and direction set by the NGPA that was designed to form more competitive natural gas markets, encourage greater efficiency, and lower costs to consumers. The common theme in many of these orders was the process of industry “unbundling,” commonly referred to as “restructuring.” This unbundling process challenged the notion that efficient natural gas market organization was defined by complete vertical integration (as supposed in the Phillips Decision). These orders, therefore, began the process of separating production operations from transportation and distribution, and ultimately, transportation from distribution.

In 1984, FERC, which has jurisdiction over interstate energy commerce only, issued Order 380, its first major competition initiative that eliminated minimum charges for pipeline customers. The policy was initiated under the premise that with minimum charges eliminated, customers would be free, and have incentives to shop for new supplies of natural gas. One year later, FERC issued Order 436, requiring pipeline companies to provide transportation service to all customers on an open and non-discriminatory basis -- a regulatory regime referred to as “open access.” Open access would allow customers to use the interstate pipeline system as a type of highway, for which they paid a fee, to move alternative sources of natural gas. Within two years, 75 percent of all interstate throughput was transported rather than resold. Finally, in the spring of 1992, FERC issued Order 636, which went one step further with its open access provisions by requiring pipelines to unbundle all of their services and functionally separate merchant natural gas sales from transportation services.

Order 636 was perhaps one of the most significant bellwether regulations promulgated by the FERC in promoting the competitive goals of the NGPA. The regulation completely changed the natural gas market structure and introduced an aspect of competition and merchantability that had not existed in prior years. Transportation and commodity sales were separated under the new rules and pipeline companies were required to treat all users of its system on an equal and non-discriminatory basis. This open access treatment extended to not only transportation functions, but natural gas storage as well.

FERC’s open access provisions were not restricted to ongoing transportation and storage services. New pipeline connections and expansions were subject to what is referred to as “open season” requirements which gives unaffiliated third parties the ability to interconnect to a pipeline capacity addition or expansion. The goal of this policy was to expand the scope and interconnectivity of the U.S. pipeline system, making a larger number of buyers and sellers available to one another. This openness, however, would create challenges for large, capital-intensive and concentrated capacities associated with a LNG regasification facility. Industry argued that some modification to these open access requirements would be necessary if new facilities were to be developed. In the new policy, FERC terminated open access requirements for LNG import terminals in an attempt to encourage more LNG site development.

In 2002, FERC issued what became known as the “Hackberry decision.” This decision granted preliminary approval, the first in over 20 years, for the construction of Dynegy’s Hackberry LNG facility located in Hackberry, Louisiana.<sup>7</sup> The order allowed the developer to provide services to its affiliates under rates and terms mutually agreed upon (i.e., market-based), rather than under regulated cost-of-service rates. It also exempted the developer from having to provide open access service. The regulatory treatment was unique since it defined a LNG import facility as a supply source rather than as part of the transportation chain.

The Hackberry decision marked a significant departure from previous FERC practice. FERC specifically stated that it hoped the new policy would encourage the construction of new LNG facilities by removing some of the economic and regulatory barriers to investment. The Hackberry decision also made onshore terminal proposals competitive with proposed offshore LNG facilities, which under amendments to the 1974 Deepwater Port Act, do not have to operate on a common carrier basis or provide access to third parties. While FERC’s decision represents a lighter-handed regulatory regime for marketing operations at onshore LNG terminals, other regulations, such as those involving siting LNG facilities and open access to newly developed transportation and storage assets supporting the LNG investment, were unchanged by this new policy (U.S. Dept. of Energy, EIA, 2005a).

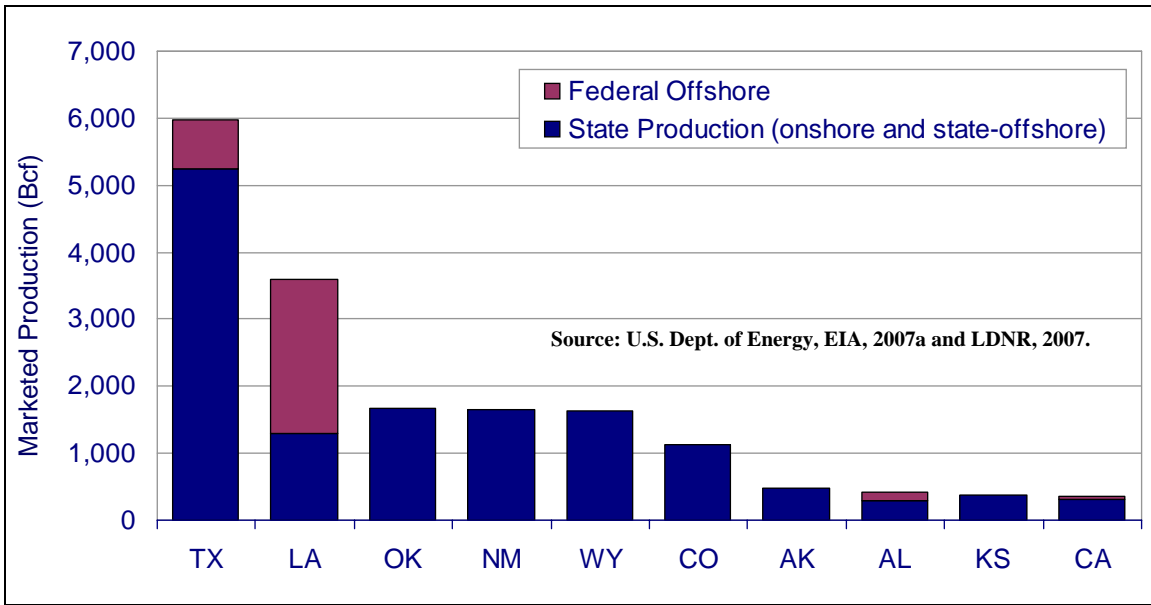
#### **2.4. LNG and Regional Natural Gas Production**

The GOM Region has one of the largest and most comprehensive energy economies in the world. Energy activities span across all areas, from production, processing, and transportation, to distribution and sales. Further, the GOM is also one of few regional economies around the globe that has such a pervasive degree of horizontal and vertical linkages between all types of energy infrastructure and activities. Natural gas is an important and integral part of the GOM energy economy. As seen in Figure 3, Texas and Louisiana are the largest two producers of natural gas in the U.S.

---

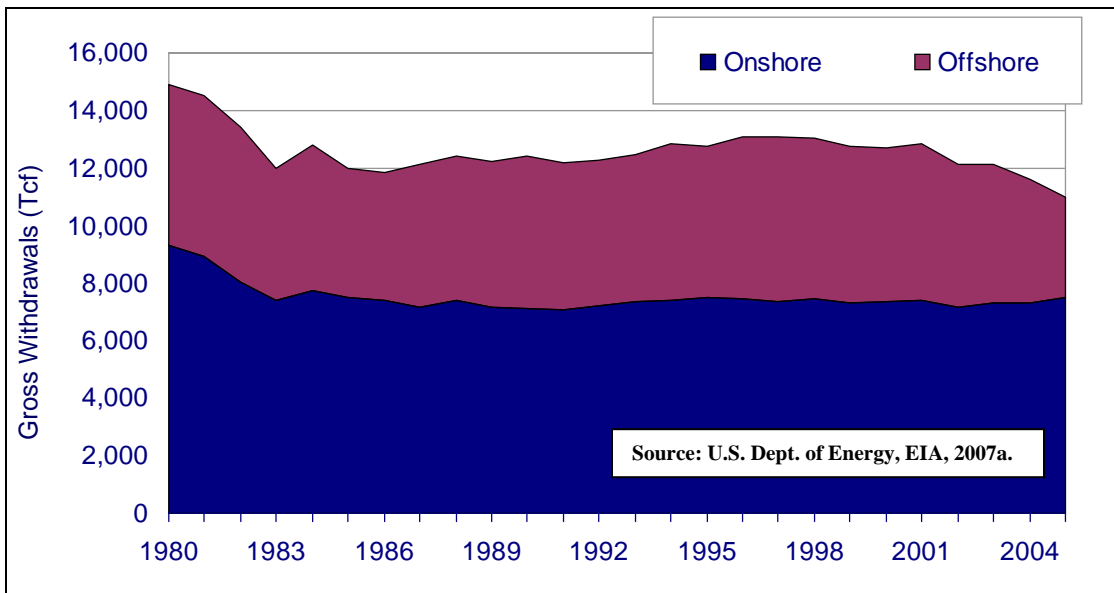
<sup>7</sup>The facility is now called Cameron LNG and is owned by Sempra Energy.





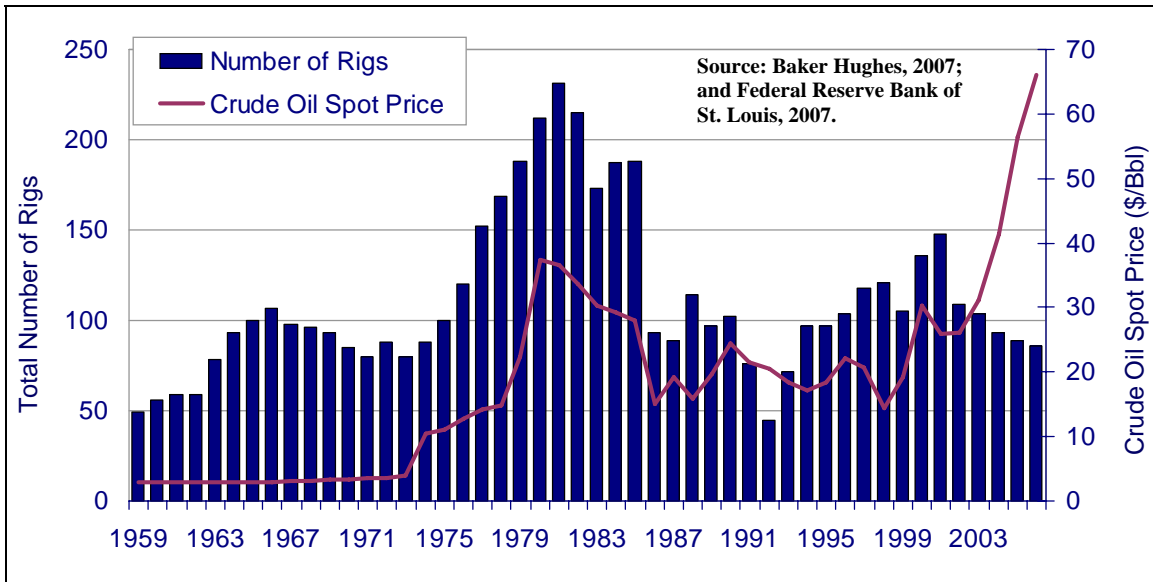
**Figure 3. U.S. Natural Gas Production by State, 2005.**

Further, the importance of natural gas production from the offshore GOM, relative to total domestic supplies, has been growing considerably over the past two decades. Figure 4 shows the relative increase in offshore GOM natural gas production relative to total U.S. production over the past several decades.



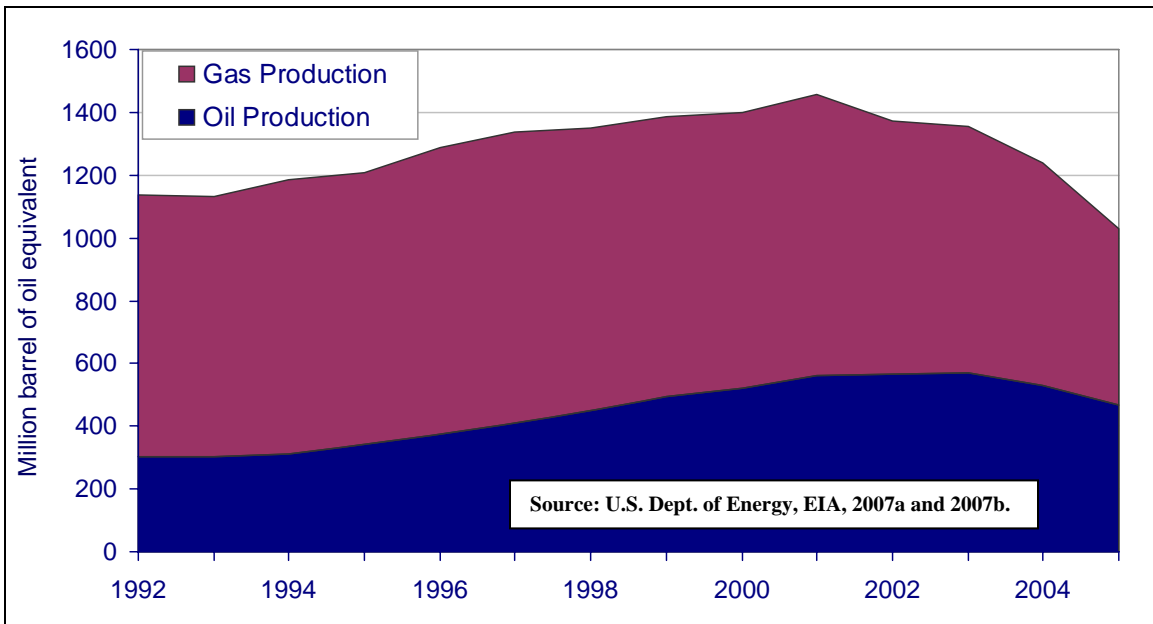
**Figure 4. GOM Natural Gas Production, Onshore and Offshore, 1980-2005.**

Typically, activity in the GOM is driven by changes in energy prices, particularly crude oil. Figure 5 shows the historic changes in the number of rigs operating in the GOM relative to crude oil prices. There was a strong historic relationship between the two series until about 2001, when crude oil prices skyrocketed and the number of active drilling rigs in the GOM steadily decreased.



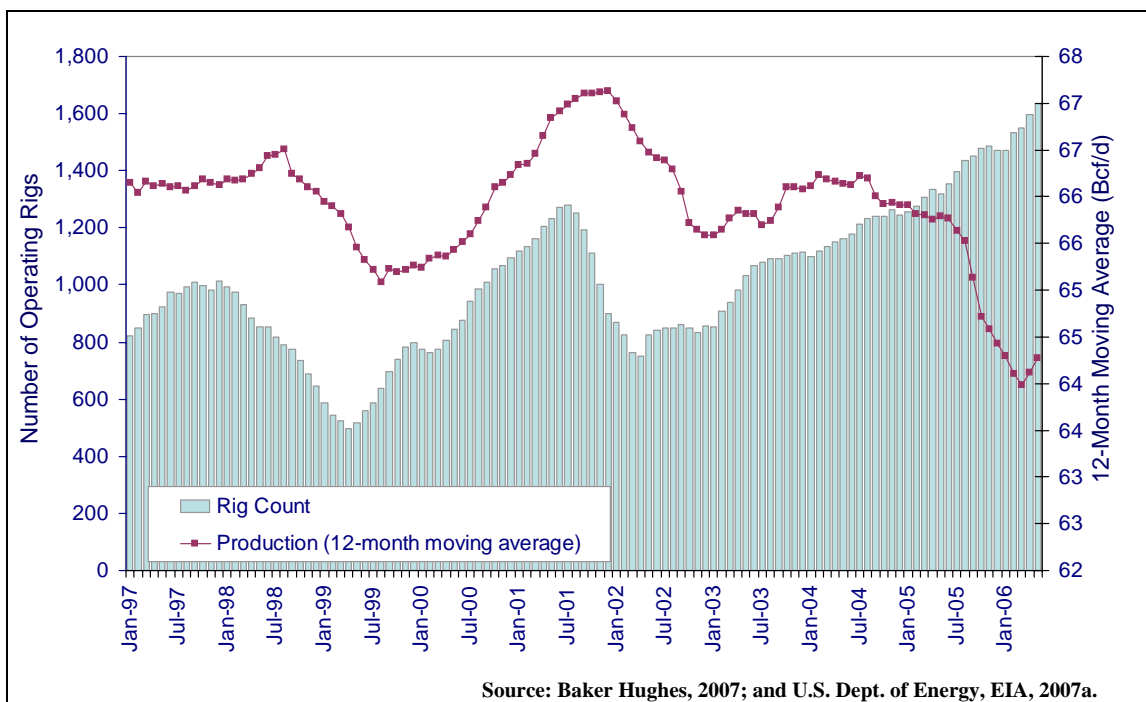
**Figure 5. Active GOM Drilling Rigs and Crude Oil Prices, 1959-2006.**

Production from the GOM was relatively positive throughout most of the 1990s, as both production from crude oil and natural gas increased. However, Figure 6 shows that overall production in the GOM decreased over the past several years for both crude oil and natural gas. These decreases in natural gas production are one of the most important factors impacting the development of LNG regasification facilities in the GOM.



**Figure 6. GOM Oil and Gas Production, 1992-2005.**

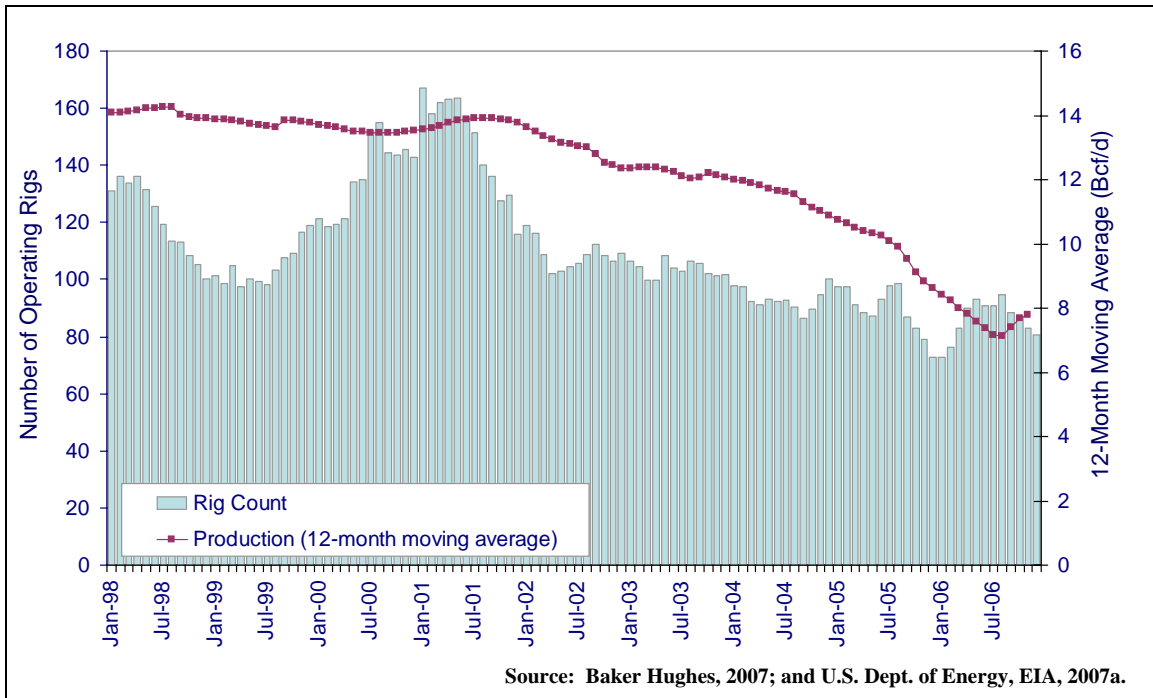
The decrease in overall natural gas production paralleled the decrease in overall drilling productivity. Figure 7 shows the relationship between U.S. drilling rigs and U.S. production on a 12-month moving average. Two clear trends are noticeable in the figure. The first trend is associated with natural gas drilling and production activity during the natural gas price run-up in the winter of 2000-2001. The industry responded almost immediately with a 158 percent increase in the number of active gas rigs throughout the U.S. The lagging production response, while somewhat muted, was still positive with an overall three percent increase in gas production following the increase in drilling activity.



**Figure 7. U.S. Drilling Activity and Production, 1997-2006.**

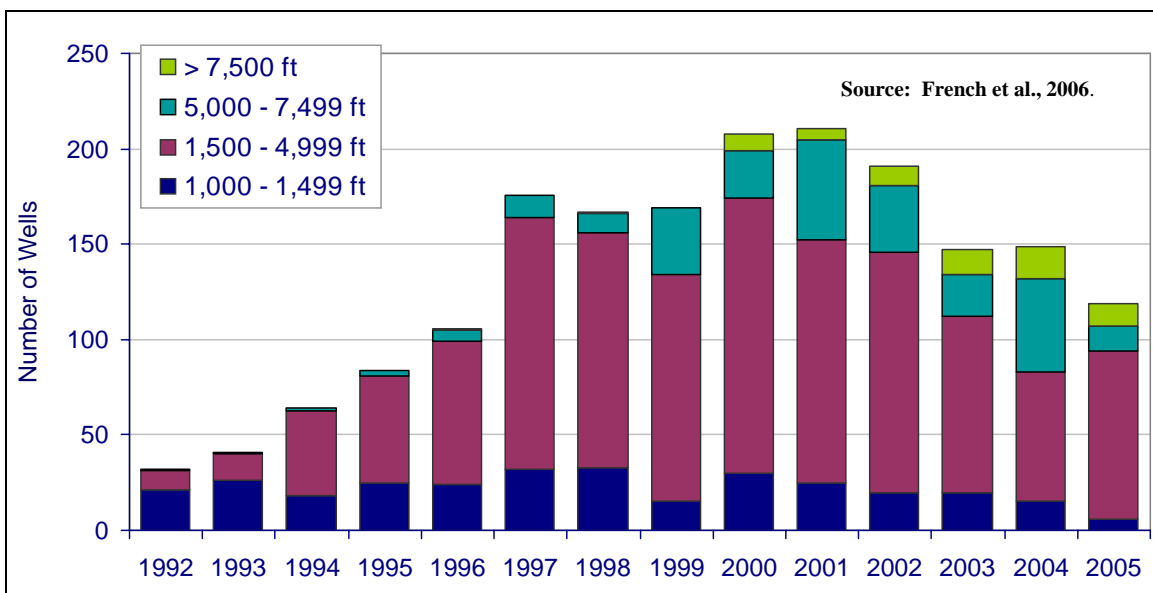
The second and more concerning trend from a natural gas market perspective was the lack of production response to the dramatic increase in post-2002 drilling activity. Active drilling rigs have increased by over 130 percent since the spring of 2002 while production has slowed by over four percent over the same period. While tropical activity in 2004 (Ivan) and 2005 (Dennis, Katrina, Rita) have contributed to these decreases, there are still some fundamental questions regarding the overall drilling productivity in the U.S. over the last four years.

Figure 8 shows the trends for GOM-specific activity. The 12-month moving average has fallen steadily since 1998, as has the GOM rig count.



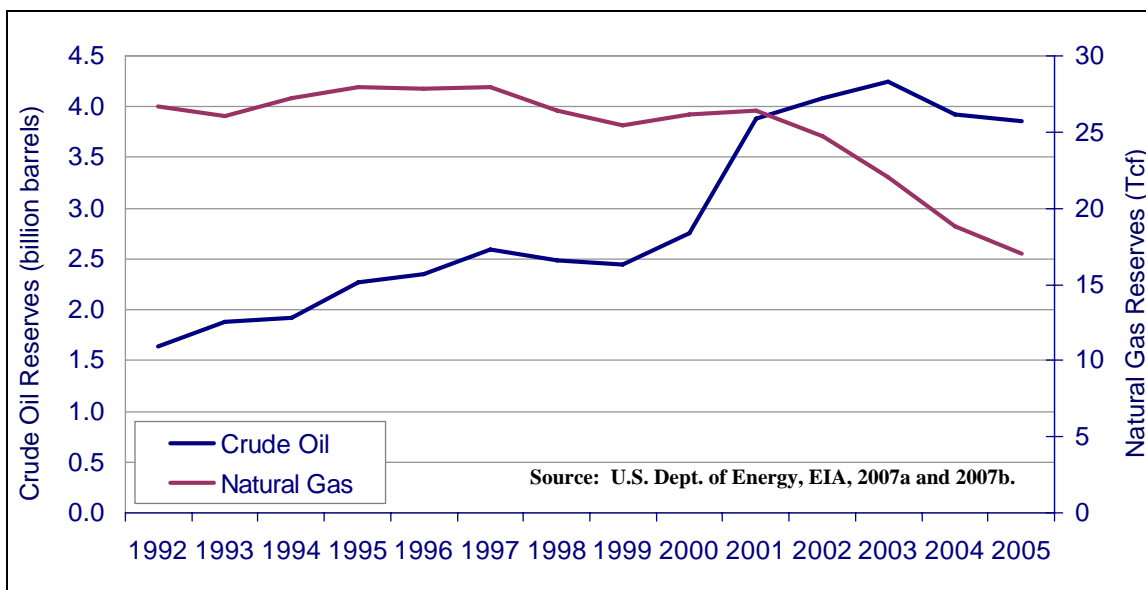
**Figure 8. GOM Drilling Activity and Production, 1998-2006.**

The nature of production and potential future production mix between oil and gas is also shifting in the GOM, creating additional implications for LNG regasification development in the region. Over the past decade, conventional wisdom held that a considerable amount of future natural gas resources would come from the GOM, particularly deepwater development. While deepwater development has clearly increased over the past several years (Figure 9), it is not clear that this activity is going to revitalize natural gas markets on its own.



**Figure 9. All Deepwater Wells Drilled in the Gulf of Mexico, by Water Depth.**

The purpose of drilling activity, onshore and offshore, is to secure reserves for future production opportunities. Throughout most of the 1990s, U.S. reserve additions were growing. However, starting in 2000-2001, those trends started to shift. Crude oil reserves have increased dramatically since that time period, while natural gas reserves have virtually plummeted. The marked decrease in reserves, particularly relative to oil, raises serious questions about the GOM's ability to meet the large and increasing gas usage requirements in the near future.



**Figure 10. U.S. Proved Oil and Natural Gas Reserves, 1990-2005.**

One concern regarding LNG regasification activity is that lower cost natural gas supplies imported from other producing basins around the world could lower overall U.S. natural gas prices, thereby displacing domestic natural gas production. While possible, it is unlikely that LNG imports will actually displace GOM production given recent trends provided in the prior figures. Natural gas production, drilling, productivity, and reserve additions have all been decreasing over the past six years and it seems these negative trends have been driven more by other exogenous factors than by LNG development.

As will be discussed in subsequent chapters of this report, LNG is more likely to serve as a supplement, but not a substitute, for GOM production and overall domestic U.S. natural gas production. The degree to which LNG will serve as a supplement to domestic production will be determined by future production and reserve addition trends on the supply side, and end-user demand requirements for natural gas.

## 2.5. LNG and Regional Natural Gas Consumption

The significance of natural gas consumption in the GOM Region is not always recognized. The region is home to two of the largest and most intensive natural gas applications in the U.S. economy: power generation and industrial usage. As noted earlier, natural gas has become an increasingly important fuel for power generation use. Power generators use natural gas for boilers, which creates steam, which, in turn, is used to power large generators. Alternatively, natural gas can be burned directly in a combustion turbine that directly spins a generator to create

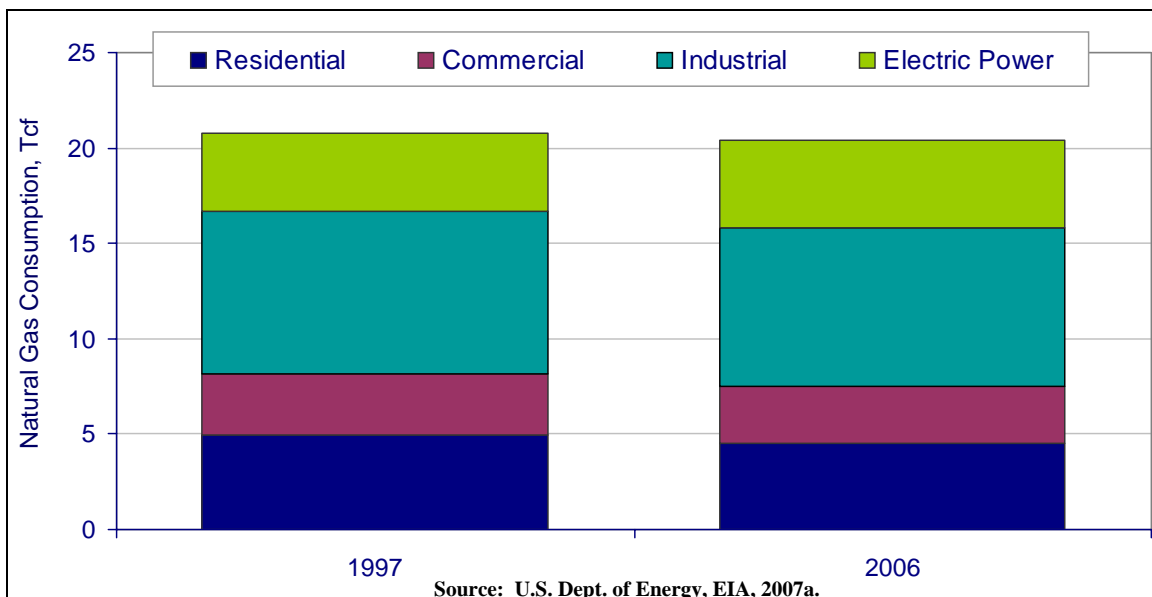
electricity. Given the affordability of natural gas and its close proximity to the producing basin, utilities across the region have historically used natural gas as a fuel for power generation.

Between 1999 and 2003, over 205,000 megawatts (MWs) of new power generation capacity was constructed in the U.S. One MW of capacity can be thought of being able to produce enough electricity to power 250 to 500 homes. At least 80 percent of that capacity is natural gas-fired and has typically been limited to intermediate and peaking applications, not baseload. Further, these new highly efficient technologies have a downside in their very limited opportunities for fuel switching due to air emission concerns and equipment sensitivity.

Building natural gas-fired generators appeared to make sense in the late 1990s considering that:

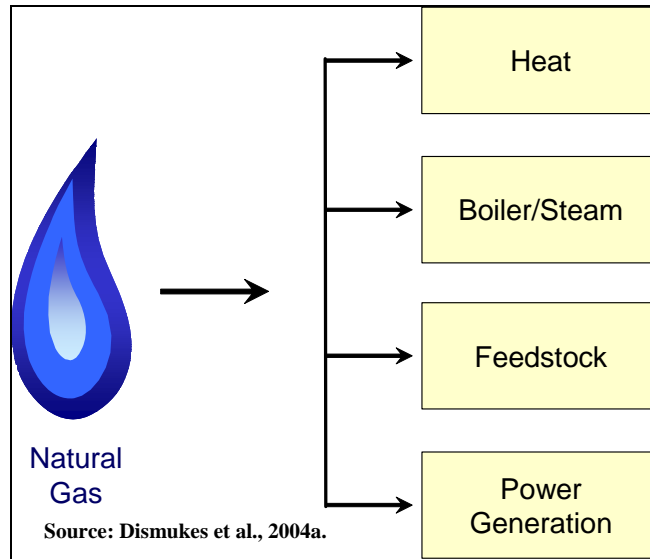
- Gas-fired combined cycle plants are highly efficient, particularly relative to the extensive number of older gas and oil-fired utility steam generators still in service;
- Gas-fired combined-cycle plants are more environmentally friendly than oil or coal generators as well as older natural gas-fired steam generation;
- New gas-fired generators can be permitted and built in a relatively quick 24 to 36 month period; and
- Prior to 2000, natural gas prices hovered around \$2.50 per thousand cubic feet (Mcf) and those prices were expected to remain below \$3.00 per Mcf for the foreseeable future, making gas-fired generation very economical.

This extensive development and use of these new generators contributed to the increase in natural gas prices seen over the past six years. In fact, as seen in Figure 11, power generation demand for natural gas accounts is the only consuming sector that has increased its usage of natural gas over the past decade – accounting for a 54 percent increase.



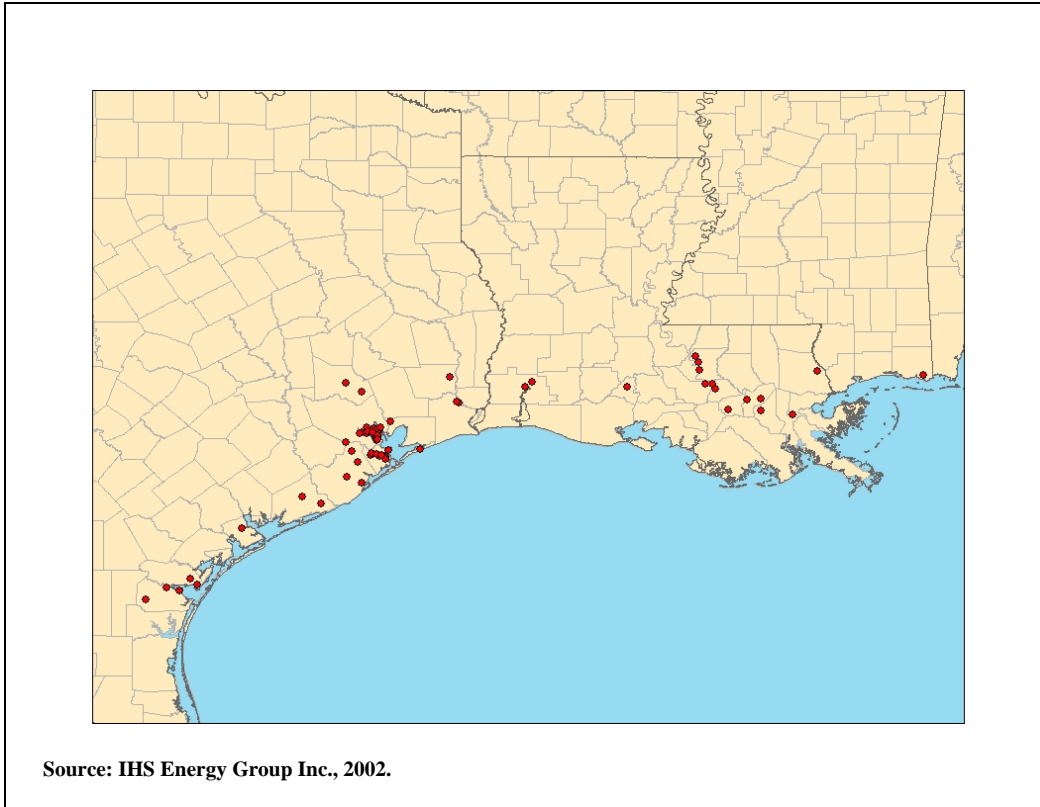
**Figure 11. Changes in Natural Gas Demand.**

Industrial uses of natural gas are equally important and more complex. Figure 12 provides an outline detailing processes in which natural gas can be used at an industrial facility. This includes using natural gas to fuel furnaces used to create process heat; boilers used to create processed steam; electricity generation (in a fashion similar to utilities); and feedstock. The feedstock use of natural gas is one of the unique and defining characteristics of industrial use of natural gas along the Gulf Coast and is primarily associated with the large number of regional petrochemical facilities.



**Figure 12. Industrial Natural Gas Usage.**

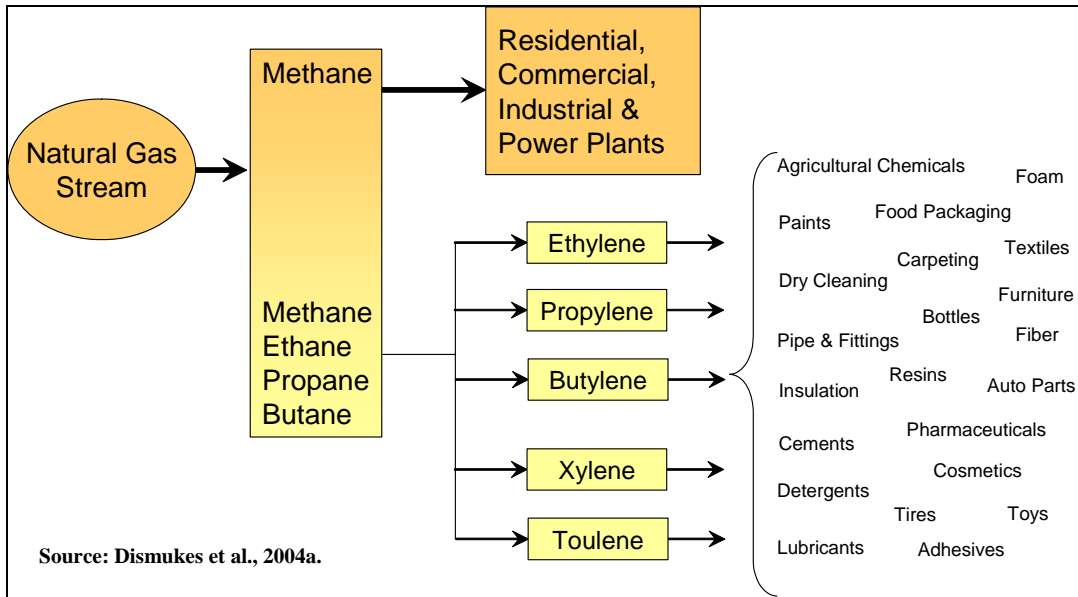
The petrochemical industry is heavily concentrated in coastal Texas, South Louisiana, and various counties along the Alabama, Mississippi, and Florida coast. Figure 13 presents a map of all the operational petrochemical plants in the GOM Region. In many ways, these petrochemical facilities can be thought of as “gas processors” since they take raw natural gas and natural gas liquids and use them to create products much like a refinery takes crude oil and converts it into a variety of products like gasoline, distillates, kerosene, and other products. Thus, the profitability of these industries, as will be discussed in greater detail later, is highly dependent on natural gas input costs.



**Figure 13. GOM Region Petrochemical Facilities.**

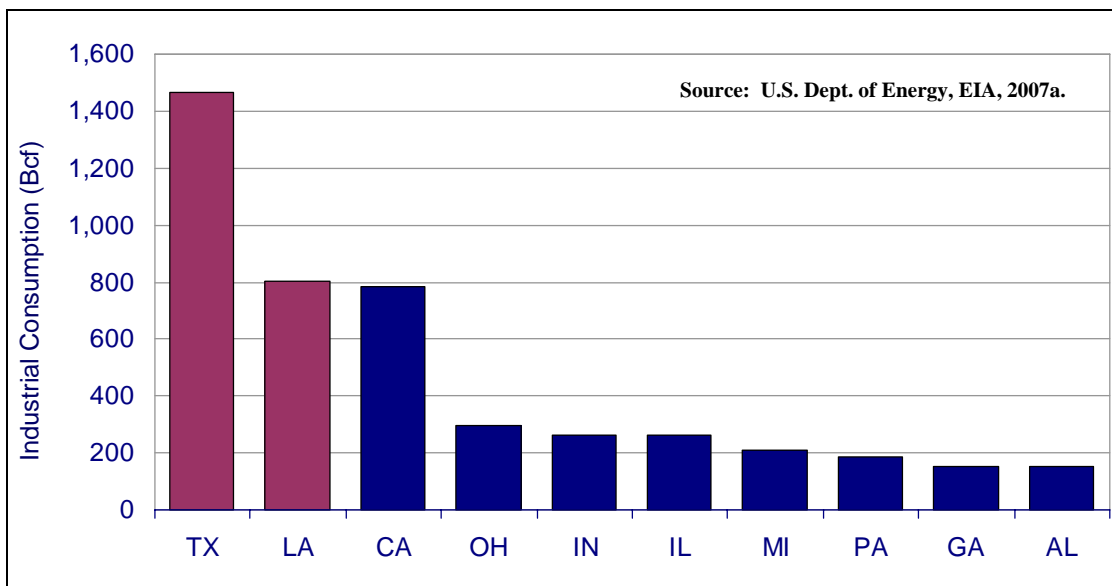
Figure 14 highlights the various inputs used to create a variety of petrochemical products used in everyday household, business, and industry applications. The entire natural gas stream, including liquids like ethane, propane, and butane, are used to create a variety of products like pharmaceuticals, paints, carpets, textiles, tires, and solvents, among other things. In fact, the chemical facilities in the GOM states account for approximately 18 percent of all U.S. value added in total manufacturing, 12 percent of all manufacturing wages, and 7 percent of all manufacturing employment.





**Figure 14. Natural Gas Components and Petrochemical Products.**

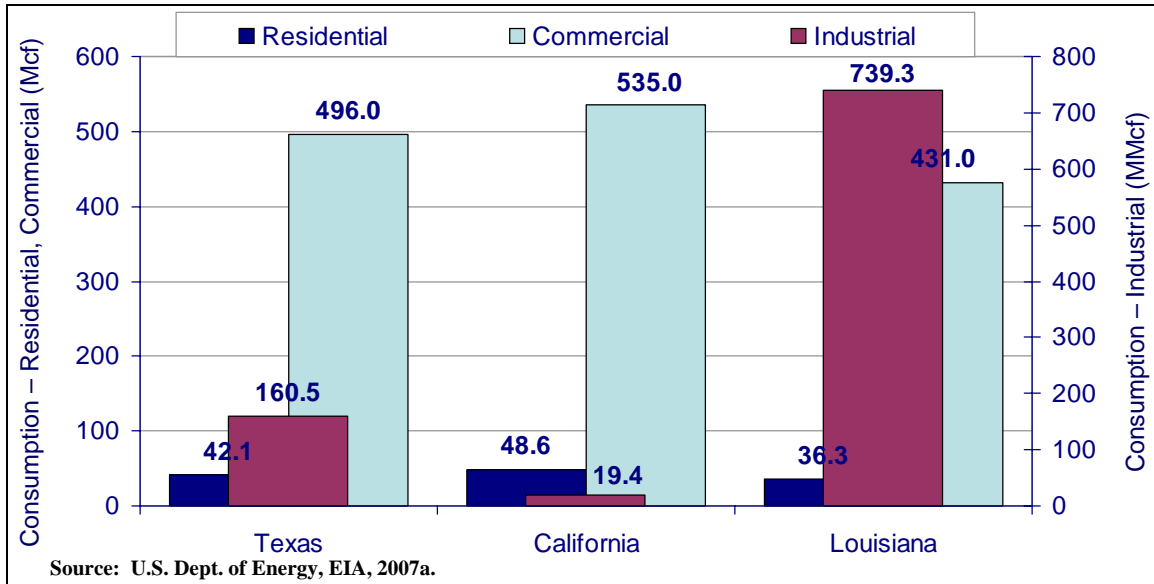
A tremendous amount of natural gas is used in the GOM to keep power generation and industrial applications going. As shown in Figure 15, in 2004, Texas and Louisiana are two of the largest industrial users of natural gas in the U.S.



**Figure 15. Industrial Consumption of Natural Gas, 2005.**

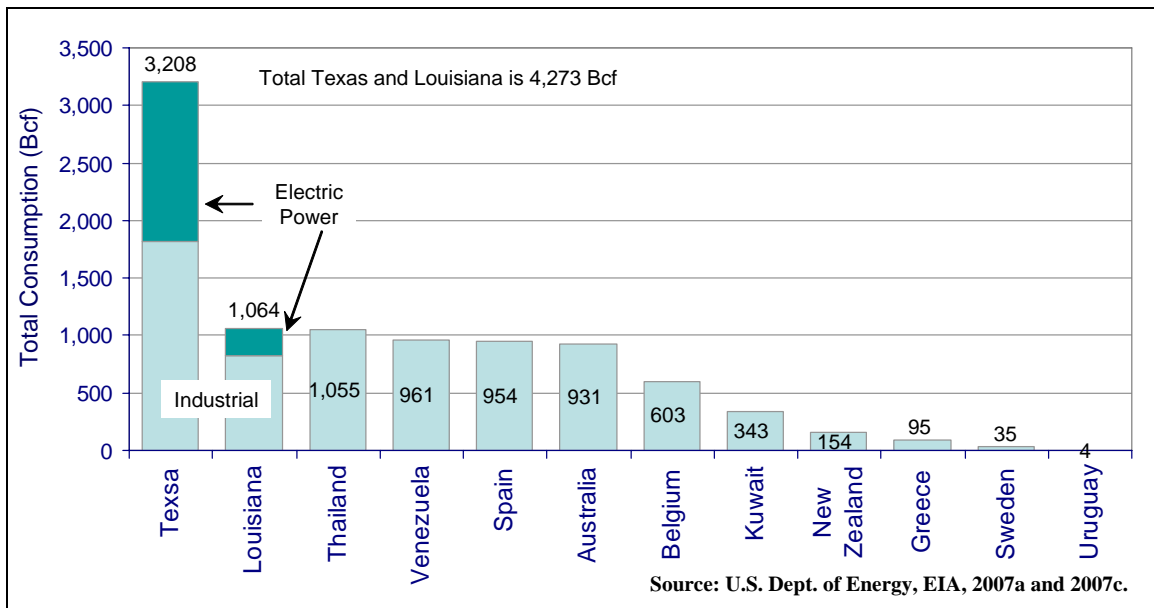
The importance of natural gas for industrial feedstock purposes in the GOM is clearly evident when comparing per customer usage figures of the top three natural gas usage states (Texas, California, and Louisiana). As seen in Figure 16, residential and commercial per customer usage is relatively close for each of the three states. However, industrial per customer usage is considerably different. A typical industrial customer in California, for instance, uses close to 20 Bcf of natural gas per year, compared with the 160 Bcf per year in Texas, and 739 Bcf per year

in Louisiana. The difference between California's industry and that of Louisiana and Texas alludes to the systemic difference in usage between the two regions. The difference in per customer usage between Texas and Louisiana shows that Louisiana's industrial economy is much less diversified than Texas' and exceptionally more natural gas dependent.



**Figure 16. Per Customer Natural Gas Consumption by Sector, 2005.<sup>8</sup>**

In fact, Louisiana's use of natural gas for industrial and power generation purposes alone is greater than that of many countries as evidenced in Figure 17. In total, industries of the GOM states surpass the total usage of all the industrial nations of the world.

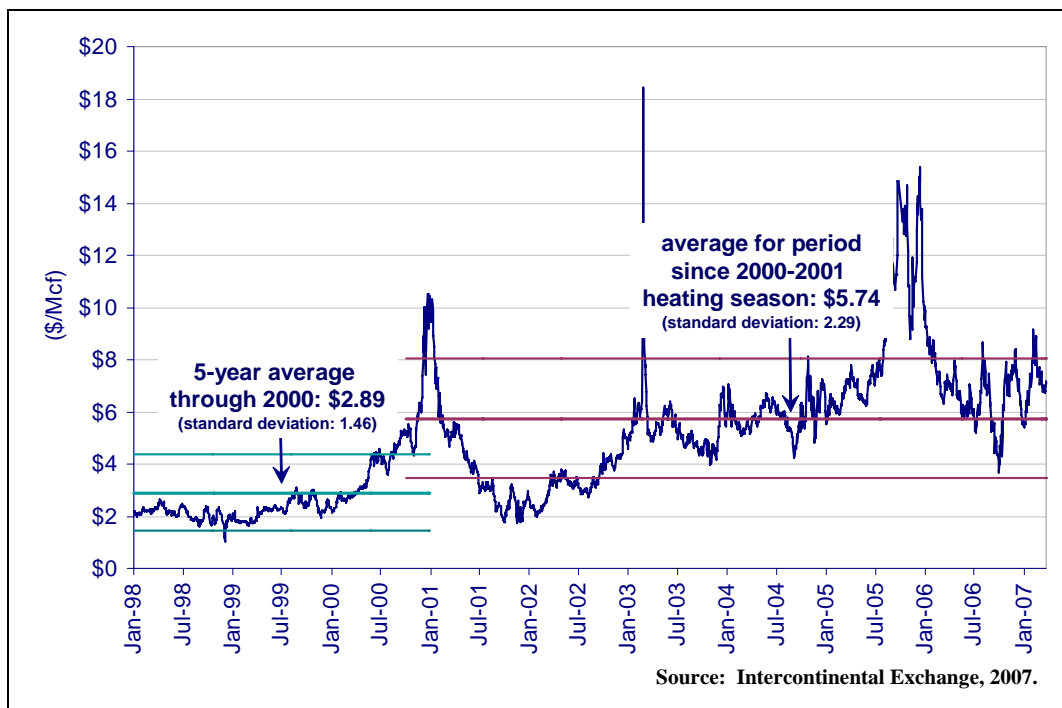


**Figure 17. Natural Gas Consumption, Texas, Louisiana and World Comparison, 2004.**

<sup>8</sup> This excludes Alaska, which has the highest industrial consumption on a per customer basis.

## 2.6. Implications of Natural Gas Price Changes and U.S. Industrial Activity

The change in natural gas prices over the past 5 years is one of the clearest indicators that structural changes have and continue to occur in the U.S. economy. The winter of 2000-2001 is commonly accepted as the transition period for natural gas markets. As seen in Figure 18, natural gas prices prior to the 2000-2001 winter were relatively low, averaging some \$2.78 per Mcf for the prior five-year period. The structural pressure building in natural gas markets as discussed in earlier subsections, resulted in an explosion of prices during the winter of 2000 to 2001 when prices peaked at a high of \$10.50 per Mcf.



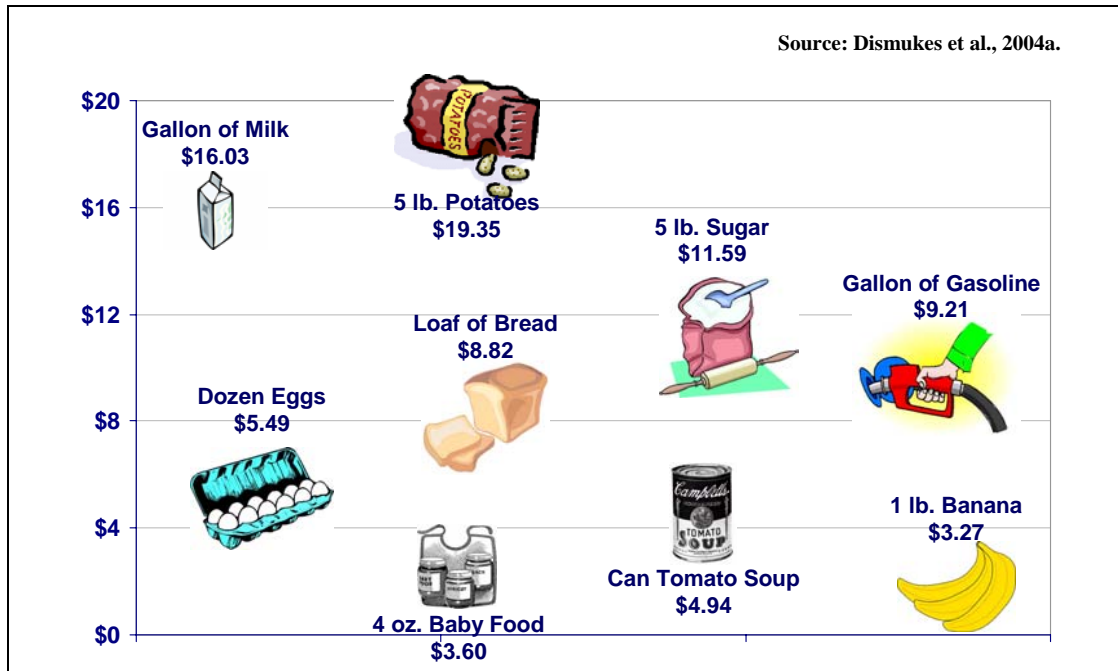
**Figure 18. Daily Henry Hub Prices, 1998 to Present.**

During the balance of 2001, prices fell as quickly as they increased. By late summer 2001, prices fell to below \$2.00 per Mcf. The sudden decrease had many questioning whether the change in gas markets was a temporary anomaly or a harbinger of a profound structural shift. Trends since the winter of 2001-2002 proved the structural shift school of thought to be correct.

With few exceptions, natural gas prices have continued to increase since January 2002. The winter of 2002-2003 saw new record price levels set with natural gas prices exceeding \$18 per Mcf. The increase in natural gas prices, coupled with increased global competition and an economic recession around the 1999-2000 period, have all reeked havoc on industrial activity in general, in particular, industrial activity along the GOM.

Figure 19 helps put the increase in natural gas prices to industry into perspective. If households faced the same degree of increase in the price of their everyday purchases with natural gas industry prices, households would be paying some \$16.03 for a gallon of milk, \$5.49 for a dozen of eggs, and \$8.82 for a loaf of bread. For industries like manufacturing, natural gas is as

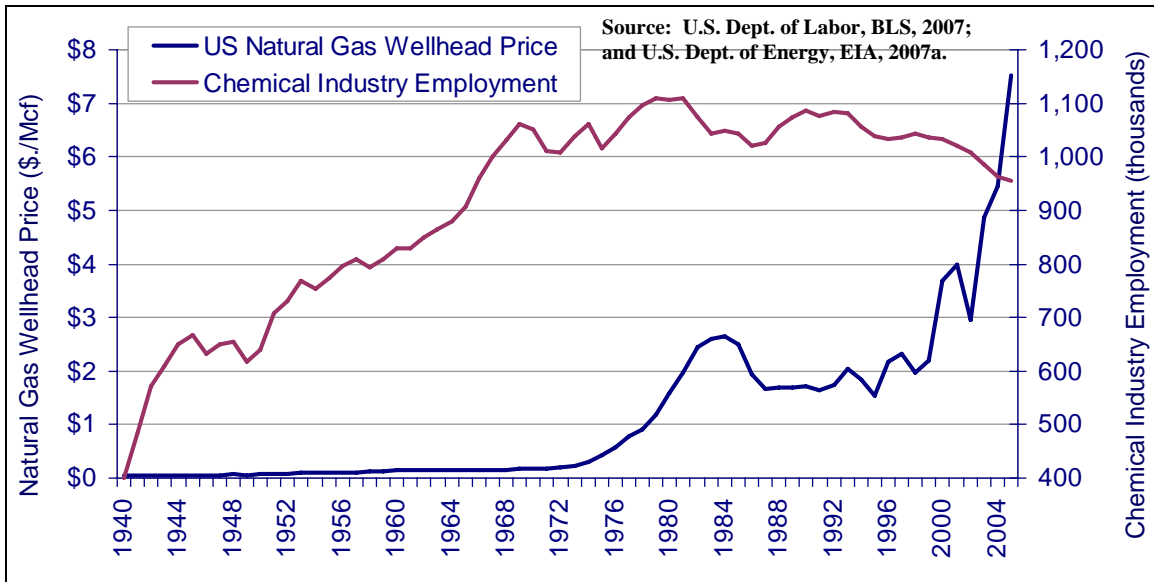
important to the production process as these groceries are to the daily maintenance of most households. Hence the price escalation has been dramatic on their manufacturing operations.



**Figure 19. Comparison of Consumer Product Price to Natural Gas.**

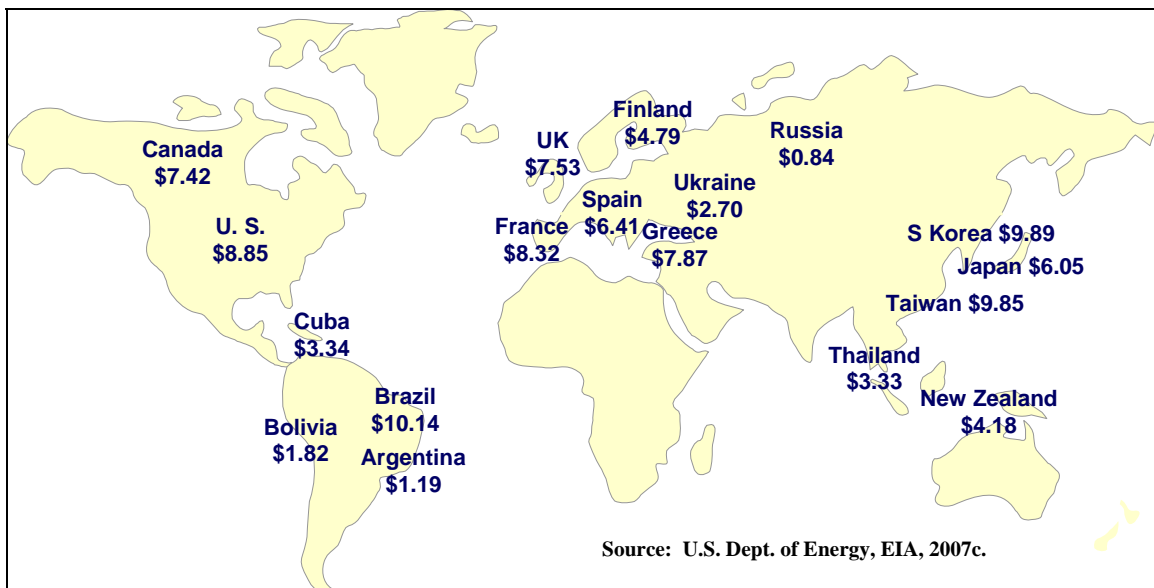
It is important to keep in mind that the chemical industry in the U.S., and the GOM Region in particular, grew from a region based on low-cost, highly available natural gas supplies. The emergence of the petrochemical industry was, in large part, to process and develop what was historically (prior to the 1980s) a relatively low-value energy commodity.

To illustrate this point, Figure 20 compares the growth of chemical industry employment with historic natural gas prices. For over thirty-five years (1940-1976), chemical industry employment growth was considerable and based upon natural gas supplies priced at less than 50 cents per Mcf. The first historic run-up in prices was met with the first significant decrease in chemical industry employment as many firms began to export operations to overseas markets. Today, the process of moving these industrial production operations is more pervasive, given the lower labor and energy costs.



**Figure 20. Historic U.S. Average Wellhead Price and Chemical Industry Employment, 1940-2005.**

The global mobility of many manufacturing processes has given rise to new concerns about high energy prices and industrial retention. Figure 21 shows a comparison of natural gas prices across the globe to U.S. prices in 2004. Several countries, particularly in Latin America, and Russia, have gas prices considerably lower than the U.S. Even China has natural gas prices at least comparable to high U.S. levels. China is an important high growth market for most international manufacturing companies.

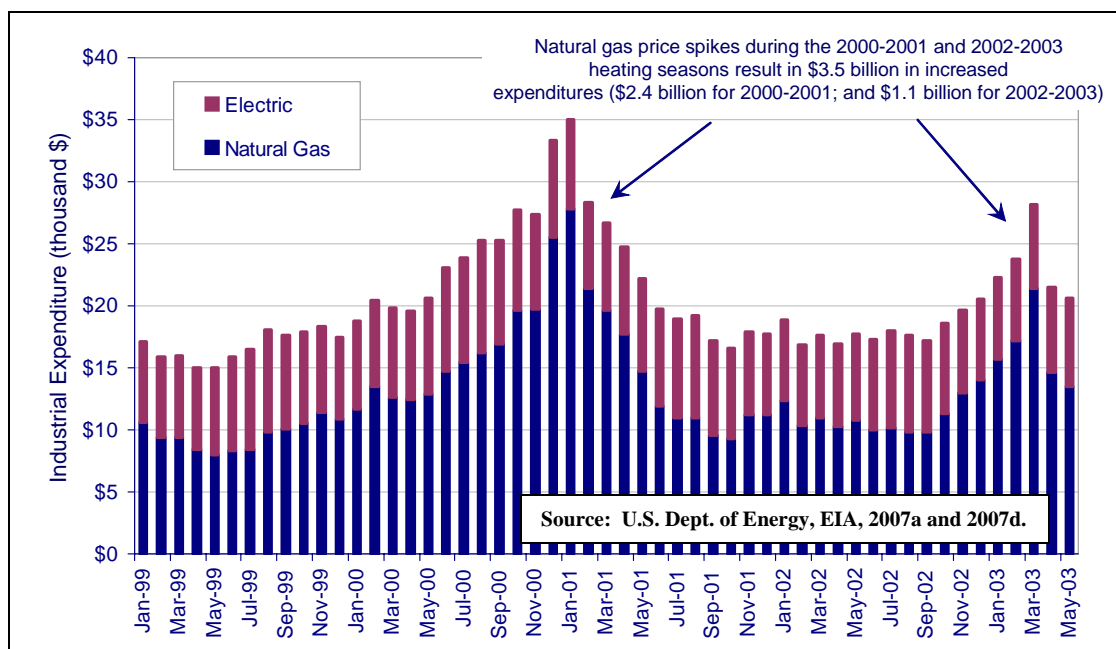


**Figure 21. Natural Gas Costs Around the World, 2005, \$/MMBtu.**

Two important questions about investment location decisions arise in looking at international natural gas cost comparisons:

- (1) Why should manufacturers continue to pay high prices for natural gas when comparable facilities could be developed in other countries where input costs are lower?
- (2) Why should manufacturers continue to make investments in slower growth, mature U.S. markets when they can pay the same (or slightly less) for natural gas in China, which is a high growth, high profitability market that will allow them to pass these costs along to consumers?

The increase in the natural gas cost is not the only negative impact felt by industry over the past several years. As noted earlier, natural gas has been the fuel of choice for new power generation investments. Every year, more electricity is generated from natural gas than from coal, nuclear, and other fuels. As the cost of natural gas increases, so too does the price of electricity. Figure 22 shows U.S. industry paid some \$2.4 billion and \$1.1 billion more than average on their total utility costs during the natural gas price run up of the winter 2000-2001, and the even larger run up in 2002-2003, respectively.<sup>9</sup>



**Figure 22. Average Monthly Expenditures by Industrial Customers in U.S. for Natural Gas and Electric, 1999-2003.<sup>10</sup>**

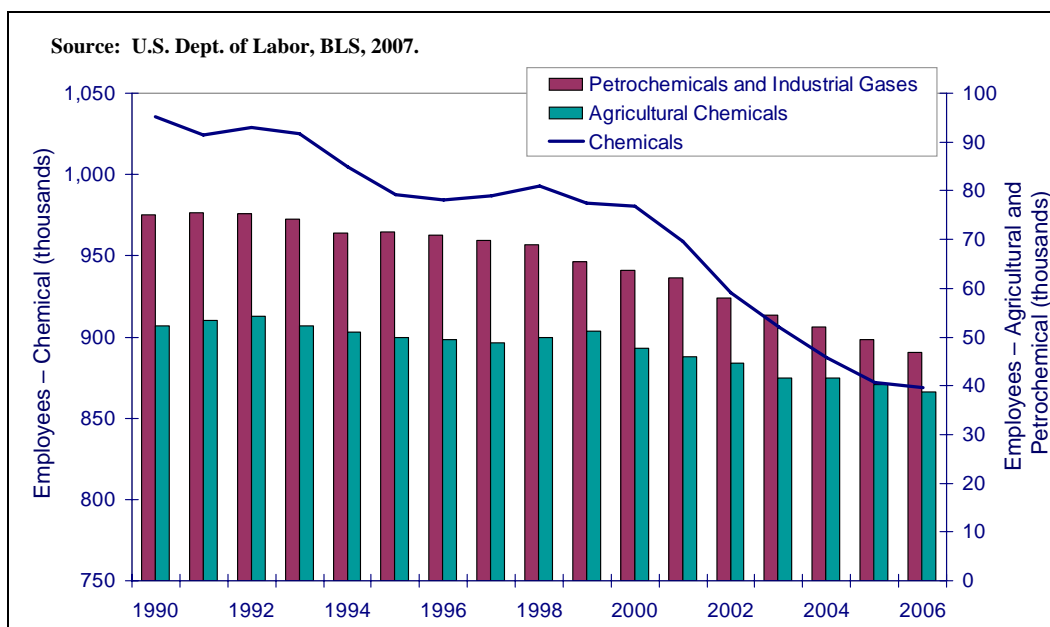
These increases in energy costs have considerably impacted U.S. industry. Figure 23 shows overall employment numbers for the chemical sector, as well as two important sub-sectors highly dependent on natural gas commodities as feedstocks: petrochemicals and agricultural chemicals.

<sup>9</sup>Utility costs comparisons are based upon the prior five-year averages for both estimates.

<sup>10</sup> Number of customers used to calculate expenditures is annual average; 2003 natural gas expenditures based on estimated number of customers.

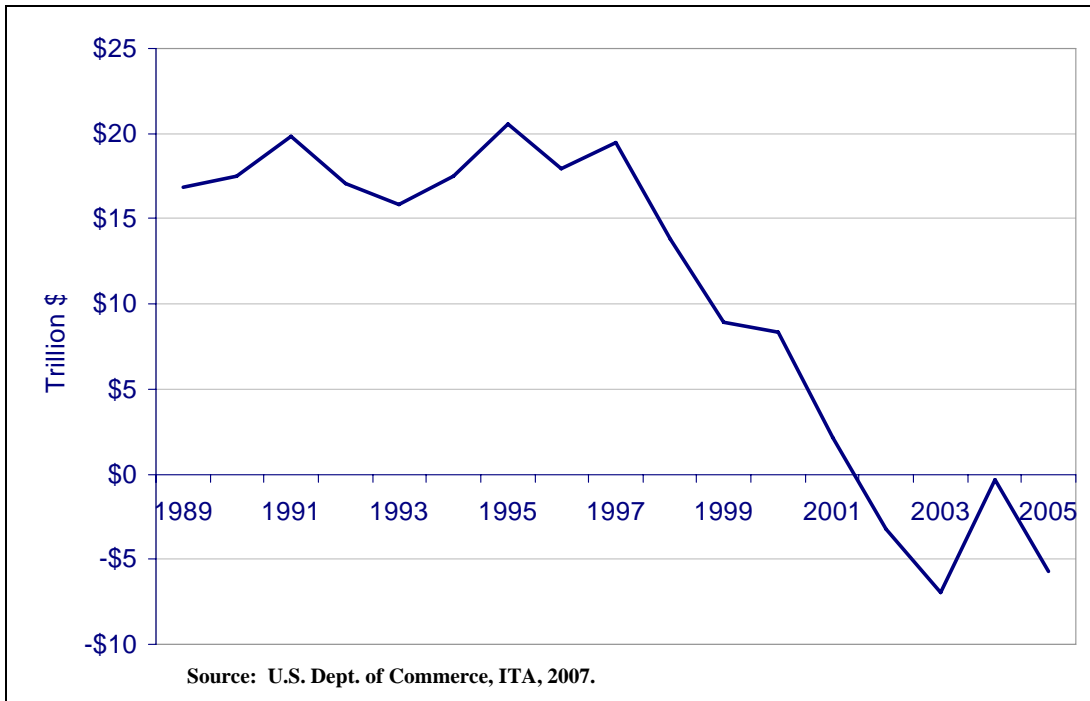
In his comments before the U.S. Senate Committee on the Environment and Public Works, American Chemistry Council (ACC) President Jack Gerard stated that natural gas costs for the industry alone rose from \$7.5 billion in 1999 to over \$30 billion in 2005 (Gerard, 2006). These increases have put exceptional strain on chemical industry performance and, more importantly, employment trends over the past several years.

Figure 23 illustrates the dramatic shift in chemical industry employment since 2000-2001, the year in which natural gas prices began their first surge. The petrochemical industry alone saw a loss of some 1,600 jobs from 2000 to 2001, and another 4,200 jobs in 2001 to 2002. Agricultural chemicals, the most dramatically-impacted of all those in the chemical sector, saw 7,500 lost jobs since 2000, a 21 percent decrease from its 1999 level. While there has been a recent pick up in jobs in 2006, overall industry employment levels are significantly lower than their 1998 levels.



**Figure 23. Employment in Chemical, Fertilizer and Petrochemical Industry in the U.S.**

Perhaps one of the most telling statistics about the impact that increased natural gas prices, in conjunction with other factors, has had on the U.S. chemical industry is its changing competitive position. Figure 24 shows that between 1989 and 1997, chemical industry net exports (exports less imports) ranged between \$17 and \$20 trillion per year. Global competition and a U.S. recession helped to reduce those exports dramatically from 1998 to 1999. The deterioration of the U.S. chemical net import position temporarily slowed in 1999 to 2000, but high gas prices in that year pushed the trend into a sharp second period of decline. By 2002, the U.S. chemical industry became a net importer, as opposed to net exporter, of chemical industry products, and has remained a net importer since that time.

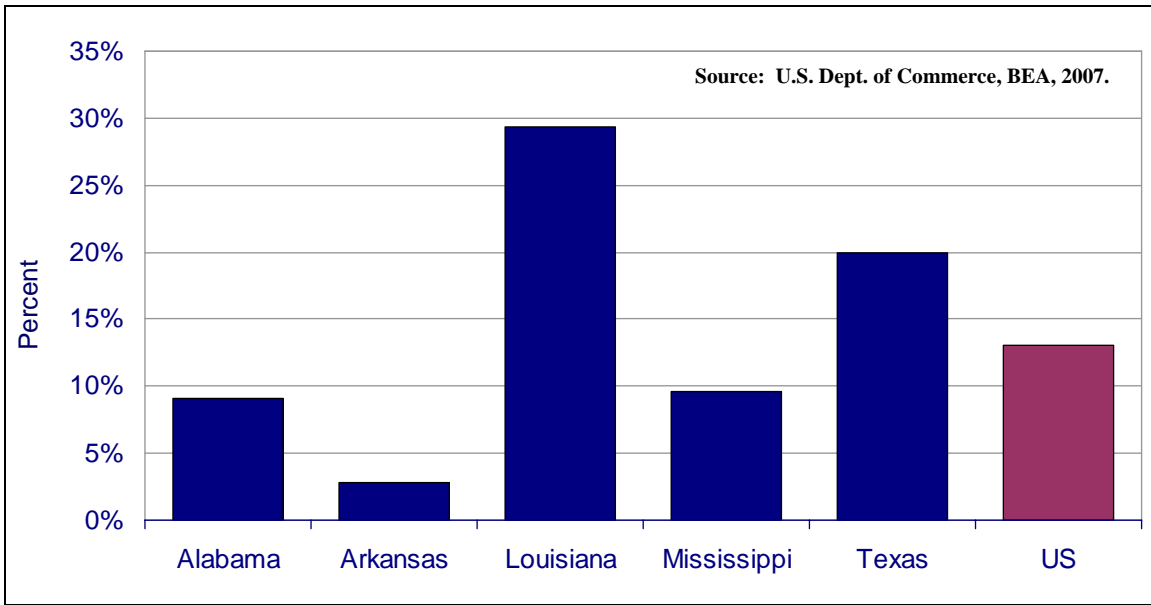


**Figure 24. Value of Net Exports of Chemicals (NAICS 325), 1989-2005.**

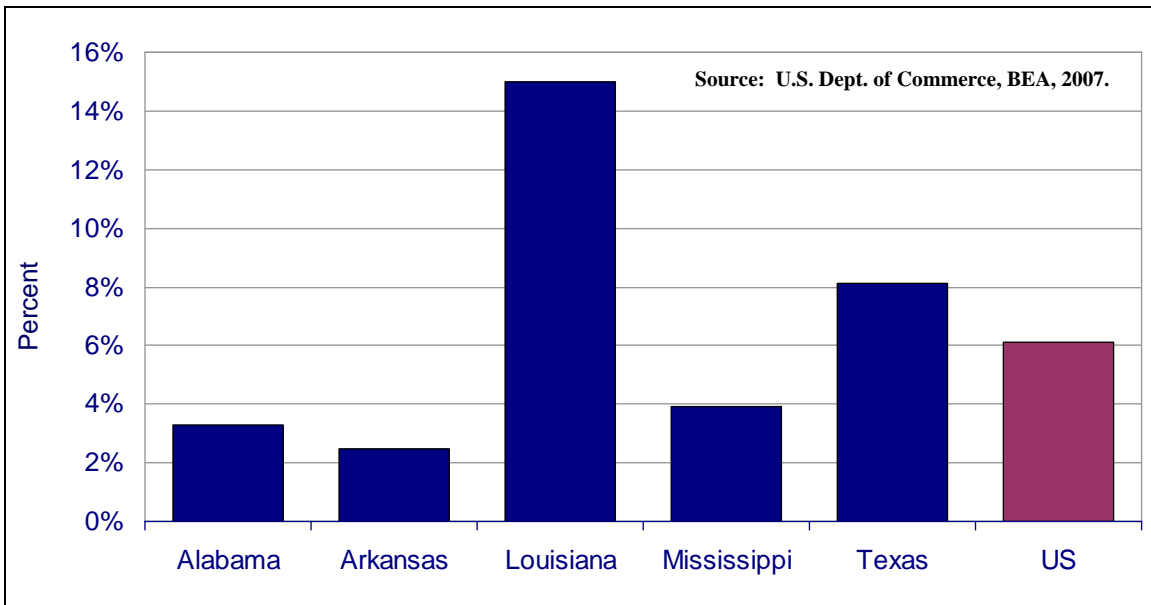
### **2.7. Implications of Natural Gas Price Changes on GOM Industrial Activity**

Recent increases in natural gas prices have resulted in comparable, negative impacts on GOM industrial activity. The importance of the chemical industry in the region is highlighted in Figure 25. This figure shows the share of chemical industry value added as a percentage of all manufacturing value added for each GOM state. Figure 26 provides a comparable regional comparison on an employment basis. The relatively high dependence that Louisiana has on its chemical sector employment, relative to overall industrial activity should be especially noted.





**Figure 25. Chemical Industry Portion of State GDP, 2004.**



**Figure 26. Chemical Industry Employment as a Percent of Total Manufacturing Employment, 2005.**

Louisiana industries are estimated to have spent almost \$3.4 billion in energy costs in 2002, \$2.2 billion of which was spent on natural gas. The three largest industrial energy-use sectors were paper and allied products, chemicals and allied products, and petroleum and coal products, with expenditures of over \$2.3 billion in gas costs alone in 2002 (Dismukes et al., 2004b).

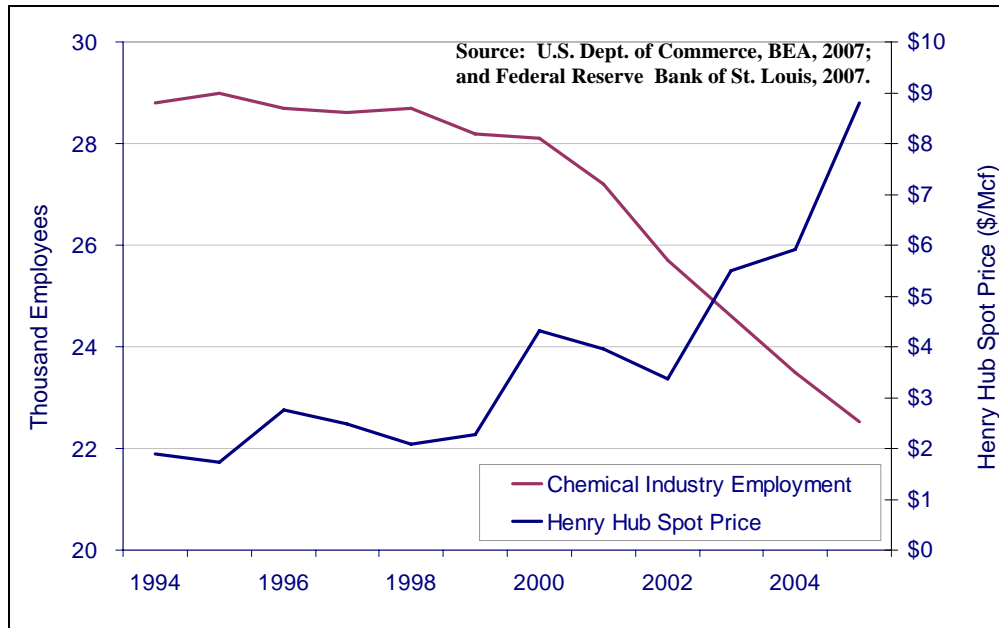
**Table 1**

**Louisiana Industrial Natural Gas and Electricity Usage and Expenditures, 2002**

SIC	Natural Gas		Electric	
	Consumption (Bcf)	Expenditures (million \$)	Consumption (MWh)	Expenditures (million \$)
20 Food and Kindred Products	5.14	\$ 17.3	316,729	\$ 14.0
22 Textile Mill Products	1.06	\$ 3.6	77,584	\$ 3.4
23 Apparel & Textile Products	0.02	\$ 0.1	6,677	\$ 0.3
24 Lumber and Wood Products	3.11	\$ 10.4	258,232	\$ 11.4
26 Paper and Allied Products	26.32	\$ 88.3	6,067,359	\$ 268.0
27 Printing & Publishing	0.04	\$ 0.1	38,682	\$ 1.7
28 Chemicals and Allied Products	544.76	\$ 1,828.6	21,626,306	\$ 955.3
29 Petroleum and Coal Products	65.75	\$ 220.7	6,639,046	\$ 293.3
30 Rubber & Misc. Plastic Prods.	0.26	\$ 0.9	377,472	\$ 16.7
31 Leather & Leather Products	-	\$ -	1,167	\$ 0.1
32 Stone, Clay & Glass Products	2.95	\$ 9.9	110,470	\$ 4.9
33 Primary Metal Industries	3.29	\$ 11.0	650,060	\$ 28.7
34 Fabricated Metal Products	0.84	\$ 2.8	83,661	\$ 3.7
35 Machinery & Computer Equip.	0.20	\$ 0.7	69,427	\$ 3.1
36 Electric & Electronic Equip.	0.45	\$ 1.5	1,029,210	\$ 45.5
37 Transportation Equipment	1.46	\$ 4.9	228,950	\$ 10.1
38 Instruments & Related Products	0.00	\$ 0.0	685	\$ 0.0
39 Misc. Manufacturing Industries	0.00	\$ 0.0	417	\$ 0.0
<b>Total</b>	<b>655.65</b>	<b>\$ 2,200.8</b>	<b>37,582,134</b>	<b>\$ 1,660.1</b>

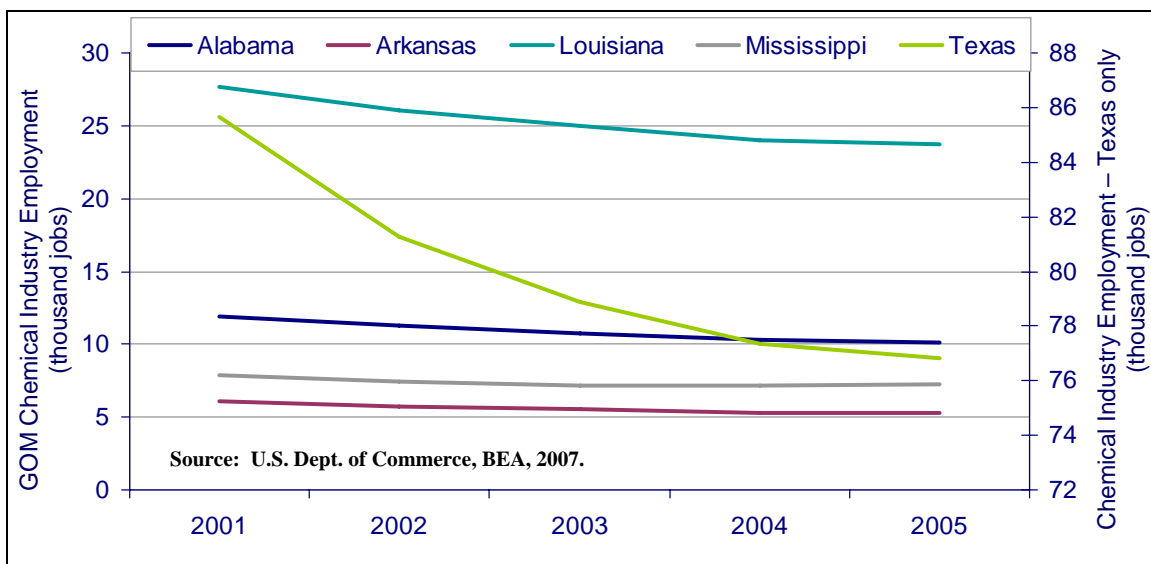
Source: Dismukes et al., 2004b.

Figure 27 focuses on activity in the Louisiana economy alone, and shows the strong relationship between chemical sector employment and natural gas prices. Two axes have been provided in this graph: on the left-hand side is total Louisiana chemical sector employment, on the right side are average natural gas wellhead prices. The inverse relationship between natural gas prices and employment has been evident since 2000, when annual average gas prices increased dramatically and employment levels fell in an equally impressive manner. In that year, gas prices increased by 80 percent while employment fell by 4 percent.



**Figure 27. Henry Hub Spot Price and Louisiana Chemical Industry Employment, 1994-2005.**

Figure 28 shows the cumulative job losses in the chemical sector for each of the GOM states since 2000. Overall, some 16,000 chemical sector jobs were lost in the GOM states since the run-up in natural gas prices of 2000. Louisiana accounts for 24 percent of these total losses while 55 percent of the losses are attributed to Texas.



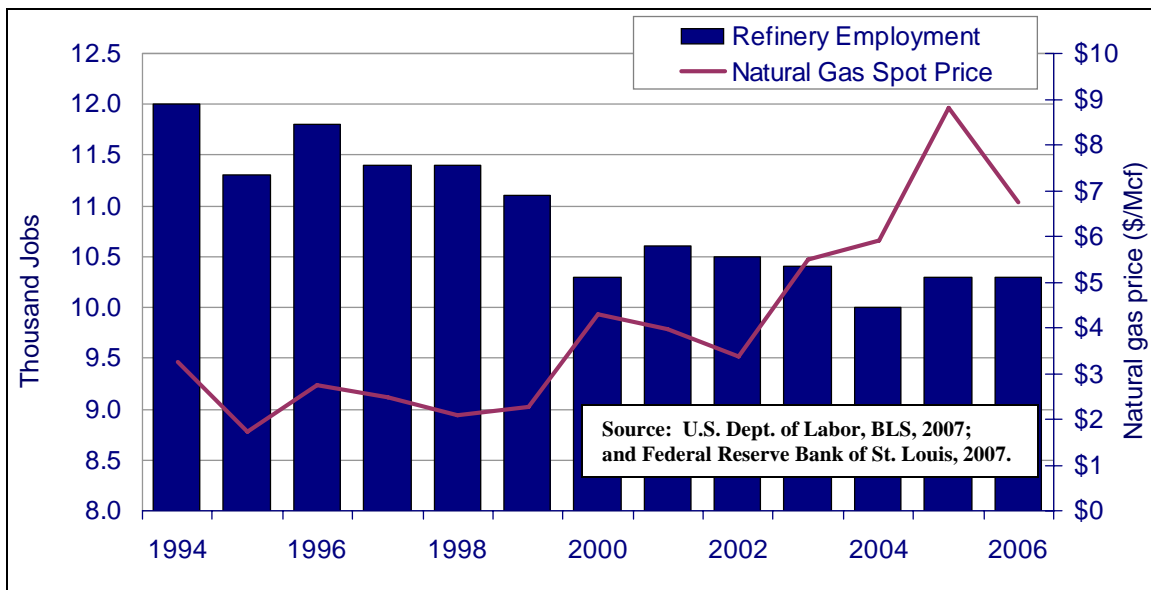
**Figure 28. GOM Chemical Industry Job Losses Since 2000.**

As highlighted in Table 1, there are two other major industrial uses of natural gas in the region: refineries and paper and pulp manufacturing. Louisiana has 17 petroleum refineries, with a combined capacity of approximately 2.77 million barrels per day. This represents over 16 percent of total U.S. refinery capacity. From these refineries Louisiana produces approximately

42.1 million gallons of gasoline per day and 29.9 million gallons of distillate fuels, such as diesel and jet fuel. In addition, 34 percent of the nation’s natural gas supply and 30 percent of the nation’s crude oil supply comes from production originating in the Gulf Region. All of this makes Louisiana an important contributor to the nation’s energy supply.

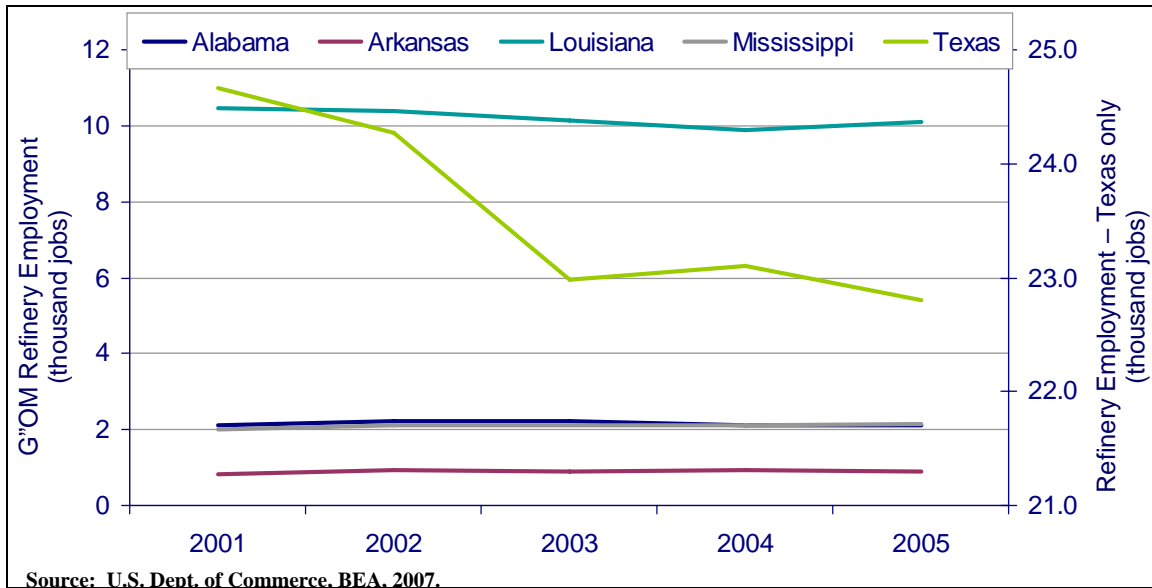
Texas is also home to a considerable amount of refinery capacity and production. Texas has some 25 petroleum refineries with roughly 4.34 million barrels per day of capacity. The largest refinery in North America is owned by ExxonMobil, located in Baytown, Texas. It has a capacity of 562.5 thousand barrels per day of capacity. Total refined capacity in Texas accounts for over 25 percent of the U.S. total (U.S. Dept. of Energy, EIA, 2007b).

Figure 29 shows the relationship between refinery employment and natural gas prices for Louisiana. Like Figure 27, the inverse relationship between natural gas prices and employment is evident since 2001, when annual average gas prices increased dramatically and employment levels fell in an equally impressive manner. Between 2001 and 2004, the refinery employment fell by 575 jobs.



**Figure 29. Louisiana Refinery Employment and Natural Gas Spot Price.**

Figure 30 shows the cumulative job losses in the refinery sector for each of the GOM states since 2000, totaling over 2,000 jobs. Louisiana accounts for 17 percent of these total losses while the remaining 83 percent were experienced in Texas. Alabama’s refinery jobs stayed the same, while Arkansas gained almost 60 jobs and Mississippi added 150 jobs.



**Figure 30. GOM Refinery Job Losses Since 2000.**

Energy is also a significant manufacturing cost component for the forest products industry, accounting for up to 15 percent of manufacturing costs. Global competition, coupled with rising natural gas prices, has resulted in a competitive disadvantage of the domestic pulp and paper industry.

Some 47 percent of the purchased energy in the paper and pulp industry is natural gas, while another 16 percent is purchased electricity (much of which is generated using natural gas). The industry, as a whole, purchases some 400 Bcf of natural gas, accounting for 20 percent of its total energy consumption. The price escalation during 2003 alone is estimated to have directly cost the industry over \$1 billion. The higher cost of natural gas also produced indirect effects, raising the price of chemicals used in paper and wood products production and the cost of purchased electricity (American Forest and Paper Association, 2005).

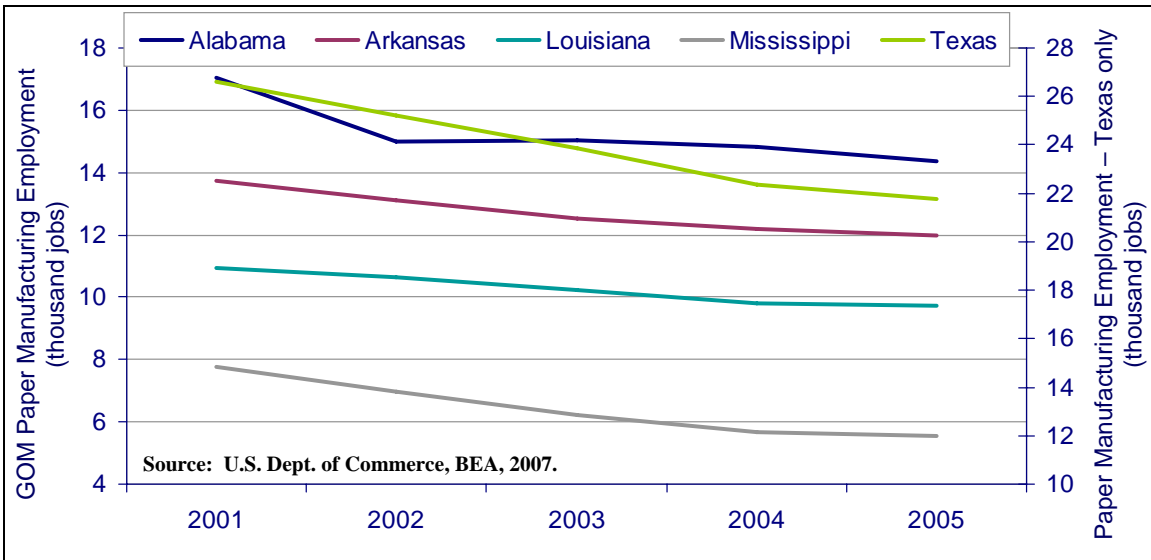
Figure 31 shows the declining employment levels in the paper manufacturing industry in Louisiana as an example in showing the relationship between high natural gas prices and employment. Since 2000, over 12,700 jobs have been lost, and in June, 2007 another mill closing was announced in Louisiana, accounting for 540 jobs. The primary reason management cited was increased natural gas costs.<sup>11</sup>

<sup>11</sup> Tembec, Inc. management stated that while it had cut gas consumption by 15 percent at this mill, gas costs increased by 17 percent, resulting in an overall cost increase of 2 percent. The price increase, coupled with equipment and market conditions were enough to make the mill unprofitable, and it was announced that it would cease operations July 31, 2007.



**Figure 31. Louisiana Paper Manufacturing Employment and Natural Gas Spot Price.**

Figure 32 shows paper and pulp industry job losses in each GOM state since 2001. Thirty-eight percent of these jobs losses were in Texas, while almost 21 percent were in Alabama. Louisiana experienced a 17.5 percent drop over the entire period examined.

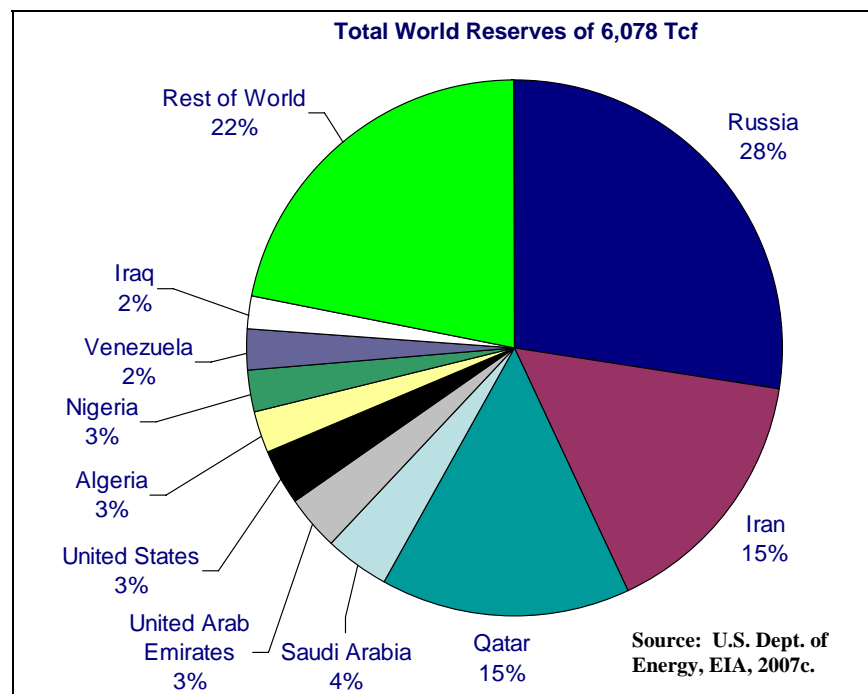


**Figure 32. GOM Paper and Pulp Industry Job Losses Since 2000.**

### 3. PRIMER ON LNG FACILITIES AND THEIR PROPOSED DEVELOPMENT IN THE U.S. AND GULF OF MEXICO REGION

#### 3.1. Introduction to LNG

There is an exceptional amount of proved natural gas reserves around the world. Recent estimates have these reserves somewhere around 6,400 trillion cubic feet (Tcf) (U.S. Dept. of Energy, EIA, 2007c).<sup>12</sup> At current global consumption levels, that is enough natural gas to meet demand for a period of 270 years. Figure 33 provides a breakdown of the distribution of these reserves by country.



**Figure 33. Natural Gas Reserves by Country, as of January 1, 2005.**

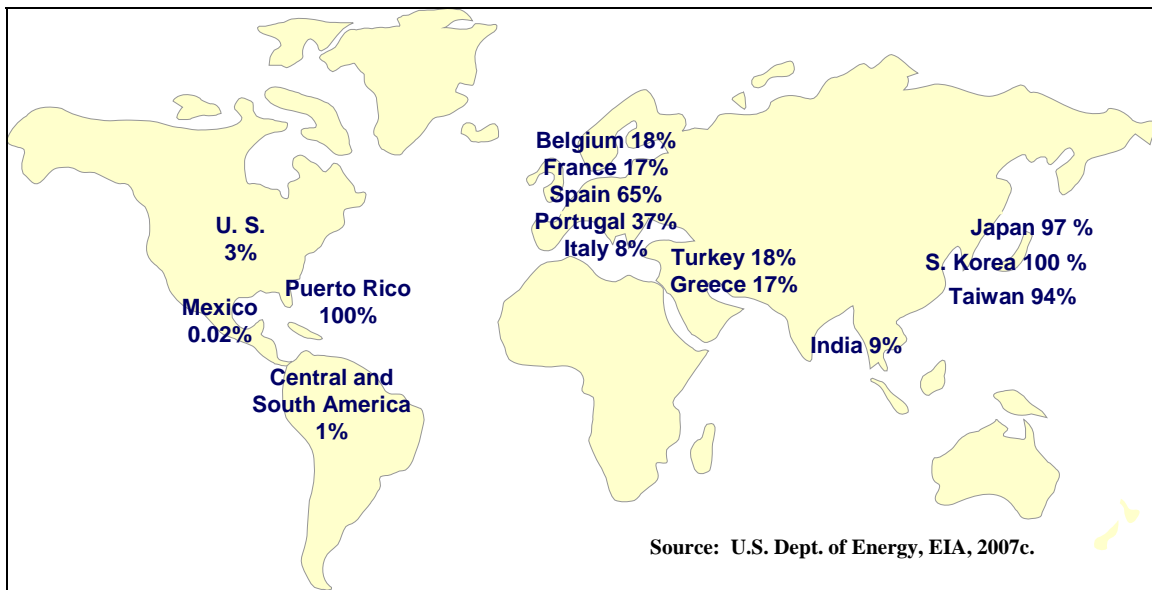
While natural gas is abundant worldwide, one of the most obvious conclusions from looking at Figure 33 is that these reserves are located in areas that do not have significant natural gas demand. In addition, much of the gas is located in and around politically instable areas such as Nigeria and the Persian Gulf. In order to move this gas from these areas of abundance to areas with higher demand, a mode of transportation needs to be engaged. Since pipeline transportation over long distances is cost prohibitive, liquefaction of natural gas has been the preferred technological means of rendering natural gas into a transportable form to move over long distances.

LNG is not a new means to transport natural gas. The process of liquefying gas for transportation has been used for over forty years. In January 1959, the world's first LNG tanker, the Methane Pioneer, carried LNG from Lake Charles, Louisiana to Canvey Island in the United

<sup>12</sup> Proved reserves are estimated quantities that analysis of geologic and engineering data demonstrates with reasonable certainty are recoverable under existing economic and operating conditions.

Kingdom. The voyage demonstrated that large quantities of liquefied natural gas could be transported safely across the ocean. In 1964, the British Gas Council began importing liquefied natural gas from Algeria, making the United Kingdom the world's first LNG importer and Algeria its first exporter (Dominion, 2007).

Figure 34 shows that numerous countries get their natural gas supplies from LNG imports. Countries in Western Europe, for instance, receive between 65 percent (Spain) and 8 percent (Italy) of their gas supplies from LNG imports. Several Pacific Rim countries attain almost all of their natural gas from LNG imports. Several countries in South America and the Caribbean also import LNG.

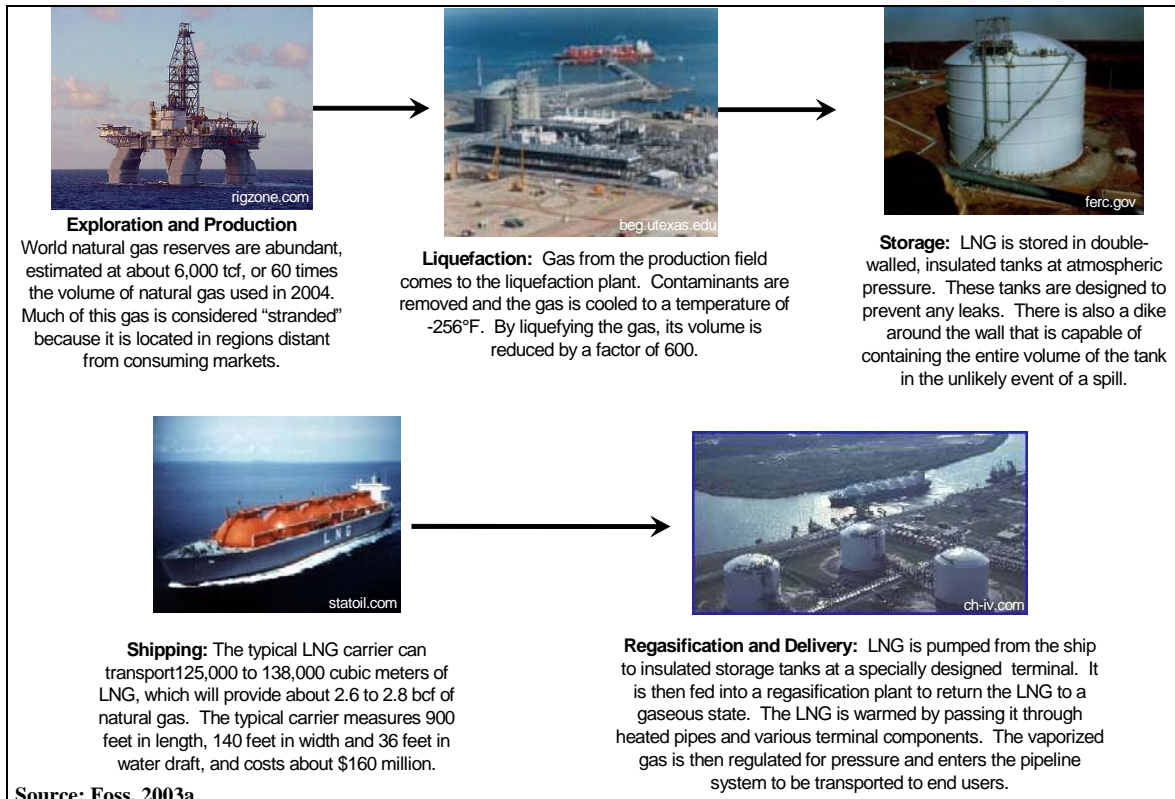


**Figure 34. World Importers of LNG: Imports as Percent of Total Natural Gas Consumption, 2004.**

Liquefied natural gas is simply natural gas that has been turned into a liquid by cooling it to a temperature of -256°F. This gas consists mostly of methane, is typically odorless, colorless, non-corrosive, and non-toxic. The liquefaction process reduces that volume of natural gas by a factor of 610 and weighs about 45 percent of water. Basically, the liquefaction process converts natural gas into a very dense and easily portable form of energy.

Figure 35 provides a schematic commonly referred to as the LNG “value chain,” showing the various stages in which natural gas is converted into LNG and delivered to end users. Exploration and production is the first stage of the process. Here, natural gas reserves are developed, wells are drilled, and production is initiated in order to extract the hydrocarbon and transport it locally to a liquefaction facility for super-cooling. Some intermediate storage is developed from which gas is offloaded into specialized, insulated tankers and transported to various places around the world for ultimate consumption.





**Figure 35. LNG Schematic, Production to End-User.**

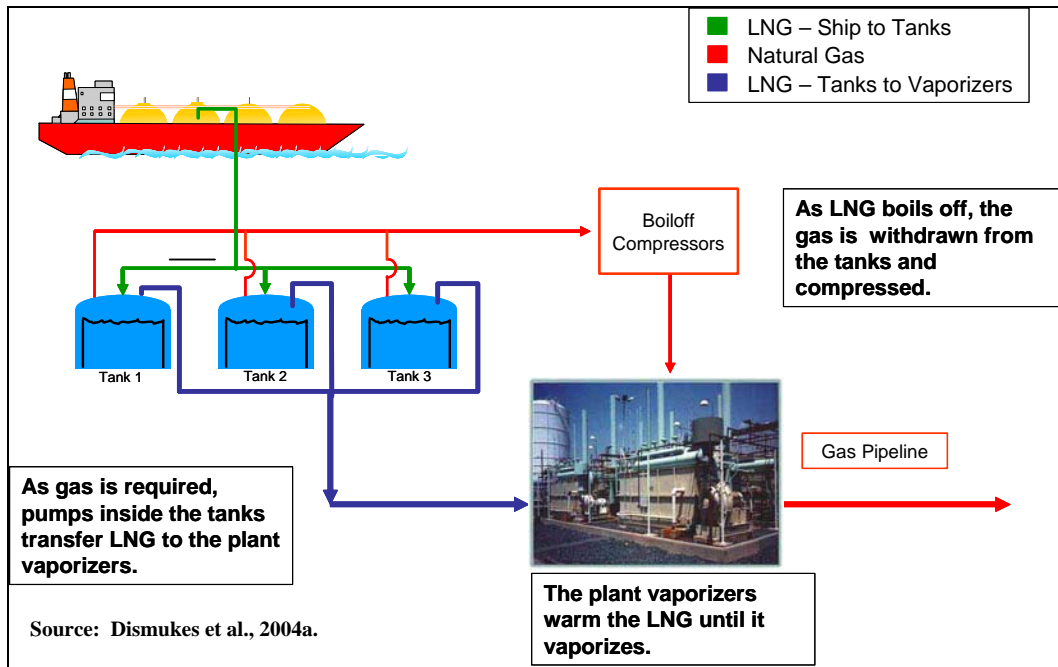
These tankers are specialized ships with insulated storage to keep the gas in its super-cooled state until it is delivered to its destination market. Any gas that naturally regasifies during the transport process (known as "boil-off") is used as transportation fuel during the trip. Tankers are large and can hold as much as 2.9 Bcf of natural gas. One tanker holds enough natural gas to fuel a typical steam electricity plant for one to two months, 51,000 residential natural gas customers in the GOM Region, or 5 typical industrial facilities (using average consumption) along the GOM.

The last step in the process is what is referred to as "regasification." A regasification facility heats the liquefied natural gas and delivers it to local destination markets or intermediate storage for future delivery to end-users. The facilities that have been proposed for development along the Gulf Coast are the regasification facilities shown in this schematic. The first three steps of the process (production, liquefaction, and transportation) originate in other locations.

Figure 36 presents a general schematic of the LNG regasification process. The process does not differ much between onshore and offshore receiving terminals.<sup>13</sup> The first step of the regasification process consists of unloading LNG from ships into a series of intermediate storage tanks. The physical process of offloading the LNG cargo usually takes about 12 hours, but can

<sup>13</sup>The one significant difference between onshore and offshore regasification processes is associated with differences between open versus closed loop vaporization. This will be discussed in greater detail in Section 7 of this report. Also, for purposes of this report, the terms "receiving terminals" and "regasification terminals" will be used interchangeably.

vary depending on the capacity of the regasification facility. The typical capacity for an onshore facility ranges between 1 Bcf/d to 3 Bcf/d. For an offshore facility, the typical capacity ranges from 0.5 Bcf/d to 1.5 Bcf/d.

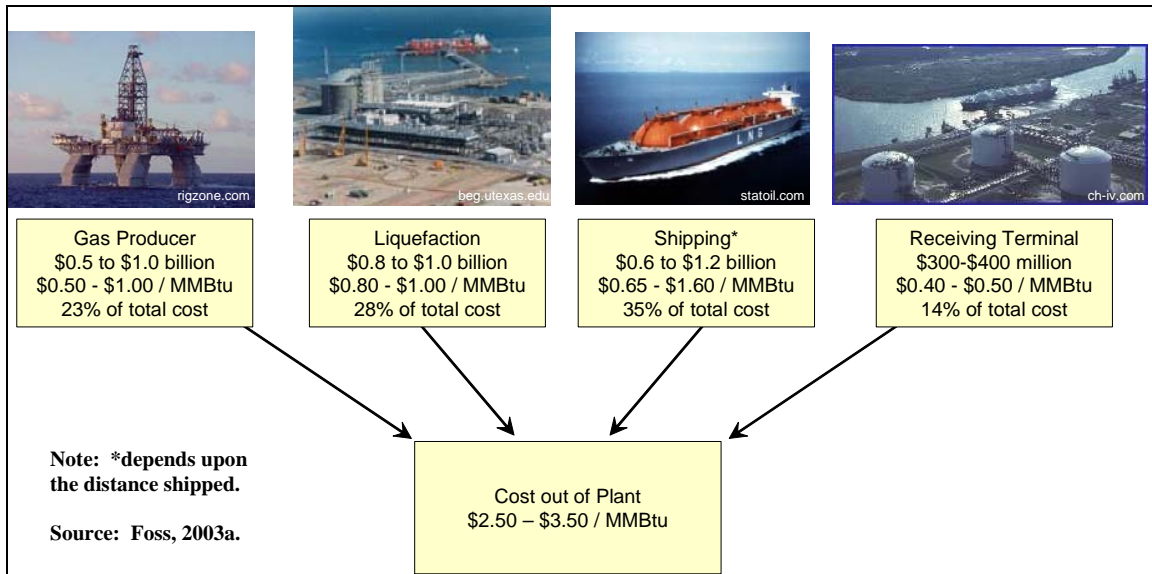


**Figure 36. Receiving Terminal – LNG Gas Flow.**

The next step in the regasification process is to heat, or vaporize, the LNG. This is completed in two different ways. The primary means is to use heat treaters or vaporizers to warm the gas and convert it from a liquid to a gaseous state. From there, the gas is injected into large interstate and/or intrastate pipelines for delivery to markets (end-users) or intermediate storage facilities.<sup>14</sup> Any boil-off associated with the liquid natural gas in storage is captured, compressed, and then combined with gas from the vaporizers to feed into pipelines for delivery to end-users or intermediate storage facilities.

Each of the physical processes that LNG goes through has a considerable investment cost. Each component, and its respective investment costs, represents one portion of the LNG value chain. Figure 37 outlines each portion of the value chain and a range on the potential cost shares associated with each linkage. Production investments, for instance, can range from a \$0.5 billion to \$1.0 billion in investment and represent close to 23 percent of the integrated total project investment costs.

<sup>14</sup> These intermediate storage facilities are typically underground natural gas storage facilities which are developed from various geological formations such as abandoned aquifers, oil and gas reservoirs and salt caverns.



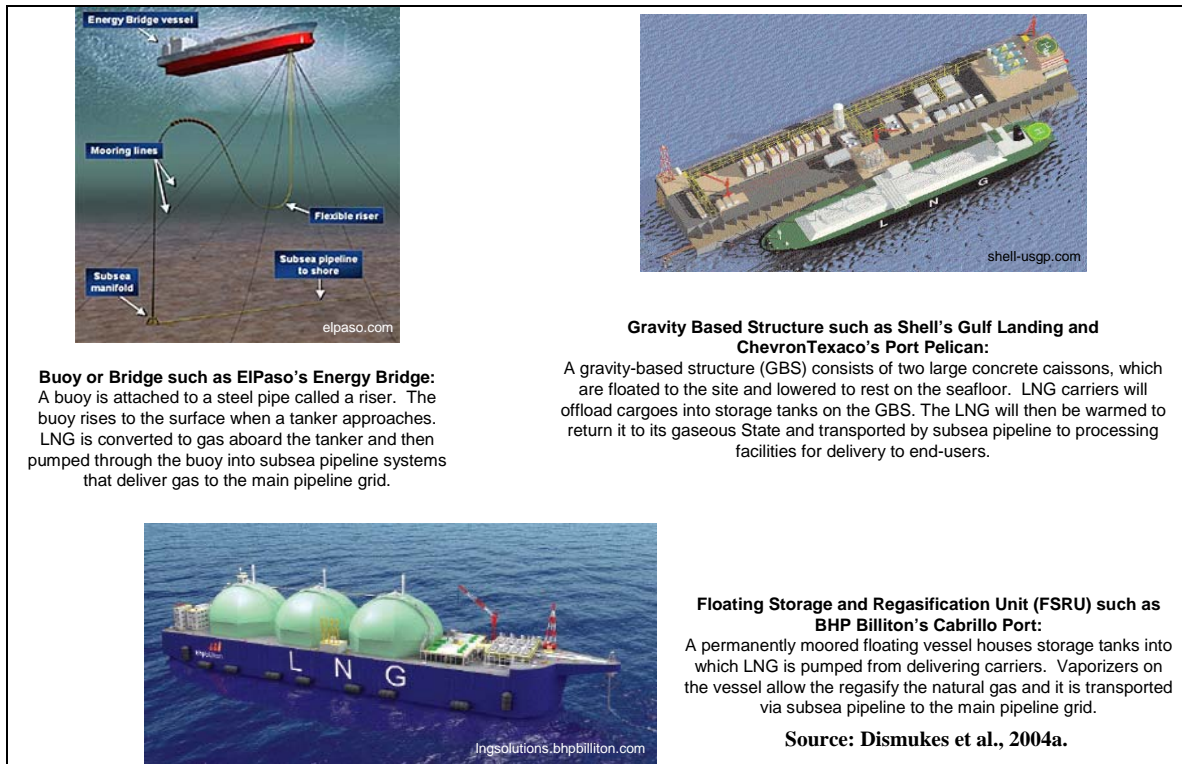
**Figure 37. The LNG Value Chain.**

Three important conclusions relative to the GOM can be reached from reviewing this LNG schematic. First, the total investment cost of delivering LNG from one country to another is considerable, currently ranging from \$2.0 to \$3.5 billion. Second, problems in any component can have considerable implications for overall project investments. Permitting problems, regulatory concerns, geopolitical risk in the host country, among other factors, can have important implications on the economics of the entire project. Third, the regasification portion, while significant in total investment value (\$300 million to \$400 million), is only 14 percent of the total, and is the smaller portion of the overall investment cost in the entire LNG value chain. It is the regasification component that has been proposed for development along the GOM.

Two types of regasification facilities—offshore and onshore facilities—are currently in development along the GOM. As will be discussed in the next section of this report, onshore regasification facilities have existed for over 40 years. There are four working onshore regasification facilities in the U.S., only one of which is located in the GOM Region, though several are under construction and more are in the permitting and proposed stages of development. The only real difference between the onshore facilities of today and those of the past are the capacity levels of the facilities. The current facilities are located at ports, where LNG tankers arrive and unload their cargoes. Because of their port locations, they are referred to as “marine” facilities. Due to recent security concerns, there has been greater interest in locating these facilities offshore, where large LNG tankers can offload their cargoes. The gas will be injected into pipelines and moved onshore, eventually reaching the downstream markets.

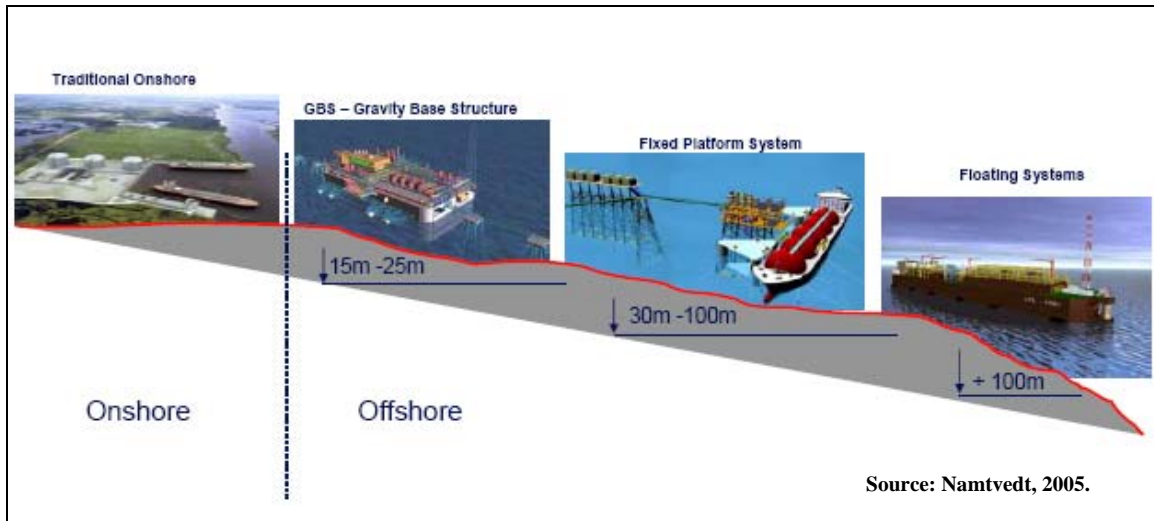
Offshore facilities, however, are different than their onshore counterparts. They are much newer and have virtually no comparable technological applications on the GOM. Figure 38 shows the three different types of offshore regasification configurations that have been proposed for the GOM. The first, presented on the left hand side of the figure, is referred to as a “gravity-based structure” or “GBS,” and consists of two large concrete caissons, that float to the site and are lowered to rest on the seabed and secured. The topside of the GBS houses the vaporizers and

other equipment used to warm the gas, where it is injected into the offshore interstate pipeline system and delivered to end-users or intermediate storage.



**Figure 38. Types of Offshore LNG Receiving Terminals.**

The other two types of facilities are floating storage and regasification units (FSRU), and submerged turret loading systems (STU). Both are similar in nature to Floating Production, Storage, and Offloading (FPSOs), currently used in the North Sea and under consideration for use in the GOM. The FSRUs are floating regasification systems where the vaporizer, storage, and other equipment is housed on the vessel itself. The vessel tethers to a buoy-based system during the regasification process. The tether connects the ship and vaporization equipment to the subsea pipeline system. Regasified LNG (natural gas) is then delivered to end-user markets or intermediate storage. When the offload is complete, the ship can leave the system to obtain additional cargoes. The FSRU system would be permanently moored to a tether system and serve as an intermediate station for offloading LNG. An LNG tanker docked at the FSRU can unload its LNG cargo at the rate of 4,000 to 6,000 cubic feet per minute (CFM). It would take approximately 16 hours to unload a LNG tanker. After unloading, the tanker undocks and returns to its origination point for another LNG cargo.



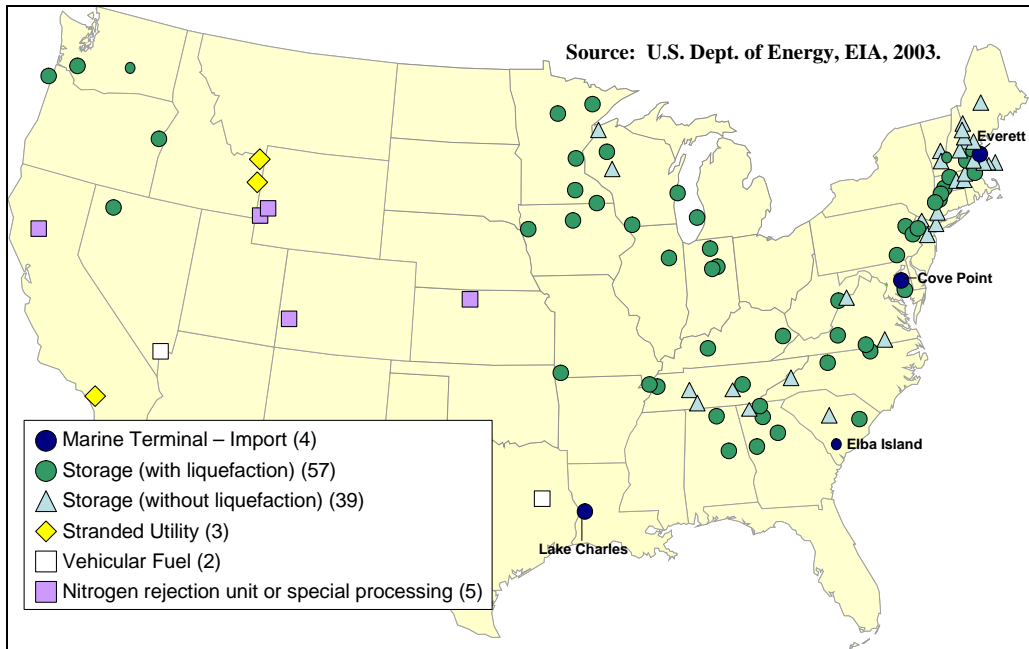
**Figure 39. Types and Locations of Typical Regasification Facilities.**

A new type of offshore-receiving technology under consideration is the regasification vessel that is used in conjunction with a STU. These vessels are standard LNG tankers modified to enable the vessel to discharge its LNG cargo offshore or onshore (or marine) facility. The Gulf Gateway Energy Bridge project is located in the western GOM, approximately 116 miles from the Louisiana coast. It is the first vessel of its type to operate in the Gulf, as well as the world’s first offshore LNG receiving facility and the first new LNG regasification facility in North America in over 20 years. Energy Bridge received its first cargo of almost 3 Bcf in March 2005 and is capable of delivering up to 690 MMcf per day to downstream markets.

### 3.2. Current and Proposed LNG Facilities

LNG is not a new means of exporting and importing natural gas from and to the U.S. As reviewed in the previous section, LNG import terminals have existed in the U.S. for several decades. Interestingly, the U.S. also has one export terminal – the ConocoPhillips LNG facility is a 68 Bcf per year liquefaction terminal located on the Kenai Peninsula of Alaska that has been exporting LNG to Japan for more than 30 years. The output from the facility has been under long-term contract with Tokyo Electric Company since 1969.

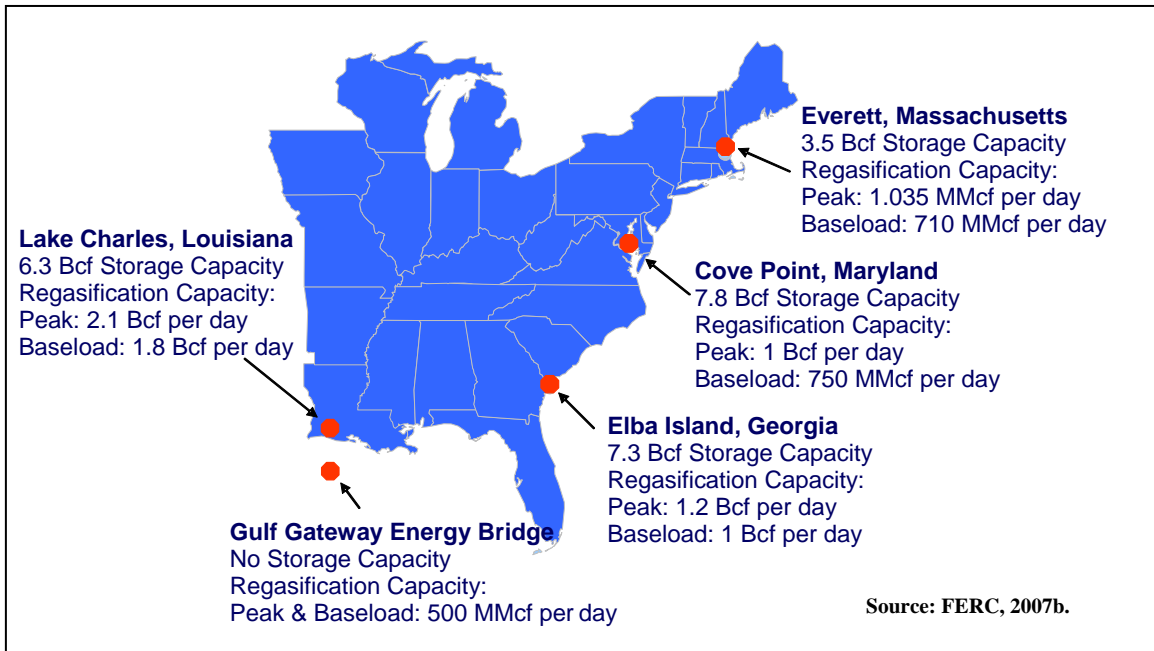
Throughout the U.S., small LNG facilities have also been in operation for several decades. Figure 40 provides a map with the location of several different types of LNG facilities located throughout the country. Most facilities are used by LDCs as storage facilities for “peak shaving” purposes. LNG peak-shaving facilities are used for storing natural gas to meet the requirements of peak consumption during high demand. Each peak-shaving facility has a regasification unit attached, but not all have a liquefaction unit. These facilities depend on tank trucks to deliver LNG from other producing or transportation terminal areas. As shown in Figure 40, about half of the LNG facilities in the U.S. are peak-shaving facilities.



**Figure 40. U.S. LNG Facilities.**

These small-scale LNG facilities can also be used by what is referred to as a “stranded utility”, or one with no interstate or intrastate transmission pipeline interconnection. These stranded utilities need truck delivery of natural gas to supply their customers. Lastly, the map shows a number of Nitrogen Rejection Units (NRU) that liquefy gas for special processing purposes. At NRU facilities, the entire gas stream is liquefied to remove impurities, then regasified and sent on as pipeline-quality gas.

The types of LNG facilities that are getting the most attention today are the large marine terminals located along the nation’s three coasts: Atlantic, Pacific and GOM. Figure 40 shows the four existing marine LNG import terminals. These facilities have served as the first opportunities for new capacity additions through site-expansion. Figure 41 provides an expanded view of these facilities, along with their locations and capacities. All of the reported capacities in the figure are based upon the new expanded levels, not the original capacity levels, which are around 50 percent of current capacity. As seen from the figure, all four are located in the eastern half of the U.S. Two of these facilities (Everett and Cove Point) were developed in the late 1970s. The other two facilities (Elba Island and Lake Charles) were developed in the late 1970s and early 1980s. All four facilities have been expanded in recent years and each have a peak sendout of one Bcf per day or more. Together, the four facilities had an annual capacity of just over 1 Tcf in 2002.



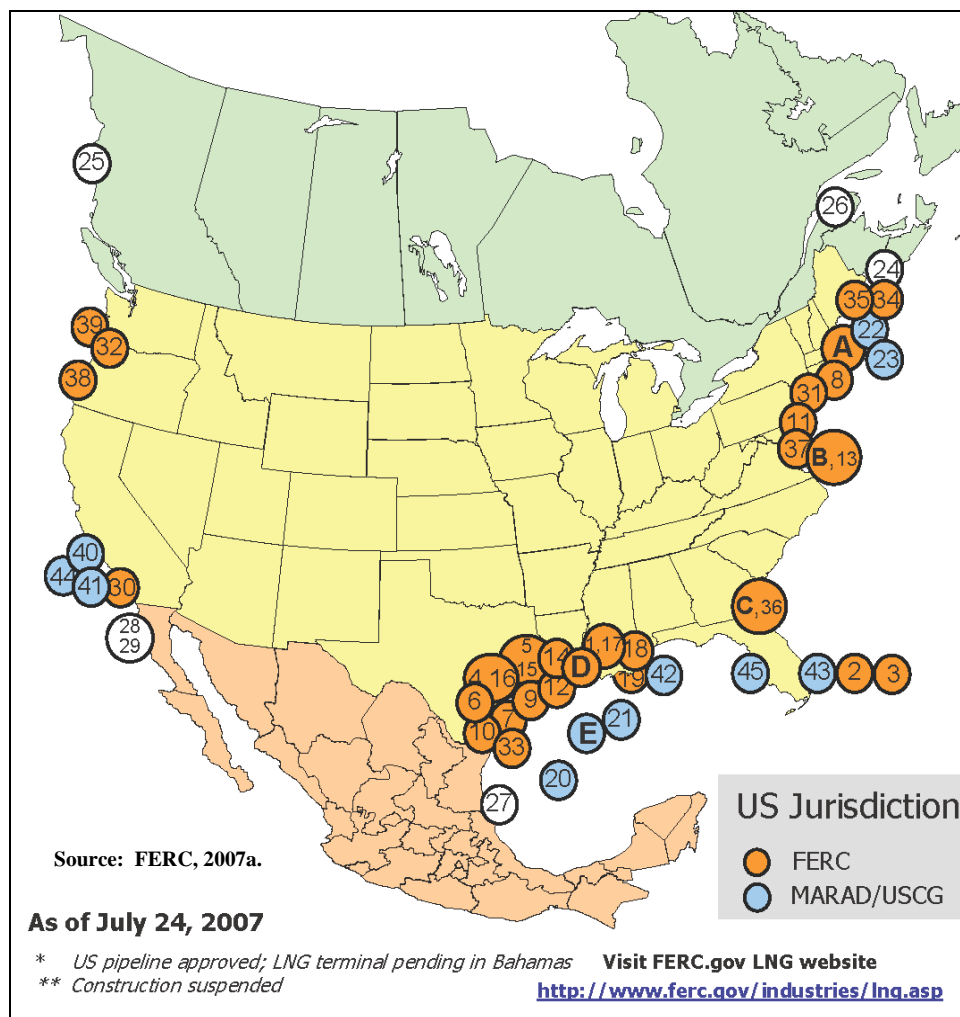
**Figure 41. Current U.S. LNG Import Terminals.**

All four of these large marine LNG terminals were developed during the era of the last major energy crisis. This was during a period, as noted earlier, when gas supply availabilities were uncertain and it was thought that LNG would be needed to fill the need. Further, these LNG facilities were developed during the era of regulated natural gas commodity prices. The opening of natural gas markets and the significant decrease in gas commodity costs eventually turned facilities into stranded investments, that is, an investment which has a cost greater than market value. In fact, the Cove Point and Elba Island facilities shut down and were put into mothball within just 2 years after their COD, before re-opening in recent years. The Everett facility had longer-term contracts and was able to continue to operate uninterrupted. The Lake Charles facility was completed in 1982, but was not operational during the period 1983 to 1989.

The economics of new development opportunities strongly favor expansion at existing sites and is one of the reasons onshore facilities have such favorable economics relative to their offshore counterparts. Expansions have recently been completed at the Everett, Massachusetts and Lake Charles, Louisiana facilities. On January 18, 2007, FERC approved Sempra Energy's plan to expand its Cameron LNG terminal which is under construction in Hackberry, LA to approximately 2.65 Bcf/d of sendout capacity. The expansion project is expected to be completed by October 2010.

Other expansions are planned at the Cove Point, Maryland and Elba Island, Georgia plants. The expansion at Cove Point will increase daily sendout capacity from 1.0 Bcf per day to 1.8 Bcf per day. The expansion at Elba Island is to be completed in two phases, and will result in an increase of 0.9 Bcf per day in sendout capacity. Plans to expand the Lake Charles facility were announced, with an additional vaporization capacity of 73 Bcf per year, bringing the total annual vaporization capacity to 438 Bcf.

In addition to the expansions at existing facilities, there has been a plethora of announcements for new regasification facilities in various parts of the coastal U.S. Figure 42 provides a map of these facilities concentrated in areas along the Atlantic seaboard, the west coast, the Gulf Coast, and Mexico as of February 16, 2007. In late December 2006, outgoing Massachusetts Governor Mitt Romney approved two offshore LNG facilities to meet the Northeast’s growing natural gas supply needs. The Northeast Gateway and Neptune projects will provide an extra 1 Bcf/d of gas to the region, which he claimed would increase supply by 20 percent and lower energy costs (Haywood, 2006).



**Figure 42. Existing and Proposed North American LNG Terminals.**

Table 2 provides a breakout of the proposed LNG regasification capacity as of May 2007. Of all the North American announced facilities, about 90 percent, with a total capacity of 52.8 Bcf/d, are in the United States, with the balance being proposed for development in Mexico and Canada. More importantly, almost 60 percent of capacity of all proposed facilities, comprising 34.8 Bcf/d, are located along the Gulf coast. This represents the single highest concentration of proposed capacity anywhere in the U.S. Of the Gulf Coast proposed facilities, 82 percent, or 28.4 Bcf/d of capacity, is proposed to be developed onshore in the region, while the remaining 6.4 Bcf/d is proposed to be located offshore in the Gulf of Mexico.



**Table 2**

**Proposed North American LNG Terminals**

	Sendout Capacity (Bcf/d)		Sendout Capacity (Bcf/d)
<b>Approved by FERC</b>		<b>Canadian Approved Terminals</b>	
<b>GOM</b>		St. John, NB	1.0
Hackberry, LA	1.8	Kitimat, BC	0.6
Freeport, TX	1.5	Riviere-du-Loup, QC	0.5
Sabine, LA	2.6	<b>Mexican Approved Terminals</b>	
Corpus Christi, TX	2.6	Altamira, Tamulipas	0.7
Corpus Christi, TX	1.1	Baja California, MX	1.0
Sabine, TX	2.0	Baja California, Offshore	1.5
Corpus Christi, TX	1.0	<b>Proposed to FERC</b>	
Port Arthur, TX	3.0	<b>GOM</b>	
Cameron, LA	3.3	Port Lavaca, TX	1.0
Sabine, LA	1.4	<b>Atlantic</b>	
Freeport, TX	2.5	Elba Island, GA	0.9
Hackberry, LA	0.9	LI Sound, NY	1.0
Pascagoula, MS	1.5	Pleasant Point, ME	2.0
Pascagoula, MS	1.3	Robbinston, ME	0.5
<b>Atlantic</b>		Baltimore, MD	1.5
Bahamas	0.8	<b>Pacific</b>	
Bahamas	0.8	Long Beach, CA	0.7
Fall River, MA	0.8	Bradwood, OR	1.0
Logan Township, NJ	1.2	Coos Bay, OR	1.0
Cove Point, MD	0.8	Astoria, OR	1.5
<b>Approved by MARAD/Coast Guard</b>		<b>Proposed to MARAD/Coast Guard</b>	
<b>GOM</b>		<b>GOM</b>	
Port Pelican	1.6	Gulf of Mexico	1.4
Main Pass	1.0	Offshore FL	1.2
<b>Atlantic</b>		<b>Pacific</b>	
Neptune	0.4	Offshore CA	1.5
Northeast Gateway	0.8	Offshore CA	1.4
		Offshore CA	1.2
		<b>Atlantic</b>	
		Offshore FL	1.9

Source: FERC, 2007a.

Table 3 presents a breakout of all proposed facilities for the GOM Region including their proposed capacity, and announced or estimated investment costs. In total, there is at least \$10.7 billion in proposed LNG regasification investments for the GOM Region. Some 25 percent of this investment (\$2.6 billion) is associated with offshore facilities while the other 75 percent of this investment (\$8.0 billion) is associated with onshore facilities.

**Table 3**

**Proposed LNG Terminals in GOM Region, 2007**

<b>Company / Facility</b>	<b>Location</b>	<b>Capacity Bcf/d</b>	<b>Cost (million \$)</b>
<b>Onshore</b>			
Sempra / Cameron LNG	Hackberry, LA	1.8	\$ 700.0
Cheniere / Freeport LNG	Freeport, TX	1.5	\$ 600.0
Cheniere / Sabine Pass	Sabine, LA	2.6	\$ 750 - \$850
Cheniere / Corpus Christi	Corpus Christi, TX	2.6	\$ 650 - \$750
ExxonMobil / Vista del Sol	Corpus Christi, TX	1.1	\$ 600.0
ExxonMobil / Golden Pass	Sabine, TX	2.0	\$ 600.0
Occidental / Ingleside Energy	Corpus Christi, TX	1.0	\$ 400.0
Sempra / Port Arthur	Port Arthur, TX	3.0	\$ 800.0
Cheniere / Creole Trail LNG	Cameron, LA	3.3	\$ 850 - \$950
Cheniere / Sabine Pass Expansion	Sabine, LA	1.4	\$ 850.0
Cheniere / Freeport LNG Expansion	Freeport, TX	2.5	\$ 400.0
Sempra / Cameron LNG Expansion	Hackberry, LA	0.9	\$ n.a.
Gulf LNG Energy LLC / Pascagoula	Pascagoula, MS	1.5	\$ 450.0
ChevronTexaco / Bayou Casotte	Pascagoula, MS	1.3	\$ n.a.
Gulf Coast LNG Partners / Calhoun LNG	Port Lavaca, TX	1.0	\$ 400.0
El Paso - Southern LNG / Elba Island Expansion	Elba Island, GA	0.9	\$ n.a.
<b>Offshore</b>			
ChevronTexaco / Port Pelican		1.6	\$ 800.0
McMoRan Exp / Main Pass		1.0	\$ 440.0
TORP / Bienville Offshore Energy Terminal		1.4	\$ 400.0
Hoegh LNG / Port Dolphin Energy		1.2	\$ 1,000.0

Source: FERC, 2007a, daily trade press and company websites.

Not all LNG regasification facilities will be developed, the reasons for which are varied and can include:

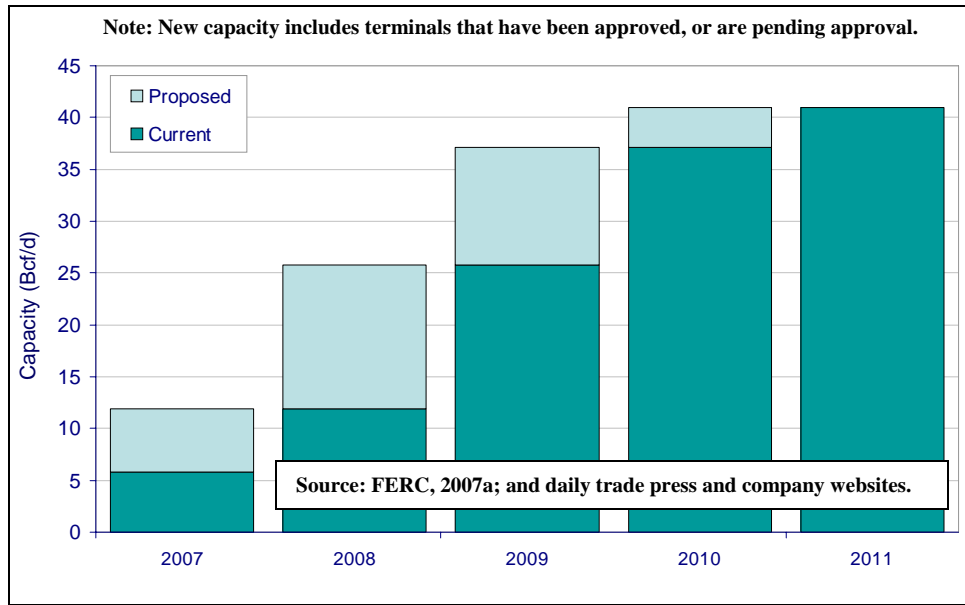
- **Permitting Challenges:** permitting can take time and is not a certain process. Some areas in the U.S., such as very populated areas of the eastern seaboard, have faced significant permitting opposition. Developers will often “hedge” this opposition by attempting to permit several projects at the same time. That way, if one project is rejected during the permitting process, there are several other projects that have the potential to replace the failed application. If several applications are approved at one time, and there are limited capital investment opportunities, developers will likely develop the project with the highest expected return on investment.

- **Speculative Investments:** Permitting a project, while expensive, is far less costly than overall development cost. For potentially high-yield investments, spending the money to develop a project through the permitting process can be a worthwhile investment since it holds out the “option” of potentially developing on a site at a later date. Thus, many sites will be announced for development for their option value alone, though few will actually be developed. The development of a project of this type is a type of hedge that can be exercised as market or regulatory conditions change. These types of projects can also be spun-off or sold to other developers that may be willing to pay a premium for projects further along in the development process.
- **Capital Requirements:** not all projects can be developed because many companies lack the capital, or have capital limitations, that prevent all proposed LNG facilities from being developed.<sup>15</sup>
- **Investment Prioritization:** in addition to capital requirements, there are also corporate investment prioritizations that rank order particular projects. These prioritizations can change as market conditions change.
- **Changing Business Environment:** The internal rate of return of a particular project is directly impacted by the outlook of the environment in which this asset operates. Of particular concern for an LNG project is the outlook for natural gas prices over a long period of time. All LNG investments (production, liquefaction, transportation, and regasification) are long-lived and the return on this investment needs to be considered on a long-term basis. If the outlook for natural gas prices changes for the worse, projects can be abandoned prior, or even during any stage, of development. This is particularly true for those projects that are further back in the LNG development queue.

As of early 2007, most of the approved projects, as well as those under construction, are located onshore. The future of offshore facilities is uncertain. The only GOM offshore projects currently approved for development are Chevron-Texaco’s Port Pelican and McMoran’s Main Pass. Thus, despite the considerable attention placed on these facilities, and the fact that many are in the permitting pipeline, few will be in a position to actually start providing important changes in domestic gas supplies in the next 24 months. Figure 43 provides a graph showing the potential LNG capacity additions, by year, based upon their reported online dates.

---

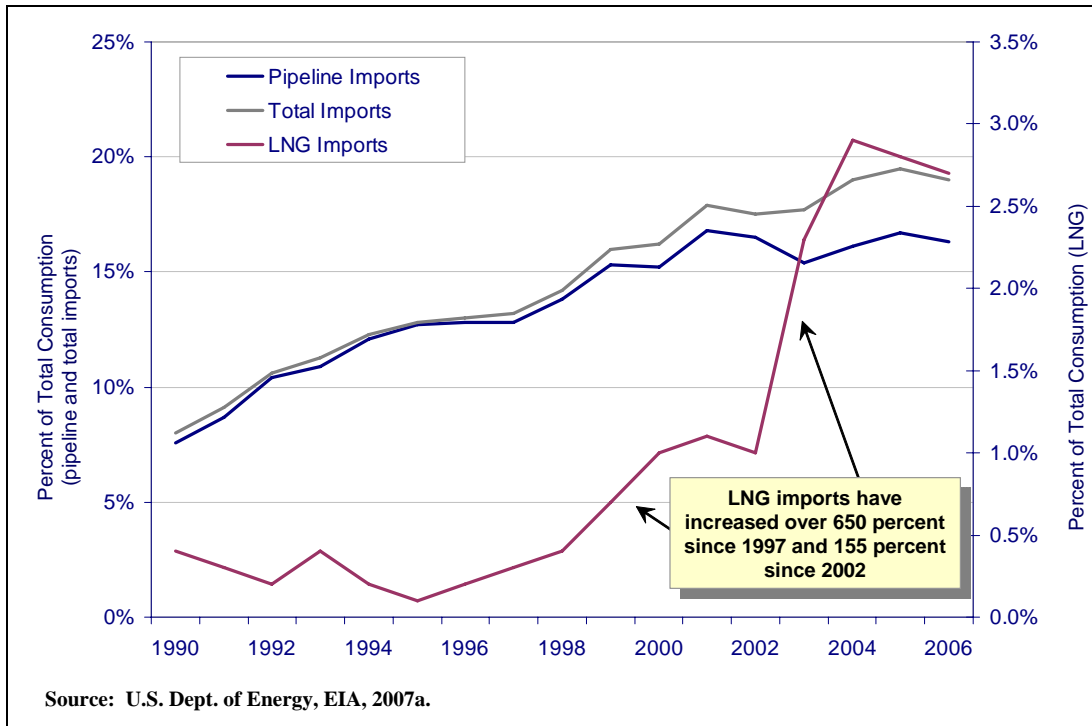
<sup>15</sup>These constraints could also include the opportunity cost of capital which would take into account that there are other investment opportunities with equal or higher rates of return, that developing companies could deploy a fixed amount of investment capital.



**Figure 43. Planned LNG Capacity Additions and Expansions, 2007-2011.**

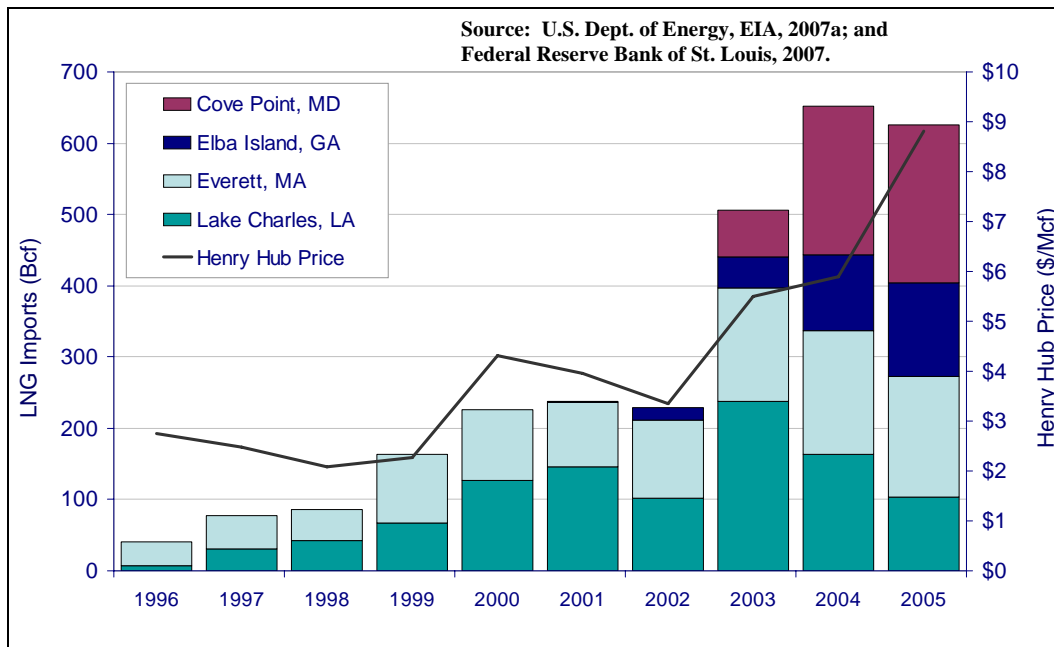
### 3.3. Importance of LNG on Future U.S. Supply Disposition

In the past, LNG has been a very small share of total U.S. natural gas supplies. The overwhelming majority of U.S. gas supplies used to meet demand have come from producing fields in the lower 48. The limited amount of natural gas that has been imported into the country, outside of LNG, has been through pipeline imports from Canada. Figure 44 shows overall natural gas import trends over the past decade. The left hand axis graphs total imports and pipeline imports (the difference between the two series being LNG). The right hand side of the figure shows the growing share of LNG as a percent of total consumption. Today, those shares are some 2.5 to 3.0 percent of total U.S. natural gas supplies.



**Figure 44. U.S. Natural Gas Imports as a Percent of Total Consumption, 1990-2006.**

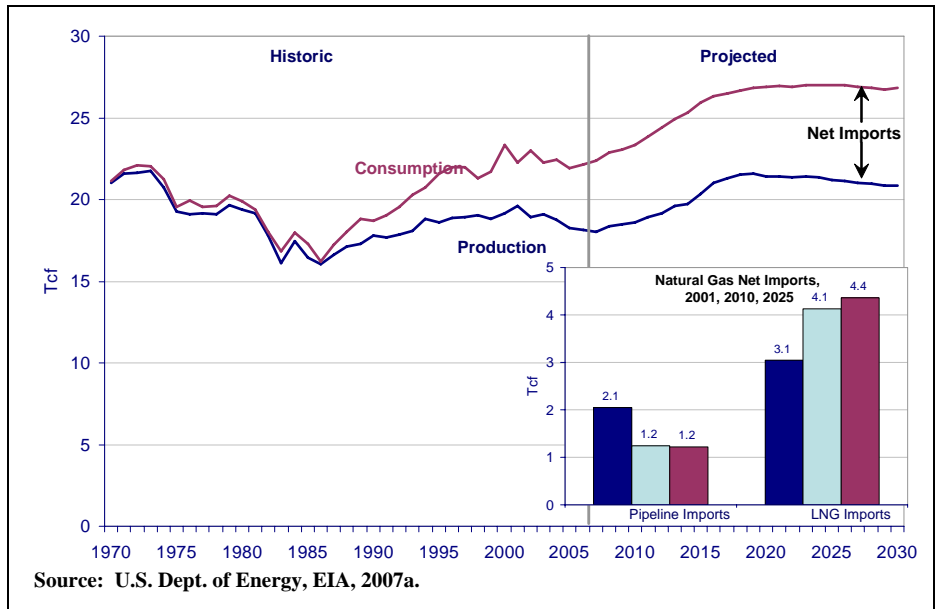
Figure 45 shows historic LNG imports per facility since the mid-1990s. The left hand side of the graph measures total LNG imports (in Bcf) and the right hand side compares those imports to trends in Henry Hub natural gas prices (i.e., wholesale prices). The graph shows the increase in imports from all three terminals starting in 2001, when Elba Island became operational. Clearly, the import trend has increased considerably since gas prices began their climb in 2000, though it actually slowed during 2005 and 2006 due to European and Asian competition. However, it is expected to continue upward in 2007 as prices decline and more LNG facilities are brought on line.



**Figure 45. LNG Imports and Natural Gas Price.**

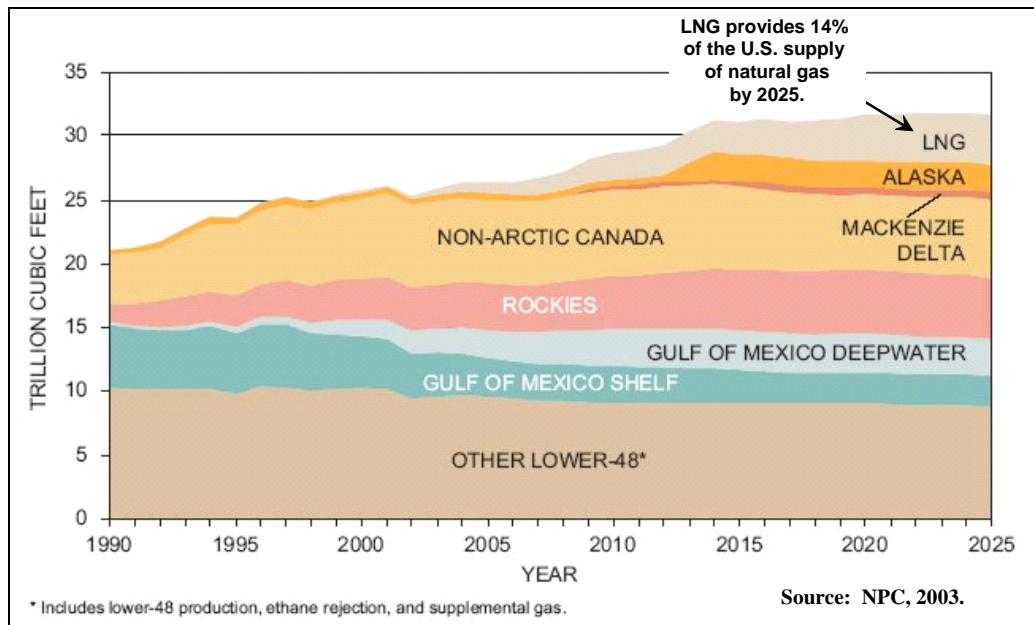
In 2006, the U.S. imported an estimated 580 Bcf, or approximately 8 percent less than the 631 Bcf imported in 2005. Through October 2006, the offshore facility, Gulf Gateway, received only one partial shipment of LNG. The EIA states that the 2006 LNG imports were lower due to a tighter and more competitive market, as well as a lack of long-term contracts relative to other markets. EIA estimates that LNG imports into the U.S. in 2007 will reach some 770 Bcf as exports from Nigeria and Trinidad and Tobago increase. Imports in 2008 are expected to reach 1,080 Bcf. EIA expects three new regasification terminals to come on line by the end of 2008, including the Freeport, Sabine Pass, and Cameron facilities in the GOM. By the end of 2008, the EIA expects the total onshore LNG capacity to reach 61.8 Bcf, with the GOM facilities (Lake Charles, Freeport, Sabine Pass and Cameron) providing 36.5 Bcf of the capacity or almost 60 percent of the total. The offshore Gulf Gateway facility provides no storage facilities – only deliverability services (Gaul and Platt, 2007).

Even though LNG is a small share of domestic supplies today, most forecasts acknowledge that its share will have to increase considerably over the next decade. Figure 46 graphs the projected changes in natural gas production and consumption to 2030 that is prepared annually by the EIA. The differential between consumption and production, as shown in the figure, began increasing in the late 1980s as pipeline imports from Canada began to increase. Future anticipated reductions in domestic gas production increase that differential, with the difference being composed of primarily LNG. Based on DOE forecasts, by 2030 total imports will comprise 22 percent of total consumption and LNG will account for 16 percent of total U.S. consumption.



**Figure 46. Natural Gas Production, Consumption and Imports, 1970-2030.**

In 2003 the National Petroleum Council (NPC) released its highly publicized study on future U.S. natural gas supplies. Figure 47 provides the projections of U.S. total natural gas supplies from that report. Most obvious is the growing share of supplies coming from LNG. These shares climb dramatically in the 2008-2010 time period, as more of the projected LNG facilities come on-line. By 2025, the NPC report forecasts LNG to comprise 14 percent of total U.S. gas supplies.



**Figure 47. U.S. and Canadian Natural Gas Supply.**

The NPC report presents another trend that magnifies the potential importance of LNG. Non-Arctic Canadian gas and GOM shelf gas production are forecasted to decrease over the forecast period (2005 to 2010). In addition, gas production in the lower 48 states is relatively flat. The sub-detail on the lower-48 production shows offsetting losses and gains from conventional and unconventional production. While conventional production falls off, unconventional is forecasted to increase by an offsetting amount.

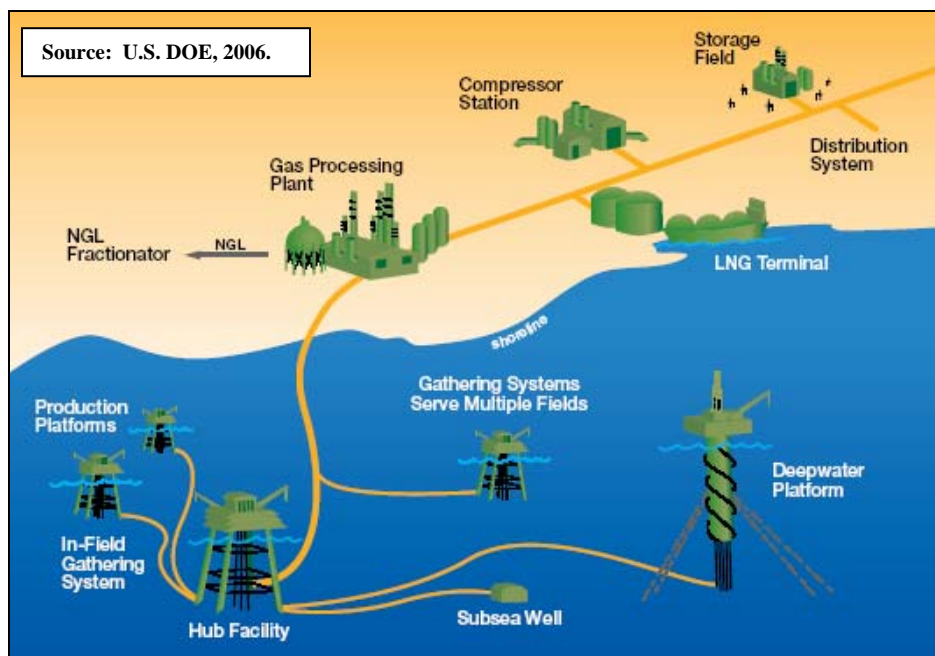
Thus, the main sources of gas supply growth over the forecast period will be: (a) lower-48 unconventional gas production; (b) deepwater GOM production; and (c) production transported by a new pipeline from the Mackenzie Delta (in Canada) and the Alaska North Slope (ANS). All of these sources have higher-than-average development risk, particularly gas from the very far reaches of the Arctic, which are dependent upon the development and timing of a major pipeline transporting gas to the lower-48. Should any of these developing sources of natural gas production fail to materialize, LNG will represent the only supply alternative that can fill the gap. Thus, LNG's 14 percent share of total gas supplies could be much higher over the forecasted period if other anticipated sources of supply fail to materialize.



#### 4. GULF OF MEXICO REGION IS WELL SUITED FOR LNG INVESTMENT

Infrastructure is the primary reason why the GOM is the best suited location in the U.S. for the development of LNG regasification facilities. The region is perhaps one of the most unique in the world in terms of its breadth and depth of energy assets; most all of which are supportive of LNG imports. As indicated in earlier sections, the GOM has some of the largest refinery, petrochemical and paper-pulp facilities in the world; all these assets either consume significant quantities of natural gas for production purposes or transform this raw material into high quality fuels or products. The region also has a large amount of natural gas processing, storage and most importantly, transportation assets of anywhere in the U.S. It is these transportation assets (pipelines) that are critical in moving LNG from its source of production to its source of consumption, just as these assets have done for domestic production over the past 50 years.

The GOM is home to over 4,000 offshore oil and gas platforms and over 33,000 miles of offshore pipeline (API, 2007). Additionally, nearly 50 major gas processing plants and 17 natural gas liquids fractionation sites are located along the Gulf coast of Texas, Louisiana, Mississippi, and Alabama. These facilities have the capacity to process 22.8 Bcf/day of natural gas.

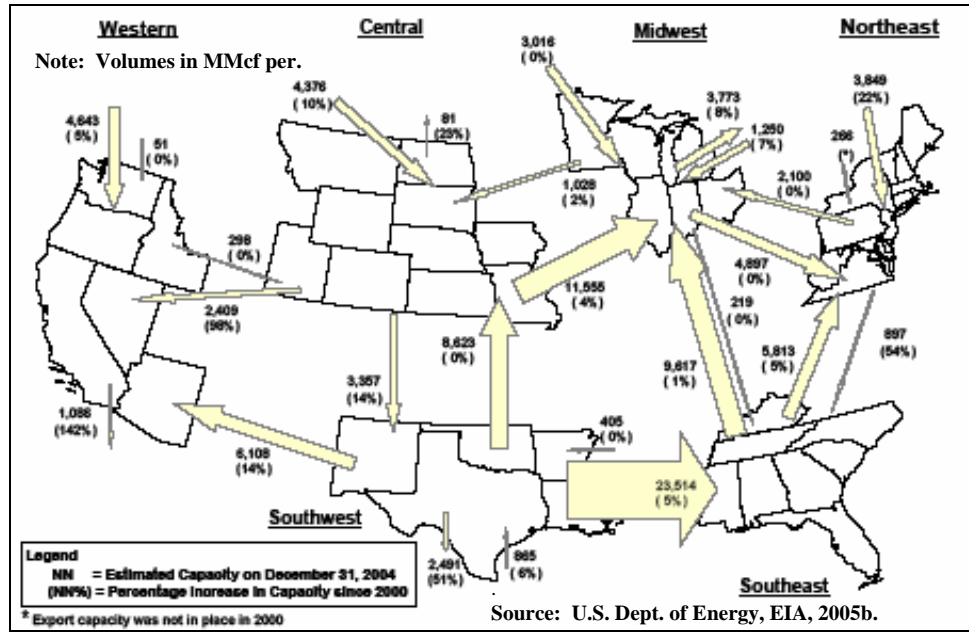


**Figure 48. GOM Gas Supply Schematic.**

The same industries and infrastructure supporting current production will be the ones to support LNG development. It is this high concentration of infrastructure that makes the GOM so attractive for LNG developers, and many analysts agree that construction costs can be minimized in the area for this very reason. As GOM natural gas production matures, this existing infrastructure can carry natural gas imported from other regions of the world to U.S. consuming regions. However, despite this considerable advantage, additional infrastructure as well as maintenance and upgrades of existing infrastructure will be necessary.

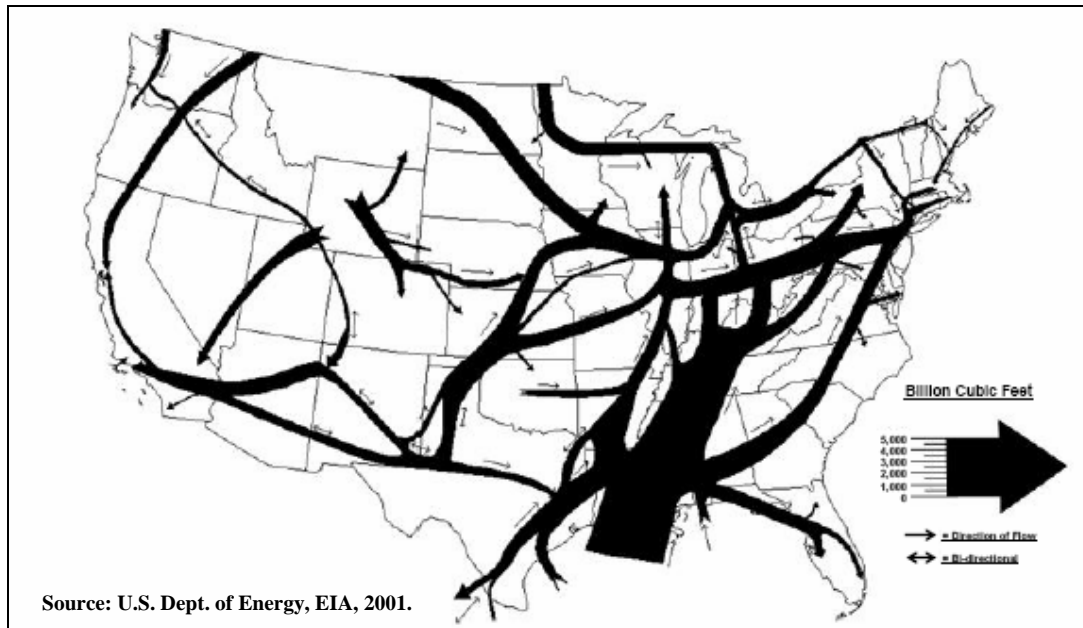
## 4.1. Transportation, Processing, and Storage Infrastructure

**4.1.1. Transportation:** The numerous natural gas pipelines that are located throughout the GOM comprise one of the most important infrastructure assets in the region, as highlighted by Figure 49. In 2004, some 26,865 miles of pipeline capacity flowed through and out of the GOM Region to areas of the U.S.



**Figure 49. Region-to-Region Natural Gas Pipeline Capacity, 2004.**

The interstate pipeline system was developed to support the onshore and offshore natural gas production of the GOM Region. This network moves gas in a number of different directions from producing regions (onshore and offshore) to consuming areas. Figure 50 is a generalized schematic highlighting gas flows from producing basins in the U.S. to consuming areas. For instance, natural gas produced in the mid-continent region typically moves into the upper Midwest. Gas from the San Juan basin and the Rockies serves the consuming regions in California and the western U.S., while gas produced in Appalachia is used almost exclusively in local markets.



**Figure 50. Principle Interstate Natural Gas Flow Summary.**

In the Gulf of Mexico Region, natural gas from Texas moves upwards from the Gulf coast area to the northeast and upper Midwest. Gas flows in Louisiana however, are more complicated and flexible offering considerable delivery options for gas produced in the region. In addition to serving local users along the GOM, gas from both onshore and offshore areas of Louisiana can serve a number of different markets. A large share of the gas that originates in the GOM is combined with gas from onshore wells and delivered to markets in the Northeast. Another share of production from Louisiana is delivered into the southeast and the mid-Atlantic states. Lastly, a share of the region’s production is moved along the GOM to other areas of the Southeast and into Florida – another large and highly natural gas dependent region of the country.<sup>16</sup>

The wide variety of pipeline systems and delivery markets makes the GOM attractive for LNG developers. In Texas, numerous large interstate pipelines parallel the Gulf Coast shoreline enroute to Louisiana and downstream markets. This would allow LNG projects to tie into multiple interstate pipeline systems, with much shorter pipeline construction needs. The capital cost savings could help to mitigate the potential for Gulf Coast prices to trade at discounts to Louisiana.

A LNG regasification facility can take advantage of this diverse pipeline system to move natural gas much like producers do today. This is true for proposed LNG facilities both on and offshore. In addition to taking advantage of the existing large trunkline system moving gas to far removed markets, LNG regasification facilities can also facilitate the natural gas gathering system located in the offshore areas of the GOM. This extensive pipeline infrastructure is what differentiates American and foreign LNG projects. In Europe and Asia, LNG projects are typically constructed near the customer, or point of use (Hopper, 2006).

<sup>16</sup> Between 1998 and 2004 total natural gas consumption in Florida increased by 46 percent, from 503 Bcf to 733 Bcf, primarily due to new gas-fired electric generation facilities, and industrial uses (U.S. Dept. of Energy, EIA, 2006).

The relationship is symbiotic for natural gas pipeline companies as well. Pipeline systems have significant capital costs that need to be recovered in charges for transportation service. Once pipeline investments are in place, variable costs, a function of natural gas flows (or throughput) of the pipe, are minimal. Thus, in the short-term the only way a pipeline can lower average costs and rates (to encourage customers) is to move more natural gas, since average costs will decrease as throughput increases. Pipelines can increase profits (to the extent allowed by regulation) by increasing these flows, lowering average costs, and increasing revenues holding other factors constant. Thus, having more LNG regasification facilities interconnected into a pipeline system is better for that system since it helps support existing capital investment.

LNG regasification investments represent an important benefit for pipeline owners. The GOM is a mature basin, thus, without the LNG investments in the GOM Region, these pipelines will become increasingly underutilized. Table 4 shows regional average annual capacity utilization of the pipeline system over time. Utilization varies greatly during the course of a year, depending upon the seasonal usage and economic activity. However, as peak production volumes have fallen, so have the overall annual average system utilization. If these trends continue, pipeline infrastructure in the region would eventually be decommissioned and abandoned. The influx of new gas volumes from LNG imports gives this infrastructure a second life, maintaining employment opportunities for local workers and becoming an important property tax base for many local GOM communities.

**Table 4**  
**GOM Pipeline Capacity Utilization, 2003-2007**

U.S. Census Region	2003	2004	2005	2006*	2007*
<b>Utilization Entering Region</b>					
South Atlantic	0.57	0.49	0.44	0.42	0.43
East South Central	0.61	0.56	0.54	0.52	0.54
West South Central	0.32	0.22	0.24	0.22	0.19
United States (Pipeline Imports)	0.64	0.63	0.61	0.60	0.56
<b>Utilization Exiting Region</b>					
South Atlantic	0.57	0.51	0.51	0.50	0.49
East South Central	0.6	0.53	0.5	0.49	0.51
West South Central	0.5	0.45	0.44	0.43	0.43
United States (Pipeline Exports)	0.48	0.47	0.46	0.45	0.35

Note: \* = projected.

Source: U.S. Dept. of Energy, EIA, 2007e.

Historically, pipeline configurations for trunklines and various radials were developed to match production with consumption. New LNG facilities are creating some geographic challenges to the pipeline system, since these facilities are being proposed in areas that may not necessarily be near producing locations or locations that have historically experienced large production volumes. As a result, most LNG regasification facilities are constructing pipeline expansions or

extensions to major trunklines at various locations of the GOM. Further, developing different pipeline interconnects enhances the flexibility and deliverability of various LNG projects.

For example, when the Gulf Gateway offshore LNG project was completed in 2005, it required an 8-mile pipeline lateral linking it to existing offshore-to-onshore systems. If the EIA projections are correct, some 17.35 Bcf per day of additional pipeline capacity is needed in the GOM by the end of 2008 just for the LNG projects under construction. To move this gas onshore, approximately 463 miles of new lateral pipelines will be required. Kinder-Morgan Energy Partners has proposed a 137-mile pipeline interconnecting its Sabine Pass facility and allowing up to 2.1 Bcf per day throughput. Unless there is significant underutilized natural gas pipeline capacity in the vicinity of these new LNG facilities, interstate natural gas pipeline companies in the area, such as Kinder-Morgan, are expected to seek approval of complementary expansion proposals as additional LNG sites near completion status (U.S. Dept. of Energy, EIA, 2006).

Table 5 lists the new pipeline projects that have been announced recently with newly proposed LNG regasification facilities. Many of these pipeline projects are quite large with 32-inch or larger pipeline diameter extensions/expansions. These projects are equally large in terms of their respective capital investments. Almost 1,000 mile of pipe is expected to be laid as part of these new facilities. This represents an estimated \$3.4 billion in pipeline expenditures.

Table 5

Investment Costs for Proposed LNG Facilities

(a)	(b)	(c)	(d)	(e)	(f)	(h) = (f) * (g)	(i)	(j)	(k) =	(l) = (i) * (k)	(m) = (h) + (l)	(n) = (d) - (m)
Project	Company	Location	Reported Total Project Installed Costs **/1 (million \$)	Capacity		Value of Storage */2 (million \$)	Installed Pipeline		Reported Pipeline Cost per Mile at Given Diameter */3 (million \$)	Value of Investment Pipeline ( $\$$ )	Estimated Supporting Infrastructure Investment ( $\$$ )	Total Project Investment Less Supporting Infrastructure ( $\$$ )
				Peak (Bcf)	Storage (Bcf)		(Miles)	(Diameter)				
<b>Onshore</b>												
Cameron LNG	Sempra Energy	Hackberry, LA	\$ 700.0	1.50	10.40	\$ 64.3	35.4	36	\$ 3.57	\$ 126.3	\$ 190.6	\$ 509.4
Freeport LNG	Cheniere	Quintana Is., TX	\$ 800.0	1.50	7.00	\$ 43.3	9.4	36	\$ 3.57	\$ 33.5	\$ 76.8	\$ 723.2
Sabine Pass	Cheniere	Sabine Pass, LA	\$ 750.0	2.60	10.10	\$ 62.4	16.0	42	\$ 3.57	\$ 57.1	\$ 119.5	\$ 630.5
Corpus Christi	Cheniere	Corpus Christi, TX	\$ 700.0	2.60	10.10	\$ 62.4	24.0	48	\$ 3.57	\$ 85.6	\$ 148.0	\$ 552.0
Vista Del Sol	Exxon Mobil	Corpus Christi, TX	\$ 600.0	1.00	10.10	\$ 62.4	25.0	36	\$ 3.57	\$ 89.2	\$ 151.6	\$ 448.4
Golden Pass	Exxon Mobil	Sabine Pass, LA	\$ 600.0	1.00	11.33	\$ 70.0	119.7	36	\$ 3.57	\$ 427.1	\$ 497.1	\$ 102.9
Corpus Christi	Occidental	Corpus Christi, TX	\$ 400.0	1.00	7.00	\$ 43.3	26.4	26	\$ 1.55	\$ 41.0	\$ 84.2	\$ 315.8
Port Arthur	Sempra	Port Arthur, TX	\$ 600.0	1.50	10.10	\$ 62.4	73.0	36	\$ 3.57	\$ 260.5	\$ 322.9	\$ 277.1
Creole Trail	Cheniere	Cameron, LA	\$ 950.0	2.60	11.04	\$ 68.2	287.3	42	\$ 3.57	\$ 1,025.2	\$ 1,093.4	\$ (143.4)
Sabine Pass - Phase II	Cheniere	Sabine Pass, LA	n.a.	1.40	10.10	\$ 62.4	16.0	42	\$ 3.57	\$ 57.1	\$ 119.5	n.a.
Freeport LNG - Phase II	Cheniere	Quintana Is., TX	n.a.	2.90	7.50	\$ 46.3				\$	\$ 46.3	n.a.
Cameron LNG Expansion	Sempra Energy	Hackberry, LA	\$ 250.0	2.65	5.66	\$ 35.0				\$ -	\$ 35.0	\$ 215.0
Gulf LNG Energy Bayou		Pascagoula, MS	\$ 450.0	1.00		\$ -	5.0	36	\$ 3.57	\$ 17.8	\$ 17.8	\$ 432.2
Cassotte	ChevronTexaco	Pascagoula, MS	n.a.	1.60	16.99	\$ 105.0	-	-		\$ -	\$ 105.0	n.a.
Calhoun LNG	Gulf Coast LNG	Port Lavaca, TX	\$ 400.0	1.00	5.7	\$ 35.2	27.0	36	\$ 3.57	\$ 96.3	\$ 131.6	\$ 268.4
<b>Offshore</b>												
Port Pelican	ChevronTexaco		\$ 800.0	1.60	6.80	\$ 42.0	42.5	42	\$ 3.57	\$ 151.7	\$ 193.7	\$ 606.3
Main Pass	McMoRanExp		\$ 440.0	1.60	28.00	\$ 173.0	192.0	36	\$ 3.57	\$ 685.1	\$ 858.1	\$ (418.1)
Bienville	TORP		\$ 400.0	1.40	-	\$ -	25.0	36	\$ 3.57	\$ 89.2	\$ 89.2	\$ 310.8
Port Dolphin	Hoegh LNG		\$ 1,000.0	1.20	-	\$ -	42.0	36	\$ 3.57	\$ 149.9	\$ 149.9	\$ 850.1
Notes:			*/1 Project dollars include all investments									
			*/2 Storage is valued at \$6.18 million per bcf									
			*/3 Cost per mile is not reported for pipelines over 36" in diameter.									

Source: FERC, 2007a, daily trade press and company websites and FERC Filings.

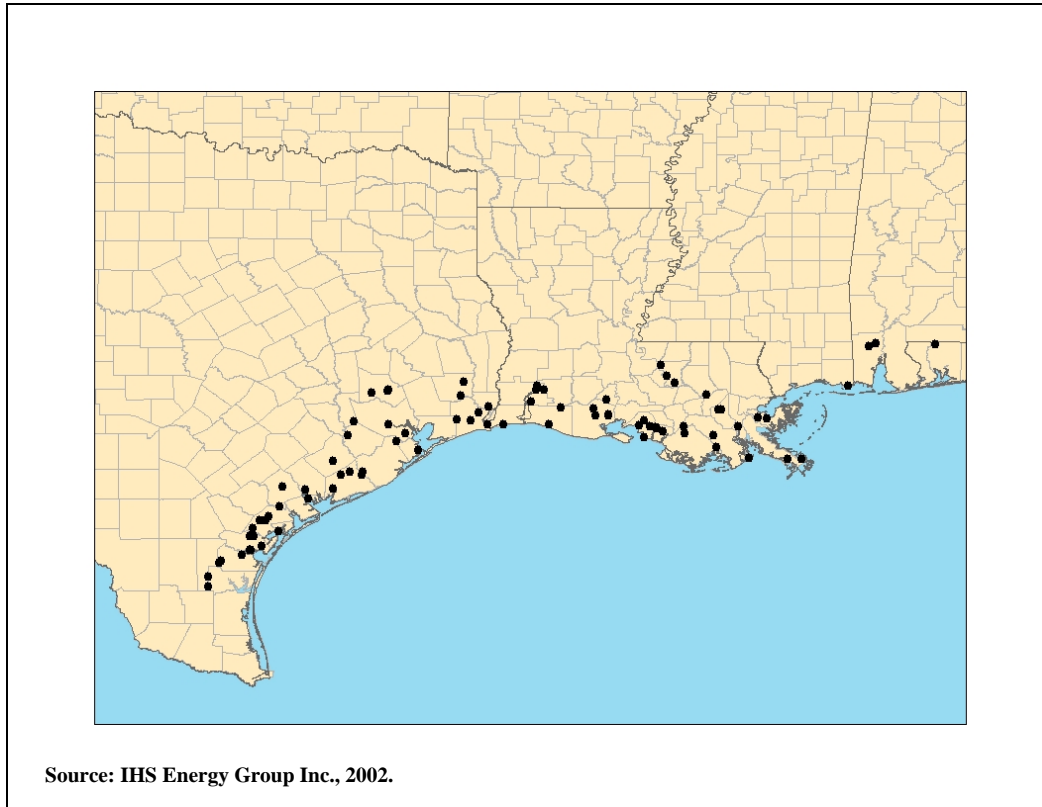
**4.1.2. Processing:** Natural gas is composed primarily of methane (about 82 percent), but may also contain a number of other chemicals, such as propane, butane, ethane and other heavier hydrocarbons. Gas quality is an important issue for both domestic and imported natural gas (including LNG) since all intrastate and interstate pipelines have quality standards which must be met before any gas can be injected into the pipeline system. Water and other impurities are removed before the gas is liquefied, keeping its methane content at approximately 95 percent. Natural gas processing is another other significant piece of infrastructure located in the GOM Region, and is both supportive and supporting of, new LNG regasification facility development. These facilities remove the heavier hydrocarbons, liquids (water vapor), and impurities that can be present in the gas stream from the production process or possibly from LNG imports. Some of these natural gas liquids, like ethane, propane, and butane, have commercial value. These liquids are stripped and then sent via natural gas liquids (NGL) pipelines to individual industrial users or other market centers.

In addition to the commercial value of these liquids, all natural gas pipelines have certain gas quality standards necessary for transporting natural gas to end-user markets. For instance, heavier gas liquids can impair pipelines and create operational concerns, particularly in cold weather, which can have the effect of causing NGLs to drop out of the gas stream and into the pipeline itself. Since LNG can include higher shares of NGLs than standard domestic pipeline quality gas, there are concerns that substantial LNG injections into the domestic pipeline may effect the quality of gas, which can affect the performance of equipment downstream such as burners, stoves, etc.

Typically, gas quality standards are defined in terms of the “Wobbe Index,” which is the main indicator of the interchangeability of fuel gases such as natural gas, LPG and LNG. This index is used to compare the combustion energy output of different composition fuel gases in an appliance (fire, cooker, etc.). Typically variations of up to 5 percent are permitted, as these would not be noticeable to the consumer. This allows the substitution of one gaseous fuel for another in a combustion application without materially changing operational safety, efficiency, performance or material increasing air pollutant emissions.

According to the AGA, interchangeability is described in “technically-based quantitative measures, such as indices, that have demonstrated broad application to end-uses and can be applied without discrimination of either end-users or individual suppliers” (American Gas Association, 2005). The closer the Wobbe Index number is between imported LNG and domestic pipeline gas, the more interchangeable is the gas, and thus, the less likely there will be any problems of dissimilar gas composition, and therefore quality. However, LNG can have a higher Wobbe Index number, and this value should be lowered to make it compatible to pipeline gas. There are several ways to do this, most notably at the LNG terminal or processing facility. The location and number of gas processing facilities in the GOM Region gives this area a competitive advantage over other LNG import areas, largely due to the demand for natural gas liquids separated from the gas at processing stations. The demand for natural gas liquids is simply greater in the GOM Region, thus keeping processing costs (including transportation) lower (American Gas Association, 2005). The future of these natural gas processing facilities could be potentially important for LNG regasification facility development as imports from other countries may have different compositions.

Figure 51 shows the large number of natural gas processing facilities that are located throughout Louisiana alone. Most of these facilities that are located along the coast of Louisiana, and to a lesser extent Texas, service gas processed from production in the GOM.

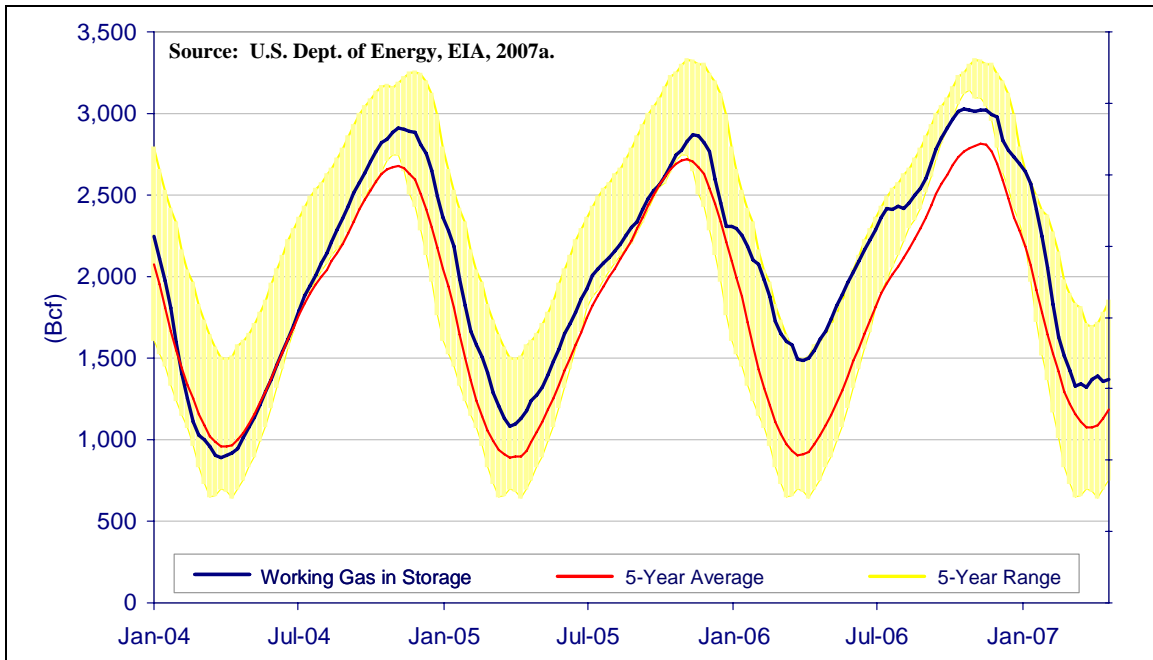


**Figure 51. Natural Gas Processing Facilities.**

As learned during the 2005 tropical season, these facilities are critically important in cleaning natural gas in order to serve markets throughout the U.S.

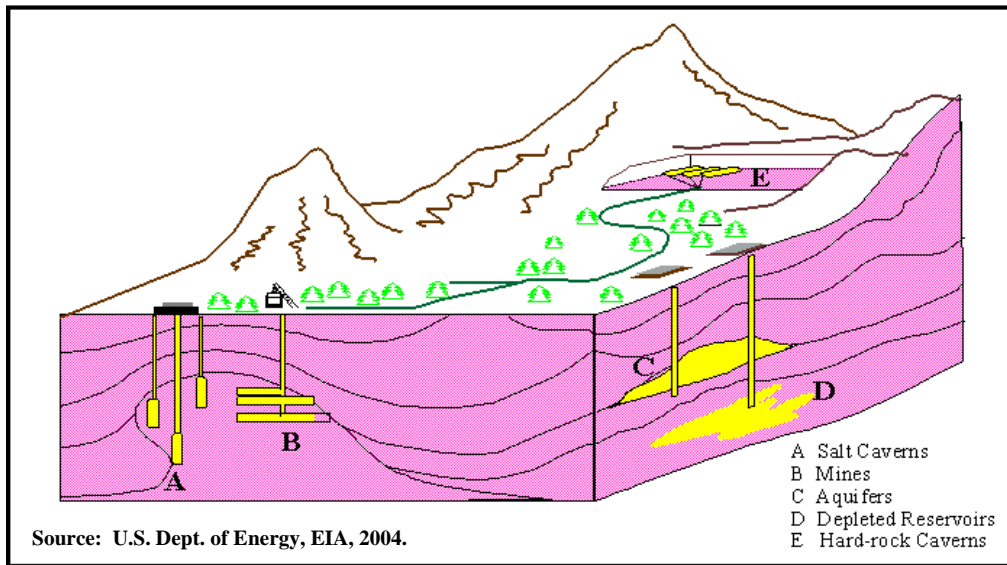
**4.1.3. Storage:** Natural gas storage is another important piece of infrastructure that is concentrated in the GOM Region and supports development of LNG regasification facilities. Natural gas storage is used in natural gas markets to balance loads across the year. Natural gas demand peaks in the U.S. in the colder winter months, when production is insufficient to cover increased heating needs. The warmer months of April to November 1 are termed the “injection season”, while the colder months of November through March are known as the “withdrawal season.” Total gas in storage usually follows a cyclical up and down pattern corresponding to these periods. Figure 52 shows this cycle over the past few years.



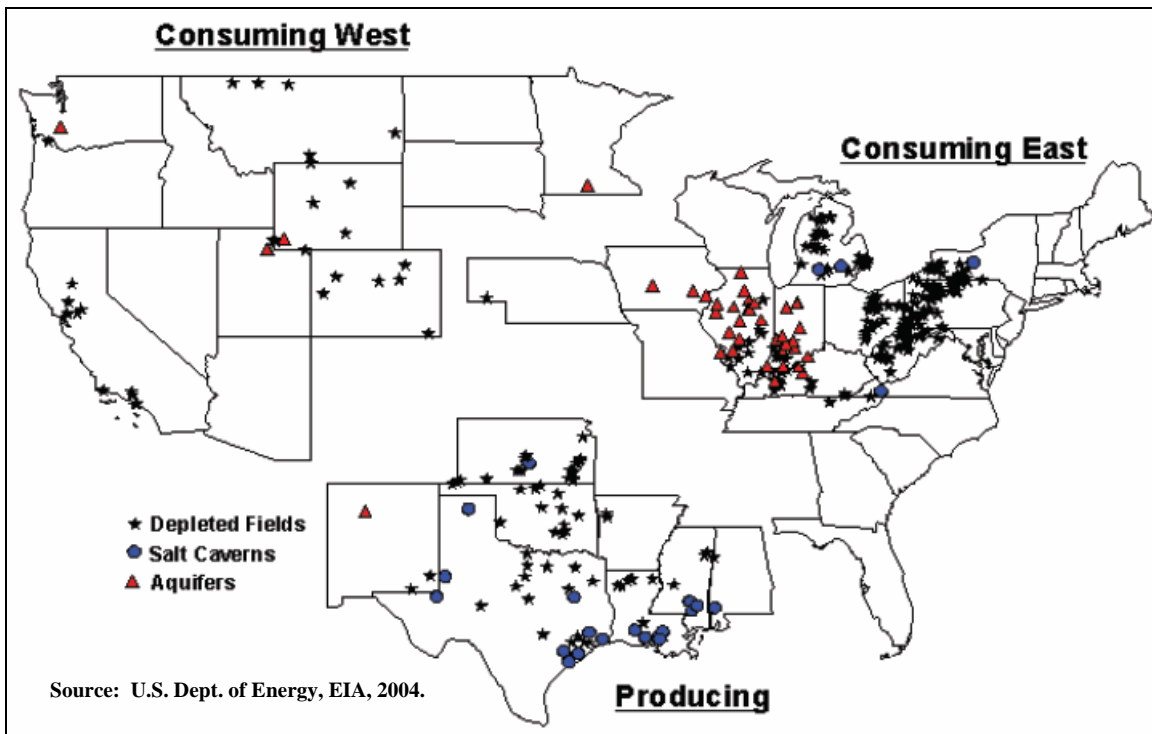


**Figure 52. Working Gas in Underground Storage.**

Storage facilities are typically created from different geological features that include aquifers, depleted oil and gas fields, and salt domes. Figure 53 provides a schematic of these different types of facilities, while Figure 54 shows the different areas of the country where these facilities are located. All three types of geological features can be found along the GOM, although most of the natural gas storage facilities in the region are developed from depleted oil and gas wells and salt domes.



**Figure 53. Natural Gas Storage Facilities.**



**Figure 54. Natural Gas Storage Facilities in the Lower 48 States.**

In all, there are approximately 385 gas storage facilities in the U.S. that can deliver up to 50 Bcf/d of withdrawals and inject up to 35 Bcf/d. Many of these facilities are located along the GOM. Table 6 provides a summary of the GOM states and their natural gas storage facilities by geological type. Within the GOM Region, some 25 percent of all storage facilities are located in Louisiana, while 60 percent and 12 percent are located in Texas and Mississippi, respectively.

However, Louisiana represents 41 percent of the GOM natural gas storage capacity and over 7 percent of U.S. natural gas storage capacity.

**Table 6**  
**GOM Natural Gas Storage Fields by Type, 2005**

	Field Type				Capacity				Percent of GOM --- (%) ---	Percent of US ---
	Salt Dome	Aquifer	Depleted Field	Total	Salt Dome	Aquifer	Depleted Field	Total		
					----- (Bcf) -----					
Alabama	1	-	1	2	8.3	-	2.7	11.0	0.8%	0.1%
Mississippi	3	-	4	7	45.6	-	105.4	150.9	10.5%	1.8%
Louisiana	6	-	8	14	63.3	-	530.4	593.7	41.4%	7.2%
Texas	14	-	20	34	120.5	-	559.6	680.1	47.4%	8.2%
<b>Total GOM</b>	<b>24</b>	<b>-</b>	<b>33</b>	<b>57</b>	<b>237.7</b>	<b>-</b>	<b>1,198.1</b>	<b>1,435.8</b>	<b>100.0%</b>	<b>17.4%</b>

Source: FERC, 2007c.

LNG regasification facilities will also need access to storage much like natural gas production does today. Like production, natural gas imports will come year-round, while demand for natural gas is cyclical. Therefore, gas from LNG imports during the injection season when demand is low will need to be injected into storage. This gas will be withdrawn in fall and winter months for peak heating demand. Since the current number of natural gas storage facilities exists to handle current production, new facilities, or facility expansions, will need to be made to accommodate the new gas supplies coming from LNG.

Since 2000, FERC has approved storage facilities totaling 263 Bcf of capacity, and 12.4 Bcf/d of deliverability. As of late 2006, FERC identified some 148 Bcf of additional storage capacity, representing 4.7 Bcf/d of deliverability. Most of this storage potential is located in the GOM Region. An increase in the amount of storage capacity will allow U.S. LNG market participants to take advantage of market development and therefore be in a better position to meet gas demands during the heating season at less volatile and, perhaps, lower prices (FERC, 2006a).

A number of new natural gas storage facilities have been announced over the past few years. Some are being developed to accommodate the natural gas supplies coming from LNG. Table 7 provides a list of those recently announced facilities and their proposed capacities. To date, almost 70 Bcf of storage capacity has been announced for the GOM. Like pipelines, these storage investments represent additional dollars in local communities, and additions to supporting infrastructure.

**Table 7**

**New and Proposed Storage Projects, as of January 2007**

Company / Project	State	Capacity (Bcf)	Deliverability (MMcf/d)	Year Certificated	Status
<b>Northeast</b>					
Dominion Transmission, Inc / Northeast Storage Project	NY, PA, WV	9.4	163	2005	In Service
Hardy Gas Storage, LLC / Hardy Storage	WV	12.4	176	2005	Under Construction
Central NY Oil and Gas Co, LLP / Stagecoach Phase II Expansion	NY, PA	13.0	-	2006	Under Construction
Tennessee Gas/National Fuel / Northeast ConneXion	PA, NJ	-	114	2006	Under Construction
Texas Eastern Transmission, LP / Accident Storage Enhancement	MD	3.0	-	2006	Under Construction
<b>South Central</b>					
Egan Hub Partners, LP / Cavern III	LA	8.0	-	2003	In Service
CenterPoint Energy Gas Transmission / Chiles Dome Expansion	OK	15.0	309	2005	In Service
Liberty Gas Storage LLC / Liberty Gas Storage	LA	17.6	1,000	2005	Under Construction
Natural Gas Pipeline Co of America / Sayre Field Expansion	OK	10.0	200	2005	Under Construction
Egan Hub Partners, LP	LA	-	1,000	2006	Approved
Natural Gas Pipeline Co of America / North Lansing Field Expansion	TX	10.0	140	2006	Under Construction
Northern Natural Gas Company / Cunningham Field Project	KS	-	70	2006	Under Construction
Port Barre Investments, LLC / Bobcat Gas Storage	LA	12.0	1,200	2006	Approved
<b>Southeast</b>					
Caledonia Energy Partners, LLC / Caledonia Energy Complex	MS	11.7	330	2005	Under Construction
Freebird Gas Storage, LLC / Freebird Storage	AL	6.1	160	2005	Under Construction
Gulf South Pipeline Company, LP / Jackson Storage Field	MS	2.4	-	2005	Approved
SG Resources Mississippi, LLC / Southern Pines Energy Center	MS	12.0	1,200	2006	Limited Service
<b>Midwest</b>					
Texas Gas Transmission, LLC / Texas Gas Storage Expansion	KY	8.2	82	2005	In Service
Bluewater Gas Storage	MI	29.2	826	2006	Approved
Northern Natural Gas Company / Cunningham Field Project	KS	-	70	2006	Under Construction
<b>Western</b>					
Unocal Windy Hill Gas Storage / Windy Hill	CO	6.0	400	2006	Approved

Source: FERC, 2007c.

## 5. REGULATORY ISSUES ASSOCIATED WITH LNG SITING AND DEVELOPMENT

Permitting LNG facilities is a laborious, expensive process than can take years before approvals, or denials, are given. Several Federal and State agencies are involved in the process, with FERC as the leading agency for onshore facilities as authorized under the Natural Gas Act.<sup>17</sup> For offshore facilities the U.S. Coast Guard is the supervising agency. As might be expected, both agencies work closely together with the Department of Transportation and other federal agencies to review LNG. It is important to note that the permitting process for onshore facilities differs from that of the offshore.

The FERC has authority over entry and exit, siting, construction, and operation of new terminals, as well as modifications or extensions of existing terminals. It also has jurisdiction over the existing import terminals and 15 peak-shaving plants involved in interstate gas trade. Facilities to be located near Canada or Mexico for import or export of natural gas also require a Presidential Permit. Every two years, FERC officials inspect LNG facilities to monitor the condition of the plant and review changes. The Coast Guard is responsible for assuring marine safety in coastal waterways under the authority of the Ports and Waterways Safety Act of 1972 and the Maritime Transportation Security Act of 2002 (which amended the Deepwater Port Act of 1974). The Coast Guard process is designed to render a decision within one year of receipt of application for the construction of an off-shore LNG terminal. The Coast Guard also regulates the design, construction, and operation of LNG ships and the duties of LNG ship officers and crews (U.S. DOE, 2005).

The Pipeline Safety Act of 1994 gave the Department of Transportation's Office of Pipeline Safety (OPS) the authority to regulate the siting and safety of LNG pipeline facilities, including LNG peak-shaving plants. The OPS is also responsible for operating, maintenance, fire protection, and safety standards for facilities under its authority. The Department of Energy's Office of Fossil Energy (OFE) coordinates across federal agencies that have regulatory and policy authority for LNG. The Natural Gas Act of 1938 requires that anyone seeking to import or export natural gas across U.S. borders to be authorized by the OFE. OFE monitors and certifies LNG shipments and also funds LNG research (U.S. DOE, 2005).

Finally, the National Environmental Policy Act (NEPA) requires that federal agencies must consider the environmental impact of all proposals for major federal actions and, when appropriate, consider alternatives. FERC is the lead agency in implementing NEPA requirements for onshore facilities, though other agencies are also involved, including the EPA. However, FERC approves or disapproves the actual Environmental Impact Statement (EIS). The Coast Guard is the lead NEPA agency for off-shore terminals (U.S. DOE, 2005). There are as many as 13 in-depth resource reports that make up the EIS for each site.

---

<sup>17</sup> The Natural Gas Act (NGA) of 1938 gave the Federal Power Commission (FPC) (subsequently the Federal Energy Regulatory Commission (FERC)) the authority to grant certificates allowing construction and operation of facilities used in interstate gas transmission and authorizing the provision of services. A "certificate of public convenience and necessity" is issued under Section 7 of the NGA, and permits pipeline companies to charge customers for some of the expenses incurred in pipeline construction and operation. The NGA also requires Commission approval prior to abandonment of any pipeline facility or services. Section 3 of the NGA requires approval by FERC for the siting, construction, and operation of onshore LNG import and export facilities.

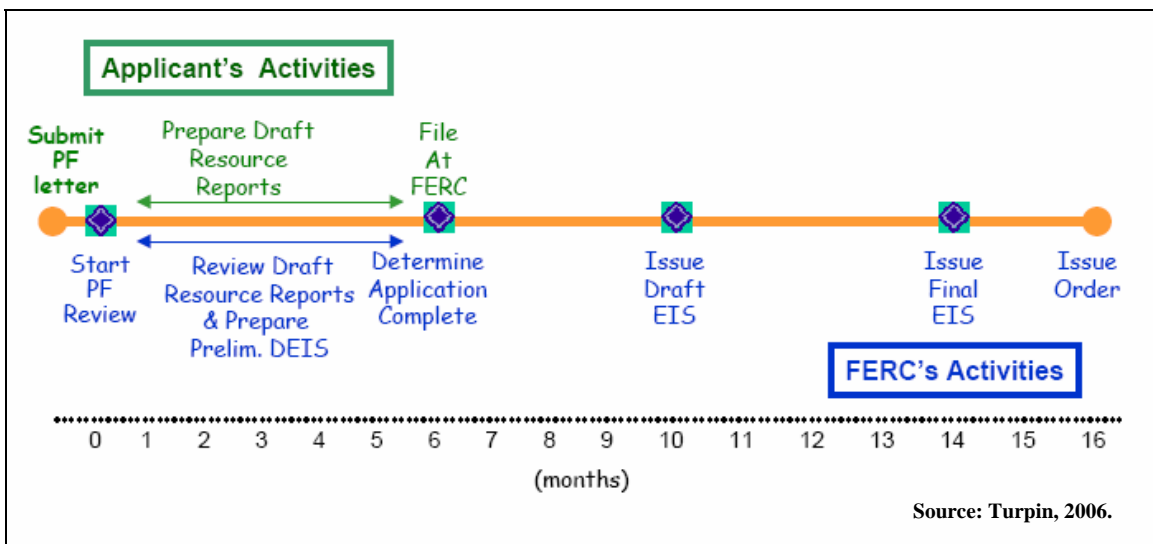
**Table 8**

**Environmental Impact Statement for Onshore LNG Terminals**

<b>Topics Included in the Environmental Impact Statement (EIS) for Onshore LNG Terminals</b>	
<ul style="list-style-type: none"> <li>• General Project Description</li> <li>• Water Use &amp; Quality</li> <li>• Fish, Wildlife &amp; Vegetation</li> <li>• Cultural Resources</li> <li>• Socioeconomics</li> <li>• Geological Resources</li> <li>• Soils</li> </ul>	<ul style="list-style-type: none"> <li>• Land Use, Recreation &amp; Aesthetics</li> <li>• Air &amp; Noise Quality</li> <li>• Alternatives</li> <li>• Reliability &amp; Safety</li> <li>• PCB Contamination (pipelines only)</li> <li>• LNG Engineering &amp; Design Details</li> </ul>

Source: FERC, 2005.

The EIS process begins almost immediately after a LNG application (or pre-filing statement) is filed for terminal construction. A draft EIS is released approximately 10 months after the application, with the final EIS issued before FERC can approve or reject a facility. As seen in Figure 55, it typically takes 14 months from application to approval of the final EIS, with a site approval/rejection decision issued within about two months of the final EIS release. For offshore facilities, the Deepwater Port Act established an expedited licensing process that is not to exceed 356 days from the receipt of a complete application. While the EPA’s permit actions are not subject to these time constraints, they are designed to be completed in time to avoid construction and operation delay (U.S. DOE, 2005).

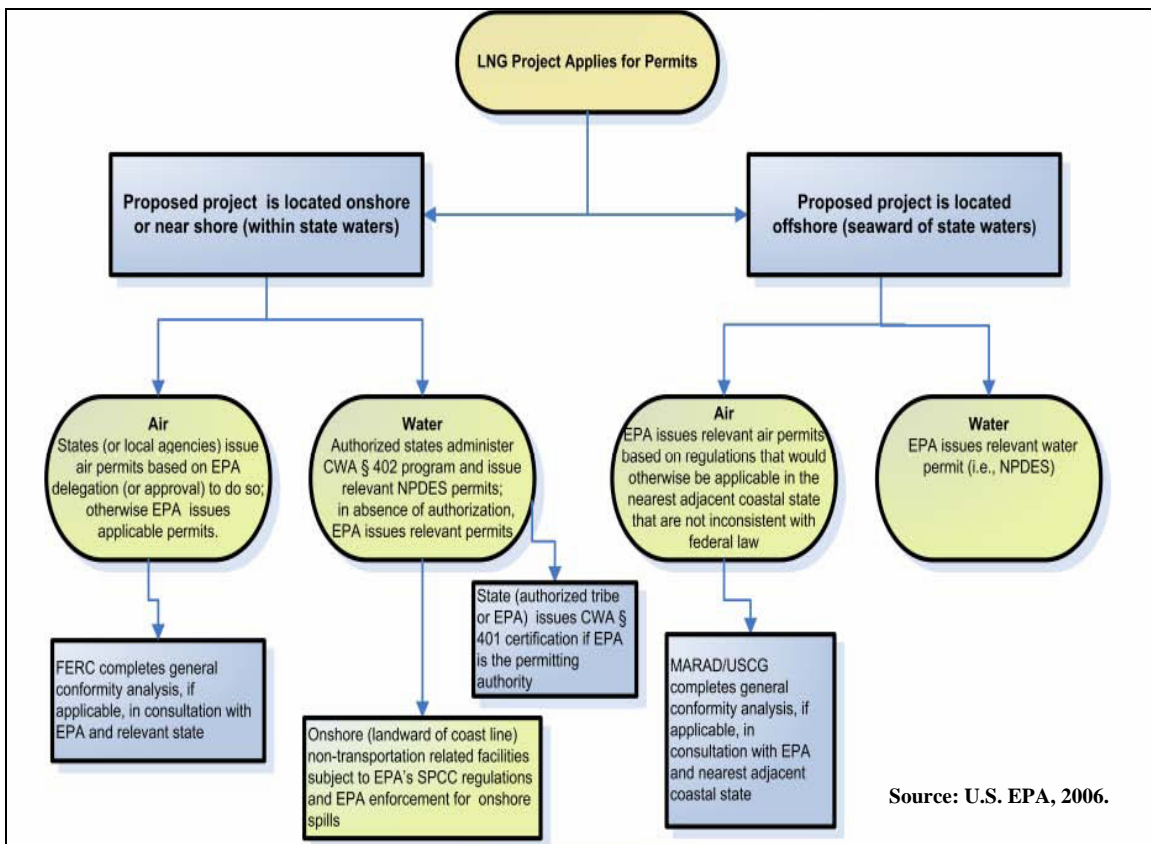


**Figure 55. Timeline for LNG Review Process.**

The EPA’s role can vary by project, depending on design and physical siting. The EPA has key input in the following areas (U.S. EPA, 2006):

- Project approval and environmental review process;
- Requirements and decision making related to air emissions;
- Requirements related to water quality; and
- Other permitting requirements and considerations.

Figure 56 highlights the EPA’s role in each area in more detail.



**Figure 56. EPA’s Role in the LNG Permitting Process.**

State agencies are also involved in the LNG terminal permitting process, and in some instances local governments, including police and fire departments, may also be involved in the process.

Over the past several years, there has been much disagreement over the different review processes for onshore and offshore projects. In 2004, the U.S. Department of Commerce, Department of Defense, Department of Energy, Homeland Security, Department of the Interior, Department of Transportation, EPA, FERC, Corps of Engineers and the Council on Environmental Quality signed a final memorandum of understanding for interagency coordination on licensing of deepwater ports in an attempt to streamline the process (U.S. DOE,

2005). Nevertheless, as many as 100 permits may be required from various federal, state, and local government agencies for a new onshore LNG regasification facility. Without significant delays, it could take up to seven years for the typical LNG import terminal to be brought on-line from initial design to the first LNG delivery, including up to three years for the necessary permits (NPC, 2004).

Despite the streamlined process, there are still many differences between how onshore and offshore LNG terminals are permitted. These differences include (Kennedy, 2006):

- Different federal laws and standards;
- Different federal agency leads;
- Different state agency leads;
- Different timelines for review;
- Different roles for governors;
- Different approaches to modeling risk.

Coordination must take place between the various federal and state agencies due to these differences. Further, some states wish to assert control over both processes, and governors were granted additional authority over proposed onshore facilities through the Energy Policy Act (EPACT) of 2005.

EPACT allows a state governor with a proposed onshore terminal to designate a state agency to consult with FERC regarding applications, which subsequently consults with the named agency regarding state and local safety considerations. EPACT also allows a state agency to furnish an advisory report on state and local safety considerations to FERC. For offshore projects, federal law allows governors to approve, approve with conditions, or veto proposed projects. For example, in 2006, Louisiana Governor Blanco vetoed Freeport McMoRan's proposed open loop Main Pass Energy Hub project offshore of its coast. Federal law states that a state's lack of action within 45 days of a final federal hearing is the equivalent of license approval (Kennedy, 2006). Thus, if the state fails to take any type of protest action in 45 days, a LNG facility can move forward with its potential license.

### **5.1. Onshore Permitting Process**

As noted earlier, the FERC has approval authority over LNG onshore facilities. It also has operational authority over all existing and proposed onshore import terminals, and peak-shaving plants involved in interstate gas trade. Other federal agencies potentially involved include (U.S. DOE, 2005):

- Department of Energy
- Coast Guard



- Department of Transportation
- Environmental Protection Agency
- Minerals Management Service
- Fish and Wildlife Service
- Department of Labor/OSHA
- Army Corps of Engineers
- Maritime Administration (MARAD)

The LNG onshore facility approval process before the FERC is typically composed of three distinct phases: 1) Pre-Filing Technical Consultation; 2) Pre-Decision Review; and 3) Post-Decision Inspection and Monitoring (FERC, 2007d).

**5.1.1. Pre-Filing Technical Consultation:** Prior to filing an LNG application, company representatives meet with FERC staff to explain the proposal and solicit advice. This is a “give-and-take” process designed to save time, money, and effort and to ensure that the project meets the minimal FERC criteria. At this time, applicants are required to implement a Public Participation Plan that identifies specific tools and actions to facilitate stakeholder communication and information dissemination. This is a critical phase, since a poorly designed public participation program can result in unneeded public opposition. The pre-filing process typically takes six months.

**5.1.2. Pre-Decision Review:** During the Pre-Decision Review process, FERC develops an Environmental Impact Statement to fulfill the requirements of the National Environmental Policy Act (NEPA). Other requirements during this stage include:

- Compliance with Section 307 of the Coastal Zone Management Act;
- Section 7 of the Endangered Species Act;
- Section 106 of the National Historic Preservation Act;
- And the Magnuson-Stevens Fishery Conservation and Management Act.

As the leading federal agency for onshore LNG regasification facilities, FERC works closely with the U.S. Army Corps of Engineers, Environmental Protection Agency, and the States in meeting the requirements of the Clean Water Act, the Rivers and Harbors Act, the Clean Air Act, and the Coastal Zone Management Act. Further, FERC collaborates with the Coast Guard to ensure issues associated with waterways management/navigation safety under the Ports and Waterways Safety Act and the maritime security issues under the Maritime Transportation Security Act are addressed. LNG projects under FERC jurisdiction may only be constructed and

operated after obtaining Clean Water Act, Coastal Zone Management Act, and Clean Air Act permits.

A thorough study of potential impacts to public safety is also included as part of the NEPA process. Part of this safety analysis includes a FERC determination regarding whether the proposal meets the siting requirements of the DOT's regulations in 49 CFR 193 and National Fire Protection Association Standard (NFPA) 59A. The siting analysis includes: verification of LNG dike and impoundment volumes; equipment spacing; design spills; and exclusion zone calculations. Also, FERC engineers calculate and verify hazard modeling, and then present the results in the EIS. FERC also determines the areas of hazard from potential LNG ship spills in its scenario analysis. The FERC Staff also addresses any waterway issues, including congestion and safety concerns. Finally, FERC engineers perform a detailed review of the proposed LNG facility design.

**5.1.3. Post-Decision Inspection and Monitoring:** Once a project is authorized, the process continues in two main phases: construction and operation. Each phase includes on-going reports and inspections throughout the operational life of the facility. An Emergency Response Plan (ERP) is developed in coordination with the Coast Guard, state, county and local law enforcement and appropriate Federal agencies.

FERC activities alone often take 16 to 18 months and can cost hundreds of thousands of dollars. Other federal and state agencies work closely with FERC to prepare the EIS and typically are involved early in the pre-filing process to ensure a smooth process. The EPA is intricately involved in the entire EIS preparation phase, and reviews and comments on the document as required by the Clean Air Act (U.S. EPA, 2006).

## **5.2. Offshore Permitting Process**

The Deepwater Port Act, as amended in 2002 by the Maritime Transportation Security Act, gives the Coast Guard approval authority over all offshore LNG facilities in federal waters. It also established an expedited license process for authorizing construction and operation of deepwater ports in U.S. waters located beyond state seaward boundaries. LNG facilities being proposed in most federal offshore areas are considered deepwater ports.

State utility commissions can also assert that they have siting and safety jurisdiction under state laws and are certified by the US Department of Transportation (DOT) if they use federal LNG safety standards as their minimum standards. At least one utility commission, the California PUC, has asserted that it has exclusive jurisdiction for LNG terminals sited in California that are intended to serve California gas markets (NARUC, 2005).

Other federal agencies involved in offshore LNG decision-making process include:

- Department of Energy
- Department of Transportation
- Fish and Wildlife Service

- National Oceanic and Atmospheric Administration
- Department of Labor/OSHA
- Army Corps of Engineers
- EPA
- Minerals Management Service
- Maritime Administration

As with onshore facilities, the EPA reviews the EIS issued by the Coast Guard as a cooperating agency under the authority granted by the Clean Air Act (CAA). It also has broad powers granted by the Clean Water Act (CWA) and the Marine Protection, Research and Sanctuaries Act (MPRSA), also known as the Ocean Dumping Act. Within 45 days of the last public hearing on the LNG license application, the EPA Administrator will provide the Secretary of Transportation a recommendation to approve or disapprove the license and inform the Secretary if the deepwater port does not conform with all applicable provisions of the CAA, CWA, and MPRSA (U.S. EPA, 2006).

### **5.3. State Input into the Permitting Process**

State authority over onshore LNG facilities varies considerably, since this authority is a function of individual state laws and regulations. Some states have siting and safety jurisdiction over LNG facilities under their state laws. State utility commissions have primary approval authority over siting intrastate natural gas lines and related facilities such as storage, peak shaving and local distribution systems. State and local governments have broad responsibilities for zoning, water, electric, construction and waste disposal permitting. Further, states have some federal permitting authority (or authorization) under the Clean Air Act, the Clean Water Act, and the Coastal Zone Management Act (CZMA).

The CZMA was passed in 1972 to encourage coastal states to take steps towards managing their coastal and other natural resources. One goal of the CZMA is the protection of coastal zone habitat areas of fish, shellfish, and other living marine resources and wildlife. If a state decides to participate in the CZMA, it must develop and implement a coastal management program (CMP) in accordance with federal requirements. CMPs are developed with the participation of federal agencies, state and local agencies, industry, and other interested public and private groups. The National Oceanic and Atmospheric Administration (NOAA) grants final approval of these CMPs.

Congress offered coastal states the incentive of consistency provisions in exchange for adopting individualized CMPs, which allows an affected coastal state to require federal actions that have reasonably foreseeable effects on land use, water use, or natural resources of the coastal zone be consistent to the maximum extent practical with the enforceable policies of its federally approved CMP. Since an offshore LNG terminal is required to obtain a federal permit for

construction and operation, it too is subject to the CZMA consistency provision (Louisiana Sea Grant Program, 2005).

There is some disagreement regarding where the federal and state responsibilities begin and end in the coastal zone. While it is clear that states cannot block a FERC-approved authorization even if there are contrary provisions found in state regulations or local laws, this is not the case with the Coast Guard for offshore facilities, because under the Deep Water Port Act, a governor can object to and stop a proposed project (NARUC, 2005).

State perception of LNG-based supply contracts will have significant effects on LNG imports and, thus, the financial viability of import terminals. Perhaps the area where state utility commissions have the most influence lies in their authority to approve interconnections between an LNG facility and intrastate regulated pipelines, distribution and storage facilities. It is not uncommon for state and federal authorities to clash over these and other overlapping processes as they relate to LNG. One such case involved the California PUC appealed FERC rulings on a proposed LNG facility at the Port of Long Beach, where the LNG facility would connect to the intrastate pipeline regulated by the state. FERC claimed it had exclusive jurisdiction over the import facility pursuant to the Natural Gas Act and claimed there was a need for a uniform federal approach to siting, construction and safety of LNG facilities (NARUC, 2005). FERC's claim of exclusive jurisdiction was upheld when the California PUC's request for a rehearing was denied (Swanstrom, 2005).

In Louisiana, deepwater port commissions and deepwater port harbor and terminal districts are not required to obtain a Coastal Use Permit (CUP). However, their activities must be *consistent* to the maximum extent practical with the state Coastal Management Plan and any affected approved local programs (Louisiana Sea Grant Program, 2005). This often requires state environmental and other agencies to also be involved in the approval process of onshore and offshore terminals.

In May 2006, Governor Blanco of Louisiana rejected an application by New Orleans-based Freeport McMoRan for its Main Pass Energy Hub, a 1 Bcf/d import facility 38 miles off Venice, Louisiana. Governor Blanco stated that the State was “unable to reach an acceptable comfort level with the potential risks presented by the cumulative impacts of multiple offshore LNG facilities that use the open rack vaporizer system” (State of Louisiana, Governor Kathleen Babineaux Blanco, 2007). She stated that she would continue to oppose open-loop systems until studies could demonstrate that their operation would not have an unacceptable impact on the surrounding ecosystem.

## 6. SAFETY ISSUES ARISING IN THE LNG PERMITTING PROCESS

### 6.1. Public Perception of LNG

LNG regasification terminals may be built onshore near populated areas which can raise concerns about potential safety and security hazards. In considering the adequacy of safety provisions in the LNG permitting process, the federal government is faced with balancing the need for increased natural gas supplies against the public's concerns about LNG safety. Public perception of safety and risk can be, and has been, a major inhibitor of facility development, particularly for projects on the eastern seaboard. It is therefore vital for both industry and government to educate the public regarding the real versus perceived hazards of LNG facilities.

One of the most common misconceptions about LNG is the belief that LNG is pressurized and explosive. This concern contributes to the "NIMBY" (Not In My Backyard) attitude prevalent in coastal communities.

Environmental impacts that LNG facilities create is another common misunderstanding impacting public perception and siting approval.

### 6.2. Background: LNG Safety Record

The LNG industry, in general, can claim a solid safety record. The industry is subject to the same safety and hazard considerations found in many industrial activities. Further, all LNG operators must conform to national and local regulations, standards, and codes. Beyond routine safety and hazard considerations, LNG has specific safety considerations. For instance, each LNG operator must set up four layers of protection, each integrated with a combination of industry standards and regulatory compliance. Each layer applies across the entire value chain of the LNG industry – production, liquefaction and shipping, to storage and regasification. The four layers are (Foss, 2003b):

- Primary containment. The most important safety requirement in the event of an LNG release is primary containment. This is accomplished by employing suitable materials for storage tanks and other equipment, and by appropriate engineering design throughout the industry.
- Secondary containment. Secondary containment ensures that, in case of a leak or spill, the LNG can be contained and isolated. For onshore facilities, dikes and berms surround storage tanks to capture the product. In some installations, a reinforced concrete tank surrounds the inner storage tank. Double and full containment systems for onshore tanks can eliminate the need for dikes and berms.
- Safeguard systems. Safeguard systems are designed to minimize and mitigate the release of LNG. Sophisticated systems are designed to rapidly detect a breach in containment. They automatically shut off the systems in case of failures.
- Separation distance. Federal regulations have always required a separation distance between LNG facilities from adjacent industrial communities and other public areas.

Safety zones are also established around LNG ships while traveling through U.S. waters and while moored. The safe distance or exclusion zones are based on LNG vapor dispersion data, and thermal radiation contours and other regulations.

The LNG shipping industry possesses an exemplary safety record, with no major incidents during the 33,000 LNG ship voyages over the last 45 years (FERC, 2007e). There are approximately 200 LNG tankers in operation worldwide (with over 100 more on order) and there has never been a fire, significant spill, explosion, or accidental death attributed to a LNG release on a tanker in the industry's history. LNG shipping vessels have never experienced a collision resulting in a loss of containment. This safety record is a result of the LNG industry's stringent design and operating standards, supported by regulatory oversight from the Federal Energy Regulatory Commission (FERC), the U.S. Coast Guard, and the Department of Transportation. In 2002, Congress passed the U.S. Maritime Transportation Security Act, requiring all ports to possess federally-approved security plans that include detailed security assessments of LNG terminals and ships. In addition, the International Maritime Organization (IMO) has developed standards for LNG shipping vessels which are specifically designed to protect the cargo tanks.

In February 2004, FERC, the Coast Guard, and the Department of Transportation signed an interagency agreement to provide for the comprehensive and coordinated review of land and marine safety and security issues at LNG waterfront facilities. This agreement clearly delineates the roles and responsibilities of each agency relative to LNG terminals and tanker operations, and stipulates that agencies will identify issues early on and work to quickly resolve them. This agreement covers LNG tankers traversing a waterway to the marine terminal, transfer of LNG to the onshore storage terminal, and terminal operations (FERC et al., 2004).

### **6.3. LNG Tanker Safety Record**

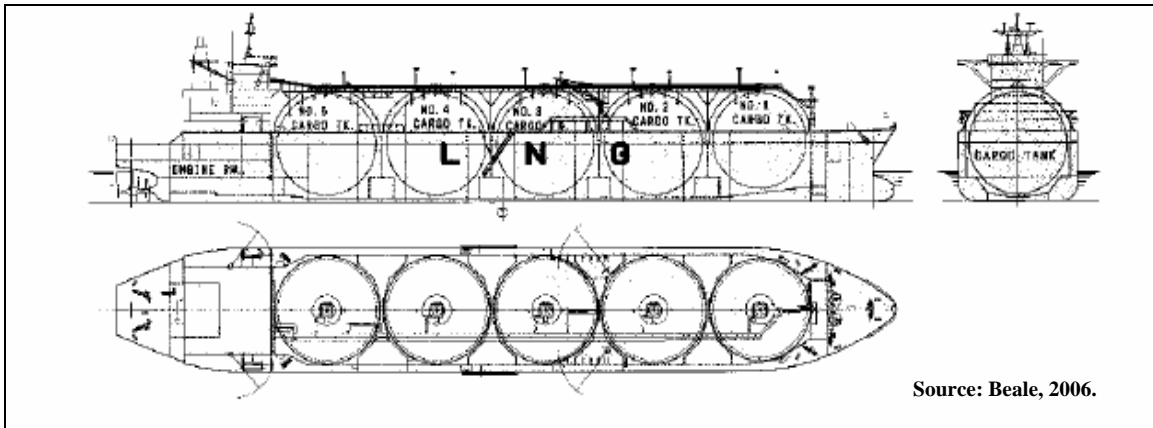
LNG ships must comply with relevant local, national and international regulations, including those of the International Maritime Organization (IMO), International Gas Code (IGC) and the U.S. Coast Guard, as well as host port authority requirements. LNG ships are designed with a double hull and a separate ballast system to provide the optimum protection of cargo in the event of grounding or collision. Tankers are also outfitted with state-of-the-art safety equipment to facilitate ship handling and cargo system handling. The cargo system handling system includes an extensive instrumentation package that safely shuts down the system if it begins to operate outside pre-determined parameters. Tankers also have gas and fire detection systems. Should fire occur on a ship, two 100 percent safety relief valves are designed to release the ensuing boil off to the atmosphere without over-pressurizing the tank (Foss, 2003b).

The typical LNG tanker carries 135,000 to 150,000 cubic meters of LNG, and is transported in double-hulled vessels, where it is stored in one of three types of tanks: 1) Self-Supporting Spherical (or Moss Design); 2) Self-Supporting Prismatic Shape; and 3) Membrane. See Figures 57-63 for a breakdown of tank designs.

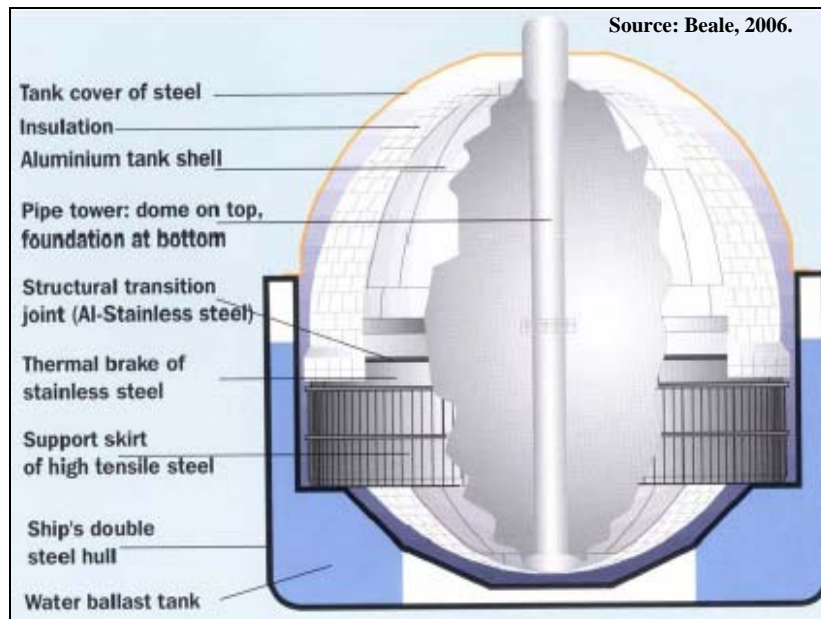
The cargo containment systems are made up of a primary container, a secondary container, and further insulation. The primary container can be constructed of stainless steel, or Invar®. The most common cargo insulation materials include polyurethane, polyvinyl chloride foam,

polystyrene and perlite. Because of its lack of reaction to other gases, nitrogen is injected into the insulation space so that even minor methane leaks can be detected (Foss, 2003b).

LNG tankers with Self-Supporting Spherical tanks are immediately recognizable by the four or five hemispherical domes located above the ship's deck. The aluminum tank shell is encased in a one-inch thick exterior steel skin with a level of insulation between that of the tanks and exterior walls (See Figure 58). The water line area of the ship is surrounded by a support skirt of high tensile steel that provides additional protection to the lower section of the cargo tank from any external penetration, whether accidental or intentional (Beale, 2006).



**Figure 57. LNG Tanker Design with Spherical Tanks.**



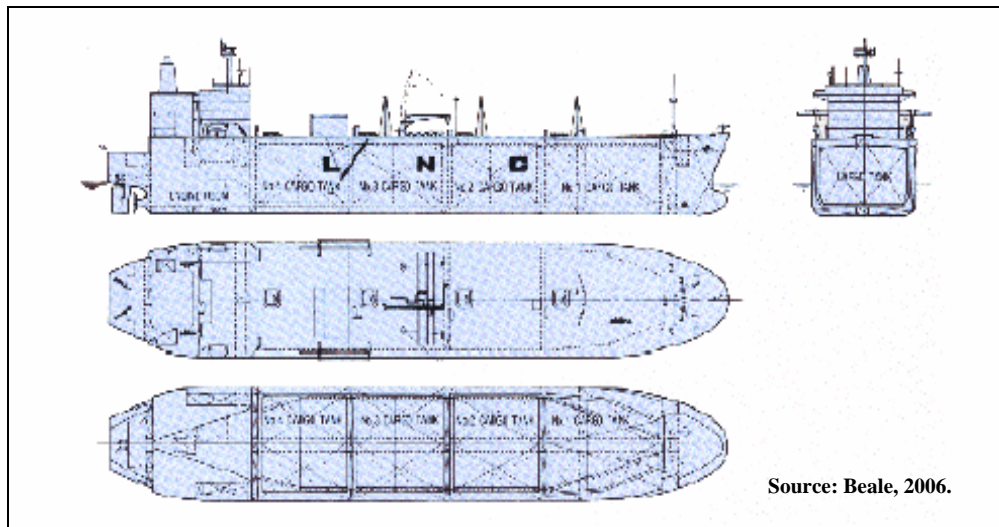
**Figure 58. Spherical Tank Design.**

Further, LNG tankers are easily identifiable by the large markings on both port and starboard sides of the ship.



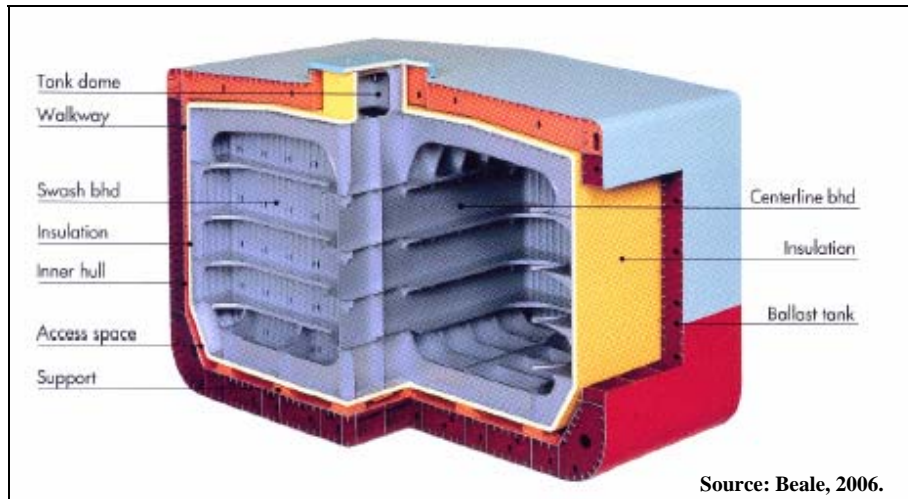
**Figure 59. LNG Tanker with Prismatic Tanks.**

LNG tankers with Self-Supporting Prismatic Shape cargo tanks (See Figure 61) conform more closely to the shape of the ship's hull than do spherical tanks (Beale, 2006). The decks of these ships are typically flat, which are very similar to conventional crude oil carriers. Typically there are three or four major cargo tanks with a smaller tank near the bow of the ship (See Figures 59 and 60).



**Figure 60. LNG Tanker Design with Prismatic Tanks.**

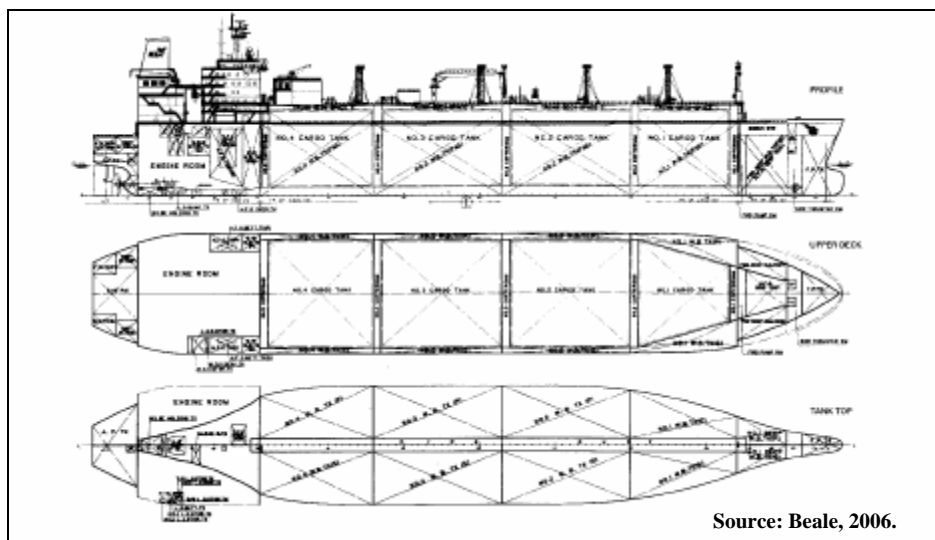




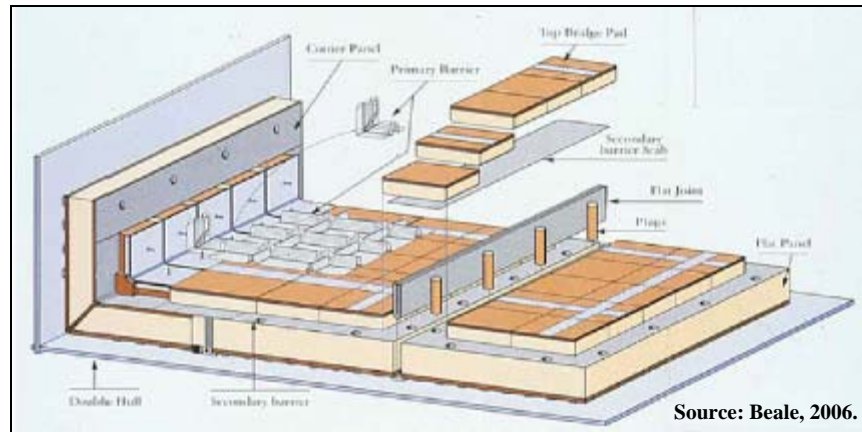
**Figure 61. Prismatic Tank Design**

The prismatic tanks have a significant amount of horizontal and vertical stiffeners and bulkheads, which add tremendous strength to each individual tank (Beale, 2006).

LNG tankers with a membrane design have an inner hull that provides integrated support for the LNG tanks, as shown in Figure 62. The outer hull is smooth externally, but the inside contains an egg-crate type of structural steel webs and stiffeners. The inner hull is supported by a similar egg-crate design. A welded stainless steel or Invar® membrane surrounds the cargo. That is surrounded by 10 inches of insulation and a second alloy metal or foil composite membrane, which is surrounded by 12 inches of more insulation. An inch-thick plate forms the inner hull. An eight-foot ballast tank sits between the inner and outer hulls. Finally, the outer hull is one-inch thick steel. The void between the inner and outer hulls provides a containment area in the unlikely event of a rupture (Beale, 2006). See Figure 63.

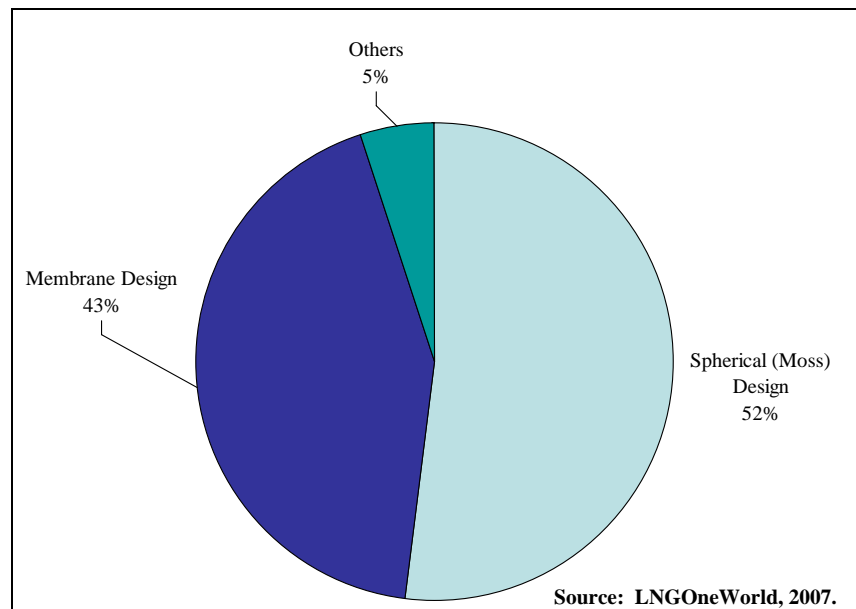


**Figure 62. LNG Tanker Design with Double Membrane Tanks.**



**Figure 63. Membrane Tank Design.**

Sensing equipment capable of detecting minute amounts of methane gas is located in the space between the inner and outer steel hulls, and can activate the ship's emergency shutdown systems. To ensure safe navigation and identify potential external hazards, LNG tankers are outfitted with advanced radar, positioning systems, and velocity meters.



**Figure 64. Global LNG Fleet Containment Design.**

#### 6.4. Tanker Incidents: LNG, LPG, and Crude Oil

The double hull design of LNG ships offers significant protection of the LNG tanks, as witnessed by three incidents (Beale, 2006). It is important to note that only one of the following examples is associated with an LNG tanker. The other two are associated with LPG and crude oil.

**6.4.1. *El Paso Paul Kayser* Grounding:** In 1979, the *El Paso Paul Kayser*, loaded with about 125,000 cubic meters of LNG, ran aground off the coast of Gibraltar when it struck a rock outcropping below the surface and gouged a 750-foot long scar into its hull. The tanker was traveling at 19 knots (near its maximum speed), yet there was no breach of the LNG tanks (the outer hull was not penetrated), and no cargo was lost. The cargo was transferred to another ship on site, and the tanker was sent to a shipyard for repairs, and later returned to service (Beale, 2006).

**6.4.2. *Yuyo Maru No. 10*:** The *Yuyo Maru No. 10* was a liquid petroleum gas (LPG) tanker of very similar design and construction to an LNG tanker. The incident is included due to the similarity in structure. In November 1974, the *Yayo Maru No. 10* collided with a steel ship in Tokyo Bay. The *Yayo Maru* was carrying over 20,000 metric tons (MT) of light naphtha, 20,000 MT of propane, and 6,400 MT of butane in separate containers. The ship suffered a large hole at the point of collision, and its cargo of naphtha instantly ignited. The naphtha was carried in its outer ballast tank (between the insulated LPG tanks and the hull of the ship). This area effectively makes up the double hull with LNG ships. The LPG cargo tank was not penetrated, and no leaks were detected.<sup>18</sup> The ship was eventually towed out to sea and sunk by the Japanese Maritime Self Defense Force (Beale, 2006).

**6.4.3. Terrorist Attack on the *Limburg* Crude Oil Tanker:** In October 2002, terrorists aboard a small boat carrying an unknown amount of explosives rammed the *Limburg*, a new double-hulled French crude oil tanker near the port of Ash Shihr, Yemen. The explosion pierced both hulls, spilling some 90,000 gallons of crude oil, and causing a brief fire (See Figure 65). One sailor was killed in the attack<sup>19</sup> (Beale, 2006).



**Figure 65. Damage to the *Limburg* Following Terrorist Attack.**

<sup>18</sup> LNG tankers do not carry anything other than air or ballast in these same tanks.

<sup>19</sup> Though the *Limburg* was double-hulled, LNG ships have at least one additional cargo containment barrier, along with substantial insulation and structural systems.

## **6.5. Onshore Facility Safety Record**

Worldwide, there are 17 onshore liquefaction terminals and 40 regasification terminals, with many additional facilities in various planning stages (Foss, 2003a). There are currently approximately 200 LNG storage and peak-shaving facilities located throughout the world (Foss, 2003a). The U.S. has the largest number of onshore LNG facilities in the world – most of which are small peak-shaving type facilities. In the early years of the U.S. LNG industry, there were a few isolated accidents at onshore facilities, all involving deaths, which resulted in more stringent operational and safety regulations. In 1944, a peak-shaving plant in Cleveland, Ohio experienced tank failure, resulting in an explosion and fire which killed 128 people. Because it was during World War II, the tank's steel alloy possessed low nickel content and was susceptible to failure when exposed to the cryogenic conditions of LNG. Two more incidents occurred in the 1970s – one in Staten Island, NY, and one in Cove Point, MD. At Staten Island, 37 workers were killed from an explosion caused by pressure irregularities while repairing an empty storage tank. At Cove Point, a gas leak led to an explosion in an electrical substation resulting in one worker's death. No deaths or serious accidents have occurred at U.S. onshore LNG facilities in the past 26 years.

The deadliest incident at an LNG onshore facility in the past 30 years involved an explosion at a gas liquefaction plant in Skikda, Algeria in January, 2004. The explosion occurred when gas leaked from a cracked pipe and was drawn into the boiler room where workers were re-lighting the unit's boiler. The leaked gas mixed with the right proportion of air, forming a gas vapor cloud which exploded, claiming 27 lives and injuring 56 others (FERC, 2007e). While the Algerian accident was quite serious, experts pointed out that the explosion did not lead to a catastrophic failure of the LNG storage tanks and there were no injuries to the general public (CRSR, 2004).

## **6.6. Storage Facilities and Safety**

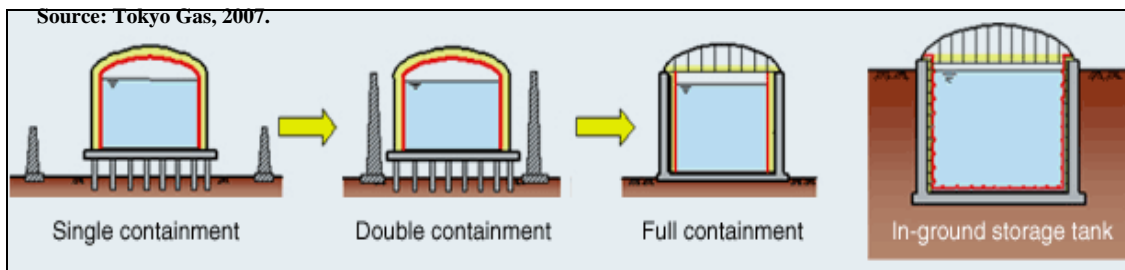
LNG operators are required to provide containment and troughs around storage tanks to direct the flow of LNG to drain into a safe location in areas where spills could occur. The safety record of onshore storage facilities demonstrates that the primary containment of tanks is safe. LNG is typically stored in double-walled tanks at atmospheric pressure. The storage tank is actually a tank-within-a-tank, with insulation between the walls. The material selected for tanks, piping, and other equipment that comes into contact with the LNG is critical. High nickel steels, aluminum and stainless steel are costly, but necessary, to prevent embrittlement and material failures. High alloy steels composed of nine percent nickel and stainless steel typically are used for the inner tank of LNG storage tanks and other LNG applications (Foss, 2003b).

The outer tank is generally constructed of carbon steel, but offers no protection if the inner tank is breached. The outer tank holds the insulation, typically polyurethane, polyvinyl chloride foam, polystyrene and perlite, in place.

As shown in Figure 66, LNG storage tanks are divided into two categories: above-ground storage and in-ground storage. The industry began with single containment above-ground storage tanks, which are comprised of an inner tank and an outer container. In single containment tanks, only the inner tank must meet the low temperature ductility requirements, and it is not designed to

contain LNG due to leakage from the inner tank. Double or full containment tanks are designed to contain the full amount of stored LNG in case of inner tank failure. Storage tanks have evolved over the years and rigorous safety codes have been enforced. The full containment storage tank is less susceptible to damage from external forces, even less so when buried. The recently permitted Cameron LNG terminal in Hackberry, LA will contain four full containment above-ground storage tanks.

In-ground storage tanks have a high level of safety and are environmentally friendly. Japan has 76 underground tanks, and Tokyo Gas is currently building a new state-of-the-art LNG underground storage facility, the world's largest with over 200,000 cubic meters of storage. In-ground LNG storage tanks are only partially visible from the outside of the terminal site, making them difficult to be targeted by terrorists. Furthermore, since the LNG is stored below the ground surface, in the unlikely event of a terrorist attack or the concrete roof being destroyed by a projectile, the LNG would not leak onto the ground. Accordingly, the tanks are accredited with the European standard EN1473, making them the safest way to store LNG (Tokyo Gas, 2007).



**Figure 66. Types of LNG Storage Tanks.**

## 6.7. Physical Properties and Associated Potential Hazards

Awareness of LNG's physical and chemical properties is necessary to understand the potential physical hazards that LNG presents. LNG is natural gas that has been turned into a liquid by cooling it to a temperature of  $-256^{\circ}\text{F}$ . Its bulk composition is methane gas. The remaining non-methane portions, consisting of water, carbon dioxide, butane and heavier hydrocarbons, must be removed for the liquefaction process to occur.

LNG is odorless, colorless, non-corrosive, and non-toxic. It weighs 45 percent of an equal measure of water, and has the highest auto-ignition temperature when compared to other fuels (e.g. LPG, gasoline, and diesel). When transported in tankers, LNG's pressure is maintained at 16-23 psig. During transport, as the LNG splashes up on the sides of the tanks, the pressure may increase, and this is mitigated by recirculation lines which are used to maintain the previously stated pressure. LNG is stored at a very minimal pressure, around 4 psig.

Liquefying LNG reduces its volume by a factor of 610, allowing for cheap long distance transportation. For onshore gas pipelines, it becomes economically viable to ship LNG when the transport distance is greater than 2,200 miles. For offshore gas pipelines, that distance is reduced to 700 miles.

Despite these benefits, LNG does present some potential hazards. Due to its cryogenic nature, direct contact with LNG will freeze the point of contact. This presents a safety hazard to workers and demands that steel alloys used in the building of LNG facilities (ships and storage tanks) withstand freezing cold temperatures.

LNG is non-explosive when it is cooled and in its liquefied state. However, if LNG is leaked or spilled from its container and mixes with air in the proper proportions, a vapor cloud fire or a pool fire may occur. In these scenarios, LNG will only ignite if its vapors are present at a 5 to 15 percent concentration in air. A vapor cloud fire can occur if the leaked LNG warms into vapors, the vapors rise and are dispersed by the wind, and an ignition source is present. Once ignited, the vapor cloud will burn back to where it originated and become a pool fire.

A pool fire differs from a vapor cloud fire in that it is located at the spill site itself. Both pool fires and vapor cloud fires are extremely hot and, in order for them to be extinguished, the LNG vapors must burn until they reach their minimum flammability limit, which is less than 5 percent in air. In the event of a spill, every LNG facility needs thermal radiation distances, flammability distances, and wind patterns calculated and reviewed in order to be prepared for an emergency.

According to at least one expert at Sandia National Laboratory, it is nearly impossible to detonate a high concentration of methane, though with heavier concentrations the odds of detonation are increased. LNG is very cold, and a 100-degree difference in temperature change decreases the ability of it to detonate by an order of magnitude. However, no one to date has conducted detonation experiments.<sup>20</sup>

Fighting an LNG spill fire is very similar to fighting any hydrocarbon fire. The Texas A&M fire school and the Northeast Gas Association have been training fire fighters and other industry professionals on LNG spill fires for over 25 years (Foss, 2003b).

Another potential LNG hazard is Rapid Phase Transitions (RPTs), which occurs if LNG is spilled on water. The LNG re-gasifies almost instantaneously from the water's heat, creating a 'flameless' explosion.

In addition to potential transportation related accidents, there are multiple potential hazards associated with storage of LNG, such as storage tank failures, failed containment barriers, and thermal radiation to storage tanks from a pool fire at an adjacent storage tank. Deluge systems can be installed to prevent thermal radiation damage from occurring to storage tanks in the event of a pool fire at an adjacent storage tank.

Vapors in LNG storage tanks must be released periodically, lest the temperature and pressure in the tank will rise (the temperature in the tank will remain constant if the pressure is kept constant by allowing the boil-off, the evaporated gas, to escape from the tank). These boil-off vapors are collected and used as a fuel source in the facility or on the shipping vessel transporting the LNG.

Potential hazards associated with the transport and unloading of LNG include potential collisions of LNG ships with other ship traffic and port structures, the safety risks of a LNG tanker maneuvering within the port (channel widths, winds, and beacons all need to be taken into

---

<sup>20</sup> Personal communication with Anay Luketa-Hanlin, Sandia labs, at DOE LNG Forum.

account), and the limited maneuverability for LNG vessels in some ports. Double containment has been the standard for LNG vessels from the start (designed to hold 110 percent of the tank's contents).

Securing land-based LNG facilities involves utilizing security patrols, protective enclosures, adequate lighting, monitoring critical equipment, and maintaining alternative power sources in the event of an emergency. Offshore, the Coast Guard can prevent other ships from getting close to LNG tankers while they are in transit or are docked at terminals.

## **6.8. Potential Vulnerabilities**

Along with the safety issues described above, there are several potential vulnerabilities of LNG terminals that need exploration. The most prominent vulnerabilities include terrorism, earthquakes and hurricanes.

**6.8.1. Terrorism:** Terrorist attacks are the most obvious potential vulnerability associated with the transport and storage of LNG. Foreign or domestic terrorist attacks could occur to storage tanks or secondary containment systems at onshore facilities or to an LNG tanker's cargo hold, either offshore or docked at an onshore receiving terminal. As shown by the 2002 Yemen attack on the French crude oil tanker *Limburg*, ships can be physically attacked in a variety of ways or commandeered to use as a weapon on coastal targets. Onshore facilities might also be physically attacked by explosives or by other means (FERC, 2004). The major hazard associated with potential terrorist attacks would be fire, not an explosion, since the amount of energy required to breach the containment is large. In this case, separation distance of the facility from heavily populated areas would mitigate the potential danger to the public.

Large onshore storage tanks are easy to identify and can also be considered terrorist targets. To date, no LNG facilities have been involved in terrorist events. Aside from separation from facilities, storage tank roofs can be lined with reinforced concrete, or the roofs of the tanks can be completely underground.

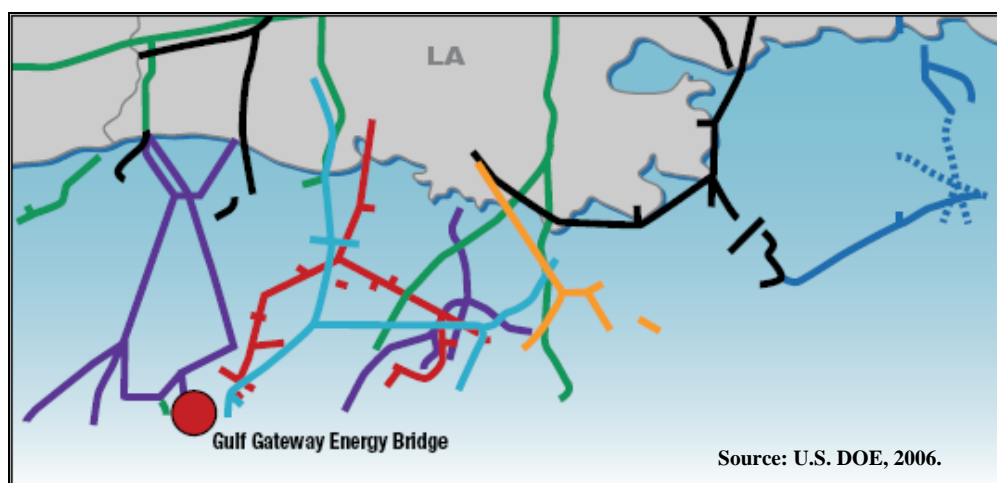
There are a variety of measures used to enhance LNG terminal security, including increased harbor and terminal patrols by the Coast Guard and local law enforcement agencies, and enhanced escort capabilities for tanker movements. Other enhancements include more advance notice of LNG shipments, rigorous inspections and crew training, and restrictions on land-based and air-based traffic during tanker off-loading (NARUC, 2005). Additionally, site-specific risk assessments are conducted with the input of all relevant agencies.

**6.8.2. Earthquakes:** Earthquake risks are taken into account when planning and designing LNG facilities. There are no known safety incidents due to seismic activity. LNG facilities located near seismically-active areas have been built in Japan. The proximity to these geologically-sensitive areas has prompted Tokyo Gas to build in-ground storage tanks. According to Tokyo Gas, the seismic motion is not amplified for in-ground storage tanks when compared to above-ground structures, making them safer in earthquake-prone regions (Tokyo Gas, 2007).

**6.8.3. Hurricanes:** Storm surge associated with hurricanes and tropical storms is often the most significant cause of damage to facilities and property in low-lying areas, and poses a risk to

onshore LNG facilities. The 2005 hurricane season produced two powerful hurricanes in the Gulf, Katrina and Rita, that affected LNG facilities.

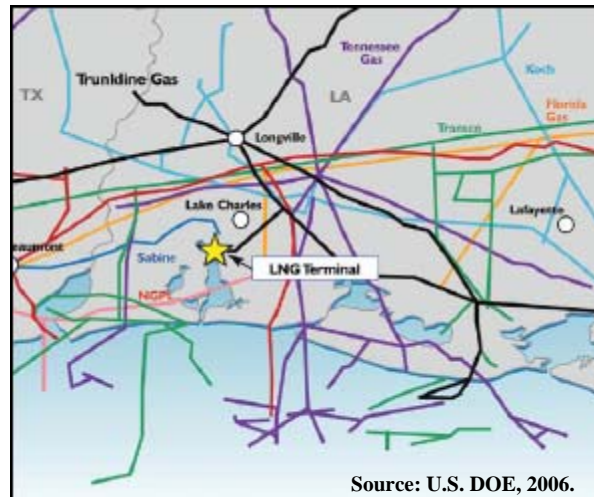
The nation's only operating offshore terminal (See Figure 67), Exceleerate Energy's Gulf Gateway Energy Bridge, located 116 miles off the Louisiana coast, narrowly avoided a direct hit by Hurricane Rita on September 23, 2005. Rita's eye passed just 25 nautical miles north of the Exceleerate facility. While Gulf Gateway suffered no major damage (the facility was designed using 100-year Gulf of Mexico storm conditions), the wind driven seas near the eye of the storm were estimated to reach 70 feet. No data of what wave conditions actually hit the LNG facility exists since the Ocean Data Acquisition System buoys along the path of the storm were destroyed (Exceleerate Energy, 2005). No damage was suffered at the facility, though pipelines serving the facility were affected and were not fully operational until mid-November (U.S. DOE, 2006).



**Figure 67. Gulf Gateway LNG Facility and Surrounding Pipelines.**

The Lake Charles LNG import facility was also in the path of Hurricane Rita (See Figure 68), but suffered little damage. However, the navigation channel to the terminal was closed for several days after the storm due to debris in the shipping channel and a lack of commercial power availability. The facility was 100 percent operational by October 5, 2005.





**Figure 68. Lake Charles LNG Facility and Surrounding Pipelines.**

To plan for, and mitigate, the effects of hurricanes on LNG facilities, designers use a variety of tools to evaluate potential surge damage. For instance, following the 2005 hurricanes, planners for the Chevron Gulf LNG facility near the port of Pascagoula, MS used two computer models to evaluate future hurricane surge events. After comparing actual hurricane surge data along the Mississippi coast to the models, designers determined that facility protection sufficient to withstand a Category 4 hurricane would provide the most benefit. This resulted in a dike wall 45 feet wide and 27 feet high to surround the entire 33.3-acre site (FERC, 2006b).

### **6.9. Review of Previous LNG Safety Issues**

The many previous government and industry LNG safety studies vary widely in their scope, analyses, and results. The most prominent studies are briefly reviewed here: Quest Consultant’s Report, the American Bureau of Shipping Consulting Group (ABSG) Study, and the Sandia National Laboratory Study.

The Quest Report was commissioned in the days after September 11, 2001 by the U.S. Department of Energy by Quest Consultants, Inc., a private company based in Oklahoma. The report provided a brief analysis of the LNG risks in Boston’s harbor (for the Everett LNG terminal) and suggested that the impact of an LNG release to be smaller than earlier studies had indicated (Burr, 2004). Conventional estimates suggested a ½-mile diameter reach for a six million gallon spill, or 1/5<sup>th</sup> of a tanker spilled. Controversy arose when the Quest report was improperly cited and used for projects other than the Everett terminal.

The FERC commissioned the ABSG Study in February 2004 to consider the consequences of LNG spills (it did not determine the risks of such an occurrence) for application to LNG project proposals. This study was non-peer-reviewed and released in May 2004. It did not address terrorism threats on LNG tankers and terminals, and concluded that in less than a minute, LNG spilled and subsequently ignited into a pool fire could burn people to death or cause severe injuries (California Energy Circuit, 2004). It postulated that if the LNG was spilled and did not ignite, it would cause a flammable vapor cloud that would spread more than 2 miles downwind.

If the vapor cloud ignited, it would burn everything it encompassed. The study did not take into account the multi-hulled nature of LNG shipping vessels and storage facilities.

The Sandia National Laboratory Study was commissioned by the U.S. Department of Energy in December 2003 to review all other previous studies and provide a more adequate scientific model for considering a variety of LNG scenarios. Released in December, 2004, the Sandia study is the most comprehensive examination of LNG tanker risks to date. Previous studies stopped at consequences, and did not explain which type of spills occurred. Sandia's report also defined safeguards and analyzed various LNG systems to determine if sufficient safeguards were in place.

The Sandia Report analyzed three controlling parameters: burn rate, (controls pool area and flame height), flame height (decreases as pool diameter increases), and surface emissive power. The study also identified the scale of potential hazards and provided a worst-case scenario for a terrorist attack upon a tanker. The report's worst-case scenario involved a terrorist attack resulting in three 16-foot holes in an LNG tanker.

Under the worst case scenario, the subsequent spill and potential pool fire could burn buildings 2,067 feet away and cause second-degree burns on people 6,949 feet away (Savage, 2004). If a pool of LNG was released into the water and then ignited as it vaporized, it would create a pool fire capable of expanding outwards twice the size of the original pool. Sandia concluded that LNG thermal hazards are a 1 to 2 mile problem at most. The report also concluded there is a low probability for a terrorist attack upon an LNG tanker.

The study's conclusions are based on computer simulations; as no major LNG accident involving a modern tanker exists, there is no data from an actual LNG spill.

The Government Accountability Office released a report in February 2007 reviewing these and other LNG safety reports and concluded that public safety consequences of a terrorist attack on an LNG tanker need to be clarified (U.S. GAO, 2007). The GAO consulted 19 LNG experts in their report, and most experts agreed with the Sandia report on the public safety impact of an LNG spill. These experts agreed that the most likely public safety impact of an LNG spill is the heat impact of a fire; that explosions are not likely to occur in the wake of an LNG spill, unless the LNG vapors are in confined spaces; and that some hazards, such as freeze burns and asphyxiation, do not pose a public hazard.

However, these experts disagreed with the heat impact and cascading tank failure conclusions reached by the Sandia study. Specifically, all experts did not agree with the heat impact distance of 1,600 meters. Seven experts thought the distance was "about right," and the remaining eight were evenly split whether the distance was too conservative or not conservative enough. The experts also disagreed with the Sandia report that only three of five LNG tanks would be involved in a cascading failure. Finally, the GAO report suggested priorities for future research aimed at clarifying uncertainties about such incidents, particularly concerning the potential for cascading failures of LNG tanks.

## 7. ENVIRONMENTAL ISSUES ARISING FROM THE LNG PERMITTING PROCESS

### 7.1. Description of Offshore LNG Regasification Configurations

In order for LNG to enter the U.S. pipeline network as natural gas, it must be returned to a gaseous state. LNG offshore terminals typically use one of two processes for vaporization, commonly referred to as open or closed-loop systems (See Figure 69). There is an on-going debate within the industry and environmental advocacy groups over the use of open loop (also called Open Rack Vaporization, or ORV) vs. closed loop (also called Submerged Combustion Vaporization, or SCV) systems. For offshore LNG projects, both systems can use ocean water to warm the LNG, thus returning it to a vapor status. The primary environmental issue associated with LNG terminals is the potential impact the open-loop systems can have on fish populations when LNG is vaporized. This concern has resulted in an intense opposition campaign by many environmental groups in South Louisiana.

Section 316(b) of the Clean Water Act requires that the location, design, construction and capacity of cooling water intake structures reflect the best technology available for minimizing adverse environmental impact.

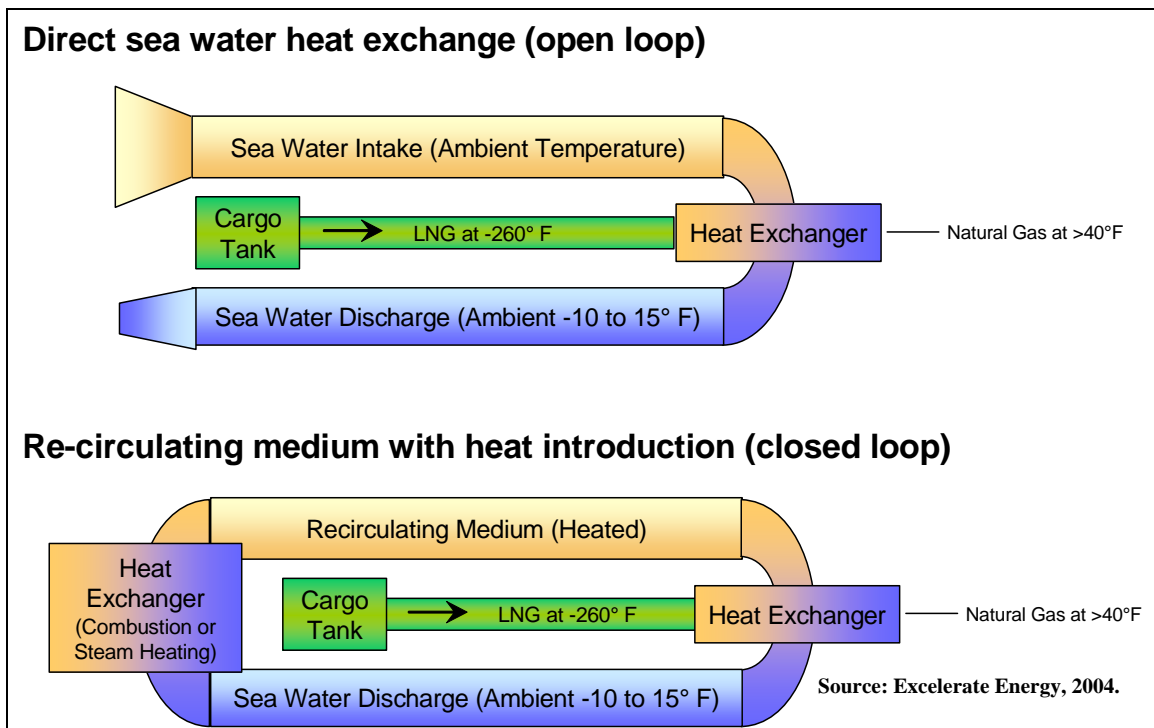


Figure 69. Primary Methods to Vaporize LNG.

**7.1.1. Open Loop (Open Rack Vaporization):** An ORV system uses ambient temperature seawater to vaporize the LNG. The primary benefit of this system is that it uses a renewable resource (water) as a thermal sink. As a result, fossil fuels are not burned, and greenhouse emissions do not increase. However, due to the large size of the terminals, hundreds of millions

of gallons of seawater are pumped through the system per day (Farrell, 2006).<sup>21</sup> In the ORV system, seawater is pumped through a series of racks or coils to reheat the LNG to a gaseous state (This method essentially is a large heat exchanger). When the water used directly in the heating process is returned to the sea, it is usually cooler than the ambient water temperatures around the offshore LNG structure (Louisiana Sea Grant Program, 2005).

Opponents of the ORV method assert that this technology will negatively impact ichthyoplankton (larval fish and eggs) populations by sucking organisms into the water intake and subjecting them to thermal shock (via the proximity to the LNG), or trapping them against the intake screens. The seawater is also chlorinated to prevent marine growth or biofouling inside the system, which is claimed to cause further damage to entrapped organisms. Though companies use screens to limit intake of organisms, fishermen and other opponents claim that the use of open loop systems will contribute to the decline of harvestable stocks of fish and affect the sustainability of some managed species. While companies can take action to mitigate the impacts of open loop systems, such as limiting seawater intakes and using wedgewire or other screens, the opposition to ORVs is strong.

The proposed Main Pass Energy Hub off the coast of Louisiana was originally slated to incorporate an open loop system, but after a tremendous outcry from fishermen, environmentalists, and coastal state agencies, the application was denied by Louisiana Governor Kathleen Blanco. The company, McMoRan Exploration, re-submitted the application after declaring a plan to incorporate the closed loop system. The permit was approved in early 2007. One month after the McMoRan project was vetoed, Alabama Governor Riley vetoed permits for ConocoPhillips' Compass Port project citing its inordinate risk to his state's fisheries (Cusick, 2006).

Notable opponents of the ORV technology include the Gulf of Mexico Fishery Management Council, which claimed that the cumulative impacts of several LNG terminals would contribute to the decline of harvestable stocks by fishermen and affect the sustainability of some managed species, as well as negatively affect the recreational and commercial fishing industries. Other organizations that have spoken out against the ORV include the Gulf Restoration Network, Sierra Club, and the Louisiana Charter Boat Association, among others (Farrell, 2006).<sup>22</sup>

The final Environmental Impact Statement (EIS) for the Shell Gulf Landing, LLC, which was to be made up of two concrete gravity-based caissons for storage, topside regasification facilities, a berth for mooring LNG carriers, and connecting to as many as five interstate pipelines, capable of delivering up to 1 Bcf/d, (also off the coast of Louisiana) license stated that the engine cooling systems found on diesel ships already use seawater in engine cooling mechanisms, whose impact is "cumulatively more substantial than any one LNG port." The EIS estimates that the amount of seawater required for the port will be less than 1 percent of the amount of water used for engine cooling purposes (Louisiana Sea Grant Program, 2005). Because of this and other reasons, the facility was approved to build and operate an open loop system. However, due to market conditions Shell withdrew its application for the facility on March 29, 2007 (Burdeau, 2007).

---

<sup>21</sup> There are differing viewpoints on the amount of water used per facility.

<sup>22</sup> A list of organizations and individuals opposed to ORV can be found at <http://louisiana.sierraclub.org/lng.asp>.

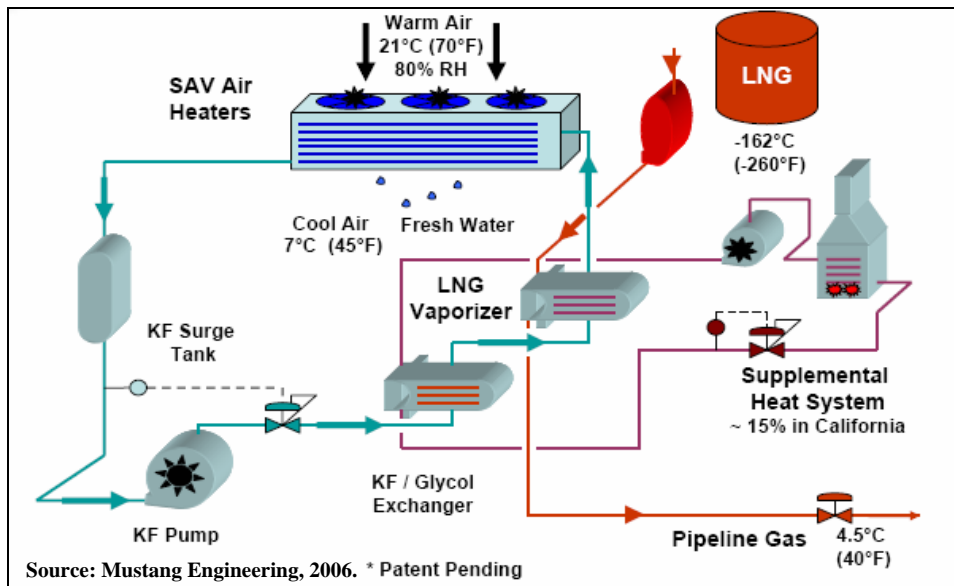
As of May 2006, of the thirty-nine proposed and existing LNG facilities in the United States, only the three licensed and four proposed facilities in the Gulf of Mexico would use open loop technology (FERC, 2006a).

The other regasification process is a closed loop system, such as submerged combustion vaporization (SCV). The SCV is a process where combusted fuel gases such as natural gas or diesel are sparged into a submerged water bath to vaporize the LNG. The SCV method would reduce the entrainment of marine species and the thermal effect of the discharged water (the temperature change in exiting seawater would be minimized), but there are other environmental considerations. Increased air emissions of NO<sub>x</sub>, CO and CO<sub>2</sub> are associated with SCV, although there appears to be no significant source of pollution to the marine environment in using this method (Farrell, 2006).

Outgoing Massachusetts Governor Mitt Romney approved two new facilities off the coast of his state in late December 2006. The Northeast Gateway and the Neptune projects, to be located approximately 13 and 7 miles off the coast of Gloucester, respectively, will provide an additional 1 Bcf/d capacity. That will provide an extra 20 percent of gas to the region and help keep energy prices lower. Both are closed loop systems, and equipment on board the incoming tankers will vaporize the gas prior to entering the adjoining pipelines. After exhaustive study by the Coast Guard and the Massachusetts Executive Office of Public Safety, both projects were found to be safe and in the public's interest (Commonwealth of Massachusetts, 2006).

To mitigate the environmental impacts of the new Massachusetts terminals, the governor's Office of Environmental Affairs required the companies involved to fund a range of activities, including \$47 million to support the commercial fishing industry, carry out resource management research, and improve recreational access to ocean waters. The companies also committed to make \$4 million contributions over two years for gas efficiency and low-income fuel assistance programs for the state (Commonwealth of Massachusetts, 2006).

**7.1.2. Other Technologies:** There are other vaporization technologies being developed, including hybrid regasification systems that use both open and closed loop systems simultaneously, and LNG Smart™ technology, an ambient air vaporization process which has the potential to reduce fuel gas consumption and NO<sub>x</sub> and CO<sub>2</sub> air emissions by as much as 90 percent. Because it uses ambient air (instead of seawater) as a heat exchanger, operating costs are also dramatically lower than the other vaporization systems (See Figure 70). Also, there are no potential thermal shock issues for concern. However, this technology is best suited for warm, humid environments found in the Gulf, and must use backup fuel-burning systems during cold weather. The LNG Smart™ technology is being installed at the Lake Charles Trunkline Enhancement Project, a 2.1 Bcf/d gas send-out expansion, with a scheduled startup in mid-2008. This technology can also be mounted on an LNG carrier, with up to 0.9 Bcf/d send-out capability (Mustang Engineering, 2006).



**Figure 70. Mustang LNG Smart™ Ambient Air Vaporization Process.**

Two other technologies being developed include Direct Fired Heaters (DFHV) and Indirect Fluid Vaporizers (IFV), though energy costs and emissions are of great concern (Namtvedt, 2005).

## 7.2. Public Opposition and Positions in the Open Loop LNG Debate

The FERC permitting process provides opportunities for public participation. Generally, the public receives notice of a proposed facility when the company proposing the project begins to prepare environmental studies required by the FERC, or when a company seeks easement or land purchase. Once an application is filed, FERC publishes a notification of application in the Federal Register. Public meetings are required by FERC, and anyone can express their views in writing to FERC during the public comment period associated with the EIS or Environmental Assessment. All comments received during the comment period are addressed in the final EA or EIS. There is also an intervener process that allows formal involvement for citizens, but requires adherence to FERC regulations (U.S. DOE, 2005).

Public opposition to open loop systems has increased and has been very effective. Louisiana fishermen and wildlife enthusiasts rallied against a proposed open loop system off the coast of Louisiana, eventually influencing the governor to veto the permit application – all despite the Environmental Impact Statement’s findings that the technology would not pose a serious risk. In May 2006, Louisiana Governor Kathleen Blanco denied the Freeport McMoRan application to build an open loop system off the coast of Louisiana, forcing the company to re-apply for a permit using the closed loop system.

In denying the original application, Governor Blanco insisted that the open loop system be dropped in favor of the closed loop system because of the potential environmental harm. The Governor’s press release included a statement by Department of Wildlife and Fisheries Secretary Dwight Landreneau that cited a study estimating the Louisiana’s marine commercial and recreational fisheries combined retail sales value to be \$2.3 billion in 2003. “As the public

trustee with responsibility for protecting, conserving, and enhancing the fish resources of the state and the Gulf of Mexico, the Department recommends against any project that would use open loop technology in the Gulf of Mexico until sufficient data has been collected and assessed so that we can clearly understand the impacts of these types of facilities on Louisiana's fisheries" (Bayou Buzz, 2006).

Governor Blanco joined adjoining states' governors Haley Barbour of Mississippi and Bob Riley of Alabama in declaring that no open loop LNG terminals would be approved until sufficient evidence is compiled that it would not cause environmental harm (Bayou Buzz, 2006).

Freeport McMoran re-filed the permit seeking approval for a closed loop system, which was granted by the Maritime Administration in early 2007 with little opposition. Additionally, many federal and state agencies, environmentalists, and others opposed the open loop technology. No publicly-available information states the estimated cost of converting the McMoran plant, but Shell, who has approval and has begun construction on the open loop Gulf Landing project stated that the increased costs of operation alone associated with open loop systems would be between \$20 and \$43 million annually (Farrell, 2006).

Opposition to the proposed Broadwater Energy project off the coast of Long Island, a closed loop system, intensified as the FERC neared a decision to approve or disapprove the project. The draft EIS found that the project would have minimal impact on Long Island Sound. Public hearings drew several hundred protestors to counter the EIS conclusions in mid-January, and demands for more hearings were turned down by FERC. Several politicians and activists called for public comments to be sent to the FERC by the deadline. Some politicians and regulators opposed to such facilities have used other measures.

For instance, the New York Attorney General, on record opposing the facility, called for a no fly zone over the proposed Broadwater facility, which would be located some 9 miles off the New York coast. The Baltimore County Council, on record as opposing the proposed Sparrows Point LNG terminal off the coast of Maryland, passed a zoning ordinance in 2006 prohibiting LNG facilities from being built within five miles of a home. However, a federal judge struck down the law in early 2007, stating that a "local government may not exercise veto power over this nationwide process by local zoning legislation." The Council also introduced zoning legislation that would not allow LNG facilities to be built in environmentally sensitive coastal areas. If this legislation is adopted, the state commission in charge of Maryland's Coastal Zone Management program would be forced to review the zoning change for the county's Chesapeake Bay Critical Area. If the state then rules the gas project to be inconsistent with the state and federal Coastal Zone Management programs, FERC would have to consider that finding (Barnhardt, 2007).

### **7.3. Industry Response to Public Opposition and Permitting Changes**

The industry has responded to opposition of open loop systems, claiming that many of the Environmental Impact Statements (EIS) overstated the risks associated with open loop systems. In a study prepared for the Center for LNG, it was reported that the data inputs, assumptions and modeling approaches used in the EISs substantially overestimate the potential for adverse impacts of LNG facilities "because an abundance of caution has been used at various stages of the assessments in dealing with uncertainties . . . [such as] the overestimates of mortality, the

conclusions of the EISs that OLV (open loop) usage will have minor impacts on GOM fisheries would be supported by a more scientifically rigorous analysis” (Nielsen et al., 2005). The study also concluded that the EISs relied too heavily on the modeling used to estimate fish mortality. The Southeast Area Monitoring and Assessment Program (SEAMAP), stated that such estimates tend to have too many uncertainties and cast doubts on the impact analysis (Nielsen et al., 2005).

The LNG industry has learned to provide the public with as much information about proposed facilities early in the process, and to seek and respond to comments from all parties. A well-planned and funded public relations campaign is a necessity for all companies interested in building LNG facilities.



## 8. CONCLUSIONS

This report has attempted to address, and clarify, the key issues surrounding increased LNG development in the GOM. Specifically, this report has addressed concerns with supply and demand, infrastructure, safety, siting concerns, environmental and regulatory issues. Specifically, it is argued that LNG will not negatively compete with domestic gas production. And, in fact, will supplement domestic production, particularly when supply is low and demand is high. However, it will be some time before LNG imports will be large enough to have a dramatic impact on prices.

The GOM Region is one of the largest and most comprehensive energy economies in the world. Energy activities span across all areas, from production, processing, and transportation, to distribution and sales. Further, the GOM is also one of few regional economies around the globe that has such a pervasive degree of horizontal and vertical linkages between all types of energy infrastructure and activities, making it uniquely situated for LNG activities.

The dramatic development of gas-powered electric generation plants in the last decade, along with use of gas as a feedstock for the chemical, pulp and paper, and other industries supports strong natural gas demand even during a period when domestic supplies are falling. If these industries are to be maintained, then high and volatile prices will need to be abated, and LNG appears to be the only short-to intermediate-run alternative to this resource challenge.

Exploration and production activities associated with natural gas development are one of the largest contributors to the GOM regional economy. Further, the importance of natural gas production from the offshore GOM, relative to total domestic supplies, has been growing considerably over the past two decades. Yet, as discussed earlier, GOM overall production for both oil and gas has decreased over the past several years. This decrease is one of the most important factors impacting the development of LNG facilities in the GOM, and has had serious price and volatility implications for natural gas.

The sources of production and potential future production appear to be shifting in the GOM, creating additional implications for LNG regasification development in the region. Over the past decade, conventional wisdom held that a considerable amount of future natural gas resources would come from the GOM and deepwater development in the region. While deepwater development has clearly increased over the past several years, it is not clear that this activity is going to revitalize natural gas markets alone.

The growing LNG infrastructure in the GOM will supplement the GOM gas production, since much of this imported natural gas will be processed, stored, shipped and even used in the GOM Region, particularly in the numerous chemical and other industrial facilities in East Texas and Louisiana. Again, infrastructure improvements will be required to fully integrate LNG into the existing natural gas system, but the very processing, storage and other facilities now being used will be at greater capacity, thus lowering the amount of investment that would otherwise be required to bring LNG onshore.

There would appear to be little support for any concerns that increased LNG imports into the GOM Region would cause the market to be oversupplied, and thus lower natural gas prices

below a level needed to sustain and encourage exploration and production activity. Most oil and gas producers remember the price shocks of the past 25 years. The development of LNG nationally, and within the GOM, seems unlikely to result in the same energy price collapse experienced during the mid-1980s. Drilling productivity throughout the region is beginning to slow as are the additions of new domestic reserves. LNG is the only substitute at the current time for these domestic resources.

The basic laws of supply and demand also dictate where, when and how much LNG is actually transported to each receiving facility around the world. Currently, LNG prices are set by activity in the Atlantic Basin, which has resulted, in part, in less LNG coming into the U.S. today. However, even under the most optimistic scenarios by the EIA and others, LNG imports to the U.S. are not expected to exceed 14 percent of total requirements for the next 20 years. [It is currently approximately 3 percent]. Thus, the argument that an influx of LNG could put a damper on prices on U.S. gas production in the immediate foreseeable future is defeated, as it will take decades of LNG infrastructure facility production and supplemental improvements to be able to reach the 14 percent import level.

Another reason to consider LNG to be a supplement (and not a substitute) to domestic gas production is the industrial base in the Gulf Region that uses gas as a feedstock including areas where gas is the marginal fuel for power production. Industrial production drops dramatically as energy prices increase. Production always follows low costs, and as seen in the domestic chemical industry, production and jobs often flow overseas, which has a dramatic economic impact domestically. As we have seen in the immediate past, low energy prices provide attractive incentives for business location decisions. Industry and manufacturing, particularly in the energy intensive chemical sector, are more often questioning the logic of continuing to pay high prices for natural gas when comparable production investments could be made in other countries where input costs are lower.

The GOM is one of the better-suited areas in the U.S. for the development of LNG facilities. From production, gathering, processing to transmission, storage and distribution, a wide range of infrastructure and industry has developed to support and use the byproducts associated with GOM production (see Figure 48). The GOM is home to over 4,000 offshore oil and gas platforms and over 33,000 miles of offshore pipeline. Additionally, nearly 50 major gas processing plants and 17 natural gas liquids fractionation sites are located along the Gulf coast of Texas, Louisiana, Mississippi, and Alabama. These facilities have the capacity to process 22.8 Bcf/day of natural gas and could serve as important support facilities for LNG imports which are typically considered to have richer gas quality than domestic production.

The same industries and infrastructure supporting current production will be the ones to support LNG development. It is this high concentration of infrastructure that makes the GOM so attractive for LNG developers, and many analysts agree that construction costs can be minimized in the area for this very reason. As the GOM natural gas production continues to mature, this energy infrastructure can carry natural gas imported from other regions.

The key remaining LNG development issues include environmental and safety concerns. The environmental impact process for LNG facilities (onshore and offshore) are some of the most thorough and stringent of all industries. Of particular concern has been the regasification

technology used for vaporizing the liquid natural gas. Open loop systems, opponents complain, can negatively impact marine life, particularly ichthyoplankton. For this reason, closed loop systems, though they require more energy, is the preferred technology.

Since 9/11 safety concerns have come to the forefront for most industries, especially the energy industry where so much of the infrastructure is exposed. This is one motivating factor for developing LNG facilities off-shore. Though numerous reports suggest the fire danger is not as great as many fear, LNG ships are still seen as a potential terrorist target, despite one of the best safety records of any industry. By having ships unload their LNG off-shore at secure facilities the safety concerns are lessened, but not entirely removed.

Such off-shore facilities are also subject to hurricanes and other natural disasters, but the one working off-shore port off the coast of Louisiana survived two major hurricanes (Charlie and Rita) without any damage. However, no man-made facility has ever been made 100 percent safe from man-made or natural disasters.

In conclusion, LNG regasification terminals represent a new and important addition to the Gulf Coast's energy infrastructure. Like the other assets along the Coast, LNG regasification terminals will serve as an integral part of the nation's energy backbone. Roughly 60 percent of all U.S. crude oil imports are off-loaded at terminals along the GOM. By 2020, the same will more than likely be true for natural gas. The GOM accounts for some 80 percent of all approved and operating LNG regasification capacity. Continued LNG opposition along the Pacific and East Coast will more than likely reinforce the large share of development along the GOM.

Like crude imports, the presence of LNG in the region is unlikely to significantly reduce domestic natural gas production and in fact will serve as an important supplement for domestic needs. The development of LNG may in fact, actually prove to support the energy industry in ways typically not considered. Locating LNG terminals in the region will provide additional support and longevity to assets that are critical for domestic production.

## REFERENCES

- American Forest and Paper Association. 2005. U.S. forest products industry -- competitive challenges in a global marketplace. Internet website: <http://www.bipac.net/page.asp?g=AFPA&content=White Paper re Competitiveness Summary&parent=AFPA>.
- American Gas Association. 2005. White paper on natural gas interchangeability and non-combustion end use. NGC+ Interchangeability Work Group. February 28, 2005.
- American Petroleum Institute (API). 2007. MMS 5-Year plan alert. Internet website: [http://www.apialert.com/page.asp?g=api\\_alert&content=mms\\_background](http://www.apialert.com/page.asp?g=api_alert&content=mms_background)
- Baker Hughes. 2007. North American rig counts. Internet website: [http://www.bhinet.com/investor/rig/rig\\_na.htm](http://www.bhinet.com/investor/rig/rig_na.htm).
- Barnhardt, L. 2007. Judge rules out zoning to block LNG terminal. Baltimore Sun. January 24, 2007.
- Bayou Buzz. 2006. Freeport McMoran LNG application. May 5, 2006. Internet website: <http://bayoubuzz.com/articles.aspx?aid=6990>.
- Beale, J.P. 2006. The facts about LNG. Prepared for AES Sparrows Point LNG. CH-IV International. CH-IV International Document: RPT-06903-01. June 9, 2006.
- Burdeau, C. 2007. Shell drops plan to build LNG terminal. International Business Times. March 29, 2007.
- Burr, M.T. 2004. LNG science: A moving target. Public Utilities Fortnightly. September, 2004.
- California Energy Circuit. 2004. New FERC report may blow onshore LNG out of the water. May 14, 2004.
- Commonwealth of Massachusetts, Executive Office of Environmental Affairs. 2006. Certificate of the Secretary of Environmental Affairs on the Final Environmental Impact Report for Northeast Gateway Energy Project. December, 2006.
- Congressional Research Service Report RL32205 (CRSR). 2004. Liquefied natural gas (LNG) import terminals: Siting, safety and regulation. May 2004.
- Cusick, D. 2006. Alabama Governor's veto threat sinks \$1B ConocoPhillips project. Internet website: [http://www.rigzone.com/news/article.asp?a\\_id=33000](http://www.rigzone.com/news/article.asp?a_id=33000).
- Dismukes, D.E., D.V. Mesyanzhinov, and E.A. Downer. 2004a. Economic opportunities for LNG development in Louisiana. Prepared for the Louisiana Department of Economic Development and Greater New Orleans, Inc. April 14, 2004.

- Dismukes, D.E., D.V. Mesyanzhinov, and E.A. Downer. 2004b. The economic opportunities for a limited industrial retail choice plan in Louisiana. Louisiana State University Center for Energy Studies. Baton Rouge. August 25, 2004.
- Dominion. 2007. History of liquefied natural gas. Dominion Cove Point LNG, LP. Internet website: [http://www.dom.com/about/gas-transmission/covepoint/lng\\_history.jsp](http://www.dom.com/about/gas-transmission/covepoint/lng_history.jsp)
- Excelerate Energy. 2004. Excelerate Energy offshore liquefied natural gas overview presentation. Public Symposium on LNG. Brunswick, Maine. July 29, 2004.
- Excelerate Energy. 2005. Press Release, September 26, 2005. Excelerate Energy's Gulf gateway energy bridge weathers Hurricane Rita.
- Farrell, J.E. 2006. Demand for liquefied natural gas development and impacts to Ichthyoplankton. Louisiana Sea Grant College Program. Presented to the 20th International Conference of The Coastal Society, May 2006.
- Federal Energy Regulatory Commission (FERC), U.S. Coast Guard, and U.S. Dept. of Transportation. 2004. LNG - safety reports - 2004 Interagency Agreement between FERC, U.S. Coast Guard and U.S. Department of Transportation. Internet website: <http://www.ferc.gov/industries/lng/safety/reports/2004-interagency.asp#skipnavsub>.
- Federal Energy Regulatory Commission (FERC). 2004. CRS Report for Congress, January 28, 2004.
- Federal Energy Regulatory Commission (FERC). 2005. Executive summary. Environmental impact statement Weaver's Cove LNG terminal, September 2005. Internet website: <http://www.ferc.gov/industries/lng/enviro/eis/2005/05-20-05-eis.asp>.
- Federal Energy Regulatory Commission (FERC). 2006a. Proceedings of the Commission Meeting, June 15, 2006. FERC Discussion Item A-3: Summer assessment on gas storage.
- Federal Energy Regulatory Commission (FERC). 2006b. LNG Clean Energy Project: Final environmental impact statement. November 2006.
- Federal Energy Regulatory Commission (FERC). 2007a. Existing and proposed North American LNG terminals, as of July 24, 2007. Internet website: <http://ferc.gov/industries/lng.asp>.
- Federal Energy Regulatory Commission (FERC). 2007b. LNG – existing LNG terminals. Internet website: <http://ferc.gov/industries/lng/indus-act/terminals/exist-term.asp>.
- Federal Energy Regulatory Commission (FERC). 2007c. Natural gas markets. Internet website: <http://www.ferc.gov/market-oversight/mkt-gas/overview.asp>.
- Federal Energy Regulatory Commission (FERC). 2007d. A guide to LNG: What all citizens should know. Internet website: <http://www.ferc.gov/for-citizens/citizen-guides/lng.asp>.

- Federal Energy Regulatory Commission (FERC). 2007e. LNG safety record. Internet website: <http://ferc.gov/industries/lng/safety/safety-record.asp>.
- Federal Reserve Bank of St. Louis. 2007. Internet website: <http://research.stlouisfed.org/fred2/data/OILPRICE.txt>.
- Foss, M. M. 2003a. Introduction to LNG. Center for Energy Economics, Bureau of Economic Geology, Jackson School of Geosciences, The University of Texas at Austin. January 2003.
- Foss, M. M. 2003b. LNG safety and security. Center for Energy Economics, Bureau of Economic Geology, Jackson School of Geosciences, The University of Texas at Austin. October 2003.
- French, L.S., G.E. Richardson, E.G. Kazanis, T.M. Montgomery, C.M. Bohannon, and M.P. Gravois. 2006. Deepwater Gulf of Mexico 2006: America's expanding frontier. U.S. Department of the Interior, Minerals Management Service, Gulf of Mexico OCS Region, New Orleans, LA. OCS Study MMS 2006-022.
- Gaul, D. and Platt, K. 2007. Short term energy outlook supplement: U.S. LNG imports, the next wave. U.S. Department of Energy, Energy Information Administration. January 2007.
- Gerard, J. 2006. Impact of Clean Air Regulations on natural gas prices. Statement of Jack N. Gerard, President and CEO, American Chemistry Council before the U.S. Senate Committee on Environment and Public Works Subcommittee on Clean Air, Climate Change and Nuclear Safety, February 9, 2006.
- GlobalSecurity.org. 2007. *Limburg* oil tanker attacked. Internet website: [http://www.globalsecurity.org/security/profiles/limburg\\_oil\\_tanker\\_attacked.htm](http://www.globalsecurity.org/security/profiles/limburg_oil_tanker_attacked.htm).
- Haywood, T. 2006. Massachusetts green-lights two LNG buoy projects off Gloucester. Natural Gas Week. December 25, 2006.
- Hopper, G.W. 2006. LNG supply growth will speed construction of North American pipelines. LNG Observer. Issue 4. October/November 2006.
- IHS Energy Group Inc. 2002. Major Industrial Plant Database<sup>®</sup> (MIPD). Houston, Texas.
- Intercontinental Exchange. 2007. North American natural gas indices. Internet website: <https://www.theice.com/marketdata/naNaturalGas/naIndex.jsp>.
- Kennedy, K. 2006. LNG permitting and environmental review: The view from California. Proceedings of the DOE LNG Forum, Los Angeles, June 1, 2006. Presented by Kevin Kennedy, California Energy Commission.
- Louisiana Sea Grant Program. 2005. Louisiana Coastal Law. Louisiana Coastal Law Newsletter. Number 86. August 2005.

- Louisiana Department of Natural Resources (LDNR). 2007. Louisiana energy facts and figures. Internet website: [http://dnr.louisiana.gov/sec/execdiv/techasmt/facts\\_figures/index.htm](http://dnr.louisiana.gov/sec/execdiv/techasmt/facts_figures/index.htm).
- LNGOneWorld. 2007. LNG terminals. Internet website: <http://www.lngoneworld.com/lngv1.nsf/portal/index.html>.
- Mustang Engineering. 2006. Presentation to LNG Interagency Working Group, California Energy Commission. December 2006.
- Namtvedt, E.H. 2005. Global market possibilities for LNG. Presented at IEA Advisory Group on Oil and Gas Technologies Roundtable, International Energy Agency, New Orleans, LA. May 27, 2005.
- National Association of Regulatory Utility Commissioners (NARUC). 2005. Liquefied natural gas: An overview of the issues for state public utility commissions. Prepared by ICF Consulting for consideration of the DOE/NARUC LNG Partnership, NARUC, and the U.S. Department of Energy. June 2005.
- National Petroleum Council (NPC). 2004. Balancing natural gas policy – fueling the demands of a growing economy, volume V, transmission & distribution task group report and LNG subgroup report. National Petroleum Council, Washington, DC. Updated August 2004.
- Natural Gas Supply Association (NGSA). 2004. The history of regulation. Internet website: <http://www.naturalgas.org/regulation/history.asp>
- Nielsen, R.D., T.C. Ginn, L.M. Ziccardi, and P.D. Boehm. 2005. An evaluation of the approaches used to predict potential impacts of open loop LNG vaporization systems on fishery resources in the Gulf of Mexico. Center for Liquefied Natural Gas, Seawater Usage Technology Committee, November.
- Savage, C. 2004. Study spells out high toll on city in LNG attack. The Boston Globe. December 21.
- State of Louisiana. Governor Kathleen Babineaux Blanco. 2007. Governor Blanco calls for an industry to produce environmentally sound LNG strategy. Internet website: <http://gov.louisiana.gov/index.cfm?articleID=1840&md=newsroom&tmp=detail>.
- Swanstrom, H.W. 2005. Who has the first say? Additional jurisdictional conflicts involving the FERC. Fourth Annual Gas and Power Institute, Houston, TX, October.
- Taylor, C. 2001. Renaissance of the U.S. LNG industry; industry overview; statistical data included. Pipeline & Gas Journal. 228(6):52-55. June 1, 2001.
- Tokyo Gas. 2007. LNG technologies. Internet website: <http://www.tokyo-gas.co.jp/lngtech/ug-tank/index.html>.

- Turpin, T.L. 2006. LNG import projects: FERC review process. LNG Engineering Branch, Federal Energy Regulatory Commission. October 18, 2006.
- U.S. Department of Commerce. Bureau of Economic Analysis (BEA). 2007. U.S. economic accounts. Internet website: <http://www.bea.gov/>
- U.S. Department of Commerce. International Trade Administration (ITA). Trade Development, Office of Trade and Economic Analysis. 2007. Internet website: <http://trade.gov/index.asp>.
- U.S. Department of Energy (DOE). 2005. Liquefied natural gas: Understanding the basic facts. Washington DC. August 2005.
- U.S. Department of Energy (DOE). 2006. Impact of the 2005 hurricanes on the natural gas industry in the Gulf of Mexico Region. Department of Energy. Washington, DC.
- U.S. Department of Energy. Energy Information Administration (EIA). 2001. U.S. natural gas markets: Recent trends and prospects for the future. U.S. Department of Energy, Energy Information Administration, Office of Integrated Analysis and Forecasting, Washington, DC. May 2001.
- U.S. Department of Energy. Energy Information Administration (EIA). 2003. U.S. LNG markets and uses. U.S. Department of Energy, Energy Information Administration, Office of Integrated Analysis and Forecasting, Washington, DC. January 2003.
- U.S. Department of Energy. Energy Information Administration (EIA). 2004. The basics of underground natural gas storage. Internet website: [http://www.eia.doe.gov/pub/oil\\_gas/natural\\_gas/analysis\\_publications/storagebasics/storagebasics.html](http://www.eia.doe.gov/pub/oil_gas/natural_gas/analysis_publications/storagebasics/storagebasics.html)
- U.S. Department of Energy. Energy Information Administration (EIA). 2005a. FERC's Hackberry decision (2005). Internet website: [http://www.eia.doe.gov/oil\\_gas/natural\\_gas/analysis\\_publications/ngmajorleg/ferc.html](http://www.eia.doe.gov/oil_gas/natural_gas/analysis_publications/ngmajorleg/ferc.html).
- U.S. Department of Energy. Energy Information Administration (EIA). 2005b. Changes in U.S. natural gas transportation infrastructure in 2004. U.S. Department of Energy, Energy Information Administration, Office of Oil and Gas, Washington, DC. June 2005.
- U.S. Department of Energy. Energy Information Administration (EIA). 2006. Additions to capacity on the U.S. natural gas pipeline network: 2005. U.S. Department of Energy, Energy Information Administration, Office of Oil and Gas, Washington, DC. August 2006.
- U.S. Department of Energy. Energy Information Administration (EIA). 2007a. Natural gas navigator. Internet website: [http://www.eia.doe.gov/oil\\_gas/natural\\_gas/info\\_glance/natural\\_gas.html](http://www.eia.doe.gov/oil_gas/natural_gas/info_glance/natural_gas.html).



- U.S. Department of Energy. Energy Information Administration (EIA). 2007b. Petroleum navigator. Internet website: [http://www.eia.doe.gov/oil\\_gas/petroleum/info\\_glance/petroleum.html](http://www.eia.doe.gov/oil_gas/petroleum/info_glance/petroleum.html).
- U.S. Department of Energy. Energy Information Administration (EIA). 2007c. International. Internet website: <http://www.eia.doe.gov/emeu/international/contents.html>.
- U.S. Department of Energy. Energy Information Administration (EIA). 2007d. Electric power annual 2005 – state data tables. Internet website: [http://www.eia.doe.gov/cneaf/electricity/epa/epa\\_sprdshts.html](http://www.eia.doe.gov/cneaf/electricity/epa/epa_sprdshts.html).
- U.S. Department of Energy. Energy Information Administration (EIA). 2007e. Annual energy outlook 2007 with projections to 2030. . U.S. Department of Energy. Energy Information Administration. Office of Integrated Analysis and Forecasting. Washington, DC. February 2007.
- U.S. Department of Labor. Bureau of Labor Statistics (BLS). 2007. Employment, hours, and earnings from the current employment statistics survey. Internet website: <http://stats.bls.gov/data/home.htm>.
- U.S. Environmental Protection Agency (EPA). 2006. EPA’s liquefied natural gas regulatory roadmap. EPA230-B-06-001. Washington, DC. July 2006.
- U.S. Government Accountability Office (GAO). 2007. Maritime security: Public safety consequences of a terrorist attack on a tanker carrying liquefied natural gas need clarification. Washington, DC. February 2007.



### The Department of the Interior Mission

As the Nation's principal conservation agency, the Department of the Interior has responsibility for most of our nationally owned public lands and natural resources. This includes fostering sound use of our land and water resources; protecting our fish, wildlife, and biological diversity; preserving the environmental and cultural values of our national parks and historical places; and providing for the enjoyment of life through outdoor recreation. The Department assesses our energy and mineral resources and works to ensure that their development is in the best interests of all our people by encouraging stewardship and citizen participation in their care. The Department also has a major responsibility for American Indian reservation communities and for people who live in island territories under U.S. administration.



### The Minerals Management Service Mission

As a bureau of the Department of the Interior, the Minerals Management Service's (MMS) primary responsibilities are to manage the mineral resources located on the Nation's Outer Continental Shelf (OCS), collect revenue from the Federal OCS and onshore Federal and Indian lands, and distribute those revenues.

Moreover, in working to meet its responsibilities, the **Offshore Minerals Management Program** administers the OCS competitive leasing program and oversees the safe and environmentally sound exploration and production of our Nation's offshore natural gas, oil and other mineral resources. The MMS **Minerals Revenue Management** meets its responsibilities by ensuring the efficient, timely and accurate collection and disbursement of revenue from mineral leasing and production due to Indian tribes and allottees, States and the U.S. Treasury.

The MMS strives to fulfill its responsibilities through the general guiding principles of: (1) being responsive to the public's concerns and interests by maintaining a dialogue with all potentially affected parties and (2) carrying out its programs with an emphasis on working to enhance the quality of life for all Americans by lending MMS assistance and expertise to economic development and environmental protection.