

PRINCIPAL INVESTIGATORS FINAL REPORTS

BLM CONTRACT NO. 08550-CT5-30

VOLUME II (VIII)

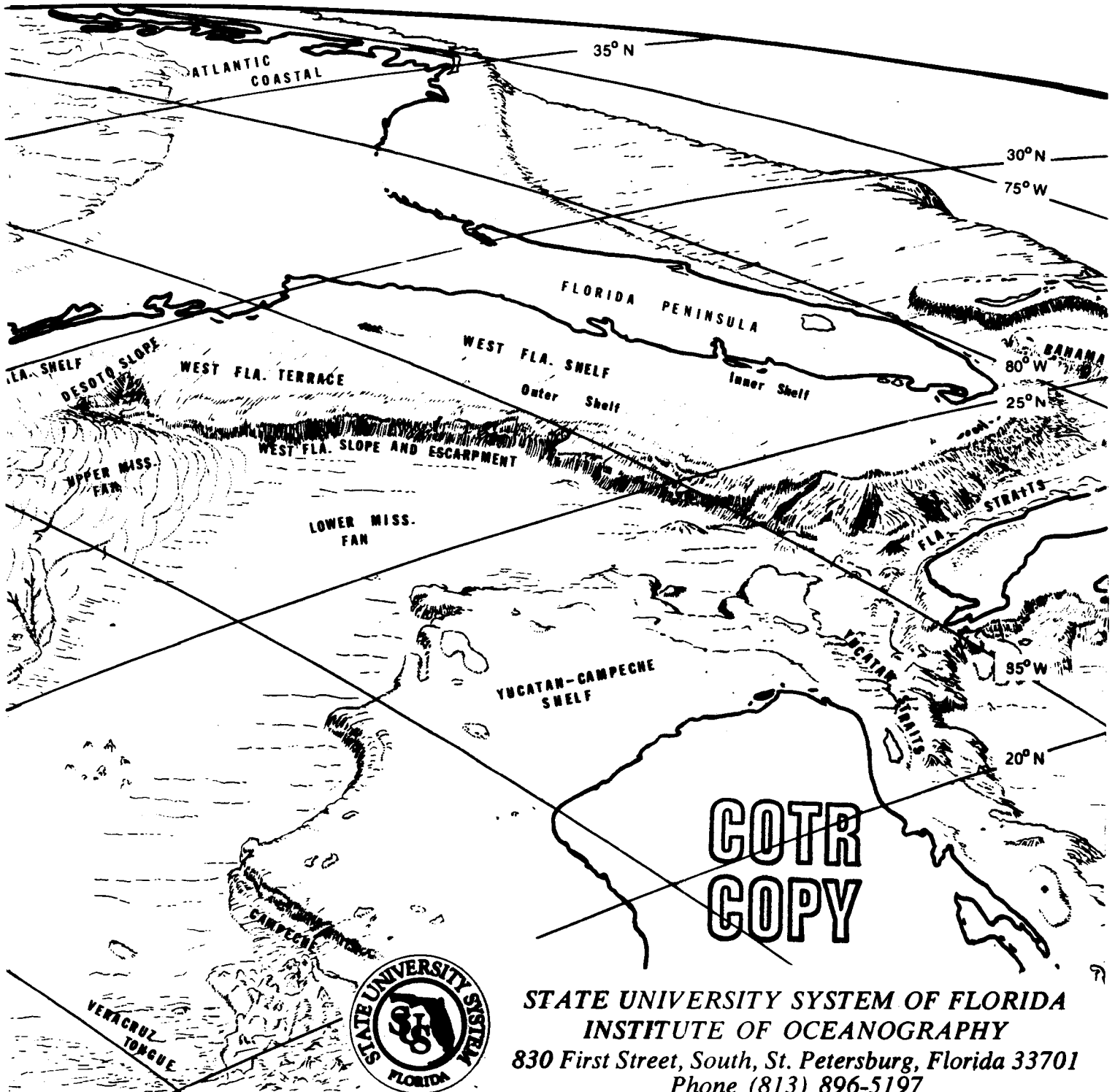

**STATE UNIVERSITY SYSTEM OF FLORIDA**  
**INSTITUTE OF OCEANOGRAPHY**  
 830 First Street, South, St. Petersburg, Florida 33701  
 Phone (813) 896-5197

- University of Florida  
Gainesville
- Florida State University  
Tallahassee
- Florida A. & M. University  
Tallahassee
- University of South Florida  
Tampa
- Florida Atlantic University  
Boca Raton
- University of West Florida  
Pensacola
- Florida Technological University  
Orlando
- University of North Florida  
Jacksonville
- Florida International University  
Miami

HYDROCARBONS IN THE WATER COLUMN OF THE MAFLA LEASE AREA, 1975-76

Florida State University, Department of Oceanography

Principal Investigator:  
John A. Calder

EXECUTIVE SUMMARY

1. No recent petroleum contamination was evident in either zooplankton water or suspended particulate material.
2. Nearly every neuston sample was contaminated by tar balls.
3. Weathered petroleum may occur in dissolved and particulate phases, particularly near Tampa Bay and near the Mississippi Sound where unresolved envelopes and a series of n-alkanes from  $nC_{21}$  to  $nC_{32}$  were found.
4. Hydrocarbons in zooplankton, water and suspended particulate materials fell into geographically coherent patterns that appeared to reflect large scale circulation phenomena.
5. In all sample types, hydrocarbon concentrations were lowest during the fall sampling period.
6. In all sample types, the aromatic/unsaturated (benzene) fraction contained significant concentration and complexity of hydrocarbons. These molecules could yield substantial information on the source, temporal variability, etc. of hydrocarbons, if only we could identify them. Techniques required under this contract permitted only a "finger print" analysis. With the background information we now have, increasing the level of effort per sample at the expense of numbers of samples is scientifically valid.
7. A more effective intercalibration program is needed. Both PI's and BLM must realize the difficulty of intercalibration at the trace level and provide the resources and effort to do it properly.
8. At the present level of technical competence, comparison between

labs of absolute concentrations of hydrocarbons is tenuous; similar comparisons of hydrocarbon ratios is more reliable.

9. Many of the large high molecular weight peaks in the benzene fraction of the zooplankton (group C) appear to be wax esters, not hydrocarbons, based on mass spectral analysis by Dick Scalan, University of Texas. They appear to have complex structure, including unsaturation and branching. Nevertheless, they should not have been in this hydrocarbon fraction. Their presence indicates a fault in the saponification procedure. This fault could have been detected earlier had GC/MS analysis been a part of this contract and under the control of the Principal Investigator responsible for hydrocarbon analysis. Given the amount of money being spent on hydrocarbon analysis, and the attention being paid to methodology, intercalibration, etc., it is inconsistent to omit the final verification provided by GC/MS. In the future, GC/MS analysis must be an integral part of the hydrocarbon program with each hydrocarbon P. I. having direct access to such instrumentation.

SEASONAL VARIATIONS OF HYDROCARBONS IN THE WATER COLUMN  
OF THE MAFLA LEASE AREA

Florida State University, Department of Oceanography

Principal Investigator:  
John A. Calder

ABSTRACT

A series of 15 stations in the northeast Gulf of Mexico were occupied during summer, fall and winter 1975-76. Samples were collected and analyzed by gas chromatography for dissolved hydrocarbons and those associated with suspended particulate material. Average concentration of total resolved hydrocarbons was 0.4  $\mu\text{g}/\text{l}$  dissolved and 0.3  $\mu\text{g}/\text{l}$  particulate. Concentrations were higher near shore. Unresolved components were present in both dissolved and particulate phases, especially near the Mississippi River and Sound which may be the source of this material. Biogenic hydrocarbons,  $\text{nC}_{15}$ ,  $\text{nC}_{17}$ , pristane and squalene in the particulate phase may be reflective of in situ biomass. A series of n-alkanes ( $\text{nC}_{21}$  to  $\text{nC}_{32}$ ) in both dissolved and particulate phases persisted during all seasons. Squalene was the dominant molecule in the dissolved unsaturated/aromatic fraction at most stations, but was very low in concentration at the offshore stations in the fall. Total dissolved hydrocarbons correlates with dissolved organic carbon. Total particulate hydrocarbons did not correlate with particulate organic carbon or Chlorophyll a.

INTRODUCTION

The sale of oil and gas leases along the entire U. S. outer-continental shelf (OCS) and heightened public awareness of the potential harmful impact of petroleum-related activities, resulted in the initiation of environmental baseline and monitoring studies in the lease areas, under the sponsorship of the U. S. Department of Interior, Bureau of Land Management. The first

of these studies was the MAFLA (Mississippi-Alabama-Florida) program in the northeast Gulf of Mexico. During 1975-76, three sets of samples were collected from the water column in June-July 1975, September 1975 and January-February 1976. Dissolved hydrocarbons and those associated with suspended particulate matter were analyzed by my laboratory. This report represents our initial evaluation of the three data sets.

#### METHODS

Fifteen stations (Figure 1) in the northeast Gulf of Mexico were occupied during summer 1975, fall 1975 and winter 1976. At each station, 80 l of water was collected from a depth of 10 m with 30 l Niskin bottles. The Niskin bottles had been rinsed with methanol prior to use and were equipped with Teflon coated spring closures. The water was drained from the Niskin bottles through Teflon tubing into a precleaned stainless steel can of the type used to contain soft drinks at soda fountains. The o-ring gasket on each can was wrapped with Teflon film. The water was immediately poisoned with  $\text{HgCl}_2$  and then filtered as soon as possible on board ship. Filtration was accomplished by pressurizing the storage can with prepurified nitrogen and forcing the water via Teflon tubing through a precombusted Whatman GF/F filter in a stainless steel Millipore filter holder and into a second stainless steel can. The filtrate was stored at ambient temperature until returned to the laboratory. The filters were wrapped in precombusted aluminum foil and frozen.

In the laboratory, the water was acidified to pH 2 with concentrated HCl and then extracted with doubly distilled chloroform or methylene chloride in two liter separatory funnels. Each extraction consists of 1500 ml of water and

3 x 50 ml of solvent. The total  $\text{CHCl}_3$  (or  $\text{CH}_2\text{Cl}_2$ ) extract was reduced to small volume in a rotary evaporator and then transferred quantitatively to a 25 ml round bottom flask. The remaining solvent was removed under a stream of prepurified nitrogen. After addition of 10 ml of 0.5 N KOH in methanol, the extract was saponified under reflux for at least four hours. Following addition of an equal volume of water, the non-saponifiable material was extracted into benzene (3 x 10 ml). The benzene was removed under nitrogen and the residue taken up in a small volume of hexane for column chromatography.

Filter pads were placed intact into an appropriately sized round bottom flask and covered with a 1:1 mixture of benzene and 0.5 N KOH in MeOH. After a four hour reflux the mixture was filtered through a precleaned glass fiber filter. Following addition of 25 ml of saline solution, the benzene layer was removed and the aqueous layer re-extracted with 3 x 25 ml of benzene. The benzene extracts were combined, reduced to dryness and taken up in hexane for column chromatography.

The non-saponifiable extracts in a small volume of hexane, were applied to a prewashed alumina overlaying silica gel column (1:3 v/v alumina to silica gel ratio, activity one) and eluted with two column volumes of hexane (aliphatic hydrocarbons) and two column volumes of benzene (unsaturated, aromatic fraction). The hexane fraction was reduced to small volume and the benzene fraction dried and taken up in a small volume of hexane for gas chromatography analysis.

Primary gas chromatographic analysis was done with 2.2 mm I.D. x 2 m



stainless steel columns packed with 4% FFAP on Gas Chrom Z, 80/100 mesh. Retention times were converted to retention indices utilizing known standards of n-alkanes. Peak areas were automatically integrated and converted to weight by applying GC response factors calculated from quantitative normal and isoprenoid alkanes and aromatics. These calculations as well as calculations of peak ratios, odd-even preference, wt. % composition and concentration were done by a computer program which produced both paper and magnetic tape output for submission to a central data bank.

Glassware was washed in detergent, soaked in acid, rinsed with distilled water and oven dried. Solvents were doubly distilled. Periodic blanks were run and rejected if material with retention index greater than 1200 was present.

#### RESULTS - WATER

The gas chromatographically derived concentrations of the aliphatic and unsaturated/aromatic fractions are listed in Table 1 for all three seasons. In summer and fall the concentrations of the unsaturated/aromatic fraction generally exceeded that of the aliphatic fraction; this situation was reversed in the winter. The fall season had the lowest average hydrocarbon concentrations and the winter the highest.

Qualitatively, the dissolved hydrocarbons displayed regional differences during each sampling season. In the summer, two distinct regions were apparent (Figure 2a). Stations 1-7 displayed a unique bimodal envelope of unresolved components in the aliphatic fraction, with the maxima centered at C<sub>17</sub> and C<sub>27</sub> (Figure 2b). Stations 8-15 had a broad envelope with no

Table 1: Concentration of aliphatic (H), unsaturated/aromatic (B) and total (T) dissolved hydrocarbons.

Station	Summer			Fall			Winter		
	H	B	T	H	B	T	H	B	T
1	.11	1.01	1.12	.01	.15	.16	.69	.49	1.17
2	.14	.22	0.36	.05	.12	.17	.45	.18	.63
3	.13	.19	0.32	.08	.06	.14	.40	.06	.69
4	.39	.30	0.69	.04	.40	.45	.14	.10	.24
5	.14	.32	0.46	.02	.12	.13	1.08	.10	1.18
6	.08	.23	0.31	.02	.08	.10	.05	.23	.28
7	.25	.22	0.47	.10	.14	.24	.08	.04	.12
8	.05	.06	0.11	.02	.19	.21	.11	.03	.14
9	.17	.09	0.26	.11	.12	.23	.07	.35	.42
10	.25	.38	0.63	.06	.27	.32	.21	.07	.28
11	.10	.30	0.40	.09	.18	.27	.07	.08	.14
12	.17	.36	0.53	.12	.36	.50	.41	.09	.49
13	.09	.43	0.52	.06	.16	.22	.46	.15	.62
14	.13	.23	0.36	.02	.10	.12	1.14	.17	1.31
15	.06	.22	0.28	.16	.09	.25	.33	.03	.36
Avg	.15	.30	.45	.06	.17	.23	.38	.14	.54
	±.09	±.22	±.24	±.04	±.10	±.12	±.35	±.13	±.40

Table 2: Average concentrations of aliphatic (H) and unsaturated/ aromatic (B) dissolved hydrocarbons.

Summer	H	B
Station 1-7 (bimodal envelope)	.18±.11	.36±.29
Station 8-15 (unimodal envelope)	.13±.07	.26±.13
Fall		
Station 1-8, 14 (no envelope)	.04±.03	.15±.10
Station 9-13, 15(envelope)	.10±.04	.20±.11
Winter		
Station 1-5, 12-15 (envelope)	.56±.34	.15±.14
Station 6-11 (no envelope)	.10±.06	.13±.13

clear maximum (Figure 2c). Both groups of samples displayed a series of n-alkanes from C<sub>21</sub> to C<sub>32</sub> with the weight ratio of total odd carbon number to total even carbon number n-alkanes averaging 1.1±0.1. The unsaturated/aromatic fractions of both groups were similar (Figure 2d) and were generally dominated by a peak at RI=3060. Chromatography on a non-polar column (Figure 2e) confirmed the identity of this molecule as squalene. The concentration of squalene averaged 0.12±0.06 µg/l. The concentrations of hydrocarbons in both fractions from the two groups were not significantly different (Table 2).

During the fall season, the concentration of dissolved hydrocarbons fell to about 50% of summer values (Table 1). This was true of both the aliphatic and unsaturated/aromatic fractions. Aliphatic fractions from stations 1-8 and 14 (Figure 3a) were characterized by a series of n-alkanes predominantly from C<sub>21</sub> to C<sub>32</sub>. The odd/even ratio for these fractions averaged 1.09±0.10. There was no detectable unresolved envelope at these stations. The remaining stations, 9-13 and 15, contained a definite envelope with a maximum near C<sub>27</sub> (Figure 3c). The envelope was of lesser magnitude relative to the n-alkanes at stations 9 and 10. The series of from C<sub>21</sub> to C<sub>32</sub> was still present and had an average odd/even ratio of 1.04±0.14, excluding one value of 0.17. Samples which contained the envelope also had greater concentrations of resolved hydrocarbons in the aliphatic fraction, averaging 0.10±0.04 µg/l for those samples without an envelope (Table 2).

The unsaturated/aromatic fractions from the shoreward stations (Figure 3a) of each transect were similar to summer samples in that squalene

was the dominant molecule in this fraction (Figure 3d). The concentration of squalene at these stations averaged  $0.06 \pm 0.03 \mu\text{g}/\ell$ , excluding one value of  $0.26 \mu\text{g}/\ell$  at station 12. The offshore stations contained very little squalene (Figure 3e) averaging  $0.002 \pm 0.002 \mu\text{g}/\ell$ .

During the winter season, the presence or absence of an envelope in the aliphatic fraction divided the stations into coherent geographical units (Figure 4a). Stations 1-5 and 12-14 contained a large envelope with a maximum at  $\text{C}_{25}$  (Figure 4b) while stations 6-11 did not contain an envelope (Figure 4c). The concentration of resolved aliphatic hydrocarbons averaged  $0.56 \mu\text{g}/\ell$  at stations exhibiting the envelope and  $0.10 \mu\text{g}/\ell$  at stations without an envelope (Table 2). The odd/even ratio from both groups averaged 1.1. At all stations, a poorly resolved cluster of peaks with RI between 1600 and 1900 was present in relatively large amounts.

The concentrations of resolved hydrocarbons in the unsaturated/aromatic fraction did not depend on the presence or absence of an envelope in the aliphatic fraction, averaging  $0.15 \mu\text{g}/\ell$  and  $0.13 \mu\text{g}/\ell$  at stations with and without the aliphatic envelope. Squalene was present in the unsaturated/aromatic fraction at all samples with an average concentration at  $0.04 \pm 0.03 \mu\text{g}/\ell$ . Many of the samples also contained an unresolved envelope in this fraction, a feature not seen in previous seasons (Figure 2e, 4d).

#### RESULTS - PARTICULATE

The average concentration of resolved particulate hydrocarbons was  $0.18 \mu\text{g}/\ell$  in the summer, with most of the material being in the aliphatic fraction (Table 3). The dominant peak in the aliphatic fraction was  $n\text{C}_{15}$

Table 3: Concentration of aliphatic (H), unsaturated/aromatic (B) and total (T) particulate hydrocarbons.

Station	Summer			Fall			Winter		
	H	B	T	H	B	T	H	B	T
1	.03	.04	.07	16.02*	1.36*	17.38*	.087	.027	.114
2	.66	.03	.69	.015	.002	.017	.050	.036	.086
3	.03	.01	.04	.011	0	.011	.323	.040	.363
4	.21	1.36*	1.57*	.113	.028	.141	.187	.022	.209
5	.06	.01	.07	.045	.006	.051	.151	.038	.189
6	.04	.03	.07	.050	.016	.066	.070	.024	.094
7	.18	.03	.21	.007	.004	.011	.058	.036	.094
8	.09	.05	.14	.144	.022	.167	.434	.193	.627
9	.07	.01	.08	.007	.003	.010	.073	.019	.092
10	.29	.01	.10	.014	.004	.018	.050	.020	.070
11	.09	.02	.11	.025	.010	.035	.080	.028	.108
12	.19	.21	.40	.095	.033	.128	3.341	.272	3.613
13	.13	.06	.19	.103	.052	.155	.391	.775	1.166
14	.09	.05	.14	.050	.007	.057	1.340	.046	1.386
15	.13	.01	.14	.088	.011	.099	.697	.220	.917
Avg	.14	.04	.18	.055	.014	.069	.49	.12	.62
	±.15	±.05	±.17	±.046	±.015	±.058	±.86	±.20	±.93

\* omitted from average

with an average concentration of  $.044 \pm .029$   $\mu\text{g}/\ell$ . Pristane and  $n\text{C}_{17}$  were present in all samples. An envelope in the aliphatic fractions was evident at stations 4 and 12-15 (Figure 5a). Its distribution maximum occurred around  $n\text{C}_{23}$  (Figure 5b). A series of n-alkanes was superimposed on the envelope.

In the unsaturated/aromatic fraction, squalene was the dominant molecule with an average concentration of  $0.016 \pm 0.014$   $\mu\text{g}/\ell$ . A peak at RI 2350 was also prominent (Figure 5c).

In fall, the concentration of particulate hydrocarbons fell to about 40% of summertime values and averaged  $0.069$   $\mu\text{g}/\ell$  (Table 3). The dominant feature was the presence or absence of the biogenic hydrocarbons  $n\text{C}_{15}$ , pristane,  $n\text{C}_{17}$  and squalene (Figure 6a). In the aliphatic fractions,  $n\text{C}_{15}$  was the dominant molecule and  $n\text{C}_{17}$  and pristane were present at stations 1, 4, 5, 6, 8, 10-15 (Figure 6b). The concentration of  $n\text{C}_{15}$  averaged  $0.025 \pm .014$   $\mu\text{g}/\ell$  at these stations. At the remaining stations, 2, 3, 7 and 9, the biogenic hydrocarbons were essentially absent (Figure 6c) with the concentration of  $n\text{C}_{15}$  being  $0.001 \pm .001$   $\mu\text{g}/\ell$ . Stations 1, 4 and 12-15 displayed envelopes in the aliphatic fraction, with station 1 having a very high concentration of both resolved and unresolved aliphatic hydrocarbons.

The unsaturated/aromatic fractions in the fall contained squalene and in general little else. The concentration of squalene averaged  $.01 \pm .01$   $\mu\text{g}/\ell$  and  $.003 \pm .004$   $\mu\text{g}/\ell$  at stations having and lacking, respectively, the aliphatic biogenic hydrocarbons.

The concentration of particulate hydrocarbons was greater during the

winter than the preceding seasons, averaging  $.62 \mu\text{g}/\ell$ . However, there was a large range of  $.07$  to  $3.6 \mu\text{g}/\ell$  (Table 3). Aliphatic fractions at all stations contained envelopes, with these being relatively large at stations 8 and 12-15 (Figure 7a). Biogenic hydrocarbons were essentially absent at all stations except 11 and 15 where  $n\text{C}_{15}$  averaged  $0.02 \mu\text{g}/\ell$ . Envelopes were also present in the unsaturated/aromatic fraction at all stations being very large at 12-15. Squalene was very low or absent at all stations except 15 where its concentration was  $0.03 \mu\text{g}/\ell$ .

#### DISCUSSION

The concentration of hydrocarbons in the water column of the MAFLA lease area compares well with the lower values reported in the literature for open ocean water. The overall average concentration was  $0.4 \mu\text{g}/\ell$  dissolved hydrocarbons, and  $0.3 \mu\text{g}/\ell$  particulate or  $0.7 \mu\text{g}/\ell$  total resolved hydrocarbons. Brown, et al, (1975) determined that total hydrocarbons in the open Atlantic and Pacific were about  $1 \mu\text{g}/\ell$  by an IR method. In the Mediterranean the concentration ranged from 2-8  $\mu\text{g}/\ell$  and near Bermuda the concentration was 3-6  $\mu\text{g}/\ell$ . Levy (1971) reported values for total hydrocarbons of 2-13  $\mu\text{g}/\ell$  in the Atlantic off Halifax by a UV-fluorescence method. Comparison of these results is made difficult because of the three different analytical methods used (G. C., IR, UVF) which are responsive to different portions of the hydrocarbons in the samples. Two reports of dissolved hydrocarbons by gravimetric analysis, which measures all hydrocarbons, indicate concentrations greater than reported above. Iliffe and Calder (1974) reported concentrations for aliphatic hydrocarbons of  $12 \mu\text{g}/\ell$  in the south-east Gulf of Mexico and Yucatan Straits and  $47 \mu\text{g}/\ell$  in the Florida Straits



while Barbier, et al, (1973) reported values of 43 and 95  $\mu\text{g}/\ell$  of total dissolved hydrocarbons from water collected at 50 m off the west coast of Africa. The gas chromatographically derived concentrations do not include contributions from the unresolved envelope when it is present. In those cases, total hydrocarbon may be a factor of ten greater than reported.

There is a general trend of higher total resolved hydrocarbon concentration near shore in both dissolved and particulate phases, although there are several exceptions to this trend.

The higher hydrocarbon concentrations near shore could be a result of direct terrestrial input or enhanced in situ production stimulated by terrestrially derived nutrients. The unresolved envelope components seem to have a terrestrial source, either Tampa Bay on Transect I, or the Mississippi River/Sound on Transect IV. These unresolved components could be the remnants of highly weathered crude oil from marine sources or waste oil from terrestrial sources. Both dissolved and particulate hydrocarbons contained a series of n-alkanes from  $n\text{C}_{21}$  to  $n\text{C}_{32}$  with an odd/even ratio of near unity. This feature might be the result of weathered petroleum residues, but could also be derived from marine phytoplankton (Clark and Blumer, 1967). This series of alkanes was present when the lower molecular weight biogenic alkanes were absent. If they are of recent biosynthetic origin, their stability in sea water must be greater than that of  $n\text{C}_{15}$ ,  $n\text{C}_{17}$  and pristane.

The biogenic hydrocarbons  $n\text{C}_{15}$ ,  $n\text{C}_{17}$  and pristane were dominant in the particulate aliphatic fraction and are probably the result of plankton collected on the filters. These hydrocarbons then should correlate with plankton biomass; however the remaining aliphatic and unsaturated/aromatic hydrocarbons in both dissolved and particulate phases are apparently not reflective

of in situ biomass. Thus total hydrocarbon should not correlate with biomass estimators, such as Chlorophyll a. No correlation was noted with Chlorophyll a values reported by Iverson (1976) on samples taken simultaneously with our hydrocarbon samples. This differs from the correlation between Chlorophyll a and total non-aromatic hydrocarbons reported by Zsolnay (1972) for waters off the west coast of Africa. However, the upwelling region off Africa was much richer in phytoplankton than the MAFLA region.

The total dissolved hydrocarbons did correlate with dissolved organic carbon analysis of samples collected simultaneously with hydrocarbon samples (Aller, 1976). The ratio of total dissolved hydrocarbons to dissolved organic carbon was  $0.4 \pm 0.2$   $\mu\text{g}/\text{mg}$  in summer,  $0.2 \pm 0.2$   $\mu\text{g}/\text{mg}$  in fall and  $0.3 \pm 0.2$   $\mu\text{g}/\text{mg}$  in winter. The relative constancy of this ratio during each season indicates that the distribution of dissolved hydrocarbons and dissolved organic carbon are controlled by similar processes. No such relationship existed between particulate hydrocarbons and particulate organic carbon.

The high concentration of squalene in the water column is very interesting. A possible source for squalene is zooplankton (Calder, 1976). The total squalene in the average standing crop of zooplankton would be a few  $\text{pg}/\ell$ , while the concentrations in the water column average several tens of  $\text{ng}/\ell$ . For zooplankton to be the source of squalene, it must have long term stability in the water column. Yet the absence of squalene at several stations in the fall indicates that squalene is subject to degradative or other loss mechanisms. The source and dynamics of squalene in sea water deserves further investigation.

### CONCLUSIONS

1. Hydrocarbons in the water column of the MAFLA area exist at low levels comparable to open ocean values.
2. The presence of weathered petroleum in dissolved and particulate phases is indicated, but not proven, by the occurrence of unresolved envelopes and n-alkanes from  $nC_{21}$  to  $nC_{32}$ .
3. The unresolved envelope material may be derived from terrestrial sources.
4. Biogenic hydrocarbons in the particulate phase may be an indicator of in situ biomass, although there is not correlation of total hydrocarbon with Chlorophyll a.
5. There is a very high concentration of material with RI=3060 on FFAP and RI=2810 on SP-2100 in the water column. This material is probably squalene.
6. Total dissolved hydrocarbon correlates well with dissolved organic carbon. There is no correlation between particulate hydrocarbons and particulate organic carbon.

ACKNOWLEDGEMENTS

This research was supported by the U. S. Dept. of Interior, Bureau of Land Management under contract number 08550-CT5-30. Excellent technical assistance was provided by L. Griffin, W. Teehan, S. Horlick, C. Byrne, D. Wynne, and D. Siebert.

REFERENCES

- Aller, C., M. S. Thesis in progress, Florida State University, 1976.
- Barbier, M., D. Joly, A. Saliot and D. Tourres, Hydrocarbons from sea water. *Deep-Sea Research*, 20, 305-314 (1973).
- Brown, R. A., J. J. Elliot, J. M. Kelliher and T. D. Searl, Sampling and analysis of nonvolatile hydrocarbons in ocean water. *Adv. in Chemistry Series*, No. 147, Ed. by T. R. P. Gibb, American Chemical Society, Washington, D. C. (1975).
- Calder, J. A., Hydrocarbons from zooplankton of the eastern Gulf of Mexico. *Proceedings of a Symposium on "Sources, Effects and Sinks of Hydrocarbons in the Aquatic Environment"*. American Institute of Biological Sciences, Arlington, Va. (1976).
- Clark, R. C. and M. Blumer, Distribution of n-paraffins in marine sediments and organisms. *Limnology and Oceanography*, 12, 79-87 (1967).
- Illiffe, T. M. and J. A. Calder, Dissolved hydrocarbons in the eastern Gulf of Mexico Loop Current and the Caribbean Sea. *Deep-Sea Research*, 21, 481-488 (1974).
- Iverson, R. L., Phytoplankton in the MAFLA lease area. MAFLA Final Report, 1976-1976, in preparation.
- Levy, E. M., The presence of petroleum residues off the east coast of Nova Scotia, in the Gulf of St. Lawrence, and the St. Lawrence River. *Water Research*, 5, 723-733 (1971).
- Zsolnay, A., Hydrocarbon and chlorophyll: a correlation in the upwelling region off West Africa. *Deep-Sea Research*, 20, 923-926 (1973).

Figure 1. Station locations. Stations 1-3 are located on transect 1, stations 4-7 on transect 2, stations 8-11 on transect 3 and stations 12-15 on transect 4. Station numbering begins on the shoreward end of each transect.

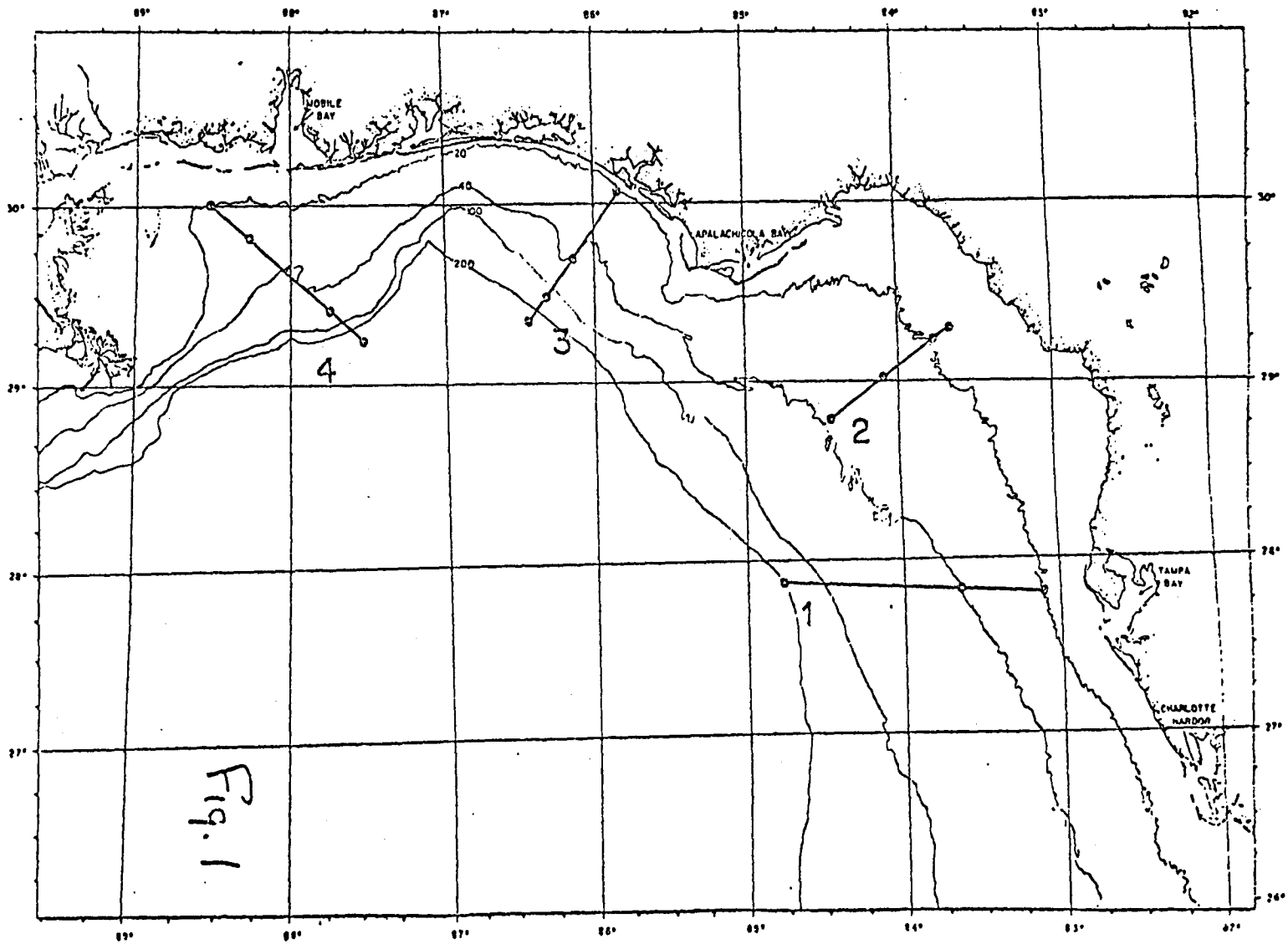

- Figure 2a. Dissolved hydrocarbon distribution, summer 1975.
- 2b. Station 2, aliphatic fraction, dissolved hydrocarbons, summer 1975.
  - 2c. Station 12, aliphatic fraction, dissolved hydrocarbons, summer 1975.
  - 2d. Station 13, unsaturated/aromatic fraction, dissolved hydrocarbons, summer 1975.
  - 2e. Station 1, unsaturated/aromatic fraction, winter 1975.



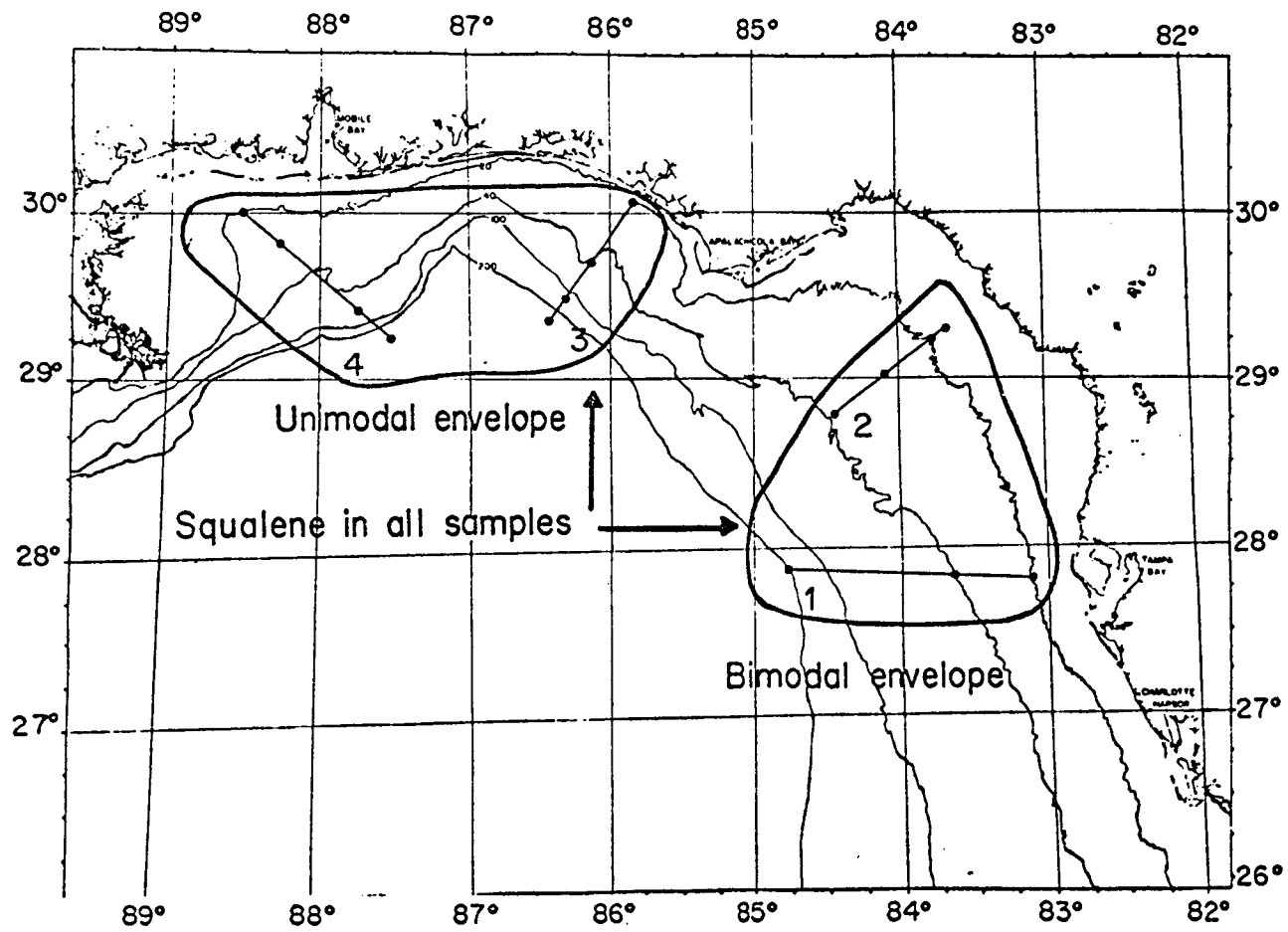

Figure 2a

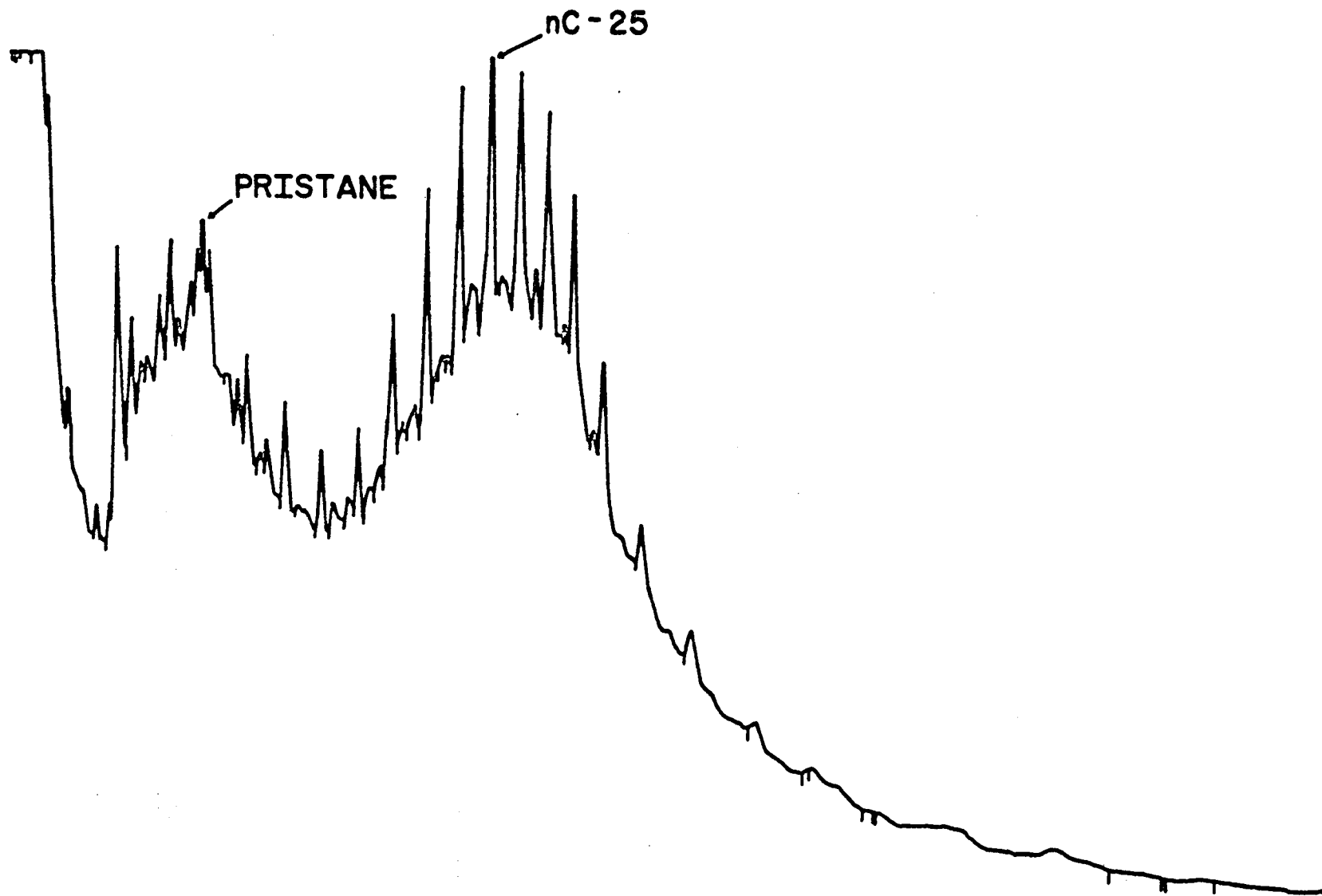

Figure 2b

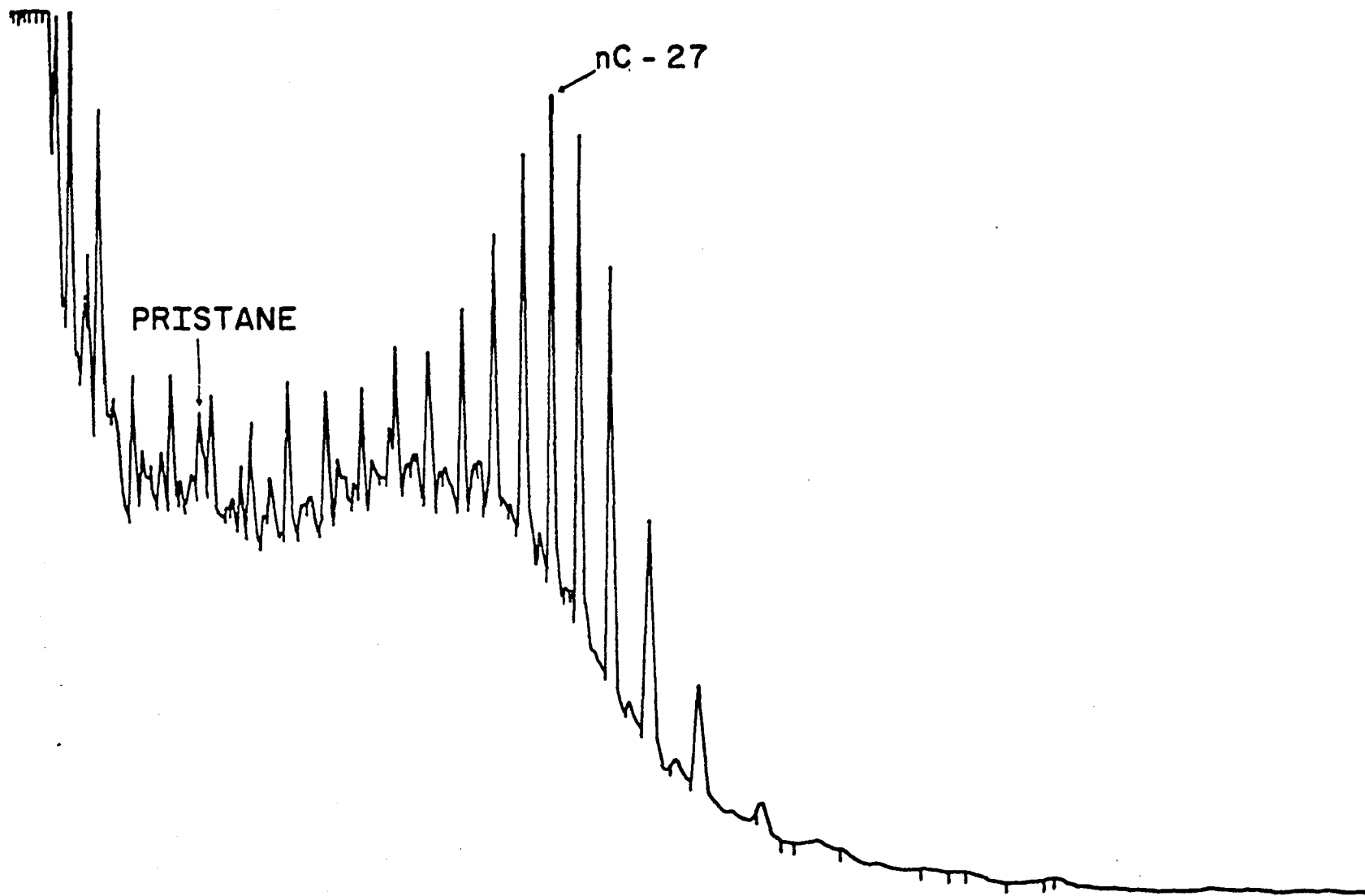

Figure 2c

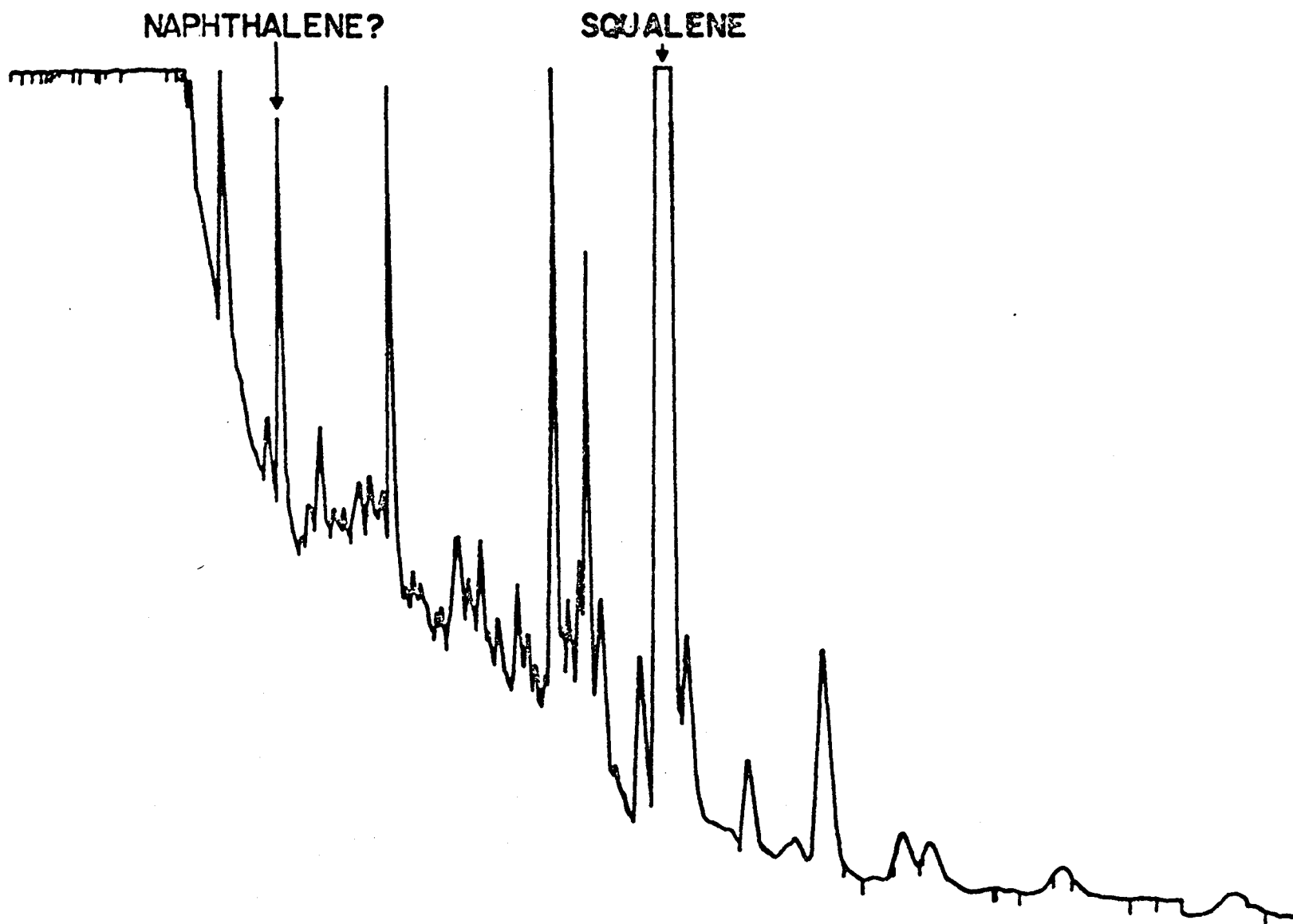

Figure 2d

Figure 3a. Dissolved hydrocarbon distribution, fall 1975.

3b. Station 2, aliphatic fraction, dissolved hydrocarbons,  
fall 1975.

3c. Station 15, aliphatic fraction, dissolved hydrocarbons,  
fall 1975.

3d. Station 1, unsaturated/aromatic fraction, dissolved hydro-  
carbons, fall 1975.

3e. Station 2, unsaturated/aromatic fraction, dissolved hydro-  
carbons, fall 1975.

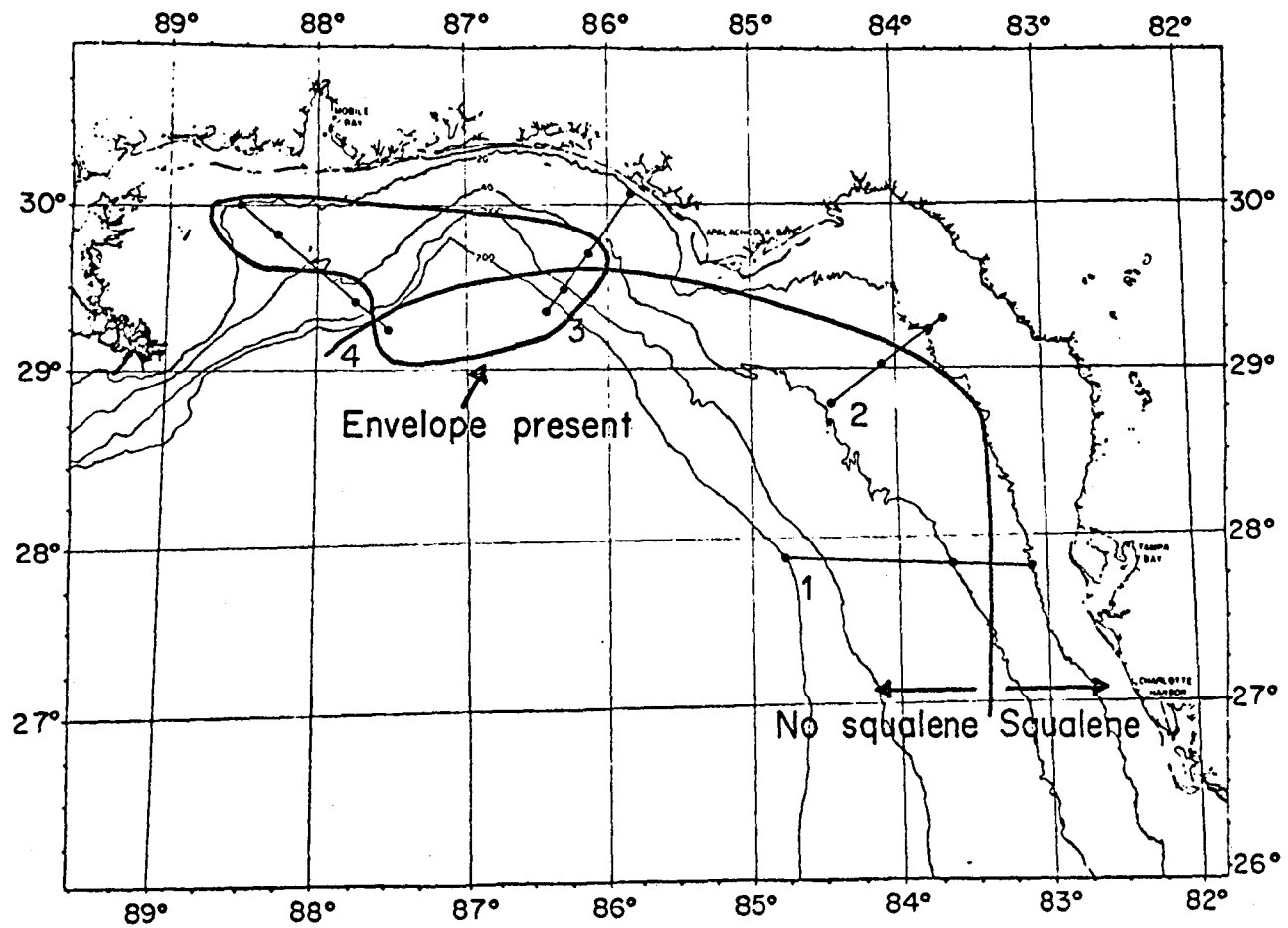

Figure 3a

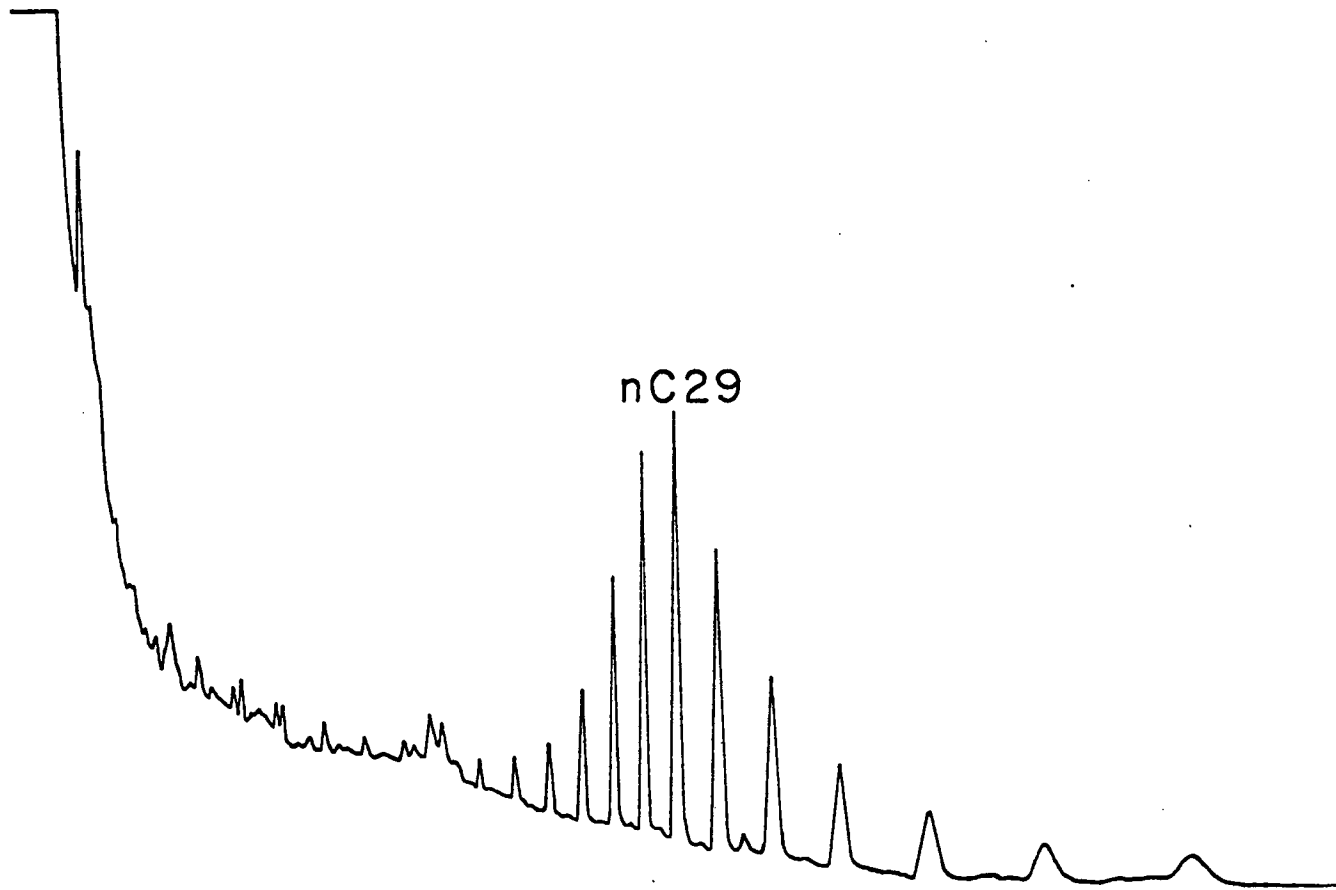

Figure 3b

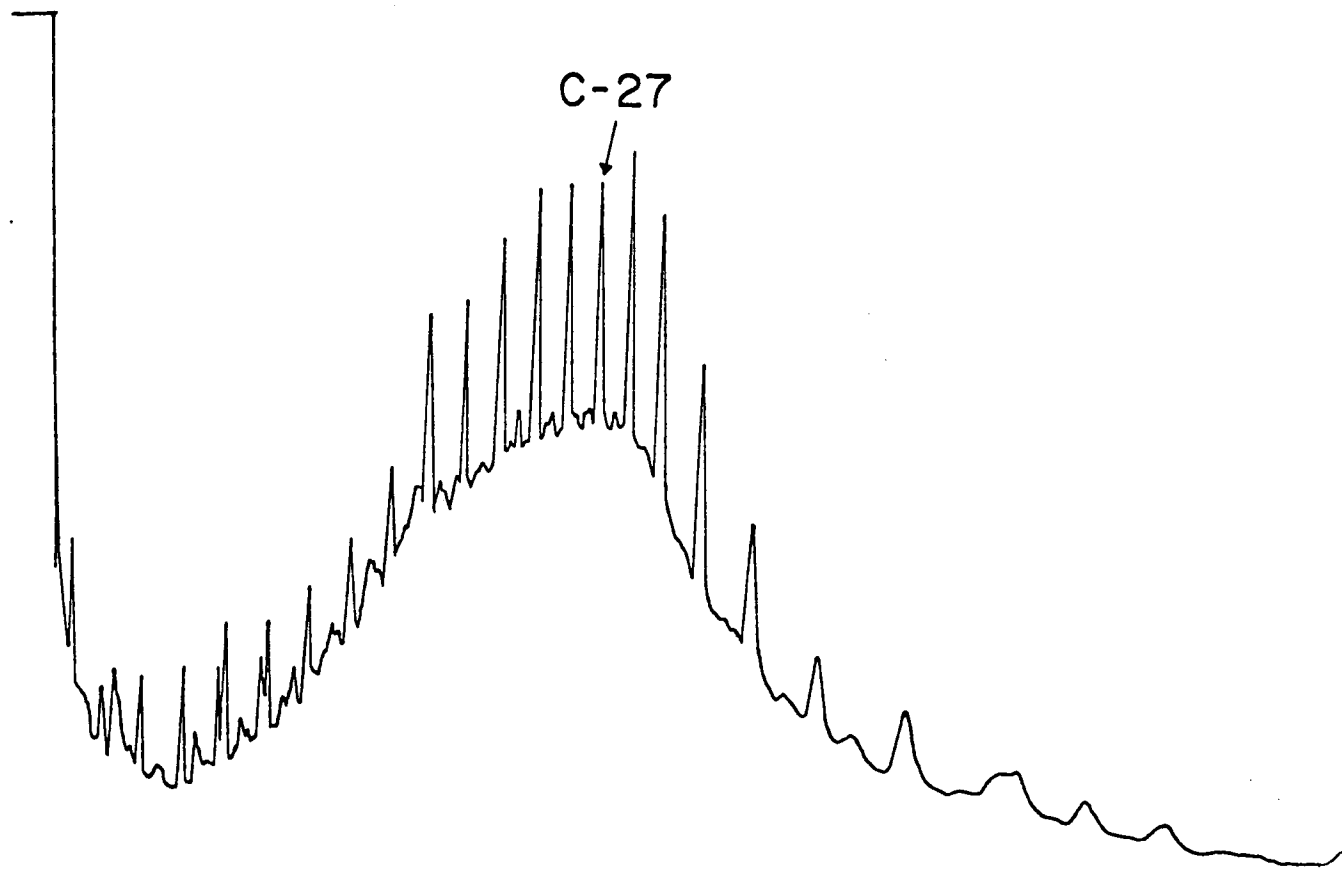

Figure 3c



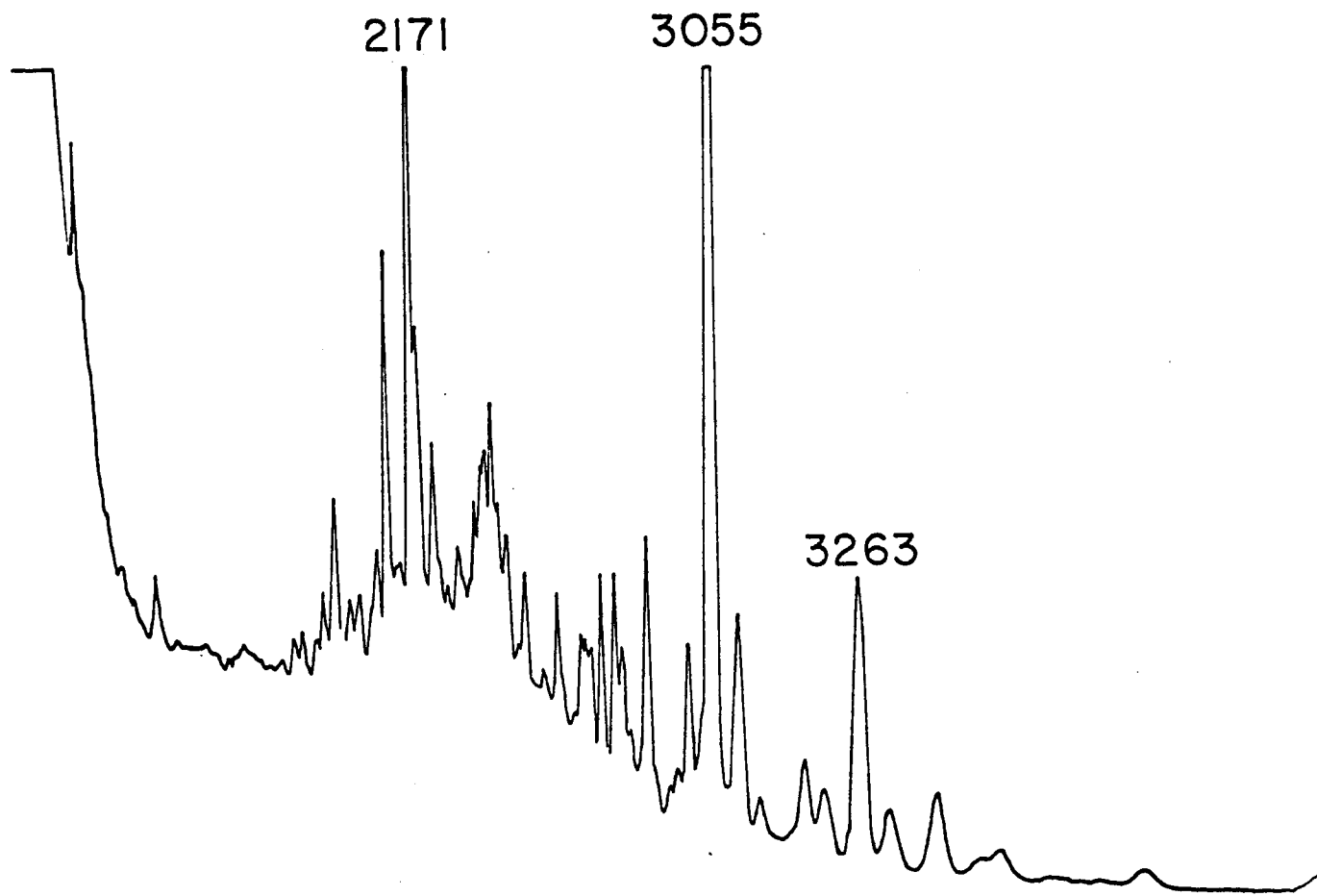

Figure 3d

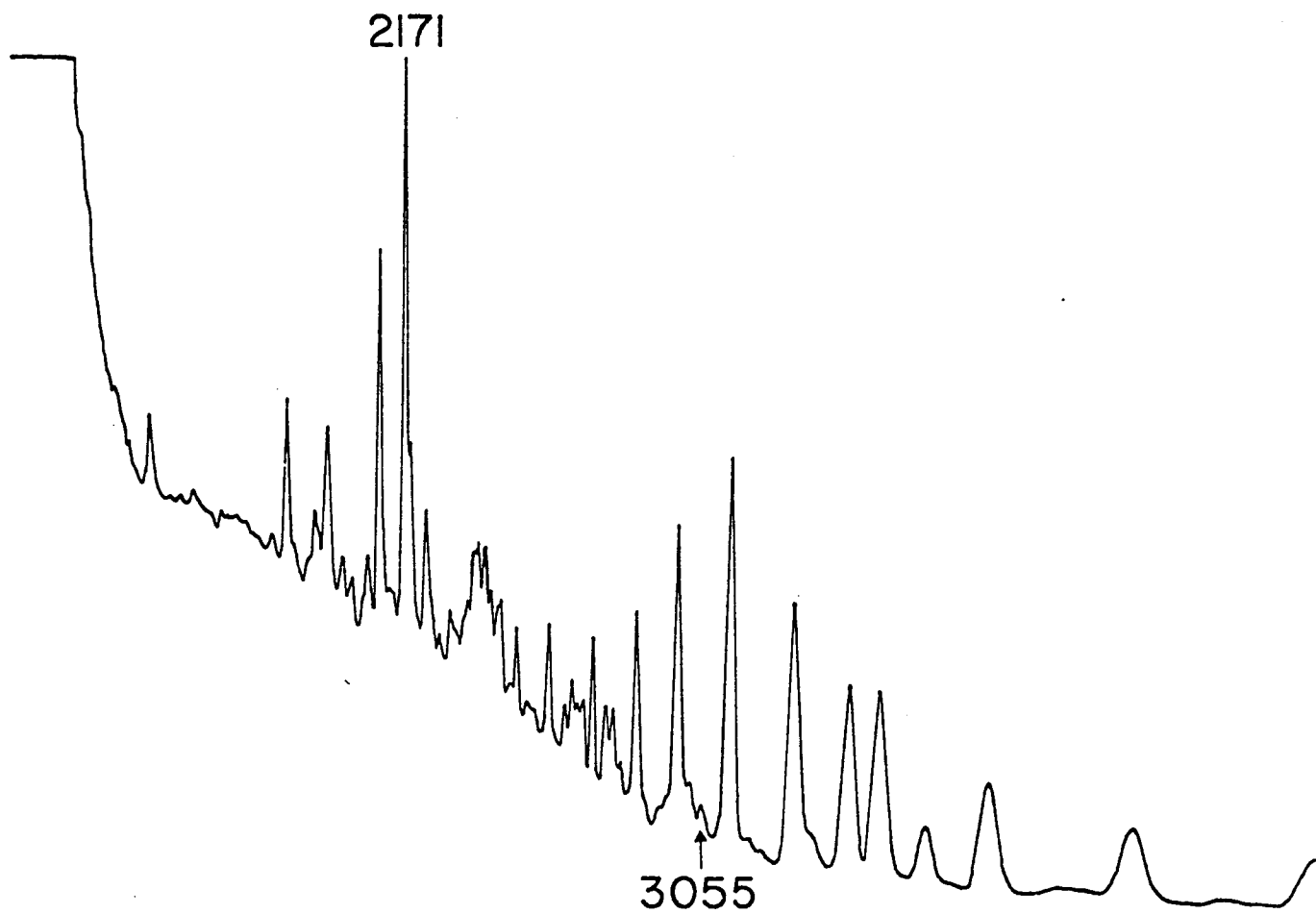

Figure 3e

- Figure 4a. Dissolved hydrocarbon distribution, winter 1976.
- 4b. Station 1, aliphatic fraction, dissolved hydrocarbons, winter 1976.
  - 4c. Station 10, aliphatic fraction, dissolved hydrocarbons, winter 1976.
  - 4d. Station 1, unsaturated/aromatic fraction, dissolved hydrocarbons, winter 1976.

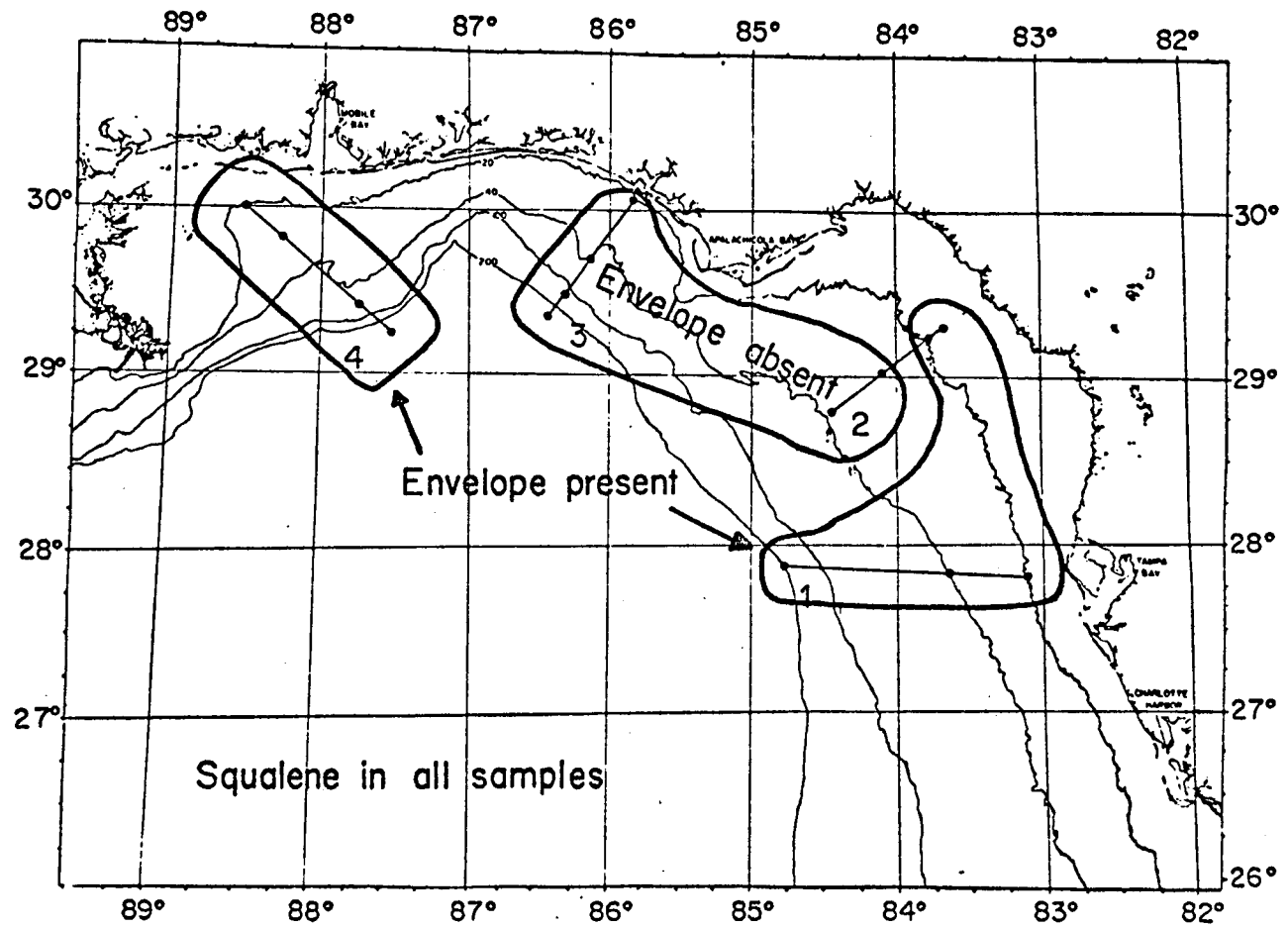

Figure 4a

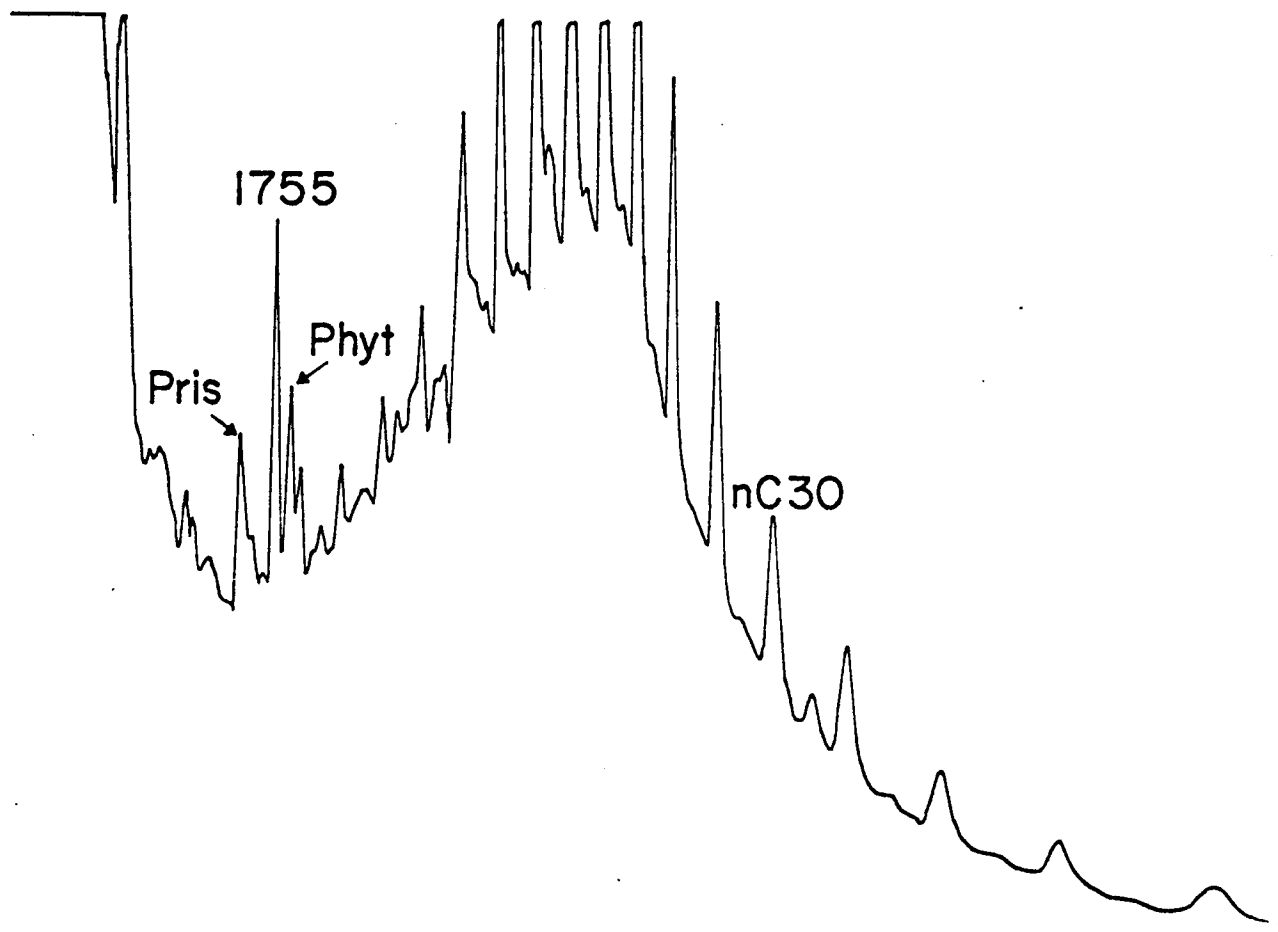

Figure 4b

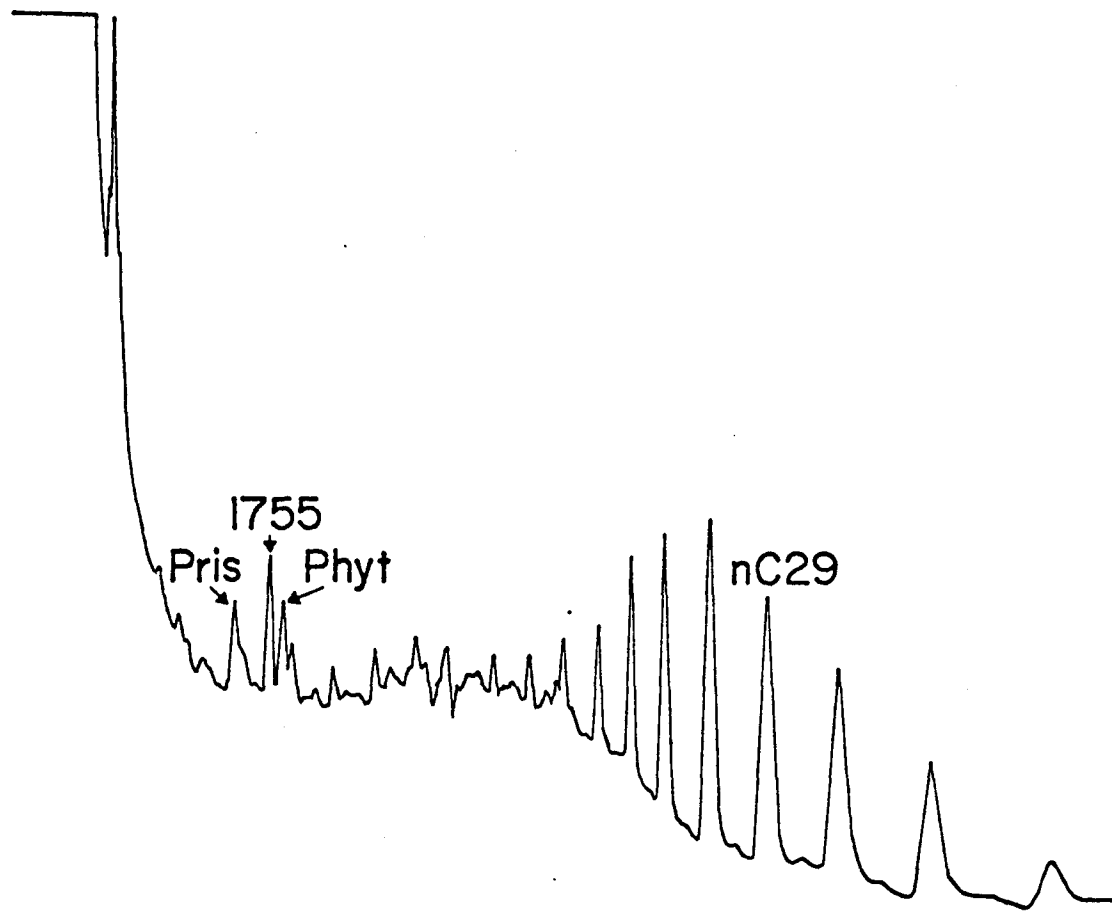

Figure 4c

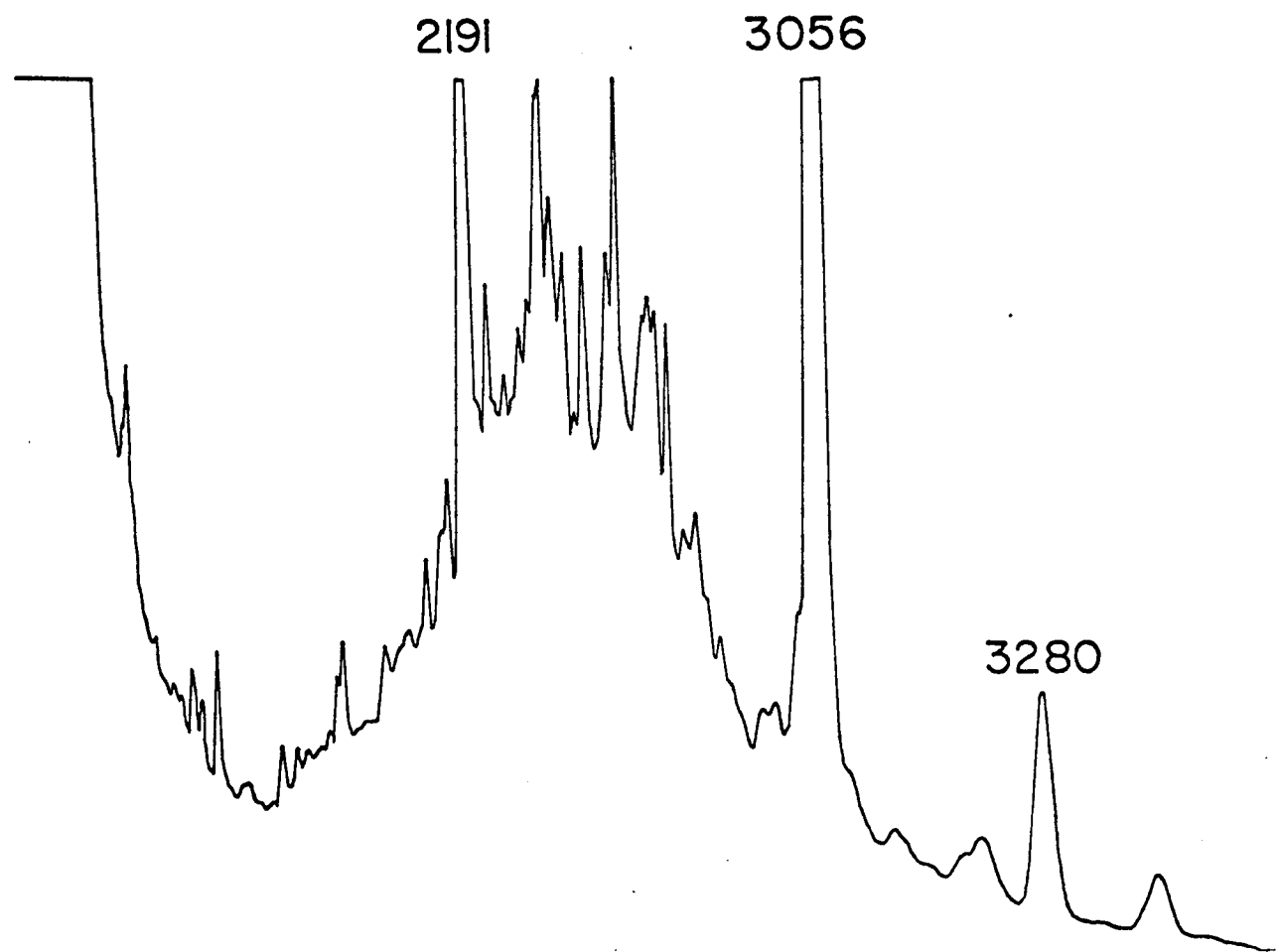

Figure 4d

- Figure 5a. Particulate hydrocarbon distribution, summer 1975.
- 5b. Station 4, aliphatic fraction, particulate hydrocarbons, summer 1975.
- 5c. Station 7, unsaturated/aromatic fraction, particulate hydrocarbons, summer 1975.



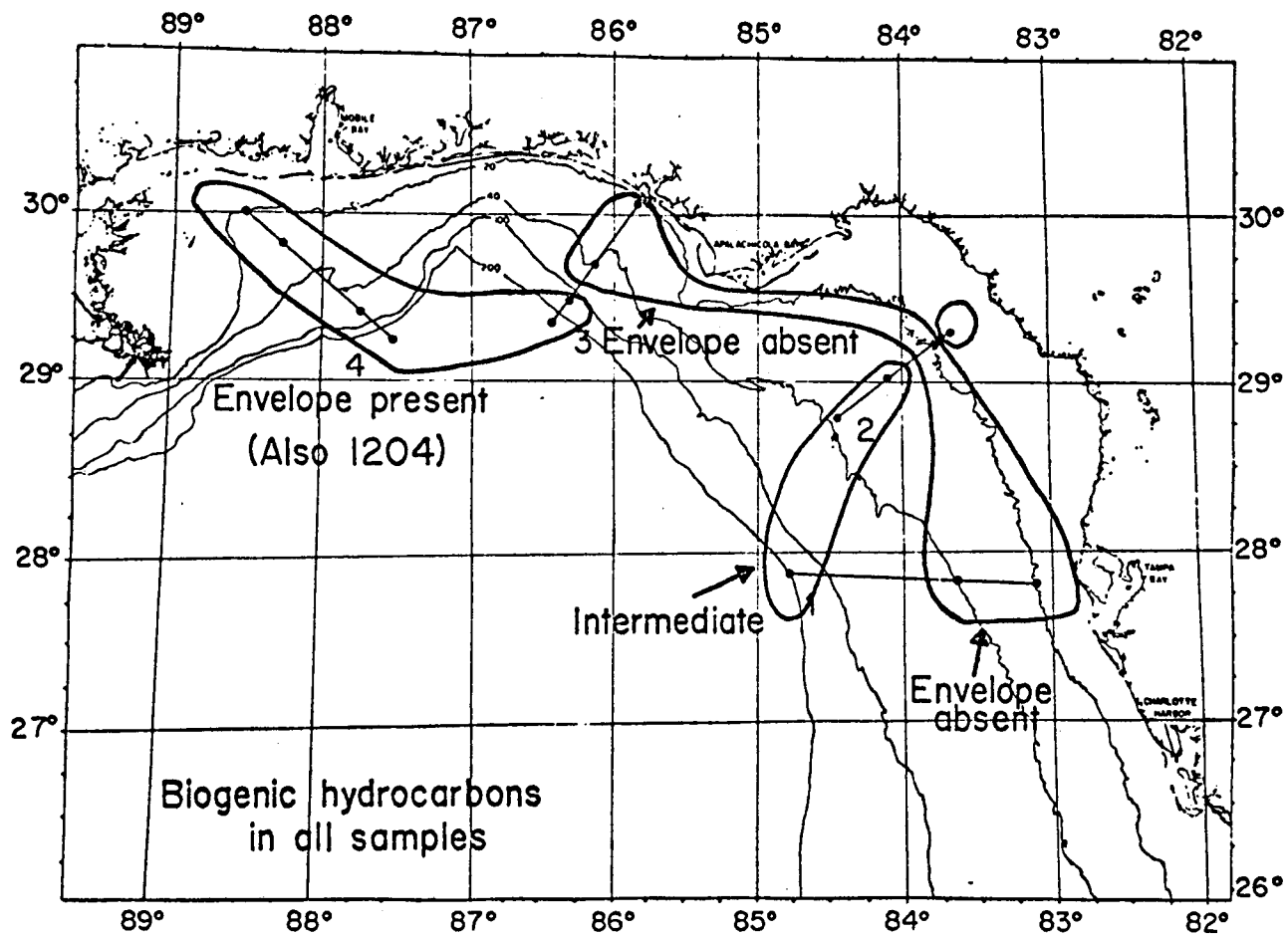

Figure 5a

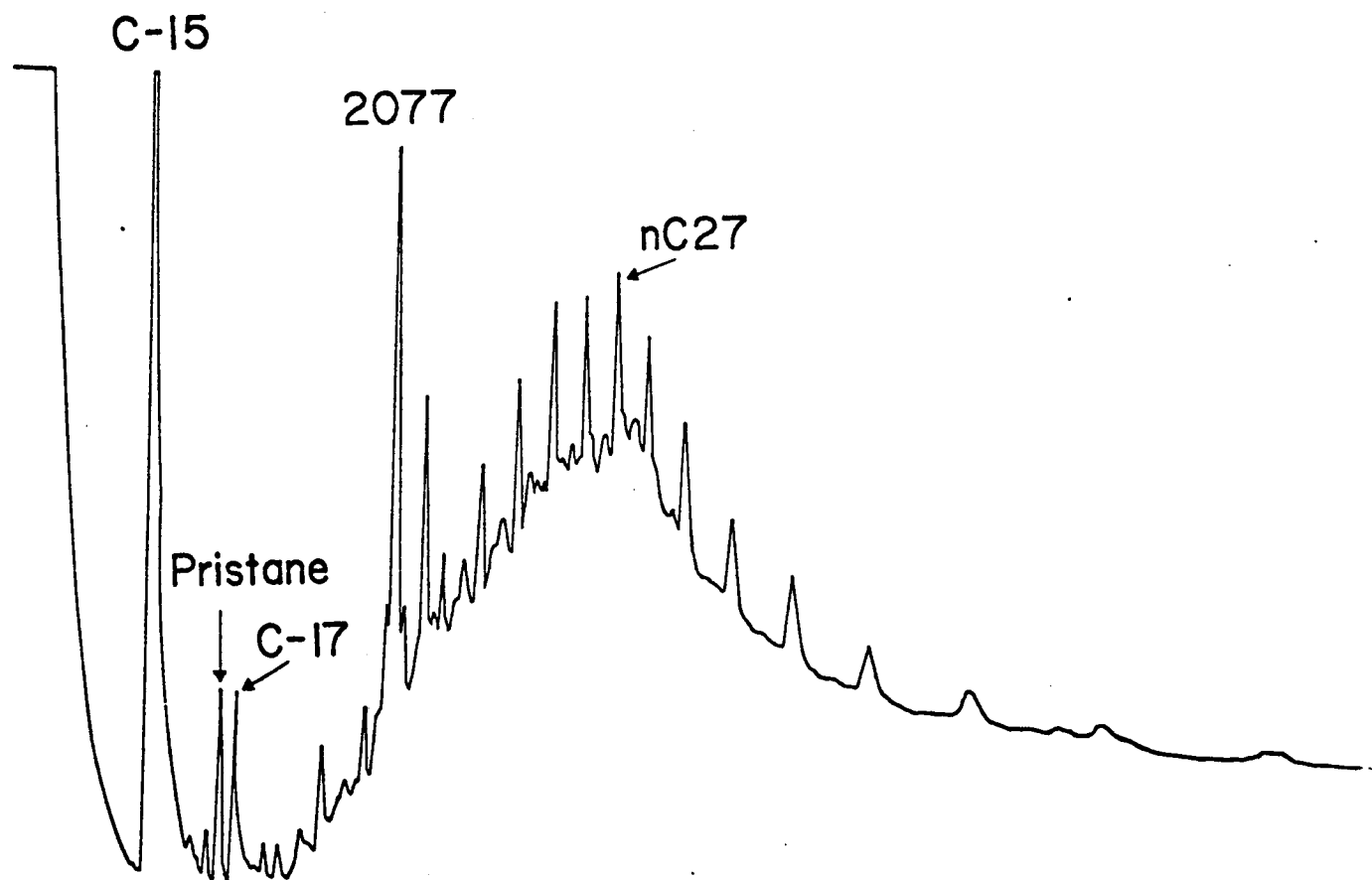

Figure 5b

18 mg dry weight/m<sup>3</sup> in fall and 13 mg dry weight/m<sup>3</sup> in winter (Table 1). Total lipid content was nearly constant at 38-50 mg/g dry wt. The total hydrocarbon content (sum of all integratable peaks in both hexane and benzene fractions) averaged 212 µg/g dry wt. in summer, 135 µg/g dry wt. in fall and 719 µg/g dry wt. in winter. In laboratory studies, Lee, et al. (1971), determined that the total lipid content of a *Calanus* sp. was related to the concentration of phytoplankton carbon fed to it. At 100 g of phytoplankton carbon per liter, the copepod contained 120 mg/g of total lipid. The lower total lipid in zooplankton from the MAFLA area may be a reflection of a low standing stock of phytoplankton. The concentration of Chlorophyll a averaged less than 0.5 µg/l (Iverson, 1976) and concentration of POC averaged less than 200 µg/l (Knauer, 1976) during the three sampling periods.

Visual inspection of chromatograms from summer 1975 indicated that the zooplankton hydrocarbons fell into three compositional patterns, which were differentiated primarily by the unsaturated/aromatic fraction. The same groupings recurred in fall and winter. The first group, A (Figure 2), is characterized by high concentrations of pristane and variable amounts of n-alkanes in the C<sub>21</sub>-C<sub>32</sub> region. (Blumer, et al., 1963). The higher n-alkanes are generally not as abundant as in this sample. Two peaks with retention indices of 1950 and 1976 appear frequently. These may be the phytadienes originally reported by Blumer and Thomas (1965). The benzene fraction of group A samples contained a group of peaks with retention indices from 2000 to 3200. There was considerable variation in the composition from station to station and season to season but the retention index range mentioned above was not exceeded. The concentration of total hydrocarbon

TABLE 1: Gravimetric Data - Seasonal

	<u>Summer</u>	<u>Fall</u>	<u>Winter</u>
Zooplankton Biomass mg dry wt./m <sup>3</sup>	91	18	13
Total lipid extract mg/g dry wt.	49.9	37.7	49.8
Total hydrocarbon µg/g dry wt.	212	135	719
Total hydrocarbon µg/m <sup>3</sup>	19.3	2.4	9.4

Fig. 2 Zooplankton hydrocarbons, Group A

- A. Station 1102, hexane fraction, summer 1975
- B. Station 1102, benzene fraction, summer 1975
- C. Station 1415, benzene fraction, fall 1975
- D. Station 1102, benzene fraction, winter 1976

Fig. 2A

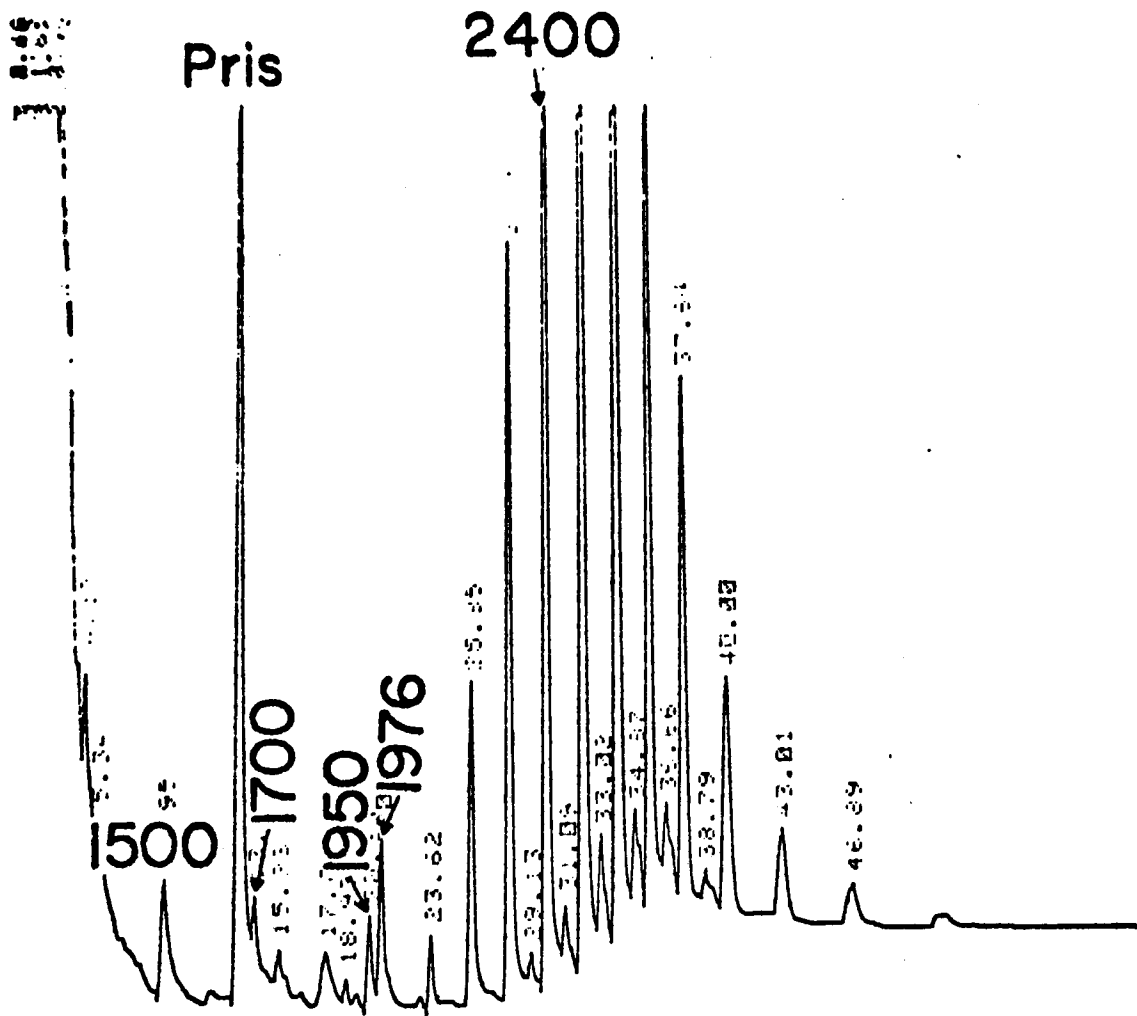
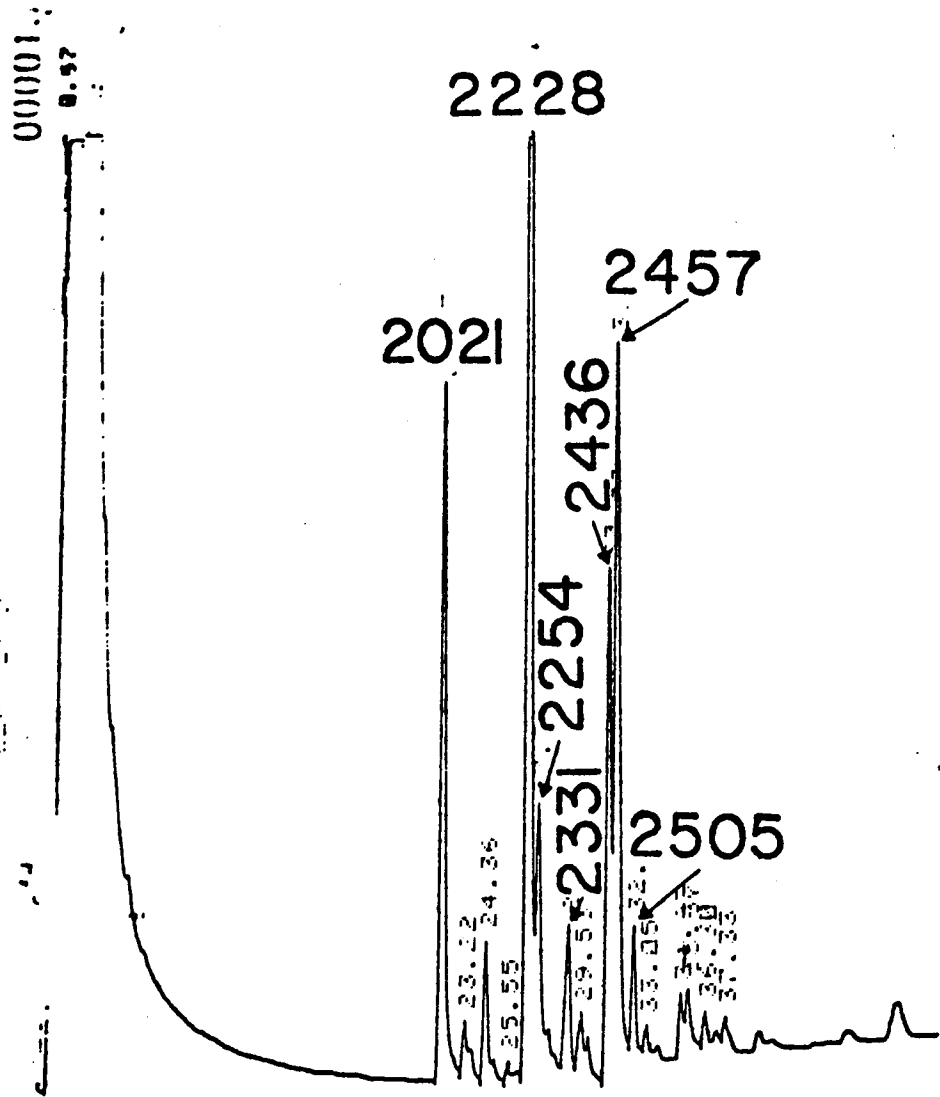

Fig 2B



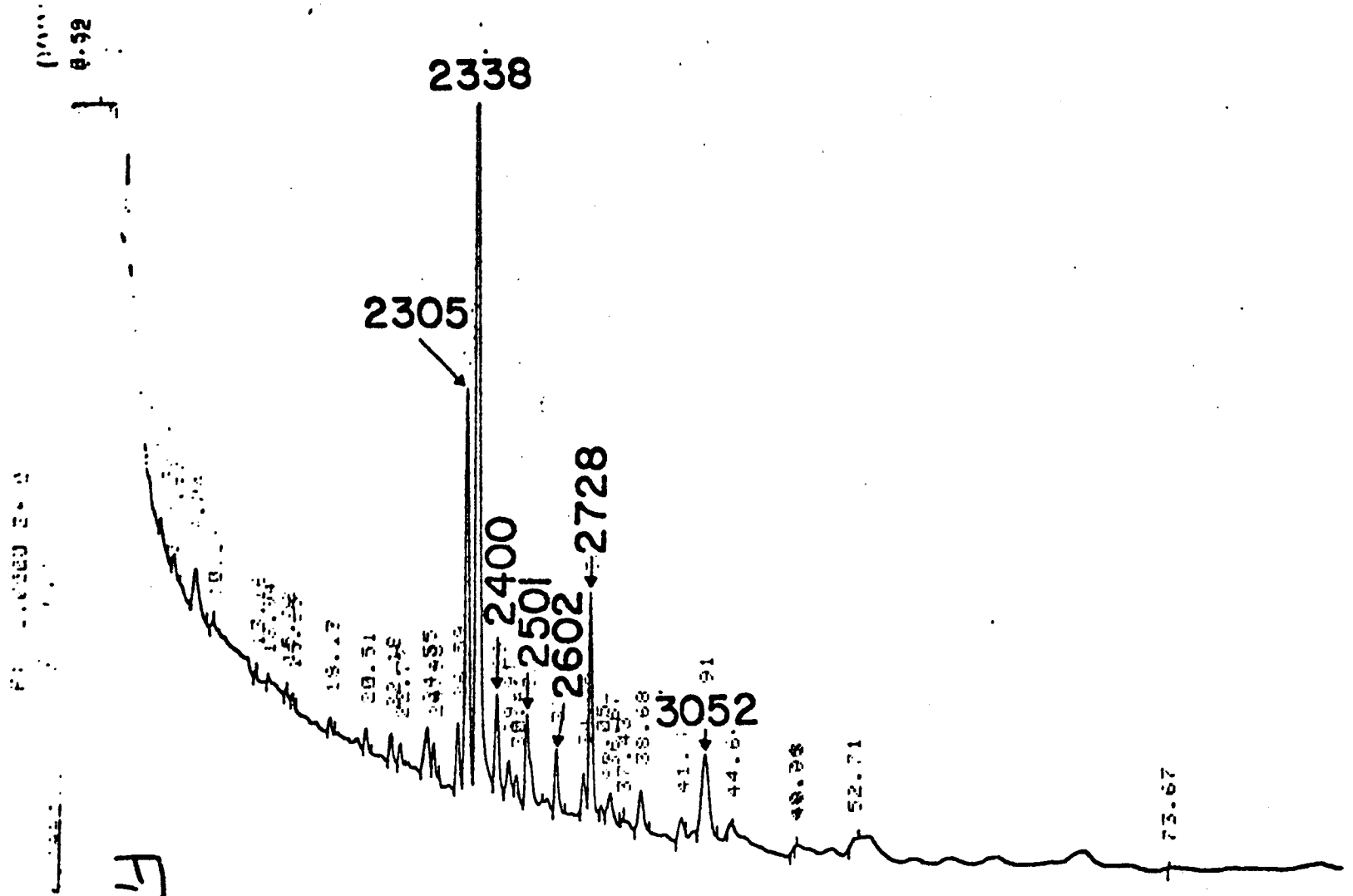

Fig. 2c



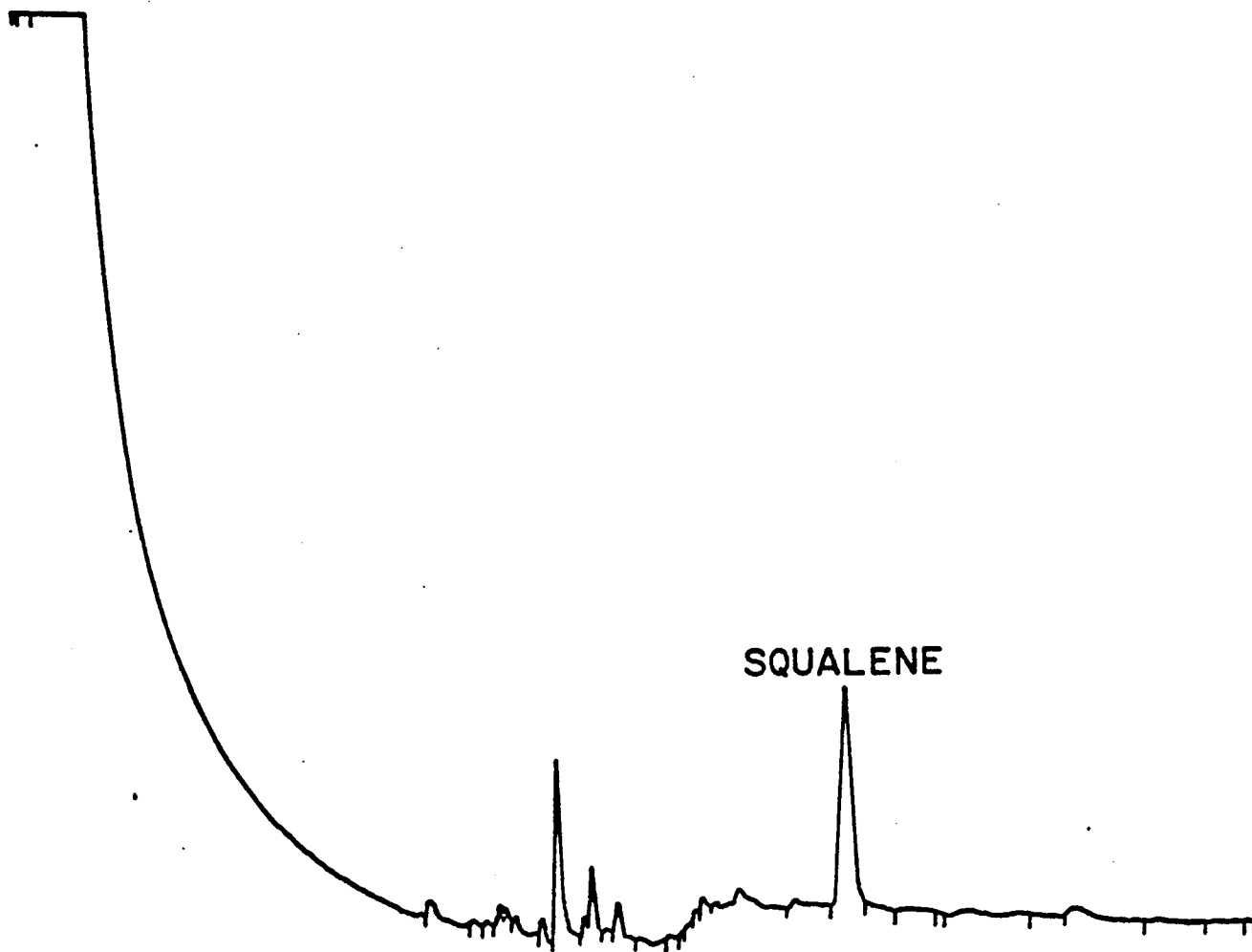

Figure 5c

Figure 6a. Particulate hydrocarbon distribution, fall 1975.

6b. Station 4, aliphatic fraction, particulate hydrocarbons,  
fall, 1975.

6c. Station 3, aliphatic fraction, particulate hydrocarbons,  
fall 1975.

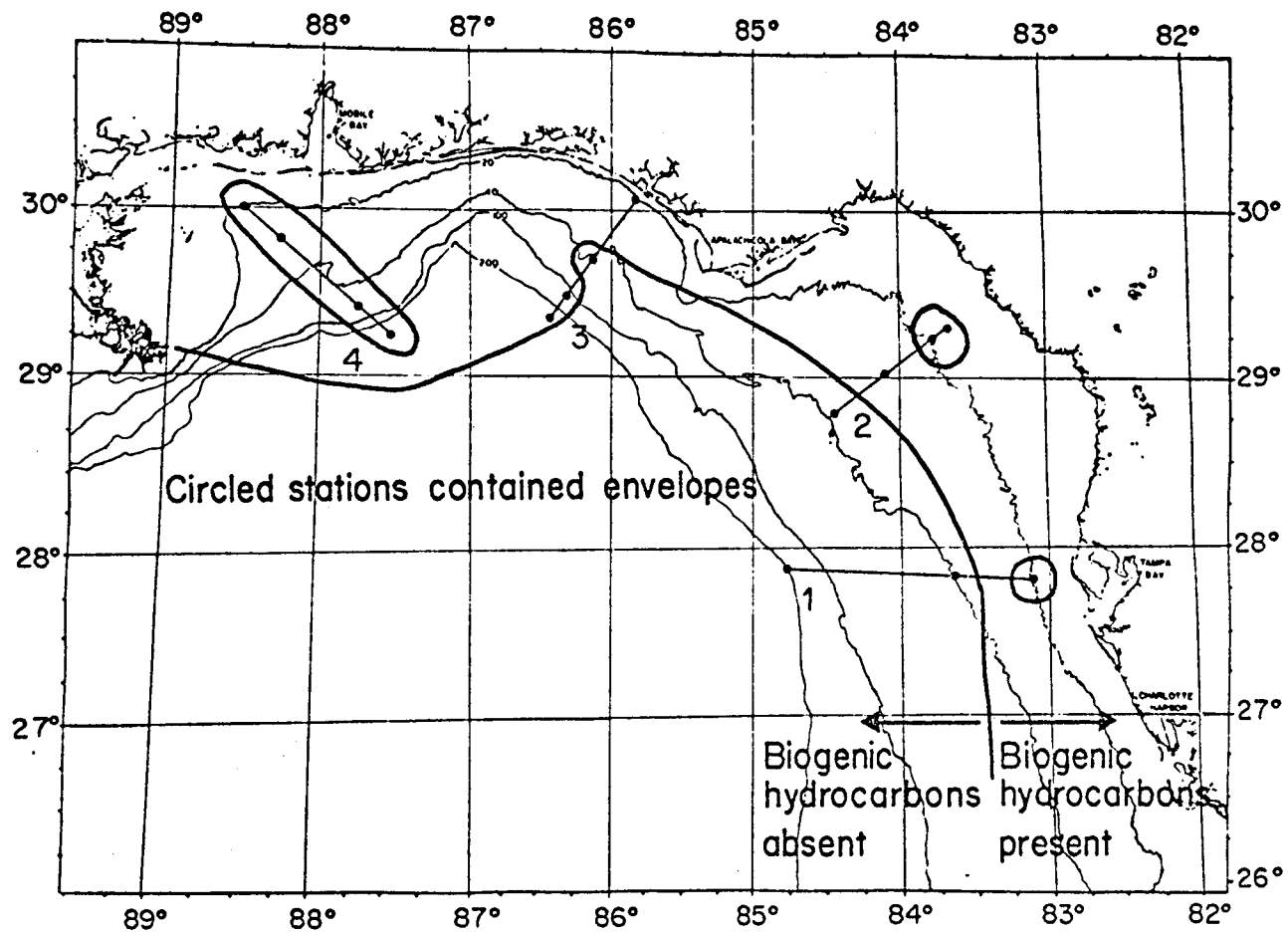

Figure 6a

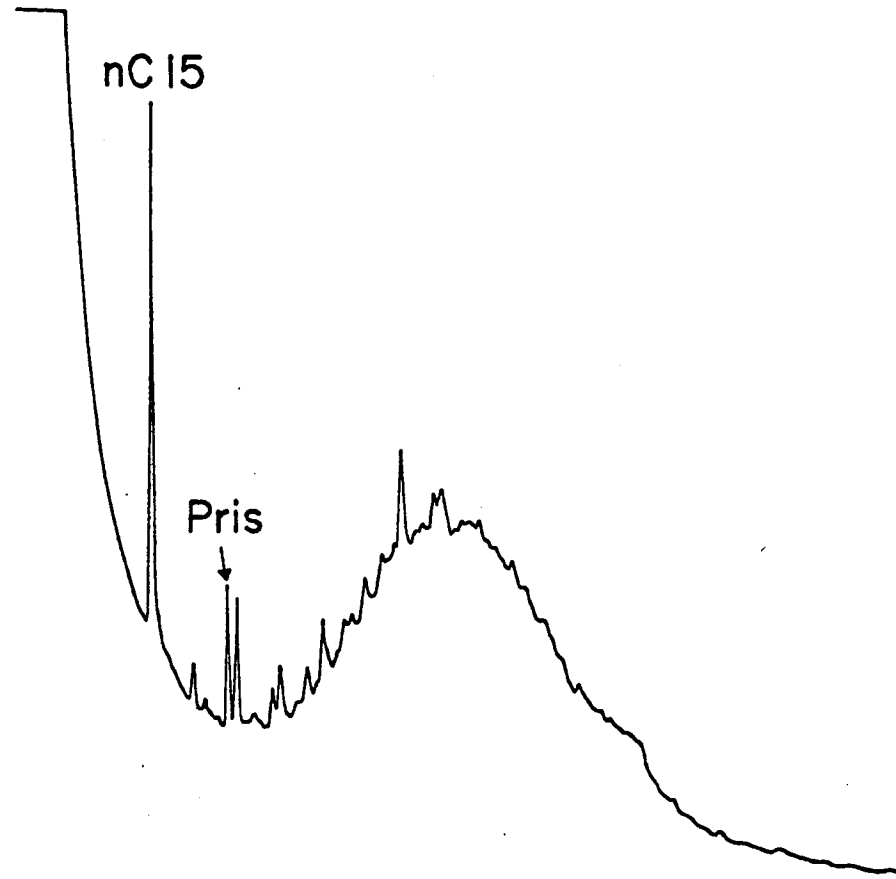

Figure 6b

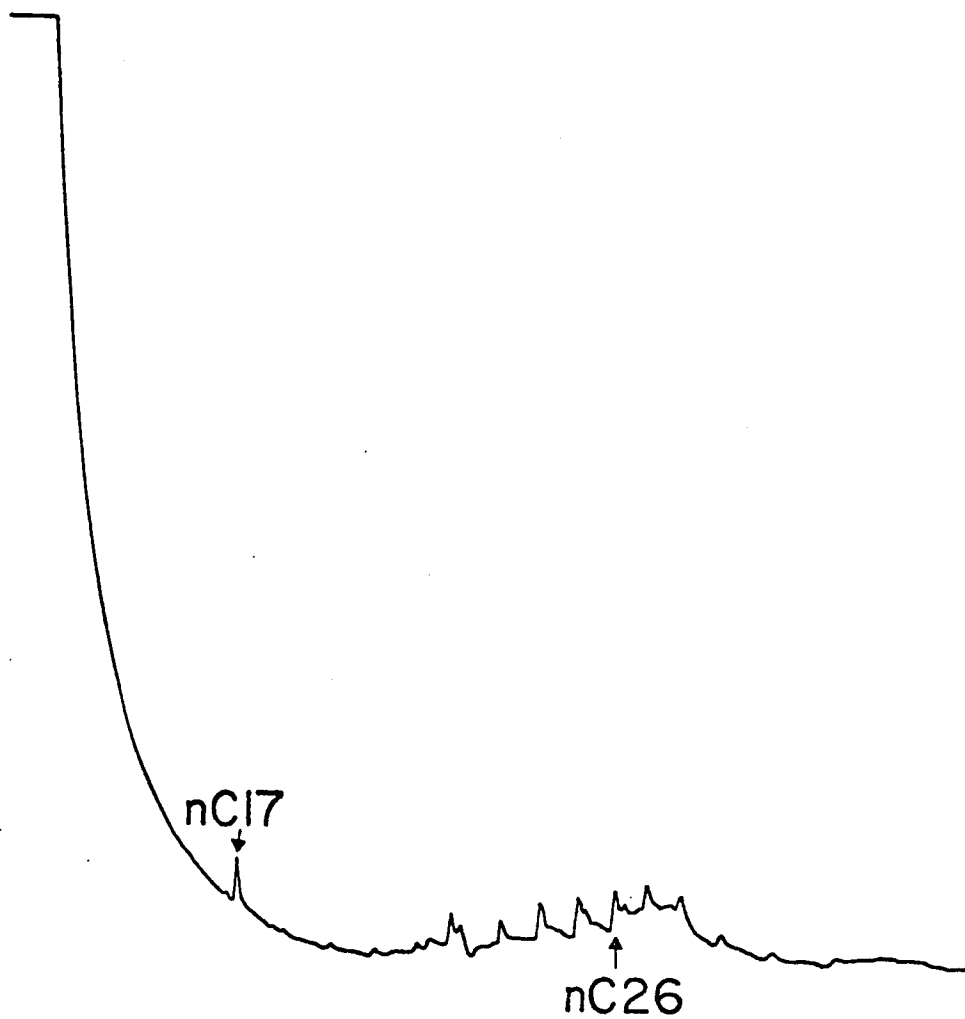

Figure 6c

Figure 7. Particulate hydrocarbon distribution, winter 1976.

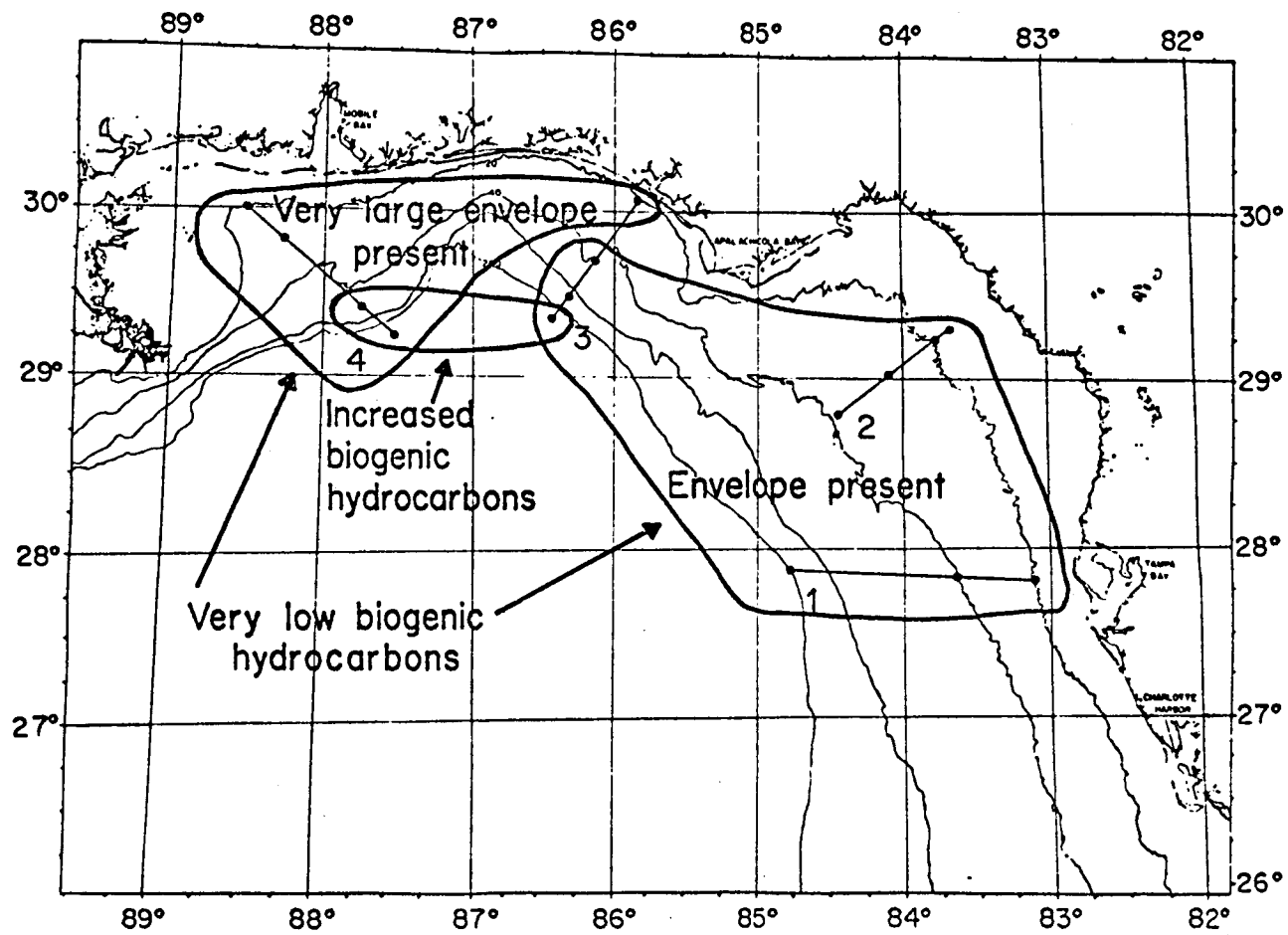

Figure 7

HYDROCARBONS FROM ZOOPLANKTON OF THE EASTERN GULF OF MEXICO

Florida State University, Department of Oceanography

Principal Investigator:  
John A. Calder



## INTRODUCTION

The sale of oil and gas leases along the entire U. S. outer-continental shelf (OCS) and heightened public awareness of the potential harmful impact of petroleum-related activities, resulted in the initiation of environmental baseline and monitoring studies in the lease areas, under the sponsorship of the U. S. Department of Interior, Bureau of Land Management. The first of these studies was the MAFLA (Mississippi-Alabama-Florida) program in the northeast Gulf of Mexico. To date, four sets of seasonal samples have been collected and analyzed, the last three of which were identical with regard to locations, measurements and techniques. My laboratory participated in the program by analyzing for hydrocarbons in water, suspended particulates, neuston and zooplankton. The latter samples are the subject of this report.

## METHODS

Zooplankton were collected by oblique tows using 0.5 m, 202  $\mu$ m nets with 5:1 length to width ratio. The zooplankton were removed from the cod end (without washing the net), placed in glass vials with Teflon-lined caps and frozen. In the laboratory, samples were thawed and foreign material was removed under a 30 power dissecting microscope. A known weight of oven dried (50°C) samples was refluxed in a 1:1 mixture of benzene and methanolic KOH for four hours.

The mixture was then filtered through pre-combusted Whatman GF/F filters to remove debris and the benzene layer was removed from the filtrate following addition of one part of distilled water. After two additional extractions of the aqueous phase with benzene, the extract was reduced to

dryness and weighed. The residue was taken up in hexane and applied to a prewashed alumina/silica gel column (1:5 v/v ratio, activity one) and eluted with two column volumes of hexane (saturated or non-polar hydrocarbon fraction) and two column volumes of benzene (unsaturated/aromatic or polar hydrocarbon fraction). The hexane fraction was reduced to small volume and the benzene fraction dried and taken up in a small volume of hexane for gas chromatographic (GC) analysis.

Primary GC analysis was done with 2.2 mm I.D. x 2 m stainless steel columns packed with 4% FFAP on Gas Chrom Z, 80/100 mesh. Retention times were converted to retention indices utilizing known standards of n-alkanes. Peak areas were automatically integrated and converted to weight by applying GC response factors calculated from quantitative normal and isoprenoid alkanes and aromatics. These calculations as well as calculations of peak ratios, odd-even preference, wt. % composition and concentration were done by a computer program which produced both paper and magnetic tape output for submission to a central data bank.

Glassware was washed in detergent, soaked in acid, rinsed with distilled water and oven dried. Solvents were doubly distilled. Periodic blanks were run and rejected if material with retention index greater than 1200 was present.

#### RESULTS AND DISCUSSION

A series of 15 stations along four transects in the MAFLA area (Figure 1) were sampled in June/July 1975, September 1975 and January/February 1976. The zooplankton biomass collected averaged 91 mg dry weight/m<sup>3</sup> in summer,

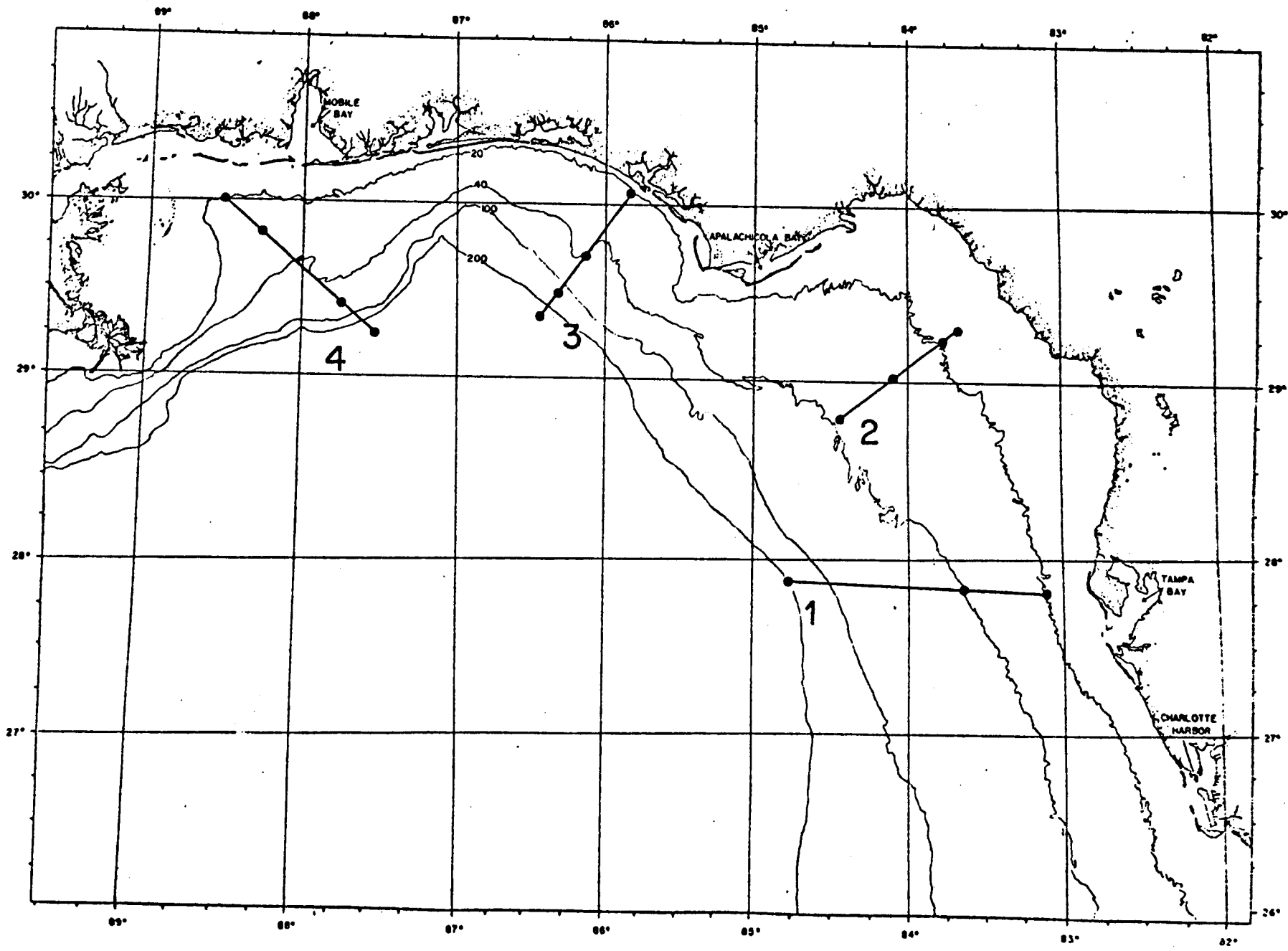
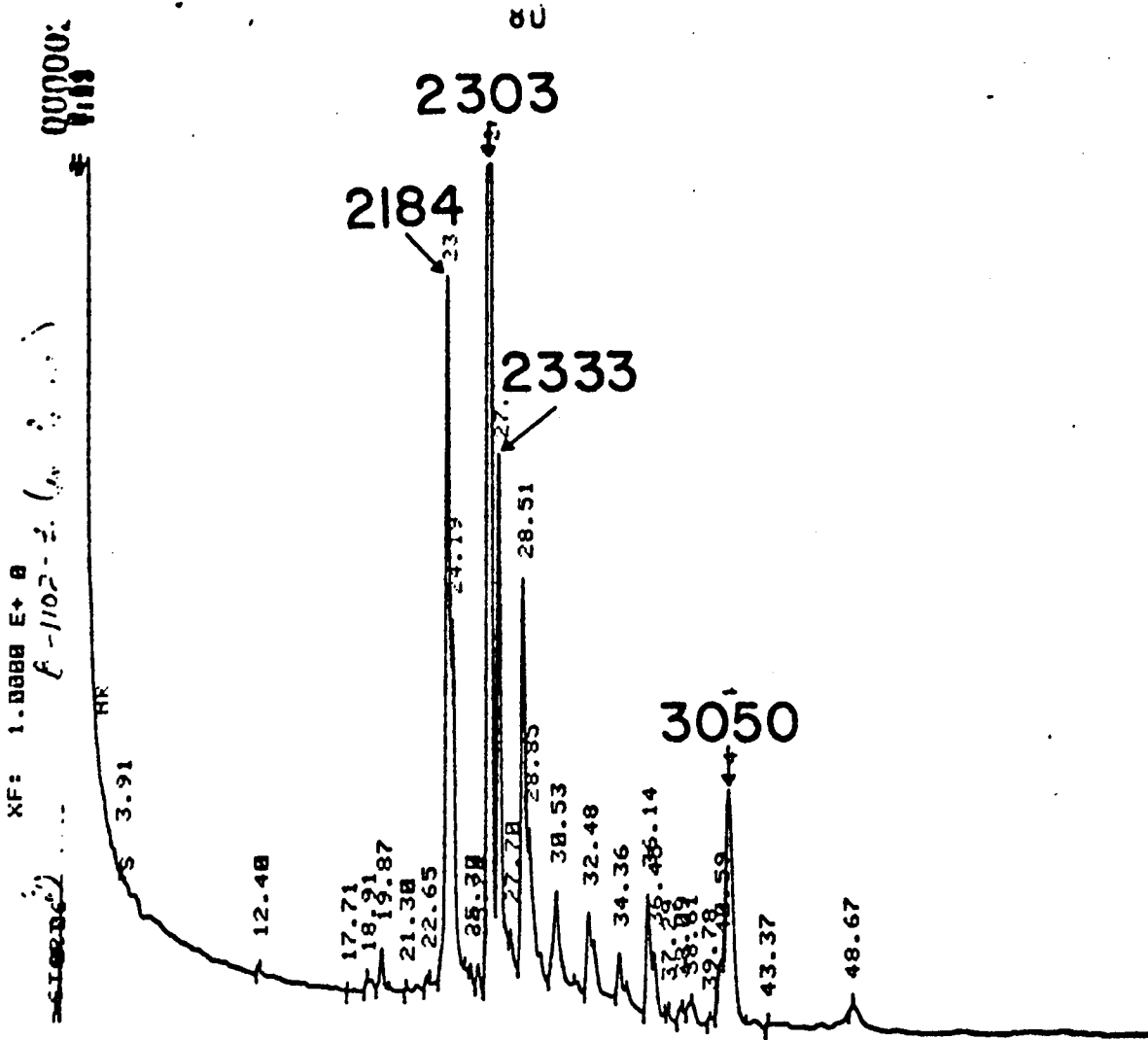

Fig. 1 Transect and station locations in the MAFLA area

Fig 2D



averaged 250  $\mu\text{g/g}$  dry wt. A peak in the benzene fraction at RI  $\sim 3055$  corresponds to squalene (Blumer, 1967). This peak has at least one other component which is resolved from squalene on a non-polar column (SP2100).

The second group, B (Figure 3) contained very low amounts of hydrocarbons, primarily pristane in the hexane fraction and a peak at RI=2350 in the benzene fraction. The total hydrocarbon content averaged 29  $\mu\text{g/g}$  dry wt.

The last group, C (Figure 4), is most interesting. The hexane fractions were much like those of group B, containing pristane and little else. The benzene fractions contained a group of peaks in the 2000-3200 retention index range although they were generally fewer in number and lower in concentration than those in Group A. The interesting feature is the group of peaks with retention index 3400 and greater, to an estimated 4000. The same peaks seem to be recurring in this RI range; a pair at 3415 and 3450, a pair at  $\sim 3600$  and a very large peak at  $\sim 3800$ . Total hydrocarbon content was 640  $\mu\text{g/g}$  dry wt. The higher retention index peaks in the benzene fraction account for the bulk of the total hydrocarbon weight. The identity of these components is still a subject of investigation.

The three zooplankton hydrocarbon groupings recurred in each of the three sampling periods. In summer (Figure 5) the C group was most abundant, occupying the offshore stations in Transects II, III and IV. The A group occurred in Transect I and two stations of Transect II while the B grouping was limited to the inshore stations of Transects II and IV. In fall (Figure 6) the B group was dominant and occupied all the inshore stations. The C group appeared offshore in Transects I and III, while the A group appeared only at the two outermost stations on Transect IV. In winter, (Figure 7) the B group was not

Fig. 3. Zooplankton hydrocarbons, Group B

A. Station 1205, hexane fraction, summer 1975

B. Station 1205, benzene fraction, summer 1975

Fig 3A

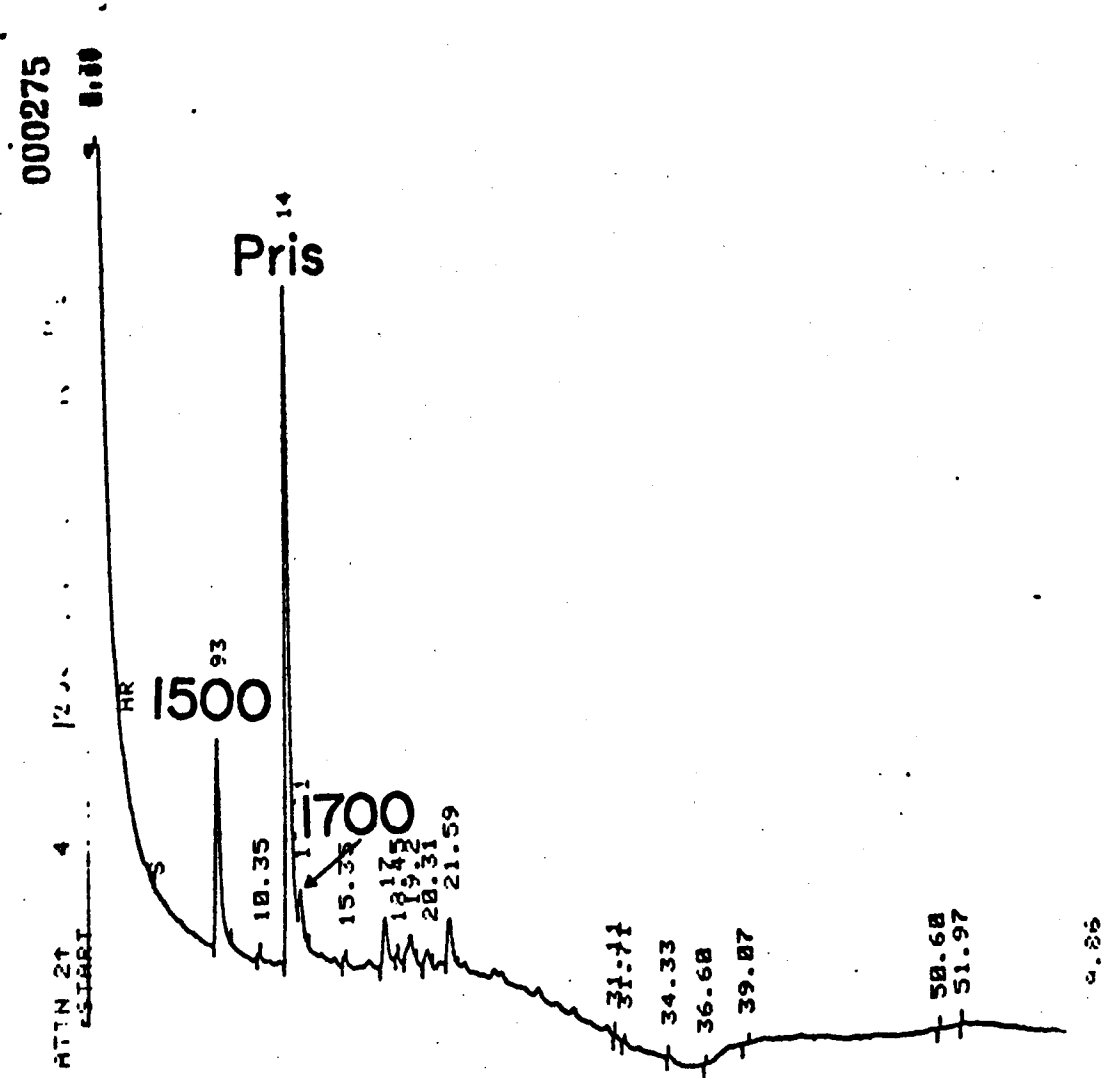
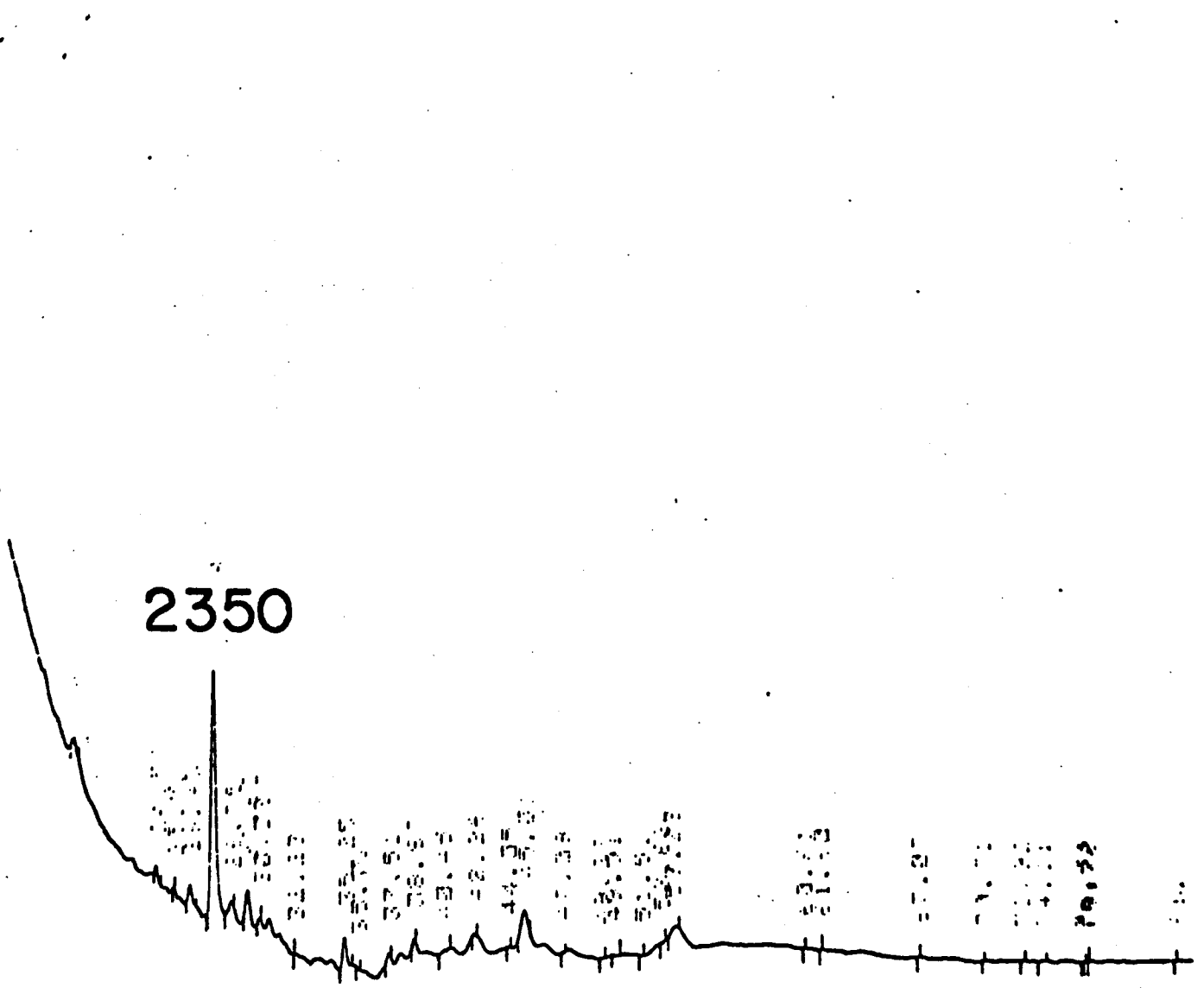

Fig. 3 B





- Fig. 4      Zooplankton hydrocarbons, Group C
- A. Station 1309, hexane fraction, winter 1976
  - B. Station 1415, benzene fraction, summer 1975
  - C. Station 1309, benzene fraction, fall 1975
  - D. Station 1309, benzene fraction, winter 1976

Fig 4 A

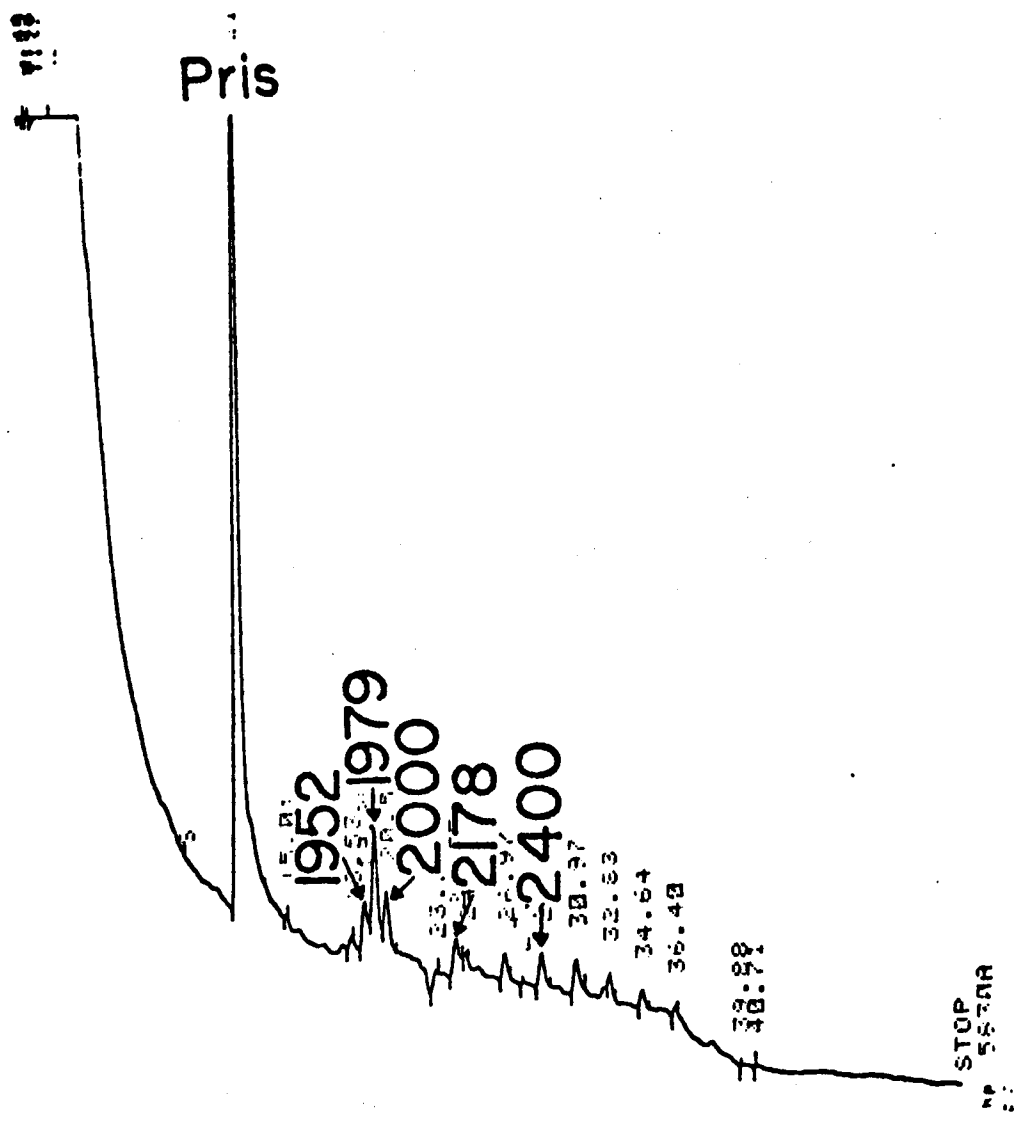

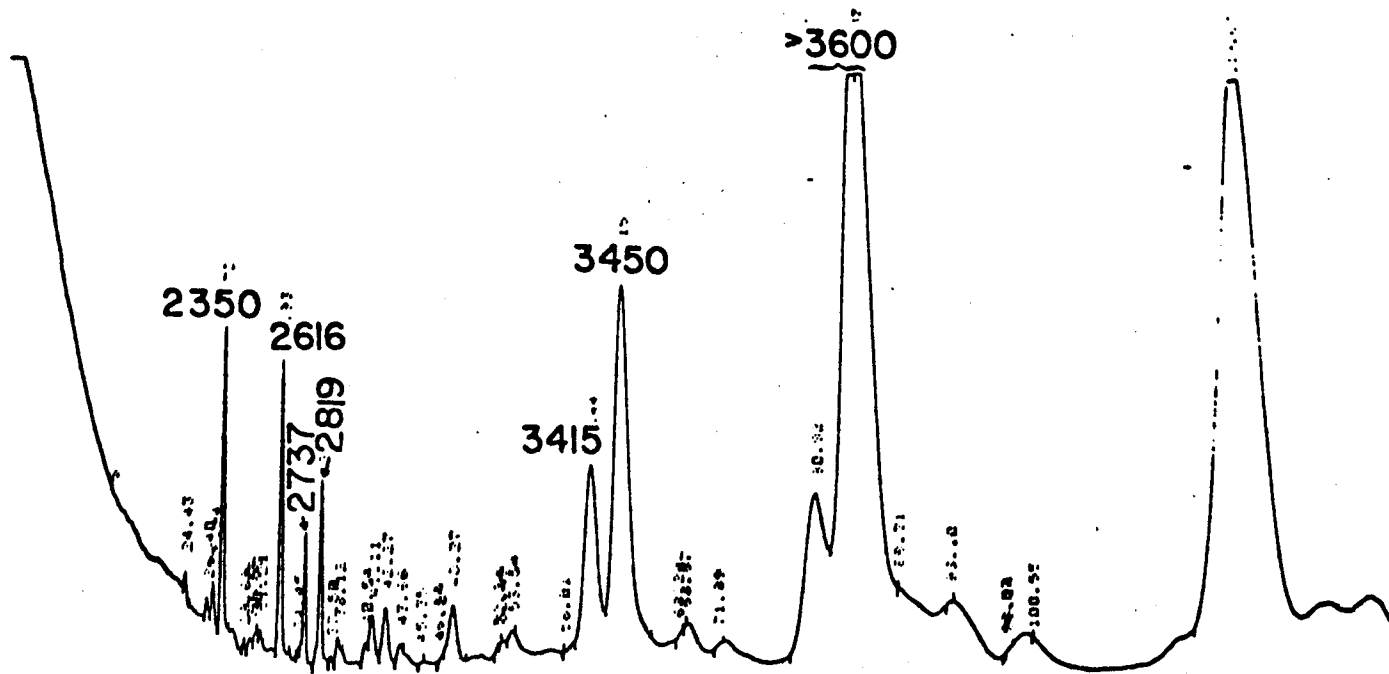

Fig. 4B

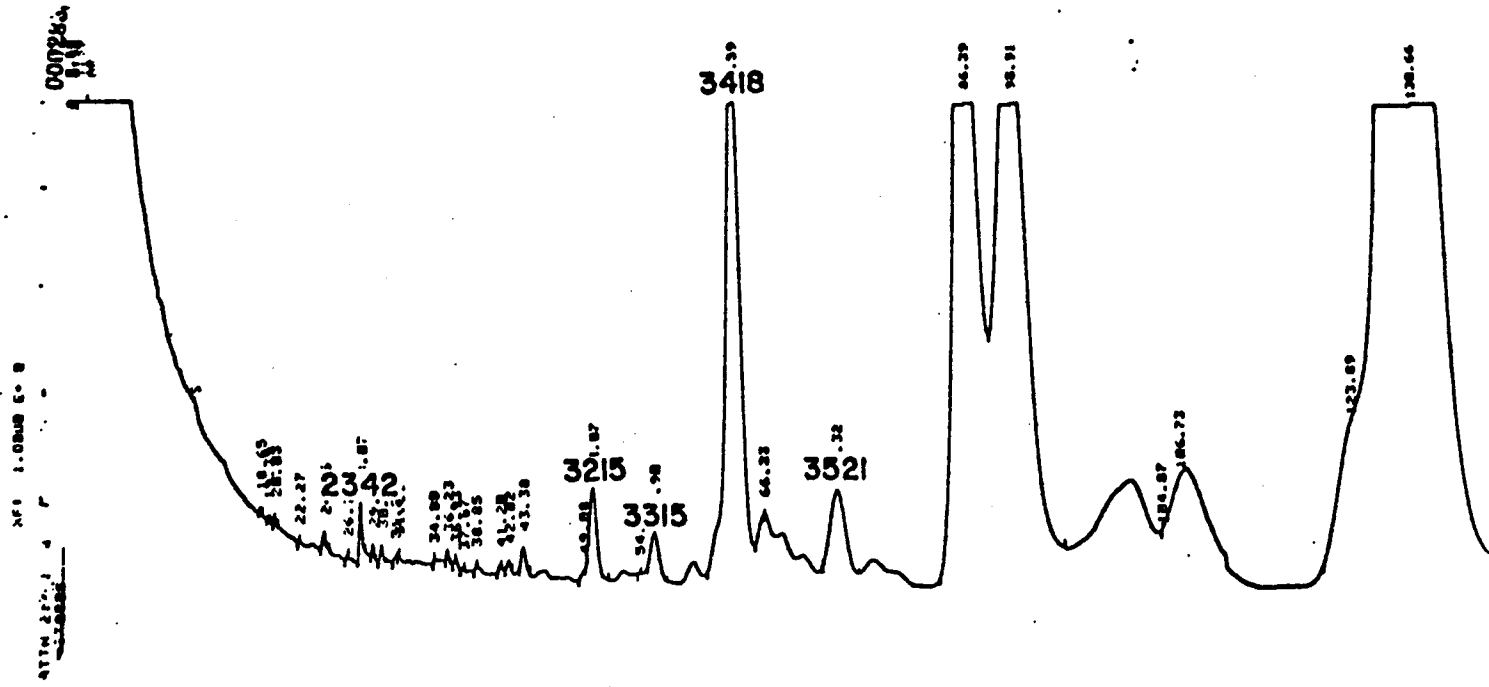

Fig. 4C

100

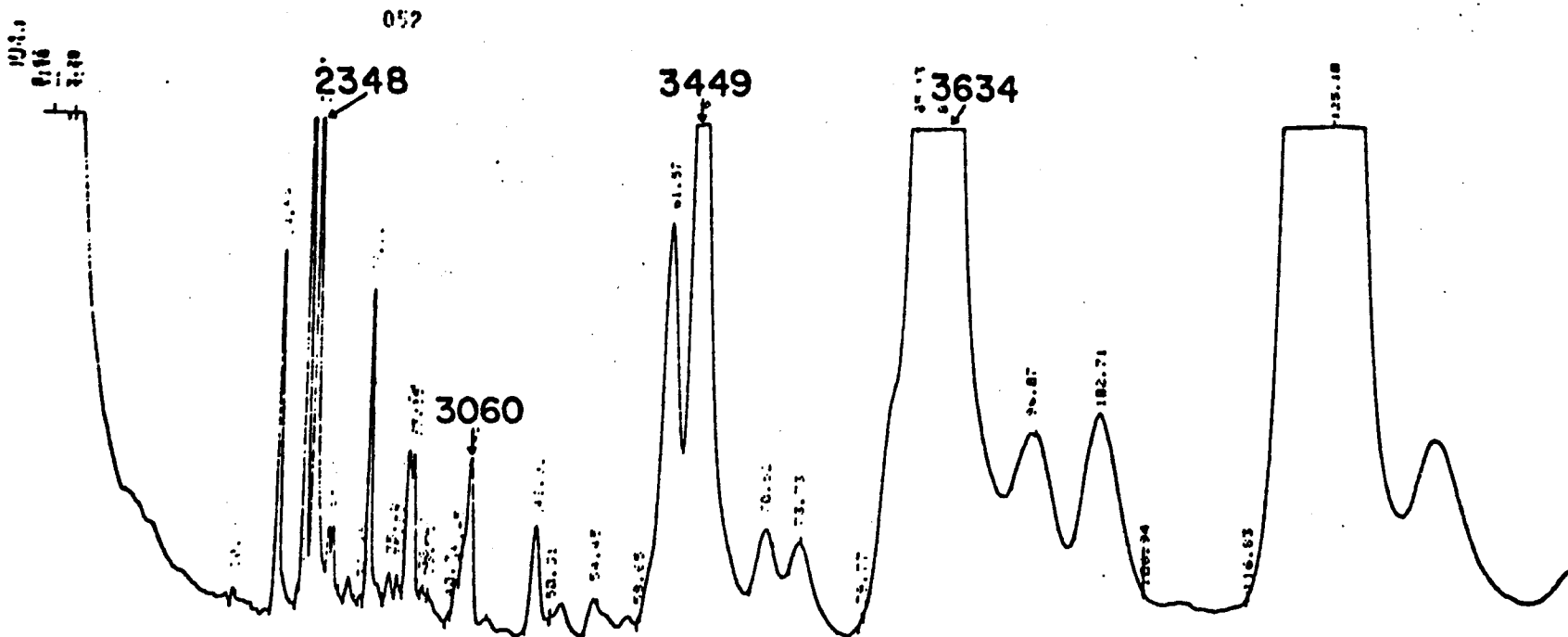

Fig. 4 D

Fig. 5 Zooplankton hydrocarbon group distribution, summer 1975

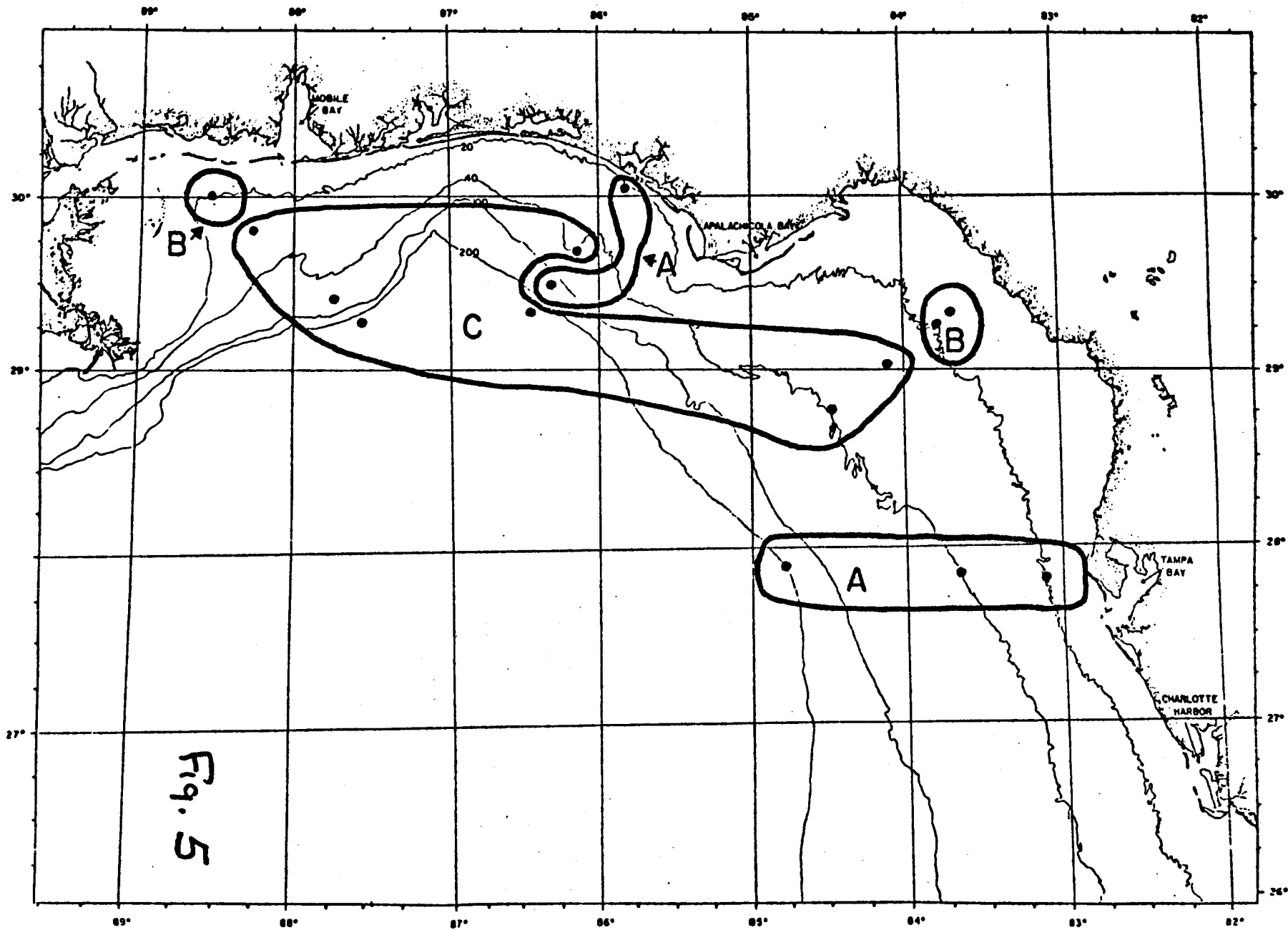

Fig. 6 Zooplankton hydrocarbon group distribution, fall 1975



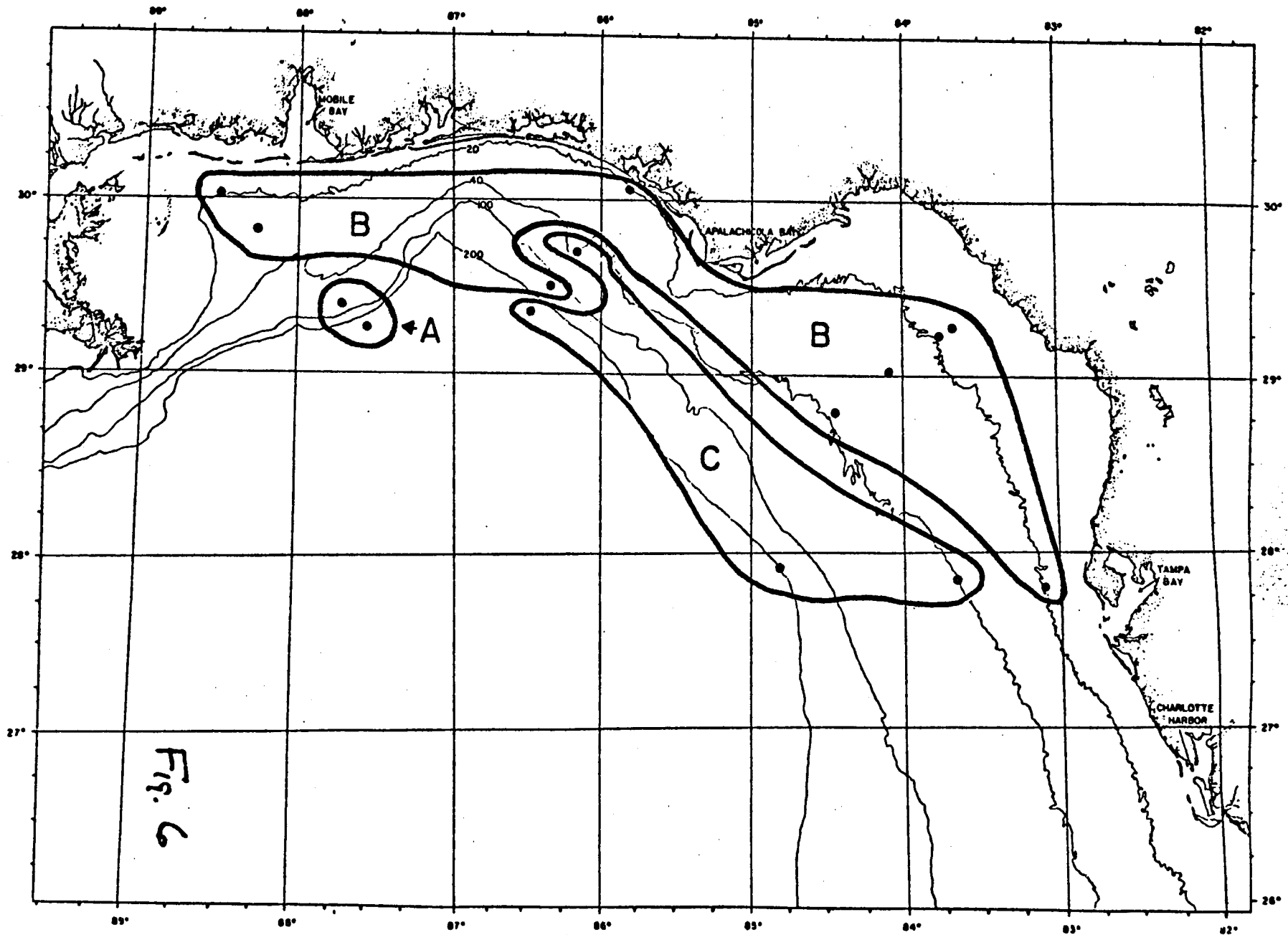
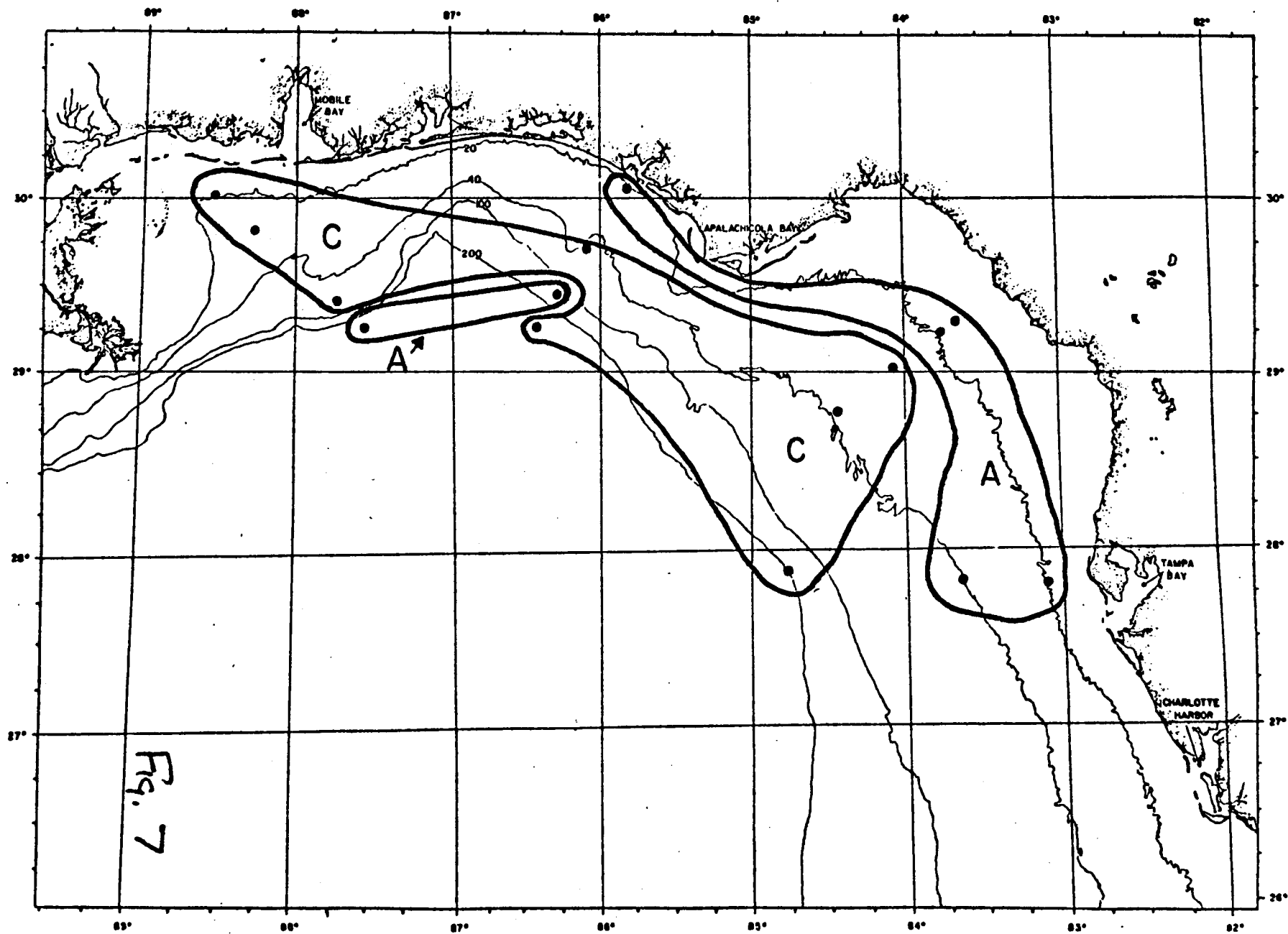

Fig. 7 Zooplankton hydrocarbon group distribution, winter 1976



present and the A group occupied the nearshore stations of Transects I, II and III as well as one offshore station on each of Transects III and IV. The C group occupied the nearshore stations of Transect IV, but was in its usual offshore spot on the other transects.

The three hydrocarbon compositions could be the result of three factors:

- a) different biosynthetic hydrocarbons from different zooplankton species
- b) different hydrocarbons taken up from different food sources or water masses
- c) different biosynthetic hydrocarbons resulting from environmental variation (e. g. temperature)

The taxonomy of the zooplankton was determined by Maturo and Caldwell (1976). A first level examination showed that the major zooplankton groupings occurred in nearly every sample at all seasons. Thus the hydrocarbons in the A and C group must be due to very lipid rich minor components of the zooplankton if taxonomic variation is responsible for observed hydrocarbon variations. This may be more likely than it first seems because the hydrocarbon extraction was done on a bulk zooplankton sample, while taxonomy was performed on a sample that had been split from seven to eleven times. The splitting could have diluted a minor yet lipid rich component.

Neither dissolved hydrocarbons nor those on suspended particulates bear any relation to the zooplankton hydrocarbons (Calder, 1976) and thus the zooplankton hydrocarbons do not appear to have been taken up from different external sources.

Because the C group was generally found offshore it came from waters

generally deeper, colder and more saline. Yet the inshore stations in winter were just as cold and saline as the offshore stations in summer (Rinkel, 1976) and contained the A, not the C group. Temperature and salinity variations do not seem to cause the zooplankton to alter their biosynthetic hydrocarbon content

Because the hydrocarbon groups do display spatial patterns, rather than random distribution, they must be the result of general circulation phenomena. Hydrocarbon analysis of the major zooplankton groups (e. g. copepods, jellies, etc) might be the best way of clarifying these observations.

Tar balls were ubiquitous in neuston samples and on rare occasion were found in a zooplankton sample. When seen they were removed before analysis. None of the zooplankton analyzed showed any evidence of either fresh or weathered petroleum. For comparison, Figure 8 shows the chromatogram of a contaminated neuston sample.

#### CONCLUSIONS

1. Zooplankton biomass in the MAFLA area is high in summer, low in fall and winter.
2. Total lipid did not vary with season, but total hydrocarbon was much higher in winter. Because of greater biomass the standing crop of zooplankton total hydrocarbons was greatest in summer.
3. The hydrocarbon composition fell into three groups, most definitively characterized by the benzene fraction. The same three groups recurred in each sampling season in spatial configurations which appear to be controlled by general circulation phenomena.

4. There was no evidence for fresh or weathered petroleum in zooplankton.

Fig. 8 Tar ball contaminated neuston sample

A. hexane fraction

B. benzene fraction

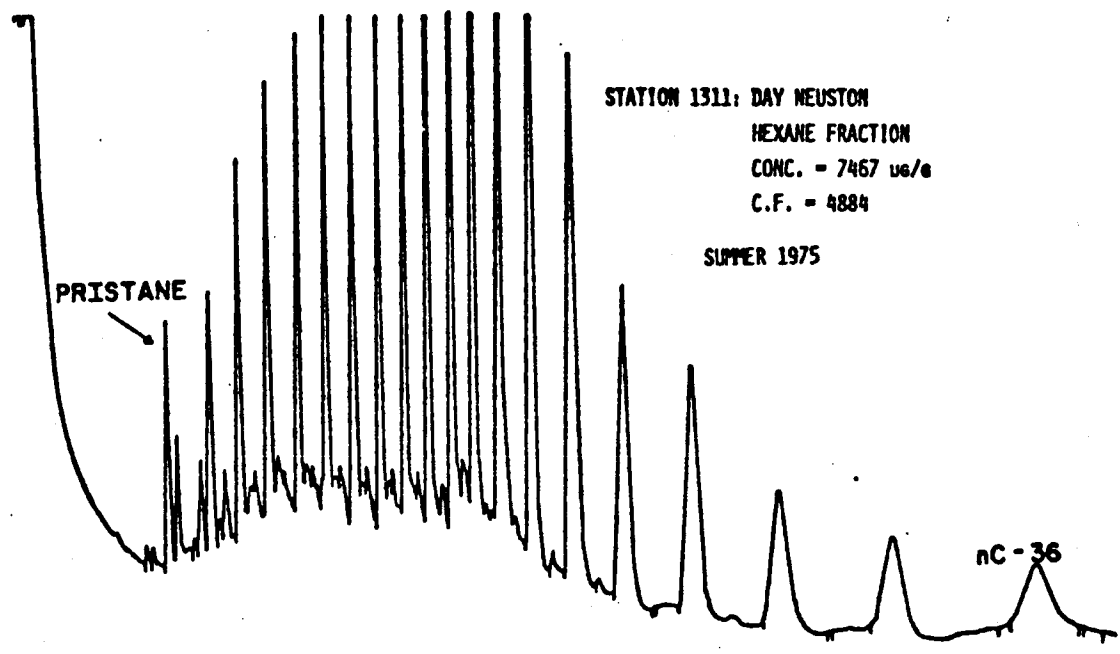

Fig 8A



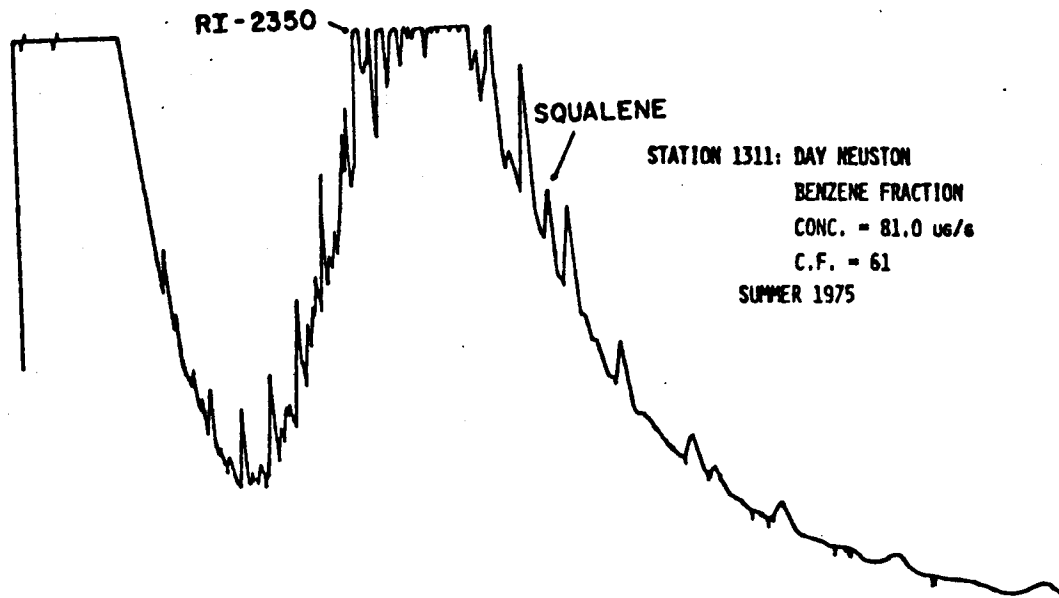

Fig 8B

ACKNOWLEDGEMENTS

This research was supported by the U. S. Dept. of Interior, Bureau of Land Management under contract number 08550-CT5-30. Excellent technical assistance was provided by L. Griffin, W. Teehan, S. Horlick, C. Byrne, D. Wynne, and D. Siebert.

REFERENCES

1. Blumer, M., Hydrocarbons in digestive tract and liver of a basking shark. *Science*, 156, 390-391 (1967).
2. Blumer, M. and D. W. Thomas, Phytadienes in zooplankton. *Science*, 147, 1148-1149 (1965).
3. Blumer, M., M. M. Mullin and D. W. Thomas., Pristane in zooplankton. *Science*, 140, 974 (1963).
4. Lee, R. F., J. C. Nevenzel and G. A. Paffenhofer., Importance of wax esters and other lipids in the marine food chain: phytoplankton and copepods. *Marine Biology*, 9, 99-108 (1971)
5. MAFLA Quarterly Reports, 1976.
  - A. Calder, J. A., Hydrocarbons in the water column of the MAFLA lease area.
  - B. Iverson, R. L., Phytoplankton productivity, chlorophyll and assimilation number.
  - C. Knauer, G. A., Dissolved and particulate organic carbon.
  - D. Maturo, F. and J. Caldwell, Taxonomy of zooplankton.
  - E. Rinkel, M., Salinity and temperature profiles.

RESULTS OF INTERCALIBRATION EXERCISES  
MAFLA PROGRAM, 1974-1976

John A. Calder  
Florida State University, Department of Oceanography

Julia S. Lytle and Thomas F. Lytle  
Gulf Coast Research Laboratory

Philip A. Meyers  
University of Michigan, Department of Atmospheric and Oceanic Science

During the 1974-75 contract, the four MAFLA investigators performing hydrocarbon analyses obtained samples of four American Petroleum Institute Reference Oils. These oils were separated into aliphatic and aromatic fractions by column chromatography and each fraction weighed. Each fraction was also analyzed by gas chromatography. The technique used for G. C. varied among the different laboratories and the G. C. results did not correlate well. Gravimetric analyses were generally reproducible both within a given lab and between the different laboratories. Two of the oils were analyzed in replicate (Table 1). As seen, the agreement within a given lab is good, often very good. Agreement between the labs is not as good as might be expected.

This exercise was repeated during the 75-76 contract (Tables 2-5). This time G. C. procedures were essentially identical and G. C. derived parameters are reported. As before, agreement within a lab is usually greater than agreement among the labs. Measurements involving ratios have better agreement both within and among labs than do the absolute weight and concentration measurements. Thus, one might expect that peak ratio measurements would be more useful than absolute measurements, both for determining regional differences and as long term trend monitors.

These oils are much richer in hydrocarbons than any environmental sample from a baseline program. Therefore, the most significant intercalibration exercise would be to exchange real environmental samples among the laboratories. To this end a Sargassum sample was distributed by the Lytles, a sea urchin extract by Meyers and a neuston sample by Calder. The results of the various analyses of these samples are reported in Tables 6-8.

The results are not as good as with the oils. As with the oils, the

Table 1 Gravimetric Intercalibration, 1974-1975

<u>Laboratory</u>	<u>Southern Louisiana Crude Oil</u>		<u>No. of Analyses</u>
	<u>Wt. % Aliphatic</u>	<u>Wt. % Aromatic</u>	
Calder	53.8 $\pm$ 1.4	17.8 $\pm$ 0.6	3
Lytle	58.1 $\pm$ 0.6	16.7 $\pm$ 0.7	2
Meyers	45.7 $\pm$ 1.5	9.05 $\pm$ .4	4
Pierce	38 $\pm$ 7	11 $\pm$ 4	3
Winters*	56	24	?
Average	50.3 $\pm$ 8.3	15.7 $\pm$ 5.9	
<u>Bunker C Residual</u>			
Calder	17.1 $\pm$ .8	42.6 $\pm$ 1.0	3
Lytle	21.4 $\pm$ .6	43.2 $\pm$ 1.9	2
Meyers	30.7	18.8	1
Pierce	21 $\pm$ 7	42 $\pm$ 5	3
Winters*	24	60	?
Average	22.8 $\pm$ 5.0	41.3 $\pm$ 14.7	

\* University of Texas, Port Aransas, Texas

Table 2 Southern Louisiana Crude Oil Intercalibration, 1975-76

<u>Gravimetric Analysis</u>	<u>Calder</u>	<u>Lytle</u>	<u>Meyers</u>
% Hexane Fraction	58.1 ± 4.1(3)	64.5 ± 3.4 (3)	----
% Benzene Fraction	15.7 ± 3.8	20.6 ± 0.8	----
% MeOH Fraction	3.9 ± 2.5	9.0 ± 2.3	----
<u>G.C. Derived*</u>			
Aliphatics mg/g	42.1 ± 6.0(3)	79 ± 7(3)	----
Aromatics mg/g	27.6 ± 15.0	23 ± 1	12.08 ± 2.73(3)
n-Alk mg/g	26.4 ± 4.5	44 ± 3	----
Pris/Phyt	1.9 ± 0.1(3)	1.8 ± 0.1(3)	1.8 ± 0.1(3)
Pris/nC <sub>17</sub>	0.79 ± 0.02	.92 ± 0.1	1.3 ± 0.1
Phyt/nC <sub>18</sub>	0.42 ± 0.03	.52 ± 0.1	0.8 ± 0.0
Pris + Phyt/ΣnAlk	.07 ± .00	.092 ± 0.01	0.18 ± 0.03
ΣnAlk/nC <sub>16</sub>	12.7 ± 0.2	15 ± 0	11.7 ± 3.4
o/e	0.87 ± .02	0.93 ± 0	1.12 ± 0.08
o/e ≤ nC <sub>20</sub>	0.83 ± .03	0.84 ± 0.2	1.21 ± 0.02
o/e ≥ nC <sub>21</sub>	1.06 ± 0.06	1.2 ± 0	0.89 ± 0.07
≤ nC <sub>20</sub> / ≥ nC <sub>21</sub>	3.8 ± 0.3	2.3 ± 0.1	5.4 ± 3.2

\* G.C. data presented in Tables 2-8 were obtained using 1/8" packed columns with FFAP liquid phase. Exact operating conditions varied.

Table 3 Bunker C Residual Intercalibration, 1975-76

<u>Gravimetric Analysis</u>	<u>Calder</u>	<u>Lytle</u>	<u>Meyers</u>
% Hex	20.29 (1)	25.7 $\pm$ 3.2(3)	----
% Benz	47.52	60.2 $\pm$ 5.9	----
% MeOH	12.00	14.6 $\pm$ 3.9	----
<u>G.C. Derived</u>			
Aliph mg/g	15.98(1)	23.67 $\pm$ 3.51	----
Arom mg/g	82.75	110.67 $\pm$ 20.21	78.20 (1)
nAlk mg/g	10.74	15.0 $\pm$ 1.73	----
Pris/Phyt	1.34	1.57 $\pm$ 0.06	1.61 (1)
Pris/nC <sub>17</sub>	0.60	0.66 $\pm$ .02	1.04
Phyt/nC <sub>18</sub>	0.37	.40 $\pm$ .01	0.69
Pris + Phyt/ $\Sigma$ nAlk	0.05	.08 $\pm$ .02	.15
$\Sigma$ nAlk/nC <sub>16</sub>	20.27	18.67 $\pm$ 1.53	12.49
o/e	.89	1.02 $\pm$ .07	.97
o/e $\leq$ nC <sub>20</sub>	.78	.84 $\pm$ .01	1.15
o/e $\geq$ nC <sub>21</sub>	1.04	1.2 $\pm$ 0.1	0.8
$\leq$ nC <sub>20</sub> / $\geq$ nC <sub>21</sub>	1.3	1.3 $\pm$ 0.1	1.35



Table 4 Kuwait Crude Oil Intercalibration, 1975-76

<u>Gravimetric Analysis</u>	<u>Calder</u>	<u>Lytle</u>	<u>Meyers</u>
% Hex	35.85 (1)	43.53 $\pm$ 4.0(3)	----
% Benz	31.73	36.77 $\pm$ 1.18	----
% MeOH	3.36	15.37 $\pm$ 5.65	----
<u>G.C. Derived</u>			
Aliph mg/g	31.58	70.0 $\pm$ 0(3)	----
Arom mg/g	11.64	12.0 $\pm$ 1.0	7.4 (1)
nAlk mg/g	21.60	32.67 $\pm$ 2.08	----
Pris/Phyt	1.10	0.61 $\pm$ 0	1.21 (1)
Pris/nC17	0.35	.18 $\pm$ 0	0.54
Phyt/nC18	0.27	.29 $\pm$ .1	0.52
Pris + Phyt/ $\Sigma$ nAlk	.03	.04 $\pm$ 0	0.09
$\Sigma$ nAlk/nC <sub>16</sub>	13.9	11.3 $\pm$ 1.5	9.64
o/e	.85	1.1 $\pm$ 0	.99
o/e $\leq$ nC <sub>20</sub>	.80	1.1 $\pm$ 0	1.12
o/e $\geq$ nC <sub>21</sub>	1.05	1.1 $\pm$ 0	0.89
$\leq$ nC <sub>20</sub> / $\geq$ nC <sub>21</sub>	3.13	1.3 $\pm$ 0	3.02

Table 5 No. 2 Fuel Oil Intercalibration, 1975-76

<u>Gravimetric Analysis</u>	<u>Calder</u>	<u>Lytle</u>	<u>Meyers</u>
% Hex	51.77 $\pm$ 2.34 (3)	67.13 $\pm$ 2.45	----
% Benz	30.21 $\pm$ 1.00	26.94 $\pm$ 3.35	----
% MeOH	7.80 $\pm$ 1.34	6.23 $\pm$ 3.97	----
<u>G.C. Derived</u>			
Aliph mg/g	192.7 $\pm$ 107.4(3)	114.3 $\pm$ 16.6(3)	----
Arom mg/g	82.8 $\pm$ 13.4	143.7 $\pm$ 67.7	138.9 $\pm$ 8.9 (3)
nAlk mg/g	88.9 $\pm$ 44.6	58.3 $\pm$ 8.5	----
Pris/Phyt	3.09 $\pm$ .8	2.07 $\pm$ 0.4	1.63 $\pm$ .08
Pris/nC <sub>17</sub>	1.02 $\pm$ .2	.69 $\pm$ .12	1.21 $\pm$ .02
Phyt/nC <sub>18</sub>	.43 $\pm$ .1	.35 $\pm$ .06	.81 $\pm$ .02
Pris + Phyt/ $\Sigma$ nAlk	.11 $\pm$ .00	.09 $\pm$ .01	.27 $\pm$ .02
$\Sigma$ nAlk/nC <sub>16</sub>	9.22 $\pm$ .95	9.67 $\pm$ 1.17	8.02 $\pm$ .78
o/e	1.07 $\pm$ .24	0.97 $\pm$ .03	0.93 $\pm$ .11
o/e < nC <sub>20</sub>	1.04 $\pm$ .26	0.90 $\pm$ .05	1.11 $\pm$ .04
o/e > nC <sub>21</sub>	1.60 $\pm$ .46	2.57 $\pm$ 0.4	1.27 $\pm$ .74
< nC <sub>20</sub> /> nC <sub>21</sub>	14.19 $\pm$ 5.26	11.0 $\pm$ 0	9.7 $\pm$ 10.6

Table 6 Sea Urchin Intercalibration, 1975-76

	<u>Calder</u>	<u>Lytle</u>	<u>Meyers*</u>
Aliphatic $\mu\text{g/g}$	11.58	106.5	.28
Aromatic $\mu\text{g/g}$	17.51	285.0	----
nAlkanes $\mu\text{g/g}$	4.43	4.84	.17
Pris/Phyt	5.00	$\infty$	2.67, 2.66
Pris/nC <sub>17</sub>	.18	.37	.55, .50
Phyt/nC <sub>18</sub>	.27	0	.33, .35
Pris + Phyt/ $\Sigma$ nAlk	.016	.146	.234, ----
$\Sigma$ nAlk/nC <sub>16</sub>	59.84	$\infty$	16.42, 25.05
o/e	.78	1.46	.98, 2.71
o/e $\leq$ nC <sub>20</sub>	.72	1.46	1.12, 1.66
o/e $\geq$ nC <sub>21</sub>	2.46	0	.76, 3.82

\* = duplicate analyses

Table 7 Neuston Intercalibration, 1975-76

	<u>Calder*</u>	<u>Lytle</u>	<u>Meyers</u>
Aliphatics $\mu\text{g/g}$	794.6(290)	106.5	Not Reported
Aromatics $\mu\text{g/g}$	3,168.9	285.0	
n-Alkanes $\mu\text{g/g}$	517.2(12.2)	4.84	
Pris/Phyt	$\infty$	84.9	
Pris/nC <sub>17</sub>	$\infty$	12.8	
Phyt/nC <sub>18</sub>	0	0.79	
Pris + Phyt/ $\Sigma$ nAlk	.09(3.87)	4.08	
$\Sigma$ nAlk/nC <sub>16</sub>	$\infty$	33.2	
o/e	.002(.10)	2.00	
o/e $\leq$ nC <sub>20</sub>	.00(.10)	4.35	
o/e $\geq$ nC <sub>21</sub>	.07(.07)	0.68	

\* = numbers in parenthesis calculated by omitting very large nC<sub>12</sub> peak.

Table 8 Sargassum Intercalibration, 1975-76

	<u>Calder(2)</u>	<u>Lytle</u>	<u>Meyers</u>
Aliphatics $\mu\text{g/g}$	2.02	19.90	Not Reported
Aromatics $\mu\text{g/g}$	39.9	12.00	
n-Alkanes $\mu\text{g/g}$	1.45	6.21	
Pris/Phyt	$\infty$	0.77	
Pris/nC <sub>17</sub>	0.06	0.04	
Phyt/nC <sub>18</sub>	0	2.87	
Pris + Phyt / $\Sigma$ nAlk	0.02	0.04	
$\Sigma$ nAlk/nC <sub>16</sub>	$\infty$	71.4	
o/e	16.15	4.94	
o/e $\leq$ nC <sub>20</sub>	30.0	20.33	
o/e $\geq$ nC <sub>21</sub>	1.37	1.29	

absolute concentrations show the greatest variance, while peak ratios are more consistent among the labs. It should be pointed out that with the environmental samples, many of the peaks are small and instrument parameters such as signal attenuation, integrator logic and setpoints, column performance etc. will affect the reported peak areas and peak ratios to a much larger extent than was the case with the oil samples.

Recommendations for Improving the Quality of Intercalibration Data:

1. Both PI's and BLM must become more aware that intercalibration cannot be a spare time activity.
2. BLM must recognize that it takes as much time and money to run an intercalibration sample as it does for any other sample. PI's must insist on being properly budgeted (time as well as money) to perform these analyses.
3. Intercalibration samples should be run after a lab is in full operational status and before routine analysis of environmental samples begins.
4. Intercalibration should be conducted on a national level among all BLM funded laboratories (and others who may desire to participate). One laboratory should be designated to prepare and distribute intercalibration samples and to receive the data for comparisons, interpretation, etc..



ANALYSIS OF ZOOPLANKTON FROM THE MAFLA OCS AREA

University of Florida, Marine Laboratory

Co-Principal Investigators:

John W. Caldwell

Frank J. Maturo

## INTRODUCTION

The zooplankton community is an important component of the water column ecosystem. In addition to containing permanently planktonic forms which play a major role in the primary food chain, the zooplankton is composed of the larvae of commercially important finfish and shellfish. Many of the holo- and meroplanktonic components are sensitive to environmental perturbations resulting from gas and oil exploration.

This report summarizes the MAFLA zooplankton monitoring study accomplished during the 1975-1976 contract year.

## MATERIALS AND METHODS

Forty-six zooplankton samples were received and processed by this laboratory.

Samples were split initially into halves using a Folsom plankton splitter. One-half was archived, the other half was used for counting purposes. The counting aliquot was split until a randomly selected subsample of approximately 200 animals was obtained. The sample was then placed in a channelled counting tray and identified/enumerated using a binocular microscope. A list of the organisms identified is on file with DMSAG.

Dry weight biomass was determined by washing the counting half of the sample in distilled water, placing it in pre-weighed aluminum weighing boats, and drying at 60°C to constant weight.

Data output furnished by DMSAG included numbers of each category/m<sup>3</sup>, dry weight biomass (mg/m<sup>3</sup>), and Shannon-Weaver diversity indices.



## RESULTS AND DISCUSSION

Total zooplankton numbers/m<sup>3</sup> and dry weight biomass (mg/m<sup>3</sup>) for each sampling period are shown in Figures 1-3.

### Summer, 1975

Overall, both organism density and biomass were highest in Transect II (Figure 1), although Station 1308 of Transect III showed the greatest density and biomass of any single station. The high population estimates at Station 1308 are due primarily to an abundance of the ostracod, Conchoecia sp., other calanoids, Centropages furcatus (calanoid copepod), Eucalanus elongatus (calanoid copepod), Oncaea sp., and cladocerans (probably Evadne sp.) which made up the bulk of the sample (Table 1). High density values recorded for Stations 1204 and 1205 were due to an abundance of cladocerans (>50% of the entire sample). The biomass estimates for Station 1204, however, were the lowest for the entire transect. In general, a pattern of decreasing density was exhibited as one moves from the inshore to the offshore stations. This is expected as inshore areas are generally considered to be more productive in terms of supporting a larger standing crop of zooplankton. Biomass estimates were not directly correlated with population densities (i.e. high density-high biomass and vice versa), however, the same general inshore-offshore trend was indicated. Reasons for this non-correlation (in some cases) of density and biomass are not clear; perhaps one explanation would be the capture of more numerous smaller organisms, although numerically dominant in the sample, would not necessarily weigh more than larger, less numerous organisms collected from another area.

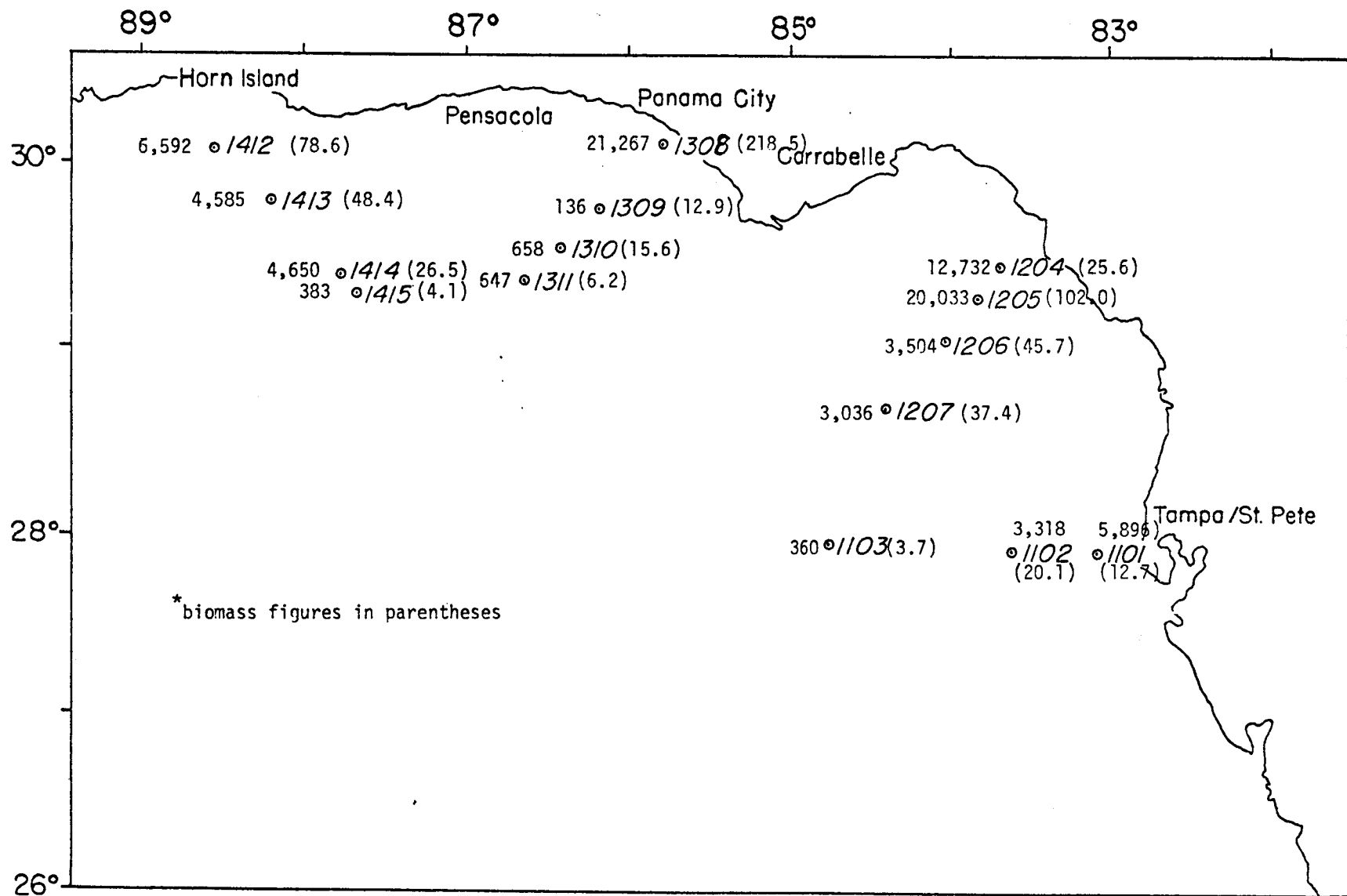

Figure 1. Total zooplankton (number/m<sup>3</sup>) and dry weight biomass\* (mg/m<sup>3</sup>) for summer, 1975.

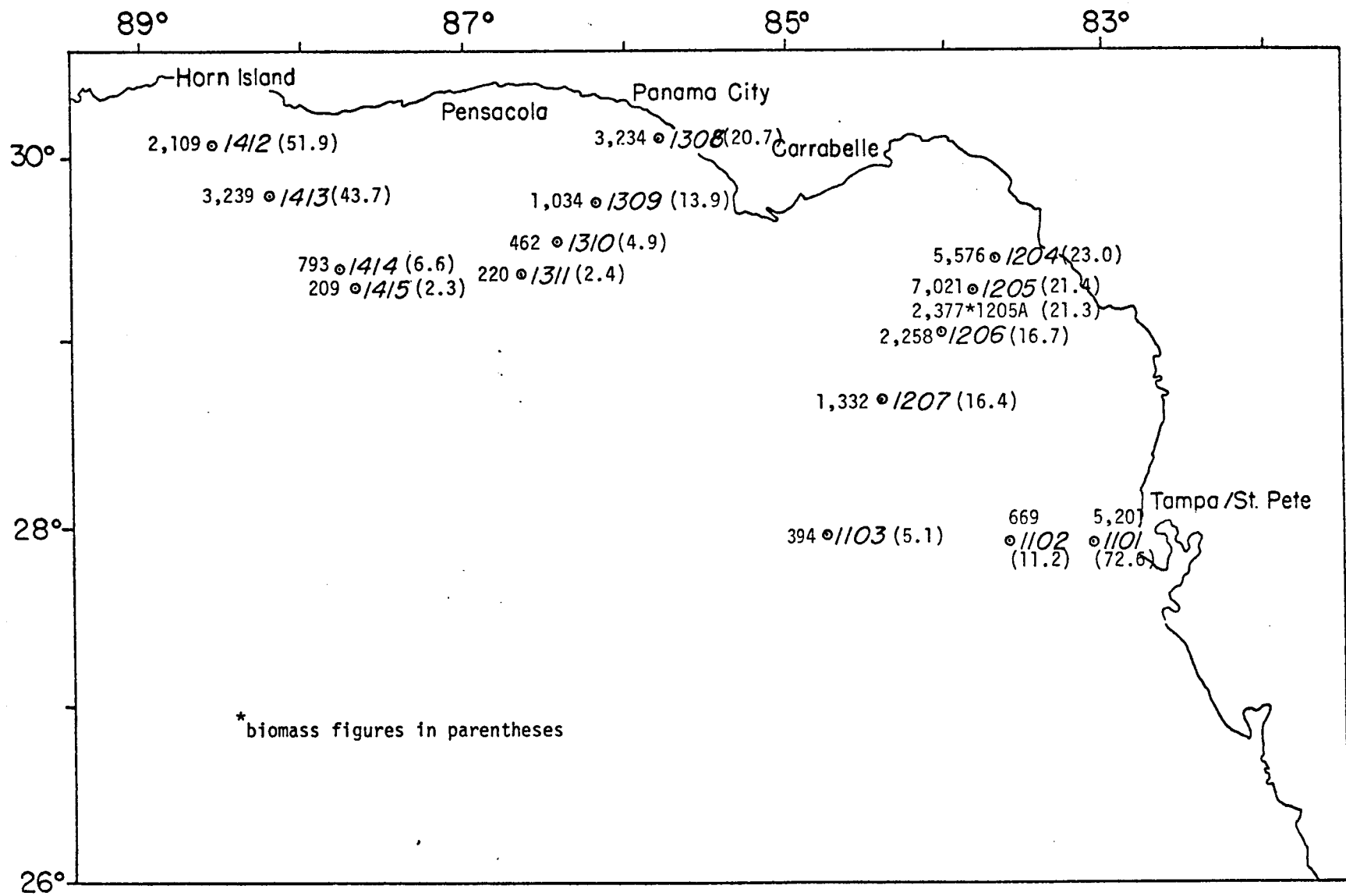

Figure 2. Total zooplankton (number/m<sup>3</sup>) and dry weight biomass\* (mg/m<sup>3</sup>) for fall, 1975.

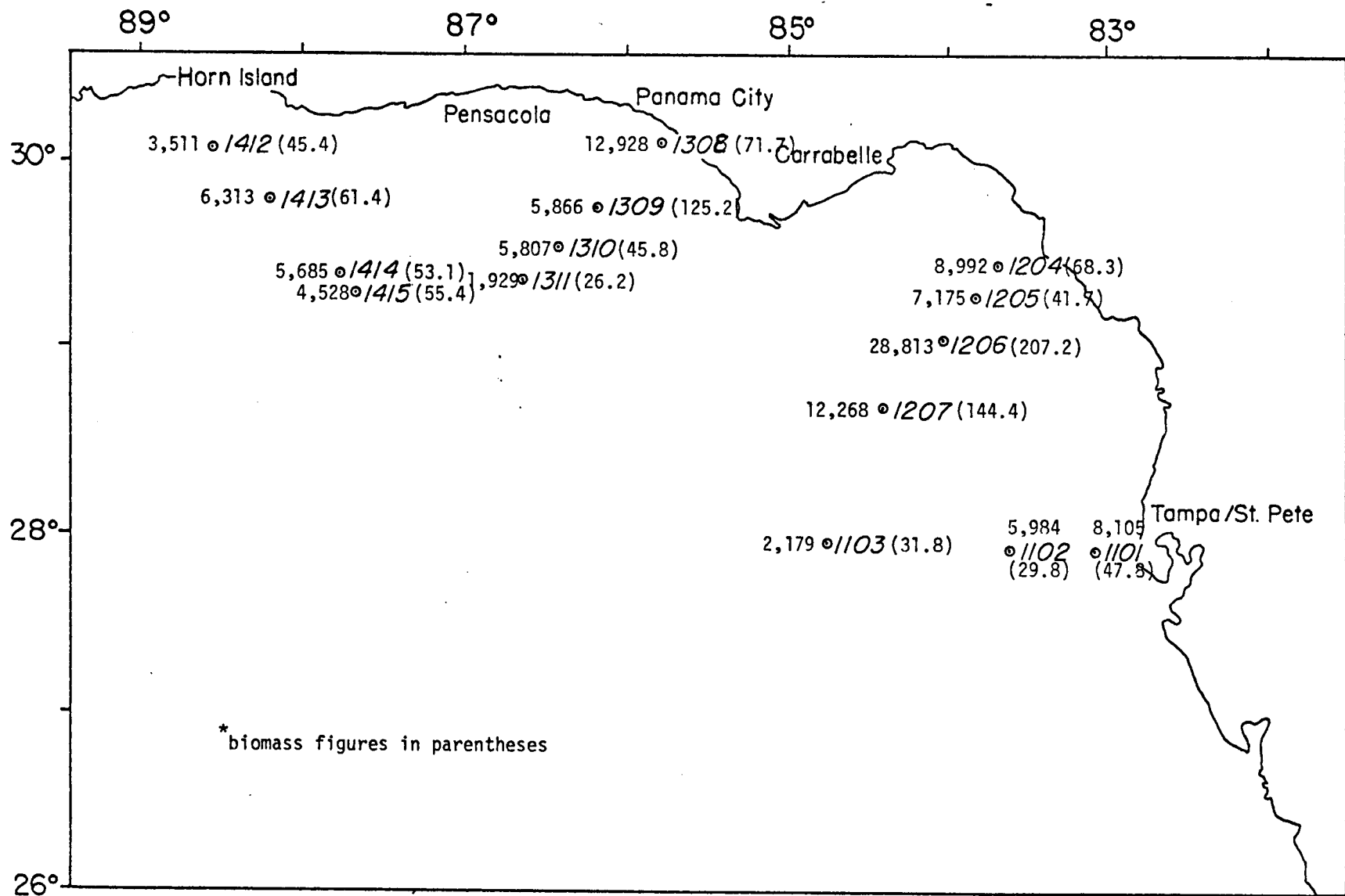

Figure 3. Total zooplankton (number/m<sup>3</sup>) and dry weight biomass\* (mg/m<sup>3</sup>) for winter, 1976

TABLE 1. DOMINANT ZOOPLANKTON GROUPS

Station	Summer, 1975	Fall, 1975	Winter, 1976
1101	other calanoids, Doliolida	cladocerans, <u>Oikopleura</u>	<u>Paracalanus</u> sp.
1102	cladocerans, Doliolida	cladocerans	<u>Conchoecia</u> sp., <u>Corycaeus</u> sp.
1103	other calanoids, <u>Oithona</u> sp.	other calanoids, <u>Pyrocystis</u>	<u>Paracalanus</u> sp., <u>Oithona</u> sp.
1204	cladocerans	cladocerans, <u>Paracalanus</u> sp.	<u>Paracalanus</u> sp., <u>Corycaeus</u> sp.
1205	cladocerans	cladocerans	<u>Paracalanus</u> sp.
1205A	--	cladocerans, <u>Temora turbinata</u>	--
1206	other calanoids, cladocerans	<u>Oncaea</u> sp., <u>Oikopleura</u>	<u>Paracalanus</u> sp.
1207	other calanoids, chaetognaths, gastropod veligers	<u>Conchoecia</u> sp., <u>Paracalanus</u> sp., other calanoids	<u>Paracalanus</u> sp.
1308	<u>Conchoecia</u> sp., other calanoids, <u>Centropages furcatus</u> , <u>Eucalanus elongatus</u> , <u>Oncaea</u> sp., cladocerans	<u>Paracalanus</u> sp., cladocerans	<u>Paracalanus</u> sp., <u>Oikopleura</u>
1309	chaetognaths, other calanoids, <u>Oithona</u> sp., <u>Eucalanus elongatus</u>	<u>Paracalanus</u> sp., <u>Oncaea</u> sp.	<u>Paracalanus</u> sp., <u>Conchoecia</u> sp.
1310	other calanoids	<u>Paracalanus</u> sp., <u>Oncaea</u> sp.	<u>Paracalanus</u> sp.
1311	other calanoids	<u>Paracalanus</u> sp., other calanoids	<u>Paracalanus</u> sp., <u>Oikopleura</u>
1412	cladocerans, other calanoids, <u>Undinula vulgaris</u> (males)	<u>Centropages furcatus</u> , <u>Acartia</u> sp.	fish eggs, foraminiferans, <u>Paracalanus</u> sp., <u>Eucalanus elongatus</u>

TABLE 1. DOMINANT ZOOPLANKTON GROUPS (CONT'D)

Station	Summer, 1975	Fall, 1975	Winter, 1976
1413	anomurans, other calanoids	<u>Oncaea</u> sp., Doliolida	<u>Paracalanus</u> sp.
1414	other calanoids, <u>Rhincalanus coronatus</u> , <u>Undinula vulgaris</u> (males)	<u>Paracalanus</u> sp., <u>Oncaea</u> sp.	<u>Paracalanus</u> sp., <u>Conchoecia</u> sp.
1415	other calanoids	cyclopid copepodites, <u>Paracalanus</u> sp.	<u>Paracalanus</u> sp.

With the major exception of Stations 1308, 1204, and 1205, calanoid copepods were the dominant zooplankton group in most areas.

#### Fall, 1975

The lowest density and biomass estimates were recorded during the fall sampling period. Samples collected during this period also showed the most marked decline in comparison of inshore to offshore stations. Stations 1415 and 1311 showed the lowest density and biomass estimates (209 and 220/m<sup>3</sup> and 2.3 and 2.4 mg/m<sup>3</sup>, respectively) while Station 1101 showed the highest biomass estimate (72.6 mg/m<sup>3</sup>) and Station 1205 the highest specimen abundance (7,021/m<sup>3</sup>) (Figure 2). The post-hurricane station (1205A) showed a drop in species abundance as compared to Station 1205 but retained virtually the same biomass.

Again, the dominant zooplankton group during this period was primarily the calanoid copepods, although cladocerans were abundant in the inshore stations of Transects I and II. Acartia sp. was found at Station 1412, suggesting the presence of water of more estuarine origin. The appearance of Temora turbinata as a dominant group at the post-hurricane station (1205A) is a result of a decrease in the cladoceran population rather than an increase in this calanoid. This would suggest that perhaps the mixing of the water column by the hurricane somehow adversely affected the cladoceran population.

#### Winter, 1976

Samples collected during the winter sampling period compared most favorably, in terms of organism density and biomass, with the summer samples. This period also showed the highest population density and biomass of all the seasons. This was due, primarily, to the great abundance of

Paracalanus sp. in almost all of the samples (Table 1), which would suggest this calanoid copepod is an active winter breeder. The highest density and biomass was recorded at Station 1206, with Paracalanus sp. being the dominant group. Although the same general inshore-offshore trend was present as in other seasons, it was much less pronounced. This is especially true in Transect IV, where it remains relatively constant throughout all the stations; in Transect II the trend is almost reversed, the offshore stations showing greater diversity and biomass than the inshore stations (Figure 3).

As mentioned previously, the dominant zooplankton group is Paracalanus sp. Exceptions to this include Station 1102 where the ostracod Conchoecia sp. and the cyclopoid copepod Oncaea sp. are dominant and Station 1412, where fish eggs and foraminiferans are dominant groups as well as Paracalanus. The abundance of fish eggs at this particular station could be the result of the net passing through a recent spawn or a group of eggs which were clumped together.

#### Shannon-Weaver Diversity Index

The Shannon-Weaver diversity index showed the expected general trend of increasing diversity as one proceeds from inshore to offshore (Table 2). Samples collected in the fall generally showed a higher diversity than the summer samples. This would also be expected due to lower numbers of animals collected in the fall and, as a result, the reduced presence of any one group which dominated the sample. Although complete diversity data from the winter samples are not available at this time, preliminary calculations indicate the same inshore-offshore trend, with a somewhat decreased diversity overall due to the dominance of the Paracalanus sp. group.



TABLE 2. SHANNON-WEAVER SPECIES DIVERSITY

<u>Station</u>	<u>Summer, 1975</u>	<u>Fall, 1975</u>	<u>Winter, 1976</u>
1101	2.165	2.085	1.948
1102	2.553	2.526	2.431
1103	2.708	2.830	2.629
1204	0.716	1.613	2.280
1205	1.063	1.692	2.084
1205A	-	2.414	
1206	2.175	2.551	2.077
1207	2.685	2.363	1.975
1308	2.179	2.399	2.316
1309	2.384	2.487	2.530
1310	2.431	2.825	2.490
1311	2.563	2.754	2.965
1412	2.316	2.185	2.868
1413	2.441	2.515	2.779
1414	2.809	2.570	2.154
1415	2.730	2.769	2.062

SUMMARY

1) The winter sampling period showed the highest overall zooplankton density and biomass of all the seasons. This was due primarily to the high abundance of the Paracalanus sp. group. Winter was followed by summer and fall, with the fall season showing the lowest values.

2) An inshore-offshore pattern of decreasing abundance and biomass as one proceeds offshore was shown for all seasons. The fall period showed the most marked decline, followed by summer and winter. This pattern was less discernible in the winter samples.

3) Shannon-Weaver diversity indices indicated a trend of increasing diversity from inshore to offshore.

4) Diversity appears to be slightly higher in the fall than in the summer. Preliminary calculations of winter data would indicate a similar inshore-offshore trend, with lower overall diversity than the other two seasons.

NEUSTON OF THE MAFLA LEASE AREA

University of West Florida, Biology Department

Principal Investigator:  
Sneed B. Collard

## INTRODUCTION

The term "neuston" (swimmers) was coined by Naumann (1917) to distinguish the surface microbiota of small freshwater ponds from their planktonic and pleustonic components. The surface biota of marine ecosystems did not receive investigative attention, however, until the 1950's (Zaitsev, 1958 et seq.). Reasons for this research hiatus are discussed by Zaitsev (1970), who also summarized the literature to date. Results of recent marine neuston investigations have been summarized and discussed in a review by Hemple and Weikert (1972), in a dissertation by Morris (1975, unpubl.), and in a thesis by Berkowitz (1976, unpubl.).

At present, relatively little is known about the physico-chemical characteristics of the air-sea interface or its possibly specialized fauna and flora (e.g., David, 1965; Khromov, 1965; MacIntyre, 1974; Pequegnat, 1976; reviews cited above). Results of pelagic neustonological studies thus far, however, have indicated that the surface of the ocean may be a unique biotope, and one of significant importance to the marine economy.

The air-sea boundary layer is both the largest ecotonal area on earth and one of the harshest of marine environments. The surface film of water transforms and redistributes a large fraction of the solar energy received by our planet; it is in constant turmoil because of its interactions with the atmosphere, and it is the surface that first feels and reacts to the impact of human ignorance, wastes and errors.

The pleustal zone feeds the oceanic food webs because organic compounds, bacteria, and many of the protistans and phytoplankters are concentrated there. Zooplankton and nekton transport energy obtained in the pleustal zone to subsurface realms, and thus support the mid- and deepwater fauna.

It may be presumptively concluded that neustonic hydrobionts are both ecologically important, and worthy of further study. 'It is clear that the surface biota is now under attack by domestic pesticide, radioactive, and thermal waste products and residues, heavy metals, poisonous gases, and petroleum exploration, production, and transport (see, e.g., Hood, 1971; Horn et al., 1970; Butler, 1975) and we do not yet know if these attacks have, or will in the future change, damage, or obliterate the surface biota upon which the survival of the rest of the sea may depend.

The composition and distribution of neustonic faunal assemblages is known with certainty over a relatively small part of the world ocean (cf., the works cited above). The purpose of the present investigation was to increase our baseline knowledge of neuston assemblages occurring over the outer continental shelf of the eastern Gulf of Mexico, as a prelude to detailed time-series studies at specific locations selected on the basis of the results here obtained. To that end, one day and one night neuston sample were collected at 15 locations during the months of June - July, 1975; September - October, 1975, and January - February, 1976 (Figure 1).

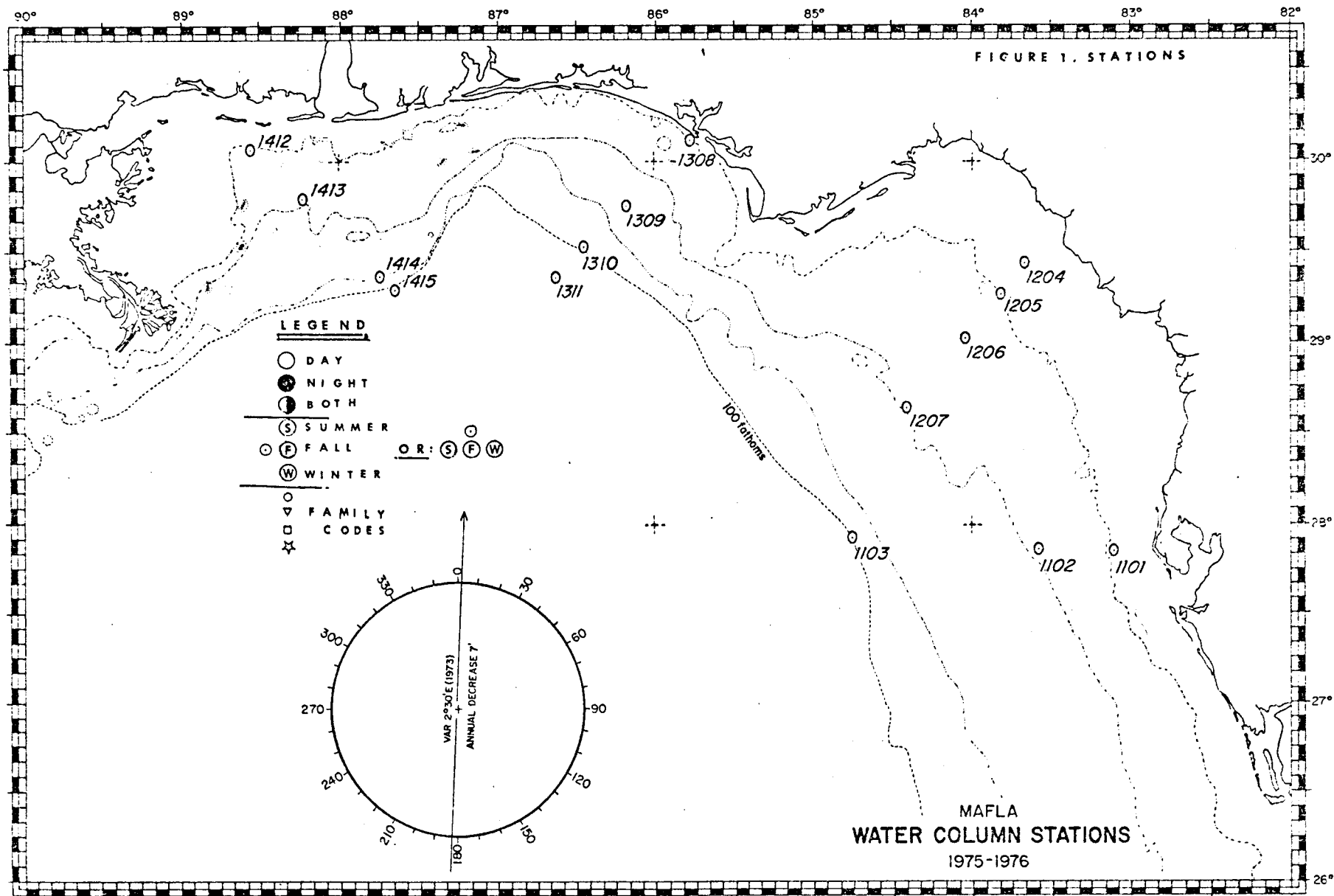

### Terminology

The vocabulary of neustonology was largely created by Geitler (1942), Zaitsev (1967), Hemple (1970, 1971, 1972) and Morris (1975). Terms will be used in the present report as follows:

**Bacterioneuston:** microorganisms that live in sea foam and in the surface layer of water.

**Benthogenic neuston:** merohyponeuston that are benthonic when adult.

**Benthohyponeuston:** facultative hyponeuston recruited on a diel basis from the benthos.

**Bathyp plankt hyponeuston:** facultative, pseudo-, or quasineuston found at the surface at times, either regularly or occasionally; they occur beneath the pleustal biotope normally (regularly).

**Epineuston:** organisms that live on the surface of the sea (e.g., Halobates spp.).

**Euneuston:** organisms that live only at the surface throughout their lives.

**Facultative neuston:** organisms that migrate from depths to the surface daily (includes benthohyponeuston, bathyp plankt hyponeuston, and some of the ichthyoneuston).

**Hyponeuston:** organisms that live beneath the surface in the pleustal zone.

**Ichthyoneuston:** fishes that occur in surface waters regardless of time of day, length of stay, ontogenetic stage, or place of origin.

**Merohyponeuston:** organisms that spend only part of their lives (usually young stages) in surface waters.

**Neuston:** Organisms which, during part or all of their lives, exist in surface waters. No absolute bathymetric depth interval is specified (cf. Surface).

Planktogenic neuston: cf. bathyplanktohyponeuston. Organisms that, when adult, live beneath the surface.

Plankton: drifters (without size limitations); hyponeuston.

Pleustal zone: "the" surface biotope.

Pleuston: organisms that are morphologically and physiologically adapted to live partially exposed to the atmosphere and partially submerged (e.g., Physalia, but not Sargassum).

Quasineuston: organisms that are surface-neutral (species that are neither euneustonic, pseudoneustonic, nor facultatively neustonic, and live either at the surface or elsewhere in the water column, or in both areas in equal abundance).

Surface-positive neuston: organisms that seek or are found only at the surface.

Surface-neutral neuston: pseudoneuston.

Surface-negative neuston: organisms that avoid the pleustal zone.

Surface: The environment from sea foam to a depth of one millimeter to 20 cm.

The surface is here recognized more by its included biota than by arbitrary bathymetric or physico-chemical limits. The surface is the pleustal biotope within which the neuston - or surface biotic assemblages of organisms occur. As incorrectly but commonly used, the term "neuston" includes both plankton and nekton. The present work will promulgate that use of the term because it is widely understood and has been found acceptable. Surface = neuston in this report.

Thanatoneuston: the dead components of neuston collections (e.g., the antirain of crustacean "skeletons"; a new term here introduced).



## MATERIALS AND METHODS

### Collections

Collections were, by contractual agreement, made with the gear and methods described below.

### Sampling

A total of 90 neuston collections was made. The collection device was a Kahlsico "Floating Plankton Sampler" equipped with a one meter, 5:1 (length/width ratio) 202  $\mu$  mesh (No. 8) Nyltex net. Samples were collected twice daily at each of 15 stations located on four transects during each of three sampling periods (June - July, 1975; September - October, 1975; January - February, 1976). One collection was made during hours of darkness, and one was made during the day at each station during each season (Figure 1). The net was towed at steerage speed (ca. 2 kt) for 4-30 minutes. Nets were fished off the port side of the 65-foot R/V TURSIOPS from a three meter boom.

### Shipboard Sample Processing

Neuston collections subject to taxonomic analyses were flushed into 10 l plastic sorting trays, then transferred to glass jars in which they were fixed in a solution of 5% formalin-seawater buffered with sodium borate. Collections subject to trace metal and hydrocarbon analyses were put into acid-washed glass jars with teflon-lined lids, and were frozen for onshore processing. Water was removed from the hydrocarbon/trace metal samples by means of a 202  $\mu$  acid-washed net.

### Laboratory Sample Processing

The volume displacement of all samples was measured prior to their transfer to alcohol. Samples were washed in tap water for 48 hr, then

transferred to 70% ethyl alcohol for permanent conservation. Separate volume displacements were measured for: Sargassum; organisms whose greatest dimension exceeded 2.5 cm, and the remaining sample after oil, tar, and other debris (e.g., plastics, wood, feathers) had been removed.

### Analyses

By means of a Folsom plankton splitter each collection was fractionated into a 500-1000 animal aliquot for taxonomic analyses. All adult animals present in the sample aliquots were counted and identified at least to the Family level when that taxon existed for the group under consideration. Larvae were identified by taxon and stage, and were counted. Fish eggs were identified as such, and counted. All counts are presented as number of individuals captured per minute fished. Estimates of the number of individuals captured per volume of water sampled were impossible to make with the gear used.

### Data Reduction

Data were coded on standard 80 column IBM forms as follows:

Card Type 1: Oceanographic Collection Data.

- a. Date.
- b. Time set and hauled.
- c. Ship heading.
- d. Engine RPM.
- e. Surface current direction.
- f. Sea state.
- g. Flowmeter start and stop reading.
- h. Secchi disk depth.
- i. Forel color.
- j. Surface temperature.
- k. Surface salinity.
- l. Station number.

Card Type 2: Meteorological Collection Data.

- a. Wind direction, speed, range, and maximum gusts.
- b. Cloud cover, and type of low, middle and high clouds present.
- c. Type of weather occurring.
- d. Visibility.
- e. Barometric pressure.
- f. Incident light.
- g. Air temperature.
- h. Time of moonrise and moonset.
- i. Time of sunrise and sunset.

Card Type 3: Totals and Volume Data

- a. Total sample volume.
- b. Number of splits made.
- c. Number of invertebrate families in the sample.
- d. Number of adult invertebrate families in the sample.
- e. Number of fish families in the sample.
- f. Number of fish eggs in the sample.
- g. Number of larval types in the sample.
- h. Number of larvae in the sample.
- i. Volume of organisms larger than 2.5 cm.
- j. Volume of sargassum in the sample.
- k. Weight of tar in the sample.
- l. Station number.

Card Type 4: Larval Types and Numbers.

Card Type 5: Fish Types and Eggs and Their Numbers.

Card Type 6: Adult Invertebrate Families and Number of Specimens.

Data Analyses

Numbers of specimens of each taxon were multiplied by the aliquot factor ( $2^n$ ), and the number caught per minute fished was calculated. The mean, median, variance, standard deviation and standard error of the mean were calculated for each taxon collected (all-station totals). A 5 X 14 correlation matrix (Table 11) and 108 analysis of variance tests (model 1, one-way; two-way, and nested) were performed using raw data, and data transformed by the  $\sqrt{X}$  and log n methods described by Barnes (1952). ANOVA results are summarized as Table 10, and individual ANOVA tables are

	<u>Number Adult Animals</u>	<u>Number Inv. Phyla</u>	<u>Number Inv. Families</u>	<u>No. Crust. Families</u>	<u>No. Copepod Families</u>
Length of time fished (min.)	0.047534 p < 0.065640	-0.032955 p < 0.75782	-0.029453 p < 0.78288	-0.085133 p < 0.42498	0.038595 p < 0.71798
Time of day fished (CDT)	0.303455* p < 0.00364	0.078498 p < 0.46208	0.149683 p < 0.15910	0.172299 p < 0.10440	0.126205 p < 0.23590
Bucket temperature (°C)	-0.086197 p < 0.41920	0.025568, p < 0.81094	-0.154877 p < 0.14496	-0.263184* p < 0.01220	-0.421558* p < 0.00004
Light (F.C.)	-0.131989 p < 0.21494	-0.502147* p < 0.00001	-0.459101* p < 0.00001	-0.548592* p < 0.00001	-0.298520* p < 0.00426
Air temperature (°C)	-0.129575 p < 0.22352	-0.098759 p < 0.35441	-0.240704* p < 0.02230	-0.388153* p < 0.00016	-0.459003* p < 0.00001
Wind speed (Kt.)	-0.025923 p < 0.80837	-0.102644 p < 0.33570	-0.003644 p < 0.97281	0.134572 p < 0.20602	0.101491 p < 0.34118
Sea state (Beaufort)	-0.123463 p < 0.24632	-0.088513 p < 0.40676	-0.102315 p < 0.33726	0.051150 p < 0.63210	-0.090191 p < 0.39789
Forel color	0.080835 p < 0.44882	-0.510168* p < 0.00001	-0.482873* p < 0.00001	-0.512852* p < 0.00001	-0.326654* p < 0.00168
Barometer (mm Hg)	-0.037943 p < 0.72255	-0.193102 p < 0.06822	-0.111450 p < 0.29566	-0.035427 p < 0.74027	0.004056 p < 0.96973
Secchi disk depth (m)	0.006814 p < 0.94918	-0.040982 p < 0.70134	-0.208181* p < 0.04895	-0.094590 p < 0.37519	-0.266234* p < 0.01120
Cloud cover (eights)	0.214204* p < 0.04263	-0.017048 p < 0.87329	-0.041148 p < 0.70018	-0.048271 p < 0.65141	-0.087232 p < 0.41361

Table 11 continued

	<u>Number Adult Animals</u>	<u>Number Inv. Phyla</u>	<u>Number Inv. Families</u>	<u>No. Crust. Families</u>	<u>No. Copepod Families</u>
Sargassum volume (ml.)	-0.051540 p < 0.62950	-0.061335 p < 0.56578	-0.099820 p < 0.34923	-0.094275 p < 0.37678	-0.200630 p < 0.05795
Tar weight (gm.)	0.104321 p < 0.32782	-0.213488* p < 0.04335	-0.244587* p < 0.02016	-0.269323* p < 0.01026	-0.231547* p < 0.02810
Total volume of sample (ml.)	0.205119* p < 0.05245	-0.070200 p < 0.51087	-0.133656 p < 0.20916	-0.119015 p < 0.26388	-0.221548* p < 0.03586

\* Coefficients significant at  $p \leq .05$  are marked with an asterisk. The notations  $p < 0. - - - - X 100$  are the probability of the r value differing from the theoretical value of zero. All tests are two-tailed (n = 90).



available from SUSIO. Pager's (1972) modification of the Shannon-Weaver Index (H') and SNK a-posteriori comparisons of the means of significant ANOVA tests were requested, but not accomplished by Data Management. Since these tests are not appropriate for the data collected, their omission is insignificant and immaterial to the discussion of results (below). Morisita's Index, Sander's Index, and an index of affinity were also calculated. These tests are not appropriate because of the high variances found and they will not be further discussed.

#### Data Display

Pertinent oceanographic, meteorological, volume and larvae data are presented by station and season in unreduced form (Tables 1-9). ANOVA results are summarized as Table 10 and the r-matrix is Table 11. Tables 12-14 are taxonomic summaries by station and season. Geographic and temporal distributions of taxa appear in Figures 1-12. Day/night abundance data by major taxon, station, and season are summarized in Figures 13-36. A complete data dump may be obtained from SUSIO.

Table 1. Oceanographic collection data, Summer, 1975 \*

Station	Date Yr/Mo/Day	Time Set	(Local) Hauled	Sea State	Secchi Depth (m)	Forel Color	Bucket Temp (°C)	Surface Salinity ‰
1412	75 06 19	0010	0015	2	--	-	28.00	27.83
1412	75 06 20	1318	1322	2	05	7	28.27	
1413	75 06 20	2243	2313	2	05	-	28.30	29.36
1413	75 06 21	1358	1428	2	07	9	28.30	
1414	75 06 21	2254	2324	3	06	-	29.00	31.40
1414	75 06 22	1402	1432	5	06	5	29.00	
1415	75 06 22	2300	2330	4	06	-	28.80	32.38
1415	75 06 23	1430	1500	4	06	3	30.78	
1311	75 06 27	0040	0110	2	14	-	28.15	32.56
1311	75 06 27	1528	1558	2	14	3	28.15	
1310	75 06 27	2245	2315	1	14	-	28.65	31.52
1310	75 06 28	1305	1335	1	14	3	28.65	
1309	75 06 28	2200	2230	2	13	-	28.59	31.93
1309	75 06 29	1255	1325	2	15	4	28.59	
1308	75 06 29	2210	2240	2	--	-	27.68	31.66
1308	75 06 30	1140	1210	2	15	6	27.74	
1204	75 07 08	0120	0135	4	98	-	28.40	32.06
1204	75 07 08	1250	1320	3	10	7	28.40	
1205	75 07 08	2210	2240	3	--	-	28.41	32.06
1205	75 07 09	1335	1405	2	15	3	28.61	
1206	75 07 10	0210	0240	3	--	-	28.39	32.36
1206	75 07 10	1225	1255	4	15	3	28.39	
1206	75 07 10	2320	2350	4	--	-	28.20	31.52
1207	75 07 11	1420	1450	5	15	3	28.20	
1207	75 07 13	2315	2345	4	--	-	28.38	35.04
1101	75 07 14	1225	1255	2	11	5	28.38	
1101	75 07 14	2205	2235	2	--	-	28.13	33.50
1102	75 07 15	1250	1320	3	14	3	28.13	
1102	75 07 16	0100	0130	2	98	-	28.16	36.27
1103	75 07 16	1330	1400	3	16	1	28.16	

\* Sea state was estimated, secchi disk depth and forel color were not measured at night



Table 2. Oceanographic collection data, Fall, 1975 \*

Station	Date			Time (Local)		Sea State	Secchi Depth (m)	Forel Color	Bucket Temp (°C)	Surface Salinity ‰
	Yr/Mo/Day	Set	Hauled							
1412	75	09	07	2215	2230	1	--	-	28.6	27.00
1412	75	09	08	1345	1400	2	07	7	28.9	--
1413	75	09	09	0110	0125	2	--	-	28.3	30.03
1413	75	09	09	1430	1500	3	--	7	28.4	--
1414	75	09	10	0015	0030	2	--	-	28.8	35.07
1414	75	09	10	1640	1725	2	22	2	29.3	--
1415	75	09	10	2210	2240	2	--	-	28.3	34.67
1415	75	09	11	1445	1545	2	--	2	28.6	--
1311	75	09	12	0200	0245	2	--	-	28.6	34.63
1311	75	09	12	1423	1508	2	31	2	28.4	--
1310	75	09	12	2210	2240	2	--	-	29.2	35.31
1310	75	09	13	1410	1455	3	25	2	28.4	--
1309	75	09	13	2230	2315	3	--	-	29.0	33.76
1309	75	09	14	1420	1505	3	15	3	28.6	--
1308	75	09	15	0030	0100	2	--	-	28.2	31.69
1308	75	09	15	1300	1330	2	12	6	28.0	--
1204	75	09	20	2200	2215	2	--	-	28.2	31.95
1204	75	09	21	1330	1340	3	08	7	28.6	--
1205	75	09	21	2150	2205	3	--	-	28.2	32.98
1205	75	09	27	1309	1339	3	10	7	28.8	--
1205	75	09	26	2220	2231	2	--	-	27.8	--
1206	75	09	28	1335	1450	3	31	3	27.0	34.46
1206	75	09	27	2226	2245	2	--	-	26.2	--
1207	75	09	29	1405	1450	3	34	2	26.8	34.91
1207	75	09	28	2220	2250	2	--	-	26.0	--
1103	75	09	30	1340	1425	2	38	2	27.6	35.92
1103	75	09	30	2027	2057	3	--	-	27.8	--
1102	75	10	01	1345	1430	2	35	2	28.0	35.11
1102	75	10	01	2037	2057	2	--	-	27.8	--
1101	75	10	02	0145	0200	2	--	-	27.0	33.71
1101	75	10	02	1250	1302	2	10	8	27.9	--

\*Sea state was estimated, secchi disk depth and forel color were not measured at night

Table 3. Oceanographic collection data, Winter, 1976 \*

Station	Date Yr/Mo/Day	Time (Local)		Sea State	Secchi Depth (m)	Forel Color	Bucket Temp (°C)	Surface Salinity ‰
		Set	Hauled					
1412	76 01 09	1315	1345	2	04	9	13.4	31.92
1412	76 01 09	2000	2045	2	--	-	13.5	--
1413	76 01 10	2210	2240	2	--	-	16.5	34.01
1413	76 01 11	1445	1530	2	07	0	16.4	--
1414	76 01 11	2140	2210	2	--	-	18.5	35.77
1414	76 01 12	1340	1410	2	11	5	18.4	--
1415	76 01 12	2205	2335	2	--	-	18.5	36.19
1415	76 01 13	1415	1445	2	04	5	19.0	--
1308	76 01 14	2250	2305	2	--	-	18.9	34.88
1308	76 01 15	1327	1357	2	14	6	18.8	--
1309	76 01 15	2200	2230	1	--	-	18.5	36.20
1309	76 01 16	1100	1130	4	05	1	19.2	--
1310	76 01 19	2355	0025	3	--	-	19.5	36.30
1310	76 01 20	1345	1430	2	20	1	20.0	--
1311	76 01 20	2200	2245	2	--	-	19.1	36.27
1311	76 01 21	1040	1125	3	23	1	20.1	--
1204	76 01 29	2250	2320	3	--	-	18.7	34.32
1204	76 01 30	1330	1405	2	07	6	17.0	--
1205	76 01 30	2210	2240	2	00	-	17.2	35.60
1205	76 01 31	1330	1400	2	12	5	15.0	--
1206	76 02 31	2005	2035	2	--	-	16.0	36.05
1206	76 02 04	1210	1230	2	07	4	16.0	--
1207	76 02 04	2130	2145	2	--	-	18.5	36.28
1207	76 02 05	1415	1430	2	07	4	18.5	--
1103	76 02 06	0210	0225	2	--	-	16.4	36.21
1103	76 02 07	1225	1245	2	20	2	19.5	--
1102	76 02 07	2210	2225	2	--	-	19.0	36.18
1102	76 02 07	0925	0940	5	10	4	17.6	--
1101	76 02 07	2215	2335	5	--	-	16.5	35.17
1101	76 02 08	1155	1225	2	05	6	18.5	--

Table 4. Meteorological collection data, Summer, 1975

Station	Wind Direction	Wind Speed	Wind speed Range	Cloud* Cover	** Light	Air Temp. (°C)
1412	15	03	02	5208	0	22.77
1412	15	02	02	3140	7500	28.33
1413	25	02	03	3901	0	23.33
1413	08	02	03	1100	6700	29.44
1414	09	08	05	4201	1	25.55
1414	09	08	05	5260	6900	27.77
1415	09	10	10	5241	0	25.66
1415	15	03	04	7720	4000	26.66
1311	05	08	10	2308	1	23.88
1311	05	02	03	3141	7100	28.33
1310	36	01	01	4221	1	25.55
1310	36	01	36	4210	6500	32.22
1309	24	02	02	3110	0	28.55
1309	36	01	01	1001	7500	32.22
1308	24	08	04	4210	0	25.00
1308	09	06	04	1100	6200	26.66
1204	27	10	04	2200	1	28.33
1204	27	06	02	2100	6800	31.10
1205	15	06	04	3261	0	25.55
1205	16	03	02	7700	1750	25.70
1206	24	07	03	3200	0	25.00
1206	24	06	03	2241	5600	29.44
1207	24	05	03	3311	0	23.88
1207	24	15	07	7700	2500	26.66
1101	24	10	05	6330	0	23.88
1101	24	02	02	3292	7250	31.11
1102	32	03	01	2300	1	22.77
1102	24	10	04	5241	5600	30.00
1103	09	08	02	1200	1	23.88
1103	15	07	03	3201	6700	31.11

\* Cloud cover in eights, followed by type of low, middle, and high clouds observed.

\*\* Light measured on deck in foot candles.

Table 5. Meteorological collection data, Fall, 1975

Station	Wind Direction	Wind Speed	Wind speed Range	Cloud* Cover	** Light	Air Temp. (°C)
1412	09	02	02	6710	0	25.90
1412	08	03	04	6200	6100	29.20
1413	11	04	05	4210	0	28.20
1413	07	06	07	4240	7500	28.00
1414	09	03	03	3300	0	28.50
1414	09	03	02	4290	6000	29.90
1415	12	03	04	3300	0	27.10
1415	13	02	02	3240	7000	30.80
1311	15	03	04	2200	0	29.20
1311	12	02	02	4360	7500	29.80
1310	14	02	02	2100	0	29.00
1310	30	05	06	6220	4500	27.80
1309	03	10	06	3200	0	27.10
1309	04	07	10	7500	2000	26.00
1308	04	05	05	4200	0	27.00
1308	06	03	04	3200	6500	28.20
1204	08	03	02	6270	0	28.80
1204	11	04	03	5210	5000	29.40
1205	01	04	02	7210	0	29.60
1205	02	03	02	8220	3700	24.20
1205	01	05	03	3200	0	28.00
1206	11	05	02	3240	5900	26.80
1206	33	03	02	3200	0	23.60
1207	16	03	02	5530	5000	27.80
1207	06	03	04	3420	0	26.50
1103	08	03	02	3250	5500	27.20
1103	09	04	02	6271	0	27.00
1102	23	03	02	4140	6100	29.40
1102	23	02	01	4241	0	28.80
1101	11	03	02	3200	0	26.80
1101	32	03	02	5241	1900	29.50

\* Cloud cover in eights, followed by type of low, middle, and high clouds observed.

\*\* Light measured on deck in foot candles.

Table 6. Meteorological collection data, Winter, 1976

Station	Wind Direction	Wind Speed	Wind speed Range	Cloud* Cover	** Light	Air Temp. (C°)
1412	01	06	03	0000	5500	17.5
1412	01	03	02	0000	ND	18.0
1413	18	05	01	7501	ND	16.0
1413	05	02	01	7030	3000	20.0
1414	21	02	02	4030	ND	18.5
1414	12	04	02	2130	4500	28.0
1415	11	03	02	1100	ND	18.0
1415	19	05	02	4081	5100	23.9
1308	27	10	05	4020	ND	19.0
1308	01	02	01	5031	4400	19.0
1309	29	01	01	3050	ND	11.0
1309	29	10	05	2200	4300	20.0
1310	09	08	03	1050	ND	15.8
1310	04	04	02	4201	2200	15.5
1311	34	02	01	1000	ND	16.0
1311	01	08	02	6520	1500	16.0
1204	27	07	02	1000	ND	18.5
1204	29	04	02	0000	5100	14.8
1205	25	06	04	0000	ND	15.0
1205	19	02	06	2041	6000	19.0
1206	14	04	02	7220	ND	15.9
1206	11	04	02	1000	5700	18.5
1207	08	02	01	0000	0001	17.0
1207	15	03	01	0000	5400	19.5
1103	29	02	01	3010	0001	16.1
1103	18	02	01	3201	5800	20.0
1102	31	01	01	6320	0001	18.5
1102	--	20	05	6820	2700	15.0
1101	33	18	07	3120	0001	15.0
1101	30	05	02	0000	5000	18.0

\* Cloud cover in eights, followed by type of low, middle, and high clouds observed

\*\* Light measured on deck in foot candles.

ND Non-detectable

Table 7. Systematic and volume data summary, Summer, 1975

Station Number	Neuston Collection No.	Sample I.D.	Total Sample Volume(ml)	No. of splits	Total Invertebrate Phyla collected	Total Invertebrate families collected	Total Fish Families collected	No. of Fish eggs collected	No. of Larval Taxa collected	No. of Larvae collected	Vol. of Organisms > 2.5cm length	Vol. displ. of sargassum	Day tar weight(g)
1412	3	N2	600.	9	7	11	0	1	6	25	0.0	0.0	0.0
1412	4	N1	220.	8	6	11	1	1	4	80	0.0	0.0	0.0
1413	7	N2	90.	9	10	16	0	0	4	107	0.0	4.00	998.00
1413	10	N1	100.	8	4	9	0	1	5	20	0.0	1.00	998.00
1414	12	N2	300.	11	8	15	0	0	7	52	0.0	10.00	0.0
1414	13	N1	535.	9	9	15	0	3	6	22	23.00	451.00	1.00
1415	16	N2	555.	12	9	17	3	4	6	24	12.00	285.00	7.00
1415	17	N1	0.	7	3	8	0	2	3	17	0.0	0.0	0.0
1311	19	N2	1050.	10	6	12	1	6	3	3	1.00	2.00	998.00
1311	24	N1	960.	8	7	11	1	0	4	31	4.00	920.00	32.00
1310	28	N2	700.	13	6	14	2	0	4	27	999.00	85.00	7.00
1310	29	N1	95.	11	4	7	1	3	5	6	0.0	0.0	998.00
1309	31	N2	550.	9	10	20	6	0	5	21	15.00	445.00	5.00
1309	34	N1	450.	4	8	16	1	22	6	558	4.00	430.00	998.00
1308	35	N2	420.	11	7	13	0	0	5	27	30.00	0.0	0.0
1308	37	N1	820.	10	3	7	0	1	2	14	0.0	0.0	998.00
1204	38	N2	195.	9	10	16	6	4	6	16	18.00	20.00	998.00
1204	39	N1	310.	11	6	13	1	0	4	23	999.00	203.00	998.00
1205	40	N2	300.	11	10	18	3	2	5	82	1.00	4.00	2.00
1205	45	N1	0.	11	9	17	4	3	7	59	0.0	0.0	0.0
1208	46	N2	330.	6	7	13	2	3	7	139	20.00	38.00	1.00
1208	47	N1	365.	7	4	8	3	2	5	34	20.00	195.00	5.00
1207	48	N2	230.	8	9	15	6	2	6	29	138.00	5.00	998.00
1207	49	N1	160.	6	7	18	2	6	5	16	7.00	101.00	1.00
1101	50	N2	580.	13	8	16	4	4	6	47	63.00	38.00	4.00
1101	51	N1	300.	9	9	16	4	126	5	47	4.00	202.00	16.00
1102	52	N2	374.	9	9	17	2	1	6	19	20.00	121.00	75.00
1102	58	N1	140.	7	5	11	1	4	5	21	0.0	85.00	97.00
1103	59	N2	225.	8	11	20	3	115	7	31	7.00	115.00	57.00
1103	61	N1	628.	8	8	17	3	23	3	53	5.00	556.00	3.00

(998 = questionable data, 999 = no data)

Table 8. Systematic and volume data summary, Fall, 1975

Station Number	Neuston Collection No.	Sample I.D.	Total Sample Volume(ml)	No. of splits	Total Invertebrate Phyla collected	Total Invertebrate families collected	Total Fish Families collected	No. of Fish eggs collected	No. of Larval Taxa collected	No. of Larvae collected	Vol. of Organisms > 2.5cm length	Vol. displ. of sargassum	Day tar weight(g)
1412	64	N2	310.	10	10	16	4	0	4	200	45.00	20.00	0.0
1412	73	N1	300.	10	2	8	0	0	3	26	0.0	5.00	0.0
1413	76	N2	80.	1	11	22	5	0	7	184	1.00	0.50	0.10
1413	79	N1	60.	8	10	16	7	0	7	183	4.00	8.00	0.10
1414	82	N2	20.	6	9	18	3	0	4	46	1.00	0.0	0.10
1414	88	N1	110.	6	7	14	2	0	4	41	0.10	50.00	4.00
1415	94	N1	30.	6	6	12	0	0	3	65	0.0	1.00	0.40
1415	91	N2	20.	6	11	21	5	0	8	84	6.00	0.10	0.0
1311	97	N2	80.	6	14	27	9	0	7	471	0.0	0.0	0.10
1311	102	N1	100.	7	6	14	2	1	6	181	0.0	0.0	0.10
1310	105	N2	40.	7	10	19	3	0	3	39	0.0	8.00	5.00
1310	109	N1	20.	6	7	15	3	0	3	30	0.0	0.0	0.0
1309	112	N2	65.	5	11	19	6	0	5	66	8.00	12.00	2.50
1309	118	N1	110.	7	8	16	2	0	4	117	0.0	30.00	36.00
1308	121	N2	280.	7	12	23	2	0	6	108	35.00	15.00	28.00
1308	123	N1	10.	5	10	18	2	0	6	89	0.0	0.50	2.00
1204	129	N1	50.	7	6	14	2	0	3	4	1.00	8.00	0.0
1204	126	N2	240.	1	8	16	2	0	5	35	3.00	118.00	0.33
1205	132	N2	0.	11	20	20	1	0	6	24	0.0	0.0	0.0
1205	135	N2	100.	6	12	23	1	0	6	24	31.00	35.00	0.0
1205	138	N1	40.	6	8	15	3	0	3	33	1.00	130.00	0.0
1206	142	N2	257.	7	12	21	1	0	7	86	47.00	65.00	1.10
1206	145	N1	74.	6	9	13	4	0	4	16	0.0	18.00	2.10
1207	148	N2	420.	8	12	20	3	0	8	98	98.00	24.00	0.0
1207	151	N1	120.	8	11	15	1	0	4	160	12.00	29.00	10.00
1103	160	N2	130.	7	10	17	1	1	8	36	1.00	27.00	43.00
1103	155	N1	120.	7	10	18	0	0	3	206	0.0	0.0	0.10
1102	167	N2	100.	7	10	19	1	0	5	85	0.0	1.00	0.0
1102	163	N1	140.	7	6	13	1	0	5	98	31.00	27.00	0.13
1101	170	N2	100.	6	10	18	0	0	3	13	0.0	0.0	0.0
1101	173	N1	60.	6	7	13	1	0	5	81	0.0	14.00	0.0

Table 9. Systematic and volume data summary, Winter, 1976

Station Number	Neuston Collection No.	Sample I.D.	Total Sample Volume(ml)	No. of splits	Total Invertebrate Phyla collected	Total Invertebrate families collected	Total Fish Families collected	No. of Fish eggs collected	No. of Larval Taxa collected	No. of Larvae collected	Vol. of Organisms > 2.5cm length	Vol. displ. of sargassum	Day tar weight(g)
1412	179	N2	110.	8	8	19	3	62	7	132	4.00	3.00	3.70
1412	177	N1	14.	6	4	12	0	8	4	199	0.0	1.00	0.30
1413	181	N2	75.	8	8	18	3	23	6	34	0.0	0.0	0.70
1413	183	N1	715.	16	8	10	4	***	3	13	7.00	6.00	1.50
1414	185	N2	630.	10	9	16	0	94	9	69	1.00	2.00	0.60
1414	194	N1	0.	8	6	15	4	6	9	41	0.0	0.0	0.0
1415	196	N2	860.	8	9	18	2	18	9	230	7.00	4.00	6.30
1415	198	N1	265.	10	7	16	0	33	5	20	1.00	165.00	0.40
1308	200	N2	40.	7	6	16	2	1	4	37	2.00	1.00	0.50
1308	203	N1	125.	7	8	15	0	2	2	202	0.0	1.00	0.40
1309	205	N2	95.	9	12	23	2	48	7	35	1.00	1.00	0.60
1309	207	N1	20.	7	10	22	1	19	6	58	0.0	3.00	0.50
1310	209	N2	45.	7	10	22	0	5	6	55	0.0	7.00	0.0
1310	211	N1	14.	7	6	18	4	2	4	52	2.00	3.00	0.70
1311	213	N2	1210.	7	12	26	1	6	8	100	640.00	1.00	0.0
1311	217	N1	100.	7	10	19	4	4	5	55	2.00	1.00	0.0
1311	219	N2	245.	4	9	17	4	1	7	19	0.0	0.0	0.0
1204	221	N1	271.	5	8	16	1	6	4	5	1.00	245.00	0.70
1204	223	N2	155.	8	6	15	1	0	7	20	10.00	8.00	0.0
1205	225	N1	120.	5	5	9	1	26	4	5	0.0	0.0	0.0
1206	229	N2	135.	8	10	18	1	3	6	63	1.00	1.00	0.10
1206	231	N1	105.	5	8	17	0	1	5	8	0.0	1.00	0.10
1207	233	N2	160.	7	12	20	1	0	6	21	40.00	1.00	0.0
1207	235	N1	160.	8	7	12	2	3	2	1	9.00	0.0	0.0
1103	237	N2	115.	8	10	20	0	7	7	53	34.00	0.0	0.50
1103	242	N1	55.	7	7	19	0	59	7	75	10.00	1.00	1.20
1102	244	N2	145.	9	10	18	0	11	9	178	5.00	2.00	0.40
1102	247	N1	31.	7	9	20	0	5	7	38	0.0	6.00	0.30
1101	250	N2	550.	8	4	11	3	3	5	14	22.00	120.00	0.0
1101	251	N1	210.	4	4	10	0	6	4	4	1.00	115.00	0.0



Table 12. Distribution of Neuston, Summer, 1975.

	Water Column Stations														
	1412	1413	1414	1415	1308	1309	1310	1311	1204	1205	1206	1207	1101	1102	1103
1. Invertebrates =															
Polyphemidae	B			B				D	N	N	N		B	B	
Conchoecidae	B														N
Tomopteridae	N	N				D			N						N
Oikopleura	B	N	D		B				N	D				D	N
Penaeidae	D								N	N		N	B		
Sagitta	B	B	B	N	N	B	B	B	B	B	N	B	B	B	B
Hyperidae		N	N	N	N	D		N		D			N		N
Euphausiacea		N	N	N	N							N	N		
Sergestidae		B	N	N	D	B	N	N		D	B	D		N	N
Portunidae		N	D	N	N	B		D	N			D			B
Sididae		N							B	N			B		D
Cumacea		N							N	N	D				
Gerridae		D					B	N				N		N	B
Gammaridae			N						N	B	N		D		
Dyphyidae			N			N	D			N			D		N
Cavolinidae			B	B	N	B	N		D		N	B			B
Hyppolytidae			D	N		N		D	D		D	D			D
Palaemonidae			D	N		N	N	D	D	N	D	D	B	N	B
Campanularidae			D			B		D				D	D	N	D
Plumularidae				N	D	D	N							N	D
Eucalanidae	N		B	B	B	B	B	N	D	B	N	B	N	N	N
Centrophagidae	B	B	B	B	B	B	N	N	B	B	N	B	B	B	B
Temoridae		N	D	B	B	B	N	N	B	B	B	B	B	B	B
Paracalanidae	D	B	B	B	B	B	B	B	B	B	N	B	B	B	B
Pontellidae	B	B	B	B	B	B	B	B	B	B	B	B	B	B	B
Corycaeidae	N	B	B	B	N	B	N		B	B	B	B	B	B	B
Oncaeidae						B	B		D	D	N			D	B
Oithonidae	B					D	N					D			N
Cirolanidae						N	N			D		N	N	N	N
Eukrohnia						N	N								
Tunicata						N									
Isopoda									N						
Doliolidae									B	D		B	D	B	
Calanidae										D		B			
Loficidae										D					
Acartiidae	D	B	N									D		B	D
Clausiidae								D							
Mysidae										B				N	
Pasiphaeidae										D					
Harpacticoidae	D		B		N	N			N				B		R

Table 12. Continued

	Water Column Stations														
	1412	1413	1414	1415	1308	1309	1310	1311	1204	1205	1206	1207	1101	1102	1103
2. Fishes =															
Synodontidae										D		H	N		
Istiophoridae															D
Diodontidae															D
Lobotidae						H									
Scombridae						H									
Coryphaenidae						H	H	D		D					
Carangidae				N	D	H		N							N
Molidae							N								
Exocoetidae				N		N			N	D	D	B	B	N	N
Serranidae												N	N		
Pleuronectidae												N	N		
Balistidae				N		B			B		D	B	D	B	B
Hemiramphidae									N	B			D	B	B
Syngnathidae													B		
Mugilidae											N				
Belonidae									N	N					
Ophichthyidae									N	N					
Clupeidae									N	N	N				
Stromateidae	D														
Bothidae							D								
Leptocephalus												N			
3. Larvae =															
Harpacticoid Copepodid						N		D		D	N				N
Brachyuran zoeae	N	B	N	N	N		B		B	B	B	B	B	B	N
Brachyuran megalopa				N	N	D		D	B	D	N	D	B	B	N
Caridean zoeae										N				N	
Squillid antizoeae	D	N	R	N	N	B	B		N		B	B	B	N	
Squillid postlarvae	B	N	D					N	N						N
Polychaete larvae	N					N									
Gastropod veligers	D	B	B	B	N	B	B	D	B	B	B	B	B	B	B
Pelecypod veligers	B	B	B	D	B	B	B	B	B	B	B	N	N	B	B
Copepod nauplii		D	B	N		D								D	
Fish eggs	B	D	D	B	D	D	D	N	N	B	B	B	B	B	B
Invertebrate eggs	N		B									N			

D = Day occurrence only  
 N = Night  
 B = Both day and night occurrence

Table 13. Distribution of Neuston, Fall, 1975.

Water Column Stations

1. Invertebrates =

	1412	1413	1414	1415	1308	1309	1310	1311	1204	1205	1206	1207	1101	1102	1103
Polyphemidae		N		B	B			B	B	B	B	B			D
Conchoecidae	N	N	N	N	B	B	B	N		N	N	N	N		N
Tomopteridae	N	N	D	N	N	N		N		N	N	N	N	N	
Oikopleura	N	N	B	B	B	B	B	B	B	B	B	B	B	B	B
Penaeidae								N		N					
Sagitta	B	B	B	B	B	B	B	B	B	B	B	B	B	B	B
Hyperidae		B	N	N		N	N	N		N	N	N	N	N	D
Euphausiacea								N							
Sergestidae		B	N	N	B	B	N		N		B	D	B	B	B
Portunidae	N	D							D	B	N	B			
Sididae									B	B			B		D
Cumacea				N			N	N	N		N				
Gerridae	N	N	N	B		N	N	B			D	D			D
Gammaridae							N	N	N		B	B	N	N	N
Cavolinidae		N	N		N	N	B	N				N		N	N
Hyppolytidae			D							N					
Campanularidae	N	D		D									D		
Plumularidae	N		D				D			B		B		D	
Eucalanidae	B	B	B	B	B	B	B	N	B		N	N	B	N	N
Centrophagidae	B	B		N	B	N			B	N	N	B		B	N
Temoridae	B	N	B	B	B		D	B	B	B	B	N	B	B	D
Paracalanidae	B	N	B	B	B	B	B	B	B	B	B	B	B	B	B
Pontellidae	D	B	B	B	B	B	B	B	B	B	B	B	B	B	B
Corycaeidae		B	B	B	B	B	B	B	B	B	B	B	B	B	B
Oncaeidae		B	D	B	N	B	B	B		B	B	N	B	B	B
Oithonidae	B	N	N	N	N	B	D	N		B	N		B		D
Cirolanidae						D				B	N	N	N	N	D
Doliolidae		D		B	N				B	N	B	N	B	N	B
Acartiidae	B	B	N	N										D	
Monifidae	N														
Limnoidinidae			N			B	N	N				N			
Salpidae	N	B						N	B						
Siphonophroa		B	B	B	B	N	B	B	B		B			B	B
Candaciidae							N	B							
Calocalanidae							B	B			N				D
Sapharinidae			N	N		D									
Harpactacoidea		N	B	B	B		B	B	D	B		D		N	B

Table 13. Continued

	Water Column Stations														
	1412	1413	1414	1415	1308	1309	1310	1311	1204	1205	1206	1207	1101	1102	1103
Calanoidae				N	D	D		B						N	B
Orthoptera		D													
Phascolosoma		B			D	D		N				D			
Palaemonidae			B		N				N	N					
Upogeidae					N							N			
Caridian															
2. Fishes =															
Synodontidae	N	B	N		B			N	D	D					
Lobotidae	N	D													
Scombridae		N			N			N							
Coryphaenidae	N	D	N			N	N	N							
Carangidae				N		N	D	N							
Exocoetidae	N	B		N		B		B			D	N			
Serranidae						N									
Balistidae			D	N	D	N	B	N	N	D	D	B		N	
Hemiramphidae		D						D	B	B	N	D	D		
Syngnathidae				N				N			D				N
Ophichthyidae												N			
Stromateidae		N	N					N							
Leptocephalus															
Tetradontidae		D	D			B	D				D			D	
Myctophidae				N				N							
Holocentridae							N								
3. Larvae =															
Brachyuran zoeae	B	B	N	N	B	B	N	N	B	N	B	B	B	B	N
Brachyuran megalopa	N	B	N	N	B	N	D	D	D	N	B	N	D	B	N
Caridean zoeae		N		N				B			N	N			N
Squillid antizoeae		N	D		B			N	N	D	N	N		B	
Polychaet larvae		B	D												
Gastropod veligers	B	B	B	B	B	B	B	B	B	B	B	B	B	B	B
Pelecypod velifers	B	B	B	B	B	B	B	B	N	B	N	B	D	B	B
Copepod nauplii				D				B							N
Squillid pseudozoeae	N		B	B				N							

Table 13. Continued

		Water Column Stations														
		1412	1413	1414	1415	1308	1309	1310	1311	1204	1205	1206	1207	1101	1102	1103
Fish leptocephalus			B	D	N				N							
Mysid					N				N	N	N	N	N			N
Copepodids			D		N	N	D		B		N		B			D
Prosobranch juveniles				B	N	N	N	B	N			B	N	N	B	N

D = Day occurrence only

N = Night

B = Both day and night occurrence



Table 14. Continued

Water Column Stations

	1412	1413	1414	1415	1308	1309	1310	1311	1204	1205	1206	1207	1101	1102	1103
Calocalanidae		D				B	H	N							D
Sapharinidae						B	N	D							B
Phascolosoma								B							
Diptera			D		N	N				D					
Euchaetidae	N		D				D	D							
Copepoda	B			D	B	D	B	N	D	B	D	B	B	D	D
Branchiostoma				D			N							N	N
Cephalopoda				N							D				
Physalia								N							B
Velella						D									N
2. Fishes															
Synodontidae		B	D				D								
Exocoetidae								D							
Serranidae												B			
Hemiramphidae	N												N		
Syngnathidae			D						N						
Mugilidae	N	B	D	N	N	N	D	D	N			D	N		
Ophichthyidae									N	N					
Stromateidae		D													
Myctophidae				N				N							
Gadidae	N	B	D		N	B	D	D	B	D	D		N		
Centriscidae							D	D							
3. Larvae															
Brachyuran zoeae	B	N	B	N		N		N	N	B	D	N		B	B
Brachyuran megalopa		D	B	N	N	B	N	N	N	N	D				D
Caridean zoeae	N		D					N		N	D		N	B	N
Squillid antizoeae			D	N		N		N							
Gastropod veligers	N	N	B	N		B	B	B	N	N	D	B	B	B	B
Pelecypod veligers	B	N	B	B		B	B	B	B	B		N	B	B	B

Table 14. Continued

Water Column Stations

	1412	1413	1414	1415	1308	1309	1310	1311	1204	1205	1206	1207	1101	1102	1103
Copepod nauplii	B	B	B	B	B	B	B	B		D		N		N	D
Fish eggs	B	B	B	B	B	B	B	B	B	D	D	D	B	B	B
Squillid pseudozoaeae	N		B	B				N	N						
Fish leptocephalus		B	D	N				N							
Mysid		N	N	N										N	
Copepodids	B	B	B	B	B	B	B	B	D	N			N		B
Prosobranch juveniles			B												
Tunicate larvae											D				
Polychaet juveniles			D						B						
Ectoproct cyphonautes larvae			N	B		D	N	D			D	N	D	B	B
Euphauslid furcilia								N				N			
Cirripede nauplii					N				N	N				B	
Pleuronectiform	N														

D = Day occurrence only

N = Night

B = Both day and night occurrence



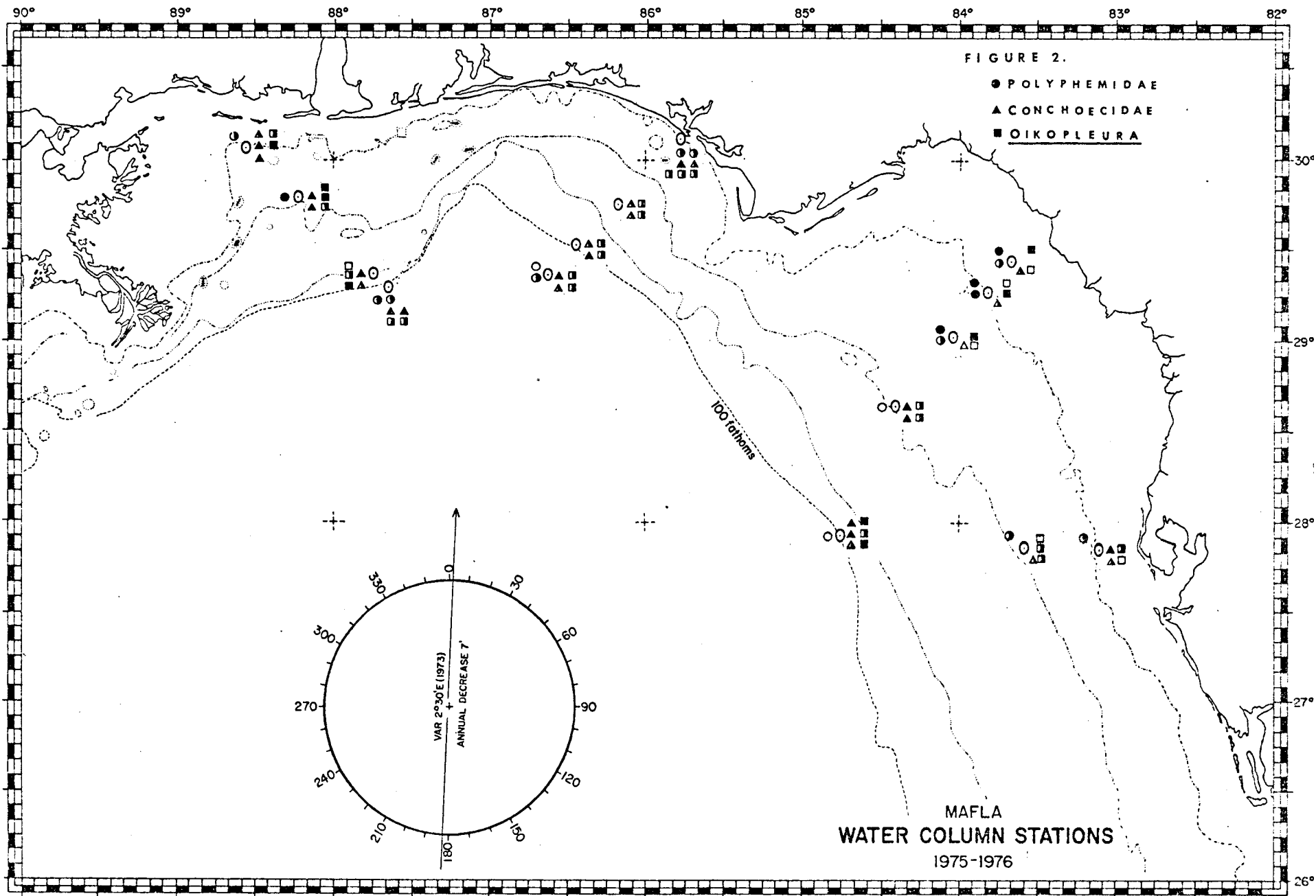

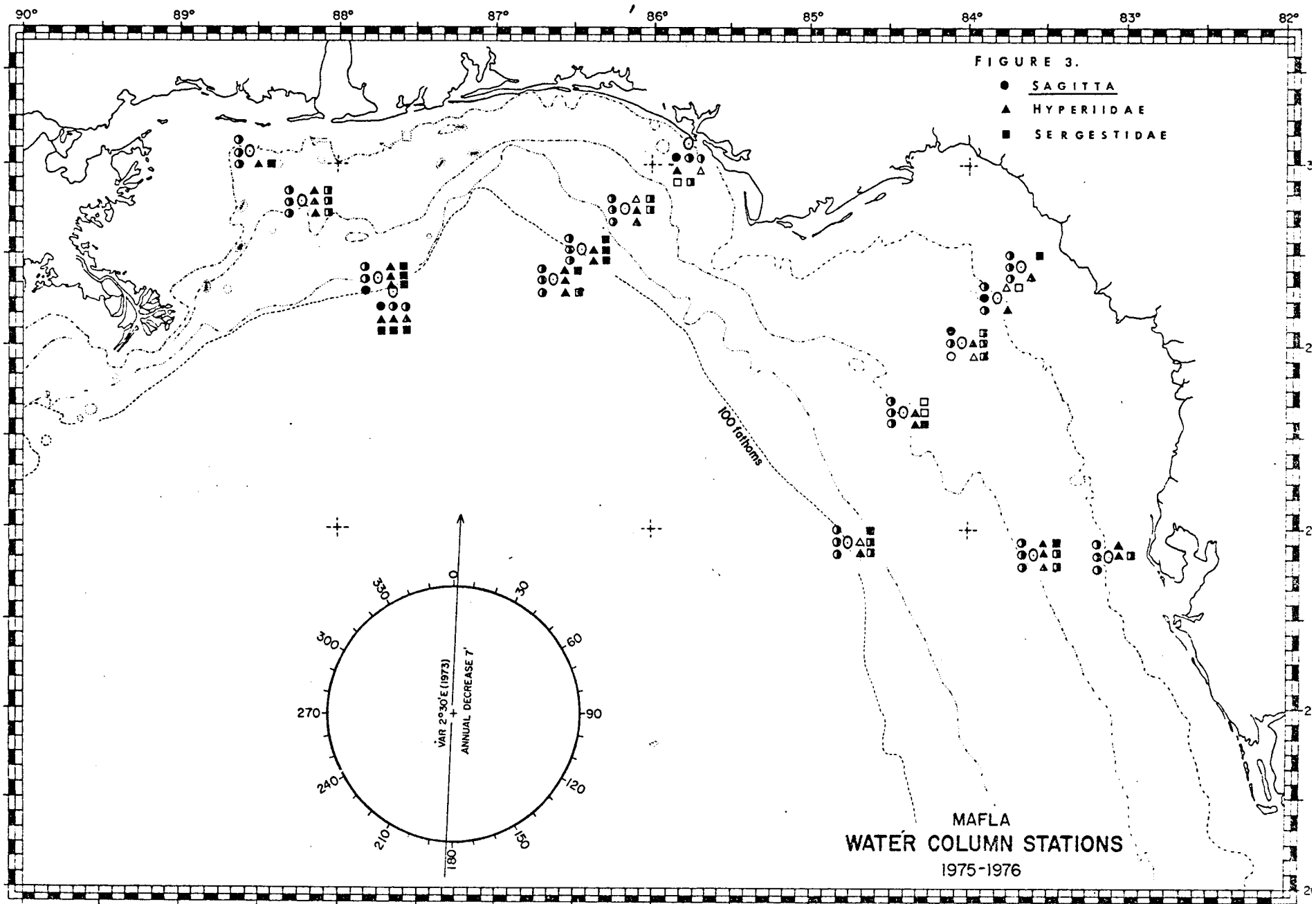
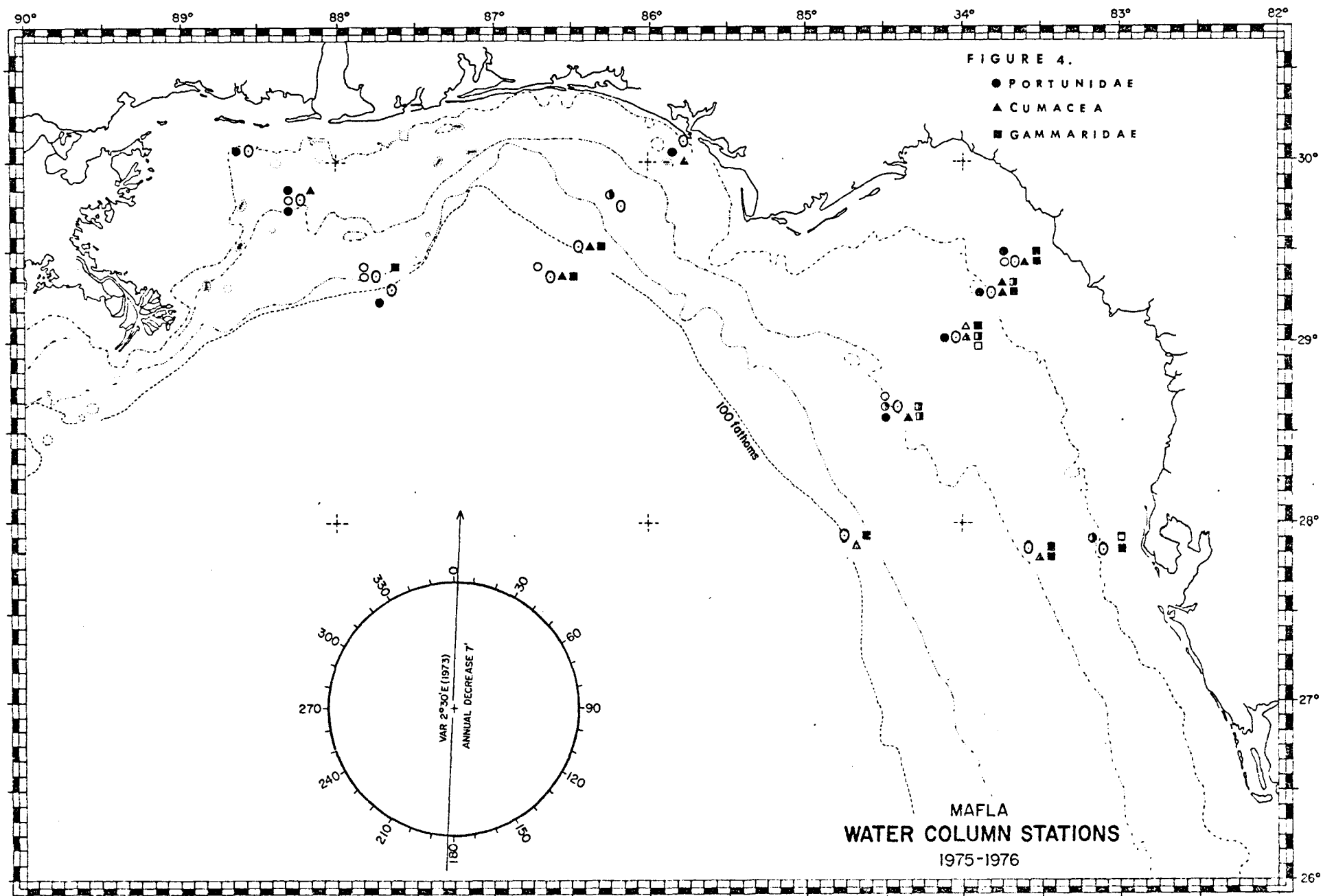
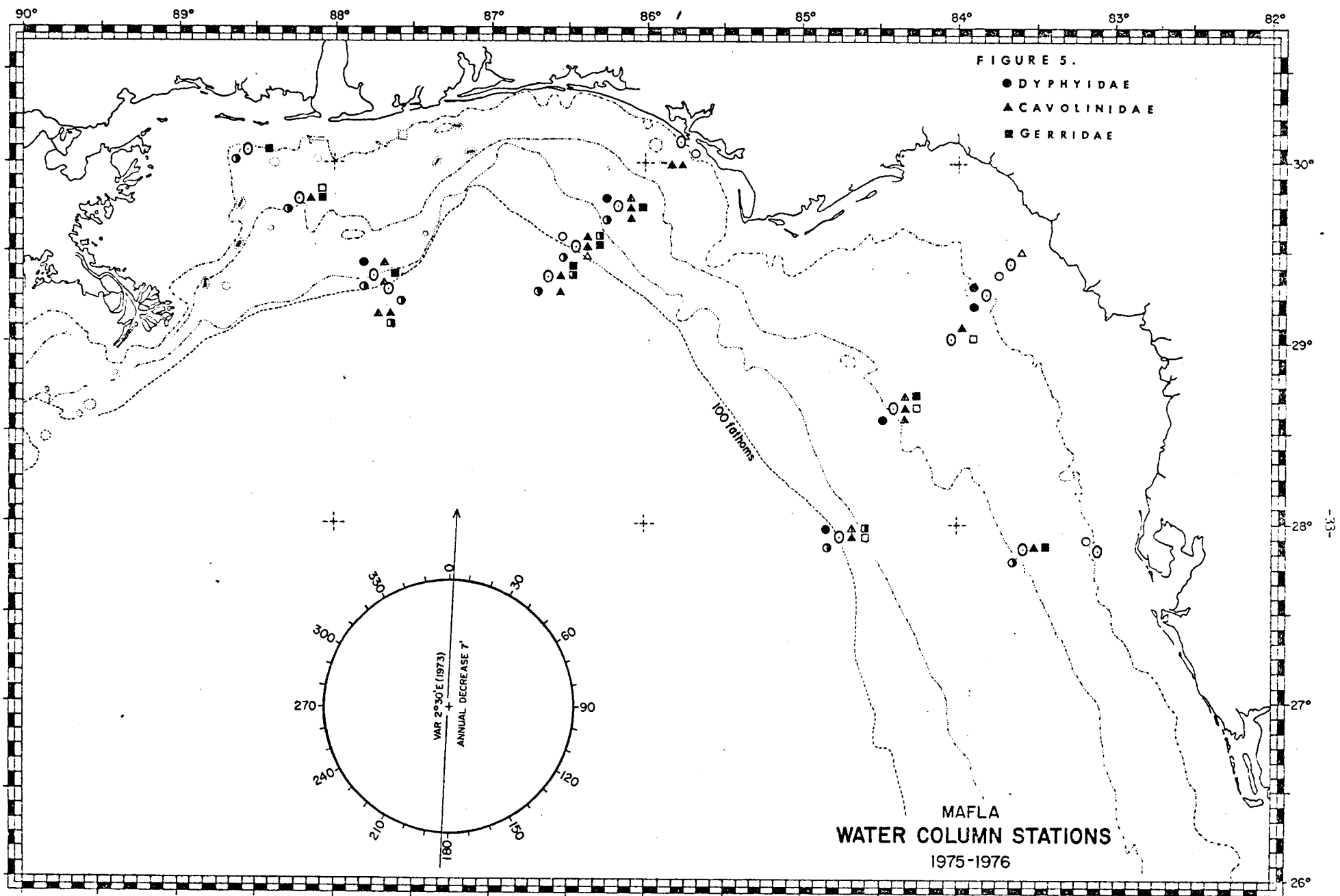

FIGURE 3.

- SAGITTA
- ▲ HYPERIIDAE
- SERGESTIDAE

MAFLA  
 WATER COLUMN STATIONS  
 1975-1976





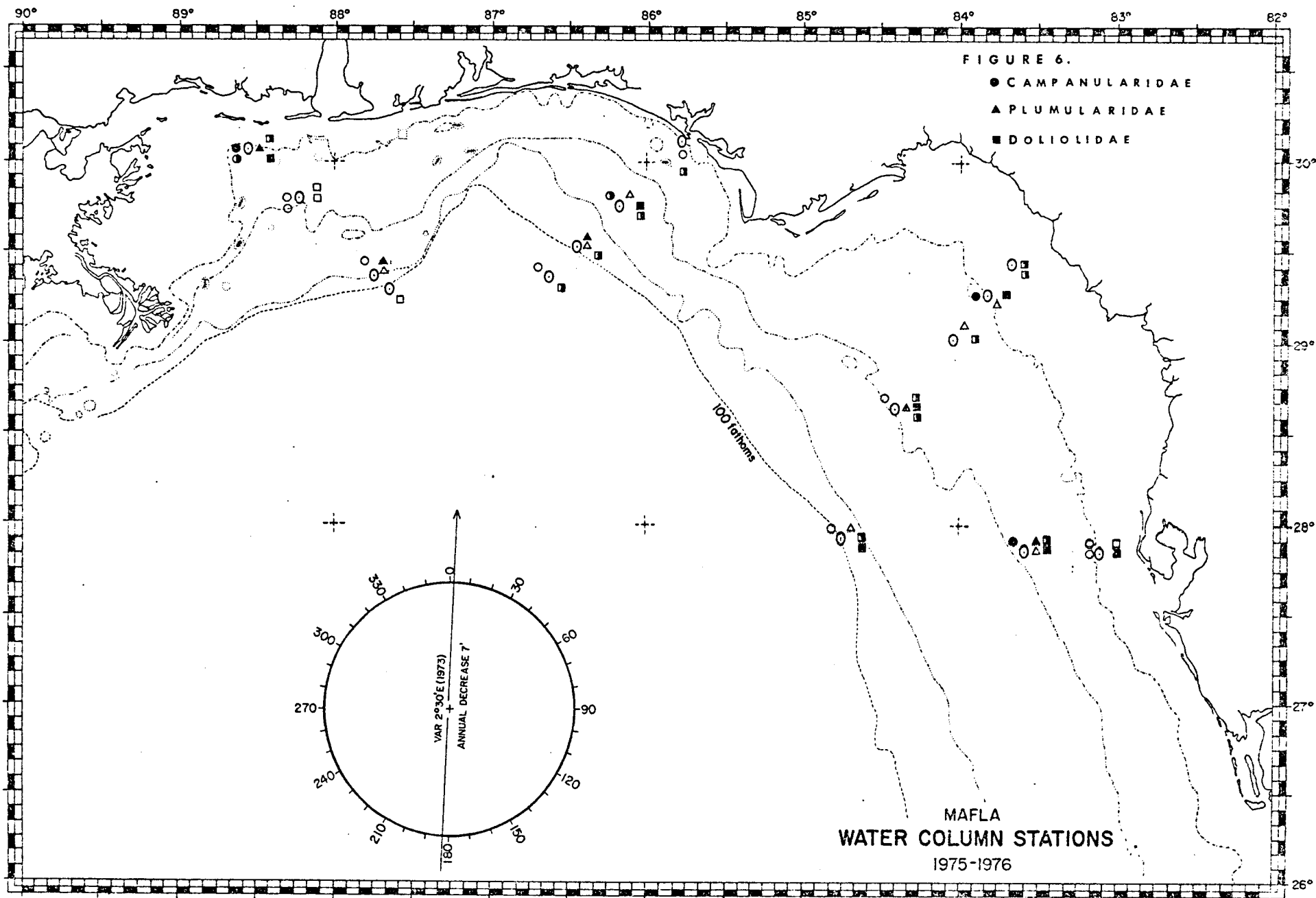

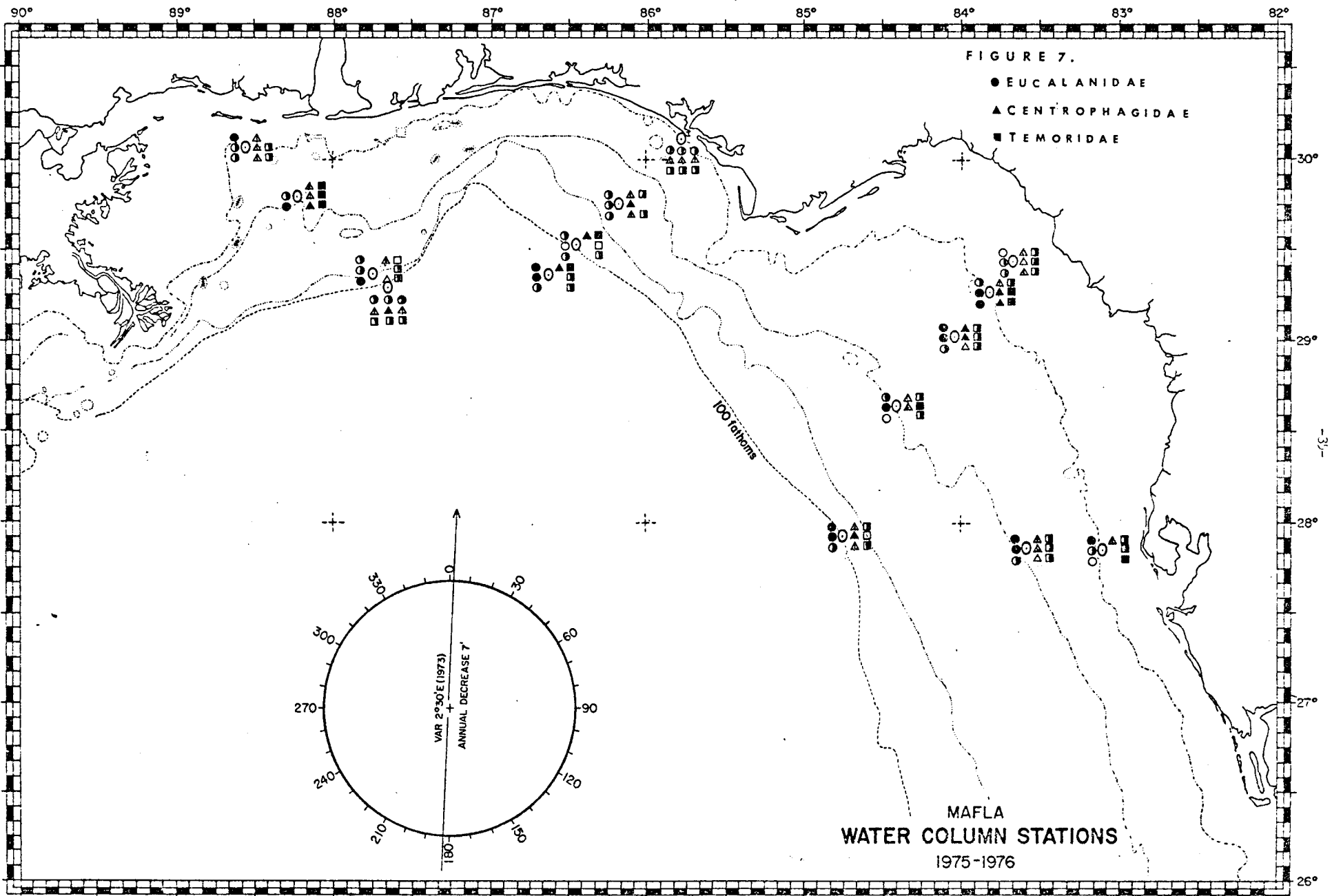

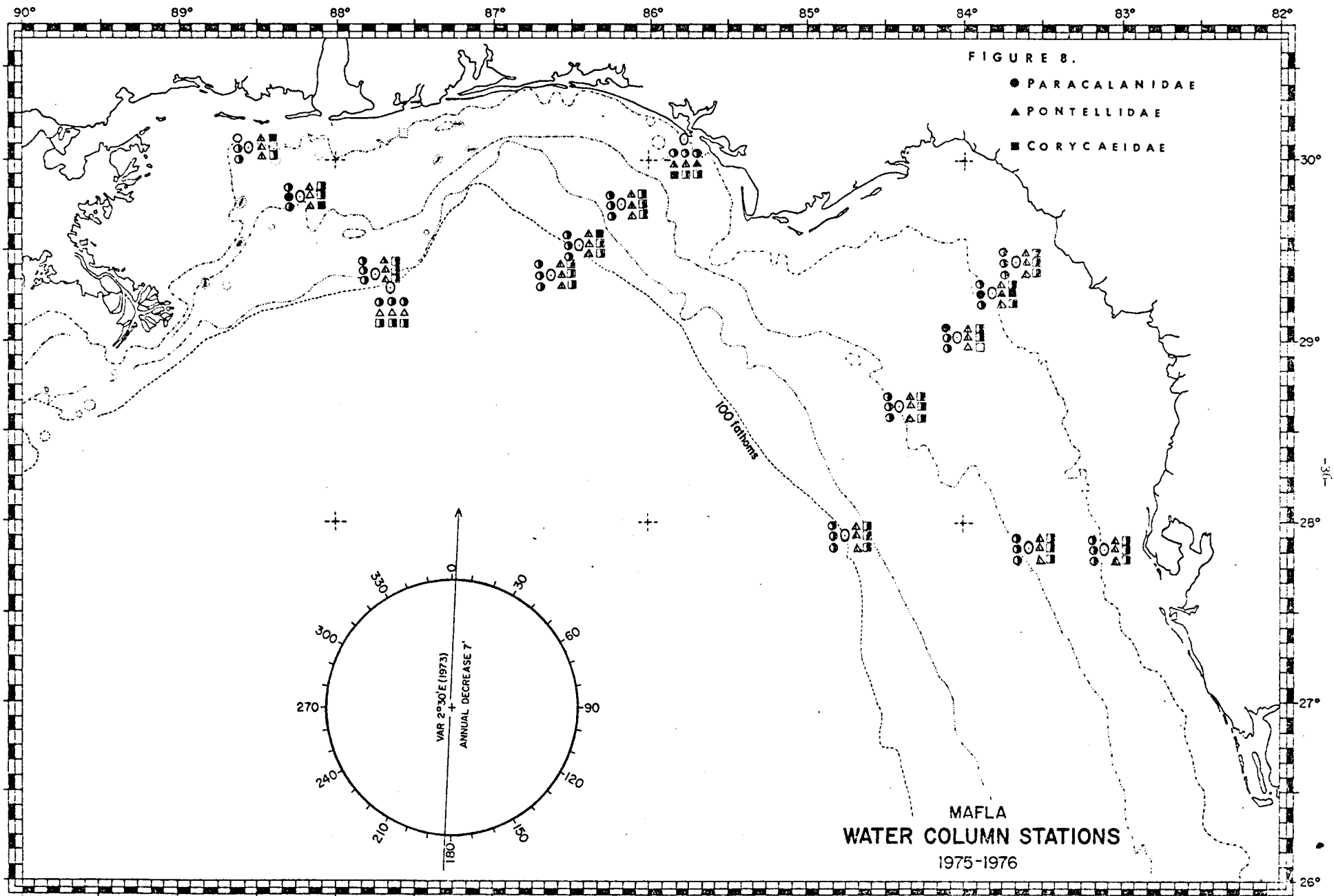

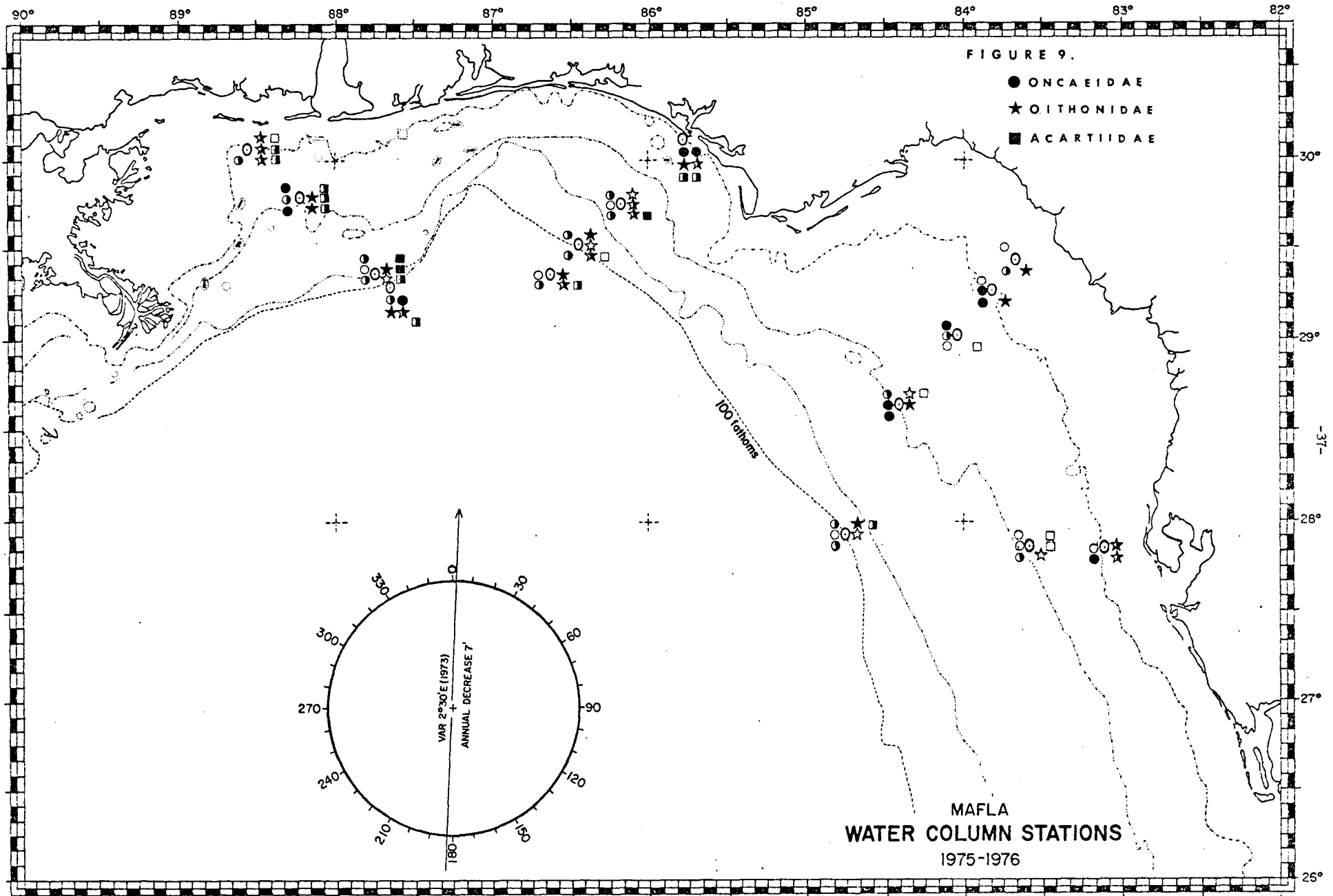



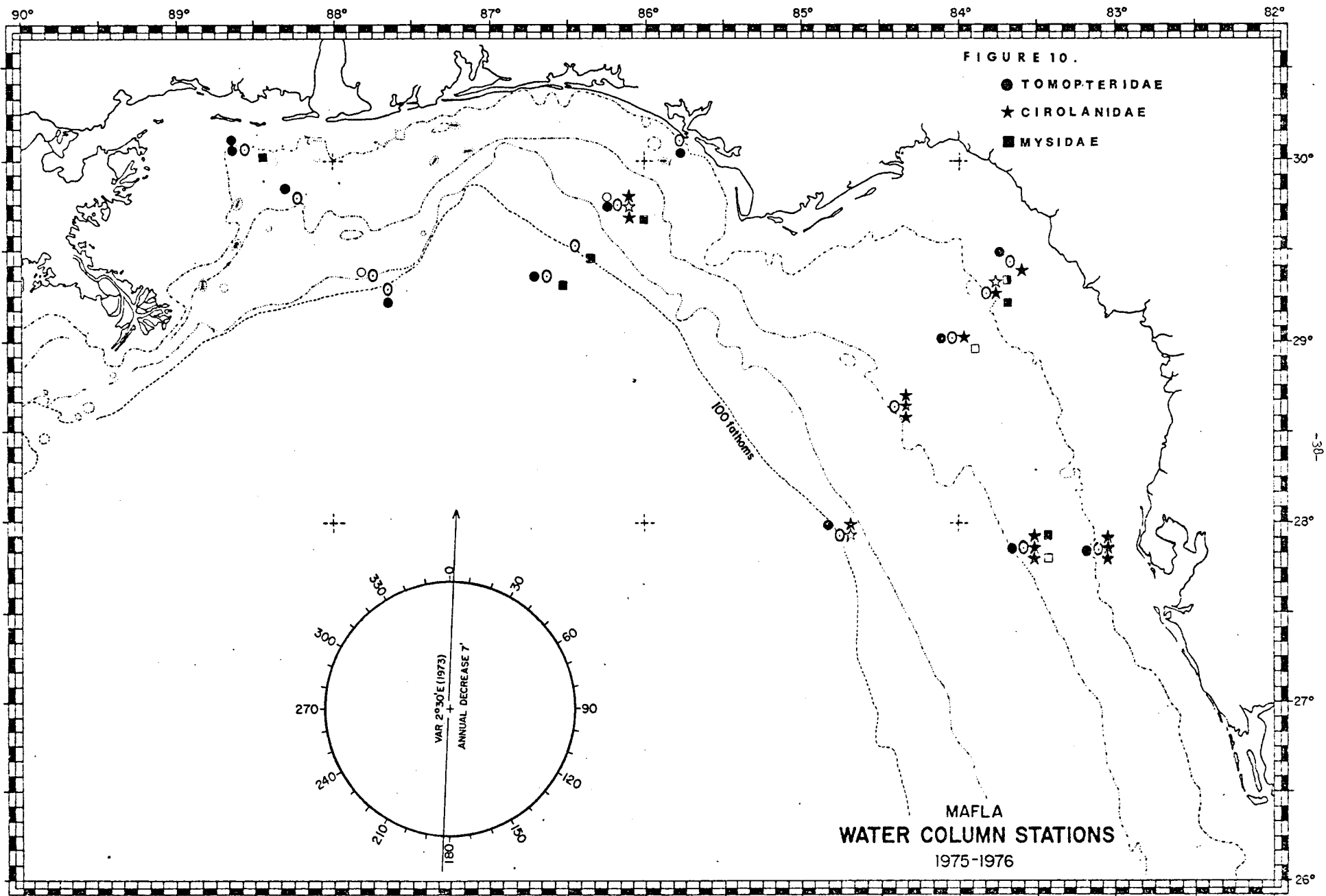

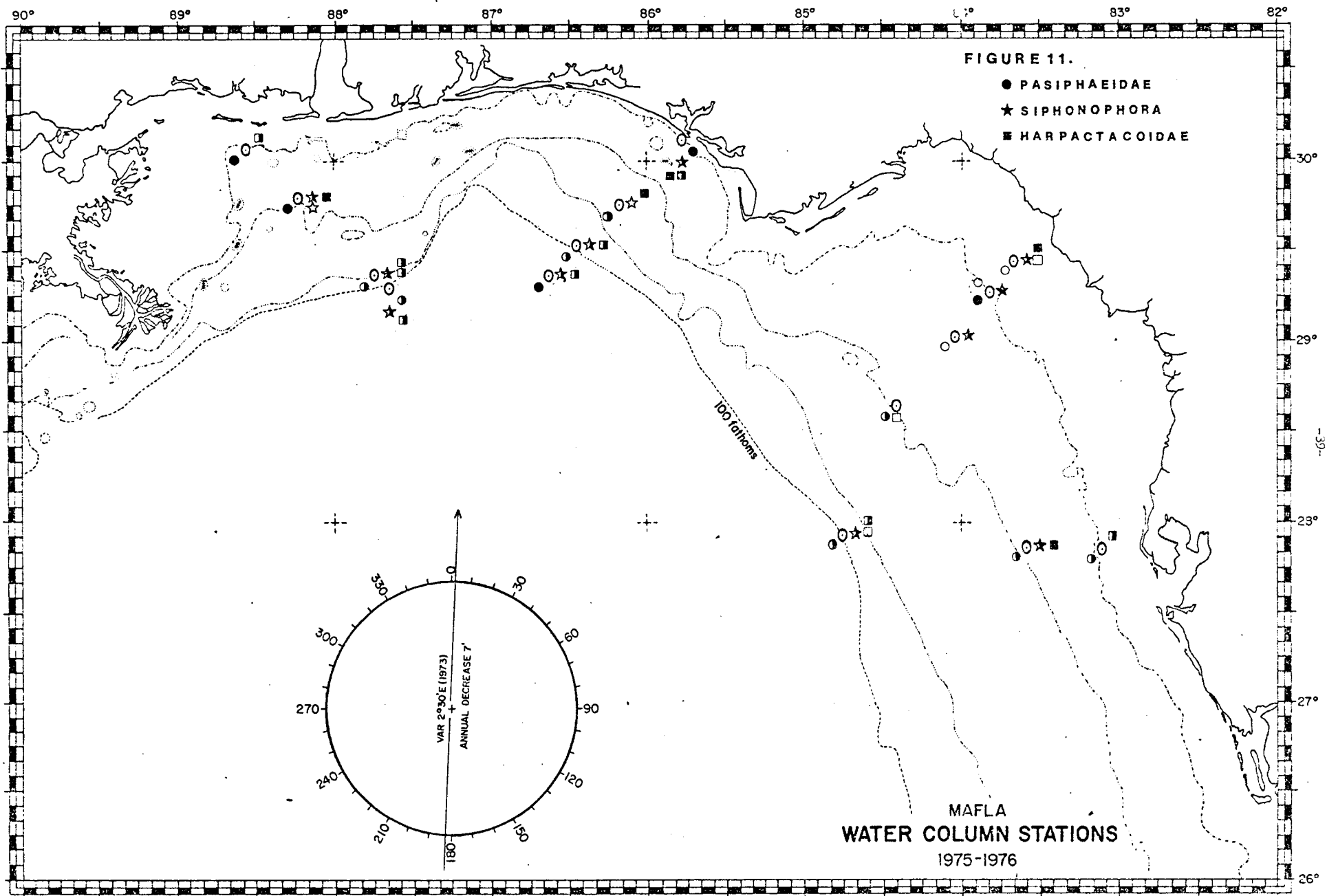

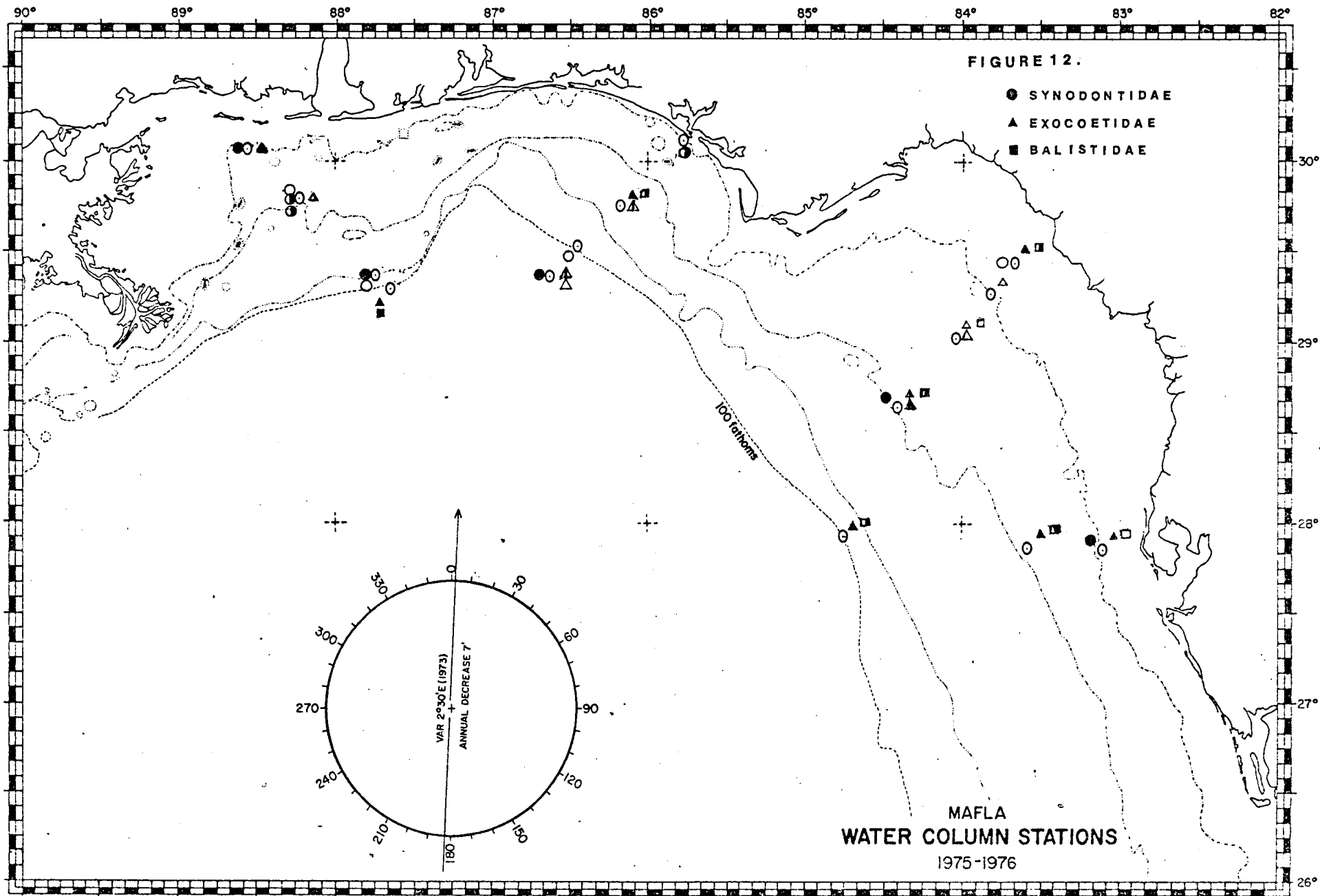

# LEGEND

-41-

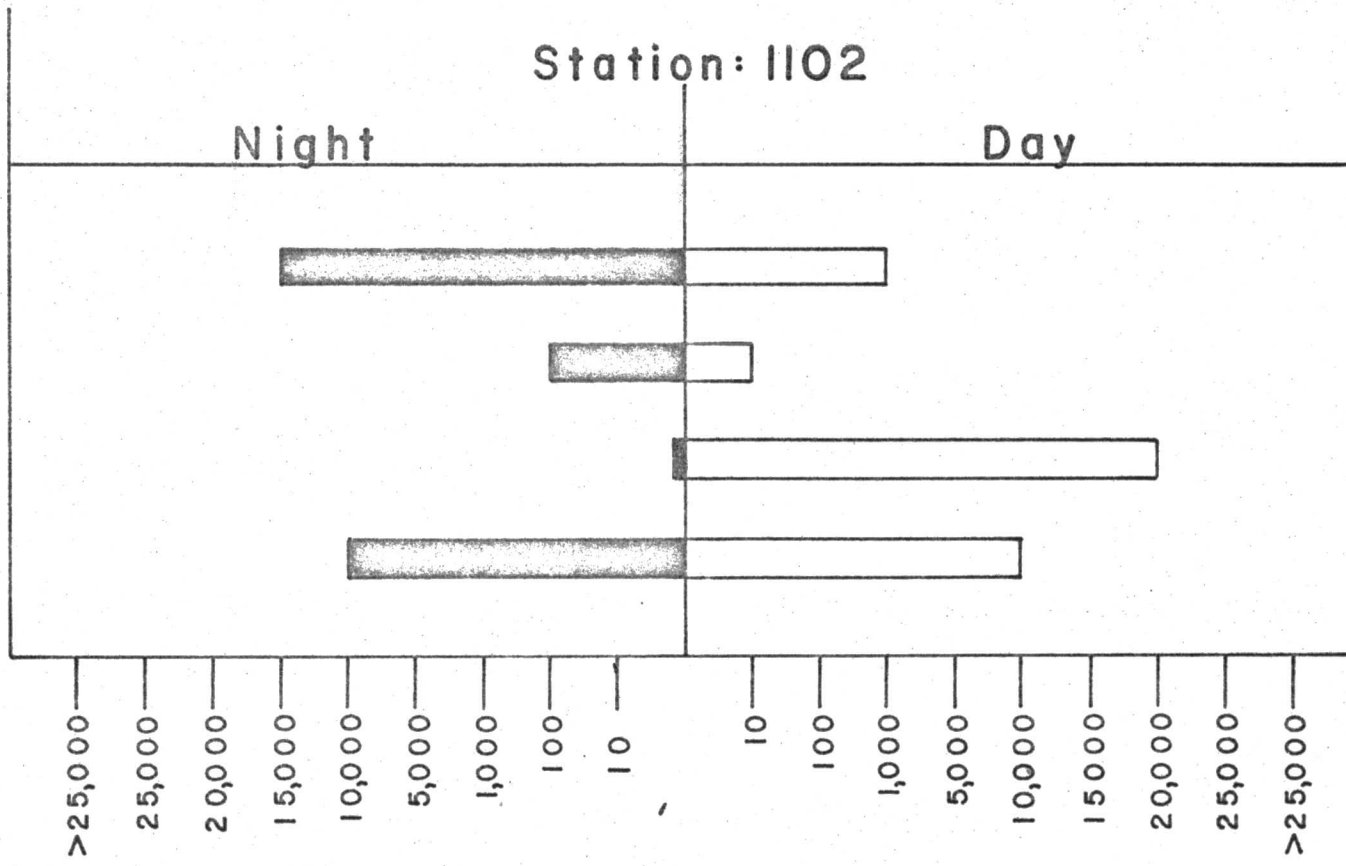

Figure 13. Day-night occurrence of adult copepod families collected on Transect IV during June-July, 1975 (see Fig. 1 for station locations). Horizontal bars represent the exponential number of individuals captured per minute. Solid bars = night; clear = day collections.

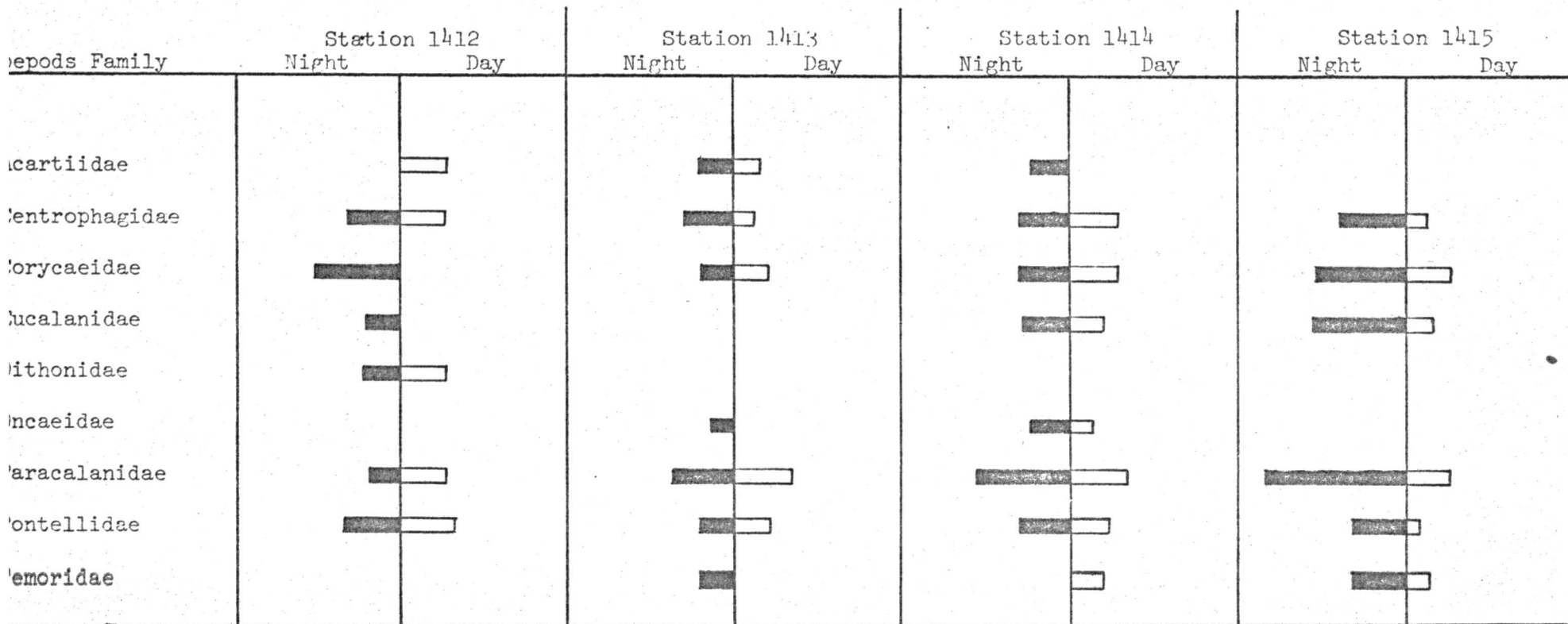

Figure 14. Day-night occurrence of adult copepod families collected on Transect IV during September-October, 1975 (see Fig. 1 for station locations). Horizontal bars represent the exponential number of individuals captured per minute. Solid bars = night; clear = day collections.

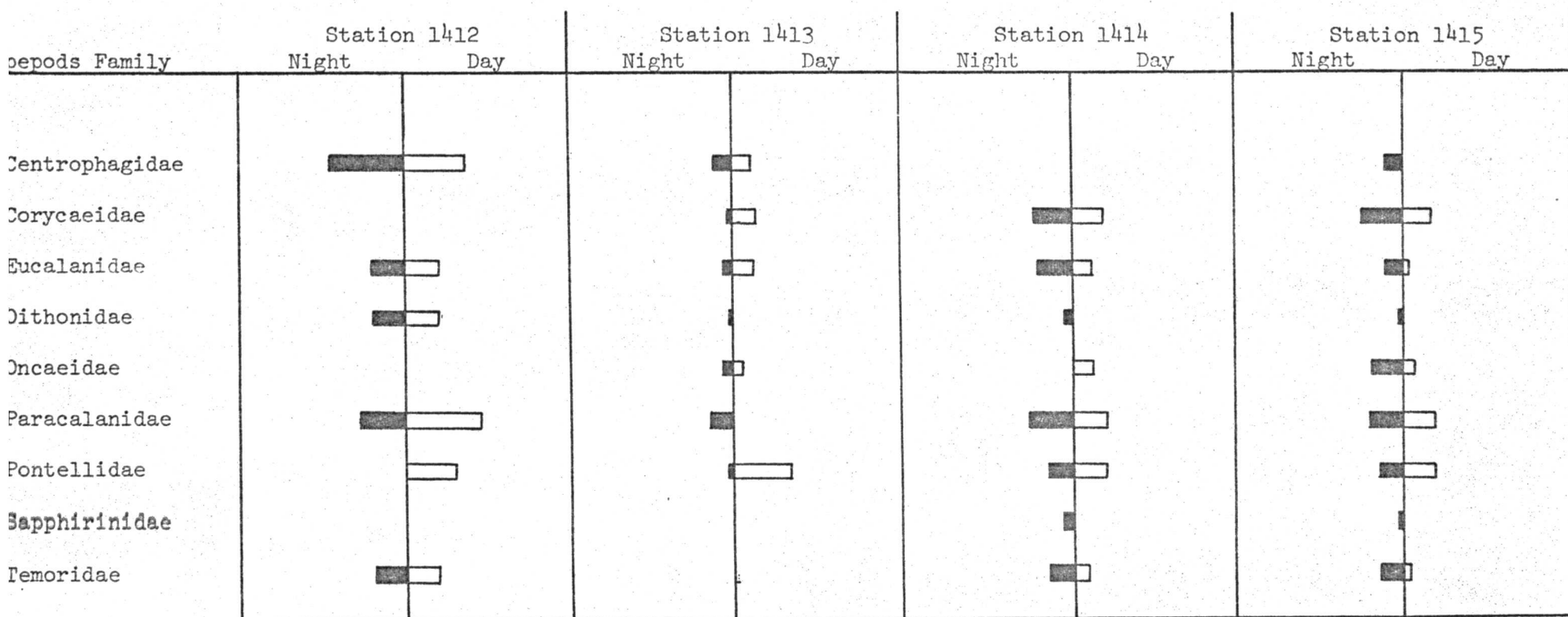

Figure 15. Day-night occurrence of adult copepod families collected on Transect IV during January-February, 1976 (see Fig. 1 for station locations). Horizontal bars represent the exponential number of individuals captured per minute. Solid bars = night; clear = day collections.

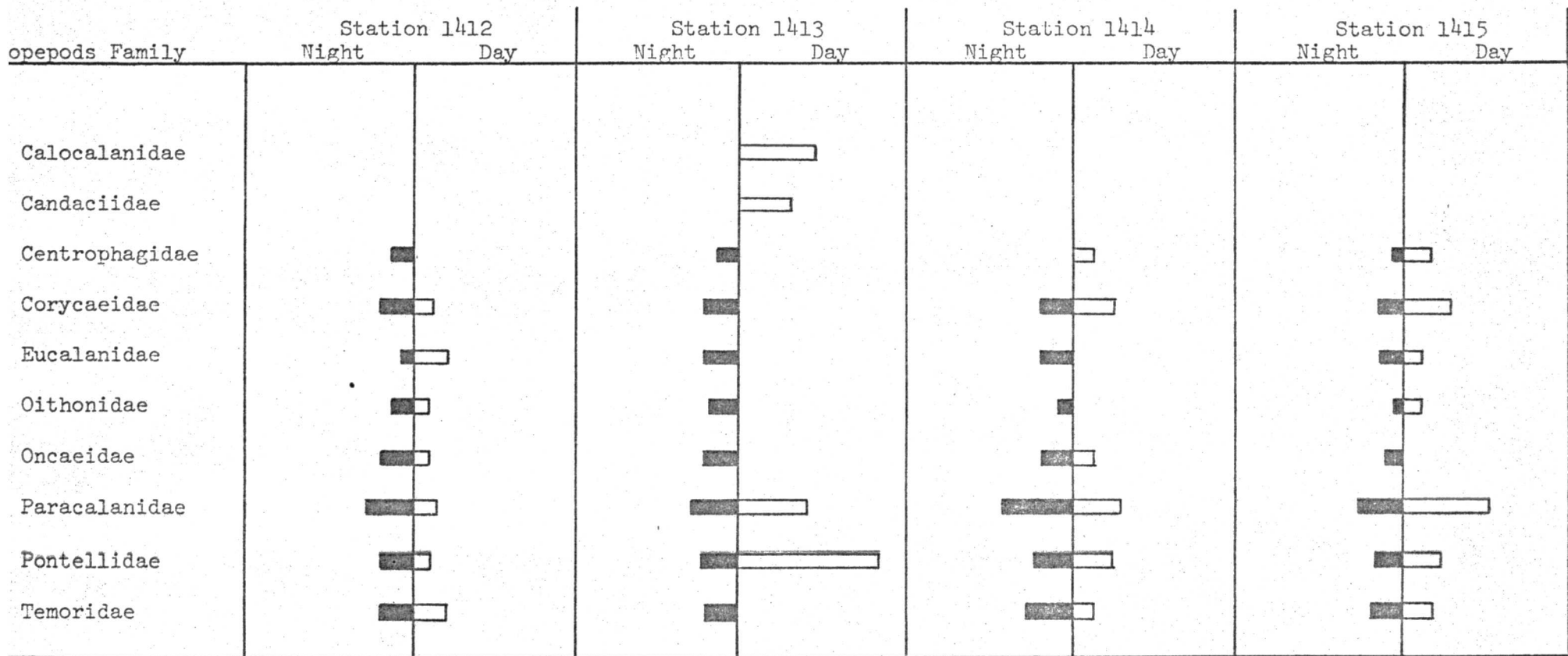

Figure 16. Day-night occurrence of adult copepod families collected on Transect III during June-July, 1975 (see Fig. 1 for station locations). Horizontal bars represent the exponential number of individuals captured per minute. Solid bars = night; clear = day collections.

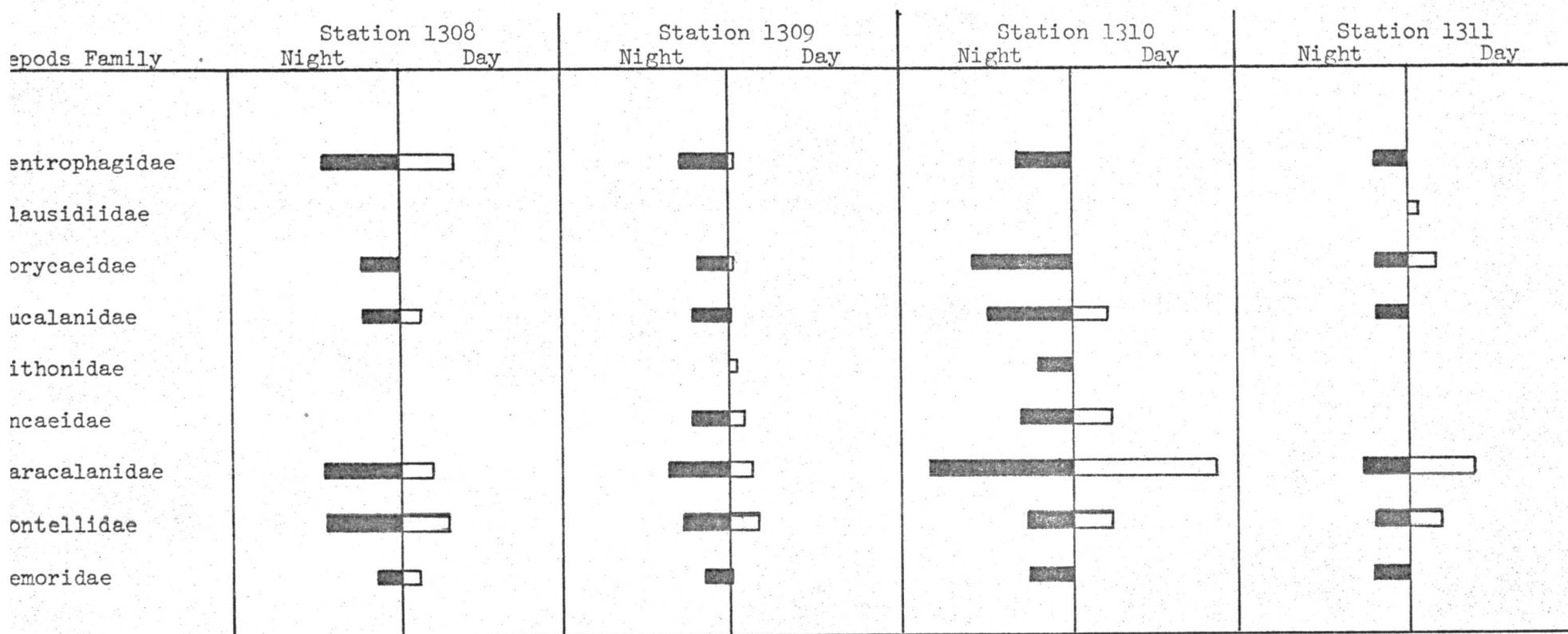



Figure 17. Day-night occurrence of adult copepod families collected on Transect III during September-October, 1975 (see Fig. 1 for station locations). Horizontal bars represent the exponential number of individuals captured per minute. Solid bars = night; clear = day collections.

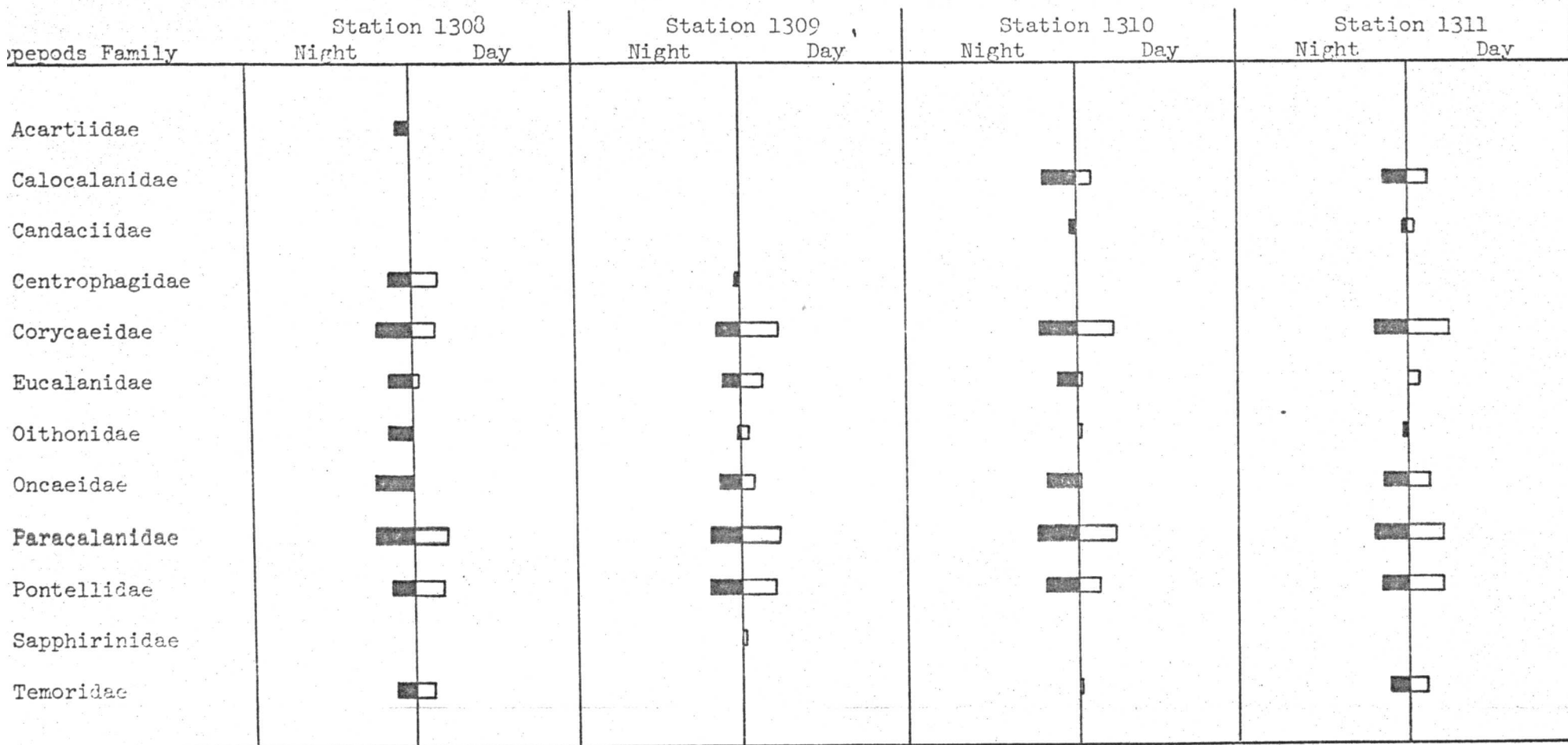

Figure 18. Day-night occurrence of adult copepod families collected on Transect III during January-February, 1976 (see Fig. 1 for station locations). Horizontal bars represent the exponential number of individuals captured per minute. Solid bars = night; clear = day collections.

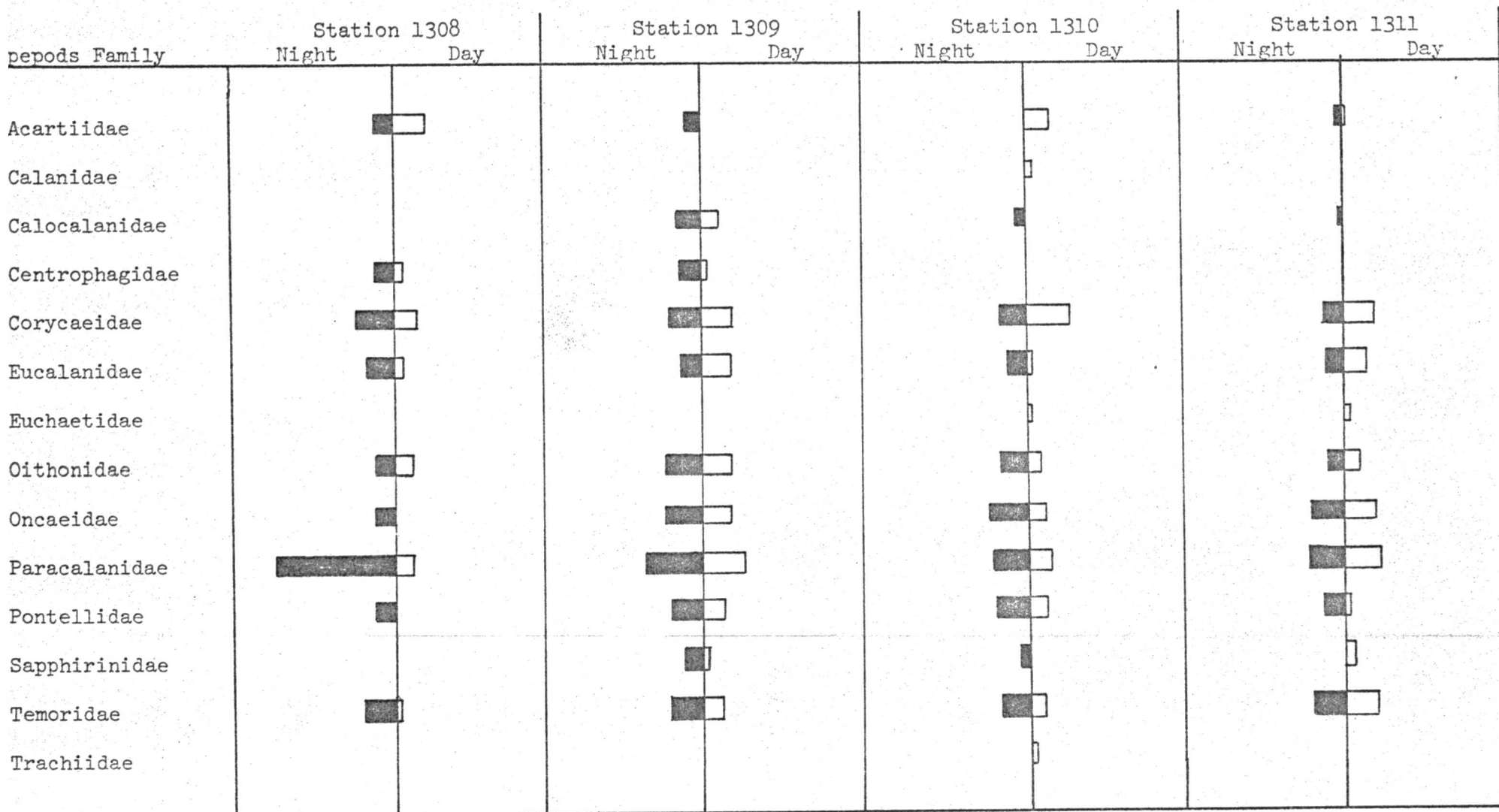

Figure 19. Day- night occurrence of adult copepod families collected on Transect II during June-July 1975 (see Fig. 1 for station locations). Horizontal bars represent the exponential number of individuals captured per minute. Solid bars = night; clear = day collections.

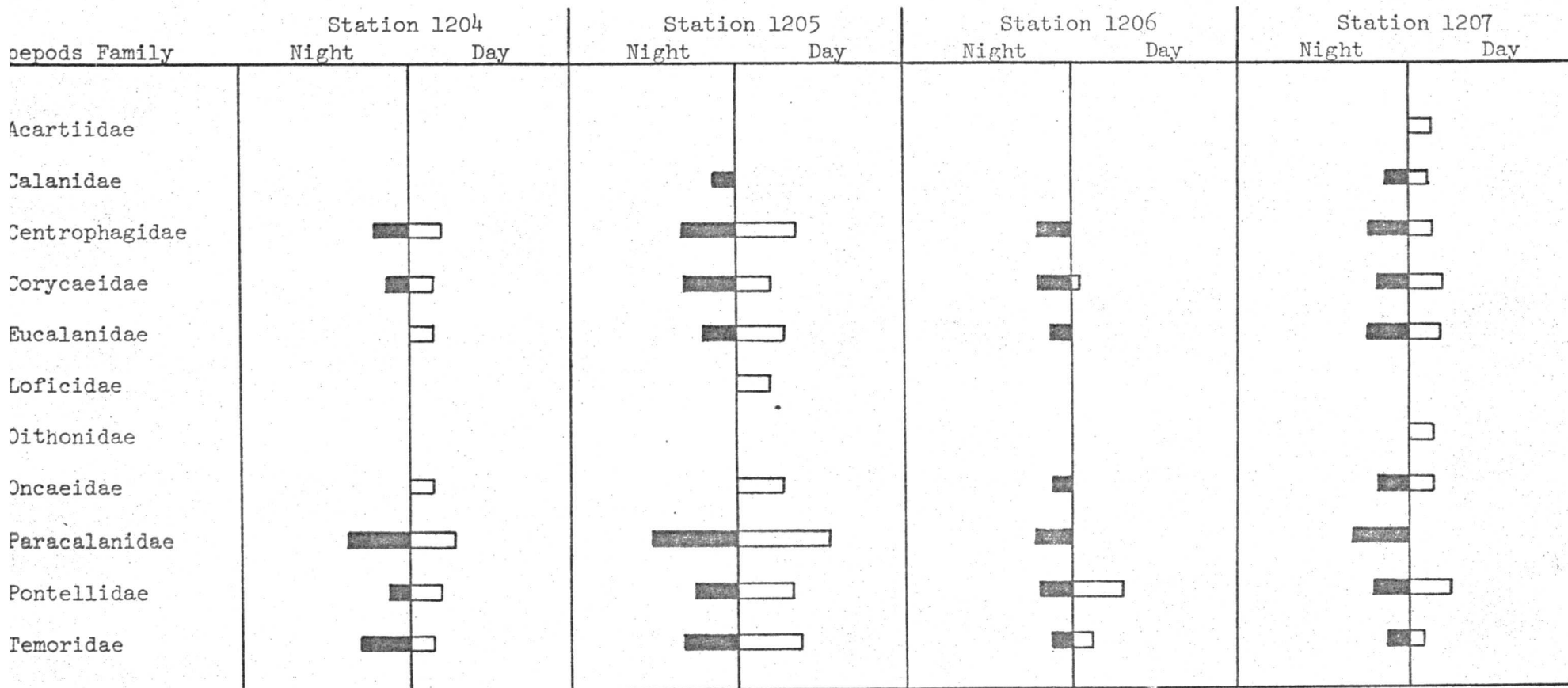

Figure 20. Day-night occurrence of adult copepod families collected on Transect II during September-October, 1975 (see Fig. 1 for station locations). Horizontal bars represent the exponential number of individuals captured per minute. Solid bars = night; clear = day collections.

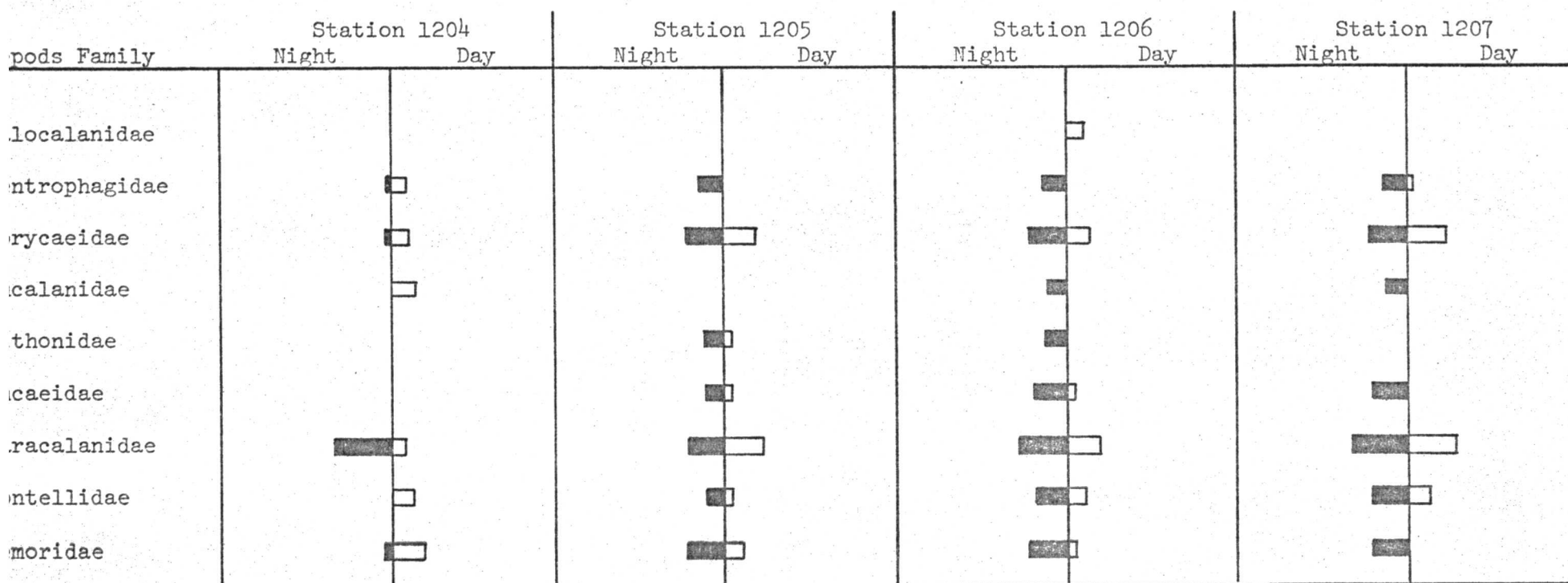

Figure 21. Day-night occurrence of adult copepod families collected on Transect II during January-February, 1976 (see Fig. 1 for station locations). Horizontal bars represent the exponential number of individuals captured per minute. Solid bars = night; clear = day collections.

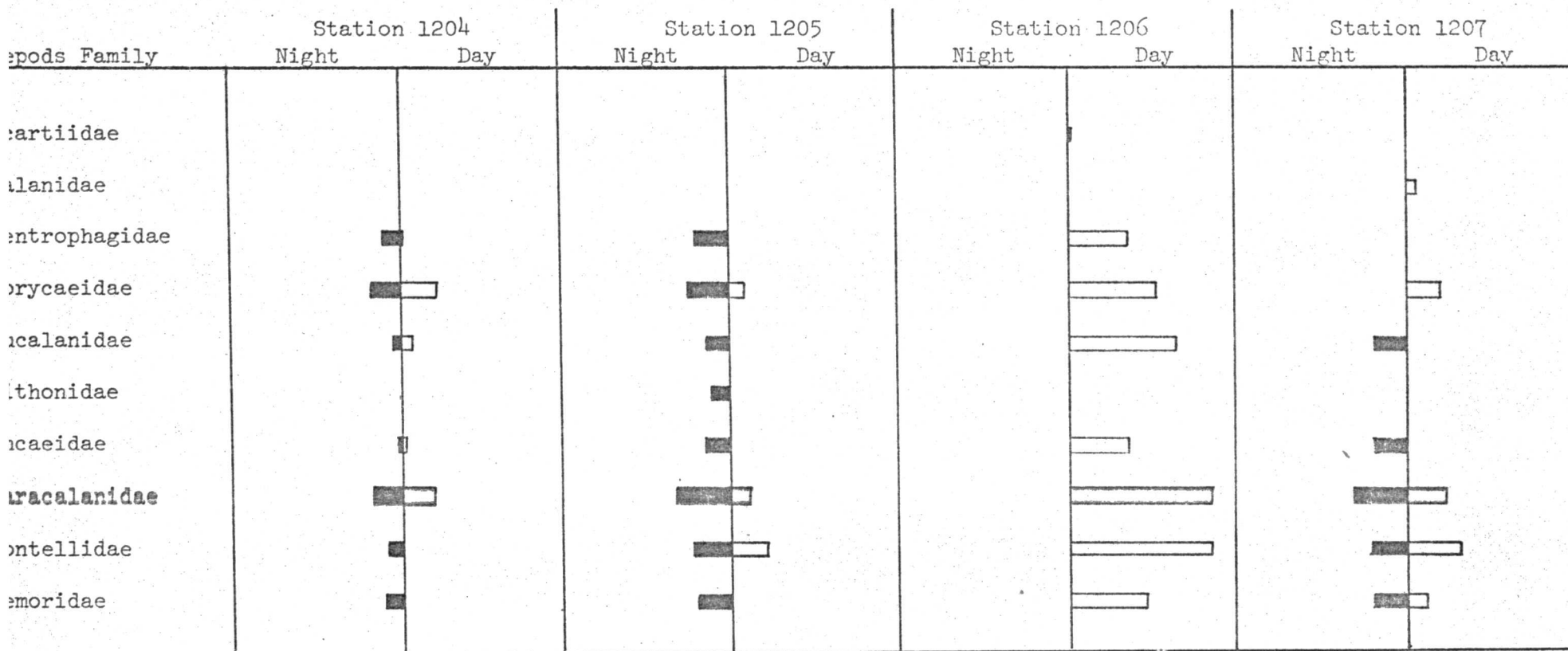

Figure 22. Day-night occurrence of adult copepod families collected on Transect I during June-July, 1975 (see Fig. 1 for station locations). Horizontal bars represent the exponential number of individuals captured per minute. Solid bars = night; clear = day collections.

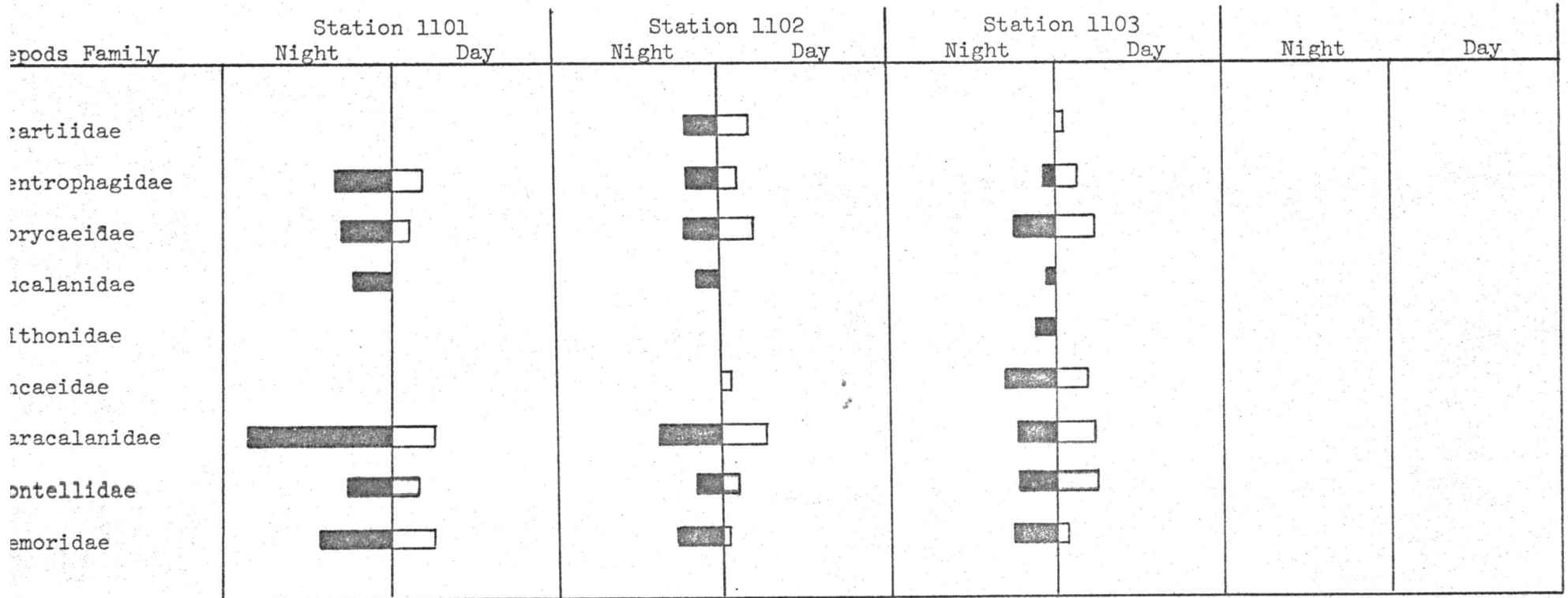

Figure 23. Day-night occurrence of adult copepod families collected on Transect I during September-October, 1975 (see Fig. 1 for station locations). Horizontal bars represent the exponential number of individuals captures per minute. Solid bars = night; clear = day collections.

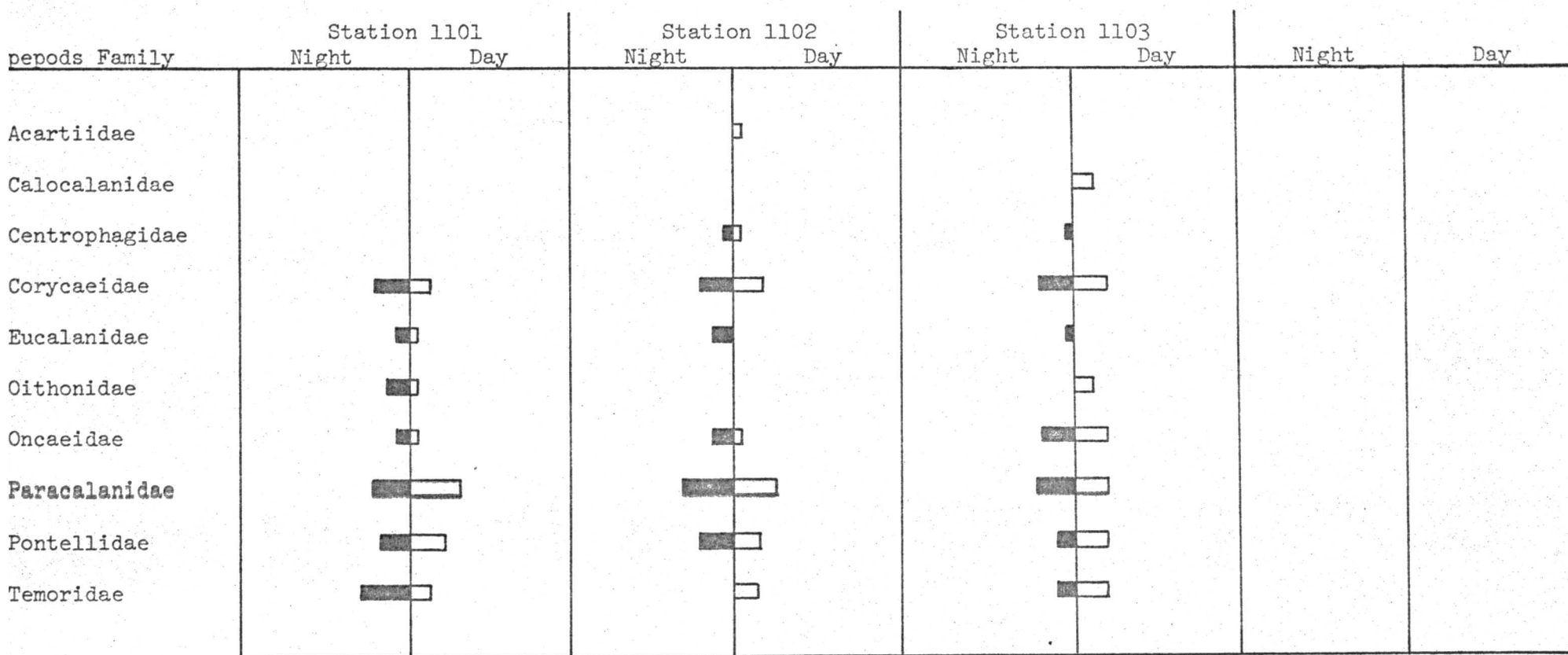

Figure 24. Day-night occurrence of adult copepod families collected on Transect I during January-February, 1976 (see Fig. 1 for station locations). Horizontal bars represent the exponential number of individuals captured per minute. Solid bars = night; clear = day collections.

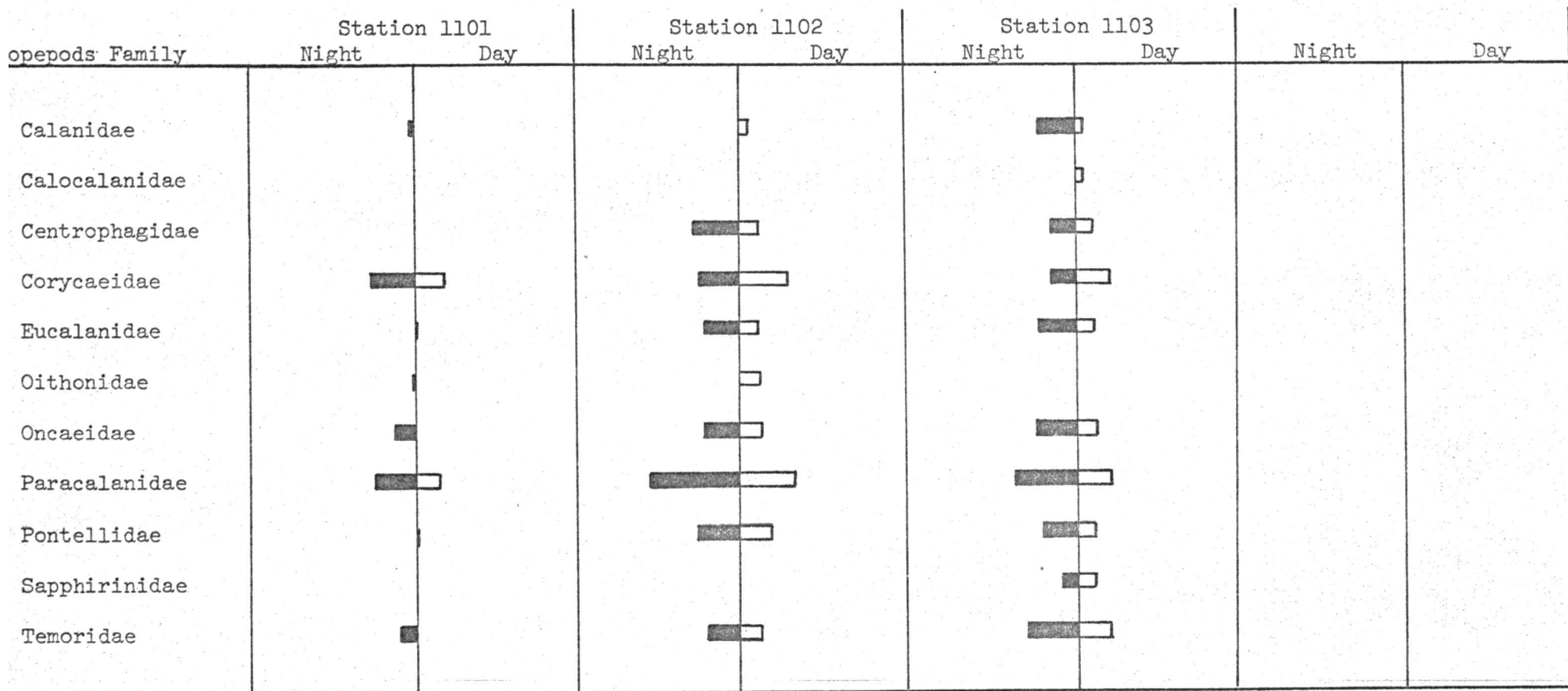



Figure 25. Day-night occurrence of adult invertebrate and fish families collected on Transect IV during June-July, 1975 (see Fig. 1 for station locations). Horizontal bars represent the exponential number of individuals captured per minute. Solid bars = night; clear = day collections.

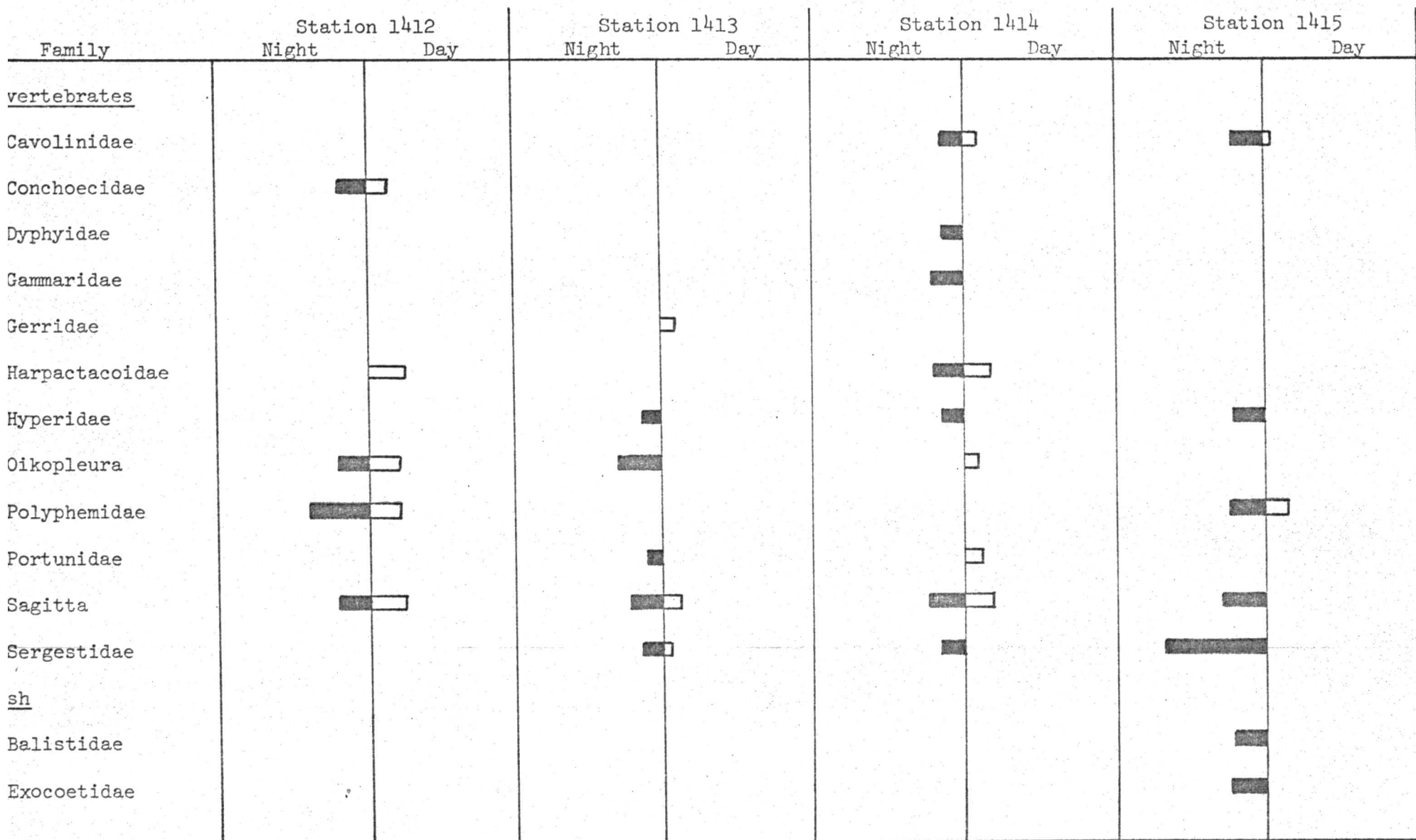

Figure 26. Day-night occurrence of adult invertebrate and fish families collected on Transect IV during September-October, 1975 (see Fig. 1 for station locations). Horizontal bars represent the exponential number of individuals captured per minute. Solid bars = night; clear = day collections.

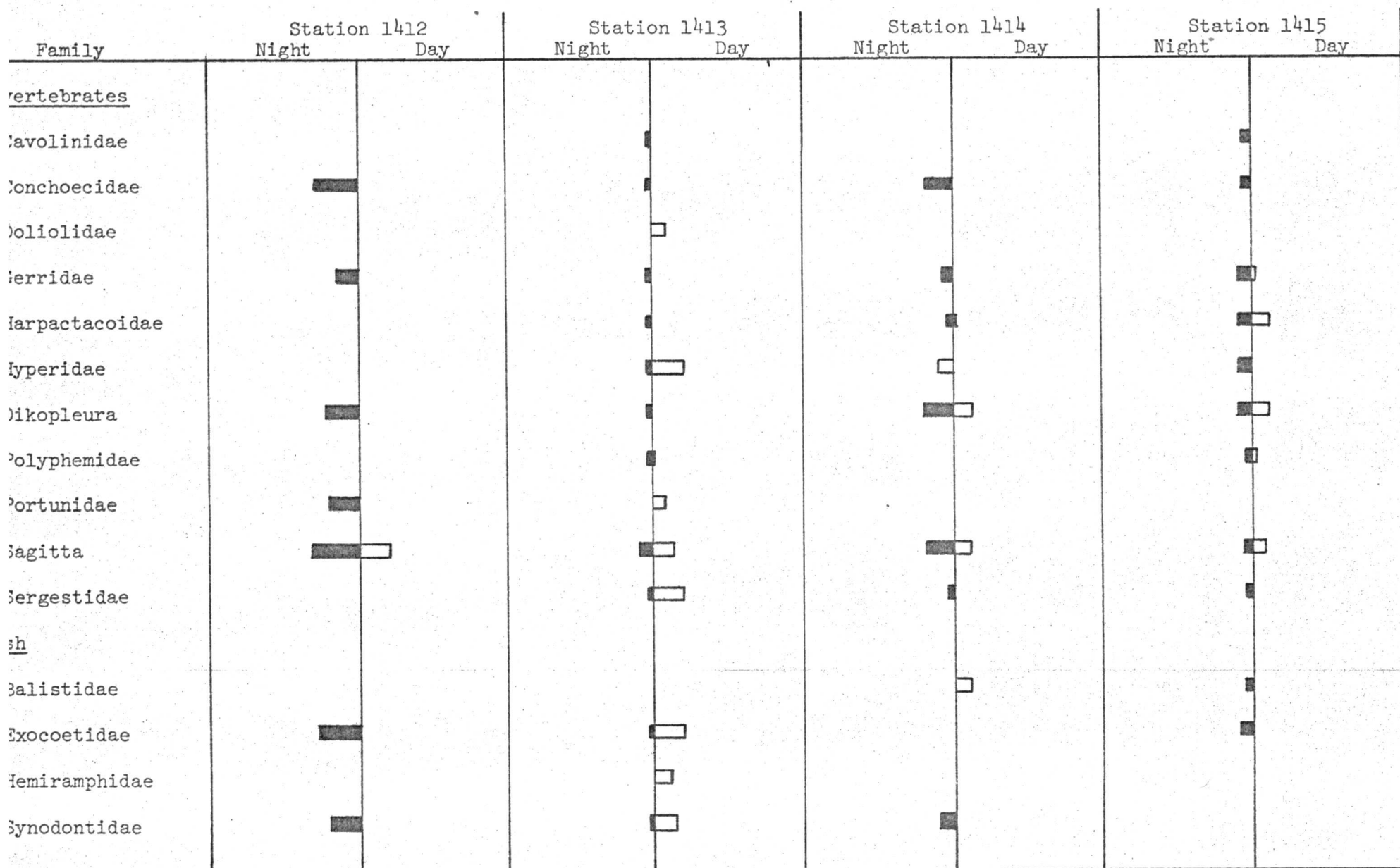

Figure 27. Day-night occurrence of adult invertebrate and fish families collected on Transect IV during January-February, 1976 (see Fig. 1 for station locations). Horizontal bars represent the exponential number of individuals captured per minute. Solid bars = night; clear = day collections.

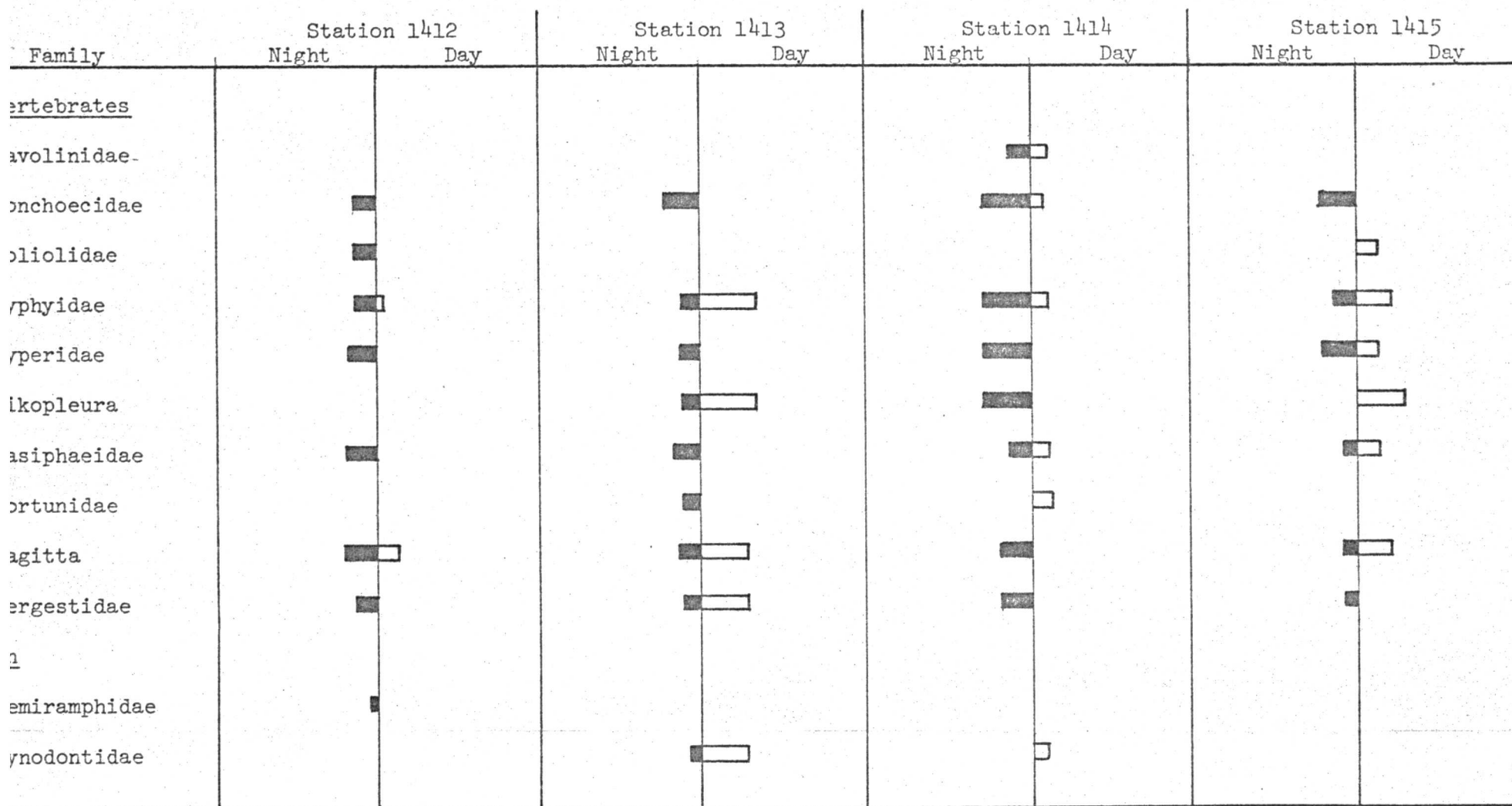

Figure 28. Day-night occurrence of adult invertebrate and fish families collected on Transect III during June-July, 1975 (see Fig. 1 for station locations). Horizontal bars represent the exponential number of individuals captured per minute. Solid bars = night; clear = day collections.

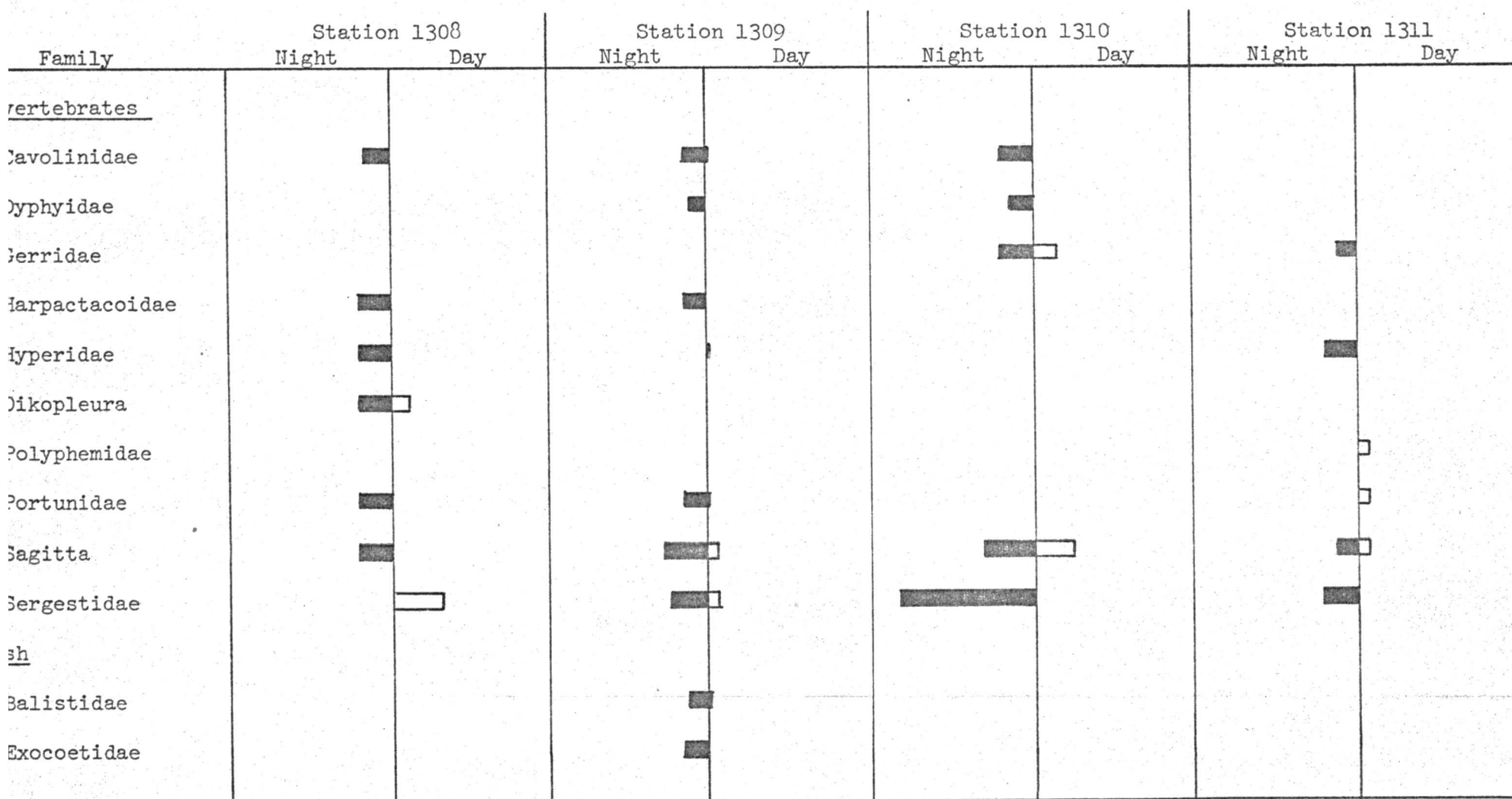

Figure 29. Day-night occurrence of adult invertebrate and fish families collected on Transect III during September-October, 1975 (see Fig. 1 for station locations). Horizontal bars represent the exponential number of individuals captured per minute. Solid bars = night; clear = day collections.

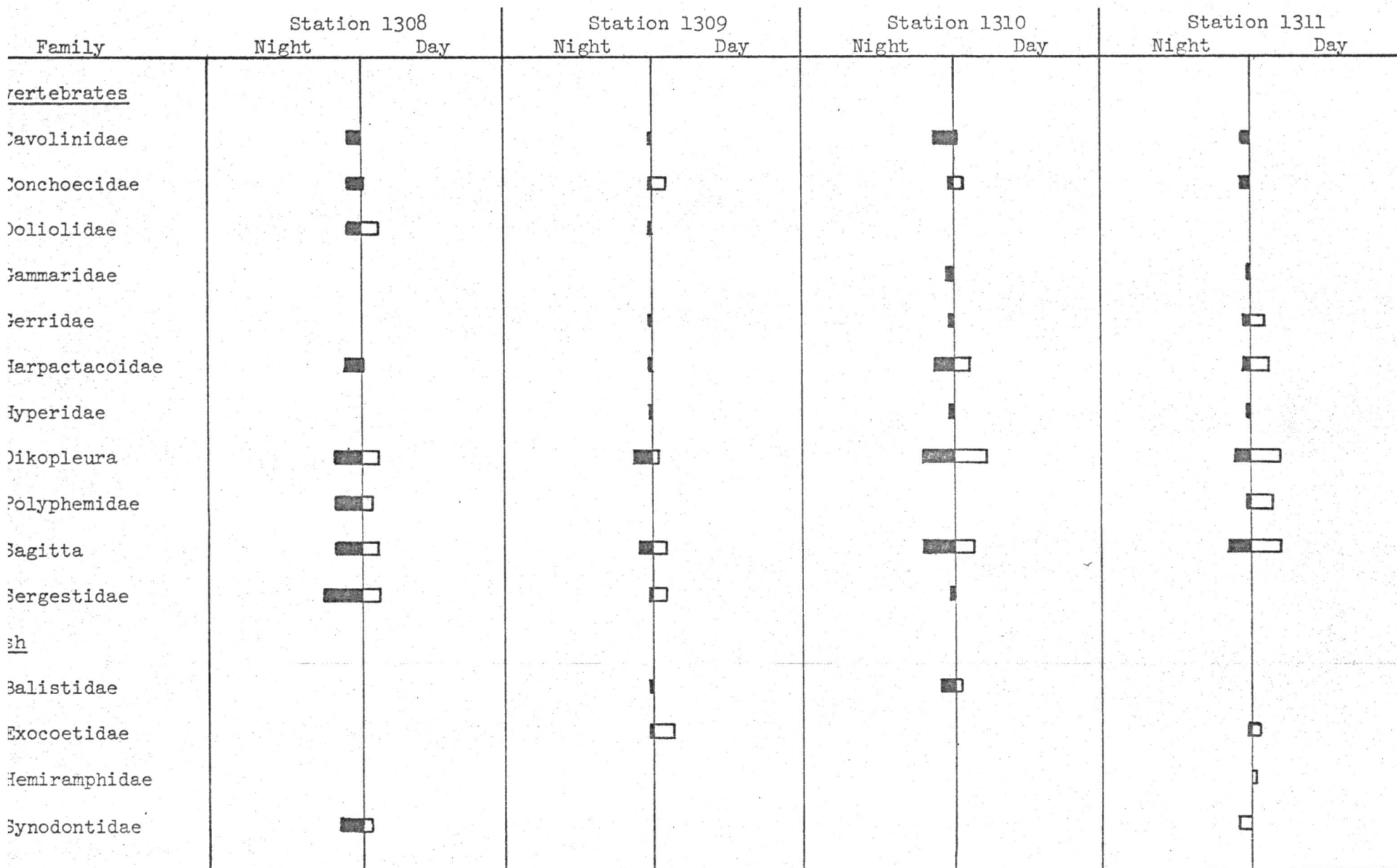

Figure 30. Day-night occurrence of adult invertebrate and fish families collected on Transect III during January-February, 1976 (see Fig. 1 for station locations). Horizontal bars represent the exponential number of individuals captured per minute. Solid bars = night; clear = day collections.

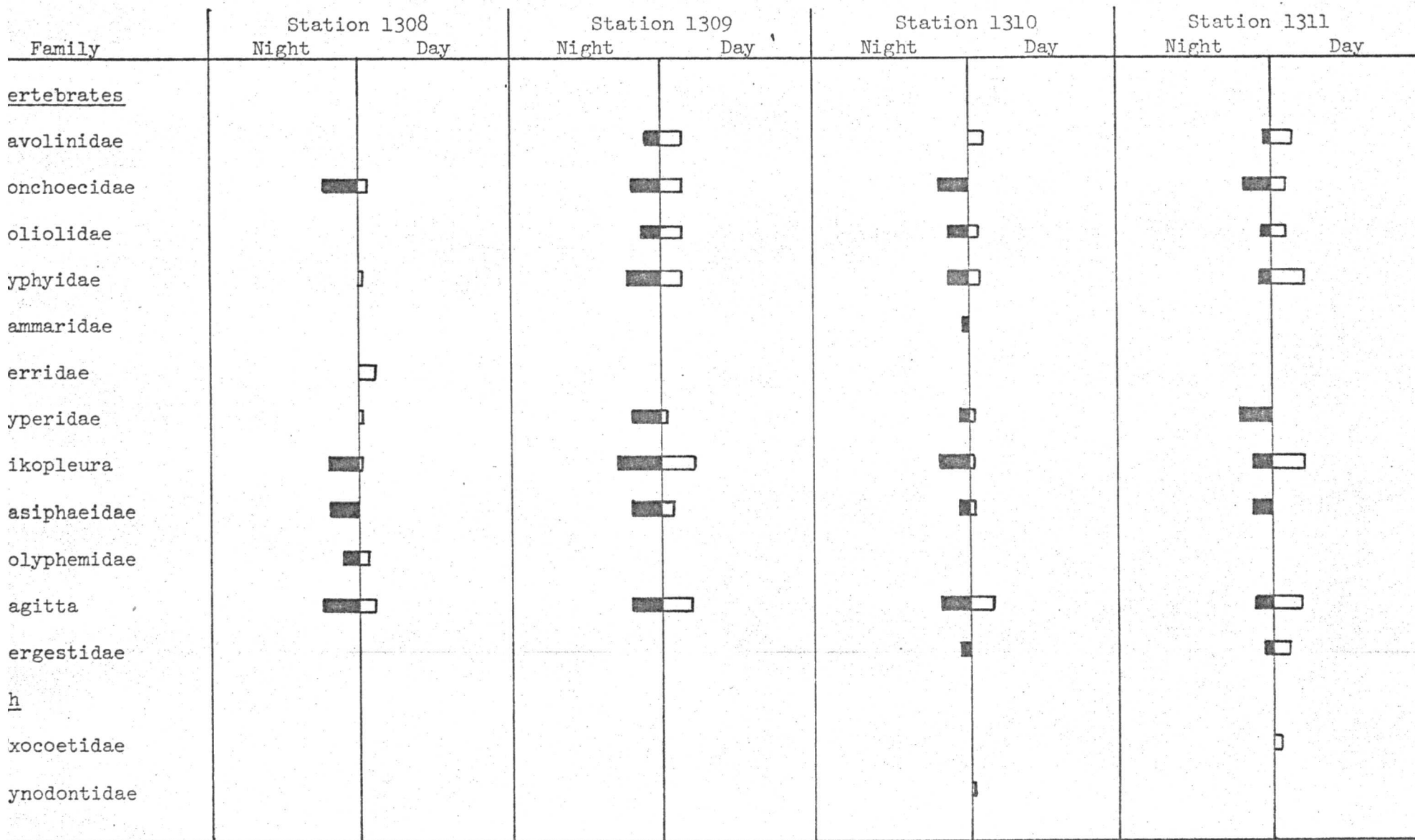

Figure 31. Day-night occurrence of adult invertebrate and fish families collected on Transect II during June-July, 1975 (see Fig. 1 for station locations). Horizontal bars represent the exponential number of individuals captured per minute. Solid bars = night; clear = day collections.

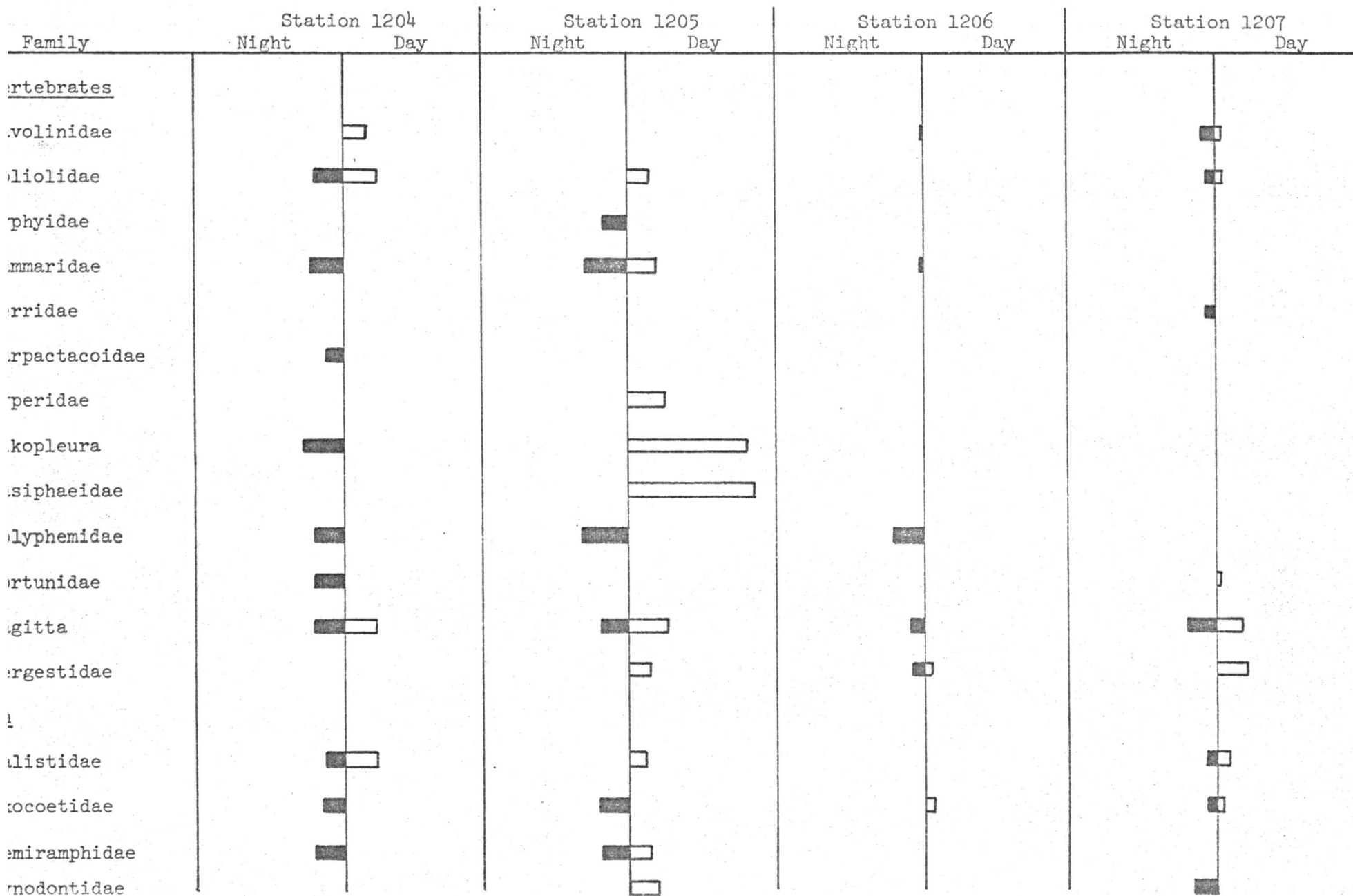

Figure 32. Day-night occurrence of adult invertebrate and fish families collected on Transect II during September-October 1975, (see Fig. 1 for station locations). Horizontal bars represent the exponential number of individuals captured per minute. Solid bars = night; clear = day collections.

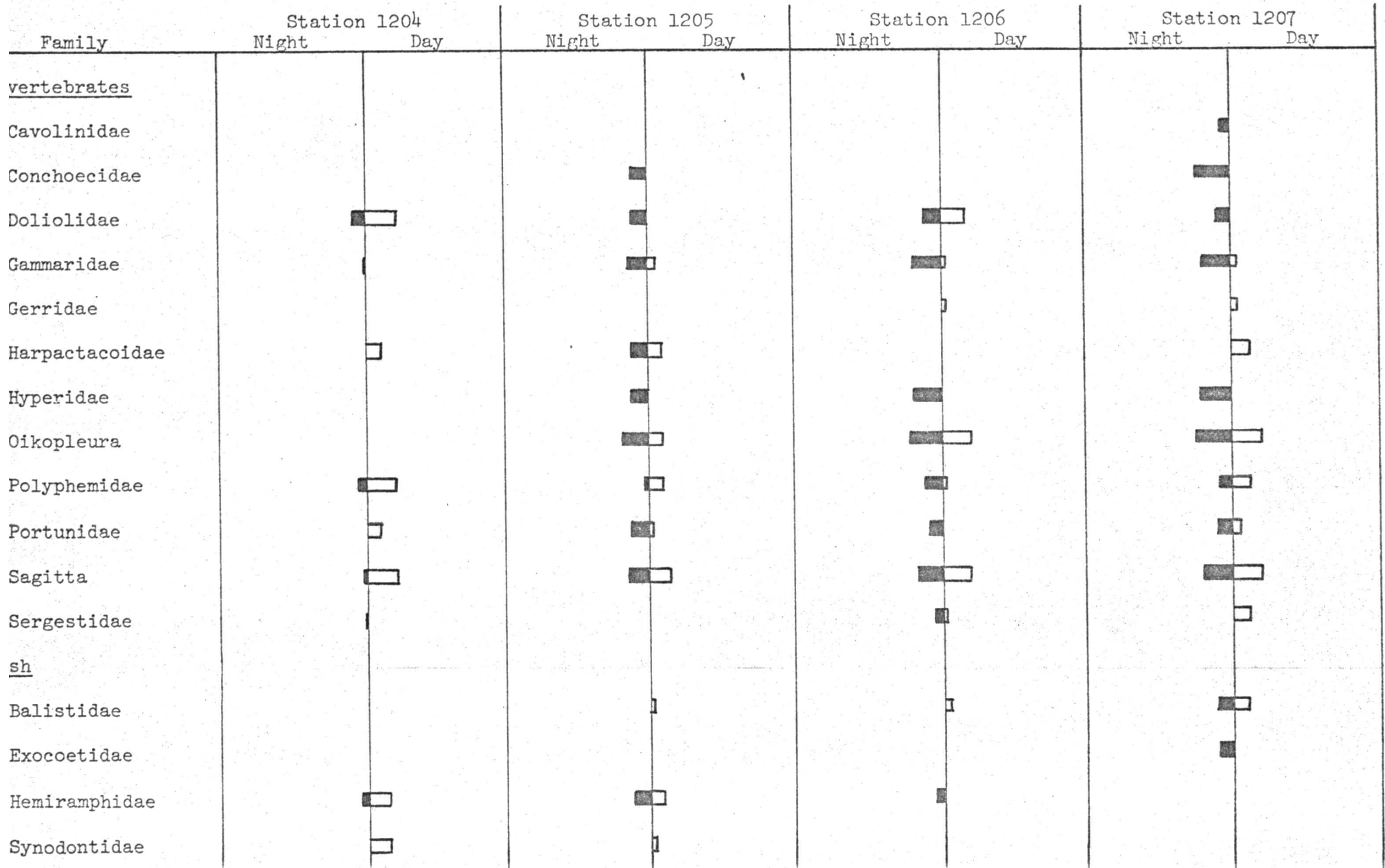
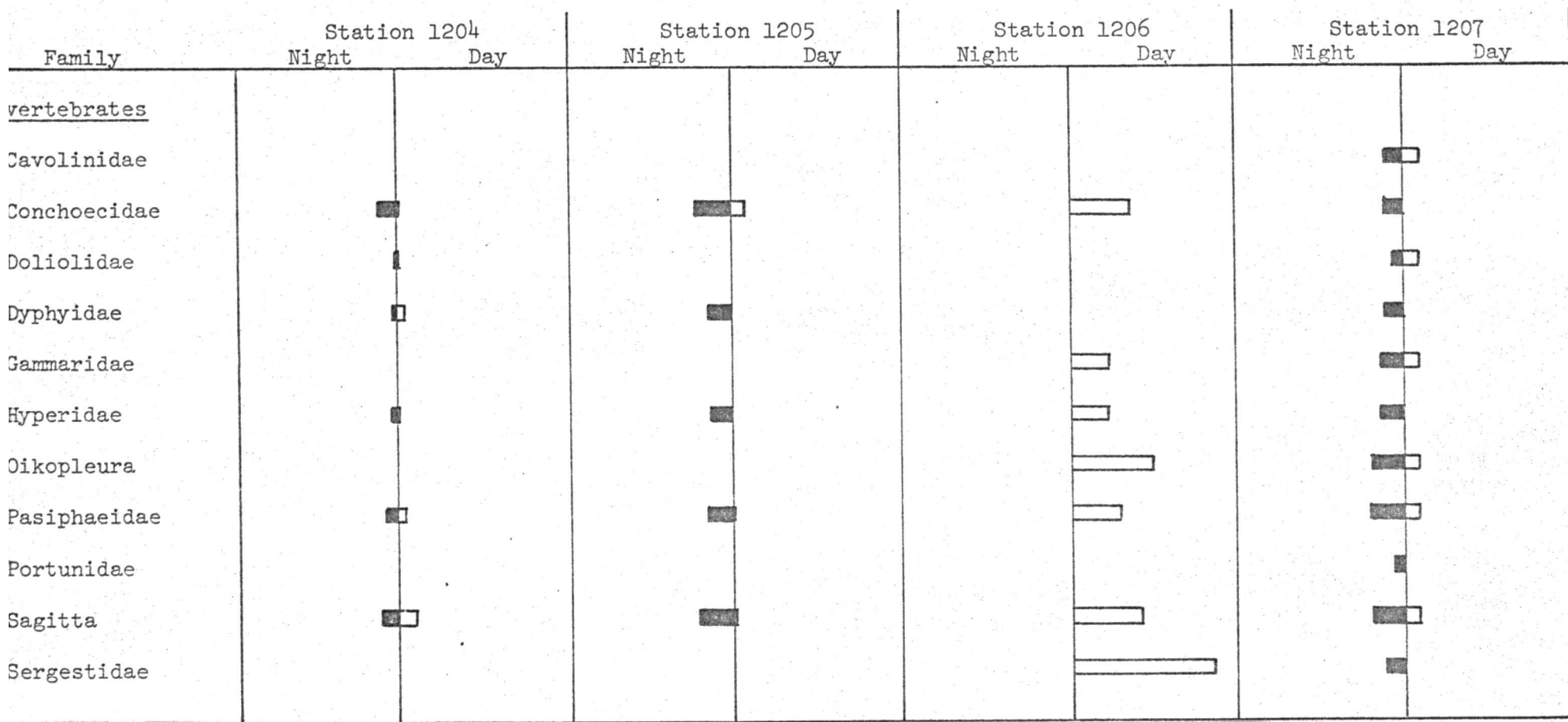



Figure 33. Day-night occurrence of adult invertebrate and fish families collected on Transect II during January-February, 1976 (see Fig. 1 for station locations). Horizontal bars represent the exponential number of individuals captured per minute. Solid bars = night; clear = day collections.



Transect I during June-July, 1975 (see Fig. 1 for station locations).  
 Horizontal bars represent the exponential number of individuals captured  
 per minute. Solid bars = night; clear = day collections.

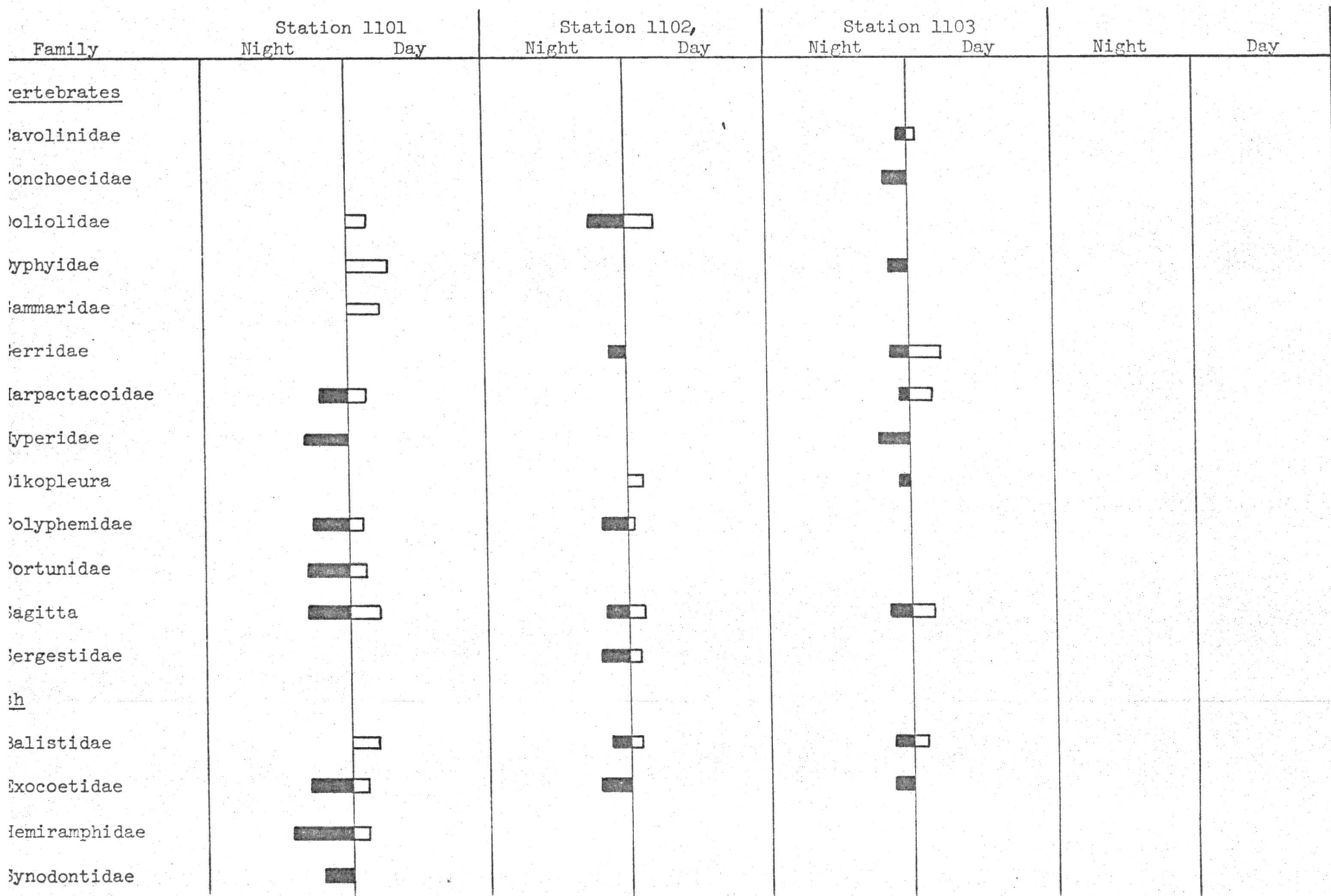

Figure 35. Day-night occurrence of adult invertebrate and fish families collected on Transect I during September-October, 1975 (see Fig. 1 for station locations). Horizontal bars represent the exponential number of individuals captured per minute. Solid bars = night; clear = day collections.

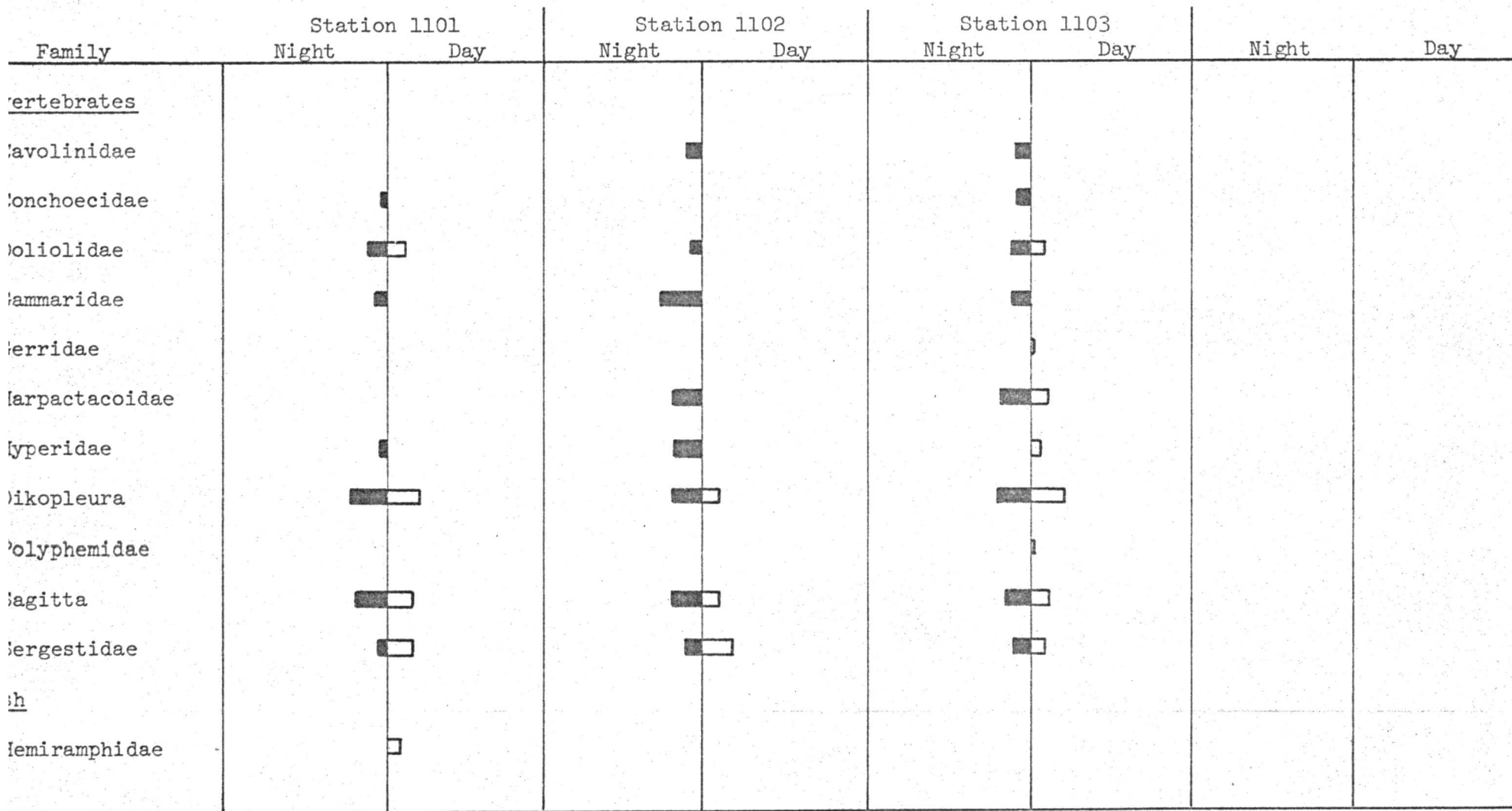
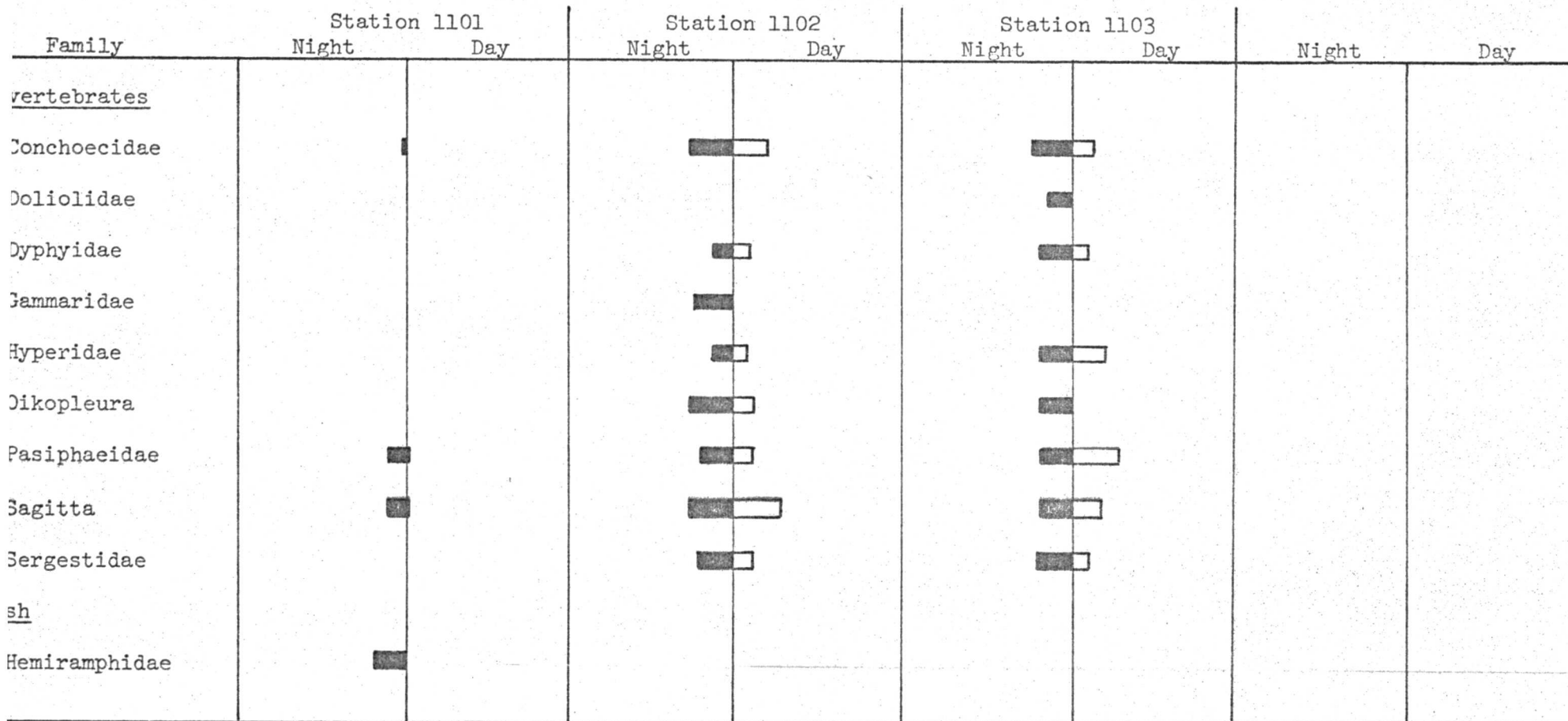

Figure 36. Day-night occurrence of adult invertebrate and fish families collected on Transect I during January-February, 1976 (see Fig. 1 for station locations). Horizontal bars represent the exponential number of individuals captured per minute. Solid bars = night; clear = day collections.



RESULTS AND DISCUSSION

A total of 78 adult animal families, and 27 different larval types (plus fish and invertebrate eggs) were identified from neuston collections. The distributions and numbers of taxa collected are presented in Figures 1-36, Tables 7-9, and 12-14, and Appendices 1-2.

Adult Invertebrate Taxa

In addition to 51 families of adult invertebrates identified from the collections (including the insect families Gryllidae, Bibionidae and Gerridae), the following forms were identified at the taxonomic level indicated: Orthoptera, Diptera (Insecta); Sagitta and Eukrohnia (Chaetognatha); Oikopleura (Larvacea); Foraminifera; Phascolosoma (Sipuncula); Physalia (Siphonophora); Velella (Chondrophora); Branchiostoma (Cephalochordata); an unidentified cephalopod, a prosobranch gastropod juvenile, an isopod, a cumacean, and a caridean; and siphonophore and salp fragments. The following adult invertebrates were identified at the Family level:

Hydrozoa

Campanularidae

Plumularidae

Siphonophora

Diphyidae

Monifidae

Gastropoda

Cavolinidae

Limacinidae

Polychaeta

Nereidae - juveniles

Spionidae - juveniles

Tomopteridae

Cladocera

Polyphemidae

Sididae

Amphipoda

Gammaridae

Hyperiididae

Ostracoda

Conchoecidae

Mysidacea

Mysidae

Isopoda

Cirolanidae

Gnathidae

Copepoda

Acartiidae  
Actideidae  
Calanidae  
Calocalanidae  
Candaciidae  
Centrophagidae  
Clausidiidae  
Corycaeidae  
Ergasilidae  
Eucalanidae  
Euchaetidae  
Laophontidae  
Loficidae  
Oithonidae  
Oncaeidae  
Paracalanidae  
Pontellidae  
Sapphirinidae  
Temoridae  
Trachiidae

Decapoda

Hippolytidae  
Palaemonidae  
Pasiphaeidae  
Penaeidae  
Pontunidae  
Sergestidae  
Upogeidae - juveniles

Euphausiacea

Euphausiidae

Thalliacea

Doliolidae  
Salpidae

Non-larval Fish Families:

Twenty-eight families of fishes were represented in neuston collections. They are:

Balistidae	Molidae
Belonidae	Monacanthidae
Bothidae	Mugilidae
Carangidae	Myctophidae
Centriscidae	Ophichthyidae
Clupeidae	Pleuronectidae
Coryphaenidae	Priacanthidae
Diodontidae	Scombridae
Exocoetidae	Serranidae
Gadidae	Stromateidae
Hemiramphidae	Syngnathidae
Holocentridae	Synodontidae
Istiophoridae	Tetradontidae
Lobotidae	Triglidae

Larval Taxa

Most of the larval metazoan meroneuston were extruded through the net meshes or lost during alcohol transfer procedures. The list of larval "types" that follows is not an accurate representation of these forms that live in the pleustal zone, but are those recovered from our samples.

Brachiuran megalopas	Invertebrate eggs
Brachiuran zoeae	Mysid mysis
Caridean zoeae	Pelycopod veligers
Cirripede nauplii	Penacid (various: zoeae, mysis)
Copepod copepodids (1-6)	Polychaete juveniles
Copepod nauplii	Polychaete nectochaetes
Cumacean	Prosobranch juveniles
Ectoproct cyphonautes	Sipunculid larvae
Euphausiid furcillae	Squillid antizoeae
Fish eggs	Squillid "postlarvae"
Fish larvae (unidentified)	Squillid pseudozoeae
Fish leptocephalus	Tunicate "larvae"
Fish pleuronectiform	Upogeid larvae-juveniles
Gastropod veligers	



### Statistical Analyses

The mean, median, variance, standard deviation and standard error of the mean were calculated for each taxon (genus, family, or phylum) collected during the sampling year (Appendix 1). These measures of dispersion clearly showed that the collections were too variable for most statistical analyses. For example, the Family Polyphemidae (Family code 01) had a mean of 403.92, a median of 1.78, a variance of 1,912,640.0, a standard deviation of 1382.98, and a standard error of 252.50. These results are representative of those found for all taxa. At the family level, at least, and probably at the species level, the organisms collected in the pleustal zone of the MAFLA OCS are neither normally nor randomly distributed with respect to day/night, station or season. The patchy distribution of zooplankton populations is well known (e.g., Cassie, 1963), and our results were anticipated.

In an effort to compare station, day-night, and seasonal collections aside from graphical displays of the data, 108 analysis of variance tests were performed (Table 10). The results of these tests found to be significant at the 5% level are, keeping the above discussion in mind, provisionally considered to be accurate, and the same is true for those 83 tests that were not significant at the 5% level. In an effort to "normalize" the data, both square-root and log n transformations were applied. The 25 significant tests are summarized in Table 10. Where raw and transformed data results differ, the latter are considered more closely to approximate the real situation.

### Seasonal Variation

During daylight hours, significant differences occurred between seasons with respect to "all invertebrate families", and "number of copepod families" categories. At night, significant seasonal differences occurred in the "all adult family" and "number of copepods" categories. Thus, day-night seasonal distributions are quite different, particularly with regard to the copepods. It appears that the eumestonic copepod fauna is influenced by climatological changes during the day, but that facultative and pseudo-neuston recruitment masks these changes at night.

### Station Variation

Daytime station variation was reflected only in the "number of copepod families" collected. Since 20 of the 51 families of adult invertebrates identified were copepods, and geographic coverage was broad, this result was expected. Night station differences were found in four of the six categories, indicating a geographic difference in subsurface "water masses". Substantiation of this presumptive conclusion demands clarification by means of SNK analyses and correlation with the physical-chemical oceanographic data. The time of day (night) during which the samples were taken may also have biased the results.

### Day/Night Variation Between Stations, By Season

Significant day/night differences were found in the "all invertebrate", "all adult" and "number of copepods" categories, but in the day/night-seasonal component of the test a significant difference occurred only in the "all invertebrate families" category. No significant interaction or residual values were found. No explanation of these results can be reasonably defended at the present time.

Day/Night Variation Within Stations, By Seasons

None of the 18 ANOVA's performed were significant at  $p \leq .05$ . The results of these tests, in particular, provide evidence of the great variability in catches that occurred at each station, during both day and night, and during each of the three sampling periods.

Taxonomic analyses conducted at the species level, based on time-sequence information, may make it possible to answer these many obvious questions left here unasked.

Correlation Analyses

A 5 X 14 correlation matrix is presented as Table 11. A total of 70 rectilinear correlation analyses were made, of which 23 were significant at the 5% level. The results of these analyses should, as has been previously discussed, be considered to approximate the actual situation. Correlations (2-tailed tests) found to be significant are described below.

1. Number of adult animals.

The number of adult animals vs the time of day fished was significant as expected. The test means, however, that an increasing number of adult animals was associated with increasing time, from 00-2300 hr. Thus, more animals were captured from hours with an arbitrarily high weight value than from hours arbitrarily low in weight. While a real correlation exists (see ANOVA tests, Table 10) between time of day and the number of adult animals captured, the r-value is spurious.

The number of animals caught per minute and cloud cover were significantly correlated. Increased cloud cover results in decreased light - and an increase in animals at the surface. This correlation was expected, and is no doubt accurate.

That the number of animals captured and the total volume of the sample are significantly correlated is expected, and redundant information.

## 2. Number of invertebrate phyla.

The number of invertebrate phyla captured at the surface decreased with an increase of incident light. Why the number of adult animals captured did not increase with a decrease in light is taken here as evidence that the parametric statistical tests used are weak in light of the variability in data noted previously.

A significant negative correlation existed between Forel color and the number of invertebrate phyla captured. An increase in Forel color evidences a decrease in water transparency, and, thus, a decrease in visual avoidance cues for plankters (see Fleminger and Clutter, 1965). This argument applies to all categories in the matrix.

A negative correlation between tar weight and the number of invertebrate phyla captured indicates that wind rafting of pollutants and surface organisms are negatively related. I do not believe this to be the case, and instead attribute the significant r-value less to the avoidance of animals for pollutants than to sampling error.

## 3. Number of invertebrate families.

The number of invertebrate families and light levels recorded show a positive avoidance of light by zooplankters.

High air temperature and low numbers of invertebrates show that climatological events directly influence the surface fauna. Higher air temperatures depress the numbers of the surface biota.

Forel color and numbers of invertebrate families recorded are associated for reasons described above.

Secchi disk depths were recorded only during the day. Thus, while a decrease in water transparency should be positively correlated with increased catches, the r-value here reported is spurious. The negative correlation between tar weight (as one measure of total surface pollutants) and the number of invertebrate families is unexplained, but apparently real.

#### 4. Number of crustacean families

The number of crustacean families and surface temperature (as measured by our bucket thermometer readings) were significantly correlated: the warmer the sea surface, the fewer crustaceans caught. With increasing light fewer crustacean families were caught, as was the case with higher air temperatures, Forel color, and tar weight.

#### 5. Number of Copepod families.

Surface temperature, light, air temperature, Forel color, Secchi disk depth, tar weight and total volume of the sample were negatively correlated with the number of copepod families captured. The first five variables are understandable; the rest are not.

### Affinity and Diversity Indices

Because of the high variances exhibited in sample statistics, the several indices of diversity and affinity in common usage (e.g., Shannon-Weaver, Morisita, Sanders, to name but a few) are not discussed.

Results of the three indices mentioned may be obtained from Management.

All existing indices are meaningless in terms of Family-level taxa, since this taxon is a contrived one with little biological significance, and less statistical significance.

### Systematic Analyses

Taxa are listed individually by station, day/night occurrence, and

by season (Appendix 1). Abundant taxa are depicted on charts (Figures 1-12) and the numbers of individuals caught per minute are summarized as Figures 13-36, and in Tables 7-9 and 12-14. Station summaries (by season) are presented as Appendix 2. The following remarks are presented to supplement graphic data displays in those cases where embellishment may serve a useful purpose. For the sake of continuity, results and discussion are presented together. Because identifications were made at the family level, it is impossible to interpret the historical literature in detail.

#### Insects

A significant number of adult insects were collected in addition to the marine Halobates micans (Gerridae). These terrestrial insects were found even at Station 1103, the most offshore location sampled.

Halobates occurs everywhere in the eastern Gulf, yet was captured at only 21 of 90 stations. Twelve collections were made during the night, and nine were made during the day. Night captures should have been much more frequent than day records because the animals are known to escape nets that they can see. Catch records substantiate the patchy distribution of these epineustonic forms.

Orthopteran, dipteran, hemipteran and coleopteran insects were captured far offshore. Craddock (1969) presented evidence that terrestrial insects may provide a significant source of food for mesopelagic fishes in the western North Atlantic. They may play an important role in the economy of the eastern Gulf of Mexico pleustal zone as well. Dozens of neuston tows made in the eastern Gulf since 1970 have contained significant numbers of insects (Collard, pers. observ.). Far too little research has been done to date on the importance of terrestrial organisms in marine food webs.

Chaetognaths

The distribution of Sagitta spp. is plotted in Figure 3. The genus was collected at every station during all three seasons. The genus Eukrohnia was collected only at night during the summer period at Station 1309. It is likely that the genus was either misidentified, or that a Caribbean (Loop Current) intrusion (or eddy) was present at that time and location (e.g., Mattlin, 1974, Rinkel, et al., 1975). Too few specimens of Eukrohnia in good condition were caught for substantive conclusions to be made.

Larvaceans

The day/night and seasonal occurrence of Oikopleura spp. is presented in Figure 2. The genus was found at all stations during all three seasons. The depth distribution of Oikopleura is not known; thus, while it is ubiquitous at the surface, the genus may well be a member of the quasi-, pseudo-, or facultative neuston. I suggest that Oikopleura is pseudoneustonic.

Protozoa - Foraminiferida

Forams were collected only during the summer sampling season. No significance can be adduced to their seasonal occurrence, since they were found on all four transects at all distances from shore. Forams no doubt occur at the surface at all station locations during all seasons. Like all plankters, these animals (protistans) occur in patches.

Cnidaria - Hydrozoa: Chondrophores and Siphonophores

Physalia and Velella were taken only at offshore stations during the winter sampling periods. Both genera are characteristically found in Caribbean waters, and are wind rafted near shore.

Cephalochordates

Branchiostoma spp. were collected only during the winter sampling period at deep stations (1415, 1310, 1103, 1102), and it is suggested that supposedly benthic Branchiostoma swarm at the surface during winter conditions. I cannot suggest a reason for such swarms - if they indeed exist.

Other Invertebrate Families

Hydromedusae were, in general, captured at offshore and southern stations during summer and fall seasons. Siphonophores (Diphyidae) were collected at both near- and offshore stations, mostly in the winter. The distribution and day-night occurrence of cavolinid pteropods is presented in Figure 5. Limacinids were taken in offshore stations at night during fall and winter seasons, and were nowhere common. Most pteropods seem to be pseudoneustonic. Neither Clio nor Peraclis (indicators of the Loop Current according to Austin, 1971) were collected.

Polychaetes were collected at 13 night and two day stations during the summer and fall. It is clear that few polychaetes occur in the neuston compared with zooplankton forms. The distribution of conchoeciid ostracods is depicted in Figure 2. Most were caught during fall and winter periods. Given the patchy nature of zooplankton distributions, it is probable that ostracods occur at the surface in all areas sampled, both day and night during all seasons of the year.

Mysids were caught at 12 stations, but high catches occurred only at Station 1205 during the summer, and 1206 (Florida Middle Ground) during the winter period.

Gnathiid isopods were caught only twice, but cirrolanids were found to be abundant on the I and II Transects. To the west they were



caught only at Station 1309 (Figure 10). Cladocerans were represented by Polyphemidae (Figure 2) and Sididae, neither of which were very common. Hyperiid amphipods were more abundant in the western part of the sampling area, and gammarids were more abundant to the east (Figures 3-4). Amphipods were usually caught in night tows. Euphausiids were collected at 10 night and one day station.

Salps were collected only seven times: five at night and two during the day. Six of the collections were made in the fall, and one during the winter. The distribution of doliolids is shown in Figure 6. No Pyrosoma were collected, although I have personally observed them at the surface in vast numbers in eastern Gulf shelf waters.

Seven families of decapod crustaceans were collected during the year. Hippolytids were caught in 12 tows (nine day, three night), primarily in the summer season. Palaemonids were taken in 14 collections, all during the summer. Pasiphaeid shrimps were widely distributed (Figure 11) and were taken only during the winter, save for a single July sample. Penaeids were recovered from 11 collections (nine night, two day). Large numbers occurred at Station 1101 at night. The distribution of portunids was irregular (Figure 4). Sergestids (primarily Lucifer faxoni) were abundant throughout the sampling area in all seasons (Figure 3). A single young upogeid was collected at Station 1308 in September.

The distributions and day-night occurrence of the eight abundant families of copepods collected are plotted in Figures 7-9. The harpacticoid families Laophontidae, Clausiidae, Trachiidae and Loficidae are combined as the "Harpacticoidae" on Figure 11. Little can be said about the day-night, geographical or seasonal distributions of the copepods recovered in the present study. The copepods are clearly the most diverse and abundant zooplankters collected.

Fishes

In general, too few fishes in any one of the 28 families represented in the collections were captured for distributional analyses to be made. The distributions of the three most abundant families (Synodontidae, Exocoetidae, and Balistidae) are shown in Figure 12. There is an apparent trend for the number of fishes to increase from east to west, and offshore to inshore. In some families (e.g., Syngnathidae) the reverse is true. Belonids, ophichthyids, clupeids and myctophids were taken only at night. Myctophids were caught during the fall and winter at Stations 1311 and 1415 - offshore stations. The species, Diaphus dumerili, is rarely found on the surface, and Gonichthys coccoi which is a common neustonic fish at night, and should have been caught, was not.

Larvae

Brachiuran zoeae were recovered from 62 of the 90 collections made. More were captured at night than during the day, but the third largest catch was made during the day at Station 1206 in January. Brachiuran megalopona were also abundant, widely distributed, and taken both day and night during the year. Caridean zoeae were caught all year, but were not abundant. Ten of 19 collections were made in winter, and 14 of 19 were made at night. Of 55 squillid collections, most were made during the summer, and 36 were made at night. Nectochaete larvae were collected only on the III, IV Transects during the summer and fall, and were not abundant. Gastropod and pelycopod veligers were everywhere abundant throughout the year, both day and night. Copepod nauplii were caught primarily in the winter on Transects III, IV. Mysid (mysis) larvae were collected at 11 night stations during the fall and winter. Copepodites were collected during the day and night, in fall and winter, primarily along Transects III and IV.

Twelve of 17 juvenile prosobranch samples were collected at night, and these were geographically widely distributed. Unidentified tunicate larvae were collected at Station 1206 (FMG). Thirteen collections of ectoproct cyphonautes larvae were made in winter. These larvae were exceptionally large, and were rather widely distributed. Euphausiid furcillae were collected only twice, at Stations 1311 and 1207, in winter. Cirripede nauplii were collected five times, also during the winter.

The number, types and distribution of larvae here reported is not an adequate - nor accurate - representation of young stages found in the neuston of the eastern Gulf. Smaller meshed nets and slower towing speeds would have yielded an orders-of-magnitude greater catch.

#### General Discussion

While T.-L. Hopkins and the National Marine Fisheries Service have collected neuston in MAFLA OCS waters, I am not aware of published results. Thus, it is difficult and premature to comment in depth on the area's neustonic fauna.

Zaitsev (1965) found only three Physalia and no Valella in 1200 miles of neuston sampling in the Gulf of Mexico and Straits of Bahama. He did find a rich hyponeuston fauna of Janthina and Glaucus. I collected the first two forms, but none of the latter two, nor have I ever collected them in the Gulf of Mexico. With respect to Gulf of Mexico neuston, Zaitsev (1970) writes, "Neuston samples from the Gulf of Mexico contain still undetermined larvae of polychaetes, lamellibranch and gastropod mollusks together with young squids, larvae of Balanus (sic) and Lepadidae (zoea, megalopa, alima, phyllosoma), Enteropneusta (tornaria) and Branchiostoma lanceolatum, (sic) fish eggs, larvae and fry, etc. As in other regions, the density of the merohyponeuston in the Gulf of Mexico is much greater over the shelf zone . . .

In the Gulf of Mexico, the benthohyponeuston consists of numerous species of polychaetes, amphipods, cumaceans, isopods and shrimps. An abundant benthohyponeuston dominated by isopods (Eurydice) (sic) and amphipods was found on 21 June 1965 at 2300-2400 hours, over a depth of about 30 m in the Old Bahamas Channel." Zaitsev's additional remarks concern more tropical waters. I caught no tornaria larvae, few polychaete larvae, and fewer of the other groups noted than Zaitsev recorded. It must be noted that Zaitsev worked in shelf water south of the MAFLA OCS lease areas.

Hemple and Weikert (1972) in their review of neuston studies in the North Atlantic (generally between the Great Meteor Seamount and the Eurasian Shelf) found that 94% of the invertebrates caught (with a variety of gear) were crustaceans. About 50% of these were copepods; 4.5% were molluscs. Day tows captured pontellid copepods, and ca. 33% of the day catches were halocyprid ostracods (Conchoecia spininostrus). They found generally, that the number of species collected was inversely related to biomass. Hemple and Weikert found that neuston biomass is high (0-10 cm depth) in shallow, boreal, or turbid water. They concluded, among other things, that "the" neuston biotope is not clearly separated from the rest of the water column. Khromov (1965) reported that the western Gulf has a lower plankton standing crop than does the eastern Gulf.

A monograph prepared for BLM by Tereco (1976; p. 115, Tables 5-13) lists common genera collected from world oceans in neuston nets. This list is suspect in that fishes (for example) include gonastomatids and sternoptychids. I have collected neither of these families in any of over 1,000 neuston tows in the Atlantic, the Gulf of Mexico, the Mediterranean, the Pacific and the Red Sea. Certainly these "genera" are not common, nor are they found at the surface in the MAFLA OCS area. In their list of organisms collected from the northwest Gulf of Mexico, (Tereco, 1976).

Leander, and Histrion are Sargassum related, and not neustonic, whereas Gonostomatidae (Viper fish) (sic; the common name is bristlemouths), simply doesn't visit the surface, to my knowledge.

Berkowitz (1976) studied neuston of the western Gulf of Mexico and found that organisms were more common in a meter net towed beneath the surface than in his neuston net; that organisms were more common during the middle of the night, and that the oceanic Gulf of Mexico neuston fauna is impoverished. I conclude that eastern and western Gulf of Mexico surface waters are as different as eastern and western Mediterranean Sea waters are. This conclusion is difficult to understand in light of Sturges' (1976) report on the Gulf Mexican Current. In other respects, the present study and those of Berkowitz (1976) are not comparable.

Morris (1975) collected neuston in deep water south of Bermuda, and in the "Gulf Stream" south of Newfoundland. He found (as have virtually all other investigators who have worked in open-ocean areas) that most of the catch was comprised of crustaceans, and that the number of animals was greater beneath the surface (i.e., >10 cm or so) than on or near the surface. Morris concluded that a unique neuston assemblage of organisms did not exist as such. I disagree with that conclusion philosophically, and anticipate an opportunity to resolve the issue. Maturo and Caldwell's (University of Florida) list of zooplankters commonly found in their zooplankton studies is in good agreement with mine.

The selected literature section of this report could and should be discussed by author. It cannot be, however, until seasonal time-sequence collections identified at the species level have been accomplished.

SUMMARY

1. Ninety neuston collections were made in the MAFLA OCS Oil Lease area during the summer and fall of 1975, and in the winter of 1976.
  - a. One day and one night collection were made at each of 15 stations on four transects, during each of three seasons.
  - b. Organisms were identified generally to the Family level; some were identifiable only to Order, and some were identified to genus and species.
2. A total of 78 adult families were identified. Twenty additional adult taxa were identified, and 23 larval types were recorded.
3. Copepods (20 families) dominated the catch.
4. Non-crustacean adult invertebrates were minor constituents of the catch.
5. Of 108 ANOVA tests, 25 were significant at the  $p < .05$  level. Of the 25 significant tests, only a fraction are credible.
6. Of 70 correlation analyses made, 23 were significant at the  $p < .05$  level. Several of these tests were inappropriate.
7. Some station, season, day/night differences are suggested.
8. Eastern Gulf of Mexico neuston data presented here are more like western North Atlantic data than those of the western Gulf of Mexico.
9. There is a paucity of information on eastern Gulf of Mexico neuston.

SELECTED REFERENCES

- Austin, H. M. 1971. The characteristics and relationships between the calculated geostrophic current component and selected indicator organisms in the Gulf of Mexico Loop Current System. Ph.D. Disert. 369 pp.
- Bance, K. 1964. On the vertical distribution of zooplankton in the sea. *Prog. Oceanogr.* 2:53-125.
- Barnes, H. 1952. The use of transformations in marine biological statistics. *Cons. Int. Explor. Mer.* 18:61-71.
- Berkovitz, S. P. 1976. A comparison of the neuston and near-surface zooplankton in the northwest Gulf of Mexico. M.S. thesis, Texas A & M Univ. 147 pp.
- Bieri, R. 1966. Feed preferences and rates of the snail, Janthina prolongata the barnacle, Lepas anserifera, the nudibranchs, Glaucus atlanticus and Fiona pinnata, and the food web in the marine neuston. *Publ. Seto Mar. Bio. Lab.* 14:161-170.
- Bogdanov, D. V., V. Sokolov, and N. S. Khromov. 1968. Regions of high biological productivity in the Gulf of Mexico and the Caribbean Sea. *Oceanol.* 8:371-381.
- Bowman, T. E. and H. E. Gruner. 1973. The families and genera of Hyperiidia (Crustacea: Amphipoda). *Smithsonian Contr. Zool.* 146:1-64.
- Bowman, T. E. and S. C. McCain. 1967. Distribution of the planktonic shrimp, Lucifer, in the western north Atlantic. *Bull. Mar. Sci.* 17:660-671.
- Breder, C. M. 1962. On the significance of transparency in osteichthid fish eggs and larvae. *Copeia* 3:561-567.
- Bsharah, L. 1957. Plankton of the Florida Current V. Environmental conditions, standing crop, seasonal and diurnal changes at a station forty miles east of Miami. *Bull. Mar. Sci. Gulf Caribb.* 7(3):201-251.
- Bullis, H. R., Jr., and R. B. Roe. 1967. A bionumeric code application in handling complex and massive faunal data. *Syst. Zool.* 16(1):52-55.
- Butler, J. N. 1975. Pelagic tar. *Sci. Am.* 232(6):90-97.
- Cassie, R. M. 1963. Microdistribution of plankton. *Oceanogr. Mar. Biol. Ann. Rev.* 1:223-252.
- Champalbert, G. 1968. L'Hyponeuston dans le Golfe de Marseille. Marseille.
- Champalbert, G. 1971. Variations nycthemerales du plancton superficiel. 1. Holohyponeuston et heterohyponeuston. *J. Exp. Mar. Biol. Ecol.* 6:23-33.
- Cheng, I. 1973. Halobates, (H. Barnes, ed.). *Oceanogr. Mar. Biol. Ann. Rev.* 11:223-235. George Allen and Unwin Ltd., London.

- Clifton, J. W. 1950. A Key to the Fishes of Mississippi Sound and adjacent waters. Gulf Coast Research Lab., Ocean Springs, MI. pp. 1-30.
- Craddock, J.W. 1969. Neuston fishing. *Oceanus* 15(1):10-12.
- Cruise, J. 1971. The planktonic shrimp genus Lucifer: its distribution and use as an indicator organism in the eastern Gulf of Mexico. M.S. thesis, Florida State Univ. 184 pp.
- Cushing, D. H. 1962. Patchiness. Rappt. Proces-Varboux Reunions, Cons. Perm. Internat. Expl. Mar. 15(26):152-163.
- David, P. M. 1965. The surface fauna of the ocean. *Endeavor* 24:95-100.
- Davis, C. C. 1950. Observations of plankton taken in marine waters of Florida in 1947 and 1948. *Quart. J. Florida Acad. Sci.* 12:67-103.
- Della Croce, N., and T. Sertorio. 1959. Microdistribuzione dello zooplankton. *Bull. Mus, Insti. Biol. Univ. Genova* 29(175/176):5-28.
- Denton, E. J. 1963. Buoyancy mechanisms of sea creatures. *Endeavor* 22 (85):3-
- Dragovich, A. 1963. Hydrology and plankton of coastal waters at Naples, Florida. *Quart. J. Florida Acad. Sci.* 26(1):22-47.
- Dunbar, M. J. 1963. Amphipoda, Sub-order: Hyperiidea, Family: Hyperiididae. *Fich. Indent. Zooplankton Cons. Int. Explor. Mer.* 103.
- Every, M. G. 1968. The taxonomy and areal distribution of the Chaetognatha in the oceanic Gulf of Mexico. M.S. thesis, Texas A & M Univ. 67 pp.
- Fager, E. W. 1972. Diversity: A sampling study. *Am. Natural.* 106(949): 293-310.
- Felder, D. L. 1973. Crabs and lobsters from coastal waters of the north-western Gulf of Mexico. Center for Wetland Resources, Baton Rouge. 1-99 pp.
- Fish, A. G. 1962. Pelagic copepods from Barbados. *Bull. Mar. Sci.* 12(1): 1-38.
- Fisher, R. A., A. S. Corbet, and C. B. Williams. 1943. The relation between the number of species and the number of individuals in a random sample of an animal population. *J. Animal Ecol.* 12:42-58.
- Fleminger, A. 1957. New calanoid copepods of Pontella Dana and Labidocera Lubbock with notes on the distribution of the genera in the Gulf of Mexico. *Tulane Stud. Zool.* 5(2):19-34.
- Fleminger, A. 1959. Distribution of calanoid copepods in the Gulf of Mexico (M. Sears, ed.). *Internat. Oceanogr. Congress* 153-154 (Preprints).
- Fleminger, A., and R. F. Clutter. 1965. Avoidance of towed nets by zooplankton. *Limnol. Oceanogr.* 10:96-104.



- Friedrich, H. 1965. Meeresbiologie Gebr. Borntraeger, Berlin 436 pp.
- Galtsoff, P. A. (ed.). 1954. Gulf of Mexico. Its origin, waters and marine life. U.S. Fish Wildl. Serv. Fish. Bull. 89. 604 pp.
- Geitler, L. 1942. Zur Kenntnis der Bewohner des Oberflächenhautchens einheimischer Gewässer. Biol. Generalis 16:450-
- Gibbs, R. H., Jr. and B. B. Colette, 1959. On the identification, distribution, and biology of the dolphins, Coryphaena hippurus and C. equiselis. Bull. Mar. Sci. Gulf Caribb. 9(2):117-152.
- Gosner, Kenneth L. 1971. Guide to identification of marine and estuarine invertebrates. John Wiley & Sons, Inc. N.Y. 66-594 pp.
- Grice, G. D. 1956. A qualitative and quantitative seasonal study of the copepoda of Alligator Harbor. Papers Oceanogr. Inst. Florida State Univ. 22:37-76.
- Grice, G. D. 1957. The copepods of the Florida west coast. Ph.D. disser., Florida State Univ. 203 pp.
- Grice, G. D. 1960. Calanoid and cyclopoid copepods collected from the Florida Gulf Coast and Florida Keys in 1954 and 1955. Bull. Mar. Sci. Gulf Caribb. 10(2):217-226.
- Grice, G. D., and K. Hulsemann. 1965. Abundance, vertical distribution and taxonomy of calanoid copepods at selected stations in the northeast Atlantic. J. Zool. 146:213-262.
- Hardy, A., and E. Gunter. 1935. Plankton and rough weather. Discovery Rep. 11:268-272.
- Harper, D. E., Jr. 1968. Distribution of Lucifer faxoni (Crustacea: Decapoda: Sergestidae) in neritic waters off the Texas coast, with a note on the occurrence of Lucifer typus. Contr. Mar. Sci, 13:1-16.
- Hart, J. 1971. Key to planktonic larvae of families of decapod Crustacea of British Columbia. Syesis, 4:227-233.
- Hartman, O. 1951. The littoral marine annelids of the Gulf of Mexico. Inst. of Mar. Sci. 2(1):7-124.
- Hemple, G. 1971. Distributional and trophic relationships of neuston and plankton. In: Proceedings of Joint Oceanography Assembly: IAPSO, IABO, CMG, SCOR, (M. Uda, ed.). Tokyo, 1970. pp. 272-273.
- Hemple, G., and H. Weikert. 1972. The neuston of the subtropical and boreal northeastern Atlantic Ocean. A review. Mar. Biol. 13:70-99.
- Herring, P. J. 1967. The pigments of plankton at the sea surface. Symp. Zool. Soc. London. 19:215-235.
- Hood, D. W. (ed.). 1971. Impingement of Man on the Oceans. Wiley-Interscience. 738 pp.
- Hopkins, T. L. 1966. The plankton of the St. Andrews Bay system, Florida. Publ. Inst. Mar. Sci. Texas. 11:12-64.

- Horn, M. H., J. M. Teal, and R. H. Backus. 1970. Petroleum lumps at the surface of the sea. *Science* 168(3928):249-256.
- Jones, J. I., R. Ring, M. Rinkel, R. Smith (eds.), 1973. A summary of knowledge of the eastern Gulf of Mexico. State Univ. System Instit. Oceanogr. Florida, St. Petersburg, Florida 111 F:1-10.
- Khromov, N. S. 1965. Distribution of plankton in the Gulf of Mexico and some aspects of its seasonal dynamics. In: Soviet-Cuban fisher research (A.S. Bogdanov, ed.). Isreal Prog. Sci. Transl. 36-56 (1969).
- King, J. E. 1950. A preliminary report on the plankton of the west coast of Florida. *Quart. of Florida Acad. Sci.* 12(2):109-137.
- Lewis, John B. 1954. The occurrence and vertical distribution of the Euphausiacea of the Florida Current. *Bull. Mar. Sci. Gulf Caribb.* 4(4):266-299.
- Lipka, D. A. 1975. The systematics and zoogeography of cephalopods from the Gulf of Mexico. Ph.D. Dissert. Texas A & M Univ. 351 pp.
- Lloyd, M., and R. H. Ghelardi 1964. A table for calculating the 'equitability' component of species diversity. *J. Animal Eco.*, 33:217-225.
- MacIntyre, F. 1974. The top millimeter of ocean. *Sci. Am* 230(5):62-67.
- Mattlin, R. H., Jr. 1974. A comparison of the Chaetognatha from three locations within the Caribbean Sea. M.S. thesis, Univ. of West Florida 81 pp.
- McFadden, J. R. 1963. An example of inaccuracies inherent in the interpretation of ecological field data. *Am. Natural.* 47(893):99-116.
- Menzies, R. J., and P. W. Glynn. 1968. The common marine isopod crustacea of Puerto Rico. *Studies on the Fauna of Curaca and other Caribbean Islands.* 27:16-133.
- Moore, H. B. 1949. The zooplankton of the upper waters of the Bermuda area of the north Atlantic. *Bull. Bingham Oceanogr. Coll.* 12(2):1-97.
- Moore, H. B., and D. L. O'Berry. 1957. Plankton of the Florida Current IV. Factors influencing the vertical distribution of some common copepods. *Bull. Mar. Sci.* 7(4):297-315.
- Moore, H. B., H. Owre, E. C. Jones, and T. Dow, 1953. Plankton of the Florida Current. III. Distribution of zooplankton in the daytime by light and temperature. *Bull. Mar. Sci. Gulf Caribb.* 3(2):83-95.
- Morris, B. F. The neuston of the northwest Atlantic. Ph.D. Dissert., Dalhousie Univ., 285 pp.
- Muss, B. J. 1953(a). Polychaeta, Families: Aphroditidae, Phyllodocidae and Alciopidae. *Fich. Ident. Zooplankton Cons. Int. Expolor. Mer.* 52.
- Muss, B. J. 1953(b). Polychaeta, Families Tomopteridae and Typhlocolecidae. *Fich. Ident. Zooplankton Cons. Int. Explor. Mer.* 53.

- Kaumann, E. 1917. Über das Neuston des Meerwasser. Biol. Centralbl. 37(2): 98-106.
- Owre, H. B., and M. Foyo, 1967. Copepods of the Florida Current. Fauna Caribaea No. 1 (F. M. Bayer and G. L. Voss, eds.). Inst. Mar. Sci., Univ. Miami, 137 pp.
- Owre, H. B., and M. Foyo, 1967. Copepods of the Florida Current Fauna Caribaea No. 1.
- Parin, N. V. 1967. Diurnal variations in the larval occurrence of some oceanic fishes near the ocean surface. Oceanol. 7:115-121.
- Park, E. T. 1970. Calanoid copepods from the Caribbean Sea and the Gulf of Mexico 2. New species and new records from plankton samples. Bull. Mar. Sci. 20(2):472-546.
- Park, E. T. 1975. Calanoid copepods of the Family Euchaetidae from the Gulf of Mexico and western Caribbean Sea. Smithsonian Contr. Zool. 196:1-26.
- Park, Tai Soo. 1970. Calanoid copepods from the Caribbean Sea and Gulf of Mexico. Bull. of Mar. Sci. 20:474-545.
- Park, T. 1974. Calanoid copepods of the genus Aetideus from the Gulf of Mexico. Fish. Bull. 72(1):215-221.
- Parsons, T. R., and J. D. Strickland. 1962. Oceanic detritus. Science 136:313-314.
- Pearse, A. S. 1912. Notes on certain amphipods from the Gulf of Mexico, with descriptions of new genera and new species. Proc. U.S. Natl. Mus. 43:369-379.
- Perkins, T. H., and T. Savage. 1975. A bibliography and checklist of polychaetous annelids of Florida, the Gulf of Mexico, and the Caribbean region. Florida Mar. Res. Publ., Florida Dept. Nat. Resources. 14:1-62.
- Pielov, E. C. 1972. Niche width and niche overlap: a method for measuring them. Ecol. 53(4):687-692.
- Pierce, E. L. 1951. The Chaetognatha of the west coast of Florida. Biol. Bull. 100:206-228.
- Rapoport, E. H., and L. Sanchez. 1963. On the epineuston or the supraquatic fauna. Oikos 14(1):96-109.
- Riley, G. A., H. Stommel, and D. F. Bumpus. 1949. Quantitative ecology of the plankton of the western north Atlantic. Bull. Bingham Oceanogr. Mus. 12(3):1-169.
- Rinkel, M. O. (ed.). 1975. Compilation and summation of historical and existing physical oceanographic data from the eastern Gulf of Mexico in support of the creation of a MAFIA sampling program. Rep. to NIM, Contract No. 08550-CT4-16.

- Roe, H. S. J. 1972(a.) The vertical distributions and diurnal migrations of calanoid copepods collected on the SOND Cruise, 1965. I. the total population and general discussion. *J. Mar. Biol. Ass. U.K.* 52:277-314.
- Roe, H. S. J. 1972(b). The vertical distributions and diurnal migrations of calanoid copepods collected on the SOND Cruise, 1965. II. Systematic account: Families Calanidae up to and including the Aetidae. *J. Mar. Biol. Ass. U.K.* 52:315-343.
- Roe, M. G. and H. B. Moore, 1965. The vertical distribution of some common copepods in the Straits of Florida. *Bull. Mar. Sci.* 15(3):565-570.
- Roper, C. G., R. E. Young, G. L. Voss. 1969. An illustrated key to the Families of the order Teuthioidea (Cephalopoda). *Smithsonian Cont. to Zool.* 13:1-32.
- Savilov, A. I. 1956. Pleustonbiozonose der Velevella lata Chamisso und Eisenhardt, Siphonophoren, im Pazifik. *Dokl. Akad. Nauk. SSSR.* 110(3):476-479.
- Schroeder, W. W. 1971. The distribution of euphausiids in the oceanic Gulf of Mexico, the Yucatan Strait, and the northwest Caribbean. Ph.D. Dissert., Texas A & M Univ., 1974 pp.
- Sherman, K. 1963. Pontellid copepod distribution in relation to surface water types in the central north Pacific. *Limnol. Oceanogr.* 8(2):214-227.
- Shih, C. -T., and M. J. Dunbar. 1963. Amphipoda, sub-order: Hyperiidea, Family: Phronimidae. *Fich. Ident. Zooplancton Cons. Int. Explor. Mer.* 104.
- Smith, R. E. (ed.). 1974. Proceedings of marine environmental implications of offshore drilling in the eastern Gulf of Mexico. State Univ. System Instit. Oceanogr. Florida, St. Petersburg, Florida. 455 pp.
- Snider, J. E. 1975. Quantitative distribution of shelled pteropods in the Gulf of Mexico including related sampling studies. Ph.D. dissert., Texas A & M Univ. 213 pp.
- Specchi, M. 1968. Observations preliminaires sur l'hyponeuston du Golfe de Trieste. *Rapp. Comm. Int. Mer Medit.* 19(3):491-494.
- Thane-Fenchel, A. 1968. A simple key to the genera of marine and brackish-water rotifers. *Ophelia* 5:299-311.
- Tsyban, A. 1971. Marine bacterioneuston. In: Proceedings of Joint Oceanographic Assembly: ISPSO, IABO, CMG, SCOR (M. Uda, ed.). Tokyo, 1970. pp. 276-277.
- Weis, J. S. 1968. Fauna associated with pelagic Sargassum in the Gulf Stream. *Am. Midland Natural.* 80(2):554-558.
- Wells, J. B. J. 1970. Harpacticoida. *Fich. Ident. Zooplancton Cons. Int. Explor. Mer.* 133.

- Williams, A. B. 1965. Marine decapod crustaceans of the Carolinas. U.S. Bur. Comm. Fish. Bull. 65(1):1-298.
- Williams, A. B. 1969. A ten-year study of the meroplankton in North Carolina estuaries; cycles of occurrence among penaeidean shrimps. Chesapeake Sci. 10(1):36-47.
- Winsor, C. P., and G. L. Clarke, 1940. A statistical study of variation in the catch of plankton nets. J. Mar. Res. 3(1):1-34.
- Woodmansee, R. A. 1958. The seasonal distribution of the zooplankton off Chicken Key in Biscayne Bay, Florida. Ecology 39(2):247-262.
- Woodmansee, R. A. 1966. Daily vertical migration of Lucifer. Planktonic numbers in relation to solar and tidal cycles. Ecology 47(5):847-850.
- Zaitsev, Yu. P. 1968. La Neustonologie marine: Objet, methodes, Realisations Principales et Problemes. Pelagos. 8:1-48.
- Zaitsev, Yu. P. 1970. Marine Neustonology. (K. A. Vinogradov, ed.). Acad. Sci. Ukrainian SSR, Kovalevseii Inst. Biol. South. Seas, Odessa Div. (In Russian, transl. by Israel Prog. Sci. Transl., Jerusalem). 148 pp.

MEIOFAUNA OF THE MAFLA AREA

University of Florida, Marine Laboratory

Co-Principal Investigators:  
Michael R. Crezee  
Frank J. Maturo

## ABSTRACT

Analysis of the quantitative samples has been completed and the data forwarded to the data management group. These data show the meiofauna to be extremely abundant, and the results of correlation analyses and other examination of the data show that meiofauna can be a particularly important group to characterize sediment types and particular stations.

## INTRODUCTION

Nematodes, copepods, crustacean larvae, polychaete larvae (less than six veligers), kinorhynchans, priapulids, tardigrads, coelenterates, and halacarid mites were counted at these levels without any further identification attempted. Ostracods were deleted from consideration when it was found that extraction methods were not efficient for them. They were too uncommon to justify attempts to recover them. Gastrotrichs were identified to the genus level, except that a difficult group of genera are included in "Mesodasys". So that at least one group could be examined in more detail, turbellarians were separated to species where possible. Unfortunately, this is not possible with juveniles, which form a sizeable percentage of the population, nor can the species be named without the reference work with the live samples. However, species codes have been assigned for the approximately 200 species encountered, and Data Management has been supplied a list assigning each of these species codes to a family. In order to make the data interpretation most meaningful to later studies, however, for analysis the turbellarians have been grouped into taxonomic units which vary from generic to ordinal level. Each grouping used is a taxonomic unit to which even juveniles, badly damaged animals and usually pieces can unhesitatingly be assigned by an experienced person.

## METHODS AND MATERIALS

For processing of many of the samples from the first sample period methods common to previous meiofauna studies were employed. It was quickly



realized that such methods were not designed for the handling of large numbers of samples in very limited time. Furthermore, these methods did not allow strictly comparable treatment of samples of different sediment types. Coarse sand and mud could not be treated in the same manner in actual practice. Therefore, a new separation technique was developed by modifications of older techniques and was standardized so that comparable treatment could be given to all sediment types. A fuller description of this technique will shortly be submitted to Limnology and Oceanography. Development of an adequate means of separation was essential, and it greatly facilitated work with the third set of samples and also the second sample period, when it was still being developed. This problem with methods created two major difficulties in the program, however. 1) Experimentation with a variety of possible improvements, together with the very time consuming assessment of the extraction efficiency of each technique, consumed large amounts of time. We could ill-afford this, for even with the new technique allowing faster and more efficient treatment of samples, the time necessary for the work had been under-guessed (for there had been no figures from any comparable studies on which to base time estimates). 2) Figures for the first sample period are undoubtedly too low because methods which were then state-of-the-art were not so efficient as the new methods.

In spite of these problems, however, and in spite of the limited amount of data analysis possible without the project continuation upon which funds for data analysis and interpretation were dependent, the data nonetheless, indicate the great promise of meiofauna in developing a robust characterization of sediment types or of particular stations.

## RESULTS AND DISCUSSION

In almost every sediment type nematodes are the most abundant metazoan. In only a very few samples were copepods more common. Averaged over the entire MAFLA region and all seasons, there are 330,775 nematodes/m<sup>2</sup> or 29.3/cm<sup>2</sup>. Yearly average densities ranged from 37/10 cm<sup>2</sup> at station 2543 up to 1,189/10 cm<sup>2</sup> at 2207. (1/10 cm<sup>2</sup> = 1,000/m<sup>2</sup>). Stations 2209 and 2419 also support over one million nematodes per m<sup>2</sup> throughout the year, and other of the shallower stations of Transects I, II, III, and IV have similar densities in many samples. Tables 1, 2 and 3 present average densities of nematodes during sampling periods I, II and III, respectively.

These densities are comparable to the 157 to 593 nematodes/10 cm<sup>2</sup> reported by Tietjen (1971) for sandy stations between 50 and 100 m water depth off the North Carolina coast. The shallow stations are also quite comparable to the range of 328-1767/10 cm<sup>2</sup> found by McIntyre and Murison (1973) on the coast of Scotland at only 6-7 m water depth. The mud stations are also near the 328/10 cm<sup>2</sup> found at 20 m in Buzzard's Bay, Massachusetts (Wieser, 1961), but less than the yearly average of 876/10 cm<sup>2</sup> in a silty sediment under 80 m of North Sea Water (Warwick and Buchanan, 1971). Finally, de Bovee and Soyer (1974) report nematode densities of 3-8x10<sup>3</sup>/10 cm<sup>2</sup> for Banyuls-sur-Mer on the French Mediterranean coast. These latter values are an order of magnitude higher than those reported by anyone else.

Although the highest nematode densities occur in the shallower stations of the southern four transects and the lowest values in the muds of Transects

V and VI, few other patterns are evident from an examination of the data. The figures in Table 4 represent the difference between highest and lowest seasonal densities divided by the yearly mean density for the station. Roman numerals in italics indicate the sampling period during which highest densities were found. The range is greater than the mean at several stations, but there is also a great amount of variation between replicates. The few other reports of seasonal collections of subtidal nematodes differ. De Bovee and Soyer (1974) found a summer maximum in nematode densities on the French coast, but Warwick and Buchanan (1971) found that month to month variation was no greater than the variation between sets of replicates at their North Sea station. In the MAFLA program the highest average nematode densities were during sample period I at 61% of the station, during period II at 27% and III at only 12% of stations. Thus, the indication is that summer is a time of maximum numbers. However, some stations rather clearly show no seasonality (2208, 2317, 2425, 2531 and 2642, for example). In any case the variation is not as patterned as to allow prediction.

Furthermore, the report of Warwock and Buchanan (1971) was rather compelling in discounting seasonality, for they considered community and population structure. They followed monthly population fluctuations of the 10 commonest species and examined the population structure of the five most dominant species. The relative ranking of the species was highly congruent from month to month, showing that no single species was increasing disproportionately. Moreover, they concluded that at least the majority of nematodes breed throughout the year with complete asynchrony in reproductive cycles, for they found that juveniles always formed over half the population and that gravid females were always present. This would be expected to even out

numbers and lead one not to expect any marked seasonality.

The ten commonest nematode species formed 45.5%-59.3% at this North Sea station. At summer in Buzzard's Bay, Wieser (1961) lists nematode species abundances for a comparable station (also ca. 30% silt-clay). Here, too, the first ten species form 48.1% of the population, and their relative rankings are as reported for the North Sea. One species and two further genera within these ten species were common to the two distant locations.

Copepod average densities for sampling periods I, II and III are presented in Tables 5, 6 and 7, respectively. Ratios of range of densities over season to annual mean density are presented together with season of highest density in Table 8. As for the nematodes, the highest values appear in the shallow stations of the southern four transects. The variability from season to season is high with the ratio of range:mean averaging 1.0. This is even higher than for nematodes where the average value for this ratio is 0.8. Maximum densities occurred in winter at only 10% of the stations, and the maxima for other stations were evenly divided between summer and fall sampling periods.

Although on the average, the ratio of range:mean was higher for copepods than for nematodes, the copepod ratio was higher at only 58% of the stations and therefore not notably different from the 50% expected with variations unrelated. Seasonal grand mean densities for periods I, II and III are 57.6, 64.5 and 52.9/10 cm<sup>2</sup>, respectively, and vary only 10% about the mean.

Although no patterns are clear from looking at the data displayed in map-like fashion according to depth in Tables 1-8, correlation analyses performed by the data management group show significant relation between abundances of different taxonomic groupings and grain size of sediments. The correlations between each group and sediment mean grain size are listed in Table 9. All correlations were significant at  $\alpha < 0.00001$  level. The very high correlations within several of the groupings would strongly indicate the promise of meiofauna in characterizing sediments. Previous studies have indicated the importance of sediments to meiofauna (review by Gray 1974), but never before so decisively. Unfortunately, these correlations appear suspiciously high and consistent and the level of significance too high to be true for every case. The 0.99 and 0.98 correlations within the turbellarians go counter to negative correlations between some of these groups, as apparent in observations as in Table 10 and discussed below.

Although the correlation values are so high as to warrant double-checking, they are certainly correct in attributing a high predictive potential to meiofauna. Several tables show distribution patterns of selected groups of meiofaunal animals which show possibilities of characterizing stations either by simple presence-absence data or by combining to form a simple ratio.

On Transect I the nematodes and copepods show a high variability between seasons. Total numbers and ratios between copepod and nematode total numbers vary greatly. Looking at turbellarians, however, there are clear trends consistent between seasons. Carcharodorhynchus is the dominant

kalyptorhynch at the two shallowest stations (2101 and 2102), then declines in abundance to be completely replaced by eukalyptorhynchs in the deeper stations. This change is not related to depth, but rather to sediment type. The sandier stations of Transects V and VI can be picked out by looking at the distribution of Carcharodorhynchus (see Table 10). (There are several species of the genus involved.) The correlation analyses also show that these two kalyptorhynch turbellarian groups are highly faithful indicators of sediment type and that their absence from a sediment type where they should occur would be strong evidence of a toxin or of some disturbance.

Other genera, also easily recognized with even limited training, are not so highly correlated with sediment type but are reliably found at certain stations. Acanthodasys (Table 11) and Diplodasys (Table 12) are two such examples. Acanthodasys is most common in coarse sands of Transects III and IV, but it also very reliably occurs at stations 2640 and 2642, the two stations in Transect VI with the lowest silt-clay contents. Diplodasys as well is characteristic of a few stations with sediment of lower silt-clay contents.

Priapulids are easily recognized with minimal experience and occur sporadically throughout the area. All of these larvae (only a very few adults were found) appear to be Tubilucus coralicola, the only known meiofaunal priapulid. The table reinforces the correlation giving only 0.23 relation to sediment type, but this preference seems to be for sediments of intermediate clay content.

Kinorhynchs (Table 14) occurred in almost all samples. They may be of special value because some of the genera are abundant in muds and remain

in high densities in most of Transect VI. The high numbers at station 2209 could be explained if sediment from Tampa Bay and rich in organics are deposited here, for kinorhynchs are presumed to be non-selective deposit feeders. Because of this type of feeding and their presence in fair number throughout the MAFLA area, the kinorhynchs could prove especially valuable indicators of pollutants, such as heavy metals, which accumulate in sediments.

#### SUMMARY

The results of this study, so far as analysis has been possible, shows an abundant nematode and copepod fauna, with densities comparable with the few values previously reported. Presumably, the nematodes will be quite diverse, with the most abundant ten species making up about 50% of the assemblage. Perhaps one-third as many species of copepods would be expected. The next most abundant groups are the Turbellaria and Gastrotricha, although Kinorhynchia may be more common in muds. We have found about 200 species of turbellarians in the MAFLA area. Although samples have been a little too small to adequately sample the turbellarian assemblage for diversity measures, characteristic groups have been found. Furthermore, grouping of species into more easily recognized taxonomic units has proven valuable. Gastrotrich genera and some of the "minor" taxonomic groups also offer promise of helping to characterize sediments with several "cross referencing" indicator groups allowing a sensitive biological indicator of environmental conditions.

(On this basis we would especially point to station 2420 as being consistently different from expectation).

Table 1. Sampling Period I, June 1975

Average number of nematodes per 10 cm<sup>2</sup>

Depth	Transects					
	VI	V	IV	III	II	I
10 m			1205			862
			650			
			1253	338	1205	858
20 m	345		353			
	397		140	548		
30 m	611		354		460	
	432				1610	
	616	132		525		
	348	100	210	X		476
40 m		57		X	196	
		67				
50 m						348
60 m	187	47				
70 m	67	40				
80 m			219			
90 m						78
100+m	101	227				
		113	114	152	179	173

Table 2. Sampling Period II, September 1975

Average number of nematodes per 10 cm<sup>2</sup>

Depth	Transects					
	VI	V	IV	III	II	I
10 m			498			1164
			42			
			535	449	1542	1562
20 m	526		173			
	321		95	505		
30 m	442		188		360	
	264				1135	
	140	207		310		
	376	82	188	721	410	553
40 m		116		X	103	
		69				
50 m		81				305
60 m	155	47				
70 m	51	39				
80 m			151			
90 m						85
100+m	39	68				
		57	182	133	127	169



Table 3. Sampling Period III, January 1976

Average number of nematodes per 10 cm<sup>2</sup>

Depth	Transects					
	VI	V	IV	III	II	I
10 m			1424 263 353	696	821	406 355
20 m	474 204		131 64	560		
30 m	322 157 572 307	62 53	206 181	130 116	374 676 658	105
40 m		52 54		579	48	
50 m		131				69
60 m	139	104				
70 m	18	32				
80 m			112			
90 m						55
100+m	16	121 126	26	50	76	72

Table 4. Nematodes

(range of average number per 10 cm<sup>2</sup> over seasons)

÷ (annual average density per 10 cm<sup>2</sup>)

Sampling season of highest density in italics (I, II, or III)

Depth	Transects					
	VI	V	IV	III	II	I
10 m			.9 <i>III</i> 1.9 <i>I</i> 1.3 <i>I</i>			.9 <i>II</i> 1.3 <i>II</i>
20 m	.4 <i>II</i>		1.0 <i>I</i>		.6 <i>II</i>	
30 m	.6 <i>I</i> 1.0 <i>I</i> 1.1 <i>I</i> .2 <i>II</i>	1.1 <i>III</i> .6 <i>I</i>	.8 <i>I</i> .7 <i>I</i> .1 <i>I</i>	.1 <i>III</i> 1.2 <i>I</i>	.2 <i>I</i> .8 <i>I</i>	1.2 <i>II</i>
40 m		.8 <i>II</i> .2 <i>II</i>			1.3 <i>I</i>	
50 m						1.2 <i>I</i>
60 m	.3 <i>I</i>	.9 <i>III</i>				
70 m	1.1 <i>I</i>	.2 <i>I</i>				
80 m			.6 <i>I</i>			
90 m						.4 <i>II</i>
100+m	1.6 <i>I</i>	1.1 <i>I</i> .7 <i>III</i>	1.5 <i>II</i>	.9 <i>I</i>	.8 <i>I</i>	.7 <i>I</i>

I 61%  
II 27%  
III 12%

Table 5. Copepods, Sampling Period I, June 1975

Depth	Average number per 10 cm <sup>2</sup>					
	VI	V	Transects			
			IV	III	II	I
10 m			137			5
			101			
			78	348	80	131
20 m	9		19			
	11		23	106		
30 m	14		53		23	
	45				57	
	52	34		75		
	56	97	84			146
40 m		99			49	
		68				
50 m			28			61
60 m	36	31				
70 m	36	39				
80 m						
90 m						18
100+m	24	32				
		8	8	15	9	15

Table 6. Copepods, Sampling Period II, September 1975

Depth	Average number per 10 cm <sup>2</sup>					
	VI	V	Transects			
			IV	III	II	I
10 m			163			45
			72			
			212	234	228	111
20 m	2		114			
	1		57	84		
30 m	3		75		74	
	16				192	
	33	58		66		
	10	85	98	32	52	50
40 m		85			54	
		84				
50 m		30				28
60 m	37	28				
70 m	42	38				
80 m			52			
90 m						35
100+m	12	4				
		2	15	10	8	19

Table 7. Copepods, Sampling Period III, January 1976

Depth	Average number per 10 cm <sup>2</sup> Transects					
	VI	V	IV	III	II	I
10 m			52 96 147	684	108	22 20
20 m	16 3		58 8	78		
30 m	12 48 42 45	15 26	19 42	100 53	46 174 48	8
40 m		39 29		46	23	
50 m		24				26
60 m	22	24				
70 m	20	20				
80 m			17			
90 m						19
100+m	12	2 6	6	10	7	12

Table 8. Copepods, seasonal highs and variation  
(range of season means) ÷ (annual mean)

Depth	Transects						
	VI	V	IV	III	II	I	
10 m			.9 <i>II</i> .3 <i>I</i> .9 <i>II</i>	1.1 <i>III</i>	1.1 <i>II</i>	1.7 <i>II</i> 1.3 <i>I</i>	
20 m	1.6 <i>III</i> 2.0 <i>I</i>		1.5 <i>II</i> 1.7 <i>II</i>	.3 <i>I</i>			
30 m	1.1 <i>I</i> .9 <i>III</i> .4 <i>I</i> 1.2 <i>I</i>	1.2 <i>II</i> 1.0 <i>I</i>	1.1 <i>II</i> .7 <i>II</i>	.4 <i>III</i>	1.1 <i>II</i> 1.0 <i>II</i>		<i>I</i> 44% <i>II</i> 46% <i>III</i> 10%
40 m		.8 <i>I</i> .9 <i>II</i>			.7 <i>II</i>		
50 m						.9 <i>I</i>	
60 m	.5 <i>II</i>	.2 <i>I</i>					
70 m	.7 <i>II</i>	.6 <i>I</i>					
80 m			1.1 <i>II</i>				
90 m						.7 <i>II</i>	
100+m	.8 <i>I</i>	2.3 <i>I</i> 1.2 <i>I</i>	.9 <i>II</i>	.4 <i>I</i>	.2 -	.5 <i>II</i>	

Table 9.

Correlations between meiofaunal taxonomic groupings and sediment mean grain size. Level of significance is  $\alpha < 0.00001$  for all correlations.

Taxonomic group	Correlation
Nematoda	0.23
Copepoda	0.24
crustacean larvae	0.22
polychaete larvae	0.20
Kinorhynchia	0.20
Priapulida	0.23
Tardigrada	0.26
all above groups combined	0.99
all Gastrotricha	0.98
<i>Acanthodasys</i>	0.26
<i>Diplodasys</i>	0.23
<i>Mesodasys</i> group	0.20
<i>Tetranchyroderma</i>	0.26
<i>Urodasys</i>	0.20
other gastrotrichs	0.26
all Turbellaria	0.99
Acoela	0.24
Macrostomida	0.26
Retronecitidae	0.25
Proseriata	0.96
Prolecithophora	0.95
Typhloplanoida	0.99
Dalyellioida	0.99
Eukalyptorhynchia	0.99
Karkinorhynchidae	0.99
<i>Carcharodorhynchus</i>	0.98
other Schizorhynchidae	0.99

Table 10. Ratio Carcharodorhynchus: Eukalyptorhynchia  
(Turbellaria)  
Average values over seasons II and III  
(~ indicates pattern not consistent between seasons)

Depth	VI	V	Transects			
			IV	III	II	I
10 m			2 → .2 4	.05	13	>10 2
20 m	0 *		.4 1	.3		
30 m	.2 ~ .5 .3	.3 0	.2 .7	.1 0	~ ~ .5	~
40 m		0 0			0	
50 m		.1				0
60 m	0	.1				
70 m	0	0				
80 m			0			
90 m						0
100+m	*	0 0	0	0	0	0

- \* both groups absent from all samples
- arrow indicates station 2420, which does not conform to expected patterns

Table 11. Seasonal presence of Acanthodasys

Numerals 1, 2 or 3 indicates presence at station in period I, II or III.

Depth	Transects					
	VI	V	IV	III	II	I
10 m			123 12 2	123	23	123
20 m	-		2			
30 m	-		-	12		
	123				-	
	-	1		23		
	123	-	12	3	-	3
40 m		-		-	-	
		3				
50 m		-				-
60 m	-	1				
70 m	-	1				
80 m			2			
90 m						-
100+m	-	1				
		-	-	-	-	-

Table 12. Seasonal presence of Diplodasys

Depth	Transects					
	VI	V	IV	III	II	I
10 m			-			-
			23			
			-	123	3	-
20 m	-		2			
30 m	-		-	12		
	-		123		-	
	13				-	
	2	12		23		
	13	12	12	3	-	-
40 m		12		-	3	
		12				
50 m						-
60 m	13	123				
70 m	-	1				
80 m			123			
90 m						-
100+m	-	-	-	-	3	-
		-	-	-		-

Table 13

Priapulid abundance by seasons.

The number separated by periods are total numbers of priapulids (nearly all larvae) at that station during sampling period I, II and III, respectively. A dash (-) means none found (=0), and a cross (x) indicates no sample or no data.

Depth	Transects					
	VI	V	IV	III	II	I
10 m			- 12 - - 1 - - 1 -	- 7 -	- - 1	- - - - 1 -
20 m	- - -		- 2.1	- - 1		
30 m	- - 1 1 - - - - 2 - - -	- 20 - - 2 -	- - - 3.8.-	4.1.1 x 1.3	- - - - - - - - 3	- - -
40 m		1.1.4 - - -		x x 7	- - 2	
50 m		x 4.7				- 13.3
60 m	7.23.24	- - -				
70 m	1 - 1	- - 1				
80 m			2.6.3			
90 m						- 3.6
100+m	- 1 -	- - - - - -	- - -	- 1 -	2.3.3	- 8.3

Table 14  
 Kinorhynchia abundance by seasons.  
 as for Table 13.

Depth	Transects					
	VI	V	IV	III	II	I
10 m			6.9.3 6.2.58 12.31.7	51.35.36	3 - 2	3.1.2 1 - -
20 m	25.14.26 17.14.1		4.12 - 6.3.3	13.10.32		
30 m	32.17.21 90.20.23 66.14.21 26. 9.12	4.11.4 16.10.4	18.8.2 16.3.4	12.4.21 x.1.2	6.1.6 47.26.106 - 1.36	12.20.3
40 m		2.8.6 2.5.1 x.6.2		x.x.29	2.1.7	
50 m						7.4.3
60 m	21.16.8	8.7.7				
70 m	7.1 -	1 - -				
80 m			23.32.8			
90 m						4.3.1
100+m	14.1.1	15.3.3 3.1 -	2.6 -	11.1.3	4.1.1	2.1.3

101



REFERENCES

- Bovee, F. de and J. Soyer. 1974. Cycle annuel quantitatif du meiobenthos des vases terrigenes cotieres distribution verticale. *Vie Milieu* 24(1B):141-157
- Gray, J. S. 1974. Animal-sediment relationships. *Oceanogr. mar. Biol. ann. Rev.* 12:223-261.
- McIntyre, A. D. and D. J. Murison. 1974. The meiofauna of a flatfish nursery ground. *J. mar. biol. Ass. U. K.* 53:93-118.
- Tietjen, J. H. 1971. Ecology and distribution of deep-sea meiobenthos off North Carolina. *Deep-Sea Res.* 18:941-957.
- Warwick, R. M. and J. B. Buchanan. 1971. The meiofauna off the coast of Northumberland. II. Seasonal stability of the nematode population. *J. mar. biol. Ass. U.K.* 51:355-362.
- Wieser, W. 1960. Benthic studies in Buzzards Bay. II. The meiofauna. *Limnol. Oceanogr.* 5:131-137.

MAFLA BASELINE STUDY  
STANDARD SEDIMENT PARAMETERS

University of South Florida, Department of Marine Science

Principal Investigator:  
Larry J. Doyle

Associate Investigators:  
Barton Birdsall  
Gary Hayward  
Linda Lehman  
Stephen Szydlik  
Earl Warren III

## INTRODUCTION

### Setting

The Mississippi River Delta System forms a continental margin province which dominates the north central portion of the Gulf of Mexico. East of the Delta, off the coast of Mississippi, Alabama, and Florida lies a second province known by the acronym MAFLA (Figure 1). The eastern part of the MAFLA margin is dominated by the Florida platform, an accumulation of over 4572 m feet of carbonate sediment ranging in age from Jurassic to Recent. West of Cape San Blas, carbonates become intercalated with more and more clastics. Across the northern extension of the Florida Escarpment (Figure 1) the sedimentary basement rocks change from dominantly carbonates on the east to Cenozoic clastics on the west. The Florida Escarpment trend therefore represents a major sedimentary boundary between the Gulf Coast Geosyncline and the Florida carbonate platform.

Most of the sediment of the Mississippi River is delivered directly to the shelf edge or is transported west by the coriolis effect, the long-shore current system, and the prevailing surface currents. As a result, the MAFLA continental margin is covered by a sand sheet which Uchupi and Emery (1968) have called relict, which is dominantly quartz west of Cape San Blas and carbonate east of Cape San Blas.

Excepting mineralogy, the MAFLA sand sheet is much like that of the continental shelf of the southeastern Atlantic margin. Rivers which empty into the MAFLA waters carry very little sediment, virtually none of which is sand sized. Furthermore, most of the fine sediments delivered to the coast are trapped in estuaries, bays, and lagoons.

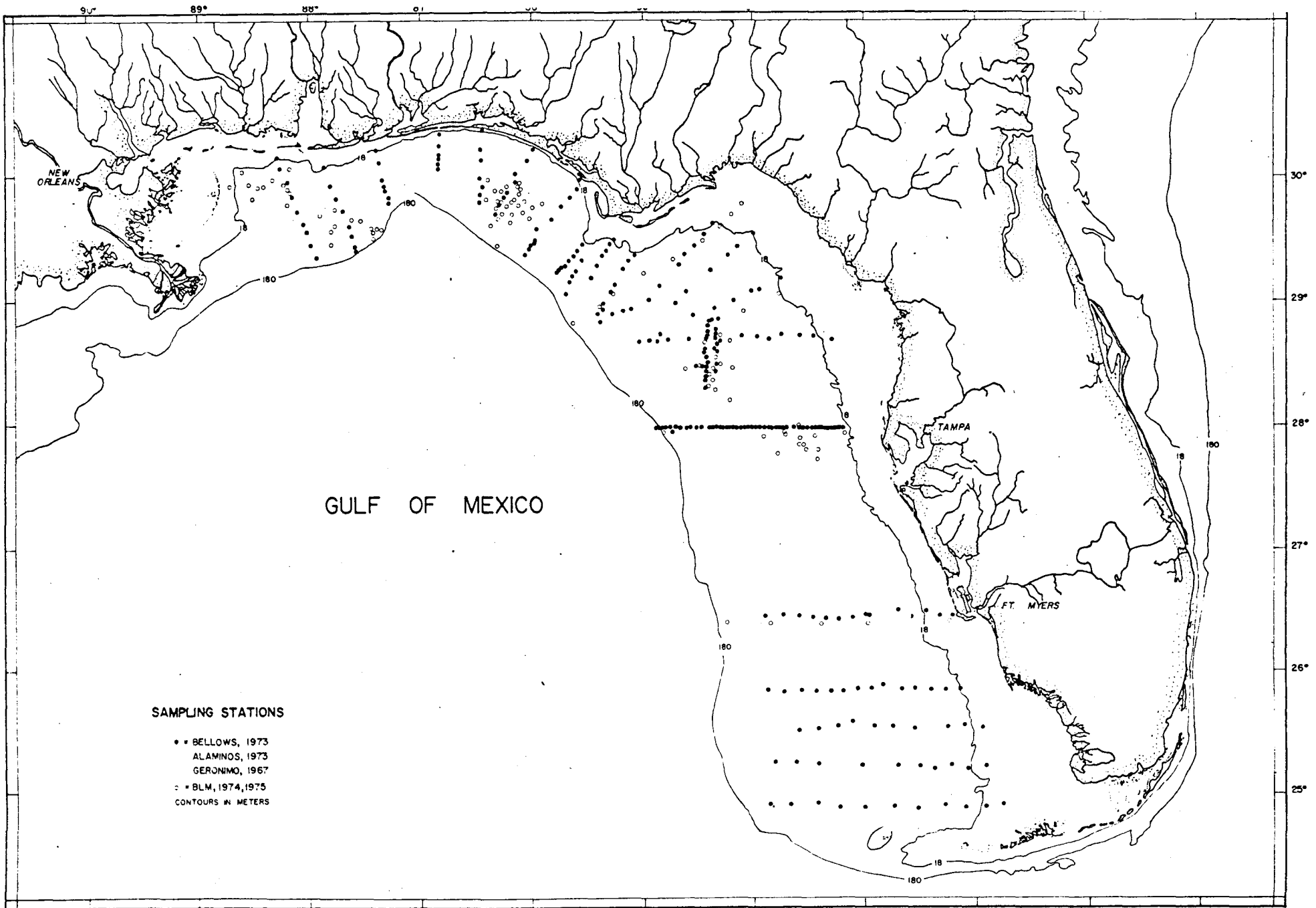

Figure 1. MAFLA study area.

### Previous Investigations

Estuaries, bays, and the coastal zone of the MAFLA area have been thoroughly investigated by Tanner (1960), Goodell and Gorsline (1961), Kofoed and Gorsline (1963), Tanner and others (1963), Kofoed and Jordan (1964), Gorsline (1966), and many more. However, surprisingly few studies of the continental shelf of the MAFLA area have been undertaken and with the exception of the broad overview of Uchupi and Emery (1968) data covering limited sectors of the area have never been integrated. Many of the individual investigations which have been conducted are listed in Brooks (1973). Gould and Stewart (1955), Ludwick (1964), and Grady (1972) have contributed most to the description of the MAFLA continental shelf. Holmes and others (1963) have investigated the innershelf sediments between Cape Romano and Cape Sable and Shepard (1956) the eastern flank of the Mississippi Delta. Gould and Stewart (1955) have depicted the central portion of the West Florida Shelf as covered with predominantly carbonate sediments zoned into quartz sand, quartz-shell sand, shell sand, algal sand, oolite sand, and foram sand and silt bands. Banded character of the sediments was also evident in Stewart and Gould's (1955) description of sediment textures. Ludwick (1964) described the sediments between the Mississippi Delta and Cape San Blas as a number of sand, mud, and transitional facies. Grady (1972) mapped sediment textures based upon a triangular diagram presentation of percent sand, silt, and clay in the northern Gulf of Mexico and his data was used to construct the latest existing sediment texture chart of the area published by BLM (1974). Finally, Van Andel and Poole (1960) and Fairbank (1962) have described the heavy mineral suites of the Eastern Gulf.

Although never before integrated, these studies are of good quality and provide a framework upon which a discussion of the sediments and

sedimentary processes of the MAFLA shelf can be built and compared and contrasted with those of the southeastern United States. Data analyzed for this study is small in comparison to those of the aforementioned work, but ties those investigations together and provides a basis for modifying interpretations put forth in them.

#### METHODS

##### At sea

At each station when box cores were obtained, two were subsampled with a five centimeter diameter sub-core for analysis for standard sediment parameters. One box core was subsampled with a five centimeter diameter sub-core for archiving. Each core collected was described and the top and one side were photographed in color. Each photograph included an identification tag, a color code system, a linear scale, and a designation of the top of the core. All sample containers were clearly labeled and boxed for delivery to shoreside facilities. The core to be archived was sent to the Florida State facility. Scoop samples were taken during the first sampling period at each dive station. These were also forwarded to a shoreside laboratory for analysis.

##### Analysis for Standard Sediment Parameters

The top ten centimeters of each sub-core and splits of each scoop sample were analyzed for grain size and percent calcium carbonate. In the former, core samples were split and wet sieved through 62  $\mu\text{m}$  mesh. If the percentage of finer than sand sized sediments exceeded ten, pipette analysis was conducted to determine the percentage of silt and clay in the sample. Coarser than 62  $\mu\text{m}$  sediments were sieved for 15 min through one phi

interval nested 7.62 cm. A second split of sediment from each sample coarser than 62  $\mu\text{m}$  was run through the rapid sediment analyzer.

Percent calcium carbonate was determined for each sample by leaching a known weight of sample with dilute hydrochloric acid until no more gas was given off, washing, drying, and reweighing. All data is stored in the DMSAG data bank and is available upon request.

### Geology Data Synthesis

Available published and unpublished data have been perused and pertinent points collated and incorporated into the biolithologic map. Figure 1 shows the locations of all samples which were used to provide direct input into the map. Splits of samples from the National Marine Fisheries Service gathered and reported upon by Grady (1972) were obtained and visually scanned for mineralogy; but at Grady's request, standard sediment parameter analyses which he had done, were not duplicated. Existing samples from the West Florida continental shelf available from the University of South Florida, Department of Marine Science sediment collection were analyzed for the standard sediment parameters as outlined above.

The digitized sediment data file at Scripps Institution of Oceanography, La Jolla, California was queried. Data within it refer to the deeper parts of the Gulf of Mexico and are not appropriate to this study.

## RESULTS AND DISCUSSION

### Sediment Sheet

Characteristics of the MAFLA sediment sheet are summarized in Figures 2 through 3 and cross sections 4 through 6 of the biolithologic map

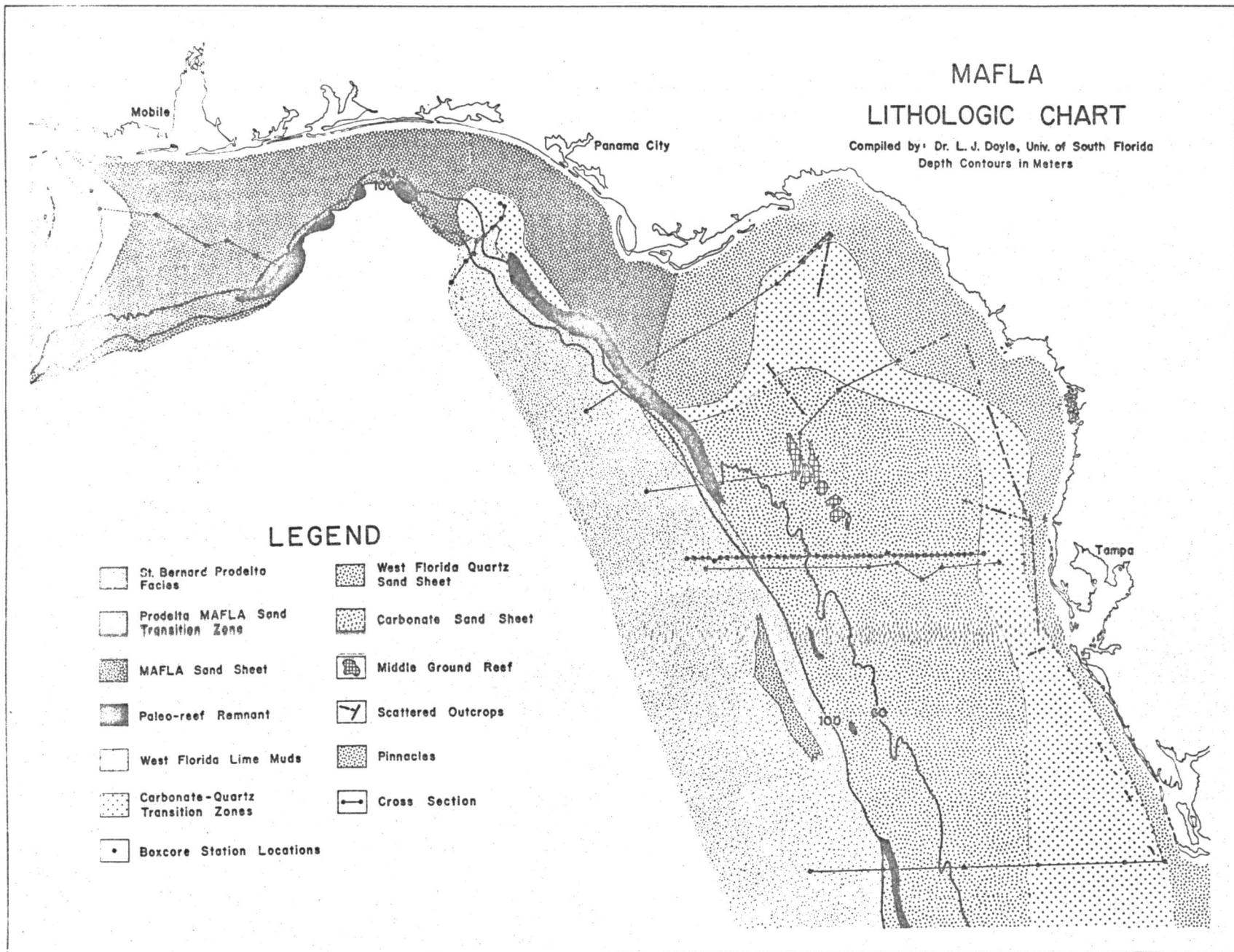

Figure 2. MAFLA Lithologic Chart.



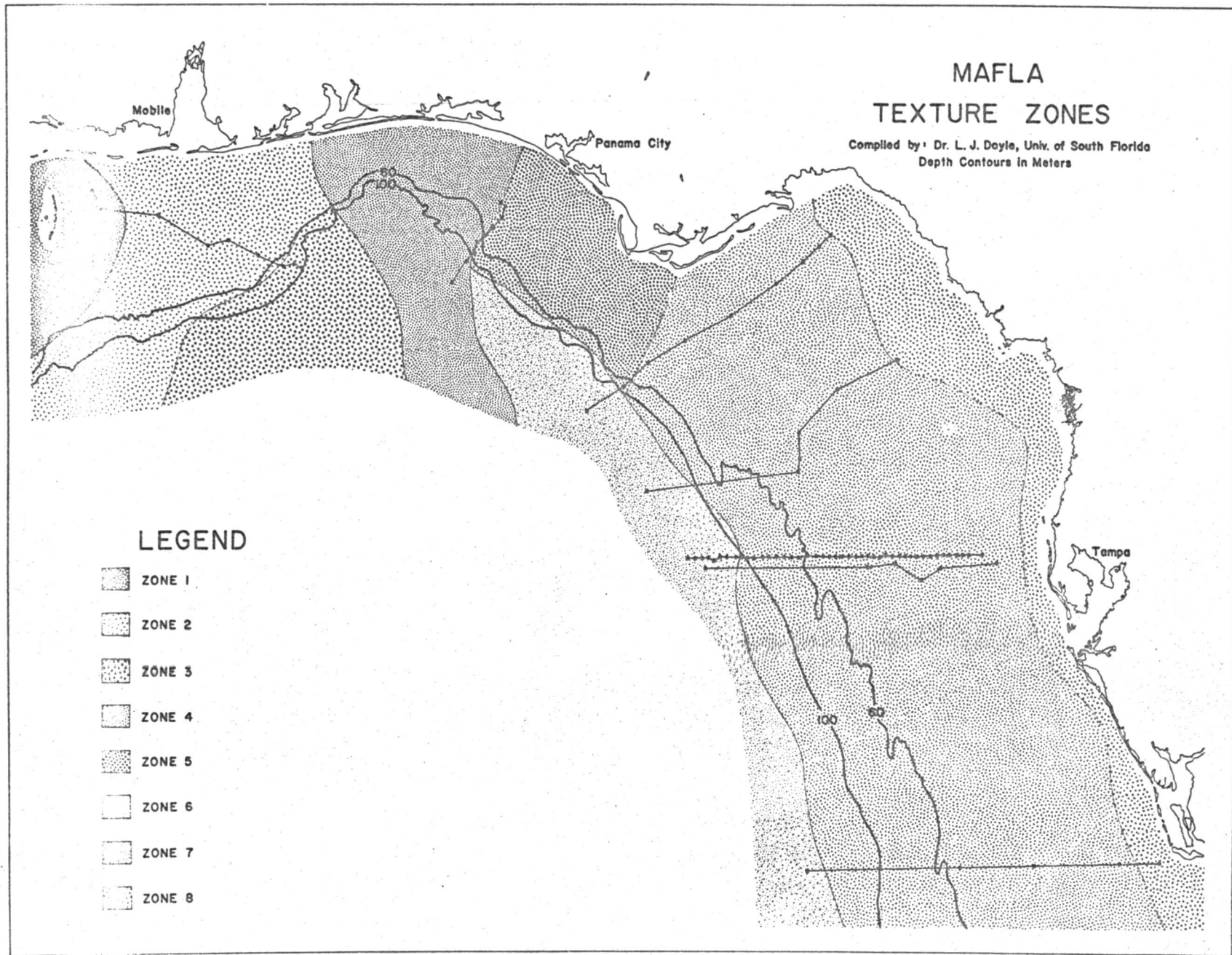
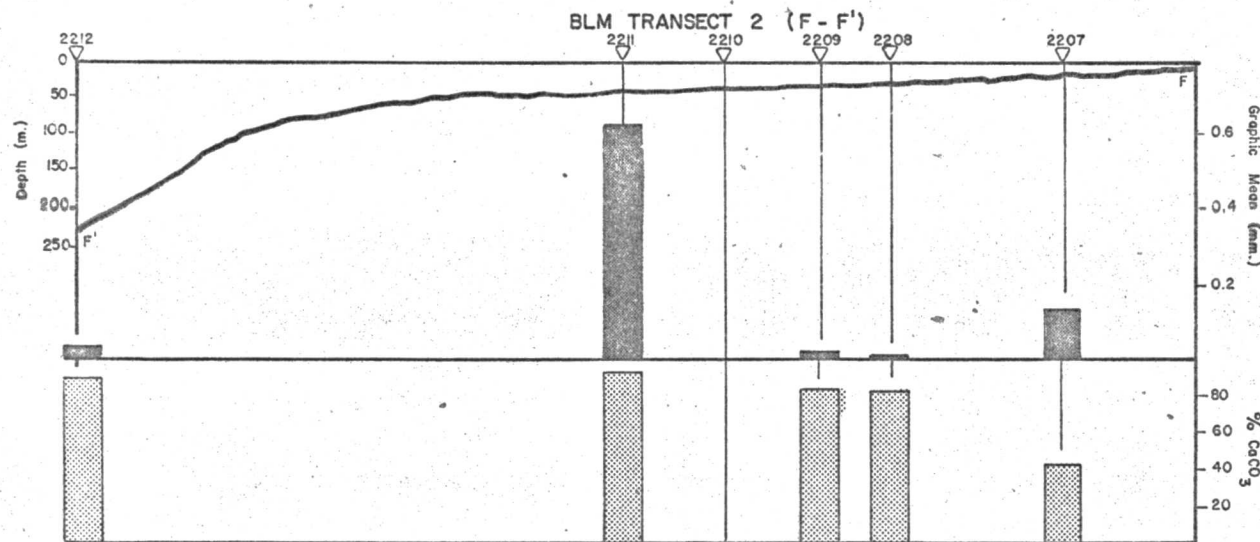
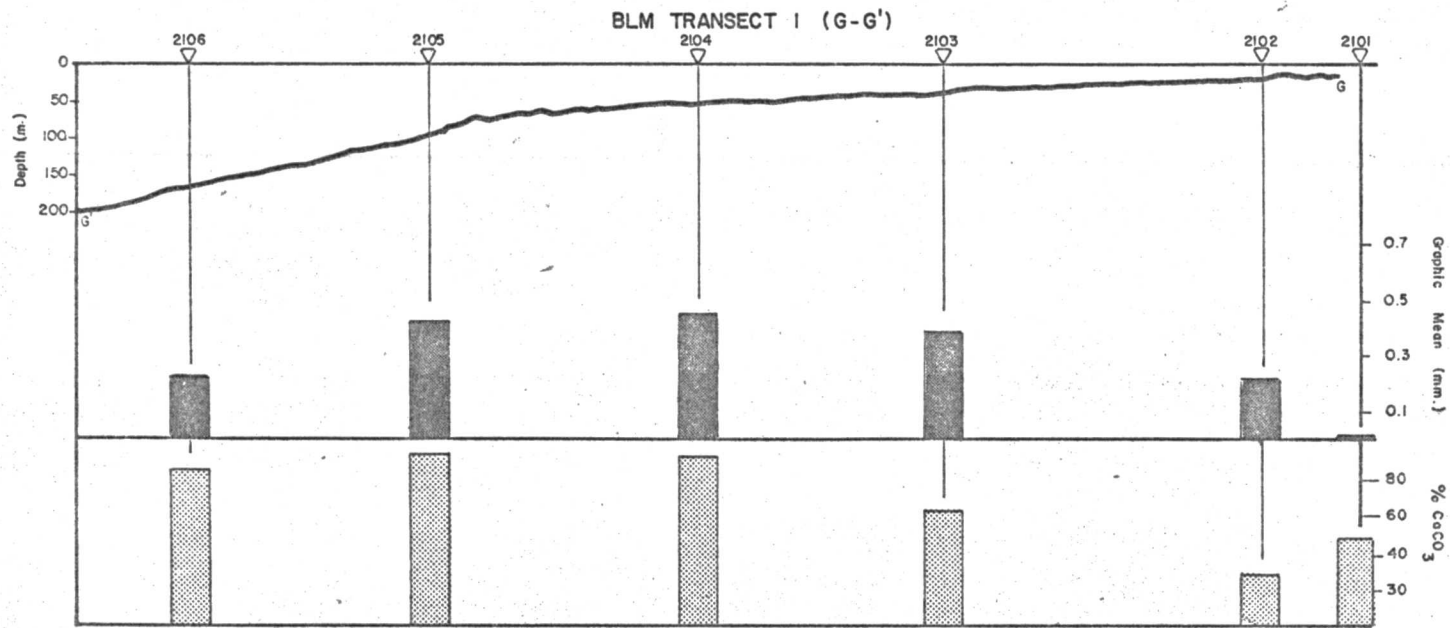

Figure 3. MAFLA Texture Chart.



**MAFLA PROGRAM  
BIOLITHOLOGIC SERIES  
TRANSECT CROSS SECTION**

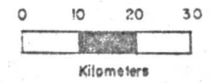
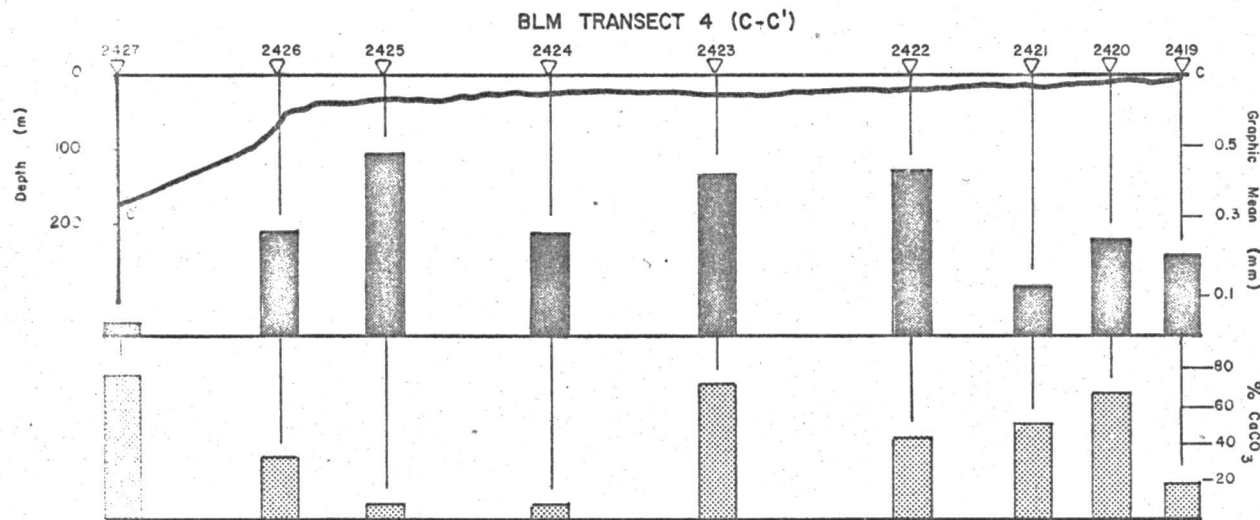
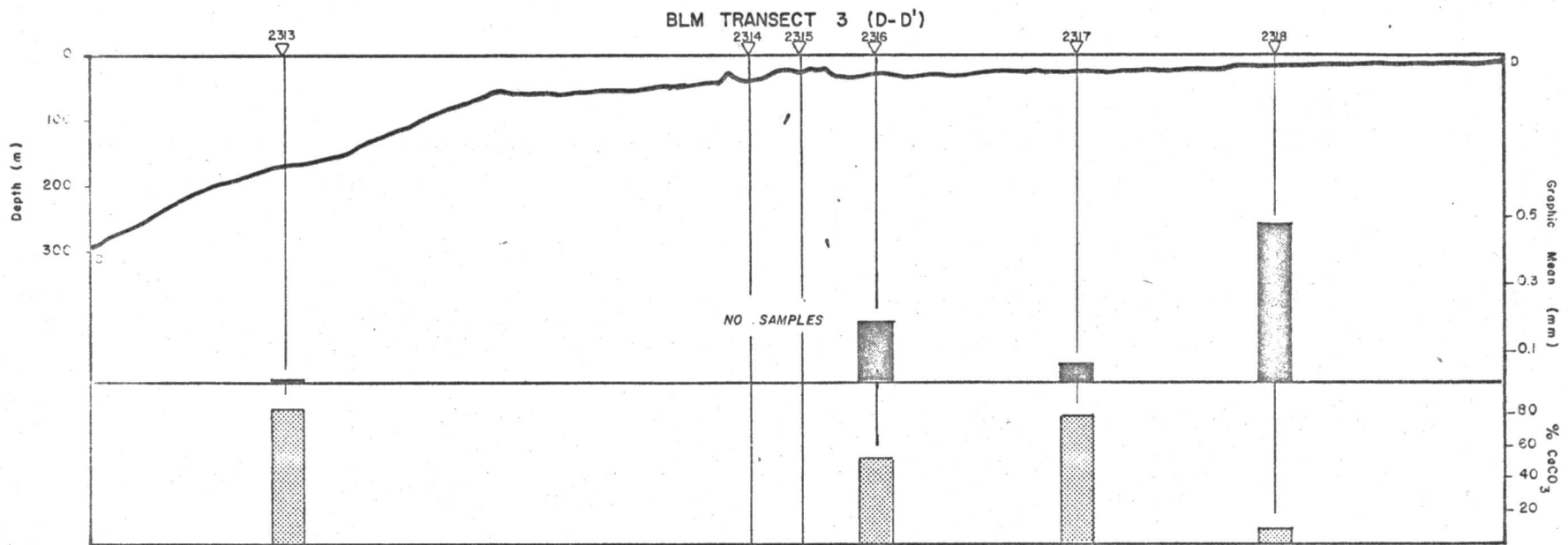

Figure 4. MAFLA Boxcore transect cross section (1 and 2).



**MAFLA PROGRAM  
BIOLITHOLOGIC SERIES  
TRANSECT CROSS SECTION**

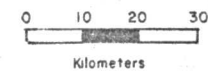

Figure 5. MAFLA Boxcore transect cross section (3 and 4).

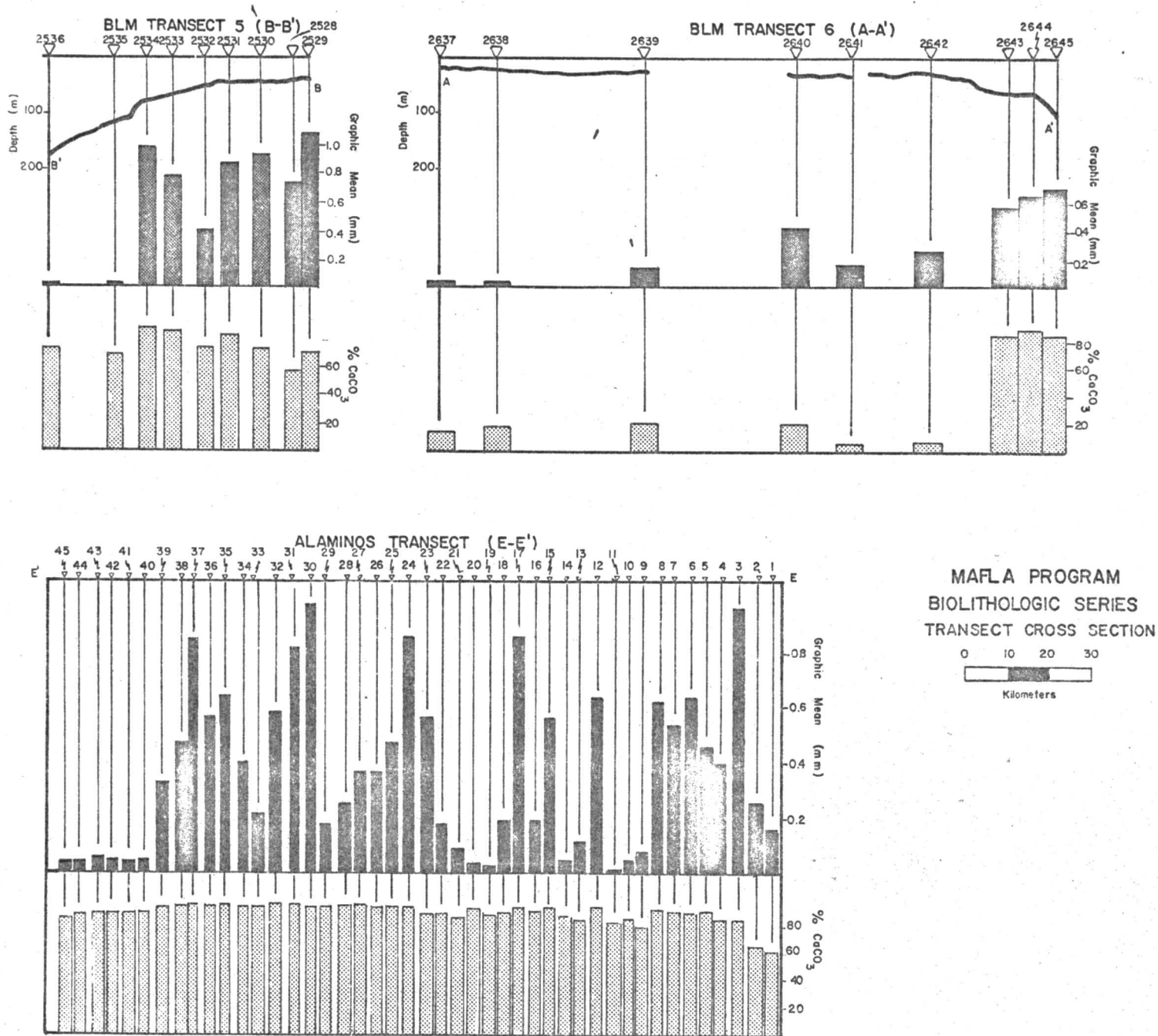

Figure 6. MAFLA Boxcore transect cross section (5,6, and 7).

which depict among other parameters, the graphic mean grain size, the sand/fine ratio (sand/silt + clay = sand/fine ratio), and the percent  $\text{CaCO}_3$  in the sediments. The sand/fine figure (2) shows the MAFLA continental shelf and upper slope divided into a number of zones and serves as a convenient base upon which to build a discussion of the MAFLA sediment sheet. One must keep in mind that zone boundaries are rather arbitrary and that transitions between zones are gradational.

Zone I reflects the influence of deposition of Mississippi River sediments. It is characterized by a sand/fine ratio of less than 1.0 and a low (less than 25%) calcium carbonate content. Silt predominates over clay sizes. Sand and silt sized particles are dominantly quartz while the clay minerals are dominated by smectite (Huang and others, 1975). The heavy mineral suite is relatively depaupered in the most resistant minerals such as zircon and is dominated by hematite, micas, amphiboles, and pyroxenes.

Zone II has a sand/fine ratio of between about 1.0 and about 58.5. The ratio increases toward the east showing the diminishing though still detectable, influence of Mississippi deposition and the exposure of the relict quartz sand sheet. Calcium carbonate in the sediments remains low at less than 25%. Kaolinite becomes a major constituent of the clay mineral assemblage although smectite remains dominant. Heavy minerals reflect a southern Appalachian provenance and are characterized as a kyanite/staurolite suite (Van Andel and Poole, 1960, and Fairbank, 1962) with ilmenite, zircon, and tourmaline common, but hematite, pyroxenes, and amphiboles diminished.

Zone III reflects the abrupt bathymetric change at the western margin of DeSoto Canyon. Sediments are still sands, but have a lower sand/fine

ratio than do those of the eastern portion of Zone II. Calcium carbonate content jumps to greater than 75% at the shelf edge. Sediments shoreward are still dominated by quartz. Heavy minerals are similar to those of Zone II.

Zone IV, containing the more gently sloping eastern margin of DeSoto Canyon, is characterized by lowered sand/fine ratios and high carbonate content typical of the western Florida lime-mud facies of Ludwick (1964) on the upper continental slope.

Zone V is a transition between the slope muds and the quartz sand sheet south and west of Cape San Blas. West of Cape San Blas the clay mineral suite becomes dominated by kaolinite showing the continued waning influence of the Mississippi River. Heavy minerals are similar to those of Zones II and III. The eastern portion of Zone V is transitional to the west Florida carbonate sand sheet.

Zone VI represents the upper continental slope of the west Florida margin. It is characterized by limey muds with a sand/fine ratio less than 1.0 and a high (>75%) carbonate content. It is similar to Zone IV.

Zone VII is the carbonate sand sheet of the west Florida shelf. While sand/fine ratios are generally greater than 1.0, they vary from 1.0 to 90.0 reflecting the effect of local bathymetry. This variation may be seen in Figure 6 which shows the graphic mean grain size of a series of stations at 1.85 km intervals across the west Florida shelf. (See Figure 3 for locations.) The variation is impressive. Stations 40-45 of Figure 2 are in the upper continental slope Zone IV. Carbonate constituents of cross sections A through D show that the banding reported by Stewart and Gould (1955) is not present with one notable exception, the inner shelf quartz band. The carbonate sand sheet is thin with many outcrops of tertiary rocks exposed through it.

Zone VIII is the inner portion of the West Florida shelf. It is a relatively pure quartz sand that also makes up the beaches of west Florida. It will be discussed in more detail in a latter section. The heavy mineral suite of the MAFLA Zone VIII east of Cape San Blas is dominated by zircon, staurolite, tourmaline, and garnet (Fairbank; 1962). As expected, heavy minerals decrease as carbonate increases and are essentially absent in Zone VII. Clay minerals are dominated in both Zones VII and VIII by kaolinite with chlorite next in abundance (Huang and others, 1975).

#### Quartz Sand Band

One of the most significant aspects of the MAFLA sediment sheet is the quartz band that is shown as Zone VIII in Figure 2 and the transition between it and the carbonate sand sheet of the west Florida continental shelf. Since virtually no sand sized sediment has been brought into the system during the present high stand of sea level, and since it is bordered on the south and west by carbonate sands, the quartz sand belt provides a natural laboratory in which to test some of the current theories on shelf sediment transport. Since it is cut off from a quartz source, longshore current systems that affect it must balance out essentially to zero net transport or else the band should have disappeared or evinced dilution with carbonates.

Pilkey and others (1972) have suggested that the beaches of the southeastern Atlantic continental margin are fed by sediments from the adjacent continental shelf. If this is indeed the case, the ramifications for the onshore transport of oil related pollutants which have become incorporated in shelf sediments are ominous.

A study should therefore be initiated to investigate the quartz band

carbonate boundary in three dimensions. The mineralogical difference will provide a definitive solution to the problem of efficacy of shelf to coastal zone sediment transport which will in turn have ramifications far beyond the MAFLA margin.

#### Small Scale Variability

Sediment texture in any sand sheet is subject to considerable variation over short distances. A major factor in controlling textural variation is local bathymetry. Thus while the attributes of a sand sheet as a whole may be accurately described, specific grain size is difficult or impossible to predict at any projected station. Small scale variability is illustrated by Figure 6 which shows a series of stations taken at 1.6 km intervals across the central portion of the west Florida carbonate sand sheet (see Figure 1 for station locations). Table 1 shows variation within the sand sheet on an even smaller scale, i.e. variation among the box cores at each station among the several sampling periods. Distances among the individual box cores are limited by the swing of the vessel and by accuracy and reproducibility of the various navigation systems used. Average maximum variation within a station among the sampling periods is 7.9% in sand sized sediment. Maximum variation in percent sand at one station is about 28.6. These variations are significant and suggest that grain size analysis should be run on each box core sample in order to have complete confidence in biological and chemical data interpretations.

#### Hydraulic Equivalency vs. Sieve Analysis

Analysis by settling tube should theoretically result in a hydraulic equivalent grain size since the particles are sized by the time it takes them to settle through a water column of known length. Sieve analysis is



TABLE 1

Station	Greatest Deviation Among Box Cores Over Three Cruises Expressed as Weight Percent
2101	8.0
2102	9.9
2103	20.6
2104	14.8
2105	12.0
2106	16.3
2207	2.3
2208	9.7
2209	8.0
2210	9.0
2211	4.8
2212	6.2
2313	9.0
2314	4.0
2315	28.2
2316	7.7
2317	15.5
2318	2.6
2419	7.6
2420	3.1
2421	6.3
2422	7.9
2423	5.1
2424	8.0
2425	5.0
2426	2.7
2427	7.6
2528	8.7
2529	3.6
2530	8.4
2531	9.3
2532	8.1
2533	6.7
2534	9.2
2535	9.9
2636	7.0
2637	7.6
2638	1.0
2639	9.3
2640	1.8
2641	7.4
2642	0.8
2643	5.9
2644	4.6
2645	3.7

a direct measure of particle diameter. Comparison of settling tube and sieve analyses (see DMSAG for data) shows no interpretable pattern of variation. It is therefore recommended that settling tube analysis of grain size be discontinued. Since organisms respond to the physical size of the particles and not to the hydraulic character of the grains, sieving should be the preferred method for MAFLA type studies.

## CONCLUSIONS

1. There are two major divisions of sediments within the MAFLA area.  
West of Cape San Blas sediments are dominantly clastic; east of Cape San Blas carbonates dominate. Within these major subdivisions, at least eight separate sediment zones can be defined on the basis of sand/fine ratios, percent carbonate, and mineralogy. Mississippi River influence diminishes from west to east and is undetectable in shelf sediments east of Cape San Blas.
2. Zone I is composed of fine grained pro-delta sediments characterized by a smectite dominated clay mineral suite.
3. Zone II is composed primarily of quartz sand with the clay fraction still dominated by smectite.
4. Zones III and IV are the steep western and gentler eastern flanks of the DeSoto Canyon. The former is made up of carbonate sands; the latter of lime muds typical of the upper west Florida continental slope.
5. Zone V is the transition from the DeSoto Canyon to the clastic shelf of the northwest Florida margin. West of Cape San Blas, transition to the Florida carbonate platform begins. Kaolinite becomes the predominant clay mineral and carbonates increase at the eastern outer edge of the shelf.
6. Zone VI represents the upper continental slope of the Florida platform.
7. Zone VII is the thin carbonate sand sheet covering most of the west Florida shelf and Zone VIII is the quartz band of the inner shelf and coastal zone.
8. The quartz band represents a closed nearshore transport system; and as such, its boundary with carbonate shelf sediments offers a unique

opportunity to test the theory that shelf sediments along with entrained pollutants are transported into the beach system.

9. Small scale textural variation due to local bathymetry within the sand sheets is significant.
10. Sieving should be the method of choice of sand fraction analysis of sediments in MAFLA type programs.
11. Bands of carbonate constituents shown by Gould and Stewart (1955) are not present, rather the carbonate sediments are patchy in distribution.

LITERATURE CITED

- BLM MAFLA Report; Final Report on the Baseline Environmental Survey of the MAFLA Lease Areas, CY 1974, BLM Contract No. 08550-CT4-11, vol. 3 of 5.
- Brooks, H.K. 1973. Geological Oceanography Section E. A Summary of the Knowledge of the Eastern Gulf of Mexico, ed. by Jones, Ring, Rinkel, and Smith, p. IIE 1-49.
- Fairbank, N.G. 1962. Minerals from the Eastern Gulf of Mexico, Deep-Sea Research, Vol. 9, p. 307-338.
- Goodell, H. G. and D. S. Gorsline. 1961. A Sedimentological Study of Tampa Bay, Florida. Internat. Geol. Cong., 21st, Copenhagen, 1960. Pt. 23, p. 75-88.
- Gorsline, D. S. 1966. Dynamic Characteristics of West Florida Gulf Coast Beaches. Marine Geology, v. 4, No. 3, p. 187-206.
- Gould, H. R. and R. H. Stewart, 1955, Continental Terrace Sediments in the Northeastern Gulf of Mexico, Soc. Econ. Paleontologists and Mineralogists, Spec. Pub. 3, p. 2-19.
- Grady, J. R., 1972, Reconnaissance Survey; Bottom Sediments on the Continental Shelf, in Report of the National Marine Fisheries Service; Gulf Coastal Fisheries Center for Fiscal Years 1970 and 1971, p. 15-19.
- Holmes, C. W. and R. G. Evans, 1963, Sedimentology of Gullivan Bay and Vicinity, Florida, Sedimentology, v. 2, p. 186-206.
- Huang, W. H., L. J. Doyle, and W. Chiou, 1975, Clay Mineral Studies of Surface Sediments From the Shelf of the Northeastern and Eastern Gulf of Mexico. Proceedings of the International Clay Conference, p. 55-70.
- Kofoed, J. W. and G. F. Jordan, 1964, Isolated Fault Scarps on the Coast of Southwest Florida, Southeastern Geol., v. 5, p. 69-76.
- Kofoed, J. W. and G. S. Gorsline, 1963, Sedimentary Environments in Apalachicola Bay and Vicinity, Florida, Jour. of Sed. Pet. v. 33, p. 205-223.
- Ludwick, J. C., 1964, Sediments in the Northeastern Gulf of Mexico, in Papers in Marine Geology: MacMillan Co., New York, p. 204-238.
- Pilkey, O. H. and M. E. Field, 1972, Onshore Transportation of Continental Shelf Sediment: Atlantic Southern United States, in Shelf Sediment Transport; ed. by D. J. P. Swift, D. B. Duane, and O. H. Pilkey: Dowden, Hutchinson and Ross, Inc., Stroudsburg, p. 429-447.

Shepard, F. P., 1956, Marginal Sediments of the Mississippi Delta, Am. Assoc. Petrol. Geol. Bull., v. 40, no. 11, p. 2537-2618.

Tanner, W. F., Jr., 1960, Florida Coastal Classification, Gulf Coast Assoc. Geol. Socs. Trans., v. 10, p. 259-266.

Tanner, W. F., R. G. Evans, and C. W. Holmes, 1963, Low-energy Coast Near Cape Romano, Florida, Jour. Sed. Petrol., v. 33, p. 713-722.

Uchupi, E. and K. O. Emery, 1968, Structure of Continental Margin Off Gulf Coast of United States, Am. Assoc. Petrol. Geol. Bull., v. 52, p. 1162-1193.

Van Andel, T. H. and D. M. Poole, 1960, Sources of Recent Sediments in the Northern Gulf of Mexico, Jour. Sed. Petrol., v. 30, p. 91-122.

SEDIMENTARY ANALYSIS FOR RIG MONITORING

University of South Florida, Department of Marine Science

Principal Investigator:  
Larry J. Doyle

## INTRODUCTION

The objectives of this investigation were to determine whether or not changes in the environment adjacent to a sub-sea drilling operation could be detected; and if so, what are they? In order to accomplish these goals, a station grid composed of three concentric rings 100, 500, and 1000 m apart was set up as shown in Figure 1. Stations were occupied before drilling commenced, during the drilling operation and after drilling had ended. Location of the experiment was off the Texas coast near Mustang Island at 27°37'14"N, 96°57'55"W. Surface sediments in this area are muds.

Samples were collected at each station by a diver filling a ten centimeter diameter by about 1/2 m long PVC core with sediment by scraping it horizontally along the bottom. The core was then capped, brought to the surface, labeled, taped, and delivered to my shoreside laboratory for sediment analysis. Sampling was difficult for the divers because the large amount of fines in the water column reduced visibility to near zero and because of the concomitant difficulty in determining the exact location of the bottom in the sometimes soupy sediments.

In the laboratory, samples were split. One aliquot was wet sieved through a 63  $\mu\text{m}$  screen. An aliquot of sediments remaining in the screen was dried, weighed, and sieved for 15 min through 7.62 cm diameter sieves nested at one phi intervals. Another aliquot of sediment remaining in the 63  $\mu\text{m}$  mesh was run through the rapid sediment analyzer. Percent silt and clay in the finer than sand sized sediment was determined by pipette analysis. The sand fraction was optically scanned in order to detect well cuttings and barite. Percent  $\text{CaCO}_3$  was determined using standard acid digestion gasification techniques.



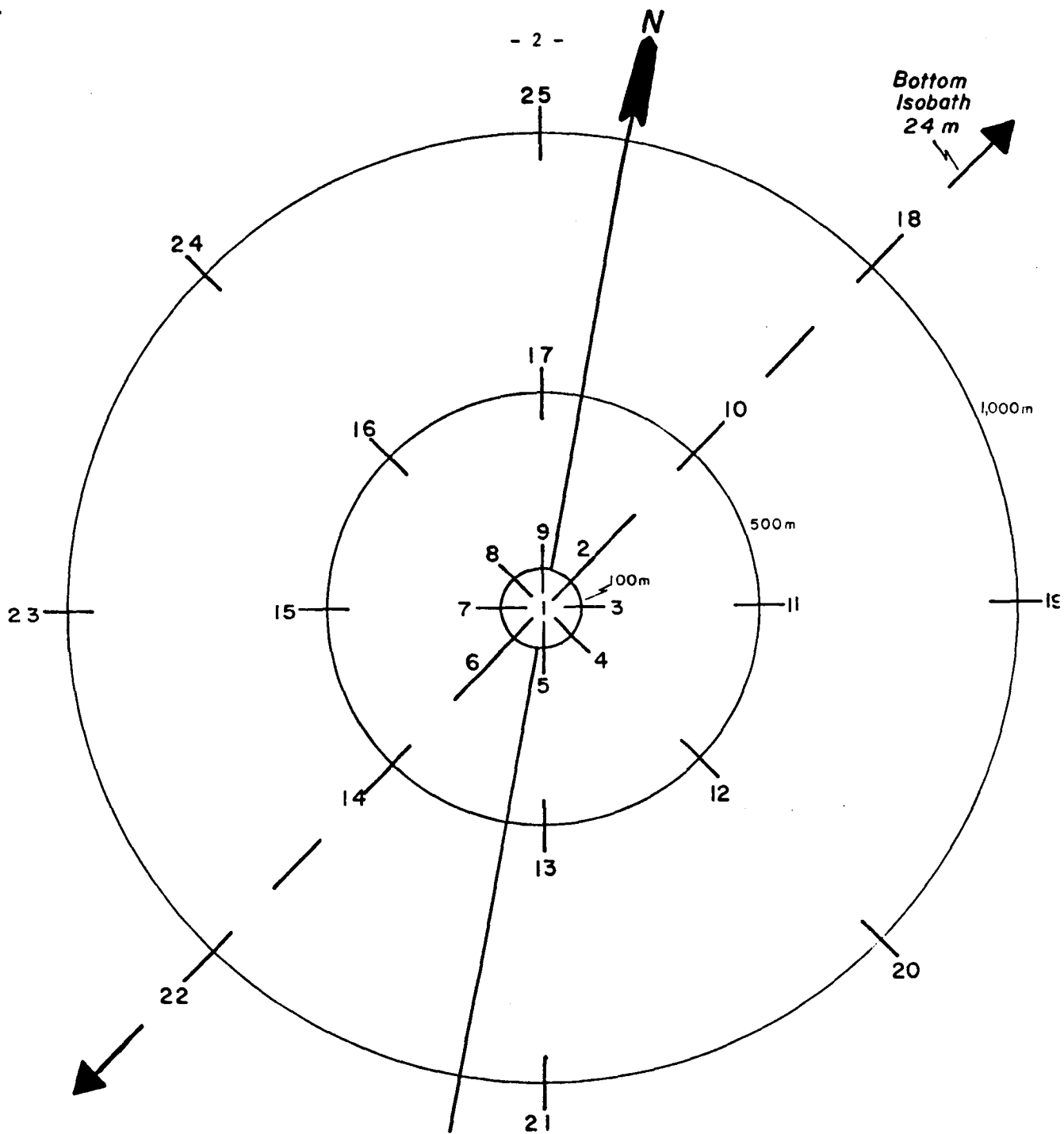

- 2 -

25

Bottom  
Isobath  
24 m

18

24

1,000m

17

10

16

500m

9

2

8

3

11

4

12

5

7

15

6

14

13

23

15

19

14

12

22

20

21

Figure 1

Station Arrangement for Rig Monitoring

Drilling occurred at Station 1

## RESULTS

Detailed grain size analysis and percent  $\text{CaCO}_3$  of each sample are stored in the DMSAG data bank. Tables 1-4 show the distribution of sand, silt, clay, and  $\text{CaCO}_3$  before, during, and after drilling operations. Within limitations of sampling the substrate, apparent differences are probably related to drilling.

Calcium carbonate increased markedly during the drilling operation at all stations measured. In addition, percentage of sand in the sediments increased in like fashion at nearly all stations. Optical scanning of the sand fractions showed well cuttings to be present at stations 2, 3, 6, 9 and 14 during the drilling operation.

Samples taken after drilling still showed the effects of the operation but to a lesser extent. Percent calcium carbonate in most samples was less than during drilling, but was not back to predrilling levels. Texture showed more variation than the carbonate percentages. Perusal of Tables 1-4 shows that at some stations, percent sand was higher after drilling than during the operation, while at others it was lower. However, percent sand in the sediment was still significantly higher than the uniformly low levels present prior to drilling. Optically obvious well cuttings were less abundant in all post-drilling samples when compared to samples taken during drilling.

## CONCLUSIONS

Effects of the drilling operation are detectable in sediment composition and texture up to the 1000 m limit of the sampling pattern. Obvious well cuttings were found during drilling operations at four stations 100 m from the rig and at one station 500 m from the rig.

TABLE 1  
% SAND BY WEIGHT

Station #	Before	During	After
1	2.1	--	19.6
2	0.6	17.3	6.4
3	0.9	6.3	4.8
4	7.9	4.9	6.0
5	1.1	6.2	16.7
6	0.5	10.2	9.8
7	1.1	8.2	7.0
8	0.9	4.8	8.7
9	0.5	4.2	8.8
10	1.4	5.9	4.9
11	0.7	4.1	9.0
12	1.0	4.9	14.1
13	1.2	5.5	26.8
14	0.9	4.8	6.1
15	0.7	6.5	6.1
16	0.7	6.9	11.5
17	1.5	10.5	12.2
18	0.9	6.8	7.7
19	0.6	8.4	6.5
20	0.5	7.5	5.3
21	0.5	4.5	4.1
22	2.0	7.4	7.3
23	1.3	6.4	6.9
24	2.0	6.9	7.1
25	0.9	8.7	4.8

TABLE 2  
% SILT BY WEIGHT

Station #	Before	During	After
1	51.4	--	49.9
2	52.5	6.6	50.9
3	47.6	47.2	55.6
4	45.0	50.5	47.2
5	54.1	53.9	51.0
6	52.6	43.5	36.6
7	57.4	1.3	50.8
8	52.2	44.7	46.3
9	67.8	55.7	56.1
10	50.4	52.0	48.1
11	53.6	52.3	57.9
12	53.1	32.4	55.1
13	53.1	51.3	46.2
14	58.4	4.4	53.0
15	47.8	50.5	50.0
16	54.6	21.3	53.2
17	59.1	51.6	52.1
18	62.4	49.6	51.0
19	55.3	44.6	52.6
20	46.6	47.2	53.6
21	59.1	1.8	54.0
22	98.0	51.1	48.6
23	54.7	52.5	47.0
24	98.0	30.4	47.1
25	47.0	45.7	51.0

TABLE 3  
% CLAY BY WEIGHT

Station #	Before	During	After
1	46.5	--	35.5
2	46.9	76.1	42.7
3	51.5	46.5	39.6
4	46.1	44.6	44.8
5	44.8	39.9	32.4
6	46.9	46.3	36.6
7	41.5	90.3	35.5
8	46.9	50.5	45.0
9	31.6	40.1	35.1
10	48.2	42.1	47.0
11	45.7	43.6	33.1
12	45.9	62.7	30.8
13	45.7	43.2	27.0
14	40.8	90.8	40.9
15	51.5	43.1	43.9
16	44.7	71.8	35.4
17	39.5	38.0	35.7
18	36.7	43.7	39.8
19	44.1	47.1	39.9
20	53.0	45.3	48.3
21	40.4	93.6	41.9
22	--	41.6	44.2
23	44.0	41.1	46.2
24	--	62.7	45.8
25	52.1	45.6	44.2

TABLE 4  
% CaCO<sub>3</sub> BY WEIGHT

Station #	Before	During	After
1	3.3	--	5.9
2	9.2	13.1	5.2
3	1.3	15.4	17.0
4	6.2	9.3	7.4
5	3.2	9.9	5.5
6	3.3	13.6	4.4
7	3.2	13.4	5.5
8	2.7	13.0	4.6
9	5.4	10.0	6.0
10	1.0	10.2	4.2
11	7.7	11.9	6.8
12	3.6	10.3	4.4
13	9.3	10.6	43.5
14	1.8	15.4	4.5
15	1.8	14.5	6.0
16	3.3	13.0	5.2
17	3.7	11.4	5.1
18	2.5	17.9	5.8
19	3.5	8.5	4.0
20	0.8	10.2	2.5
21	3.1	12.3	3.3
22	4.0	9.7	1.9
23	7.0	15.3	5.1
24	4.8	12.2	1.4
25	2.2	13.8	4.1

Compositional effects of drilling upon the sediments are muted in the post drilling samples; textural changes are less so.

GEOPHYSICAL INVESTIGATIONS OF THE MAFLA LEASE AREA

Vernon J. Henry

See Thomas E. Pyle



EPIFAUNAL AND EPIFLORAL BENTHIC COMMUNITIES IN THE MAFLA YEAR 02 LEASE AREA

University of Alabama, Marine Science Program

Principal Investigator:  
Thomas S. Hopkins

Associate Investigator:  
GRUNT Laboratory Staff

## INTRODUCTION

The following summary report is in partial fulfillment of Contract 08550-CT5-30 between the State University System of Florida and the Bureau of Land Management, Department of the Interior. As a result of a subcontract with the State University System of Florida, this investigator and his associates undertook the responsibility for those portions of the Contract dealing with the Benthic Sampling and subsequent analyses as defined by (1) epifaunal and epifloral elements (exclusive of demersal fishes) of Trawl and Dredge and (2) the epifloral and epifaunal elements of Diving. This responsibility also included collection, preparation and delivery of samples for chemical and histopathological analysis.

In addition to the above, this investigator and his associates assumed responsibility for the total benthic sampling program in the Rig Monitoring effort.

As a result of these activities, this principal investigator performed 154 days of Chief Scientist's duties aboard ship during this Contract. These days are exclusive of report writing, meetings attended, or time spent in laboratory analyses.

## METHODS

### A. Field

1. Diving - The mode of collection during diving operations was principally by hand although nets, bags, trawls, and scoops were used with a variety of estimates of success. Photography was accomplished with hand held 35 mm Nikonos II cameras using close-up, 28 mm and 35 mm lenses and Sub Sea Mk 150 strobes for illuminations. In addition, Super 8 movies were taken

with a Nikon Super 8 Camera or a Kodak XL 55 Super 8 Camera in a pressure resistant housing outfitted with dual 100 w cinema lights. Only color film was used.

Quantitative measures involving individuals per area were done by two methods as appropriate to the task.

(a) The 5 m<sup>2</sup> System - At each of the Florida Middle Ground (FMG) stations, a 5 m x 50 m strip transect was deployed. The strip transect was further segmented into 5 m subunits by attaching cross lines at 5 m intervals along the 50 m line thus producing 10 5-m<sup>2</sup> quadrats. As a point of reference, Quadrat one was always the deepest quadrat with Quadrat ten intended to be the shallowest inasmuch as the strip transect was intended to lay in consort with a deep to shallow axis. (We were not totally successful with this objective during all sampling efforts.)

This system was used to delineate "Community Structure" at the dive site, and for quantitative studies of Scleractinia and Octocorallia.

(b) The 0.25 m<sup>2</sup> System - At each of the FMG stations and at Clearwater (CW) too, we employed a 0.25 m<sup>2</sup> grid (inside area) to count and measure suitable biota e.g. algae. This grid was deployed in the study area for both random and biased collections for algal species diversity and biomass.

2. Dredge/Trawl - Dredging was accomplished through the use of a Capetown Dredge with removeable/interchangeable basket. Trawling was accomplished with a 9.1 m semi-balloon trawl.

3. Ship-board Photography - On board photography was accomplished through a Testrite Copy Stand fitted with a Nikon F2S SLR Camera Macro lens; this work was also accomplished with a Canon FTQL with a natural light.

A. Laboratory

1. Microscopy - Faunal identifications were taken to "best available" level through the use of a Wild M-20 binocular compound phase microscope, a Wild M-5 binocular dissecting microscope, or a Nikon binocular dissecting microscope depending on material examined and microscope available. The Nikon microscope was found to be decidedly inadequate for most all work beyond the family level. (It is furnished with a poorly designed/constructed illumination system, and its optics are incapable of resolving structural detail at its listed higher magnification.) It should be noted that although these Nikon microscopes were not purchased by BLM they were used because a BLM representative specifically stated during contract negotiations that he thought this brand microscope should be adequate for the level of results they sought. I disagreed, and I was not allowed to purchase the number of correct microscopes I thought necessary for the project.

2. Numerical Analysis

(a) Faunal Similarity - In order to determine faunal similarities between samples (= station locations) the "index of similarity" (S) used by Bray and Curtis (1957) has been used:

$$S = \frac{2 C}{A + B}$$

where:

A = number of species in Sample A  
B = number of species in Sample B  
C = number of species common to both samples

the results of which are plotted by way of a matrix with stations or transects linearly arranged. A "Sanders type" (Sanders, 1960) "trellis diagram" can

be adopted by arranging the stations so that samples with highest values are brought into closer proximity.

Species diversity of selected biota will be based on the Shannon measure of diversity (Pielou, 1966) where:

$$H = -\sum p_i \ln p_i$$

in which  $p_i$  represents the proportion of the  $i$ -th species. In order to measure the evenness with which individuals are divided among species found, Pielou's (Pielou, op. cit.) measure of evenness will be used:

$$J' = H'/H' \max$$

in which  $H' \max = \log s$  and  $s$  = number of species present.

#### MATERIALS

In accordance with II.B.2.a.i.(b) of Contract 08550-CT5-30. Dredge/Trawl samples were fine sorted into Molluscs, Arthropods, Echinoderms, Polychaetes, and "miscellaneous". Identifications were to be carried out to the family level and to genus and species for polychaetes and molluscs where possible. Algae and sea grass were to be carried to species level. Biomass determinations were not required. In case of diver collected samples all organisms were to be identified to species level. Labeling and archiving was required of all materials collected.

The effort described in this final report surpasses that required by the Contract. We have dealt with the below listed groups with explanatory notations and limitations as follows.

1) Molluscs

Dredge/Trawl - We have carried most all molluscs to beyond the family.

Diving - Same as above; mostly to species.

2) Arthropods

Dredge/Trawl - Amongst the arthropod macrofauna we were able to sort out Decapod Crustaceans, Stomatopod Crustaceans, and Pycnogonids. These have been carried well beyond the family level and most are to species rank.

Diving - Same as above; mostly to species.

3) Echinoderms

Dredge/Trawl - All echinoderms are carried to at least the family rank; depending on literature which is difficult to come by, the majority are carried beyond the family rank.

Diving - All echinoderms are carried to specific rank with the exception of a few possible new species.

4) Polychaetes

Dredge/Trawl - All polychaetes are carried to at least the family rank; the majority are carried beyond the family.

Diving - Same as above.

5) Miscellaneous

a) Octocorallia and Scleractinia

Dredge/Trawl - All material carried to at least family rank; the majority beyond family, dependent on literature.

Diving - All material to species rank.

b) Poriferans (Sponges) - A general statement must be made with

regard to all "sponge" material: We have found that the field of systematics in sponges is fraught with uncertainties even above the family level. We have sought and received help from three qualified workers in the field. We are still very much in the dark on much of our material, but we are reporting at levels that we feel are equivalent to the "state of the field".

c) Reef Fish Observations

Diving - We provide these data, although not required, in the interest of community characterization and good science.

6) Algae

Dredge/Trawl - All algae are carried at least to generic rank.

Diving - All algae are carried to the specific rank where possible.

RESULTS

Results of the benthic macro-epifaunal/epifloral study through dredging, trawling, and diving can be summarized by groups as follows:

I. Molluscs

A. Number of species recorded overall - 236

1. Total through Dredge/Trawl - 189

- a. Transect I - 70
- b. Transect II - 57
- c. Transect III - 68
- d. Transect IV - 60
- e. Transect V - 59
- f. Transect VI - 70

2. Total through Diving - 105

- a. Florida Middle Ground (FMG) - 70
- b. Clearwater (CW) - 57

B. Prospective "New" species

Dendrodoris sp. (from II A, and VI B); specimens are now being examined by a specialist.

C. New Distribution Records

1. Dredge/Trawl

- a. Platydoris angustipes
- b. Anisodoris prea
- c. Peltodoris greeleyi
- d. Malluvium benthophilum
- e. Dentalium taphrium
- f. Dentalium floridense
- g. Dentalium laqueatum

2. Diving

- a. Coralliophila abbreviata
- b. Antillophos adelus
- c. Crassispira cubana
- d. Pisania tineta
- e. Muricopsis oxytatus

In addition we have forty-six possible additional new records. These additional new records await verification.

D. Predominant species at each station.

1. Dredge/Trawl

- IA Chlamys benedicti, Aequipecten muscosus, Hiatella arctica
- IB Chlamys benedicti, Turritella exoleta, Xenophora conchyliophora
- IC Murex beauui, Murex hidalgo, Tuqurium caribeum
- IIA Aequipecten muscosus, Hiatella arctica, Calliostoma pulchrum
- IIB Chlamys benedicti, Chama congregata, Antillophos candei
- IIC Murex beauui, Tuqurium caribeum, Antillophos candei
- IIIA Chlamys benedicti, Lima pellucida, Spondylus americanus
- IIIB Pteria colymbus, Lima pellucida, Barbatia domingensis
- IIIC Murex beauui, Tuqurium caribeum, Aequipecten glyptus
- IVA Chlamys benedicti, Aequipecten muscosus, Argopecton gibbus
- IVB Oliva sayana, Mercenaria campechiensis, Argopecton gibbus
- IVC Murex beauui, Tuqurium caribeum, Polystira tellea
- VA Pecten raveneli, Turritella exoleta, Argopecton gibbus
- VB Turritella exoleta, Mercenaris campechiensis, Barbatis domingensis
- VC Aequipecten glyptus, Nuculana acuta, Polystira tellea
- VIA Distorsio clathrata, Murex fulvescens, Jouannetic quillingi
- VIB Turritella exoleta, Malluvium benthophilum, Barbatia domingensis
- VIC Murex beauui, Antillophos candei, Fusinus eucosmius



2. Diving

FMG 047, 147, 151, 247, 251

Spondylus americanus, Cerithium litteratum, Pteria colymbus  
146

Spondylus americanus, Cerithium litteratum, Hiatella arctica

CW

062 - Aequipecten muscosus, Calliostoma pulchrum, Hiatella  
arctica

064 - Aequipecten muscosus, Calliostoma pulchrum, Crepidula  
plana

ARTHROPODS

II. Decapod Crustacea

A. Number of Species Recorded Overall - 190

1. Dredge/Trawl by Transect Total 134

- a. Transect I - 76
- b. Transect II - 51
- c. Transect III - 66
- d. Transect IV - 47
- e. Transect V - 59
- f. Transect VI - 63

2. Diving by Area Total 74

- a. Florida Middle Ground (FMG) - 55
- b. Clearwater (CW) - 35

B. Prospective "New" Species

1. Dredge/Trawl

- a. Periclimenacus n. sp. (from IA, IIIA)
- b. Alpheus n. sp. I (from IIC, IIIB, IIIC)

2. Diving

- a. Pericliminaeus n. sp. (from 151)
- b. Synalpheus n. sp. I (from 147, 151, 146, 247, 047)
- c. Synalpheus n. sp. II (from 047, 251, 151, 147)

C. New Distribution Records

1. Dredge/Trawl

a. Gulf of Mexico

Alpheus n. sp. I (near A. macrocheles)  
Periclimenaeus n. sp.

b. Eastern Gulf

Periclimenaeus caraibicus  
Lysmata intermedia  
Lysmata rathbunae  
Alpheopsis labis  
Lipkebe holthuisi  
Upogebia operculata

2. Diving

a. Gulf of Mexico

Synalpheus brevifrons  
Synalpheus n. sp. I (near S. rathbunae)  
Synalpheus n. sp. II (near S. townsendi)  
Trachycaris restrictus  
Alpheopsis labis  
Periclimenaeus bredini

b. Eastern Gulf

Gnathophyllum modestum  
Pontonia margarita  
Periclimenaeus perryae  
Periclimenaeus ascidiarum  
Periclimenaeus perlatus  
Periclimenes iridescens  
Lysmata rathbunae

D. Predominant Species at Each Station

1. Dredge/Trawl

- IA Portunus spinicarpus, Stenocionops furcata coelata,  
Stenorynchus seticornis  
IB Dormidia antillensis, Portunus spinicarpus, Parthenope  
agona  
IC Pylopagurus discoidalis, Pyromaia arachna, Palicus sica  
IIA Calappa flammaea, Sicyonia brevirostris, Fenaeus duorarum  
IIB Dardanus insignis, Iliacantha subglobosa, Anasimus latus  
IIC Myropsis quinquespinosa, Acanthocarpus alexandri, Goneplax  
hirusta  
IIIA Mithrax acuticornis, Stenorynchus seticornis, Portunus  
spinicarpus  
IIIB Portunus spinicarpus, Podochela gracilipes, Palicus sica

- IIIC Goneplax hirusta, Acanthocarpus alexandri, Portunus spinicarpus
- IVA Ranilia muricata, Osaclita semitovis, Stenocionops furcata coelata
- IVB Portunus spinicarpus, Anasimus latus, Sicyonia brevirostris
- IVC Acanthocarpus alexandri, Goneplax hirusta, Myropsis quinquespinosa
- VA Parthenope fraterculus, Collodes trispinosus, Portunus spinicarpus
- VB Anasimus latus, Osachila semilevis, Sicyonia brevirostris
- VC Pyromaia arachna, Ethusa microphthalma, Myropsis quinquespinosa
- VIA Portunus spinicarpus, Sicyonia brevirostris, Dridopagurus dispar
- VIB Stenorynchus seticornis, Anasimus latus, Podochela sp.
- VIC Pyromaia arachna, Ethusa microphthalma, Dardanus insignis

2. Diving

FMG 047, 147, 251, 151, 247, 146

Stenorynchus seticornis, Synalpheus townsendi, Mithrax acuticornis

CW 062

- Stenorynchus seticornis, Mithrax pleuracanthus, Lobopilumnus agassizii

III. Echinoderms

A. Number of species recorded overall - 65<sup>+</sup>

1. Total through Dredge/Trawl - 61

- a. Transect I - 32
- b. Transect II - 17
- c. Transect III - 38
- d. Transect IV - 20
- e. Transect V - 18
- f. Transect VI - 28

2. Total through Diving - 20

- a. Florida Middle Ground (FMG) - 18
- b. Clearwater (CW) - 6

B. Prospective "New" Species

Ophiactis sp. (from all FMG stations)

C. New Distribution Records

1. Dredge/Trawl

a. Gulf of Mexico

None verified as yet

2. Diving

a. Gulf of Mexico

Prospective new species (above)

D. Predominant Species at Each Station (maximum of three(3))

1. Dredge/Trawl

- IA Luidia clathrata, Ophiothrix angulata, Lytechinus variegatus
- IB Comactinia meridionalis, Anthenoides piercei, Astroporpa annulata
- IC Astropecten cingulatus, Aracosoma violaceum, Brissopsis elongata
- IIA Luidia clathrata, Lytechinus variegatus, Arbacia punctulata
- IIB Astroporpa annulata, Clypeaster ravenelli
- IIC No truly dominant form established
- IIIA Goniaster tessellatus, Ophiolepis elegans, Eucidaris tribuloides
- IIIB Luidia elegans, Astroporpa annulata, Clypeaster ravenelli
- IIIC No truly dominant form established
- IVA Luidia clathrata, Ophiolepis elegans, Lytechinus variegatus
- IVB Anthenoides piercei, Clypeaster ravenelli
- IVC No truly dominant form established
- VA Luidia clathrata, Ophiolepis elegans, Eucidaris tribuloides
- VB Astroporpa annulata, Clypeaster ravenelli, Schizaster orbignyus
- VC No truly dominant form established
- VIA Luidia clathrata, Ophiolepis elegans, Clypeaster durandi
- VIB Anthenoides piercei, Astroporpa annulata, Stylocidaris affinis
- VIC Luidia elegans, Clypeaster ravenelli, Coclopleurus floridanus

2. Diving

FMG 047, 146, 147, 151, 251

Coscinasterias tenuispina, Ophiothrix angulata, Diadema antillarum

047

Coscinasterias tenuispina, Ophiothrix angulata, Arbacia punctulata

CW 062

Arbacia punctulata, Lytechinus variegatus, Ophiothrix angulata  
064

Arbacia punctulata, Lytechinus variegatus

COELENTERATES (Octocorallia/Scleractinia)

IV. Octocorallia

A. Number of Species Recorded - 25

1. Total through Dredge/Trawl - 19

- a. Transect I - 3
- b. Transect II - 8
- c. Transect III - 15
- d. Transect IV - 8
- e. Transect V - 1
- f. Transect VI - 8

2. Total through Diving -

- a. Florida Middle Ground (FMG) - 13
- b. Clearwater (CW) - 1

B. Prospective "New" Species

None at this time

C. New Distribution Records

1. Dredge/Trawl

- a. Bebryce parastellata
- b. Bebryce grandis
- c. Nidalia occidentalis
- d. Villogorgia nigrescens
- e. Neospongodes agassizi
- f. Scleracis quadaloupensis

2. Diving

- a. Lophogorgia cardinalis
- b. Diodogorgia nodulifera
- c. Pterogorgia quadalupensis
- d. Pseudopterogorgia rigida

D. Predominant Species at Each Station

1. Dredge/Trawl

- IA Diodogorgia nodulifera, Bebryce parastellata, Ellisella  
barbadensis
- IB Bebryce parastellata
- IC No truly dominant form established
- IIA Diodogorgia nodulifera, Bebryce grandis
- IIB Bebryce parastellata, Neospongodes agassizii
- IIC Bebryce grandis
- IIIA Bebryce parastellata, Villogorgia nigrescens, Muricea  
elongata
- IIIB Bebryce parastellata, Bebryce grandis, Paramuricea sp. A
- IIIC Bebryce parastellata, Villogorgia nigrescens
- IVA Bebryce parastellata, Bebryce grandis, Ellisella elongata
- IVB Bebryce parastellata, Bebryce grandis, Nidalia occidentalis
- IVC Ellisella barbadensis
- VA Bebryce parastellata
- VB Bebryce parastellata
- VC No truly dominant form established
- VIA Bebryce parastellata, Scleracis guadalupensis, Ellisella  
barbadensis
- VIB Bebryce parastellata, Bebryce grandis, Villogorgia nigrescens

2. Diving

- FMG - all stations  
Muricea laxa, M. elongata, Funicea calvculata
- CW - all stations  
Diodogorgia nodulifera

V. Scleractinia

A. Number of Species Recorded - 30

1. Total through Dredge/Trawl - 21

- a. Transect I - 5
- b. Transect II - 9
- c. Transect III - 4
- d. Transect IV - 2
- e. Transect V - 5
- f. Transect VI - 7

2. Total through Diving - 17

- a. Florida Middle Ground (FMG) - 1
- b. Clearwater (CW) - 8

B. Prospective "New" Species

Caryophyllia horologium n. sp.  
Flabellum fragile n. sp.

C. New Distribution Records

1. Dredge/Trawl

- a. Cladocora debilis
- b. Solenastrea hyades
- c. Paracyathus defilippi
- d. Oculina tenella

2. Diving

- a. Manicina areolata
- b. Scolymia lacera
- c. Dichocoenia stokesii
- d. Meandrina meandites
- e. Cladocora arbuscula

D. Predominant Species at Each Station

1. Dredge/Trawl

- IA Cladocora arbuscula, Oculina diffusa, Oculina tenella
- IB Caryophyllia horologium
- IC Paracyathus pulchellus, Trochocyathus rawsoni, Caryophyllia berteriana
- IIA Phyllangia americana, Oculina diffusa, Stephanocoenia michelini
- IIB Cladocora arbuscula, Paracyathus pulchellus, Caryophyllia horologium
- IIC Balanophyllia floridana, Flabellum fragile, Caryophyllia berteriana
- IIIA Madracis decactis
- IIIB Paracyathus pulchellus
- IIIC Paracyathus pulchellus, Balanophyllia floridana
- IVA Oculina tenella
- IVB Paracyathus pulchellus, Balanophyllia floridana
- IVC Nothing recorded
- VA Cladocora debilis
- VB Madracis asperula, Balanophyllia floridana
- VC Paracyathus pulchellus
- VIA Madrepora carolina, Oculina diffusa
- VIB Paracyathus pulchellus, Madrepora carolina
- VIC Paracyathus pulchellus

2. Diving

FMG - all stations

Madracis decactis, Porites divaricata, Dichocoenia stellaris

CW - all stations

Solenastrea hyades, Cladocora arbuscula, Phyllangis americana

VI. Polychaete Annelids

A. Number of Species Recorded Overall - 100+

1. Total through Dredge/Trawl - 97

- a. Transect I - 31
- b. Transect II - 14
- c. Transect III - 46
- d. Transect IV - 34
- e. Transect V - 47
- f. Transect VI - 34

2. Total through Diving - 41

- a. Florida Middle Ground (FMG) - 41
- b. Clearwater (CW) -

B. Prospective "New" Species

Awaiting examination and comparison with type material.

C. New Distribution Records

1. Dredge/Trawl

- a. Euphrosine triloba

2. Diving

D. Predominant Species at Each Station

1. Dredge/Trawl

- IA Eunice sp. A, Eunice antennata, Ceratoneris mirabilis
- IB Polyodontes sp. A
- IC Aphrodita sp. A, Armandia maculata, Sabella melanostigma
- IIA Pomatoceros americanus, Eunice antennata, Nereis sp. A
- IIB Eunice rubra, Phyllodoce groenlandica, Thelepus setosus
- IIC Polyodontes lupina
- IIIA Eunice rubra, Hermenia verruculosa, Spirobranchus giganteus
- IIIB Vermiliopsis sp. A, Nereis sp. A, Eunice sp. A
- IIIC Potogenia sericoma



IVA Eunice sp. A, Eunice antennata, Ceratoneris mirabilis  
IVB Eunice sp. A  
IVC Hydroides protulicola, Eunice rubra  
VA Hermodice carunculata, Eunice sp. A, Eunice rubra  
VB Melinna maculata, Glycera americana  
VC Eunice sp. A, Eupanthalis kinbergi, Sabellid sp.  
VIA Pseudovermilia sp. A  
VIB Eunice sp. A, Phyllodoce groenlandica  
VIC Eupanthalis kinbergi, Lepidametria commensalis  
(spp. of Eunicidae dominate both in numbers and Biomass)

2. Diving

FMG - all stations

Eunice rubra, Ceratoneris mirabilis, Hermedia verruculosa,  
Spirobranchus giganteus

(spp. of Eunicidae dominate both in numbers and Biomass)

CW - all stations

VII. Porifera

A. Number of species recorded to date - 48

1. Total from Dredge/Trawl to date - 30

2. Total from Diving - 48

a. Florida Middle Ground (FMG) - 41

b. Clearwater (CW) - 12

B. Prospective "New" Species

Prosuberites sp.

Cliona sp.

We anticipate many more

C. New Distribution Records

1. Dredge/Trawl

2. Diving

a. Verongia cauliformis rufa

b. Aeglas dispar

c. Erylus sp.

d. Pseudoceratina crassa

e. Thalysias sp.

f. Pseudaxinella lunaecharta

g. Guitara sp.

h. Spongosorites

- i. Epallax
- j. Asteropus sp.
- k. Yvesia sp.
- l. Grayella sp.
- m. Prosuberites sp.
- n. Cliona sp.

D. Predominant Species at each Station

- 1. Dredge/Trawl
- 2. Diving

FMG - Ircinia strobilina, Cinachyra sp., Pseudoceratina crassa  
CW - Names not established

VIII. Algae

A. Number of species recorded over all - 194

1. Total through Dredge/Trawl - 106

- a. Transect I - 25
- b. Transect II - 72
- c. Transect III - 41
- d. Transect IV - 13
- e. Transect V - 16
- f. Transect VI - 0

2. Total through Diving - 164

- a. Florida Middle Ground (FMG) - 163
- b. Clearwater (CW) - 71

B. Prospective "New" Species

We anticipate at least eleven (11) new species and two (2) new genera.

C. New Distribution records

We report that about 99 species have been added to those Cheney and Dyer (1974) reported.

D. Predominant Species at Each Station

- 1. Dredge/Trawl

- IA Halymenia floridana, Gracilaris mammillaris, Caulerpa mexicana
- IIA Caulerpa sertularioides, Pseudocodium floridanum, Halymenia floridana
- IIIA Caulerpa sertularioides, Halymenis floridana, Pseudocodium floridanum
- IVA Halymenia sp., Gracilaria mammillaris, Agardhinula browneae
- VA Gracilaris mammillaris, Rhodymenia pseudopalmata, Sargassum filipendula

2. Diving

FMG #147

Botryocladia occidentalis, Codium carolinianum, Halimeda discoidea

#47

Laurencia intricata, Dictyota bartayresii, Codium carolinianum

#146

Codium intertextum, Halimeda discoidea, Botryocladia occidentalis

#151

Laurencia intricata, Codium intertextum, Codium carolinianum

#251

Halimeda discoidea, Galaxaura squalida, Botryocladia occidentalis

#247

Codium intertextum, Halimeda discoidea, Kalymenia perforata

#64

Pseudocodium floridanum, Caulerpa sertularioides, Gracilaria mammillaris

#62

Caulerpa sertularioides, Udotea conglutinata, Halimeda

cf. tuna

FISH FAUNA OF THE FLORIDA MIDDLE GROUND (FMG)

Through the exclusive use of SCUBA our diver scientists have greatly increased (by 37 species) our knowledge of the fish fauna associated with this biolithological formation.

We are able to report sightings on 134 species from 47 families. These species may be sub-categorized as:

Primary Reef Species	78	(24 new to FMG)
Secondary Reef Species	39	(7 new to FMG)
Pelagic Species	13	(6 new to FMG)

With the encounter of these new sightings we also note that these species are apparent new records in the northeastern Gulf of Mexico.

Distribution Records

Rypticus bistrispinus

Previously recorded only from W. Atlantic including Florida Keys, Bahamas, Jamaica and Southward, Tortugas

Rypticus subbifrenatus

Previously recorded from Florida Keys, Bahamas, Jamaica, Puerto Rico, Virgin Islands, Flower Garden, Yucatan, Curacao

Anisotremus virginicus

Previously recorded from Florida Keys, Bahamas, Bermuda, Central America coast south to Brazil, Tortugas

Holacanthus tricolor

Previously recorded from Florida Keys, Bahamas, Bermuda, Tortugas to southeast Brazil, West Flower Garden

Sparisoma atomarium

A redescribed species whose distribution is poorly known but from Florida Keys, Bahamas, and Western Atlantic perhaps Tortugas

Gobiosoma xanthiprora

Smith et al., misidentified specimens of this species as G. horsti. G. xanthiprora is known from the Florida Keys, Tortugas and off Nicaragua

Although the diversity of FMG fishes compares well in number with other Gulf ichthyofaunas:

Seven and One-Half Fathom Reef, Off Texas.....	87	Causey, 1969
Flower Garden Reef.....	128	Cashman, 1973

the composition does not favor a western Gulf affinity. It would appear that the DeSoto Canyon coupled with the outflow of the Mississippi River provides a significant influence in the separation of Northeast and Western Gulf reef fauna.

When we compare the actual number of FMG species occurring at the other sites we get the impression of a distinct eastern gulf fish fauna which is of a Bahamian-Florida Keys origin:

Bahamas - 104 of 134  
Tortugas - 99 of 134  
Alligator Key - 115 of 134

as opposed to a Caribbean-Yucatan flavor as seen on the Texas coast:

Caribbean - 84 of 134  
Yucatan - 45 of 134  
Alacran - 45 of 134  
Flower Garden - 49 of 134

and we see the DeSoto Canyon barrier - 33 of 134.

This apparent dissimilarity loses some edge, however, if we examine it with the Bray-Curtis Similarity Index whose values are recorded as follows:

FMG to Bahamas - 32.4%  
FMG to Caribbean - 38.1%  
FMG to Tortugas - 34.5%  
FMG to Alligator Reef - 35.3%  
FMG to DeSoto Canyon - 30 %  
FMG to Flower Garden - 37.4%  
FMG to Alacran - 38.6%  
FMG to Yucatan - 26.2%

#### Trellis Diagrams

Figures 1-5 display the Bray-Curtis similarity percentages both numerically and graphically. By arranging the stations in seriatum by depth, we develop a fairly consistent grouping for Molluscs, Decapod Crustaceans, and Echinoderms. The association of Polychaetes and of Hard/Soft Corals is not so evident.

Figure 1.

Trellis Diagram Molluscan Fauna  
MAFLA - 1975

	I A	II A	III A	IV A	V A	VI A	I B	II B	III B	IV B	V B	VI B	I C	II C	III C	IV C	V C	VI C
I-A		40	33	44	36	28	20	16	15	7	14	20	18	4	8	7	7	6
II-A			34	35	26	7	15	27	13	8	16	12	13	0	4	4	0	3
III-A				36	32	19	12	19	25	6	18	18	13	3	3	3	3	6
IV-A					44	24	17	18	18	11	14	20	14	4	4	4	3	6
V-A						11	28	14	11	8	13	23	14	8	0	0	4	7
VI-A							6	10	5	14	9	10	9	7	14	13	6	5
I-B								30	18	9	21	25	22	26	18	8	14	25
II-B									36	7	37	36	33	21	15	14	12	26
III-B										7	23	25	19	7	7	7	6	10
IV-B											12	12	6	22	12	10	9	7
V-B												36	21	12	12	24	21	23
VI-B													27	19	8	11	28	29
I-C														31	39	42	38	28
II-C															47	42	52	34
III-C																67	45	21
IV-C																	42	33
V-C																		41
VI-C																		

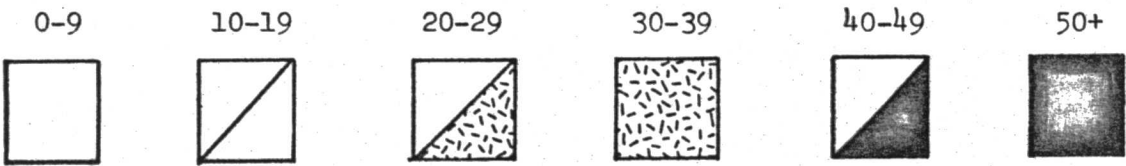

Figure 2.

Trellis Diagram Decapod Crustacean Fauna  
MAFLA - 1975

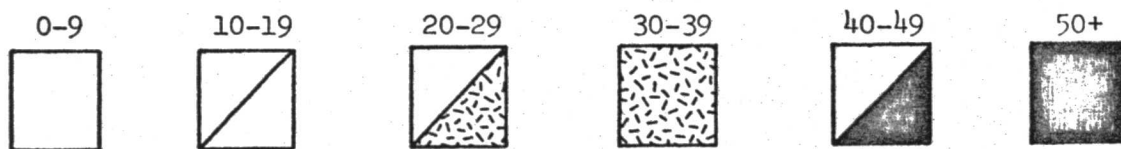
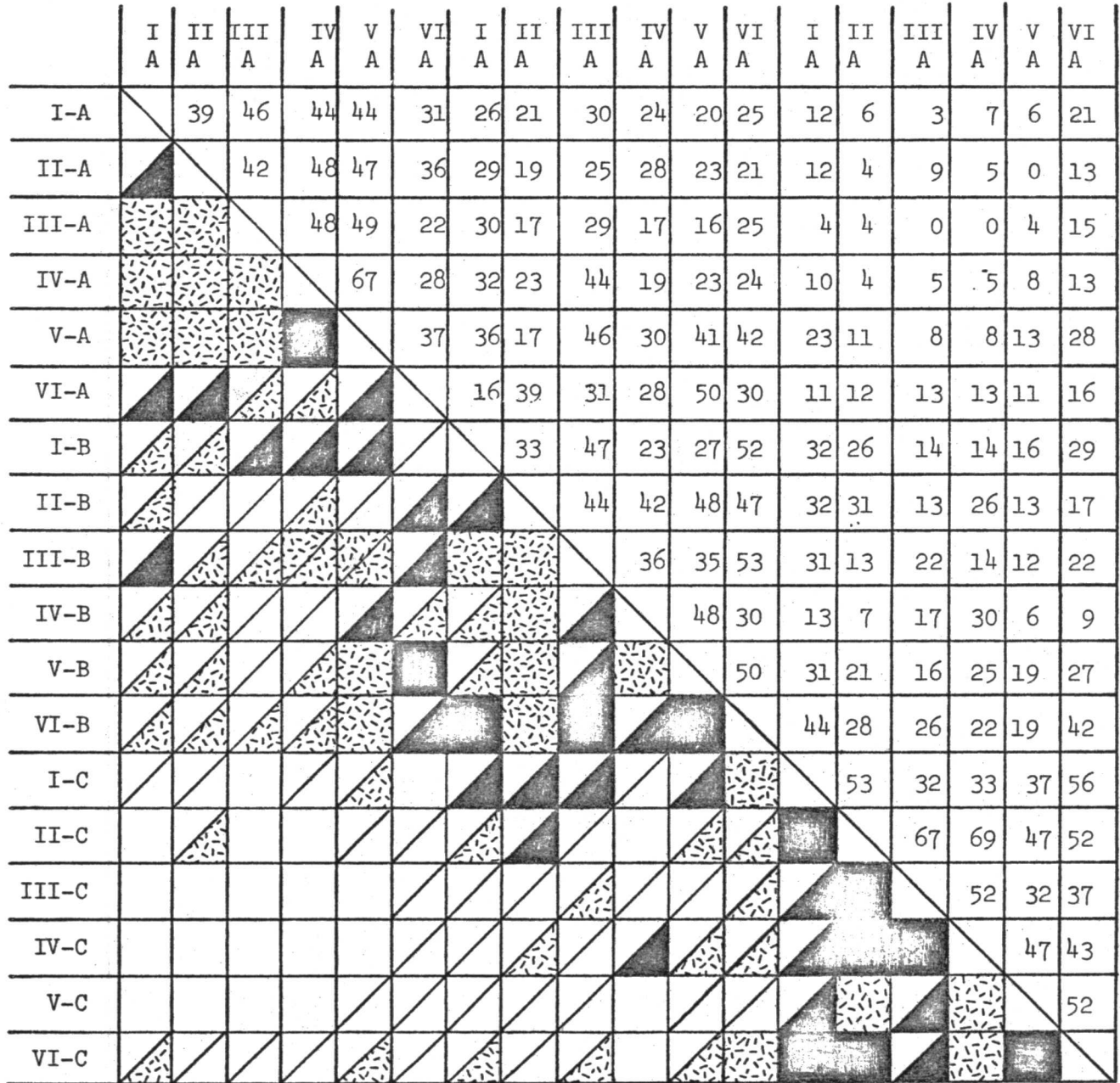

Figure 3.

Trellis Diagram Echinoderm Fauna  
MAFLA - 1975

	I A	II A	III A	IV A	V A	VI A	I B	II B	III B	IV B	V B	VI B	I C	II C	III C	IV C	V C	VI C
I-A		69	63	59	64	32	15	9	7	10	0	0	0	0	0	0	0	0
II-A			34	50	45	50	26	30	16	23	0	0	12	17	0	0	0	9
III-A				43	34	21	11	3	11	3	0	0	0	0	0	0	0	0
IV-A					83	33	24	18	30	0	0	0	11	14	0	0	0	0
V-A						25	17	10	16	0	0	0	0	0	0	0	0	0
VI-A							12	14	11	0	25	0	18	33	0	0	0	13
I-B								48	54	33	38	54	11	15	0	14	0	35
II-B									52	27	31	52	13	17	0	0	0	20
III-B										30	44	36	10	13	0	0	0	24
IV-B											0	0	17	29	0	0	29	0
V-B												44	0	0	0	0	0	27
VI-B													0	0	25	0	0	32
I-C														29	0	0	0	12
II-C															0	0	0	17
III-C																0	0	0
IV-C																	0	0
V-C																		0
VI-C																		

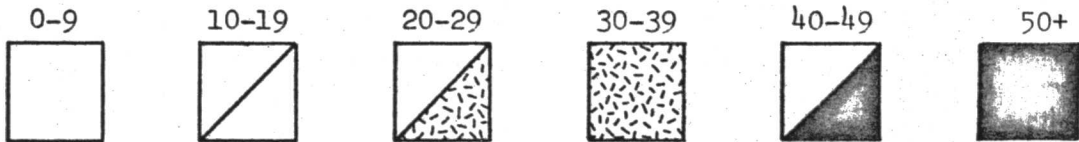



Figure 4.

Trellis Diagram of Polychaeta Fauna  
MAFLA - 1975

	I A	II A	III A	IV A	V A	VI A	I B	II B	III B	IV B	V B	VI B	I C	II C	III C	IV C	V C	VI C
I-A		13	56	42	40	12	1	29	21	21	13	37	29	0	0	21	11	29
II-A			10	18	14	35	0	0	18	17	0	6	10	0	0	0	0	0
III-A				37	44	20	6	22	70	17	21	31	23	6	3	11	19	19
IV-A					28	0	6	6	36	3	6	8	15	6	0	23	0	10
V-A						26	5	5	27	10	14	39	16	5	5	5	25	29
VI-A							0	0	24	13	12	12	6	17	18	0	27	9
I-B								2	0	22	18	17	1	33	0	40	12	12
II-B									0	20	17	8	0	0	0	36	0	0
III-B										30	18	23	22	0	0	19	15	30
IV-B											17	24	35	0	0	9	12	12
V-B												39	10	0	0	31	10	32
VI-B													25	0	0	15	19	38
I-C														14	0	22	17	17
II-C															67	25	14	0
III-C																0	15	0
IV-C																	0	22
V-C																		33
VI-C																		

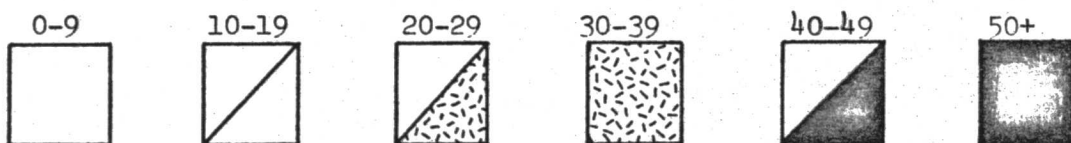

Figure 5.

Trellis Diagram for Octocorals and Scleractinia  
MAFLA - 1975

	I A	II A	III A	IV A	V A	VI A	I B	II B	III B	IV B	V B	VI B	I C	II C	III C	IV C	V C	VI C
I-A		40	42	36	40	36	25	25	27	27	18	18	0	18	18	25	0	0
II-A			16	17	0	0	0	12	12	13	0	9	0	17	0	0	0	0
III-A				29	20	10	22	15	32	24	0	19	0	19	0	0	0	0
IV-A					57	25	40	31	17	33	25	21	0	25	25	0	0	0
V-A						29	50	0	18	18	29	22	0	0	29	0	0	0
VI-A							40	31	33	33	25	42	0	0	25	40	0	0
I-B								40	22	44	40	25	0	0	40	0	0	0
II-B									47	24	46	42	44	0	31	0	18	20
III-B										63	17	61	25	33	33	0	20	22
IV-B											33	61	25	17	33	22	0	0
V-B												11	40	0	50	0	0	0
VI-B													27	11	21	13	12	13
I-C														0	0	0	100	100
II-C															25	0	0	0
III-C																0	33	0
IV-C																	0	0
V-C																		67
VI-C																		

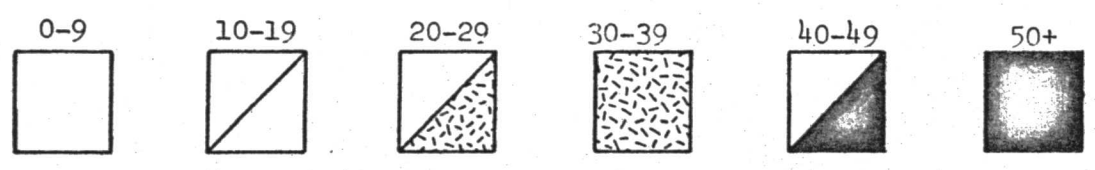
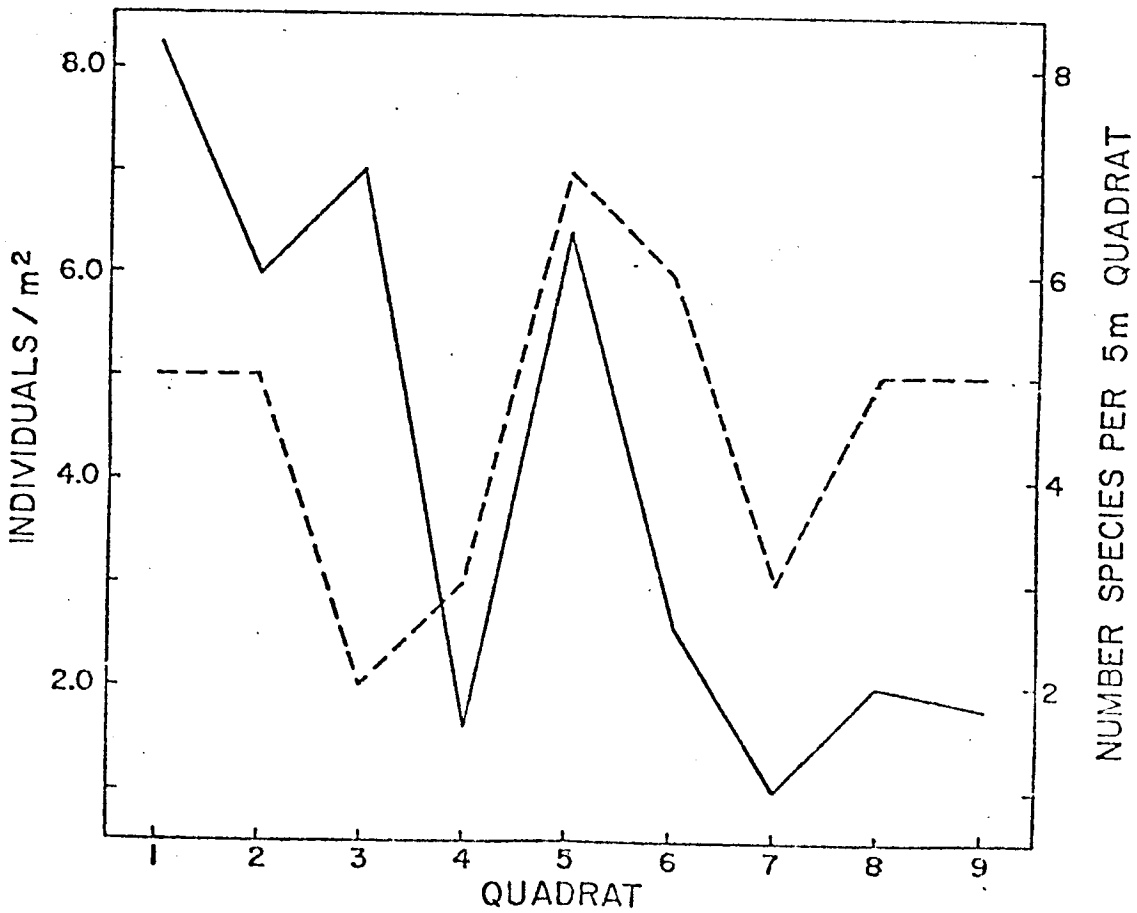
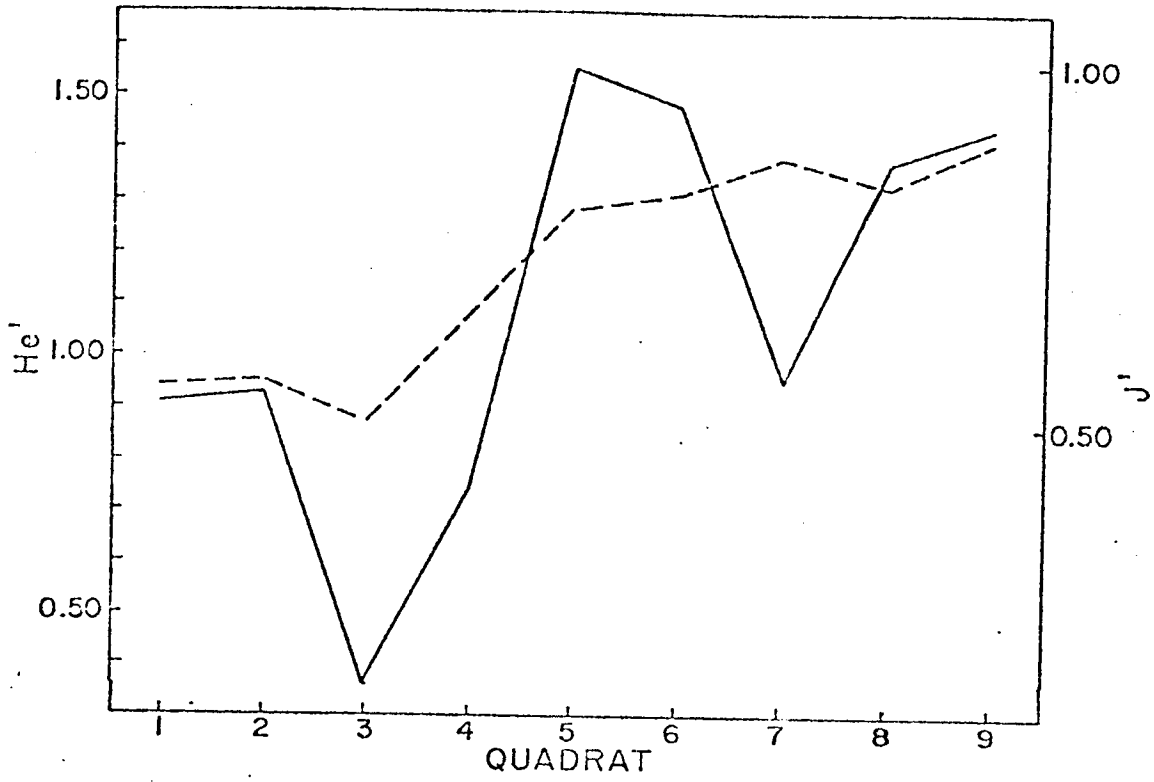

Figure 6A, 6C - Hard Coral Species Diversity and Evenness for BLM 19 and 32/34 Respectively at Station 146.

He' \_\_\_\_\_ J'-----

Figure 6B, 6D - Hard Coral Number of Individuals and Number of Species/5M Quadrat for BLM 19 and 32/34 Respectively at Station 146.

Individuals/M<sup>2</sup> \_\_\_\_\_ No. Species/5M Quadrat -----



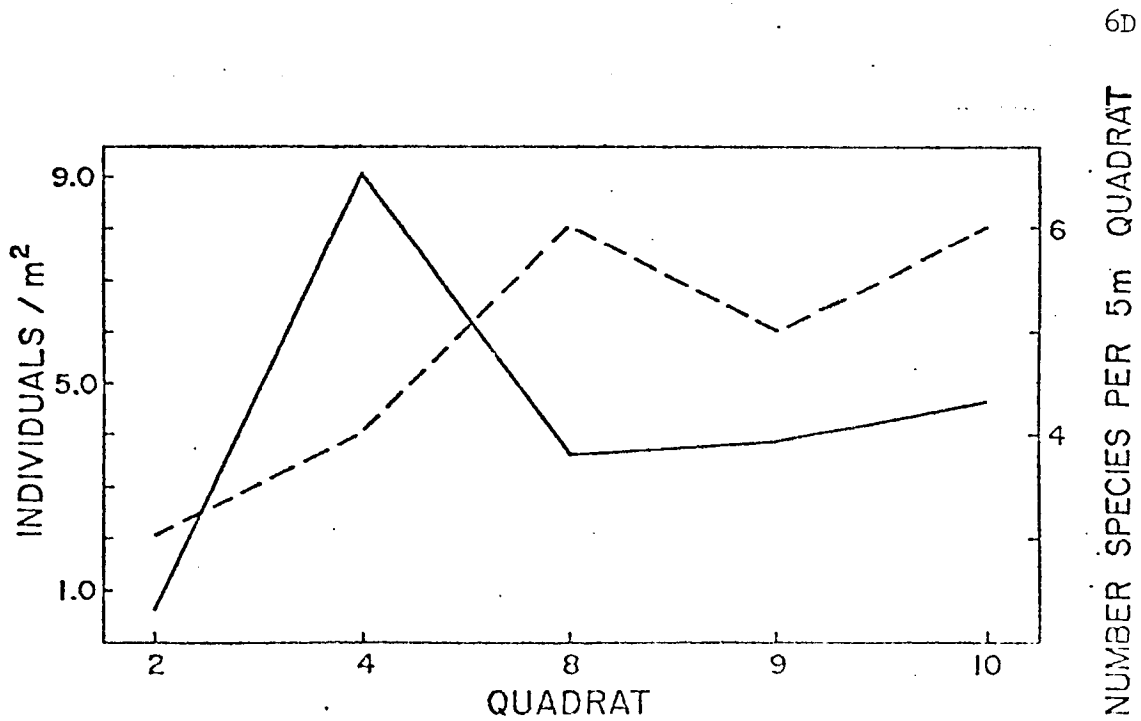
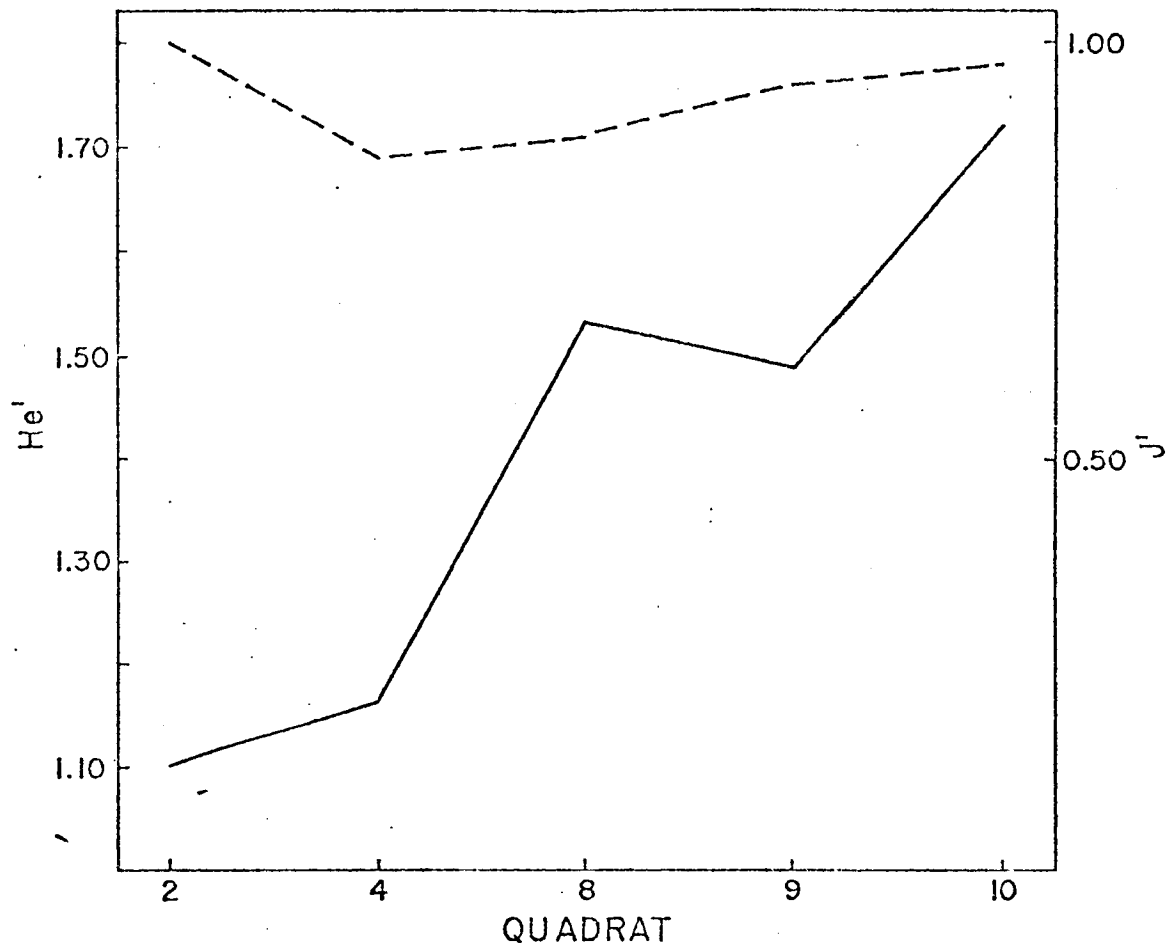

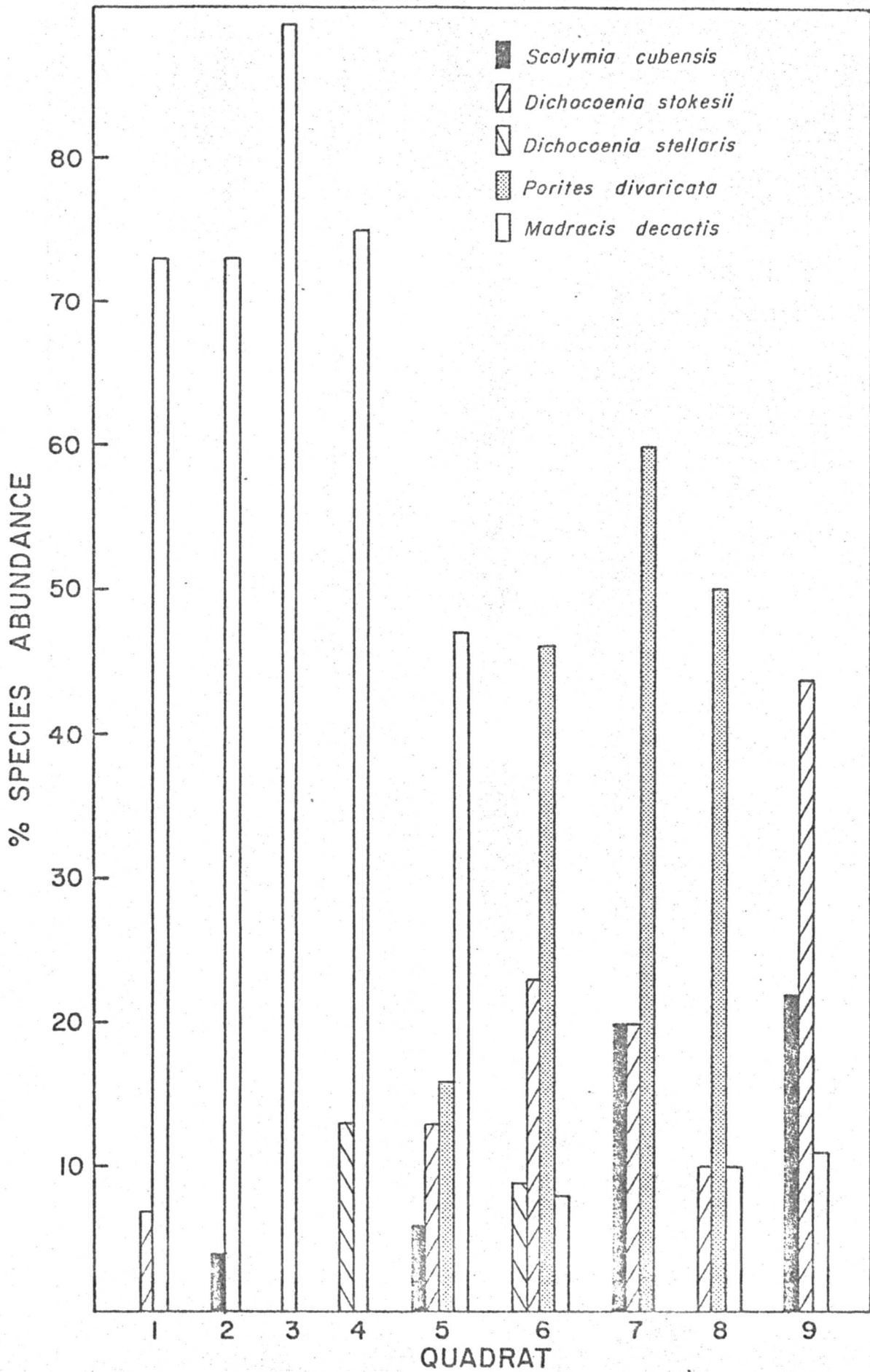

Figure 6E - Hard Coral Species Abundance, BLM 19 at Station 146.

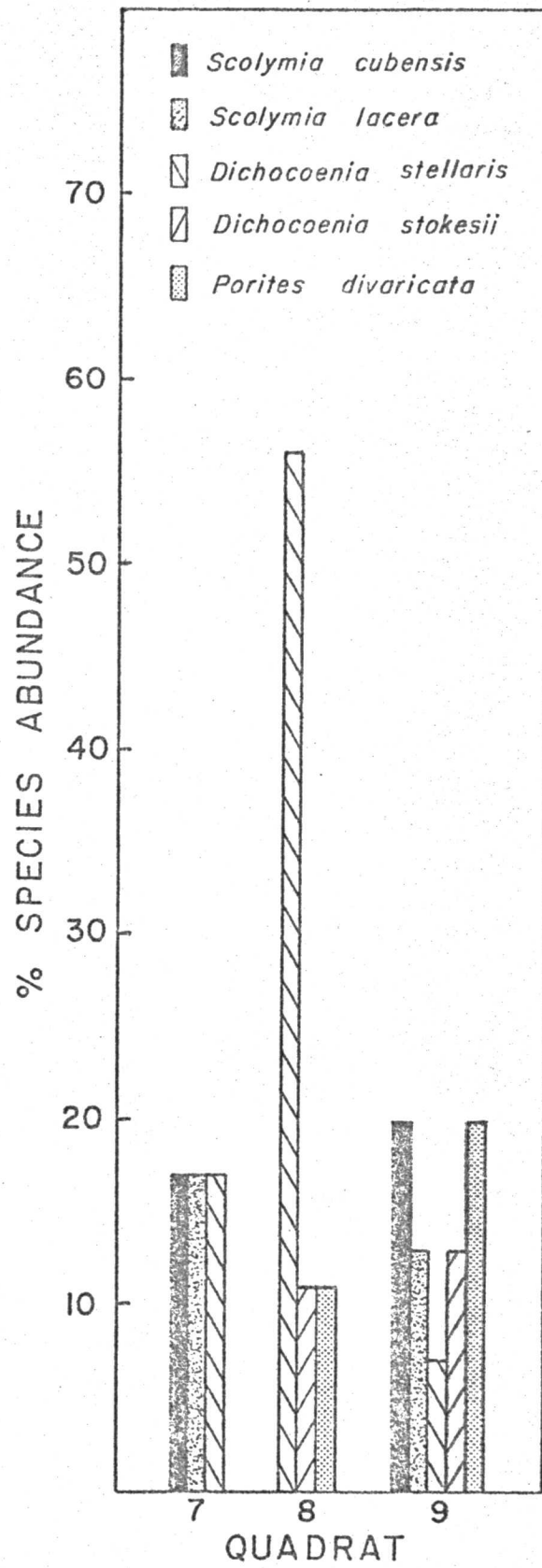

Figure 6F - Hard Coral Species Abundance, BLM 32/34 at Station 146.

Figure 7A, 7C - Soft Coral Species Diversity and  
Evenness for BLM 19 and 32/34 Respectively at  
Station 146.

He' \_\_\_\_\_ J' -----

Figure 7B, 7D - Hard Coral Number of Individuals and  
Number of Species/5M Quadrat for BLM 19 and 32/34  
Respectively at Station 146.

Individuals/M<sup>2</sup> \_\_\_\_\_ No. Species/5M Quadrat -----



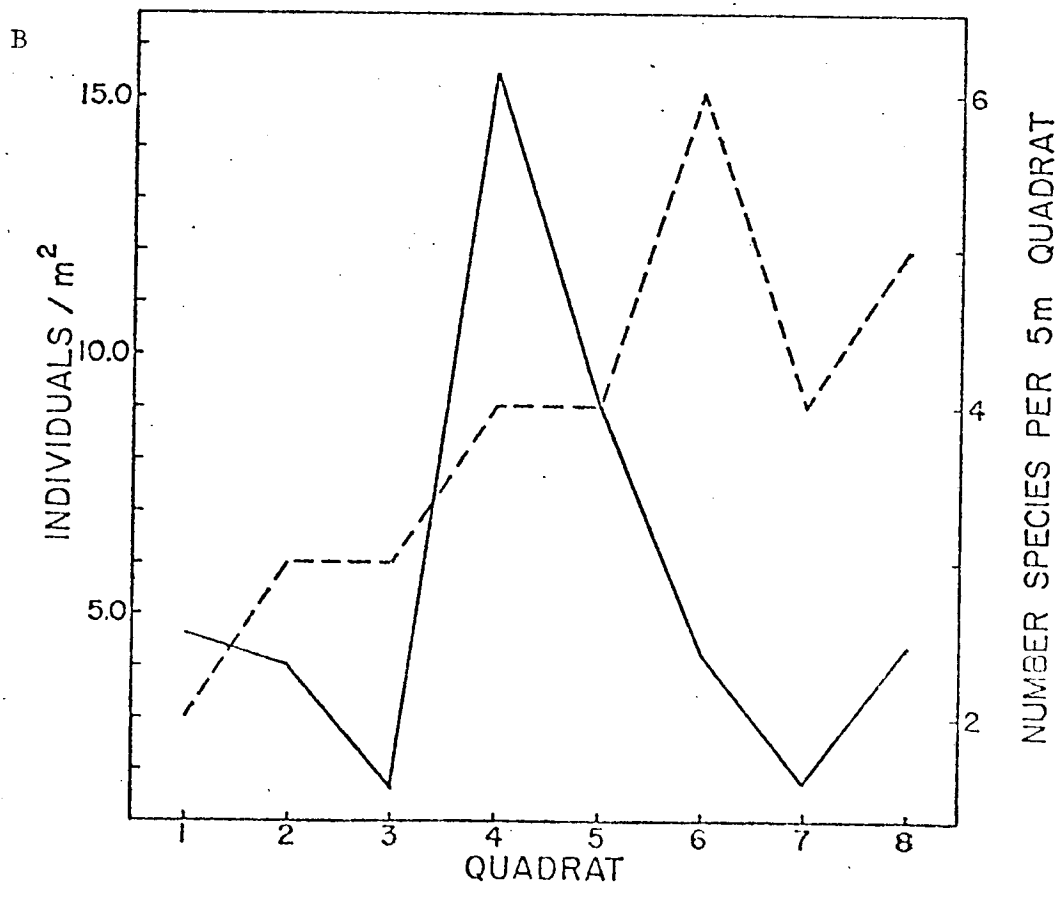
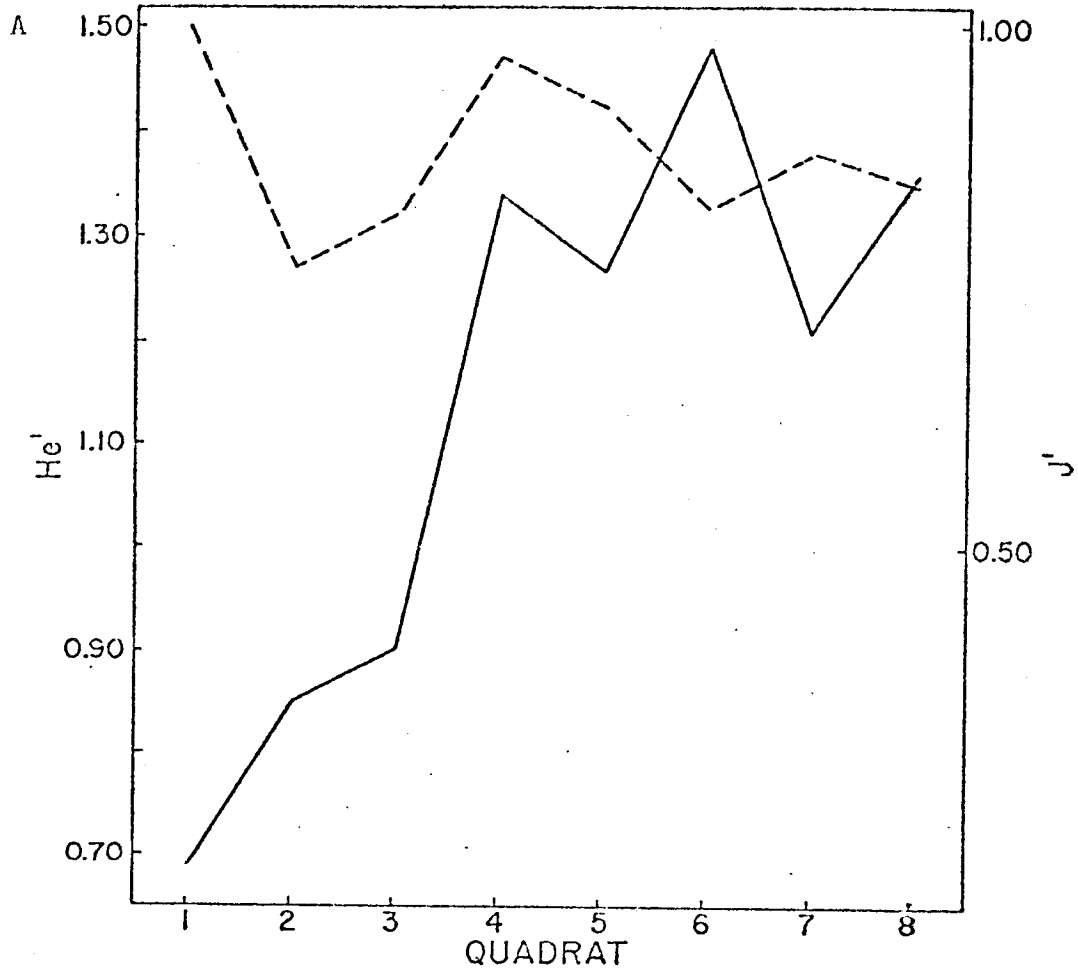

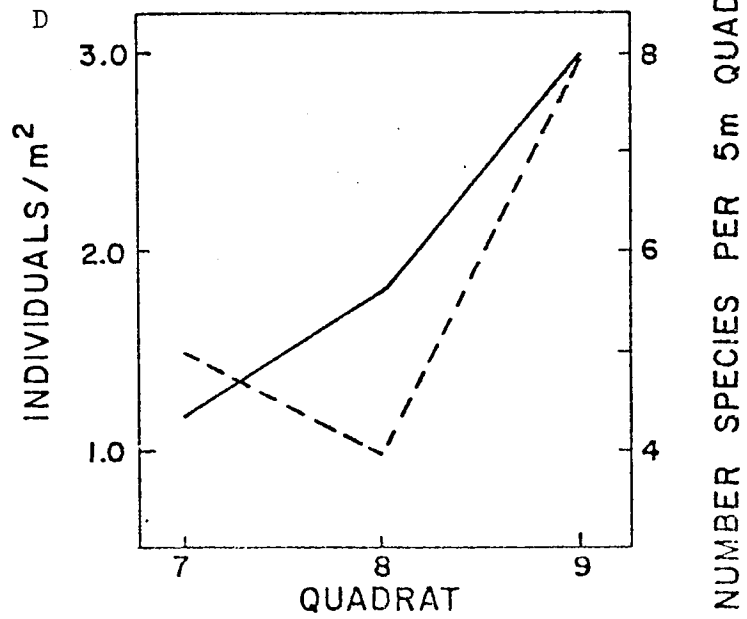
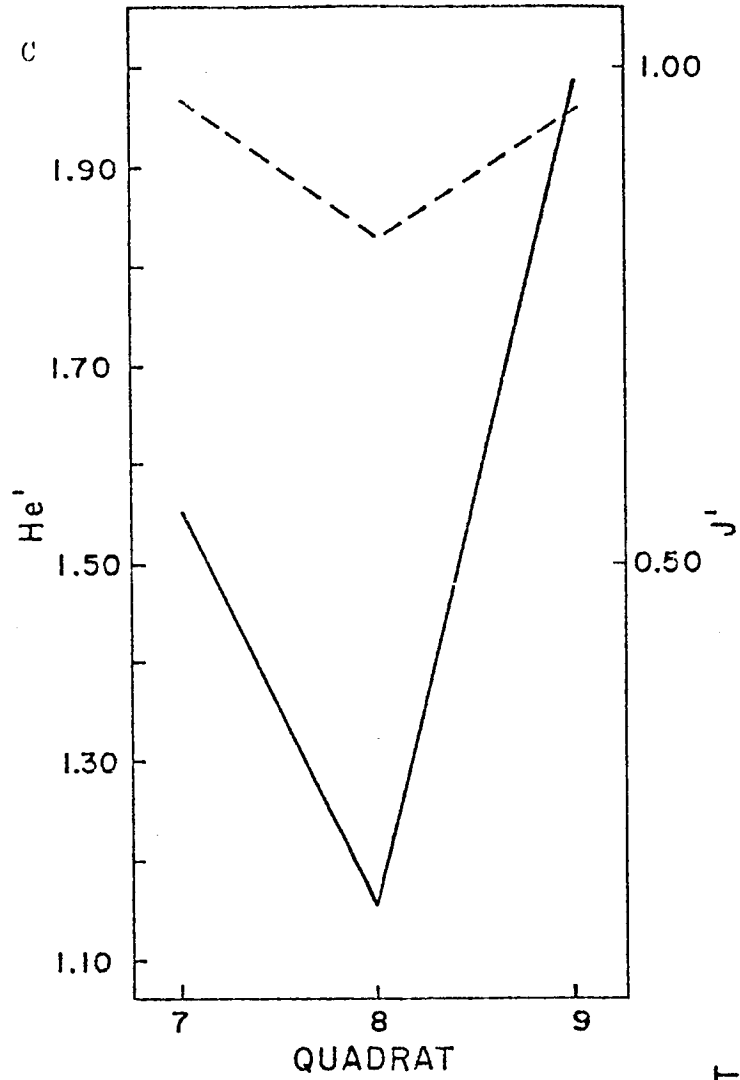

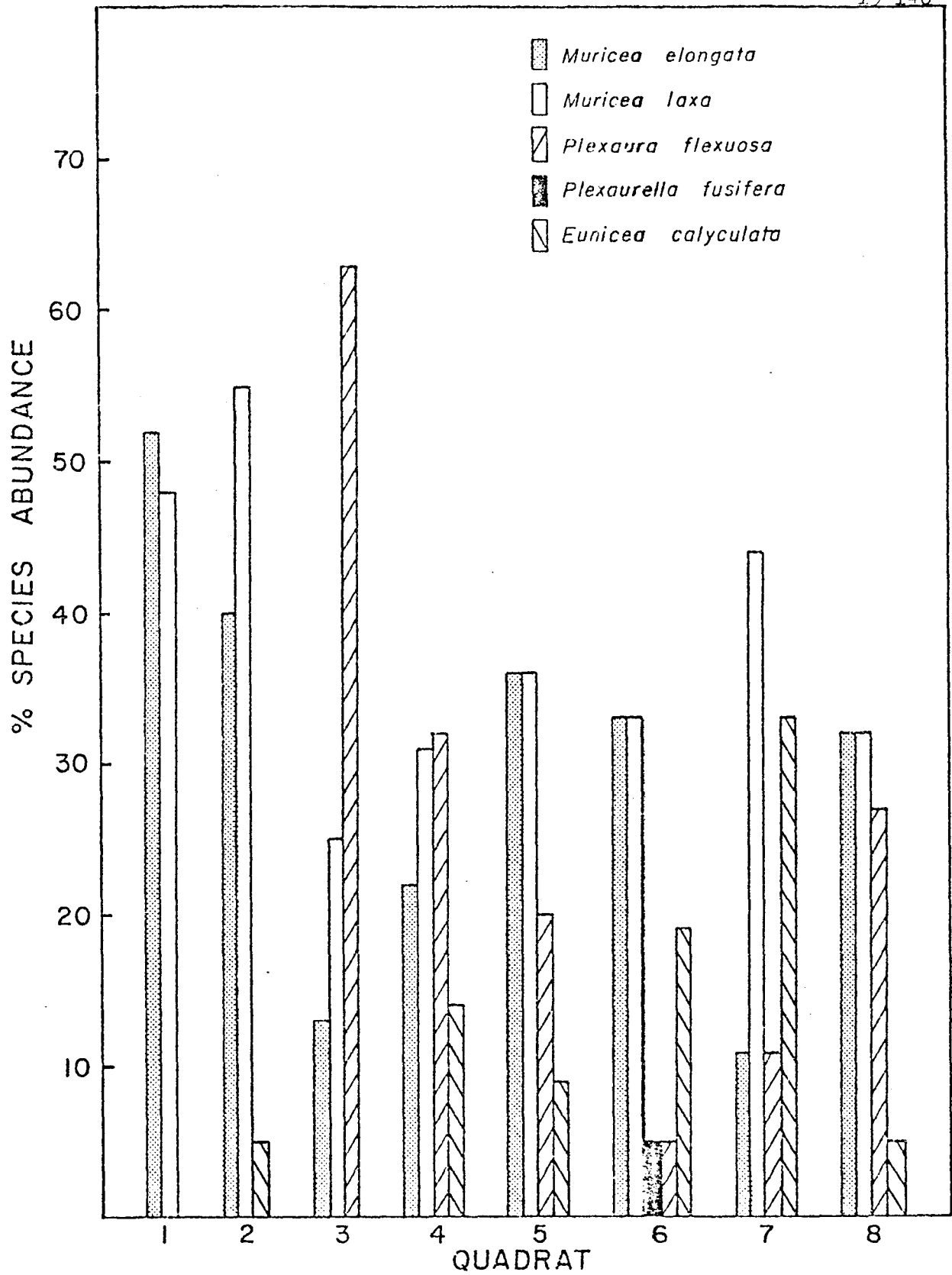

Figure 7E - Soft Coral Species Abundance, BLM 19  
at Station 146.

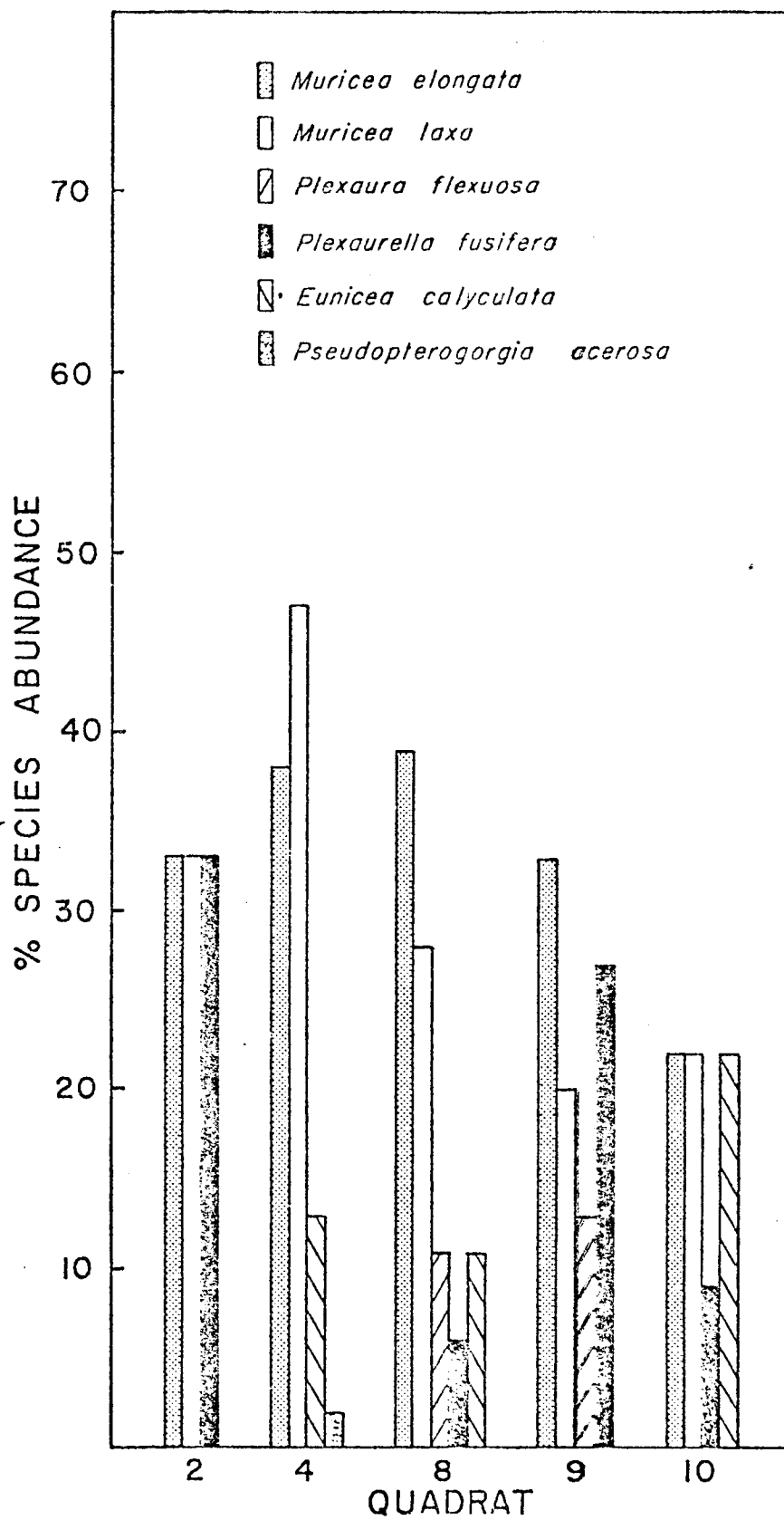

Figure 7F - Soft Coral Species Abundance, BTM 32/34 at Station 146.

Figure 8A, 8C - Hard Coral Species Diversity and Evenness for BLM 19 and 32/34 Respectively at Station 147.

He' \_\_\_\_\_ J'-----

Figure 8B, 8D - Hard Coral Number of Individuals and Number of Species/5M Quadrat for BLM 19 and 32/34 Respectively at Station 147.

Individuals/M<sup>2</sup> \_\_\_\_\_ No. Species/5M Quadrat -----

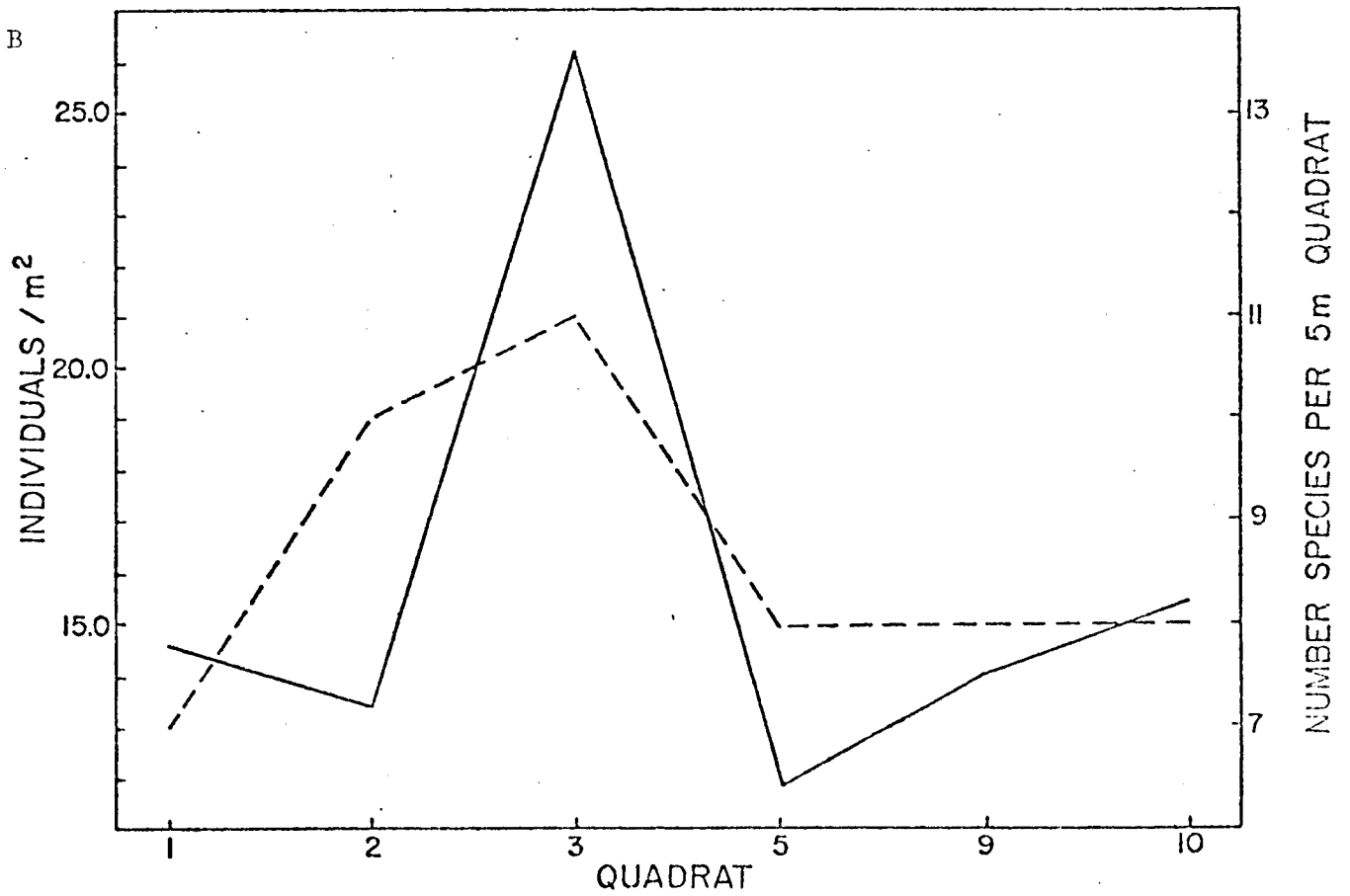
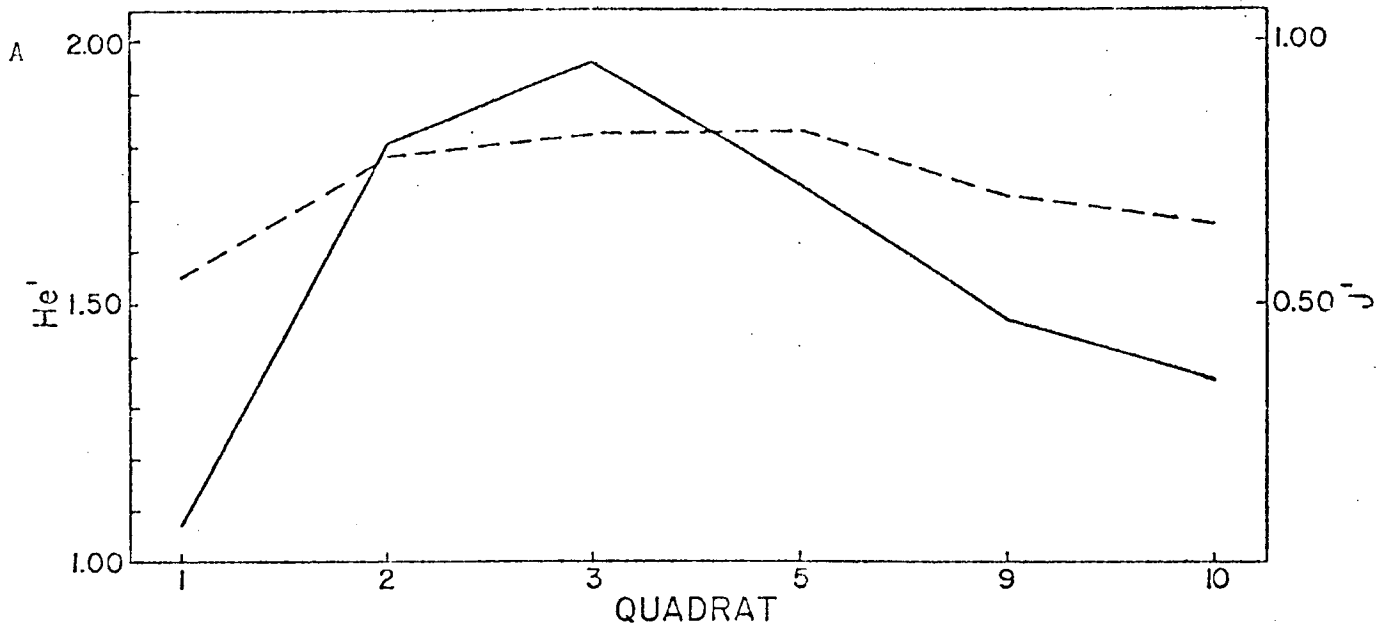

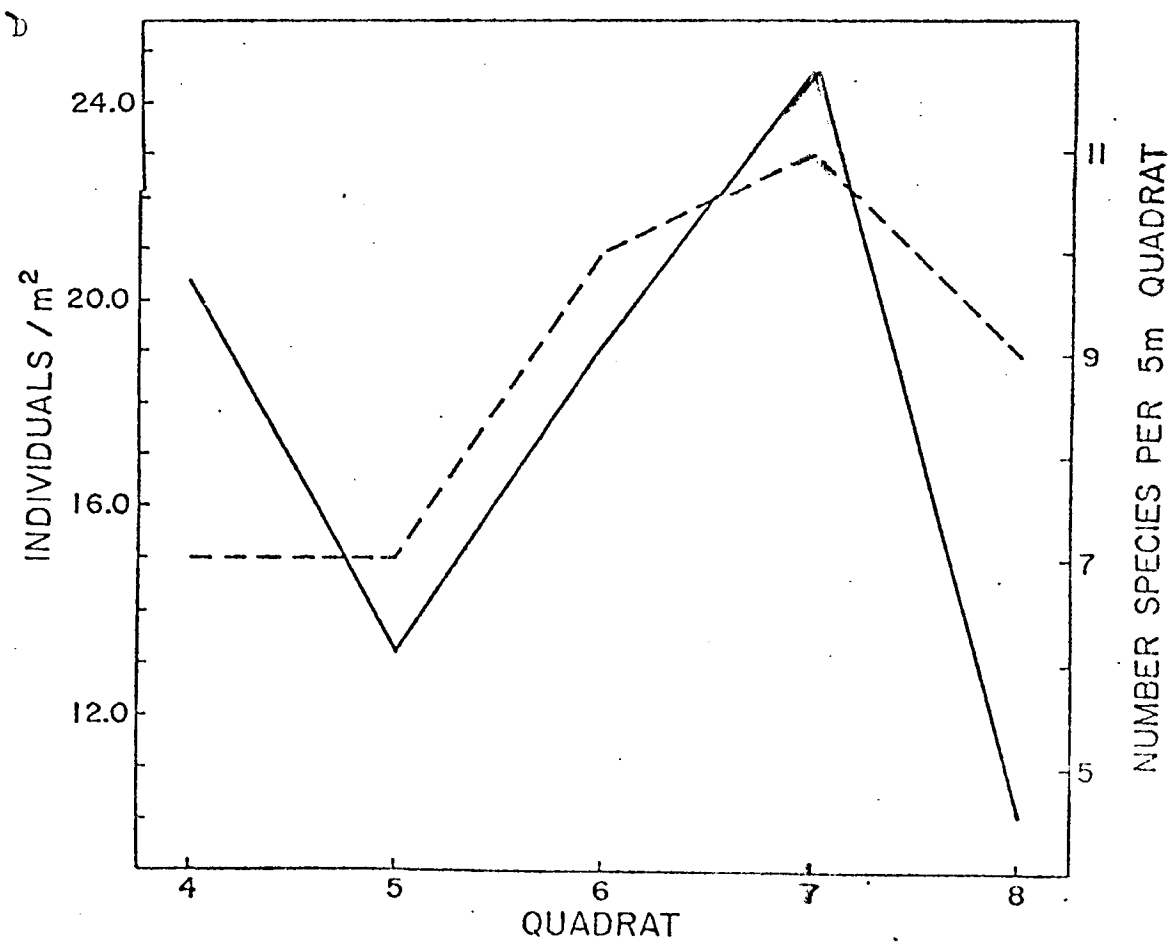
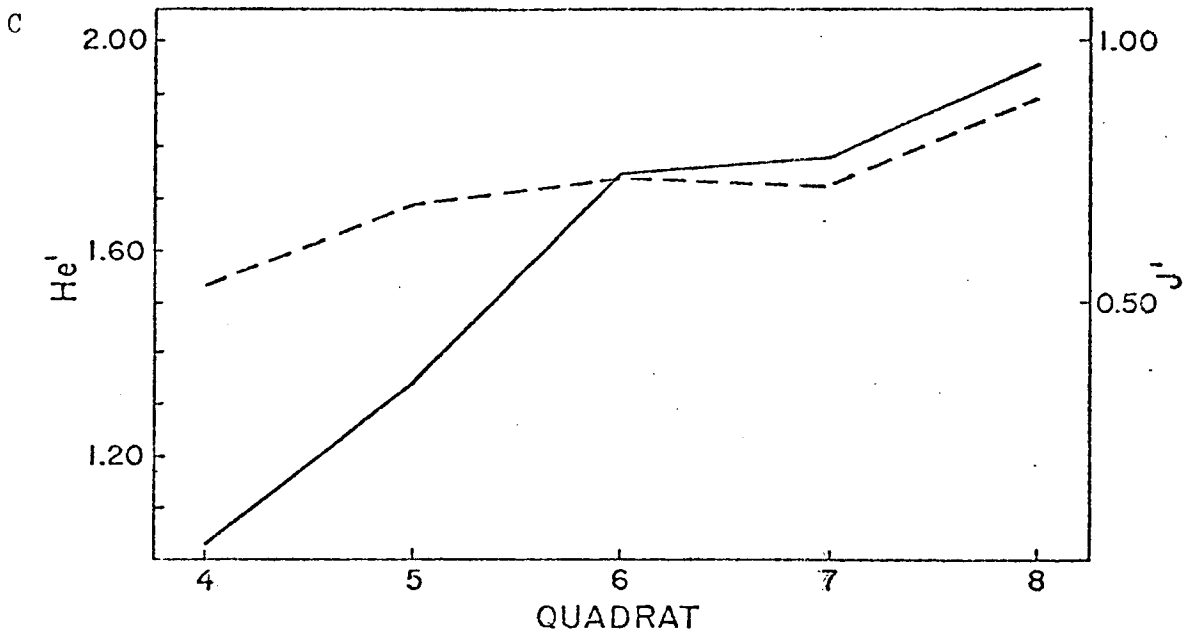

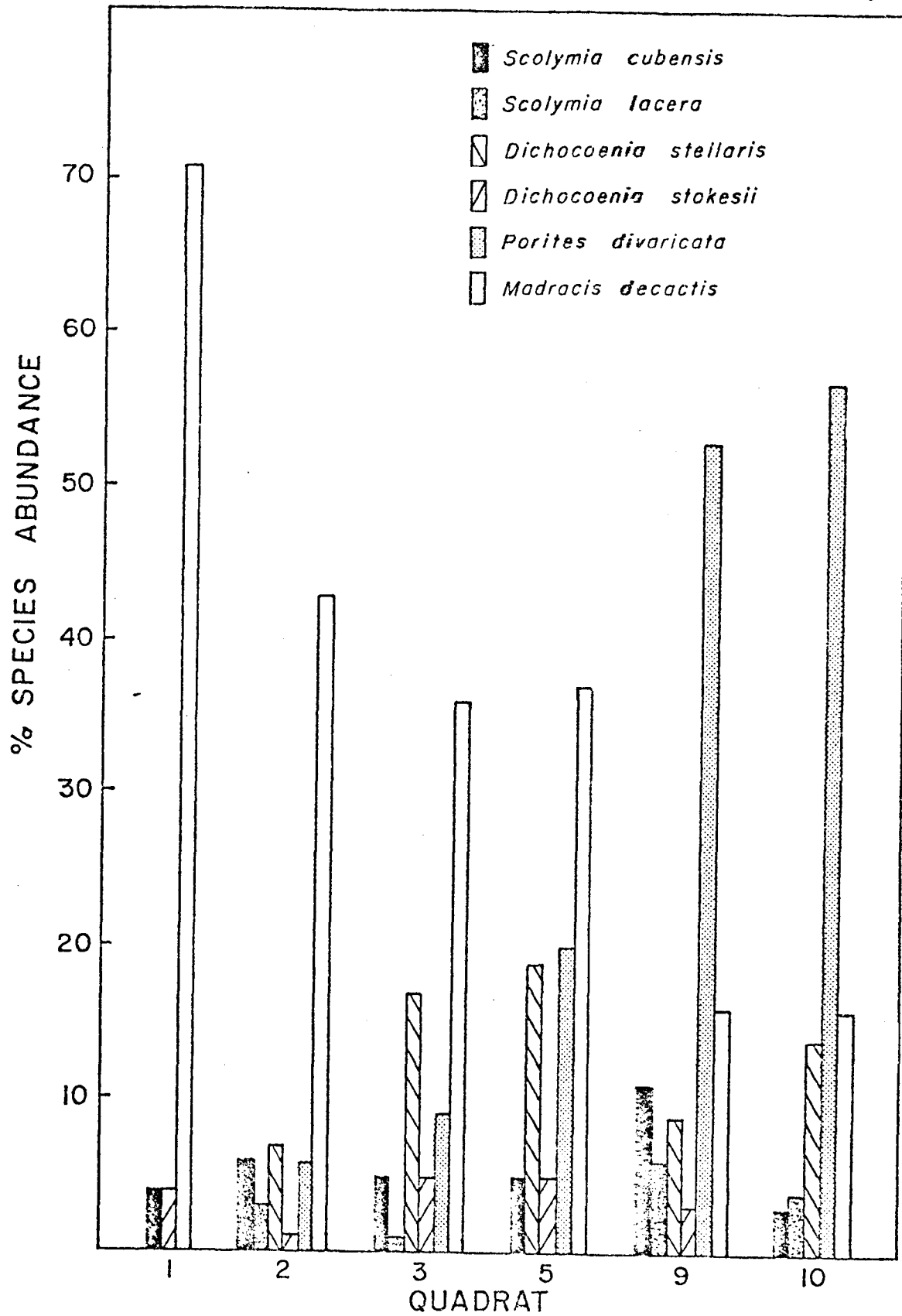

Figure 8E - Hard Coral Species Abundance, BLM 19  
at Station 147.



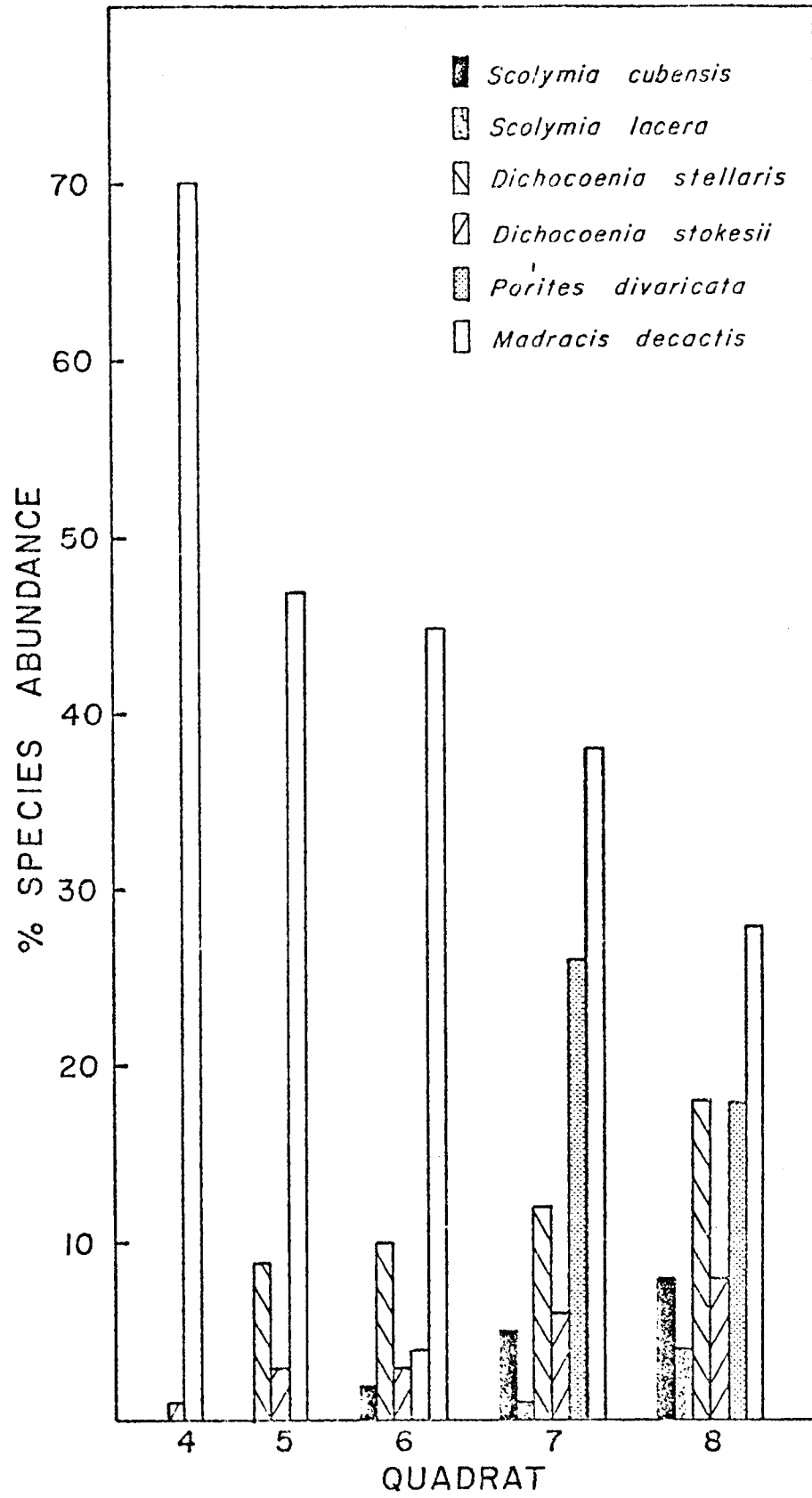

Figure 8F - Hard Coral Species Abundance, BLM 32/34 at Station 147.

Figure 9A, 9C - Soft Coral Species Diversity and Evenness for BLM 19 and 32/34 Respectively at Station 147.

He' \_\_\_\_\_ J' -----

Figure 9B, 9D - Soft Coral Number of Individuals and Number of Species/5M Quadrat for BLM 19 and 32/34 Respectively at Station 147.

Individuals/M<sup>2</sup> \_\_\_\_\_ No. Species/5M Quadrat -----

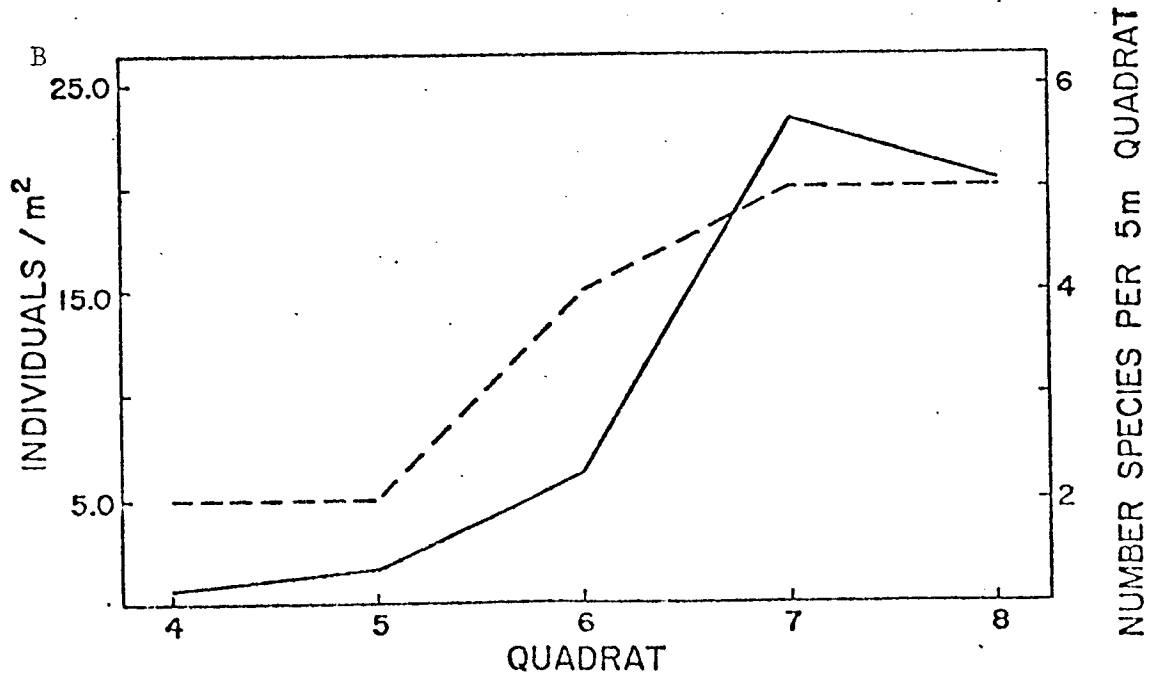
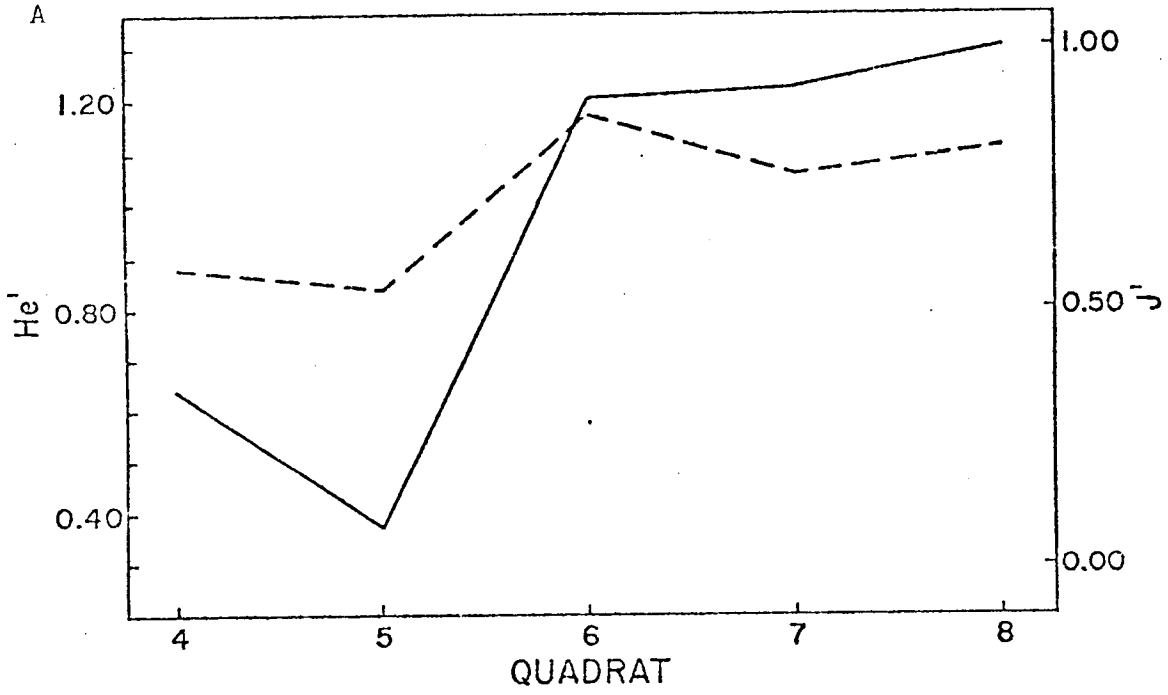

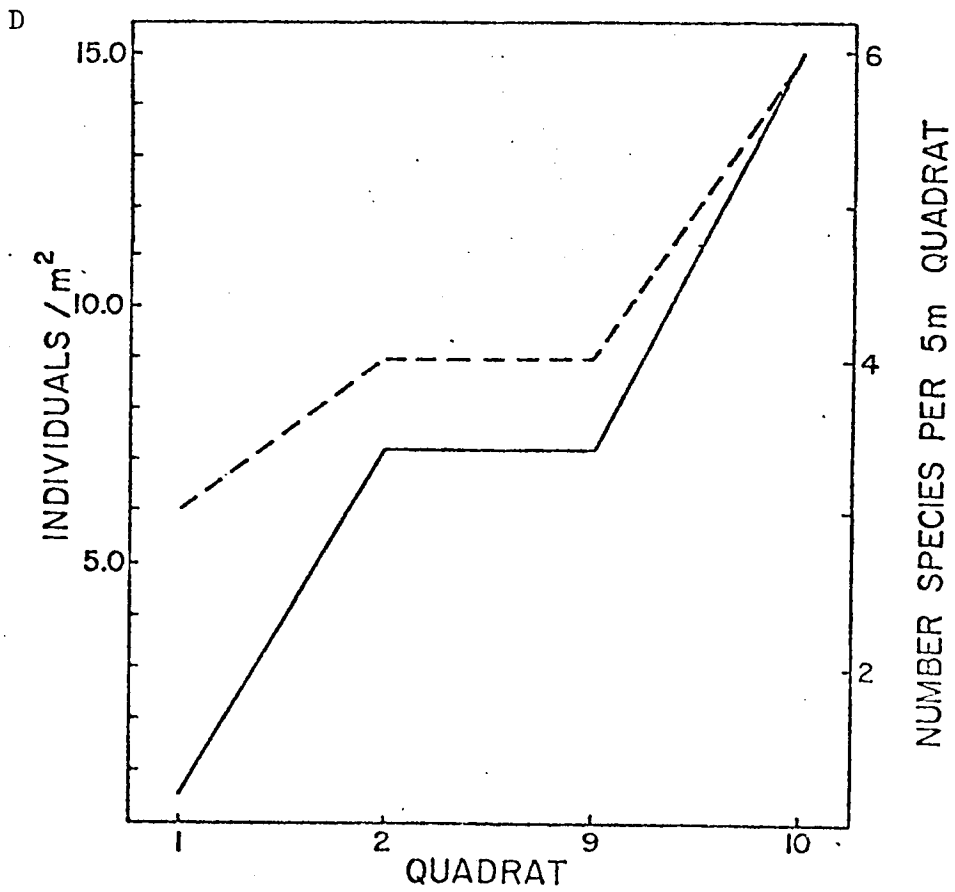
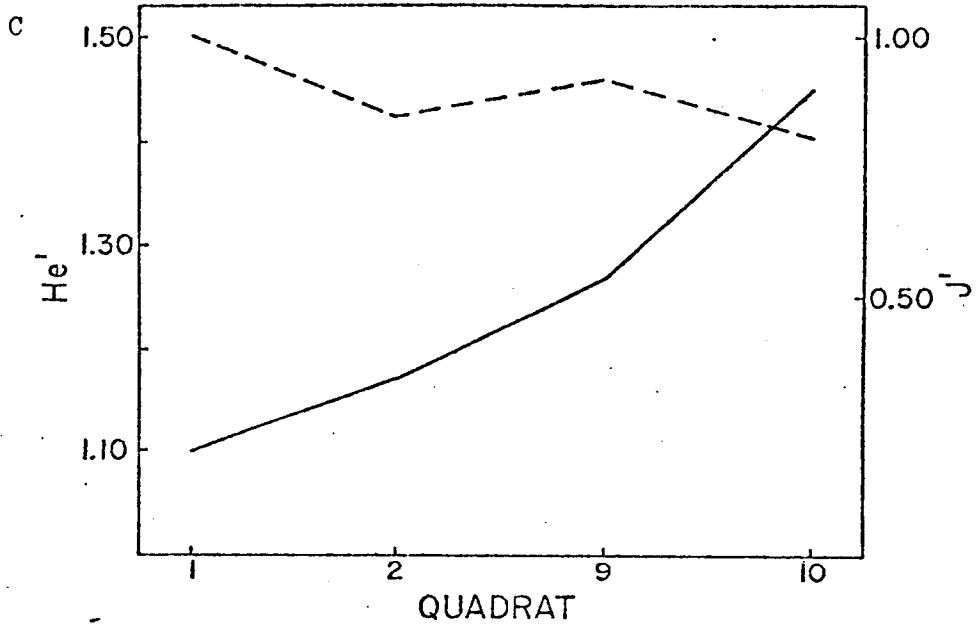

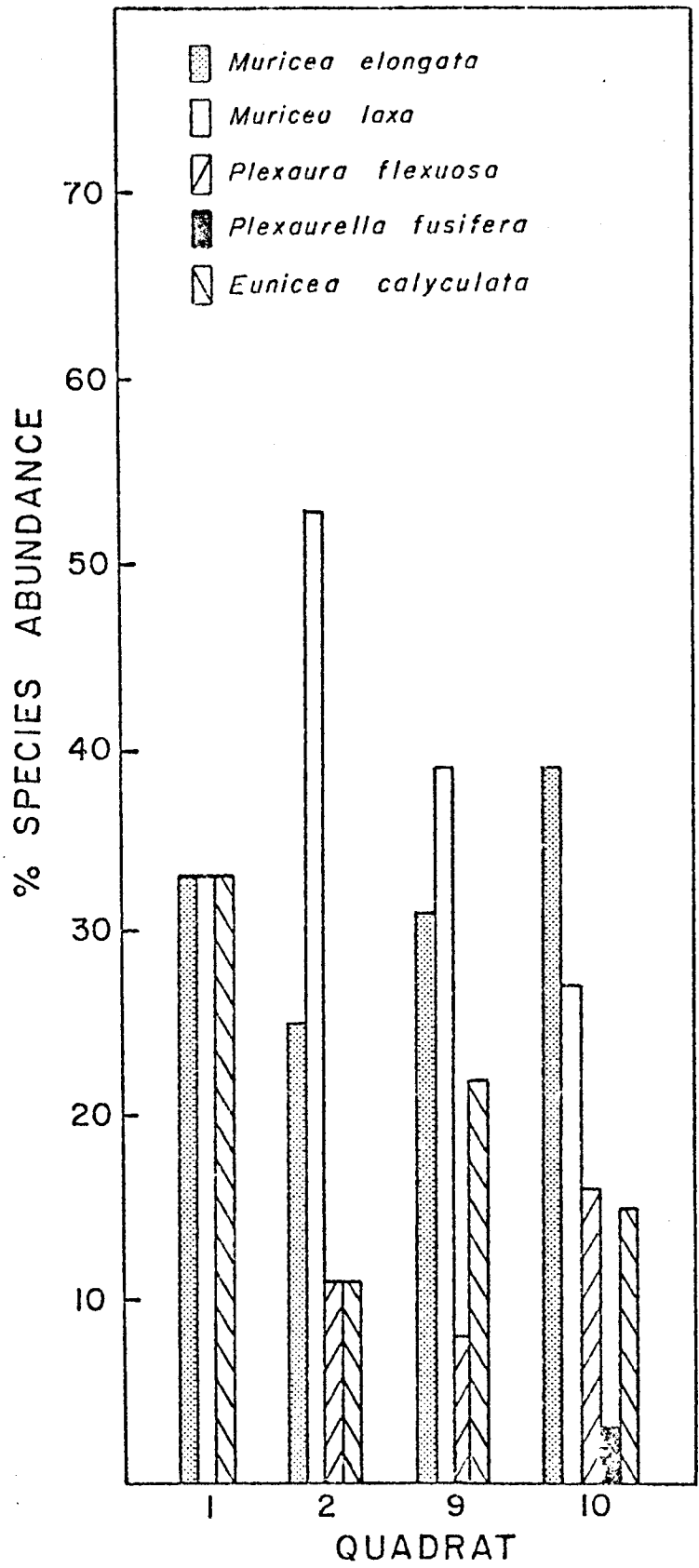

Figure 9E - Soft Coral Species Abundance, BLM 19 at Station 147.

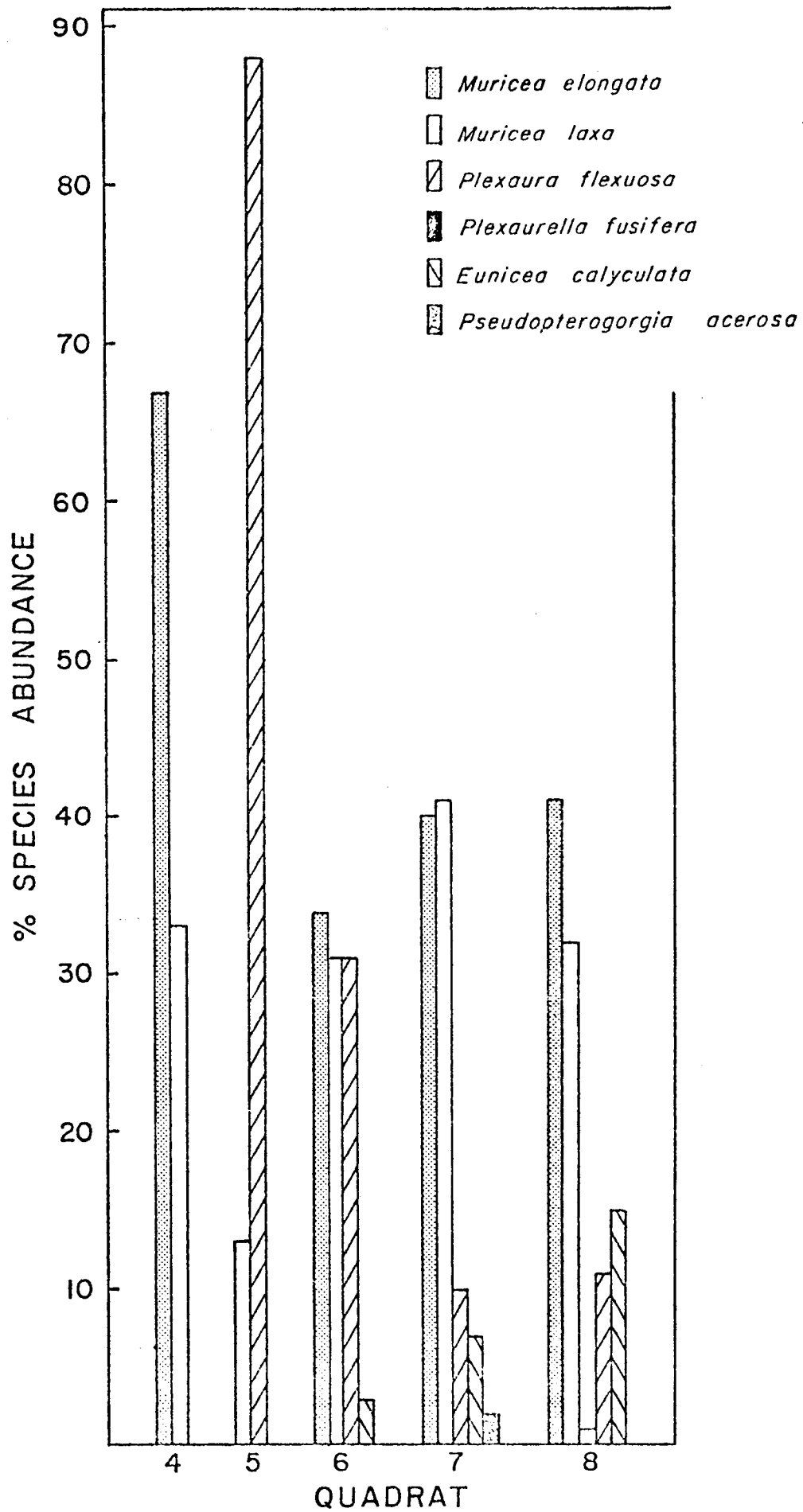

Figure 9F - Soft Coral Species Abundance, BLM 32/34 at Station 147.

Figure 10A, 10C-Hard Coral Species Diversity and Evenness for BLM 19 and 32/34 Respectively at Station 047.

He' \_\_\_\_\_ J'-----

Figure 10B, 10D - Hard Coral Number of Individuals and Number of Species/5M Quadrat for BLM 19 and 32/34 Respectively at Station 047.

Individuals/M<sup>2</sup> \_\_\_\_\_ No. Species/5M Quadrat -----

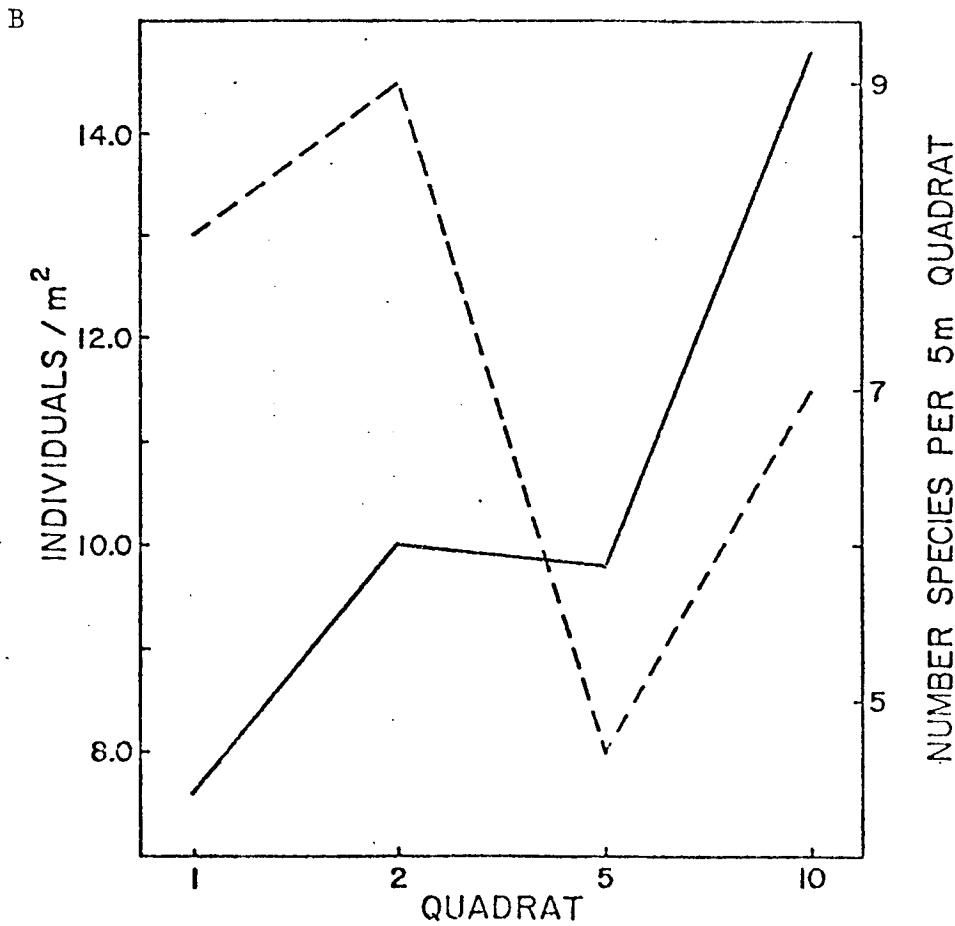
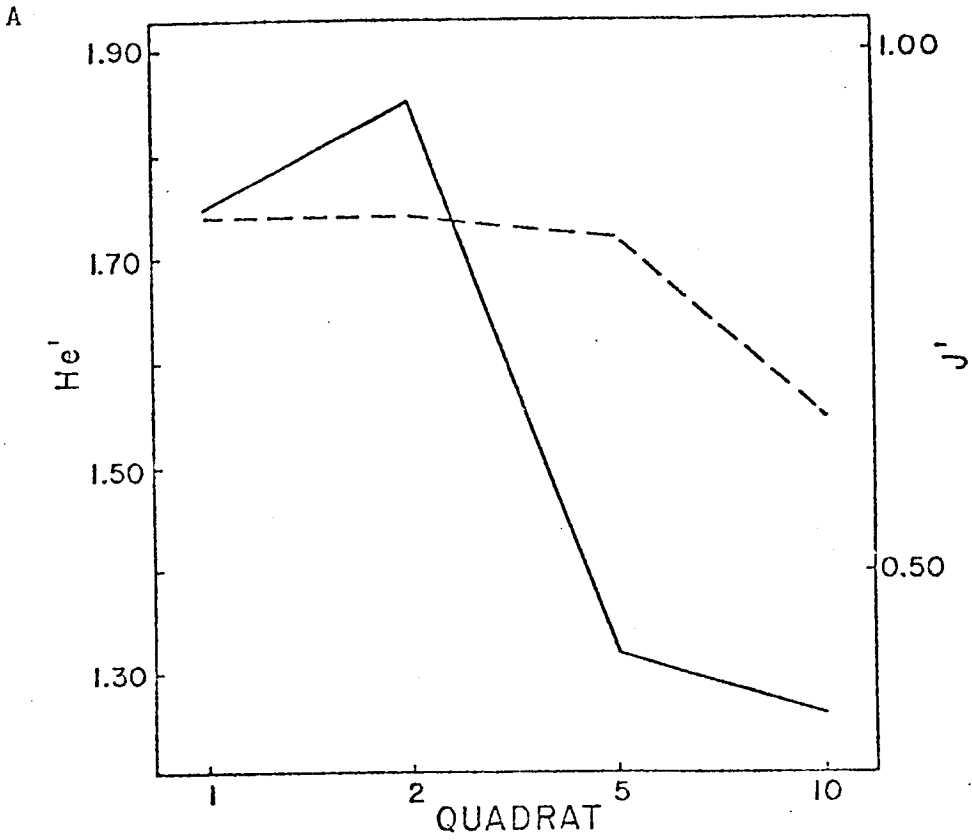



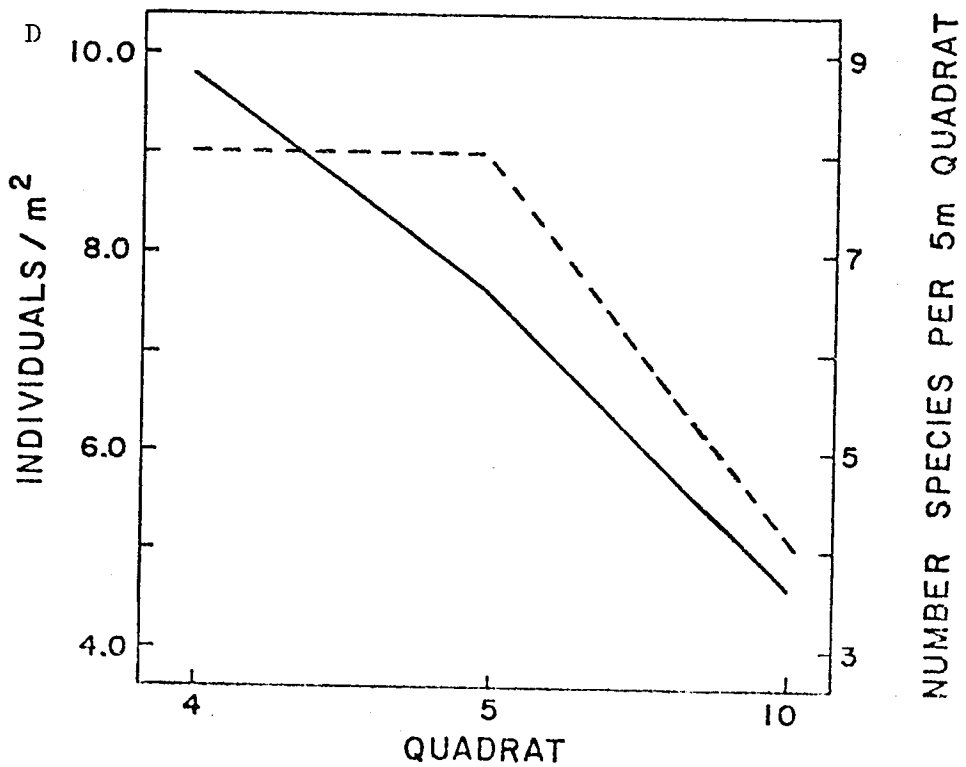
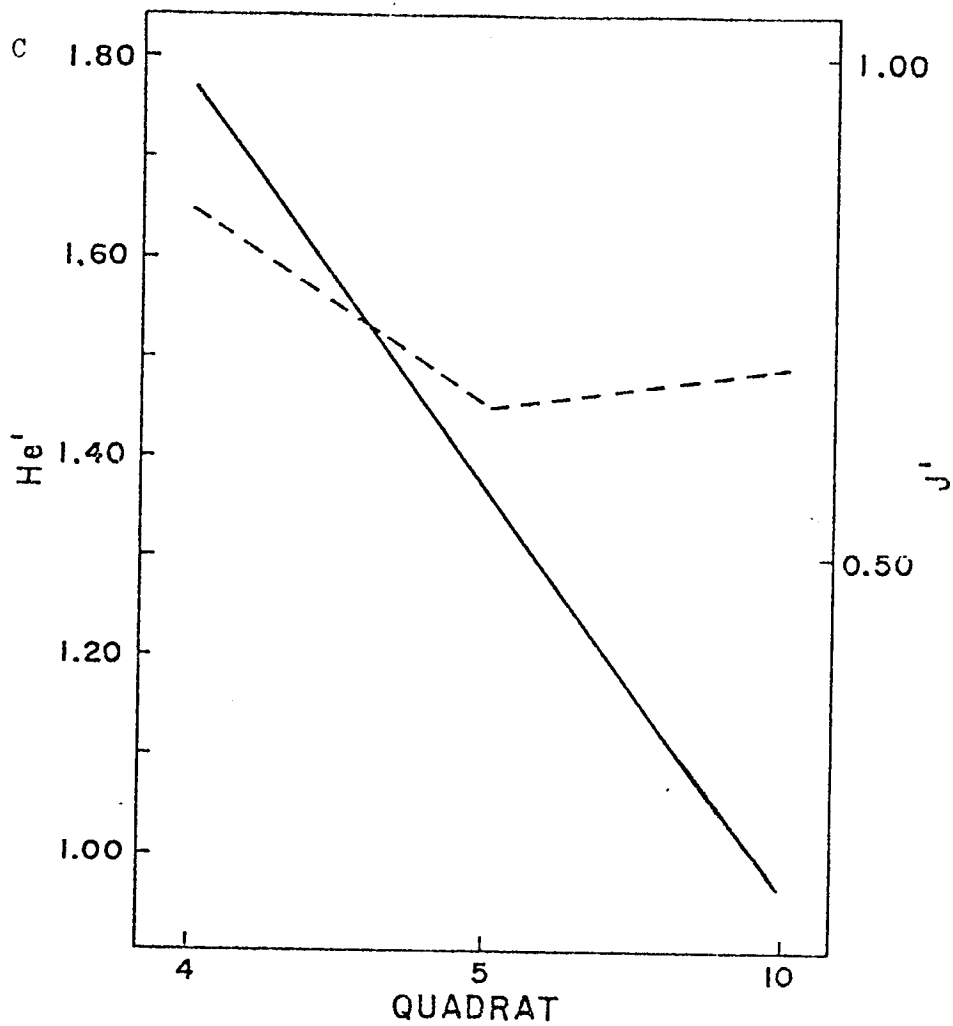

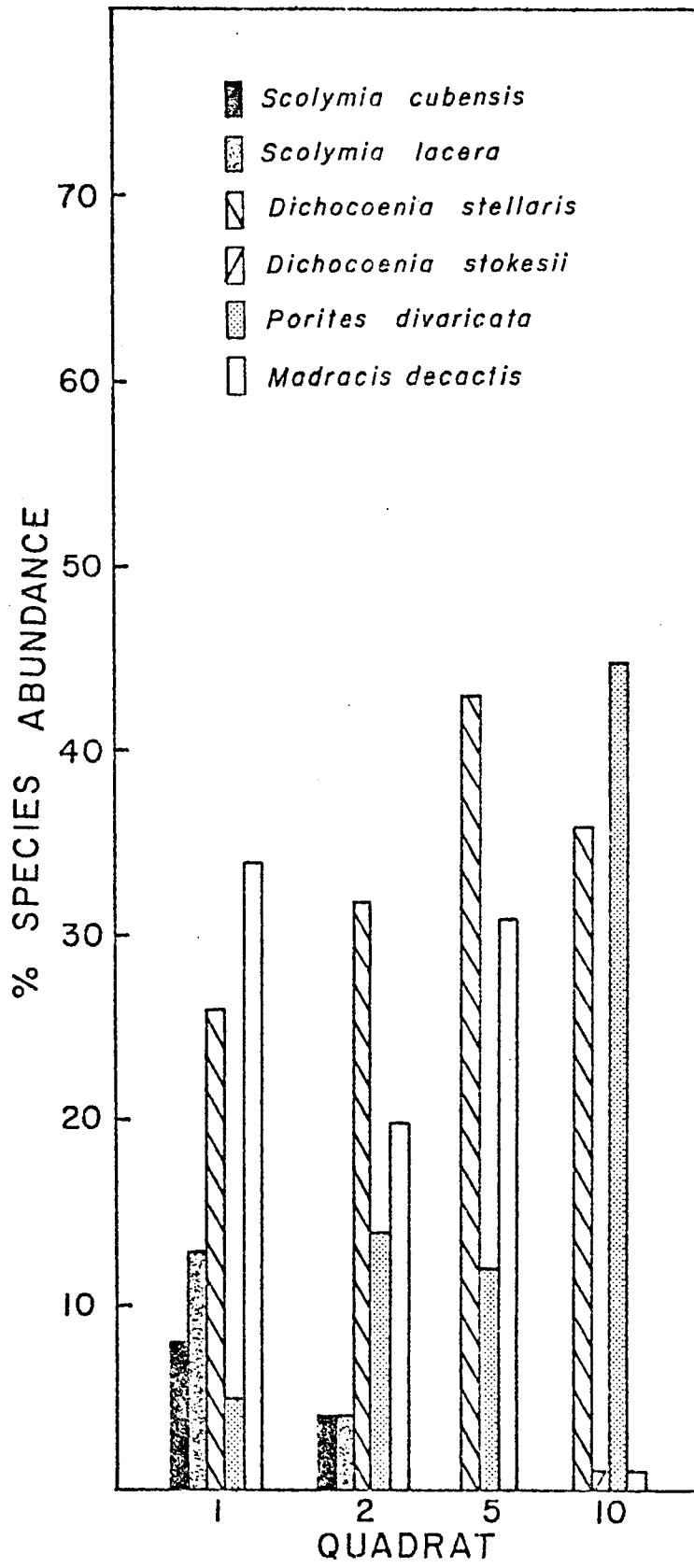

Figure 10E - Hard Coral Species Abundance, BLM 19 at Station 047.

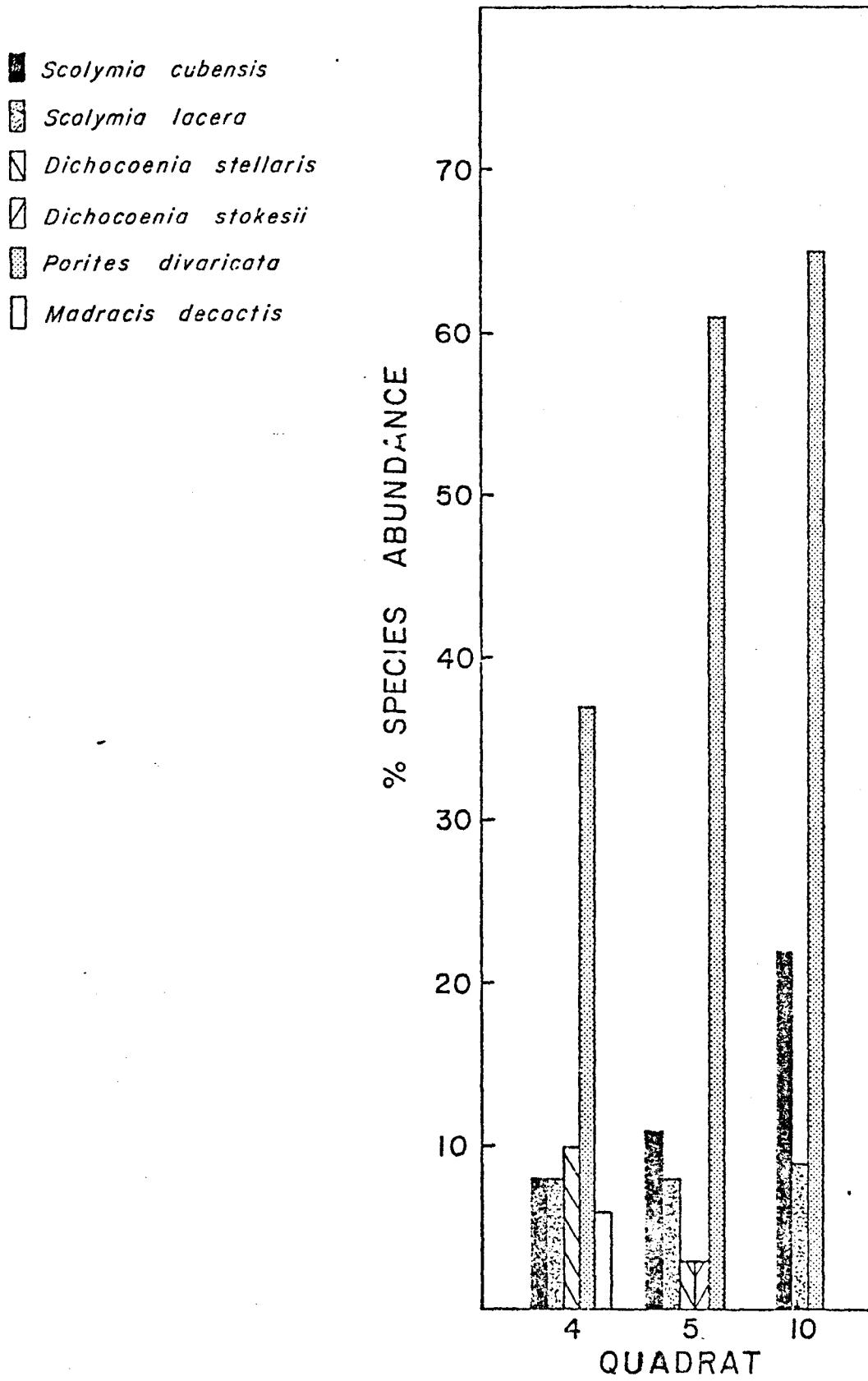

Figure 10F- Hard Coral Species Abundance, BLM 32/34  
at Station 047.

Figure 11A, 11C - Soft Coral Species Diversity and Evenness for BLM 19 and 32/34 Respectively at Station 047.

He" \_\_\_\_\_ J'-----

Figure 11B, 11D - Soft Coral Number of Individuals and Number of Species 5M Quadrat for BLM 19 and 32/34 Respectively at Station 047.

Individuals/M<sup>2</sup> \_\_\_\_\_ No. Species/5M Quadrat -----

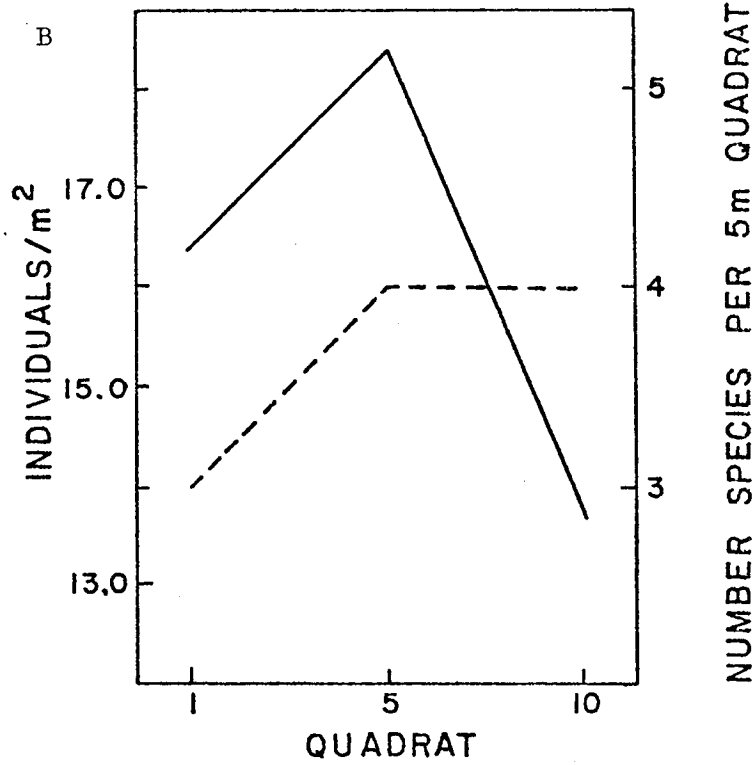
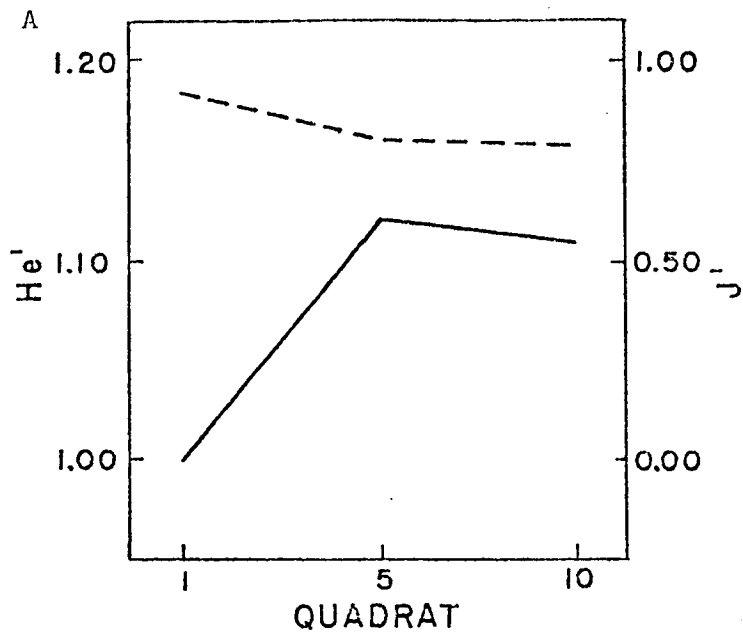

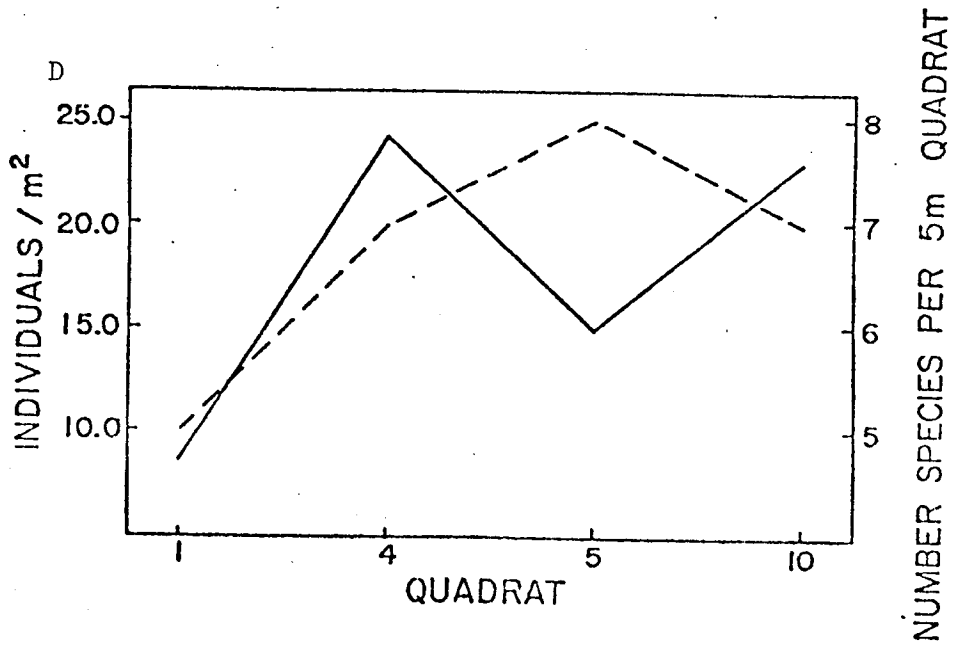
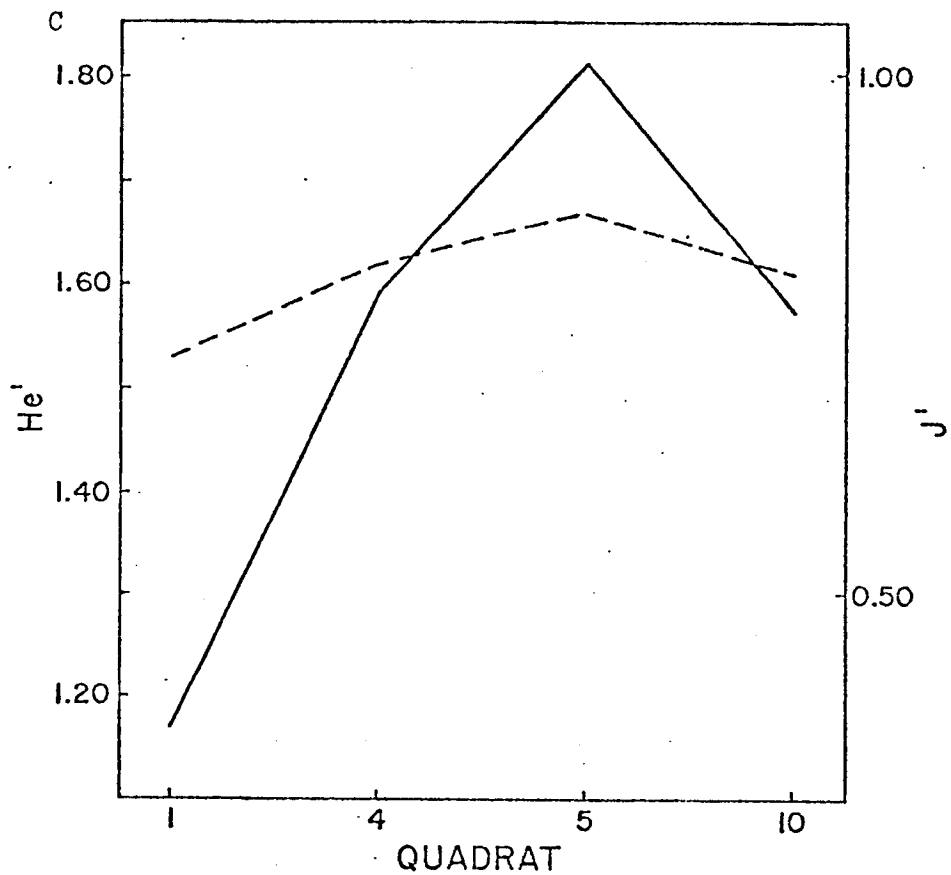

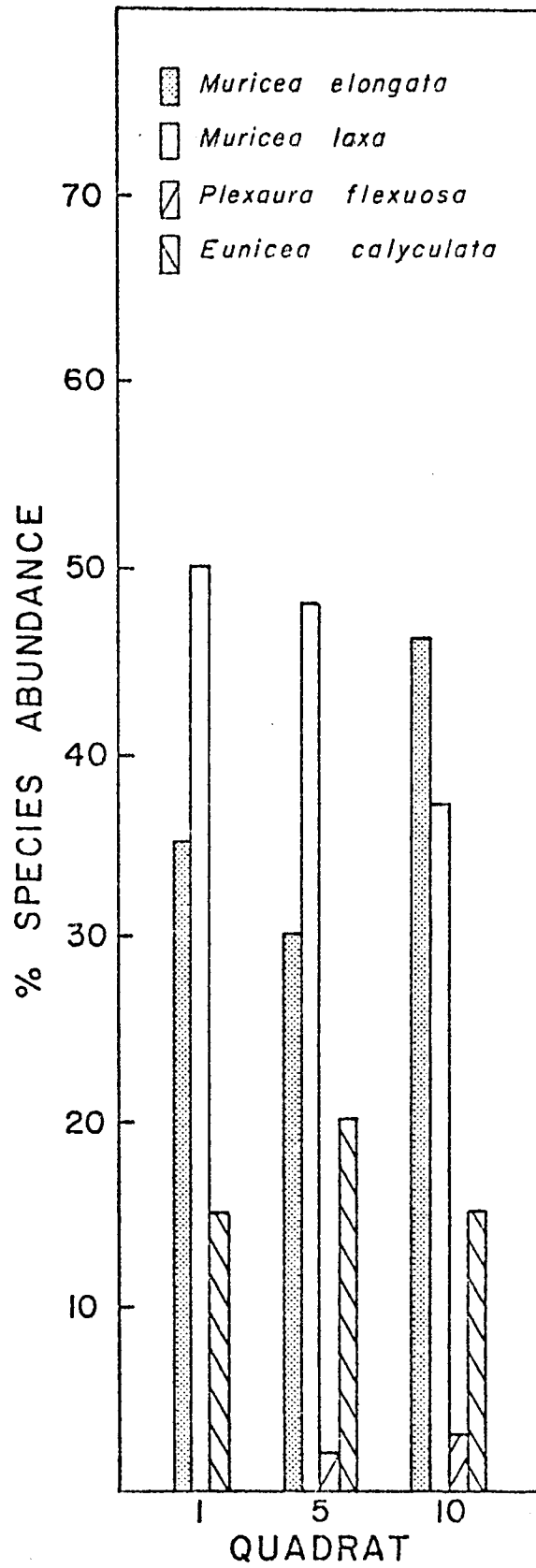

Figure 11E - Soft Coral Species Abundance, BLM 19  
at Station 047.

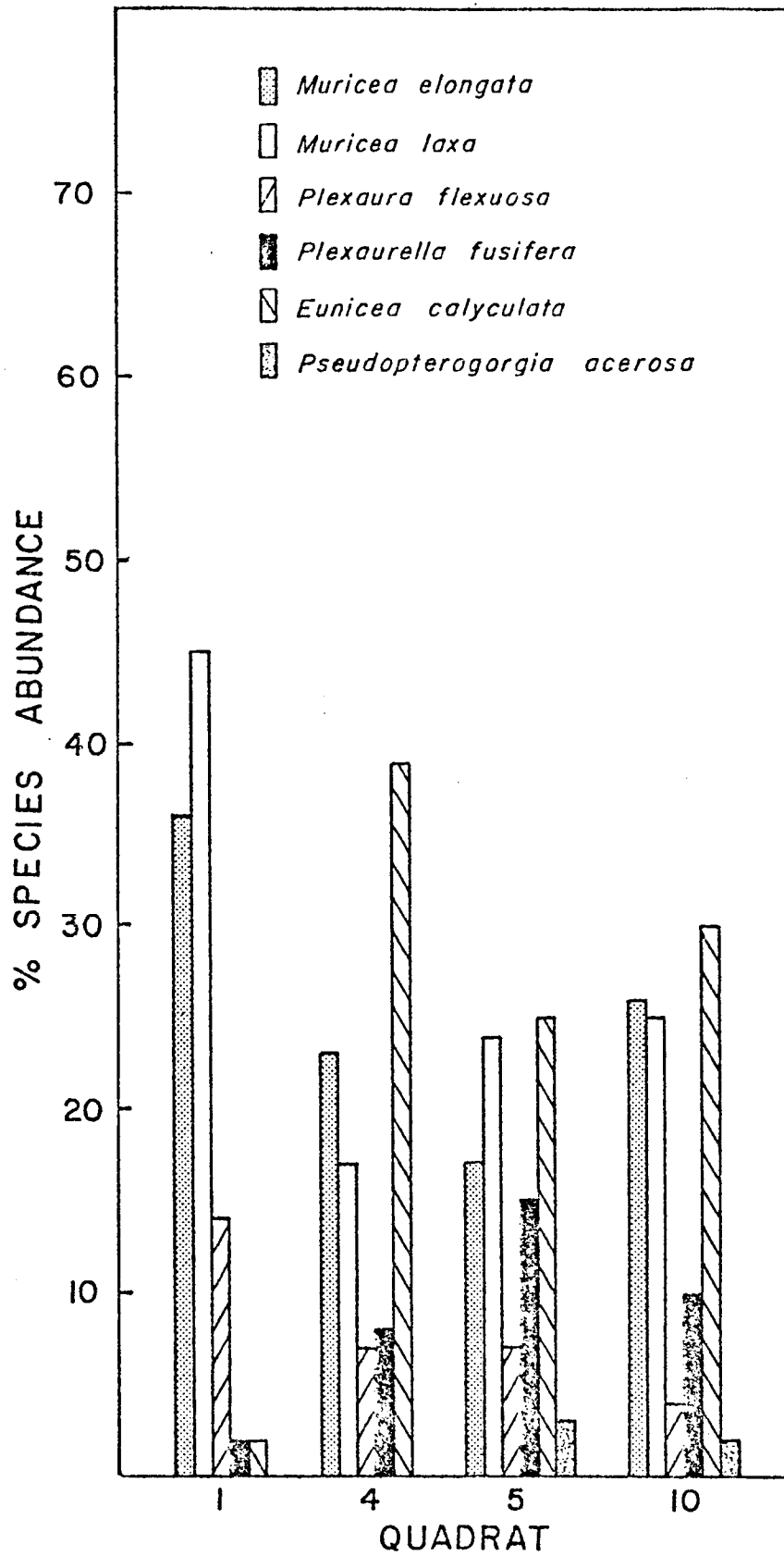

Figure 11F - Soft Coral Species Abundance, BLM 32/34 at Station 047.

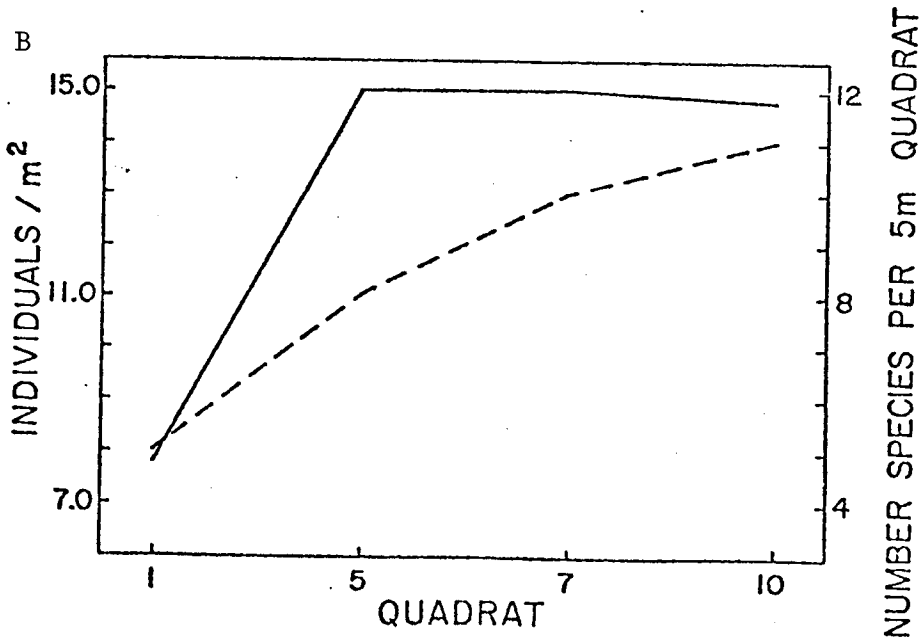
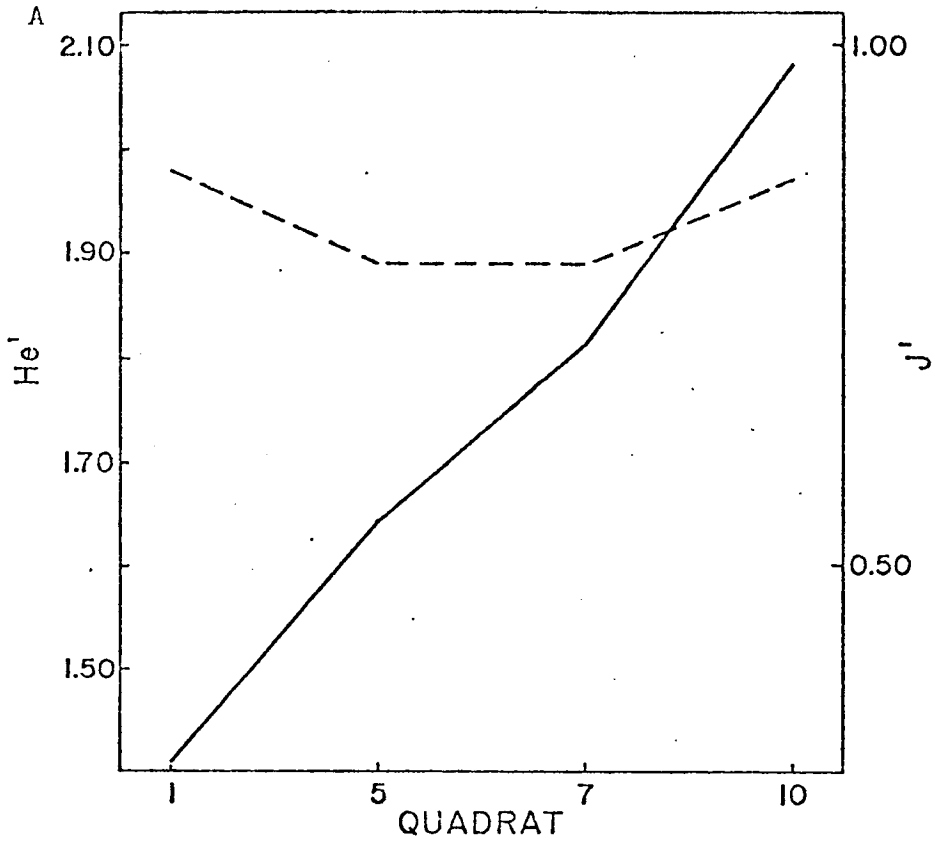

Figure 12A,12C- Hard Coral Species Diversity and  
Evenness for BLM 19 and 32/34 Respectively at  
Station 151.

He' \_\_\_\_\_ J'-----

Figure 12B, 12D - Hard Coral Number of Individuals and  
Number of Species/5M Quadrat for BLM 19 and 32/34  
Respectively at Station 151.

Individuals/M<sup>2</sup> \_\_\_\_\_ No. Species/5M Quadrat -----



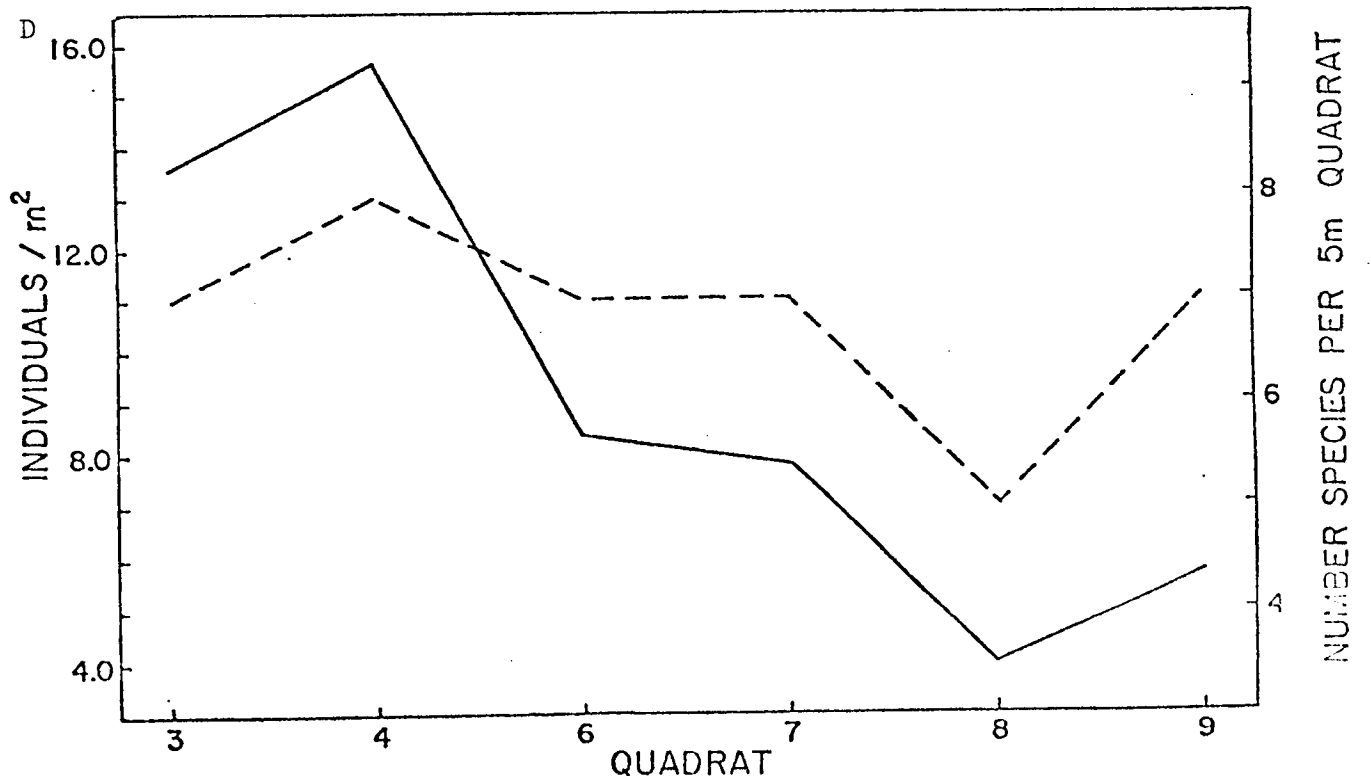
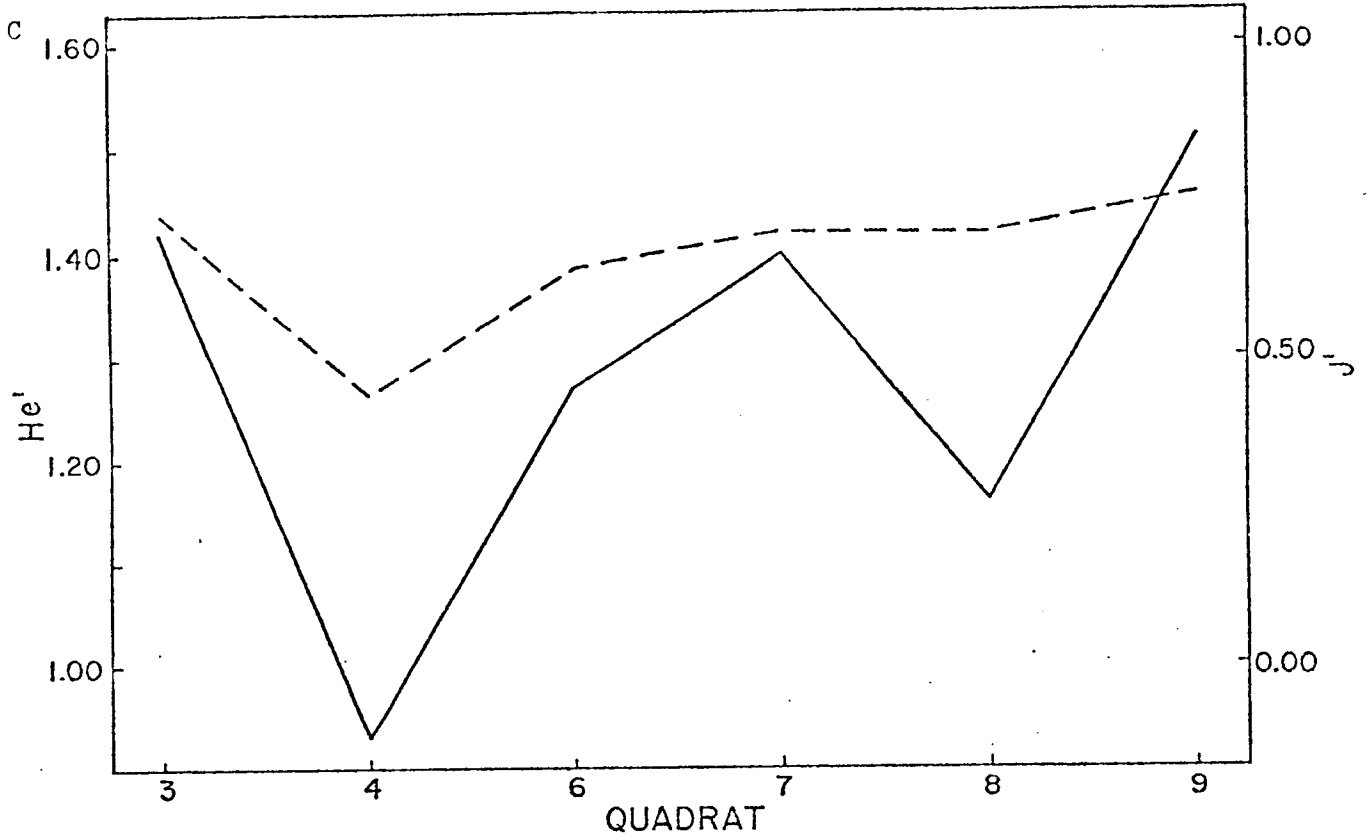

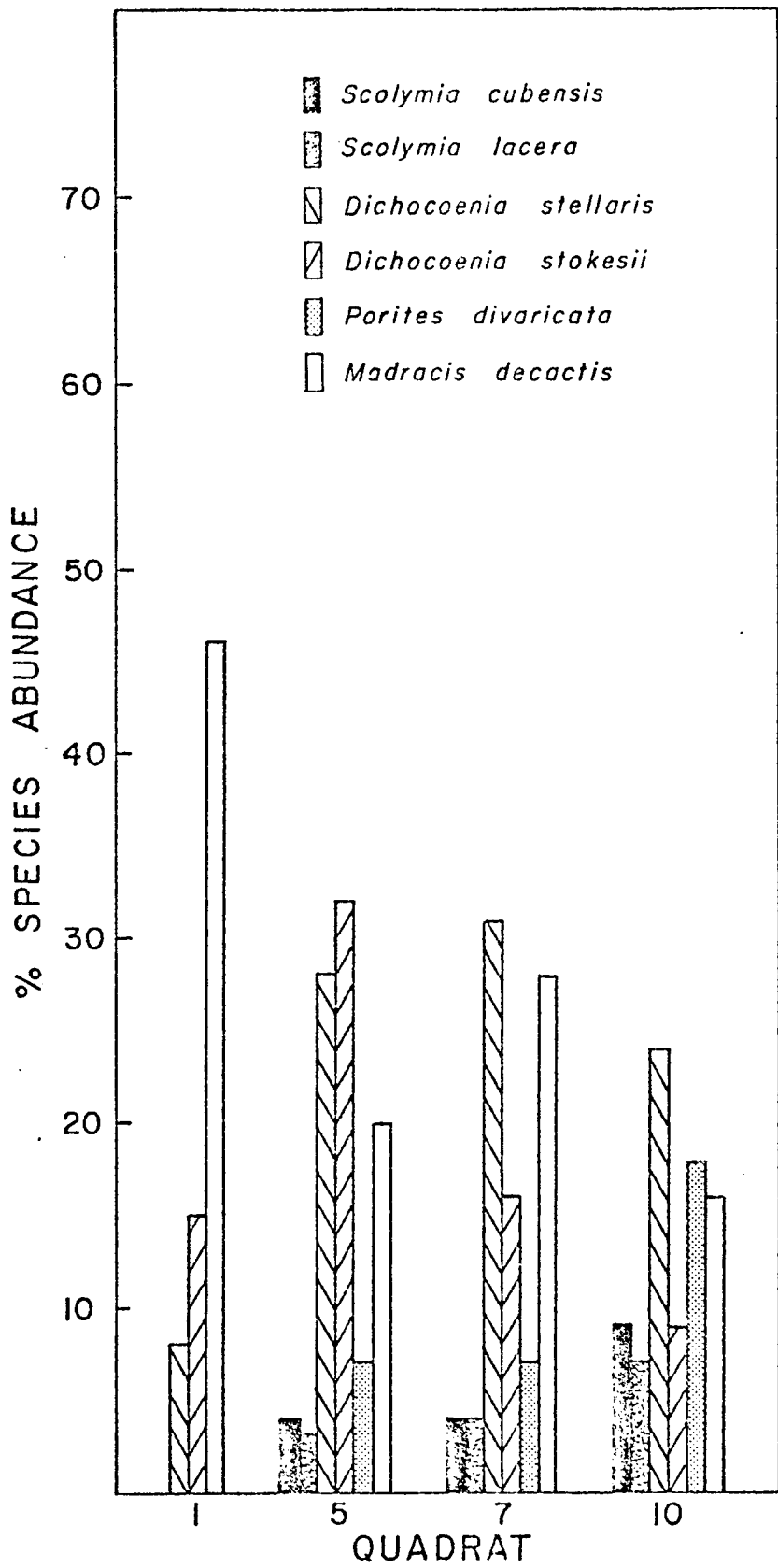

Figure 12E - Hard Coral Species Abundance, BLM 19 at Station 151.

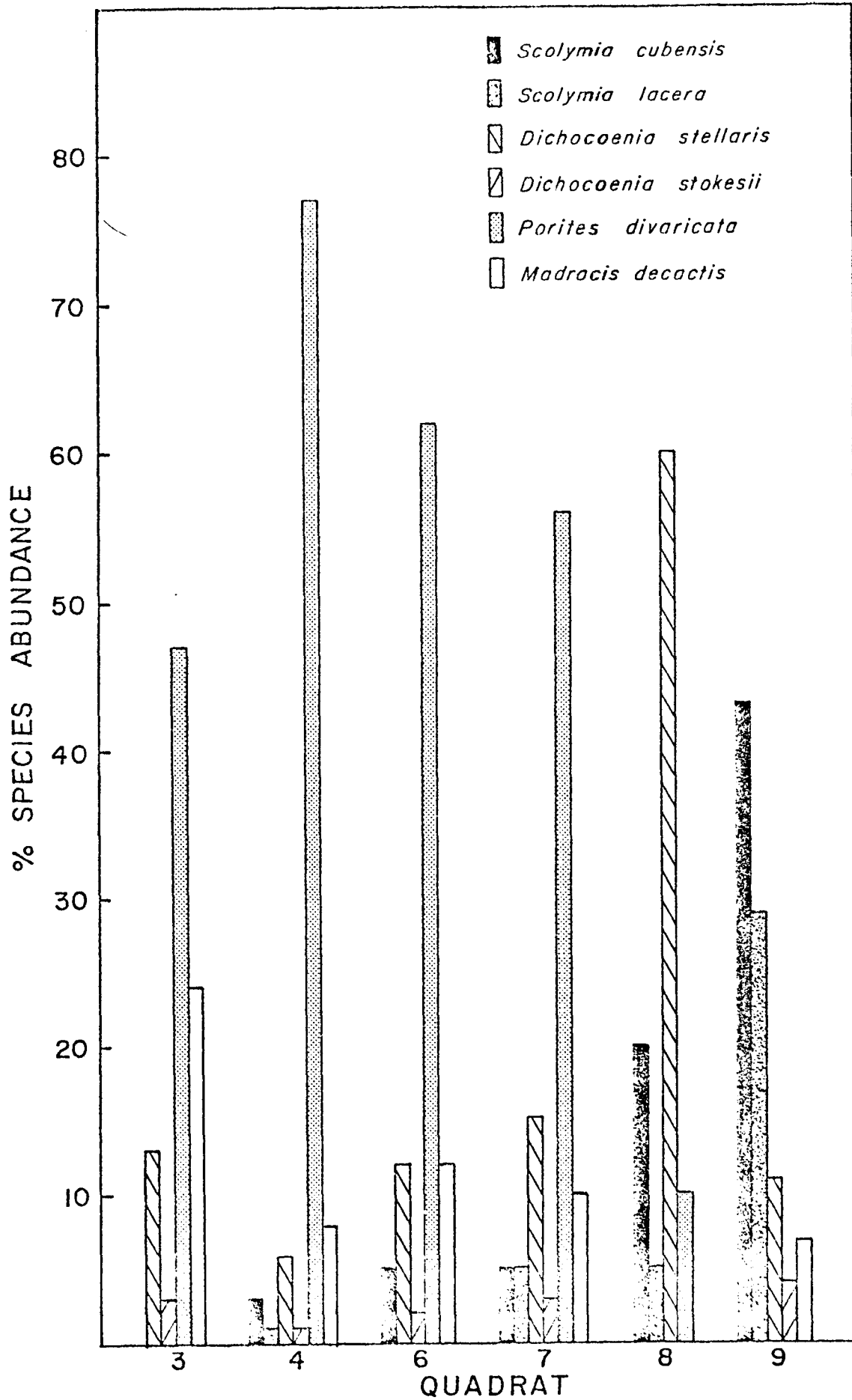

Figure 12F- Hard Coral Species Abundance, BLM 32/34 at Station 151.

Figure 13B, 13D - Soft Coral Number of Individuals and  
Number of Species/5M Quadrat for BLM 19 and 32/34  
Respectively at Station 151.

Individuals/M<sup>2</sup> \_\_\_\_\_ No. Species/5M Quadrat -----

Figure 13A, 13C - Soft Coral Species Diversity and  
Evenness for BLM 19 and 32/34 Respectively at  
Station 151.

He' \_\_\_\_\_ J' -----

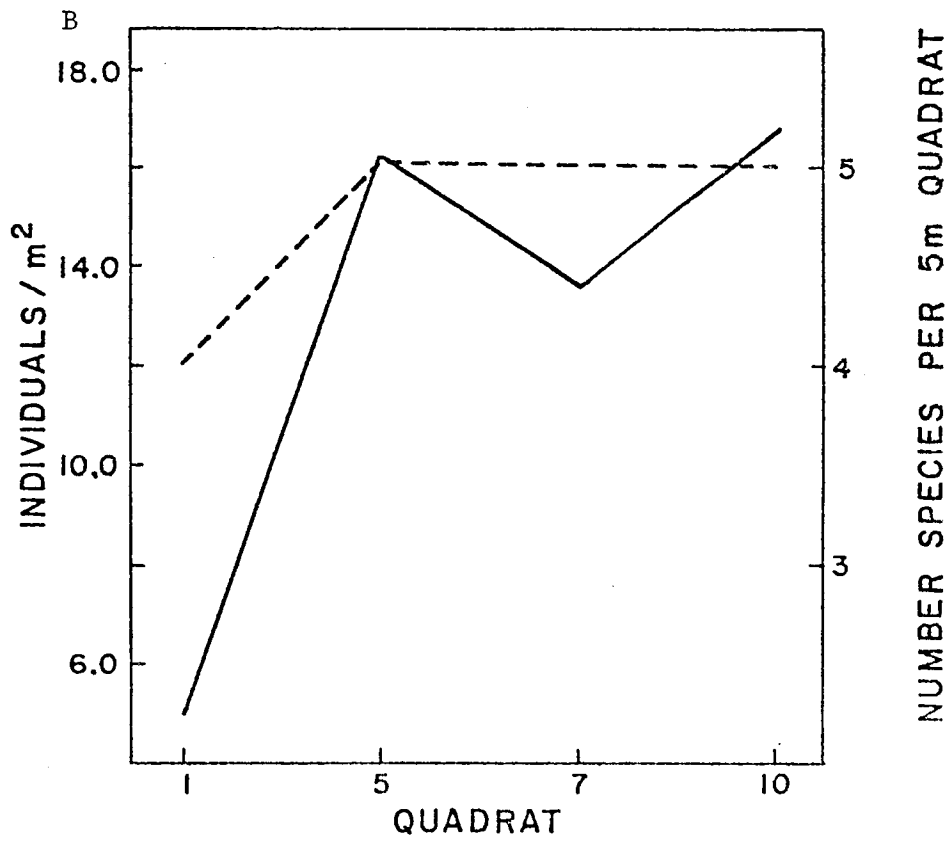
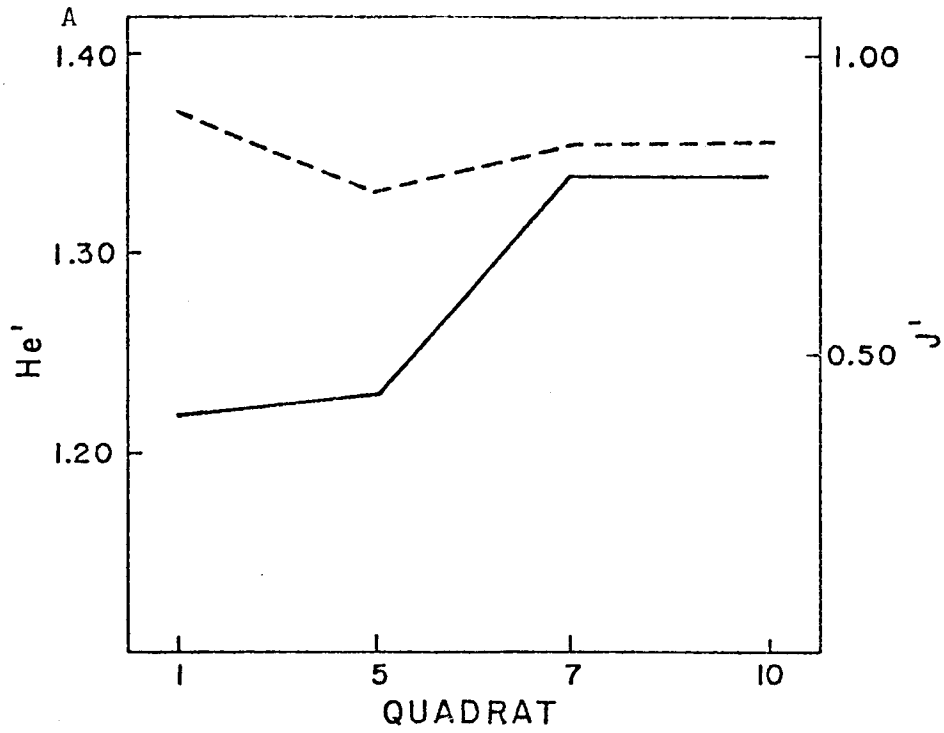

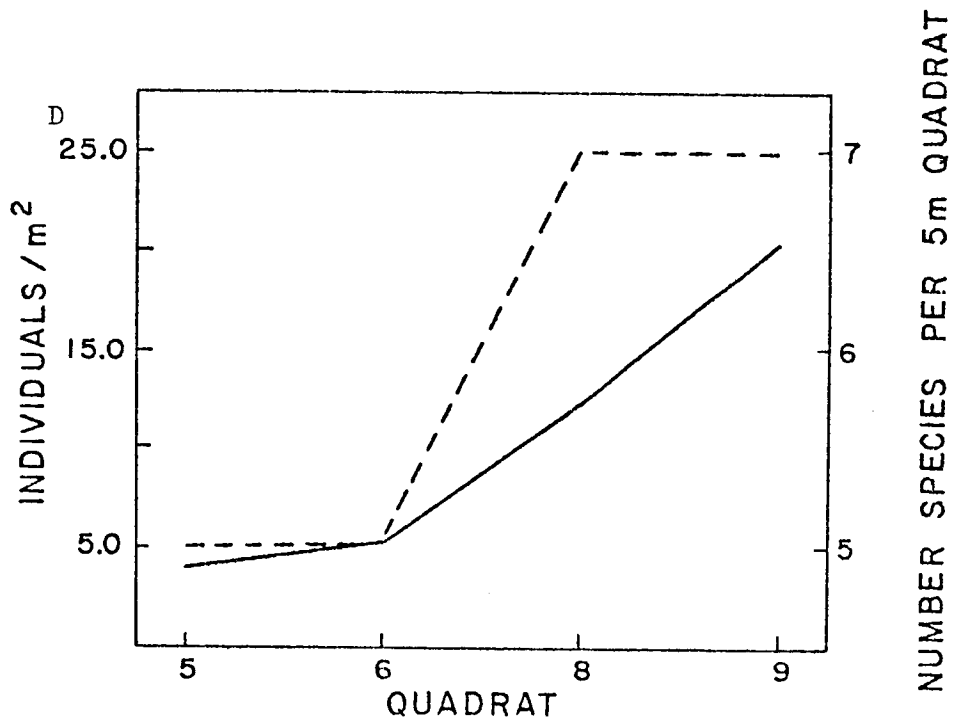
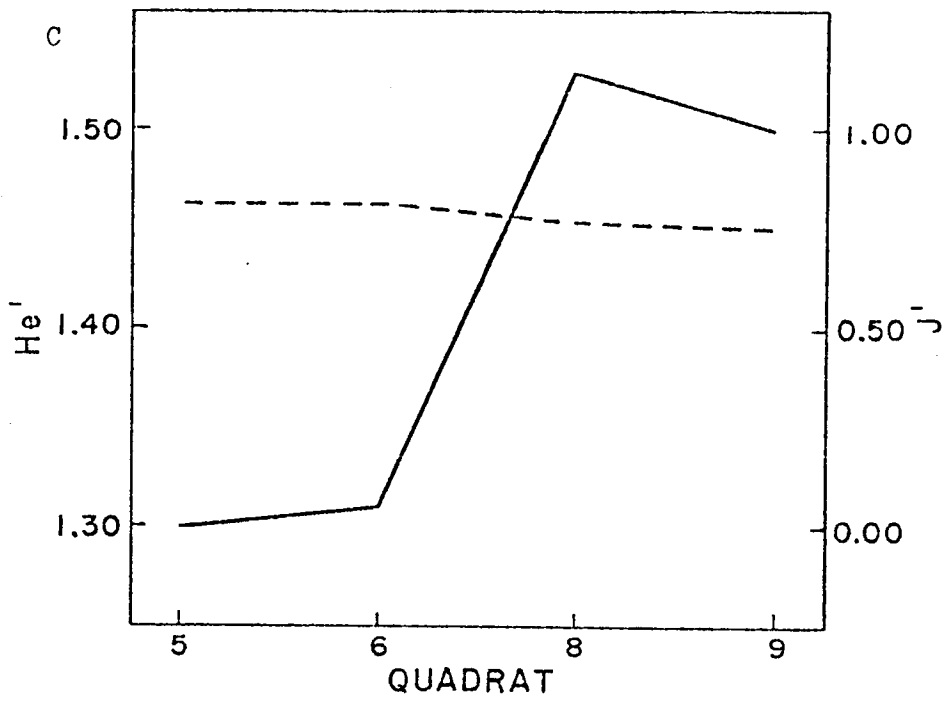



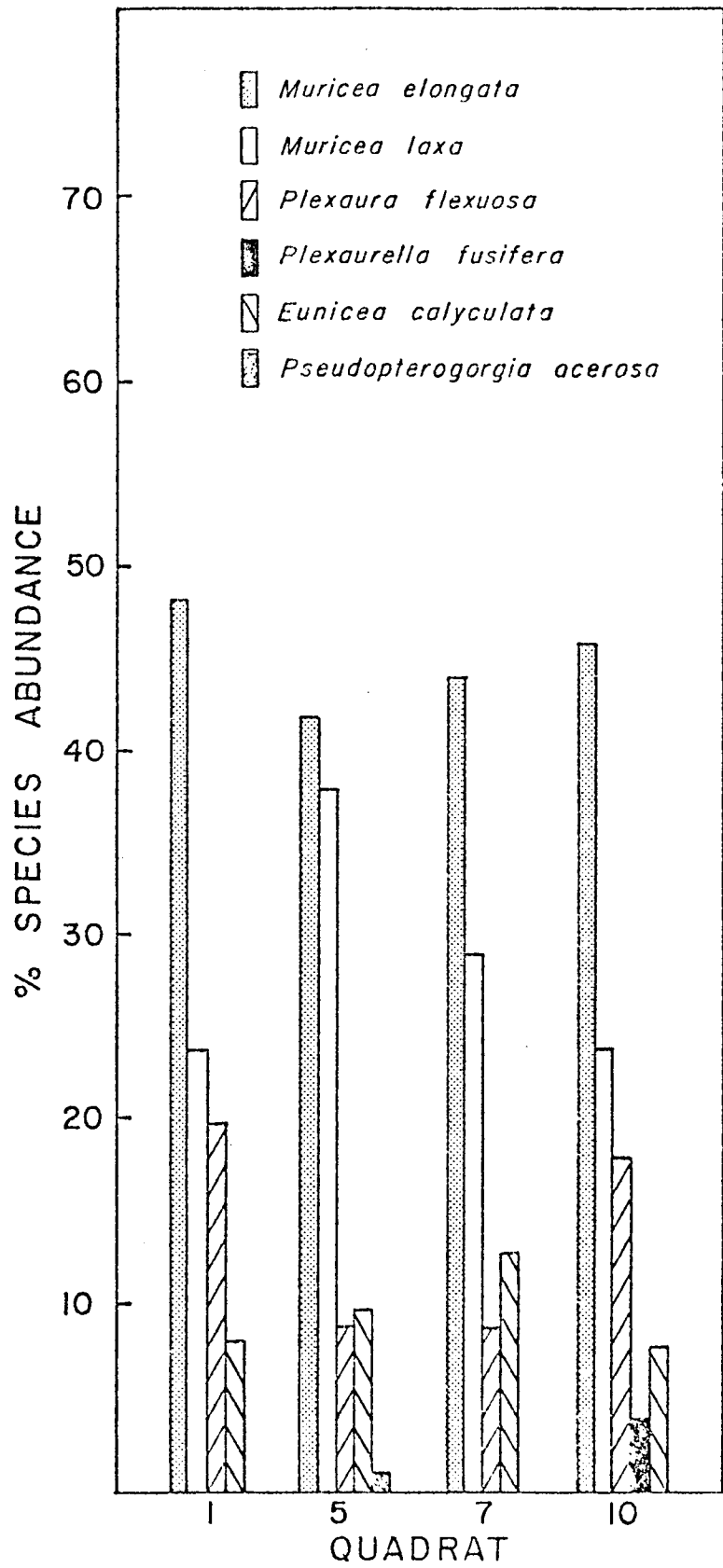

Figure 13E - Soft Coral Species Abundance, BIM 19 at Station 151.

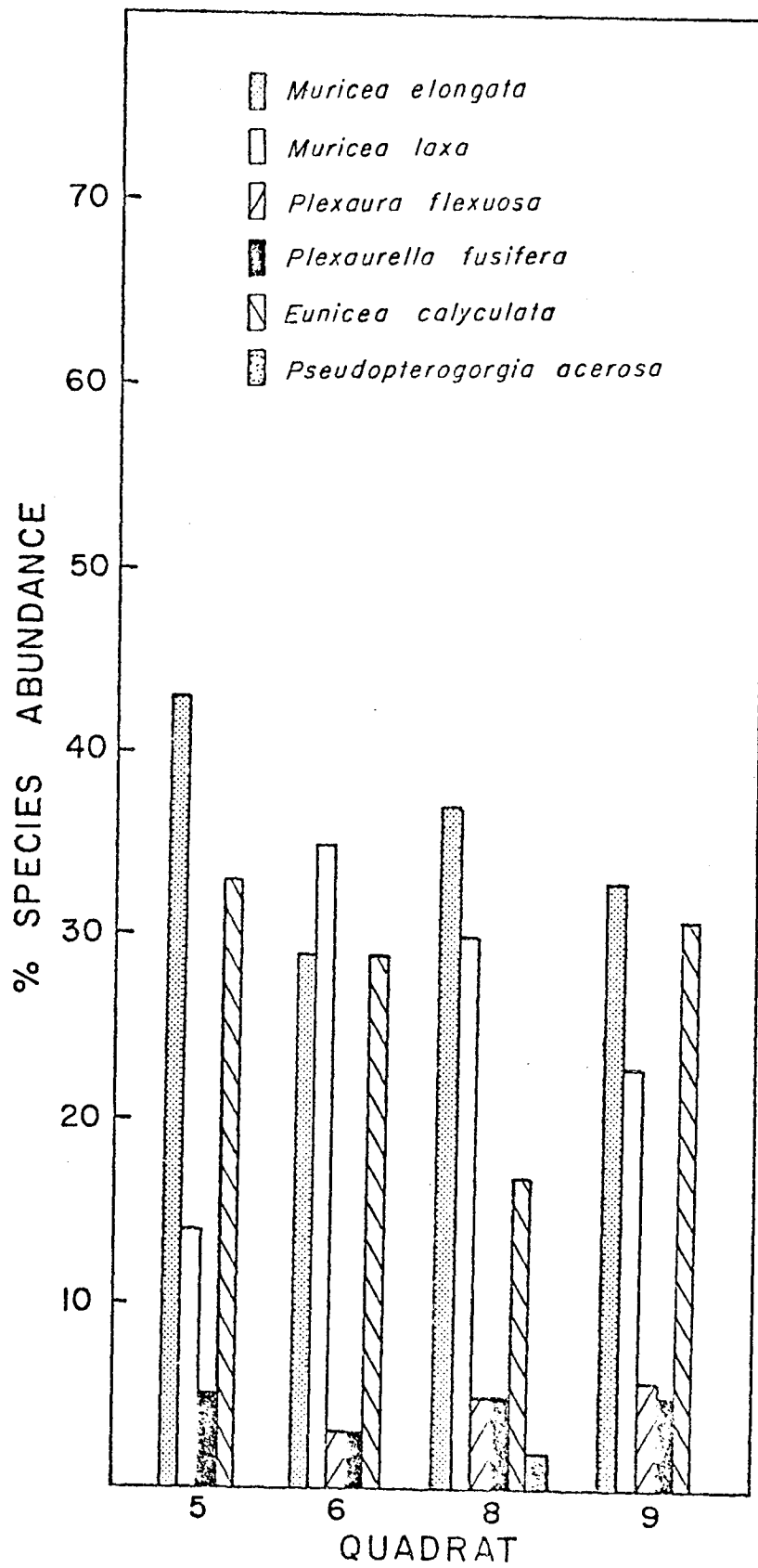

Figure 13F - Soft Coral Species Abundance, RLM 32/34 at Station 151.

Figure 14A,14C-- Hard Coral Species Diversity and Evenness for BLM 19 and 32/34 Respectively at Station 251.

He' \_\_\_\_\_ J'-----

Figure 14B, 14D - Hard Coral Number of Individuals and Number of Species/5M Quadrat for BLM 19 and 32/34 Respectively at Station 251.

Individuals/M<sup>2</sup> \_\_\_\_\_ No. Species/5M Quadrat -----

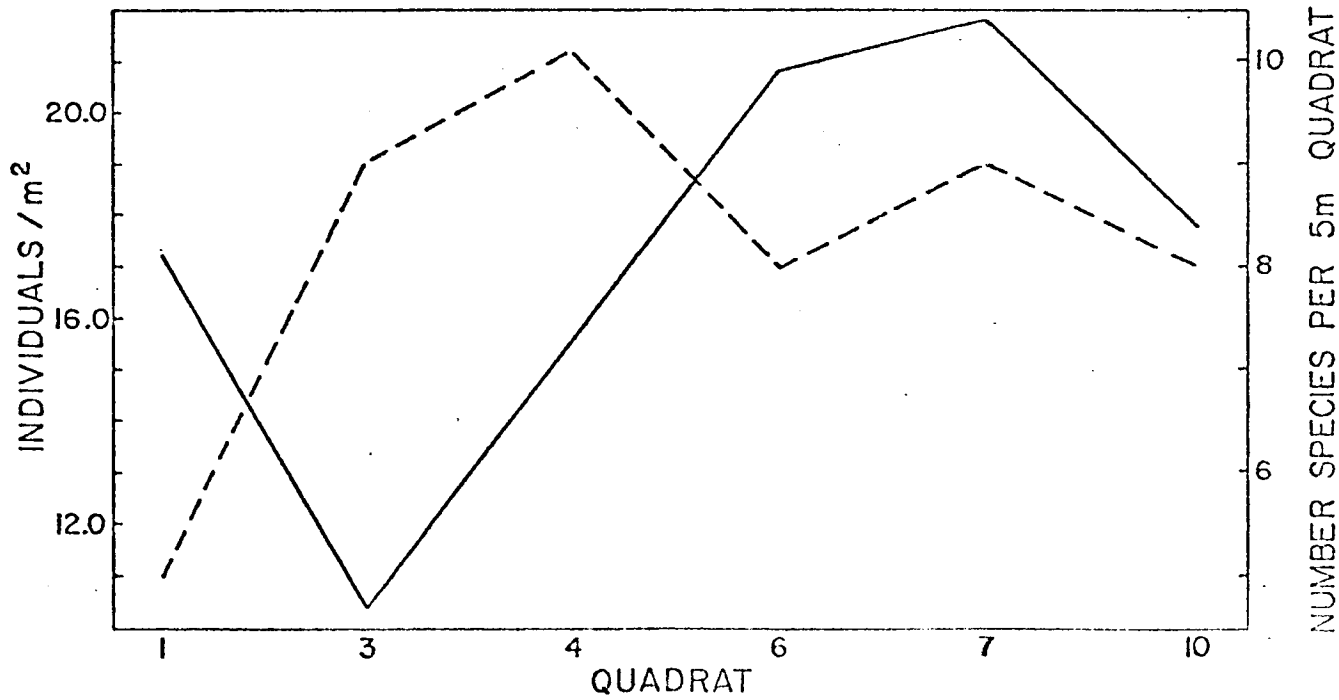
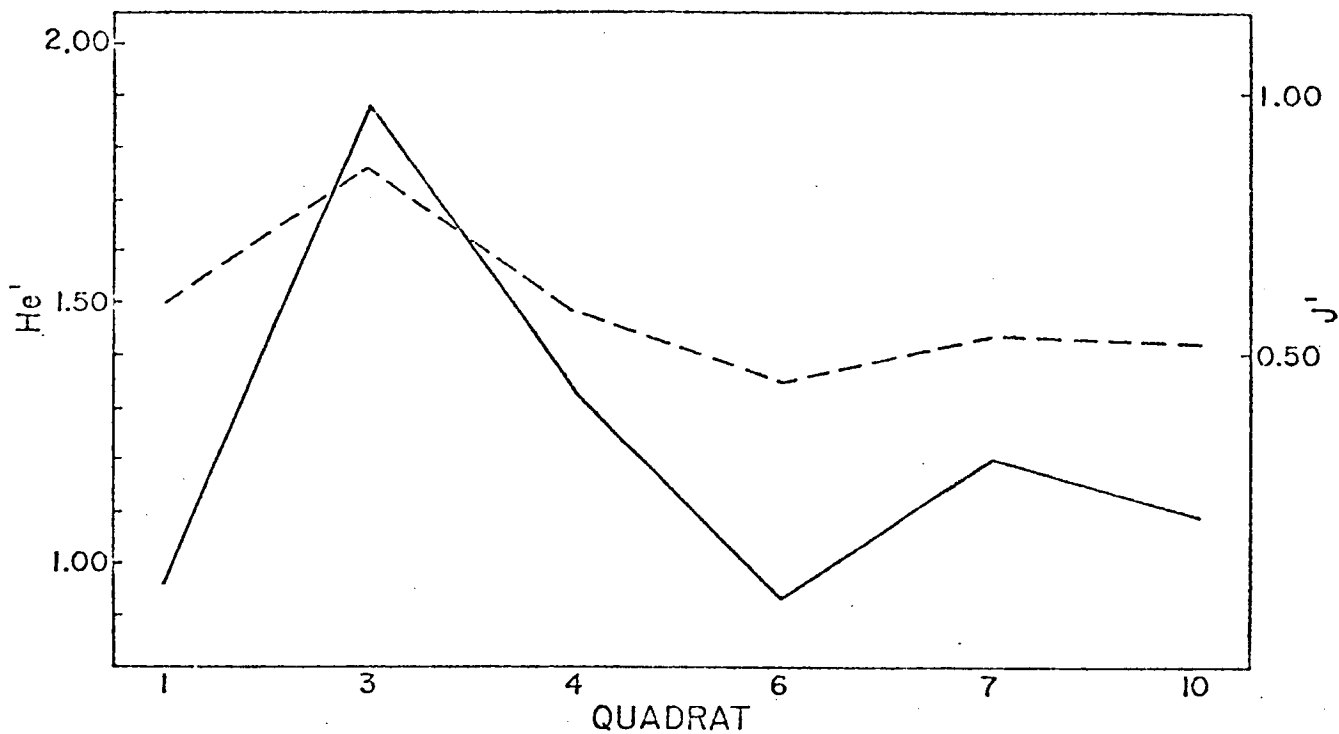

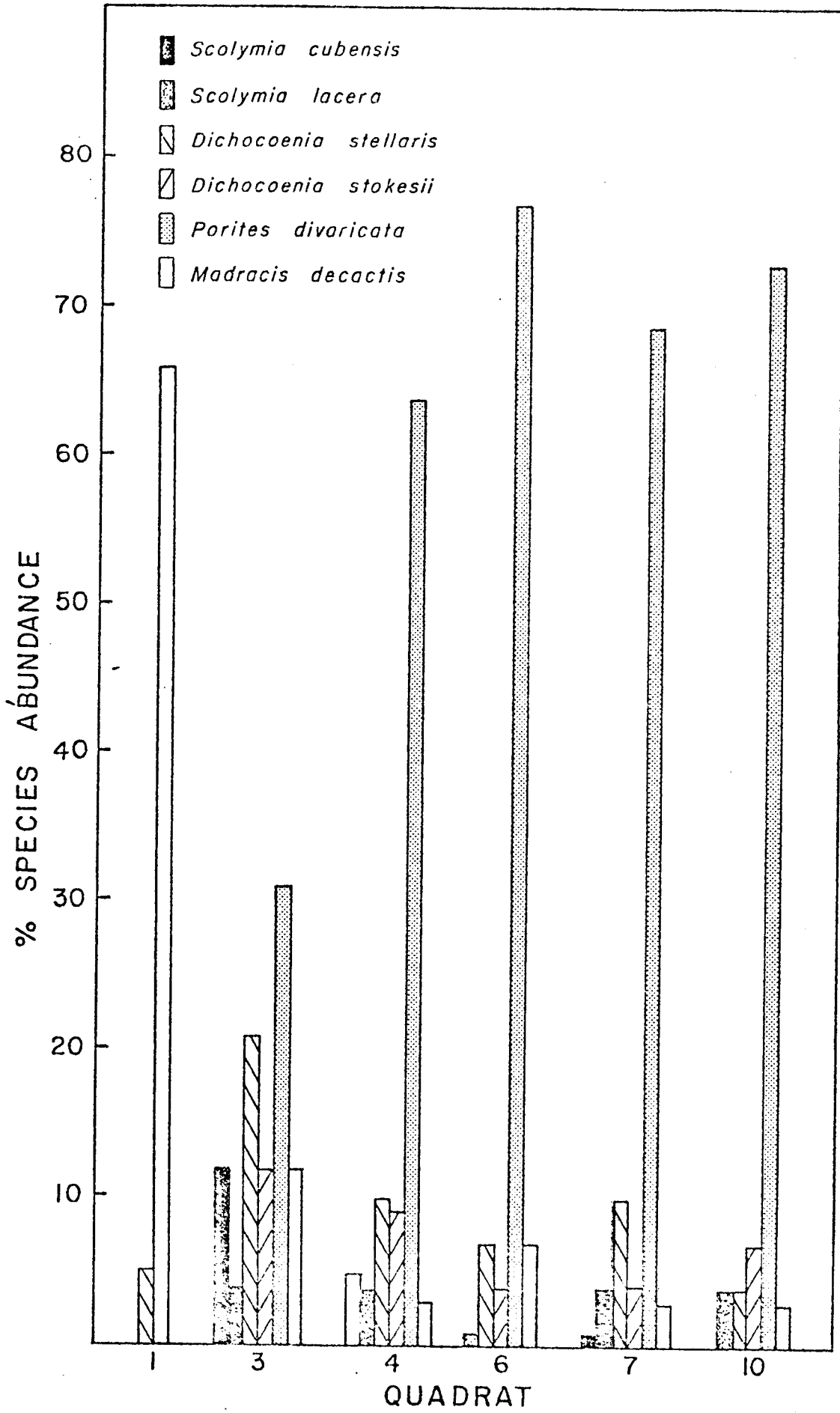

Figure 14E - Hard Coral Species Abundance, BLM 19

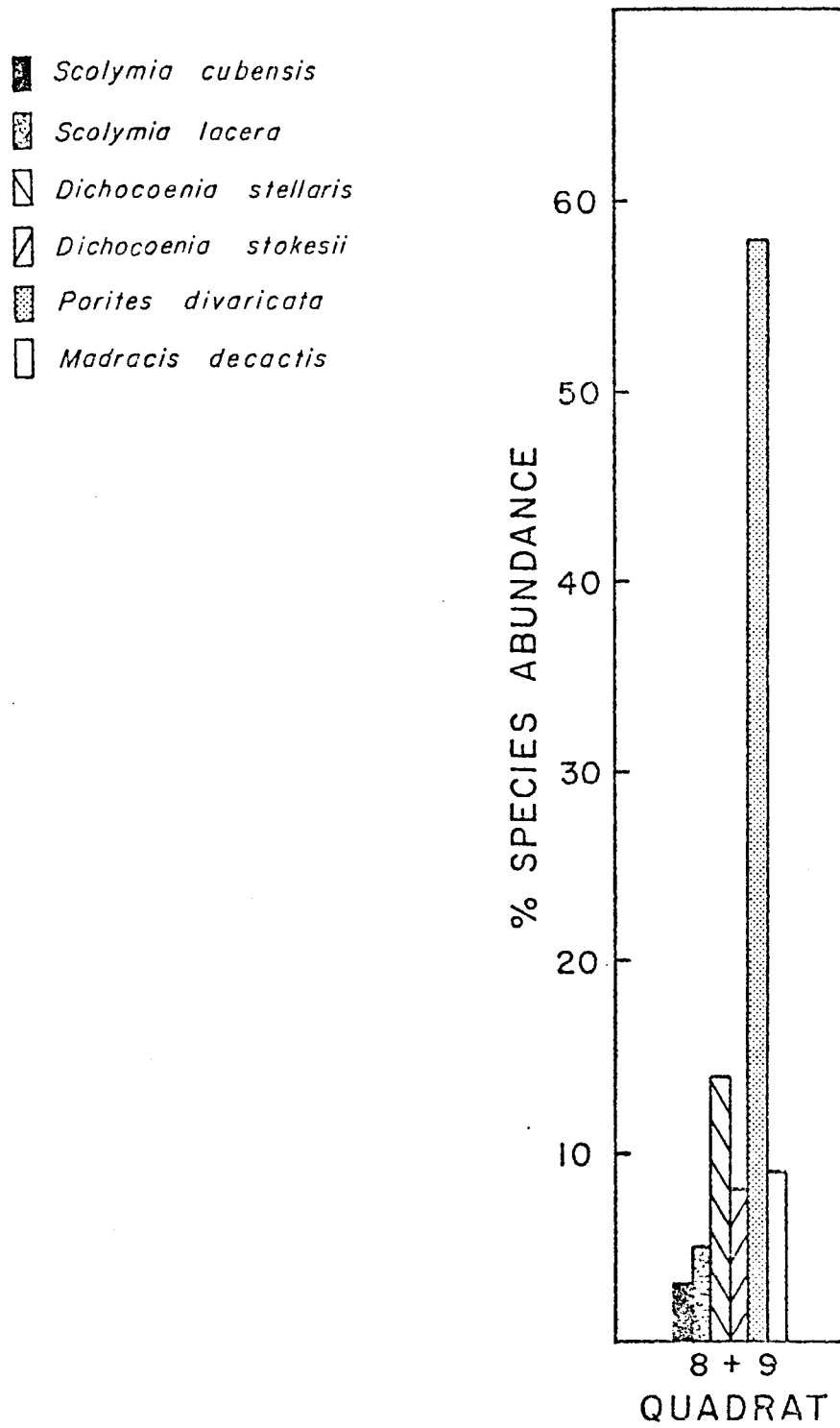

Figure 14F - Hard Coral Species, BM-34 at Station 251.

Figure 15A, 15C - Soft Coral Species Diversity and Evenness for BLM 19 and 32/34 Respectively at Station 251.

He' \_\_\_\_\_ J' -----

Figure 15B, 15D - Soft Coral Number of Individuals and Number of Species/5M Quadrat for BLM 19 and 32/34 Respectively at Station 251.

Individuals/M<sup>2</sup> \_\_\_\_\_ No. Species/5M Quadrat -----

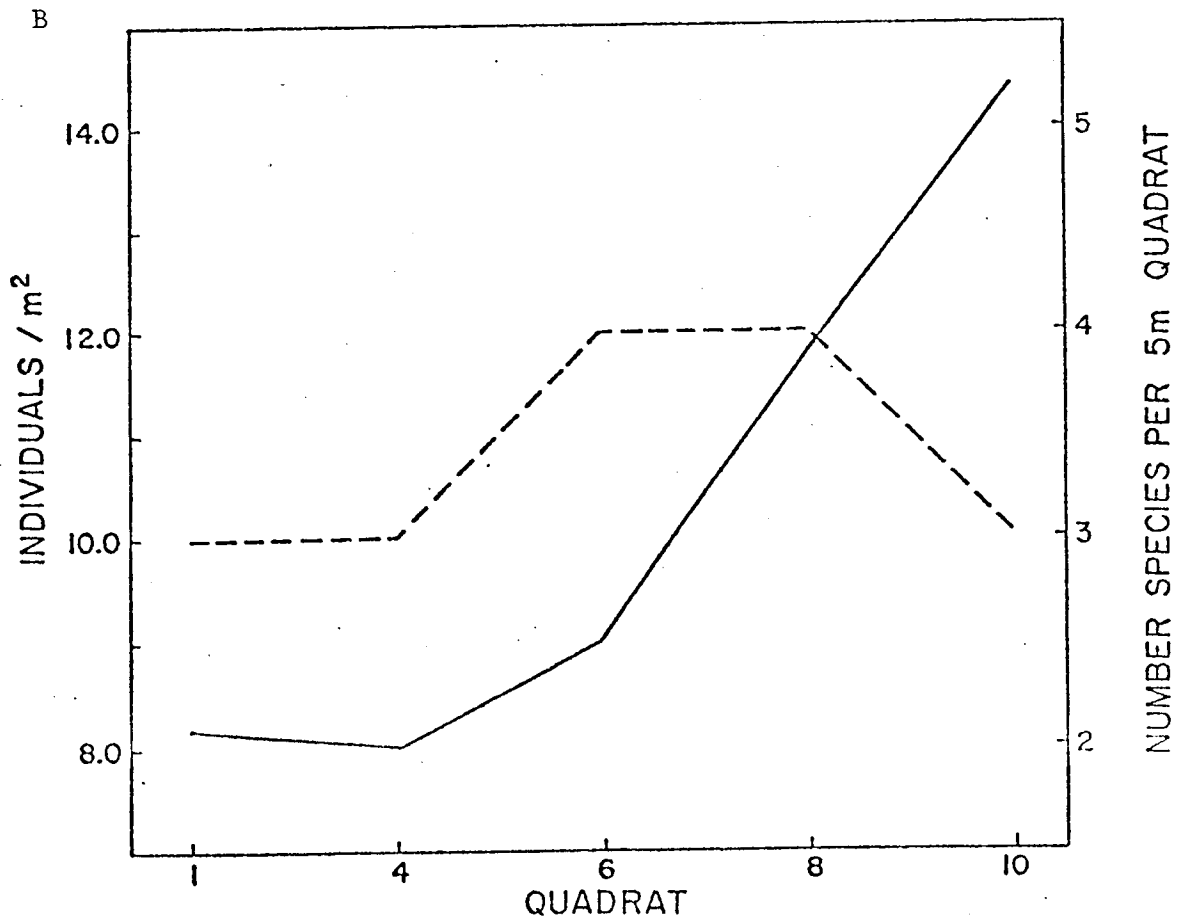
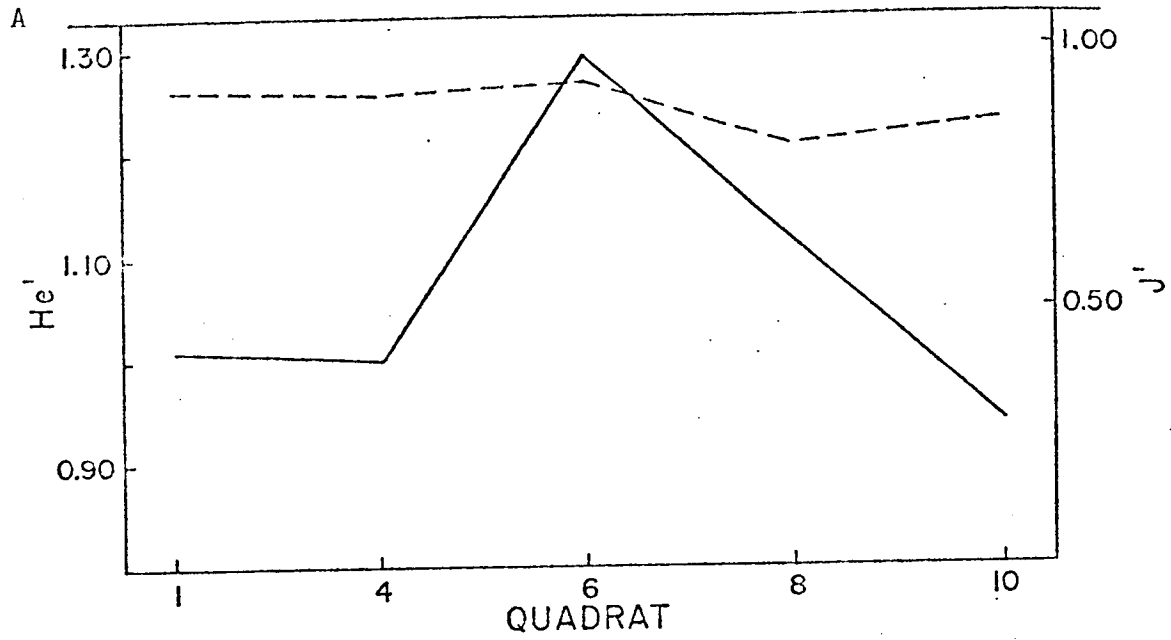



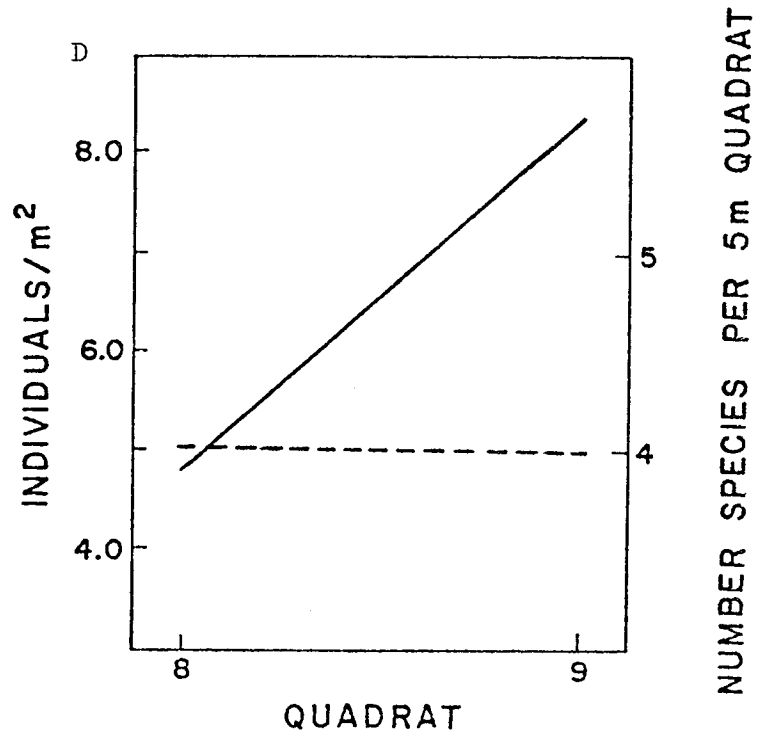
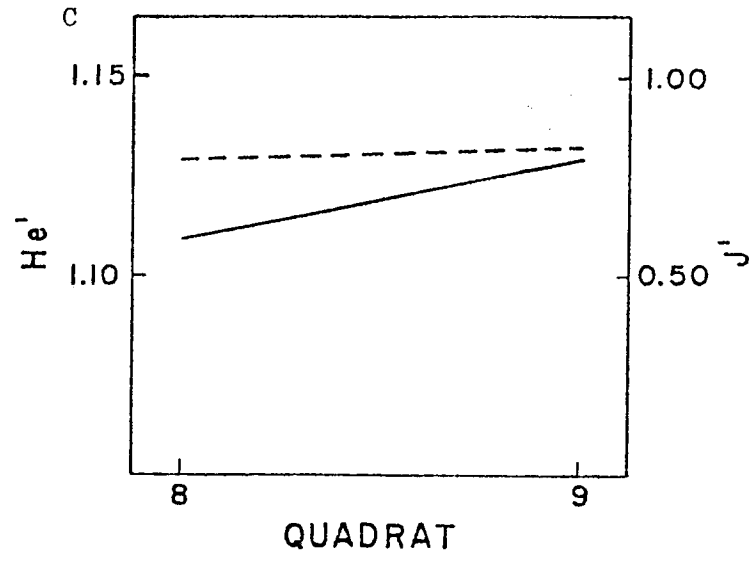

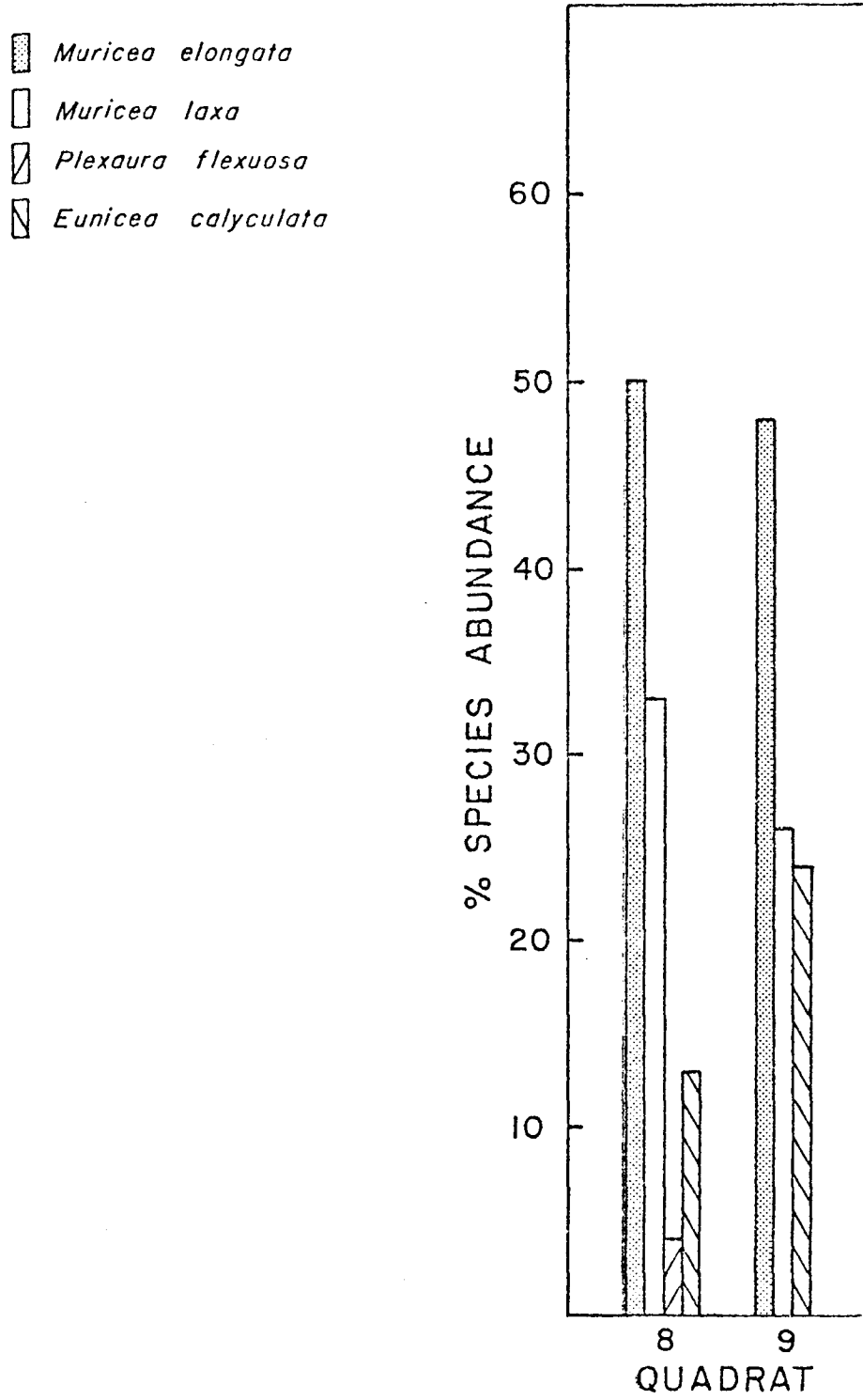

Figure 15F- Soft Coral Species Abundance, BLM 32/34 at Station 251.

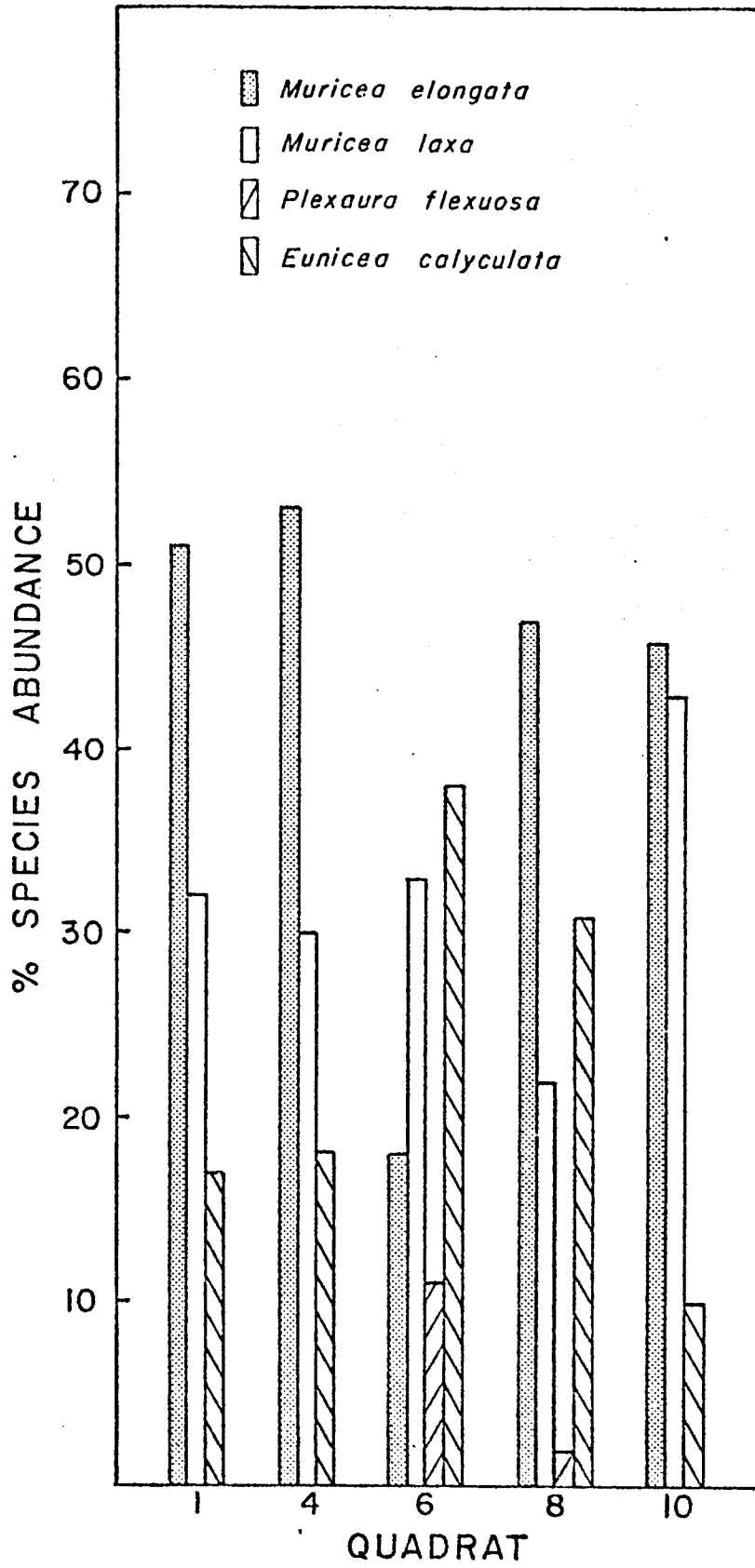

Figure 15E - Soft Coral Species Abundance, BLM 19 at Station 251.

Figure 16A,16C- Hard Coral Species Diversity and Evenness for BLM 19 and 32/34 Respectively at Station 247.

He' \_\_\_\_\_ J'-----

Figure 16B, 16D - Hard Coral Number of Individuals and Number of Species/5M Quadrat for BLM 19 and 32/34 Respectively at Station 247.

Individuals/M<sup>2</sup> \_\_\_\_\_ No. Species/5M Quadrat -----

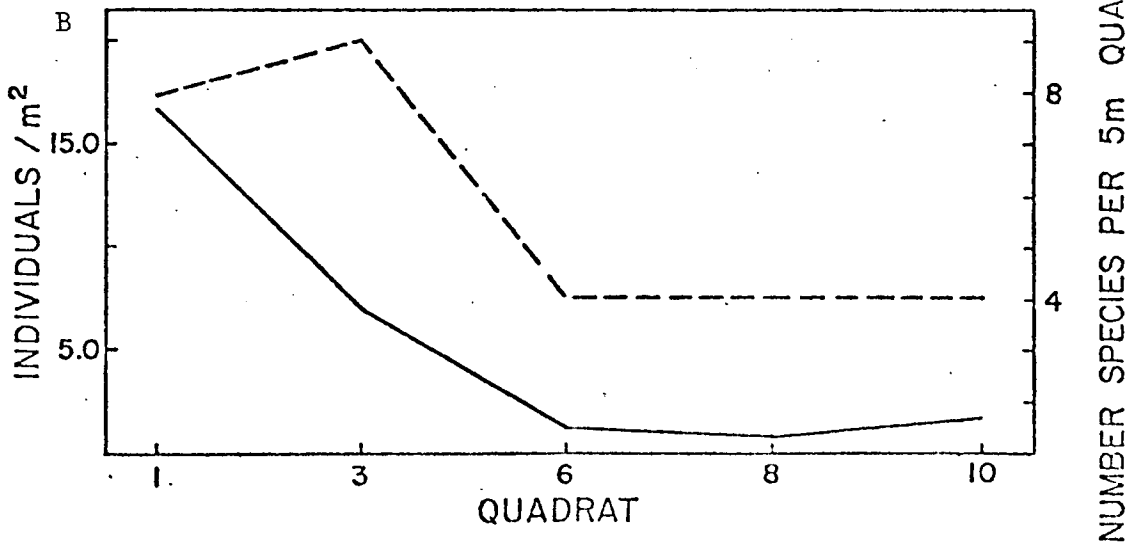
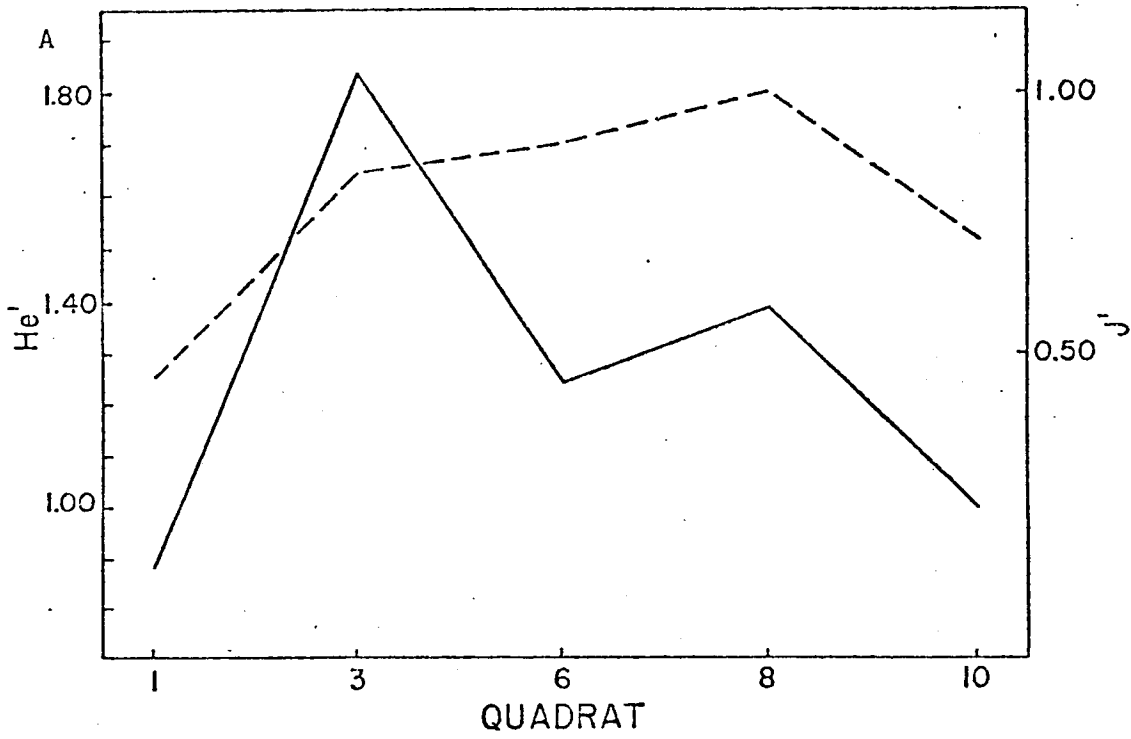

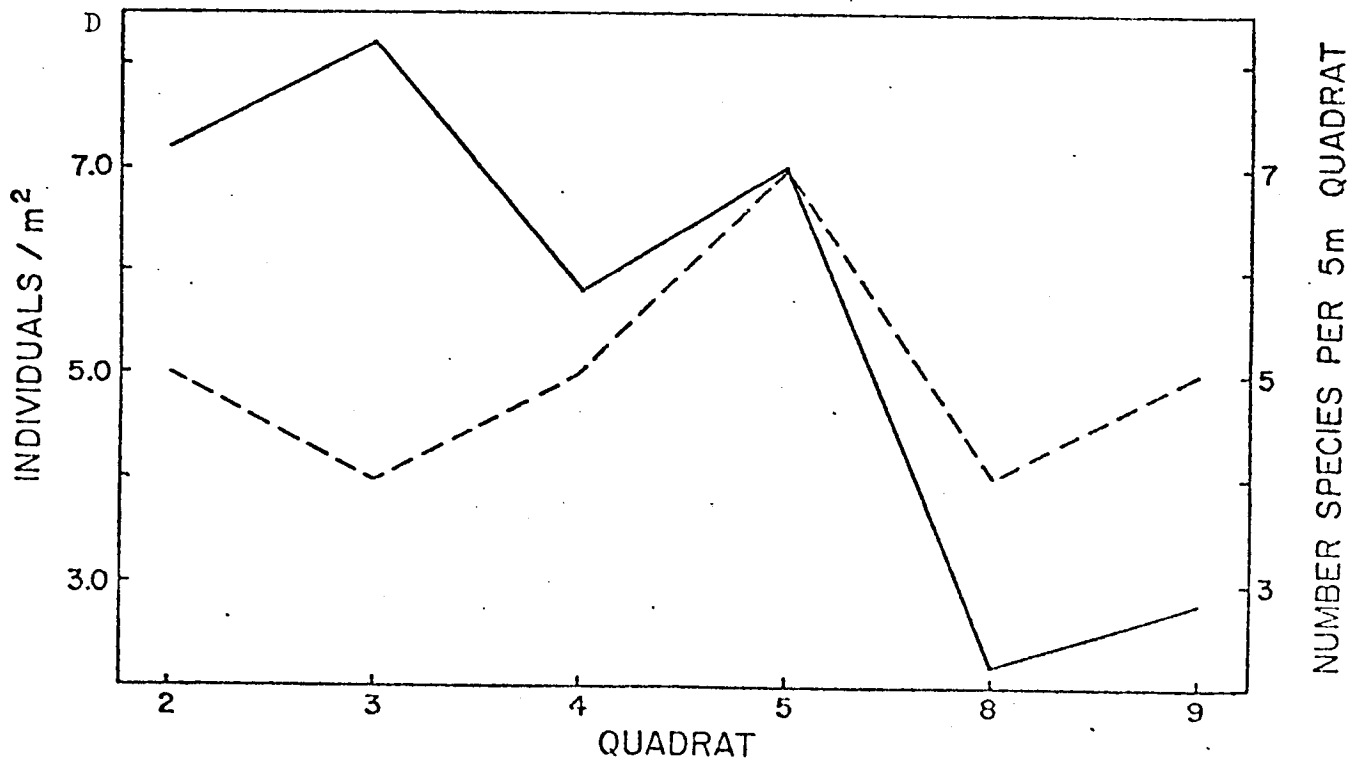
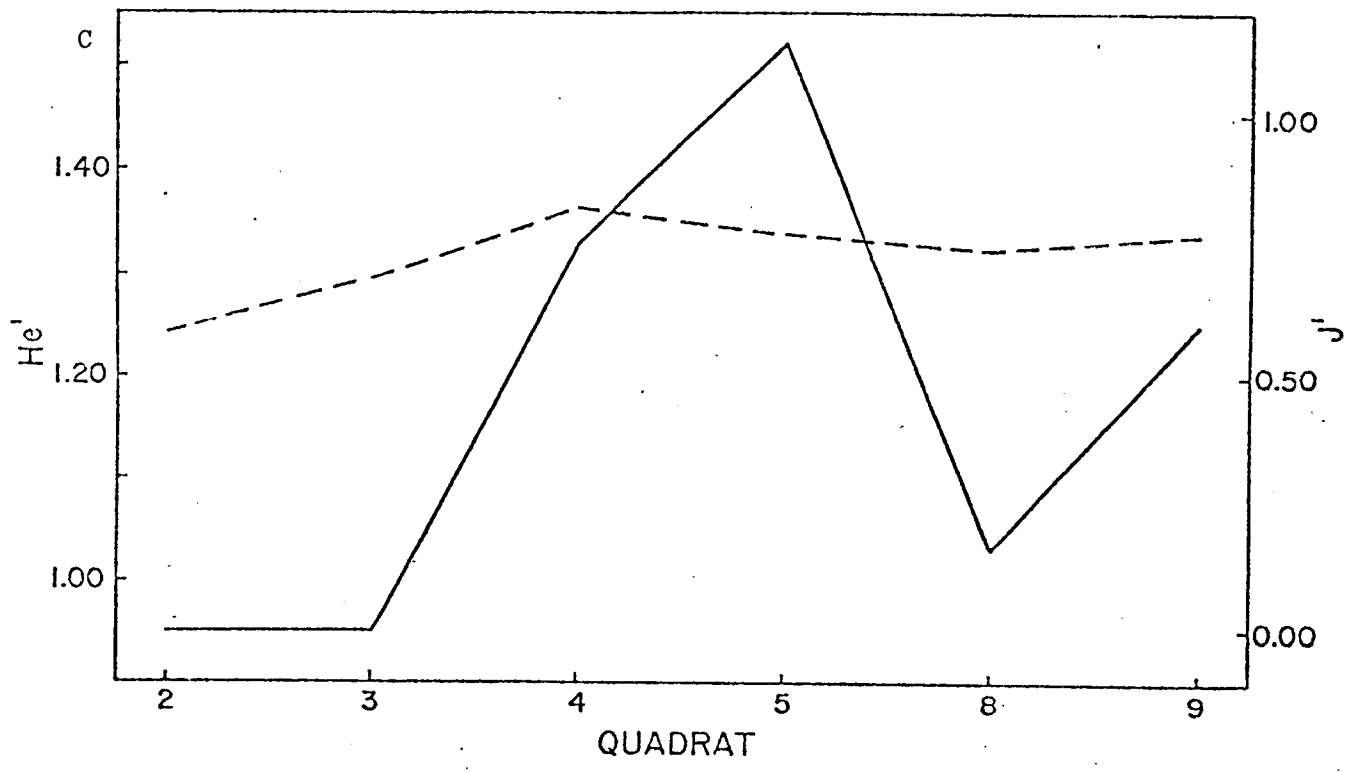

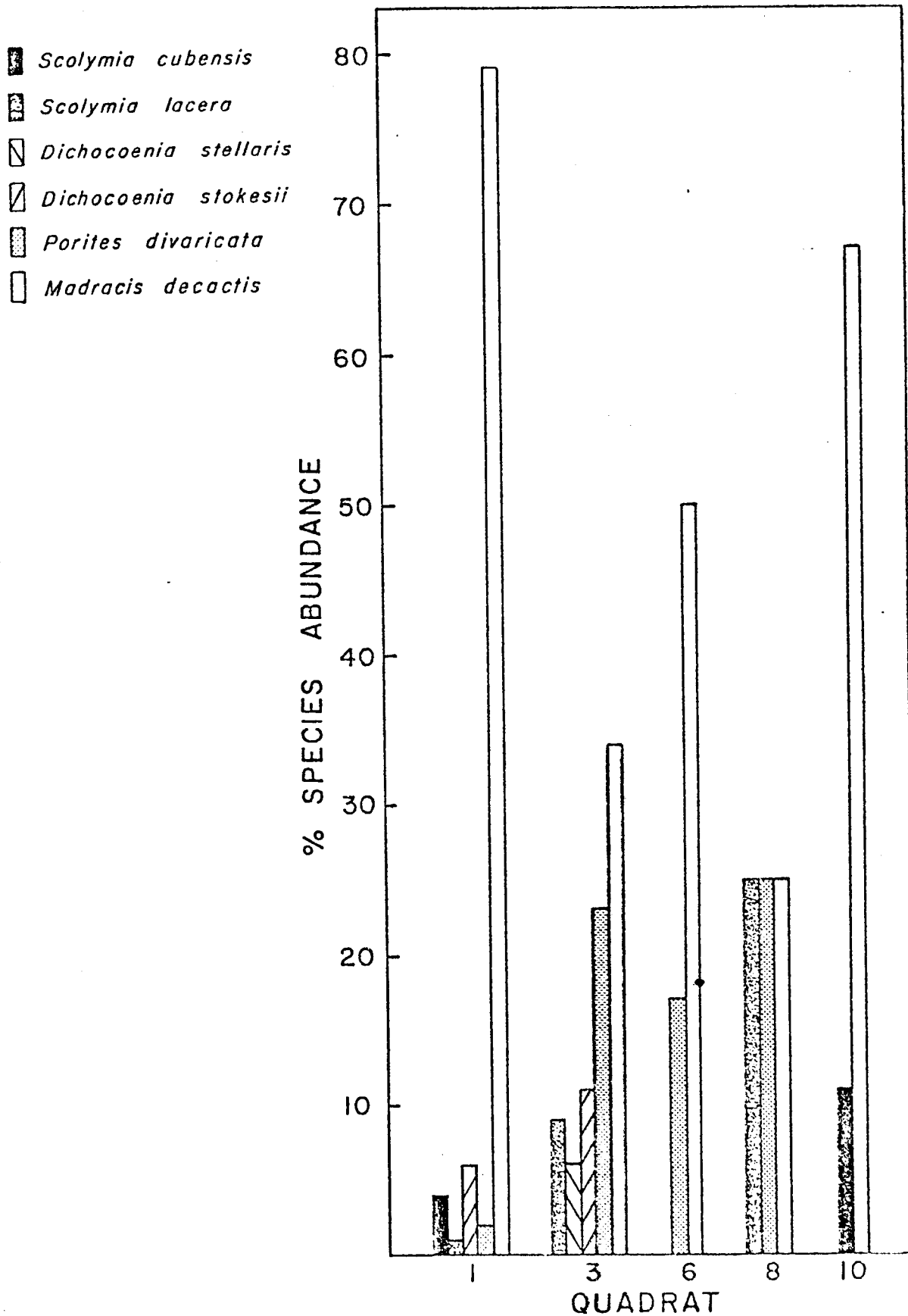

Figure 16E - Hard Coral Species Abundance, BLM 19 at Station 247.

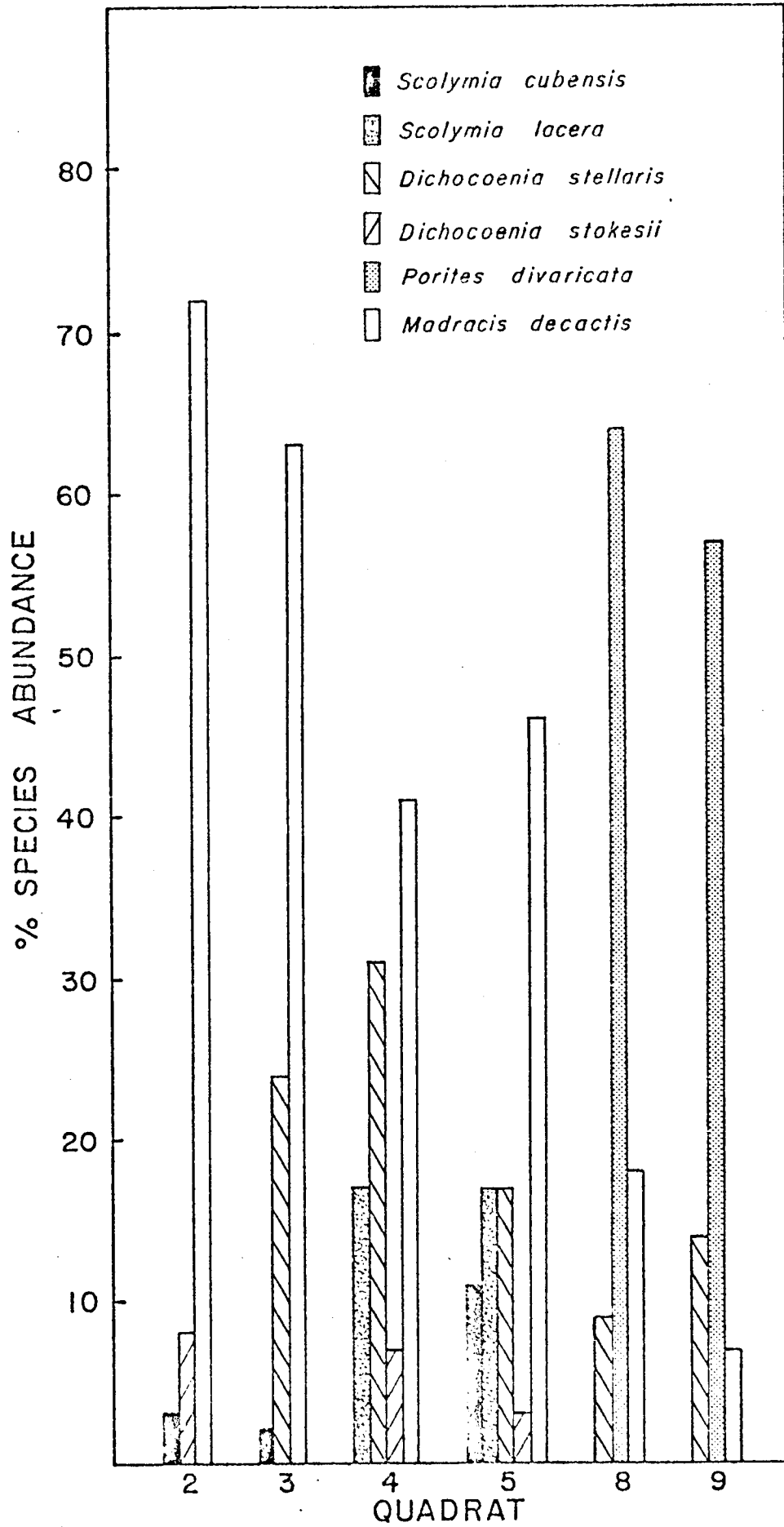

Figure 16F- Hard Coral Species Abundance, BLM 32/34

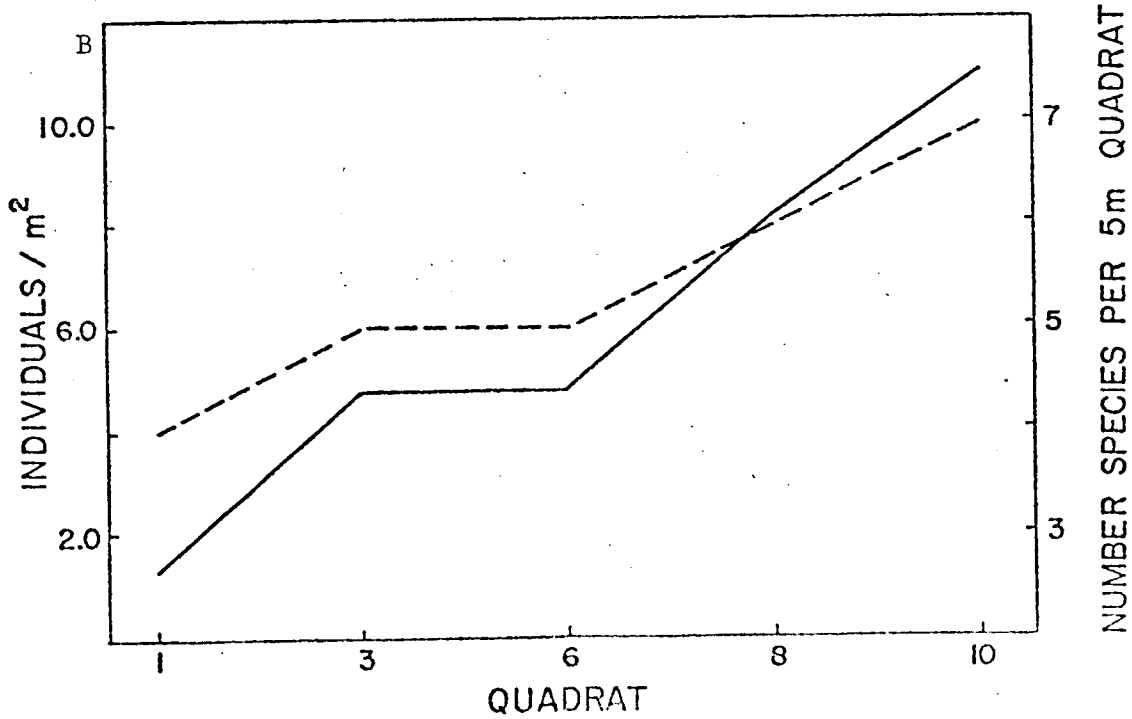
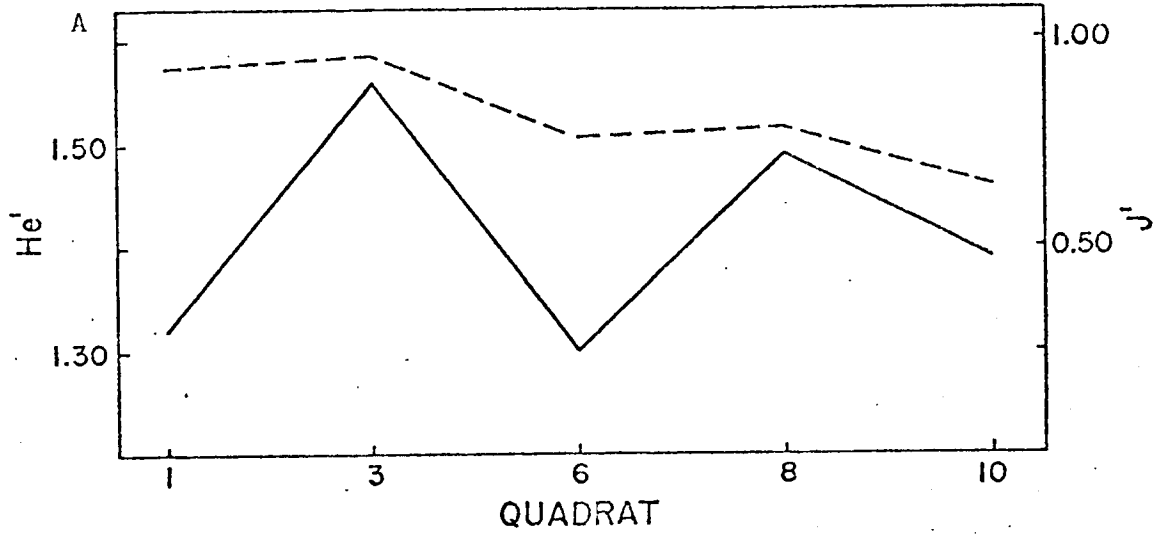

Figure 17A, 17C - Soft Coral Species Diversity and Evenness for BLM 19 and 32/34 Respectively at Station 247.

He' \_\_\_\_\_ J' -----

Figure 17B, 17D - Soft Coral Number of Individuals and Number of Species/5M Quadrat for BLM 19 and 32/34 Respectively at Station 247.

Individuals/M<sup>2</sup> \_\_\_\_\_ No. Species/5M Quadrat -----



32-247 SC

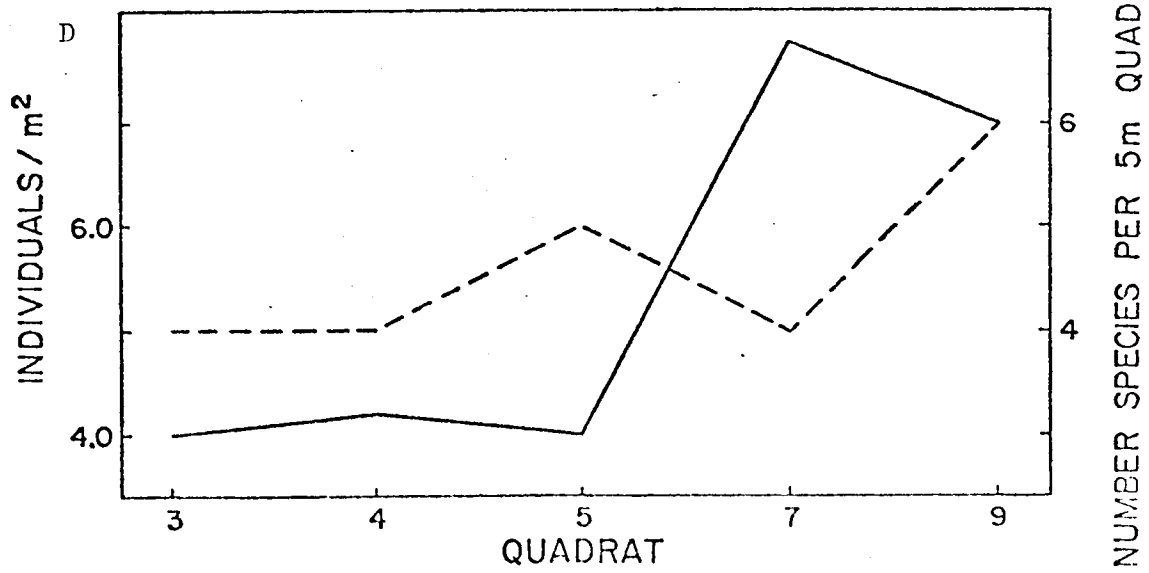
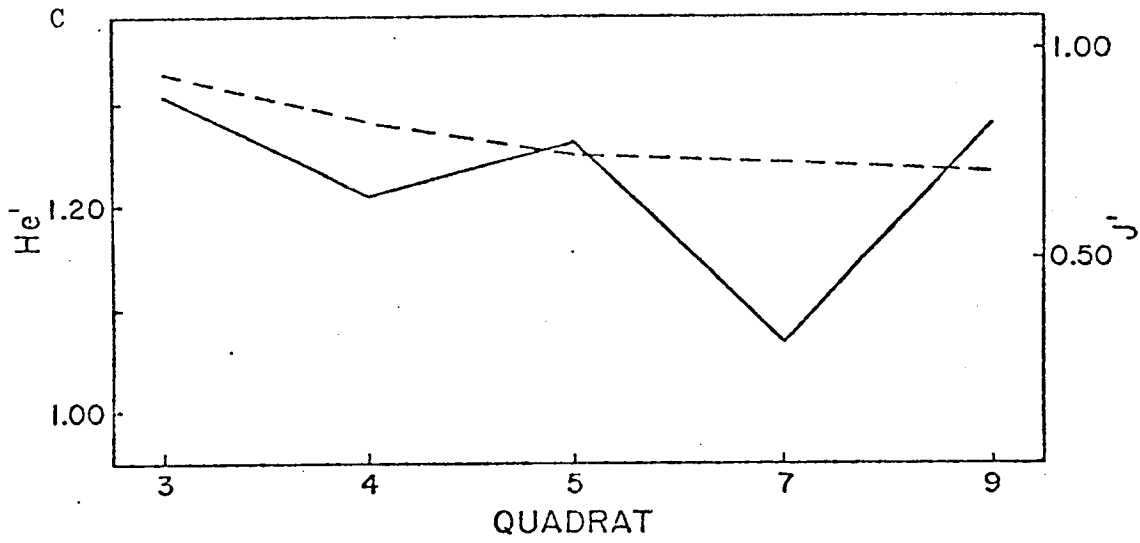

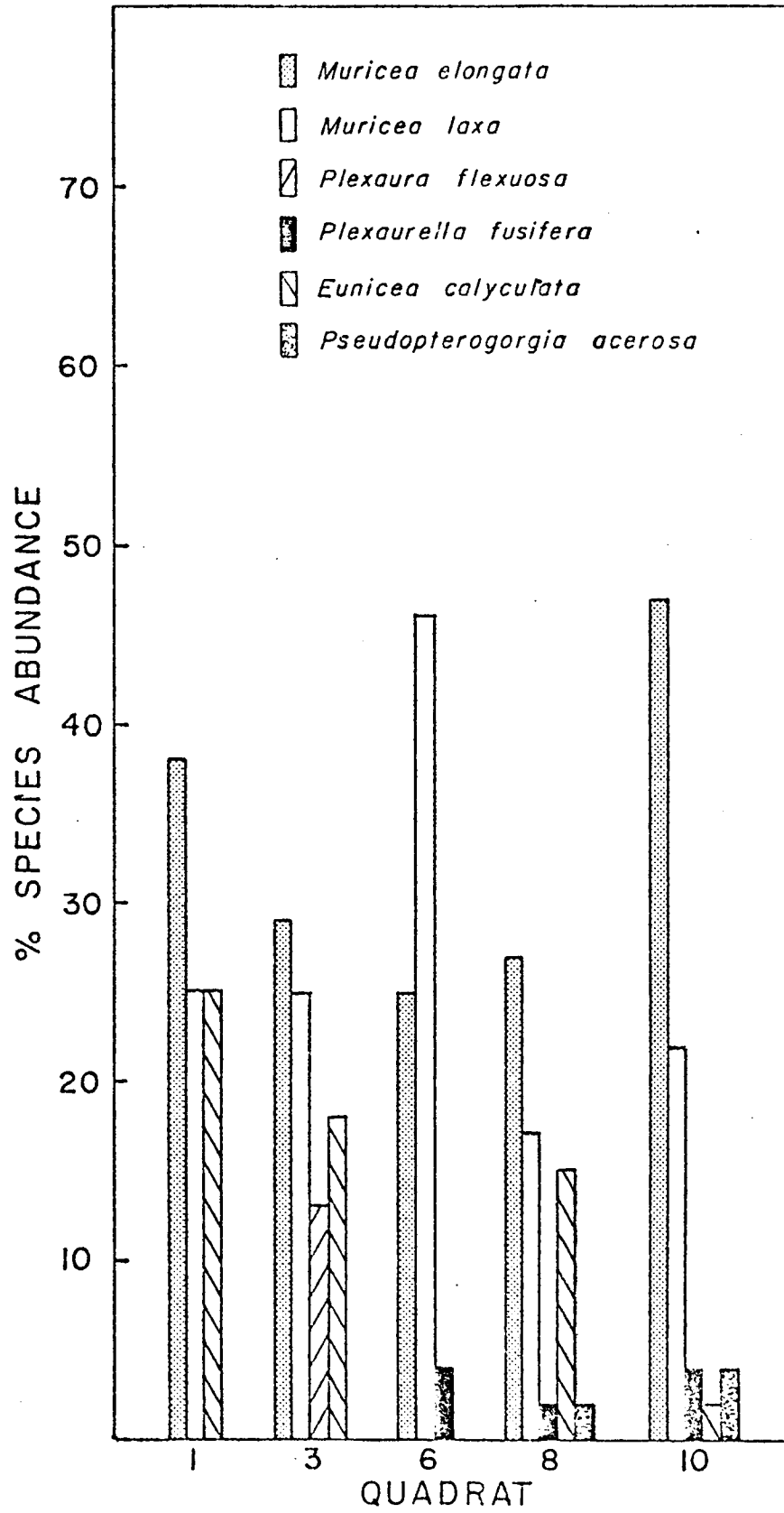

Figure 17E - Soft Coral Species Abundance, BLM 19 at Station 247.

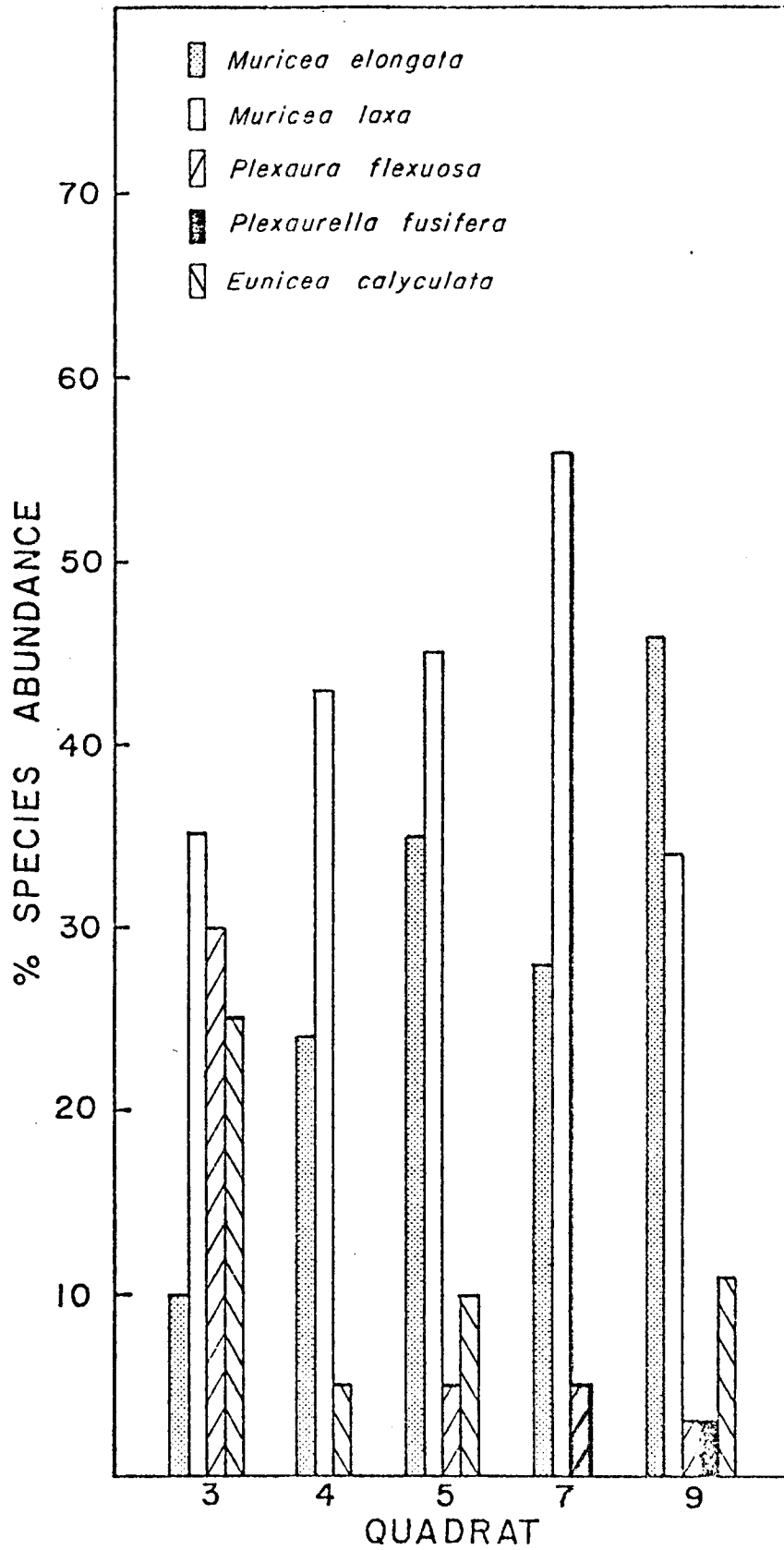

Figure 17F- Soft Coral Species Abundance, BLM 32/34 at Station 247.

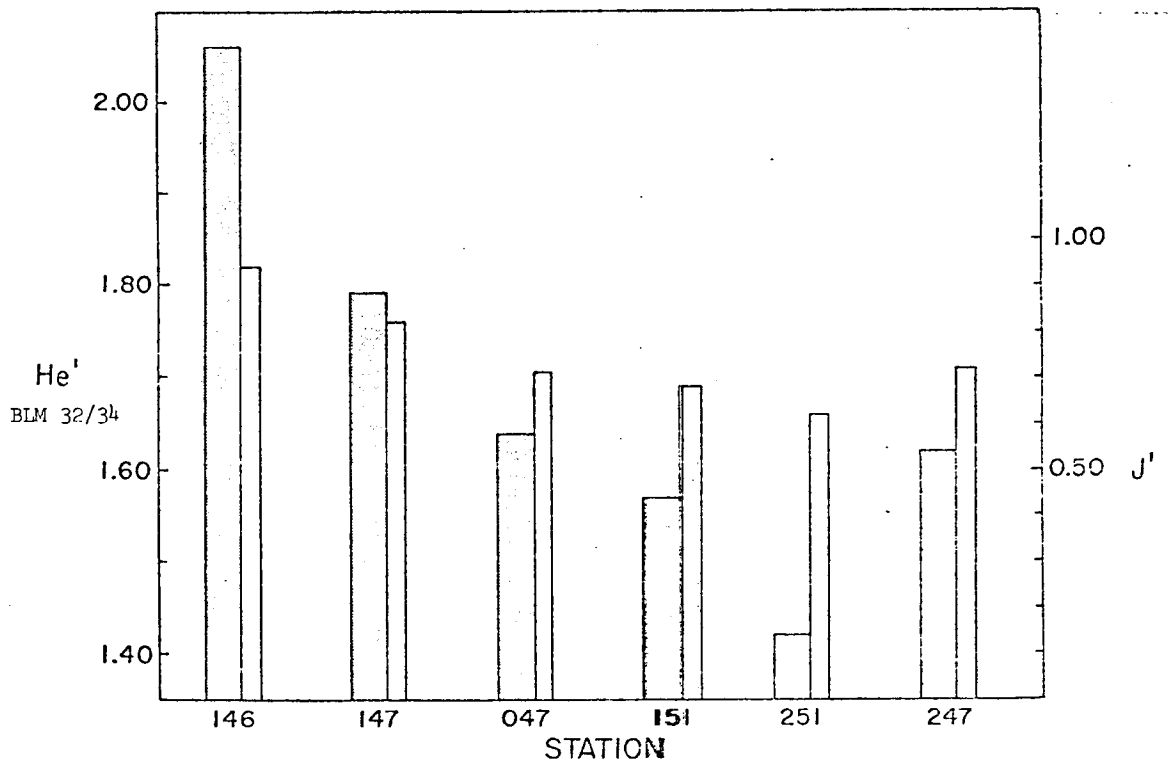
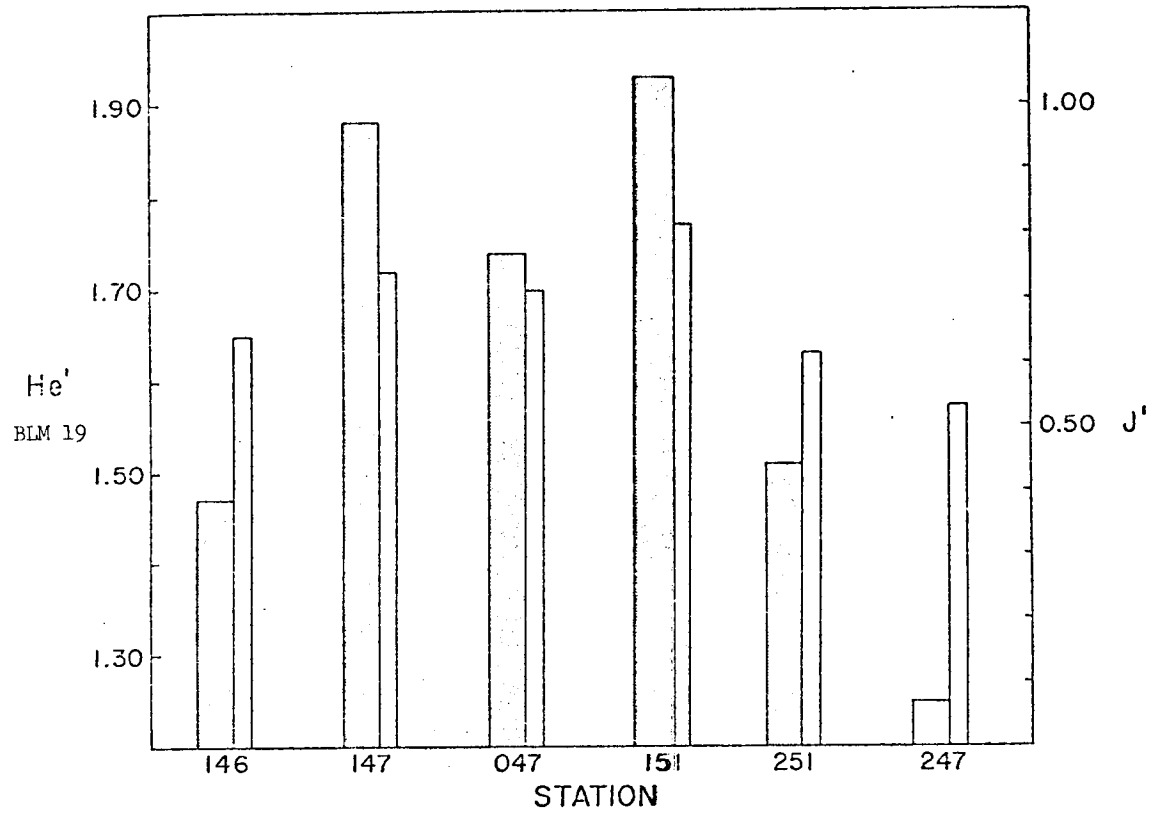

Figure 18 - Graphic Relation of Species Diversity and Evenness of Hard Corals Based on Two Transects. (BLM 19 and BLM 32/34)

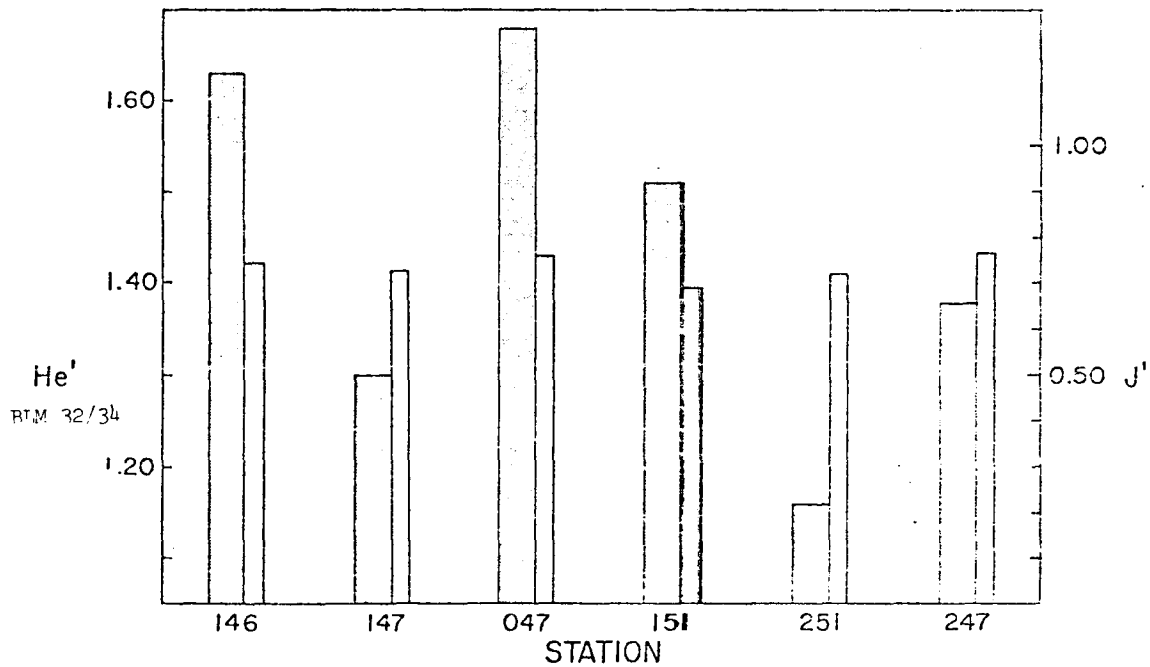
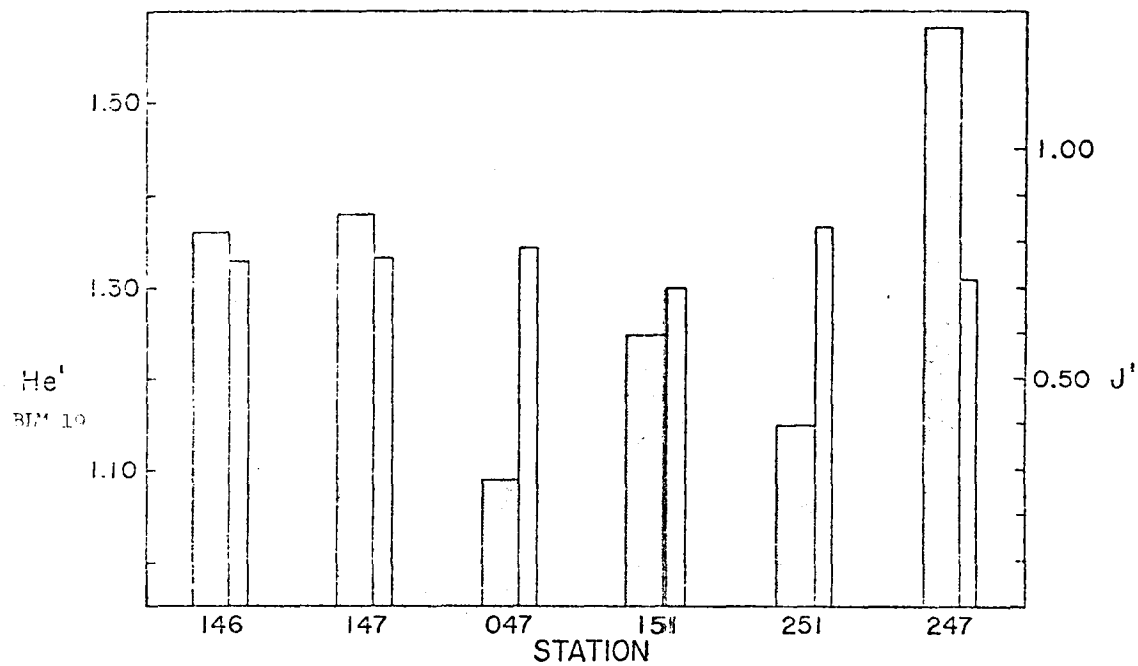

Figure 19 - Graphic Relation of Species Diversity and Evenness of Soft Corals Based on Two Transects. (BLM 19 and BLM 32/34)

DISCUSSION

A. The Dredging/Trawling Program

1. Overview

The results of the dredge/trawl program are portrayed by group in Figures 1 through 5. These trellis diagrams are constructed in such a way as to group all stations in-seriatum by depth, e.g. IA-VIA followed by IB-VIB, etc. This, albeit artificial, clustering analysis presents the stations in a grouping that most readily allows us to see inter-relations between (a) all stations at the same depth, (b) all stations of the same transect but different depth, and (c) all stations of differing transects.

Example (a)

Question: What is relationship between Station IA and IVA in Figure 1.

Procedure: Locate Station IA at the side of the page and read across the column to VA. The reader finds a value of "36"; in reciprocal fashion he sees a square which is 50% solid shaded.

Answer: This tells the reader that there is a 36% Bray-Curtis similarity between Stations IA and VA.

Example (b)

Question: What is the relationship between Station IA and IC in Figure 1.

Procedure: Locate Station IA at the side of the page and read across the column to IC. The reader finds a value of "18"; in reciprocal fashion he sees a square which has only a diagonal bar.

Answer: This tells the reader that there is an 18% Bray-Curtis similarity between Stations IA and IC.



Example (c)

Question: What is the relationship between Station IIA and VC in Figure 1.

Procedure: Locate Station IIA at the side of the page and read across the column to VC. The reader finds a value of "0"; in reciprocal fashion he sees an empty square.

Answer: This tells the reader that there is no Bray-Curtis similarity between Stations IIA and VC.

For the purpose of this study, this investigator proposes that greater than 50% similarity may be "highly significant" and greater than 40 but less than 50% is "highly indicative".

2. Mollusca

Figure 1 displays the Bray-Curtis similarity percentages and mosaic for the Mollusca. From the Mosaic we can see a pattern which is "highly indicative" of association with depth. That is, A stations have greater similarity to each other than they do to their corresponding B or C stations. As for the relative strength of their associations, C stations (183 m) show stronger affinities among themselves than do A stations (37 m) or B stations (91 m) in that order.

Between individual stations, "highly significant" similarities are found between IIC and VC and between IIC and IVC. Highly indicative similarity is found between II and IIC; I and IVC; II and IVC; III and VC; IV and VC; and V and VIC. Overall this pattern suggests a cosmopolitan and substrate independent distribution with depth.

3. Decapod Crustaceans

The inter-relationships of decapod crustacean similarity are portrayed in Figure 2. The mosaic again shows both highly indicative and highly significant associations with depth. As in the mollusca A, B, and C stations are

showing strong inter-relationships among themselves. As for relative strength, clearly C stations (183 m) are very strong followed by A and B stations in that order.

Among A stations, highly indicative similarity is found between: I and IIA, I and IVA, I and VA, II and IIIA, II and IVA, II and VA, III and IVA, and III and VA. A highly significant association is found between IV and VA.

Among B stations we see some very interesting departures from the observed patterns. For example, we might not have expected to see similarities between VIA and VB or IV and VA with IIB. On the other hand, the high values for IB, IIB, IIIB, and VB with VIB are to be expected as are the relationships of IIB with III-VIB. But again, how do we explain VIB and IC?

Concluding our review of station similarities with a synopsis of the C stations from 183 m we return to a more uniform and predicted pattern e.g., I and IIC, II with III and IVC, III with IVC, V and VIC, etc.

A review of substrates from the lithologic map does not really help us because substrates are clearly changing but percentage similarities are not. We can conclude that the decapod crustacea are probably showing a cosmopolitan and substrate independent distribution very similar to molluscs, but they have an added advantage of mobility that allows them greater latitude in their movement along a depth gradient.

#### 4. Echinoderms

These animals show a remarkable depth limited pattern as seen in Figure 3. Notice that they have strong affinities at A stations, reasonably strong similarities at B stations, and no similarity at all with C stations. This is a marked departure from Molluscs and Decapod Crustacea both of which

showed strong affinities at C stations.

We note a large degree of overlap for IA through VA and between IIA and VIA along with IV and VA. Among the B stations, I and II are highly significant in similarity to IIIB and I, II and V are highly significant in similarity to VIB. As noted earlier, C stations are conspicuous by their absence.

We might very well point out again via the A station data that substrate in apparently not a major factor in their distribution. In contrast to molluscs and decapods, however, they are far less mobile and they suggest this through their apparent tight clustering.

#### 5. Polychaetes

The polychaete data (Figure 4) is not totally coherent but, to be candid, it is more a function of collection and identification than real-time disjunctiveness. Polychaetes are not truly epifaunal, and our ability to capture them consistently in the Capetown Dredge was inconsistent. As for identification in many cases the best we could do was family or perhaps genus sp. A, B, etc. With these stipulations and reservations we do note an affinity pattern for IA and III-VA, and between III and VA. The similarity between IIA and IIIB is very high (70%) and the affinity between II and IIIC is likewise strong (67%). Since many of these data overlap the box core data, a truly more proper interpretation should be gained therein.

#### 6. Octocorals and Scleractinia

Data for these animals similarity is presented in Figure 5 and as the title implies we have lumped two groups in order to build a larger data base for co-occurrence.

Interestingly enough we see some fairly strong patterns among B stations and among C stations. However, bearing in mind the fact that these animals really should be substrate related, we came away disappointed when we try and make a lithological association. There consistently does not seem to be one.

## B. Faunal Assemblages

### 1. Overview

Collard and D'Asaro (1973) have summarized the knowledge of benthic invertebrates in the eastern Gulf of Mexico and in doing so they propose three "synthetic communities" (communities or faunal assemblages synthesized from the existing literature). These were:

- a. Shallow shelf communities: Carolinian affinities
- b. Deep shelf communities: West Indian affinities
- c. Slope communities:

Lyons and Collard (1974) have taken a less "synthetic" approach and divided the area under discussion into (a) West Florida Shelf and (b) Mississippi-Alabama Shelf. The areas of most concern to us under (a) above are:

1. Middle Shelf I (30-60 m)
2. Middle Shelf II (60-140 m)
3. Deep Shelf (140-200 m)

and under (b) the authors conclude "Species from these calcareous communities are essentially the same as from others further south, but diversity may be reduced".

### 2. Benthic Communities

The collections at hand do not fit well with the synthetic communities of Collard and D'Asaro (1973), however Lyons and Collard (1974) have taken

an approach which has some faunistic support from this study. It might be proposed that the Middle Shelf I (30-60 m) be characterized by the fauna listed in Figure 20.

Figure 20

Suggested Middle Shelf I Epifaunal Assemblage  
(30-60 m)

Molluscs

Pecten raveneli  
Argopecten gibbus

Decapod Crustacea

Sicyonia brevirostris  
Stenorynchus seticornis  
Portunus spinicarpus  
Solenocera atlantidis  
Callapa flammea  
Porcellana sayane  
Scyllarus chacei

Stomatopod Crustacea

Gonodactylus cf. bredini

Octocorals

Bebryce parastellata

Echinoderms

Lytechinus variegatus  
Arbacia punctulata  
Luidia clathrata  
Luidia alternata  
Astropecten duplicatus

It seems apparent that the species portrayed in Figure 6 have affinities with the Carolinian Province and because of this they are cosmopolitan in the MAFLA 30-60 m zone.

Although Lyons and Collard op. cit. alluded to the existence of "tropical species" in the Middle Shelf they did not attempt to amplify where and how such species might occur in the Northeastern Gulf. On the other hand, Hopkins (1974), Smith and Ogren (1974) and Cheney and Dyer (1974), have clearly

established the tropical nature of the Florida Middle Ground. It is further proposed that the Middle Shelf I (30-60 m) does have areas of high relief with a characteristic fauna. One such area, of course, is the North Middle Grounds which can be characterized by the fauna listed in Figure 21.

Figure 21

North Middle Ground High Relief Epifaunal Assemblage

Molluscs

Spondylus americana  
Cerithium litteratum  
Pteria colymbus

Decapod Crustacea

Stenorynchus seticornis  
Synalpheus townsendi  
Mithrax acuticornis

Echinoderms

Ophiothrix suenoni  
Diadema antillarum  
Coscinasterios tenuispina

Octocorallia

Muricea laxa  
Muricea elongata  
Muricea calyculata

Porifera

Pseudoceratina crassa  
Aegeles dispar  
Cinachyra sp.

Polychaetes

Eunice rubra  
Ceratonereis mirabilis  
Spirobranchus giganteus

Hydrozoa

Millepora alcicornis

Scleractinia

Madracis decactis  
Porites divaricata  
Dichocoenia stellaris

As indicated by the stony hydrozoan Millepora and the scleractinian hermatypic corals, this fauna is distinctly of a Western Indian origin and

maintains a tropical affinity even though surrounded by and impinged upon by temperate species.

The Middle Shelf II (60-140 m) fauna is sharply reduced in numbers overall but shows some continuity with that by Collard and D'Asaro (op. cit.) for this area ("Deep Shelf Community") but not to the extent they suggested. A proposed cosmopolitan distribution for this group is found in Figure 22.

Figure 22

Suggested Middle Shelf II Epifaunal Assemblage  
(60-140 m)

Molluscs

Barbatia domingensis  
Lopha frons

Decapod Crustacea

Synalpheus townsendi  
Hymenopenaeus tropicalis  
Iliacantha subglobosa

Octocorals

Bebryce parastellata

Echinoderms

Astroporpa annulata  
Stylocidaris affinis  
Clypeaster raveneli

The last faunal assemblage reflects the further reduction in species which we might expect according to Lyons and Collard (op. cit.) as determined from previous workers. The "Deep Shelf" is suggested to contain the species assemblage found in Figure 23.

Figure 23

Suggested Deep Shelf Epifaunal Assemblage

Molluscs

Murex beauii  
Tugurium caribeum

Decapod Crustacea

Parapenaeus longirostris  
Pyromaia arachna  
Myropsis quinquespinosa  
Palicus obesa  
Dardanus insignis  
Goneplax hirsuta

With regard to Figures 20, 21 and 23, it must be realized that these are tentative assemblages based on one year's effort, and the effort itself has some inconsistencies in the "catch data" that are not totally inexplicable. It is proposed that the listed groups will not only hold up under additional scrutiny, but additional efforts will in fact fill in gaps and thus enlarge our data base for faunal groups.

C. The Florida Middle Ground - Diving

1. Overview

Figure 24 displays the generally known distribution of hermatypic coral communities in the Gulf of Mexico. The Florida Middle Ground is the most northern hermatypic coral community in the Gulf of Mexico (Hopkins 1974). Figure 25 shows the location of diving stations in the study area while Figure 26 generally contrasts the faunal-floral/geological makeup at the two



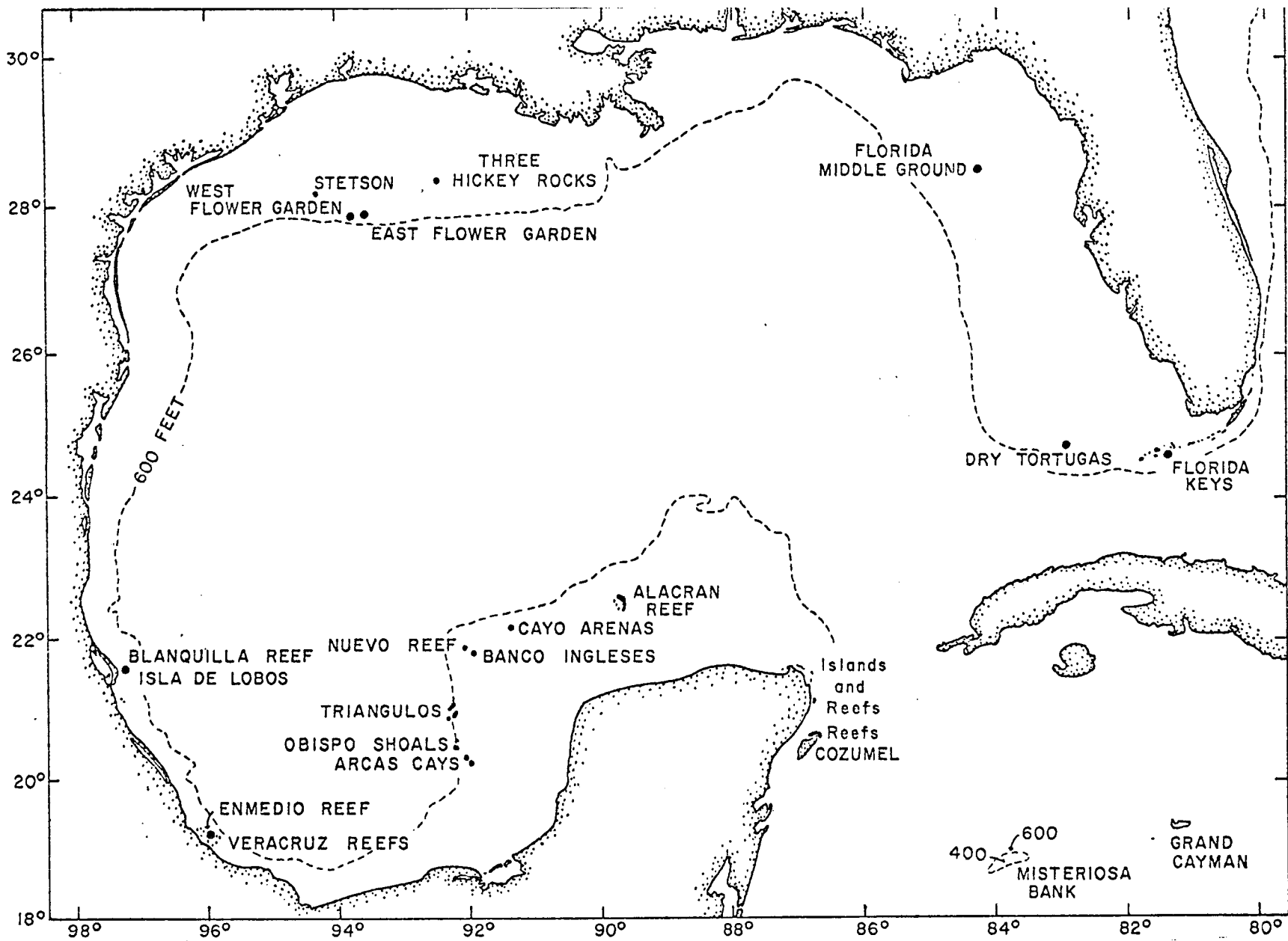

FIGURE 24 Map of the Gulf of Mexico showing locations of known coral reefs (after 1).

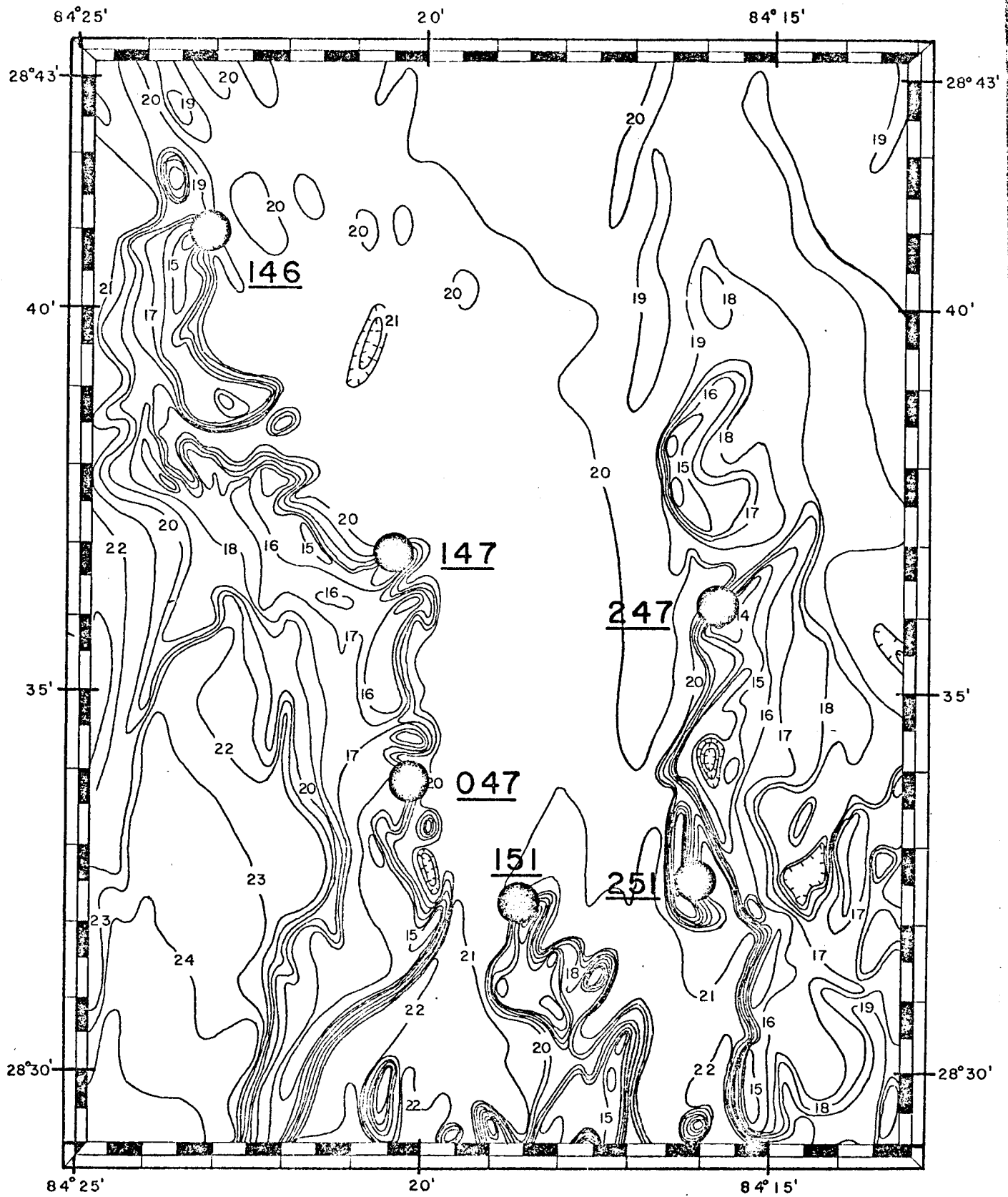

Figure 25. Location of Middle Ground stations.

sites, Station 151 and Station 247. It is estimated that we invested about 10 hr/diver scientist on the Florida Middle Ground over three seasons. Observed temperatures are in good agreement with published mean monthly temperatures.

## 2. Faunal Assemblages

### a. Coelenterate

(1) General - Overall, the coelenterates of the Florida Middle Ground show strong tropical affinities. As reported earlier (Hopkins, 1974) the hydrozoan coral Millepora alcicornis forms massive colonies along the rocky margins at about 27 m depth. It is our present contention that M. alcicornis is the major contributor to frame building on the Florida Middle Ground. M. camplanata is present to a lesser extent as incrustations on octocorallian skeletons. Hydroids of note were Aglaophenia, Monostaechas, Plumularia, and Sertularis spp. Among the Anthozoa, tropical anemones of note were Condylactis gigantea, and Bartholomea annulata along with commensal shrimps (Periclimenes); the most wide spread anemone was Phymanthus crucifer with a variety of color patterns. Phymanthus seemed generally distributed between 25-27 m in the transected area.

Scleractinian and octocorallian fauna were studied quantitatively and are described elsewhere in these proceedings. Thirteen species of octocorallians were encountered along with fifteen species of scleractinian corals. Among the octocorallians the occurrence of Lophogorgia cardinalis, Diodogorgia nodulifera, Pterogorgia guadalupensis and Pseudopterogorgia rigida are new distribution records as are the scleractinian corals Cladocora arbuscula, Dichocoenia stokesii, D. stellaris, Manicina areolata, Meandrina meandrites,

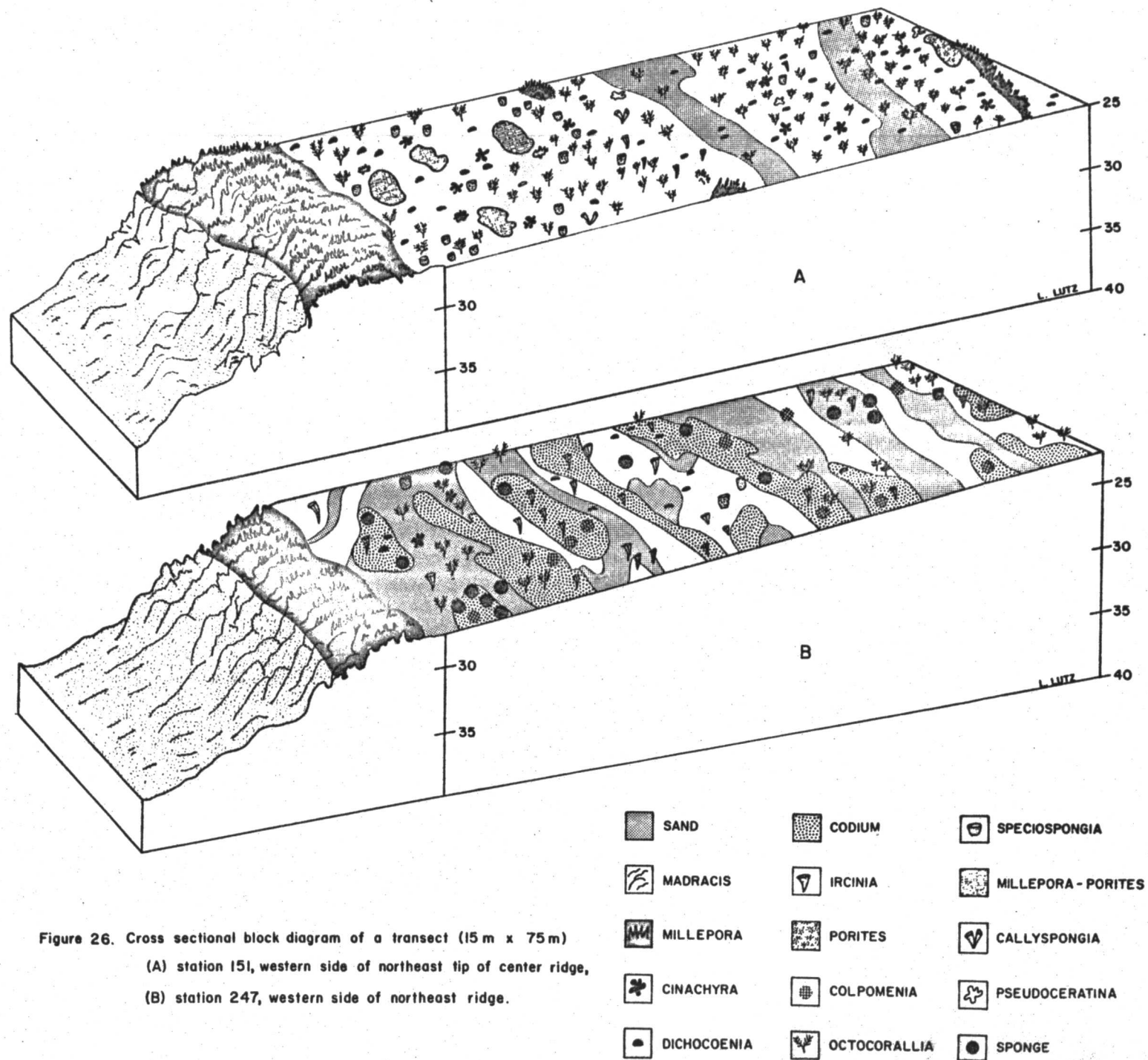

Figure 26. Cross sectional block diagram of a transect (15 m x 75 m)  
 (A) station 151, western side of northeast tip of center ridge,  
 (B) station 247, western side of northeast ridge.

Scolymia cubensis, and Scolymia lacera.

Of the seventeen species of scleractinians reported from the West Flower Garden Bank (2), only five are in common with the Florida Middle Ground (s = 31%). Of remarkable note, however, is the fact that octocorals do not appear to occur at similar depths in the former habitat.

(2) Studies of Species Abundance and Diversity

Station 146 - Figures 6A and 6C show that hard coral diversity increases with distance from the ridge front. The evenness component (J') appears to be erratic but generally shows a concurrent increase with distance. Figures 6B and D displaying individuals/m<sup>2</sup> generally follow the trends set by species diversity. The number of species per 5 m quadrat clearly show the expected increase in number of species. The erratic nature of 6B illustrates the nonuniformity of the transected area being studied on that cruise. The sharp rise and fall of the lines graphically illustrate abrupt changes in topography, e.g., sand patches.

Figures 6E and 6F illustrate hard coral zonation at this site. The inverse relationship between Madracis decactis and Porites divaricata is graphically apparent; Porites replaces Madracis as a function of distance from ridge. It is also apparent that percent species abundance increases as a function of horizontal distance from the ridge.

Figures 7A and C similarly show that soft coral diversity increases "reefward." Figures 7B and D show some erratic patterns but nevertheless, the number of species per 5 m quadrat increases as expected.

Graphs of "species abundance" (Figures 7E and F) show soft coral zonation in a manner opposed by their hard coral counterparts. There does not appear

to be any replacement phenomenon occurring. Muricea laxa and M. elongata do decrease in number but they are not replaced in dominances as the quadrats move "reefward." Species abundance does increase reefward and percentages become more uniform.

In summary of 146, hard and soft corals do not appear to be competing in dominance as indicated by the similarity in values for H'. The greater number of species of hard corals and higher species abundance does not appear to be at the expense of soft corals.

Station 147 - Figures 8A and C showing hard coral diversity are in sharp contrast indicating (a) different locations from cruise to cruise and (b) habitat variability. A better clue to the latter [(b) above] is seen in graphs 8B and D where peaks are found in Quadrat 3 and 7 respectively abruptly followed by sharp declines. This would suggest that hard corals had encountered a habitat not conducive to their colonization, e.g., Algal or sand patches.

Figures 8E and F suggest a zonation pattern similar to Station 146.

In Figures 9A and C dealing with soft corals at this station we do not see the patterned inconsistency observed with hard corals. The low values for He' in Quadrats 1 and 2 can be accounted for by the presence of Millepora and hard corals. Figures 9B and D show the same consistency with individuals/m<sup>2</sup> and number of species per 5 m quadrat showing an increase with distance from the ridge.

Figures 9E and F indicate the dominance of Muricea laxa and M. elongata by 10-20%. The large stand of Plexaura flexuosa in 9F (Quadrat 5) may stem from the remarkable ability of this species to adapt to unstable or less desirable substrata. This ability is portrayed by variation in forms from tall erect to low stolon-like colonies.

Overall there appears to be a slight inverse relationship between hard and soft corals as seen by decreasing abundance and species diversity in hard corals with a concomitant increase in soft corals from the reef face reefward.

Station 047 - As seen in Figures 10A and C hard coral diversity declines rapidly from Quadrat 1-10. Figures 10B and D are studies in contrast because the transects involved different zonation patterns at the same site. (This is also evident in Figures 10E and F). In contrast to Stations 146 and 147, Madracis is not dominant, in Figure 10, whereas Porites continues its increasing dominance in both 10E and 10F. These figures show Dichocoenia stellaris exhibiting an unusual dominance at this station; a pattern not repeated at other stations.

Continuing our contrast to 146 and 147, Figures 11A and C show a peak midway through the transect and then a decline as the transect moves reefward. Figures 11B and D additionally mirror this fact. On the other hand, Figures 11E and F show zonation patterns similar to 146 and 147 in which Muricea laxa and M. elongata continue their dominance. A further comparison of 11E and F offers credence to the fact that the transects involved different substrates at the same site (Figure 11F is considerably richer overall).

Station 047 has an unusual configuration in that there is no distinct ridge and there is no distinct depth change. The basic configuration is flat and the inverse relationship between Madracis and Porites is distinct.

Station 151 - This station repeats some of the patterns of inconsistency seen at other stations. Whereas Figure 12A shows a steady increase in He', 12C indicates a very erratic net increase in hard coral diversity which further indicates the erratic nature of the area transected. Figures 12B and D generally

mirror the foregoing suggestions.

The species abundance figures (12E and F) also show the inconsistency encountered at other stations. Figure 12E shows a typical replacement pattern between Madracis and Porites along with an increased dominance of Dichodoenia stellaris. In contrast, Figure 12F does not mirror a replacement pattern and Madracis is inconsequential throughout. The emergence of Dichocoenia and Scolymia would indicate an increase in hard substrate which would replace Porites which competes well on unstable substrates.

Puzzlingly enough, the soft corals show a pattern of classic consistency. (Figures 13A and C along 13B and D). Classic consistency is also seen in the zonation pattern for soft corals where Muricea laxa and M. elongata predominate.

In summary, although hard corals have a larger number of species and higher species diversity, they do not appear to be restraining the development of soft coral fauna which is remarkably high and consistent in both transects.

Station 251 - Hard coral diversity at Station 251 is limited to only one transect due to time restrictions during the winter season. The data at hand, Figures 14A and B provide some interesting intra-station contrasts. Figure 14A shows an erratic pattern of species diversity with a peak at Quadrat 3; in contrast this same quadrat shows sharp dips in individuals/m<sup>2</sup> (Figure 14B). It is noteworthy that this quadrat occurs in the transition zone between the ridge and the reef flat area. Figure 14B also shows that there is an increase in individuals/m<sup>2</sup> even though the number of species/5 m decreases. Figure 14C indicates that Porites divaricata accounts for this phenomenon. This figure also shows the competition between Madracis and Porites.

Figures 15A and C reflect inexplicable inconsistencies for no evident



reason; field notes indicate that the area was flat and reasonably consistent. Figures 15B and D are more consistent in showing an increase in individuals/m<sup>2</sup> and an equal number of species per 5 m Quadrat (4/Quadrat 8).

Figures 15E and F show the expected dominance of Muricea, however, M. elongata is dominant to M. laxa and Eunicea calyculata makes a strong showing.

Of all stations considered in this report, Station 251 is the most impoverished for hard and soft corals.

Station 247 - Species diversity indices for hard corals at this station (Figures 16A and C) show a general decline as the transect ascends reefward. The peaks at Quadrats 3 and 5 in 16A and C respectively probably reflect the relative positions of the transition zone for each transect. Figures 16B and D reinforce this suggestion as seen in the respective high points for number of species/5m quadrat.

Figures 16E and F are a study in contrast. Whereas 16E does not show a relationship between Madracis and Porites, it is clear that 16F shows the pattern usually encountered at other stations.

With regard to soft corals we see the same erratic pattern in species diversity (Figures 17A and C) that we saw in hard corals at this station. The sharp fluctuations in both graphs reflect the same variability along this transect. Figures 17B and D indicate a very consistent increase in individuals/m<sup>2</sup> and number of species as the transect proceeds from the reef-face.

As expected Muricea laxa and M. elongata are the dominant soft corals (Figures 17E and F).

Overall, it does appear that there is an inverse relationship between hard and soft corals at this station. That is hard coral individuals/m<sup>2</sup>

decrease as soft coral individuals/m<sup>2</sup> increase from Quadrat 1 through 10 on either transect. This is in spite of the habitat irregularity.

Figure 18 shows a graphic comparison of diversity and evenness for hard corals study station by station via two transects. The contrasting results are remarkable in their inconsistency. The same is essentially true for soft corals (Figure 19). Cumulative diversities (not graphed) would suggest that hard coral diversity is highest on the western ridge line and lowest on the eastern ridge. Soft coral cumulative diversities favor a north-south gradient with higher diversities being found at the northern and southernmost stations.

b. Mollusca - The present study reports 75 species of molluscs from the Florida Middle Ground which includes 43 species of gastropods, 24 species of pelecypods, three species of cephalopods, and two polyplacophoran species. Particularly noteworthy among the gastropods are two species of opisthobranchs of which one has just been described as new to science.

Studies of a similar nature in the western Gulf are those of Tunnel (1974) who reported 290 species (211 gastropods, 73 pelecypods, two cephalopods, and two polyplacophorans) from Enmedio and Lobos reefs along the Mexican coast. (Figure 1); depth ranged from supralittoral to 23 m. Lipka (1974) reported 65 molluscs from the West Flower Garden Bank which included 41 gastropods, 21 pelecypods, two cephalopods, and one polyplacophoran species. The occurrence of opisthobranch molluscs was not reported.

Of the material presently reported from the Middle Ground effort, only eight species of gastropods collected also occurred at the Flower Garden site. Cerithium litteratum was the most abundant gastropod surveyed in situ at either site. Of the 24 species of Middle Ground pelecypods collected, only seven were found to be in common with the West Flower Garden Bank. Lithophaga

bisulcata was less abundant than L. aristata. Malleus candeanus was found as an inhabitant of sponges during this study, but Lipka (1974) reports it only from hard substrate. Other prominent pelecypods were Chlamys benedicti, Chama macerophylla, Lopha frons, Pteria colymbus, and Spondylus americanus.

The Middle Ground molluscan assemblage is quite dissimilar (X = 23%) from the West Flower Garden Bank.

Decapod Crustacea - This group is represented by fifty-six species from six sections and eighteen families. Families with major contributions are Palaemonidae (12 species), Majidae (11 species), Xanthidae (10 species), and Alpheidae (nine species). Among the decapods collected, approximately ten to fifteen percent (seven-eight species) will probably end up being new to science. A particular example is Pseudocryptochirus hypostegus n. sp. a commensal of Agaricia fragilis currently being described (Shaw and Hopkins, 1977). Of pertinence too, are new records for Synalpheus brevifrons, Trachycaris restrictus, Alpheopsis labis, Periclimenaeus bredini, P. pennyae, P. ascidiarum, P. perlatus, Periclimenes iridescens, Gnathophyllum modestus, Pontonia margarita, and Lysmata rathbunae from among the caridean shrimps alone. It is of further pertinence to note that there is very little overlap in species occurrence between the Florida Middle Ground and the West Flower Garden Bank (Pequegnat and Ray, 1974). For example, although they report sixteen species of alpheids, only three are in common with the nine species encountered during this study. Of contrasting interest is the greater number of palaemonids (12 vs seven species) and the presence of stenopid shrimp on the Florida Middle Ground. Stenopus hispidus and S. scutellatus are established on the Florida Middle Ground, but were not reported from the West Flower Garden Bank.

The greater number and dissimilarity ( $S = 34\%$ ) of the Middle Ground Decapod Crustacean fauna is in keeping with our observations about the coral fauna. Furthermore, the more diversified habitat located in the northeastern Gulf of Mexico apparently provides opportunities for the occurrence of both semi-tropical and temperate species occupation.

Echinoderms - the echinoderms on the deep reefs of both the Middle Ground and the Flower Garden Bank are somewhat less well represented than other fauna. The principal asteroid is Coscinasterias tenuispina which is found both up on the reef proper and in the valleys between major formations. Echinaster sp., Oreaster reticulatus, and Narcissia trigonias all inhabit the sand floor at about 36-37 m depth. With the exception of a single station (No. 247), Diadema antillarum is the primary echinoid followed by Arbacia punctulata and Lytechinus variegatus: at Station 247 A. punctulata quite unexpectedly and unexplainably replaces the abundant Diadema. Eucidaris tribuloides and Meoma ventricosa inhabit the sand-shell rubble area between major reef formations. Among the ophiuroids which contribute the single greatest number of species to the group, Astrophyton muricatum is a dominant. Its presence along the Millepora reef at night is as conspicuous as its absence during the day where it forms tightly coiled mounds deep in the large interstices of the Millepora projections. Ophiothrix angulata and O. suenoni are ectocommensal of sponges whereas Ophiactis sp. is an endocommensal of Aegeles dispar, an orange sponge. Burke (1974) regards this Ophiactis as being O. savignyi, however, we regard the Middle Ground form as definitely not being O. savignyi and probably an endemic.

Overall the Middle Ground reef top is considerably better represented by echinoderms than the Flower Garden Bank (23 vs. 10) and with little similarity ( $S = 36\%$ ) (Burke, 1974).

Polychaetous Annelids - Among the 41 polychaete species encountered in the study area to date, certain forms predominate: Eunice rubra, Ceratonereis mirabilis, Hermania verruculosa, and Spirobranchus giganteus. Members of the family Eunicidae dominate both biomass and species number. Identifiable forms with West Indian affinities were: Hermodice carunculata, Hesione picta, and Hermania verruculosa: forms showing circumtropical distribution in warm tropical seas were: Ceratonereis mirabilis, Eunice antennata, E. siciliensis, Lumbrinereis inflata, and Spirobranchus giganteus.

It is remarkable to note that only eight species of polychaetes were recorded from the West Flower Garden Bank (Wills, 1974). We can expect a larger polychaete faunal assemblage after we complete studies underway. As in the case of the Decapod Crustacea, it is proposed that the Middle Ground is a more productive area due to greater habitat diversity and potential niches.

Poriferans (Sponges) - Of all the groups we have attempted to study, the sponges are proving to be the most difficult. This problem is primarily due to the large apparent diversity coupled with the subtlety which characterizes (or fails to characterize) a species in the field, and secondarily to the apparent lack of cohesion in recognizing or organizing sponge families at the present time. This faunal group is rich and diverse in the eastern Gulf of Mexico and is very deserving of extensive study.

We are presently working with about 40 species; the final number could well reach 100. The most well represented family is the Spongiidae with six species (three Ircinia and three Verongia) followed by the Axinellidae with four species. Conspicuous and common species are Callypongia vaginalis, Neofibularia nolitangere, Cinachyra sp., Ircinia campana, I. strobilina, I. fasciculata, Verongia longissima, V. fistularis, V. cauliformes, Pseudoceratina crassa, Sphaciospongia vesparia, Haliclona rubens, Placospongia sp., Mycale angulosa,

and Agelas dispar. Agelas dispar seems to be the only restricted species as it occurs along the reef face at 30-32 m; the others are generally well distributed over the depth range.

Cursory review of manuscript information dealing with the Flower Garden Bank sponges indicates very little similarity between the two areas.

Fishes - One hundred-seventy species of fish from 56 families have been observed and/or collected on the Florida Middle Ground. Of these, 97 are considered primary and 45 as secondary reef fishes as defined by Starck (1968). The greatest familial representation is by the Serranidae with 21 species followed by Gobiidae (eight species), and Pomacentridae, Labridae, and Balistidae each with seven species. Numerically (biomass and numbers of individuals) important members of the community include Mycteroperca microlepis, M. Pherax, Holocanthus bermudensis, Chromis scotti, Halichoeres bivattatus, Scarus croicensis, Gobiosoma oceanops, and G. xanthipora.

The Millepora ridge serves as both a focal point and demarcation zone between shallower back-reef species and deeper fore-reef species. During the day, large aggregations (100-300 individuals) of Chromis scotti are found consistently feeding in the water column two-to-five m above the ridge; large groups of Equetus umbrosus and Holocentrus asensionis remain within the large crevices of the ridge, but below these crevices beneath the ridge line Centropristes ocyurus, Chromis enchrysurus, and Sparisoma atomarium are in frequent residence. In the more reefward, octocorallian zone. Eupomacentrus variabilis, Chromis scotti, Holocanthus bermudensis, Halichoeres bivattatus and Scarus croicensis are common inhabitants.

A comparison of the deep reef ichthyofauna of the Middle Ground with

that of shallower water (12-18 m) reefs of the Eastern Gulf of Mexico reveals a far richer and more tropical faunal tropical assemblage with increasing depth. Seventy-one species have been reported from these shallow reefs, 44% of which also occur on the Middle Ground which additionally harbor many insular species not found on the shallow reefs (Smith, 1976). It has been postulated that buffered environmental conditions associated with offshore distance, reef structural complexity, water column and benthic primary productivity are important features contributing to Middle Ground diversity and abundance (Smith and Ogren, 1976).

Although Starck (1968) cautioned against using a quantitative index of faunal similarity because it may not consider variations in geography, hydrography or reef biology, such an index does reveal certain interesting relationships. For example, comparisons of the Middle Ground and other Western Atlantic reef ichthyofaunas reveal greater Caribbean-West Indian affinity and intra-Gulf homogeneity than previously expected. The Middle Ground reef ichthyofauna is most closely allied to that of the Florida Keys (S = 49%). Comparisons with the West Flower Garden Bank ichthyofauna (Bright and Cushman, 1974) show a 44% similarity (this is considerably higher than any of the invertebrate values). This greater similarity may be the result of occupation of these deep reefs by stenocious and insular fishes.

#### Floral Assemblages

Algal Composition - At the present time, we are able to report 103 species of algae from this study of which 48 species (14 Chlorophyta, five Phaeophyta, and 29 Rhodophyta) are new to the Middle Ground; 20 are new range records. Our list coupled with Cheney and Dyer (1976) brings the

Middle Ground total to about 140 species. We estimate that at least four new species are in order, however, they will be treated in detail elsewhere.

Commonly encountered members of the Chlorophyta were Anadyomene stellata, Bryopsis pennata, Caulerpa microphysa, Codium carolinianum, C. intertextum, C. isthmocladium, Ernodesmus verticellata, Halimeda discoidea, Udotea flabellum, and Valonia macrophysa. Among the Phaeophyta, Dictyota bartayresii and D. dichotoma are well distributed. The Rhodophyta were represented by Amphiroa fragilissima, Botryocladia occidentalis, Coelarthrum albertisii, Erythrocladia subintegra, Eucheuma isforme, Galaxaura oblongata, Halymena spp., Kallymenia perforata, Laurencia intricata and Paragonolithon sp. to mention a few.

Algal Distributions - Overall, red algae are the most diverse, comprising 61% of the species present, with Chlorophyta contributing 28% and Phaeophyta 11%. Abundance in any given area varies widely, however, with species of Chlorophyta often dominating in terms of biomass.

In winter, the total number of species is about one-third of the total present in early summer and autumn. The two species of brown algae found in February, Dictyota dichotoma and Dictyota bartayresii, are essentially warm-water plants. Encrusting Rhodophyta are perennial, but most of the fleshy, filamentous, and leafy red algae die back during the winter and were represented in the February collections by small "germlings". These included Kallymenia, Coelarthrum, and Champia -- species that exhibit luxuriant growth by June and make up much of the biomass of the reds present in summer and early autumn. Filamentous reds were most conspicuous and abundant in early autumn.

Most of the plant biomass present in winter consists of perennial green algae including Codium carolinianum, Codium intertextum, Valonia macrophysa,



Halimeda discoidea, and Udotea flabellum.

Throughout the year, there is greater diversity and abundance of plants present in the northern part of the Middle Ground than in the southern region. Two interacting biological factors may account for this. The southern stations include extensive areas of branching corals with associated populations of herbivorous fishes. It is likely that competition for space on hard substrate, necessary for many corals and many plants, reduces the potential opportunities for spore settling and survival. Coupled with this is the grazing pressure exerted by numerous parrotfishes and damselfishes, and to some extent, herbivorous sea urchins. Although corals and herbivores occur throughout the Middle Ground stations, they are most abundant in the southern area.

Wire cages were placed at various locations during June, 1975 to exclude grazers. Unfortunately, the cages were destroyed by Hurricane ELOISE before definitive observations could be made.

Storm Effects - The effect of Hurricane ELOISE in September, 1975, was dramatic and substantiates Cheney and Dyer's (1974) observations that autumn storms may cause drastic reduction of plants through scouring and wave action. Some species were completely eliminated from Middle Ground sites at which they had been abundant only a week before. Reduction of red algae was especially evident. Halymenia plants, formerly large, luxuriant blades, were torn or reduced to only a holdfast with a small residual stipe and blade fragment. The spherical green alga, Valonia, was often found plasmolyzed, perhaps a result of wave action. Many fleshy and leafy species were cut off by the rapid flow of sediment over the reef.

The cumulative effects of later autumn and winter storms were even more

severe. Sandy areas became churned into deep sand ripples and extensive Caulerpa communities were destroyed. Some Caulerpa was found in adjacent areas on hard substrate, apparently less affected by sand movement. Botryocladia occidentalis plants were often sheared abruptly to one half their former size, as were other common species.

Despite the apparent devastation caused by autumn and winter storms, it is evident from three seasons of observations (1974, 1975, 1976) that the plant populations recover each year with the coming of summer.

#### 4. Conclusions about the Florida Middle Ground

There are very strong and positive indications that the Florida Middle Ground has unique faunal and floral assemblages which make it dissimilar from the West Flower Garden Bank reef in the northwestern Gulf. This may very well be explained by the apparent circulation patterns which bring larvae and/or "sporlings" to the respective areas. It is proposed that the Florida Middle Ground is maintained by the Loop Current (Austin and Jones, 1974) bringing water from the Bahamian and Florida Keys environments whereas the West Flower Garden Bank is maintained by the Mexican Current (Sturges and Blaha, 1976).

REFERENCES

- Austin, H. and J. Jones, 1974. Seasonal variation of physical oceanographic parameters on the Florida Middle Ground and their relation to zooplankton biomass on the West Florida Shelf. *Quar. J. Fla. Acad. Sci* 37(2).
- Bray, J.R. and J.T. Curtis, 1957. An ordination of the upland forest communities of southern Wisconsin. *Ecol. Monogr.*, 27: 325-349.
- Bright, T.J. and C.W. Cashman, 1974. Fishes p. 340-409 in *Biota of the West Flower Garden Bank*. Ed. Bright T.J., and L.H. Pequegnat. Gulf Publishing Co. 435 pp.
- Bright, T.J. and L.H. Pequegnat, 1974. *Biota of the West Flower Garden Bank*. Gulf Pub. Co., Houston, Texas. 435 pp.
- Burke, T.E., 1974. Echinoderms p. 312-331 in *Biota of the West Florida Garden Bank*. Ed. Bright, T.J. and L.H. Pequegnat. Gulf Publishing Co. 435 pp.
- Cheney, D.P. and J.P. Dyer, III, 1974. Deep-Water benthic algae of the Florida Middle Ground. *Mar. Biol.* 27, 185-190.
- Collard, S.B. and C.N. D'Asaro, 1973. Benthic invertebrates of the Eastern Gulf of Mexico. 27 p. In: *A summary of knowledge of the Eastern Gulf of Mexico 1973*. State University System of Florida Institute of Oceanography, St. Petersburg, Fla.
- Hopkins, T.S., 1974. Observations on the Florida Middle Ground through the use of open-circuit SCUBA. In R.E. Smith, Ed. "Proc. of Mar. environ. implications of offshore drilling eastern Gulf of Mexico: 1974" p. 227-228.
- Lipka, D.A., 1974. Mollusks. p. 143-196 in *Biota of the West Florida Garden Bank*. Ed. Bright, T.J. and L.H. Pequegnat. Gulf Publishing Co. 435 pp.
- Lyons, W.G. and S.B. Collard, 1974. Benthic invertebrates communities of the eastern Gulf of Mexico. *Proc. Mar. Env. Implications of offshore Drilling Eastern Gulf of Mexico* 157-165. State University System Institute of Oceanography, St. Petersburg, Fla.
- Pequegnat, L.H. and J.P. Ray, 1974. Crustacea and other Arthropods ;. 232-288 in *Biota of the West Flower Garden Bank*. Ed. Bright, T.J. and L.H. Pequegnat. Gulf Publishing Co. 435 pp.
- Pielou, E.C., 1966. The measurement of diversity in different types of biological collections. *J. Theor. Biol.* 13: 131-144.

REFERENCES - continued

- Sanders, H.L., 1960. Benthic studies in Buzzard's Bay. III The structure of the soft-bottom community. *Limnol. Oceanogr.* 5, 138-153.
- Shaw, J.K. and Hopkins, T.S., 1977. The occurrence of two members of the Hapalocarcinidae (Crustacea: Brachyora) on the Florida Middle Ground. In Press. *Proc. 3rd Intl. Symp. Coral Reefs.*
- Smith, G.B., 1976. Ecology and distribution of Eastern Gulf of Mexico Reef fishes. *Fla. Mar. Res. Publ. No. 19*, 78 pp.
- Smith, G.B., H.M. Austin, S.A. Bortone, R.W. Hastings and L.H. Ogren, 1975. Fishes of the Florida Middle Ground with comments on ecology and zoogeography. *Fla. Mar. Res. Publ. No. 9*, 14 pp.
- Smith, G.B. and L.H. Ogren, 1974. Comments on the nature of the Florida Middle Ground reef ichthyofauna. in R.E. Smith, Ed. "Proc of Mar. environ. implications of offshore drilling eastern Gulf of Mexico: 1974. p. 229-232.
- Starck, W. A., II, 1968. A list of the fish at Alligator Reef Florida, with comments on the nature of the Florida reef fish fauna. *Undersea Biol. Vol. I(1)*, 4040.
- Sturges, W. and J.P. Blaha, 1976. A Western boundary current in the Gulf of Mexico. *Science*, 192, 367-369.
- Tresslar, R.C., 1974. Corals p. 116-139. in *Biota of the West Flower Garden Bank*. Ed. Bright, T.J. and L.H. Pequegnat. Gulf Publishing Co. 435 pp.
- Tunnell, J.W., 1974. Ecological and Geographical distribution of Mollusca of Lobos and Enmedio Coral reefs, Southwestern Gulf of Mexico. PhD Dissertation, Texas A&M University.
- Wills, J.B., 1974. Worms. p. 292-309 in *Biota of the West Flower Garden Bank*. Ed. Bright, T.J. and L.H. Pequegnat. Gulf Publishing Co. 435 pp.

