

NASA Technical Memorandum 73295

Gulf of Mexico Satellite Radar Altimetry

C. G. Parra
R. G. Forsythe
and
C. L. Parsons

COAR
COPY

August 1981

NASA

National Aeronautics and
Space Administration

Wallops Flight Center

Wallops Island, Virginia 23337
AC 804 824-3411

Gulf of Mexico Satellite Radar Altimetry

C. G. Parra, R. G. Forsythe, and C. L. Parsons

NASA Wallops Flight Center
Wallops Island, Virginia 23337

This study was funded through Interagency Agreement
AA851-IA0-11 between the Bureau of Land Management and
the National Aeronautics and Space Administration.



National Aeronautics and
Space Administration

Wallops Flight Center

Wallops Island, Virginia 23337
AC 804 824-3411

INTRODUCTION

Since the pioneering work on Skylab's S-193 radar altimeter, NASA has embarked in the development and production of improved satellite radar altimeters. The first totally dedicated satellite radar altimeter, the Geodetic Experimental Ocean Satellite (GEOS-3, Figure 1), was launched on April 9, 1975. A newer, more sophisticated instrument was placed aboard SEASAT (Figure 2) which was launched on June 28, 1978.

The GEOS-3 radar altimeter was designed to operate on a frequency of 13.9 GHz with both a global and an intensive mode. The intensive mode produces a compressed pulse of 12.5 nanoseconds and provides measurements with a precision of about 20 cm from a one second average. This configuration yields a footprint size of 3.6 km wide and 11 km along the track from an orbit of 840 km altitude, an inclination of 115° and a period of 101.8 minutes. SEASAT was also designed to operate at a frequency of 13.9 GHz but with a pulse compressed to 3 ns which provided measurements with a precision of about 10 cm for a one second average. The footprint produced by SEASAT's configuration is of 1.6 km in width and 12 km along the track. The orbit is about 800 km high with an inclination of 108° and a period of 100.75 minutes. Detailed technical discussions on both GEOS-3 and SEASAT altimeters can be obtained from Hofmeister *et al.* (ref. 1) and from Townsend (ref. 2), respectively.

Three products from these radar altimeters that have had large oceanographic implications are the ocean dynamic heights (DH), the significant wave heights (SWH) and the surface wind speed (WS). The algorithms to obtain these three estimates from the radar return pulse have been developed under rigorous statistical analysis and they have proven to be as good, and often times more accurate, than any available hydrographic data (ref. 3). A summary on the development of the estimates for DH, SWH and WS has been presented to the United States Department of Interior, Bureau of Land Management, New Orleans Outer Continental Shelf Office (USDI/BLM, NOOCSO) for the South Atlantic Bight (SAB) (ref. 4). The present study, also sponsored by USDI/BLM, NOOCSO is similar in nature with the addition of SEASAT data which were not included in the SAB study.

The estimates by both sensors, GEOS-3 and SEASAT agree over the position of western boundary currents and in the relative definition of the DH as demonstrated by Leitao *et al.* (ref. 5). A similar comparison between the two sensors and from ground truth was reported at the Second SEASAT Gulf of Alaska Workshop (ref. 6). This report indicates that the SEASAT results compare well with both GEOS-3 and ground truth measurements.

DATA PROCESSING

Data processing for DH, SWH and WS from both GEOS-3 and SEASAT radar altimeters followed procedures very similar to those used for the SAB study. So, as to avoid a lengthy discussion on the algorithm development and the analytical procedures used for this study, only those which differ from the material included in the SAB report (ref. 4) are included here.

Sea Surface Dynamic Height Profiles

The procedures used to obtain sea surface DH profiles differed from those outlined in the SAB report (ref. 4) on two fundamental aspects. The first is that the 5' x 5' gravimetric geoid for the NW Atlantic (ref. 7), obviously could not be used for the Gulf of Mexico. A new gravimetric geoid was obtained from the Defense Mapping Agency (DMA) with a resolution of 30' x 30' (Figure 3). The implications on the use of this geoid are serious and are explained in detail in the discussion section below. It is sufficient to say here that a 30' x 30' geoid resolution is not fine enough to resolve the geoid heights accurately enough for this type of study. The second difference between the present study and the SAB study is the length and location of the straight line fit to the geoid. Presently the entire altimeter profile over the Gulf of Mexico is fit to the geoid whereas in the SAB the fit was done only over oceanographic static areas, that is, areas with minimum dynamic slopes. The reason for this change in methodology is that it is almost impossible to obtain an oceanographic static area in the Gulf of Mexico, particularly in the Eastern Gulf. This is due to the numerous and pronounced northward intrusions of the Gulf of Mexico Loop Current (ref. 8) and its associated eddies.

Sea Surface Topographic Variations

Since the gravimetric geoid received from DMA did not model the geoid accurately, it was decided that only the seasonal variations from an overall mean would have statistical significance. A three year mean topographic map (Figure 4) and a three year standard deviation map (Figure 5) were calculated using all available GEOS-3 and SEASAT passes over the Gulf of Mexico (Figure 6) averaging the DH profiles within a 15' grid. It is obvious that such a topographic map includes all the errors found in obtaining the differences between a highly accurate altimeter profile and a grossly interpolated geoid heights profile. The sea surface topographic variations are considered free of this type of

interpolation error since they are calculated by obtaining the difference between two values from each of which value the geoid has been subtracted. These variations were obtained by calculating a profile of the three year mean surface along each subsatellite track. Such profiles were obtained by interpolating values on a 15' grid, and they were then subtracted from the DH profile for each pass so as to obtain a pass by pass variation. Since the temporal distribution of all passes is not evenly distributed, the pass variations were combined seasonally within each year from Spring of 1975 to Fall of 1978. The topographic variation maps are then the average of the pass by pass variation calculated over a 15' grid over the entire Gulf of Mexico and processed seasonally (see Appendix A).

Significant Wave Height

Data processing for SWH for the GEOS-3 altimeter is discussed in the SAB report (ref. 4) and for SEASAT in MacArthur (ref. 9). One point to remember is that the SEASAT altimeter computed SWH onboard the spacecraft and provided it in the data stream at approximately a 10/s rate, whereas the GEOS-3 SWH was computed on the ground from the waveform sampler data. For the purpose of this study the 10/s SEASAT data was averaged over a telemetry major frame on the ground to yield a data rate of approximately 1/4.6 s. For GEOS-3 SWH was provided at the major frame rate, which is 1/3.2 s for the high data rate and 1/2.0 s for the low data rate. The histograms for significant wave height are presented in Appendix B. In each figure, the abscissa (x axis) is graduated in meters and the ordinate (y axis) is graduated in percent. In addition, each bin of the histogram is labelled with the actual number of samples included in the bin and each figure contains the number of points in the total distribution as well as the mean and standard deviation of the distribution. The study region was divided into two areas: east and west, at 90°W longitude.

Surface Wind Speed

The computation of wind speed for SEASAT is very similar to that for GEOS-3 which is discussed in the SAB (ref. 4). One difference is that the plot of σ_0 versus wind speed for SEASAT suggests a two cusped curve (Figure 7) rather than the one cusped curve (Figure 8) of GEOS-3. Although the one cusp is obvious in the GEOS-3 plot, the two cusps are not readily noticed in the SEASAT plot because it is done in a log x log scale. For both SEASAT and GEOS-3 wind speed is computed from

$$W = \exp \frac{10^X - B}{A}$$

where

$$X = \frac{\sigma_o(0^\circ) + 2.1}{10}$$

and $\sigma_o(0^\circ)$ is given in dB. The values of A and B for GEOS-3 are given in SAB (ref. 4). For SEASAT the values are A = 0.01595 and B = 0.017215 for winds below 7.81 m/s. For winds between 7.81 and 10.03 m/s the values are A = 0.039893 and B = -0.031996. And, for winds greater than 10.03 m/s, A = 0.080074 and B = -0.124651. For wind speeds less than or equal to 16 m/sec there is a polynomial correction. For a detailed discussion of this correction see Brown et al. (ref. 10). For SEASAT the σ_o , corrected for pointing angle, was initially computed at a 10/s rate. These values were then used to compute 10/s wind speeds which were averaged to yield the same 1/4.6 s rate as for SWH. The data rates for wind speed for GEOS-3 are the same as for SWH; 1/3.2 s for the high data rate and 1/2.0 s for the low data rate.

During the course of this study, some anomalous GEOS-3 passes were discovered which contained wind speeds of 20 to 40 m/s and for which no plausible explanation could be found. The preponderance of these passes was in July 1975 with a few others scattered through August, September, and October of 1975. Since no surface phenomena could be found to explain these data, and since they did produce slight changes in the final statistics, they were edited from the final data set. The following table shows the number of points edited for each of these four months as well as the percentage of data edited for each month and the percentage for the total of that month over the entire GEOS-3 mission. A total of 290 data points, which represents approximately one percent of the GEOS-3 WS data, was edited for this reason. Histograms appear in Appendix C.

<u>Month</u>	<u># Pts. Edited</u>	<u>% of Data</u>	<u>GEOS % of Total</u>
July 1975	176	75	5
August 1975	41	9	1
September 1975	10	3	0.3
October 1975	63	5	3

RESULTS AND DISCUSSION

The results and discussion of this material is best presented under the three following subcategories: Analysis of Sea Surface Topographic Variations; Analysis of Significant Wave Height Histograms; and Analysis of Surface Wind Speed Histograms.

Analysis of Sea Surface Topographic Variations

To fully document the sea surface variation maps shown in Appendix A, the implications of the problems associated with the gravimetric geoid used to obtain the residuals from the altimeter heights must be fully understood. Geoidal undulations of small horizontal scales but ranging in amplitude from one to four meters appear poorly modelled and caused inaccurate results in the DH. For example, if a geoidal undulation happens to cover an area within the 30' grid it can very well be that the interpolated geoid heights over such area will differ by as much as four meters from the altimeter reading. There is little doubt that such large excursions in the residuals are caused by the lack of geoidal resolution.

Another problem associated with the variation maps is that the mean surface topography is greatly biased by the large number of passes in the last few months of the study. An inspection of a frequency distribution of passes (Figure 9) leaves no doubt that Summer and Fall 1978 carry very heavy weights in a mean surface topography. Furthermore seasonal maps obtained from just a few passes contain large areas of interpolated results which should be viewed with deep reservations. Fortunately these interpolated areas can be readily noticed since the contour lines appear as almost straight lines. For example, coverage of Summer 1977 shows there is a large area in the western middle Gulf of Mexico centered around 27°N, 267°E where there are no altimeter passes, the topography for that same season shows the distinct straight lines indicative of the automatic interpolation which is performed to fill in grid squares void of values. Yet the variations shown on that same map for the Eastern Gulf are reliable since there is a good distribution of passes.

Analysis of the altimeter coverage for the fifteen seasonal topographic variation maps (see Figures 10, 11, 12, and 13) reveal that the first two maps are totally unreliable because of poor coverage. Eight other seasons show fairly good coverage for the Eastern Gulf but poorly covered in the Western sectors. The remaining five seasonal maps show excellent coverage. It is important to note that only the very major features can be obtained; many smaller variations may be due to ocean dynamics but the results are inconclusive at best. The probability that features in excess of 150 cm shown in these

maps are caused by dynamic features in the Gulf of Mexico is high. Some large features, such as the -200 to -250 centimeter low centered at about 24°N, 271°E, are not dynamic; this one in particular is produced by poor geoidal resolution at the steep gradients over the Campeche Escarpment.

Analysis of Significant Wave Heights

As in the SAB report (ref. 4), the analysis of SWH and WS climatology must address the impact of spatial and temporal sampling. The WS analysis is described in the next section. In this section, the SWH climatology in the Gulf of Mexico is described. The same data products that were generated for the SAB report (ref. 4) are used here. Figure 14 shows the variation of the mean of bi-monthly wave height distributions and the change of the variance of these distributions with time from May 1975 to October 1978. The key observation to make is the small magnitude of the mean wave height. Only in the winter of 1976 did the mean height exceed 2 m. Of course, the Gulf of Mexico is a body of water that has limited fetch because of its dimensions, and it lies within a zone of latitude that does not support the cyclone-type disturbances that produce high sea states at higher latitudes. Because of the altimeter's design, it is a more reliable sensor for high wave heights than for low (ref. 11). Indeed, for wave heights below 2 m, the altimeter measurement is quite noisy. That is, it is modulated with random errors. To further complicate the issue, for the time period during which both GEOS-3 and SEASAT SWH measurements are available, the random contributions from the two sensors are different (ref. 11). Figure 15 shows that there is a slightly larger mean SWH for the composite winter months than for the summer. Therefore, the data display the expected behavior with the seasons. A quantitative representation of SWH in the Gulf of Mexico using altimeter data should, however, be avoided because of the noisiness of the satellite altimetry measurement process for low SWH.

Analysis of Surface Wind Speed

The situation is improved for the wind speed data sets as shown in Figure 16. Distinct seasonal fluctuations can be seen that exceed the RMS error associated with the altimeter's wind speed measurement. This was conservatively set at +2.5 m/sec by Brown (ref. 12). The variance record also contains a small seasonally variable component. The composite record in Figure 17 closely resembles the corresponding result in the SAB report. There does not appear to be a systematic difference between the eastern and western sectors of the Gulf.

ACKNOWLEDGMENTS

This study was funded by the Department of Interior Bureau of Land Management, New Orleans Outer Continental Shelf Office, under interagency agreement. The authors wish to thank C. D. Leitao and N. E. Huang of NASA for their valuable advice. The authors also wish to thank J. L. Wessells and P. A. Lewis of Computer Sciences Corporation for their work in developing the computer programs and data processing procedures which made this study possible.

REFERENCES

1. Hofmeister, E. L., B. N. Keeney, T. W. Godbey and R. T. Berg: "Design Error Analysis of the GEOS-C Radar Altimeter," Utica, NY, General Electric Co., Aerospace Electronics Department, 1975.
2. Townsend, W. F.: "An Initial Assessment of the Performance Achieved by the SEASAT-1 Radar Altimeter," Ocean Engineering, v. OE-5, No. 2, pp. 80-92, 1980.
3. McGoogan, J. T.: "Satellite Altimeter Applications," IEEE, MIT-23, 970-978, 1975.
4. Leitao, C. D., N. E. Huang, C. L. Parsons, C. G. Parra, J. D. McMillan and G. S. Hayne: "Final Report of GEOS-3 Radar Altimeter Study for the South Atlantic Bight," NASA TM-73286, May 1980.
5. Leitao, C. D., N. E. Huang and C. G. Parra: "Sea Surface Topography from SEASAT and GEOS-3," Marine Technology, October 1980.
6. SEASAT Gulf of Alaska Workshop II Report. NASA, JPL 622-107, January 1980.
7. Mader, G. L.: "A Revised 4' Gravimetric Geoid and Associated Errors for the North Atlantic Calibration Area," NASA CR-156851, 1979.
8. Vukovich, F. M., B. W. Crissman, M. Bushnell and W. J. King: "Some Aspects of the Oceanography of the Gulf of Mexico Using Satellite and In-Situ Data," J. Geophys. Res., v. 84, No. C12, 7749-7768, 1979.
9. McArthur, J. L., SEASAT-A Radar Altimeter Design Description, Applied Physics Laboratory, The Johns Hopkins University, SDO-5232, November 1978.
10. Brown, G. S., H. R. Stanley and N. A. Roy, "The Wind Speed Measurement Capability of Spaceborne Radar Altimeters," Ocean Engineering, v. OE-6, No. 2, 1981.
11. Walsh, E. J.: "Extraction of Ocean Wave Height and Dominant Wavelength from GEOS-3 Altimeter Data," J. Geophys. Res., v. 84, No. B8, 4003-4010, 1979.
12. Brown, G. S., "Estimation of Surface Wind Speeds Using Satellite-Borne Radar Measurements at Normal Incidence," J. Geophys. Res., v. 84, No. B8, 3974-3978, 1979.

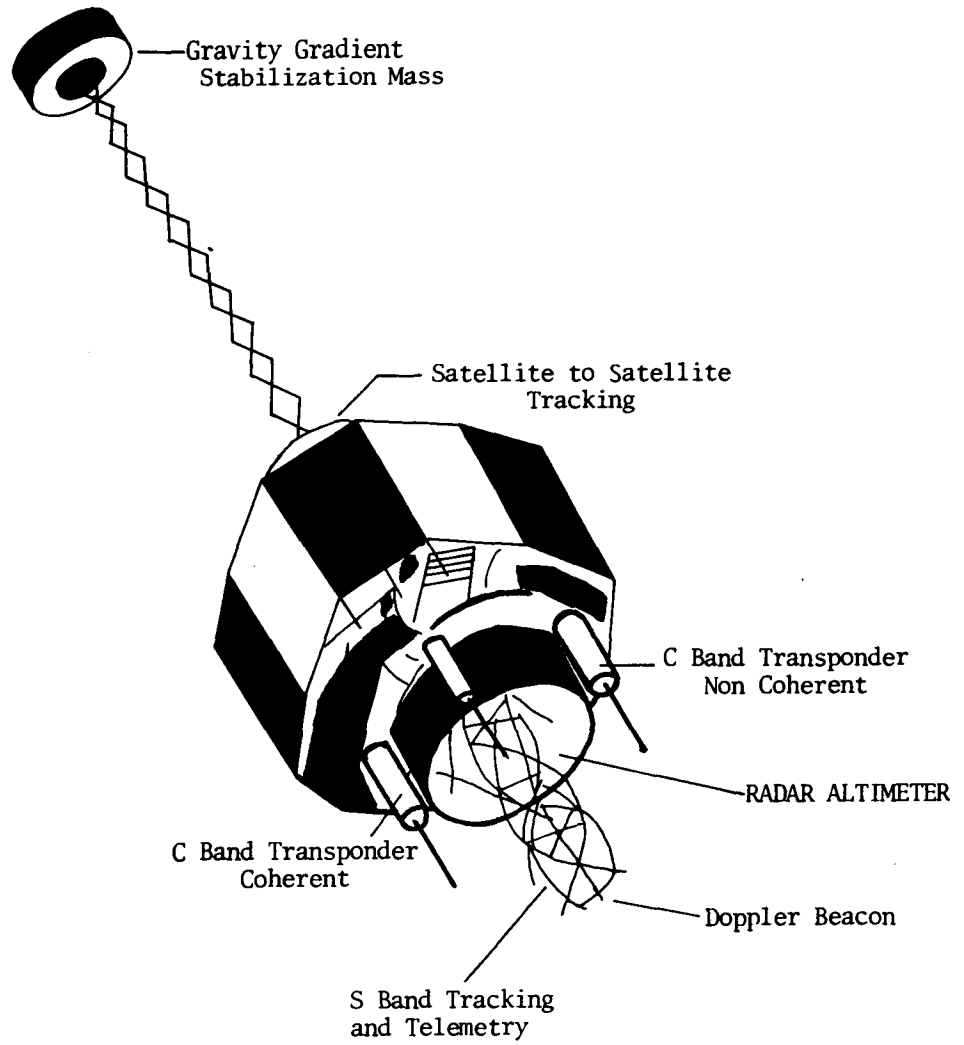

Figure 1. GEOS-3 satellite.

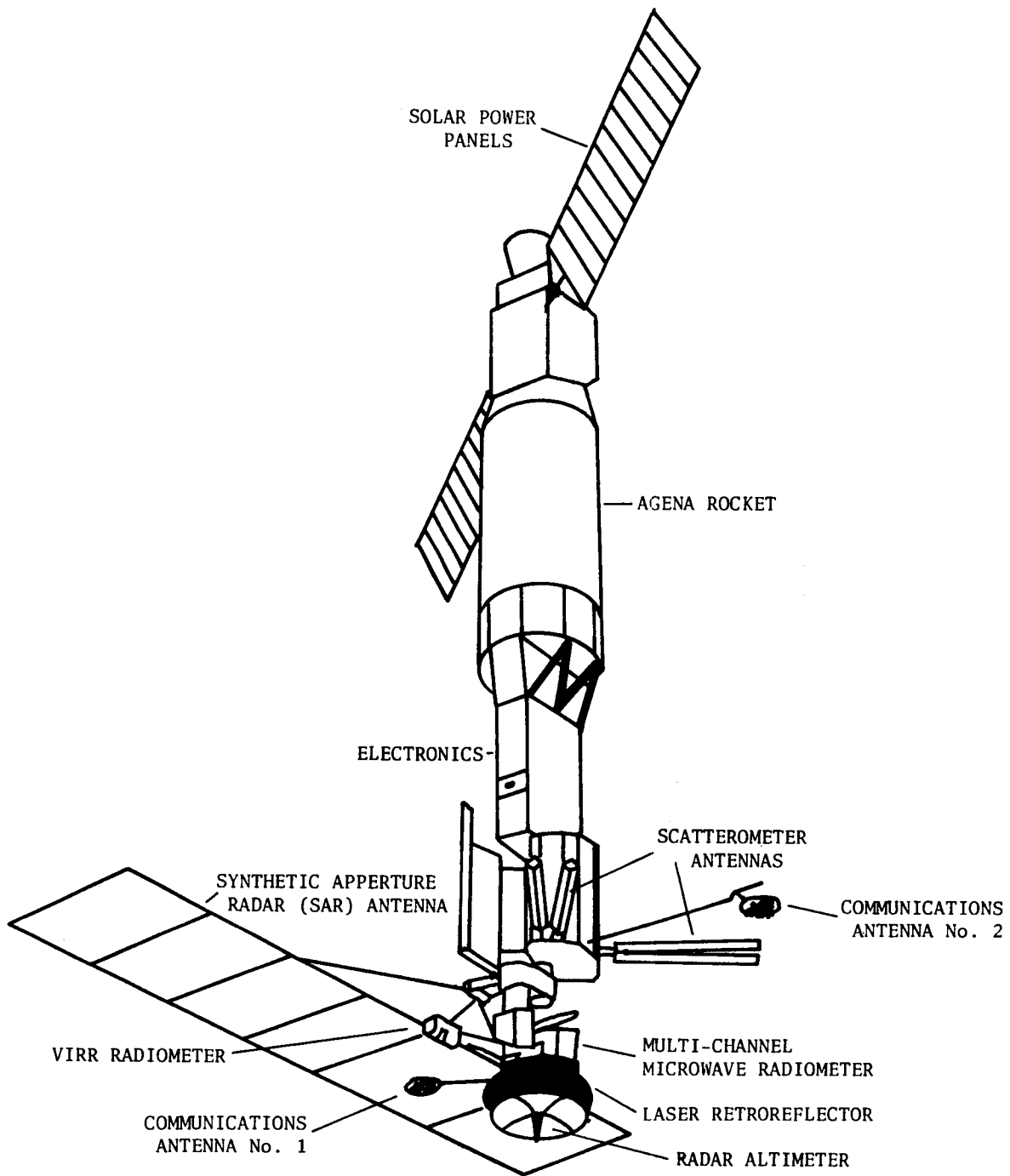

Figure 2. SEASAT satellite.

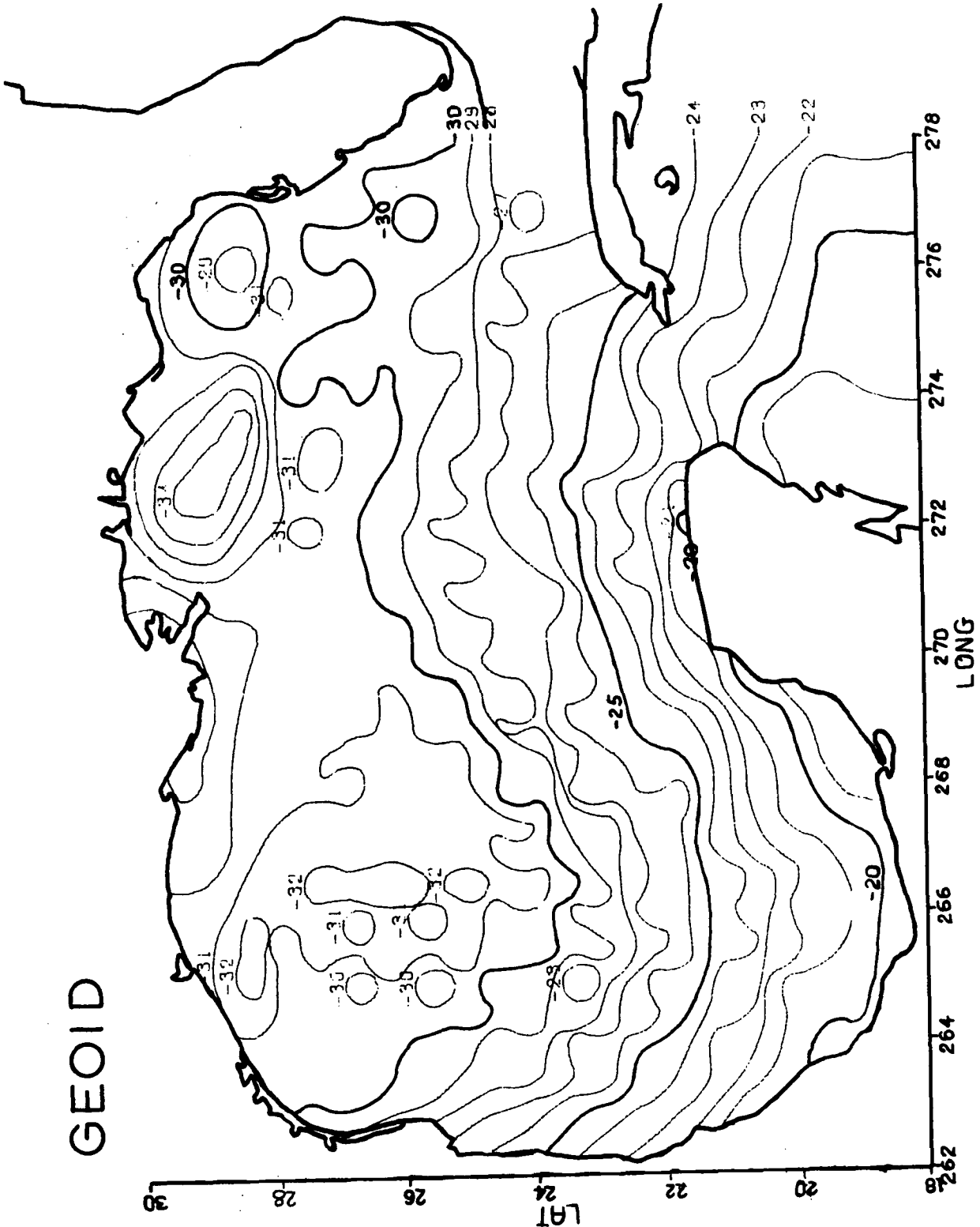

Figure 3. Geoid heights from DMA's Gulf of Mexico 30' x 30' geoid (in meters).

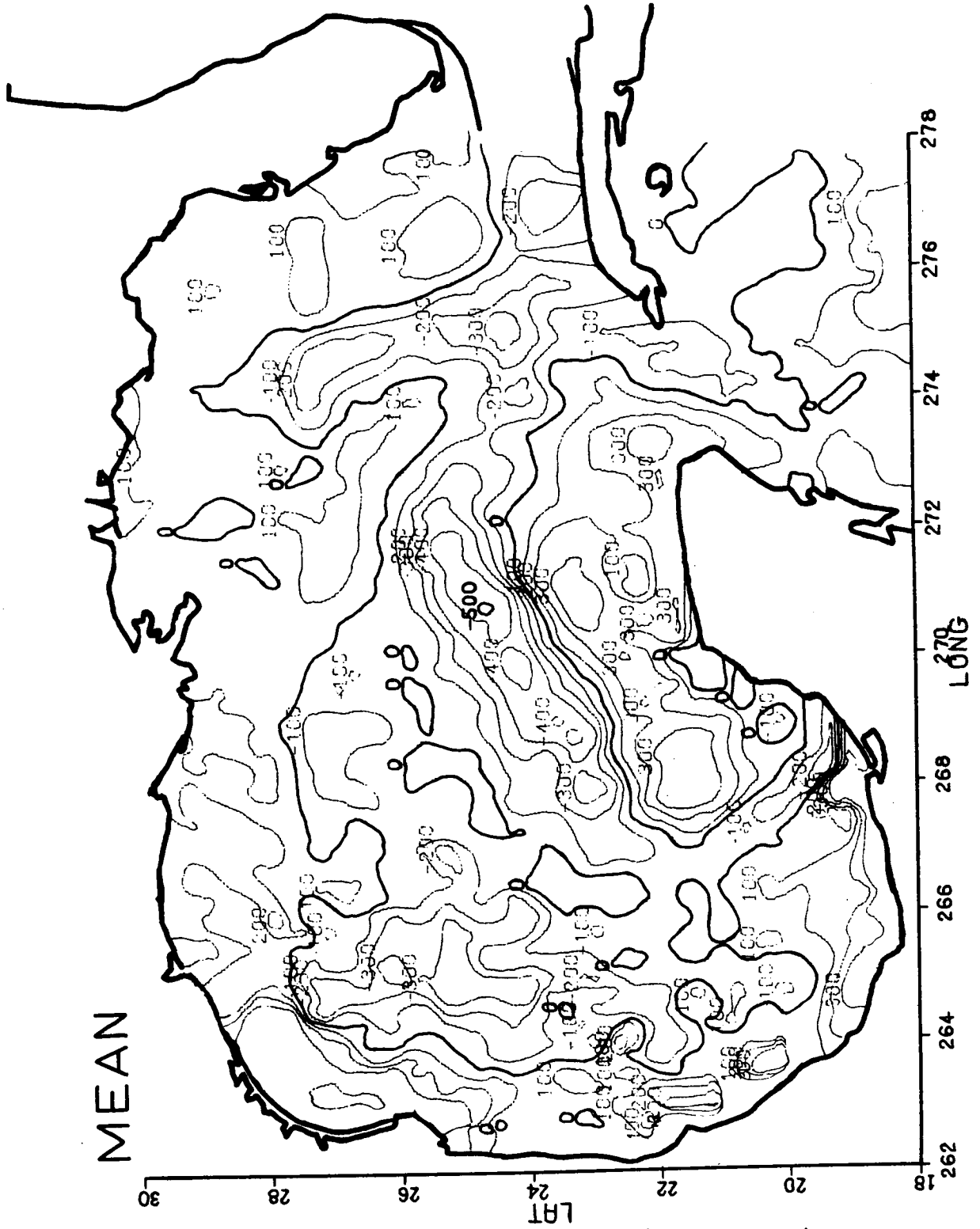

Figure 4. Mean sea surface topography (in centimeters).

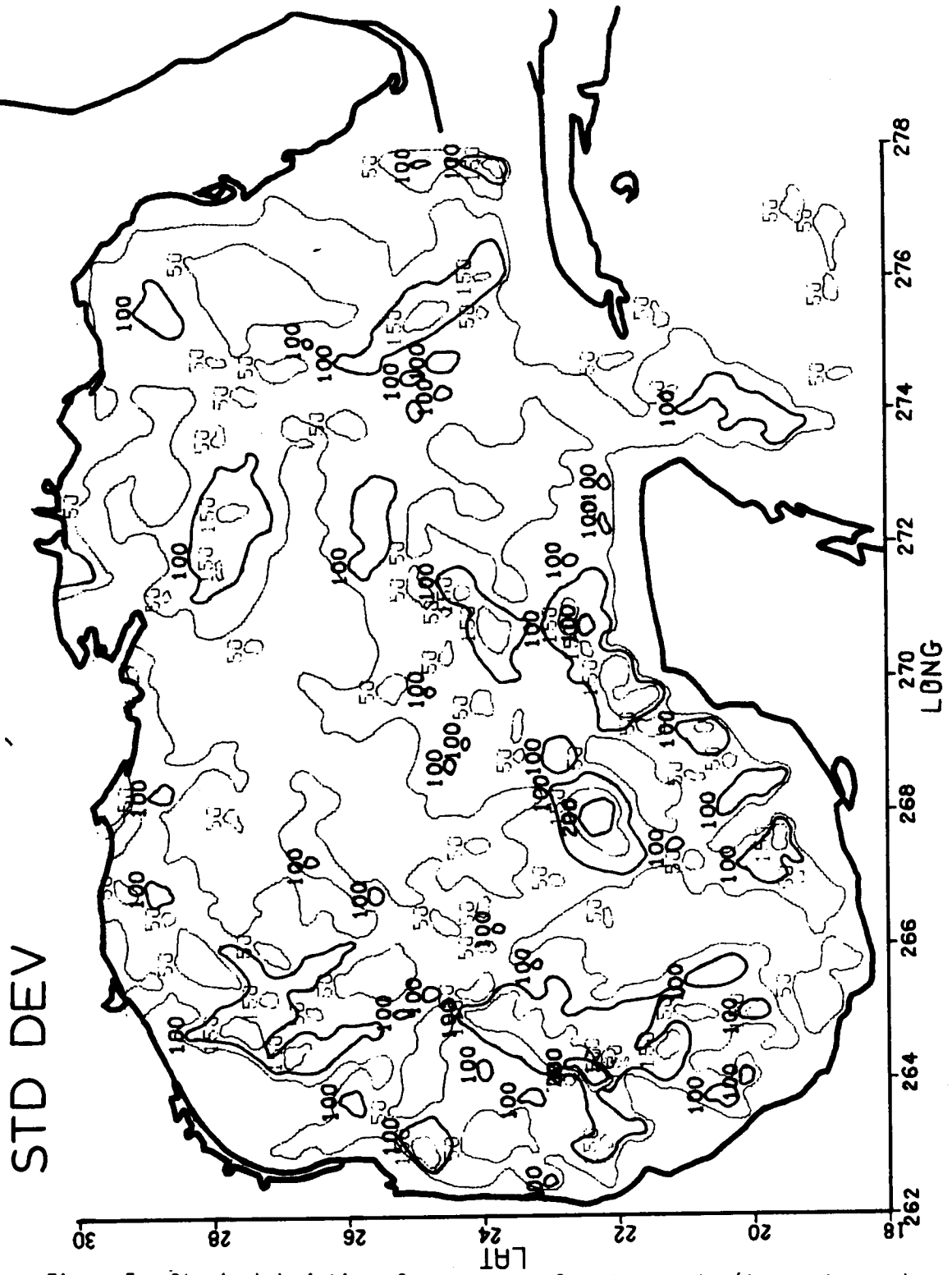

Figure 5. Standard deviation of mean sea surface topography (in centimeters).

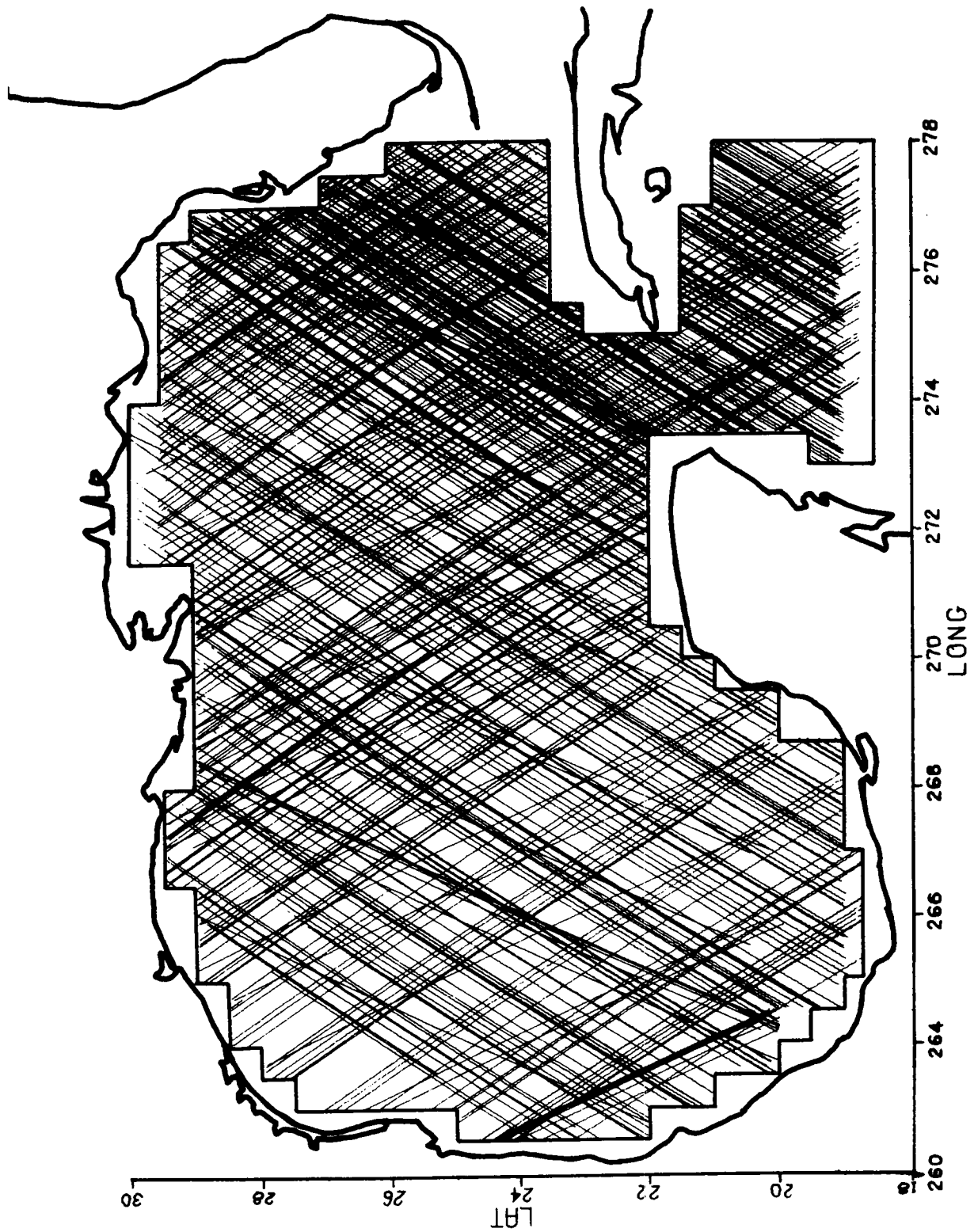

Figure 6. Altimeter coverage for the Gulf of Mexico.

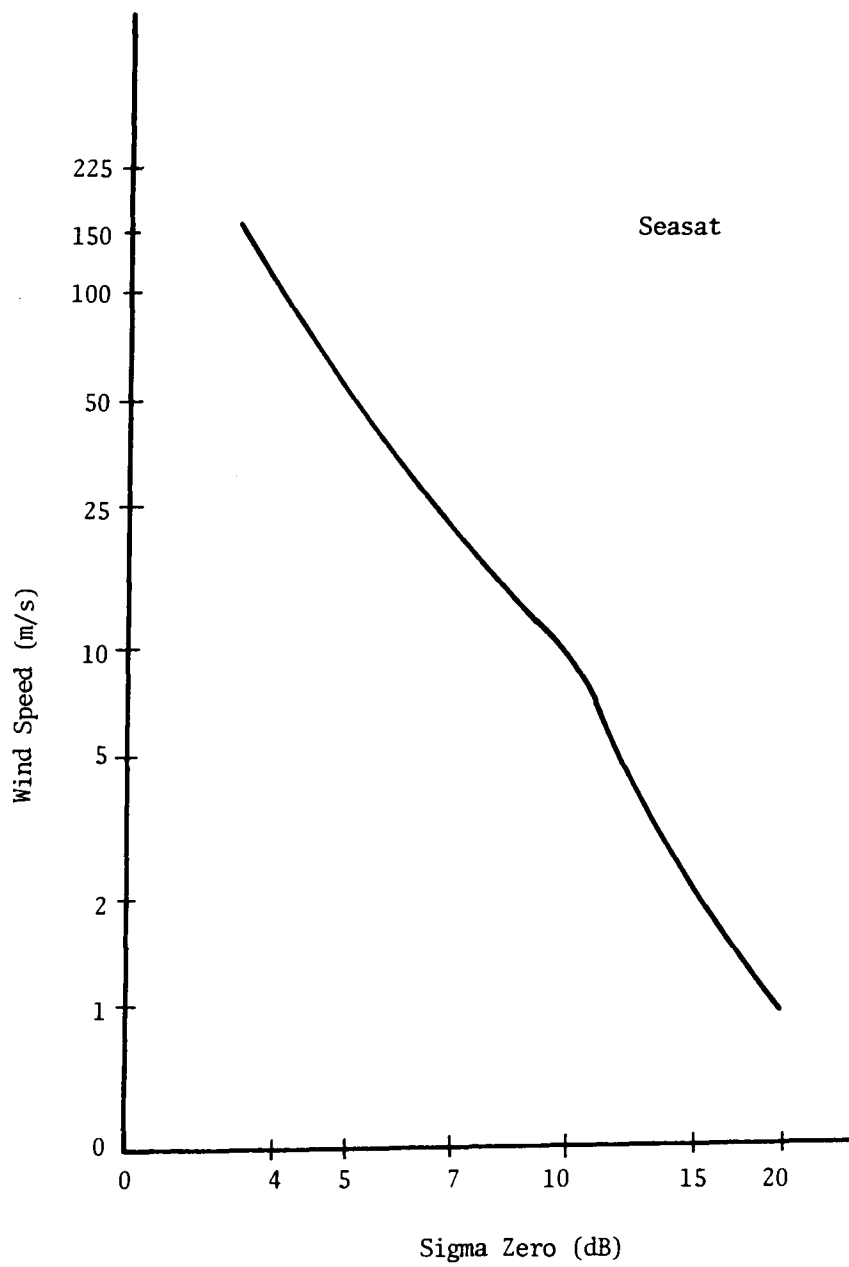

Figure 7. SEASAT.

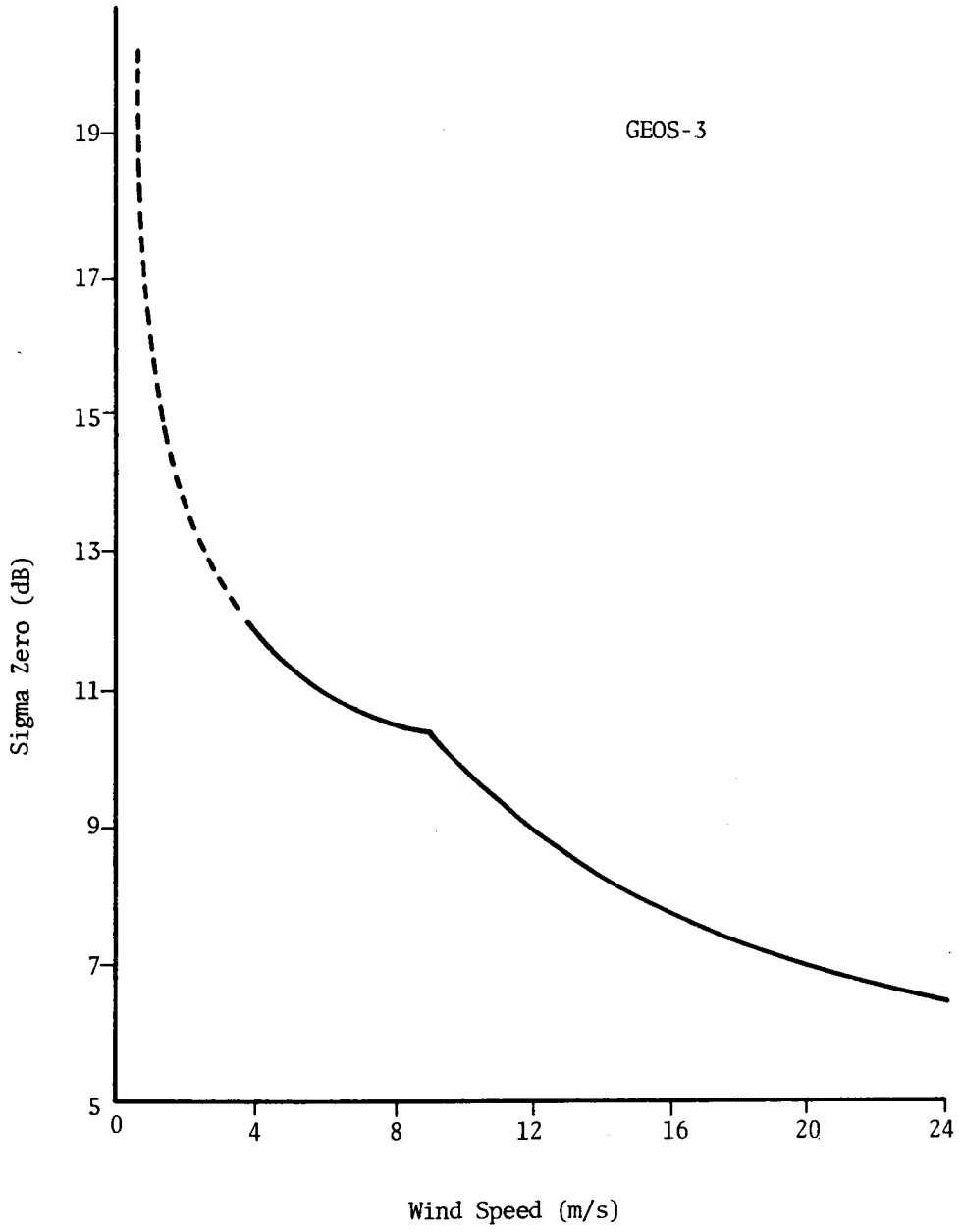

Figure 8. GEOS-3.

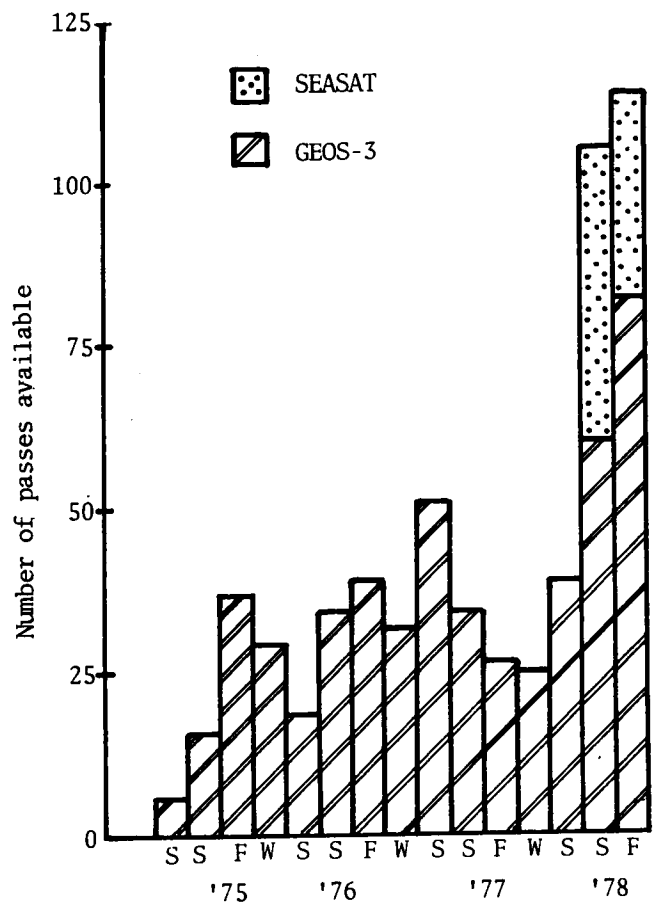

Figure 9. Seasonal frequency distribution of altimeter passes over the Gulf of Mexico.

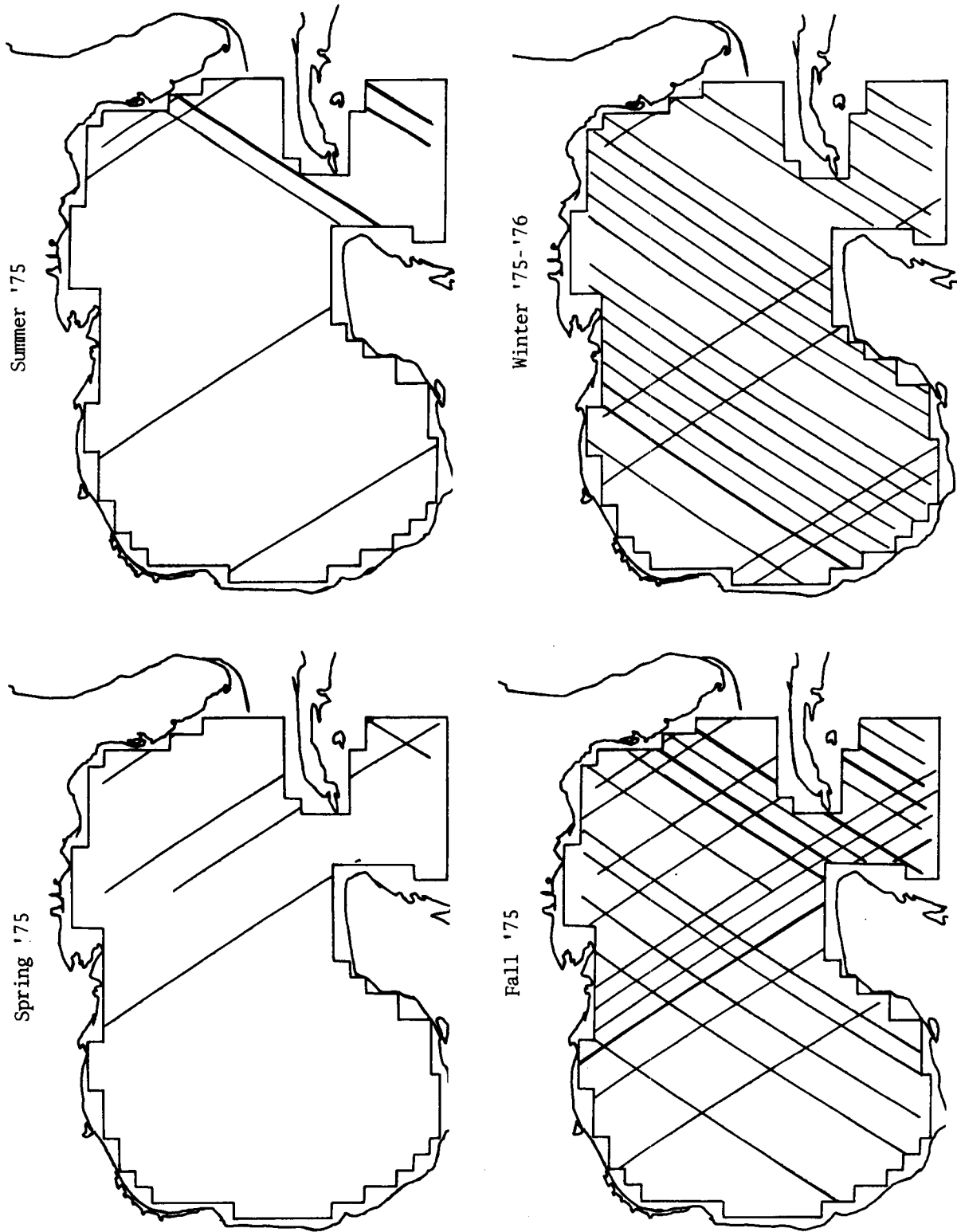

Figure 10. Seasonal coverage Spring, Summer, Fall '75, Winter '75 - '76.

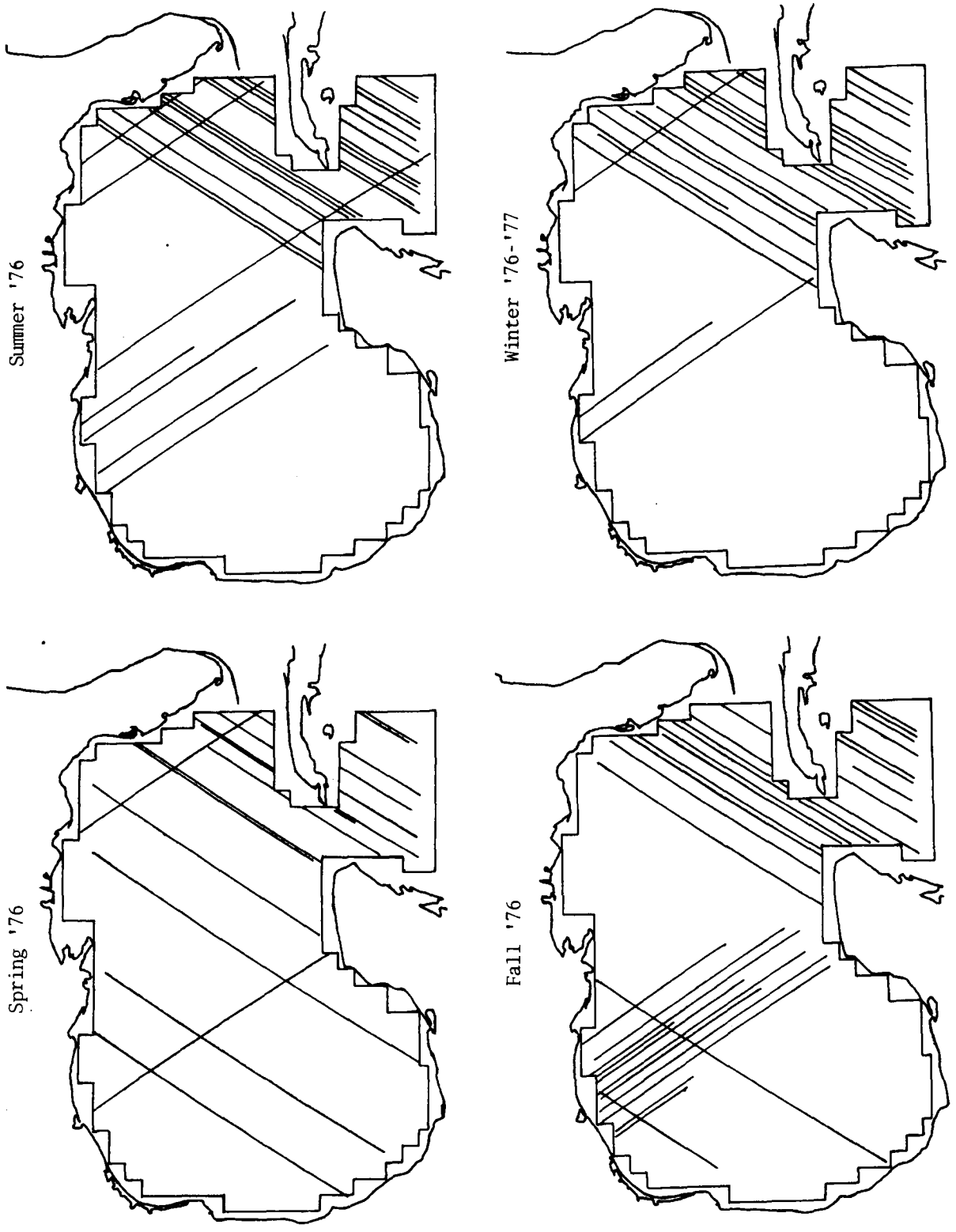

Figure 11. Seasonal coverage Spring, Summer, Fall '76, Winter '76, '77.

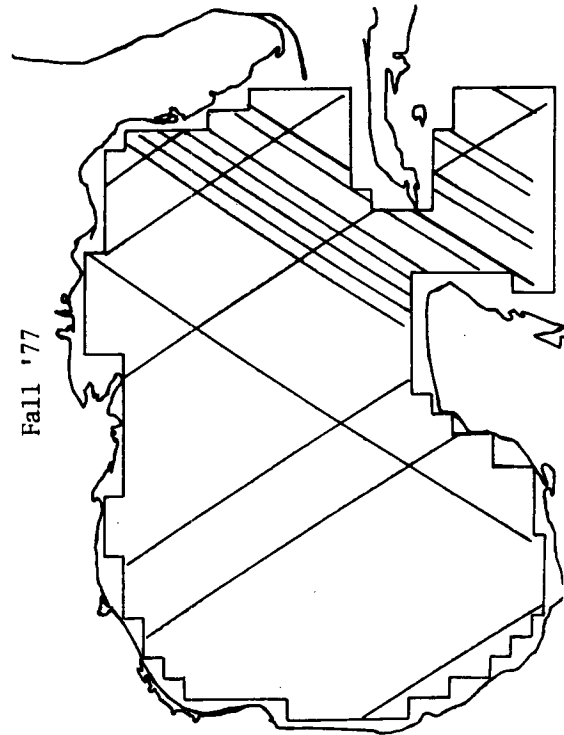
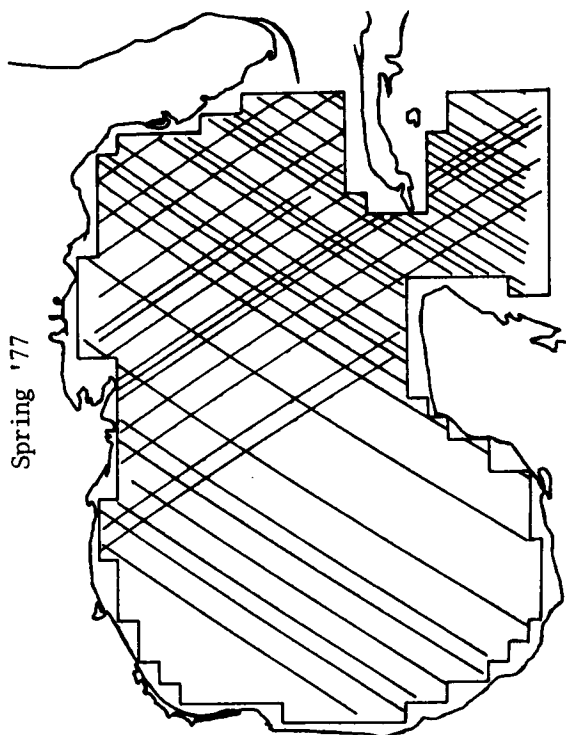
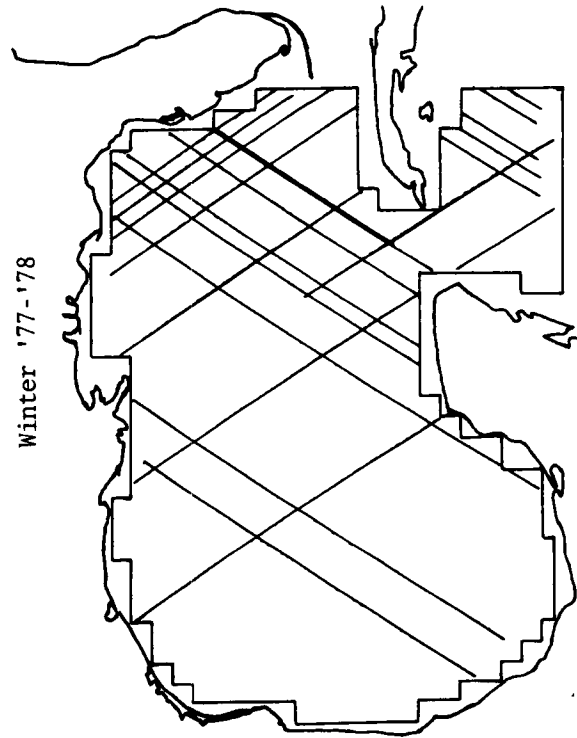
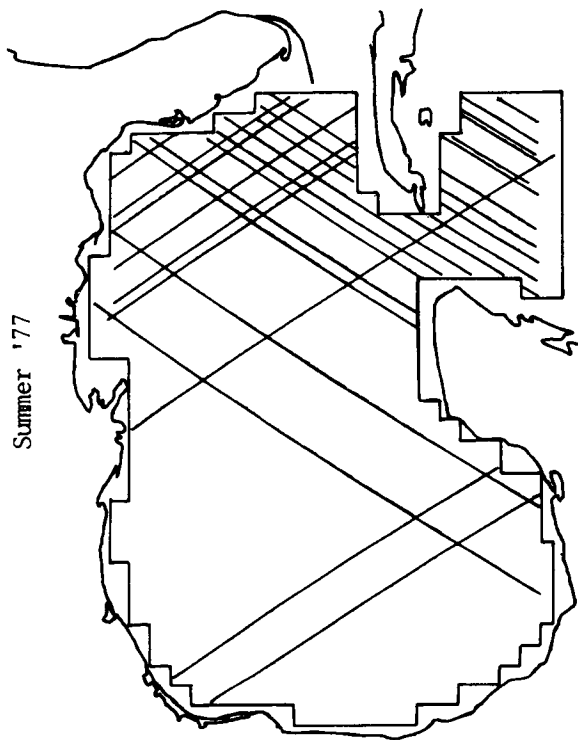

Figure 12. Seasonal coverage Spring, Summer, Fall '77, Winter '77 - '78.

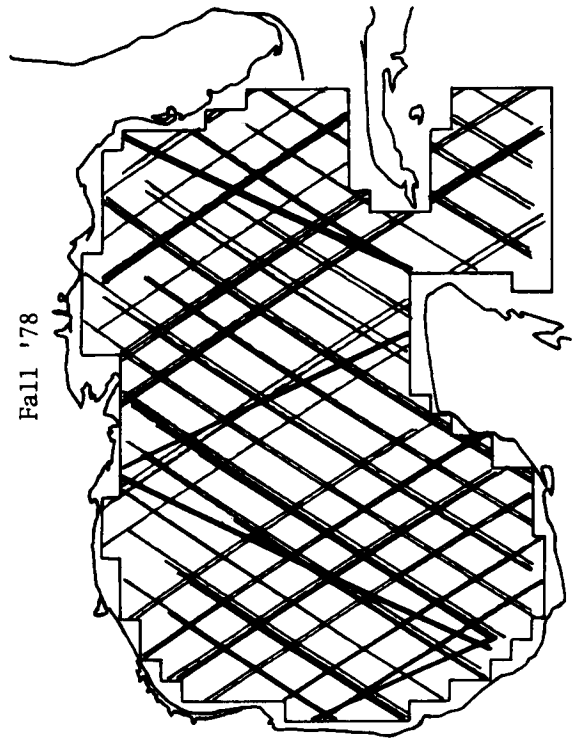
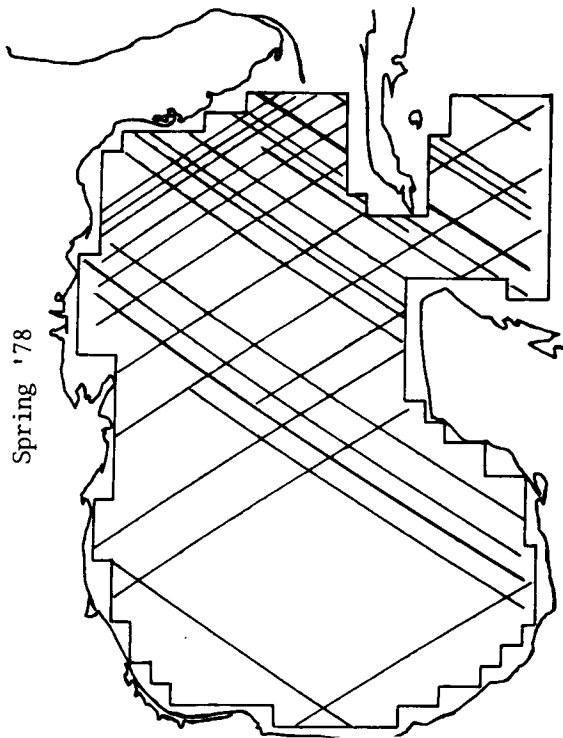
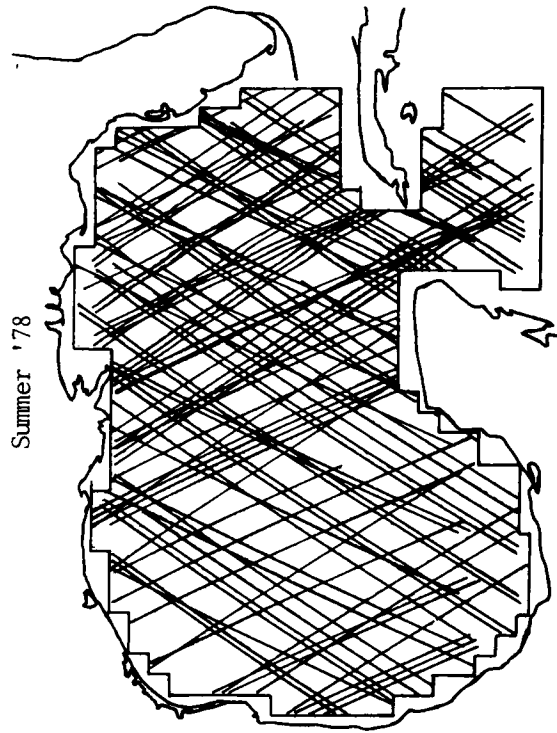

Figure 13. Seasonal coverage Spring, Summer, Fall '78.

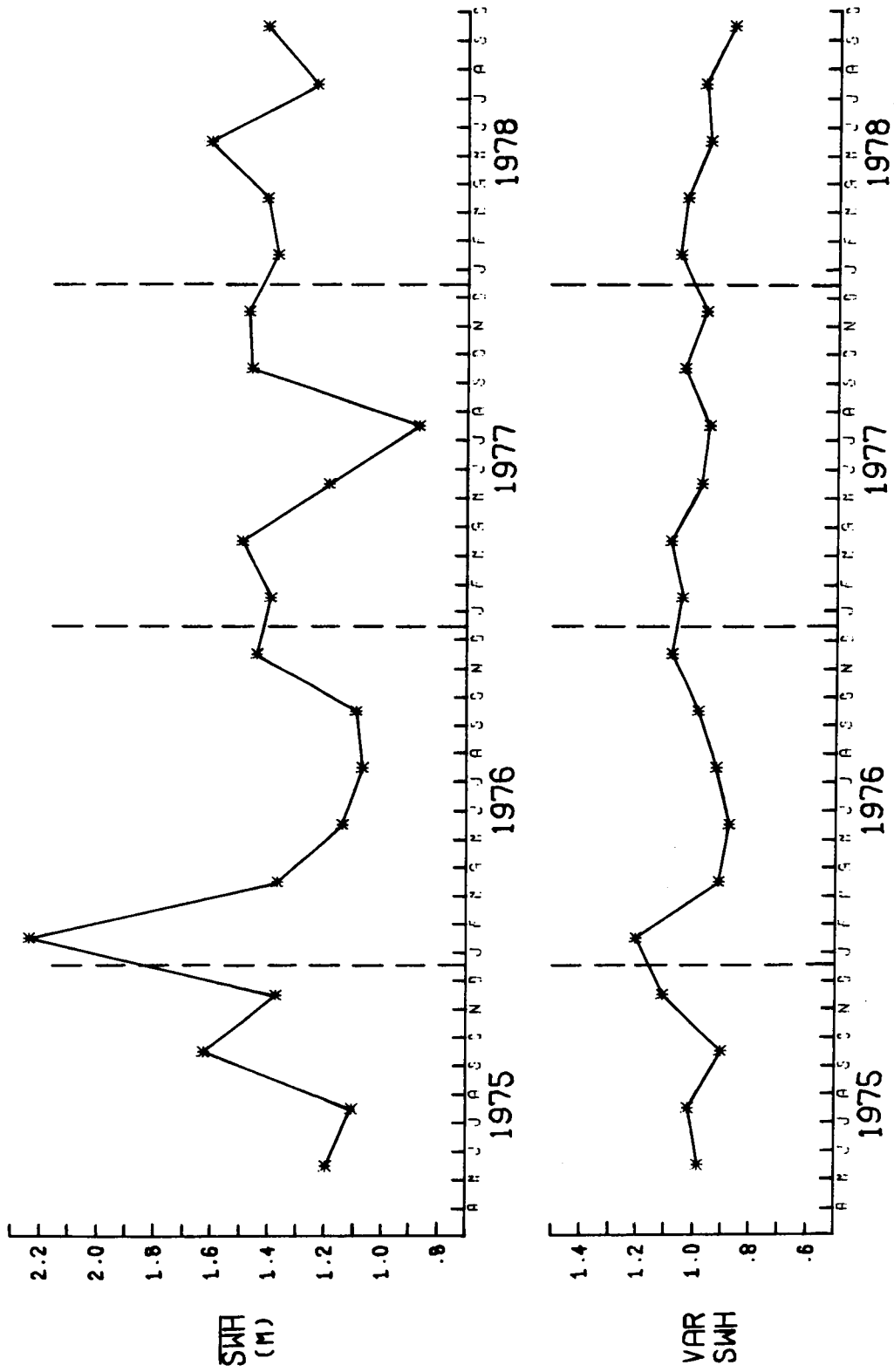

Figure 14. Monthly distribution of the mean significant wave height and its variation.

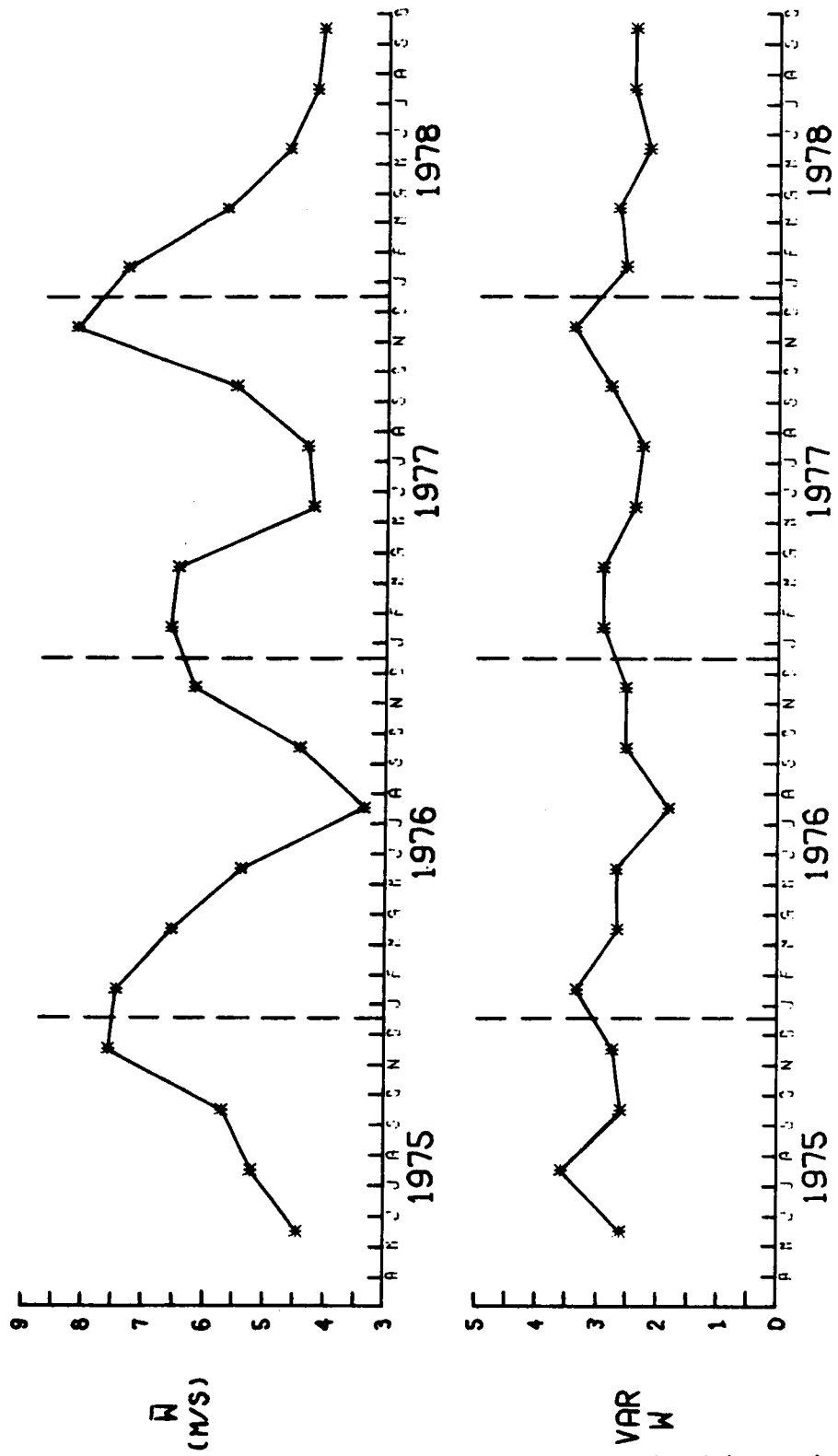

Figure 15. Monthly distribution of the mean surface wind speed and its variation.

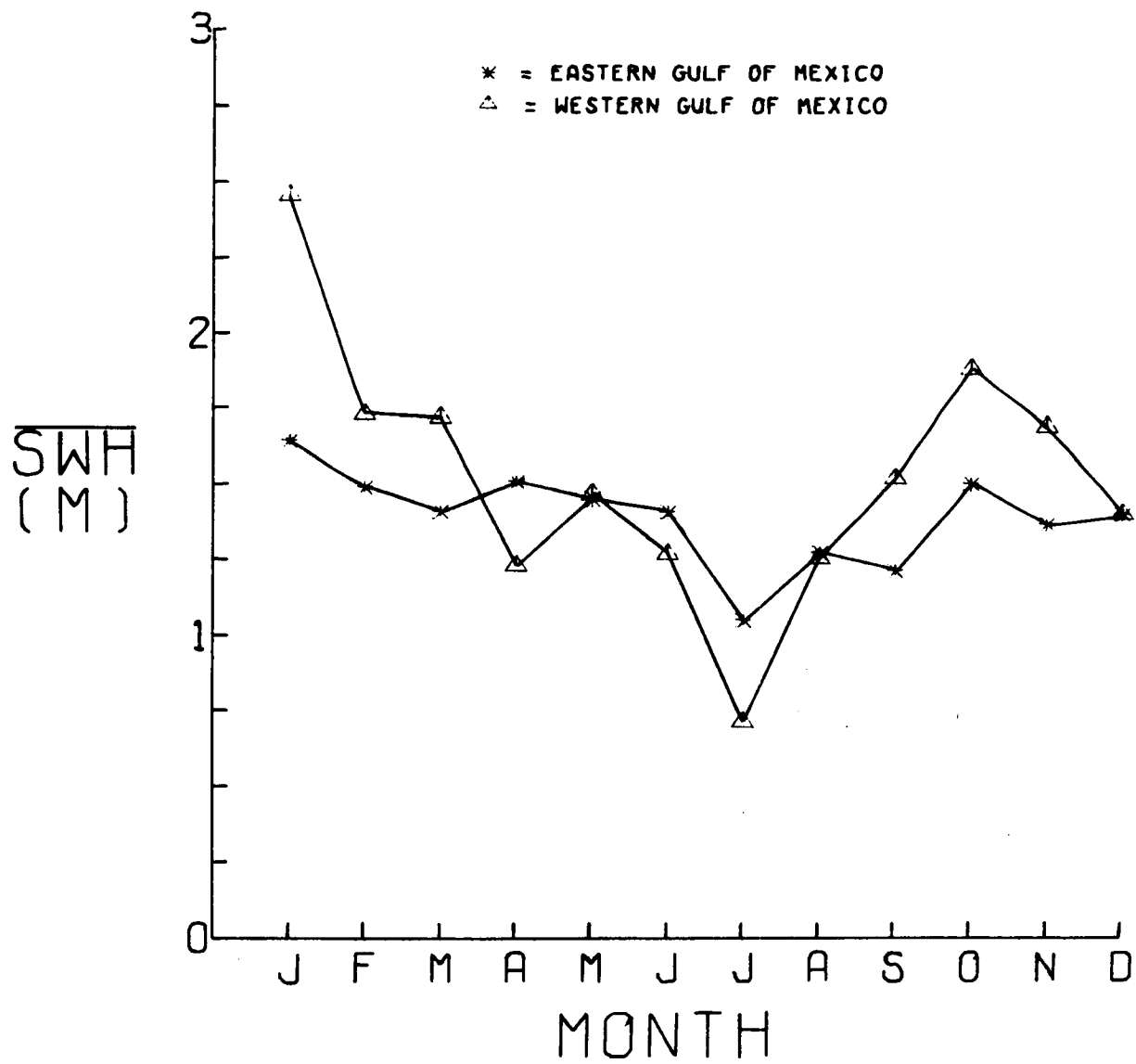

Figure 16. Average monthly significant wave height for the eastern and western Gulf.

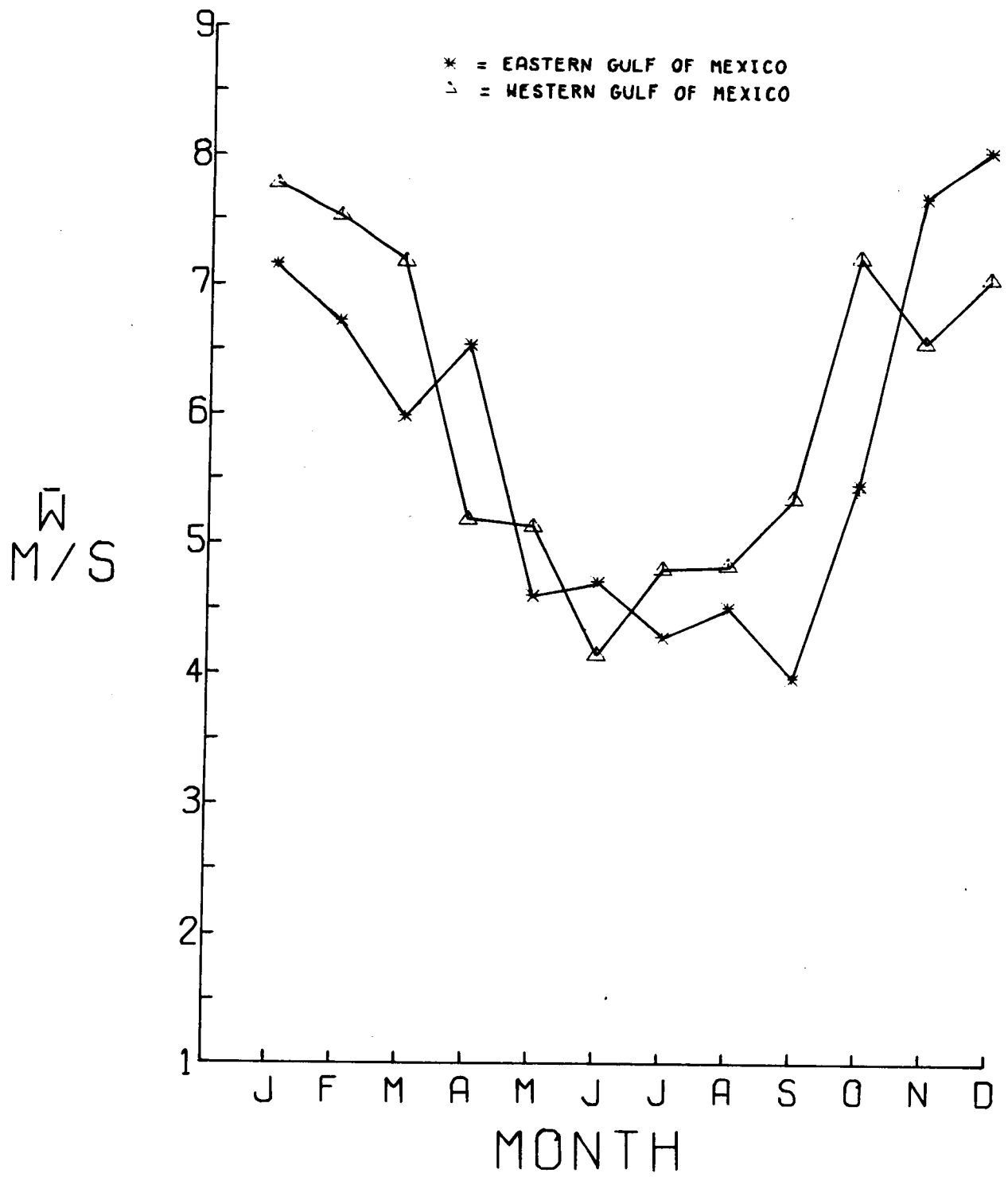

Figure 17. Average monthly surface wind speed for the eastern and western Gulf.

APPENDIX A

SEA SURFACE TOPOGRAPHIC MAPS

Spring 1975.	A1
Summer 1975.	A2
Fall 1975.	A3
Winter 1975-76	A4
Spring 1976.	A5
Summer 1976.	A6
Fall 1976.	A7
Winter 1976-77	A8
Spring 1977.	A9
Summer 1977.	A10
Fall 1977.	A11
Winter 1977-78	A12
Spring 1978.	A13
Summer 1978.	A14
Fall 1978.	A15

SPRING '75

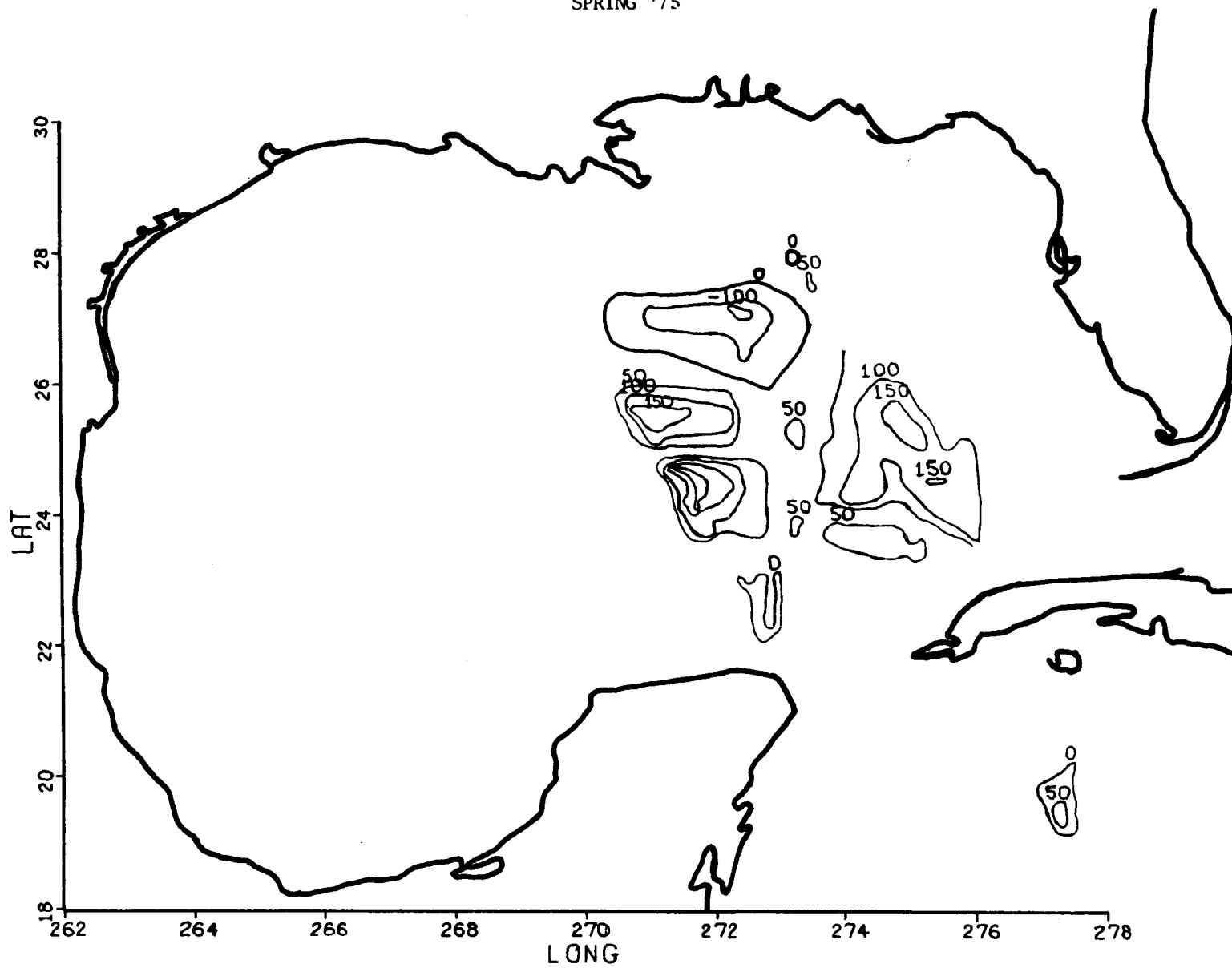

A-1

SUMMER '75

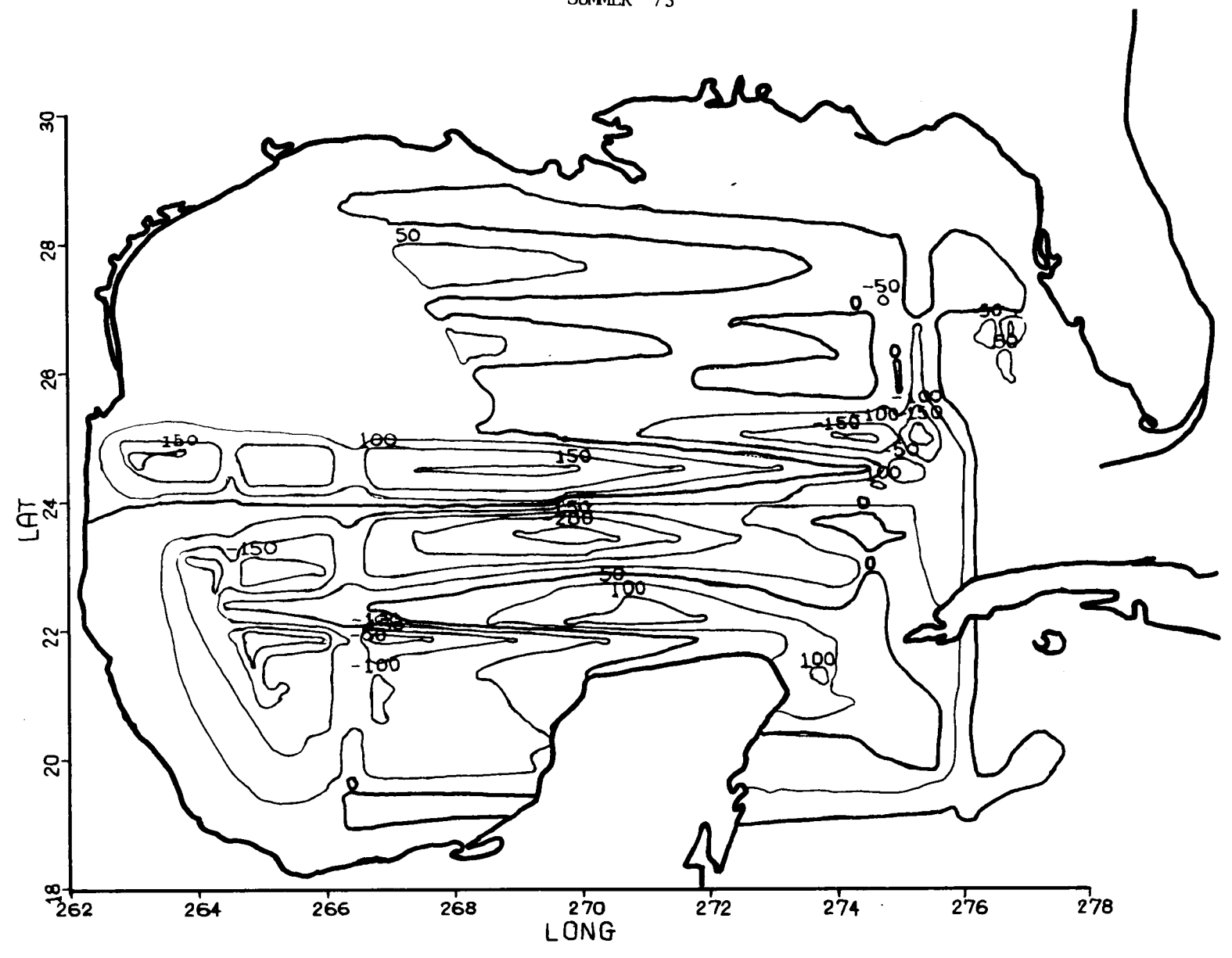

FALL '75

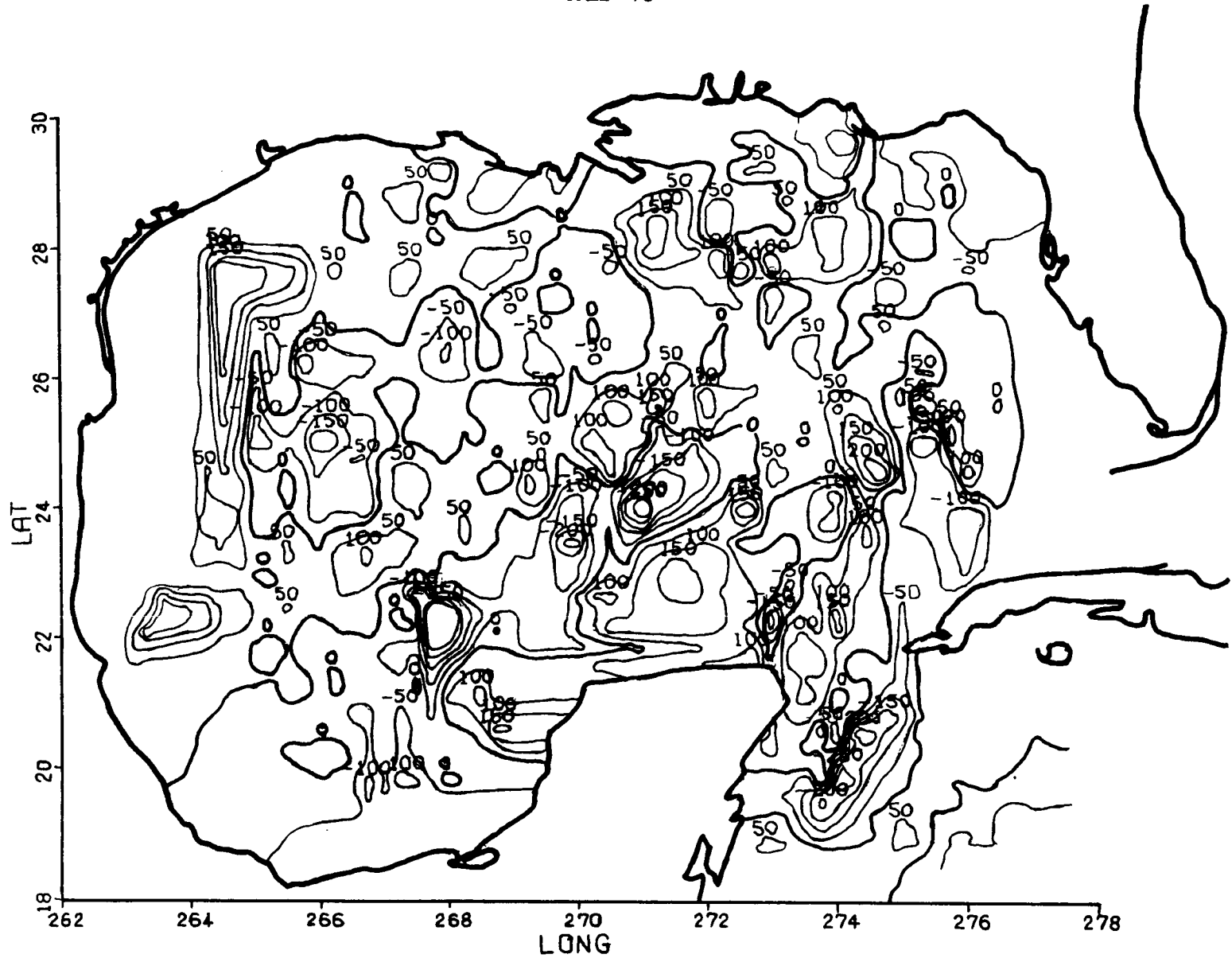

A-3

WINTER '75-'76

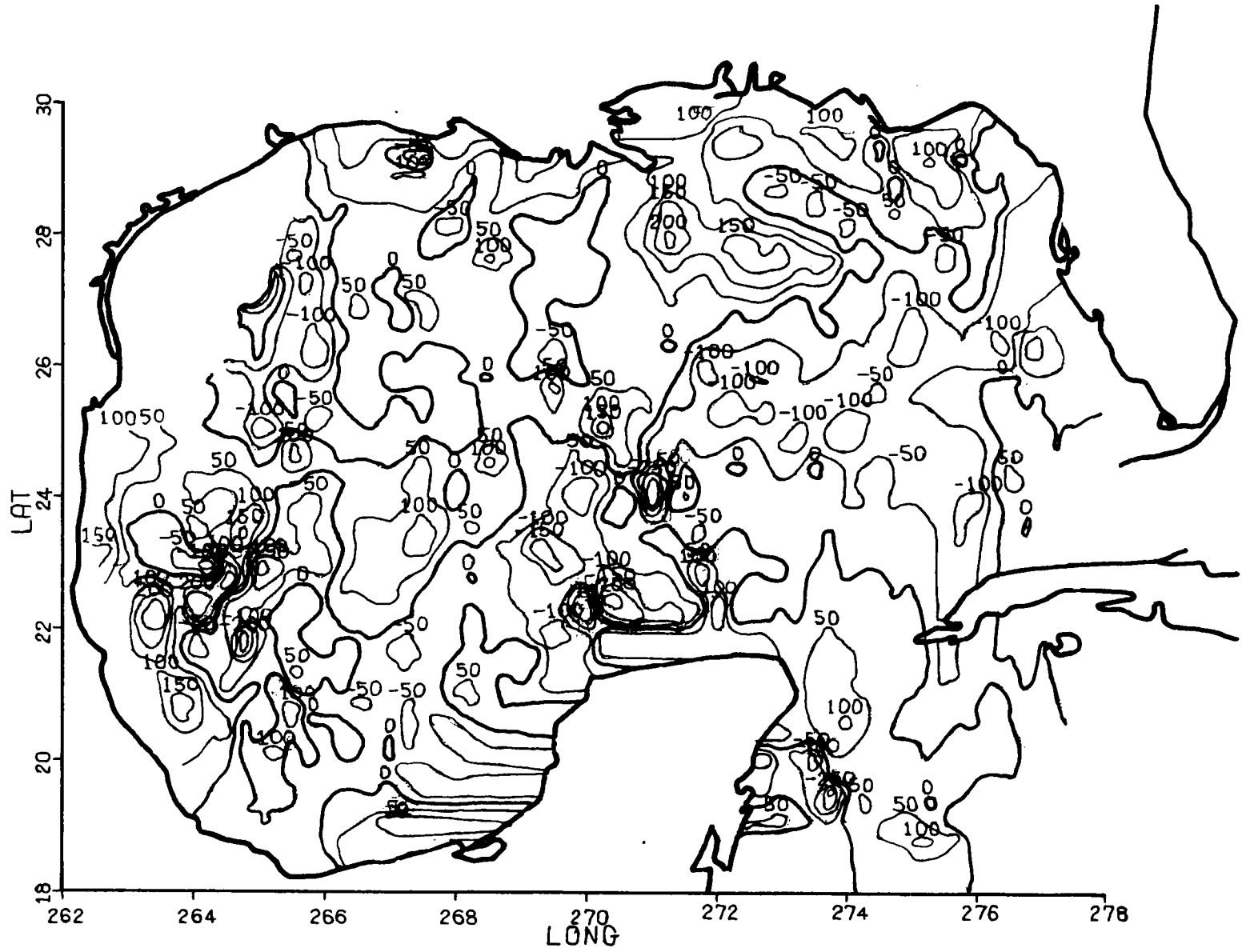

SPRING '76

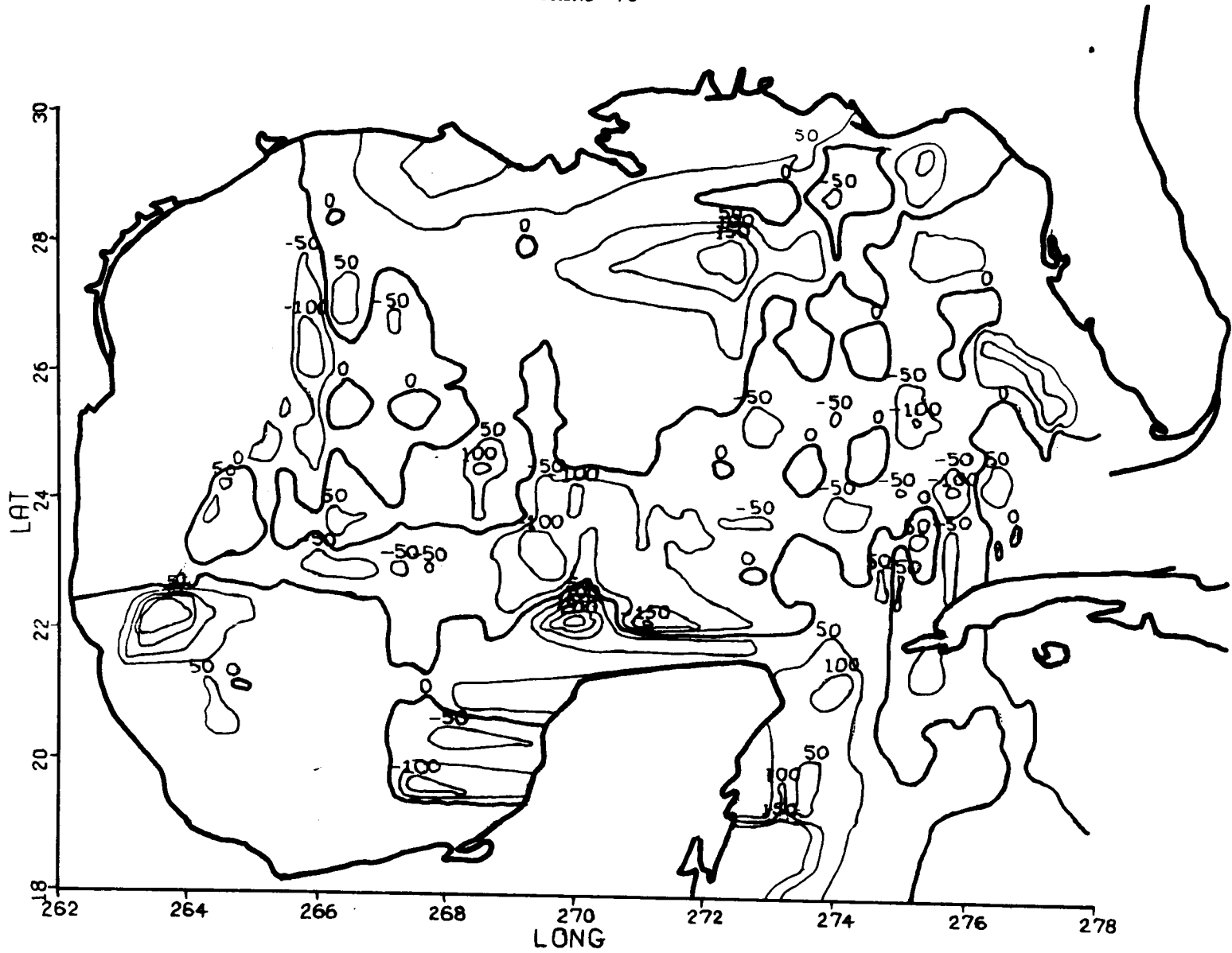

A-5

SUMMER '76

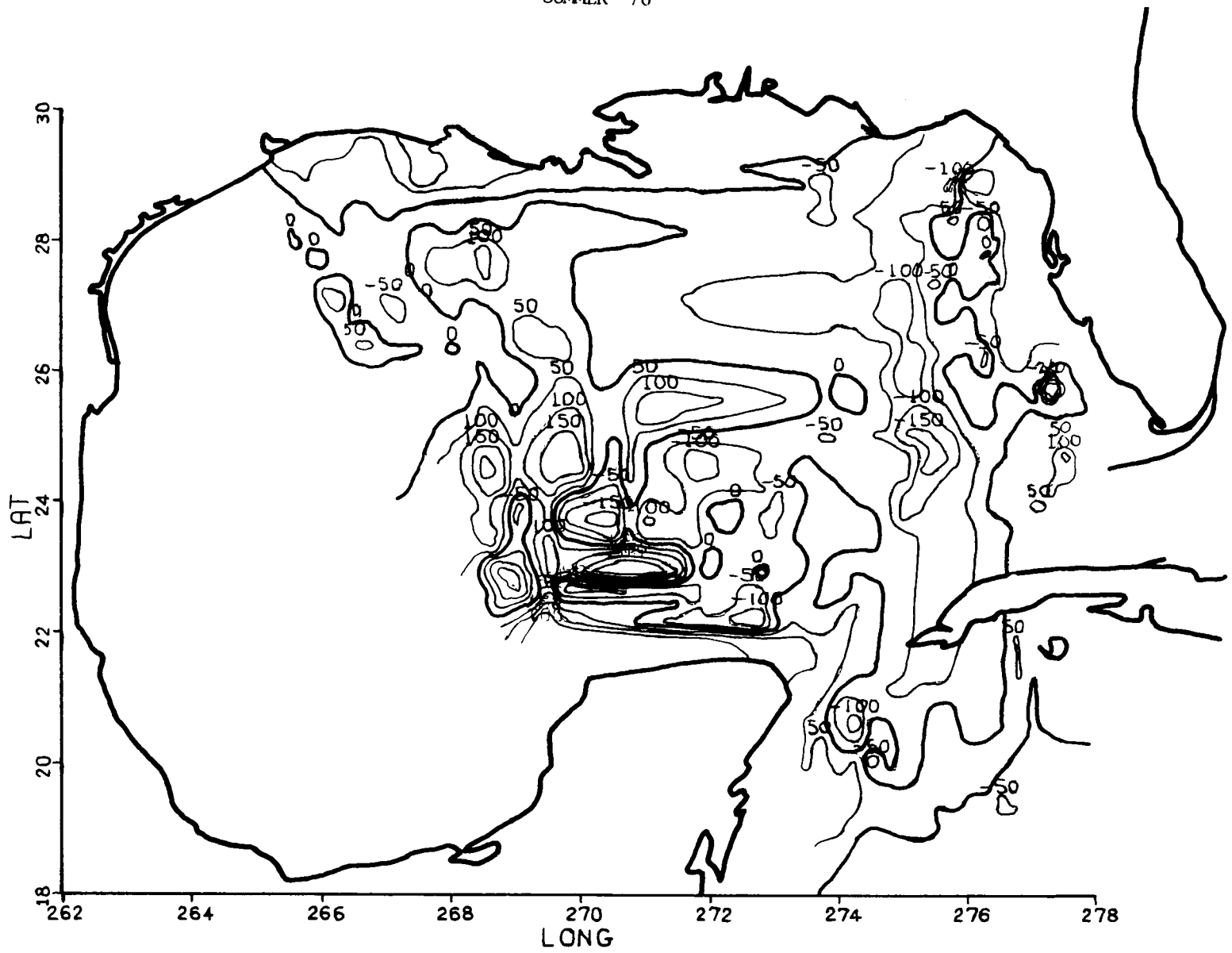

FALL '76

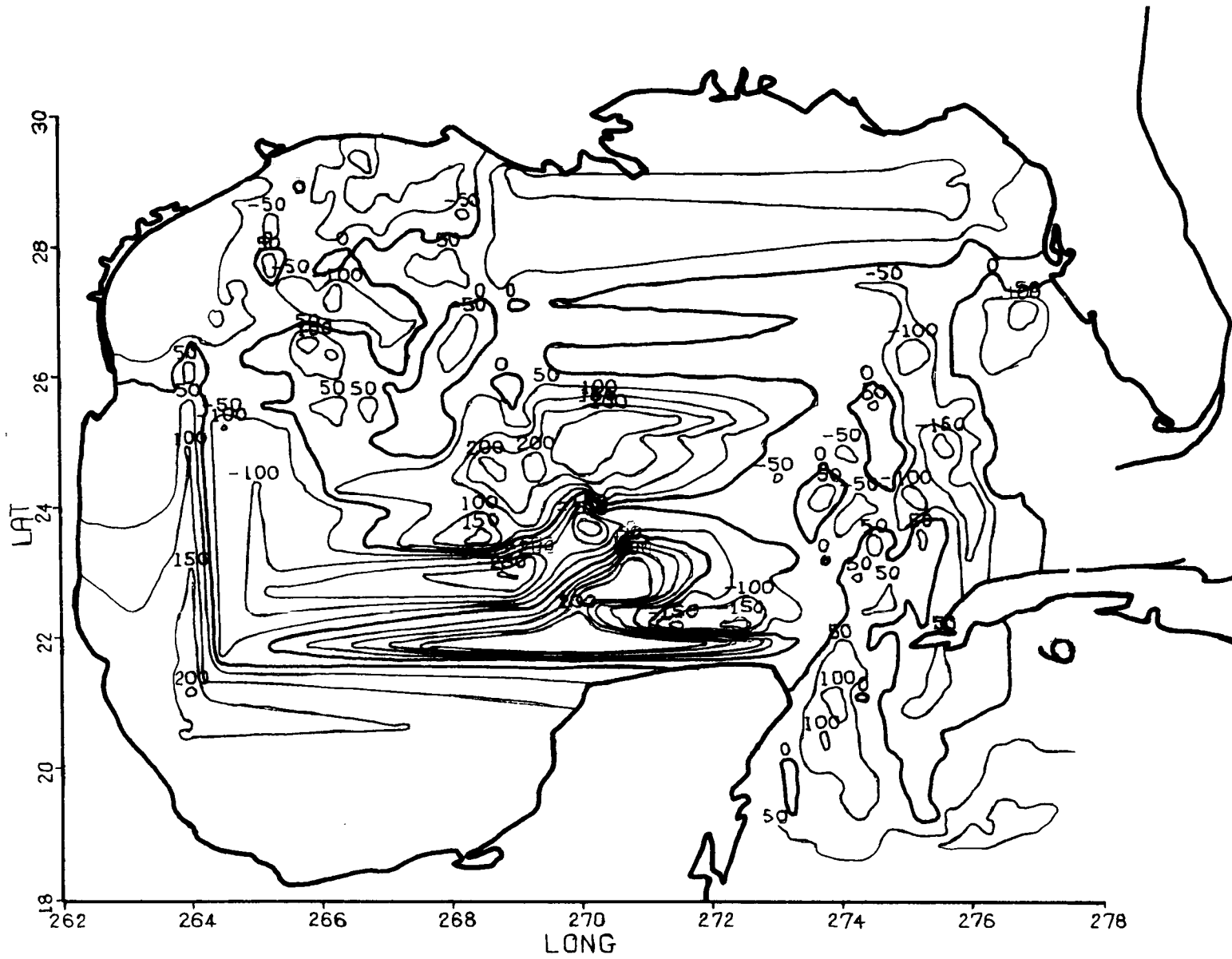

WINTER '76-'77

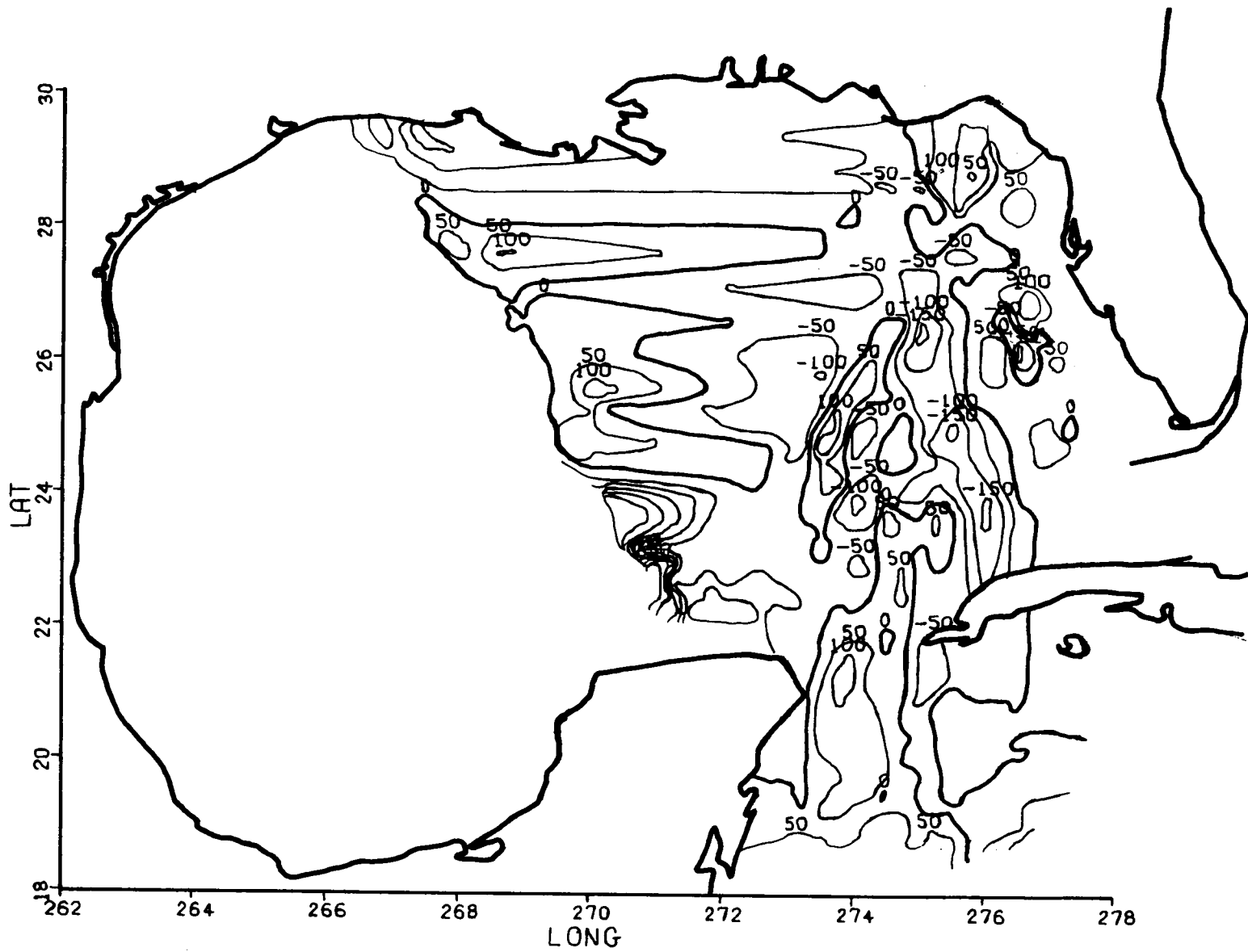

SPRING '77

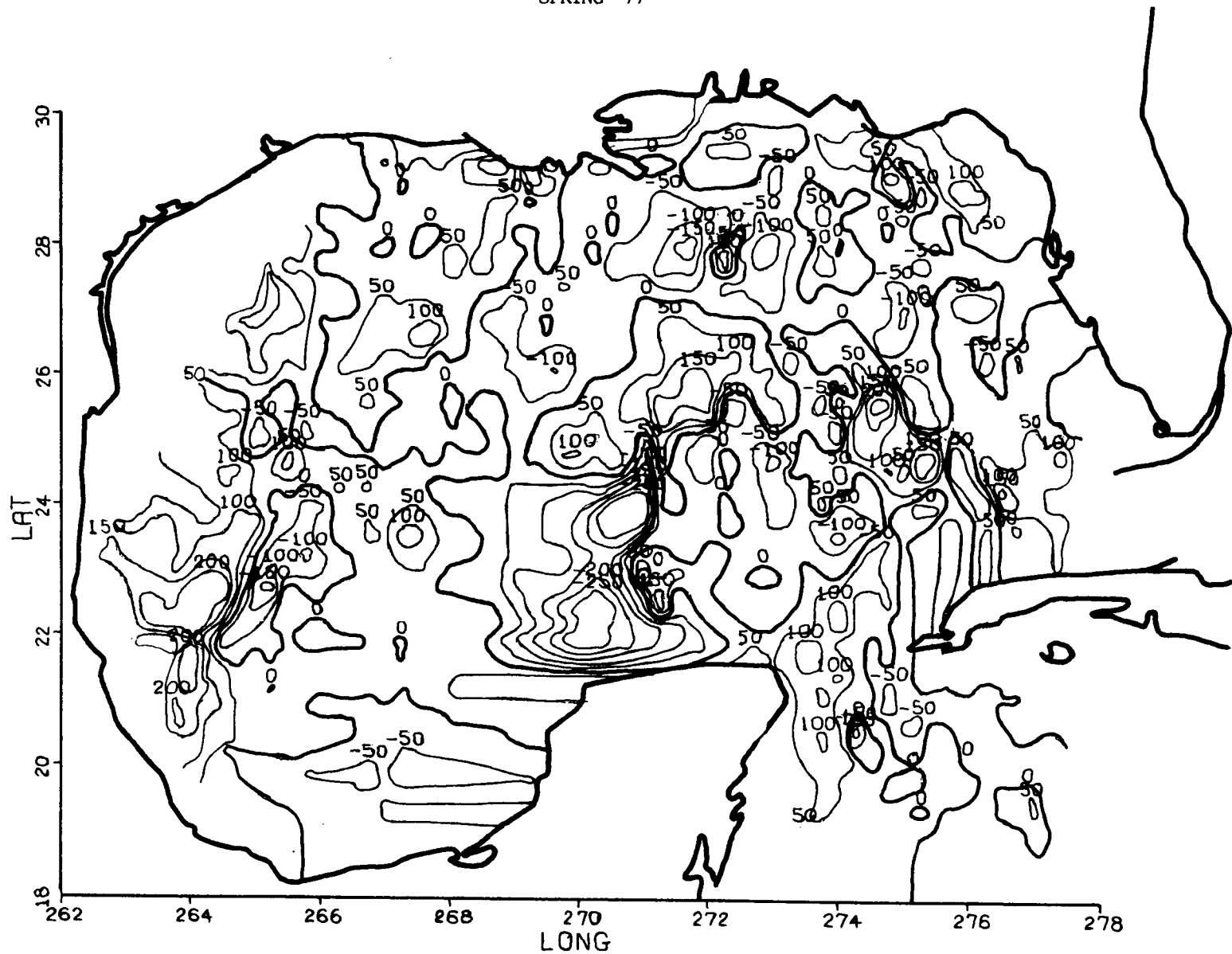

SUMMER '77

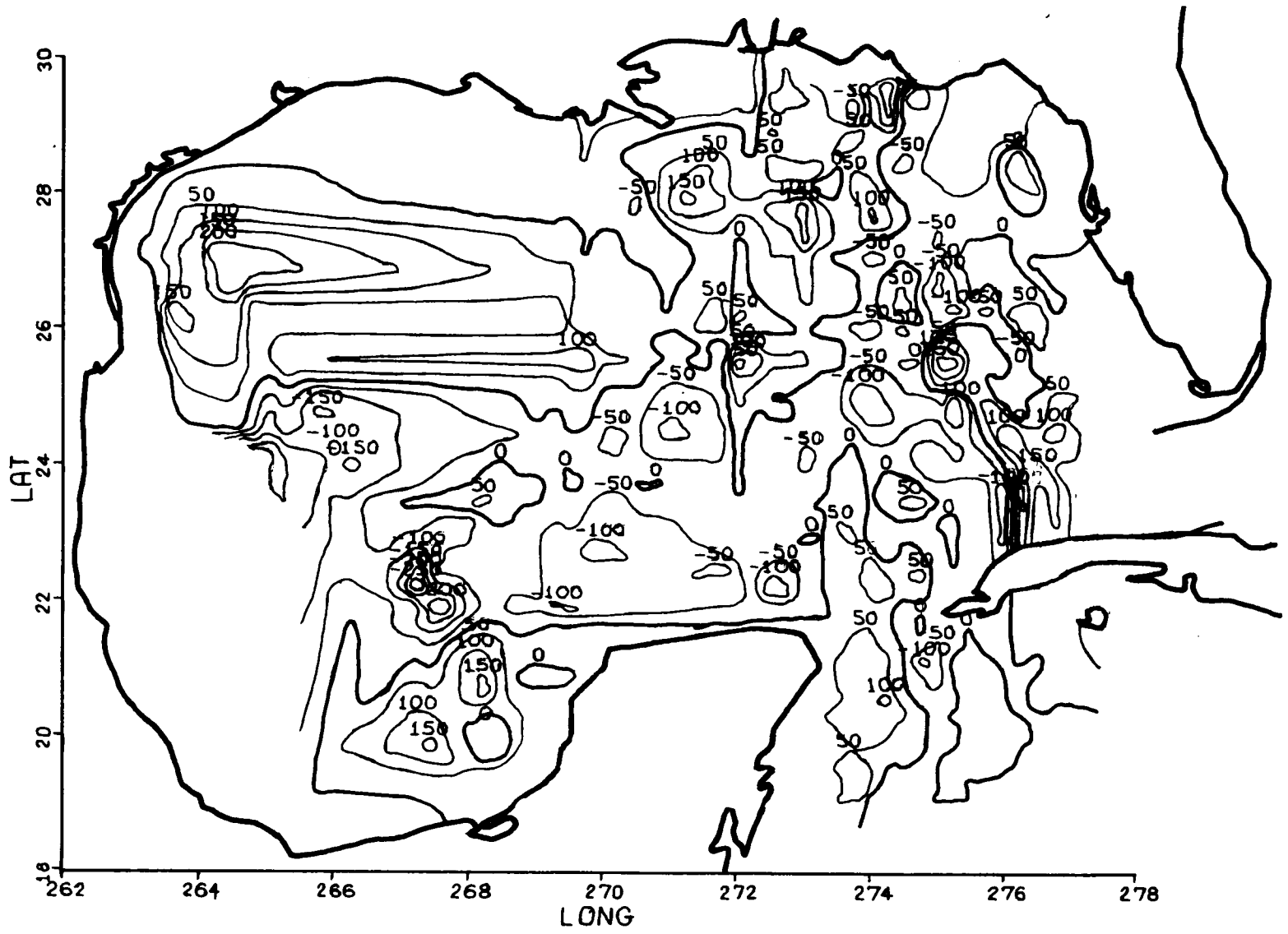

FALL '77

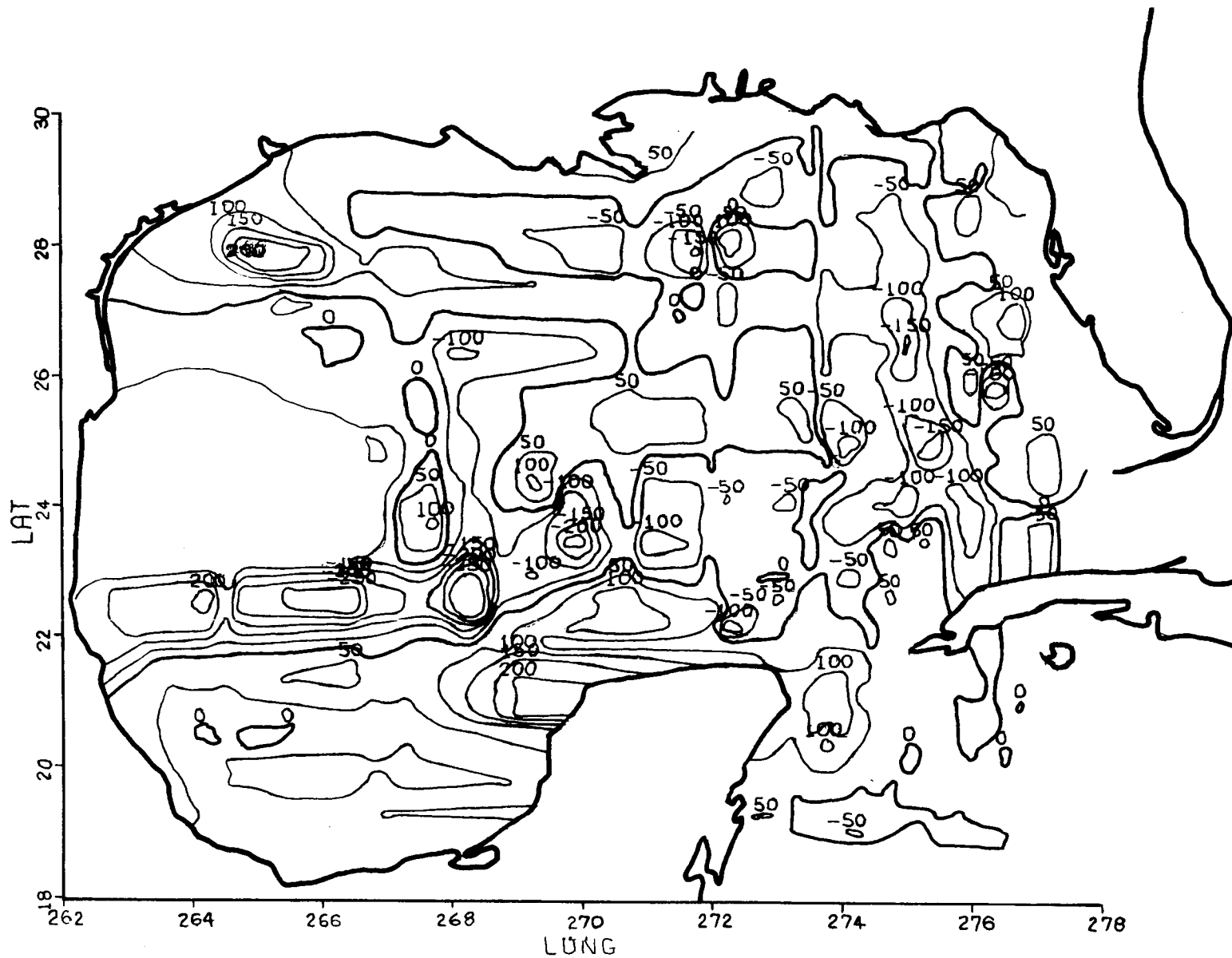

A-11

WINTER '77-'78

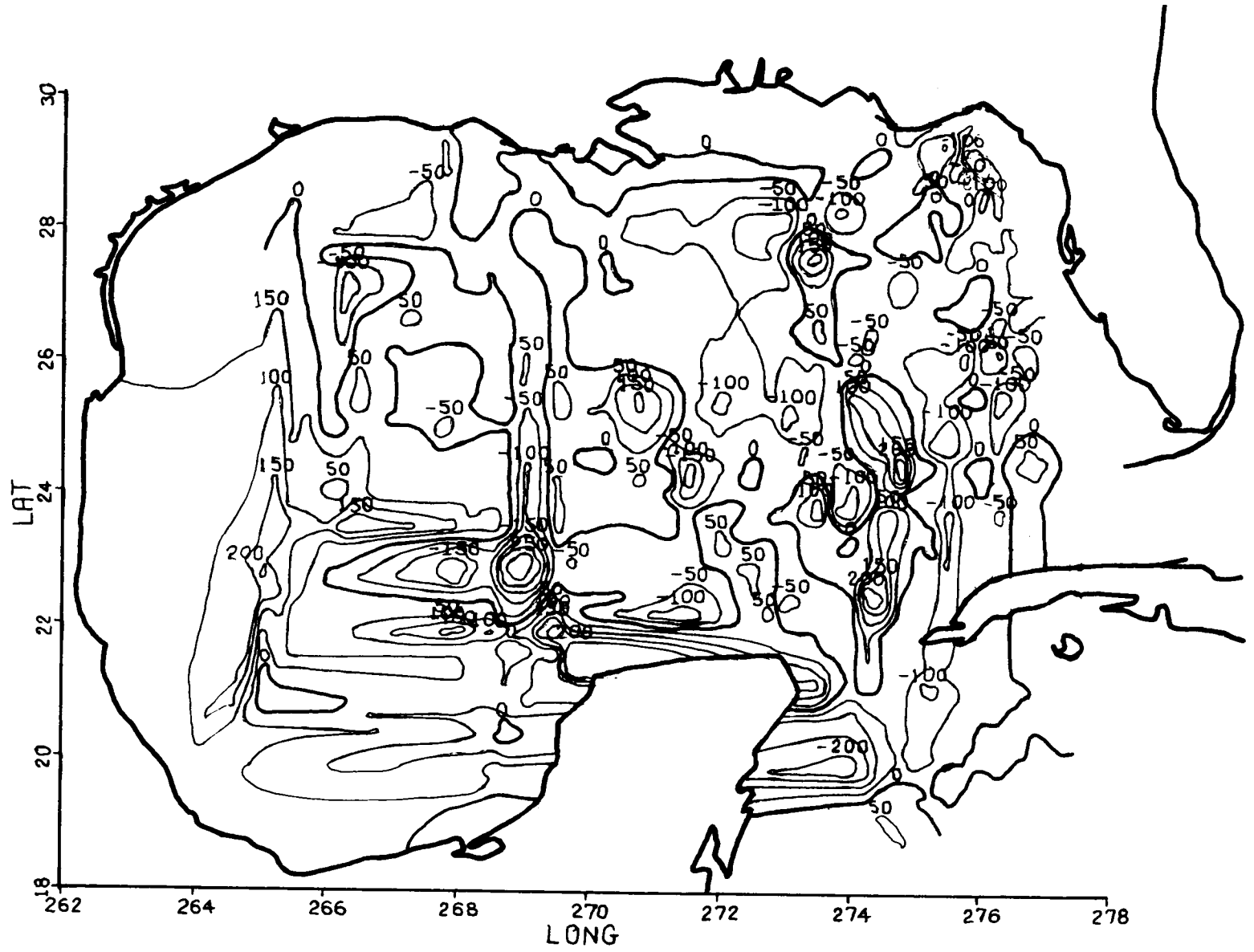

SPRING '78

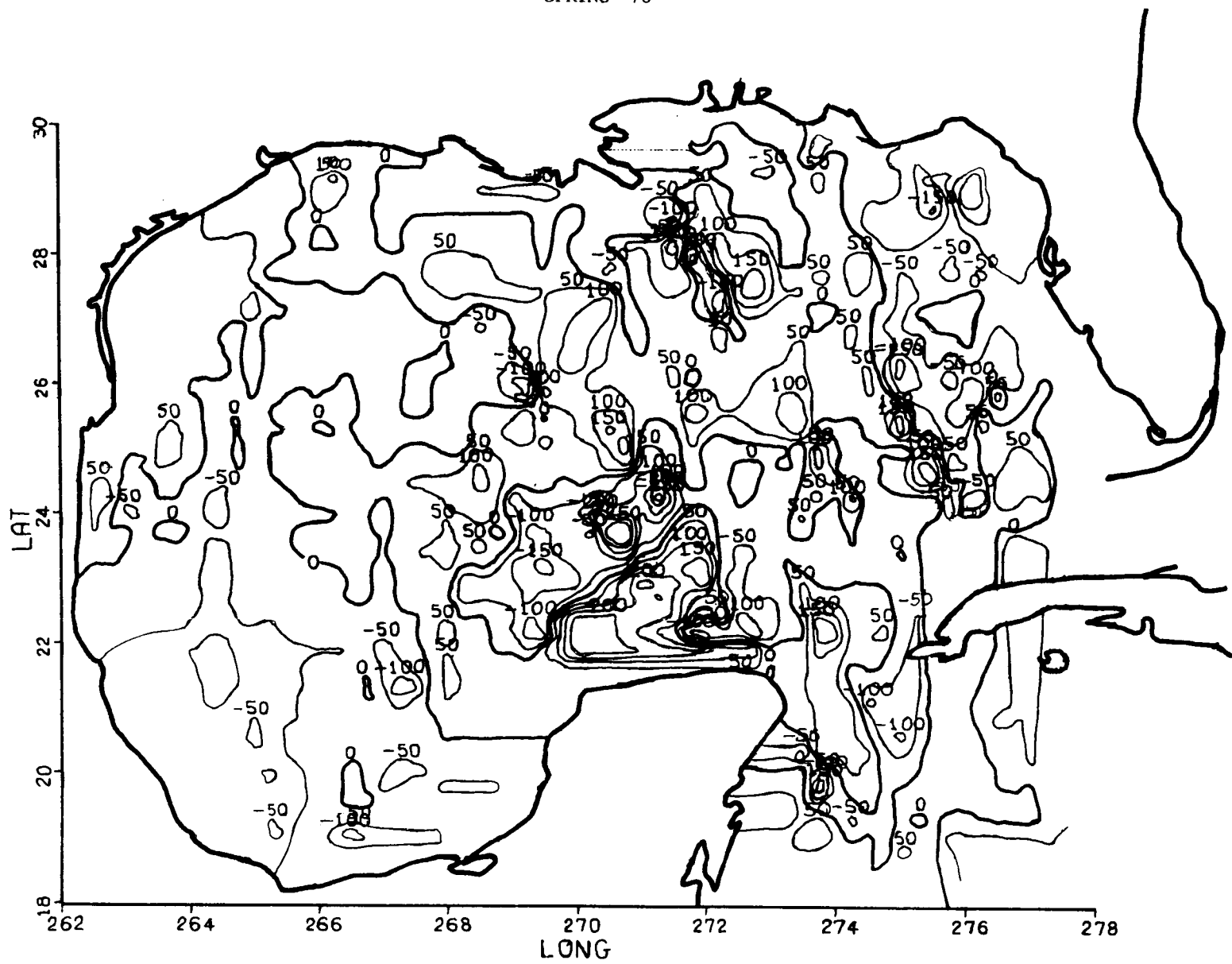

SUMMER '78

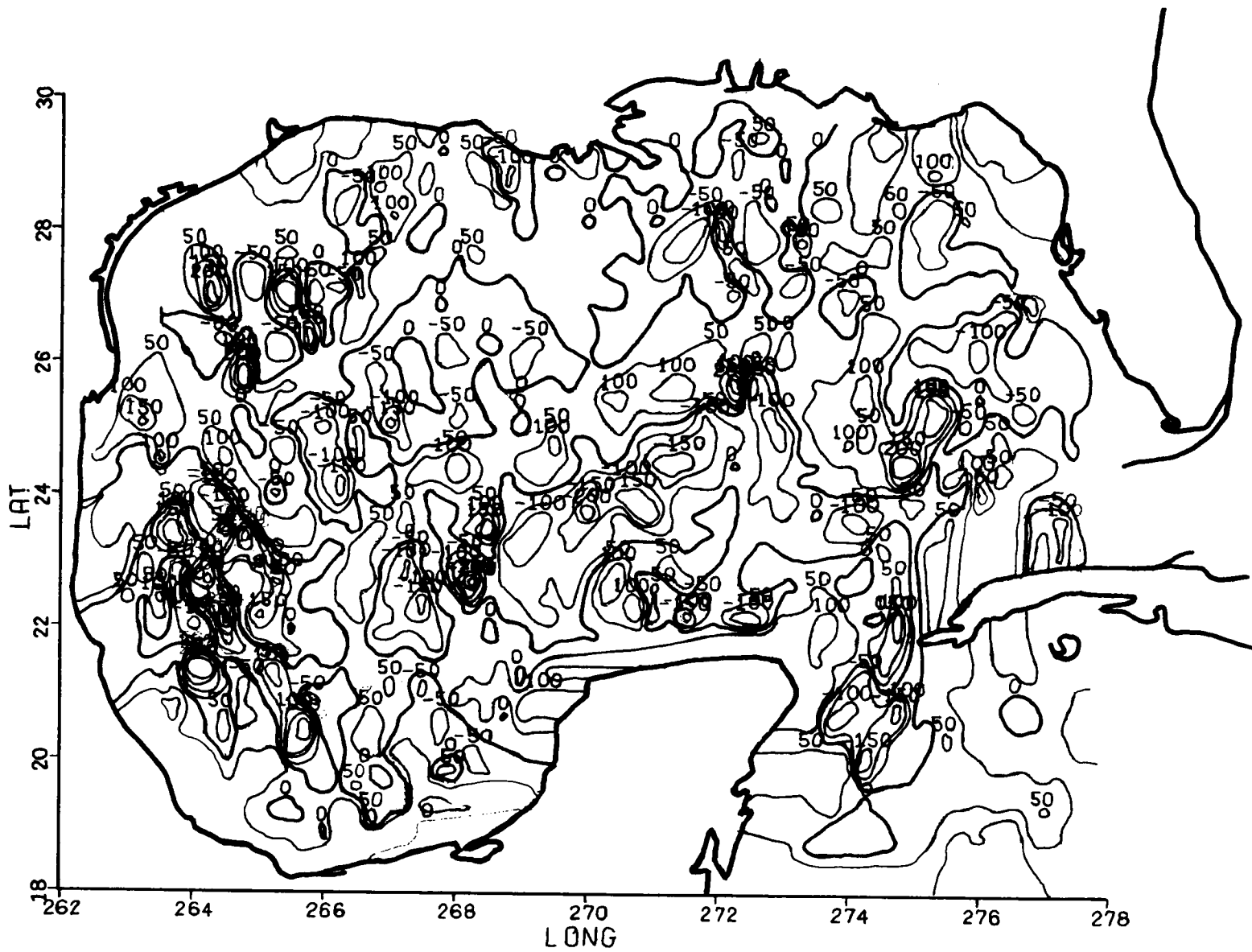

FALL '78

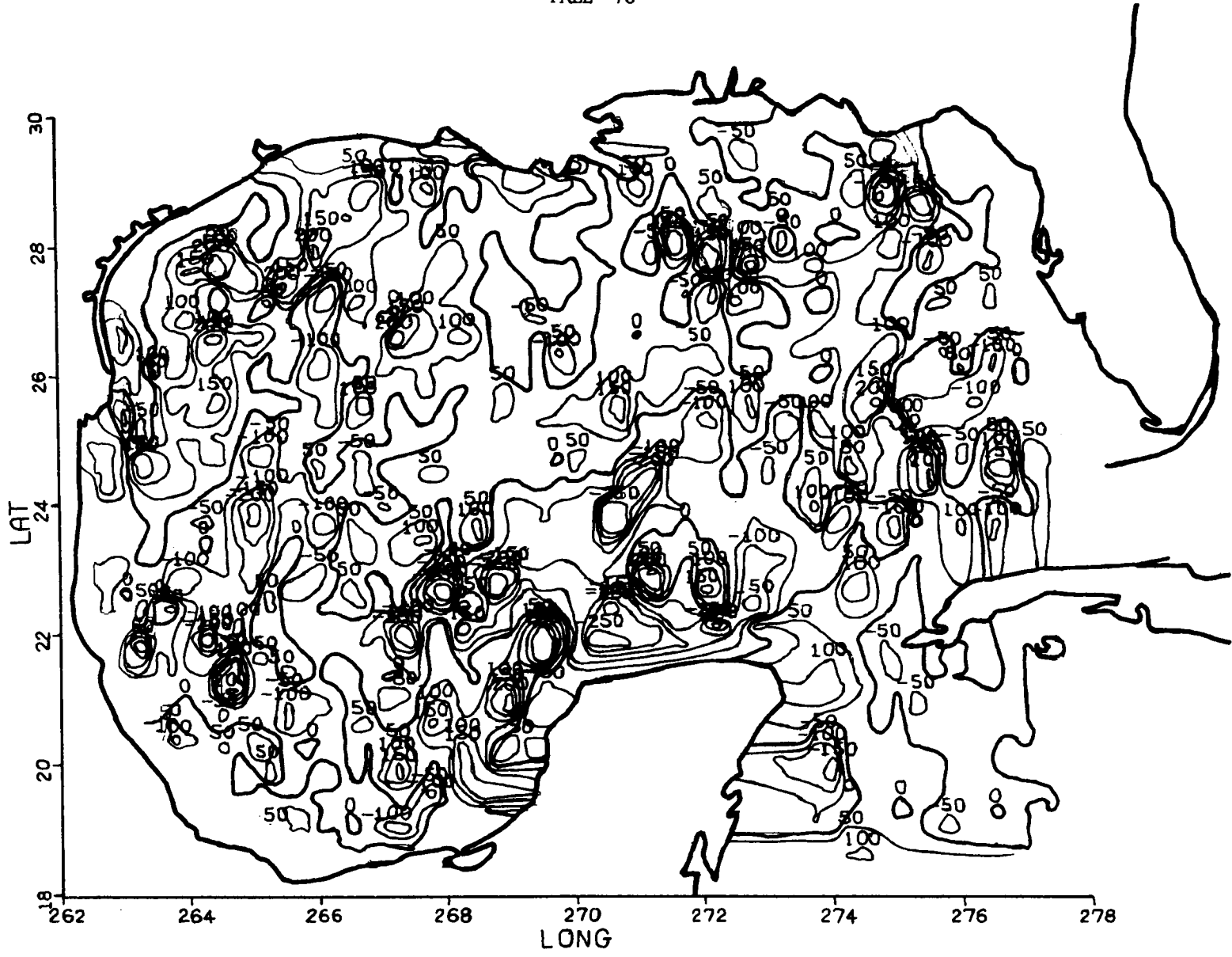

APPENDIX B

SIGNIFICANT WAVE HEIGHT

HISTOGRAMS

GEOS-3 Monthly (3 year)	B1 - B36
GEOS-3 Seasonal (3 year)	B37 - B48
GEOS-3 Composite (3 year)	B49 - B51
GEOS-3 1978 Monthly (July-October)	B52 - B63
GEOS-3 1978 Seasonal (Summer and Fall)	B64 - B69
SEASAT Monthly	B70 - B81
SEASAT Seasonal	B82 - B87
SEASAT Composite	B88 - B90
GEOS/SEASAT Composite	B91 - B93

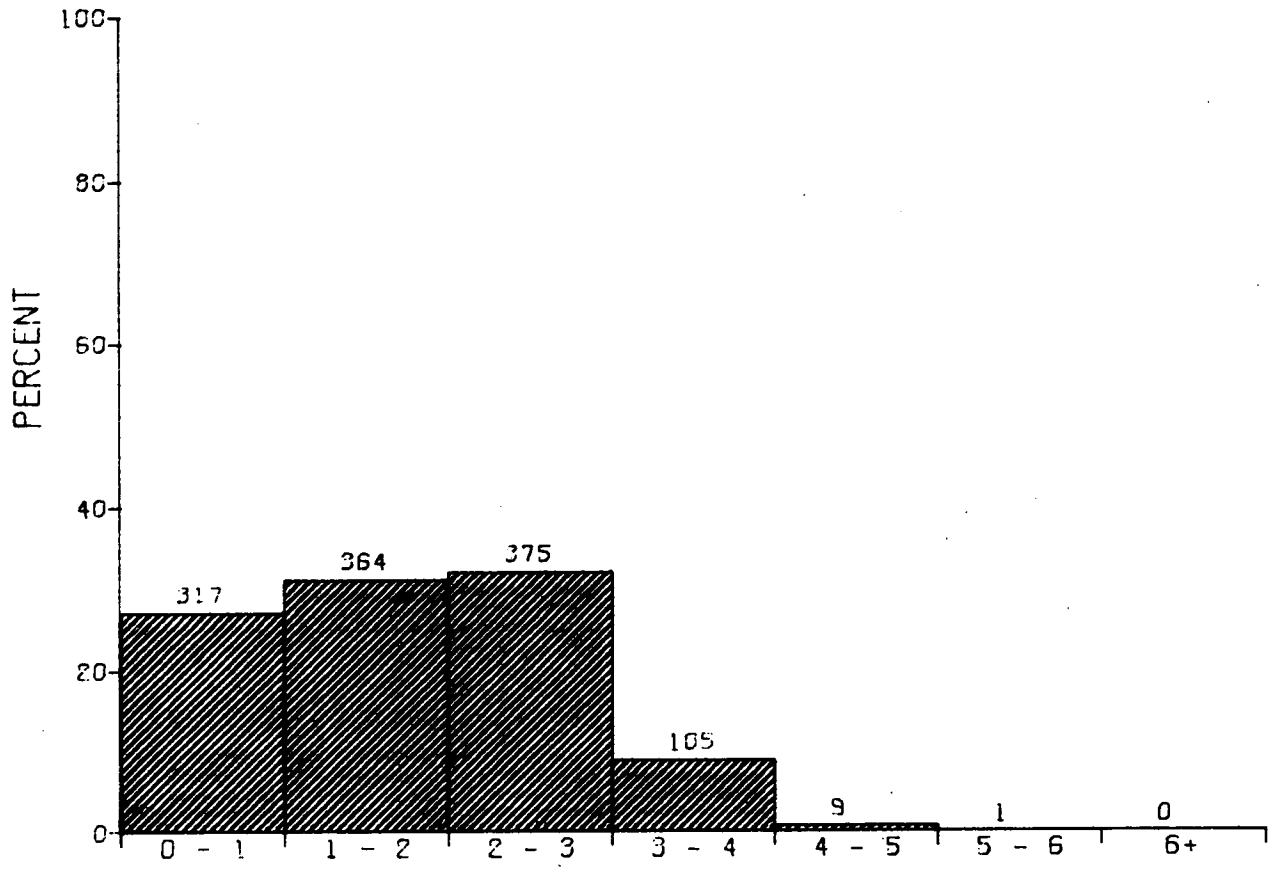

DISTRIBUTION OF SIGNIFICANT WAVE HEIGHT IN METERS

GEOS DATA- JANUARY

EASTERN GULF OF MEXICO

N = 1171.

MEAN = 1.64

SIGMA = 1.07

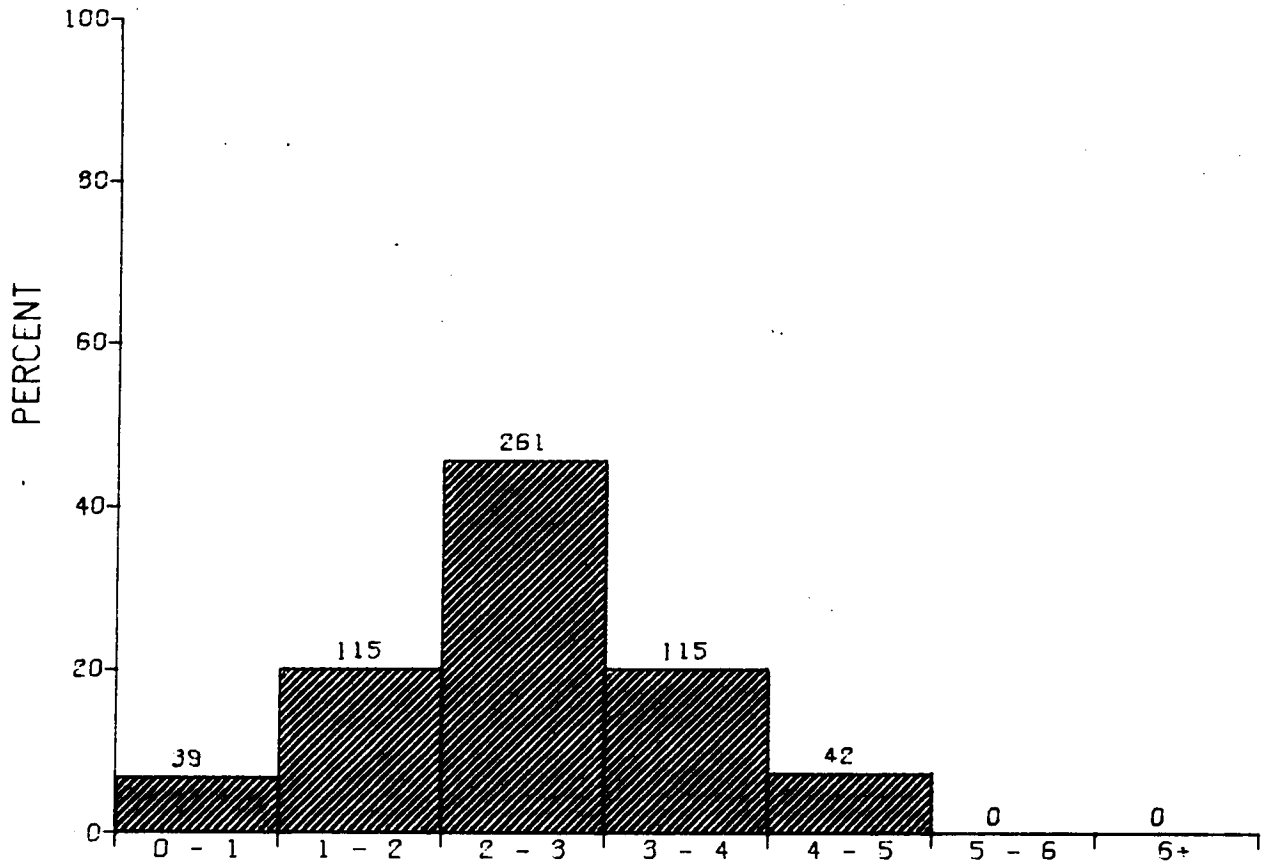

DISTRIBUTION OF SIGNIFICANT WAVE HEIGHT IN METERS

GEOS DATA- JANUARY

WESTERN GULF OF MEXICO

N = 572.

MEAN = 2.45

SIGMA = 1.0

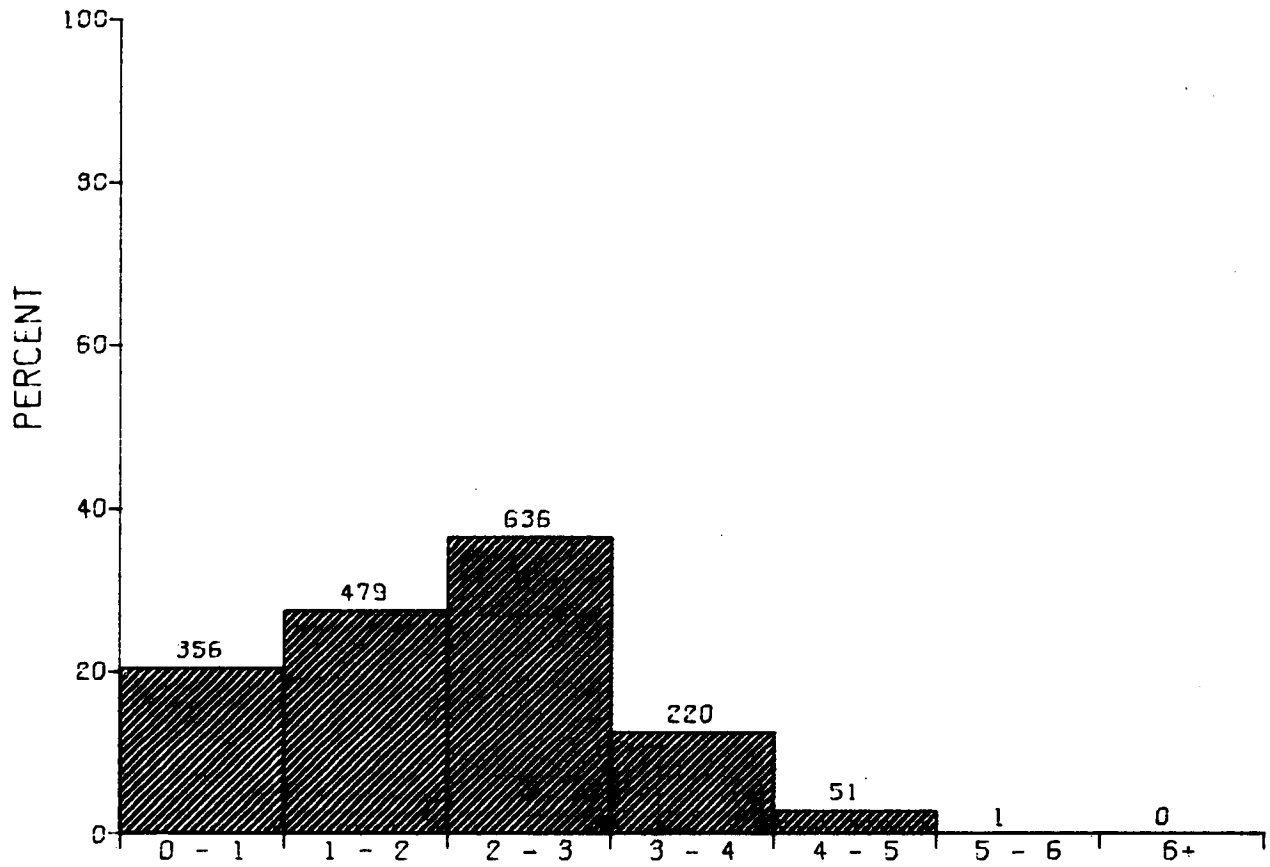

DISTRIBUTION OF SIGNIFICANT WAVE HEIGHT IN METERS

GEOS DATA- JANUARY

ENTIRE GULF OF MEXICO

N = 1743.

MEAN = 1.90

SIGMA = 1.1

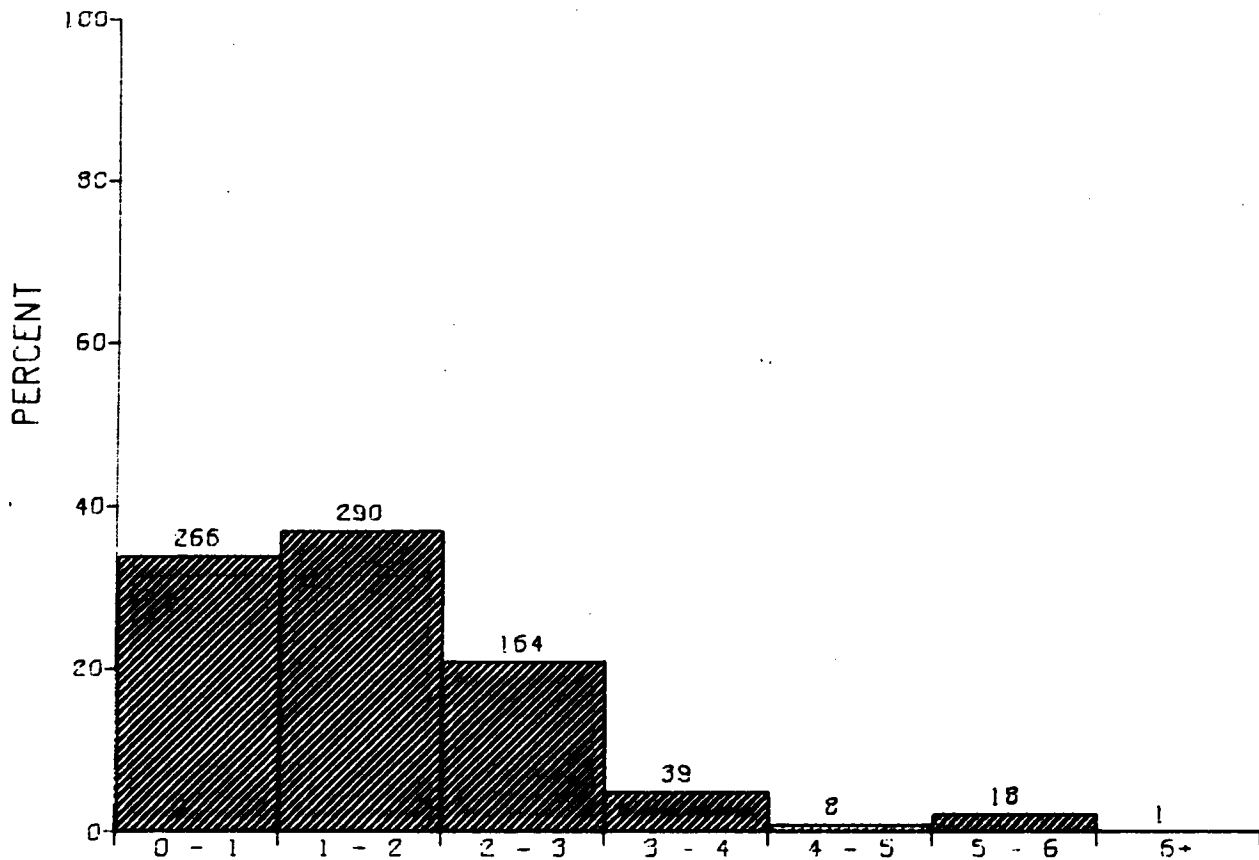

DISTRIBUTION OF SIGNIFICANT WAVE HEIGHT IN METERS

GEOS DATA- FEBRUARY

EASTERN GULF OF MEXICO

N = 786.

MEAN = 1.48

SIGMA = 1.20

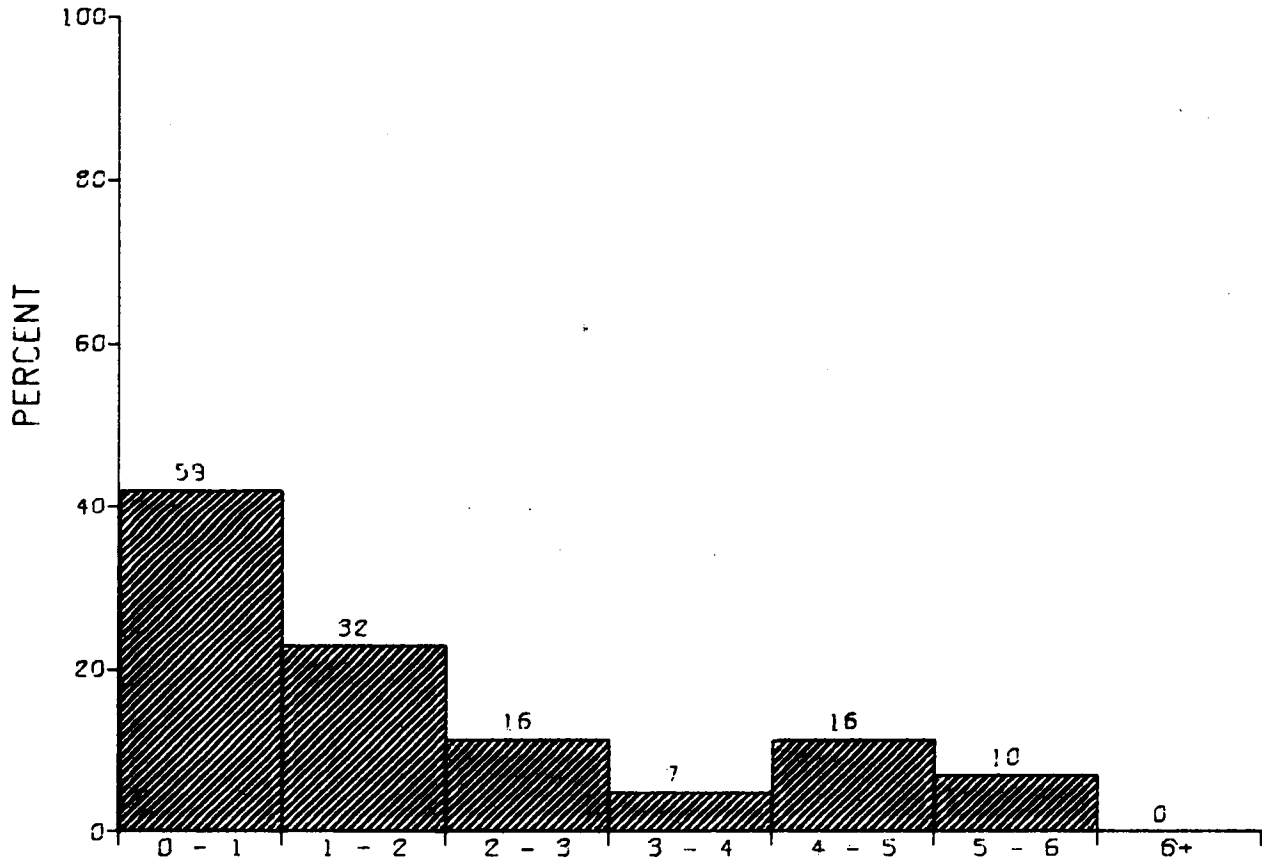

DISTRIBUTION OF SIGNIFICANT WAVE HEIGHT IN METERS

GEOS DATA- FEBRUARY

WESTERN GULF OF MEXICO

N = 140.

MEAN = 1.72

SIGMA = 1.8

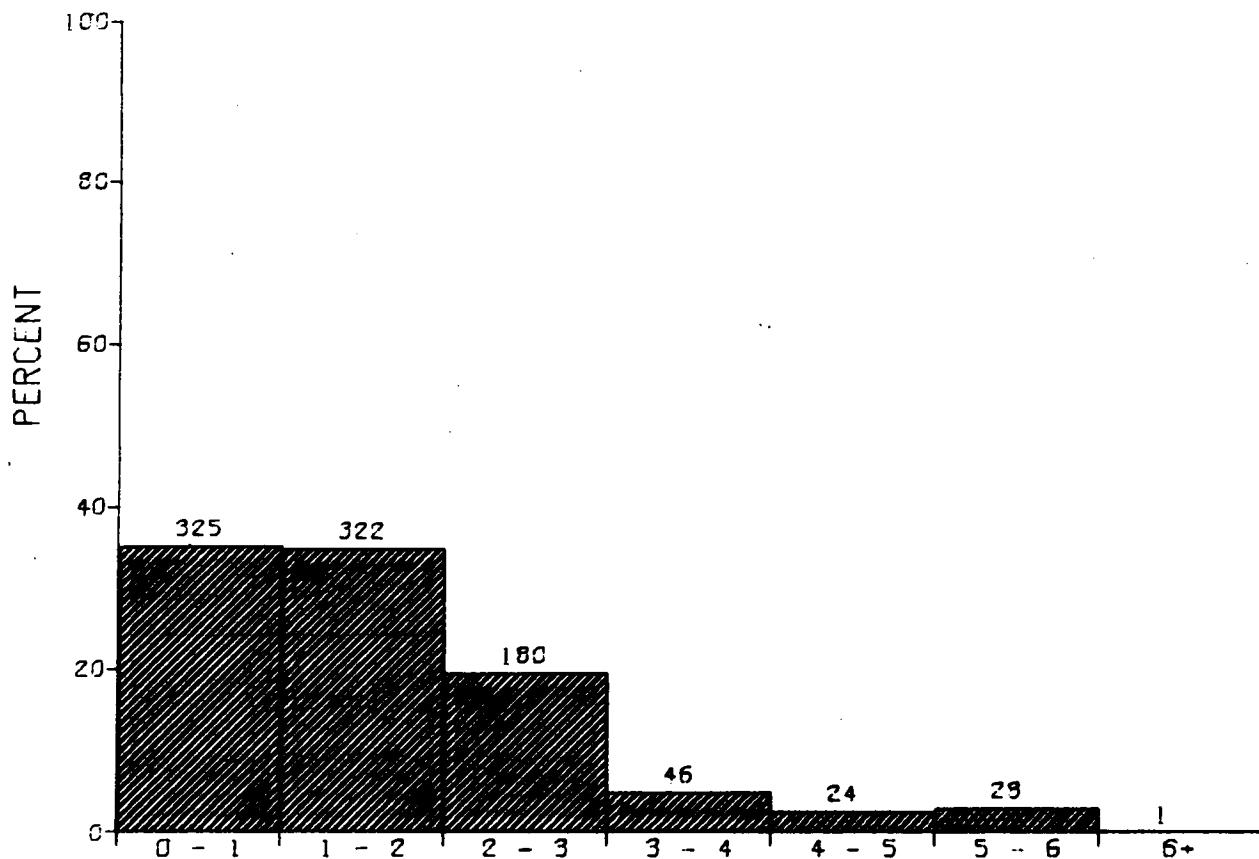

DISTRIBUTION OF SIGNIFICANT WAVE HEIGHT IN METERS

GEOS DATA- FEBRUARY

ENTIRE GULF OF MEXICO

N = 926.

MEAN = 1.52

SIGMA = 1.3

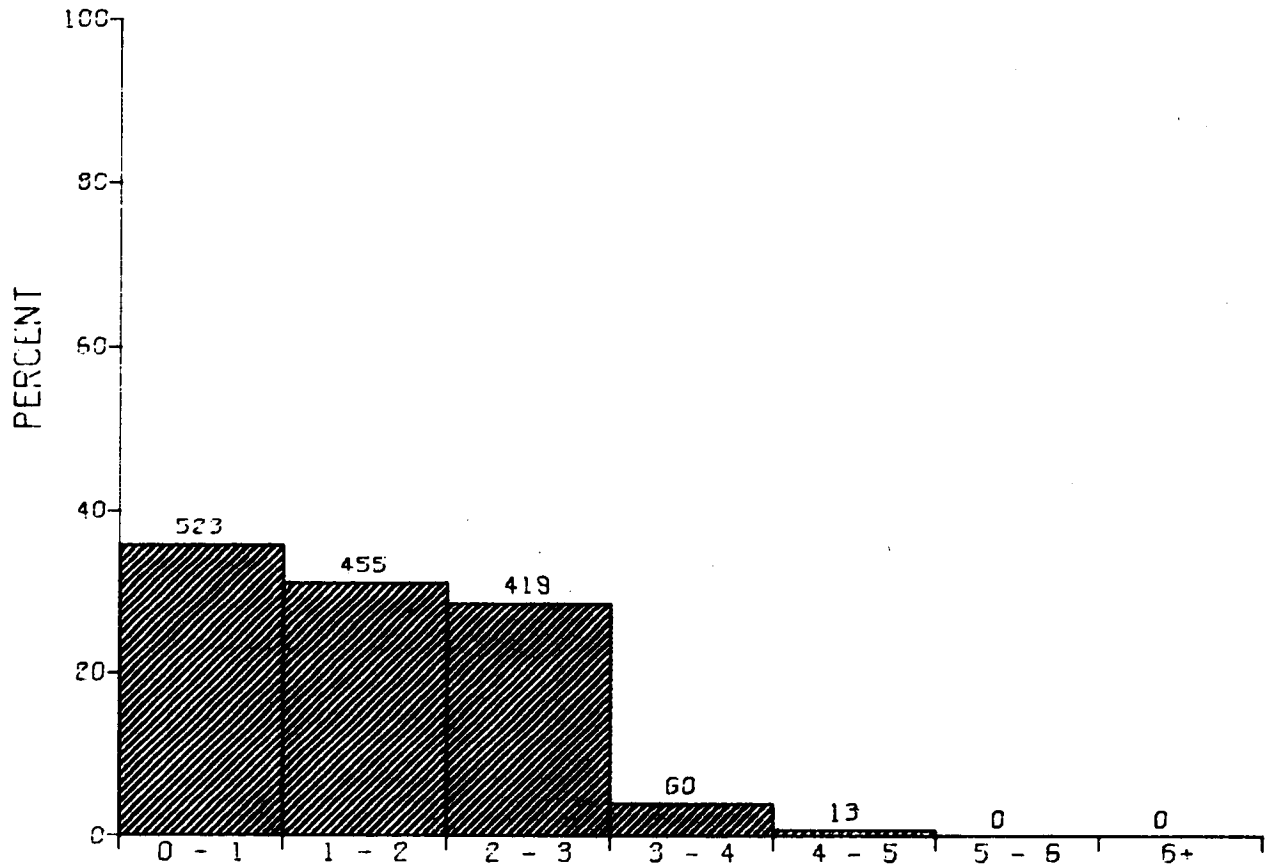

DISTRIBUTION OF SIGNIFICANT WAVE HEIGHT IN METERS

GEOS DATA- MARCH

EASTERN GULF OF MEXICO

N = 1470.

MEAN = 1.41

SIGMA = 1.06

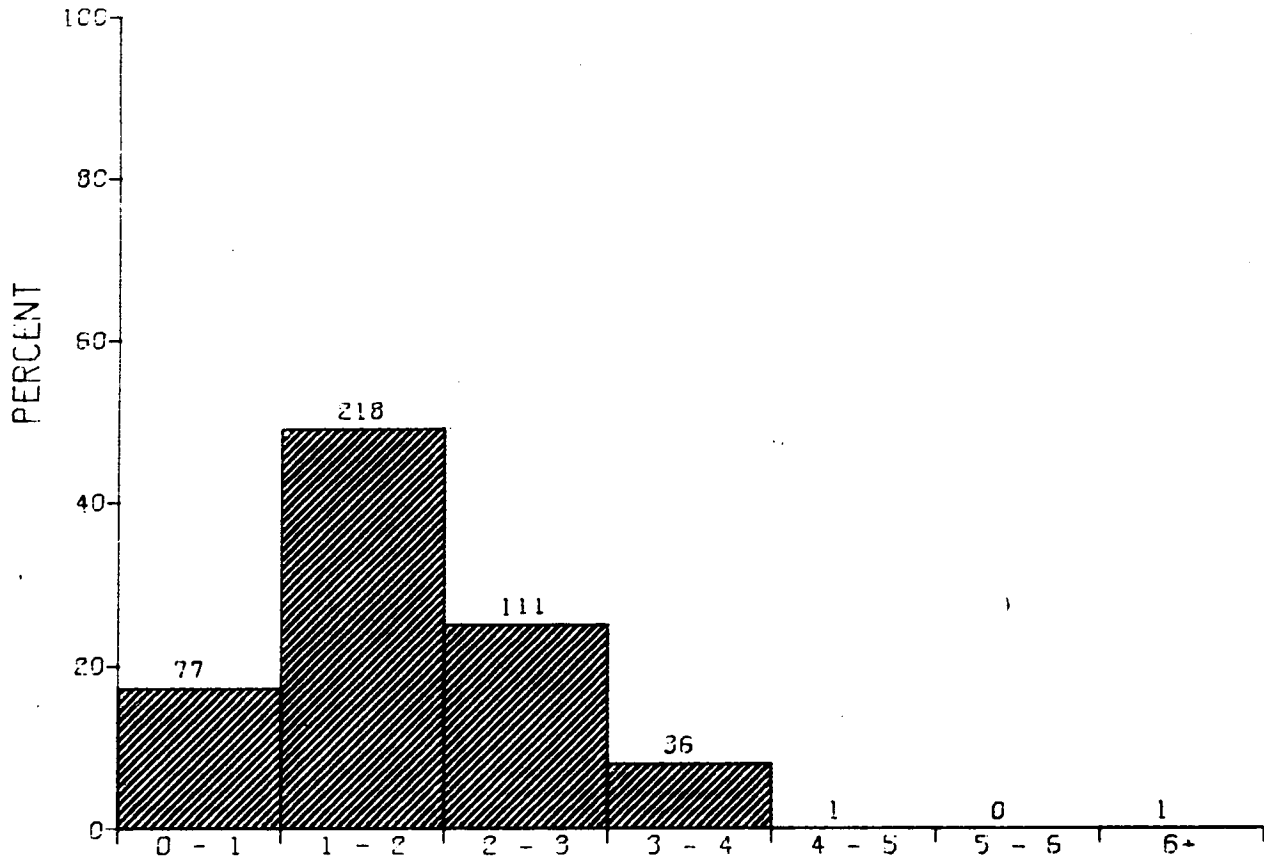

DISTRIBUTION OF SIGNIFICANT WAVE HEIGHT IN METERS

GEOS DATA - MARCH

WESTERN GULF OF MEXICO

N = 444.

MEAN = 1.71

SIGMA = 0.9

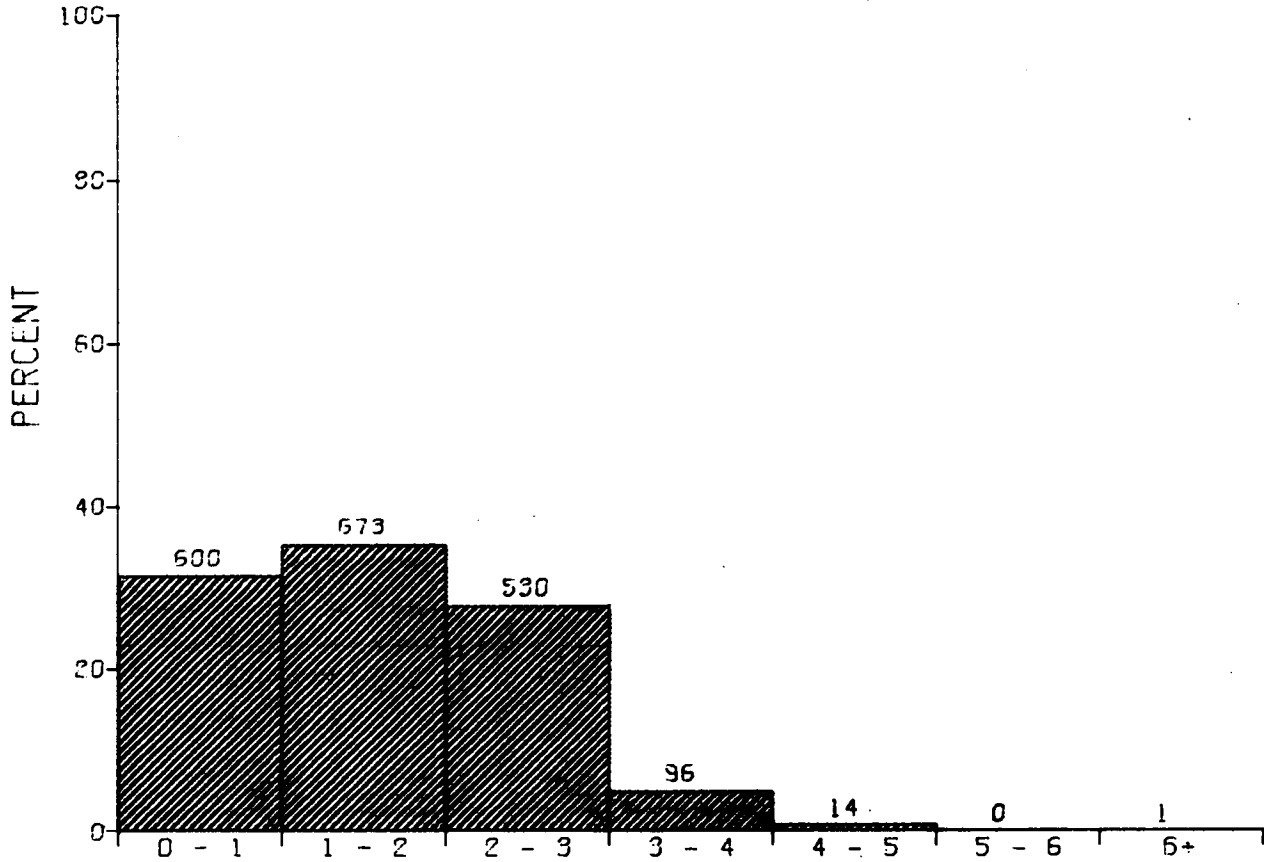

DISTRIBUTION OF SIGNIFICANT WAVE HEIGHT IN METERS

GEOS DATA- MARCH

ENTIRE GULF OF MEXICO

N = 1914.

MEAN = 1.48

SIGMA = 1.0

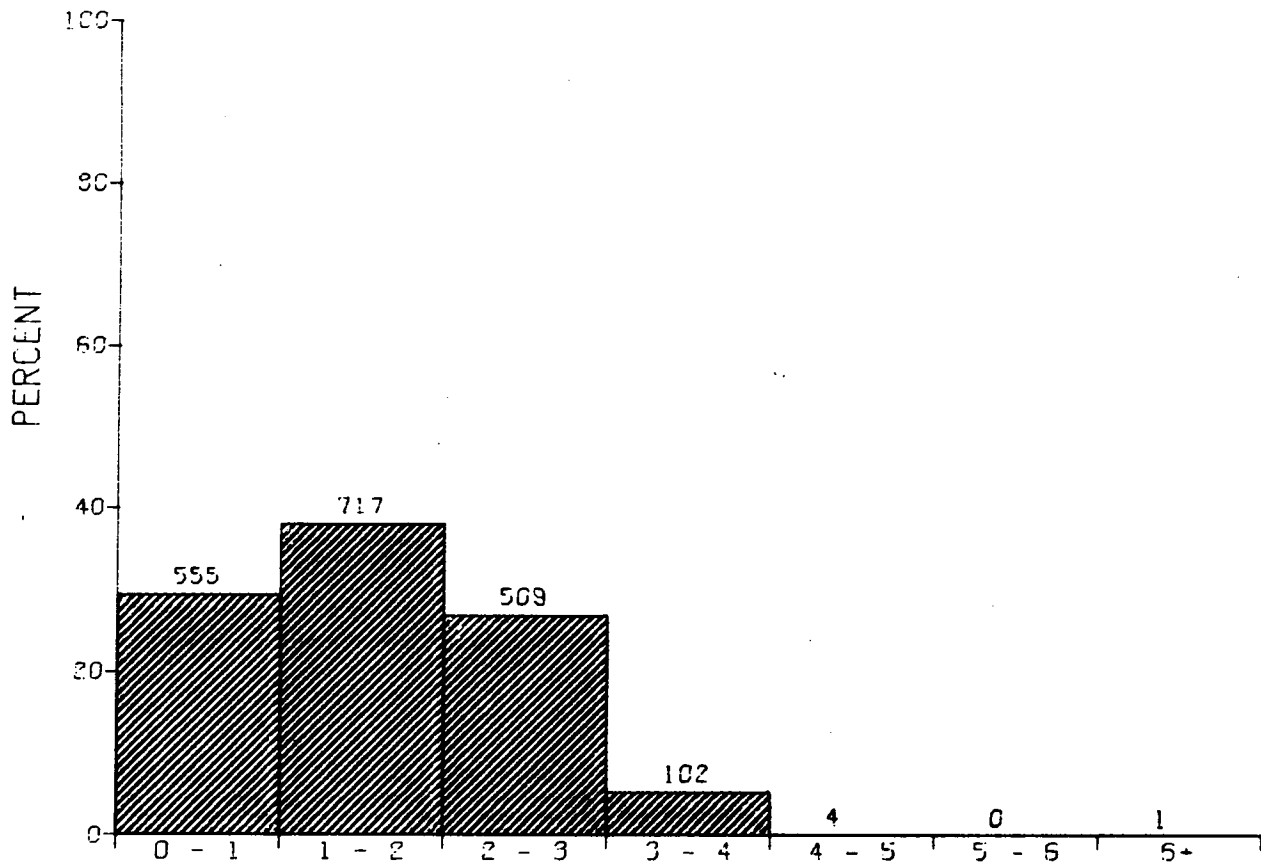

DISTRIBUTION OF SIGNIFICANT WAVE HEIGHT IN METERS

GEOS DATA- APRIL

EASTERN GULF OF MEXICO

N = 1888.

MEAN = 1.50

SIGMA = 0.99

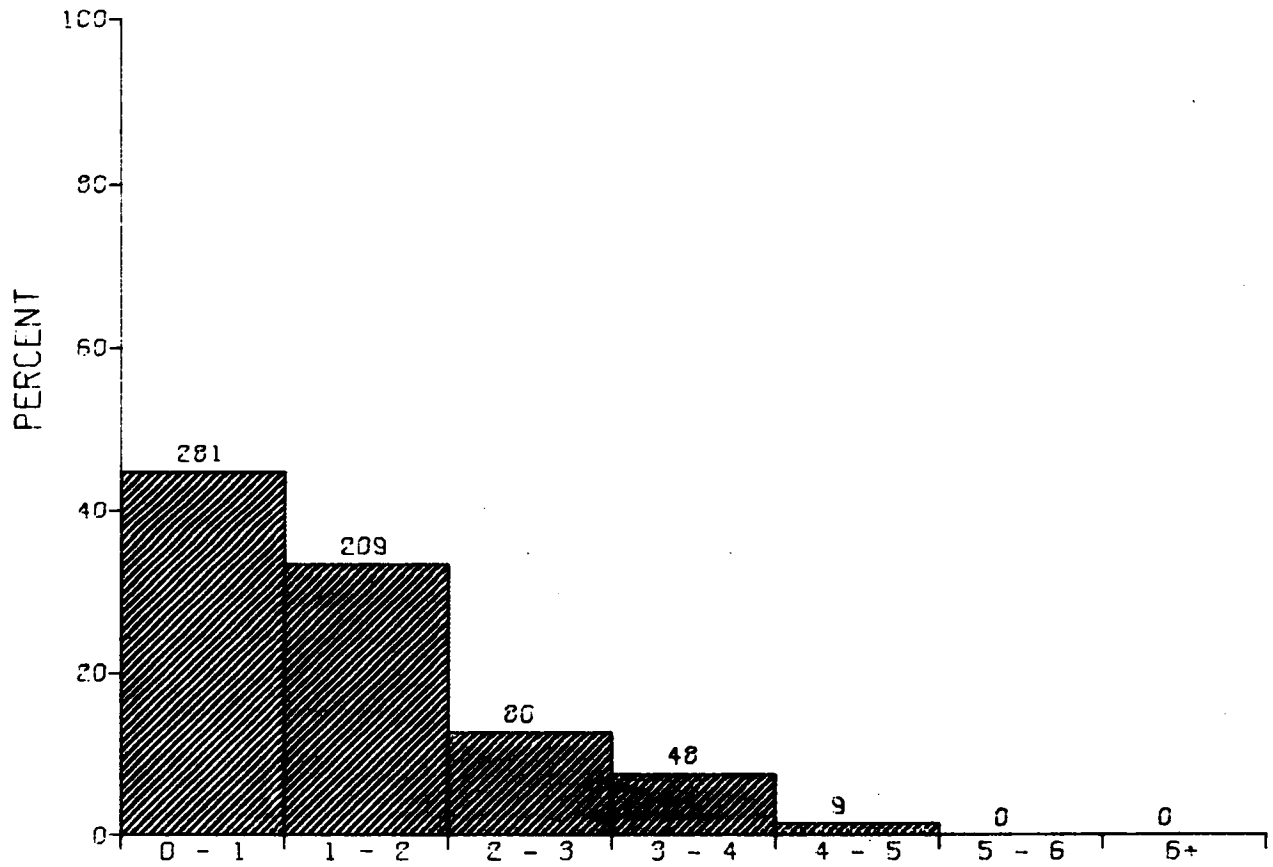

DISTRIBUTION OF SIGNIFICANT WAVE HEIGHT IN METERS

GEOS DATA - APRIL

WESTERN GULF OF MEXICO

N = 627.

MEAN = 1.22 — SIGMA = 1.1

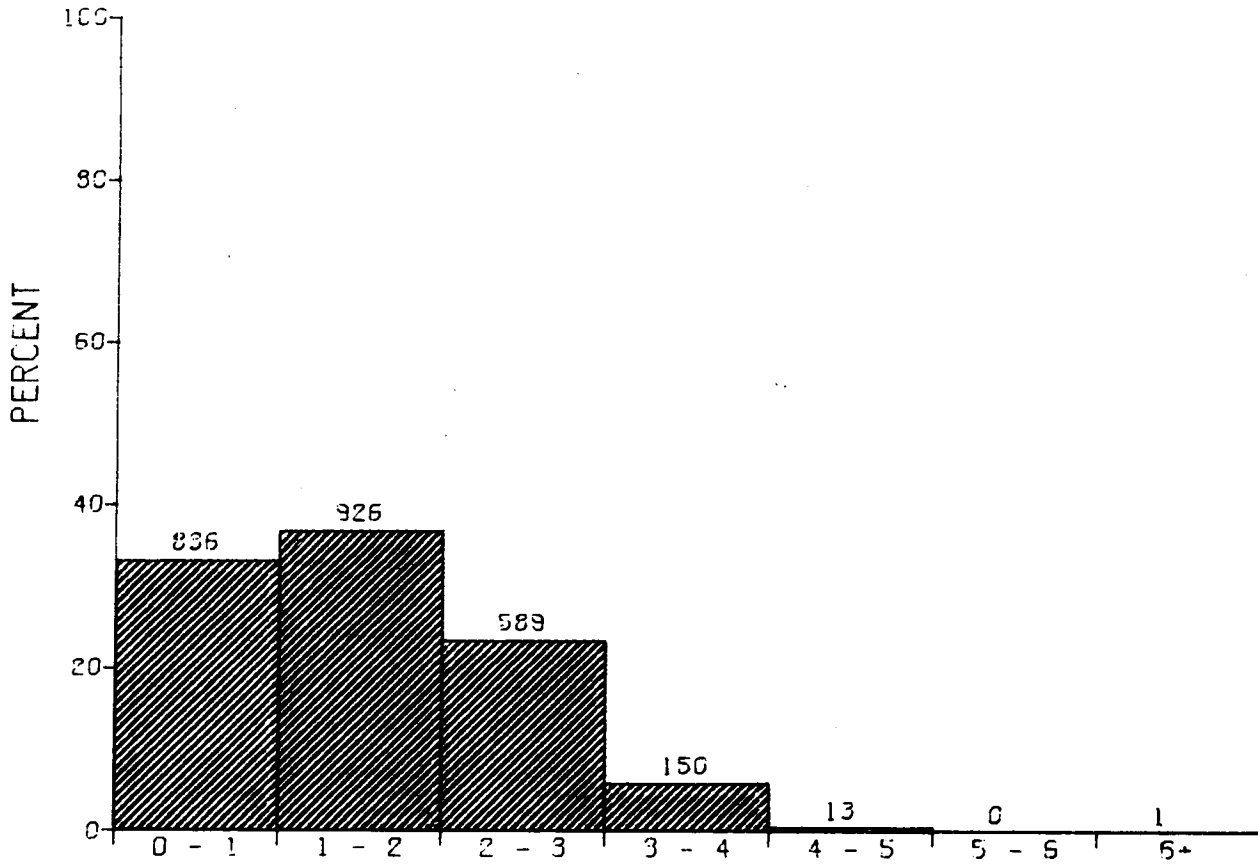

DISTRIBUTION OF SIGNIFICANT WAVE HEIGHT IN METERS

GEOS DATA- APRIL

ENTIRE GULF OF MEXICO

N = 2515.

MEAN = 1.43

SIGMA = 1.0

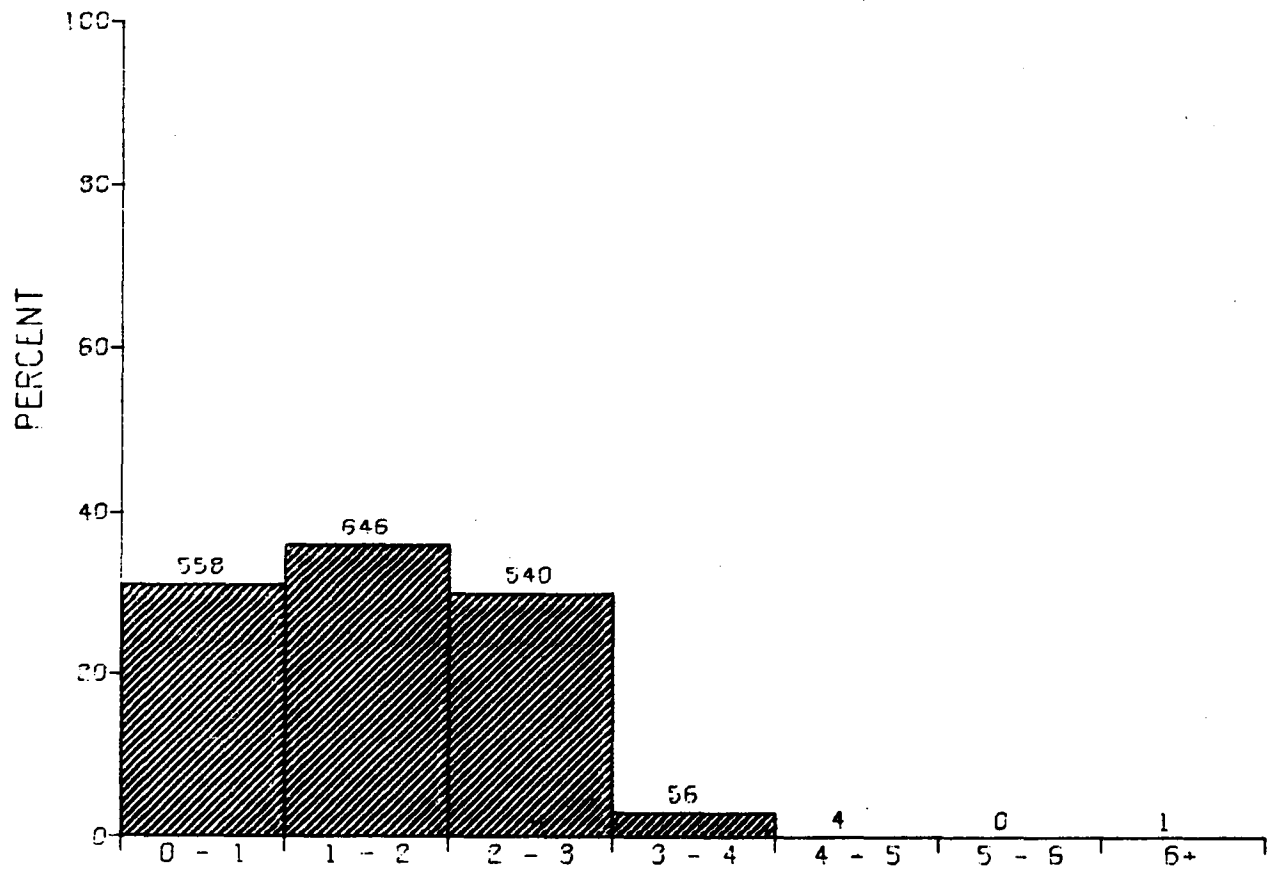

DISTRIBUTION OF SIGNIFICANT WAVE HEIGHT IN METERS

GEOS DATA- MAY

EASTERN GULF OF MEXICO

N = 1805. MEAN = 1.44 SIGMA = 0.98

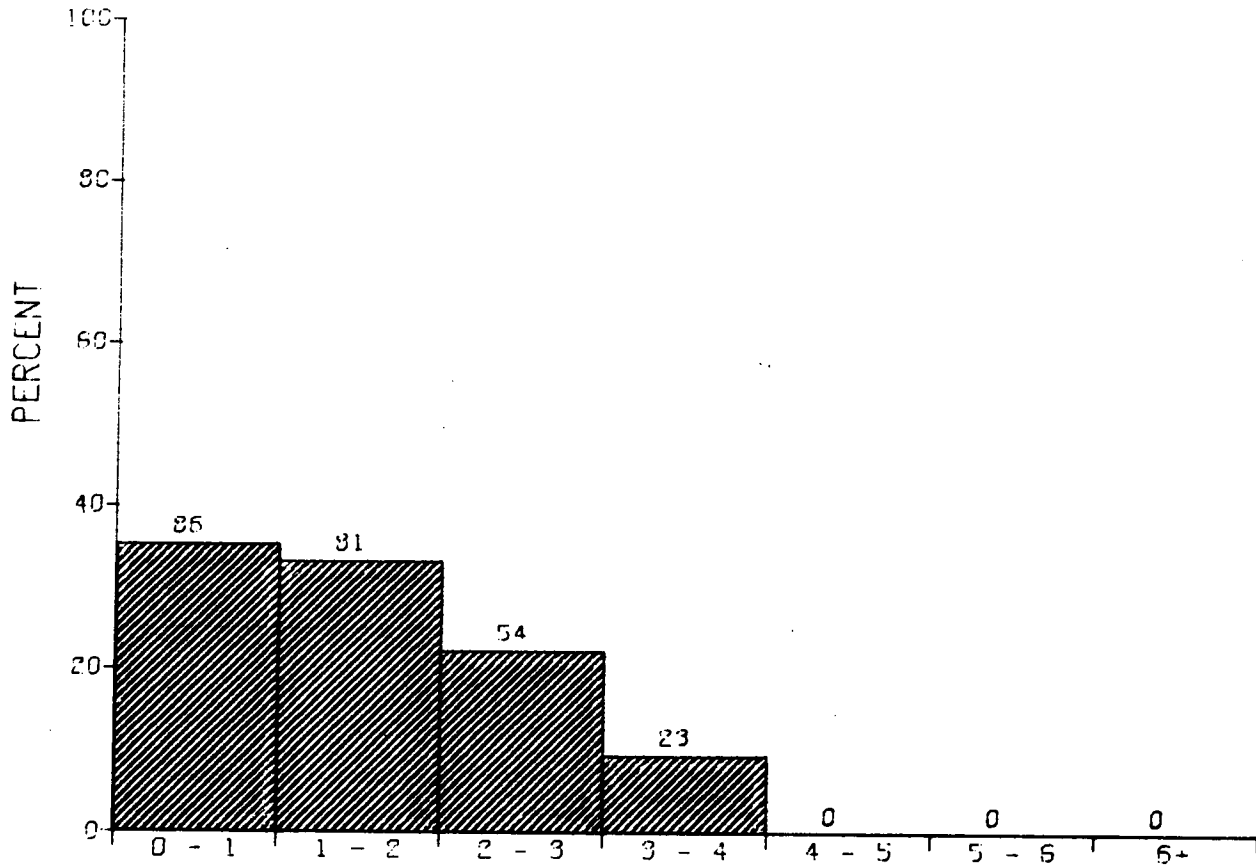

DISTRIBUTION OF SIGNIFICANT WAVE HEIGHT IN METERS

GEOS DATA- MAY

WESTERN GULF OF MEXICO

N = 244.

MEAN = 1.46

SIGMA = 1.1

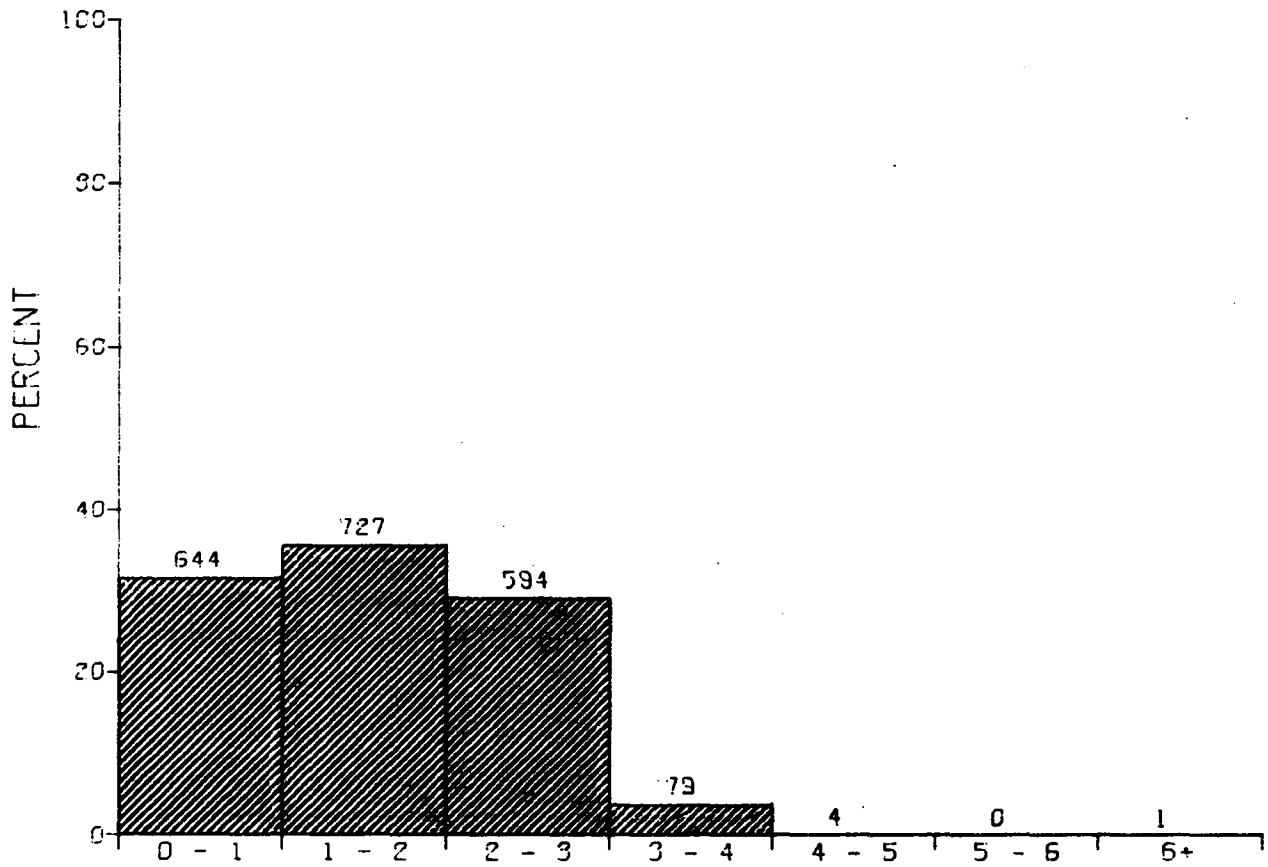

DISTRIBUTION OF SIGNIFICANT WAVE HEIGHT IN METERS

GEOS DATA- MAY

ENTIRE GULF OF MEXICO

N = 2049.

MEAN = 1.45

SIGMA = 1.0

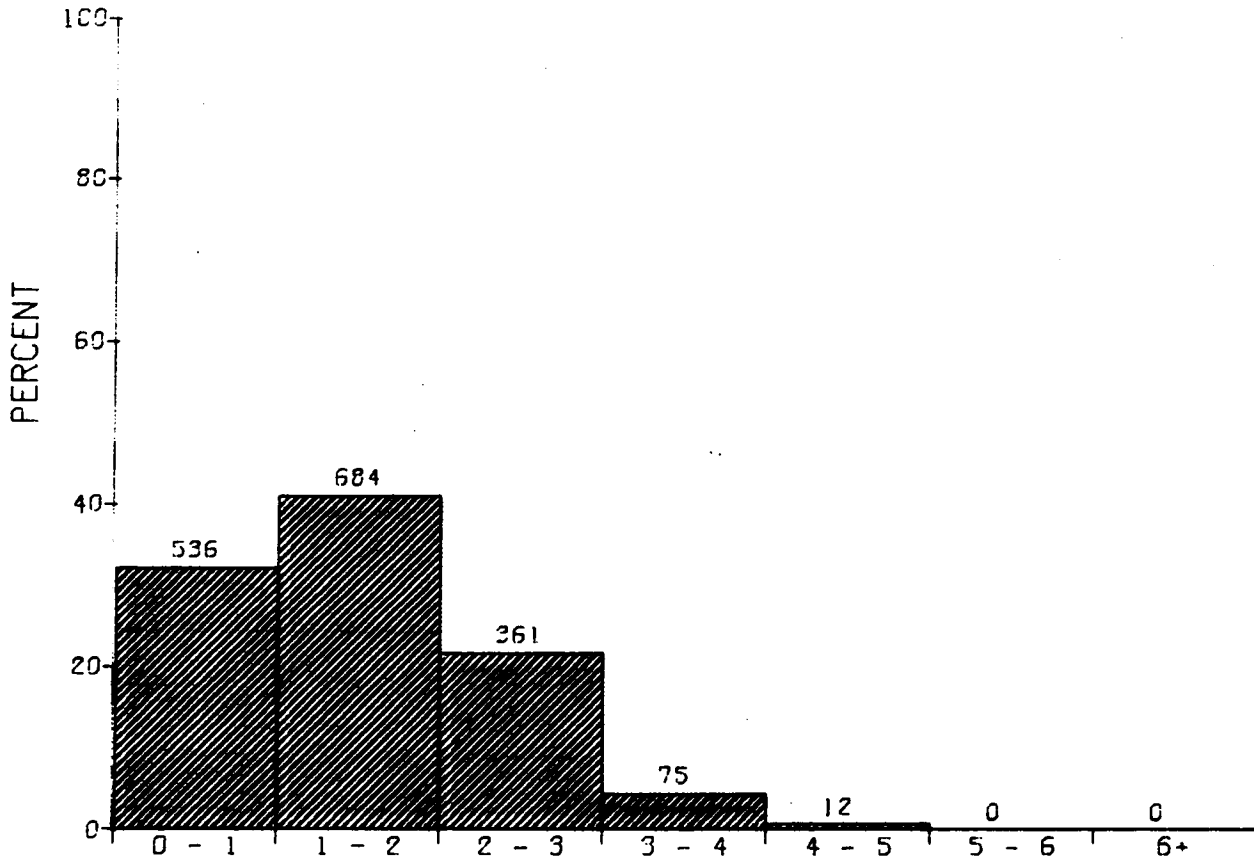

DISTRIBUTION OF SIGNIFICANT WAVE HEIGHT IN METERS

GEOS DATA- JUNE

EASTERN GULF OF MEXICO

N = 1668.

MEAN = 1.40

SIGMA = 0.97

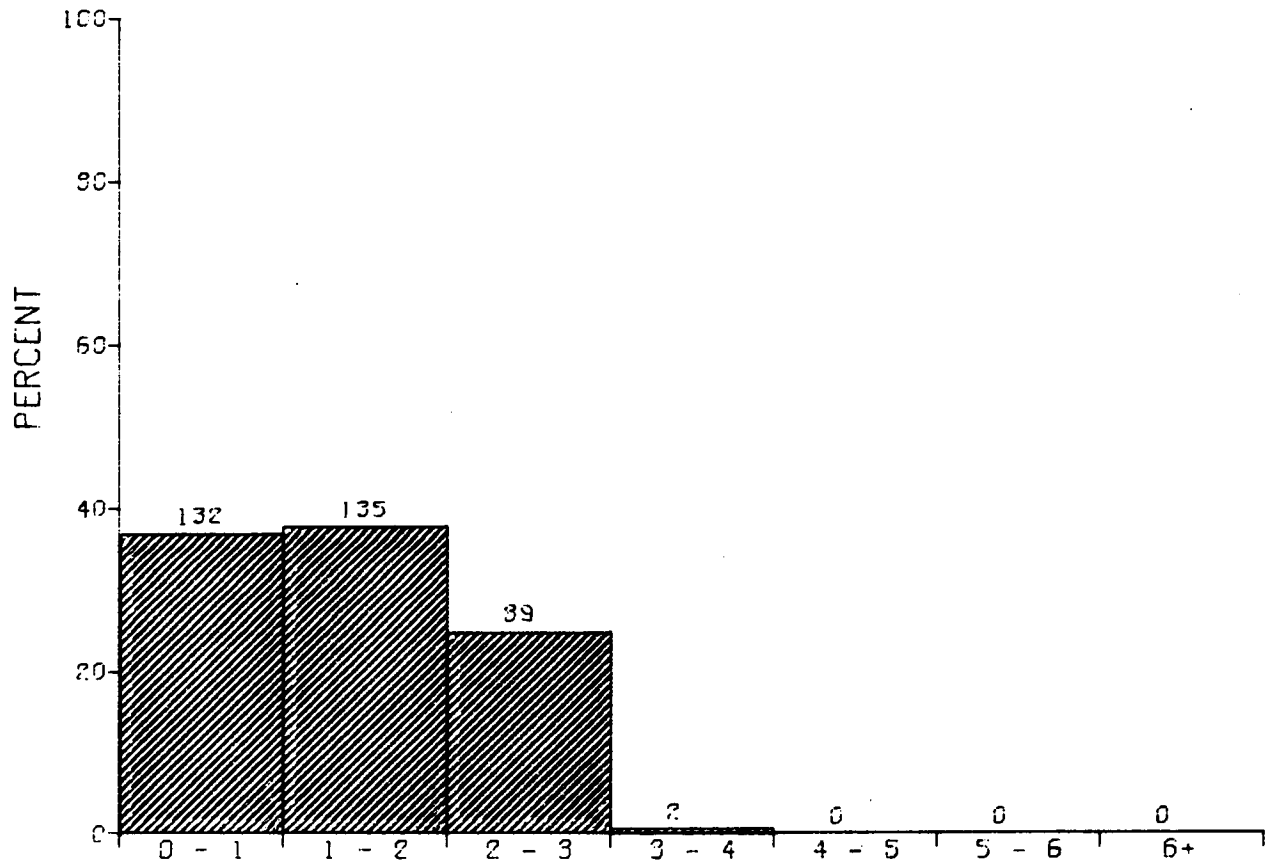

DISTRIBUTION OF SIGNIFICANT WAVE HEIGHT IN METERS

CEOS DATA-- JUNE

WESTERN GULF OF MEXICO

N = 358.

MEAN = 1.26

SIGMA = 0.9

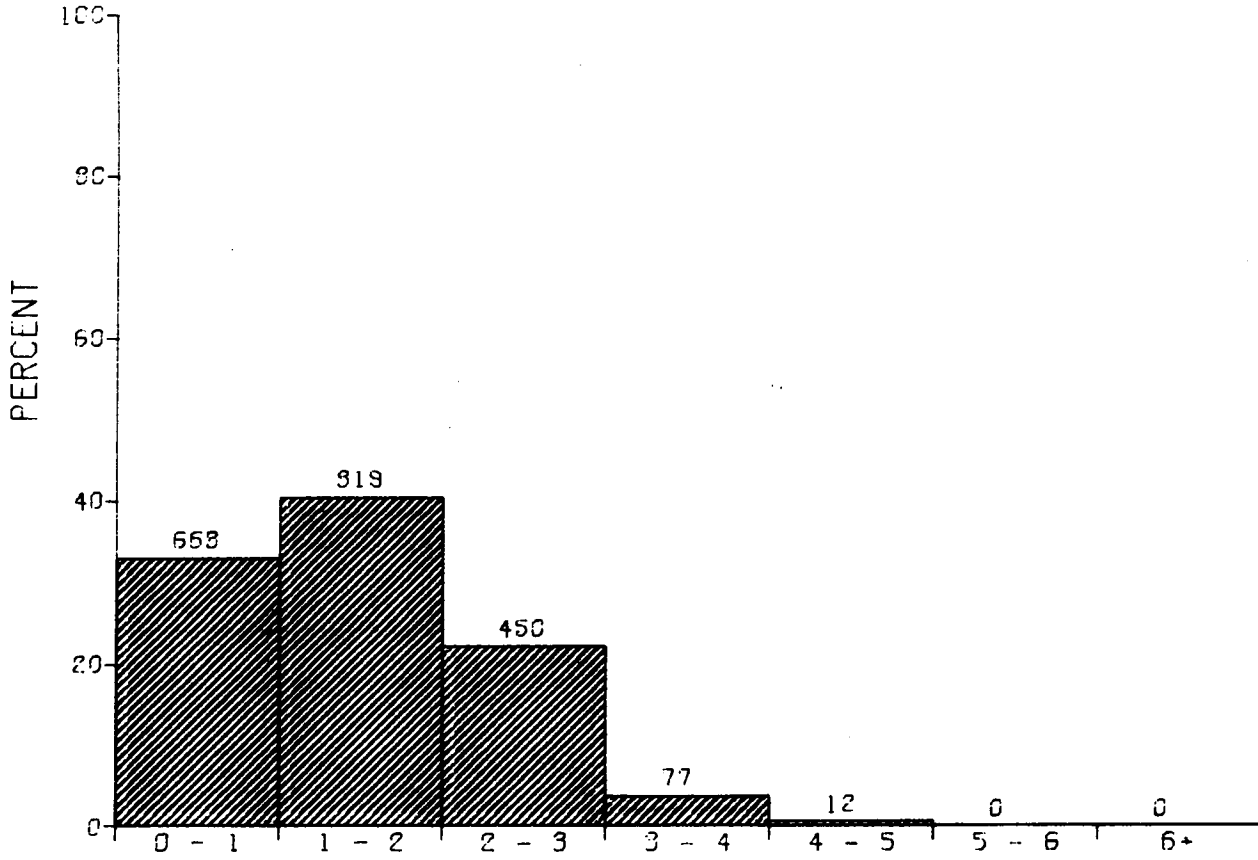

DISTRIBUTION OF SIGNIFICANT WAVE HEIGHT IN METERS

GEOS DATA- JUNE

ENTIRE GULF OF MEXICO

N = 2026.

MEAN = 1.38

SIGMA = 1.0

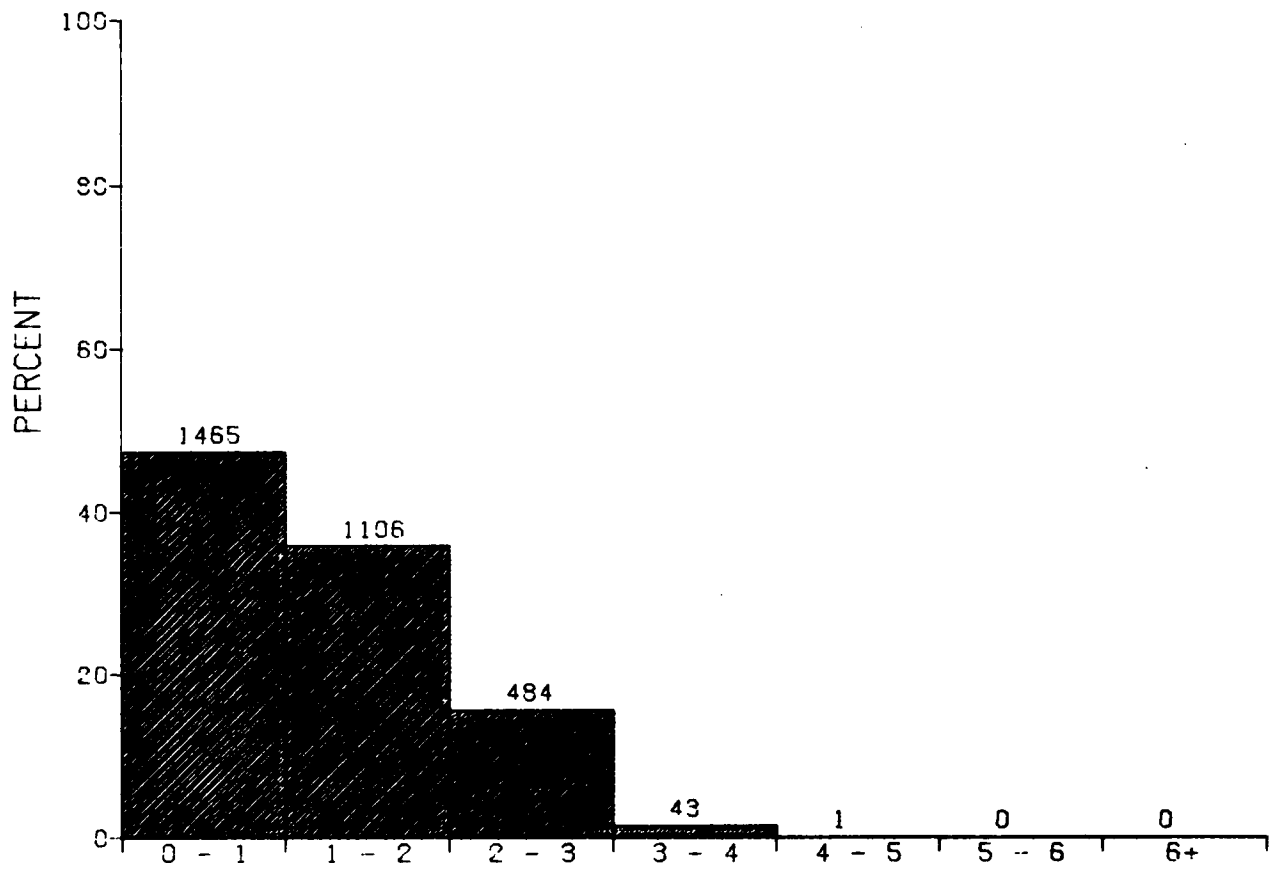

DISTRIBUTION OF SIGNIFICANT WAVE HEIGHT IN METERS

GEOS DATA- JULY

EASTERN GULF OF MEXICO

N = 3099. MEAN = 1.04 SIGMA = 0.92

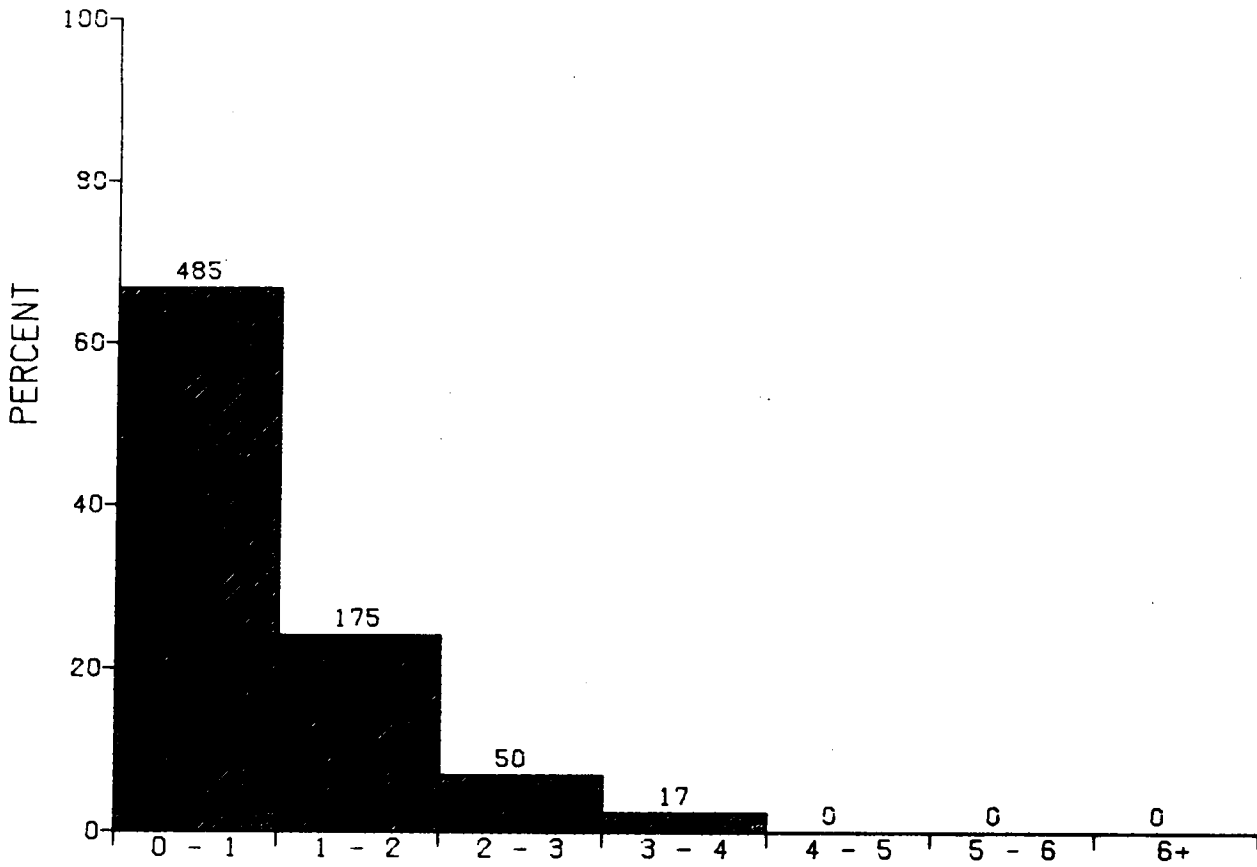

DISTRIBUTION OF SIGNIFICANT WAVE HEIGHT IN METERS

GEOS DATA- JULY

WESTERN GULF OF MEXICO

N = 727.

MEAN = 0.71

SIGMA = 0.9

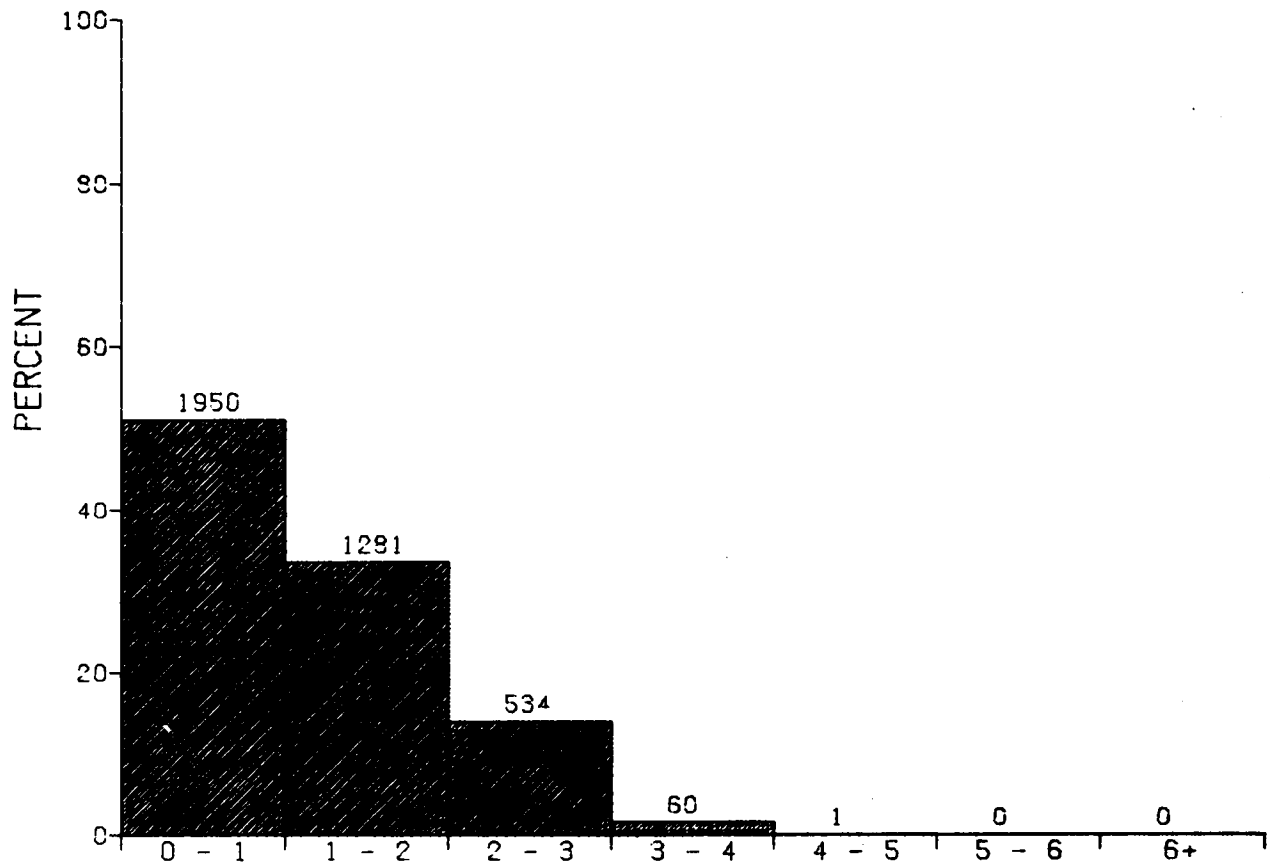

DISTRIBUTION OF SIGNIFICANT WAVE HEIGHT IN METERS

GEOS DATA- JULY

ENTIRE GULF OF MEXICO

N = 3826.

MEAN = 0.98

SIGMA = 0.9

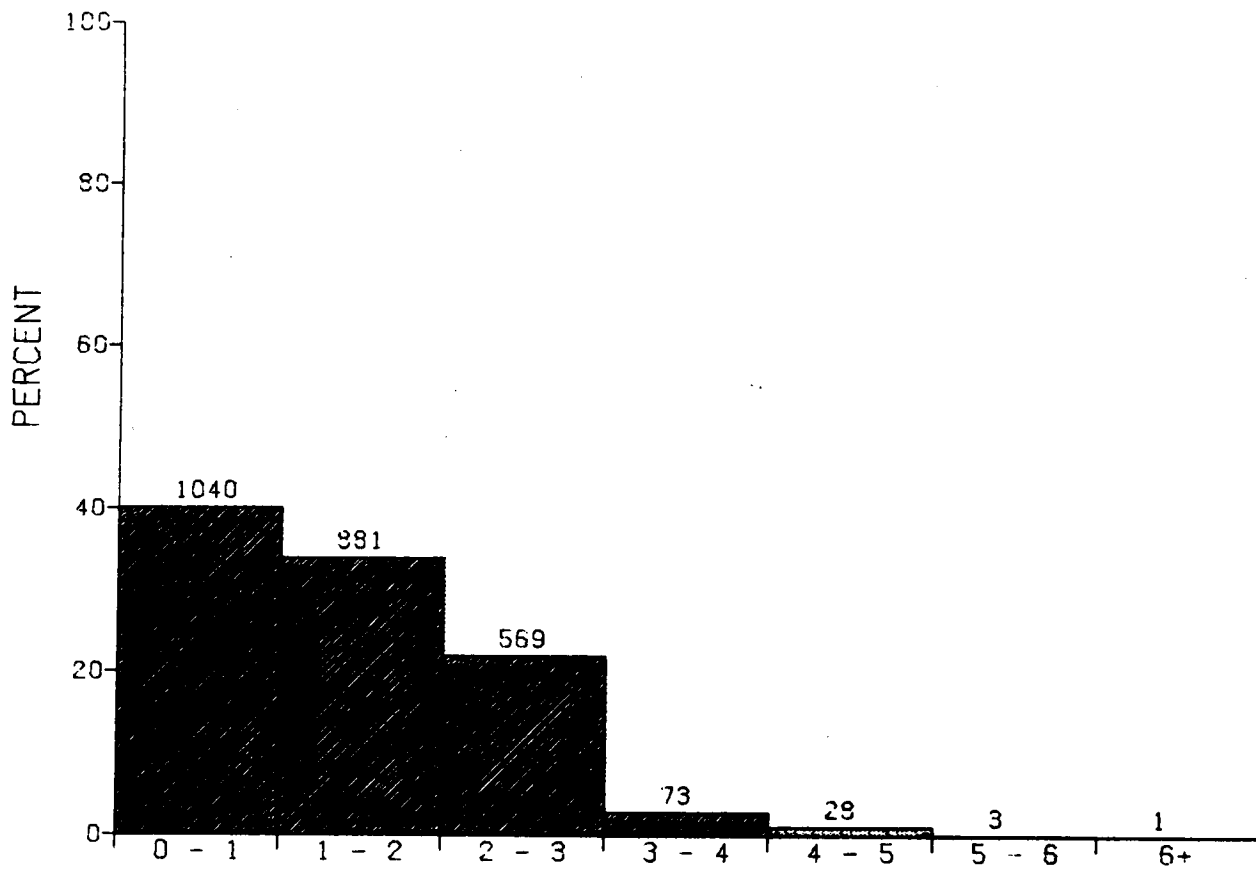

DISTRIBUTION OF SIGNIFICANT WAVE HEIGHT IN METERS

GEOS DATA- AUGUST

EASTERN GULF OF MEXICO

N = 2595.

MEAN = 1.27

SIGMA = 1.05

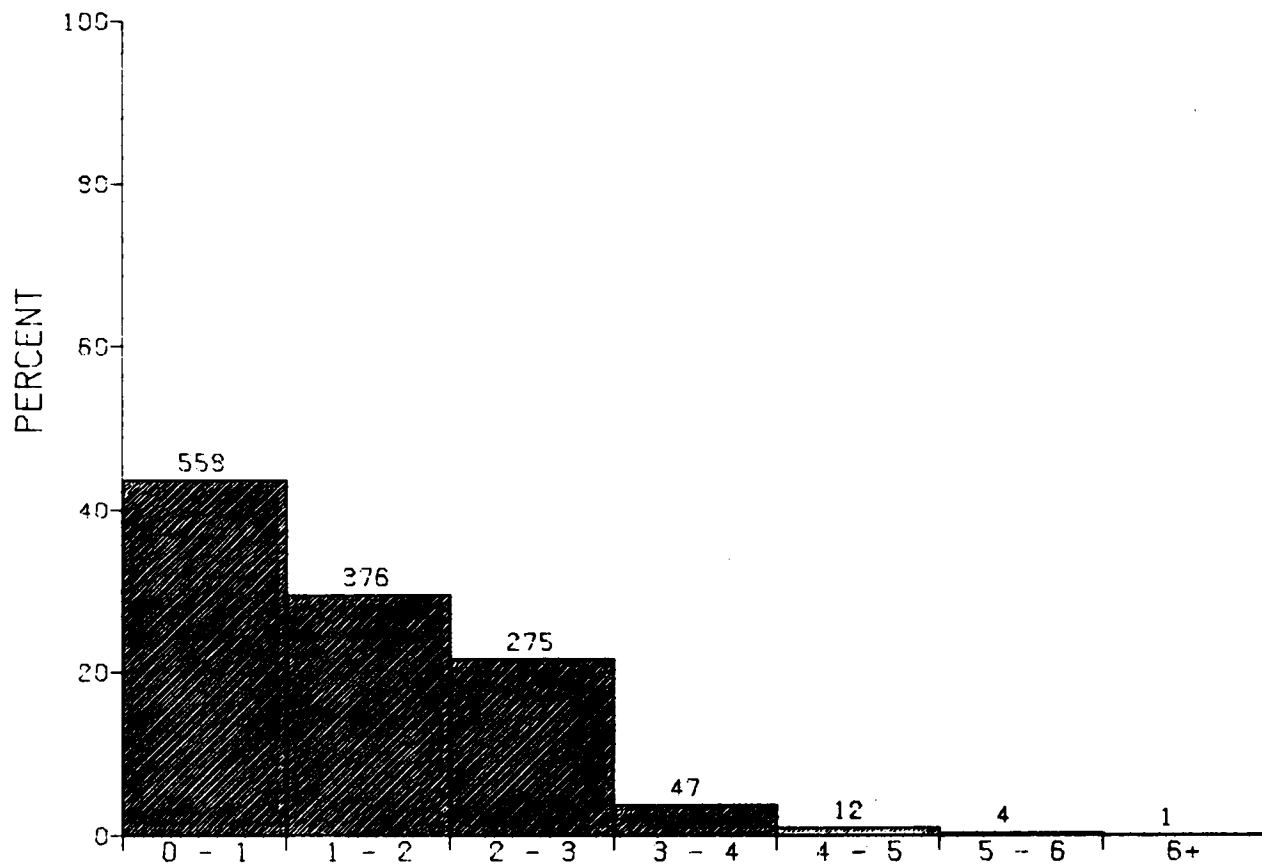

DISTRIBUTION OF SIGNIFICANT WAVE HEIGHT IN METERS

GEOS DATA- AUGUST

WESTERN GULF OF MEXICO

N = 1273.

MEAN = 1.25

SIGMA = 1.1

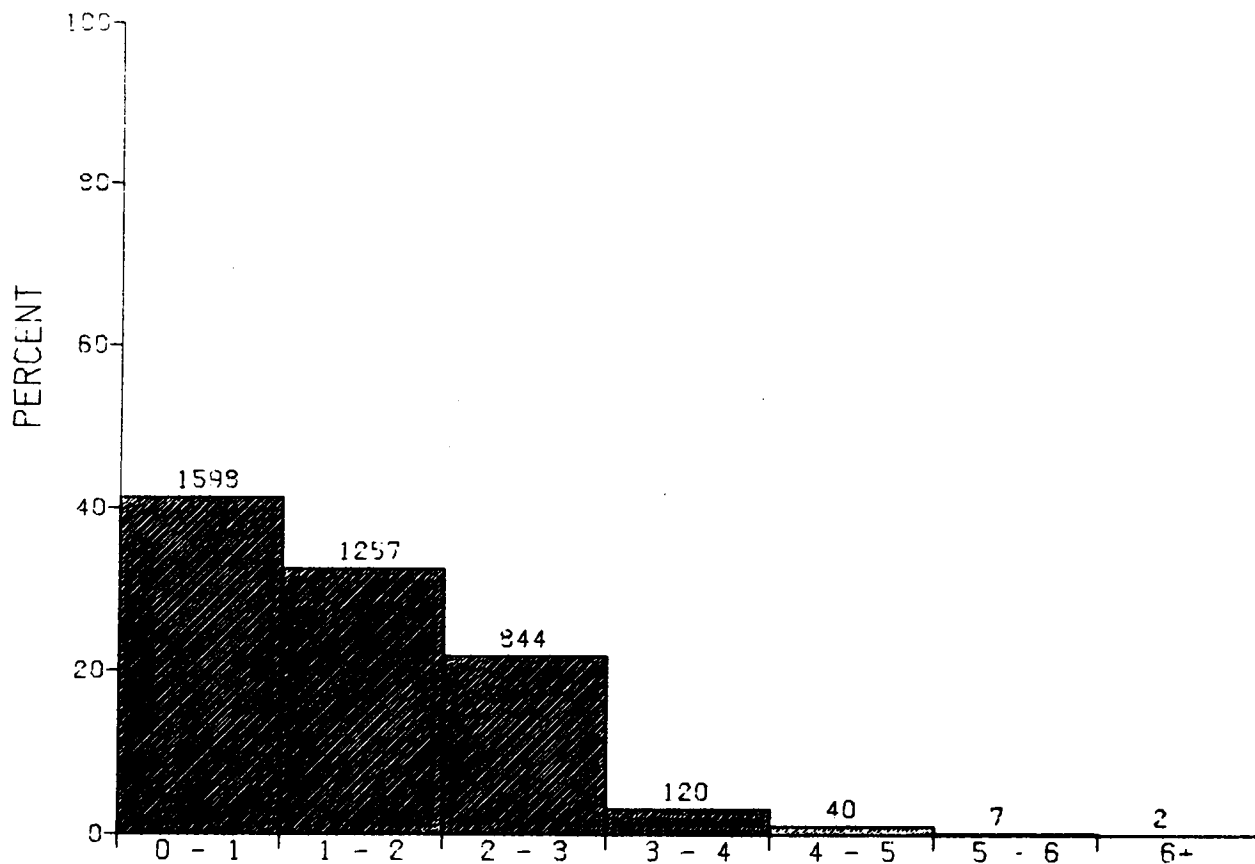

DISTRIBUTION OF SIGNIFICANT WAVE HEIGHT IN METERS

GEOS DATA- AUGUST

ENTIRE GULF OF MEXICO

N = 3868. MEAN = 1.26 SIGMA = 1.1

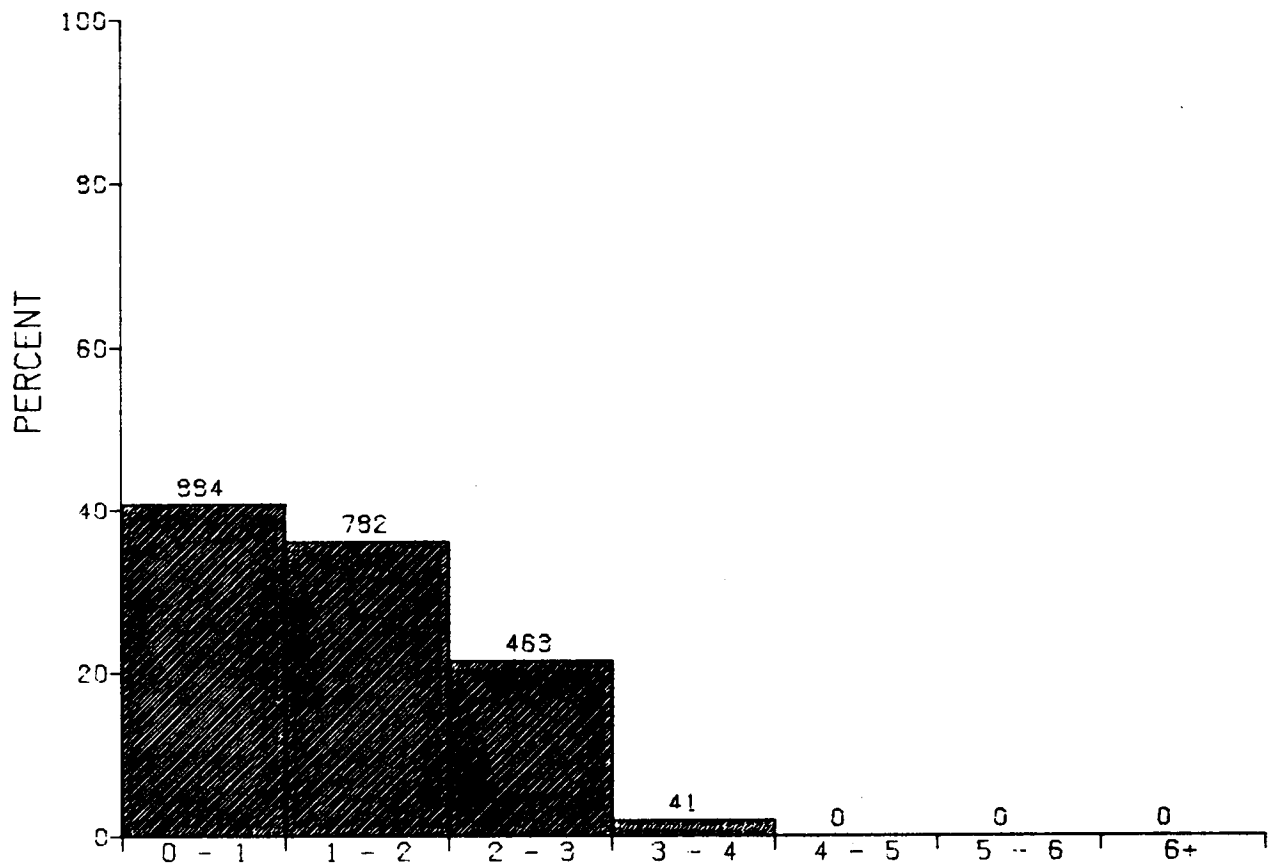

DISTRIBUTION OF SIGNIFICANT WAVE HEIGHT IN METERS

GEOS DATA- SEPTEMBER

EASTERN GULF OF MEXICO

N = 2170.

MEAN = 1.21

SIGMA = 0.94

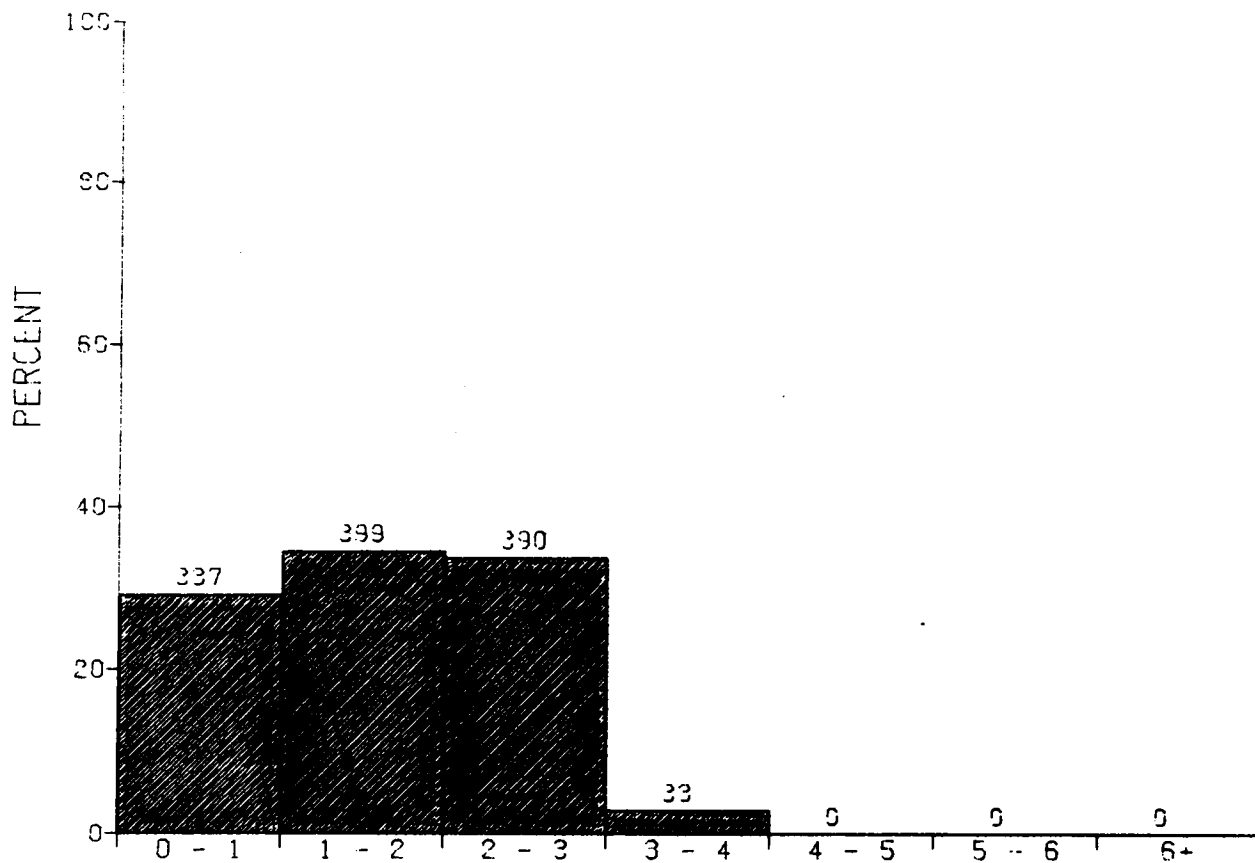

DISTRIBUTION OF SIGNIFICANT WAVE HEIGHT IN METERS

GEOS DATA- SEPTEMBER

WESTERN GULF OF MEXICO

N = 1159.

MEAN = 1.51

SIGMA = 1.0

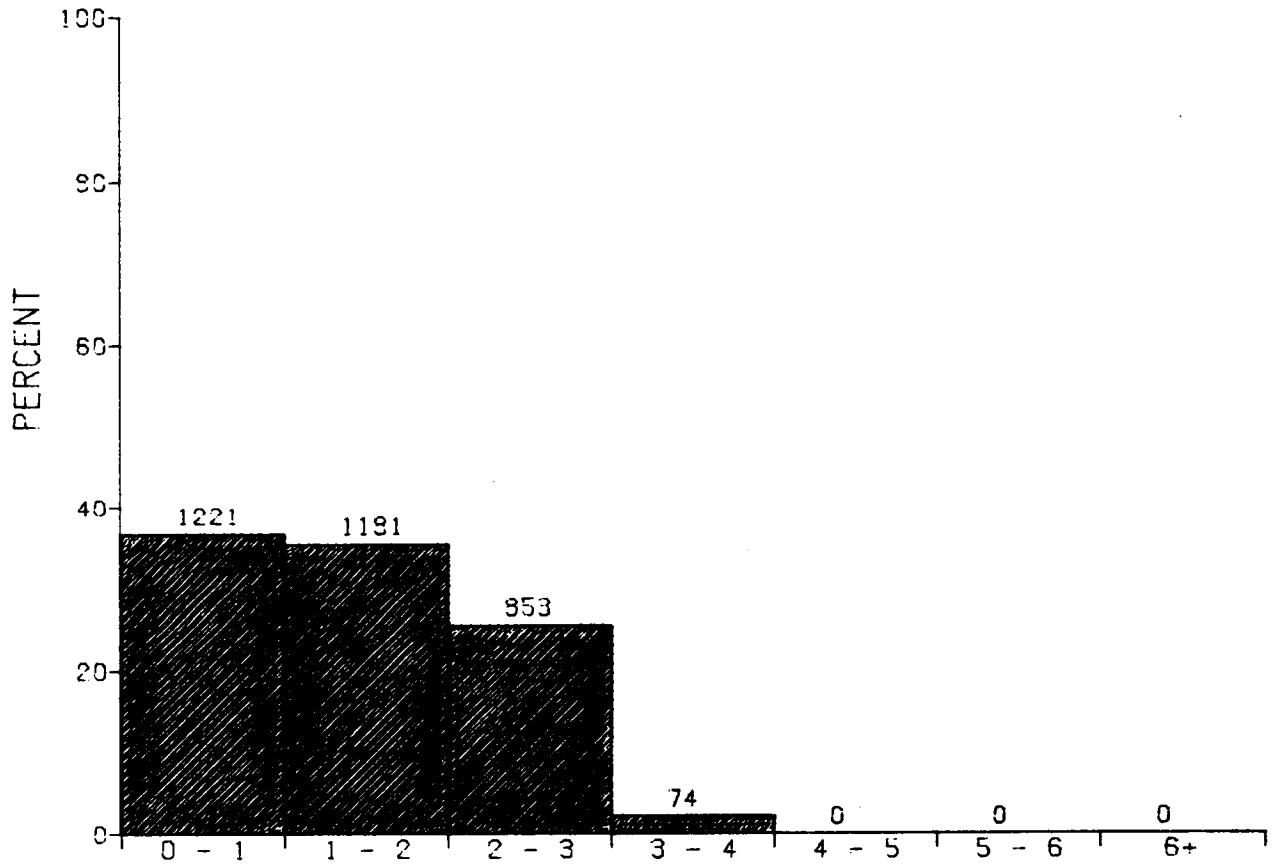

DISTRIBUTION OF SIGNIFICANT WAVE HEIGHT IN METERS

GEOS DATA- SEPTEMBER

ENTIRE GULF OF MEXICO

N = 3329.

MEAN = 1.31

SIGMA = 1.0

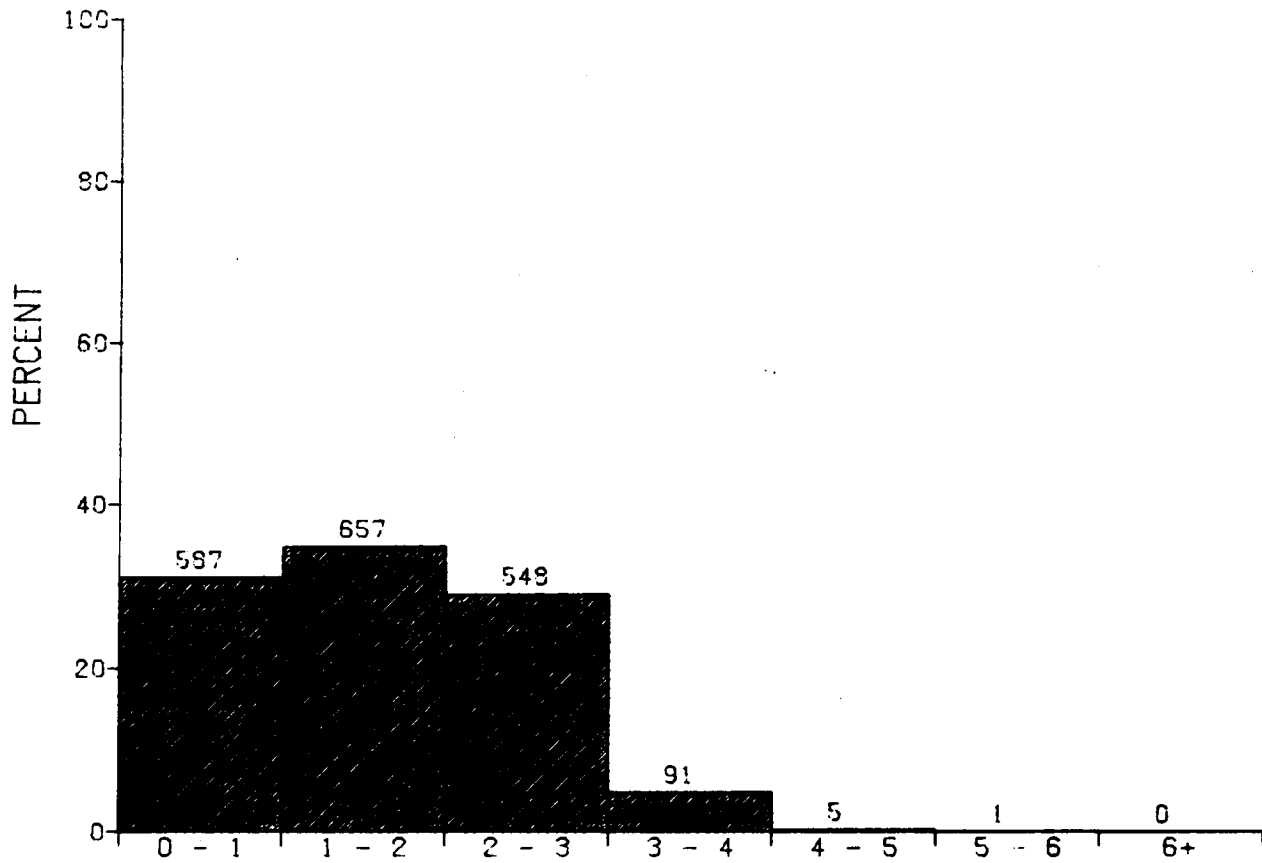

DISTRIBUTION OF SIGNIFICANT WAVE HEIGHT IN METERS

GEOS DATA- OCTOBER

EASTERN GULF OF MEXICO

N = 1889.

MEAN = 1.49

SIGMA = 0.99

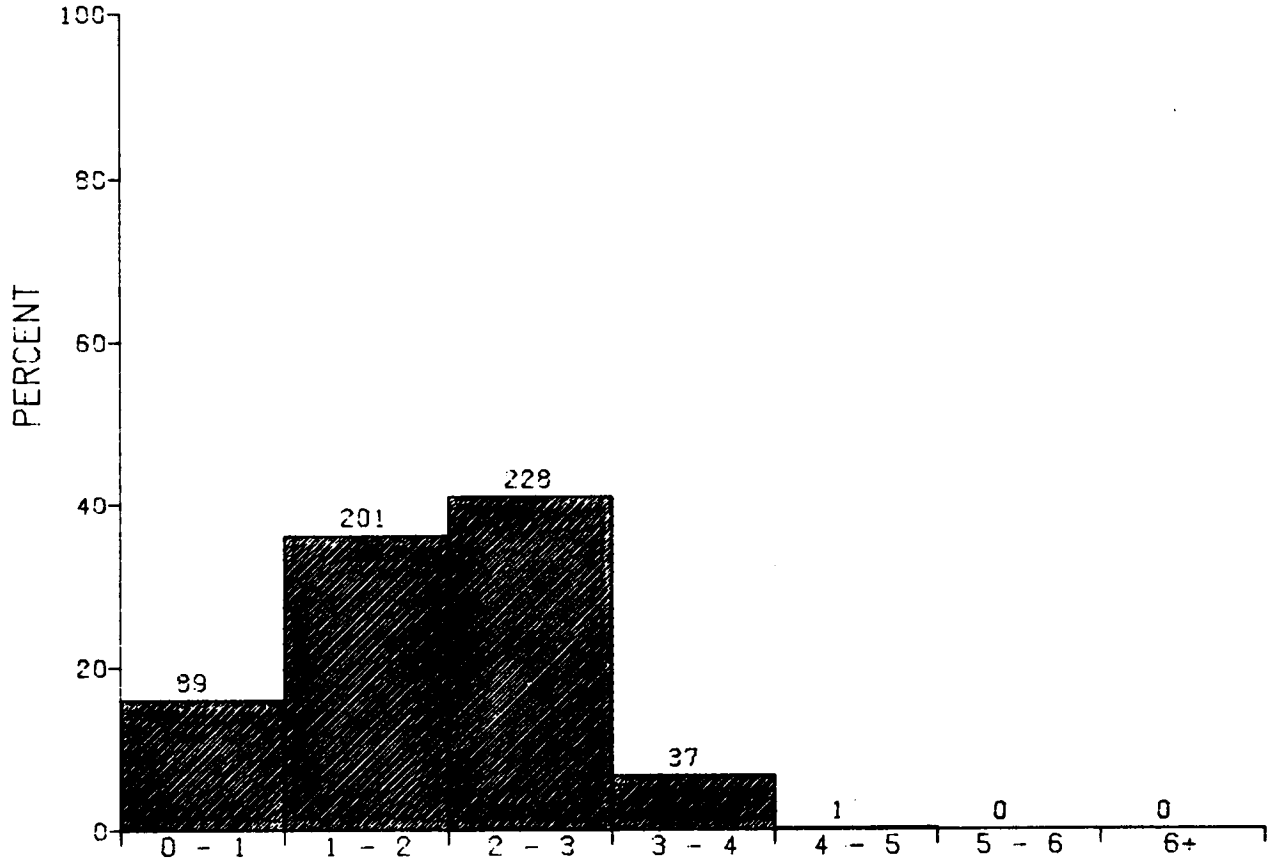

DISTRIBUTION OF SIGNIFICANT WAVE HEIGHT IN METERS

GEOS DATA- OCTOBER

WESTERN GULF OF MEXICO

N = 556.

MEAN = 1.88

SIGMA = 0.9

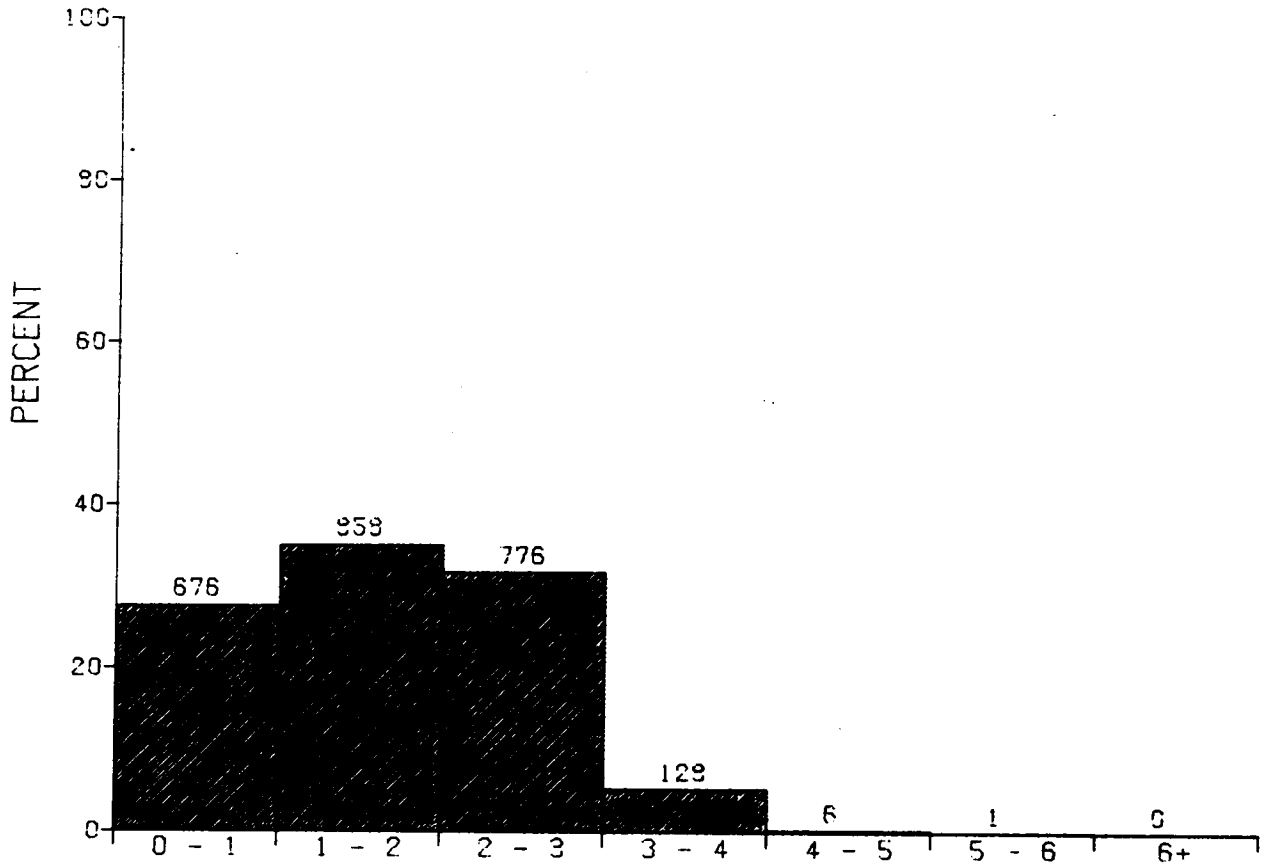

DISTRIBUTION OF SIGNIFICANT WAVE HEIGHT IN METERS
 GEOS DATA- OCTOBER
 ENTIRE GULF OF MEXICO

N = 2445. MEAN = 1.58 SIGMA = 1.0

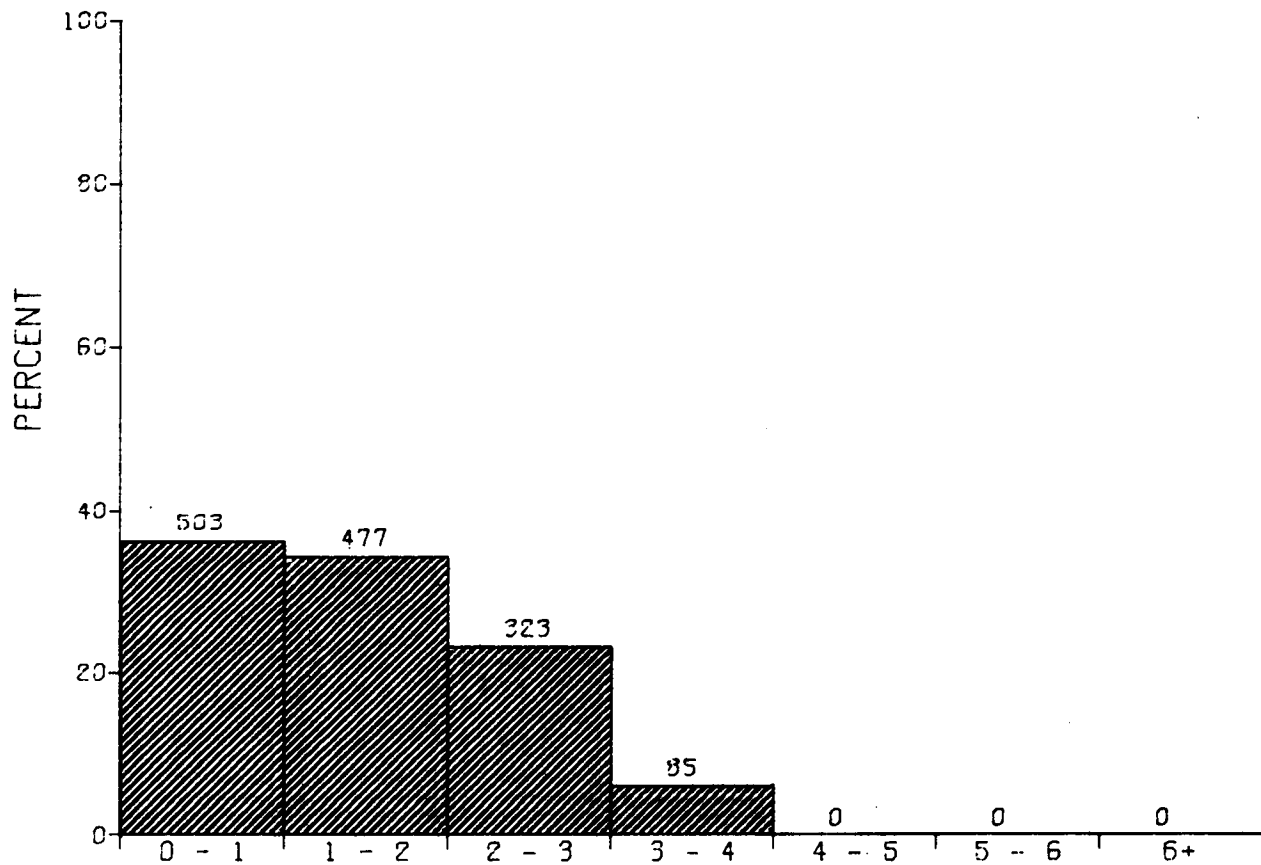

DISTRIBUTION OF SIGNIFICANT WAVE HEIGHT IN METERS

GEOS DATA- NOVEMBER

EASTERN GULF OF MEXICO

N = 1388.

MEAN = 1.36

SIGMA = 1.02

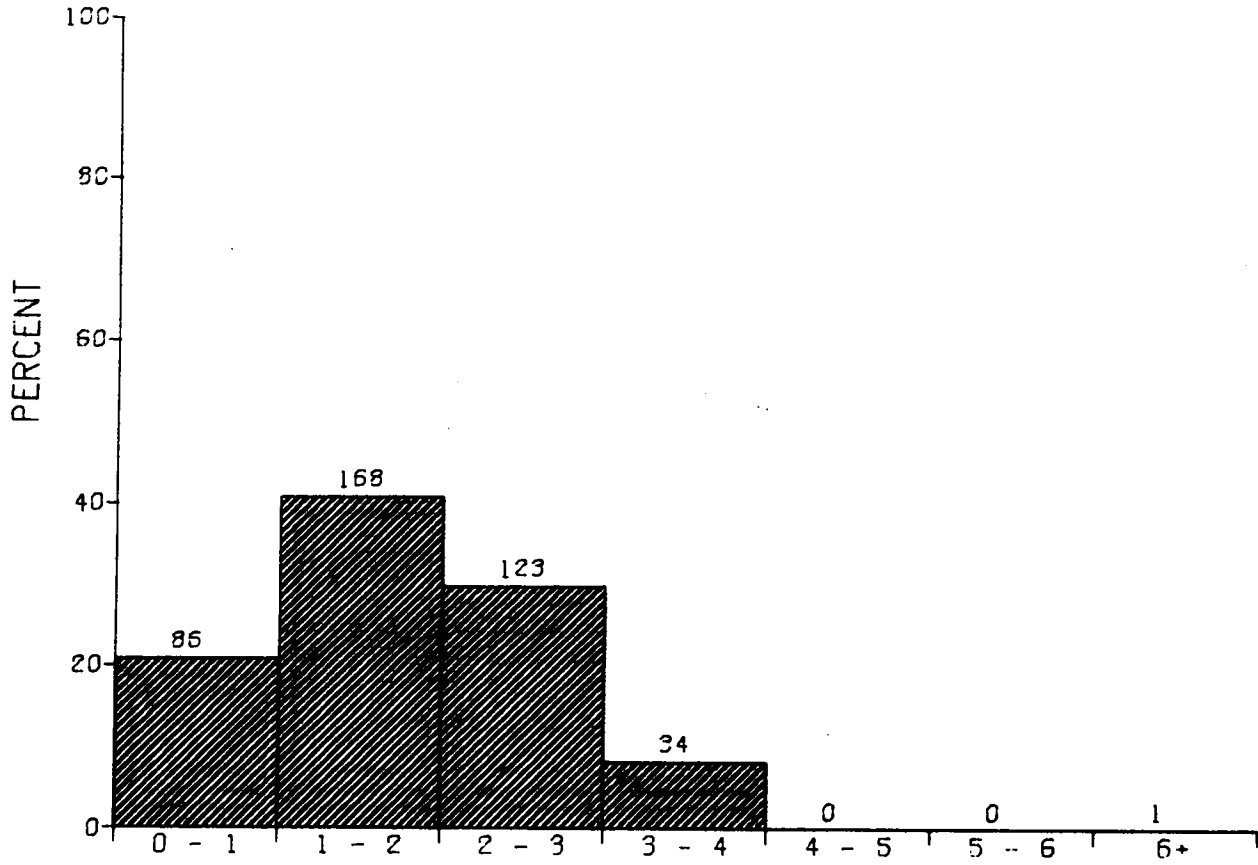

DISTRIBUTION OF SIGNIFICANT WAVE HEIGHT IN METERS

GEOS DATA- NOVEMBER

WESTERN GULF OF MEXICO

N = 412.

MEAN = 1.68

SIGMA = 1.0

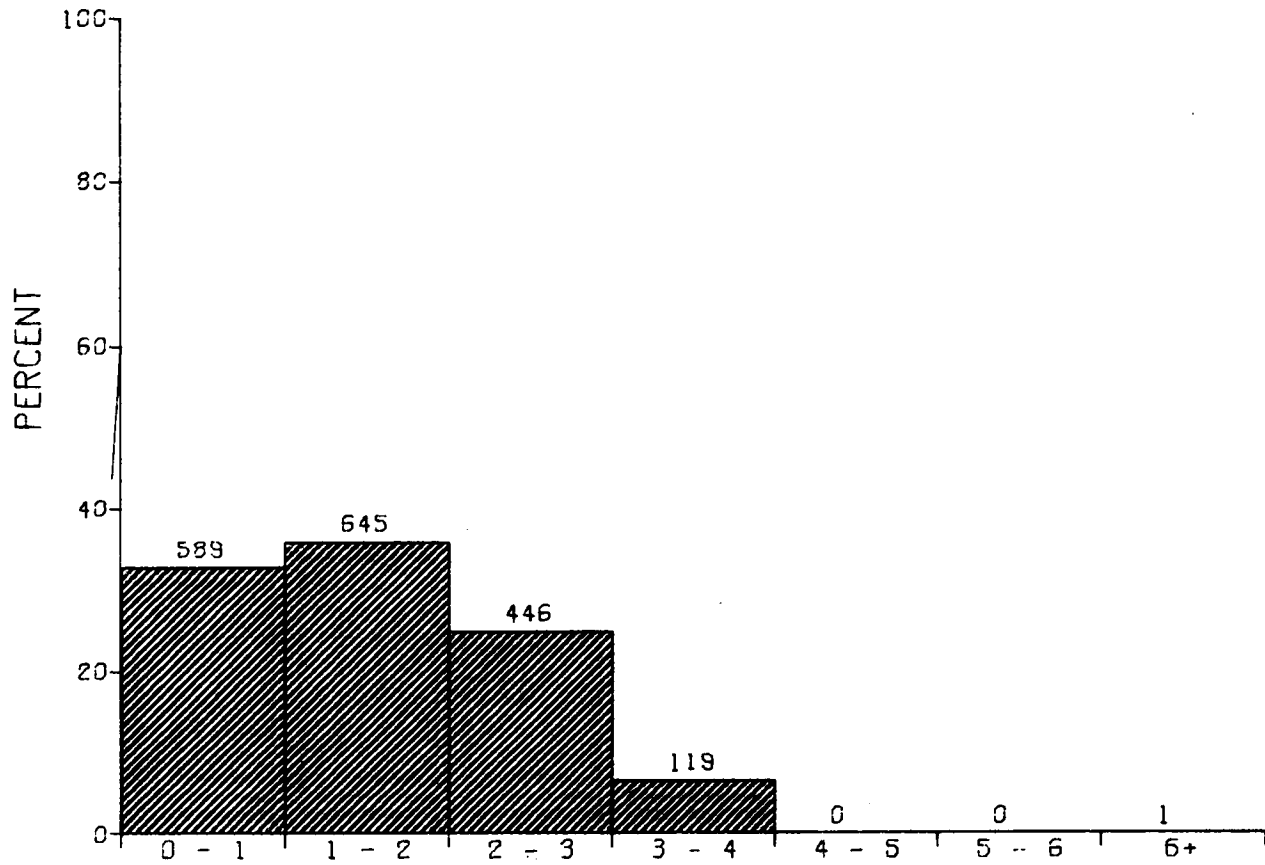

DISTRIBUTION OF SIGNIFICANT WAVE HEIGHT IN METERS

GEOS DATA- NOVEMBER

ENTIRE GULF OF MEXICO

N = 1800.

MEAN = 1.43

SIGMA = 1.0

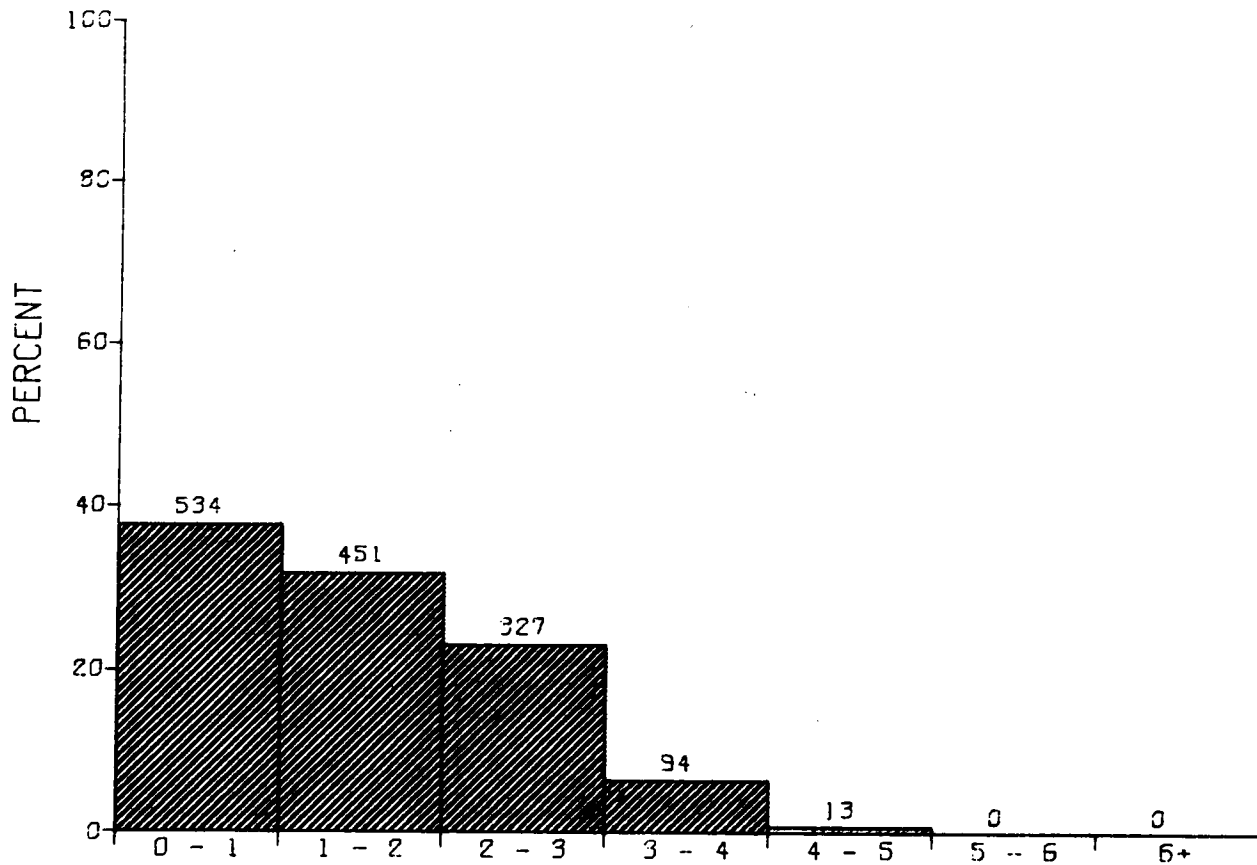

DISTRIBUTION OF SIGNIFICANT WAVE HEIGHT IN METERS

GEOS DATA- DECEMBER

EASTERN GULF OF MEXICO

N = 1419.

MEAN = 1.40

SIGMA = 1.09

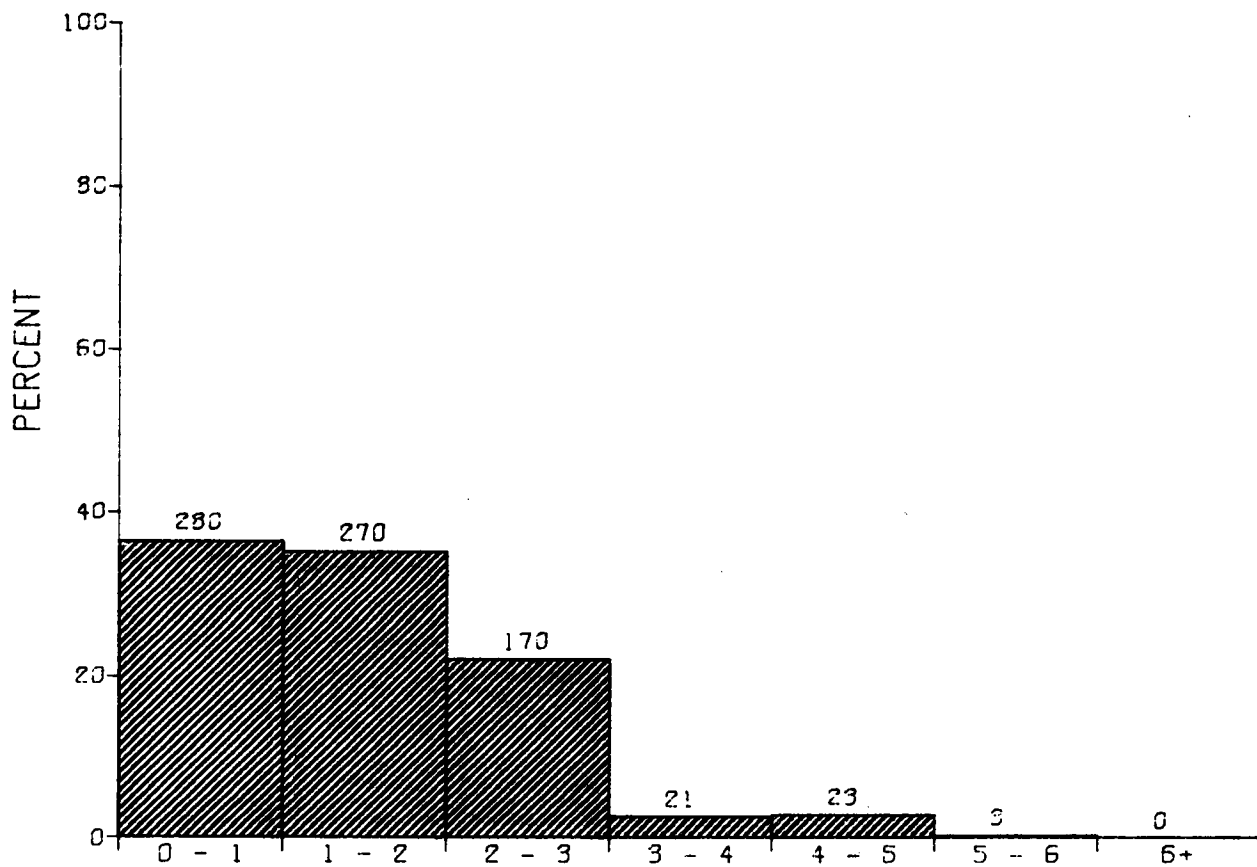

DISTRIBUTION OF SIGNIFICANT WAVE HEIGHT IN METERS

GEOS DATA- DECEMBER

WESTERN GULF OF MEXICO

N = 767.

MEAN = 1.40

SIGMA = 1.1

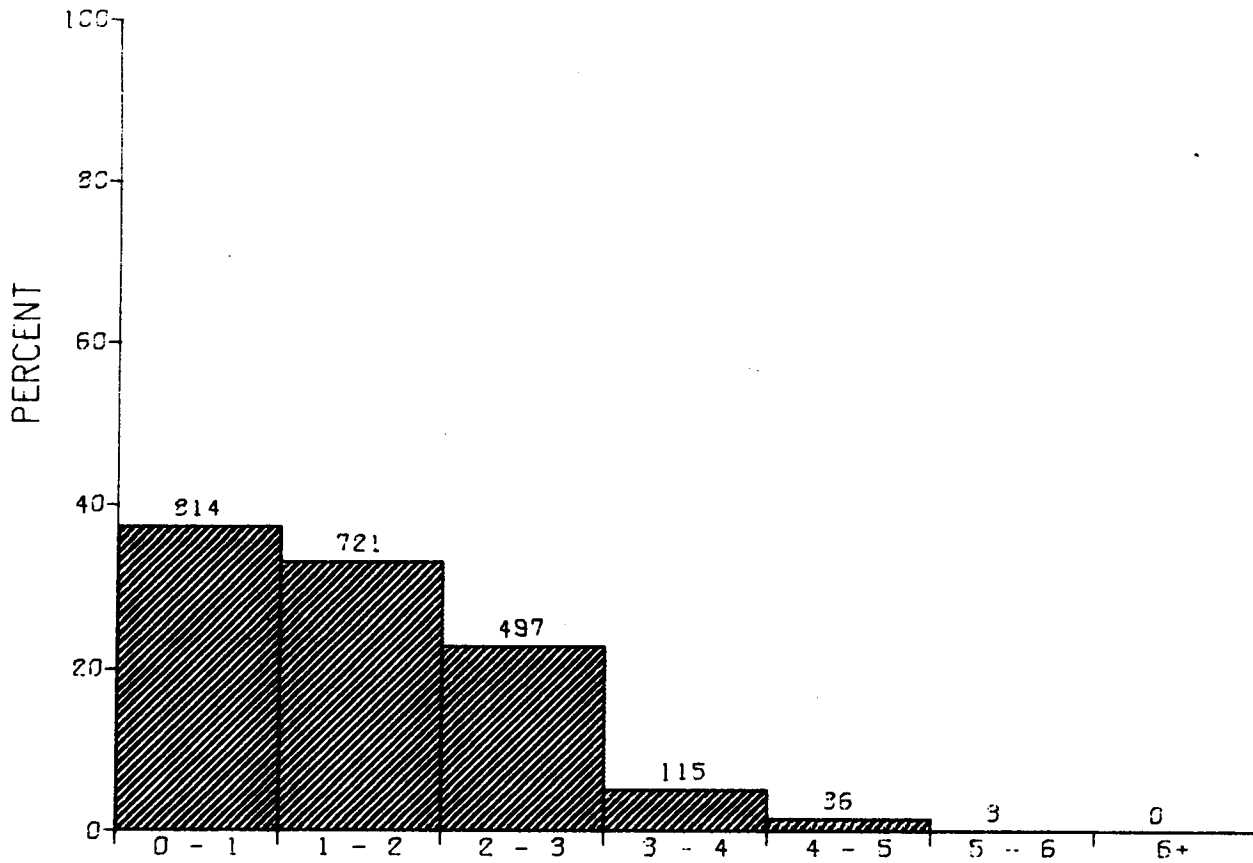

DISTRIBUTION OF SIGNIFICANT WAVE HEIGHT IN METERS

GEOS DATA- DECEMBER

ENTIRE GULF OF MEXICO

N = 2186.

MEAN = 1.40

SIGMA = 1.1

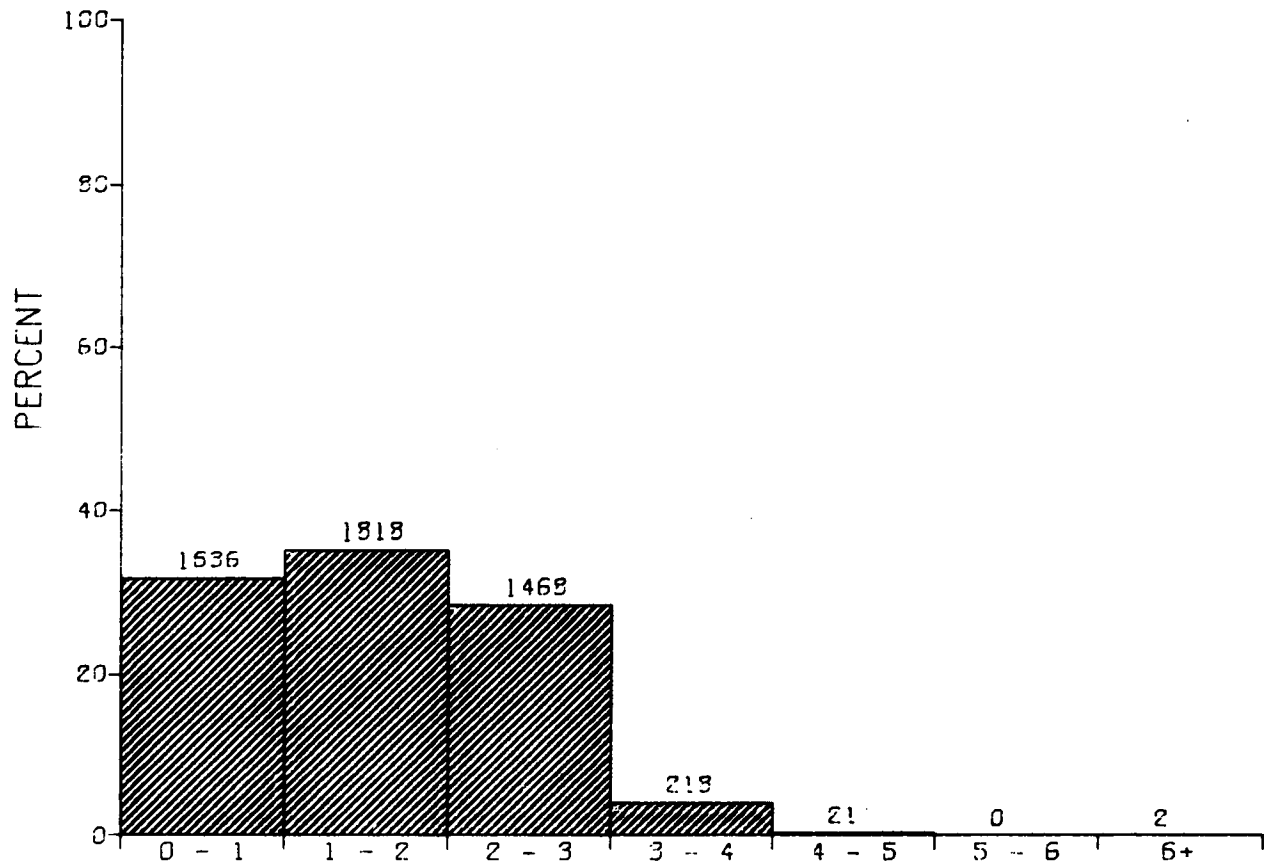

DISTRIBUTION OF SIGNIFICANT WAVE HEIGHT IN METERS

GEOS DATA- SPRING

EASTERN GULF OF MEXICO

N = 5163.

MEAN = 1.45

SIGMA = 1.01

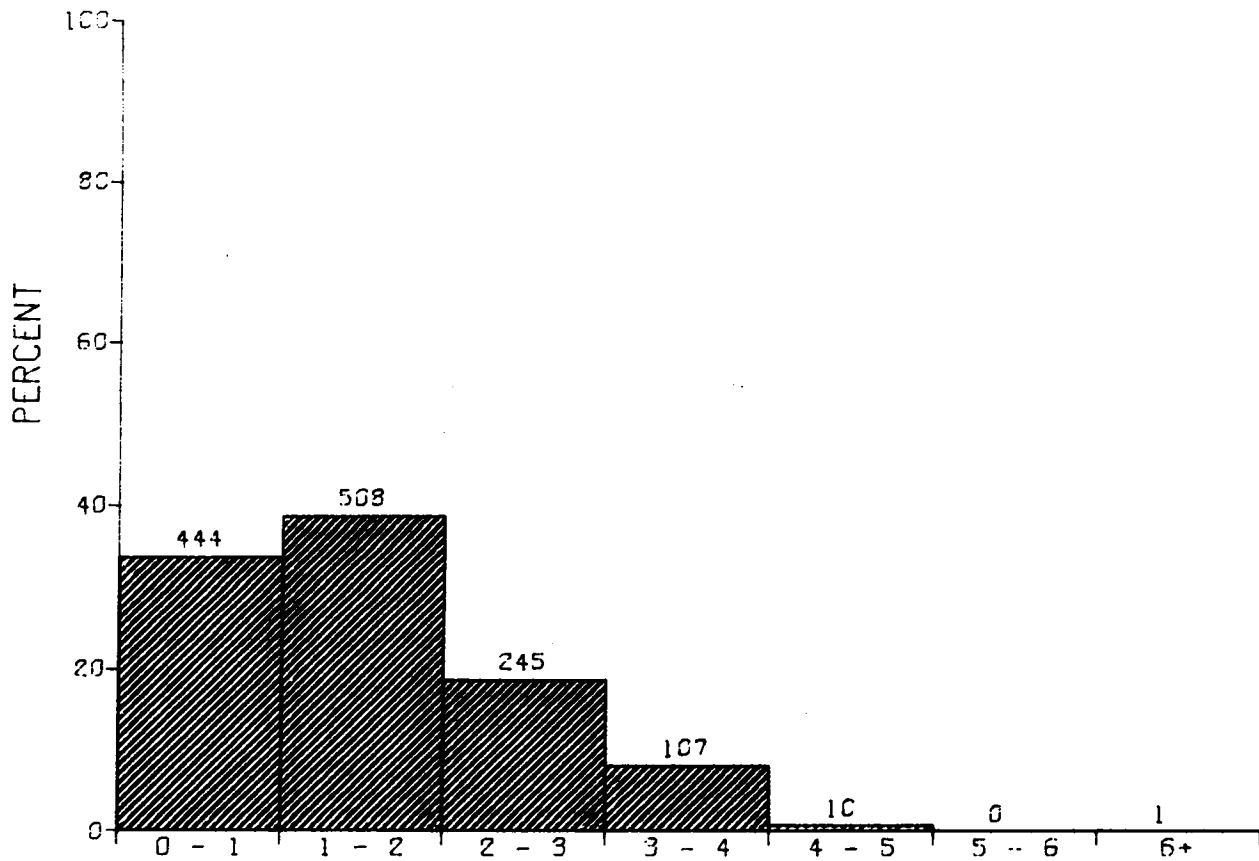

DISTRIBUTION OF SIGNIFICANT WAVE HEIGHT IN METERS

GEOS DATA- SPRING

WESTERN GULF OF MEXICO

N = 1315. MEAN = 1.43 SIGMA = 1.1

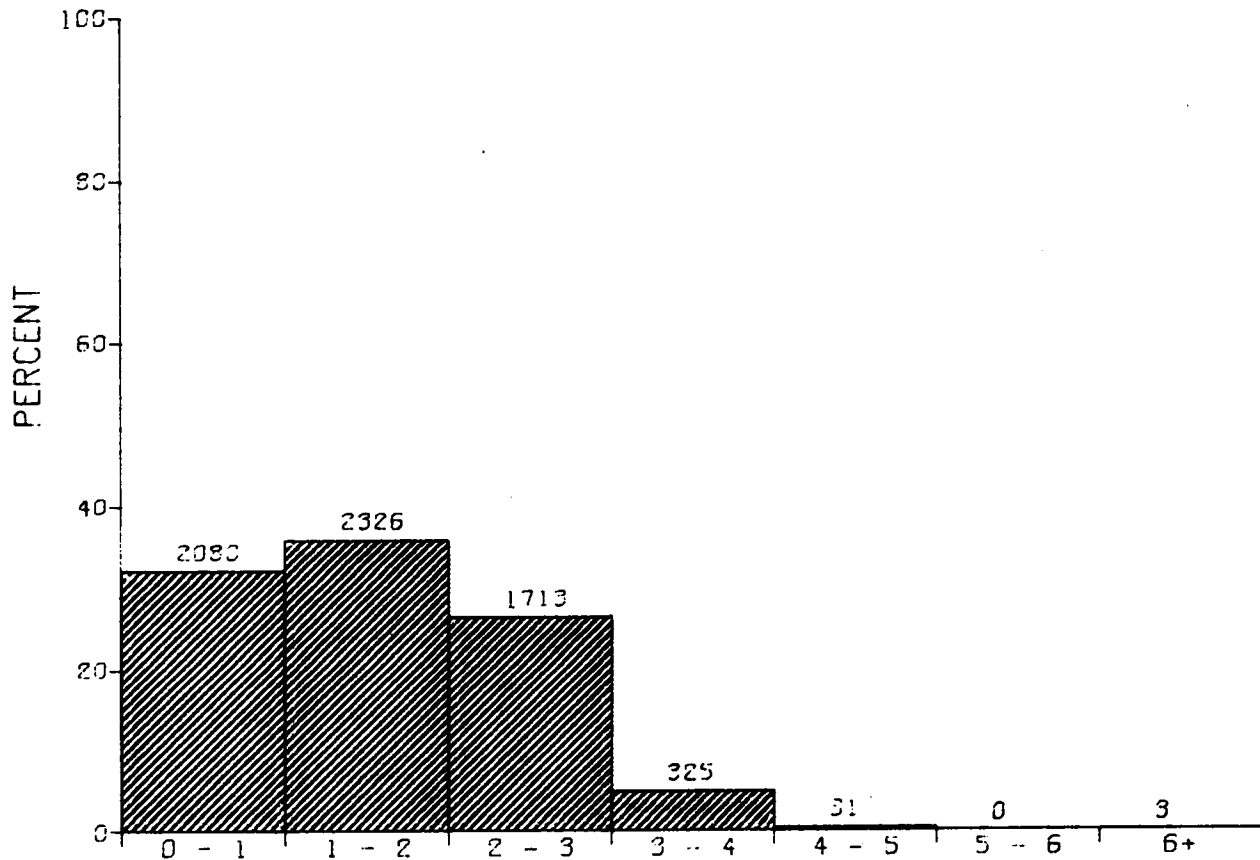

DISTRIBUTION OF SIGNIFICANT WAVE HEIGHT IN METERS

GEOS DATA- SPRING

ENTIRE GULF OF MEXICO

N = 6478.

MEAN = 1.45

SIGMA = 1.0

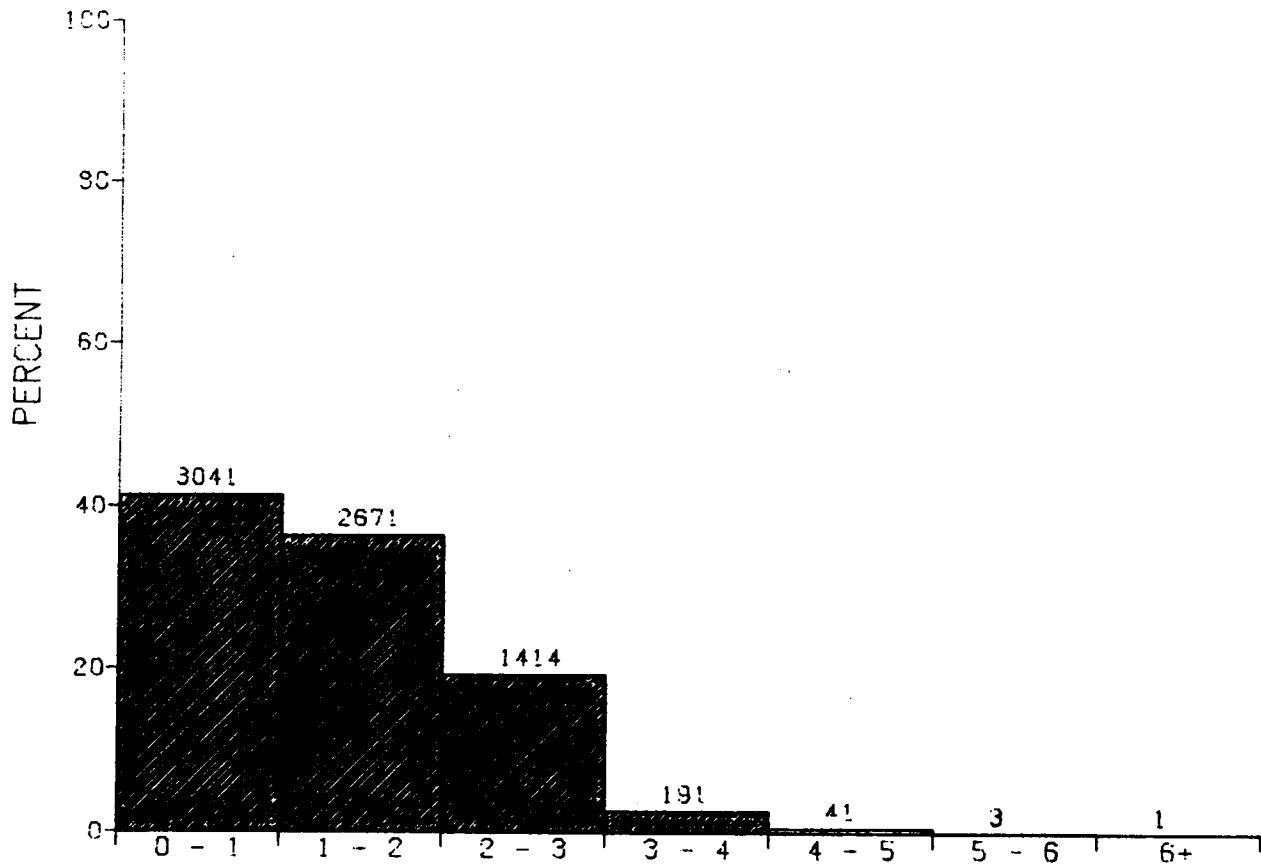

DISTRIBUTION OF SIGNIFICANT WAVE HEIGHT IN METERS

GEOS DATA- SUMMER

EASTERN GULF OF MEXICO

N = 7362.

MEAN = 1.20

SIGMA = 0.99

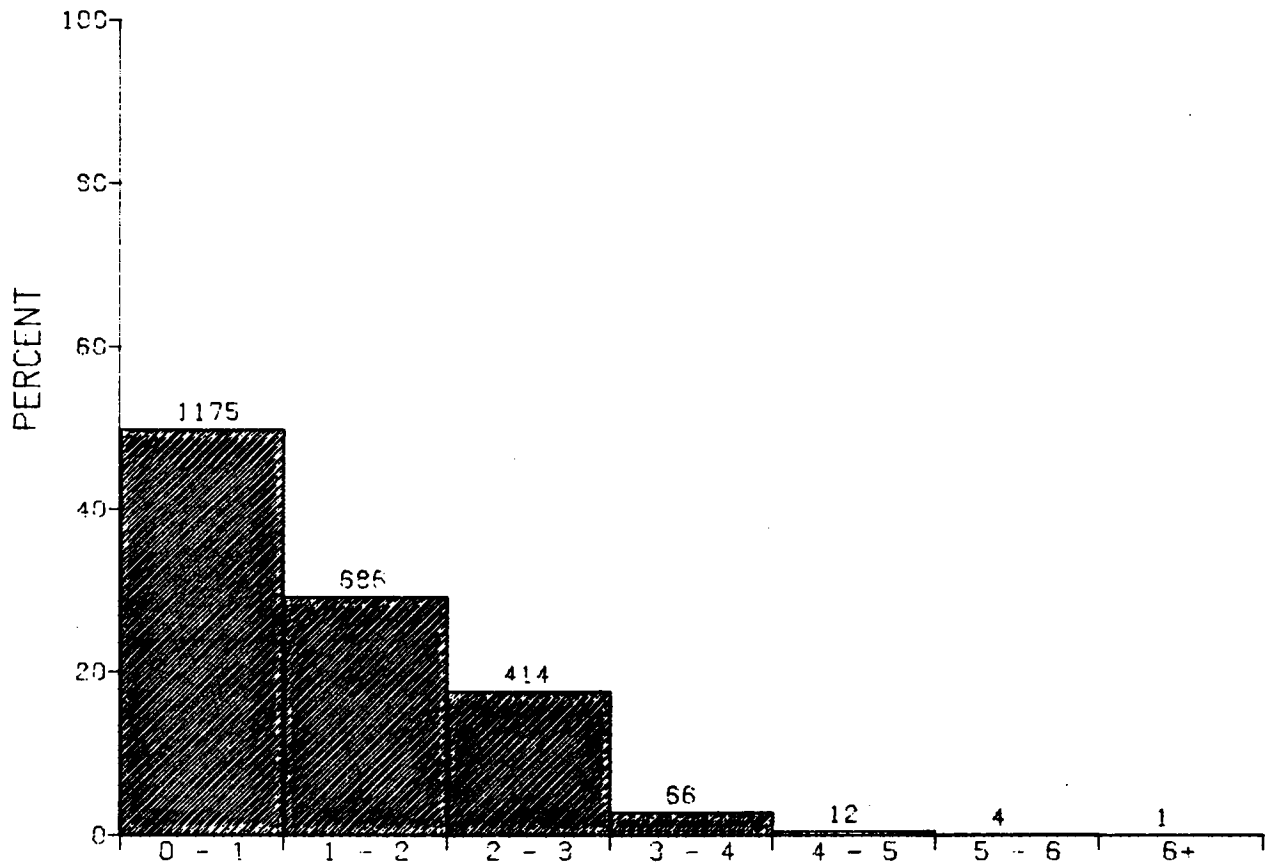

DISTRIBUTION OF SIGNIFICANT WAVE HEIGHT IN METERS

GEOS DATA- SUMMER

WESTERN GULF OF MEXICO

N = 2358.

MEAN = 1.08

SIGMA = 1.0

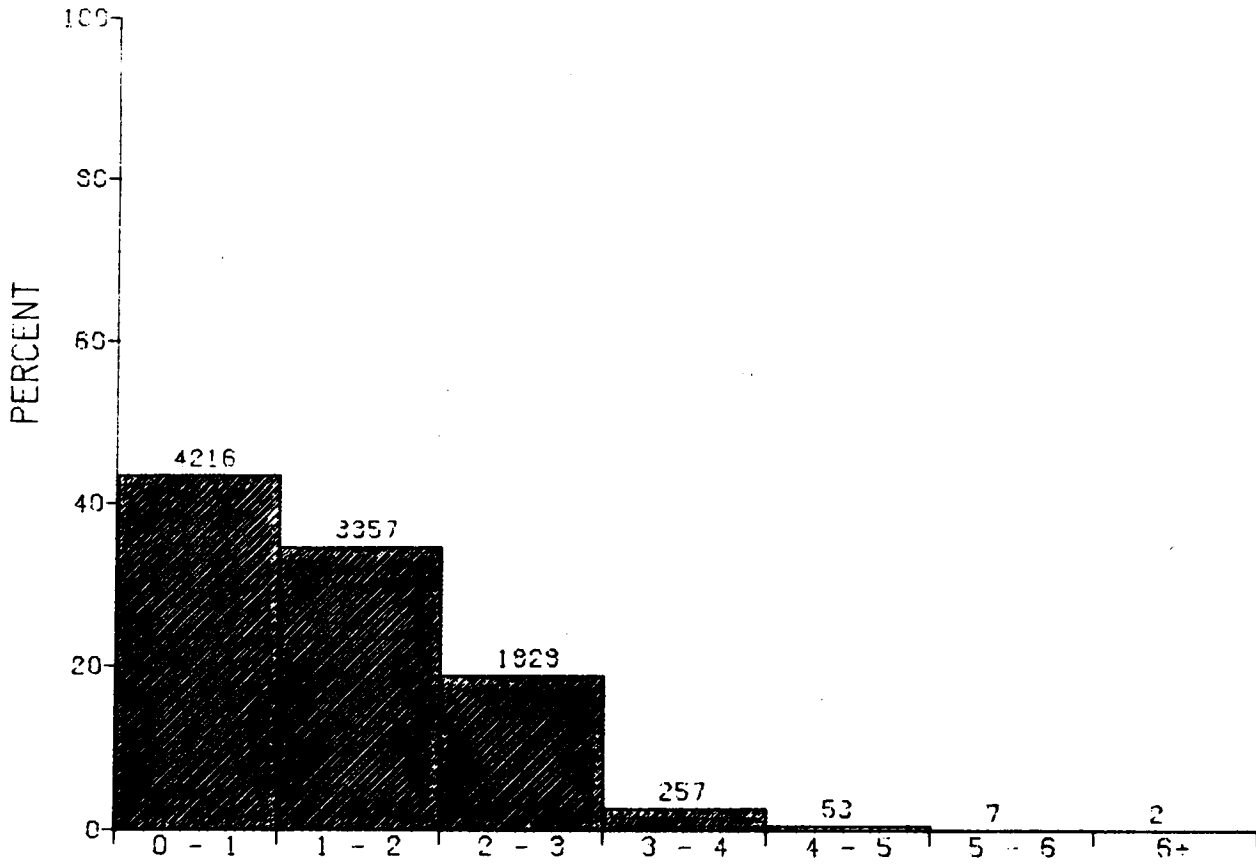

DISTRIBUTION OF SIGNIFICANT WAVE HEIGHT IN METERS

GEOS DATA- SUMMER

ENTIRE GULF OF MEXICO

N = 9720.

MEAN = 1.17

SIGMA = 1.0

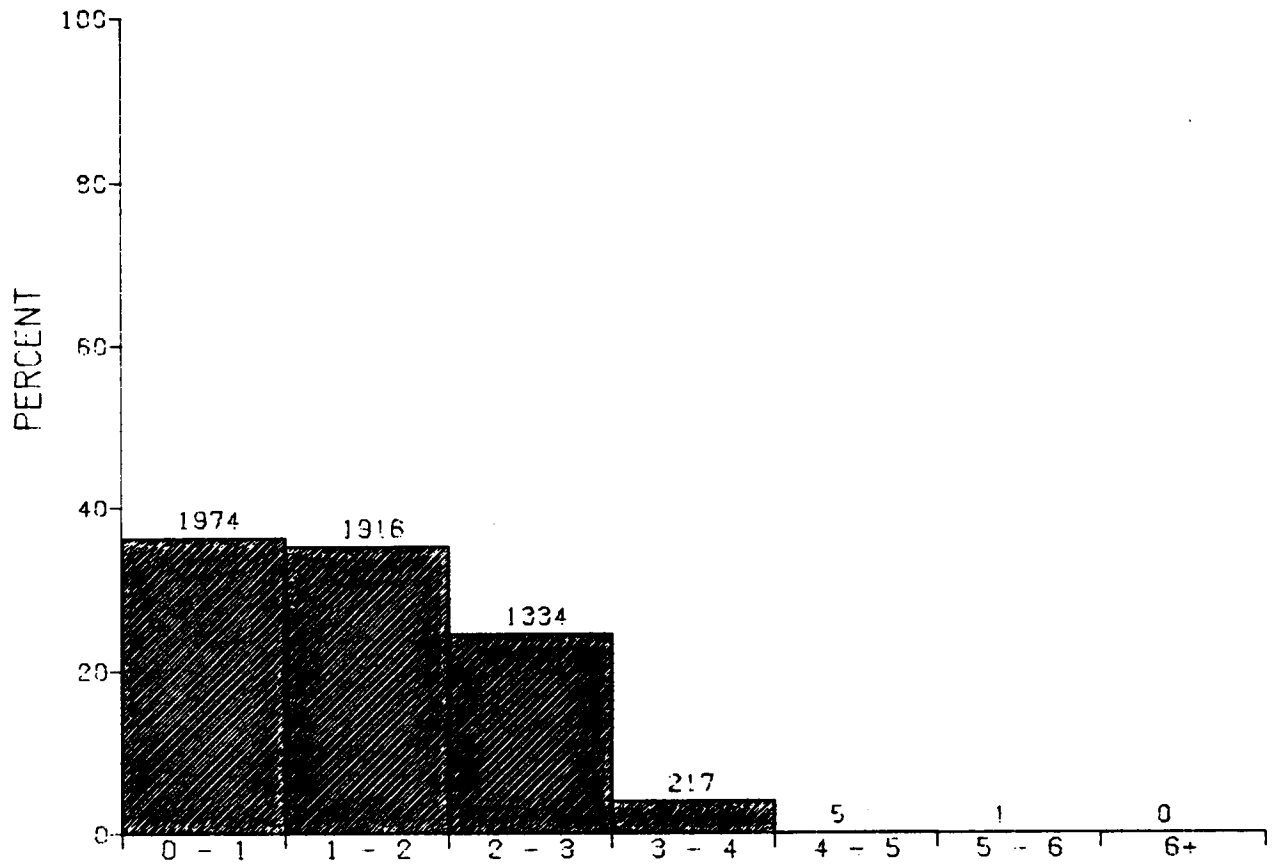

DISTRIBUTION OF SIGNIFICANT WAVE HEIGHT IN METERS

GEOS DATA-- FALL

EASTERN GULF OF MEXICO

N = 5447.

MEAN = 1.35

SIGMA = 0.99

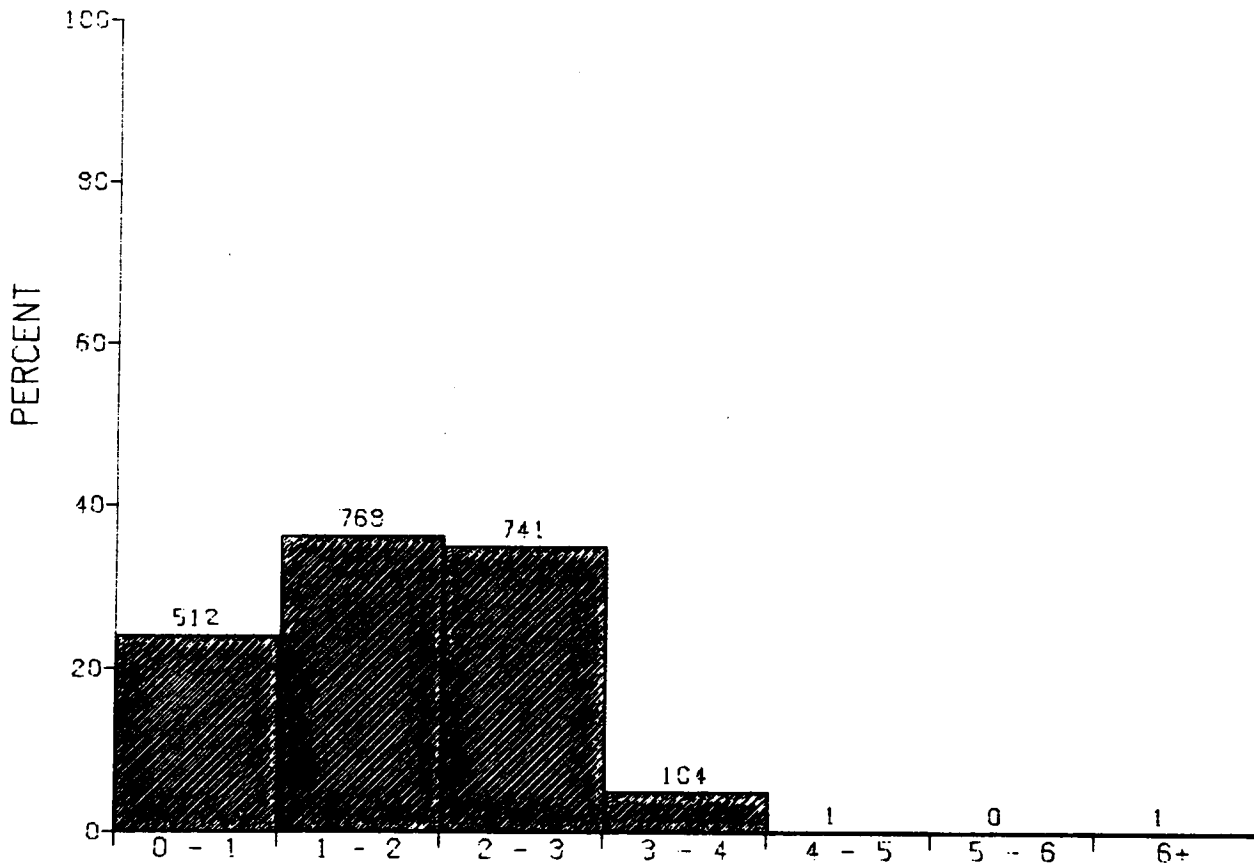

DISTRIBUTION OF SIGNIFICANT WAVE HEIGHT IN METERS

GEOS DATA-- FALL

WESTERN GULF OF MEXICO

N = 2127.

MEAN = 1.64

SIGMA = 1.0

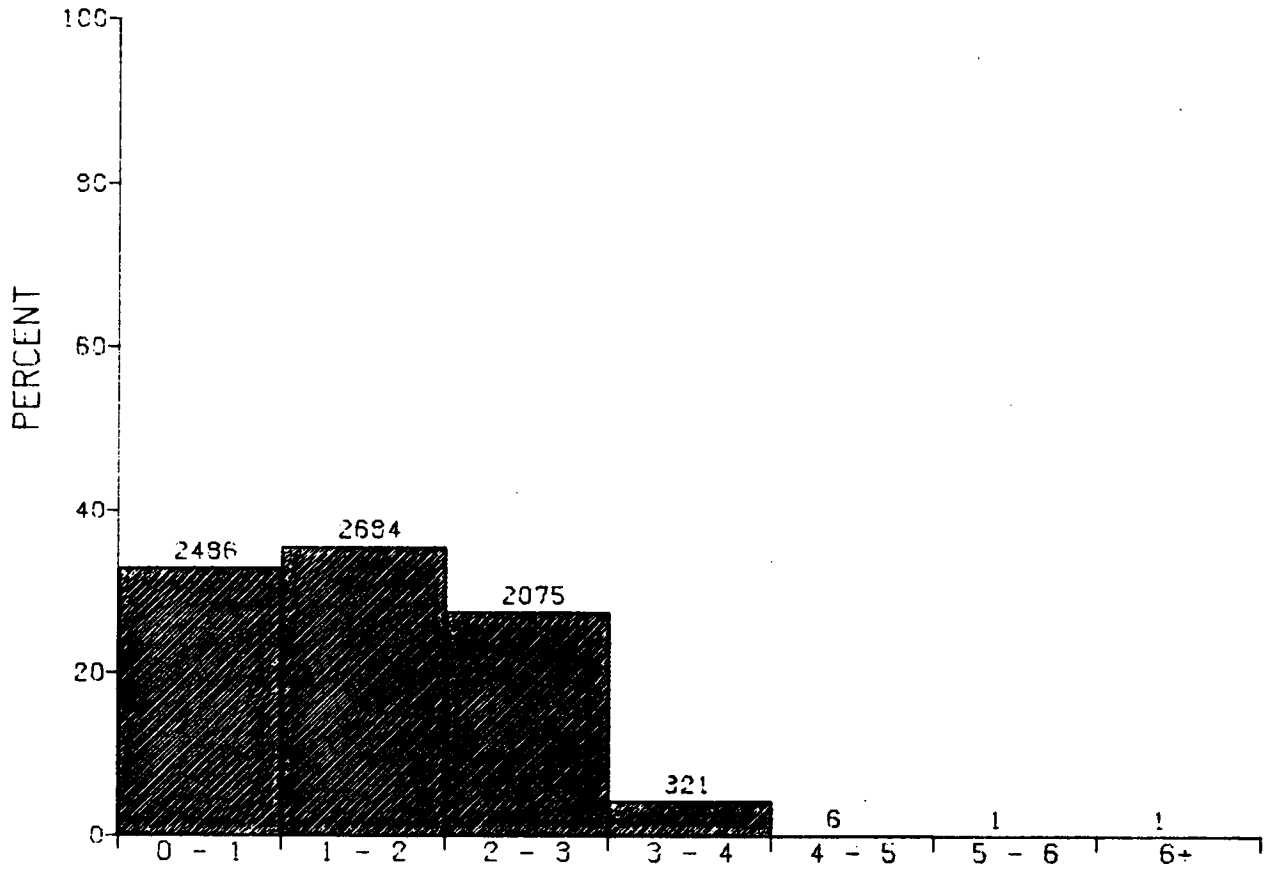

DISTRIBUTION OF SIGNIFICANT WAVE HEIGHT IN METERS

GEOS DATA-- FALL

ENTIRE GULF OF MEXICO

N = 7574.

MEAN = 1.43

SIGMA = 1.0

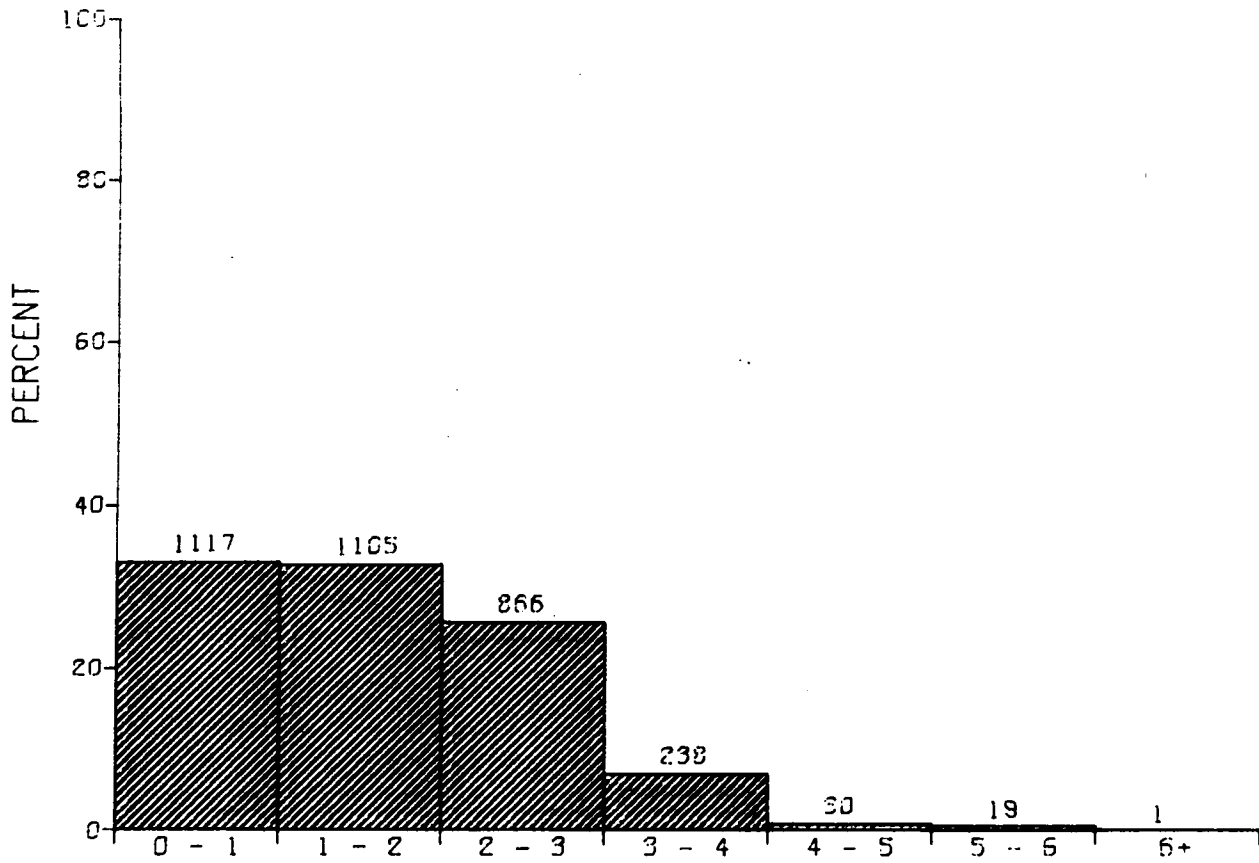

DISTRIBUTION OF SIGNIFICANT WAVE HEIGHT IN METERS

GEOS DATA- WINTER

EASTERN GULF OF MEXICO

N = 3376.

MEAN = 1.50

SIGMA = 1.12

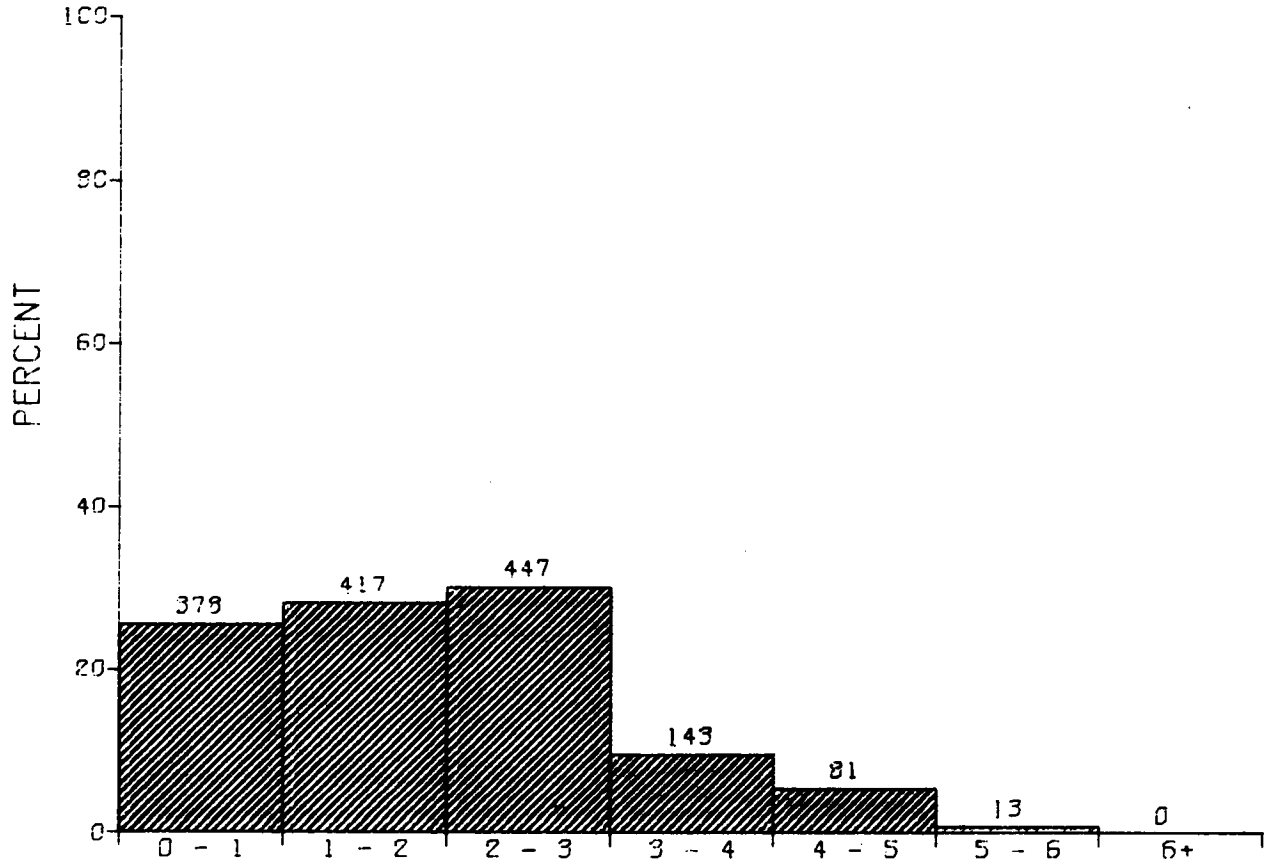

DISTRIBUTION OF SIGNIFICANT WAVE HEIGHT IN METERS

GEOS DATA- WINTER

WESTERN GULF OF MEXICO

N = 1479.

MEAN = 1.83

SIGMA = 1.3

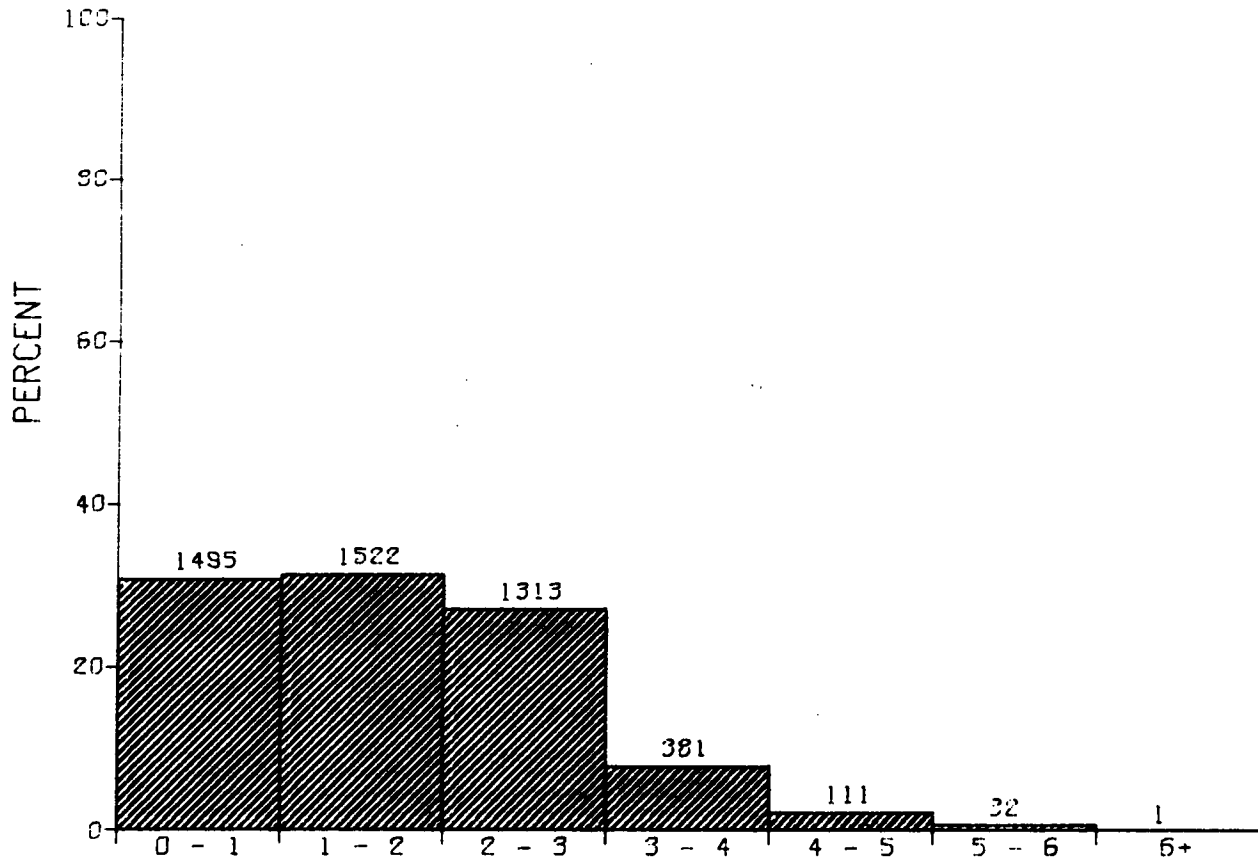

DISTRIBUTION OF SIGNIFICANT WAVE HEIGHT IN METERS

GEOS DATA- WINTER

ENTIRE GULF OF MEXICO

N = 4855.

MEAN = 1.60

SIGMA = 1.2

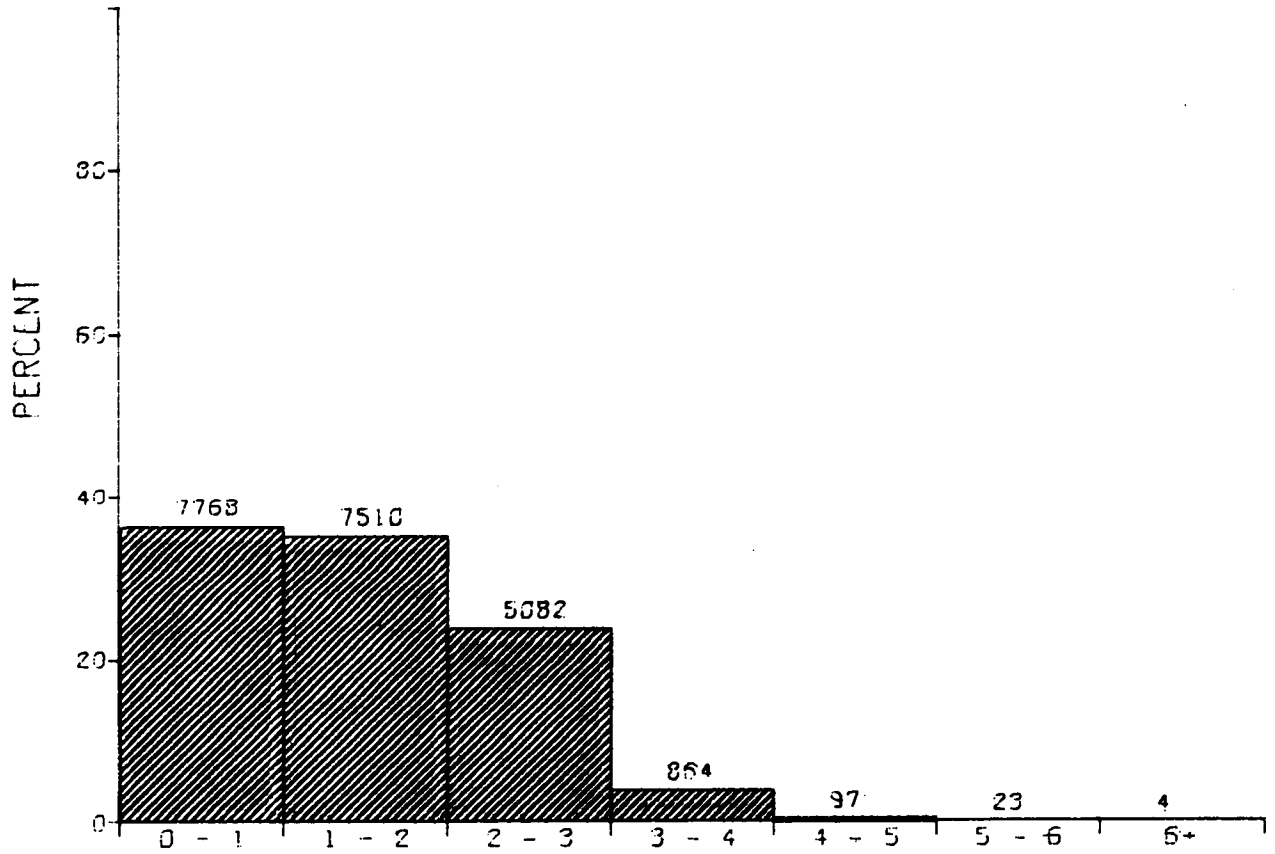

DISTRIBUTION OF SIGNIFICANT WAVE HEIGHT IN METERS

ALL GEOS DATA

EASTERN GULF OF MEXICO

N = 21348. MEAN = 1.35 STDMA = 1.02

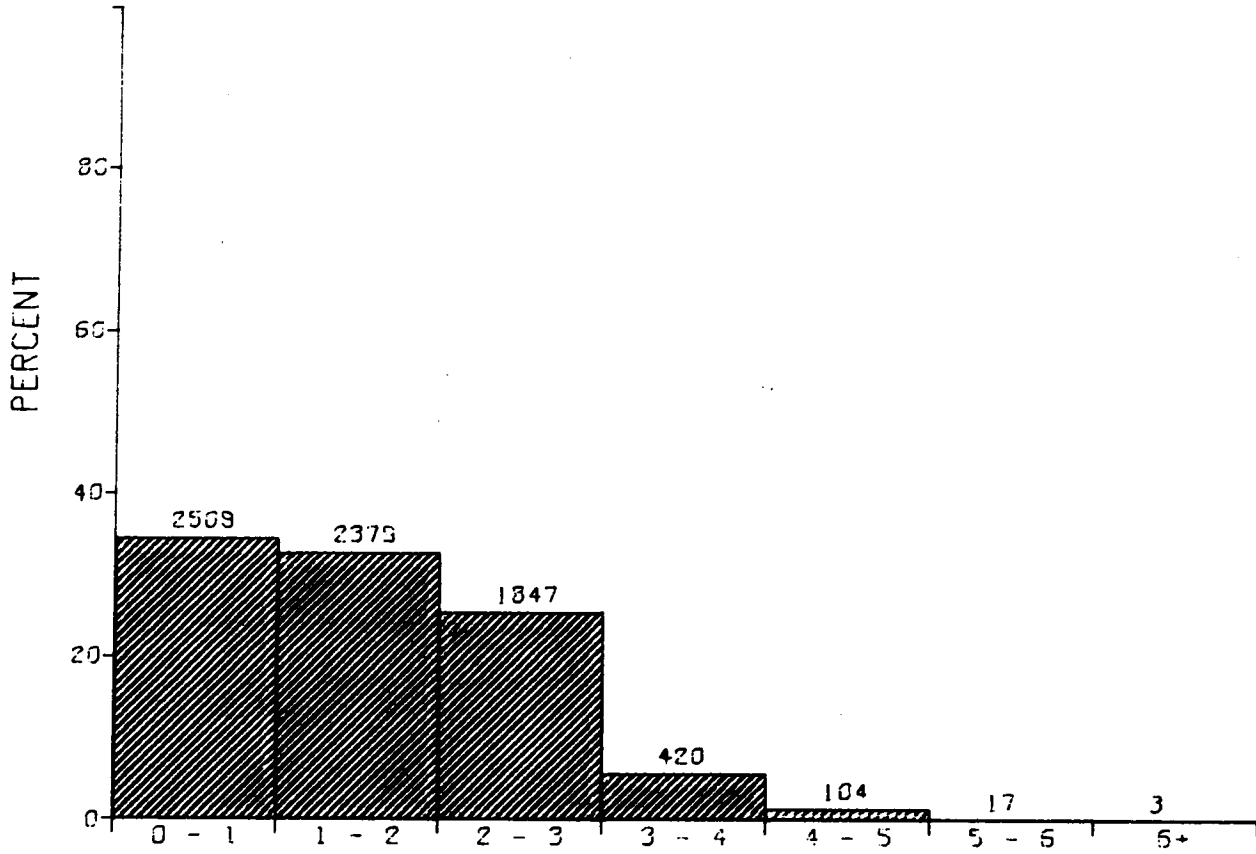

DISTRIBUTION OF SIGNIFICANT WAVE HEIGHT IN METERS

ALL GEOS DATA

WESTERN GULF OF MEXICO

N = 7279.

MEAN = 1.46

SIGMA = 1.1

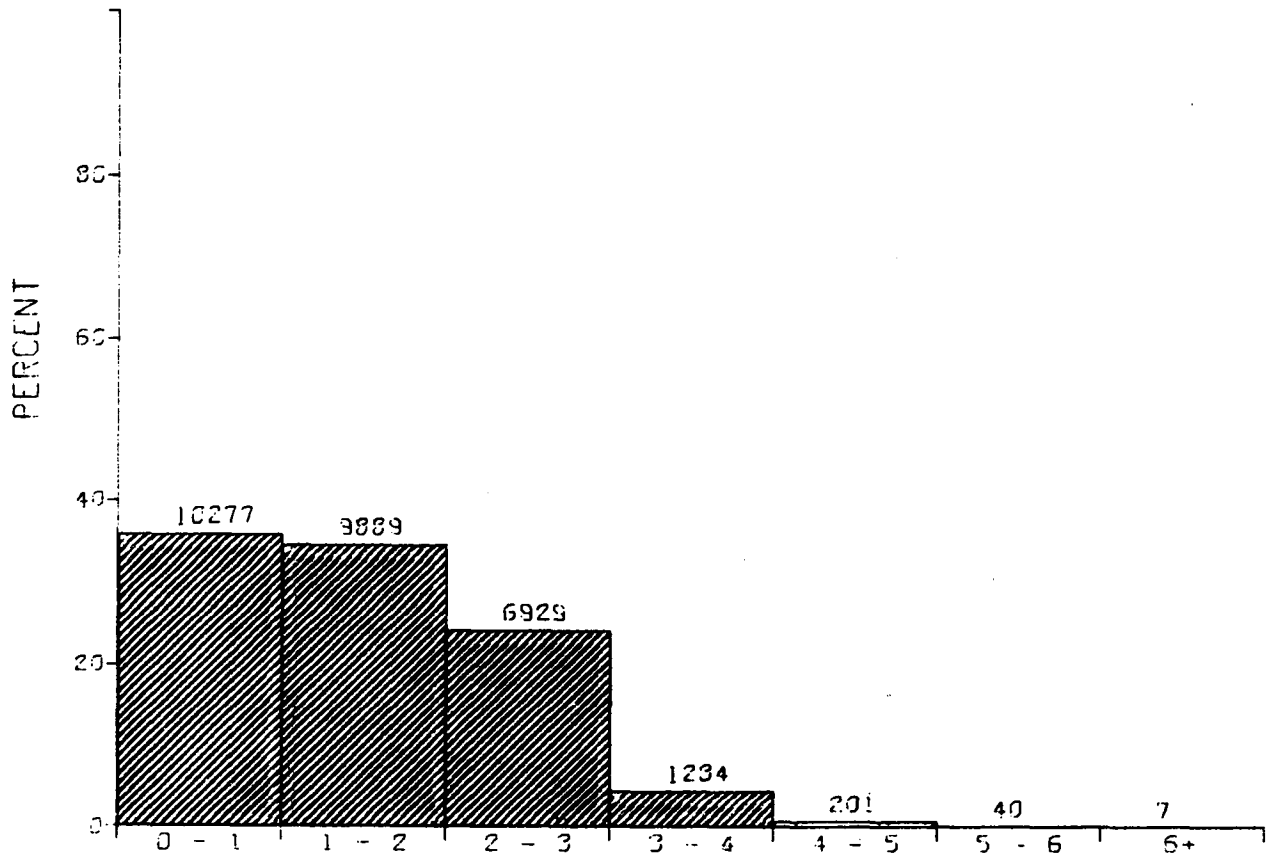

DISTRIBUTION OF SIGNIFICANT WAVE HEIGHT IN METERS

ALL GEOS DATA

ENTIRE GULF OF MEXICO

N = 28627. MEAN = 1.33 SIGMA = 1.0

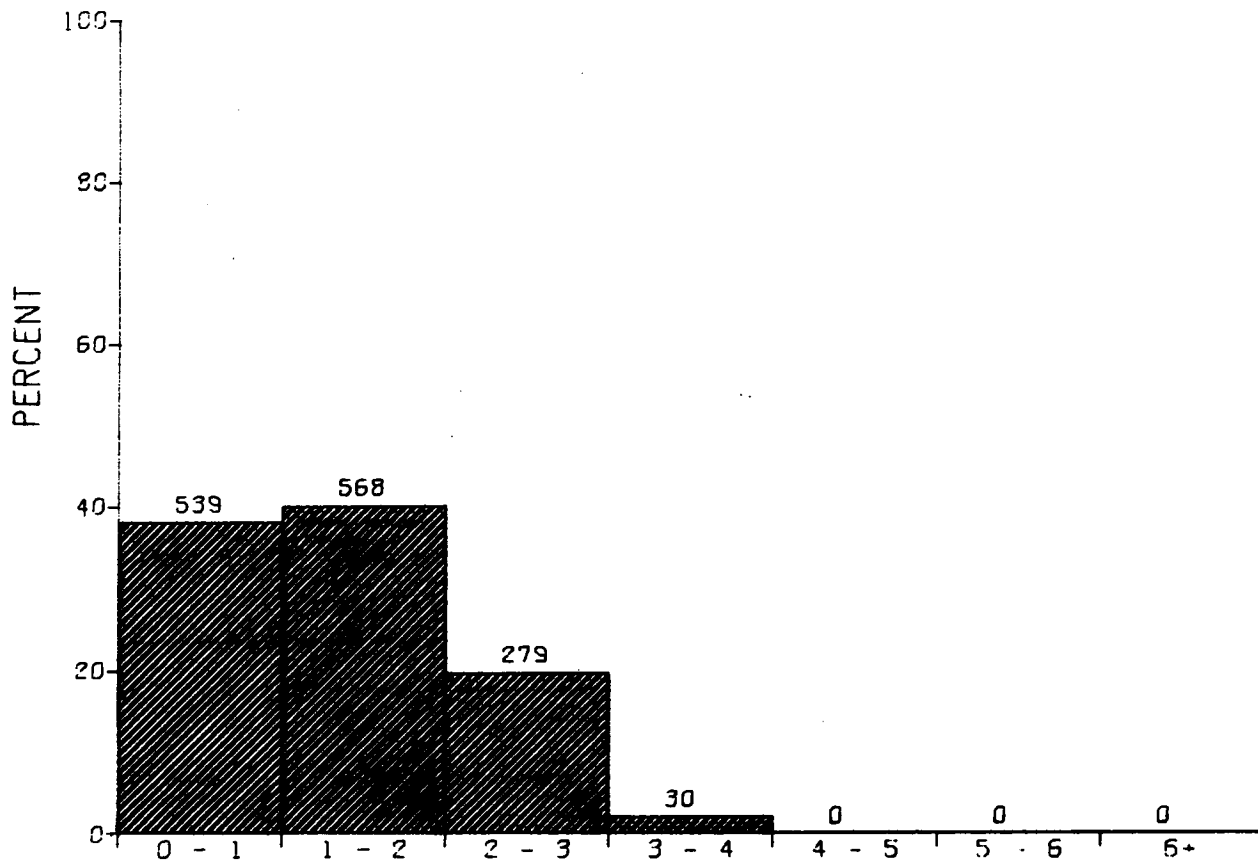

DISTRIBUTION OF SIGNIFICANT WAVE HEIGHT IN METERS

GEOS DATA- JULY 1978

EASTERN GULF OF MEXICO

N = 1416. MEAN = 1.23 SIGMA = 0.92

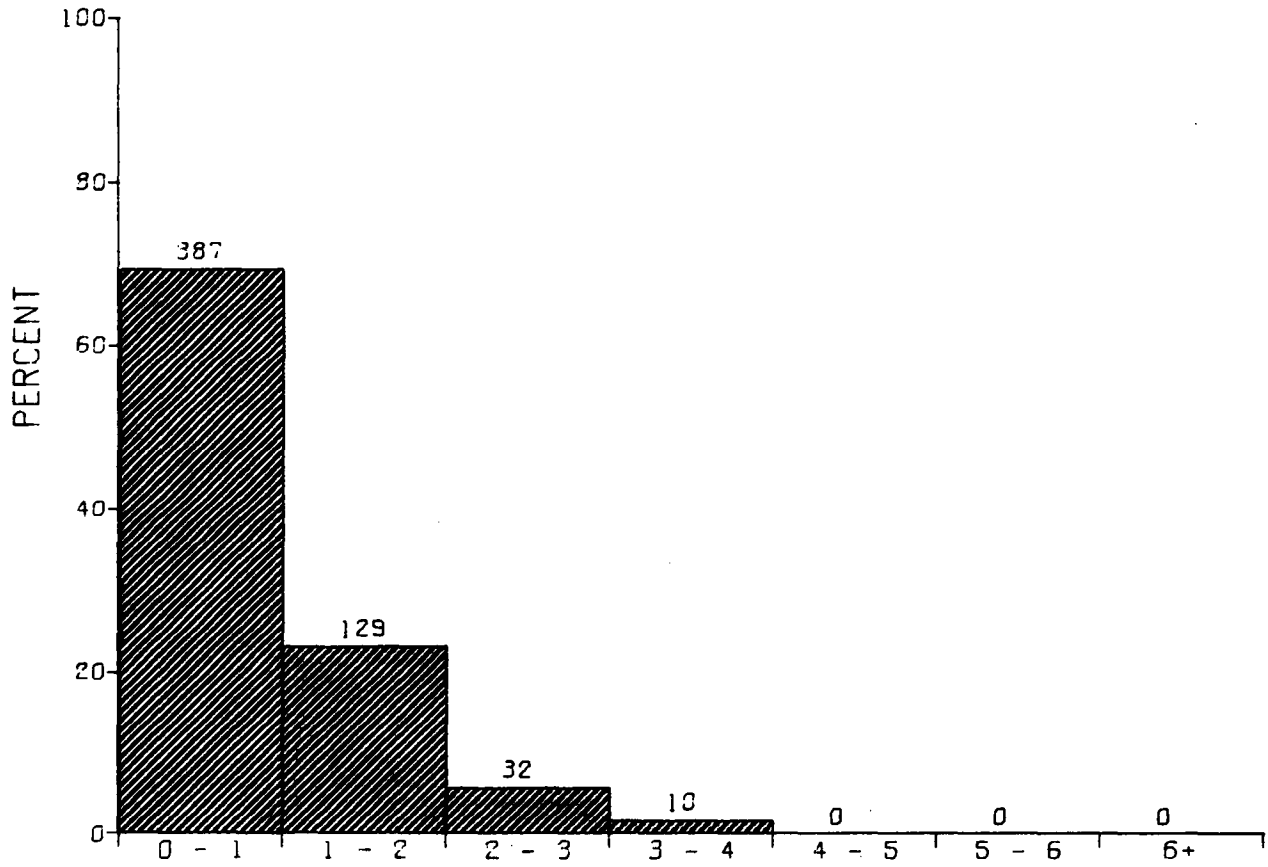

DISTRIBUTION OF SIGNIFICANT WAVE HEIGHT IN METERS

GEOS DATA- JULY 1978

WESTERN GULF OF MEXICO

N = 558.

MEAN = 0.65

SIGMA = 0.3

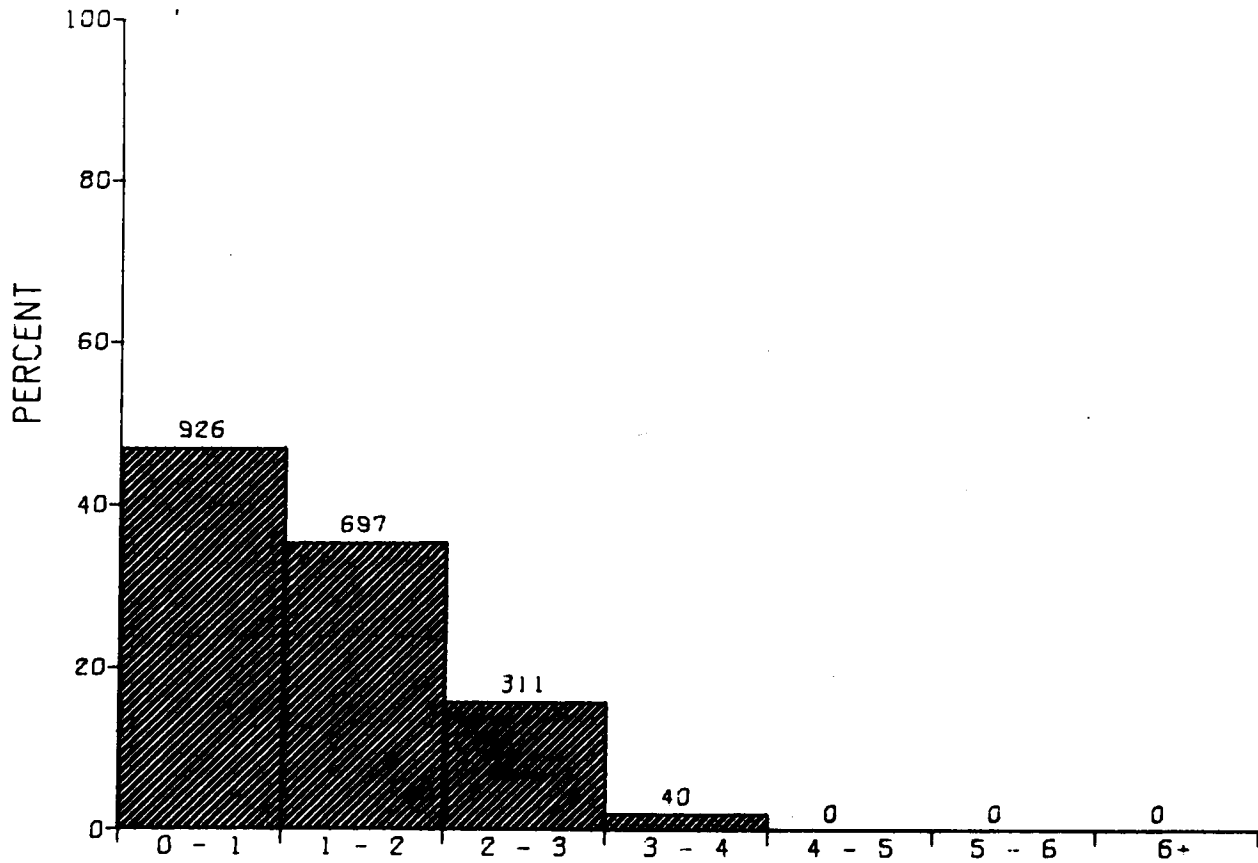

DISTRIBUTION OF SIGNIFICANT WAVE HEIGHT IN METERS

GEOS DATA- JULY 1978

ENTIRE GULF OF MEXICO

N = 1974.

MEAN = 1.06

SIGMA = 0.9

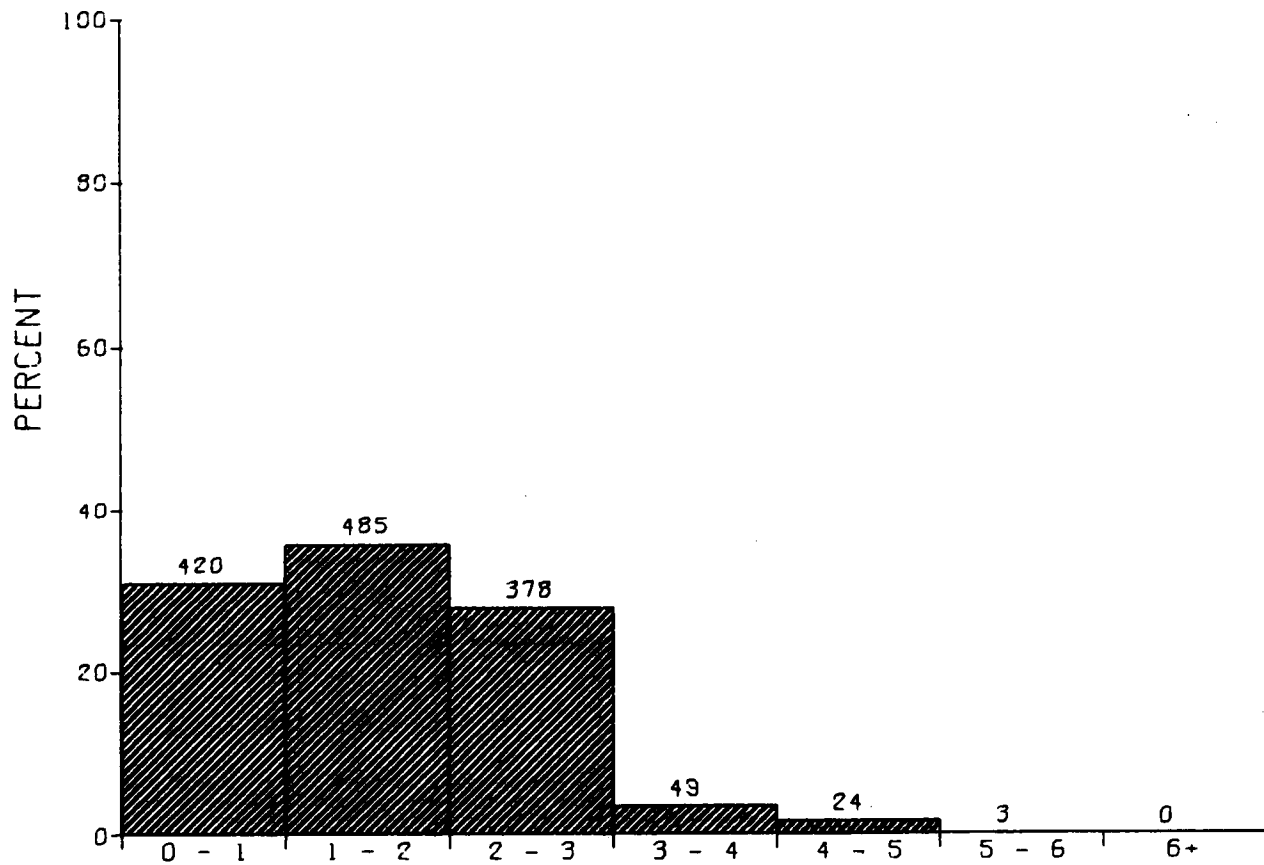

DISTRIBUTION OF SIGNIFICANT WAVE HEIGHT IN METERS

GEOS DATA- AUGUST 1978

EASTERN GULF OF MEXICO

N = 1359.

MEAN = 1.48

SIGMA = 1.07

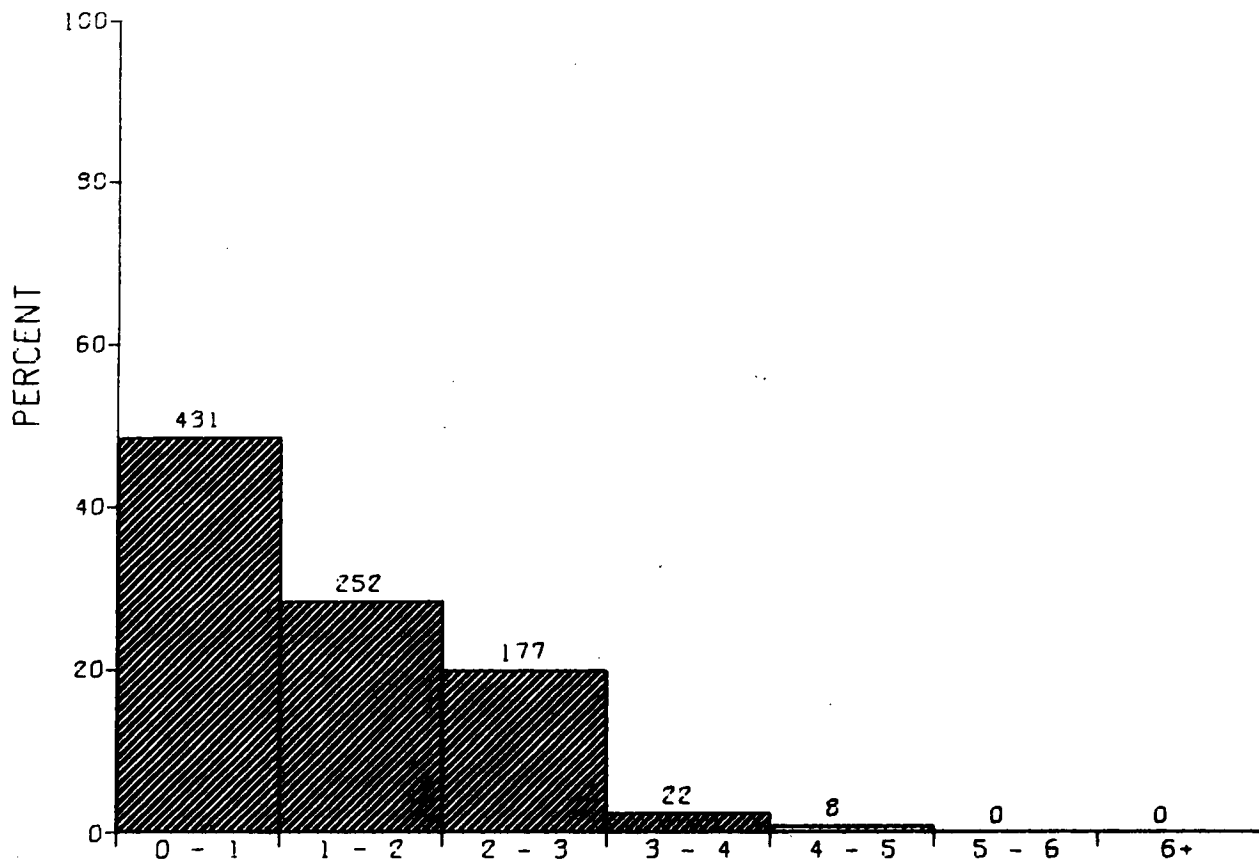

DISTRIBUTION OF SIGNIFICANT WAVE HEIGHT IN METERS

GEOS DATA- AUGUST 1978

WESTERN GULF OF MEXICO

N = 890.

MEAN = 1.13

SIGMA = 1.0

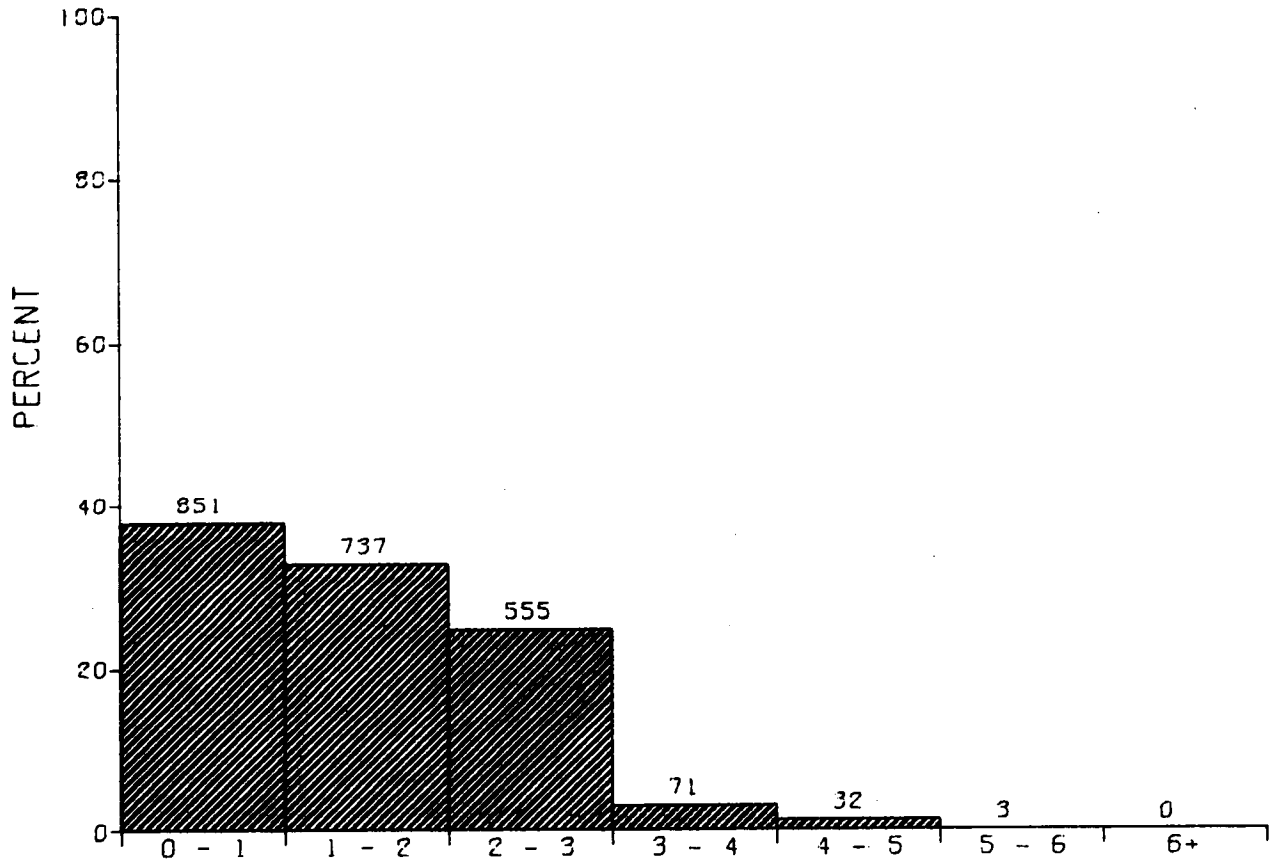

DISTRIBUTION OF SIGNIFICANT WAVE HEIGHT IN METERS

GEOS DATA- AUGUST 1978

ENTIRE GULF OF MEXICO

N = 2249.

MEAN = 1.34

SIGMA = 1.1

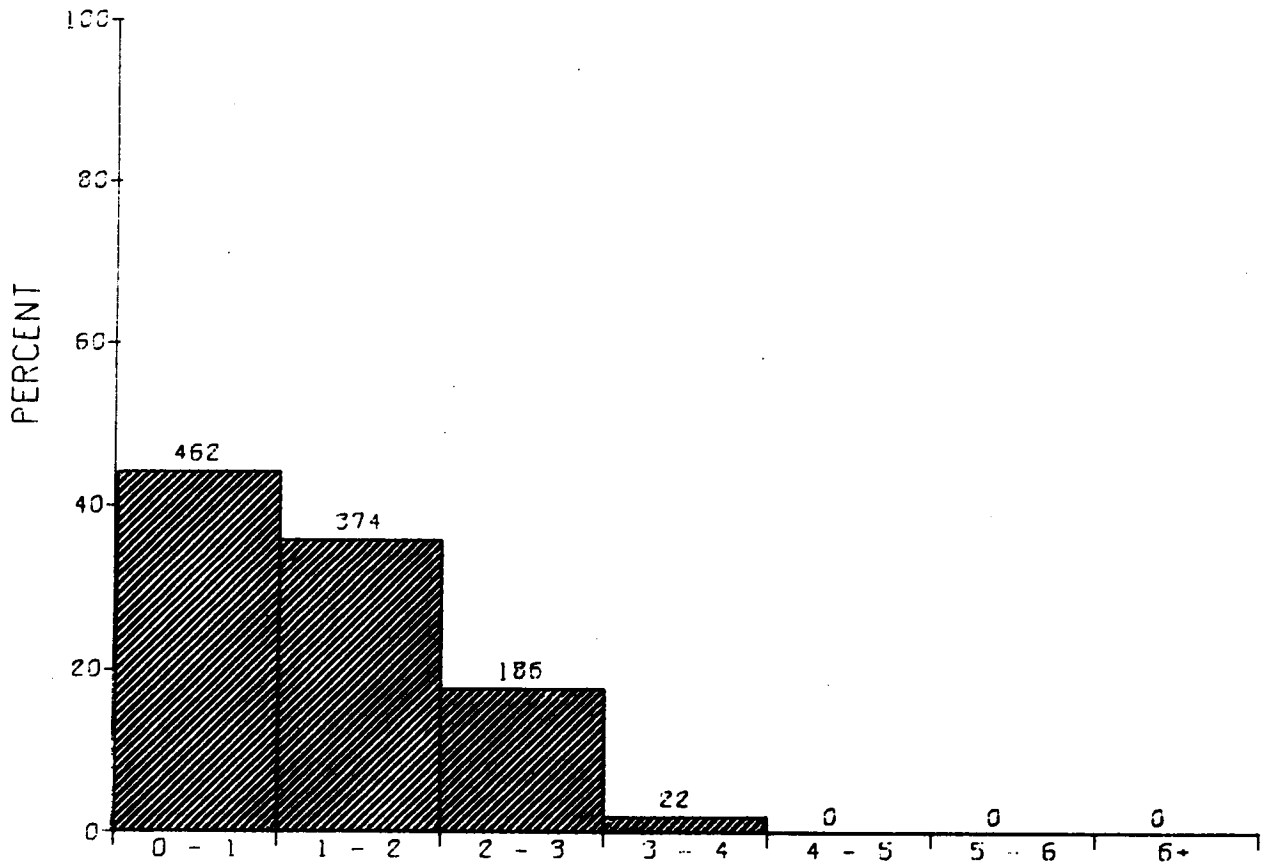

DISTRIBUTION OF SIGNIFICANT WAVE HEIGHT IN METERS

GEOS DATA- SEPTEMBER 1978

EASTERN GULF OF MEXICO

N = 1044.

MEAN = 1.11

SIGMA = 0.94

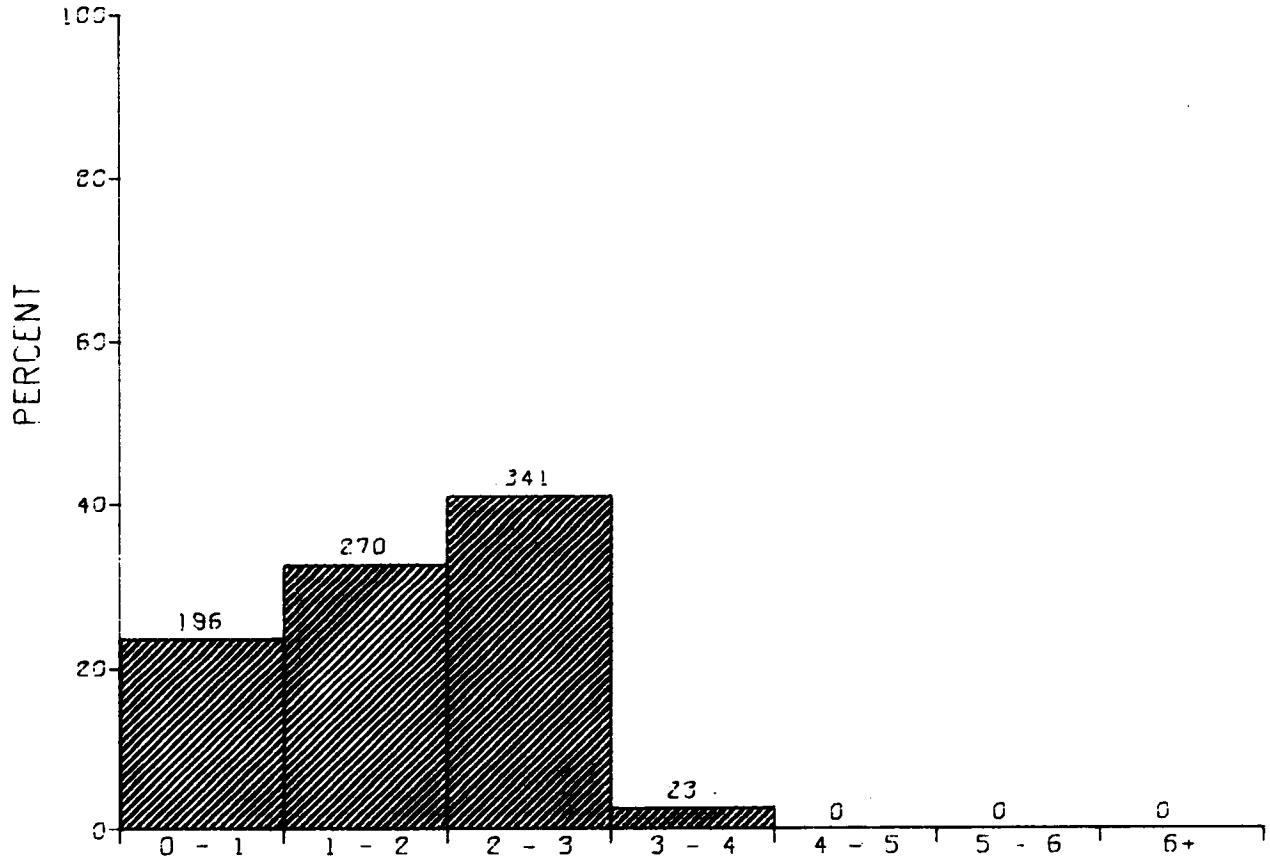

DISTRIBUTION OF SIGNIFICANT WAVE HEIGHT IN METERS

GEOS DATA- SEPTEMBER 1978

WESTERN GULF OF MEXICO

N = 830.

MEAN = 1.65

SIGMA = 1.0

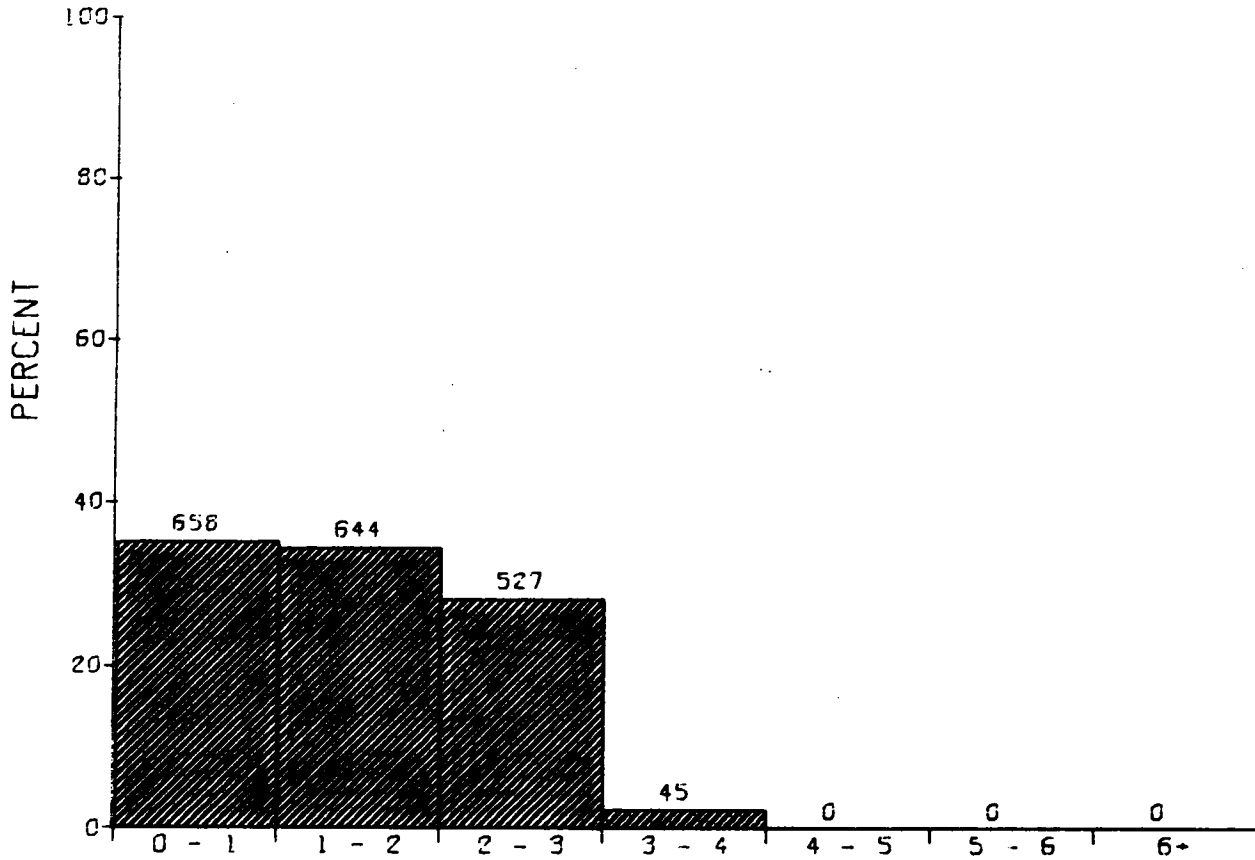

DISTRIBUTION OF SIGNIFICANT WAVE HEIGHT IN METERS

GEOS DATA- SEPTEMBER 1978

ENTIRE GULF OF MEXICO

N = 1874.

MEAN = 1.35

SIGMA = 1.0

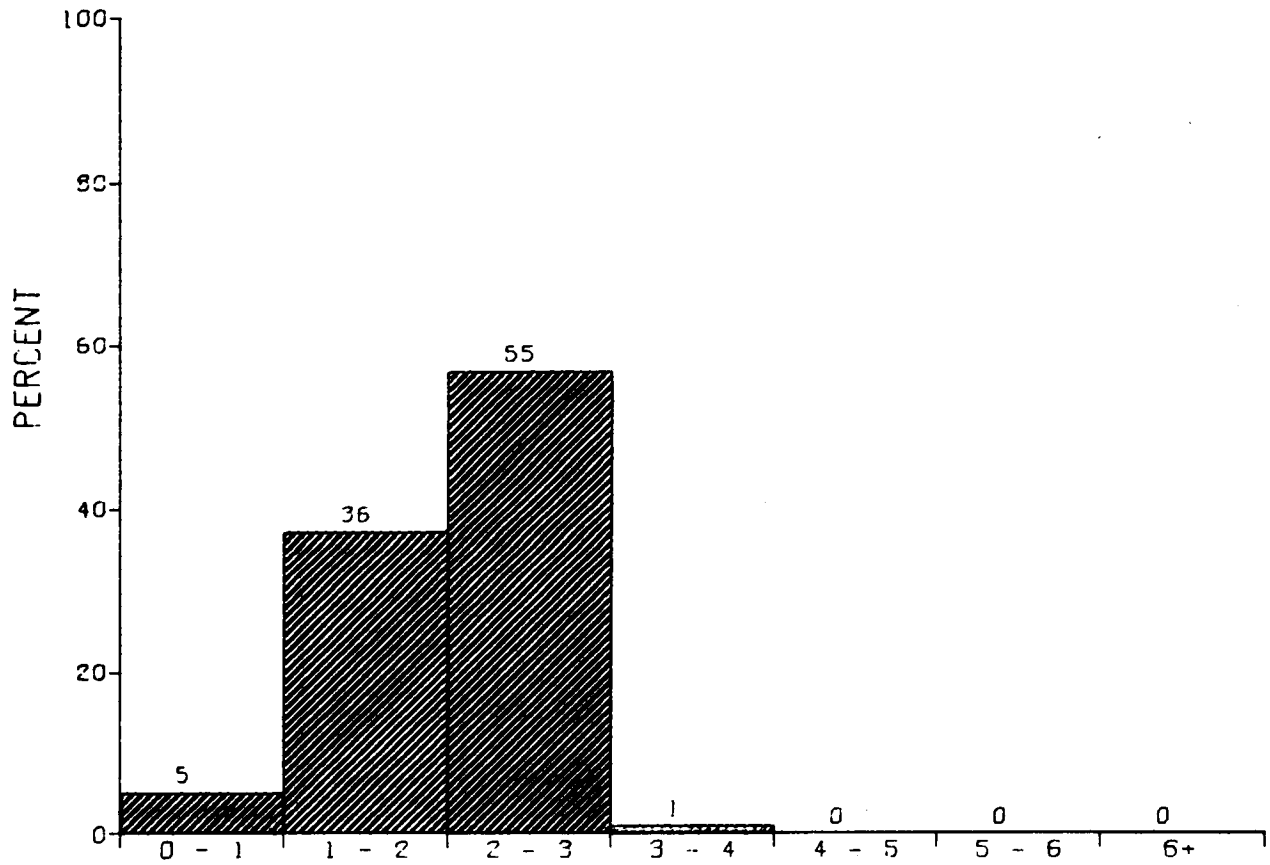

DISTRIBUTION OF SIGNIFICANT WAVE HEIGHT IN METERS

GEOS DATA- OCTOBER 1978

EASTERN GULF OF MEXICO

N = 97.

MEAN = 1.99

SIGMA = 0.54

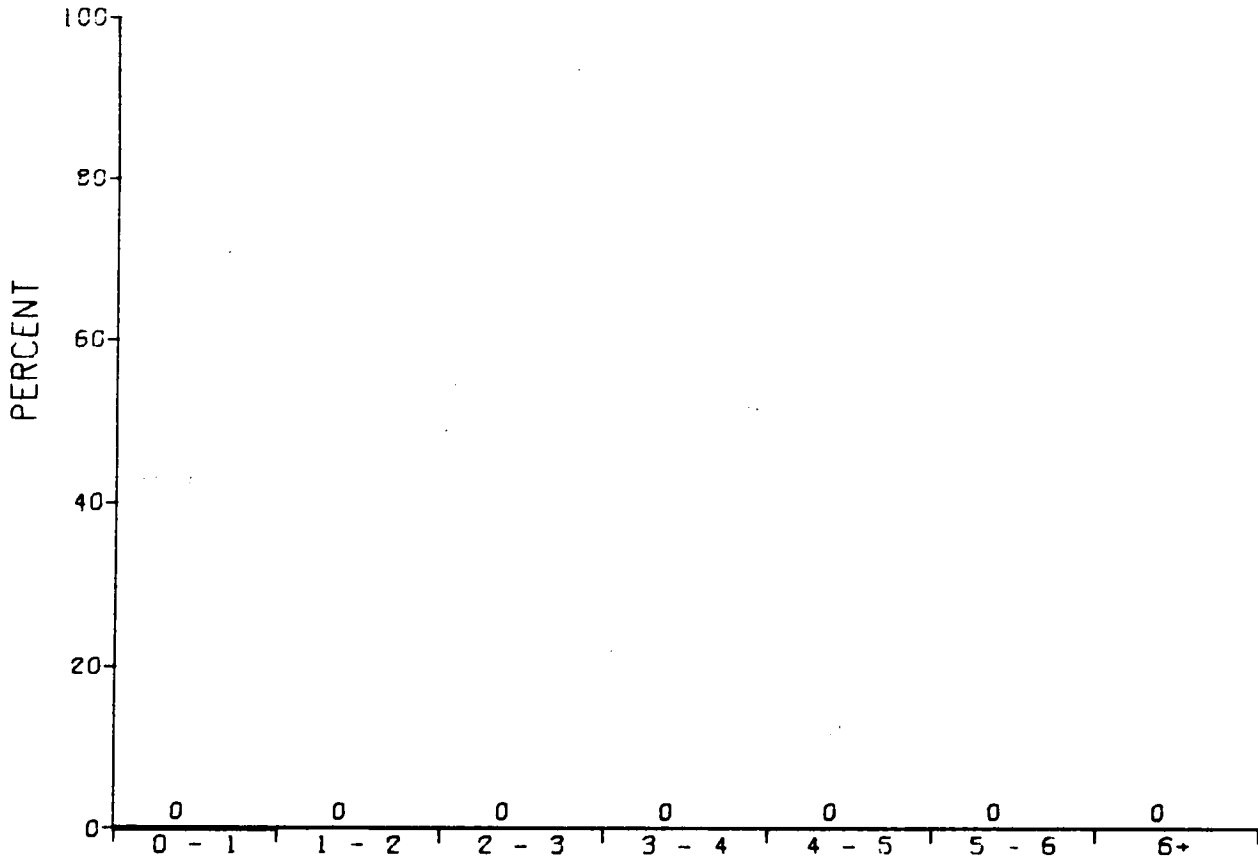

DISTRIBUTION OF SIGNIFICANT WAVE HEIGHT IN METERS

GEOS DATA- OCTOBER 1978

WESTERN GULF OF MEXICO

N = 0. MEAN = 0.00 SIGMA = 0.0

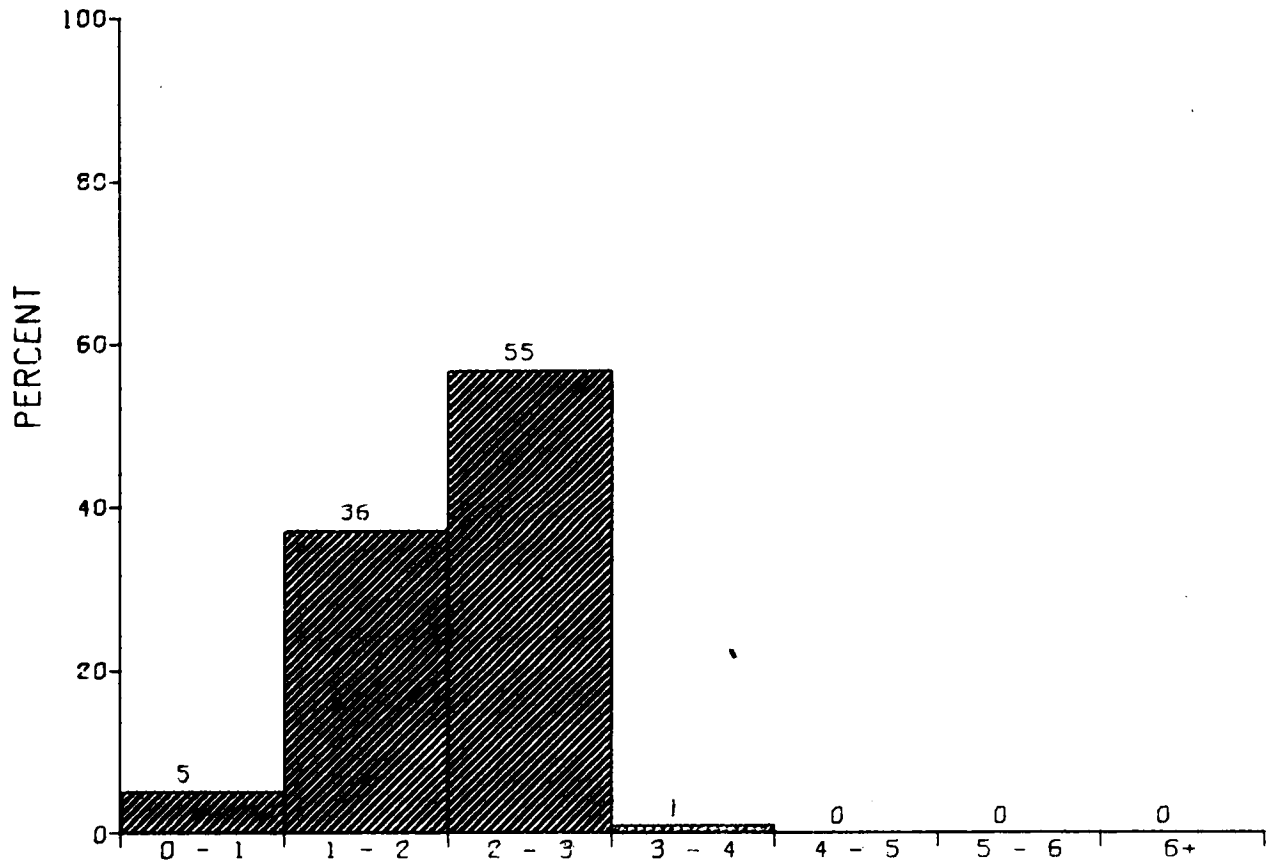

DISTRIBUTION OF SIGNIFICANT WAVE HEIGHT IN METERS

GEOS DATA- OCTOBER 1978

ENTIRE GULF OF MEXICO

N = 97.

MEAN = 1.99

SIGMA = 0.5

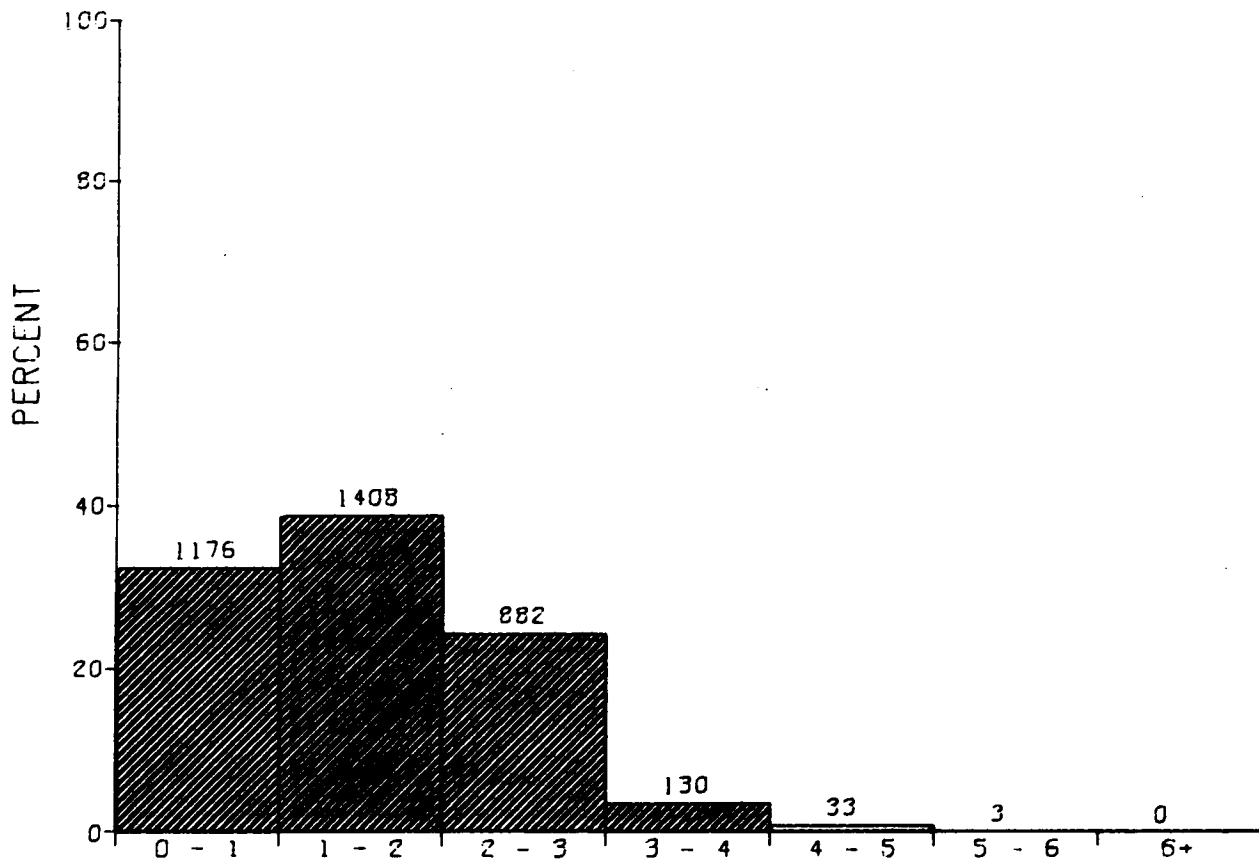

DISTRIBUTION OF SIGNIFICANT WAVE HEIGHT IN METERS

GEOS DATA- SUMMER 1978

EASTERN GULF OF MEXICO

N = 3632.

MEAN = 1.41

SIGMA = 1.00

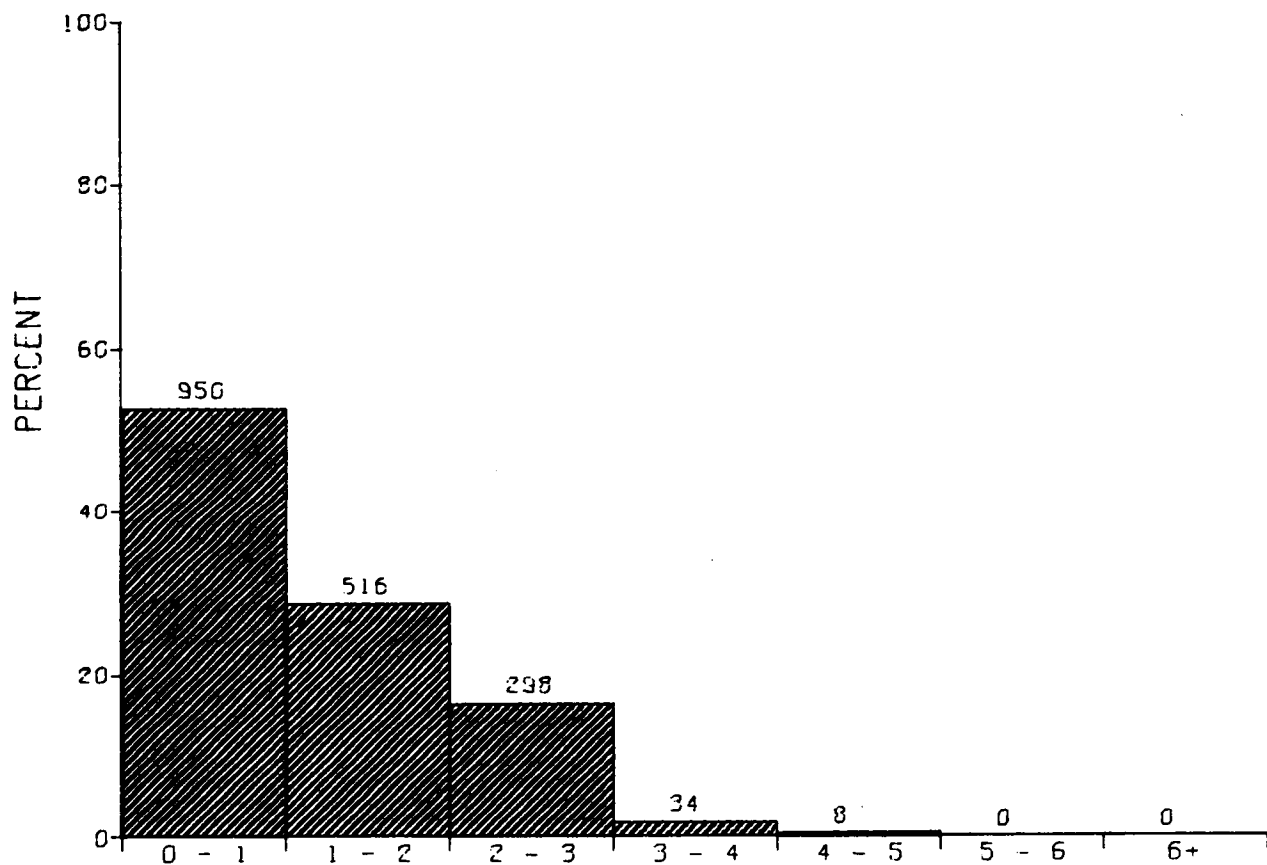

DISTRIBUTION OF SIGNIFICANT WAVE HEIGHT IN METERS

GEOS DATA- SUMMER 1978

WESTERN GULF OF MEXICO

N = 1806.

MEAN = 1.01

SIGMA = 1.0

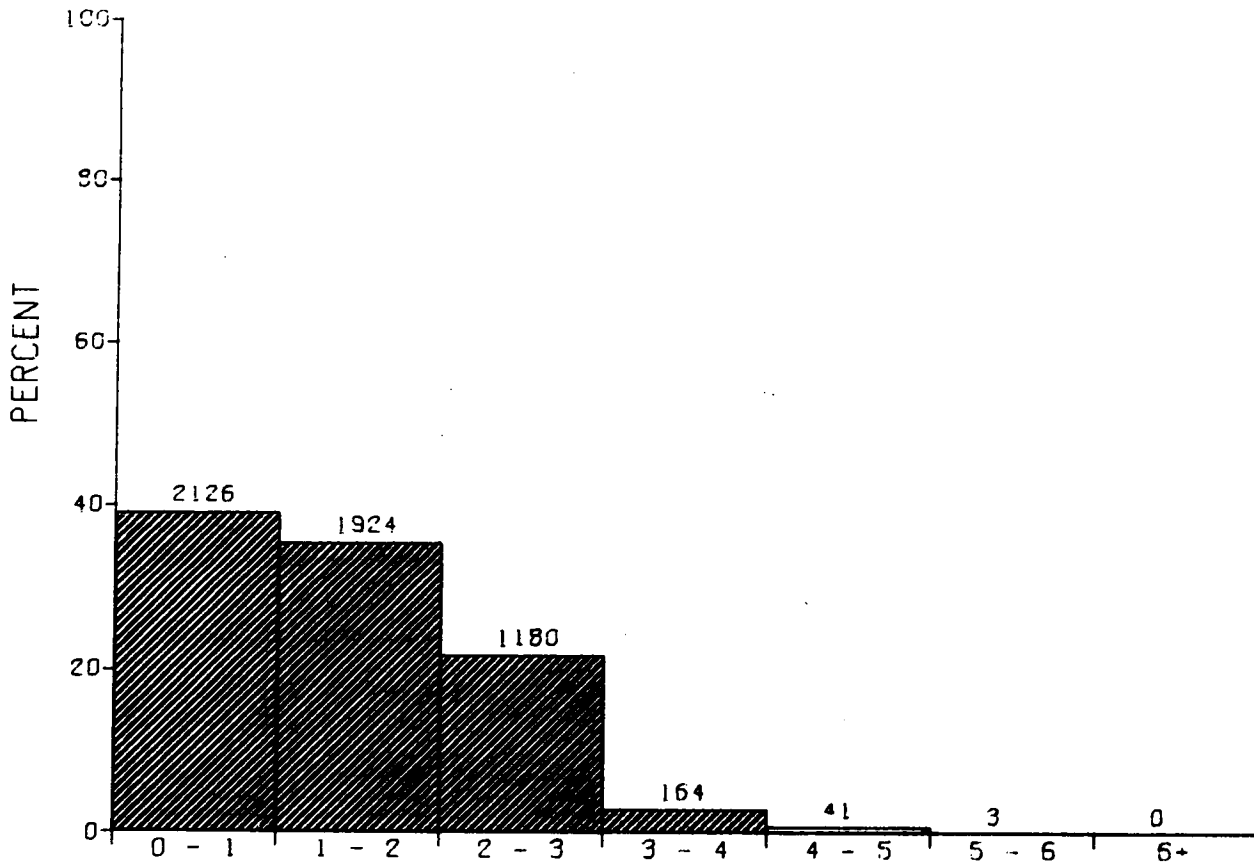

DISTRIBUTION OF SIGNIFICANT WAVE HEIGHT IN METERS

GEOS DATA- SUMMER 1978

ENTIRE GULF OF MEXICO

N = 5438.

MEAN = 1.27

SIGMA = 1.0

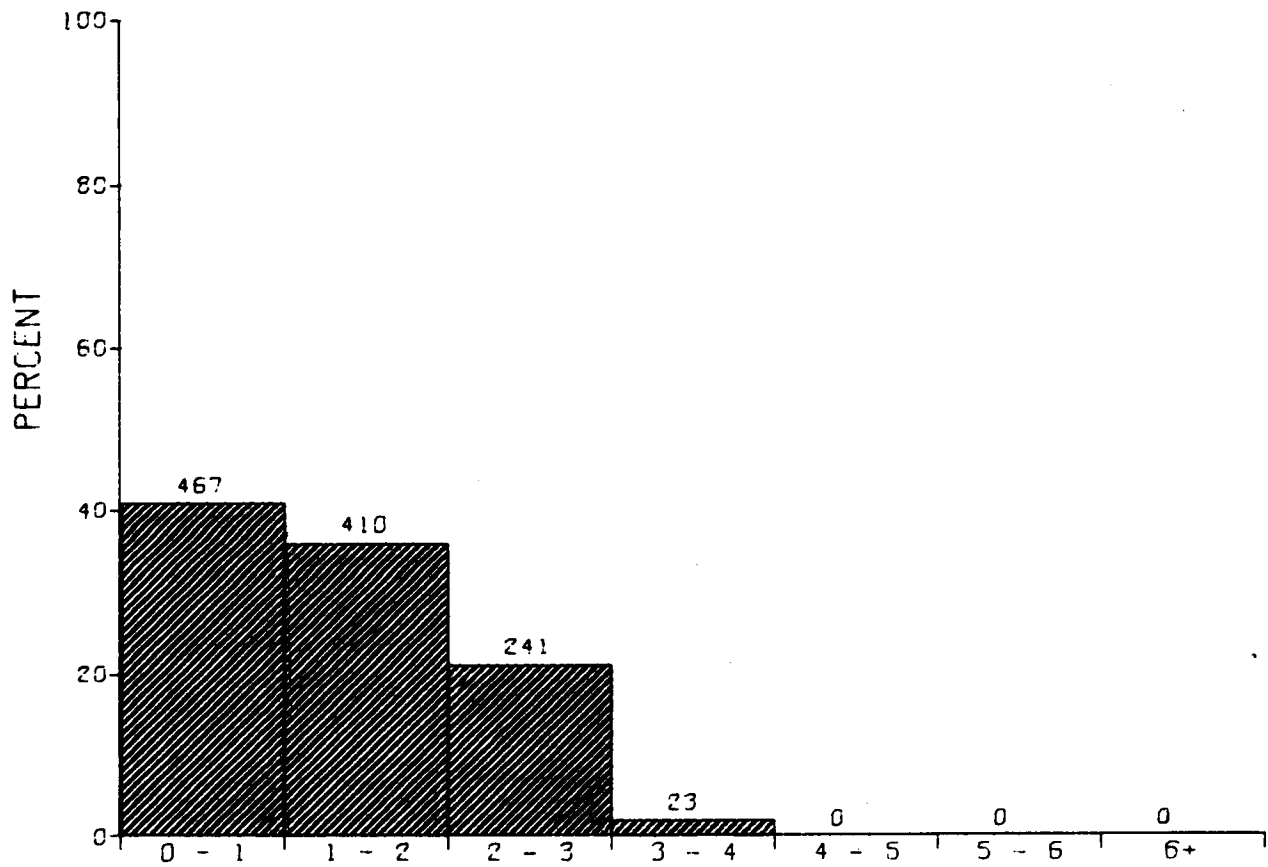

DISTRIBUTION OF SIGNIFICANT WAVE HEIGHT IN METERS

GEOS DATA- FALL 1978

EASTERN GULF OF MEXICO

N = 1141. MEAN = 1.19 SIGMA = 0.94

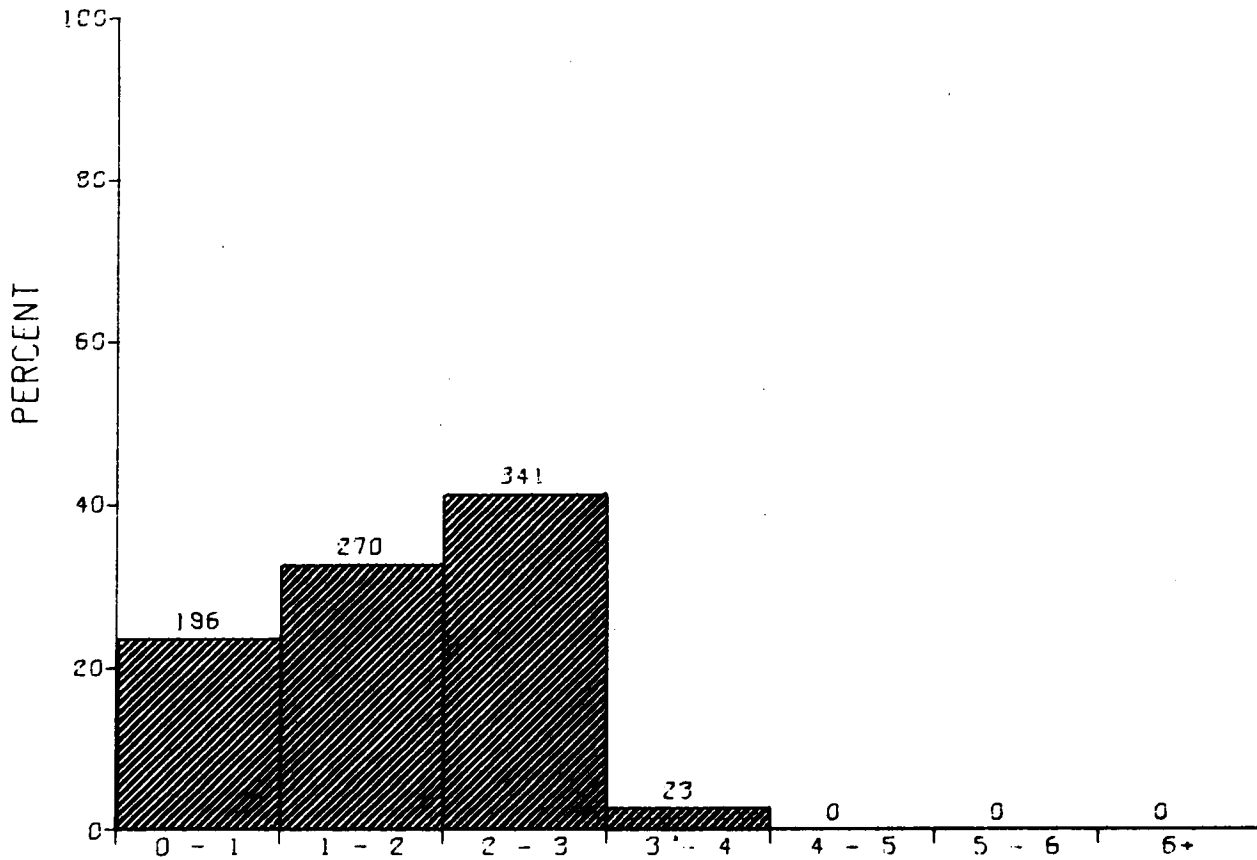

DISTRIBUTION OF SIGNIFICANT WAVE HEIGHT IN METERS

GEOS DATA- FALL 1978

WESTERN GULF OF MEXICO

N = 830

MEAN = 1.65

SIGMA = 1.0

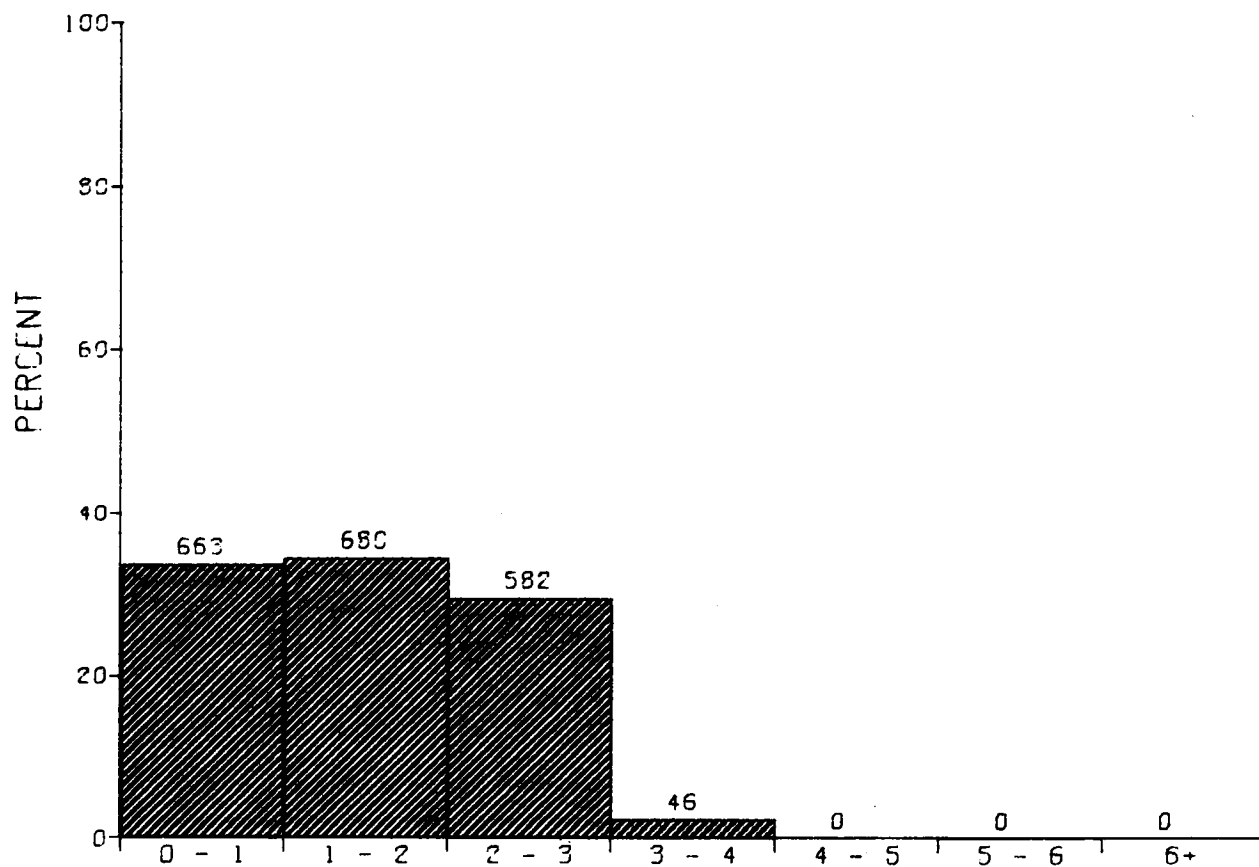

DISTRIBUTION OF SIGNIFICANT WAVE HEIGHT IN METERS

GEOS DATA- FALL 1978

ENTIRE GULF OF MEXICO

N = 1971.

MEAN = 1.38

SIGMA = 1.0

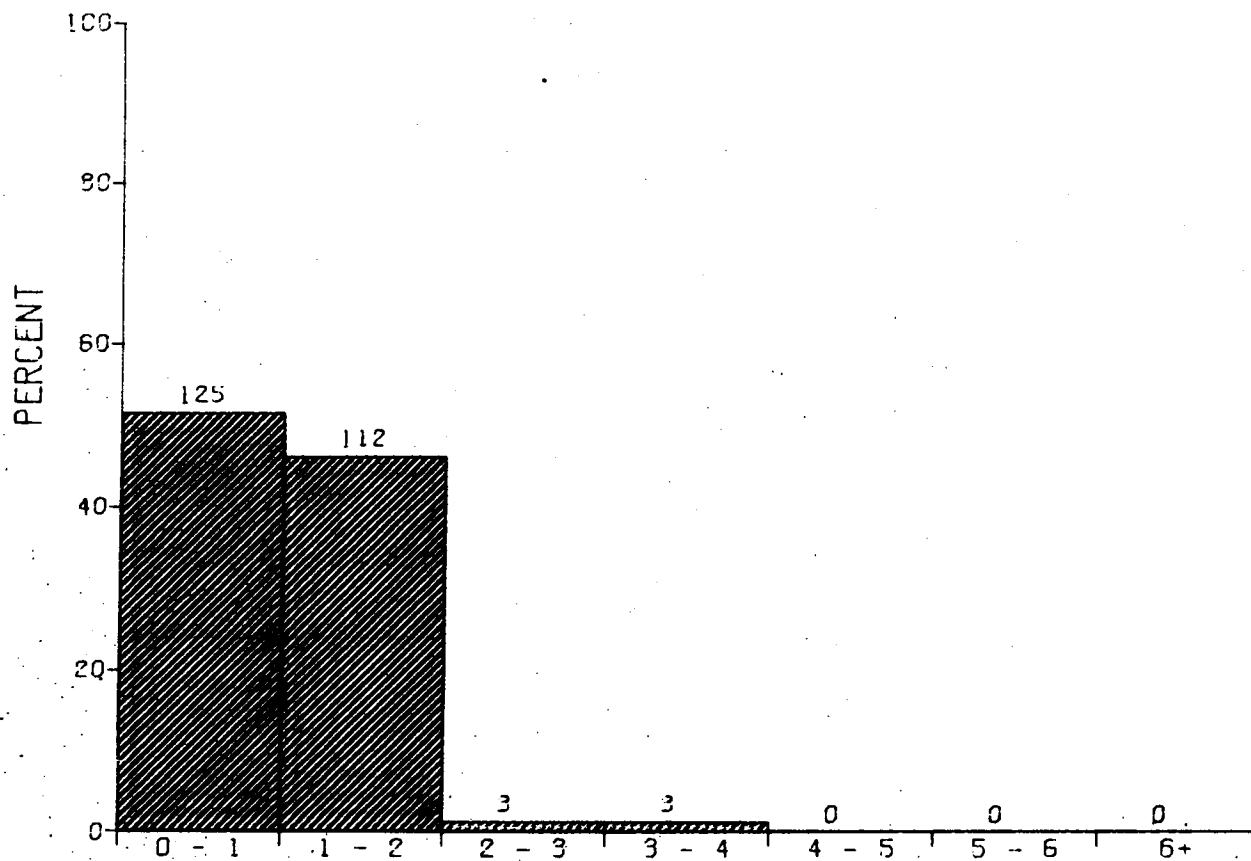

DISTRIBUTION OF SIGNIFICANT WAVE HEIGHT IN METERS

SEASAT DATA- JULY

EASTERN GULF OF MEXICO

N = 243.

MEAN = 1.08

SIGMA = 0.40

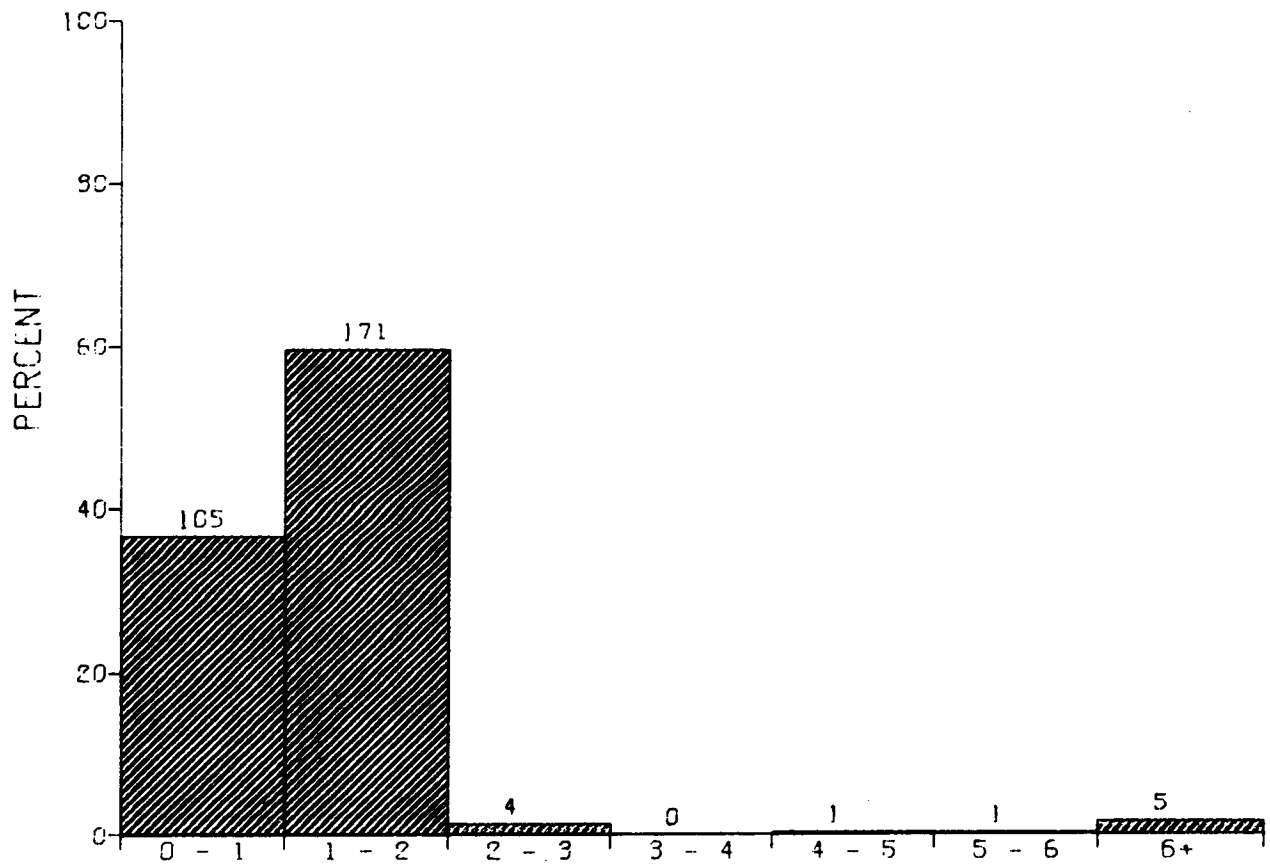

DISTRIBUTION OF SIGNIFICANT WAVE HEIGHT IN METERS

SEASAT DATA- JULY

WESTERN GULF OF MEXICO

N = 287.

MEAN = 1.37

SIGMA = 1.2

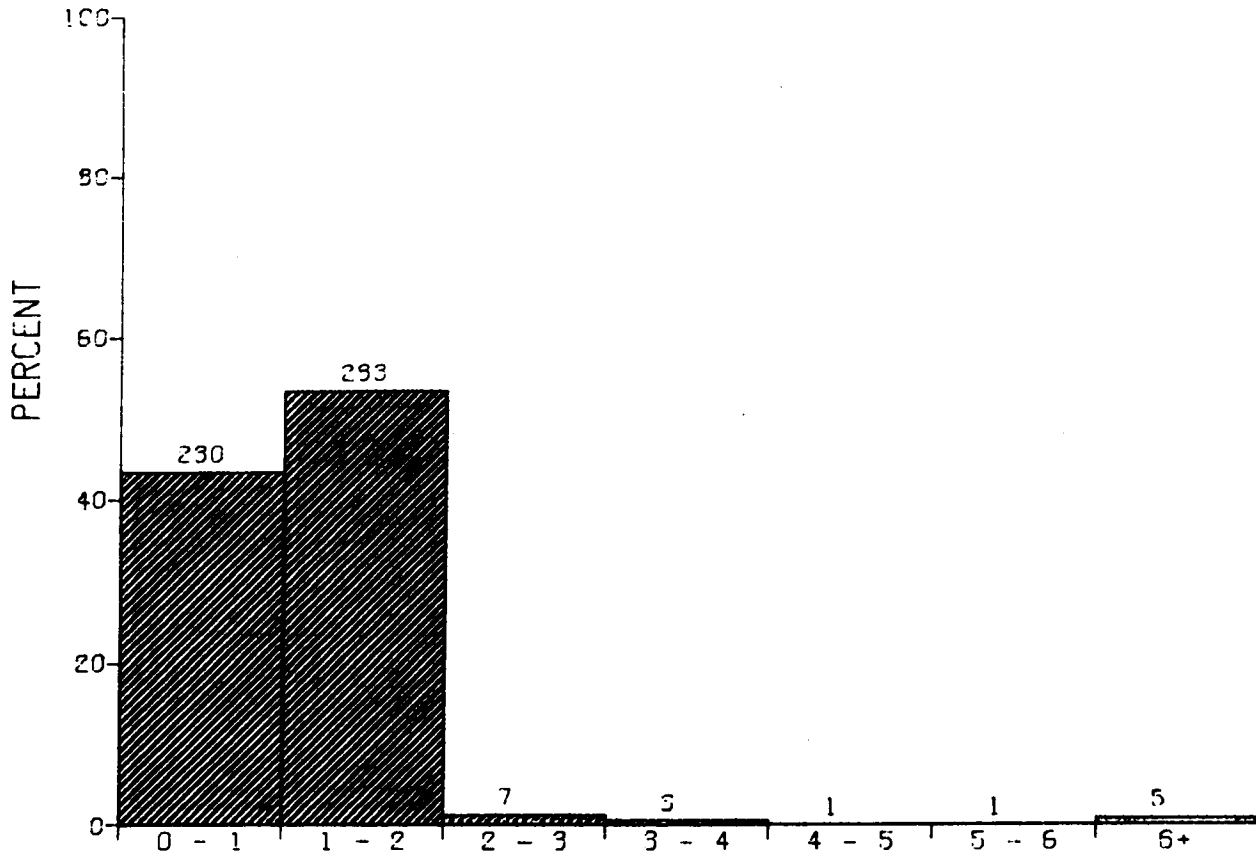

DISTRIBUTION OF SIGNIFICANT WAVE HEIGHT IN METERS

SEASAT DATA- JULY

ENTIRE GULF OF MEXICO

N = 530.

MEAN = 1.24

SIGMA = 0.9

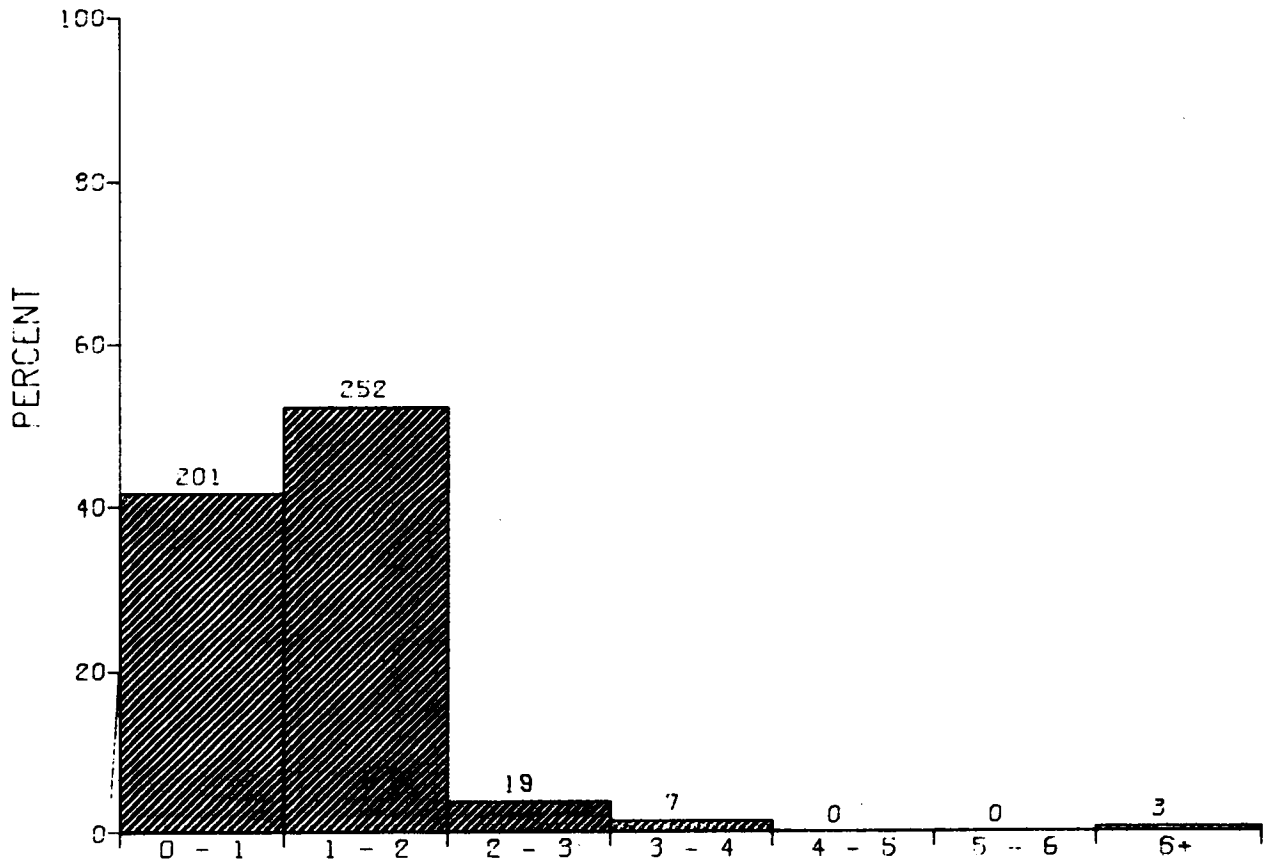

DISTRIBUTION OF SIGNIFICANT WAVE HEIGHT IN METERS

SEASAT DATA- AUGUST

EASTERN GULF OF MEXICO

N = 492.

MEAN = 1.22

SIGMA = 0.65

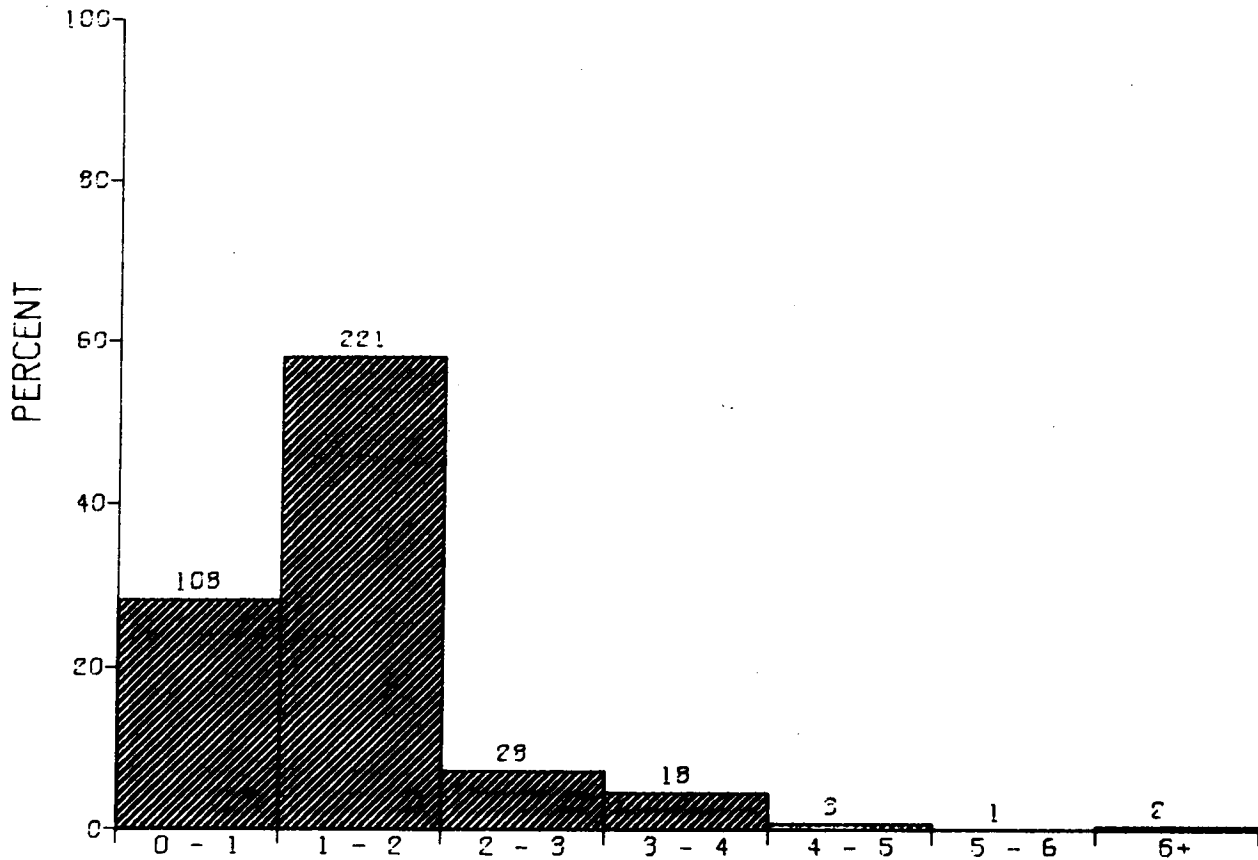

DISTRIBUTION OF SIGNIFICANT WAVE HEIGHT IN METERS

SEASAT DATA- AUGUST

WESTERN GULF OF MEXICO

N = 381.

MEAN = 1.44

SIGMA = 0.9

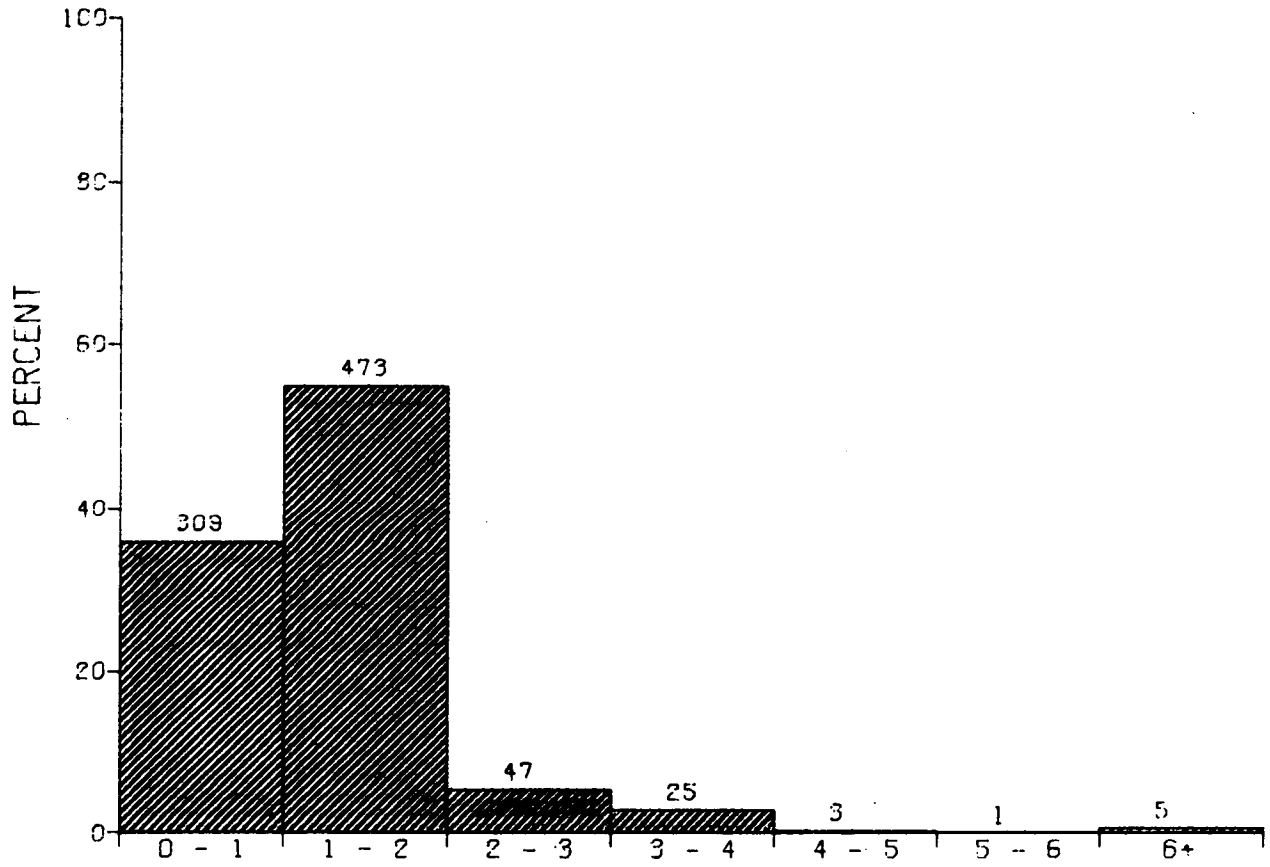

DISTRIBUTION OF SIGNIFICANT WAVE HEIGHT IN METERS

SEASAT DATA- AUGUST

ENTIRE GULF OF MEXICO

N = 863.

MEAN = 1.32

SIGMA = 0.8

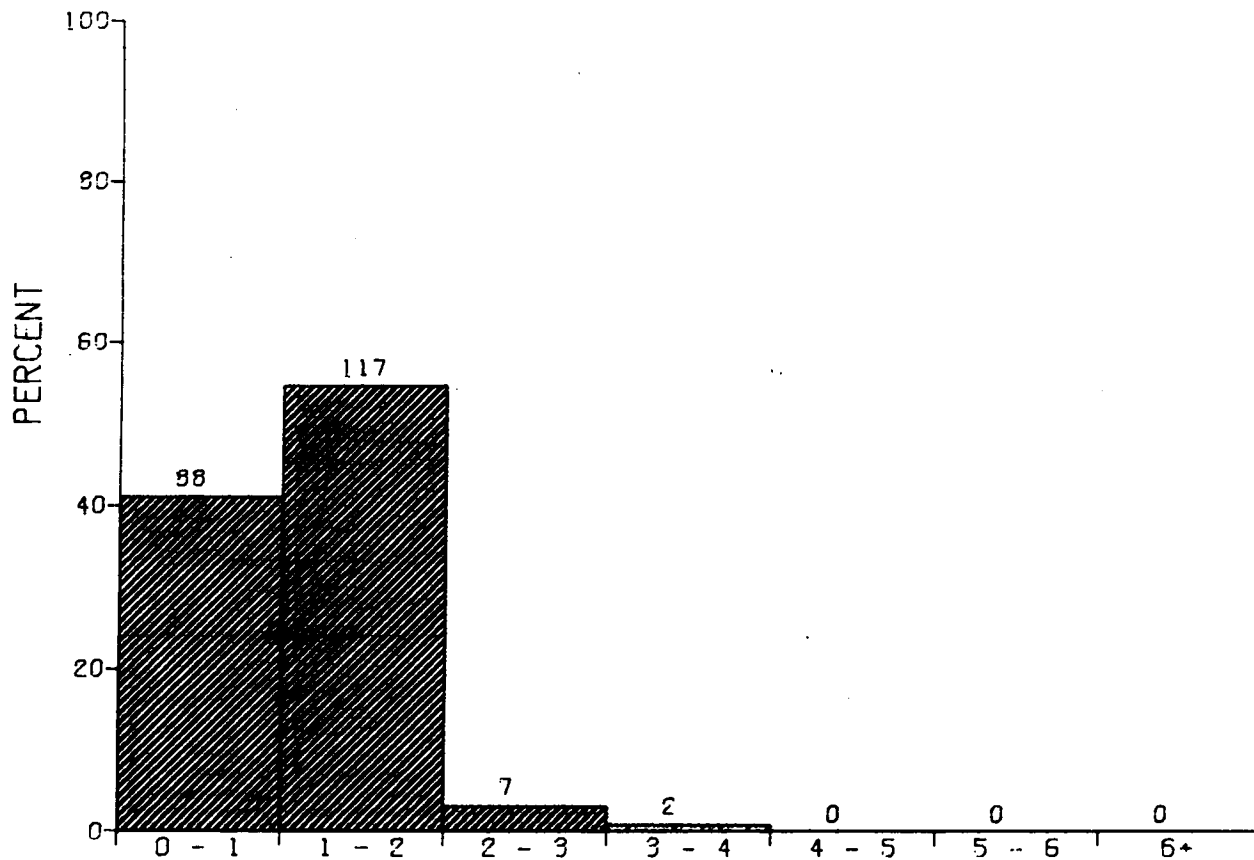

DISTRIBUTION OF SIGNIFICANT WAVE HEIGHT IN METERS
 SEASAT DATA- SEPTEMBER
 EASTERN GULF OF MEXICO

N = 214. MEAN = 1.26 SIGMA = 0.48

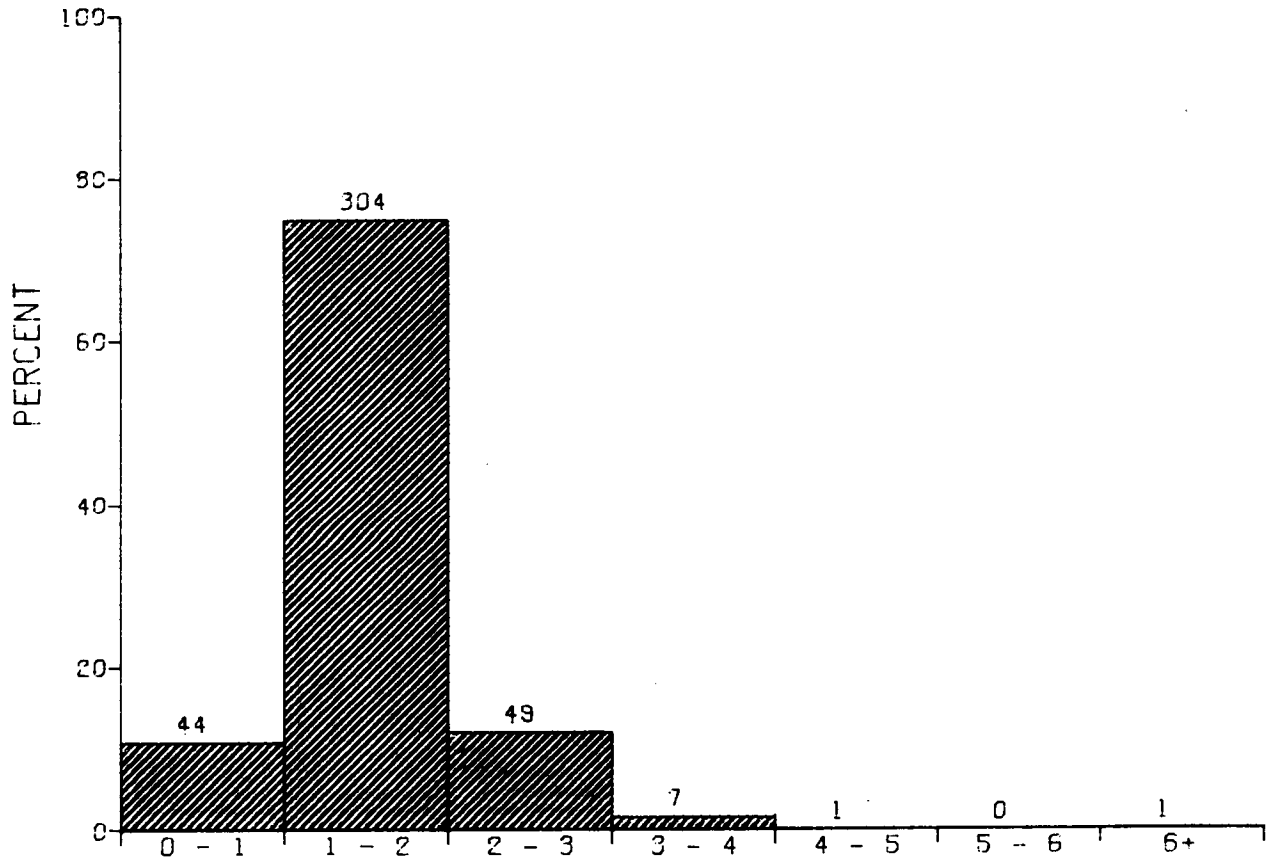

DISTRIBUTION OF SIGNIFICANT WAVE HEIGHT IN METERS

SEASAT DATA- SEPTEMBER

WESTERN GULF OF MEXICO

N = 406.

MEAN = 1.57

SIGMA = 0.7

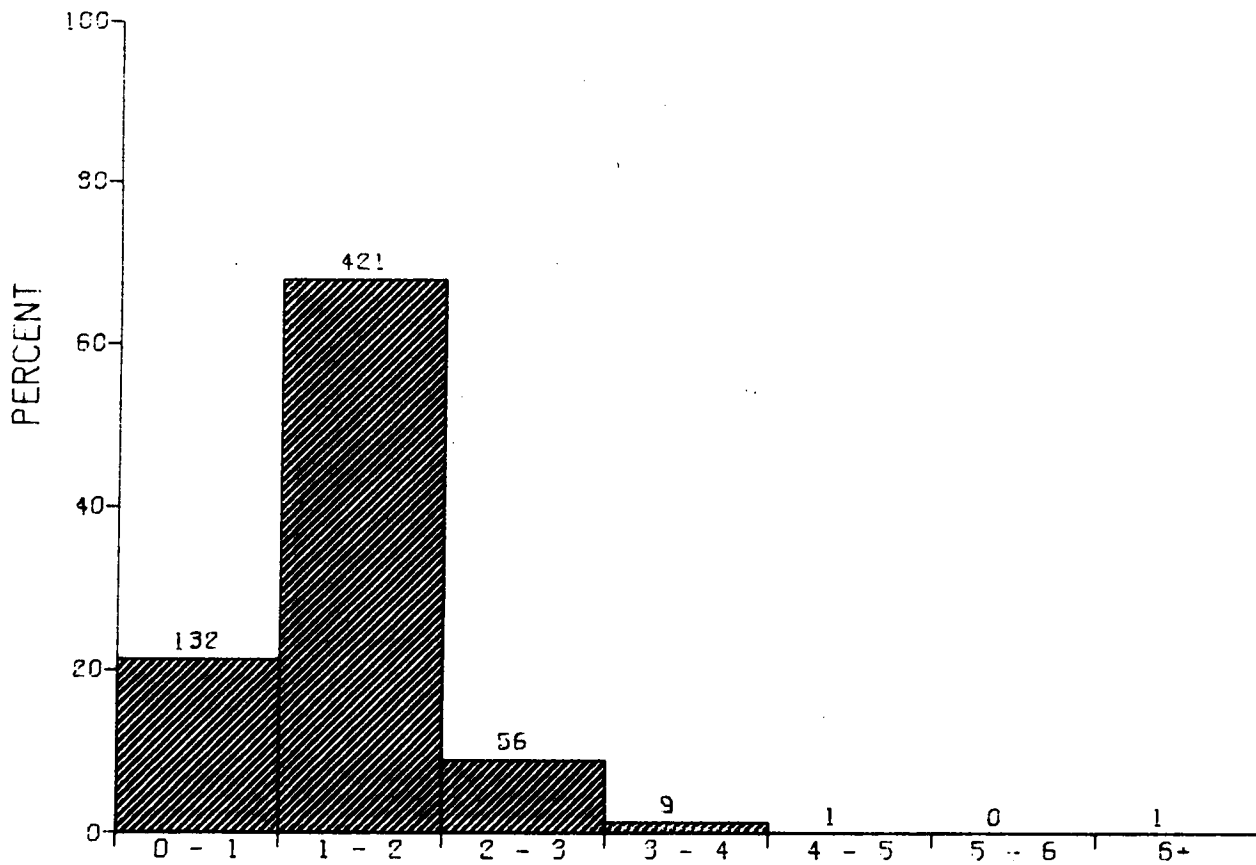

DISTRIBUTION OF SIGNIFICANT WAVE HEIGHT IN METERS
 SEASAT DATA- SEPTEMBER
 ENTIRE GULF OF MEXICO

N = 620. MEAN = 1.46 SIGMA = 0.6

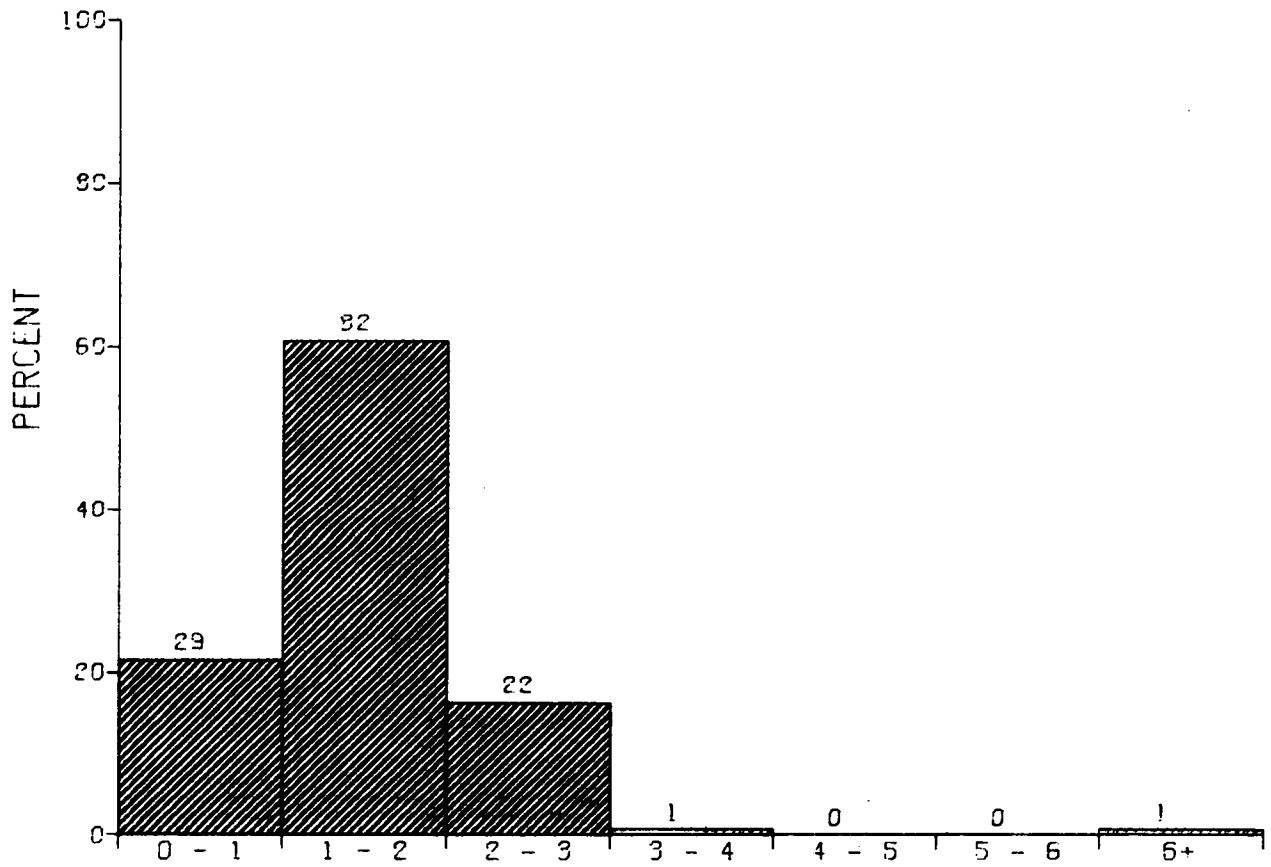

DISTRIBUTION OF SIGNIFICANT WAVE HEIGHT IN METERS

SEASAT DATA- OCTOBER

EASTERN GULF OF MEXICO

N = 135.

MEAN = 1.46

SIGMA = 0.67

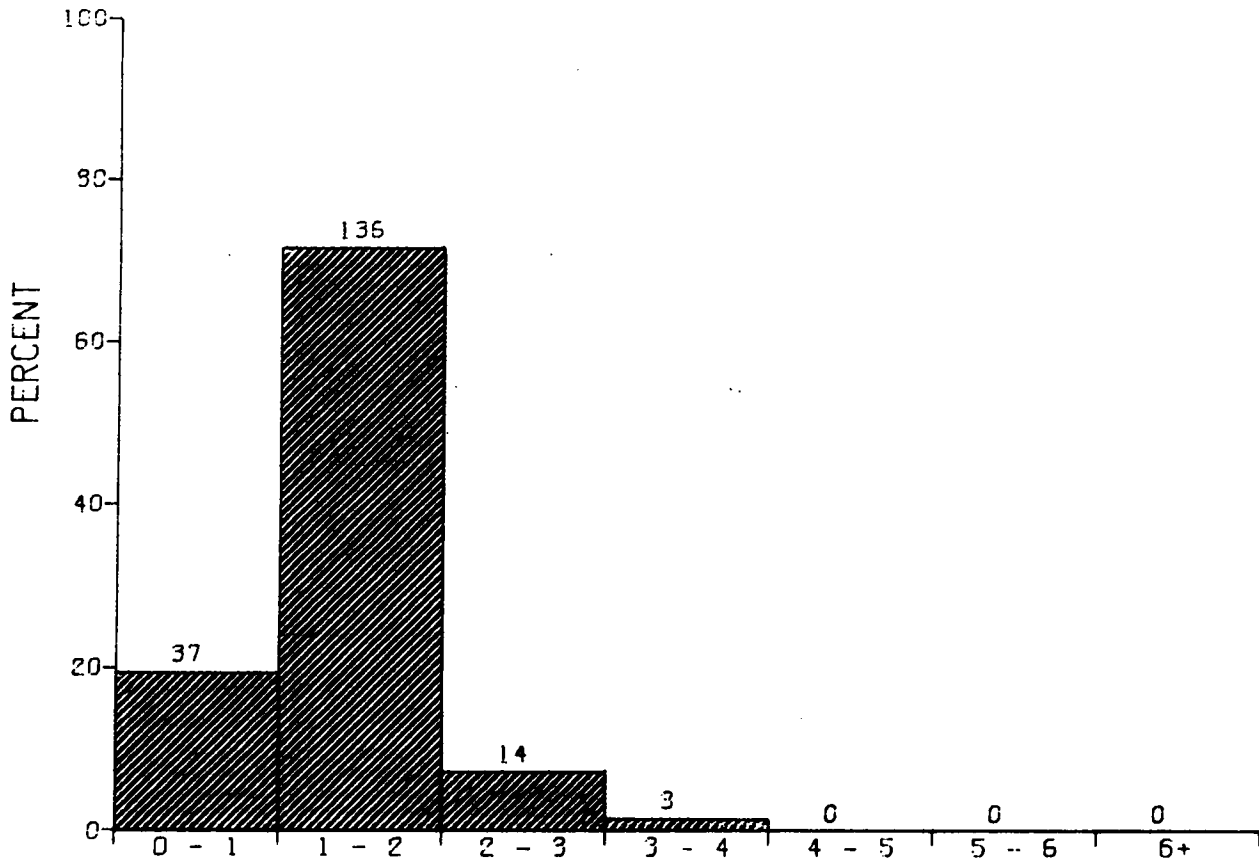

DISTRIBUTION OF SIGNIFICANT WAVE HEIGHT IN METERS
 SEASAT DATA- OCTOBER
 WESTERN GULF OF MEXICO

N = 190. MEAN = 1.40 SIGMA = 0.5

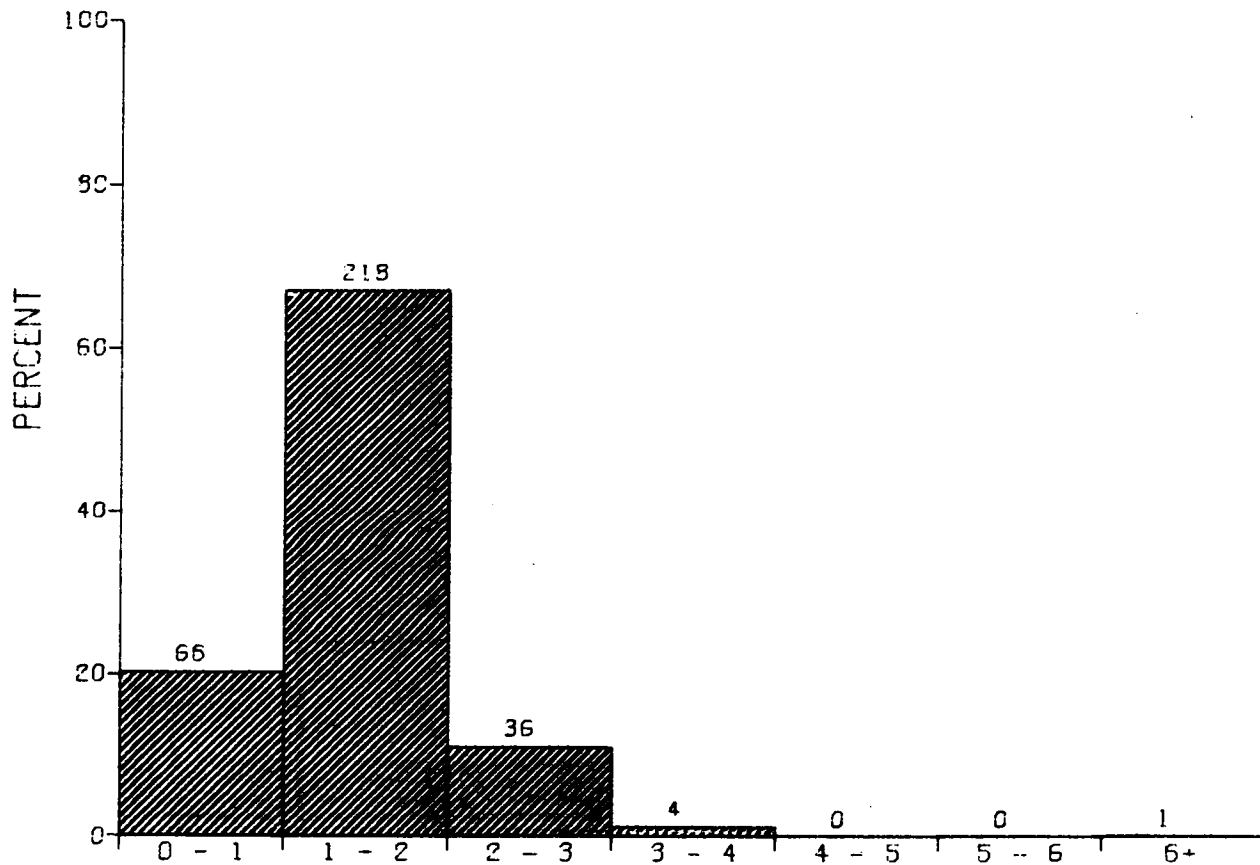

DISTRIBUTION OF SIGNIFICANT WAVE HEIGHT IN METERS

SEASAT DATA- OCTOBER

ENTIRE GULF OF MEXICO

N = 325.

MEAN = 1.43

SIGMA = 0.6

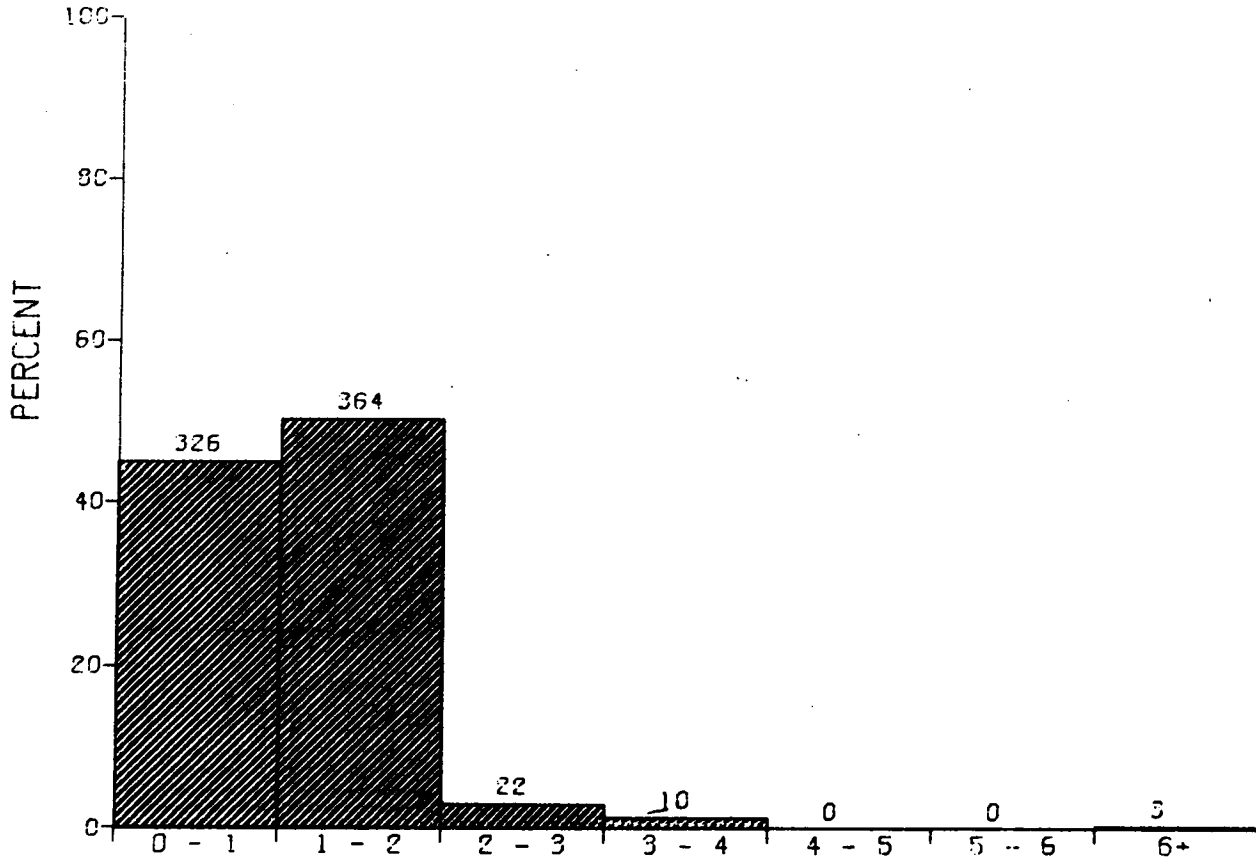

DISTRIBUTION OF SIGNIFICANT WAVE HEIGHT IN METERS

SEASAT DATA - SUMMER

EASTERN GULF OF MEXICO

N = 725.

MEAN = 1.17

SIGMA = 0.58

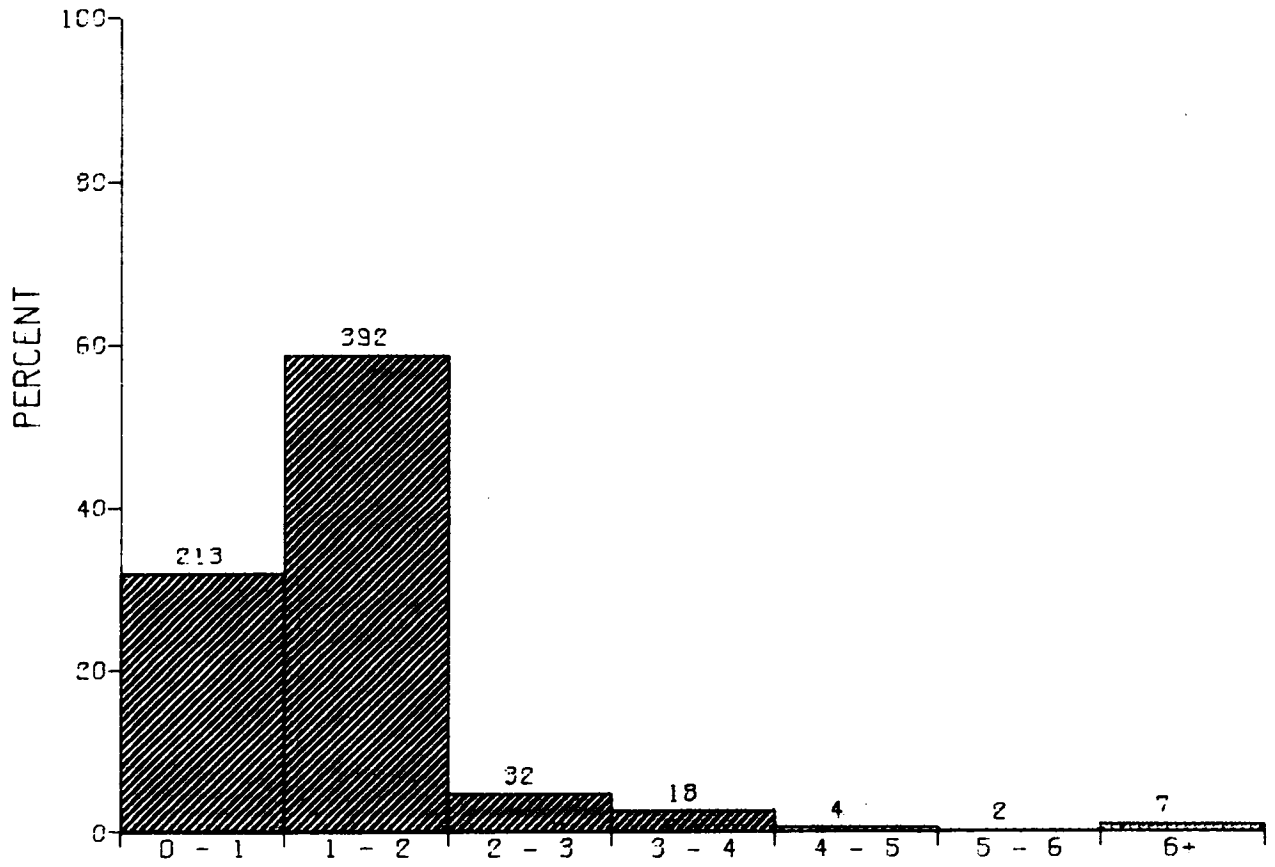

DISTRIBUTION OF SIGNIFICANT WAVE HEIGHT IN METERS

SEASAT DATA- SUMMER

WESTERN GULF OF MEXICO

N = 668.

MEAN = 1.41

SIGMA = 1.0

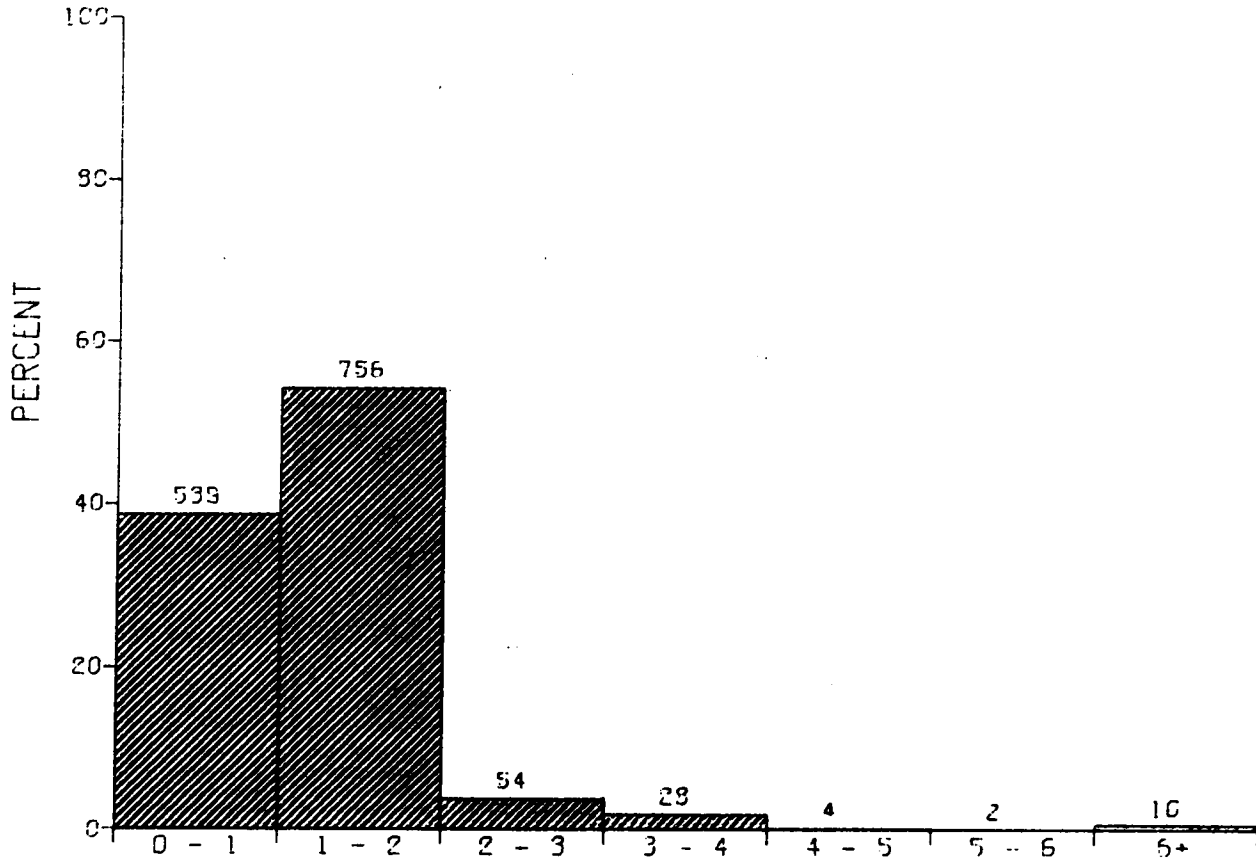

DISTRIBUTION OF SIGNIFICANT WAVE HEIGHT IN METERS

SEASAT DATA- SUMMER

ENTIRE GULF OF MEXICO

N = 1393.

MEAN = 1.29

SIGMA = 0.8

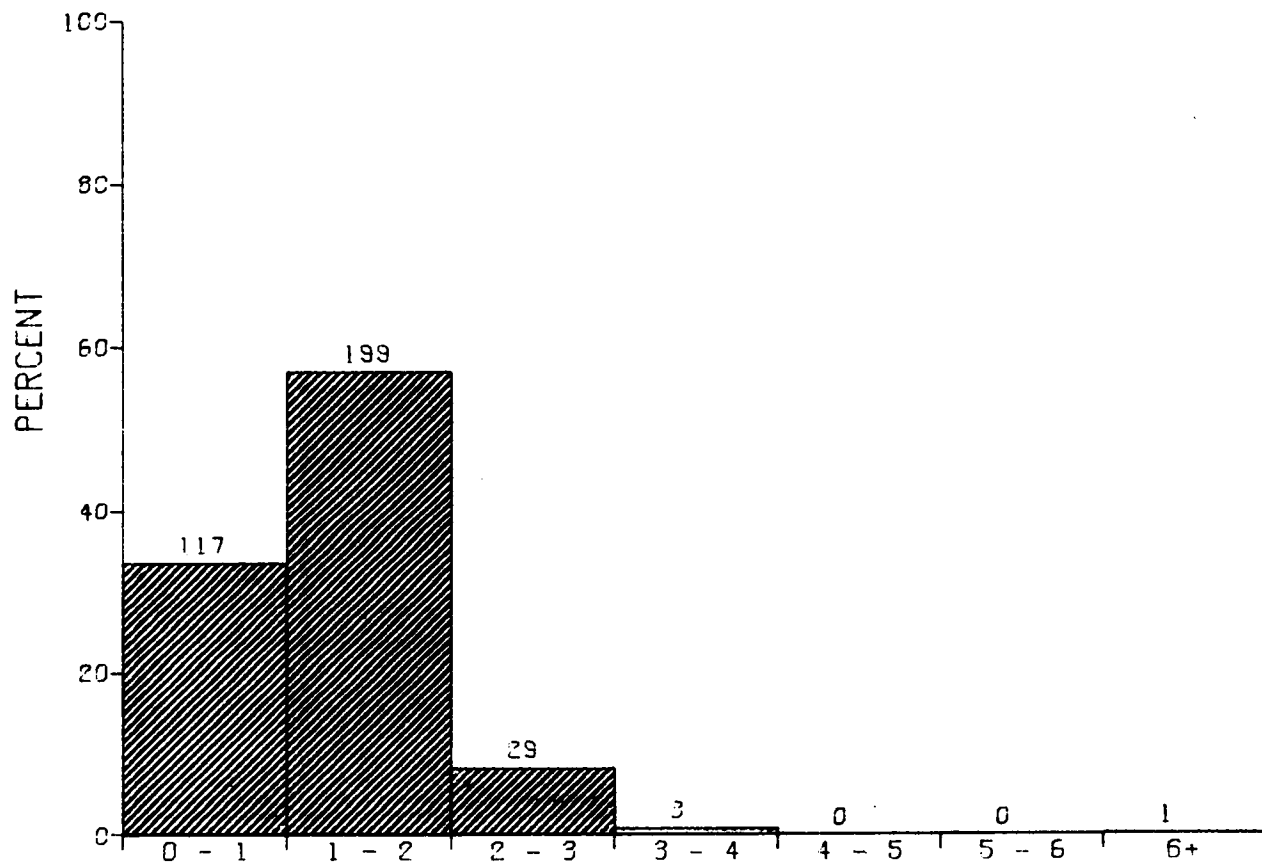

DISTRIBUTION OF SIGNIFICANT WAVE HEIGHT IN METERS

SEASAT DATA- FALL

EASTERN GULF OF MEXICO

N = 349.

MEAN = 1.34

SIGMA = 0.57

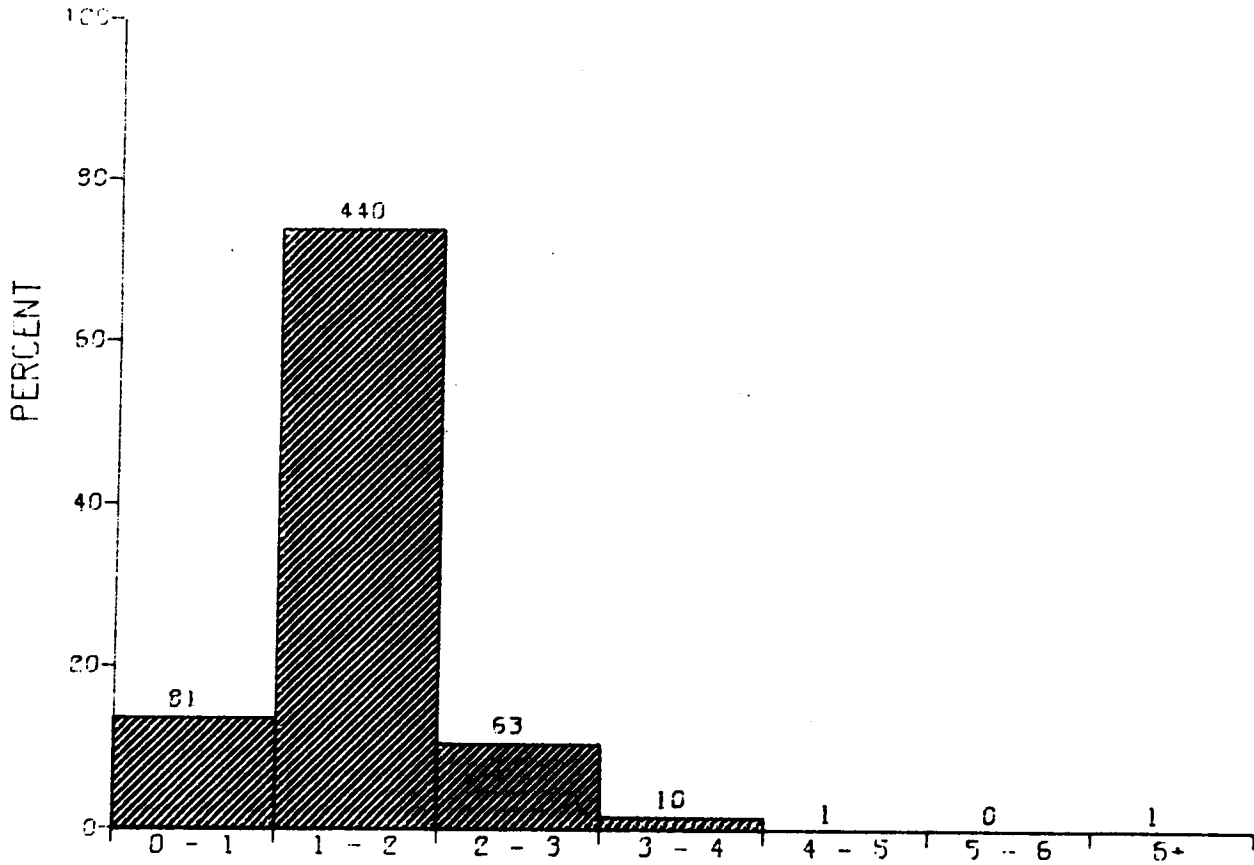

DISTRIBUTION OF SIGNIFICANT WAVE HEIGHT IN METERS

SEASAT DATA- FALL

WESTERN GULF OF MEXICO

N = 596.

MEAN = 1.52

SIGMA = 0.6

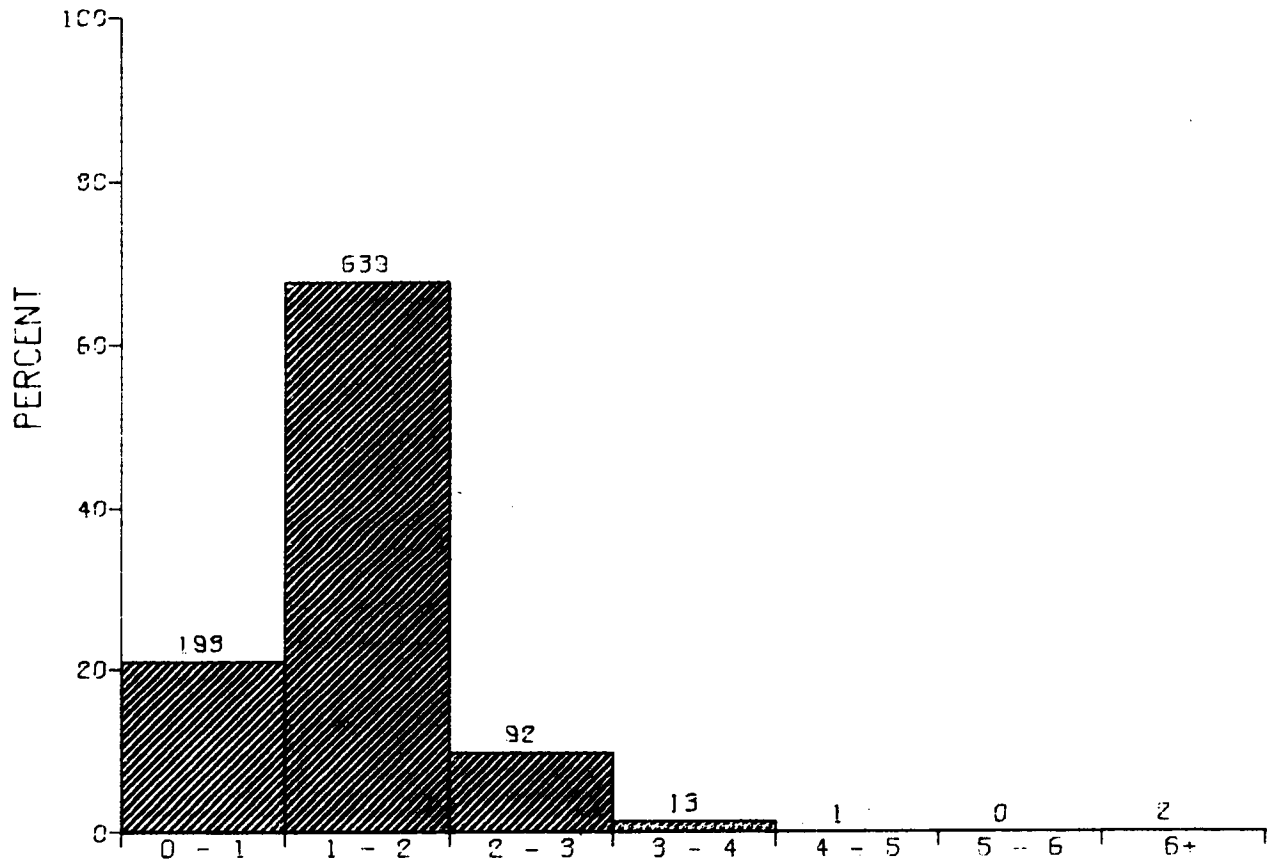

DISTRIBUTION OF SIGNIFICANT WAVE HEIGHT IN METERS

SEASAT DATA- FALL

ENTIRE GULF OF MEXICO

N = 945.

MEAN = 1.45

SIGMA = 0.6

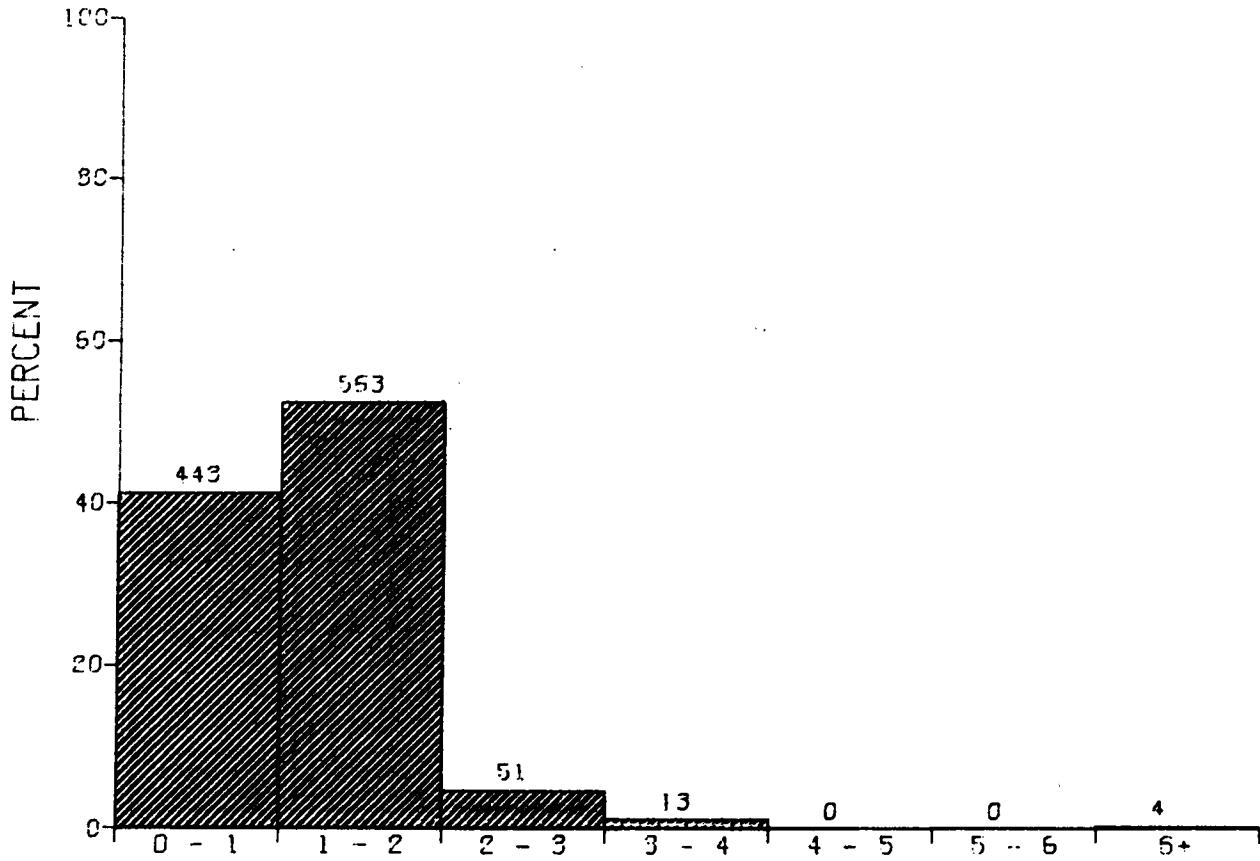

DISTRIBUTION OF SIGNIFICANT WAVE HEIGHT IN METERS

ALL SEASAT DATA

EASTERN GULF OF MEXICO

N = 1074.

MEAN = 1.23

SIGMA = 0.58

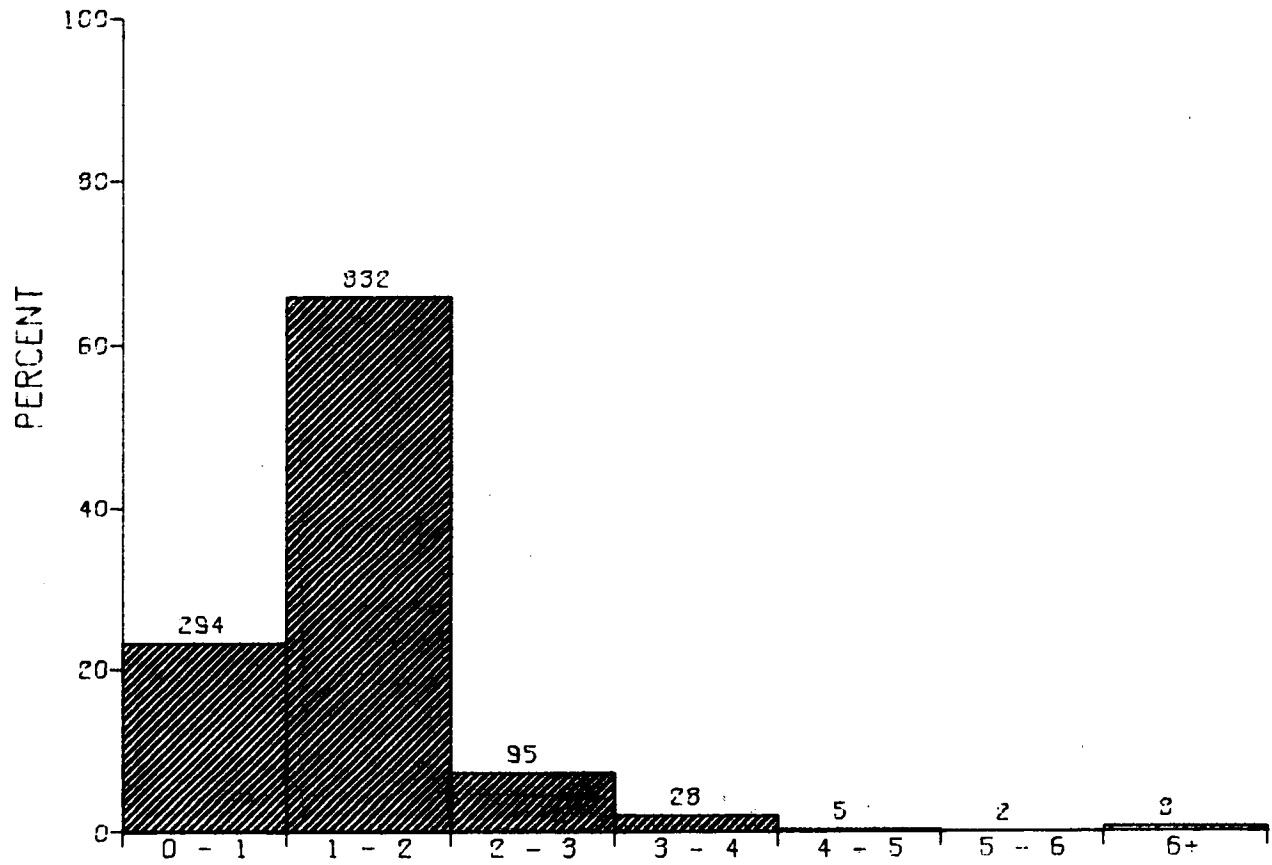

DISTRIBUTION OF SIGNIFICANT WAVE HEIGHT IN METERS

ALL SEASAT DATA

WESTERN GULF OF MEXICO

N = 1264.

MEAN = 1.46

SIGMA = 0.9

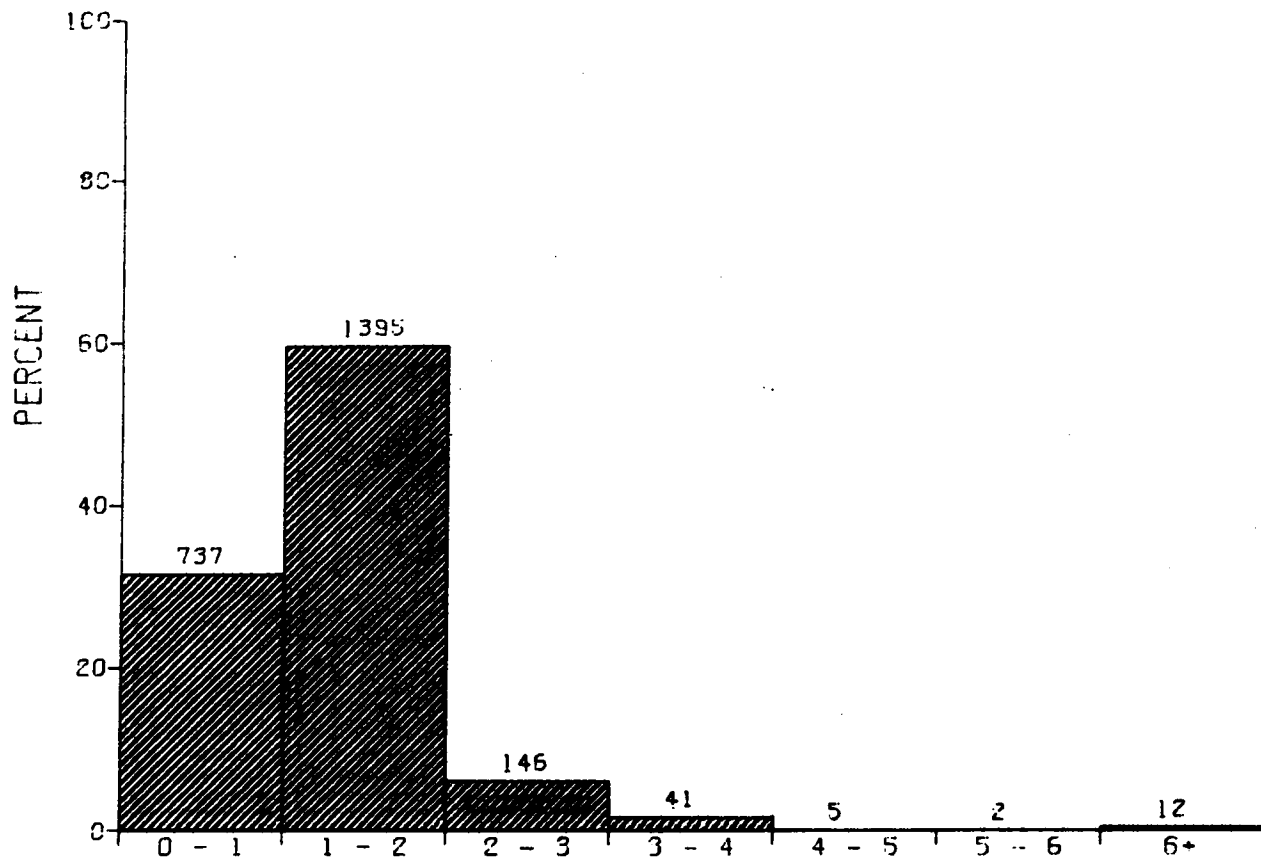

DISTRIBUTION OF SIGNIFICANT WAVE HEIGHT IN METERS

ALL SEASAT DATA

ENTIRE GULF OF MEXICO

N = 2338.

MEAN = 1.35

SIGMA = 0.7

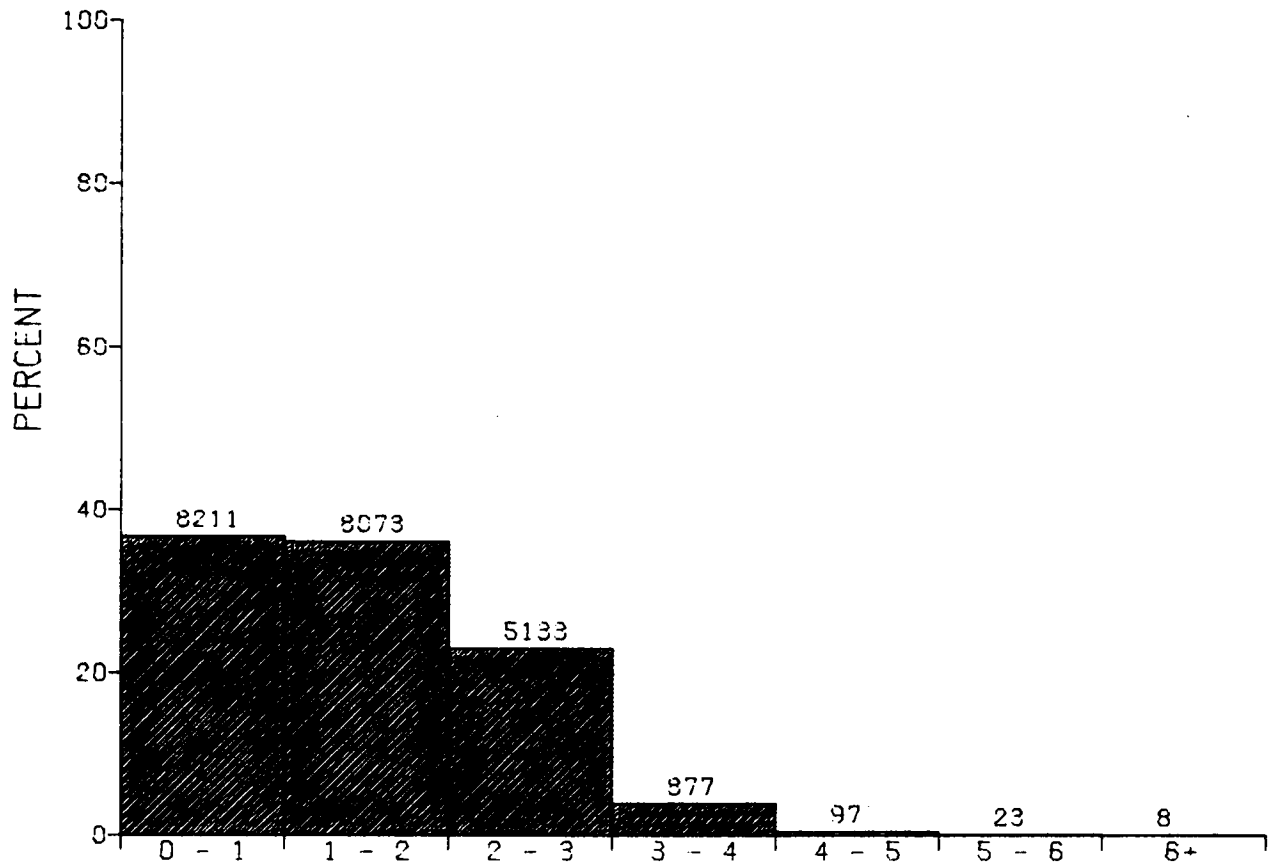

DISTRIBUTION OF SIGNIFICANT WAVE HEIGHT IN METERS

ALL GEOS/SEASAT DATA

EASTERN GULF OF MEXICO

N = 22422. MEAN = 1.34 SIGMA = 1.00

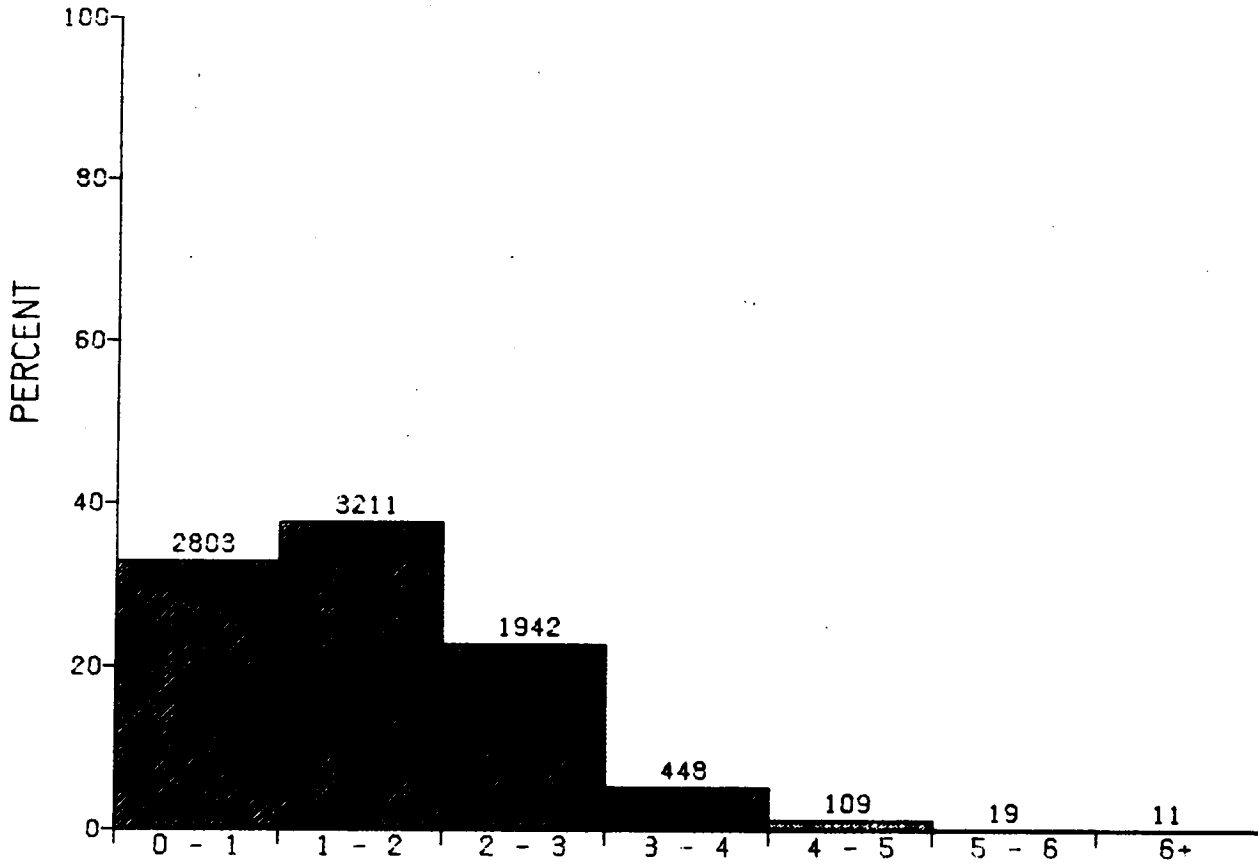

DISTRIBUTION OF SIGNIFICANT WAVE HEIGHT IN METERS

ALL GEOS/SEASAT DATA

WESTERN GULF OF MEXICO

N = 8543.

MEAN = 1.46

SIGMA = 1.1

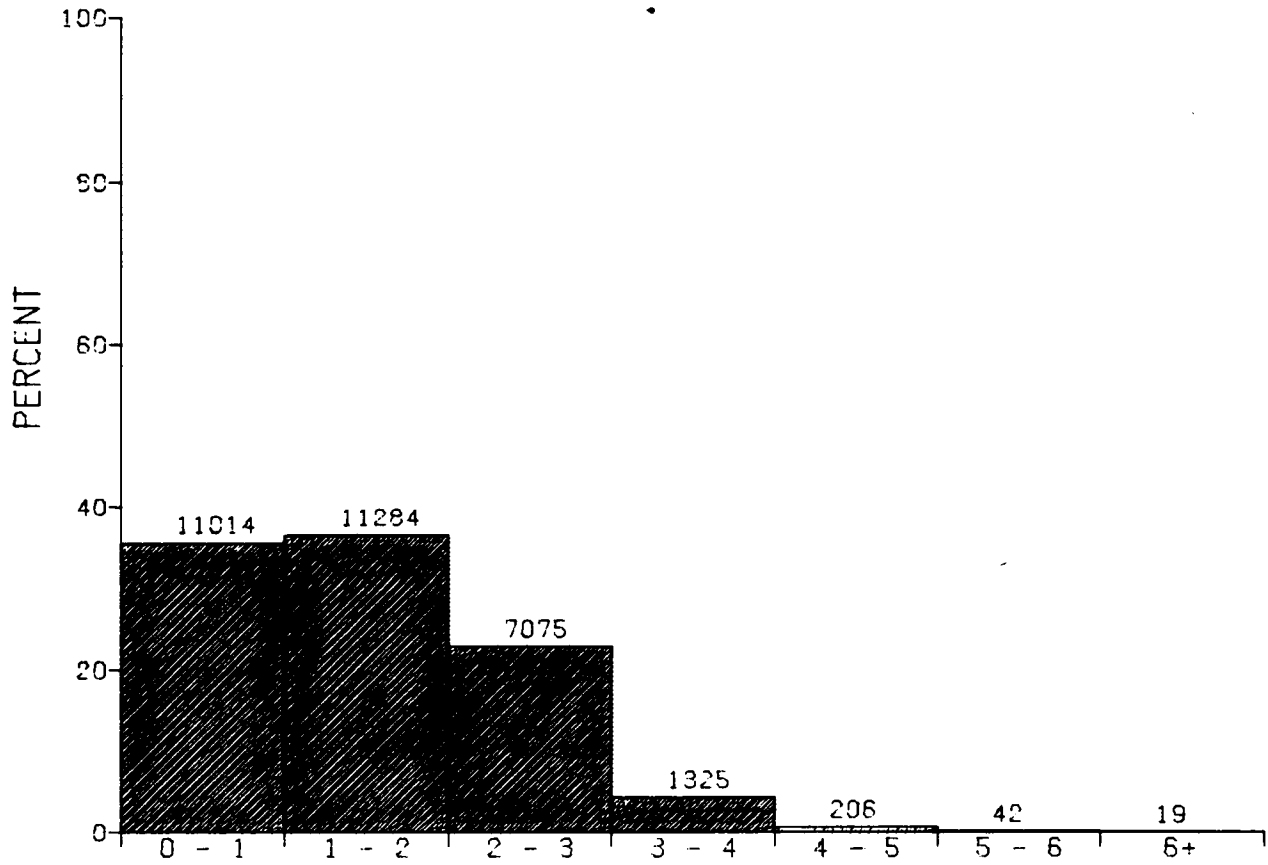

DISTRIBUTION OF SIGNIFICANT WAVE HEIGHT IN METERS

ALL GEOS/SEASAT DATA

ENTIRE GULF OF MEXICO

N = 30965. MEAN = 1.37 SIGMA = 1.0

APPENDIX C

SURFACE WIND SPEED

HISTOGRAMS

GEOS-3 Monthly (3 year)	C1 - C36
GEOS-3 Seasonal (3 year)	C37 - C48
GEOS-3 Composite (3 year)	C49 - C51
GEOS-3 1978 Monthly (July-October)	C52 - C63
GEOS-3 1978 Seasonal (Summer and Fall)	C64 - C69
SEASAT Monthly	C70 - C81
SEASAT Seasonal	C82 - C87
SEASAT Composite	C88 - C90
GEOS/SEASAT Composite	C91 - C93

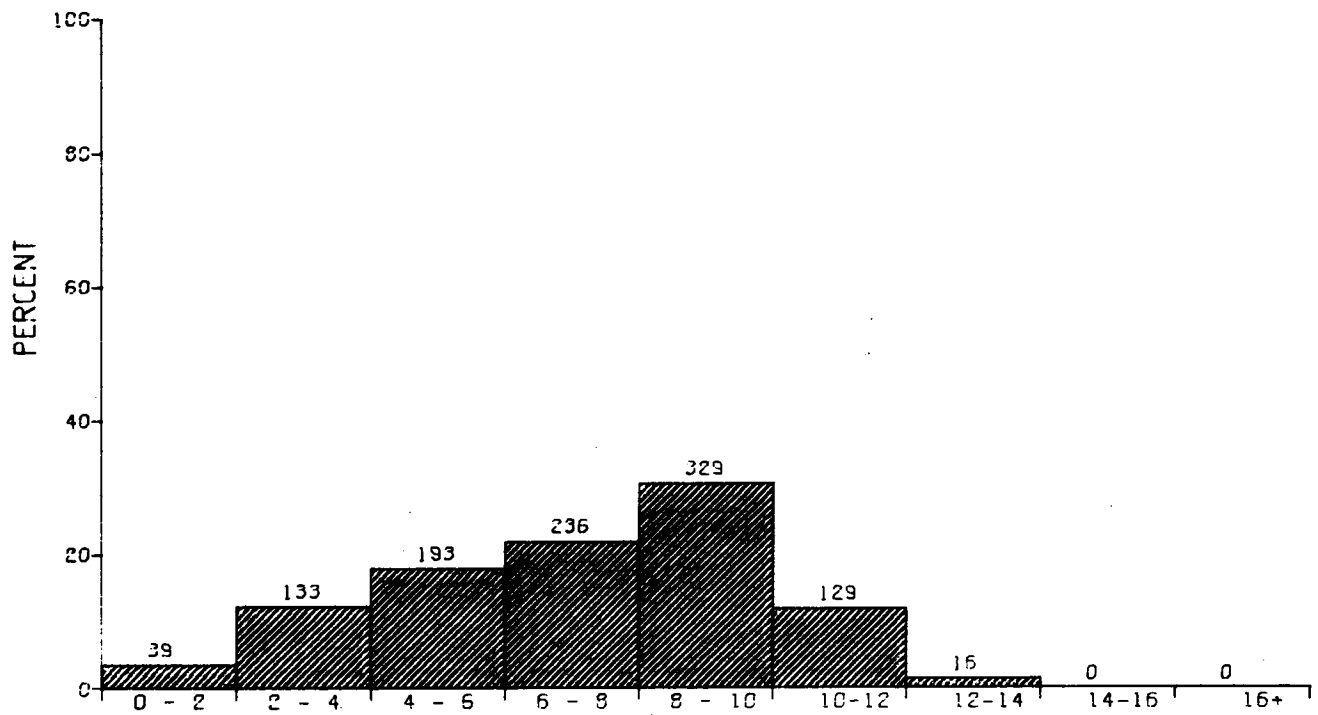

DISTRIBUTION OF WIND SPEED IN METERS PER SECOND
 GEOS DATA- JANUARY
 EASTERN GULF OF MEXICO

N = 1075. MEAN = 7.14 SIGMA = 2.71

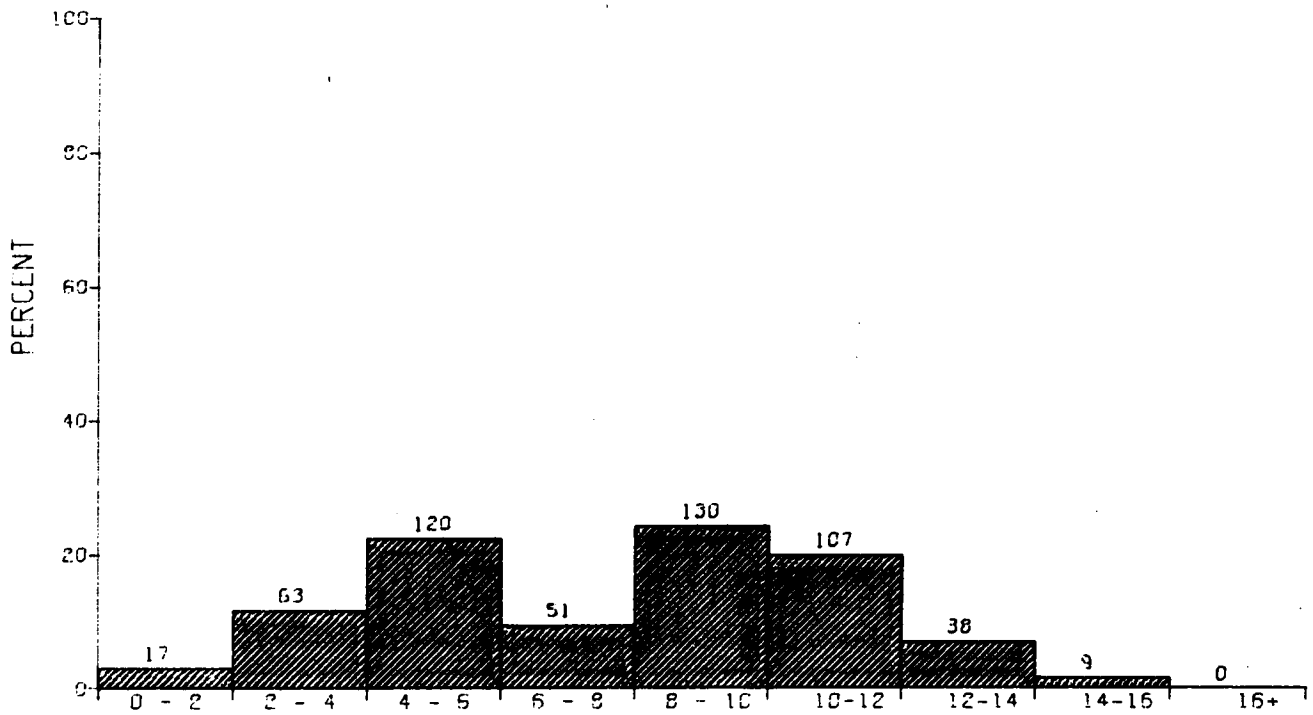

DISTRIBUTION OF WIND SPEED IN METERS PER SECOND
 GEOS DATA - JANUARY
 WESTERN GULF OF MEXICO

N = 535 MEAN = 7.76 SIGMA = 3.3

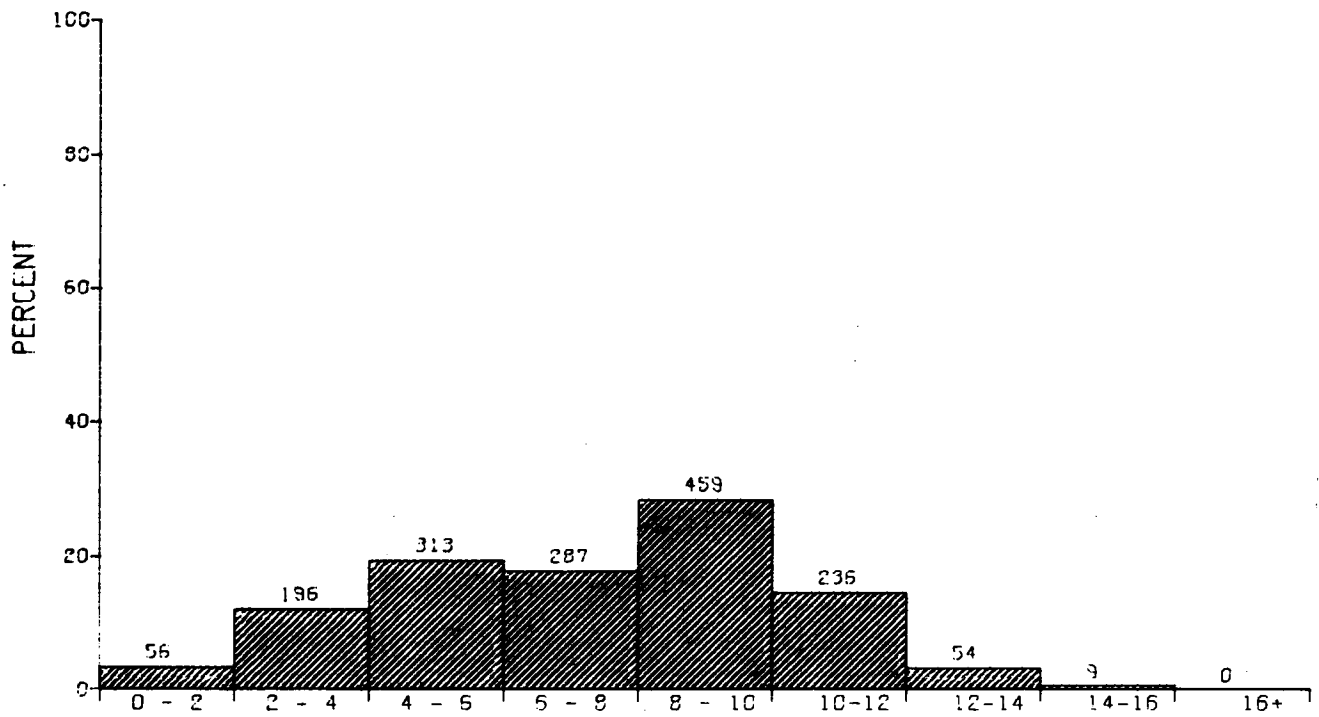

DISTRIBUTION OF WIND SPEED IN METERS PER SECOND

GEOS DATA- JANUARY

ENTIRE GULF OF MEXICO

N = 1610. MEAN = 7.35 SIGMA = 2.9

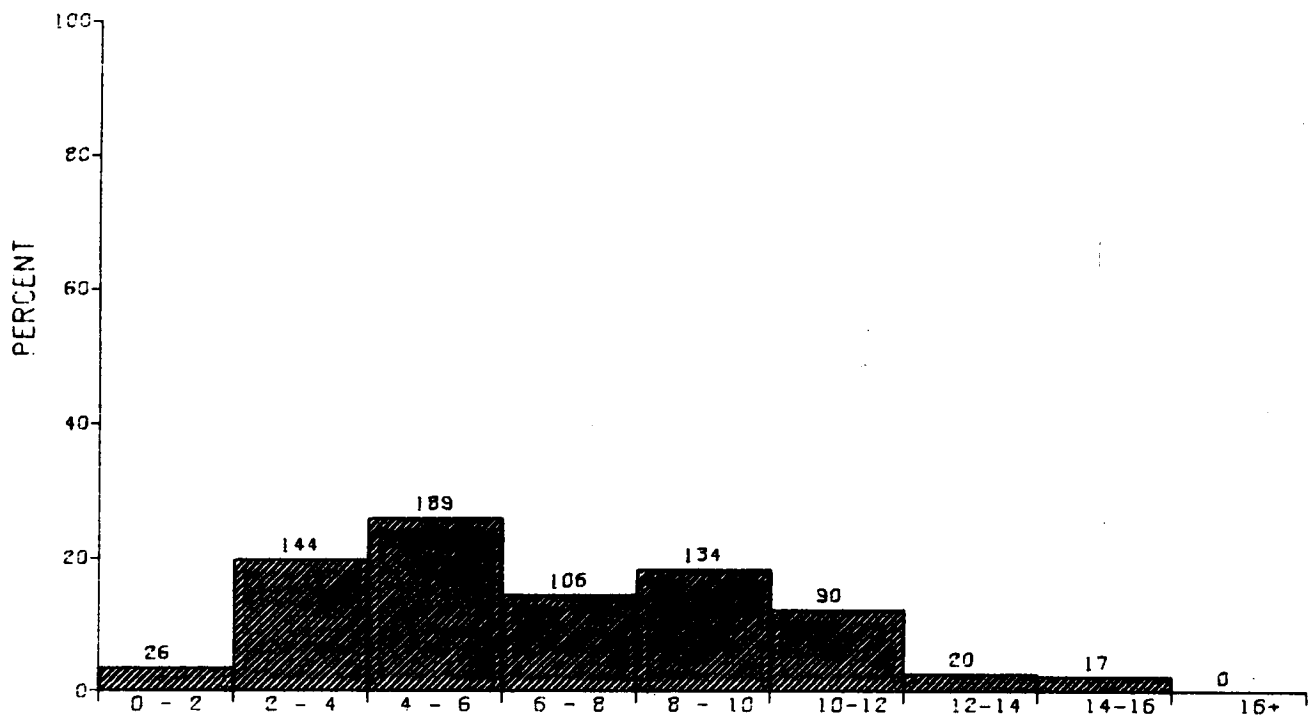

DISTRIBUTION OF WIND SPEED IN METERS PER SECOND
 GEOS DATA- FEBRUARY
 EASTERN GULF OF MEXICO

N = 726. MEAN = 6.71 SIGMA = 3.20

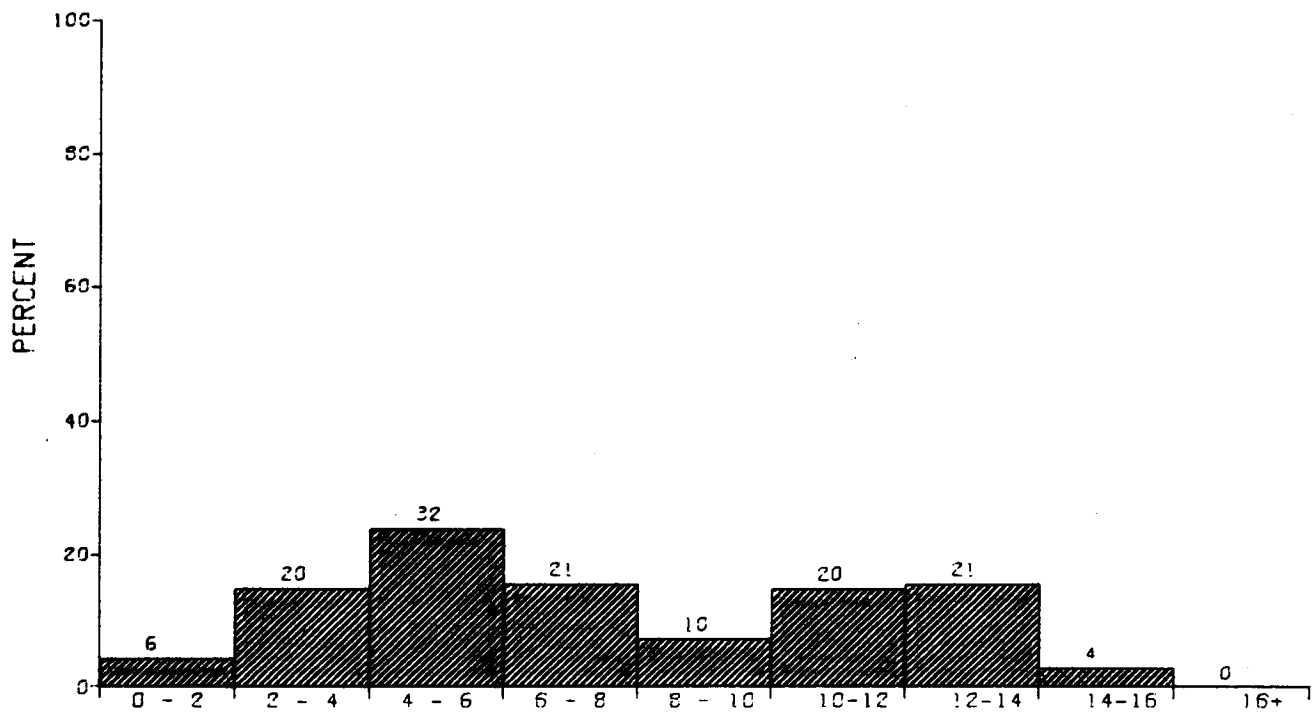

DISTRIBUTION OF WIND SPEED IN METERS PER SECOND

GEOS DATA-- FEBRUARY

WESTERN GULF OF MEXICO

N = 134.

MEAN = 7.51

SIGMA = 3.8

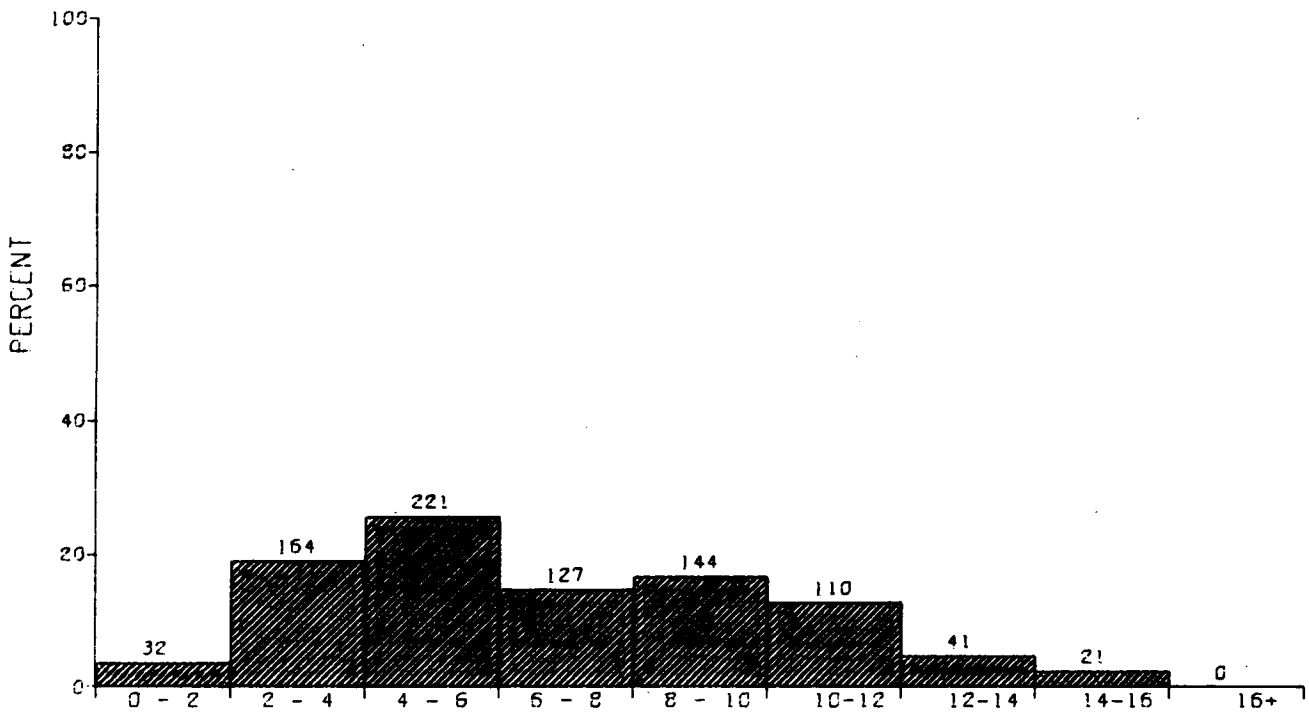

DISTRIBUTION OF WIND SPEED IN METERS PER SECOND
 GEOS DATA- FEBRUARY
 ENTIRE GULF OF MEXICO

N = 860 MEAN = 6.83 SIGMA = 3.3

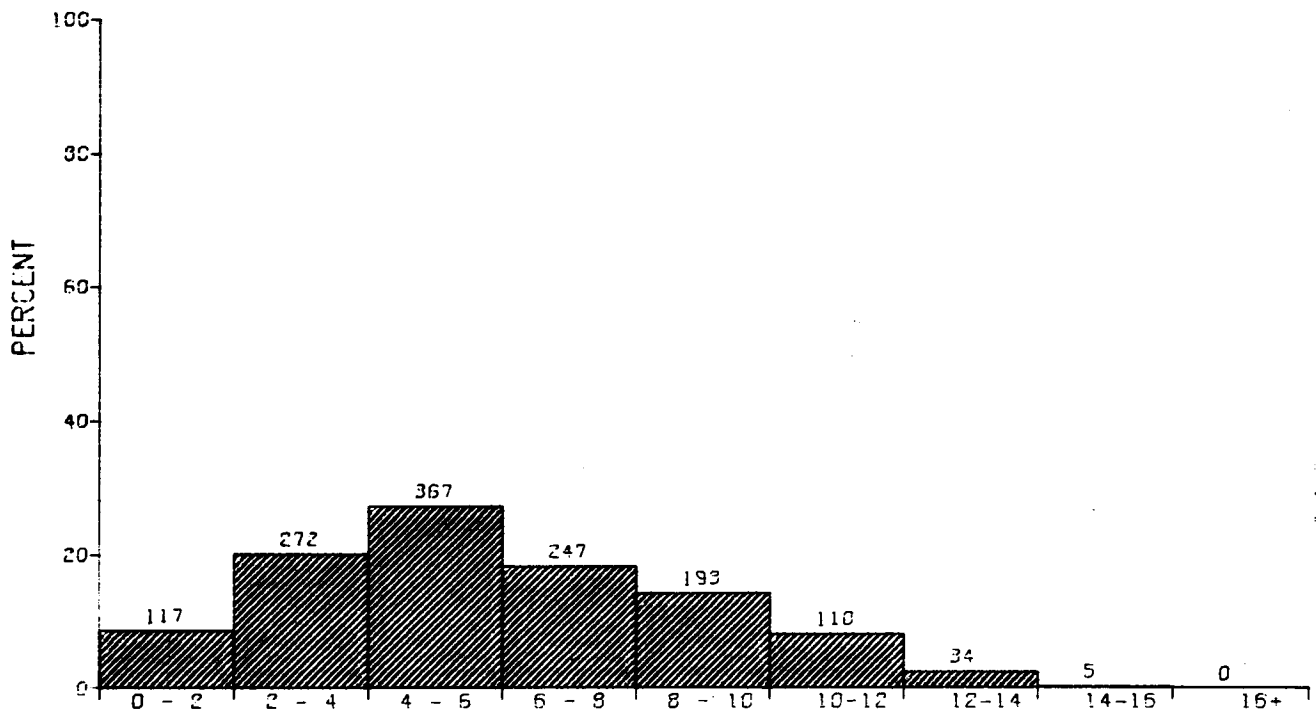

DISTRIBUTION OF WIND SPEED IN METERS PER SECOND

GEOS DATA - MARCH

EASTERN GULF OF MEXICO

N = 1345. MEAN = 5.98 SIGMA = 3.00

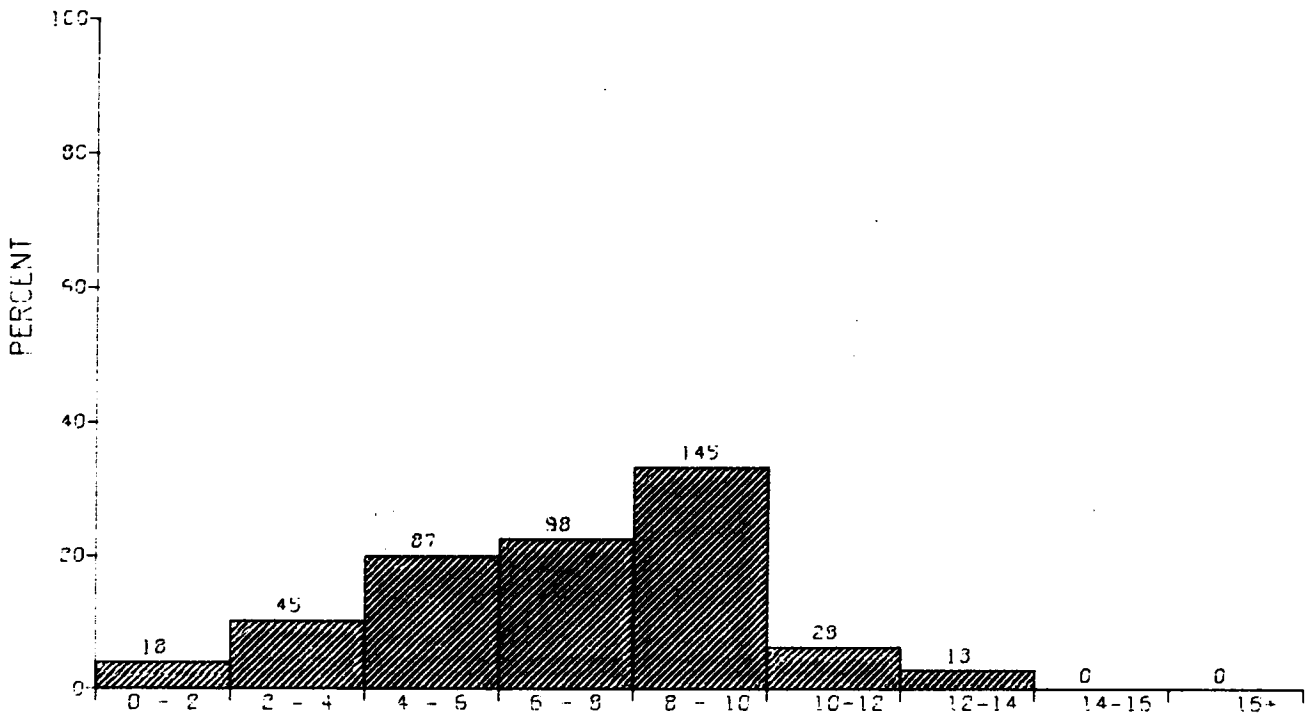

DISTRIBUTION OF WIND SPEED IN METERS PER SECOND

GEOG DATA - MARCH

WESTERN GULF OF MEXICO

N = 434

MEAN = 7.16

SIGMA = 2.8

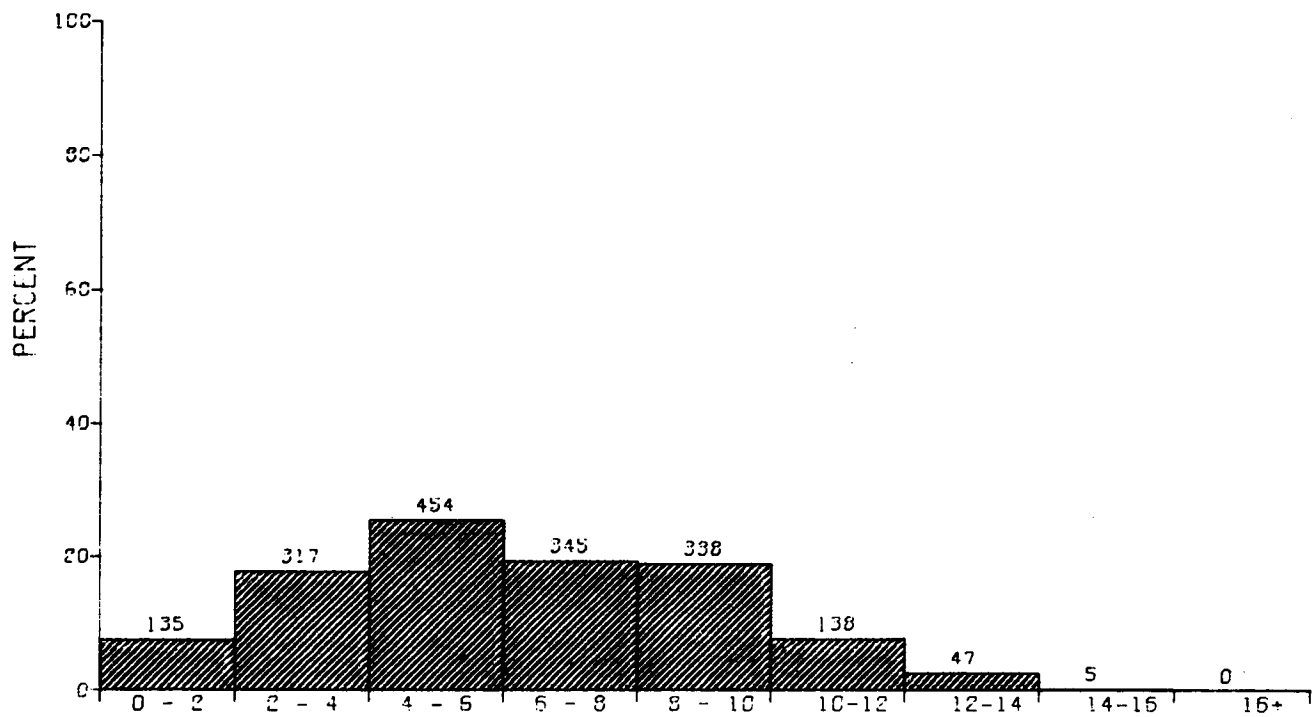

DISTRIBUTION OF WIND SPEED IN METERS PER SECOND

GEOS DATA - MARCH

ENTIRE GULF OF MEXICO

N = 1779. MEAN = 6.26 SIGMA = 3.0

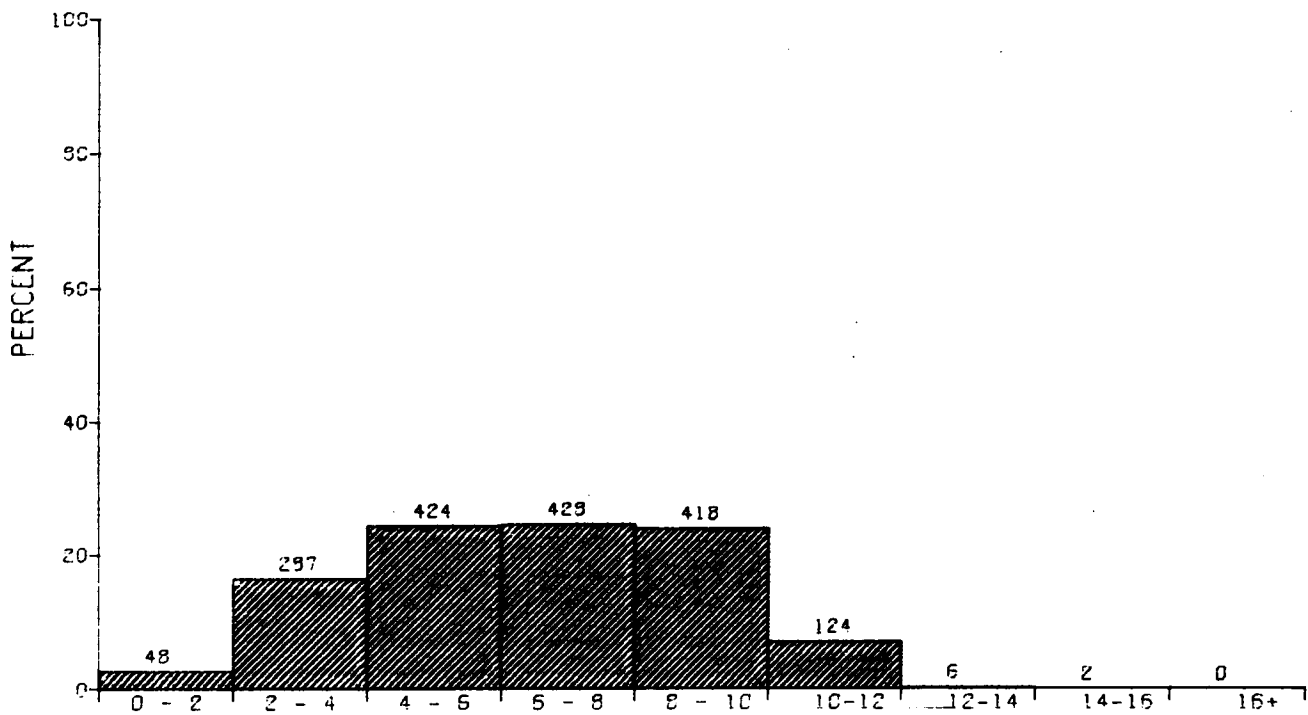

DISTRIBUTION OF WIND SPEED IN METERS PER SECOND

GEOS DATA- APRIL

EASTERN GULF OF MEXICO

N = 1737. MEAN = 6.52 SIGMA = 2.54

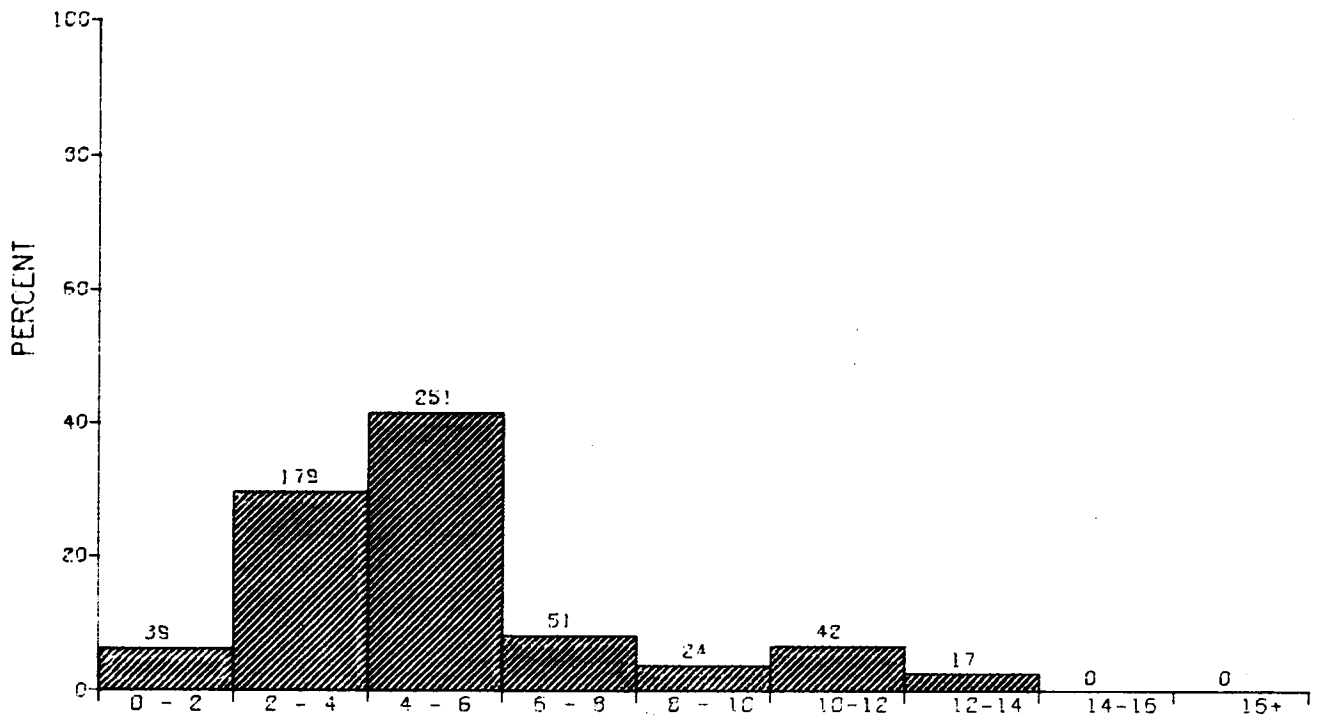

DISTRIBUTION OF WIND SPEED IN METERS PER SECOND
 GEOS DATA- APRIL
 WESTERN GULF OF MEXICO

N = 603. MEAN = 5.17 SIGMA = 2.7

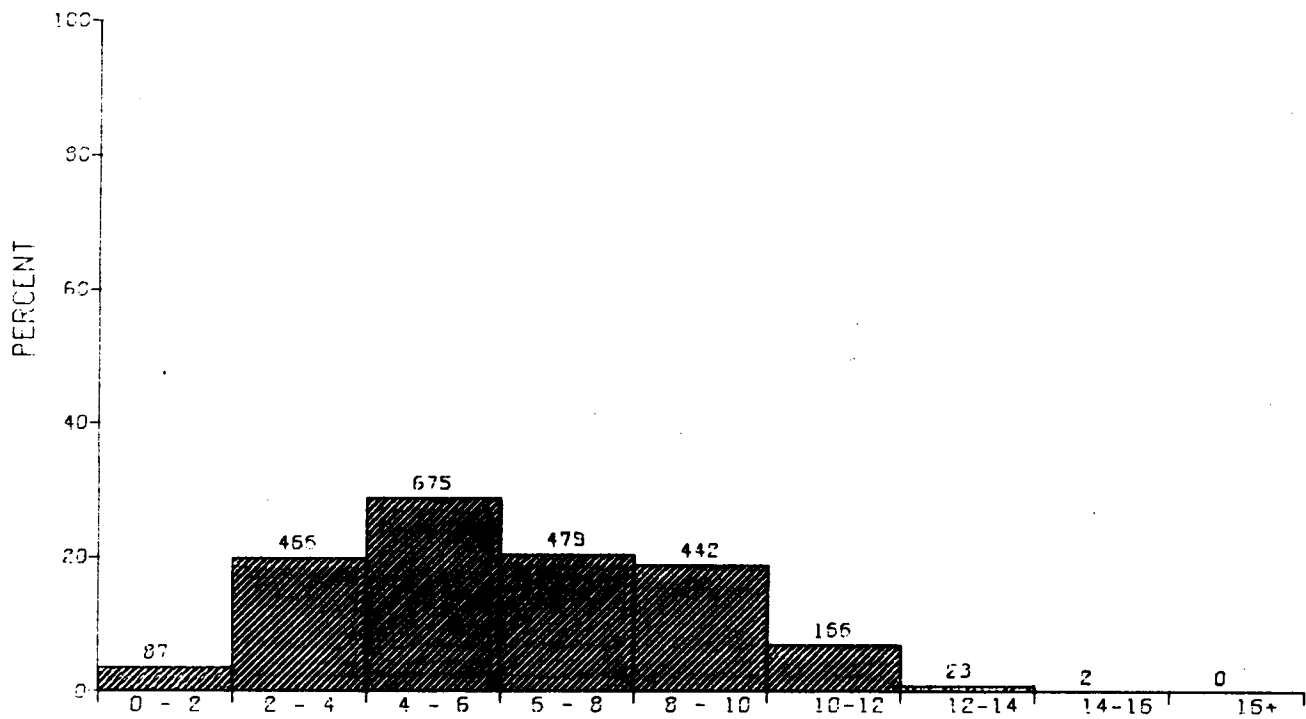

DISTRIBUTION OF WIND SPEED IN METERS PER SECOND

GEOS DATA- APRIL

ENTIRE GULF OF MEXICO

N = 2340.

MEAN = 6.17

SIGMA = 2.7

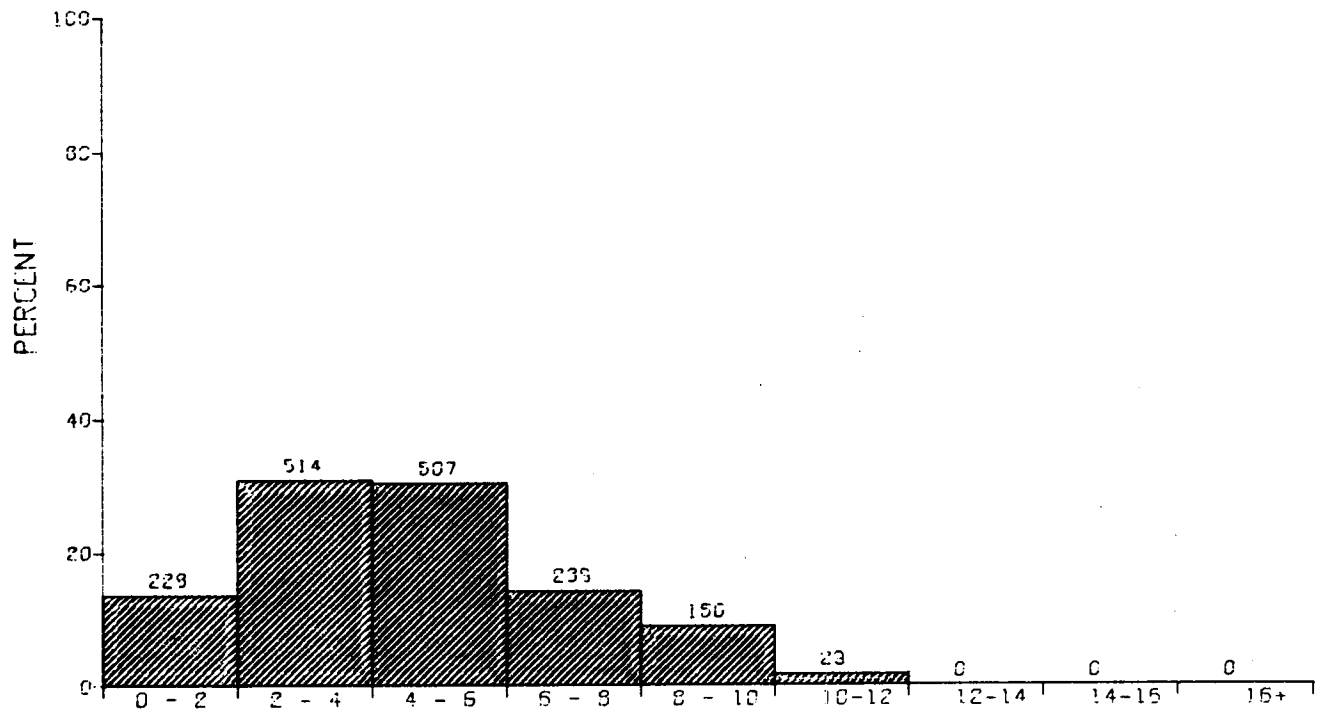

DISTRIBUTION OF WIND SPEED IN METERS PER SECOND
 GEOS DATA- MAY
 EASTERN GULF OF MEXICO

N = 1667. MEAN = 4.59 SIGMA = 2.40

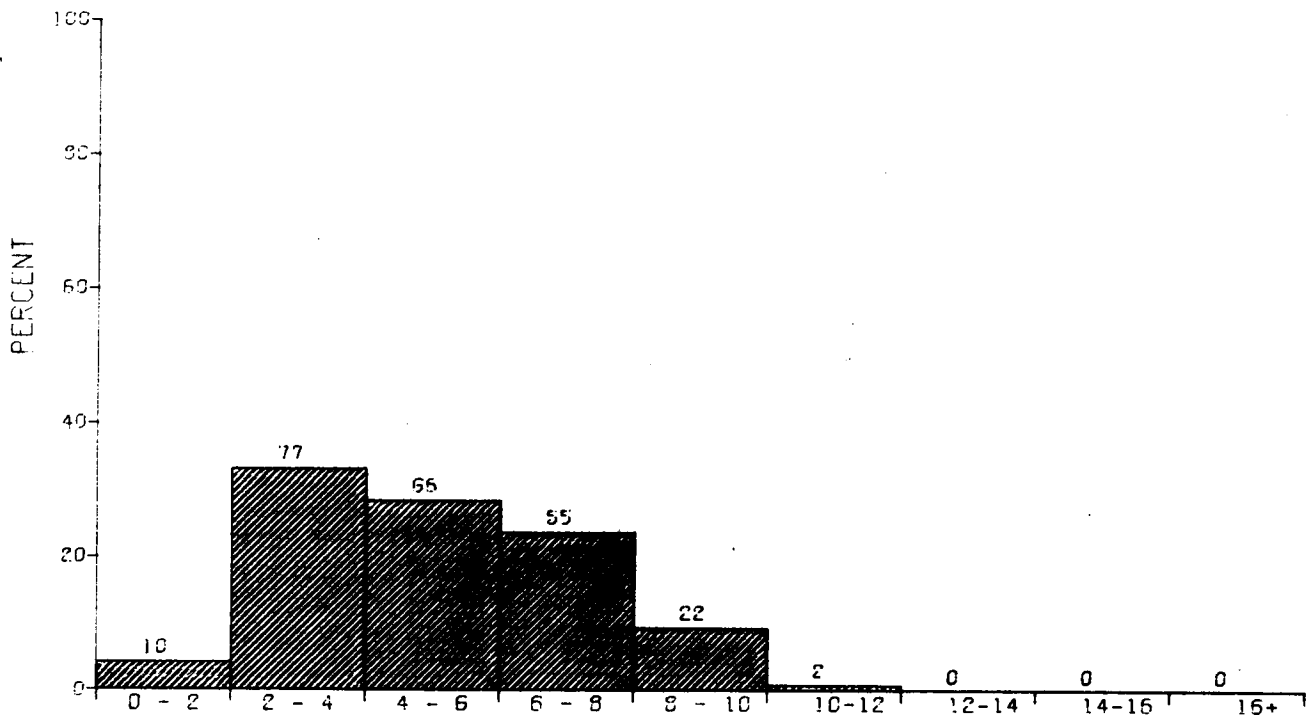

DISTRIBUTION OF WIND SPEED IN METERS PER SECOND

GEOS DATA - MAY

WESTERN GULF OF MEXICO

N = 232

MEAN = 5.12

SIGMA = 2.1

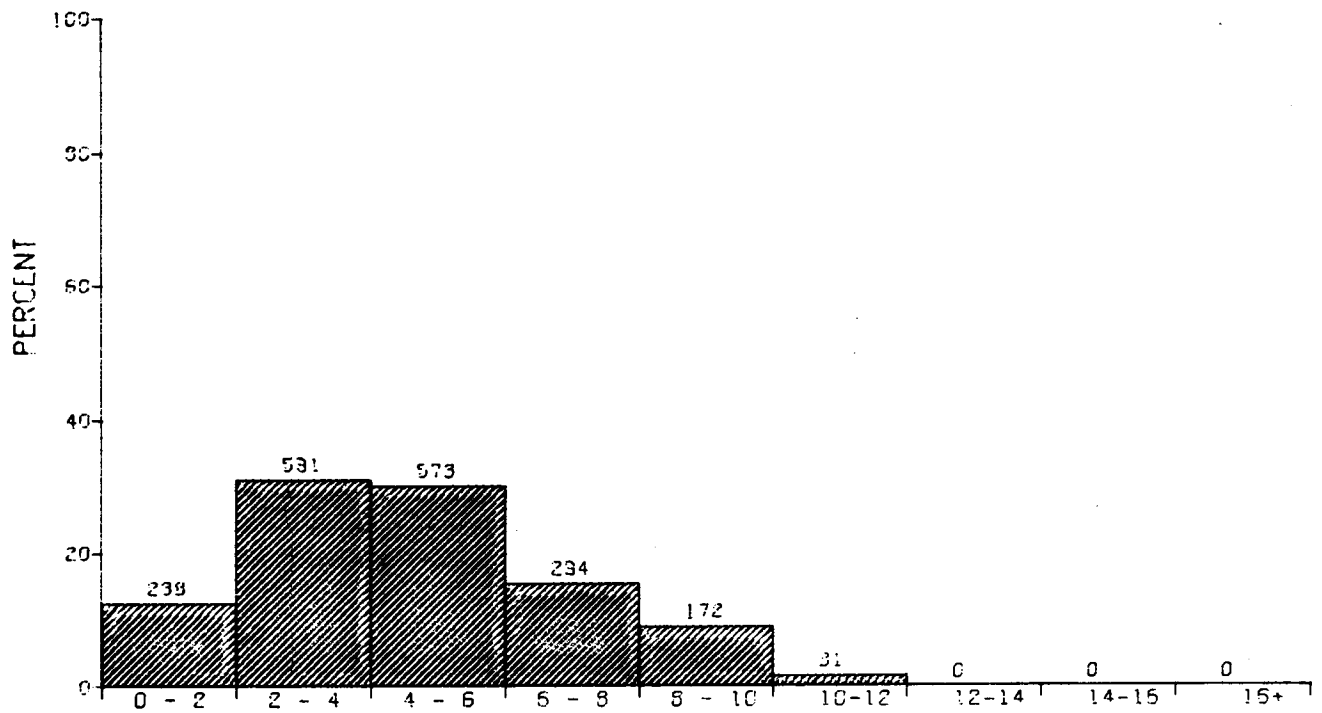

DISTRIBUTION OF WIND SPEED IN METERS PER SECOND

GEOS DATA - MAY

ENTIRE GULF OF MEXICO

N = 1899.

MEAN = 4.66

SIGMA = 2.4

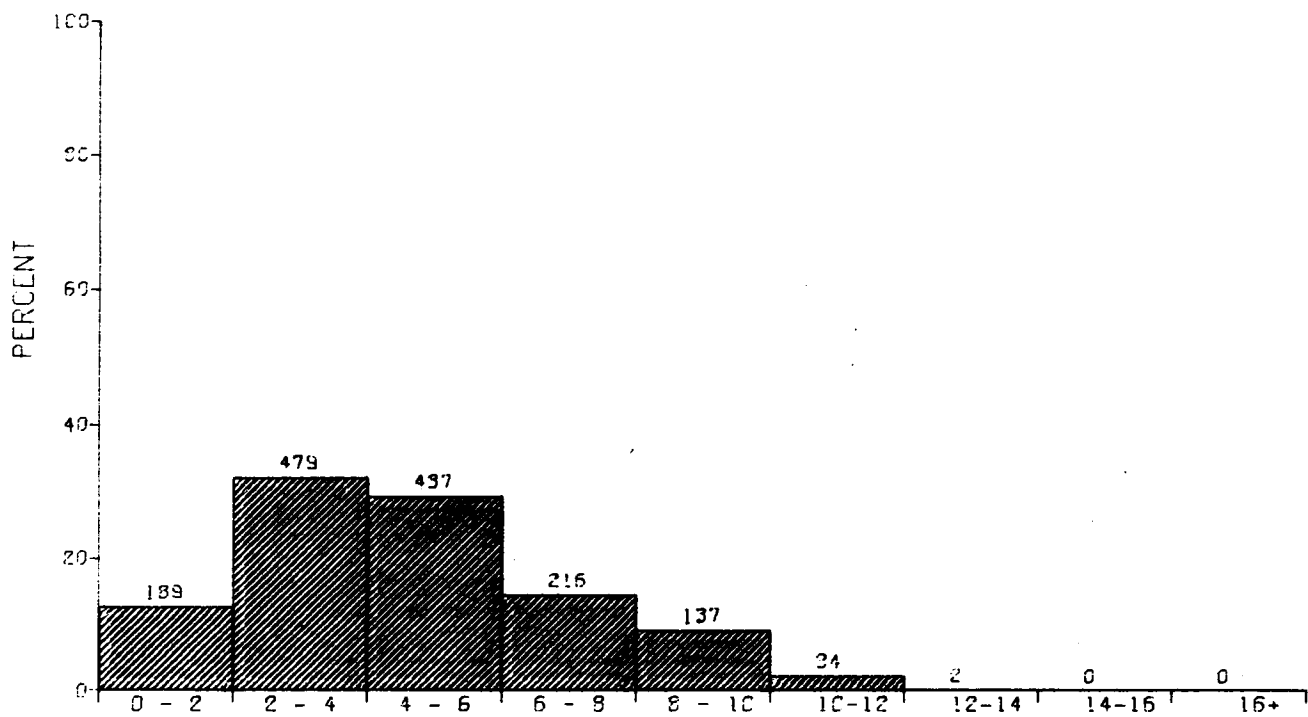

DISTRIBUTION OF WIND SPEED IN METERS PER SECOND

GEOS DATA- JUNE

EASTERN GULF OF MEXICO

N = 1494.

MEAN = 4.70

SIGMA = 2.43

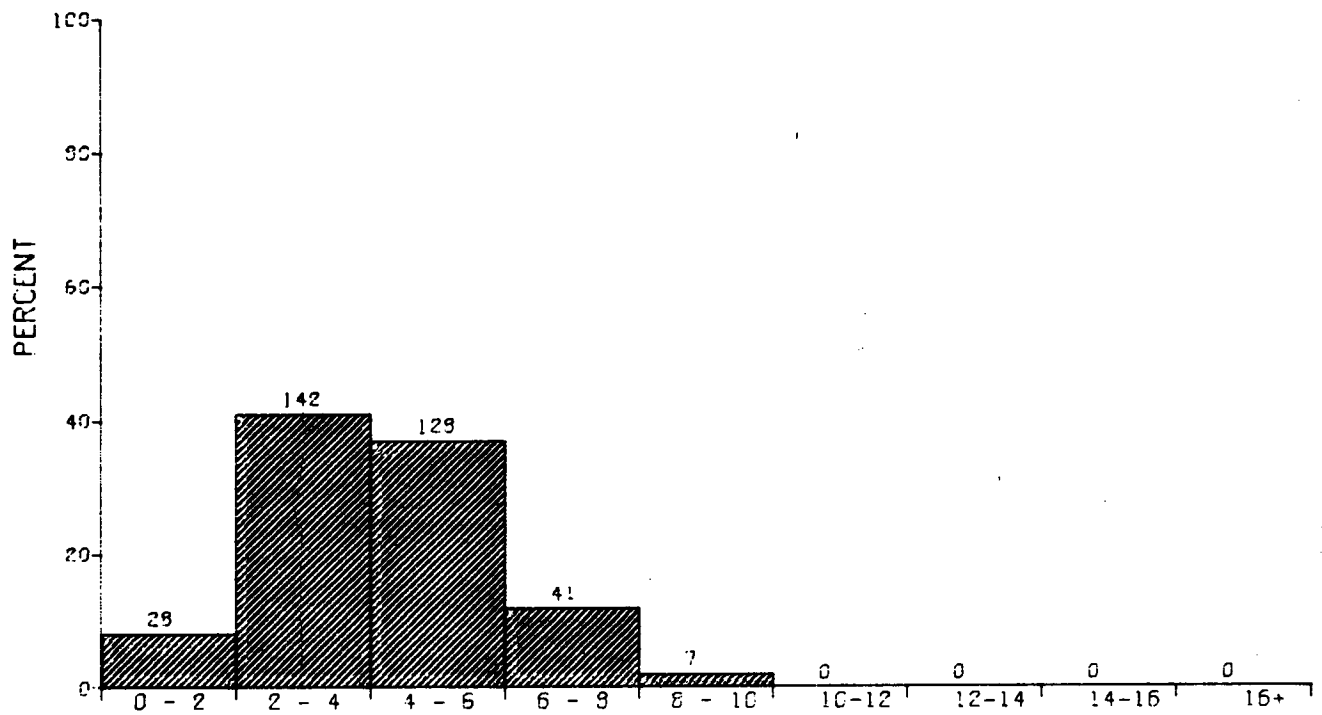

DISTRIBUTION OF WIND SPEED IN METERS PER SECOND
 GEOS DATA- JUNE
 WESTERN GULF OF MEXICO

N = 346. MEAN = 4.14 SIGMA = 1.7

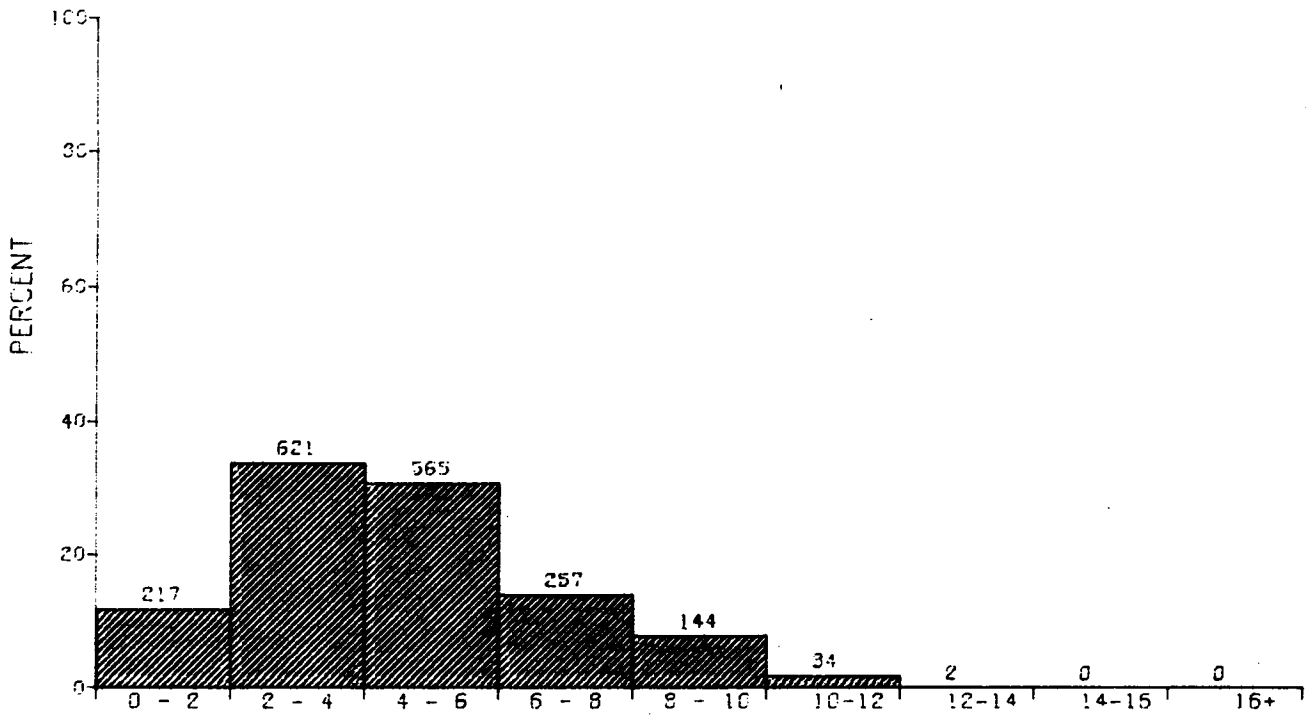

DISTRIBUTION OF WIND SPEED IN METERS PER SECOND

GEOS DATA - JUNE

ENTIRE GULF OF MEXICO

N = 1340. MEAN = 4.59 SIGMA = 2.3

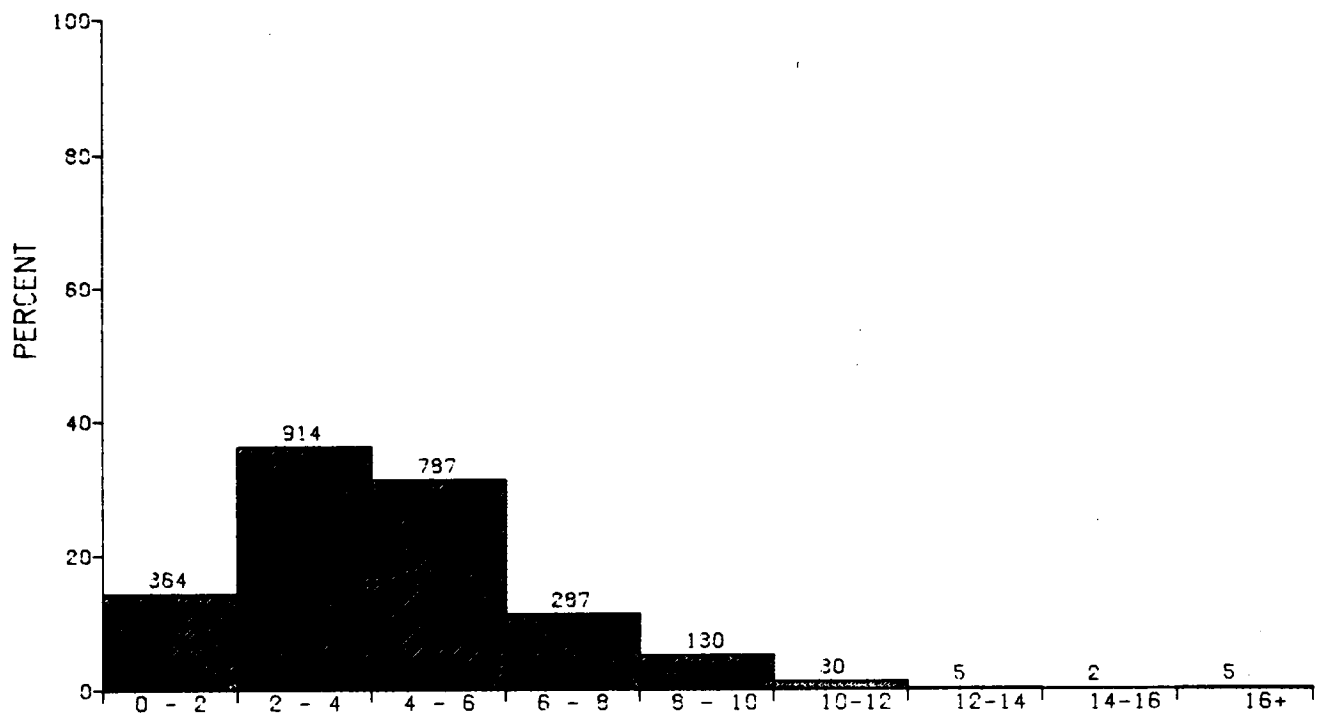

DISTRIBUTION OF WIND SPEED IN METERS PER SECOND
 GEOS DATA-- JULY
 EASTERN GULF OF MEXICO

N = 2524. MEAN = 4.28 SIGMA = 2.26

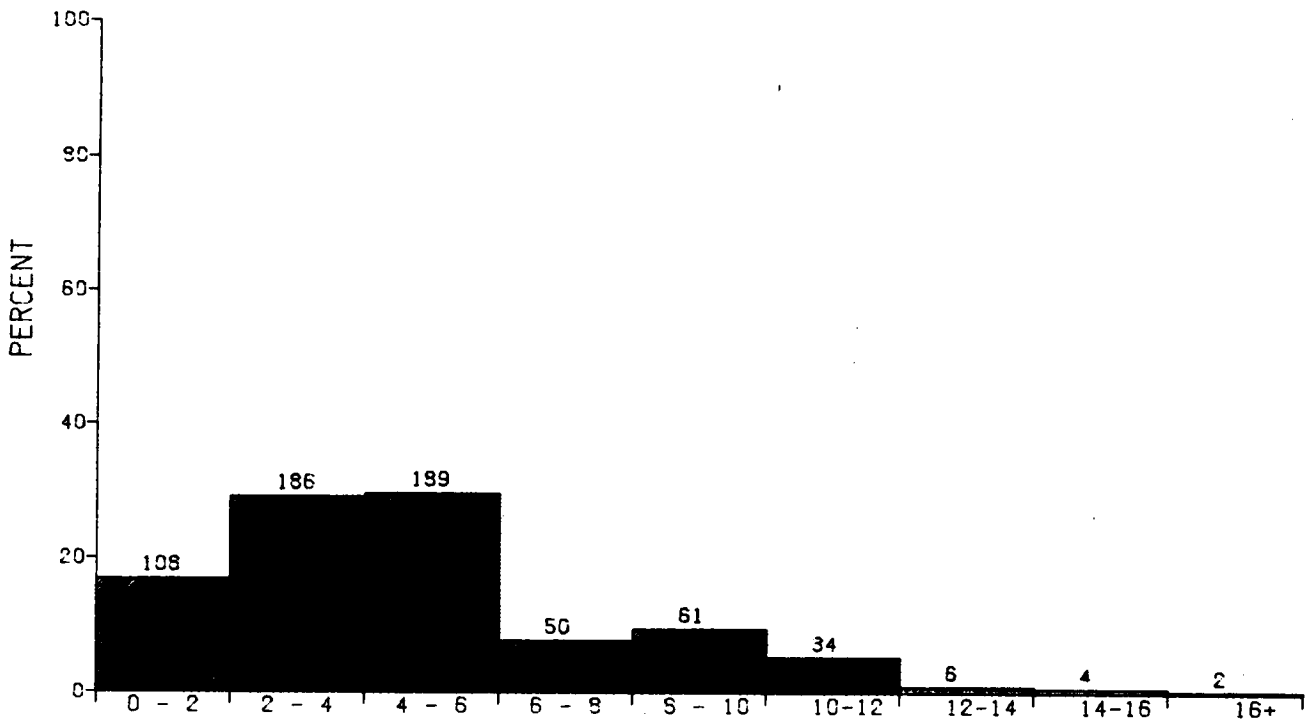

DISTRIBUTION OF WIND SPEED IN METERS PER SECOND
 GEOS DATA- JULY
 WESTERN GULF OF MEXICO

N = 640. MEAN = 4.80 SIGMA = 3.0

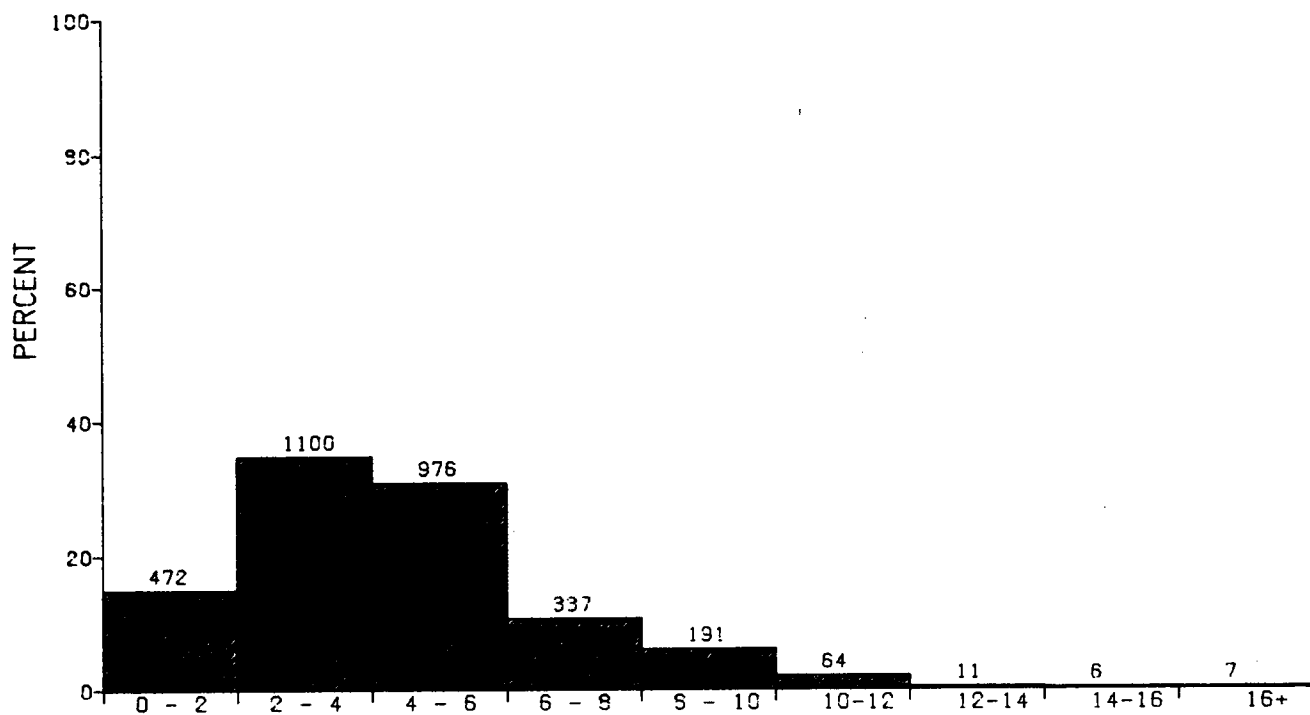

DISTRIBUTION OF WIND SPEED IN METERS PER SECOND

GEOS DATA- JULY

ENTIRE GULF OF MEXICO

N = 3164.

MEAN = 4.38

SIGMA = 2.4

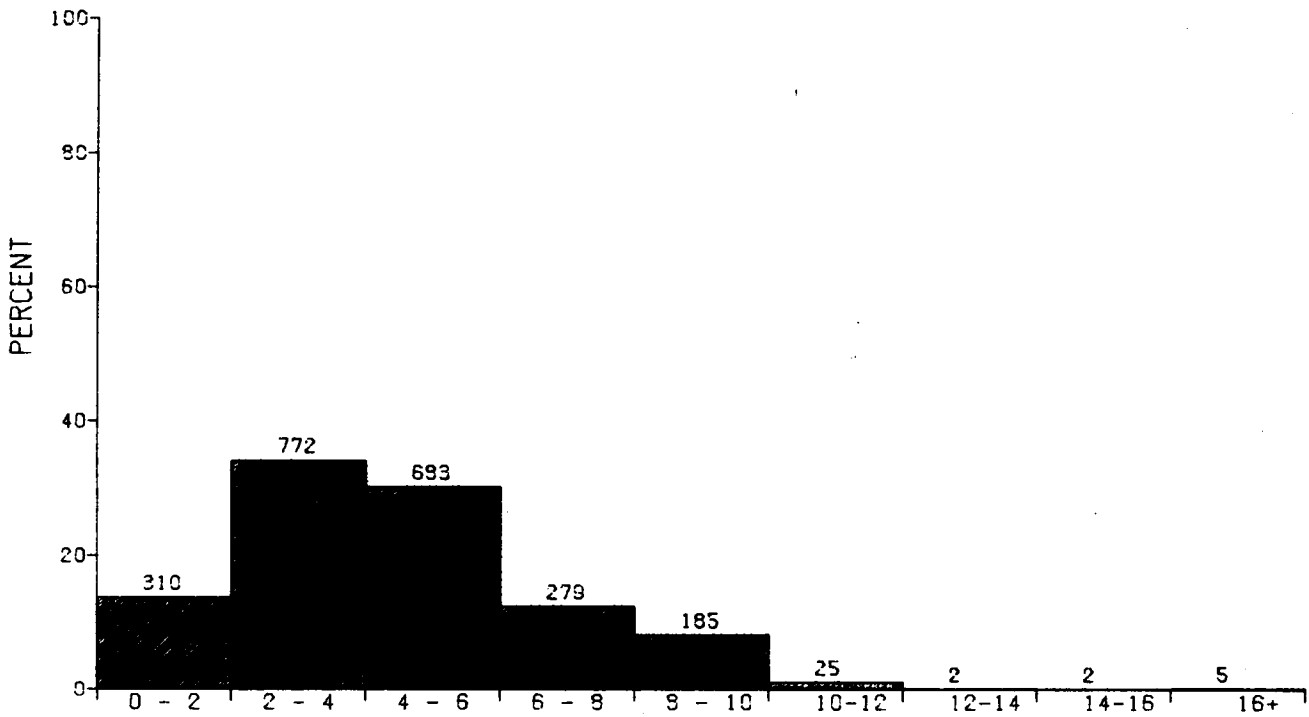

DISTRIBUTION OF WIND SPEED IN METERS PER SECOND

GEOS DATA- AUGUST

EASTERN GULF OF MEXICO

N = 2263. MEAN = 4.51 SIGMA = 2.61

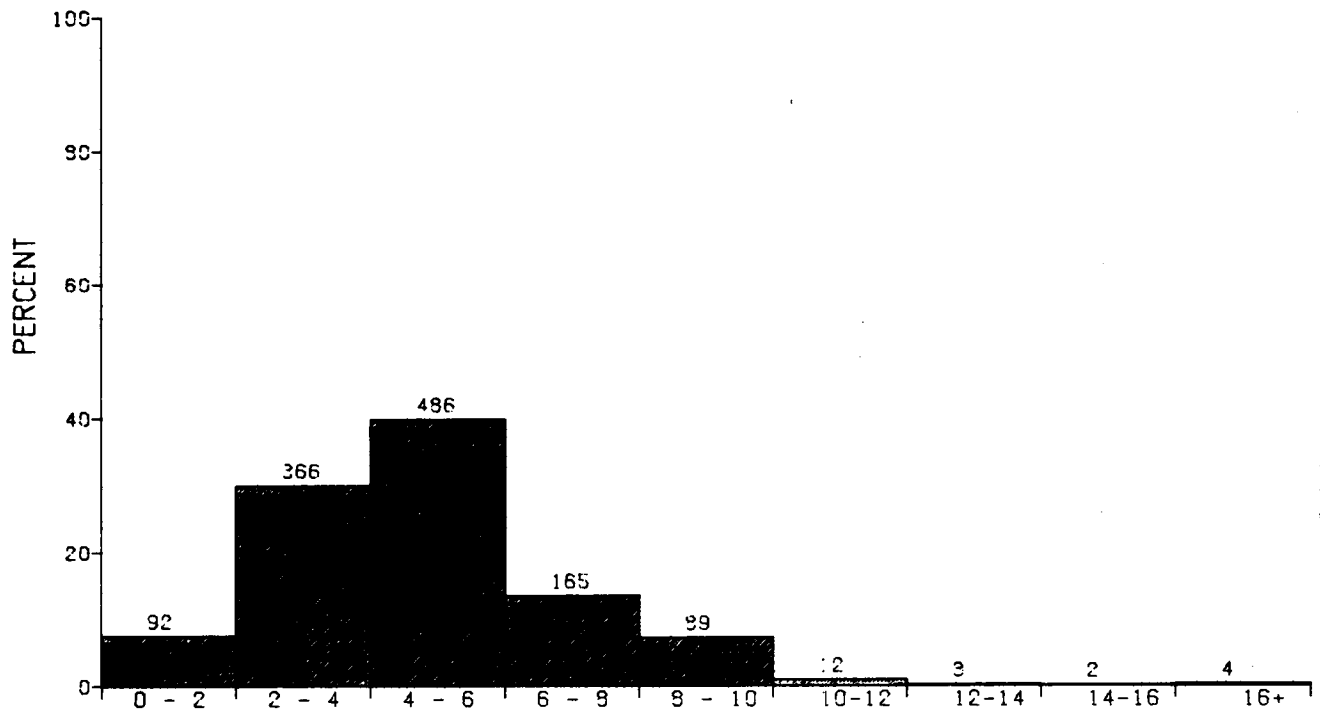

DISTRIBUTION OF WIND SPEED IN METERS PER SECOND

GEOS DATA-- AUGUST

WESTERN GULF OF MEXICO

N = 1219.

MEAN = 4.83

SIGMA = 2.3

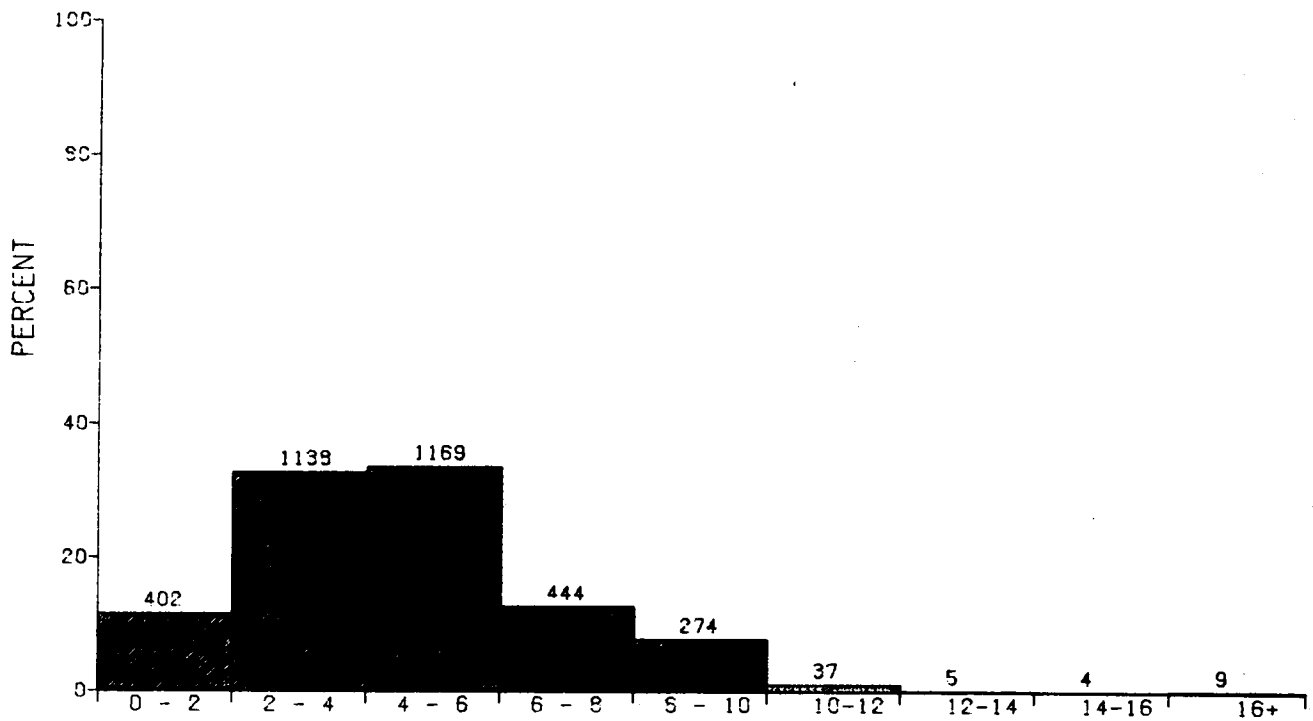

DISTRIBUTION OF WIND SPEED IN METERS PER SECOND

GEOS DATA- AUGUST

ENTIRE GULF OF MEXICO

N = 3482.

MEAN = 4.62

SIGMA = 2.5

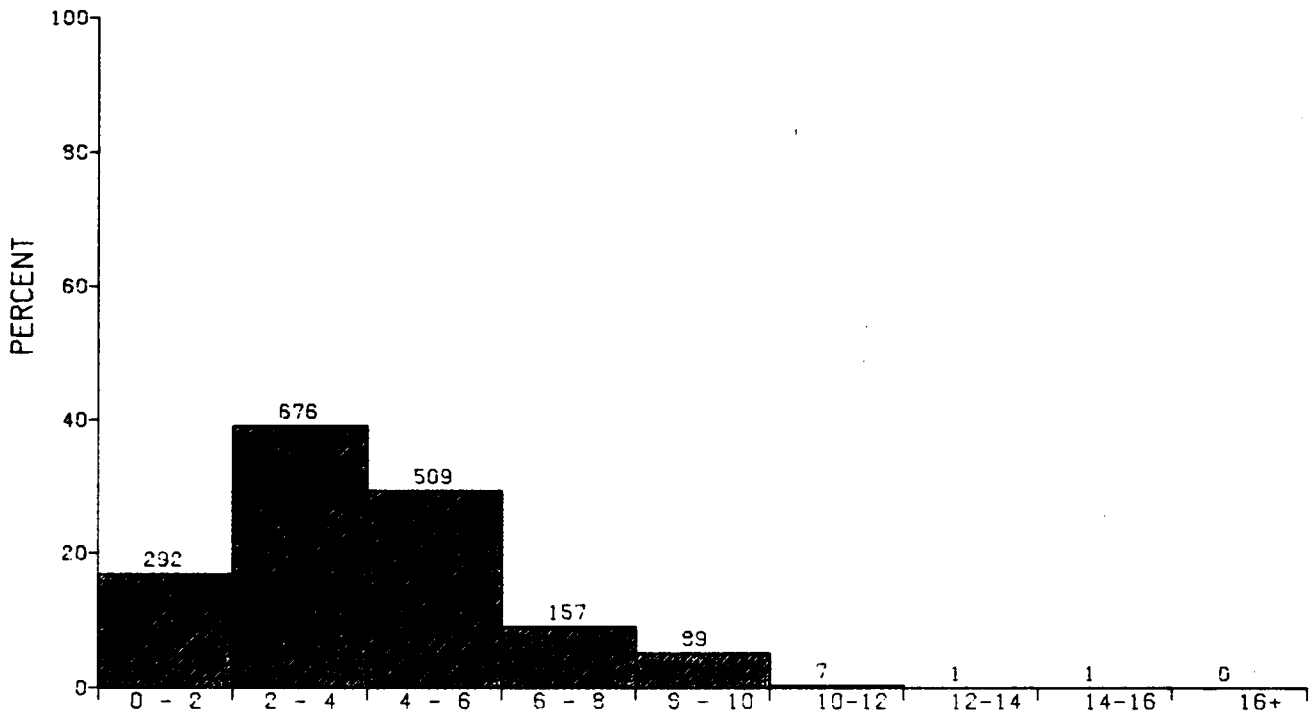

DISTRIBUTION OF WIND SPEED IN METERS PER SECOND

GEOS DATA- SEPTEMBER

EASTERN GULF OF MEXICO

N = 1732. MEAN = 3.96 SIGMA = 2.06

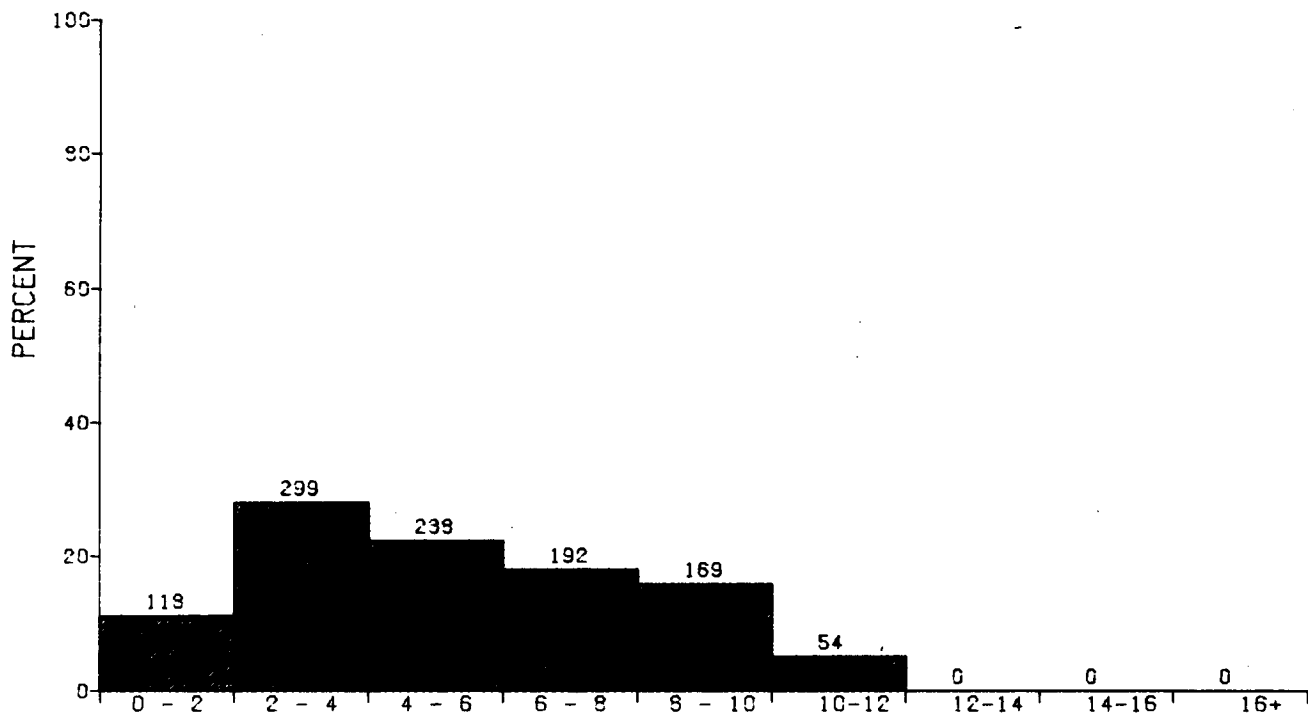

DISTRIBUTION OF WIND SPEED IN METERS PER SECOND

GEOS DATA- SEPTEMBER

WESTERN GULF OF MEXICO

N = 1070. MEAN = 5.34 SIGMA = 2.8

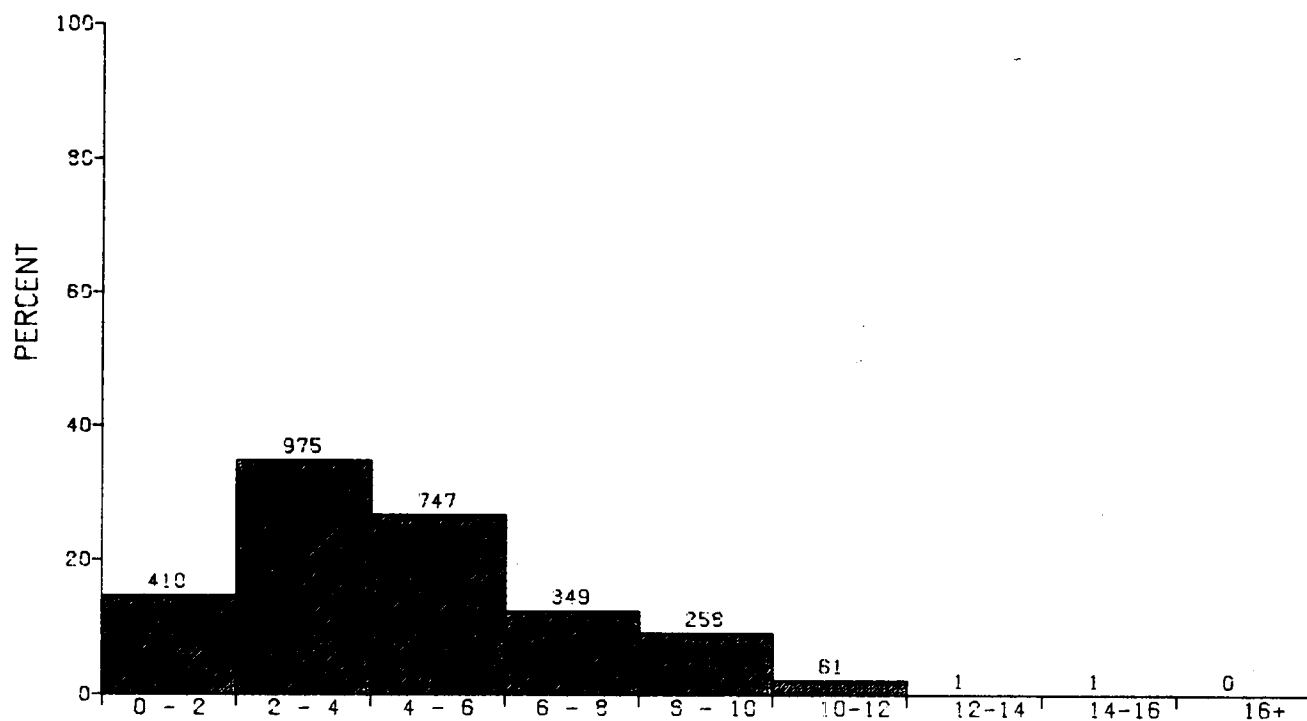

DISTRIBUTION OF WIND SPEED IN METERS PER SECOND
 GEOS DATA-- SEPTEMBER
 ENTIRE GULF OF MEXICO

N = 2802. MEAN = 4.49 SIGMA = 2.5

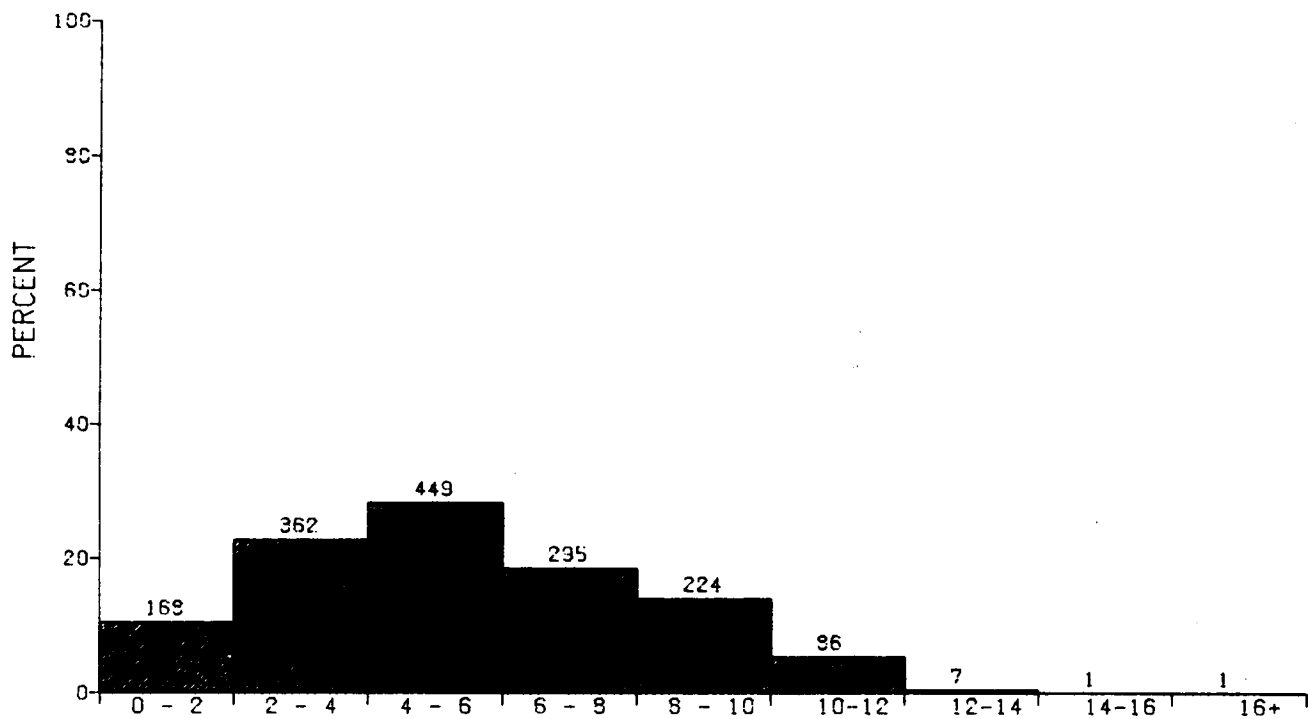

DISTRIBUTION OF WIND SPEED IN METERS PER SECOND

GEOS DATA-- OCTOBER

EASTERN GULF OF MEXICO

N = 1593. MEAN = 5.45 SIGMA = 2.74

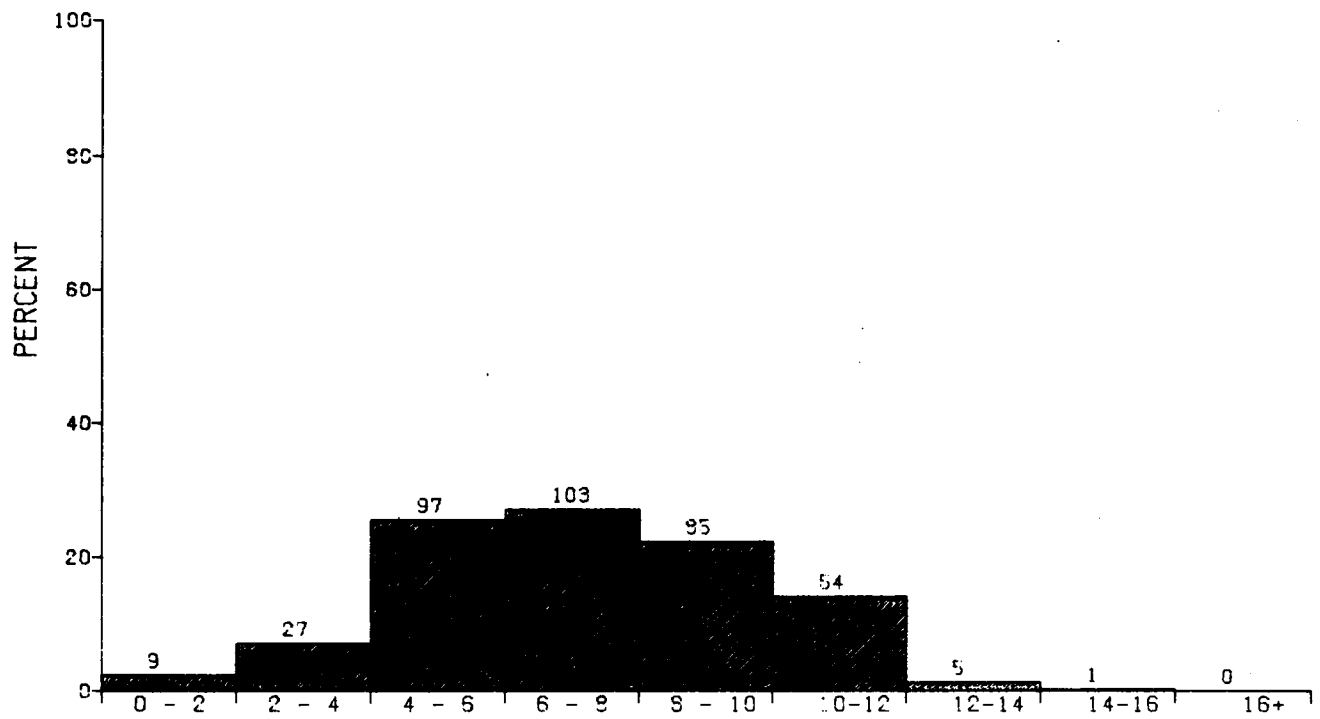

DISTRIBUTION OF WIND SPEED IN METERS PER SECOND

GEOS DATA- OCTOBER

WESTERN GULF OF MEXICO

N = 381.

MEAN = 7.20

SIGMA = 2.5

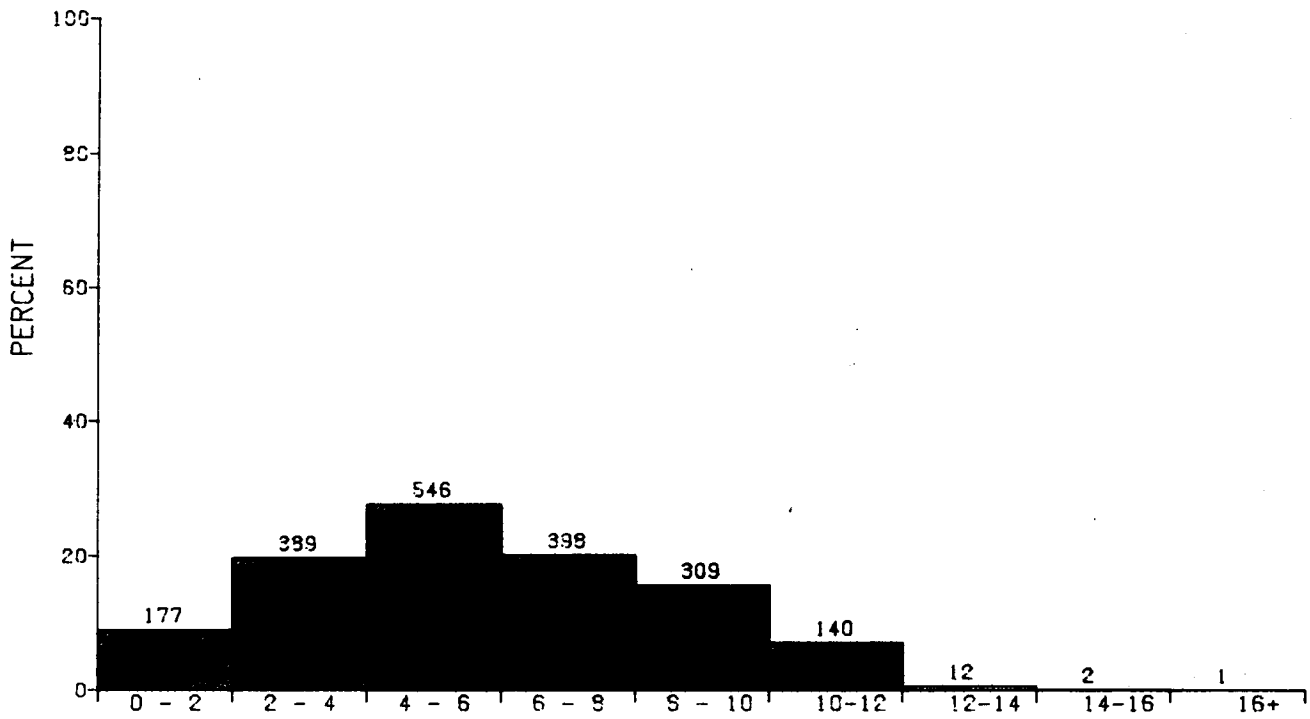

DISTRIBUTION OF WIND SPEED IN METERS PER SECOND

GEOS DATA-- OCTOBER

ENTIRE GULF OF MEXICO

N = 1974.

MEAN = 5.79

SIGMA = 2.8

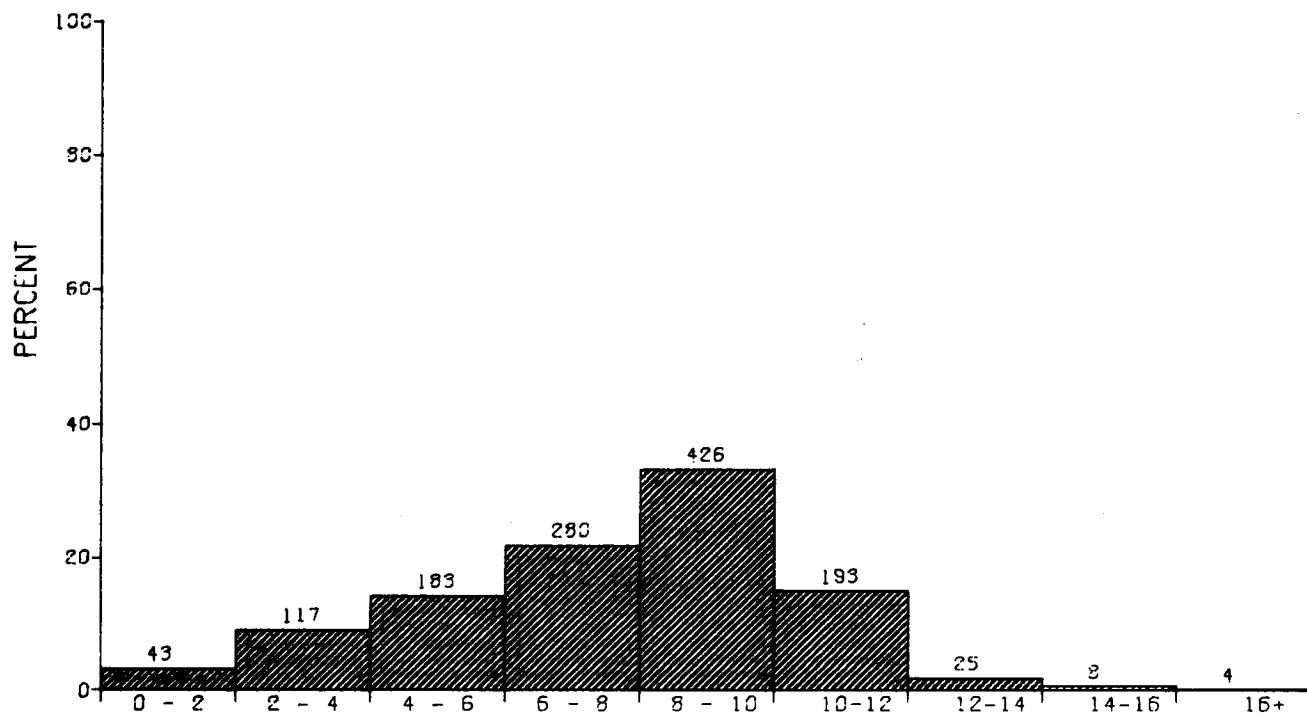

DISTRIBUTION OF WIND SPEED IN METERS PER SECOND
 GEOS DATA- NOVEMBER
 EASTERN GULF OF MEXICO

N = 1279. MEAN = 7.67 SIGMA = 2.79

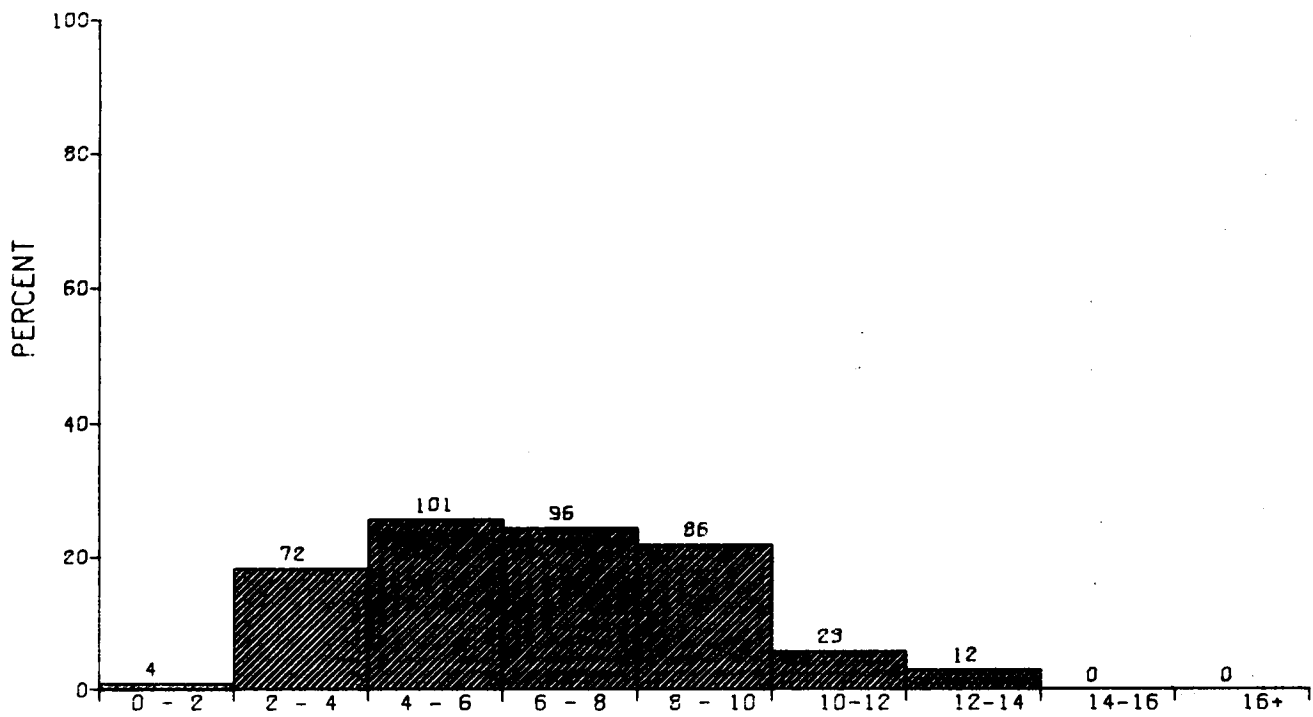

DISTRIBUTION OF WIND SPEED IN METERS PER SECOND

GEOS DATA- NOVEMBER

WESTERN GULF OF MEXICO

N = 394.

MEAN = 6.55

SIGMA = 2.7

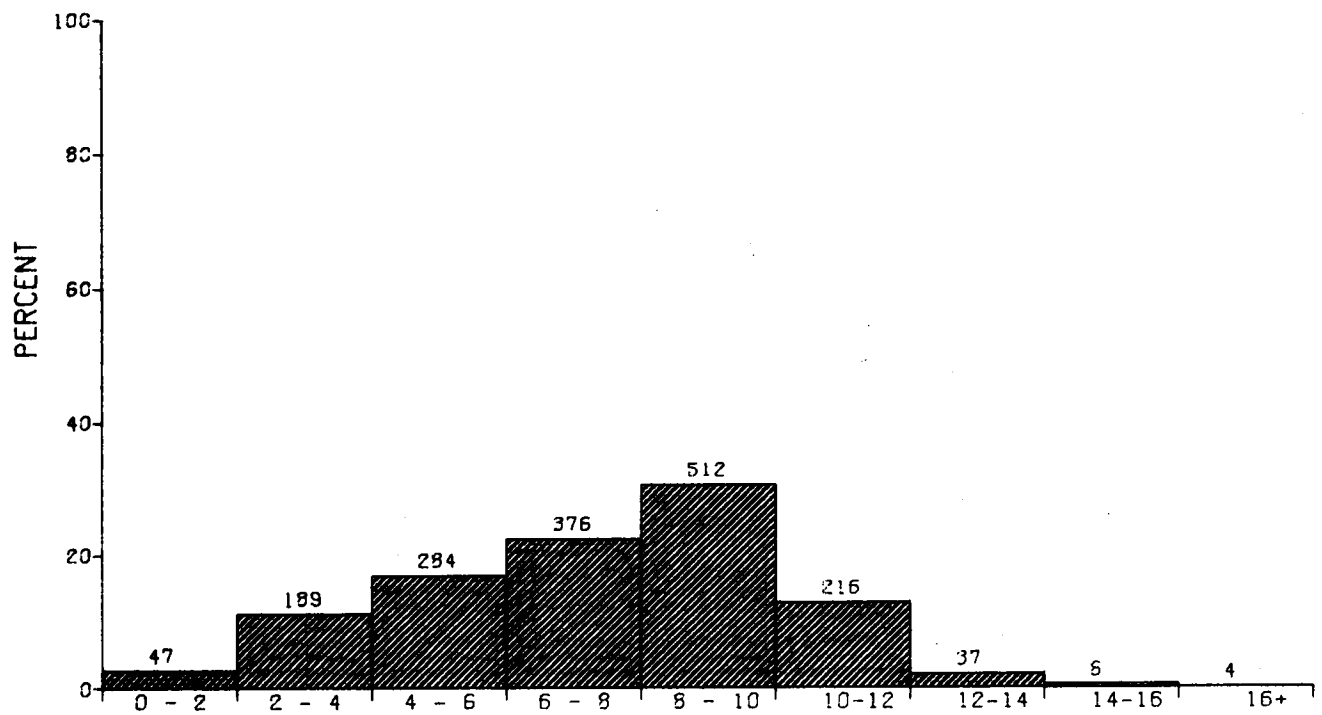

DISTRIBUTION OF WIND SPEED IN METERS PER SECOND
 GEOS DATA- NOVEMBER
 ENTIRE GULF OF MEXICO

N = 1673. MEAN = 7.40 SIGMA = 2.8

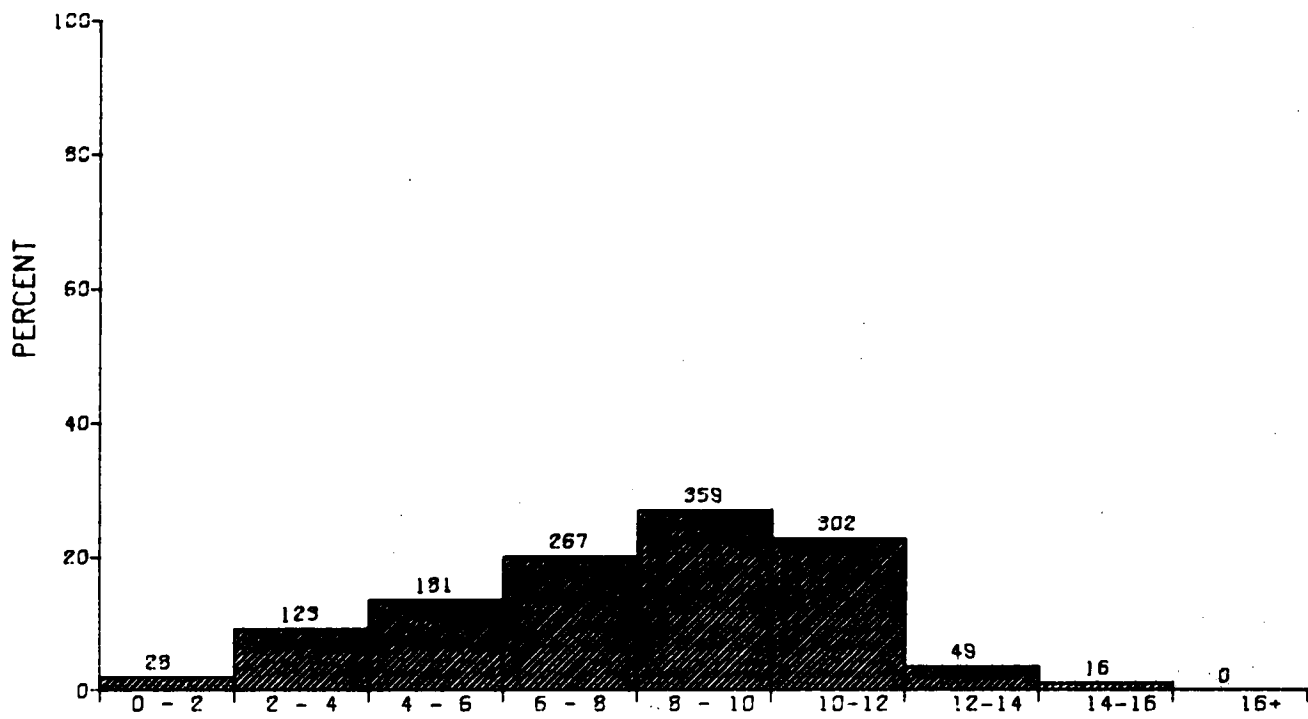

DISTRIBUTION OF WIND SPEED IN METERS PER SECOND
 GEOS DATA- DECEMBER
 EASTERN GULF OF MEXICO

N = 1325. MEAN = 8.03 SIGMA = 2.90

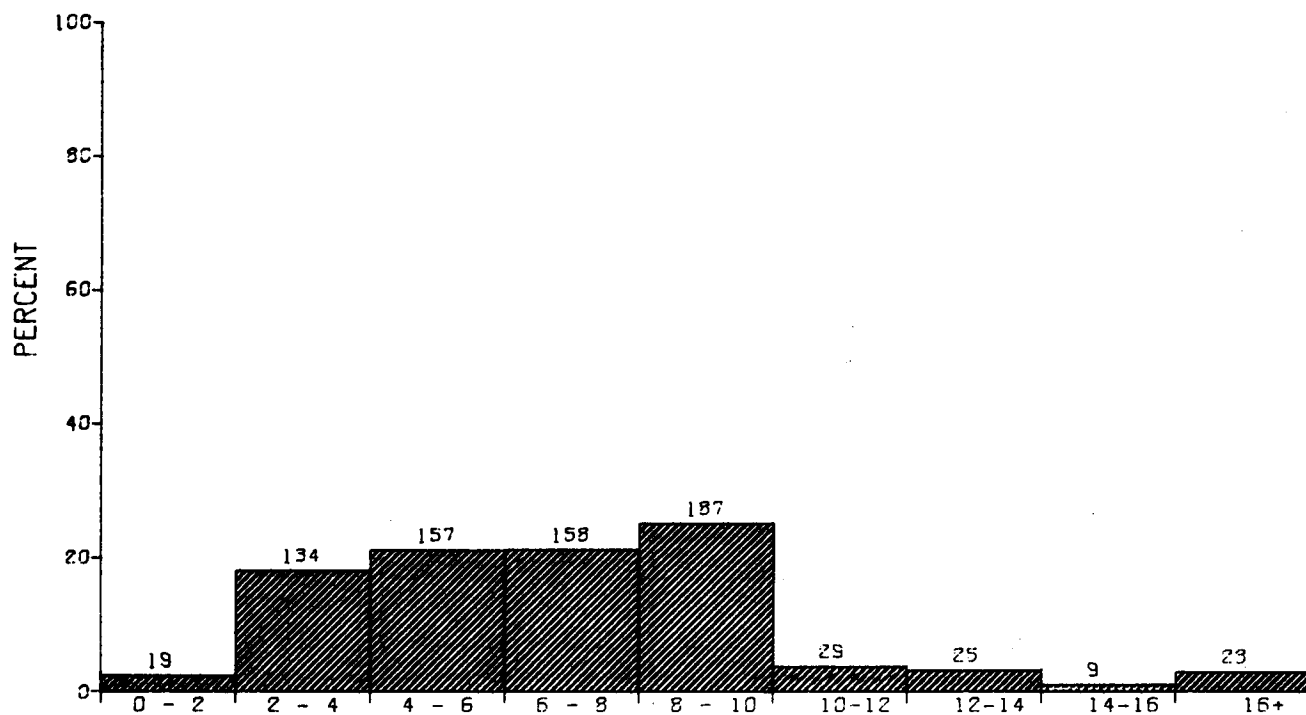

DISTRIBUTION OF WIND SPEED IN METERS PER SECOND

GEOS DATA- DECEMBER

WESTERN GULF OF MEXICO

N = 741.

MEAN = 7.05

SIGMA = 3.5

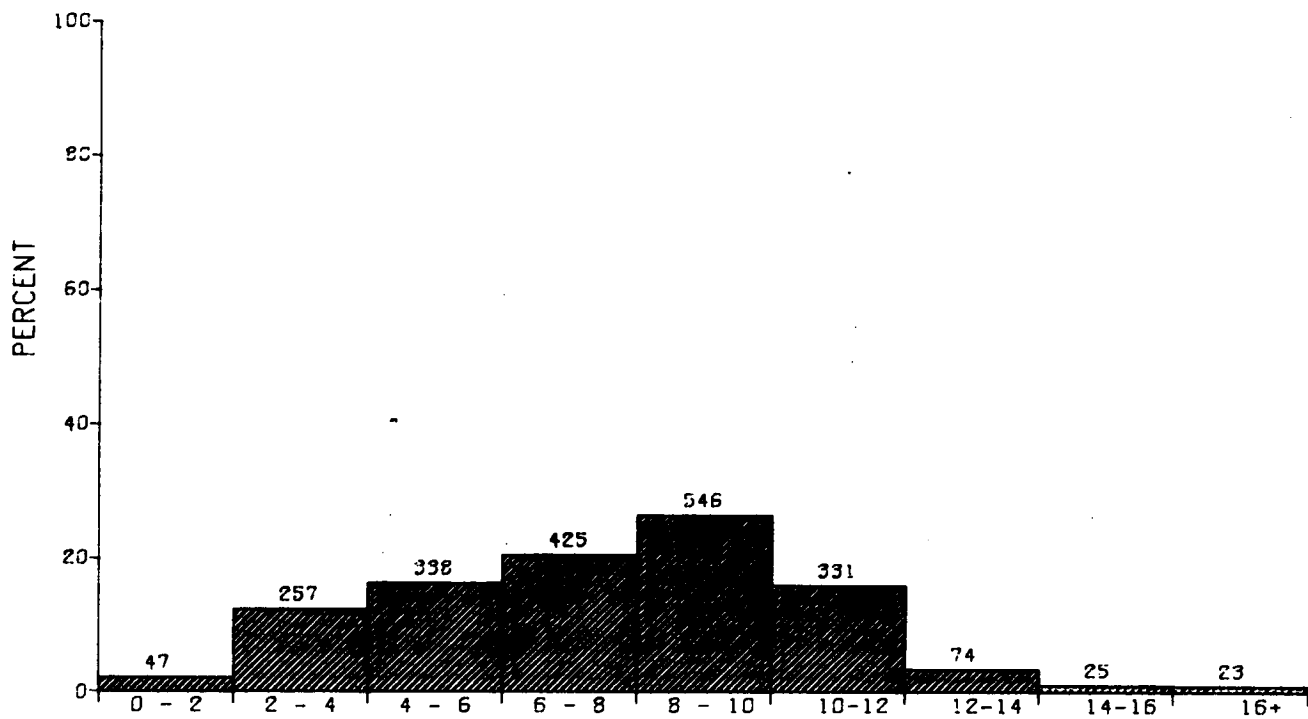

DISTRIBUTION OF WIND SPEED IN METERS PER SECOND
 GEOS DATA- DECEMBER
 ENTIRE GULF OF MEXICO

N = 2066. MEAN = 7.68 SIGMA = 3.2

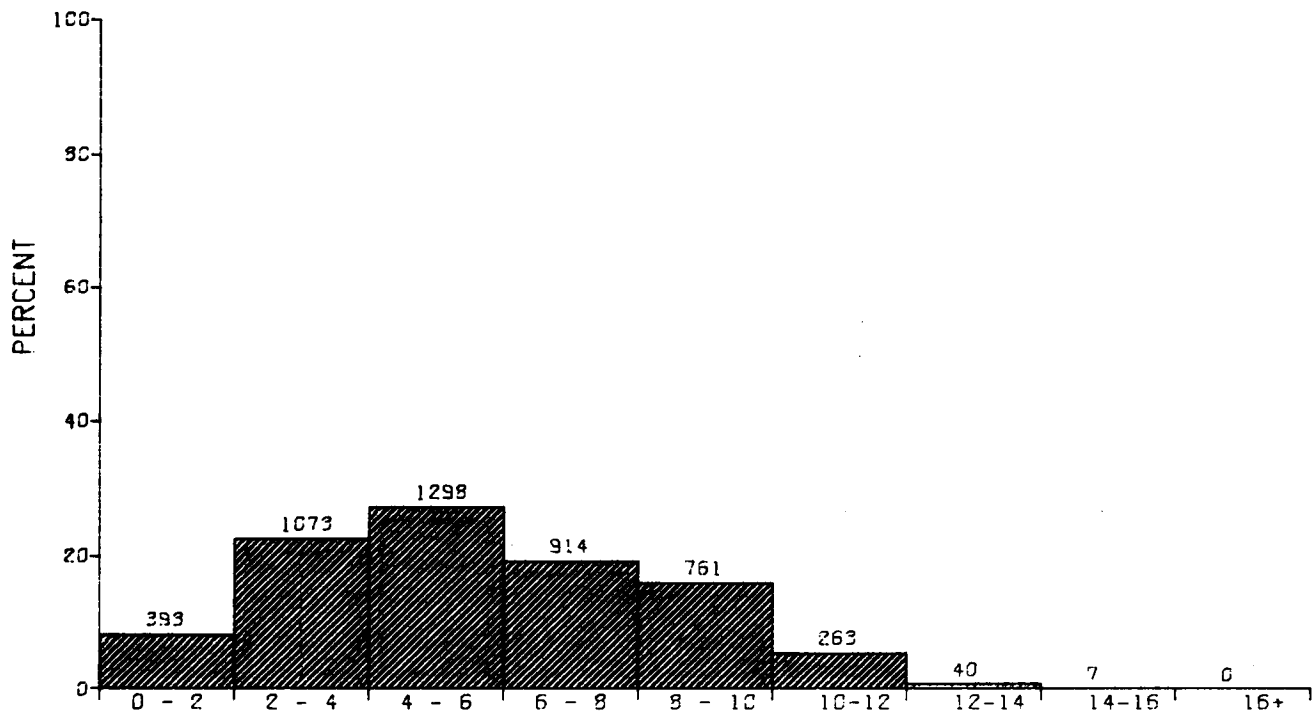

DISTRIBUTION OF WIND SPEED IN METERS PER SECOND
 GEOS DATA- SPRING
 EASTERN GULF OF MEXICO

N = 4749. MEAN = 5.69 SIGMA = 2.76

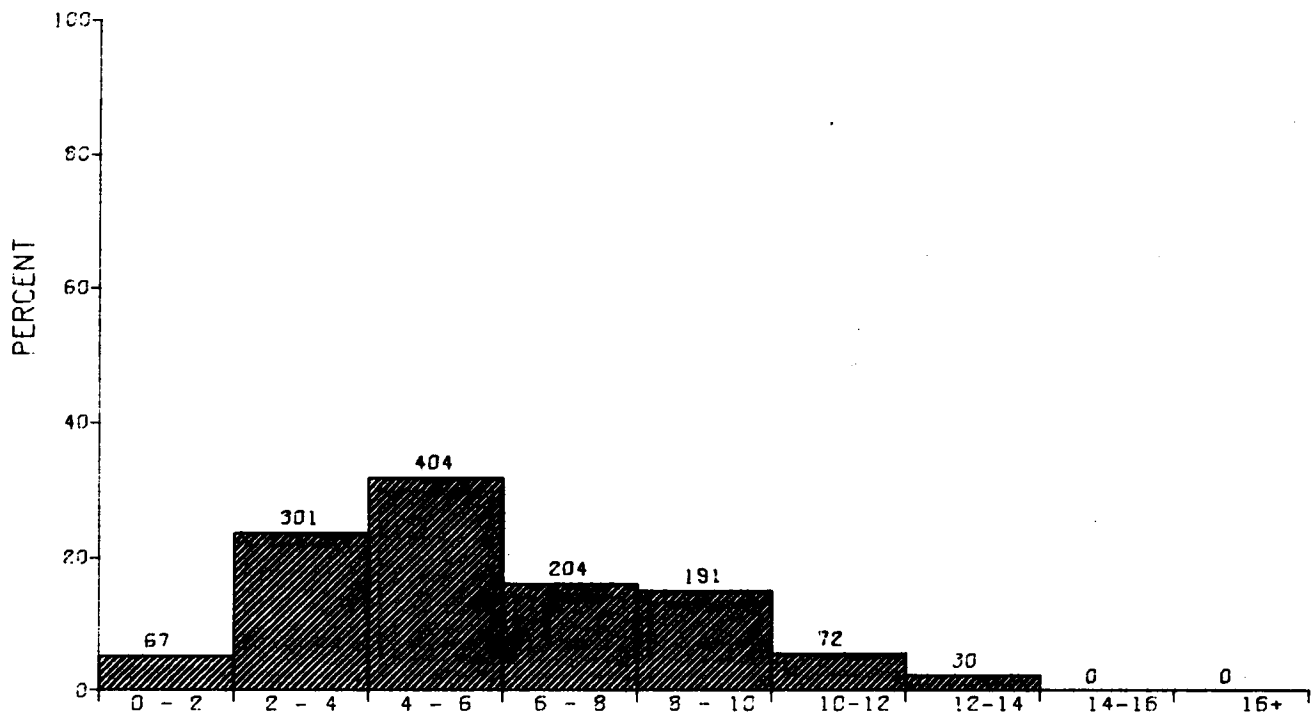

DISTRIBUTION OF WIND SPEED IN METERS PER SECOND

GEOS DATA- SPRING

WESTERN GULF OF MEXICO

N = 1269.

MEAN = 5.94

SIGMA = 2.8

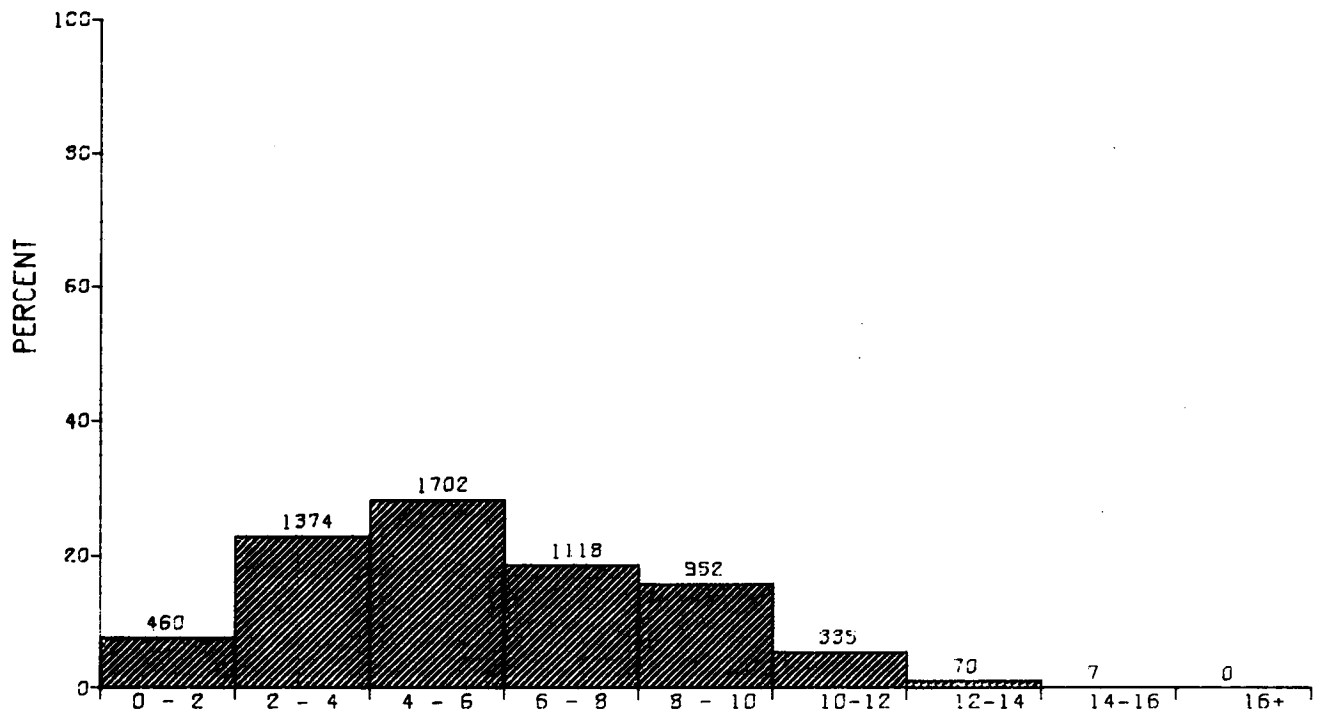

DISTRIBUTION OF WIND SPEED IN METERS PER SECOND

GEOS DATA- SPRING

ENTIRE GULF OF MEXICO

N = 6018.

MEAN = 5.72

SIGMA = 2.8

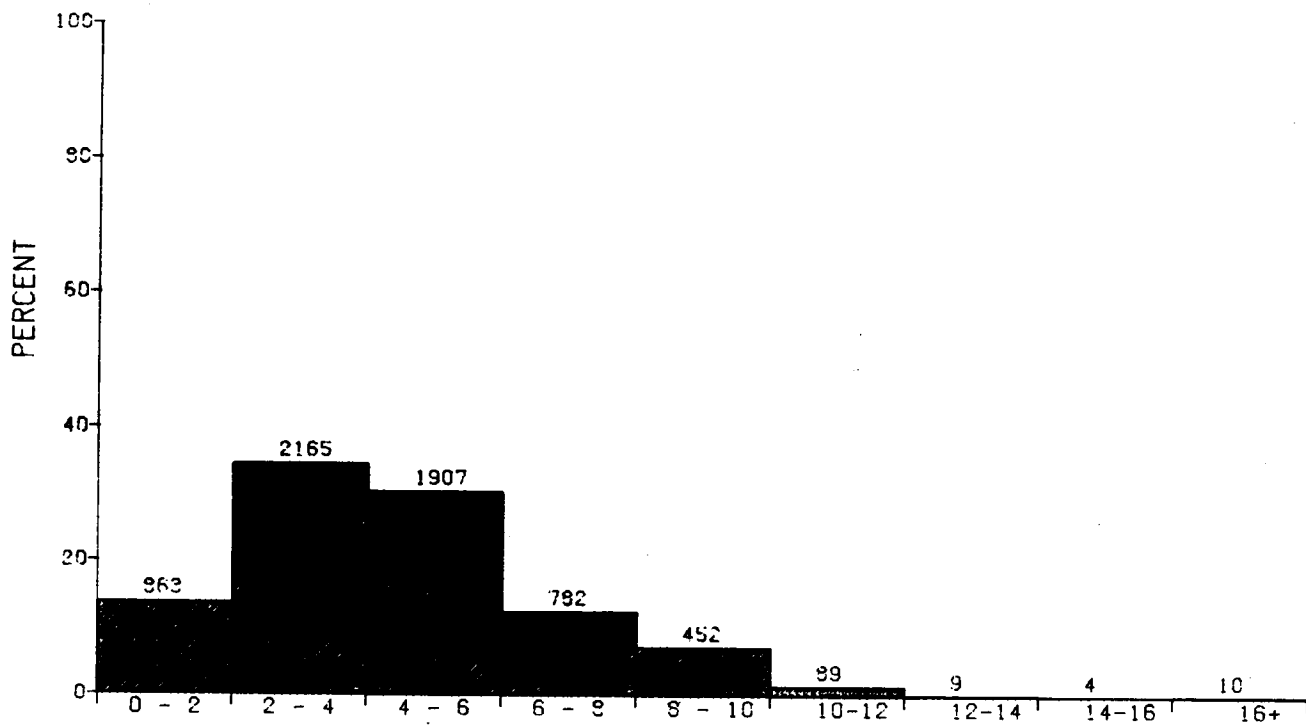

DISTRIBUTION OF WIND SPEED IN METERS PER SECOND

GEOS DATA- SUMMER

EASTERN GULF OF MEXICO

N = 6281. MEAN = 4.46 SIGMA = 2.44

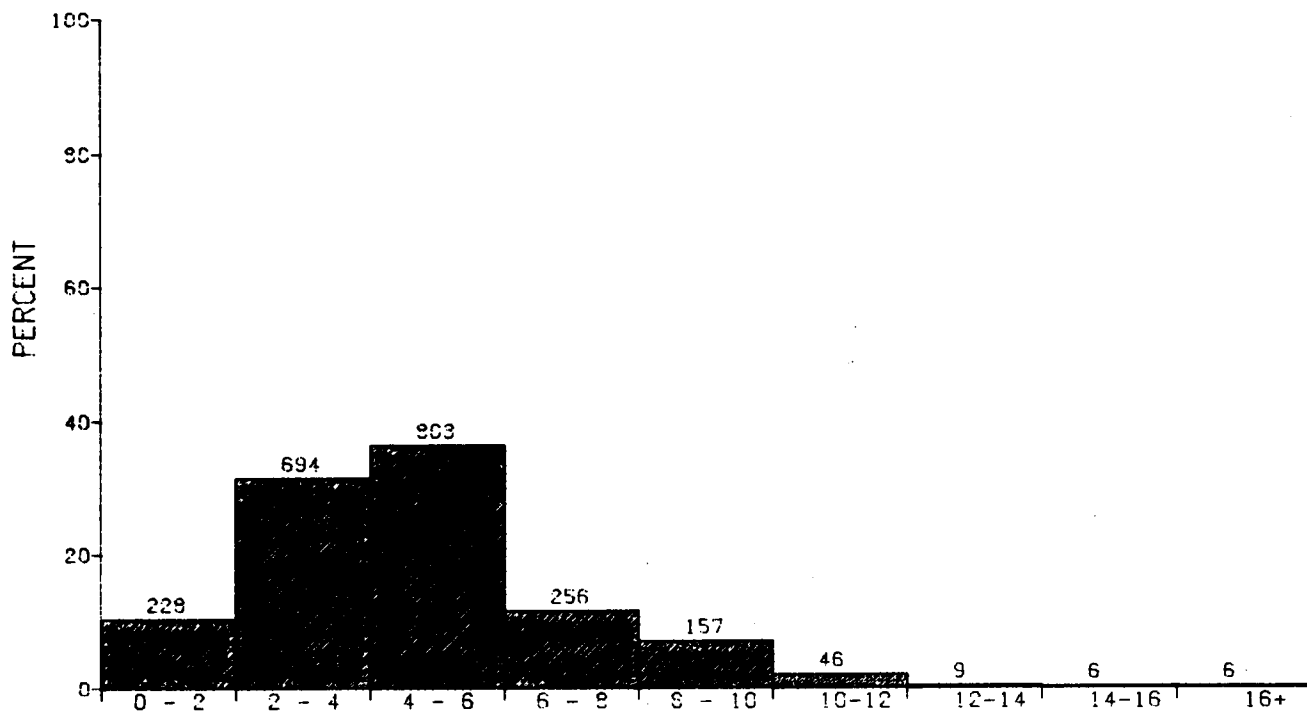

DISTRIBUTION OF WIND SPEED IN METERS PER SECOND

GEOS DATA- SUMMER

WESTERN GULF OF MEXICO

N = 2205. MEAN = 4.71 SIGMA = 2.4

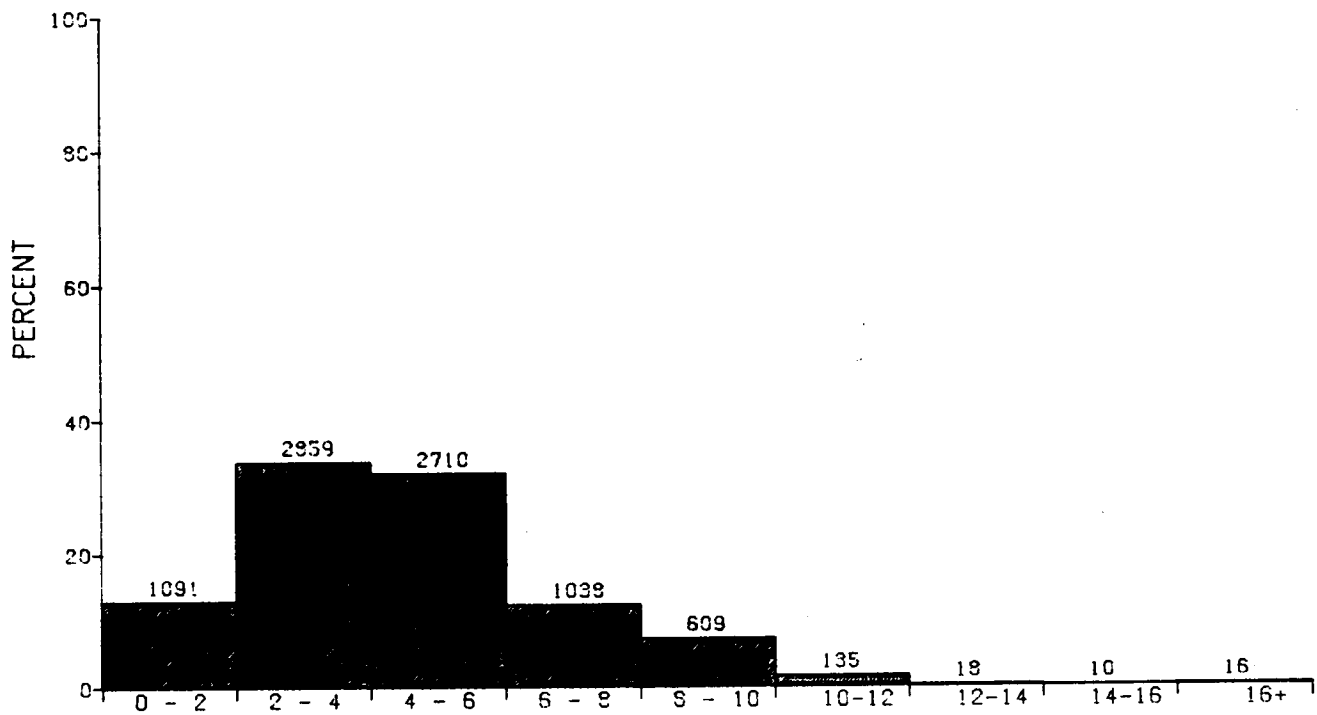

DISTRIBUTION OF WIND SPEED IN METERS PER SECOND
 GEOS DATA- SUMMER
 ENTIRE GULF OF MEXICO

N = 8486 . MEAN = 4.52 SIGMA = 2.4

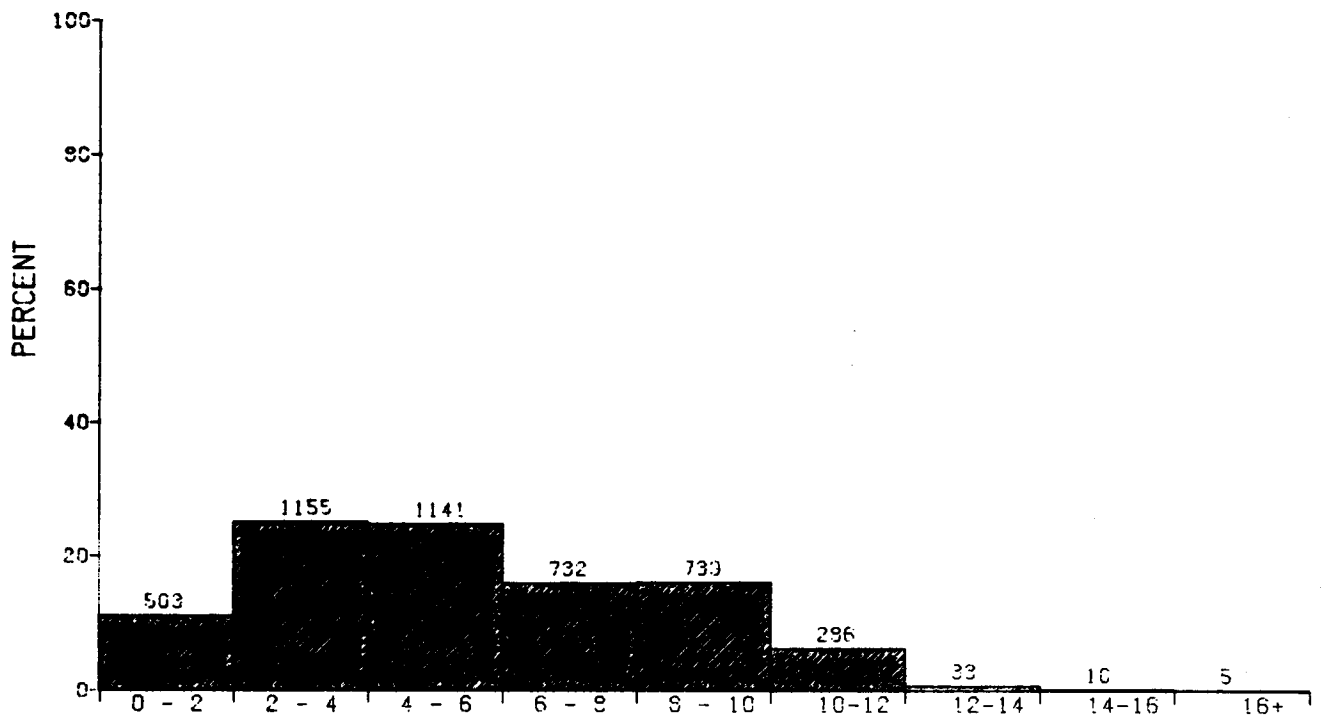

DISTRIBUTION OF WIND SPEED IN METERS PER SECOND

GEOS DATA- FALL

EASTERN GULF OF MEXICO

N = 4604. MEAN = 5.51 SIGMA = 2.92

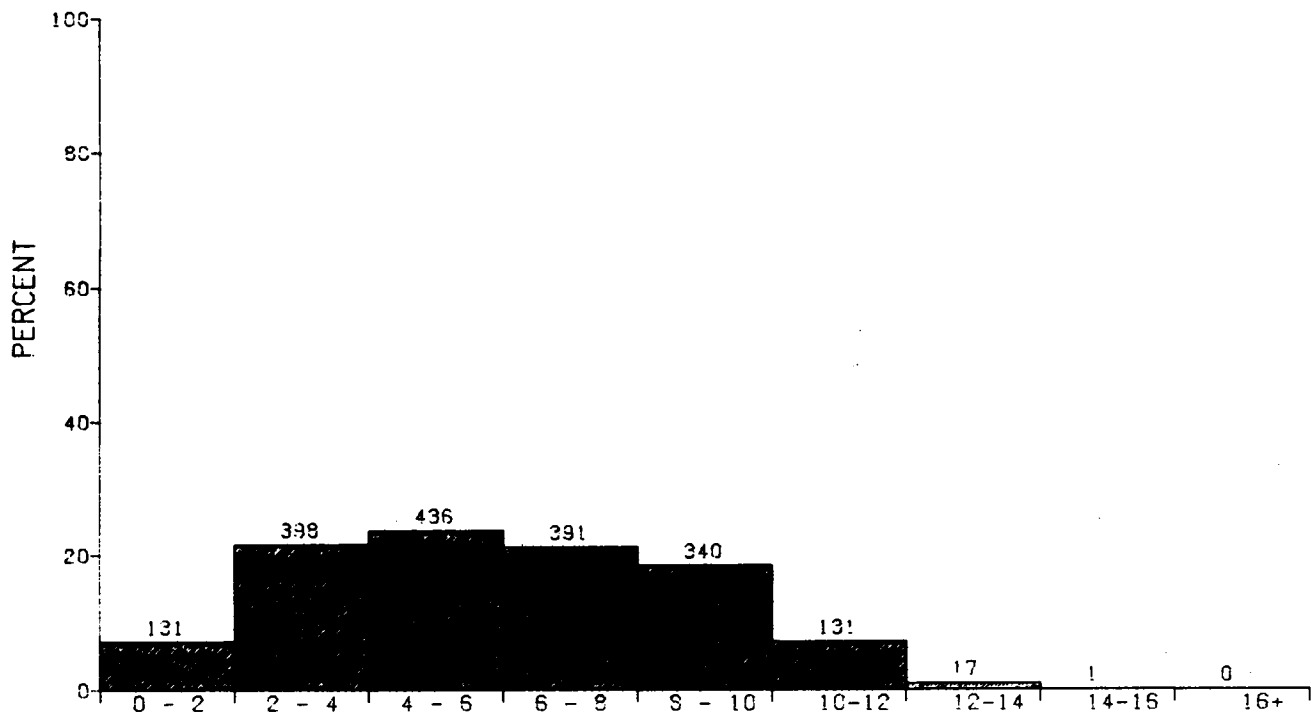

DISTRIBUTION OF WIND SPEED IN METERS PER SECOND

GEOS DATA - FALL

WESTERN GULF OF MEXICO

N = 1845. MEAN = 5.99 SIGMA = 2.8

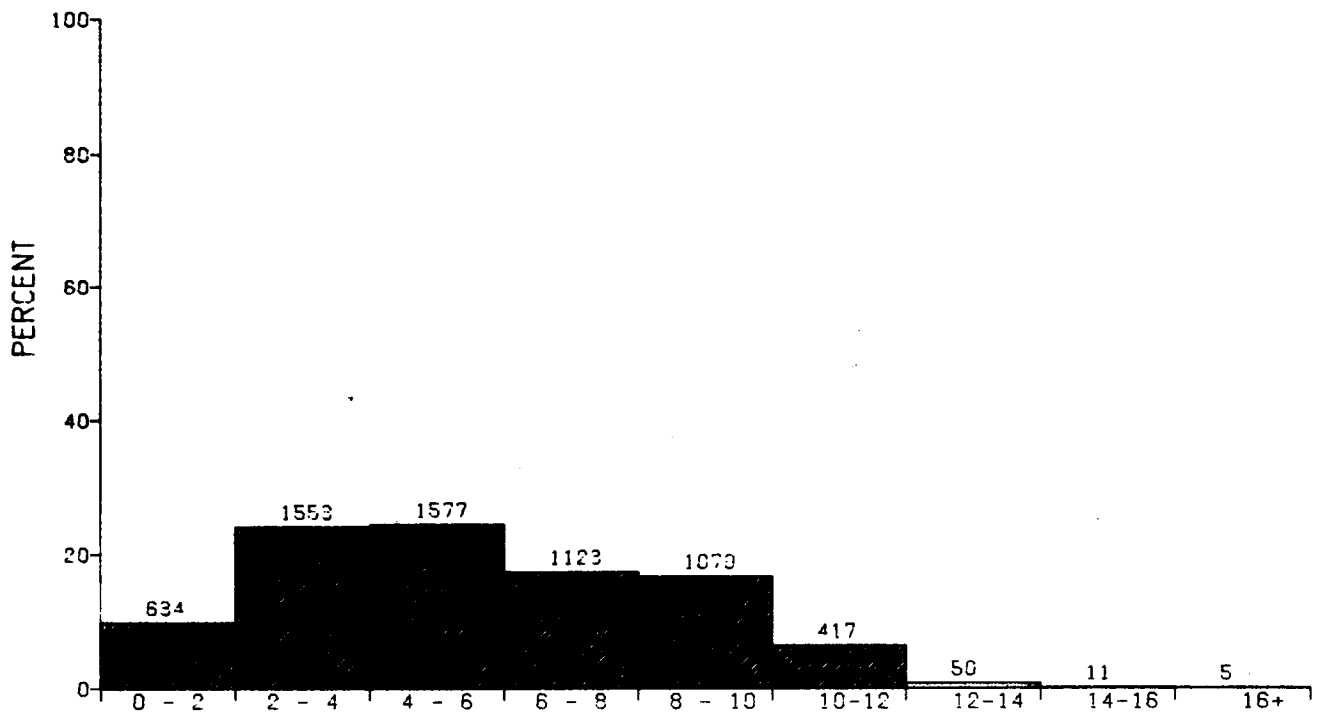

DISTRIBUTION OF WIND SPEED IN METERS PER SECOND

GEOS DATA- FALL

ENTIRE GULF OF MEXICO

N = 6449. MEAN = 5.64 SIGMA = 2.9

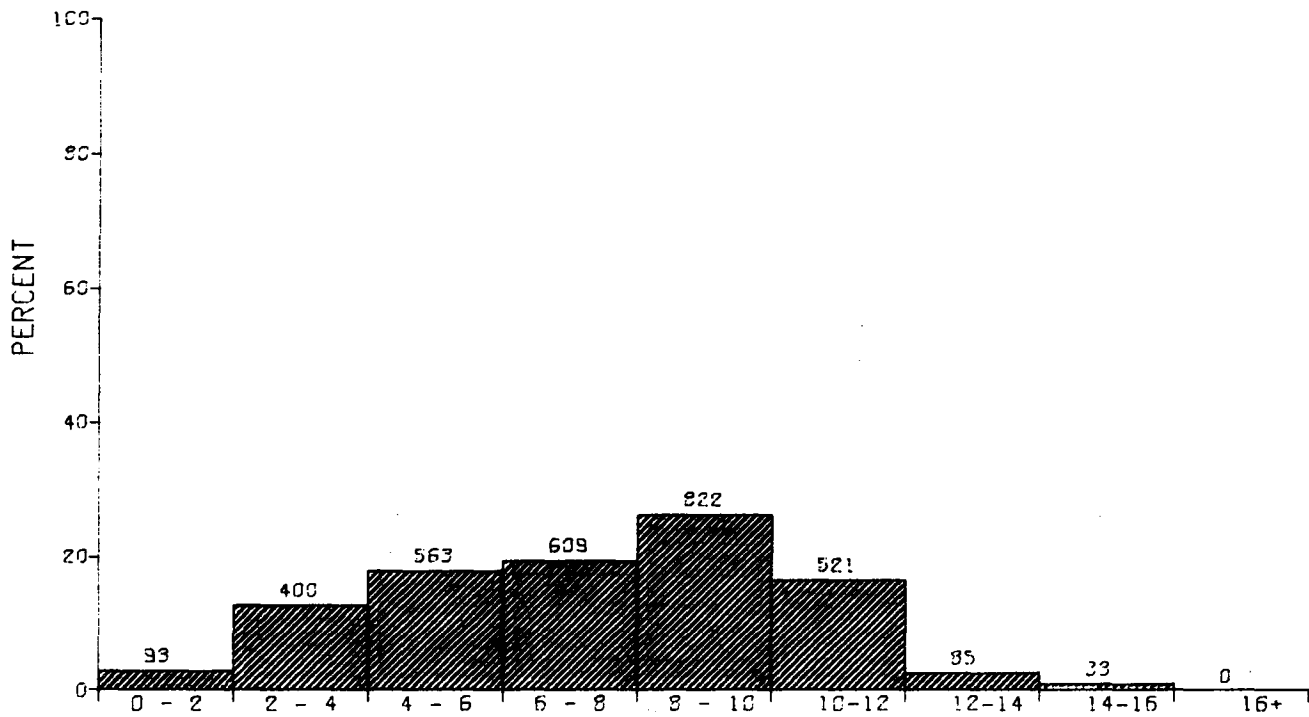

DISTRIBUTION OF WIND SPEED IN METERS PER SECOND
 GEOS DATA- WINTER
 EASTERN GULF OF MEXICO

N = 3126. MEAN = 7.42 SIGMA = 2.96

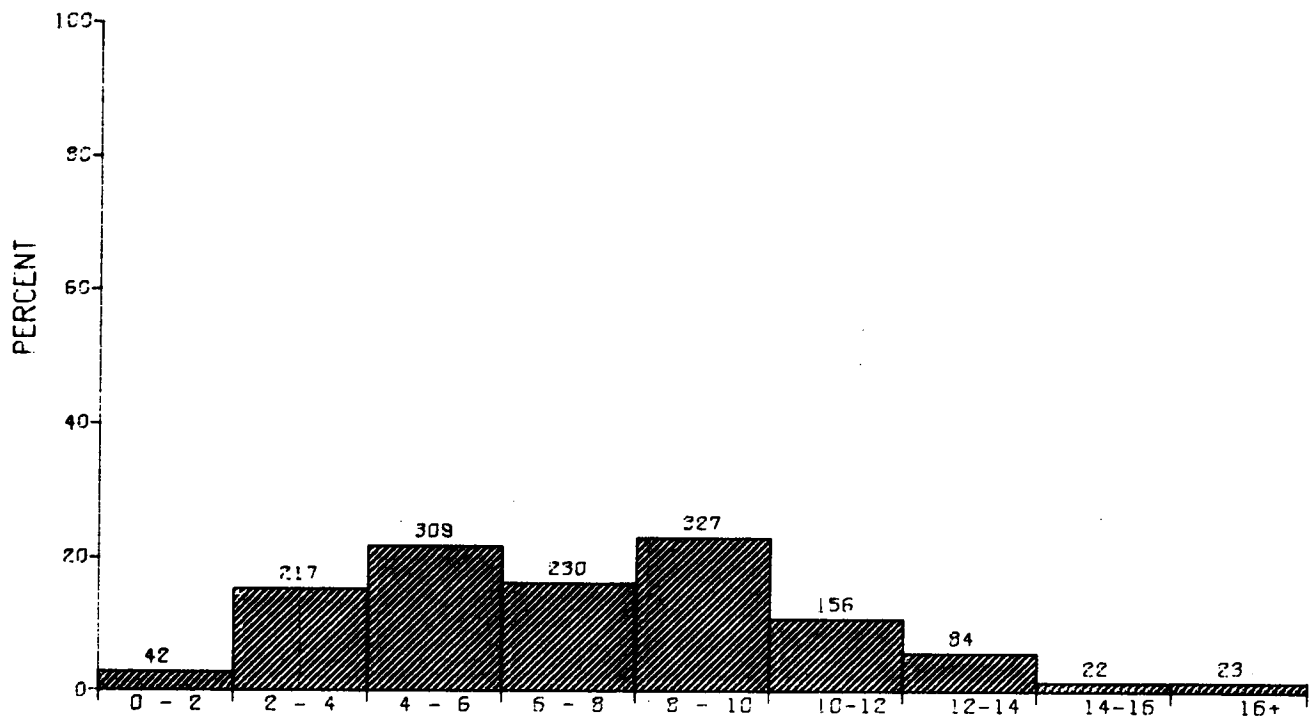

DISTRIBUTION OF WIND SPEED IN METERS PER SECOND
 GEOS DATA- WINTER
 WESTERN GULF OF MEXICO

N = 1410. MEAN = 7.36 SIGMA = 3.5

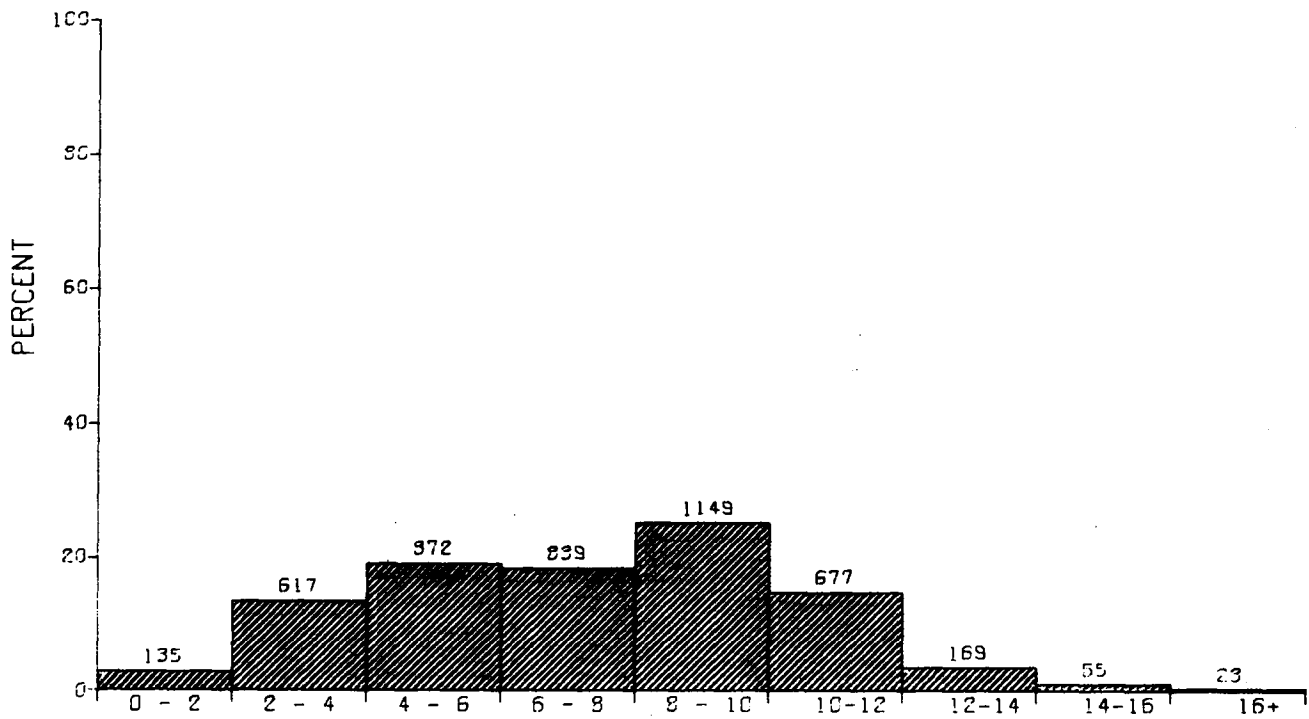

DISTRIBUTION OF WIND SPEED IN METERS PER SECOND
 GEOS DATA- WINTER
 ENTIRE GULF OF MEXICO

N = 4536. MEAN = 7.40 SIGMA = 3.1

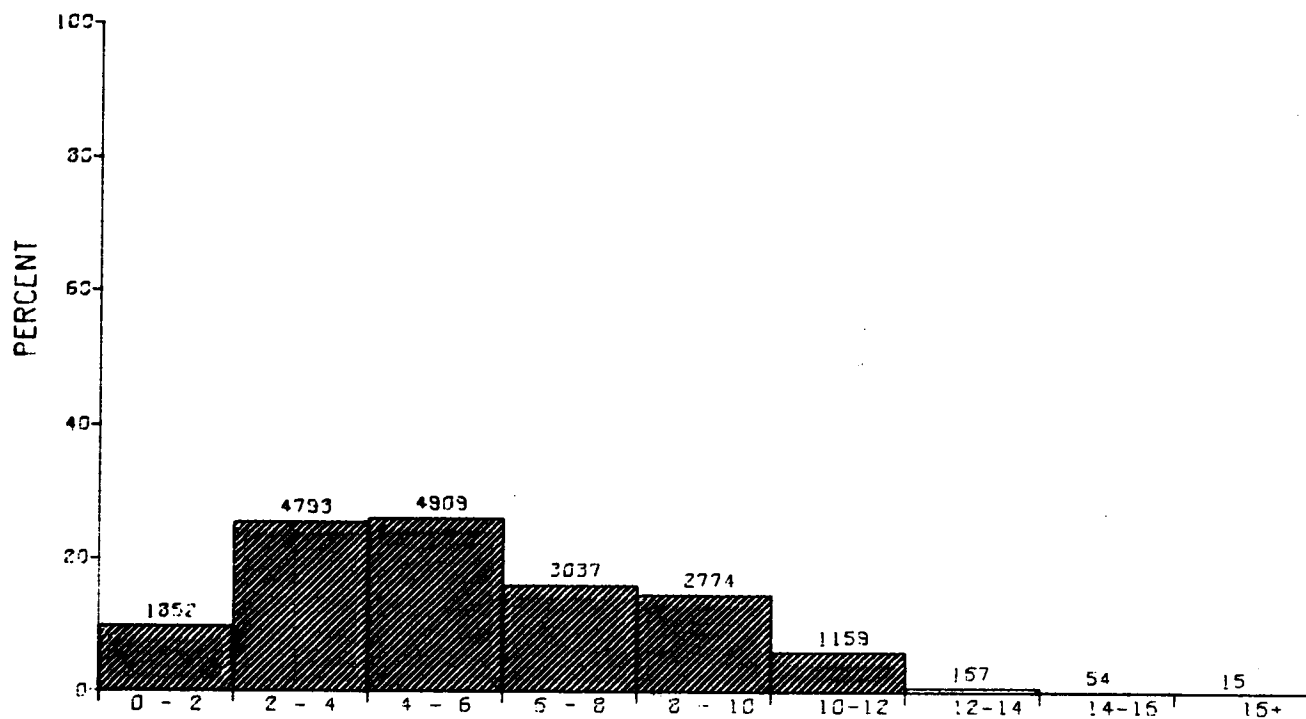

DISTRIBUTION OF WIND SPEED IN METERS PER SECOND
 ALL GEOS DATA
 EASTERN GULF OF MEXICO

N = 18760. MEAN = 5.52 SIGMA = 2.91

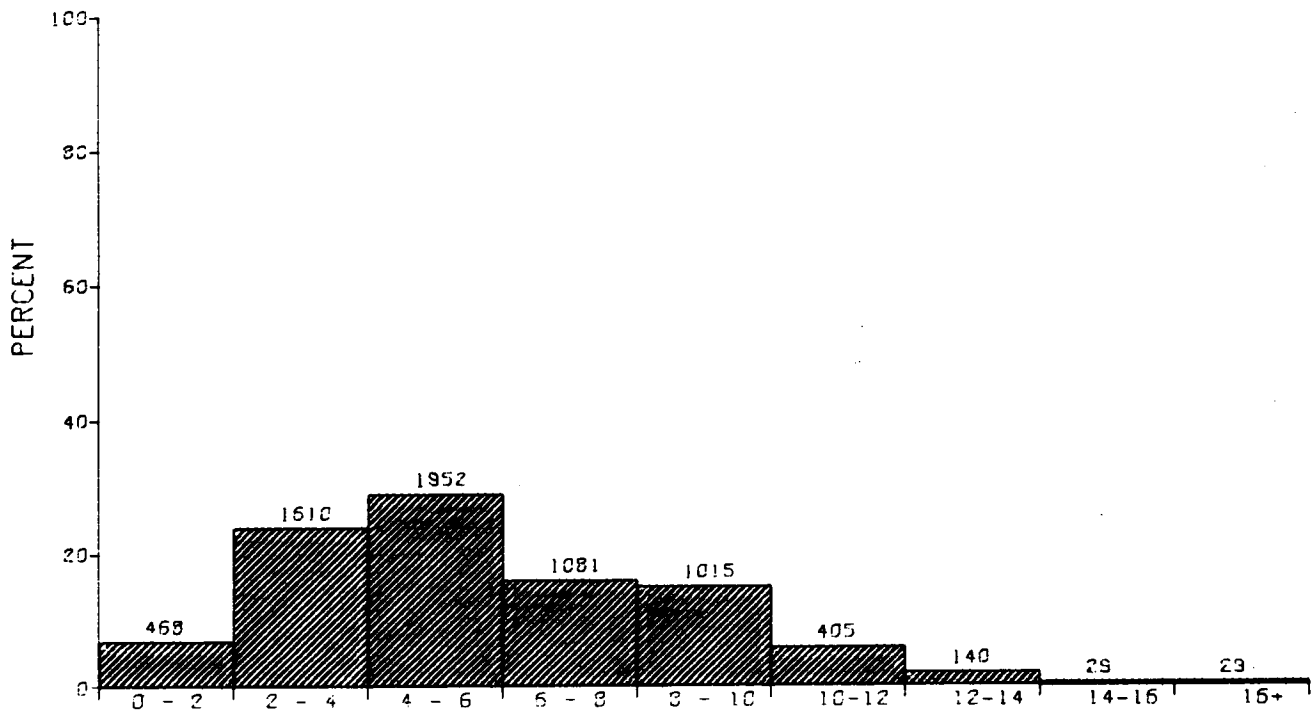

DISTRIBUTION OF WIND SPEED IN METERS PER SECOND
 ALL GEOS DATA
 WESTERN GULF OF MEXICO

N = 6729. MEAN = 5.83 SIGMA = 3.0

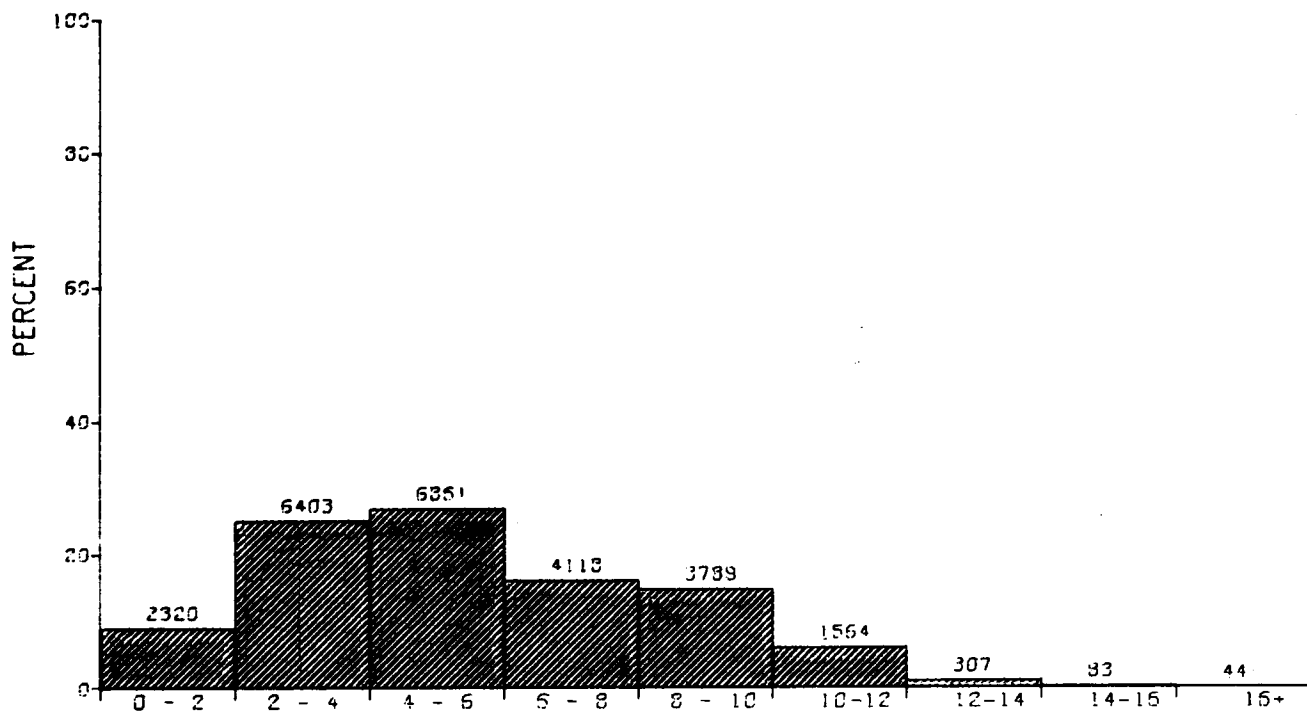

DISTRIBUTION OF WIND SPEED IN METERS PER SECOND

ALL GEOS DATA

ENTIRE GULF OF MEXICO

N = 25489. MEAN = 5.60 SIGMA = 2.9

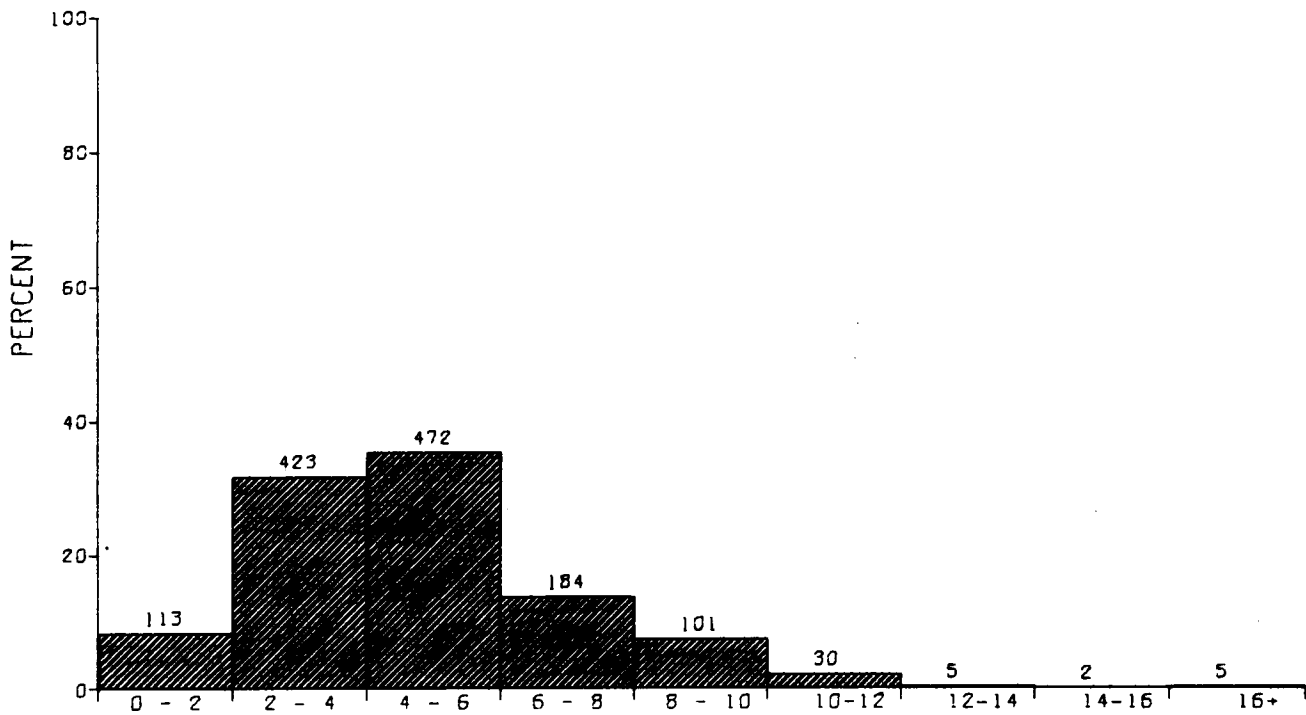

DISTRIBUTION OF WIND SPEED IN METERS PER SECOND

GEOS DATA- JULY 1978

EASTERN GULF OF MEXICO

N = 1335.

MEAN = 4.86

SIGMA = 2.44

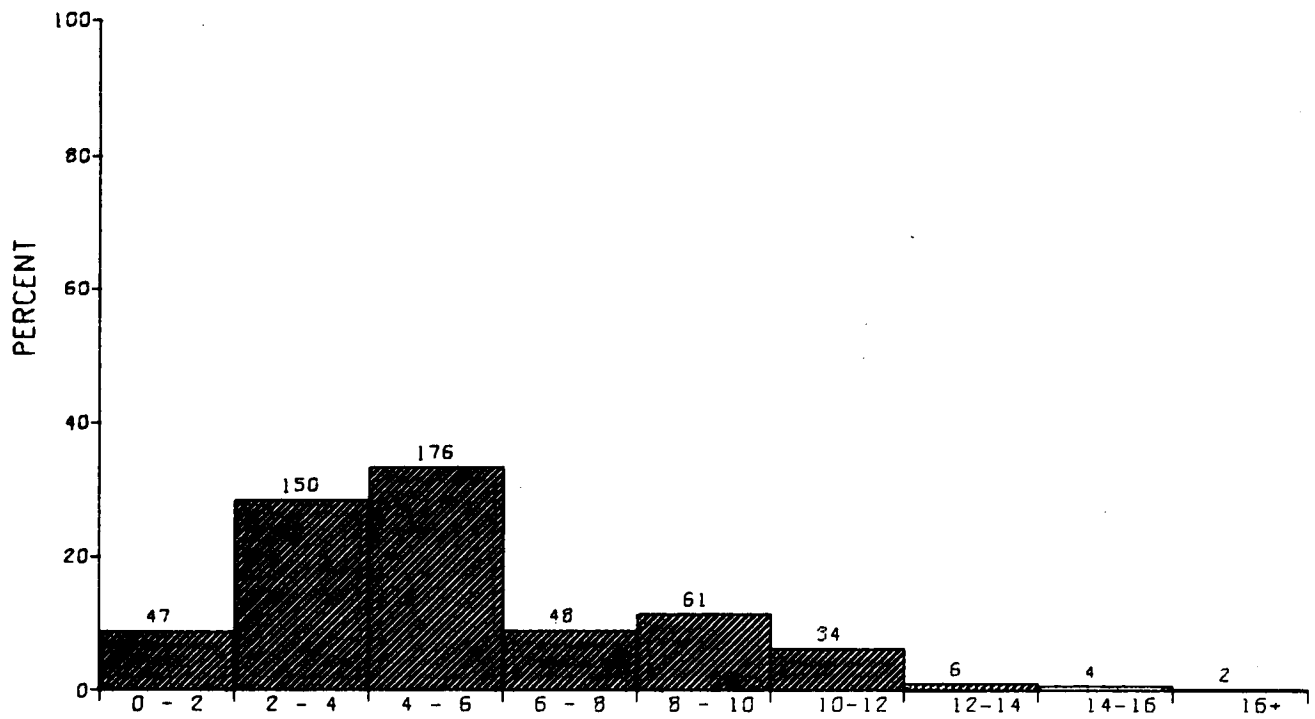

DISTRIBUTION OF WIND SPEED IN METERS PER SECOND
 GEOS DATA- JULY 1978
 WESTERN GULF OF MEXICO

N = 528. MEAN = 5.30 SIGMA = 3.0

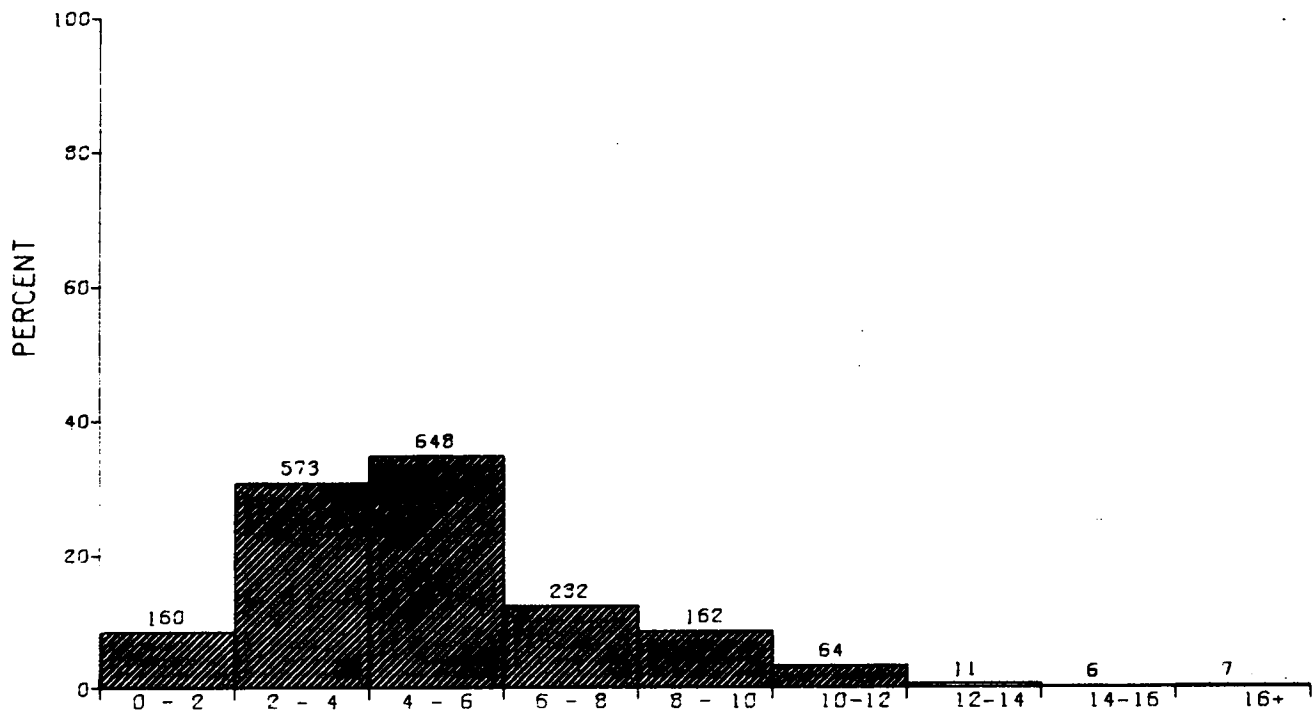

DISTRIBUTION OF WIND SPEED IN METERS PER SECOND

GEOS DATA- JULY 1978

ENTIRE GULF OF MEXICO

N = 1863. MEAN = 4.99 SIGMA = 2.6



DISTRIBUTION OF WIND SPEED IN METERS PER SECOND

GEOS DATA-- AUGUST 1978

EASTERN GULF OF MEXICO

N = 1262.

MEAN = 4.65

SIGMA = 2.48

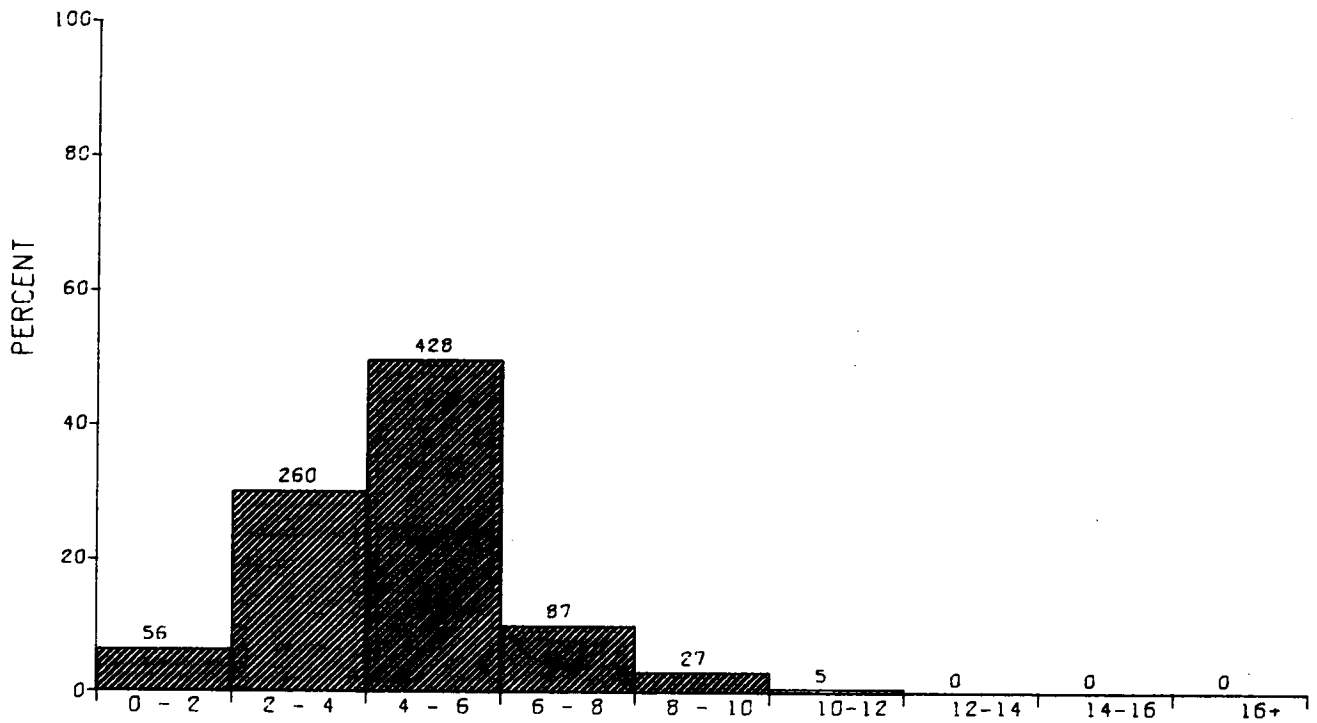

DISTRIBUTION OF WIND SPEED IN METERS PER SECOND

GEOS DATA- AUGUST 1978

WESTERN GULF OF MEXICO

N = 863.

MEAN = 4.50

SIGMA = 1.7

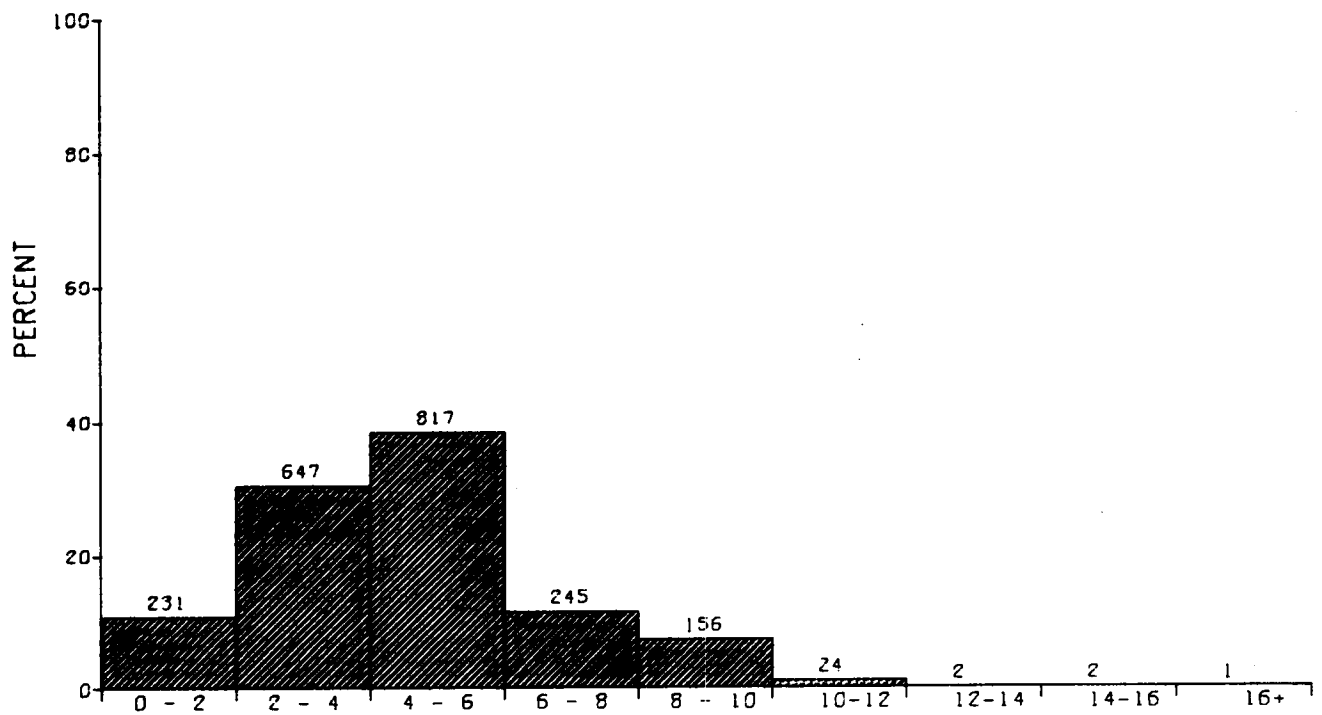

DISTRIBUTION OF WIND SPEED IN METERS PER SECOND

GEOS DATA- AUGUST 1978

ENTIRE GULF OF MEXICO

N = 2125. MEAN = 4.53 SIGMA = 2.2

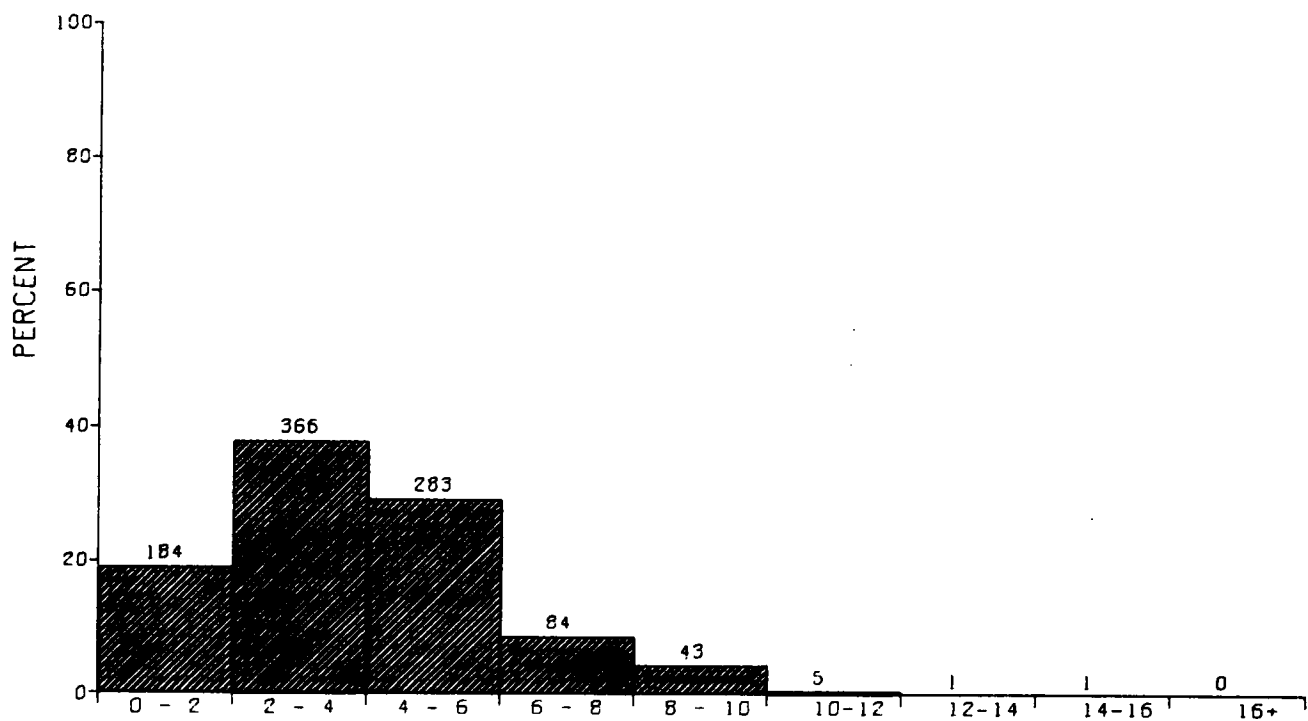

DISTRIBUTION OF WIND SPEED IN METERS PER SECOND

GEOS DATA-- SEPTEMBER 1978

EASTERN GULF OF MEXICO

N = 967.

MEAN = 3.88

SIGMA = 2.08

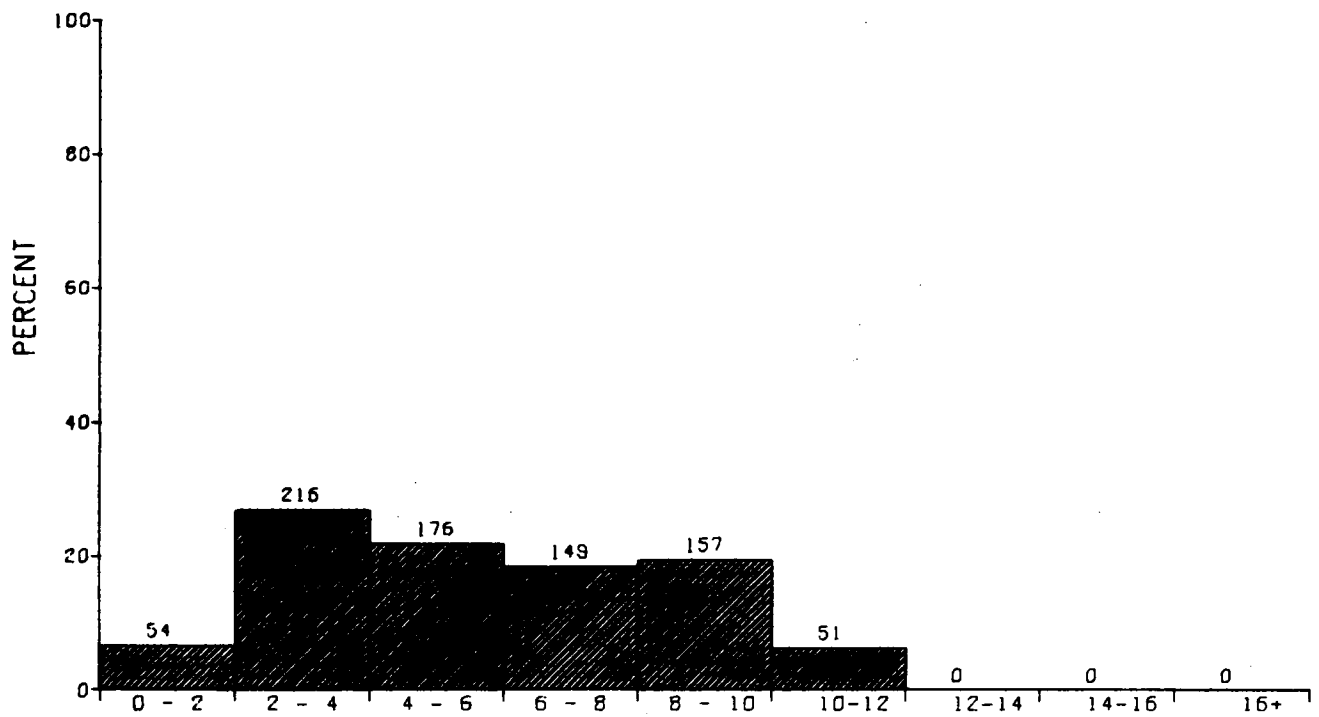

DISTRIBUTION OF WIND SPEED IN METERS PER SECOND
 GEOS DATA- SEPTEMBER 1978
 WESTERN GULF OF MEXICO

N = 803. MEAN = 5.76 SIGMA = 2.8

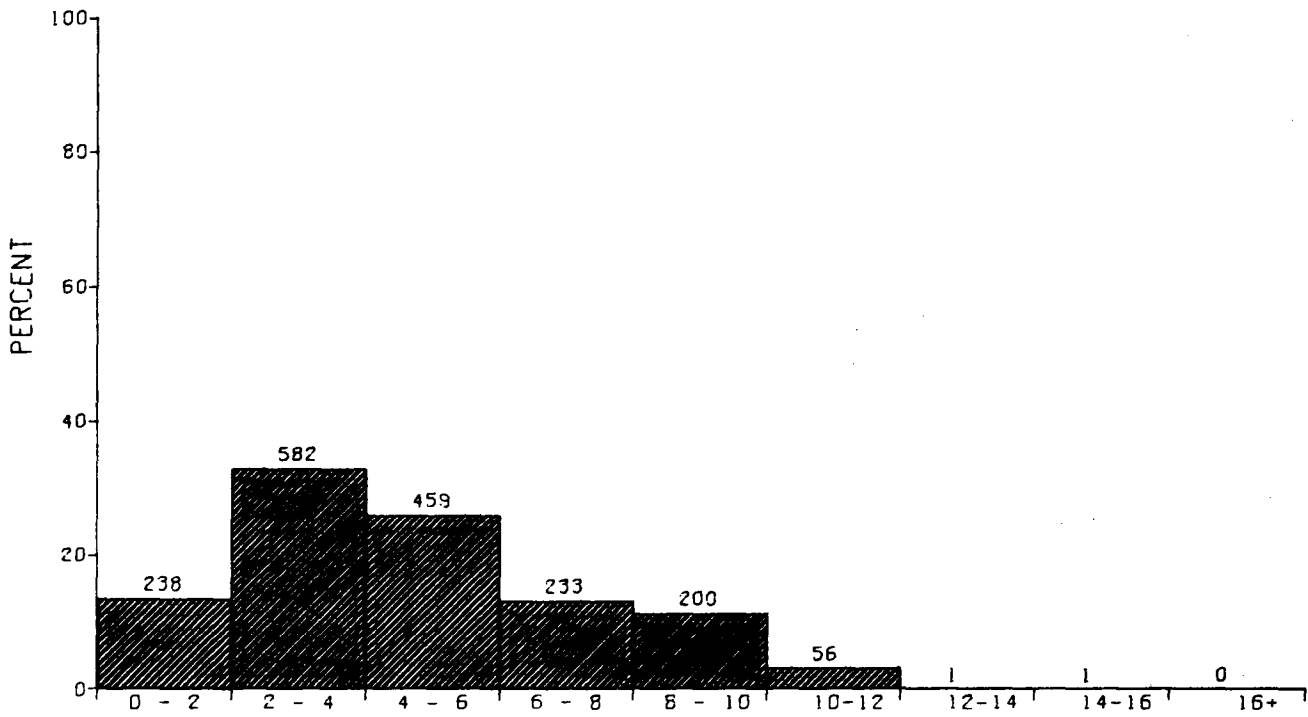

DISTRIBUTION OF WIND SPEED IN METERS PER SECOND

GEOS DATA-- SEPTEMBER 1978

ENTIRE GULF OF MEXICO

N = 1770.

MEAN = 4.73

SIGMA = 2.6

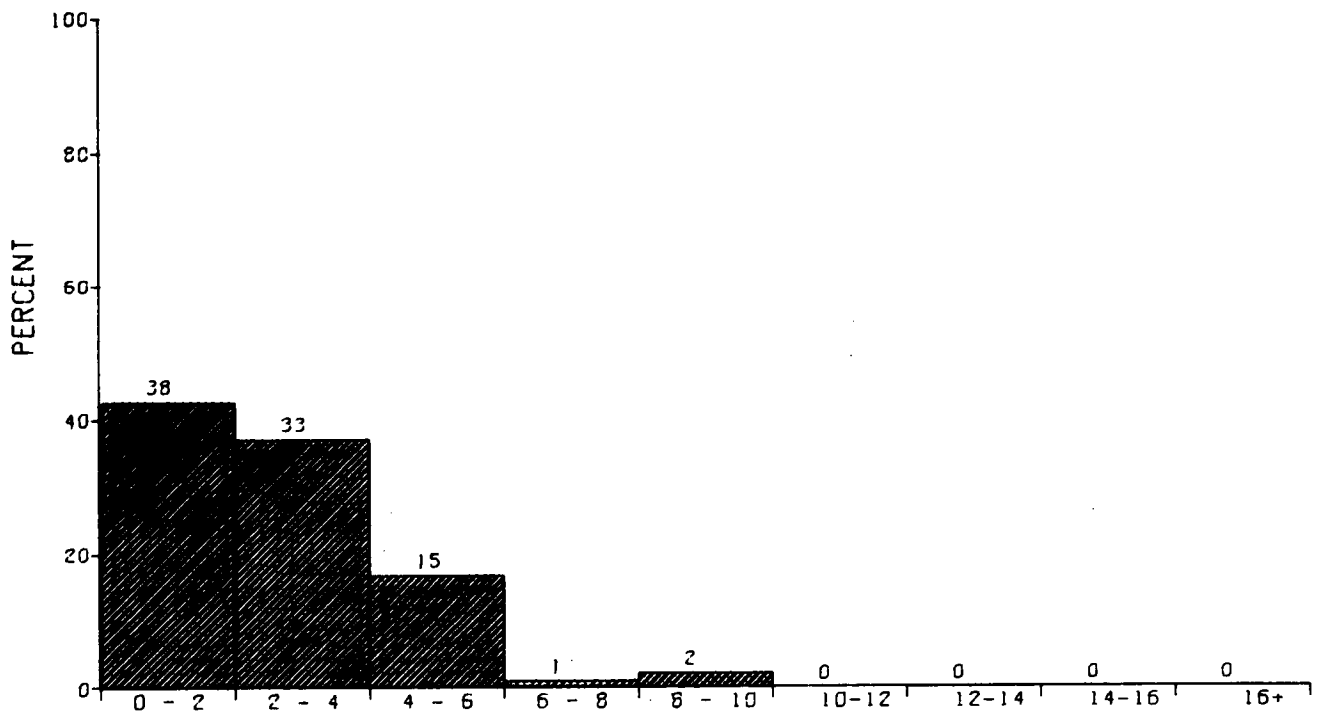

DISTRIBUTION OF WIND SPEED IN METERS PER SECOND
 GEOS DATA- OCTOBER 1978
 EASTERN GULF OF MEXICO

N = 89. MEAN = 2.69 SIGMA = 1.89

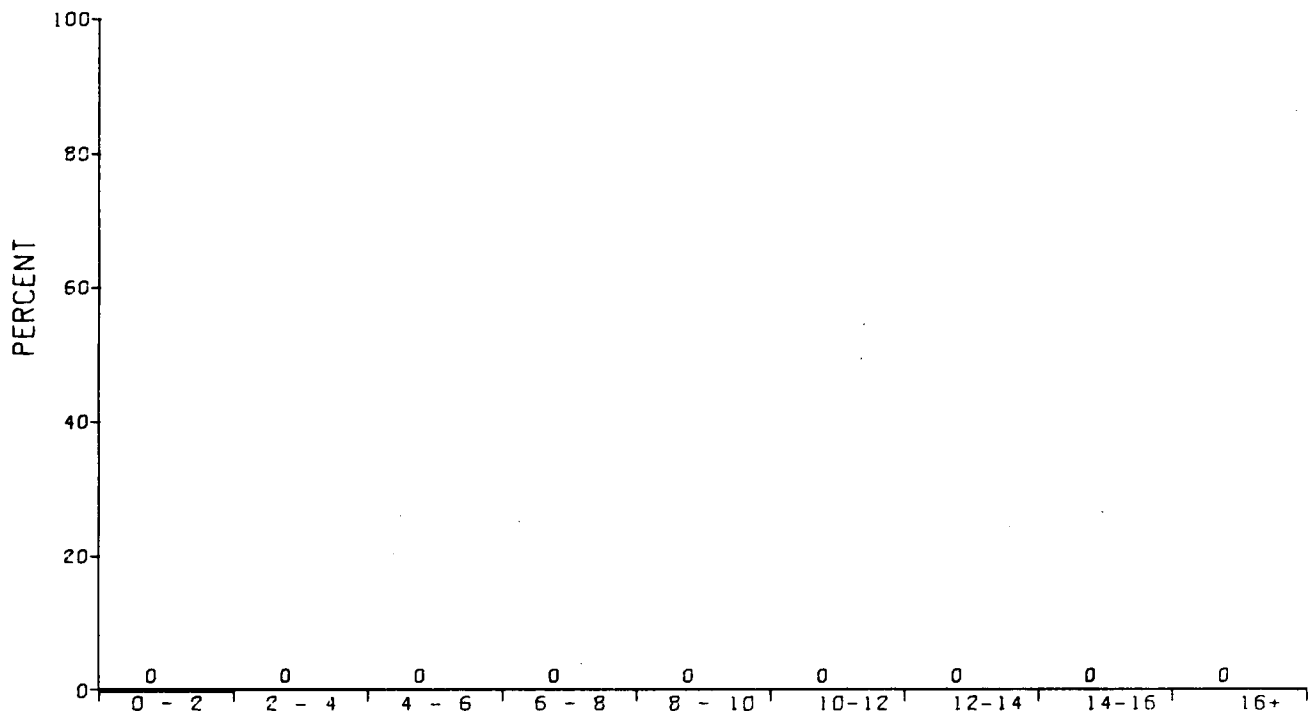

DISTRIBUTION OF WIND SPEED IN METERS PER SECOND

GEOS DATA- OCTOBER 1978

WESTERN GULF OF MEXICO

N = 0.

MEAN = 0.00

SIGMA = 0.0

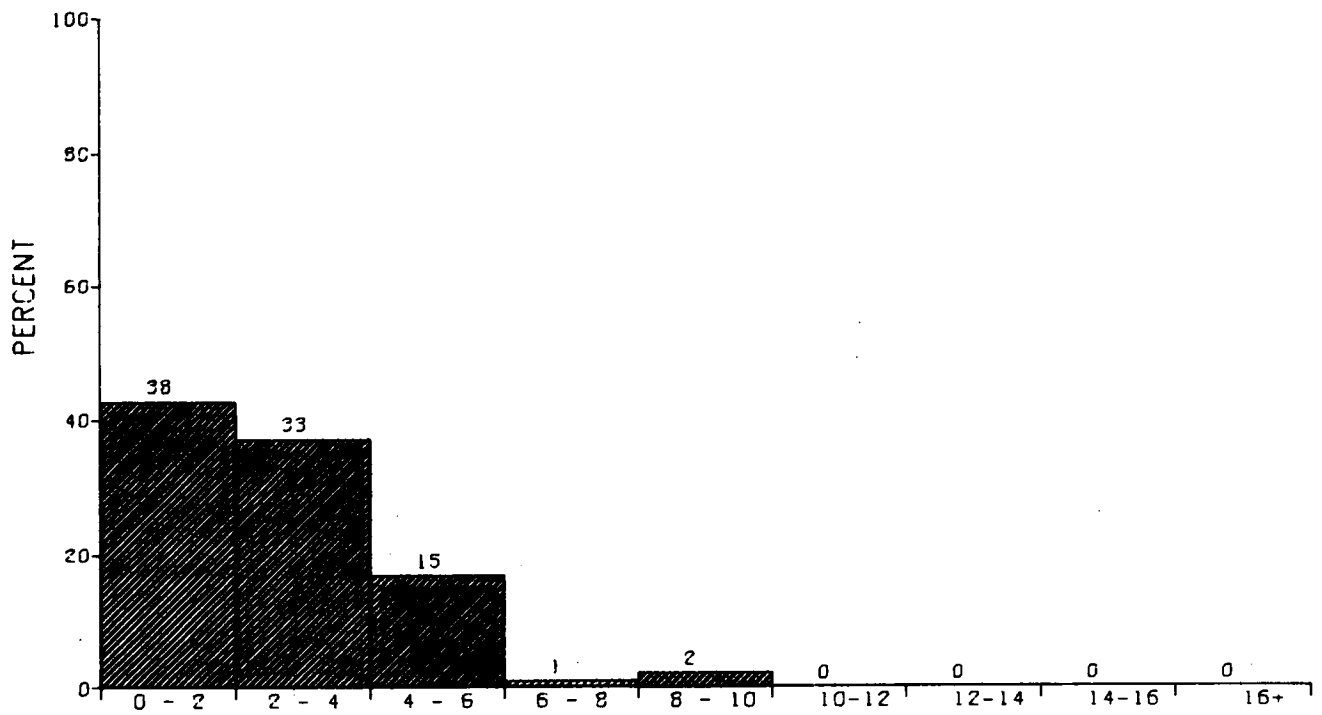

DISTRIBUTION OF WIND SPEED IN METERS PER SECOND
 GEOS DATA-- OCTOBER 1978
 ENTIRE GULF OF MEXICO

N = 89. MEAN = 2.69 SIGMA = 1.9

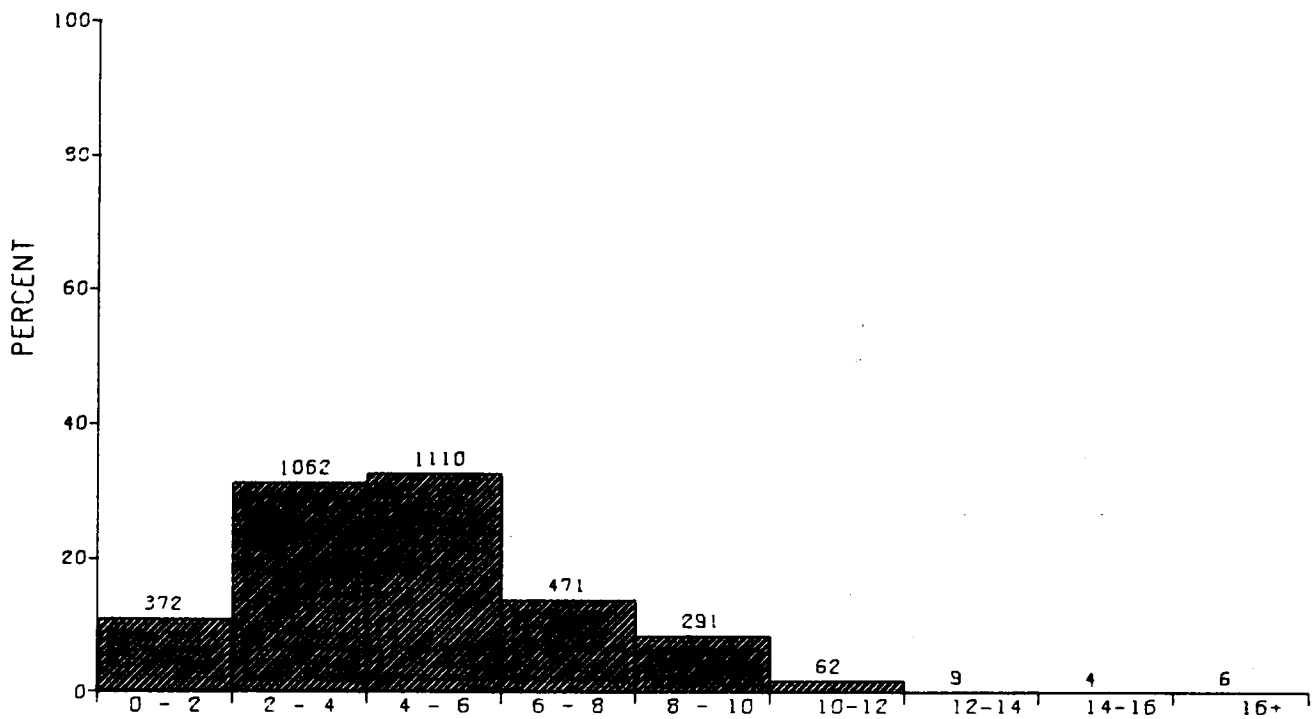

DISTRIBUTION OF WIND SPEED IN METERS PER SECOND

GEOS DATA- SUMMER 1978

EASTERN GULF OF MEXICO

N = 3387.

MEAN = 4.75

SIGMA = 2.43

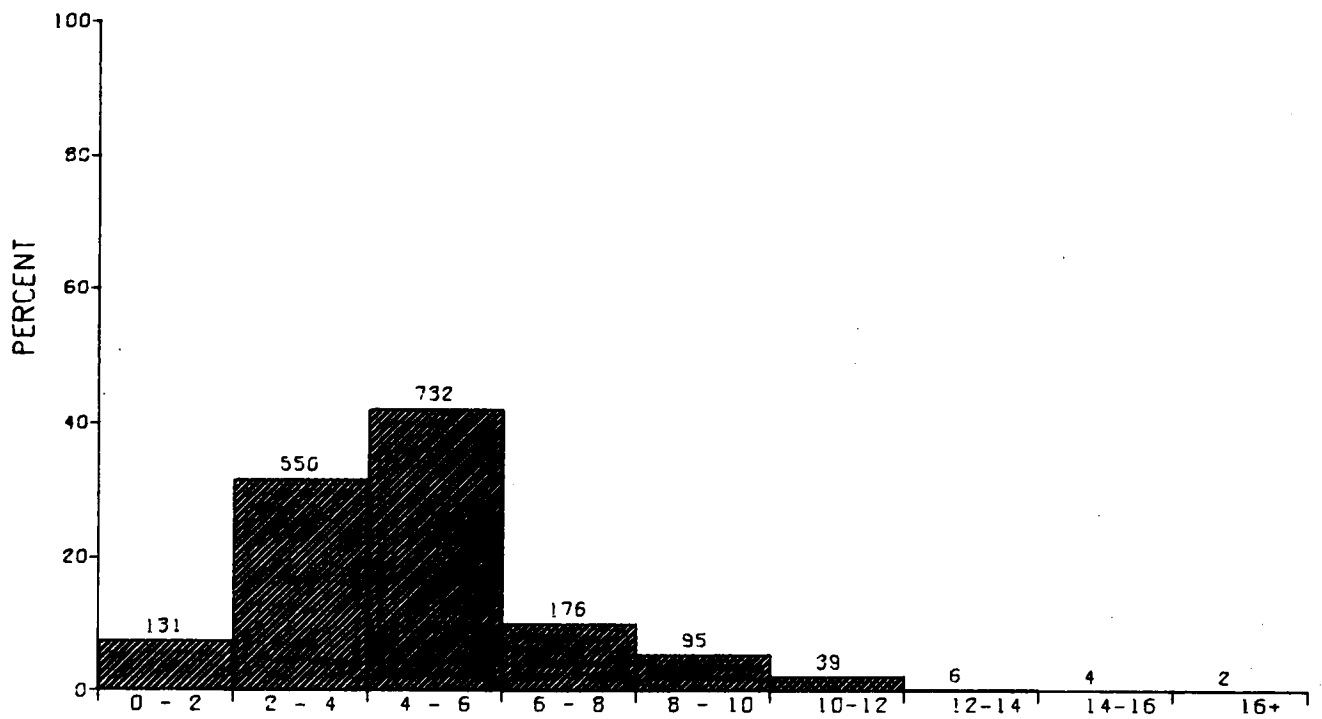

DISTRIBUTION OF WIND SPEED IN METERS PER SECOND

GEOS DATA- SUMMER 1978

WESTERN GULF OF MEXICO

N = 1735.

MEAN = 4.67

SIGMA = 2.2

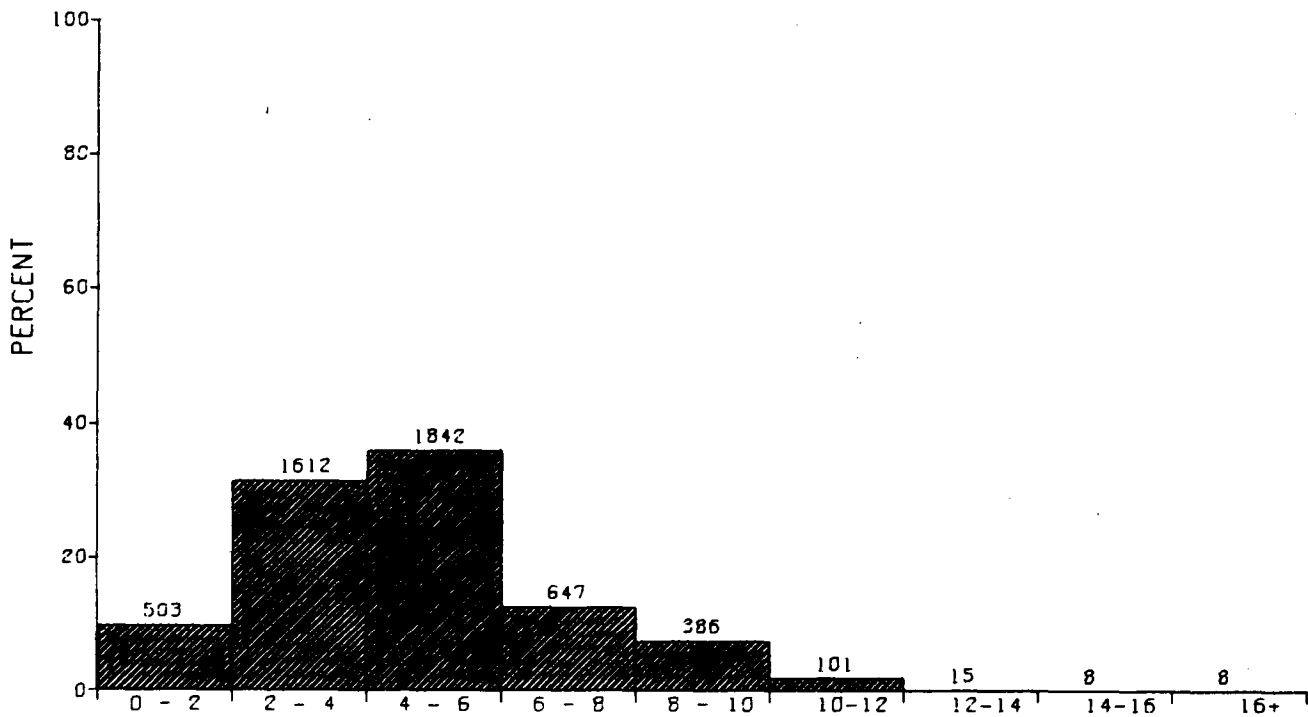

DISTRIBUTION OF WIND SPEED IN METERS PER SECOND

GEOS DATA- SUMMER 1978

ENTIRE GULF OF MEXICO

N = 5122.

MEAN = 4.72

SIGMA = 2.4

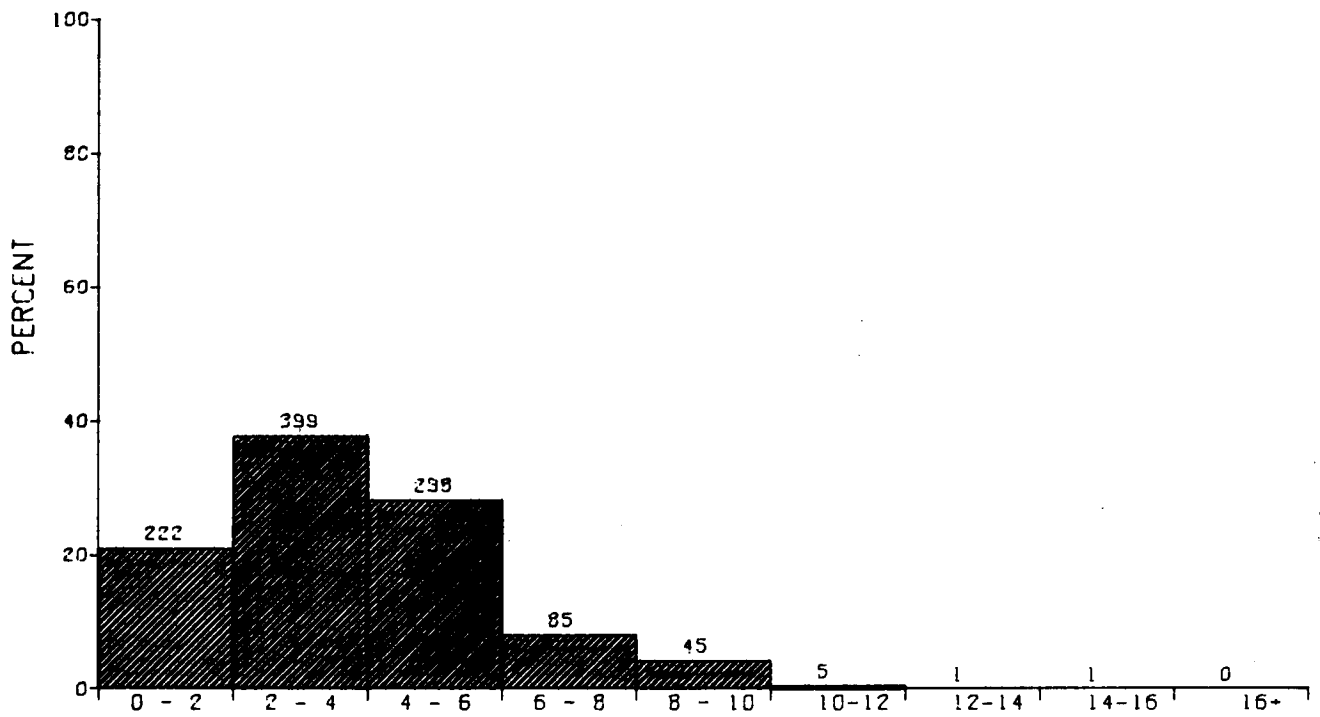

DISTRIBUTION OF WIND SPEED IN METERS PER SECOND
 GEOS DATA- FALL 1978
 EASTERN GULF OF MEXICO

N = 1056. MEAN = 3.78 SIGMA = 2.09

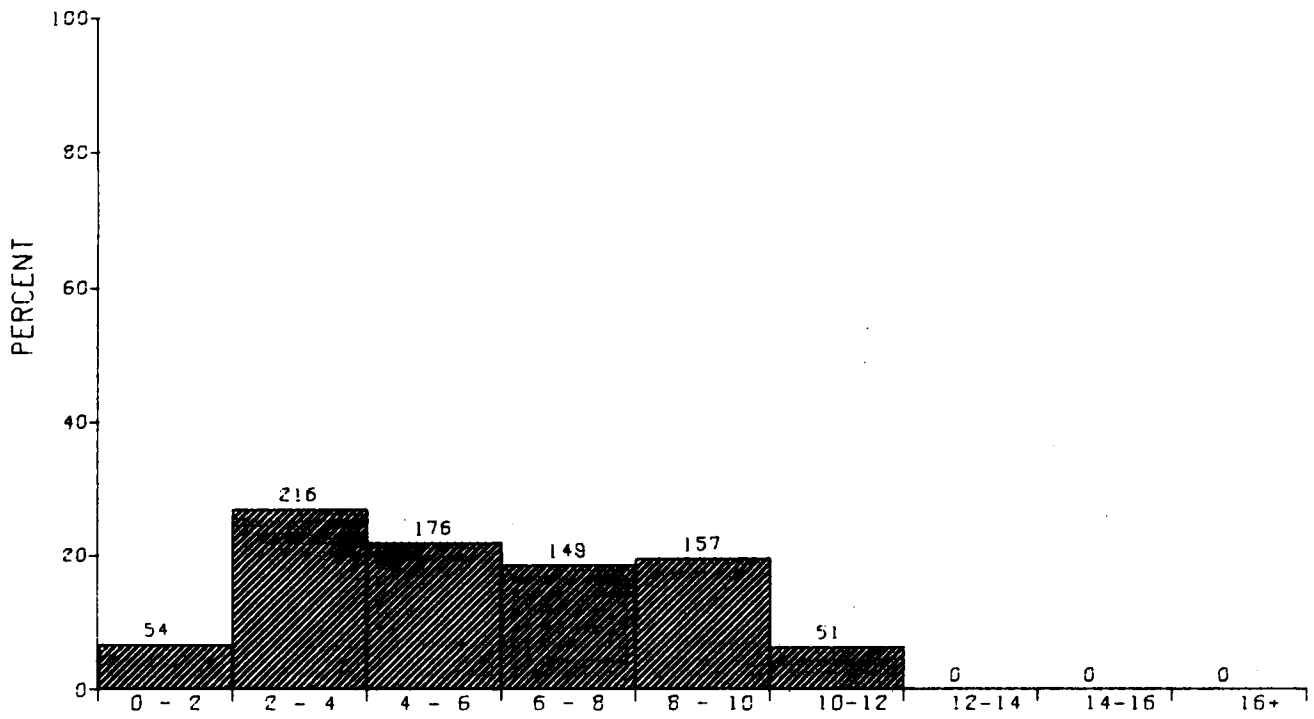

DISTRIBUTION OF WIND SPEED IN METERS PER SECOND
 GEOS DATA-- FALL 1978
 WESTERN GULF OF MEXICO

N = 803. MEAN = 5.76 SIGMA = 2.8

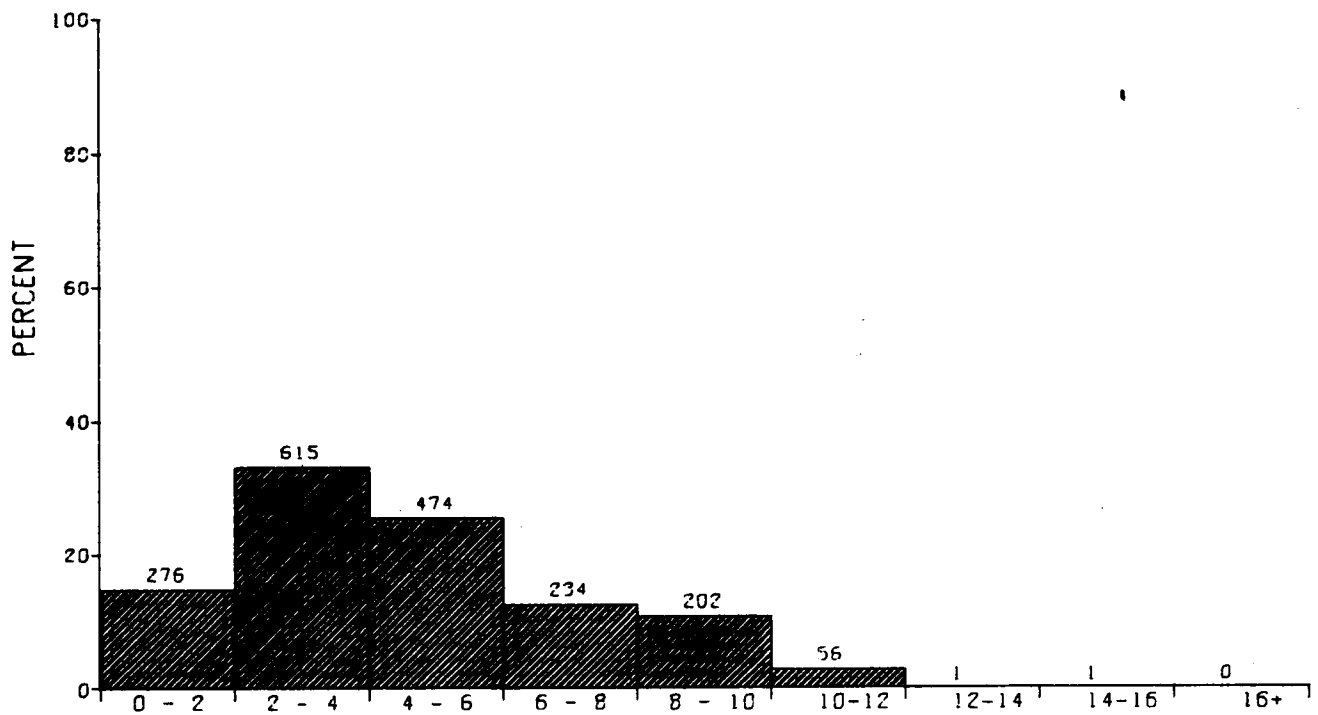

DISTRIBUTION OF WIND SPEED IN METERS PER SECOND

GEOS DATA- FALL 1978

ENTIRE GULF OF MEXICO

N = 1859. MEAN = 4.64 SIGMA = 2.6

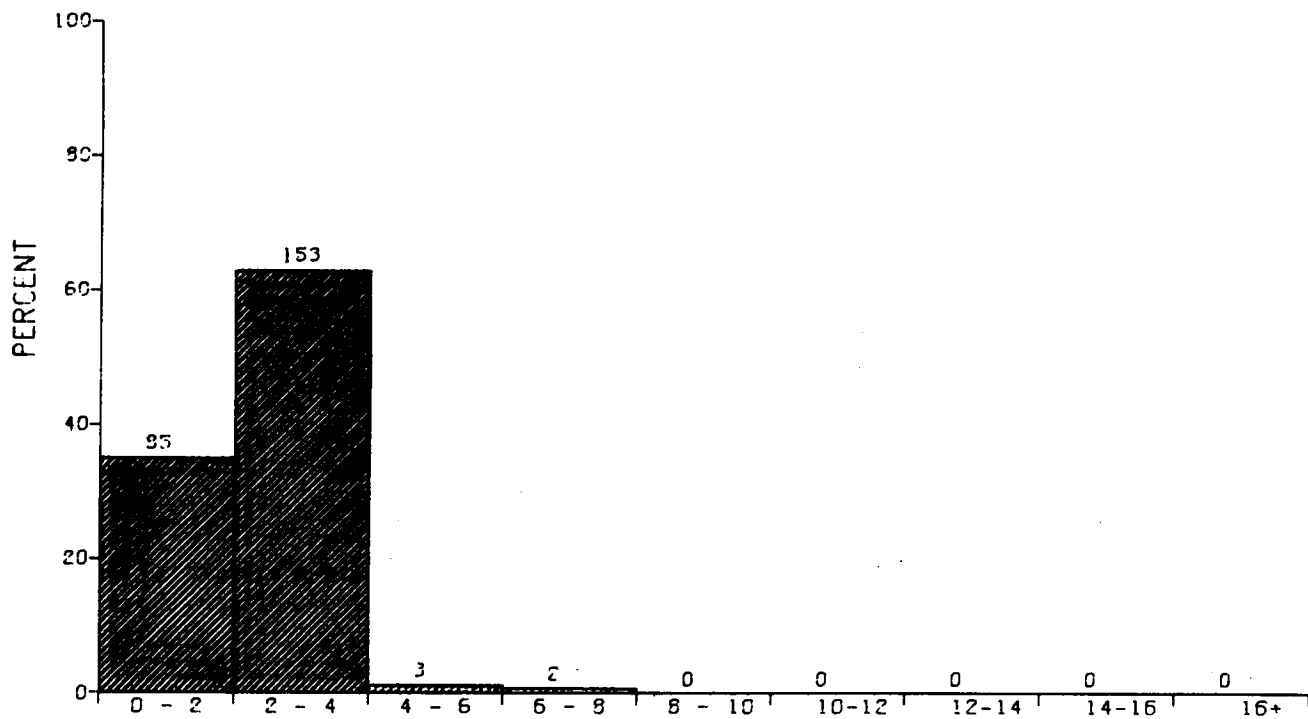

DISTRIBUTION OF WIND SPEED IN METERS PER SECOND
 SEASAT DATA- JULY
 EASTERN GULF OF MEXICO

N = 243. MEAN = 2.24 SIGMA = 0.79

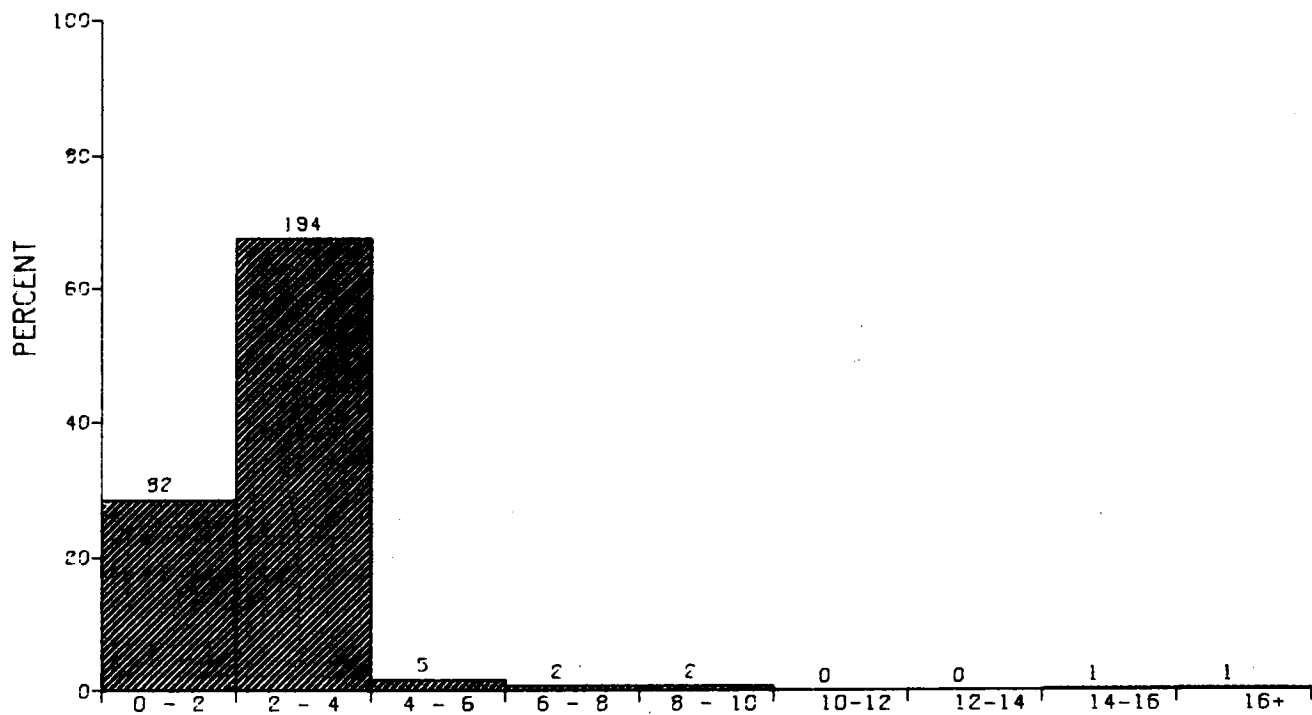

DISTRIBUTION OF WIND SPEED IN METERS PER SECOND

SEASAT DATA- JULY

WESTERN GULF OF MEXICO

N = 287.

MEAN = 2.59

SIGMA = 1.6

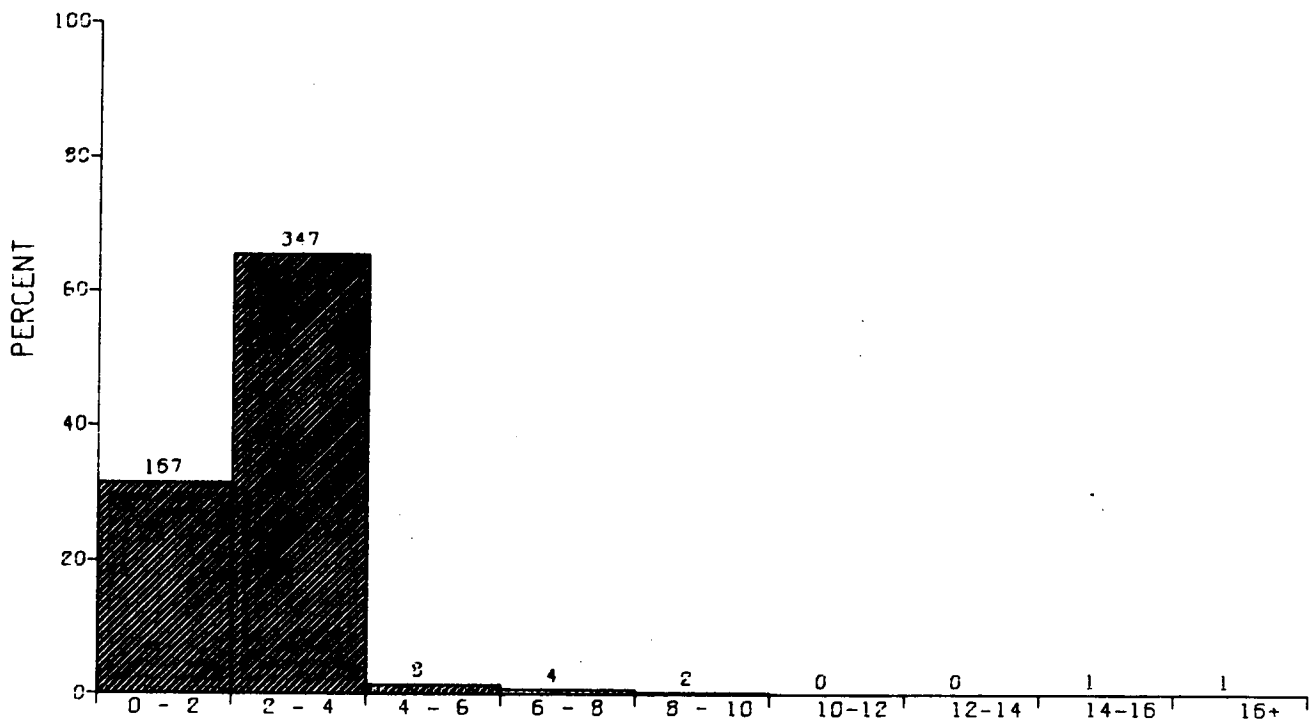

DISTRIBUTION OF WIND SPEED IN METERS PER SECOND

SEASAT DATA- JULY

ENTIRE GULF OF MEXICO

N = 530.

MEAN = 2.43

SIGMA = 1.3

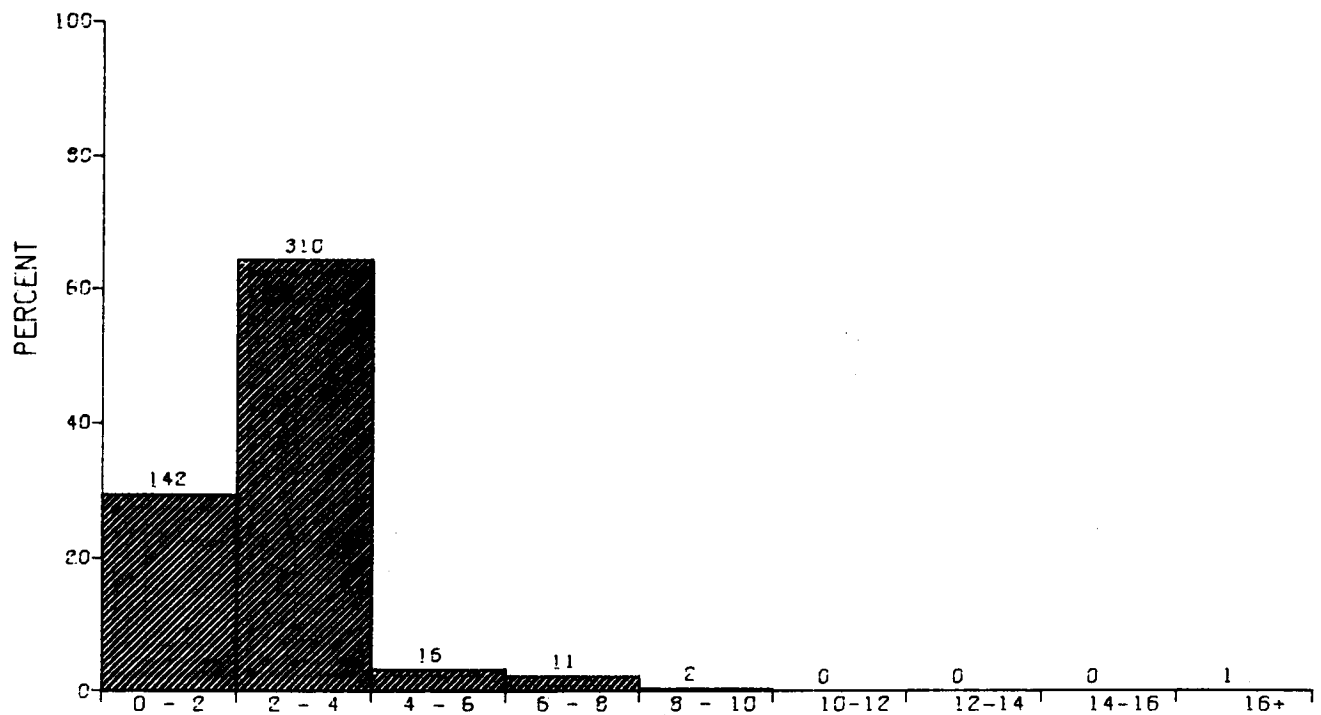

DISTRIBUTION OF WIND SPEED IN METERS PER SECOND

SEASAT DATA- AUGUST

EASTERN GULF OF MEXICO

N = 482.

MEAN = 2.53

SIGMA = 1.35

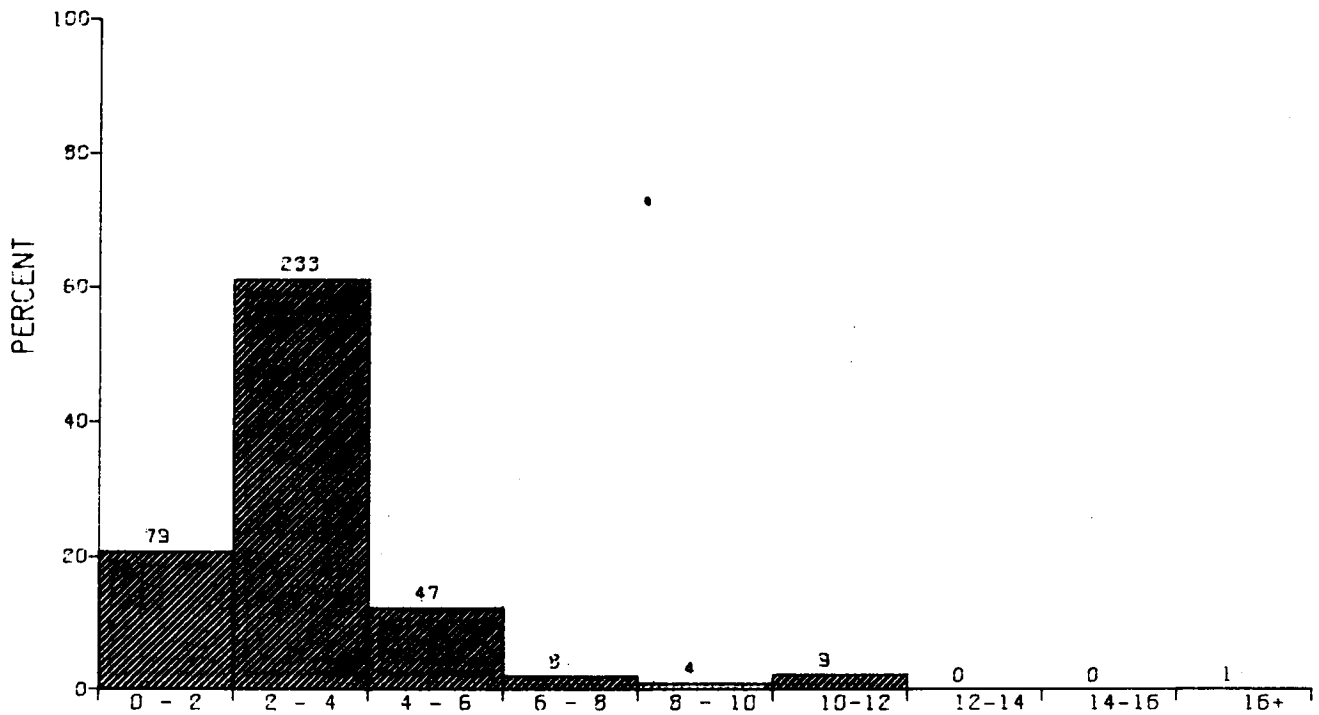

DISTRIBUTION OF WIND SPEED IN METERS PER SECOND
 SEASAT DATA-- AUGUST
 WESTERN GULF OF MEXICO

N = 381. MEAN = 3.01 SIGMA = 2.1

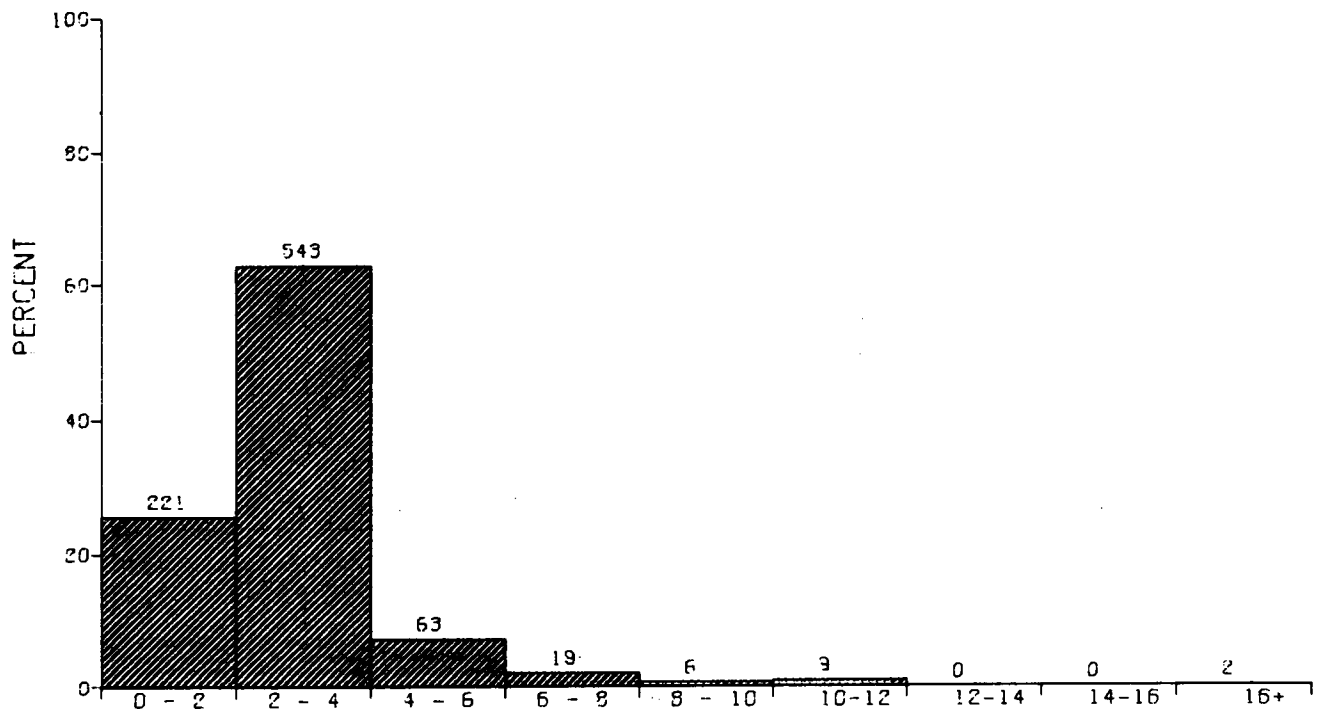

DISTRIBUTION OF WIND SPEED IN METERS PER SECOND
 SEASAT DATA- AUGUST
 ENTIRE GULF OF MEXICO

N = 963. MEAN = 2.74 SIGMA = 1.7

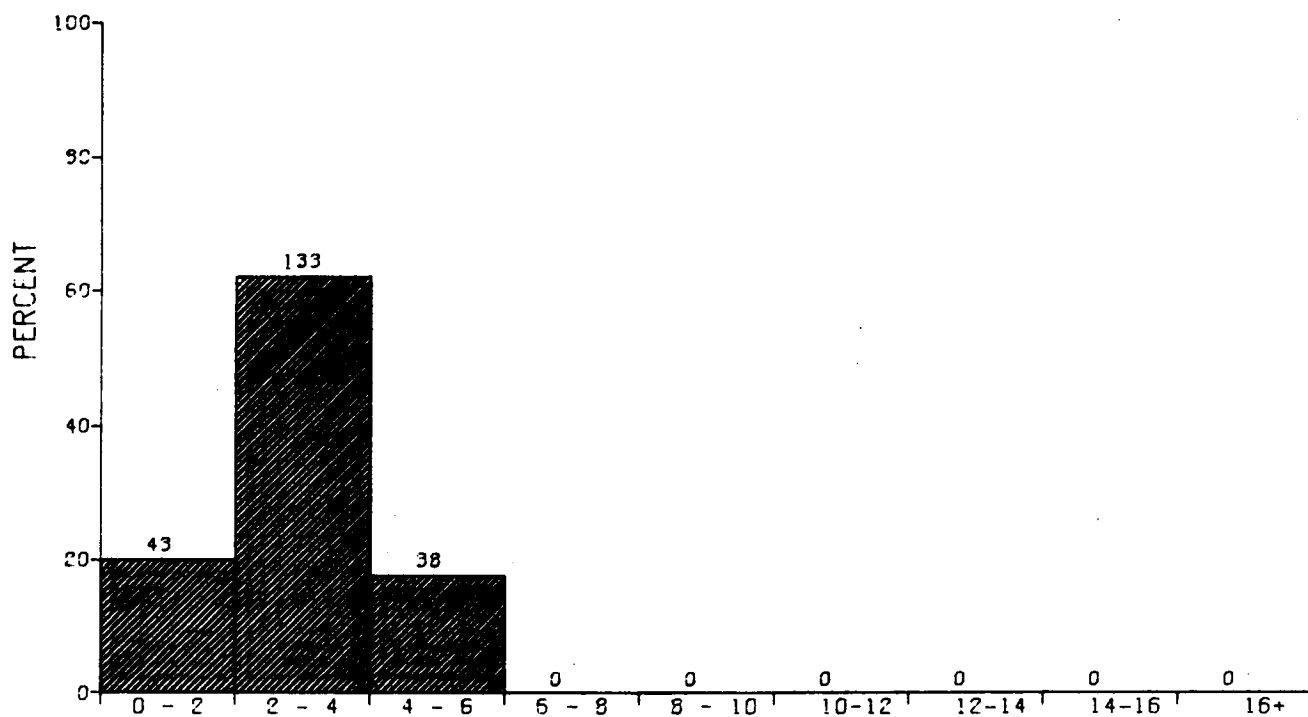

DISTRIBUTION OF WIND SPEED IN METERS PER SECOND

SEASAT DATA-- SEPTEMBER

EASTERN GULF OF MEXICO

N = 214.

MEAN = 2.97

SIGMA = 1.06

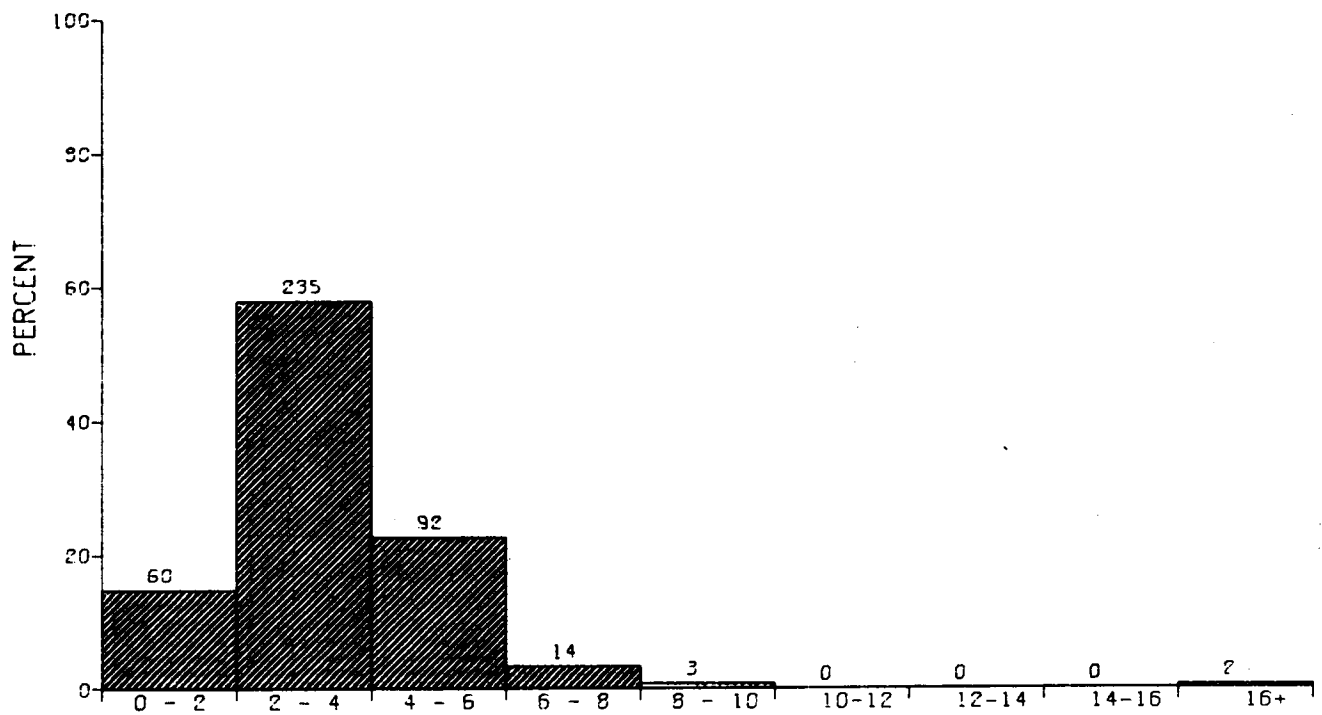

DISTRIBUTION OF WIND SPEED IN METERS PER SECOND
 SEASAT DATA- SEPTEMBER
 WESTERN GULF OF MEXICO

N = 406. MEAN = 3.26 SIGMA = 1.6

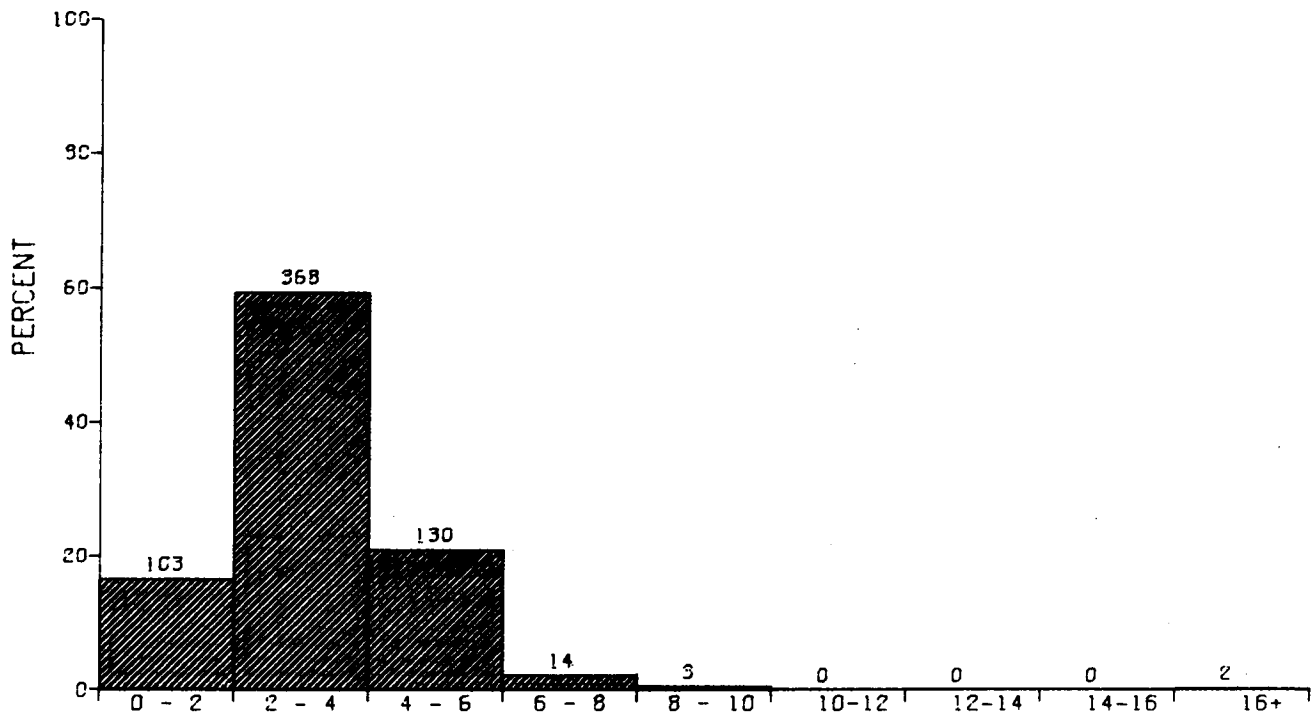

DISTRIBUTION OF WIND SPEED IN METERS PER SECOND
 SEASAT DATA- SEPTEMBER
 ENTIRE GULF OF MEXICO

N = 620. MEAN = 3.16 SIGMA = 1.4

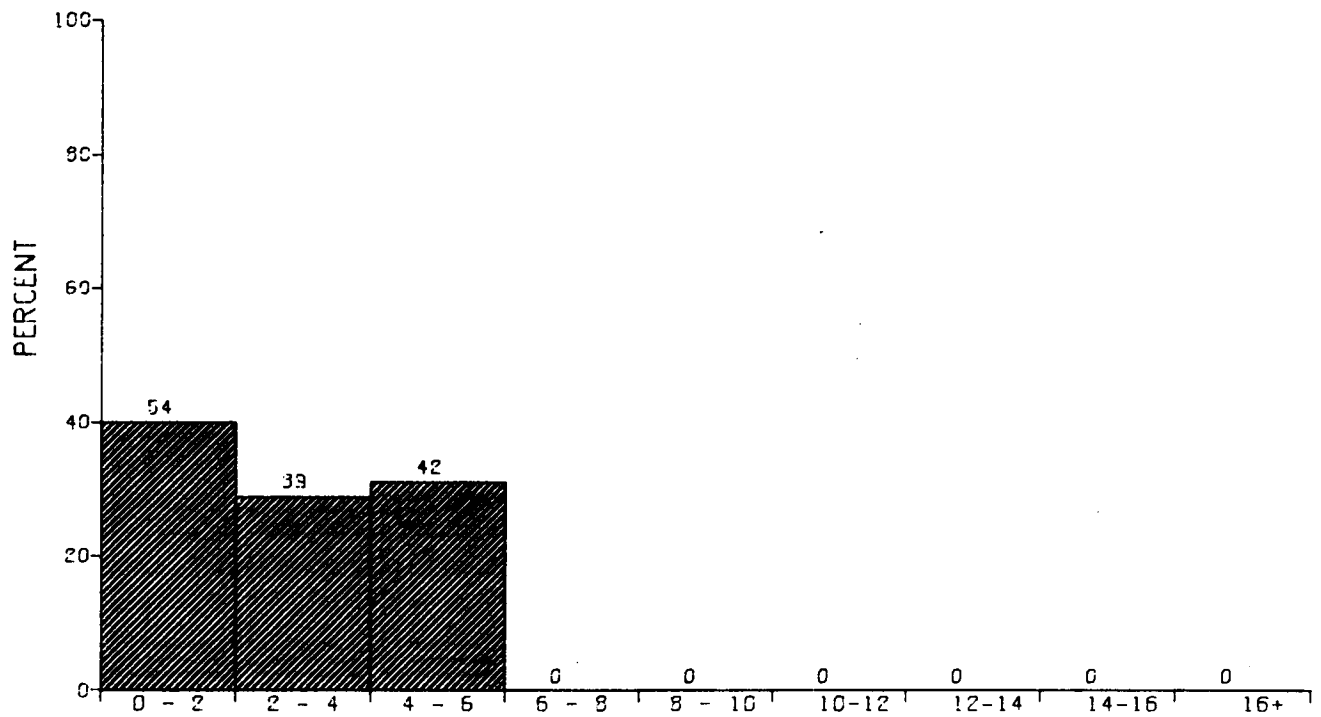

DISTRIBUTION OF WIND SPEED IN METERS PER SECOND
 SEASAT DATA - OCTOBER
 EASTERN GULF OF MEXICO

N = 135. MEAN = 2.68 SIGMA = 1.37

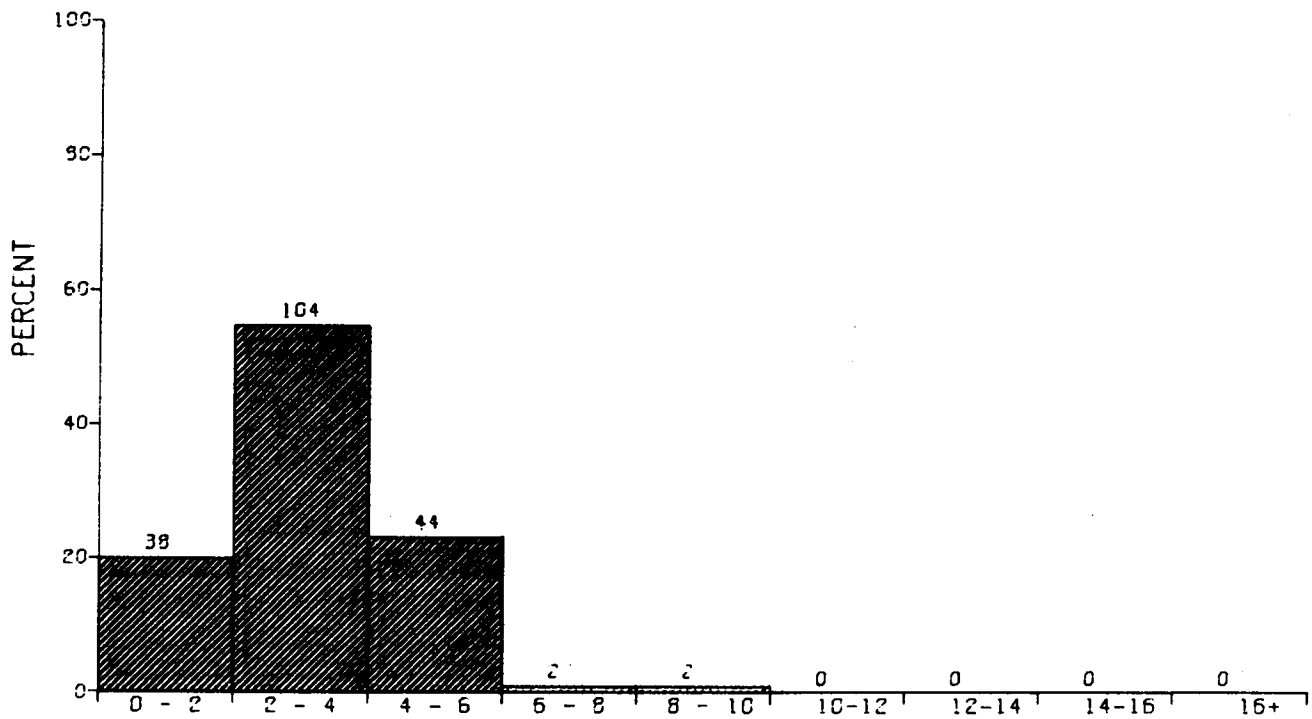

DISTRIBUTION OF WIND SPEED IN METERS PER SECOND

SEASAT DATA- OCTOBER

WESTERN GULF OF MEXICO

N = 190.

MEAN = 3.03

SIGMA = 1.4

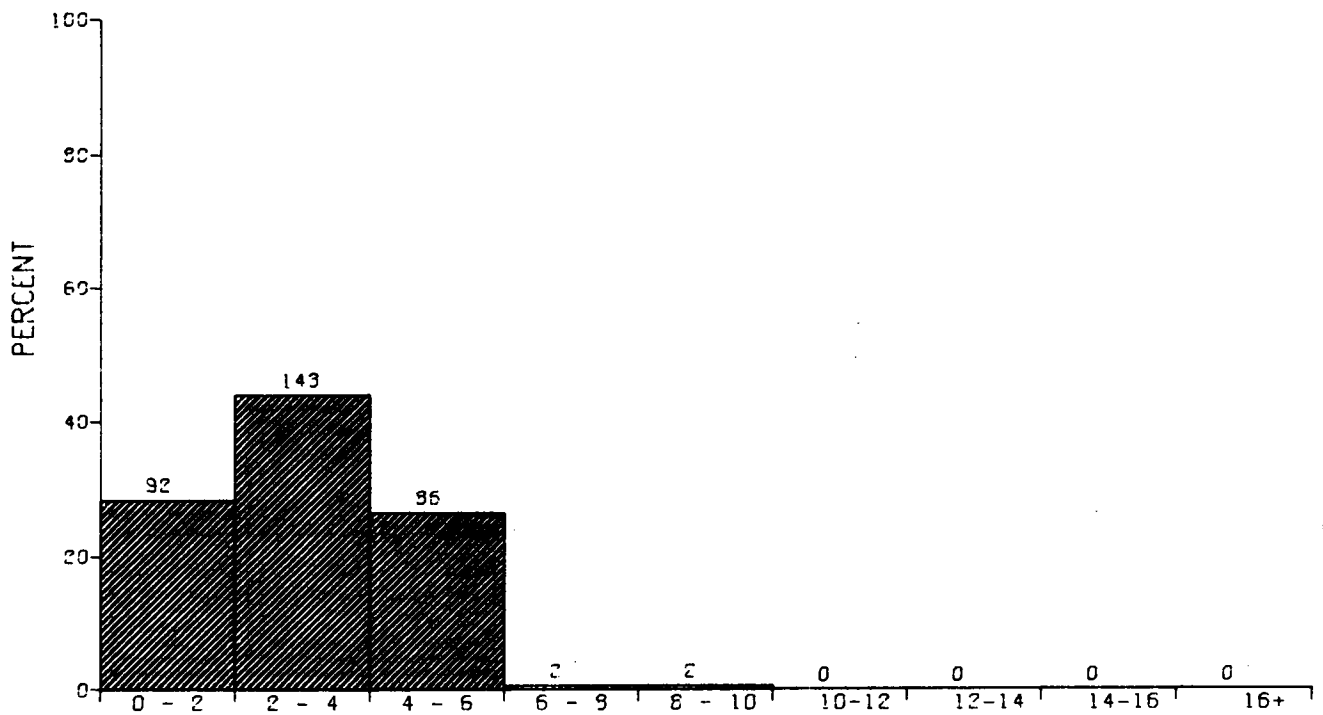

DISTRIBUTION OF WIND SPEED IN METERS PER SECOND
 SEASAT DATA- OCTOBER
 ENTIRE GULF OF MEXICO

N = 325. MEAN = 2.88 SIGMA = 1.4

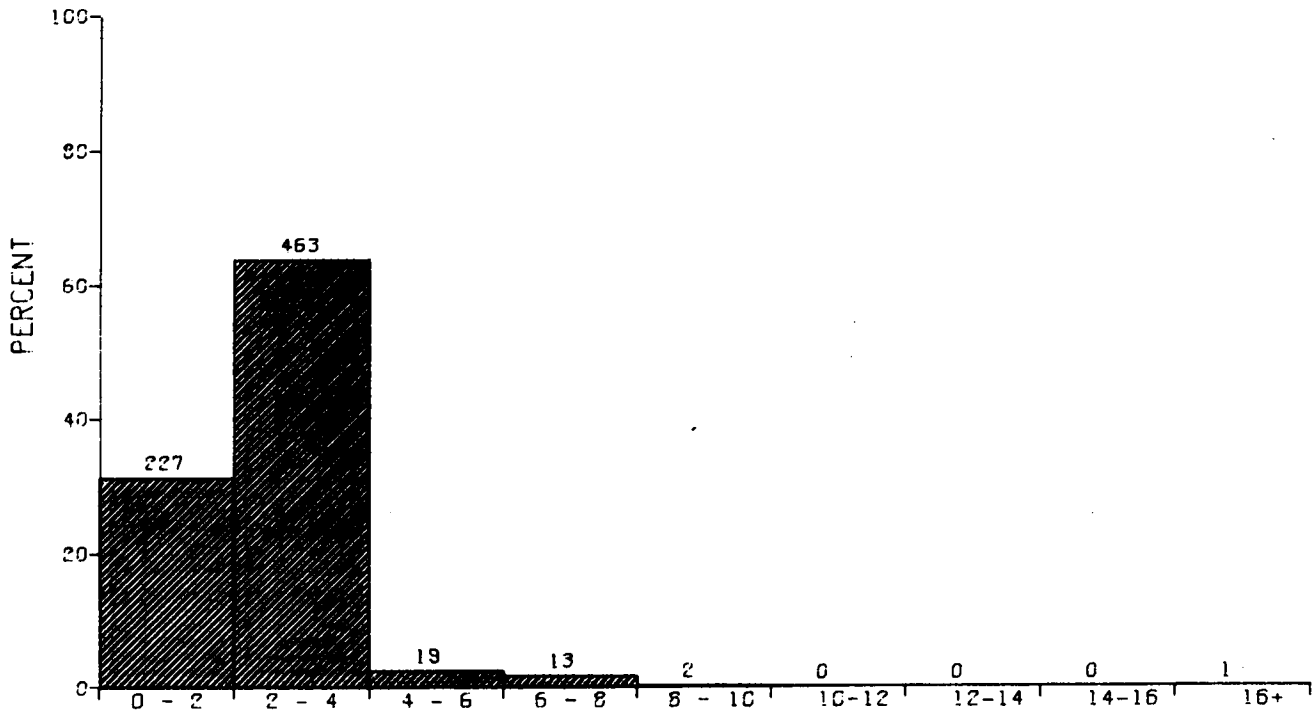

DISTRIBUTION OF WIND SPEED IN METERS PER SECOND

SEASAT DATA - SUMMER

EASTERN GULF OF MEXICO

N = 725.

MEAN = 2.43

SIGMA = 1.20

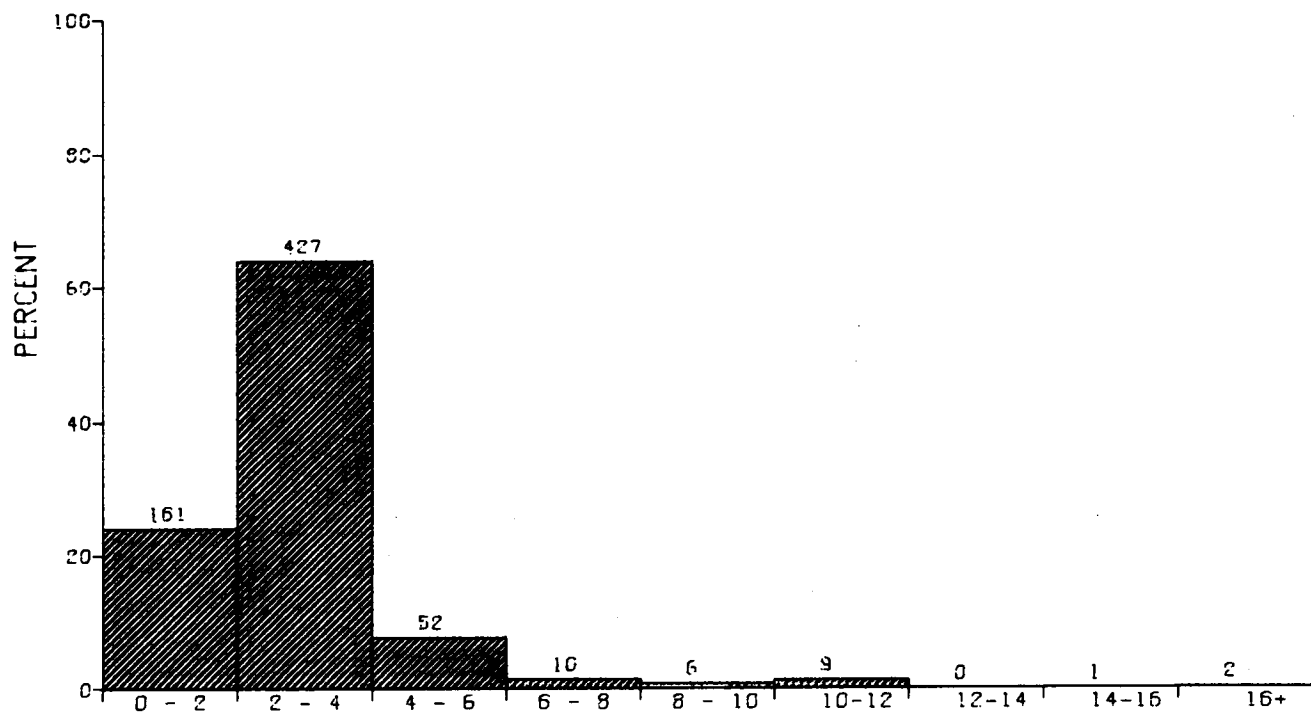

DISTRIBUTION OF WIND SPEED IN METERS PER SECOND
 SEASAT DATA- SUMMER
 WESTERN GULF OF MEXICO

N = 668. MEAN = 2.83 SIGMA = 1.9

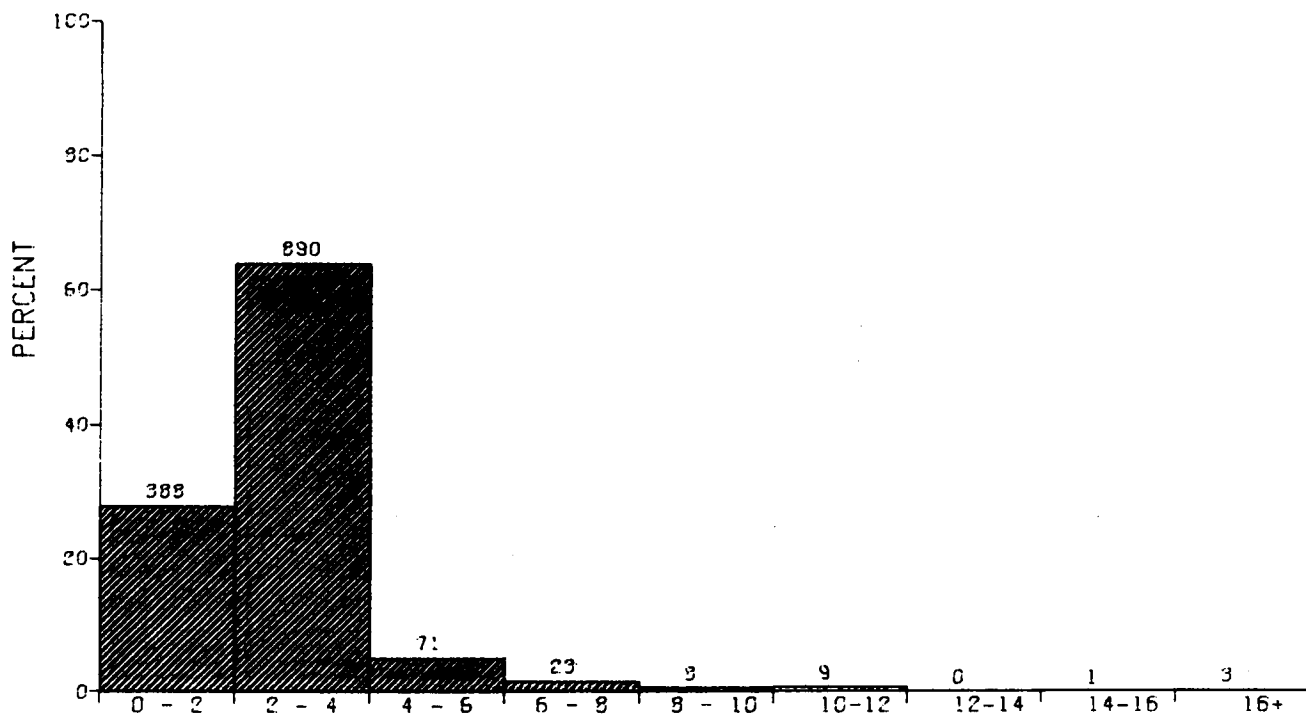

DISTRIBUTION OF WIND SPEED IN METERS PER SECOND

SEASAT DATA- SUMMER

ENTIRE GULF OF MEXICO

N = 1393.

MEAN = 2.62

SIGMA = 1.6

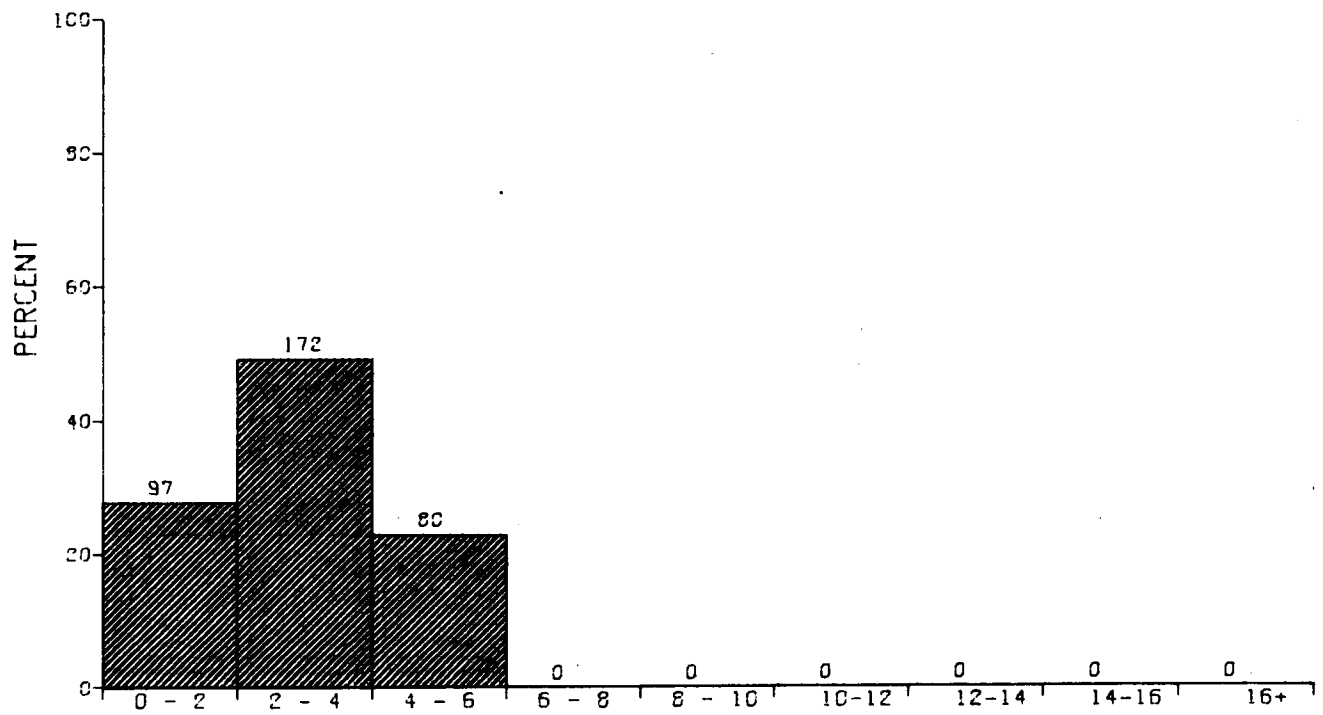

DISTRIBUTION OF WIND SPEED IN METERS PER SECOND

SEASAT DATA- FALL

EASTERN GULF OF MEXICO

N = 349.

MEAN = 2.86

SIGMA = 1.20

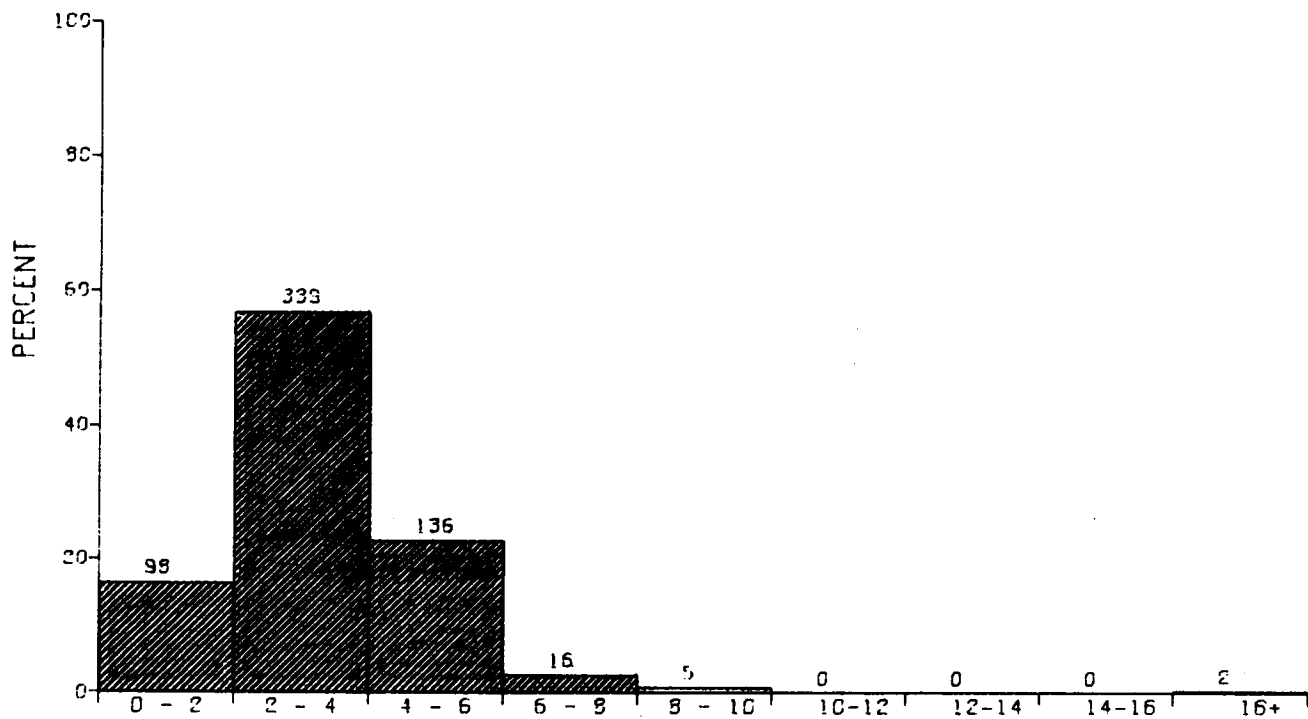

DISTRIBUTION OF WIND SPEED IN METERS PER SECOND

SEASAT DATA- FALL

WESTERN GULF OF MEXICO

N = 596.

MEAN = 3.18

SIGMA = 1.5

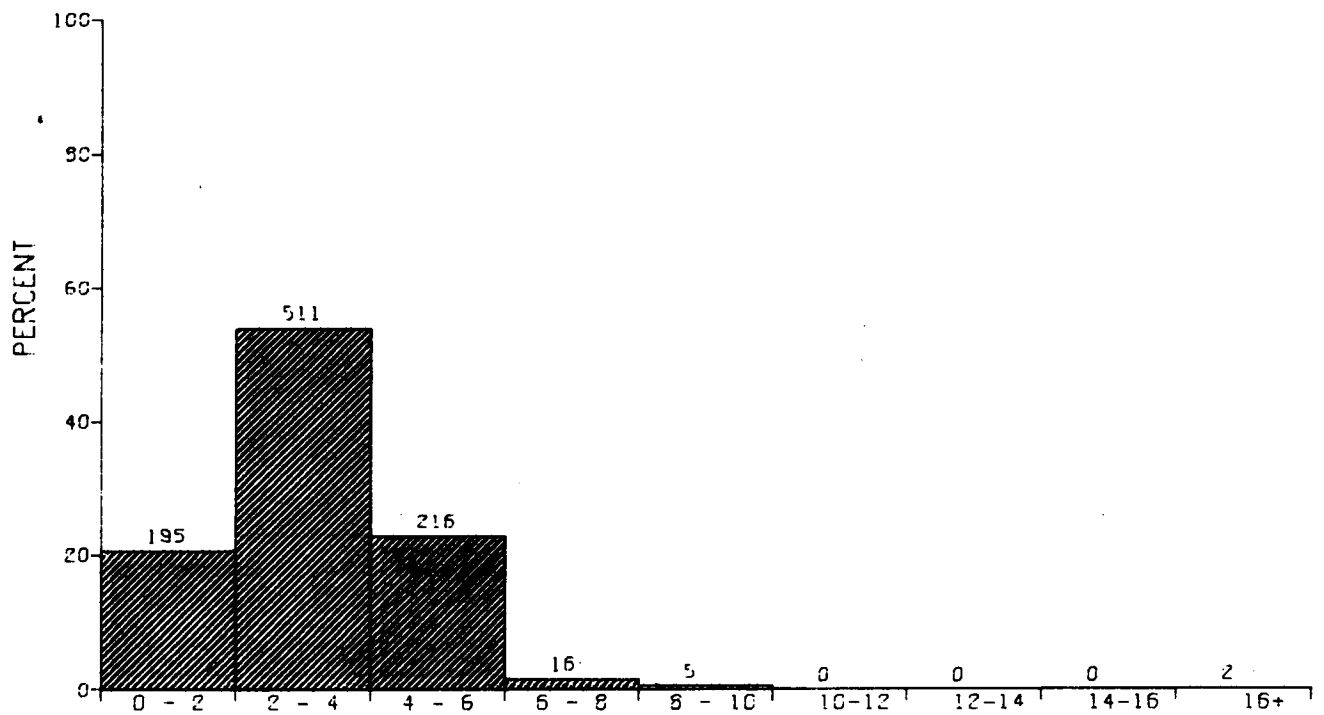

DISTRIBUTION OF WIND SPEED IN METERS PER SECOND
 SEASAT DATA- FALL
 ENTIRE GULF OF MEXICO

N = 945. MEAN = 3.06 SIGMA = 1.4

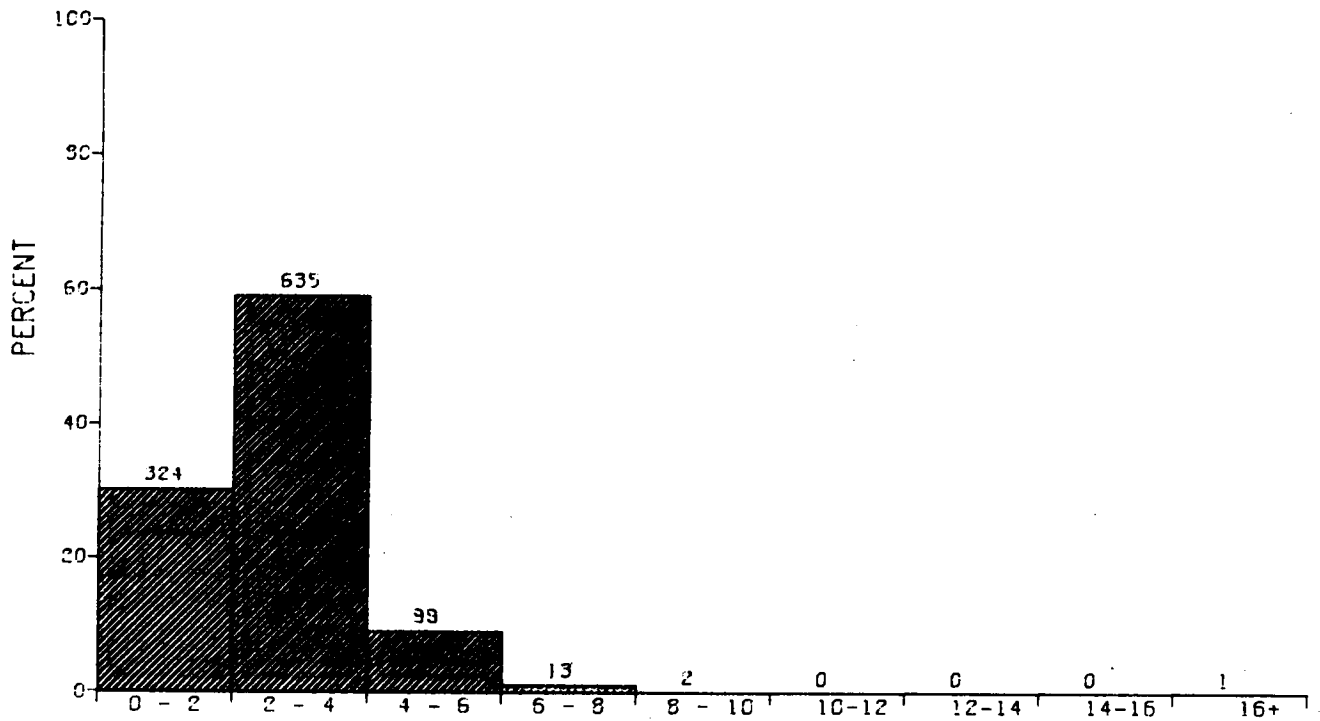

DISTRIBUTION OF WIND SPEED IN METERS PER SECOND

ALL SEASAT DATA

EASTERN GULF OF MEXICO

N = 1074.

MEAN = 2.57

SIGMA = 1.21

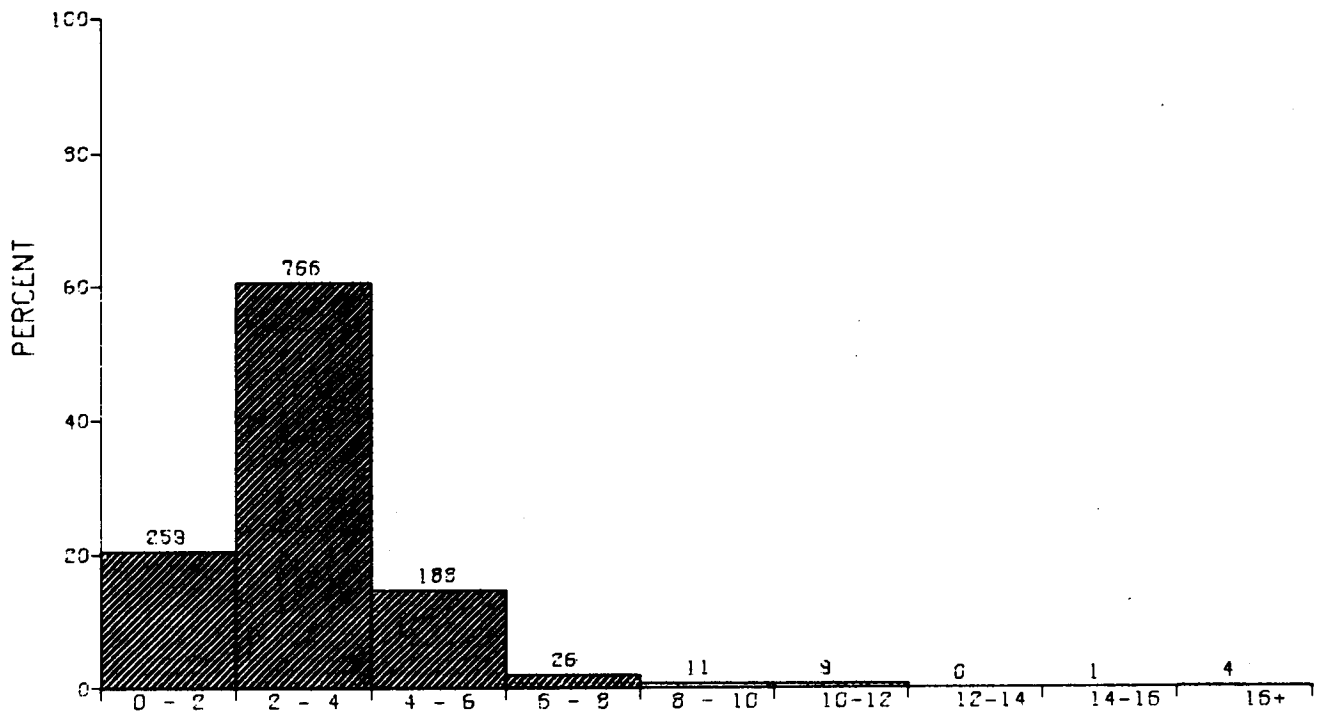

DISTRIBUTION OF WIND SPEED IN METERS PER SECOND

ALL SEASAT DATA

WESTERN GULF OF MEXICO

N = 1264. MEAN = 3.00 SIGMA = 1.7

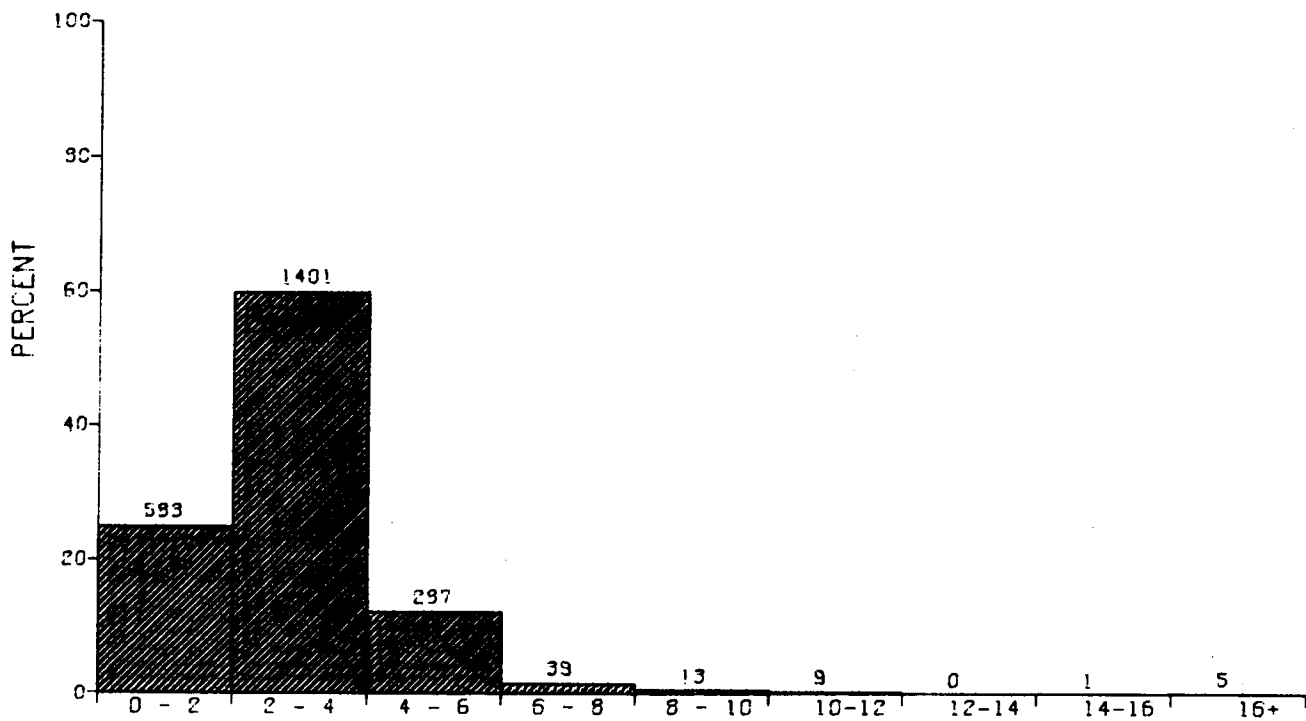

DISTRIBUTION OF WIND SPEED IN METERS PER SECOND

ALL SEASAT DATA

ENTIRE GULF OF MEXICO

N = 2338.

MEAN = 2.80

SIGMA = 1.5

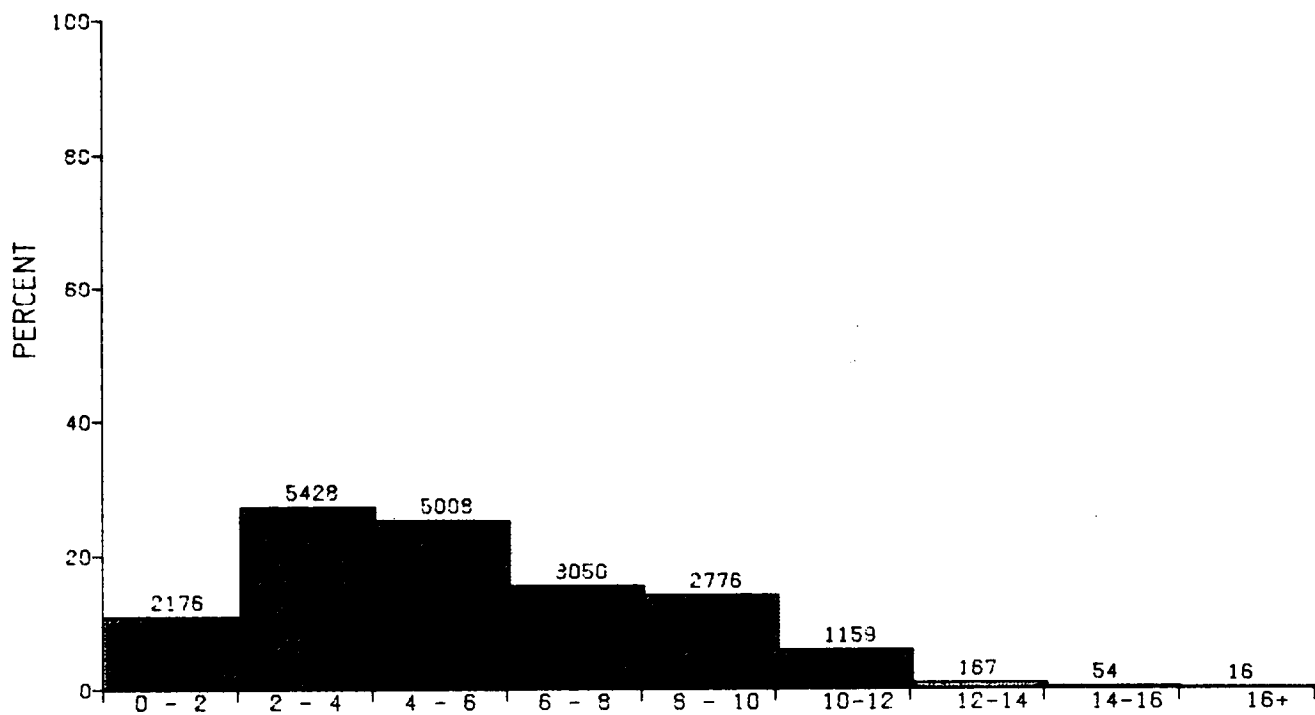

DISTRIBUTION OF WIND SPEED IN METERS PER SECOND
 ALL GEOS/SEASAT DATA
 EASTERN GULF OF MEXICO

N = 19834. MEAN = 5.36 SIGMA = 2.92

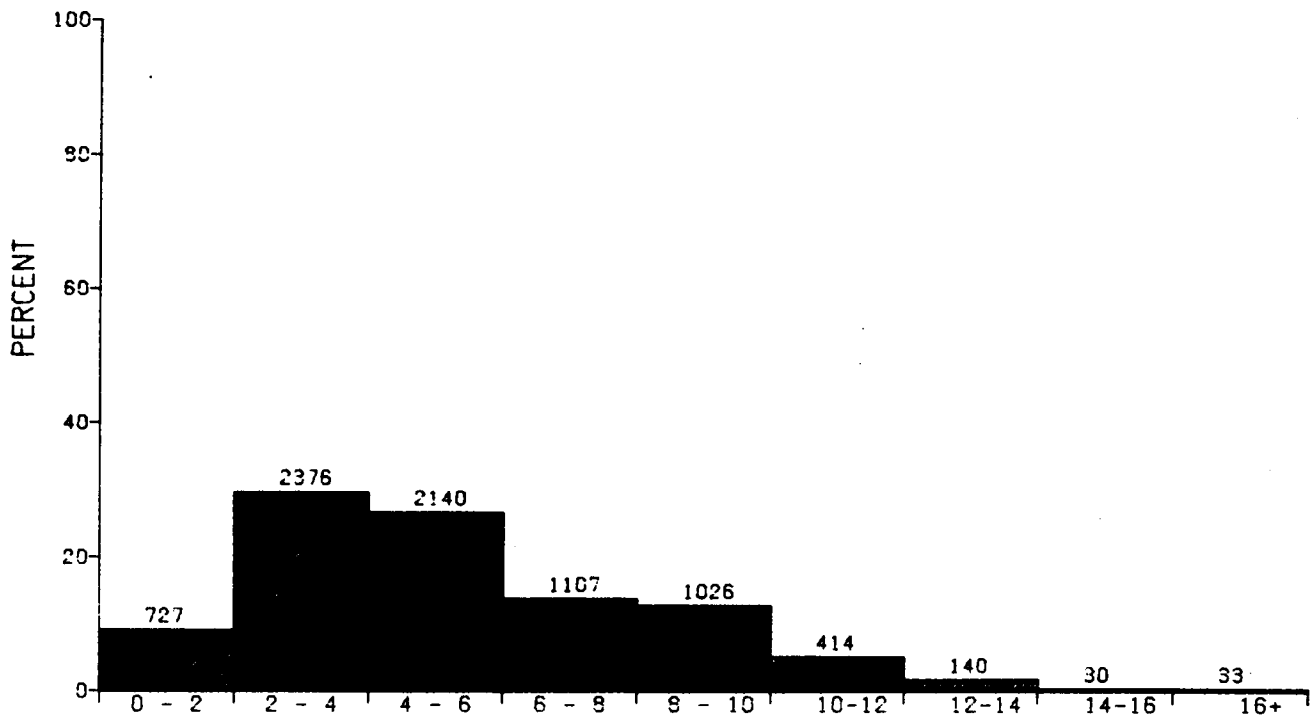

DISTRIBUTION OF WIND SPEED IN METERS PER SECOND

ALL GEOS/SEASAT DATA

WESTERN GULF OF MEXICO

N = 7993. MEAN = 5.38 SIGMA = 3.0

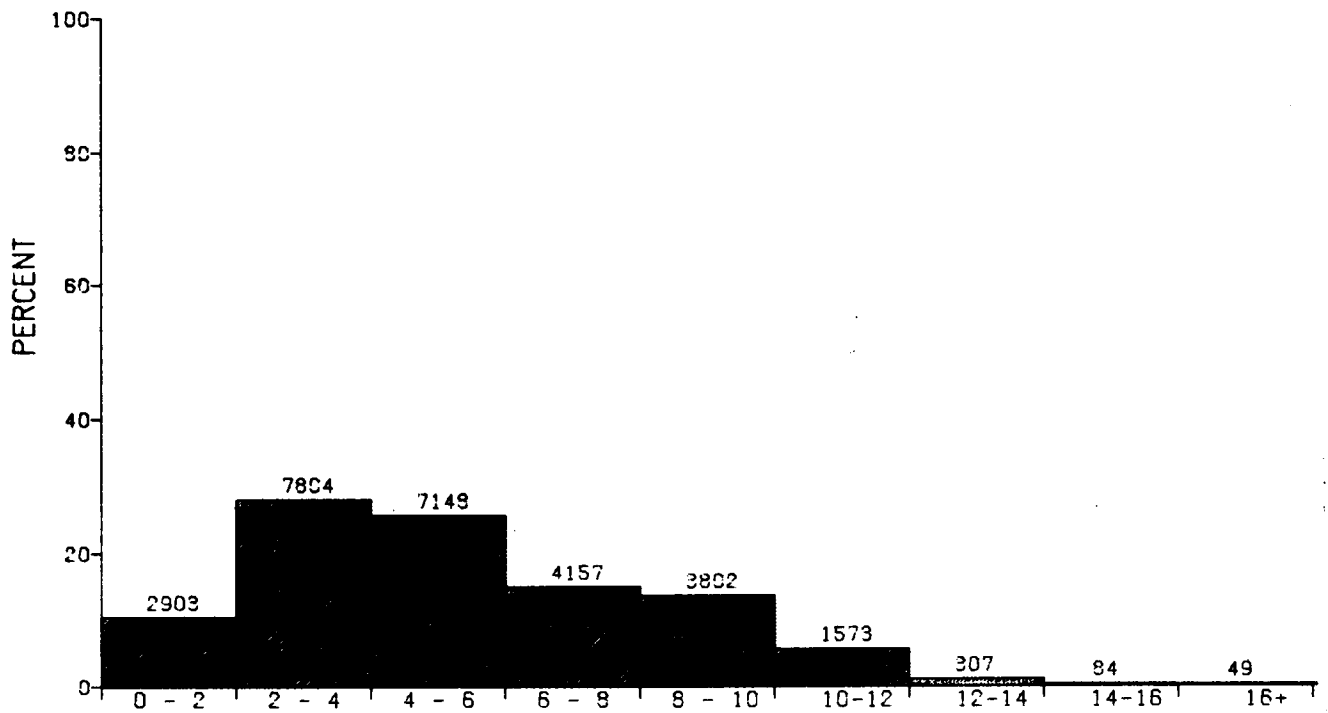

DISTRIBUTION OF WIND SPEED IN METERS PER SECOND
 ALL GEOS/SEASAT DATA
 ENTIRE GULF OF MEXICO

N = 27827. MEAN = 5.37 SIGMA = 2.9



The Department of the Interior Mission

As the Nation's principal conservation agency, the Department of the Interior has responsibility for most of our nationally owned public lands and natural resources. This includes fostering sound use of our land and water resources; protecting our fish, wildlife, and biological diversity; preserving the environmental and cultural values of our national parks and historical places; and providing for the enjoyment of life through outdoor recreation. The Department assesses our energy and mineral resources and works to ensure that their development is in the best interests of all our people by encouraging stewardship and citizen participation in their care. The Department also has a major responsibility for American Indian reservation communities and for people who live in island territories under U.S. administration.



The Minerals Management Service Mission

As a bureau of the Department of the Interior, the Minerals Management Service's (MMS) primary responsibilities are to manage the mineral resources located on the Nation's Outer Continental Shelf (OCS), collect revenue from the Federal OCS and onshore Federal and Indian lands, and distribute those revenues.

Moreover, in working to meet its responsibilities, the **Offshore Minerals Management Program** administers the OCS competitive leasing program and oversees the safe and environmentally sound exploration and production of our Nation's offshore natural gas, oil and other mineral resources. The MMS **Minerals Revenue Management** meets its responsibilities by ensuring the efficient, timely and accurate collection and disbursement of revenue from mineral leasing and production due to Indian tribes and allottees, States and the U.S. Treasury.

The MMS strives to fulfill its responsibilities through the general guiding principles of: (1) being responsive to the public's concerns and interests by maintaining a dialogue with all potentially affected parties and (2) carrying out its programs with an emphasis on working to enhance the quality of life for all Americans by lending MMS assistance and expertise to economic development and environmental protection.