

Proceedings: Gulf of Mexico Fish and Fisheries: Bringing Together New and Recent Research

October 2000



Proceedings: Gulf of Mexico Fish and Fisheries: Bringing Together New and Recent Research

October 2000

Editors

Melanie McKay
Copy Editor

Judith Nides
Production Editor

Debra Vigil
Editor

Prepared under MMS Contract
1435-00-01-CA-31060
by
University of New Orleans
Office of Conference Services
New Orleans, Louisiana 70814

Published by

**U.S. Department of the Interior
Minerals Management Service
Gulf of Mexico OCS Region**

**New Orleans
February 2002**

DISCLAIMER

This report was prepared under contract between the Minerals Management Service (MMS) and the University of New Orleans, Office of Conference Services. This report has been technically reviewed by the MMS and approved for publication. Approval does not signify that contents necessarily reflect the views and policies of the Service, nor does mention of trade names or commercial products constitute endorsement or recommendation for use. It is, however, exempt from review and compliance with MMS editorial standards.

REPORT AVAILABILITY

Extra copies of this report may be obtained from the Public Information Office (Mail Stop 5034) at the following address:

U.S. Department of the Interior
Minerals Management Service
Gulf of Mexico OCS Region
Public Information Office (MS 5034)
1201 Elmwood Park Boulevard
New Orleans, Louisiana 70123-2394
Telephone Numbers: (504) 736-2519
1-800-200-GULF

CITATION

This study should be cited as:

McKay, M., J. Nides, and D. Vigil, eds. Proceedings: Gulf of Mexico fish and fisheries: bringing together new and recent research, October 2000. U.S. Dept. of the Interior, Minerals Management Service, Gulf of Mexico OCS Region, New Orleans, La. OCS Study MMS 2002-004. 674 pp.

ABOUT THE COVER

Blue angelfish, *Holocanthus bermudensis* taken on a Gulf of Mexico platform. Photo by Gregory S. Boland.

TABLE OF CONTENTS

	<u>Page</u>
LIST OF FIGURES	vii
LIST OF TABLES	xix
ACKNOWLEDGMENTS	xxvii
SESSION 1: PLENARY	1
SESSION 2: OUTER CONTINENTAL SHELF AND DEEPWATER MARINE ECOLOGY Moderators: Mark Benfield & Gilbert Rowe	21
SESSION 3: OFFSHORE PLATFORMS AND THEIR MULTIPLE USER GROUPS Moderators: Ron Lukens & Villere Reggio	71
SESSION 4: PRESENT AND FUTURE FISHERIES MANAGEMENT I Moderators: Hal Osborne & Bob Shipp	99
SESSION 5: OFFSHORE PLATFORM COMMUNITIES I Moderators: Benny Gallaway & Gregg Gitschlag	167
SESSION 6: PRESENT AND FUTURE FISHERIES MANAGEMENT II Moderators: Hal Osborne & Bob Shipp	281
SESSION 7: OFFSHORE PLATFORM COMMUNITIES II Moderators: Benny Gallaway & Gregg Gitschlag	355
SESSION 8: EVALUATION OF NATURAL AND/OR ARTIFICIAL REEF PRODUCTIVITY I Moderators: Kathy Scanlon & Quenton Dokken	497
SESSION 9: EVALUATION OF NATURAL AND/OR ARTIFICIAL REEF PRODUCTIVITY II Moderators: Kathy Scanlon & Quenton Dokken	599
INDEX TO AUTHORS	661
ATTENDEES	665

LIST OF FIGURES

<u>No.</u>	<u>Page</u>
1.1.	Distribution of Gulf of Mexico oil and gas platforms visited by scientists from 1985 – 2000. 7
1.2.	Estimated number of fish around platforms and reef sites. 9
2.1.	Bacterial abundance (per gram dry sediment); and ammonium and nitrate concentrations (micromoles) in sediment pore waters as a function of depth (cm) into the sediments. 29
2.2.	Conceptual model and carbon budget of the benthic food web on the western Sigsbee Deep abyssal plain, at a depth of 3.65 km. 33
2.3.	Variations in biomass of the bacteria (top), meiofauna (middle), and macrofauna (bottom) as a function of time in response to a seasonal input of organic matter (POC) from the water column. 37
2.4.	Deepwater production systems in the Gulf of Mexico. 69
2.5.	Spatial distribution of surface longline sets made in the Gulf of Mexico during 1998 (Source: National Marine Fisheries Service longline logbook data 1999). 70
3.1.	Representation of the Gulf of Mexico Offshore Aquaculture Consortium Ocean Spar Sea Station and single-point mooring (SPM) design. 80
3.2.	Hypothetical illustration of a lift-barge potentially designed for offshore aquaculture operations (courtesy of Dennis Good, Goodstreak Marine, Slidell, LA). 85
3.3.	Platform distribution in the northern Gulf of Mexico. 94
3.4.	Gulf of Mexico platform distribution by depth. 95
3.5.	Gulf of Mexico platform removals by depth. 95
4.1.	Map of Florida and shelf waters showing the location of Madison-Swanson, Steamboat Lumps, and Oculina MPAs and the proposed routes for Buccaneer and Gulfstream gas pipelines. 110
5.1.	Mean Ucrit (BL s ⁻¹) of Florida pompano before and after a 24 h exposure to 3.0% ethylene glycol (treatment), and before and after sham exposure (control). 177
5.2.	Sites sampled during the course of the study 193
5.3.	Mean Shannon-Weiner diversity indices (with standard error bars) for plankton net (GC 18, GI 94, and ST 54) or pushnet (Belle Pass) collections (upper panel) and light-trap collections (lower panel) from each sampling site. 243

LIST OF FIGURES
(continued)

<u>No.</u>	<u>Page</u>	
5.4.	Total length frequency histograms for red snapper <i>Lutjanus campechanus</i> from the northern Gulf of Mexico: (top) 1,109 specimens from the commercial harvest of 1998; (middle) 663 specimens from the recreational harvest, April-August 1999; and (bottom) 300 specimens from among mortalities subsequent to the explosive removal of an oil and gas platform located in Ship Shoal Block 209, July 1998. The stippled area indicates those TL below the 381 mm (15 inch) TL minimum size which applied to the commercial fishery through out 1998 and to the recreational fishery through 3 June 1999. The hatched area delimits the 457 mm (18 inch) TL minimum under which the recreational fishery operated from 4 June to 29 August 1999.	274
5.5.	Age frequency histograms for red snapper <i>Lutjanus campechanus</i> from the Northern Gulf of Mexico: (top) 1,095 specimens from the commercial harvest of 1998; (middle) 646 specimens from the recreational harvest, April-August 1999; and (bottom) 295 specimens from among mortalities subsequent to the explosive removal of an oil and gas platform located in Ship Shoal Block 209, July 1998.	275
5.6.	Scattergram of total length (mm) at age (yr) for 295 red snapper <i>Lutjanus campechanus</i> sampled from the mortalities subsequent to the explosive removal of an oil and gas platform located in Ship Shoal Block 209, July 1998.	276
6.1.	The occurrence of <i>Peprilus burti</i> at the stations sampled in this study	290
6.2.	The occurrence of <i>Etrumeus teres</i> at the stations sampled in this study	291
6.3.	The occurrence of <i>Trachurus lathami</i> at the stations sampled in this study.	292
6.4.	The occurrence of <i>Loligo</i> sp. at the stations sampled in this study.	293
6.5.	The occurrence of <i>Scomber japonicus</i> at the stations sampled in this study	294
6.6.	The occurrence of <i>Stenotomus caprinus</i> at the stations sampled in this study	297
6.7.	The occurrence of <i>Chloroscombrus chrysurus</i> at the stations sampled in this study	298
6.8.	The occurrence of <i>Engraulis eurystole</i> at the stations sampled in this study	299
6.9.	The occurrence of <i>Decapterus punctatus</i> at the stations sampled in this study	301
6.10.	The occurrence of <i>Sardinella aurita</i> at the stations sampled in this study.	302
6.11.	The occurrence of <i>Diaphus</i> sp. at the stations sampled in this study.	303
6.12.	The occurrence of <i>Anchoa hepsetus</i> at the stations sampled in this study.	304
6.13.	The occurrence of <i>Steindachneria argenta</i> at the stations sampled in this study	305
6.14.	The occurrence of <i>Trichiurus lepturus</i> at the stations sampled in this study	306

LIST OF FIGURES
(continued)

<u>No.</u>	<u>Page</u>
6.15.	The occurrence of <i>Micropogonias undulatus</i> at the stations sampled in this study 307
6.16.	Length frequency distribution of <i>S. aurita</i> across the depth strata in this study 311
6.17.	Length frequency distribution of <i>C. chrysurus</i> across the depth strata in this study . . . 312
6.18.	Length frequency distribution of <i>D. punctatus</i> across the depth strata in this study . . . 312
6.19.	Length frequency distribution of <i>A. hepsetus</i> across the depth strata in this study 313
6.20.	Length frequency distribution of <i>E. eurystole</i> across the depth strata in this study 313
6.21.	Length frequency distribution of <i>Diaphus</i> sp. across the depth strata in this study 315
6.22.	Length frequency distribution of <i>S. caprinus</i> across the depth strata in this study 315
6.23.	Length frequency distribution of <i>Loligo</i> sp. across the depth strata in this study 316
6.24.	Length frequency distribution of <i>P. burti</i> across the depth strata in this study 316
6.25.	Length frequency distribution of <i>M. undulatus</i> across the depth strata in this study . . . 317
6.26.	Length frequency distribution of <i>E. teres</i> across the depth strata in this study 317
6.27.	Length frequency distribution of <i>T. lepturus</i> across the depth strata in this study 318
6.28.	Length frequency distribution of <i>T. lathami</i> across the depth strata in this study 318
6.29.	Length frequency distribution of <i>S. japonicus</i> across the depth strata in this study . . . 319
6.30.	Length frequency distribution of <i>S. argentea</i> across the depth strata in this study 319
6.31.	Location of Texas recreational headboat sets in August and September 1999. 337
6.32.	Fishing depth by port for recreational headboat sets in August and September 1999. A. Galveston; B. Port Aransas; C. Port Isabel (August); D. Port Isabel (September). 338
6.33.	Size distribution of red snapper caught and measured during Texas recreational headboat sets in August and September 1999. A. Summary; B. Galveston (August only); C. Port Aransas (August only); D. Port Isabel (August); E. Port Isabel (September). 341
6.34.	Depth and condition (when brought on board) of red snapper caught and measured during Texas recreational headboat sets in August and September 1999 by fishing port. A. Galveston; B. Port Aransas; C. Port Isabel. 343
6.35.	Fate of red snapper caught and measured during Texas recreational headboat sets in August and September 1999 by fishing port. A. Summary; B. By port and month. 345

LIST OF FIGURES
(continued)

<u>No.</u>	<u>Page</u>
6.36. Depth and fate of red snapper caught and measured during Texas recreational headboat sets in August and September 1999 by fishing port. A. Galveston; B. Port Aransas; C. Port Isabel.	346
6.37. Size and fate of red snapper caught and measured during Texas recreational headboat sets in August and September 1999 by fishing port. A. Galveston; B. Port Aransas; C. Port Isabel.	348
7.1. Map of study sites.	361
7.2. Schematic of sampling design showing transect lines, circular surveys, and sampling area under platform.	362
7.3. Red snapper assessment results, including platform removals, using Data Set E (represents arbitrary doubling of moderate to high estimate of red snapper mortality at <i>platforms</i>) compared to base case assessment (<i>base</i>).	368
7.4. Appearance of Mobile High Island A389-A platform on 21 October 1981.	375
7.5. Juvenile gray triggerfish recruited to the platform prior to Survey 1.	375
7.6. Typical appearance of platform structure three weeks after installation.	378
7.7. Similar location as Figure 7.6 photographed during Survey 2, seven months (211 days) after installation with now noticeable epifaunal community development evident.	378
7.8. Diverse fish community around well casing area at horizontal cross member level, Survey 3, ten months (308 days) after installation.	380
7.9. Small spiny lobster at Figure 7.8 site, Survey 3, ten months (308 days) after installation.	380
7.10. Atlantic pearl oyster (<i>Pinctada radiata</i>) with attached anemones during Survey 4, 13 months (389 days) after installation.	382
7.11. Acorn barnacles (<i>Megabalanus antillensis</i>) with attached anemones during Survey 4, 13 months (389 days) after installation.	382
7.12. Well-developed fouling community on HI A389-A during Survey 5 in October 1992 (4,020 days after installation)	383
7.13. Well-developed fouling community on HI A389-A during Survey 5 in October 1992 (4,020 days after installation)	383
7.14. Colony of <i>Porites astreoides</i> documented from horizontal support at depth of 9 m, June 1992.	385

LIST OF FIGURES
(continued)

<u>No.</u>		<u>Page</u>
7.15.	The same colony of <i>Porites astreoides</i> as in Figure 7.14, taken August 1995, colony measuring 42 by 38 cm with mortality in center approximately 8 by 6 cm. . . .	385
7.16.	Colony of <i>Diploria strigosa</i> at depth of 15.5 m. Photographed August 1995 when the coral measured 19 by 16 cm.	386
7.17.	The same colony of <i>Diploria strigosa</i> as in Figure 7.16. Photographed August 1998.	386
7.18.	View of 53-m horizontal support and descending diagonal on HI A389-A platform from depth of 58 m.	387
7.19.	Location of eight platforms sampled on MS/AL shelf during a pilot study on fish assemblages associated with oil and gas platforms in 1995.	397
7.20.	Water column transmissivity for the eight oil and gas platforms surveyed on the MS/AL shelf during 1995.	401
7.21.	Transmissometer profile from platform 4 (MP-202-A) during a pilot study of oil and gas platforms on the MS/AL shelf in 1995.	402
7.22.	Number of taxa observed by each gear from pilot study of oil and gas platforms on the MS/AL shelf in 1995	405
7.23.	Number of taxa observed within each platform and outside each platform from pilot study of oil and gas platforms on MS/AL shelf in 1995	406
7.24.	Mean density of selected taxa recorded by the Aimed Video gear during a pilot study of oil and gas platforms on the MS/AL shelf in 1995	407
7.25.	Mean density of selected taxa recorded by the Pan & Tilt and 4-Camera Array video gears during a pilot study of oil and gas platforms on the MS/AL shelf in 1995	407
7.26.	Mean density of all fish observed at each depth for P&T, AV and 4-C video gears combined, during a pilot study of oil and gas platforms on the MS/AL shelf in 1995	409
7.27.	Mean density of red snapper by depth for the P&T, AV and 4-C video gears combined, during a pilot study of oil and gas platforms on the MS/AL shelf in 1995.	410
7.28.	Mean density of gray snapper by depth for the P&T, AV and 4-C video gears combined, during a pilot study of oil and gas platforms on the MS/AL shelf in 1995.	411
7.29.	Mean number of fish per 100 m ³ (+/- SE) for each oil and gas platform surveyed during a pilot study on the MS/AL shelf in 1995	412

LIST OF FIGURES
(continued)

<u>No.</u>		<u>Page</u>
7.30.	Mean density of total fish versus dominant attached epifauna from eight oil and gas platforms surveyed during a pilot study on the MS/AL shelf in 1995	413
7.31.	Mean densities of snappers versus dominant attached epifauna from eight oil and gas platforms surveyed during a pilot study on the MS/AL shelf in 1995	413
7.32.	Schematic view of stationary hydroacoustic transducer deployment to measure <i>in situ</i> target strength and density of fishes throughout the water column on each side of the platform for the three study sites.	424
7.33.	Schematic view of stationary hydroacoustic transducer deployment to measure horizontal relative density of fishes associated with petroleum platforms.	425
7.34.	Mean fish density (number of fish/m ³) by year at Green Canyon 18 (GC18) and Grand Isle 94 (GI94) from July 1994 to March 1997 and South Timbalier (ST54) from August 1995 to February 1997.	429
7.35.	Mean fish density (number of fish/m ³) by season at Green Canyon 18 (GC18) and Grand Isle 94 (GI94) from July 1994 to March 1997 and South Timbalier 54 (ST54) from August 1995 to February 1997.	429
7.36.	Mean fish density (number of fish/m ³) by time of day from Green Canyon 18 (GC18) and Grand Isle 94 (GI94) from July 1994 to March 1997 and South Timbalier 54 (ST54) from August 1995 to February 1997.	430
7.37.	Mean fish density (number of fish/m ³) by platform side from Green Canyon 18 (GC18) and Grand Isle 94 (GI94) from July 1994 to March 1997 and South Timbalier 54 (ST54) from August 1995 to February 1997.	430
7.38.	Mean relative fish density (number of fish/m ³) by distance from the platform at Green Canyon 18 (GC18) and Grand Isle 94 (GI94) from July 1994 to March 1997 and South Timbalier 54 (ST54) from August 1995 to February 1997.	432
7.39.	Mean fish density (number of fish/m ³) by depth at Grand Isle 94 (GI94) from July 1994 to March 1997 and South Timbalier 54 (ST54) from August 1995 to February 1997.	434
7.40.	Estimated number of fishes for each quarterly sample period at Green Canyon 18 (GC18) and Grand Isle 94 (GI94) from July 1994 to March 1997 and South Timbalier (ST54) from August 1995 to February 1997.	441
7.41.	Mean fish density (number of fish/m ³) by depth at Green Canyon 18 from October 1994 to March 1997.	444
7.42.	Map of the sites surveyed in June 1999 and 2000.	474

LIST OF FIGURES
(continued)

<u>No.</u>	<u>Page</u>
7.43. Mean fish energy/m ³ (antilog of volume backscattering) by depth stratum for HI A350	478
7.44. Estimated mean fish density (fish/m ³) at depth for HI A350	479
7.45. Line drawings of WC 617A (toppled platform) and HI A355 (partially removed platform with a small four leg section to the southwest).	481
7.46. Plot of vessel track (dotted lines) over WC 617A (A) and HI A355 (B) for surveys conducted June 1999 and June 2000. Bathymetry contour show depths at each reef site and indicate the platforms	482
7.47. Acoustic depth profiles of WC 617A and HI A355 based on a geo-referenced plot of depth from the hydroacoustic survey conducted in June 1999 and 2000	484
7.48. Estimated mean fish energy /m ³ (antilog of volume backscatter) at distance from reef site for WC 617A (A) and HI A355 (B)	485
7.49. Estimated mean target strength (dB) at depth stratum for WC 617A (A) and HI A355 (B)	487
7.50. Estimated mean fish density (fish/m ³) by depth stratum for WC 617A (A) and HI A355 (B)	488
8.1. Numerical proportion (upper row) and gravimetric proportion (bottom row) for the prey items in the diets of blue runner from the two platforms sampled	504
8.2. Monthly variation in Index of Relative Importance (IRI) for dominant prey taxa from the two platforms.	505
8.3. Stomach fullness values for blue runner collected over the summer at GI94B (top) and MP259A (below)	506
8.4. Length frequency distributions for decapods taken from surface plankton net and stomachs of concurrent captured blue runner (n=4) during June 1999.	507
8.5. Length distributions of hyperiid amphipods collected from a surface plankton net and from blue runner stomachs in June 1999 at Main Pass 259A.	508
8.6. Specifications for the modified quatrefoil light-trap used in this study.	517
8.7. Mean plankton net densities (a) and light-trap CPUEs (b) with standard errors for each sampling trip at Green Canyon 18 (1995-96)	520
8.8. Mean plankton net densities (a) and light-trap CPUEs (b) with standard errors for each sampling trip at Grand Isle 94 (1996)	524
8.9. Mean plankton net densities (a) and light-trap CPUEs (b) with standard errors for each sampling trip at South Timbalier 54 (1997)	526

LIST OF FIGURES
(continued)

<u>No.</u>		<u>Page</u>
8.10.	Mean pushnet densities (a) and light-trap CPUEs (b) with standard errors for each sampling trip at Belle Pass (1997)	527
8.11.	Mean plankton net densities (a) and light-trap CPUEs (b) with standard error bars for depths/locations within each platform site	528
8.12.	Size distributions of fish collected with light-traps (shaded bars) and plankton nets (open bars) at the Green Canyon site (1995-1996)	529
8.13.	Size distributions of fish collected with light-traps (shaded bars) and plankton nets (open bars) at the Grand Isle site (1996)	531
8.14.	Size distributions of fish collected with light-traps (shaded bars) and plankton nets (open bars) at the South Timbalier site (1997)	534
8.15.	Size distributions of fish collected with light-traps (shaded bars) and a pushnet (open bars) at the Belle Pass site (1997)	537
8.16.	Mean plankton net density (a) and light-trap CPUE (b) with standard error bars for each lunar phase sampled at Grand Isle 94 (Apr-Sep 1996)	540
8.17.	Mean plankton net density (a) and light-trap CPUE (b) with standard error bars for each lunar phase sampled in May 1996 at Grand Isle 94	541
8.18.	Mean plankton net density (a) and light-trap CPUE (b) with standard error bars for each lunar phase sampled at South Timbalier 54 (Apr-Sep 1997)	542
8.19.	Mean pushnet density (a) and light-trap CPUE (b) with standard error bars for each lunar phase sampled at Belle Pass (Apr-Sep 1997)	543
8.20.	Mean Shannon-Weiner diversity indices (with standard error bars) for each gear type and sampling location for each sampling site	545
8.21.	Southeast Area Monitoring and Assessment Program (SEAMAP) survey areas sampled during Summer Groundfish, Fall Plankton, Fall Groundfish and Spring Plankton cruises.	556
8.22.	Occurrence of holocentrid, priacanthid, labrid and scarid larvae taken during the 1982 to 1996 Summer Groundfish Surveys	558
8.23.	Occurrence of holocentrid, priacanthid, labrid and scarid larvae taken during the 1986 to 1994 and 1996 Fall Plankton Surveys	559
8.24.	Occurrence of holocentrid, priacanthid, labrid and scarid larvae taken during the 1986 to 1995 Fall Groundfish Surveys	560
8.25.	Occurrence of holocentrid, priacanthid, labrid and scarid larvae taken during the 1982 to 84 and 1986 to 1996 Spring Plankton Surveys	561

LIST OF FIGURES
(continued)

<u>No.</u>		<u>Page</u>
8.26.	Annual frequency of occurrence (%) of holocentrid, priacanthid, labrid and scarid larvae by year and area for the 1982 to 1996 Summer Groundfish Surveys.	563
8.27.	Annual frequency of occurrence (%) of holocentrid, priacanthid, labrid and scarid larvae by year and area for the 1986 to 1994 and 1996 Fall Plankton Surveys.	564
8.28.	Annual frequency of occurrence (%) of holocentrid, priacanthid, labrid and scarid larvae by year and area for the 1986 to 1995 Fall Groundfish Surveys.	565
8.29.	Annual frequency of occurrence (%) of holocentrid, priacanthid, labrid and scarid larvae by year and area for the 1982 to 1984 and 1986 to 1996 Spring Plankton Surveys.	567
8.30.	Overall frequency of occurrence (%) of holocentrid, priacanthid, labrid and scarid larvae by SEAMAP survey and area	568
8.31.	Occurrence of labrid and scarid larvae in relation to surface salinity for the 1992 to 1994 Summer Groundfish, Fall Plankton and Fall Groundfish surveys	569
8.32.	Occurrence of labrid and scarid larvae in relation to surface transmissivity for the 1992 to 1993 Summer and Fall Groundfish surveys	570
8.33.	Distribution and abundance of labrid and scarid larvae during Oregon II, Cruise 203 in relation to sea surface height. Black vectors are relative geostrophic currents	572
8.34.	Distribution and abundance of labrid and scarid larvae in relation to sea surface height during the Spring Plankton survey from April 19 to May 19, 1993. White vectors represent relative geostrophic currents	573
8.35.	Distribution and abundance of labrid and scarid larvae in relation to sea surface height during the Spring Plankton survey from May 20 to June 19, 1993	574
8.36.	Map of the sites surveyed in June 1999 and 2000.	583
8.37.	Recorded track lines of the WFGB hydroacoustic survey conducted in June 2000.	587
8.38.	Echogram of WFGB survey conducted June 2000. (A). Screen image includes dB color scale on left and depth on the right side; red box highlights an area of high acoustic reflectance presumed to be fish and plankton. (B). Magnified image of a gentle slope onto the upper Terrace (@40m); arrows highlight fish targets.	588
8.39.	Echograms from June 2000 hydroacoustic survey of the WFGB. (A) Linear changes in reflectance illustrate the value of hydroacoustics in characterizing bottom type. (B) Large areas of low reflectance on the bottom are thought to be gas seeps on the lower terrace.	589

LIST OF FIGURES
(continued)

<u>No.</u>		<u>Page</u>
8.40.	An image of the relative horizontal acoustic reflectance over a bathymetry outline of the WFGB	591
8.41.	An image weighted by depth of the relative horizontal acoustic reflectance over a bathymetry outline of the WFGB	591
8.42.	Estimated density of fish (fish/m ³) over the West Flower Garden Bank based on a dual beam hydroacoustic survey conducted in June 2000	592
8.43.	Mean target strength (dB) by Terrace over the West Flower Garden Bank based on a dual beam hydroacoustic survey conducted in June 2000	592
9.1.	Relationship between temperature and standing stock for the amphipods <i>Gammarus</i> sp. and <i>Corophium</i> sp. at EB165A and HI389A.	605
9.2.	Relationship between temperature and standing stock for the amphipods <i>Corophium biglovia</i> and <i>Corophium louisiana</i> at EB165A and HI389A.	606
9.3.	Relationship between temperature and standing stock for the amphipod <i>Caprella equilibris</i> at EB165A and HI389A.	607
9.4.	Artificial Reef Study Site. High Island A-532.	617
9.5.	Monitoring station locations: stations 1 through 5.	619
9.6.	Digital images of upper 50 cm of stations 1 through 5.	620
9.7.	Average growth measured at station 1 from 5/11/00 - 8/8/00	622
9.8.	Average growth measured at station 3 from 5/11/00 - 8/8/00	622
9.9.	Summary of growth measurements taken at station 1 from 5/11/00 - 8/8/00.	623
9.10.	Summary of growth measurements taken at station 3 from 5/11/00 - 8/8/00	624
9.11.	Average growth measured at station 1 from 8/8/00 – 9/13/00	624
9.12.	Average growth measured at station 2 from 8/8/00 – 9/13/00	625
9.13.	Average growth measured at station 3 from 8/8/00 – 9/13/00	626
9.14.	Average growth measured at station 4 from 8/8/00 – 9/13/00	626
9.15.	Map of existing petroleum platforms in the U.S. Gulf of Mexico (source: U.S. Department of Interior, Minerals Management Service, http://www.mms.org).	635
9.16.	Map of artificial reef permit areas off the coast of Alabama in the northern Gulf of Mexico.	635
9.17.	Map of the State of Alabama’s Hugh Swingle permit area for artificial reef deployment with nine artificial reef sites over which red snapper were tagged.	636

LIST OF FIGURES
(continued)

<u>No.</u>	<u>Page</u>
9.18. Distribution of total length at tagging of red snapper tagged in this study.	641
9.19. Distribution of total length at recapture of terminal recaptures at tagging sites (black bars, n = 192) and measured terminal recaptures from fishers (gray bars, n = 97).	641
9.20. Distribution of number of recaptures made on tagging trips over time and fitted non-linear decay models for A. all terminal recaptures (n = 191), B. terminal recaptures not at liberty during hurricanes (n = 149), C. terminal recaptures not transported prior to release (n = 172), and D. terminal recaptures not at liberty during hurricanes or transported prior to release (n = 139)	642
9.21. Spatial distribution of recaptures reported by fishers (n = 251)	642
9.22. Delta method estimates of mean distance and mean velocity of movement	643

LIST OF TABLES

<u>No.</u>	<u>Page</u>
1.1.	The number of platforms incorporated in Rigs-to-Reefs programs in the GOM compared to numbers present by water depth from 1987-1999. 6
1.2.	Estimates of research support and value provided by the GOM oil and gas industry 9
2.1.	Standing stocks of benthic biota at 3.65 km depth site in the NW Gulf of Mexico 28
2.2.	Landings of tunas and wahoo from the Gulf of Mexico in 1998 (Source: NMFS). . . . 58
3.1.	Comparison of marine aquaculture strategies as categorized by degree of exposure operation to natural oceanographic and storm events. 76
3.2.	Open Ocean Aquaculture (OOA) Symposia allowing open dialogue and promotion of international development of open ocean aquaculture. 77
3.3.	Growth performance index (Φ') ^a calculated from cited L_{∞} (cm) and K values for potential aquaculture species indigenous to the northern Gulf of Mexico 79
3.4.	Permits acquired to deploy an aquaculture cage on a single-point mooring (SPM) in Gulf of Mexico federal U.S. waters and conduct Year 1 oceanographic research (upper portion of table) and potentially necessary for Year 2 aquaculture research (lower portion of table). 81
3.5.	Comparison of scenarios for integration of oil and gas (O&G) platforms in the development of offshore aquaculture in the Gulf of Mexico. 82
3.6.	Simplistic outline of potential expenses experienced for each of the offshore aquaculture strategies outlined in Table 3.4. 87
4.1.	Total estimated private boat fishing trips near oil and gas structures. 146
4.2.	Total estimated charter boat fishing trips near oil and gas structures. 147
4.3.	Total estimated party boat fishing trips near oil and gas structures. 147
4.4.	Total estimated dive trips near oil and gas structures. 148
4.5.	Total economic impact of combined annual trip and equipment expenditures for fishing and diving near oil/gas structures in coastal counties by state and mode. 149
4.6.	Target species for fishermen. 150
4.7.	Average catch per trip for selected species: Private boats in Alabama. 151
4.8.	Average catch per trip for selected species: Private boats in Mississippi. 151
4.9.	Average catch per trip for selected species: Private boats in Louisiana. 151

LIST OF TABLES
(continued)

<u>No.</u>		<u>Page</u>
4.10.	Average catch per trip for selected species: Private boats in Texas.	152
5.1.	Daily schedule for swimming performance tests.	173
5.2.	Weight (g), fork length (mm), pre-exposure U_{crit} and post-exposure U_{crit} ($cm\ s^{-1}$, BL s^{-1}) for treatment and control Florida pompano.	176
5.3.	Estimated LC_{50} values for several fish species exposed to ethylene glycol.	178
5.4.	Summary of the commonly observed adult fish assemblages associated with natural reefs or offshore oil and gas platforms by depth zones as reported in Gallaway <i>et al.</i> (1980) and subsequently modified by Gallaway (1981)	188
5.5.	Number of samples collected at each site by date, gear type, and depth/location. No lunar phase information was recorded for West Cameron 352	197
5.6.	Total plankton net density (fish/100 m^3) and light-trap CPUE (fish/10 min) for fish collected at Green Canyon 19 with standard error (SE), rank, percent of total catch (%), and months collected for each taxa	200
5.7.	Total plankton net density (fish/100 m^3) and light-trap CPUE (fish/10 min) for fish collected at Grand Isle 94 with standard error (SE), rank, percent of total catch (%), and months collected for each taxa	209
5.8.	Total plankton net density (fish/100 m^3) and light-trap CPUE (fish/10 min) for fish collected at South Timbalier 54 with standard error (SE), rank, percent of total catch (%), and months collected for each taxa	219
5.9.	Total mean light-trap CPUE (fish/10 min) and pushnet density (fish/100 m^3) for fish collected at Belle Pass with standard error (SE), rank, percent of total catch (%), and months collected for each taxa	227
5.10.	Total plankton net density (fish/100 m^3), pushnet density (fish/100 m^3), and light- trap CPUE (fish/10 min) for reef-dependent (RD) and reef-associated (RA) families of fish collected at each site with standard error (SE)	236
5.11.	Schoener's Index of Niche Overlap for all sampling sites. Values range from 0-1 and include taxa (at least to the level of genus) from all gears used at each site	242
5.12.	Results of a canonical correlation analysis on log-transformed plankton net densities (15 most dominant taxa) and environmental variables for Green Canyon 18	244
5.13.	Results of a canonical correlation analysis on log-transformed light-trap CPUEs (18 most dominant taxa) and environmental variables for Green Canyon 18	246
5.14.	Results of a canonical correlation analysis on log-transformed plankton net densities (15 most dominant taxa) and environmental variables for Grand Isle 94	247

LIST OF TABLES
(continued)

<u>No.</u>		<u>Page</u>
5.15.	Results of a canonical correlation analysis on log-transformed light-trap CPUEs (16 most dominant taxa) and environmental variables for Grand Isle 94	248
5.16.	Results of a canonical correlation analysis on log-transformed plankton net densities (15 most dominant taxa) and environmental variables for South Timbalier 54	249
5.17.	Results of a canonical correlation analysis on log-transformed light-trap CPUEs (16 most dominant taxa) and environmental variables for South Timbalier 54	250
5.18.	Results of a canonical correlation analysis on log-transformed pushnet densities (15 most dominant taxa) and environmental variables for Belle Pass jetty	251
5.19.	Results of a canonical correlation analysis on log-transformed light-trap CPUEs (15 most dominant taxa) and environmental variables for Belle Pass jetty	252
6.1.	Summary of trawling effort for this study. Latitudes and longitudes are in degrees and minutes North and West respectively. Gear size is the headrope length, in meters, of the trawl. SysRdm=systematic random, 2DSys=two-dimensional systematic, StratRdm= stratified random.	287
6.2.	Summary of mean CPUE (No./hr, kg/hr) of the major fish in the coastal pelagics complex.	288
6.3.	Mean (+/- S.E.,in No. hr ⁻¹) of these species in each GOMEX zone	295
6.4.	Species with the most biomass or most occurrences predominating in the different regions.	296
6.5.	Mean catch (+/- S.E., in No. hr ⁻¹) of squid across depth (m) strata	308
6.6.	Species with biomass or occurrence predominant at the different depths	309
6.7.	Mean length (cm) and weight (g) of major pelagic species.	310
6.8.	Number of trips and sets sampled from Texas recreational headboats in August and September 1999 by fishing port.	336
6.9.	Frequency distribution (A. Total %; B. Cumulative %) for total length (mm) of red snapper measured during Texas recreational headboat sets in August and September 1999.	339
6.10.	Percentage of red snapper measured greater than or equal to 450, 425, 400, and 375 mm (18, 17, 16, and 15 inches) total length caught during Texas recreational headboat sets in August and September 1999.	342

LIST OF TABLES
(continued)

<u>No.</u>		<u>Page</u>
6.11.	Mean depth (m) and frequency for condition (when brought on board) of red snapper measured during Texas recreational headboat sets in August and September 1999.	344
6.12.	Mean depth (m) and frequency for discard fate of red snapper measured during Texas recreational headboat sets in August and September 1999.	347
6.13.	Mean total length (mm) and frequency for discard fate of red snapper measured during Texas recreational headboat sets in August and September 1999	347
6.14.	Discards and landings (numbers) of red snapper measured from Texas recreational headboat sets in August and September 1999 by fishing port.	349
6.15.	Discards and landings (whole weight, kg) of red snapper measured from Texas recreational headboat sets in August and September 1999 by fishing port	349
6.16.	Discards and landings (mean total length, mm) of red snapper measured from Texas recreational headboat sets in August and September 1999 by fishing port	350
7.1.	Estimated mortality and descriptive statistics by species and platform.	359
7.2.	Estimated mortality of the five most impacted species.	363
7.3.	Recapture rates (100 x number of tags recovered/number of tags released) for tag-recapture study.	364
7.4.	Population estimates by species and platform.	364
7.5.	Mortality rates (100 x estimated mortality / population estimate) by species and platform.	364
7.6.	Comparison of red snapper mortalities collected at the surface (floaters) with estimated mortality from the sea floor (sinkers).	366
7.7.	Comparison of total length of positively (floater) and negatively (sinker) buoyant red snapper by platform.	366
7.8.	Species list and estimated abundance above 37 m depth at platform HI A389-A	376
7.9.	Location, depth and date sampled, of each oil and gas platform surveyed on the MS/AL shelf during the 1995 pilot study	396
7.10.	Video sampling effort by depth at eight oil and gas platforms surveyed during 1995 on the MS/AL shelf	399
7.11.	Sampling volume of video cameras used to survey oil and gas platforms on the MS/AL shelf, during 1995.	400

LIST OF TABLES
(continued)

<u>No.</u>		<u>Page</u>
7.12.	Families observed in all video samples combined from oil and gas platform pilot study on the MS/AL shelf during 1995.	403
7.13.	Percent occurrence of all taxa observed at eight oil and gas platforms with all video gears from a pilot study on the MS/AL shelf in 1995	404
7.14.	RBD ANOVA (block on platform side) results of vertical log fish density log (fish density/m ³) with platform side, year, season, time of day, depth, current vectors, temperature, salinity, dissolved oxygen, and selected interactions at the ST54 petroleum platform.	428
7.15.	RBD ANOVA (block on platform side) results of horizontal log relative fish density (log (fish density/m ³) with platform side, year, season, time of day, distance from the platform, and selected interactions at the ST54 petroleum platform.	431
7.16.	Mean estimated number of fish by species and mean number enumerated and percent species composition by depth strata at South Timbalier 54 for all research trips from July 1995 to March 1997 from hydroacoustic and visual point count surveys.	433
7.17.	RBD ANOVA (block on platform side) results of vertical log fish density (log(number of fish/m ³) with platform side, year, season, time of day, depth, current vectors, temperature, salinity, dissolved oxygen, and selected interactions at the GI94 petroleum platform.	436
7.18.	RBD ANOVA (block on platform side) results of horizontal relative log fish density (log(number of fish/m ³) with platform side, year, season, time of day, distance from the platform, and selected interactions at the GI94 petroleum platform.	437
7.19.	Mean estimated number of fish by species and mean number enumerated and percent species composition by depth strata at Grand Isle 94 for all research trips from July 1994 to March 1997 from hydroacoustic and visual point count surveys.	439
7.20.	RBD ANOVA (block on platform side) results of vertical log fish density (log(number of fish/m ³) with platform side, year, season, time of day, depth, current vectors, temperature, salinity, dissolved oxygen, and selected interactions at the GC18 petroleum platform.	443
7.21.	RBD ANOVA (block on platform side) results of horizontal log relative fish density (log(number of fish/m ³) with platform side, year, season, time of day, distance from the platform, and selected interactions at the GC18 petroleum platform.	445

LIST OF TABLES
(continued)

<u>No.</u>		<u>Page</u>
7.22.	Mean estimated number of fish by species and mean number enumerated and percent species composition by depth strata at Green Canyon 18 for all research trips from August 1994 to March 1997 from hydroacoustic and visual pointcount surveys.	446
7.23.	RBD ANOVA (block on platform side) results of vertical target strength (dB) with platform side, year, season, time of day, depth, current vectors, temperature, salinity, dissolved oxygen, and selected interactions at the ST54 petroleum platform.	450
7.24.	Mean target strengths (dB), with Tukey's studentized means test results by season at South Timbalier 54.	451
7.25.	Mean target strengths (dB) with Tukey's studentized means test results by time of day at South Timbalier 54.	451
7.26	Mean target strengths (dB) with Tukey's studentized means test result by platform side at South Timbalier 54	451
7.27.	Mean target strength (dB) with Tukey's studentized means test by water depth (m) at South Timbalier 54.	452
7.28.	RBD ANOVA (block on platform side) results of vertical target strength (dB) with platform side, year, season, time of day, depth, current vectors, temperature, salinity, dissolved oxygen, and selected interactions at the GI94 petroleum platform.	453
7.29.	Mean target strength (dB) with Tukey's studentized means test by year at Grand Isle 94.	453
7.30.	Mean target strength (dB) with Tukey's studentized means test by season at Grand Isle 94.	454
7.31.	Mean target strength (dB) with Tukey's studentized means test by time of day at Grand Isle 94.	454
7.32.	Mean target strength (dB) with Tukey's studentized means test by platform side at Grand Isle 94.	454
7.33.	Mean target strength (dB) with Tukey's studentized means test by water depth (m) at Grand Isle 94.	455
7.34.	RBD ANOVA (block on platform side) results of vertical target strength (dB) with platform side, year, season, time of day, depth, current vectors, temperature, salinity, dissolved oxygen, and selected interactions at the GC18 petroleum platform.	456

LIST OF TABLES
(continued)

<u>No.</u>		<u>Page</u>
7.35.	Mean target strength (dB) with Tukey's studentized means test by time of day at Green Canyon 18.	456
7.36.	Mean target strength (dB) with Tukey's studentized means test by platform side at Green Canyon 18.	457
7.37.	Mean target strength (dB) with Tukey's studentized means test by water depth (m) at Green Canyon 18.	457
7.38.	Species common names and scientific names, numbers of individuals by stratum, totals, and percent composition from visual point counts using video from a remotely operated vehicle (ROV) from High Island A350, June 1999.	480
7.39.	Species common names and scientific names along with numbers of individuals by stratum, totals, and percent composition from visual point counts using video from a remotely operated vehicle (ROV) from a toppled platform (West Cameron 617A) June 1999.	489
7.40.	Species common names and scientific names along with numbers of individuals by stratum, totals, and percent composition from visual point counts using video from a remotely operated vehicle (ROV) from a partially removed platform (High Island A355), June 1999 and 2000.	490
8.1.	Regressions fitted for three prey categories commonly consumed by blue runner	502
8.2.	Number of samples, total individuals, families, and taxa collected at each site with a passive plankton net, light-trap, and plankton pushnet	519
8.3.	Size ranges (SL in mm) and percent of the total catch by gear for dominant taxa (>1%) collected by at least one gear type	521
8.4.	Schoener's Index of Niche Overlap values for different surface gear and location comparisons. (OL) off-platform light-trap, (SL) surface light-trap, (SN) surface net, (TL) total light-traps, (TN) total nets.	544
8.5.	SEAMAP surveys sampling effort	557
8.6.	Logistic analysis results of fish energy (antilog of volume backscatter) with class variables terrace level (Terrace), depth stratum (Stratum), and time of day (TOD) at WFGB.	582
8.7.	Species common names and scientific names along with numbers of individuals by stratum, totals, and percent composition from visual point counts using video from a remotely operated vehicle (ROV) from the West Flower Garden Banks, June 2000.	594

LIST OF TABLES
(continued)

<u>No.</u>	<u>Page</u>
9.1. Cohort Statistics for the amphipod <i>Gammarus</i> sp. at HI389A from March 1995-August 1995	608
9.2. Cohort Statistics for the amphipod <i>Corophium</i> sp. at EB165A, September 1996-July 1997	608
9.3. Cohort Statistics for the amphipod <i>Corophium biglovia</i> at EB165A, September 1996-April 1997	610
9.4. Cohort Statistics for the amphipod <i>Corophium louisiana</i> from EB65A, October 1996-April 1997	610
9.5. Cohort Statistics for the amphipod <i>Caprella equilibris</i> at EB165A, September 1996-April 1997	611
9.6. Composition and total volume of the nine artificial reef tagging sites	637
9.7. Dates of tagging trips, tagging sites samples, and number of red snapper tagged.	640
9.8. Literature review of some red snapper diet studies relevant to the present study.	657

ACKNOWLEDGMENTS

Dr. Ann Scarborough Bull, a former Gulf of Mexico Region staff member, came up with the idea to have this fisheries workshop. It was her goal to have a comprehensive document of fisheries research conducted in the Gulf of Mexico.

The success of this meeting is credited to all participants, especially the speakers and moderators for the time spent preparing for each session. Moderators and speakers are listed by name at the beginning of each session.

The University of New Orleans, Office of Conference Services, was the contractor responsible for logistics of the meeting. The dedicated staff and subcontractors play an integral role in the execution of this meeting and the compilation of the proceedings. Their efforts are greatly appreciated.

The staff of the Hilton New Orleans Airport was professional and attentive to our needs.

**SESSION 1:
PLENARY**

Date: October 24, 2000

Presentation	Author/Affiliation
Welcome	Ann Scarborough Bull Minerals Management Service David Stanley Beak International Incorporated
Rigs to Reefs: A Cooperative Effort Among Government, Industry, and Academia	Charles A. Wilson Department of Oceanography & Coastal Sciences and Coastal Fisheries Institute Louisiana State University Richard A. Kasprzak Louisiana Department of Wildlife & Fisheries
Bringing Together New and Recent Research	Andrew J. Kemmerer National Marine Fisheries Service
Ocean Policy	Roger McManus U.S. Department of the Interior

WELCOME

Ann Scarborough Bull
Minerals Management Service

David Stanley
Beak International Incorporated

Offshore petroleum platforms are uniquely designed to span from the bottom of the ocean through the wave-swept surface. From the beginning in 1947, platforms influenced the marine community and resource utilization of the Gulf of Mexico region. Domestic energy development increased the number of offshore platforms to the present level of over 4,000 structures in outer continental shelf waters. Along with the expansion of hydrocarbon extraction over this period, harvest and exploitation of fisheries resources also intensified. Prior to oil and gas development (1945 to 1950) in the Gulf of Mexico, commercial landings of finfish and shellfish in Louisiana and Texas ranged from 185 to 413 million pounds. As the petroleum industry expanded so did commercial fishery catches from the Gulf, peaking in the mid-1980s at about 1,700 million pounds. The current commercial landings are around 1,200 million pounds per year.

Offshore platforms and fisheries of the Gulf of Mexico continue to coexist. Over 90% of commercial red snapper landings (approximately 4 million pounds per year) originate in Louisiana waters, and while the exact amount harvested at petroleum platforms is unknown, it is known to be a significant portion of the harvest. In addition to the commercial fishers frequenting offshore structures, recreational fishers and SCUBA divers are common platform visitors. Surveys of recreational use found that 70% of all fishers in coastal Louisiana utilized petroleum platforms as fishing destinations and catches of anglers at these structures were the highest in the published scientific literature.

The use of offshore structures by marine organisms and the utilization of these resources by commercial and recreational fishers and SCUBA divers came long before scientific study of platform communities. While recreational and commercial users may not have understood the scientific relationship between the structures and species abundance, they were knowledgeable of the resources at these sites. As the importance of these structures became evident, scientific examination of how and why they impact the ecosystem in the Gulf of Mexico began.

Initially, research focused on possible impacts from the discharge of materials and the potential harm from hydrocarbon spills. Much later the scientific community realized that the actual physical presence of these structures could be affecting the abundance and distribution of marine organisms in the region. This later issue has been the focus of recent research.

Through the lay and scientific knowledge gained over the past 40 years, the common perception is that the 4,000 structures in the region constitute the largest artificial reef complex in the world. A typical four-pile platform jacket (the underwater support structure of an offshore platform) provides two to three acres of living and feeding habitat for thousands of underwater species. It is

hypothesized that artificial reefs and platforms improve and/or diversify habitat, increase resources, modify the assemblages of organisms in the region, or concentrate existing resources. The placement of these defacto reefs has impacted the regional marine community and, with assessments of the assemblages, modeling of discharges, and research into the non-target use of these structures, information exists as to the how and why these structures have impacted the marine ecosystem of the region.

Despite the long-term relationship between the Gulf of Mexico and hydrocarbon production, a compendium of the results from fisheries-related research does not exist. It is the goal of this meeting to bring together 30 years of widely spread investigations from the offshore waters of the Gulf of Mexico. Although we highlight the relationship between petroleum production and the environment, we include studies well beyond the scope of that topic. The 48 presentations at this meeting represent the culmination of research by academic, state, federal and private sector scientists from all areas of the Gulf. A lesson learned from the sessions was that, while many issues have been resolved for every question answered, new and important investigations result. Thus, while this may be the first summary of the impact and relationship between offshore structures, the marine ecosystem and fisheries, it will not be the last.

We acknowledge the efforts and guidance of the many people who contributed to the workshop and this document. First, we would like to thank the Minerals Management Service (MMS) for sponsoring the workshop and a large portion of the research presented. We would also like to thank Ms. Debra Vigil (MMS), Ms. Anne O’Heren Jakob and Ms. Patricia Artega (University of New Orleans) for the organization, logistics and managing both the workshop and this document. Finally, we acknowledge the efforts of the authors and their efforts in the laboratory and field resulting in a better understanding of our interaction with the marine environment of the Gulf of Mexico.

Ann Scarborough Bull, Ph.D.
Minerals Management Service
770 Paseo Camarillo
Camarillo, CA 93010
E-mail: Ann.Bull@mms.gov
Phone: (805) 389-7855

David Stanley, Ph.D.
Beak International Incorporated
14 Abacus Road
Brampton, ON, Canada. L6T 5B7
E-mail: DStanley@beak.com
Phone: (905) 794-2325

RIGS TO REEFS: A COOPERATIVE EFFORT AMONG GOVERNMENT, INDUSTRY, AND ACADEMIA

Charles A. Wilson
Department of Oceanography & Coastal Sciences and
Coastal Fisheries Institute
Louisiana State University

Richard A. Kasprzak
Louisiana Department of Wildlife & Fisheries

This paper provides an introduction to Rigs-to-Reefs and associated research activity in the Gulf of Mexico (GOM). Herein, we provide a summary of that activity with emphasis on Louisiana and present some new information on the role and value of the cooperation between industry, academia, and government in pursuit of science.

Most proponents of the Rigs-to-Reefs program know the story about the evolution of the oil and gas industry offshore. It began in the early 1940s as technology and demand for hydrocarbon took the United States into progressively deeper waters of the GOM and other parts of the world. The first offshore structures were in the Ship Shoal area. These old wooden structures have since been replaced by large steel towers, but even as early as the 1940s, the fishing value of this “new habitat” was realized by local fishers.

By the late 1970s and early 1980s, several grass roots organizations and officials within the Minerals Management Service (MMS) began to raise awareness of the pending loss of fishing hot spots that fishers had come to enjoy. Then Secretary James Watt and Mr. Villere Reggio of the MMS began to advocate the concept of Rigs-to-Reefs. Dr. Bob Ditton of Texas A&M, working with Mr. Reggio, used platform-based volunteers to record the frequency of visits to platforms by fishers. They showed up to 70% of the trips that venture beyond the Barrier Islands made use of platforms for fishing activities. This information gave science its first insight into the fisheries’ value and the economic importance of fish associated with oil and gas platforms (Ditton *et al.* 1984).

In the early 1980s, Congressman John Breaux introduced the National Fishing Enhancement Act (NFEA), which set into place mechanisms by which artificial reefs could be created. This new law encouraged states to develop well-planned, well-organized artificial reef programs (Stone 1985).

In response to the NFEA and a local interest in preserving the oil and gas platforms to which people had become accustomed, the Louisiana Artificial Reef Initiative began at Louisiana State University (LSU) in cooperation with the Louisiana Department of Wildlife and Fisheries (LDWF). This ad hoc group worked together to develop state legislation that became known as the Louisiana Fishing Enhancement Act of 1986 and set into motion the first state supported “Rigs-to-Reefs” program. The act addressed the long-term liability of state funding and called for the development of the State plan. Later in 1986, a plan was developed by LDWF and LSU, which included input from identified user groups (commercial, recreational, and industry) and regulatory agencies. Using exclusion

mapping, the authors identified areas that were compatible with artificial reef development off Louisiana, which led to the establishment of nine Planning Areas (Wilson *et al.* 1987).

Shortly after Louisiana's efforts to develop a program, Texas set in motion a similar program, and both states have been very active in turning platforms into reefs. By the end of 1999, 145 oil and gas structures had been made into artificial reefs in the GOM (Table 1.1). Over the past 12 years, activity has varied from year to year with as many as 30 platforms being emplaced in one year. At this point, Rigs-to-Reefs programs are well entrenched within the industry; participants know whom to call and know the process by which reef permitting and reef establishment takes place.

Table 1.1. The number of platforms incorporated in Rigs-to-Reefs programs in the GOM compared to numbers present by water depth from 1987-1999.

Water Depth (ft)	Oil & Gas Structures	Structures Removed	Artificial Reefs Gulf of Mexico
0-20	330	230	0
21-100	2335	916	7
101-200	770	220	79
201-400	433	67	59
401+	70	1	0
TOTAL	3938	1434	145

The public is fairly unaware, however, of the fact that depth limits the logistics of reef creation. Some 10% of the platforms that have been retired since 1986 have made it into reef programs. However, most of the platforms in water depths greater than 200 ft., (59 of 67) and nearly half (79 of 220) in water depths between 100 ft. and 200 ft. have been used in reef programs since 1986 (Table 1.1). Unfortunately, in water depths less than 100 ft., liability associated with clearance and required navigation aids limits their utilization. Our prediction for the future is that there will be a short-term hiatus in reef development due to new oil and gas recovery technology; however, removal is inevitable. There are proponents within user groups that say we should keep all structures in place.

Louisiana recently took a major step in preserving a very popular fish area by converting the Freeport McMoran Sulfur Rig off Grand Isle, Louisiana, into an artificial reef. This large, unique design incorporates the platform legs as anchors for the crossmembers and decking laid on the bottom; a five-point lighting system provides constant navigational aids that are monitored and maintained by LDWF. This new reef has been shown to harbor a great number of amberjack, cobia, and mangrove snapper. It is a primary destination for many fishers fishing just offshore of the Grand Isle area.

Thanks to funds made available to this program through the Sportfish Restoration Act, the Artificial Reef Trust Fund, and most recently the MMS Coastal Marine Initiative (CMI), we are now learning a great deal about platforms and the associated life. Scientists at LSU, Texas A&M, and elsewhere have explored around and under these platforms with divers, videos and hydroacoustic equipment. For the first time ever, we can put fish numbers to platforms (Figure 1.1). We are now confident that approximately 10,000-20,000 fish live around each operating platform in depths over 100 ft. and that desired species such as creole fish, red snapper, and mangrove snapper are abundant. A simple calculation of the density of red snapper around platforms in water depths of 70-250 ft. yields an estimate of red snapper in excess of one million red snapper associated with these platforms alone.

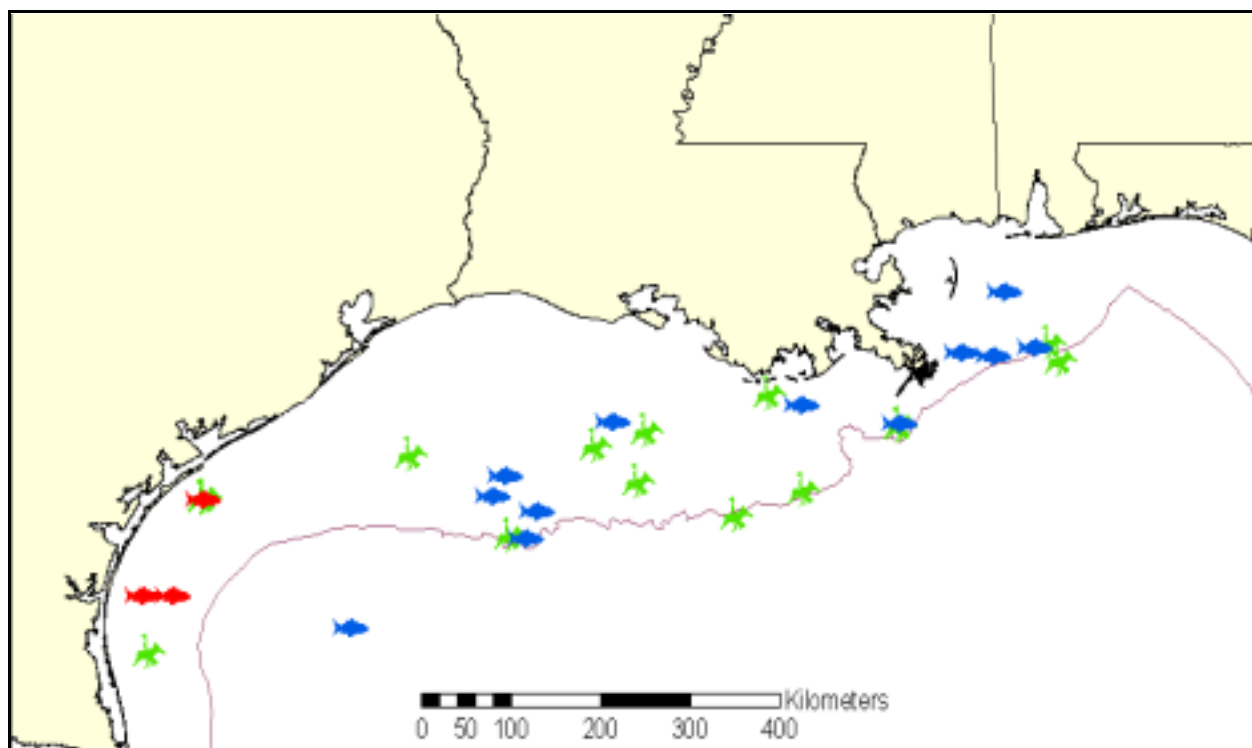

Figure 1.1. Distribution of Gulf of Mexico oil and gas platforms visited by scientists from 1985 – 2000. Symbols indicate either bird or fishery research.

This research has only been possible because of the cooperative attitude between industry, academia, and government. Although funding has been available to conduct this research, it would not have been possible had certain grass roots elements within the infrastructure of the industry been willing to take a step (or leap of faith) in working out legal agreements to allow scientists to visit and conduct research on platforms. Companies like Mobil, BP, Chevron, Amoco, Texaco, and Exxon are just a few who helped pioneer cooperative agreements and set in motion what will probably become one of the most successful cooperative research efforts ever.

A number of different researchers have benefitted from industry's willingness to support research. As an example of how important this cooperative research is, we offer the following summaries. Dr. Bob Russell of the Center for Coastal Energy and Environmental Resources at LSU has been

actively engaged in tracking the migration of birds across the northern GOM. He has documented many new species-specific migrations; this research would not have been possible without industry cooperation. Dr. Russell estimates that his three-year CMI-funded research effort (with 100% in kind match from industry) would have required eight man-years of ship time. Species of interest include Prothonotary Warblers, hummingbirds, and Peregrin Falcons. Not only have the sightings of falcons off platforms dwarfed the previous estimates of population size, but Dr. Russell also believes that the placement of platforms in the GOM has likely increased the survival of migrating birds.

Another important example of industry cooperation that exemplifies long-term vision and cooperation is WAVCIS. This program, established by Dr. Greg Stone of LSU's Coastal Studies Institute and the Department of Oceanography, depends upon oil and gas cooperators such as Paul Broussard of Texaco to establish permanent sea-state monitoring stations on a gridwork of platforms off Louisiana. These stations were designed and funded to serve as early warning systems for the projection of tidal surge associated with hurricanes; they are also great aids to fishers heading offshore. The information associated with this project is particularly important to organizations like FEMA and even Baton Rouge's Office of Emergency Preparedness.

There is still more to come; the Minerals Management Service, through the Coastal Marine Initiative at LSU, has launched a biotechnology initiative. Scientists are now proposing to study the plethora of organisms associated with platforms that might be useful in biomedical research. Several projects have already been funded to archive organisms, the results of which will be later targeted for medical research.

One can understand the commitment that the oil and gas companies have made to research effort by looking at a simple map of the Gulf showing where research has taken place. Figure 1.2 illustrates the different sites off Louisiana, Texas, Alabama, and Mississippi that serve on platform-based research projects. Furthermore, Table 2 illustrates the value of that research. We estimate that over 120 scientists and students have collectively made 400+ trips to platforms since 1985; they spent a total of 22 platform man-years offshore, logged over 2,000 helicopter hours, and over 250 vessel days. The applied research value (match used by researchers as in-kind support) of this contribution exceeds \$3,500,000. The real cost to duplicate such research platforms would be much more, considering that research vessels cost over \$4,000 per day.

As scientists, we recognize that platforms are unique research stations for oceanography, meteorology, and now even bird and medical research. We, as benefactors of this cooperation in the name of science, pose the question, "What can we do to assure that this cooperation will continue and grow?" We must ask industry, "What can we do to help them continue to make the corporate commitment to supporting research activities?" The concept of "good corporate citizens" eventually dwindles with fiscal reality. These potential research platforms are scattered throughout the world; over 6,000 are currently in use. Future cooperation will not be just limited to the GOM. In addition, our visions should not be limited to the continental shelf but should include deep water. As the industry approaches the ocean basin, this cooperative research activity will become even more valuable.

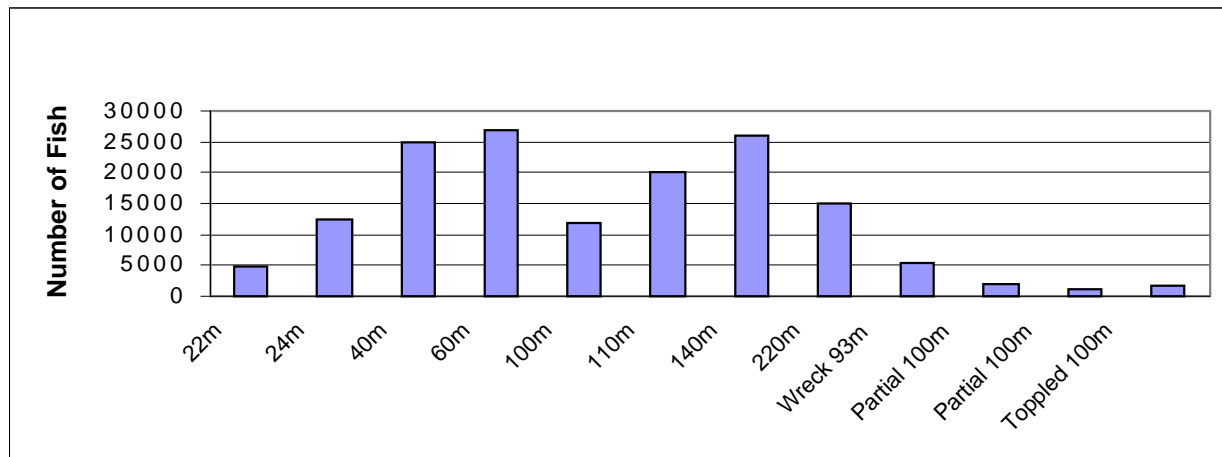

Figure 1.2. Estimated number of fish around platforms and reef sites. Depth in meters (m) refers to water depth of standing platforms. Wreck 93m refers to a drilling rig that sank during a hurricane, Partial 100m refers to partial removal projects, both in 100m water depth, and Toppled 100m refers to a platform toppled on its side.

Table 1.2. Estimates of research support and value provided by the GOM oil and gas industry. Data were provided by Texas A&M and LSU scientists.

Number of Trips	Platform Man Years	Helicopter Hours	Vessel Days	Research Value
406	22.0	2,077	263	\$3,600,000

38 Scientists
91 Students

RECOMMENDATIONS

We encourage MMS to work with industry and interested academic entities to identify mechanisms to encourage and reward industry for such risk-taking. Since they will incur the expense of infrastructure support for research, there should be some incentives (tax credits, mitigation) to continue or even increase industries' desire to cooperate. As scientists, we want industry to continue to be our partners, and it is only through active dialogue that we can ensure that this will continue.

REFERENCES

- Ditton, R., J. Auyong, and V. Reggio. 1984. Fishing Offshore Platforms Central Gulf of Mexico. Minerals Mgmt. Service OCS Monograph MMS 84-0006.
- Stone, R. 1985. National Artificial Reef Plan. NOAA Tech. Mem. NMFS-OF-6. Washington D.C.
- Wilson, C.A., V. Van Sickle, and D.L. Pope. 1987. Louisiana Artificial Reef Plan. Louisiana Department of Wildlife and Fisheries Technical Bulletin 41, Baton Rouge Louisiana.

BRINGING TOGETHER NEW AND RECENT RESEARCH

Andrew J. Kemmerer
National Marine Fisheries Service

The ecosystem from the Texas mud flats and Louisiana wetlands to the reefs off Florida then to the deeper waters of the shelf is truly unique. It supports a broad range of important industries. Management or conservation strategies associated with this ecosystem simply always involve uncertainty and risk; the question is how much risk we are willing to accept. We need to minimize the risks, but at the same time we need to try to maximize the benefits.

After almost a decade of serving as a member of three different fishery management councils, all at the same time, I am convinced that reasonable people can work together to achieve reasonable solutions to complex environmental issues as long as these solutions have a firm footing in science. Good science is key, but unfortunately it will never be quite good enough for some, so there will continue to be controversy.

The Magnuson-Stevens Act provides the national framework for conserving and managing our wealth of fishery resources. In 1996, the U.S. Congress acknowledged the importance of habitat in achieving the full benefits from fishery resources when they enacted the Sustainable Fisheries Act (SFA). One aspect of the SFA was to refine the focus of fisheries management by emphasizing the need to protect fisheries habitat. Consistent with this emphasis, Congress required that fishery management plans identified as “essential fish habitat” (EFH) those areas necessary to fish for their basic life functions. EFH was defined as “...those waters and substrate necessary to fish for spawning, breeding, feeding, or growth to maturity.” The areas that may be defined as EFH are waters of the United States—that is, state and federal waters with the offshore boundary being the outer limit of the Exclusive Economic Zone (EEZ). EFH only includes water, but indirectly involves watersheds as well because actions there can affect the waters they drain into.

EFH, probably cannot be considered new any more, except on a relative basis, compared to some of the other requirements of the Magnuson-Stevens Act. It is, however, controversial and I have been asked to talk about it in the context of OCS oil and gas development. The effectiveness of EFH depends on its reasonable application by reasonable people based on good science. The National Marine Fisheries Service was sued on its implementation of EFH. It is a good topic and one I struggled with over the last several years.

As most people here are well aware, most of the requirements of the Magnuson-Stevens Act are being addressed through eight regional fishery management councils, as prescribed by the Act. The exceptions are the highly migratory species including many of the sharks, billfishes, and tunas, which are being handled by the Secretary of Commerce through the National Marine Fisheries Service (NMFS). Congress imposed a deadline of October 1998 for EFH amendments to each of the fishery management plans, and I believe that all but one of the EFH amendments has been completed. However, the EFH amendments by three of the fishery management councils were only partially approved. This approval included the amendments by the Gulf of Mexico Fishery

Management Council. The problem with the Gulf Council's amendments, which I had a part in preparing, was that they did not fully address all managed species, mainly due to a lack of information. NMFS is working with the affected councils and we hope that the deficiencies will be corrected soon.

Overall, the work done by the fishery management councils to respond to the EFH requirements of the Sustainable Fisheries Act was quite good, and I would strongly recommend that anyone dealing with marine and estuarine waters get copies of the appropriate amendments. They contain a tremendous amount of information consisting of maps, lots of tables, and good descriptive summaries. A high priority for the agency is to get this information into GIS systems so it will be even more useful and available. Already, this has been done for the New England, Pacific, and North Pacific Councils.

The best way to conceptualize Essential Fish Habitat is that it is the habitat necessary for federally managed fish species to complete their life cycles. Generally, EFH for any given fish species constitutes only a portion of the total available habitat. Usually, this is between 50 and 70% of the geographic range of a life stage of a managed species. However, once individual EFH designations for all species in an area are overlaid, the mosaic of designations tends to be inclusive. That is, there are few marine and estuarine areas in federal and state waters which are not EFH for something. This designation has caused considerable controversy and has been a principal point of discussion at a number of Congressional hearings. It is, however, something that should have been expected, especially considering the number of species and life stages involved. Throughout U.S. waters, we are talking about more than 700 species each with distinct life stages and habitat requirements. Interestingly, each of the eight fishery management councils realized essentially the same result with most of their waters being designated EFH.

At my last count, the Gulf of Mexico Fishery Management Council had seven fishery management plans for reef fish, red drum, shrimp, coastal migratory pelagics, stone crab, spiny lobster, and coral and coral reefs. In addition, the Secretary of Commerce, through the NMFS, has two plans including billfish and highly migratory species such as the tunas and sharks. A substantial number of species are represented by these plans, each with unique habitat requirements. A number of these species occur in the Outer Continental Shelf (OCS) area and as a result, their habitat needs have to be considered through the EFH provisions of the plans in any development of offshore oil and gas.

Because of the expected broad designations of EFH, a provision for designating habitat areas of particular concern (HAPCs) was used to help focus EFH conservation priorities. These are areas within EFH that provide extremely important ecological functions and/or are especially vulnerable to degradation. This designation has caused controversy first because HAPCs were not specifically mentioned in the Sustainable Fisheries Act and second because some want to limit EFH designations to HAPCs, which was never the intent. The Gulf Council designated a number of areas in the Gulf as HAPCs, including the familiar Flower Garden Banks off Texas and Louisiana. These areas tend to be quite small and environmentally unique. The HAPC designation does not change anything not already dealt with through an EFH designation, but it does raise a red flag for HAPC areas and for this reason should help developers and managers alike to be especially careful when dealing with these areas.

Establishing EFH designations was difficult for all of the councils mainly because there is not an abundance of good habitat information for all managed species. The information tends to be spotty and limited to the more popular species. To help deal with this problem, the EFH rule identified information that could be used for the EFH designations at four levels. The first level, for example, was for situations where information on the distribution of a species was all that was available, compared to the fourth level where information on production rates by habitat was all that was available. The North Pacific Council went a step further by defining a “zero” level of information where even good distributional information was lacking and much of the spatial distribution of a species had to be assumed. Fortunately, the Gulf Council did not have to go quite this far for their managed species, for the most part, they were at least able to designate at the first, or distributional, level. But once again, the Gulf Council’s EFH amendments were only partially approved because they did not specifically address all managed species.

Probably the most serious misconception about EFH and the EFH rule is that it has created a new bureaucracy replete with new regulations and requirements, a misconception being promoted by some who know better. Except in the limited context of fishing effects on EFH, there is very little regulatory policy about EFH that was not already in effect before the adoption of the Sustainable Fisheries Act. Prior to EFH, federal agencies had to consult with the NMFS on actions that might affect fisheries habitat under a host of authorities including the Magnuson-Stevens Act, the Clean Water Act, the Fish and Wildlife Coordination Act, the National Environmental Policy Act (NEPA), the Federal Power Act, the Endangered Species Act, and others. Indeed, NMFS was doing well over 10,000 consultations annually, with many of them being done in the Gulf of Mexico, prior to EFH. The Fish and Wildlife Service, Environmental Protection Agency (EPA), and states provided similar consultations, and this practice has continued. The major differences before and after EFH are that now the consulting federal agency has to specifically focus on how their actions might affect Federally managed species and their habitats, and very importantly, now the consulting agency must respond in writing to the NMFS recommendations. If the agency disagrees with the NMFS advice, they have to explain why. In other words, they do not have to accept the advice, only acknowledge it, though the advice has been accepted over 80% of the time.

The Sustainable Fisheries Act requirement that federal action agencies have to consider how their actions affect EFH does shift some of the burden from NMFS to the action agencies. So undoubtedly this shift will increase the agencies’ work load (although one might argue that they should have been doing this work before in their NEPA analyses). On the other hand, an even better argument is that NMFS should be doing everything it can to minimize the burden to other federal agencies, which is exactly what the agency has been trying to do.

Several approaches are outlined in the EFH rule that specifically address this issue of minimizing the work load for federal agencies, including the NMFS. These are defined in the EFH rule; anyone in EFH consultations should review them. The most common of these is establishment of a “finding” between the action agency and NMFS. Usually a “finding” is at the district or regional level. A finding is nothing more than an agreement between NMFS and the action agency that their existing process, or their existing process with some agreed upon modification, is adequate to satisfy the NMFS need for notification and information—that is, it provides the basic information for consultation.

Other approaches include completion of general concurrence or programmatic consultations. The general concurrence consultation is the easiest, as it asks for a group of current or future similar actions that may affect EFH, but which are likely to result in no more than minimal adverse effects individually and cumulatively. Often, reporting requirements exist to allow NMFS to keep track of what is going on, but most often, little or nothing else is required. The next level is the programmatic consultation, which allows for a group of similar actions to be evaluated collectively and appropriate recommendations provided. The best example of such consultations in the Gulf of Mexico is the one done with the Minerals Management Service (MMS) late last year. This consultation addressed pipeline rights-of-way, plans for exploration and production, and platform removal on the federal Outer Continental Shelf. It was done through an MMS-prepared EFH assessment, which was based to a considerable extent on an analysis of past lease sales, MMS funded research, and past interagency consultation activities. The programmatic consultation contains a number of agreed-upon mitigation measures including the protection of live bottoms and a number of other bottom features, elimination of the Flower Garden Banks from lease sales, oil spill response plans, and control and removal of pollution. The consultation also includes exceptions for certain types of activities for which individual consultations will continue to be required, as well as a five-year review requirement and annual reports.

EFH offers a valuable tool to help protect and conserve habitat vital to the health and well being of our fishery resources. It is especially important in the Gulf of Mexico because of the importance of its fishery resources commercially and recreationally, and because of the multitude of other industries which utilize the Gulf, all of which are important locally and nationally—oil and gas, shipping, mining, recreation and many others.

Unfortunately, there remains a considerable opposition to EFH from some quarters. Until September 2000, I was unaware of a single instance where an EFH consultation or related requirement caused an unreasonable delay in any given activity, such as dredging a channel or laying a pipeline. I believe this is still the case. Yet, some congressional testimony and articles in the trade media suggest that EFH is the end of any further coastal or offshore development. The data and information indicate otherwise.

I mentioned at the outset the NMFS was sued over its implementation of EFH. The suit was filed in 1999 by a consortium of environmental organizations. The suit challenged whether NMFS had complied with the requirements of the Sustainable Fisheries Act when the agency approved, or partially approved, the Essential Fish Habitat amendments. The suit specifically addressed effects of fishing on EFH claiming that not enough was done to minimize these effects. The U.S. Court for the District of Columbia recently upheld the agency's approval of the EFH amendments because it found the decision to approve was reasonable and consistent with the requirements of the Act. That is the good news. The bad news is that the court also found that the Environmental Assessments, or EAs, prepared for the amendments, were deficient under NEPA because they failed to examine a broad enough range of alternatives in dealing with fishing effects. Based on this assessment, the court issued an injunction prohibiting NMFS from enforcing the EFH amendments until the agency performs a new and thorough EA or Environmental Impact Statement (EIS) for each amendment. NMFS is currently evaluating the judge's order to determine next steps.

Should Gulf of Mexico oil and gas structures be considered essential fish habitat? The preamble to the EFH rule notes that not all human-made structures should be considered essential fish habitat - only those that meet the EFH criteria and are designated as EFH in an approved amendment. The Gulf Council took a very broad approach in designating EFH, and unfortunately was not very clear on this issue. And because of this broad approach and inclusive nature of the Council's amendments, one would have to assume that the oil and gas structures in the Gulf do constitute EFH under the rule. However, I do not believe this necessarily means that all such structures should be considered good and that NMFS will oppose any removal or modification. This scenario would not make sense. What it probably means is that each instance of installation, removal, or significant modification will have to be evaluated at least until more experience is gained and/or the Gulf Council provides clarification. Overall, I do not see a significant problem. The EFH rule is designed to allow reasonable people to make reasonable decisions. I am comfortable that this will happen with oil and gas structures in the Gulf of Mexico.

The NMFS is still operating under an interim EFH rule mainly because the agency wanted to ensure time for public comment, after some experience with the interim rule. Overall, the experience has been good and the public comments fairly consistent; therefore, significant changes with the final rule are unlikely.

Again, I wanted to thank the Minerals Management Services for the invitation to participate in the conference.

OCEAN POLICY

Mr. Roger McManus
U.S. Department of the Interior

One of the accomplishments of the Clinton administration was that it brought more attention to the marine environment at a higher level within the Executive Branch than any other administration in the history of the country. The possible exception would be the Johnson Administration in which Vice President Humphrey and the Stratton Commission conducted the first and only comprehensive review of national ocean policy. That review took place 30 years ago, and there is plenty of information to suggest that we should be revisiting the issues studied by Stratton and issues that have emerged since.

Earlier this year Congress passed the Oceans Act, which would do just that. The act provides authority for establishing a second oceans Commission, which will have a similar mandate as the Stratton Commission's. It will have about 18 months to complete its work and make its recommendations to the new President and Congress.

The passage of the Oceans Act may be viewed as the conclusion of a national movement that started several years ago when the growing need for reform in ocean resource management began to be recognized. The beginning was the most recent historic reauthorization of the Magnuson Act and the national media attention that focused on the problems facing America's fisheries. Other highlights included the celebratory years of the oceans and the coral reefs, the national Monterey conference and the significant preparatory work for it by the Heinz Center, the President's Ocean Task Force, and several White House initiatives including executive orders to protect coral reefs and otherwise to improve the U.S. system of marine protected areas.

Many individuals and institutions have contributed to this progress. Especially important was the leadership of the President's Council on Environmental Quality, and within the Council, the work of Ellen Athas. We all owe Ellen and CEQ a great deal for what they have accomplished. I should highlight also the work of the Center for Marine Conservation in regard to the Oceans Act and particularly Eli Weissman for garnering the heavy industry support that proved critical for final passage.

There have yet been few significant real changes, however, in U.S. ocean policy during this period. Among the most important was the reauthorization of the Magnuson Act, signifying a change in Congress's view of the law as a primarily constituent issue to one of national, natural resource policy. NOAA is implementing the new changes to Magnuson; it will be a few years before we see how well they are working.

Among other significant achievements in ocean policy reform was the Department of Defense's policy shift that promoted conservation of Right Whales on the east coast and established the

Navassa Island National Wildlife Refuge and the red hind closure in the Caribbean. There is time for more such significant action, but that time is running out.

The lack of real change is understandable when one considers that resistance to changes in current ocean policy is powerful and entrenched. U.S. ocean policy is largely driven by national security and international policy concerns. Natural resource management issues have been routinely considered by the State Department and the Department of Defense as complications to their primary missions, and they have resisted modifications to allow for routine examination of policy needs.

That is why we have no cabinet-level mechanism to resolve marine policy issues for resource management; all such matters are viewed at a national security level. If we are going to manage our resources better, we must find the means to address the problems as they arise. In the absence of such mechanisms, we fail to have transparent and public debate about the future of our oceans and their resources. Energy policy has been a primary victim. Another has been the reconciliation of the needs to maintain our fisheries and conserve marine biological diversity.

In a recent book on U.S. ocean policy, authors Biliانا Cicin-Sain and Robert Knecht have noted that “U.S. ocean policy is less than the sum of its parts.” They remind us that recent history has seen the development of single-purpose legal authorities for marine management, but we now need a second generation policy to guide us in establishing priorities and reconciling conflicts for a comprehensive management regime. At the end of the Clinton Administration the United States still had no such comprehensive plan for its Exclusive Economic Zone.

I am honored to be before such a distinguished group today. The Secretariat and the Secretary of the Interior is very proud of you and MMS and the work you do for the Department and the country. I am particularly pleased to take talk to marine scientists today.

Good science is essential to marine policy. We need more of your work and that of your colleagues in and out of government.

Natural resource policy should be informed by the best science available. Nevertheless, there is a widespread misconception that science can or should dictate policy. As we all know, we use science to describe and predict how our natural world operates. Human political policy, however, is usually based on a variety of factors including those that have nothing to do with science or what science can tell us. Science does not tell us it is a good thing to take care of our environment; it can merely inform us about the possible results of how we treat that environment. Science cannot tell us how to be equitable or fair, what to value. We should let science off the hook where it cannot help us and take responsibility for our philosophies and value judgments.

Unfortunately, policy makers do not approach science that way. They are not trained in scientific method, and they often misunderstand how science can help them. Sometimes, policy makers even intentionally misrepresent the role of science to advance their agendas. I was in a meeting recently in which an administrator was questioning whether one proposed policy was “scientific,” at the same time acknowledging that the hypothesis she advanced could not be proved. Of course, the issue

being discussed was predominantly one of values, not which hypothesis was bearing out best under experimental testing.

Ideally, of course, we need, particularly for purposes of government work intended to inform policy, to design our observations and experimental designs to provide answers to carefully thought-out questions, the answers to which are intended to directly influence policy choices. This happens all too rarely.

In discussing the role of science in informing policy, I am going to take the opportunity to discuss a policy problem that has resulted from inattention to some rather basic observational and experimental information.

Every nation on the planet has the responsibility to help provide for the needs and quality of life for people. Increasingly, we have recognized that responsibility includes embracing the obligation to protect the environment. Many people, including myself, believe that obligation includes responsibility to protect “wildness,” wild places and wildlife. Whether we protect them or not has huge implications for this and future generations and for how we provide for people and protect the planet.

The concept of sustainable use has evolved as a goal we can use to achieve both objectives through balanced mechanism ensuring that our resource use satisfies our needs without undermining future use. The underlying sustainable use assumption is that you do not have to choose: you can have your cake and eat it too.

Sustainable use has done a lot of good. In practice, it has promoted environmentally sensitive management, and the more of that the better. Most of the time, however, development for human needs alters nature. You cannot have the intensive agriculture, transportation systems, and human communities people need without making major changes to the sustainability of the natural environment. You cannot have intensive harvest of timber or grazing or energy development without significant changes to the sustainability of the natural environment. Such human activities do change the abundance and diversity of wild living organisms, and they do alter ecological systems. With respect to those values, in many cases changes are not for the better; they are almost always non-sustainable.

Sustainable use is a fantasy. And, while it has been very useful in promoting environmental protection, it belongs in the virtual museum of improbable theories such as perpetual motion.

I suggest that the scientific community in particular must contribute to the conversation about developing a new paradigm for taking care of people and the planet. I propose that this paradigm have three elements:

1. That we subscribe to the notion that all human development be conducted in an environmentally sensitive manner to maintain environmental quality (air, water, soil, noise, etc.) That the resulting environmental standards be conducive to maintaining the quality of life for humans and other life forms.

2. That we adopt a proactive strategy for meeting human needs. Already the amount of human suffering resulting from the lack of basic necessities, clean and healthful living environments, and the lack of opportunity for productive lives is intolerable. It is a human tragedy, and a political and environmental powder keg. To the extent that in meeting those needs, we provide for other life forms as well, that is good and right, but we will accept that in meeting human needs we are going to sacrifice parts of the planet for ourselves.
3. That we adopt a proactive strategy for protecting wildness. With increasing human numbers, the days when substantial global wilderness was protected by remoteness are fast receding. We need to accelerate the protection of such places and their wildlife if we want them present for future generations. That includes marine places and marine wildlife.

The last topic I want to raise with you is the future of MMS. MMS is an interesting institution. On the one hand it is the Darth Vader for the environmental community. On the other it is widely regarded as a professional organization producing practical and credible science and an effective manager of public resources. MMS is the largest manager of public revenues from marine resources, and ironically, notwithstanding the Service's reputation among environmental organizations, it is a chief source of national conservation funding.

As I noted before, ocean policy experts Biliana Cincin Sain and Robert Knecht have suggested that we are at the beginning of second generation environmental law where we seek to establish priorities and reconcile conflict among single uses of marine resources.

I believe MMS has a future as part of this second generation of new authorities. The Service has taken a major step in this direction with its recent, significant initiatives in marine biotechnology. I believe that within this century, marine biotechnology products will be the most economically valuable products we take from the sea. Thanks to the leadership of you and your colleagues, particularly Ken Turgeon, the Service is well positioned to take a major role in this future.

Here is one more example of what your future role could look like. The most prevalent offshore structures in this country are navigational aids and oil and gas development structures, the latter being the most significant in mass and complex in administration. A national debate is now occurring over how to manage aquaculture structures. In the future, the challenge will be with renewable energy structures. New uses for offshore structures will increase as they prove to be more feasible for access to marine resources and as alternative to shore-based facilities. Besides the authorities provided to MMS for managing oil and gas structures, the only major authority provided for governing offshore structures is a 19th century law providing for the U.S. Army Corp of Engineers to judge proposals pertaining solely to navigational concerns. We have a policy and legal authority vacuum in the face of a clearly coming wave of proposals.

I believe we need a single agency to manage offshore structures, one agency to which a permittee can apply, an agency to take the lead in NEPA compliance. I would suggest that the substantive decisions should remain in the domain of the most appropriate agencies, but that conflict resolution and final siting decisions be with the lead of one agency. I believe that agency should take charge of collecting revenues for use of the public's resources. I believe that in designating an agency to

take on these responsibilities, we should look to the agency that is most experienced with managing such structures and most experienced with collecting large revenues from industrial users. I believe MMS should be that agency.

I urge the MMS to start looking at its basic research and management program and consider what its expanded role should be as the new oceans act commission starts its work and prepares its recommendations for the next administration and Congress.

**SESSION 2:
OUTER CONTINENTAL SHELF AND DEEPWATER MARINE ECOLOGY**

Moderators: Mark Benfield
Gilbert Rowe

Date: October 24, 2000

Presentation	Author/Affiliation
Benthic Community Structure and Function in the Sigsbee Deep, Northern Gulf of Mexico	Gilbert T. Rowe Angela Lohse Fain Hubbard Texas A&M University Gregory S. Boland Minerals Management Service Elva Escobar-Briones Universidad National Autonoma de Mexico Jody Deming University of Washington
Distribution and Abundance of Phytoplankton, Zooplankton, Ichthyoplankton, and Micronekton in the Deepwater Gulf of Mexico	Douglas C. Biggs Patrick H. Ressler Department of Oceanography Texas A&M University
Deepwater Petroleum Structures as Fish Aggregating Devices: An In-Progress Project Report	Randy E. Edwards Kenneth J. Sulak Doug Weaver U.S. Geological Survey Biological Resources Division Florida Caribbean Science Center
Habitat Use of Shelf-Edge Topographic Highs in the Northwestern Gulf of Mexico by Sharks and Rays (Subclass Elasmobranchii)	Jeff Childs Center for Coastal Studies Texas A&M University-Corpus Christi

(Continued on next page)

Presentation	Author/Affiliation
Life Along the Edge: the Whale Shark (<i>Rhincodon Typus</i>) in the Northern Gulf of Mexico	Jeff Childs Center for Coastal Studies Texas A&M University-Corpus Christi Carolyn M. Burks Keith D. Mullin Southeast Fisheries Science Center National Marine Fisheries Service NOAA Mississippi Laboratories John D. Hewitt IV Aquarium of the Americas New Orleans
Potential Conflicts Between Deepwater Fishing and Oil and Gas Operations in the Gulf of Mexico	David B. Snyder Luis Lagera Continental Shelf Associates, Inc. Peter Arnold Mandeville, Louisiana LeRay de Wit Concord, California George H. Burgess Florida Museum of Natural History University of Florida Chris Friel Florida Marine Research Institute

BENTHIC COMMUNITY STRUCTURE AND FUNCTION IN THE SIGSBEE DEEP, NORTHERN GULF OF MEXICO

Gilbert T. Rowe
Angela Lohse
Fain Hubbard
Texas A&M University

Gregory S. Boland
Minerals Management Service

Elva Escobar-Briones
Universidad Nacional Autonoma de Mexico

Jody Deming
University of Washington

ABSTRACT

The standing stocks and rates of heterotrophic metabolism of the benthos have been estimated in a joint U.S./Mexican study at a site on the abyssal plain (3.65 km) of the western Gulf of Mexico (GOM). Total densities and biomass of the principal size categories of the community (bottom fishes, megafauna, macrofauna, meiofauna and bacteria) were low, as expected from similar studies in other ocean basins. The total stock sizes, in terms of organic carbon, were lowest in the largest-sized organisms and increased in importance as mean size decreased, with the greatest total biomasses in the bacterial and meiofaunal fractions. The respiration rate of each of the above size groups was estimated on the basis of mean size, abundance and temperature from established allometric relationships in the literature. These estimates were incorporated into a carbon budget for the benthic boundary layer at this site. The total organic carbon remineralization and burial estimated from the model ($10.4 \text{ mg C m}^{-2}\text{d}^{-1}$) was more than two times that estimated from the oxygen consumption in a benthic chamber (ca. $4.0 \text{ mg C m}^{-2}\text{d}^{-1}$). A time-dependent numerical simulation of carbon cycling was constructed from the budget to investigate potential effects of variations in particulate organic carbon (POC) flux to the sea floor.

INTRODUCTION

Abyssal plains constitute a significant proportion of the surface of the earth. Although generally acknowledged as the ultimate sink of detritus from the continents, their biota has long been considered sparse and depauperate. The abysso-benthic communities of the Sigsbee Deep in the western GOM, known as one of the flattest surfaces on the deep ocean floor, are less well known than many other abyssal plains, in spite of its modest depth (3.6 to 3.8 km) and proximity to the United States and Mexico. Studies in the western basin of the gulf were initiated in the mid-1960s by Willis E. Pequegnat and his graduate students. This work encompassed the continental slope, rise and abyssal plain, including what is now well within the Mexican Exclusive Economic Zone

(EEZ). These expeditions aboard R/V ALAMINOS included the Caribbean, as well as the GOM. Faunal groups studied from the deep gulf included the crustaceans (Pequegnat, L., 1970; Firth 1971), echinoderms (Carney 1971; Booker 1971), molluscs (James 1972), and fishes (Bright 1968), among others. Studies included both the megafauna and the macrofauna. Tabulation of fish gut contents were intended to link the two (Rayburn 1975). Photographs of an “iron stone bottom” north of the Yucatan Strait suggested deep bottom currents can be strong enough in the eastern Gulf to sweep large areas free of unconsolidated sediments (Pequegnat 1972). The macrofauna appeared to be grouped into assemblages that were distributed within zones down the slope onto the abyssal plain (Kennedy 1976), but no justification was found for separating the abyssal plain fauna into zoogeographic provinces by latitude or longitude.

Anchor dredge samples across the Sigsbee Deep and van Veen grabs from the northern continental slope and shelf suggested that the deep benthos was depauperate in numbers and biomass, with values below those in other ocean basins; the mean size of individual macrofauna was in general smaller than in the Atlantic at similar depths (Rowe 1971, Rowe and Menzel 1971, Rowe, *et al.* 1974; Rowe 1983). A log-normal relationship between biomass and depth has been confirmed now for numerous ocean basins (Rowe 1983), but the decline with depth in the gulf appeared to be steeper than in most basins. The steep decline was attributed to the gulf’s low primary productivity.

The most extensive sampling of the sediment biota of the continental slope of the northern GOM was conducted in the 1980s by LGL Ecological Research Associates, with support from the Minerals Management Service of the Dept. of the Interior. This consisted of paired Gray-O’Hara or GOMEX box cores (Boland and Rowe 1991), bottom survey camera lowerings and bottom trawling. The stations studied included three transects down the continental slope off Texas, Louisiana and Florida. This work stopped at depths just shy of 3 km and therefore did not extend out onto the abyssal plain. The work on deep-water benthos at Texas A&M beginning in the 1960s up through the MMS-supported studies of the 1980s has been reviewed in a concise summary by Pequegnat *et al.* (1990). However, little information on the abyssal plain was included because the focus was on the more recent studies of the northern continental slope. Other documentation of the studies of the slope include reports to MMS (Gallaway 1988 and Gallaway *et al.* 1988) and a dissertation on the polychaete annelid worms (Hubbard 1995).

The *Instituto de Ciencias del Mar y Limnología* (ICMyL) of the *Universidad Nacional Autónoma de México* (UNAM) initiated extensive studies in the southern GOM with the acquisition of the deep ocean research vessel JUSTO SIERRA. Mexican biologists are conducting studies of megafauna, demersal fishes, macrofauna and meiofauna from the continental shelf down across the slope onto the Sigsbee Abyssal Plain. Stable C and N isotopes have been used to infer pathways through a benthic food chain (Soto and Escobar-Briones 1995). Deep water studies across the *Cordilleras Mexicanas* or “Mexican Ridges” have identified regions that contain enhanced biomass under surface water masses characterized by accelerated rates of primary production (Escobar-Briones and Soto 1997; Escobar-Briones *et al.* 1999). Polychaetes dominated the infauna; they encountered a mid-slope maximum in abundance similar to that described in the northern gulf (Pequegnat *et al.* 1990). The fauna could be partitioned into three groups that conformed to depth intervals of > 3 km, between 1.5 and 3 km, and < 1.5 km. This contrasts with the view of Pequegnat *et al.* that the slope in the gulf can be divided into 5 zones.

There are several reasons why the deep-living benthos of the gulf might not be similar to that in the deep western North Atlantic. For example, their geologic histories are very different. The abyssal plain of the western GOM began formation on the order of 100×10^6 ybp when the Yucatan Peninsula separated from the North American continental plate to form the present deep basin (Buffler 1978). Much of the abyssal plain is thought to have been formed by turbidity flows of fine-grained material originating on the Mississippi Cone. Approximately one to two meters of pelagic sediments have accumulated since the Holocene. The continental margin south of Texas and Louisiana and along the western side of Yucatan are both underlain by salt deposits which form diapiric structures pushing up through the pelagic sediments. Both areas have petroleum deposits associated with the salt but the degree to which these extend out under the flat sediments of the abyssal plain is not well-established. Cores from the Sigsbee Knolls in the NE central Sigsbee are known to be characterized by oily sediments (Rezak *et al.* 1969).

The western gulf basin has maximum depths of 3.8 km, but this is separated from the Atlantic and Caribbean by sill depths at 1.5 to 2.0 km stretching between the Yucatan, Cuba and Florida. This could impede larval dispersal into the GOM at abyssal depths. The deep bottom water of the Sigsbee Deep is slightly warmer (*ca.* 4.2°C) than equivalent depths in the Atlantic or Pacific. Thus, all else being equal, the turnover of organic matter might be slightly faster in the deep gulf than at equivalent depths in the Atlantic or Pacific Oceans.

In 1997, a two-ship operation by Texas A&M and UNAM was conducted to add to general knowledge of the deep gulf biota. The R/V GYRE met the R/V JUSTO SIERRA at a common station (25°15' N. Lat. x 93°26' W. Long.) on the northern Sigsbee Abyssal Plain, at a depth of 3.65 km. The JUSTO SIERRA traveled up from Tuxpan, sampling along an east - west line across the Mexican Ridges off Tampico (Escobar Briones *et al.* 1999), while the GYRE went due south out of Galveston, directly to the site. According to Escobar-Briones *et al.* (1999), the sediments at this site contain 3.8% sand, 1.3% organic matter, and 0.17 mg m⁻³ Chl. a. The near-bottom water contains 6.0 mg L⁻¹ oxygen and 34.8 psu of dissolved salts. As this site is well within the Mexican Exclusive Economic Zone (EEZ), all sampling conducted from the GYRE was approved a priori by a suite of Mexican federal agencies. This location in the deep gulf is of potential importance to the economies of both countries because it lies between, and is potentially underlain by, plentiful offshore fossil fuel resources (Vargas 1996). The joint study was a component of the longterm Memorandum of Understanding between UNAM and TAMU. Its specific purpose was to gain a more comprehensive understanding of community function at a common location in the deep benthic boundary layer of the GOM.

METHODS

A large-diameter version of the GOMEX or Gray-O'Hara box core (0.2 m²), as described by Boland and Rowe (1991), was used to take relatively undisturbed bottom samples. These were subsampled for meiofauna, bacteria and sediment pore water nutrient analyses with subcores of various diameters. Plastic hypodermic syringes (20 ml) cut off to make small piston corers were used to sample bacteria. They extended from the surface of the sediments down to a depth of 8 cm. These were preserved in 2% formalin and sea water solution filtered through a 0.2 micrometer filter to exclude contamination. A 20 cm long subcore for nutrient analysis was extruded from the bottom

and sectioned at 5 cm intervals. The sections were squeezed through paper filters in a stainless steel press powered with an hydraulic jack. Blanks were run to determine potential contamination by the filters. Nutrients were analyzed with an AutoAnalyzer using standard colorimetric reactions. Just prior to squeezing, the sediments on the top of each section were subsampled for bacteria using a 5 ml plastic hypothermic syringe corer. Two ml were taken at each level sampled. The bacteria samples were stored at 4° C until return to Seattle, where they were analyzed. Approximately 20 ml of surface mud was scooped with a single table spoon into a plastic bag and frozen for analyses of organic and carbonate carbon concentrations. The remainder of each core was sieved through 0.25 and 1.0 mm mesh sieves for estimation of macrofauna species composition, abundance and biomass.

Following laboratory procedures described by Schmidt *et al.* (1998), the sediment bacteria were diluted, treated with detergent and sonicated to remove the bacteria from sediment particles for more even distribution on the counting filter. They were then stained with DAPI and counted under an epifluorescent microscope.

The meiofauna were sampled by taking 5 replicates from each core with a 60 ml hypodermic syringe barrel. These were preserved whole with 5% buffered formalin in sea water and Rose Bengal stain aboard ship. Back in the laboratory these samples were sieved through 175 and 53 micrometer sieves to remove as much sediment as possible and then sorted to major group using a dissecting microscope. Lengths and diameters of the harpactoid copepods and nematodes were measured using an ocular micrometer. Their volumes were calculated and used to estimate wet preserved biomass; this was converted to carbon biomass from published conversion factors (Rowe 1983).

The macrofauna were sorted to major group in the laboratory using dissecting microscopes. Individual organisms were removed from the samples and estimates were made of wet weight biomass by direct weighing using a microbalance or by measuring individual lengths and widths to determine volume. Organic carbon biomass was calculated from published wet weight to carbon conversion factors for each of the major taxonomic groups (Rowe 1983). Following sorting to major taxa and weighing, the animals were transferred to 70% ethanol. The polychaete fraction, which constituted approximately 65% of the total macrofauna, was sorted to species.

Total sediment community respiration was measured using a benthic lander containing a pair of automatically operated benthic incubation chambers. The lander and its operation have been described previously by Rowe *et al.* (1994; 1997). Two plexiglass incubation chambers contain polarographic oxygen electrodes with internally recording data logger to monitor oxygen concentrations within the chambers continuously. Oxygen consumption by the bottom and its contained biota is calculated from the decline of oxygen within the chamber over time, the volume of the chamber (7 l) and the area of the sea floor it covers (0.09 m²). It was deployed once at the study site.

Motile scavengers were sampled by attaching a baited trap to the bottom strut of the lander on the opposite side from the chambers. The trap used was a commercially available minnow trap constructed of a plastic cylinder 20 cm in diameter and 40 cm long. Each end of the cylinder was an inward-facing funnel with a terminal hole measuring 2 cm in diameter. The trap was made of square mesh measuring 5 mm on a side. The trap was baited with codfish tissue measuring 2 x 7 x

7 cm. This muscle tissue had been frozen but was thawed before deployment. This bait was protected within the trap in a 100 ml plastic jar into which 1 mm diameter holes had been punched at 1 cm intervals. The purpose of this container was to allow “scent” from the fish flesh to escape into the bottom water, but prevent the bait from being consumed. This internal container was wired in place in the center of the cylinder. The trap was wired onto the bottom horizontal aluminum frame of the lander so that it would be in contact with the sediment when deployed.

No direct quantitative estimate of sedentary megafauna or bottom fishes was made during the joint study aboard GYRE and JUSTO SIERRA, but earlier work sampled these important size groups (Pequegnat 1983). The principal sampler used was a benthic “skimmer” equipped with an odometer wheel to estimate area of sea floor covered (Pequegnat *et al.* 1970). The anterior “mouth” of the skimmer measured 3 m wide by 1 m high. The anterior frame of the rigid, hour glass-shaped structure was covered with 1.25 cm galvanized wire mesh and its bulbous cod end was covered with 0.6 cm mesh. The original meter wheel data are available in the field notes taken aboard ship at the time of sampling; distances travelled averaged several kilometers. The notes from Pequegnat’s work aboard the R/V ALAMINOS are archived at Texas A&M University’s Department of Oceanography.

Biomass was not measured in the earlier studies. However archived material enabled us to make size and weight measurements on preserved specimens 30 years after capture. The material used by us had been dried for storage (ophiuroid and asteroid echinoderms) or retained in 70% ethyl alcohol (holothuroids).

The information on the stock sizes and respiration rates of the biota tabulated in the joint study are put together in a carbon budget to allow a comparison of how carbon is both stored and cycled within an ecosystem. The respiration of the individual groups of metazoans was estimated independently from known size and temperature relationships in the literature (Grant and Schwingamer 1987; Mahaut *et al.* 1995; Cruz Kaegi 1998). The rate constants for the size groups were multiplied by total biomass per square meter to give conversion of organic matter to CO₂. The estimates of respiration for each size category were then used to partition the flow of organic matter through the food web. Secondary production in the metazoans was assumed to be 10% of the assimilated carbon (P/R=0.1). For the bacteria however it was assumed that the growth and respiration are equal (P/R=1). This growth efficiency is somewhat higher than those in previous studies of deep-sea sediment bacteria reviewed by Deming and Baross (1993), but is similar to several of the measurements described in Relexans *et al.* (1996). Using a lower growth efficiency (a lower P/R) would increase the carbon remineralization relative to biomass production that is necessary to meet the organic carbon requirements up the food chain. This would increase the total SOC, thus increasing the disparity between the model estimated SOC and the SOC measured by the lander.

Given the information generated on the respiration rates of each of the components above, along with our assumptions concerning P/R, we calculated predator-prey exchanges required to maintain steady state. This is a step-wise analysis that has been utilized previously on benthos in the Demerara Abyssal Plain (Rowe and Deming 1985) and on the continental margin off NE Greenland (Rowe *et al.* 1997). The resulting solutions for the predator-prey relationships are not unique, but

are based on inferences about how the size classes are most likely partitioning their resources. The POC input term was assumed to be the sum of the losses to respiration and burial because POC flux has not been measured in the deep GOM. The simulation of the coupled equations of state for the standing stocks is solved numerically using the software application STELLA II.

RESULTS

Bacteria

The standing stocks of the size categories of the biota have been grouped together, in terms of biomass and numbers per square meter, for comparison (Table 2.1). Bacteria densities (Figure 1) declined from the sediment-water interface into the sediments. The values in the 8 cm deep cores had a mean value that approximated the mean value over the top 8 cm in the profile. The values in Table 2.1 are a vertical integration to the bottom of the core. The variation around the mean is the Standard Deviation of the mean of the 8 cm long cores. The “counting error” of similar studies conducted on deep-sea sediments by this laboratory is approximately 22%. The biomass is the mean value (Table 2.1) multiplied by a standard conversion factor for carbon per cell for deep-sea bacteria (10^{-14} g C per cell, from Williams and Carlucci 1976) used previously in sediment bacterial biomass estimates (Rowe and Deming 1985).

Table 2.1. Standing stocks of benthic biota at 3.65 km depth site in the NW Gulf of Mexico. Values in parentheses are numbers of replicates (n) and \pm standard deviation.

TAXON	ABUNDANCES	BIOMASS
Bacteria	6.9 x 10 ⁸ cells/ml* (n=5, \pm 1.2 x 10 ⁸)	408 mg C m ⁻² -20 cm
Meiofauna	2.87 x 10 ⁵ ind. m ⁻² (n=25, \pm 8 x 10 ⁴)	83 mg C m ⁻² (n=25, \pm 22)
Macrofauna	318 ind. m ⁻² (macrofaunal taxa) 490 ind. m ⁻² (meiofaunal taxa)	32.5 mg C m ⁻² (n=5, \pm 15.3 mg C m ⁻²)
	Total 808 ind. m ⁻²	
Megafauna** (Asteroid <i>Dytaster insignis</i> (sea star) and holothuroid <i>Benthoctes typica</i> (sea cucumber))	10.5 ha ⁻¹	0.15 mg C m ⁻²
Scavengers (<i>Eurythenes grillus</i> , amphipod crustacean)	21 per 20-hour trap deployment	

* Reported as per gram dry sediment in Figure 2.1; ‘per ml’ used for carbon budget (Figure 2.2).

** from Pequegnat, 1983

Pore Water Nitrate and Ammonium

The concentrations of nitrate and ammonium in the interstitial water have been plotted as a function of depth into the sediments (Figure 2.1) along with the bacteria. The NH_4^+ ranged from a low of 25 micromoles at 5 cm up to almost 200 micromoles at the deepest sample. The pattern with depth was not smooth but erratic. By contrast, the NO_3 declined smoothly from a high of 70 micromoles near the sediment-water interface down to a minimum at the deepest sample, the inverse pattern of NH_4^+ , as expected. The bacterial densities followed much the same pattern relative to sediment depth. The patterns suggest that nitrification is occurring in the top few cm's but denitrification is being utilized in heterotrophic remineralization down to the bottom of the core.

Meiofauna

The mean density of meiofauna-sized organisms was $2.87 \times 10^5 \text{ m}^{-2}$ ($s = \pm 8 \times 10^4$, $n=25$). They were composed primarily of nematodes, accompanied by harpacticoid copepods. Wet preserved weights, based on volume, had means of 6.8 micrograms for the nematodes and 3.4 micrograms for the harpacticoids. While it is not unusual for the nematodes to be numerically dominant, it is unusual for them to be bigger than the crustaceans. Mean biomass was 82.9 mg C m^{-2} ($s = \pm 22$, $n=25$), based on conversion of the wet weights to carbon (Rowe 1983).

Macrofauna

The mean macrofauna density was $318 \text{ indiv. m}^{-2}$ ($s = \pm 159$, $n=5$), composed of macrofauna taxa (polychaetes (65%), molluscs (9%) and crustaceans (27%)). In addition, there were 490 ind. m^{-2} ($s=147$, $n=5$) belonging to meiofaunal taxa (harpacticoid copepods, nematodes and ostracods). Biomass of all taxa retained by the 0.25 mm sieve was 32.5 mg C m^{-2} ($s = \pm 15.3$, $n = 5$). The mean weight therefore was $0.05 \text{ mg C ind}^{-1}$, based on the total of 808 ind. m^{-2} , regardless of taxon.

Out of a total of 146 individual polychaete annelids in the 5 cores, 96 different species were encountered. Of these, 61 occurred only once. The highest number for any species was only 8 individuals, a paraonid, possibly *Aedicira* sp. Only four species out of the total occurred in more than one box core. Thus, each box core was almost entirely different from the others. The mean $H'(s)$ for the polychaetes of individual 0.20 m^{-2} cores was 2.78 ($s = \pm 0.32$, $n=5$). The $H'(s)$ calculated with the samples lumped together was 4.03.

Megafauna

The deep gulf summary by Pequegnat (1983) revealed that megafauna on the abyssal plain was substantially reduced in both numbers and species compared to the continental slope. The megafauna was dominated by the carnivorous sea star *Dytaster insignis* and the surficial deposit feeding sea cucumber *Benthoodytes typica*. Both of these species had wide bathymetric distributions that extended well up onto the continental slope. Other, less abundant megafauna species were also observed with some regularity. This included the brittle star *Ophiomusium planum*, which reached high densities in isolated locations. Other species observed were the sea cucumber *Psychropotes semperiana* and the penaeid crustacean *Benthesicymus cereus/iridescens*. A number of other large

crustacean species were observed in these earlier studies, but it is not clear if they are living near the bottom or were captured up in the water column (*Nematocarcinus ensifer*, for example). Information on the fish populations in the Sigsbee Deep is meagre, with only 4 species listed by Pequegnat for depths equivalent to or greater than our site.

The sea star *D. insignis*, according to Pequegnat, had mean densities of approximately 5 per hectare at depths of 3.6 km. *B. typica* reached similar values: from 4 to 7 individuals per hectare. Lower, less reliable numbers were observed for the large crustaceans *B. cereus/iridescens* and *Nematocarcinus ensifer* and the sea cucumber *P. semperiana*. It is not known if the crustaceans were caught on the bottom or in the water column.

The *D. insignis* had a mean dry weight of 2.88 g per individual ($s=\pm 2.2$, $n=11$). Mean disk diameter was 23.3 mm ($s=\pm 9$, $n=11$). The holothurian *B. typica* individuals had been preserved in 70% ethanol and their mean wet preserved weight was 4.04 grams per individual ($s=\pm 1.4$, $n=13$). They had a mean length of 6.6 cm ($s=\pm 1.1$, $n=13$) and a diameter of 1.7 cm ($s=\pm 0.35$, $n=13$). Thus, the sea star had a mean dry weight of 14.4 g per hectare and the holothurian had a mean wet weight of 22.2 g wet preserved weight per hectare. The latter value would be equivalent to approx. 3.3 g per hectare dry weight (Rowe 1983). The two species together would be equivalent to approximately 1.77×10^{-3} g dry weight m^{-2} .

Scavengers

In the baited trap, a single species was sampled: the cosmopolitan amphipod crustacean *Eurythenes grillus*. A total of 21 were captured, ranging in size from 5 mm to 4 cm. The abundance in the trap can be compared with other studies as a comparison, but no absolute estimates of abundance are possible. The trap had been in the water for 20 hours.

Sediment Community Oxygen Consumption (SOC)

Only one of the two oxygen electrode recorders functioned properly, and the decline in oxygen in the chamber was equal to a value was 0.186 millimoles $O_2 m^{-2}hr^{-1}$. This is equivalent to approximately 4.0 mg C $m^{-2}d^{-1}$ (as CO_2)

The incubations were not completed because the lander left the bottom prematurely. [A backup corrosive link dissolved more rapidly than predicted.] As a result, no syringe samples of chamber water were taken at the end of the incubations. The oxygen demand estimate is based on the data logged from the oxygen electrode.

DISCUSSION

Food Web Carbon Budget

The information above on stock sizes and respiration rates have been put together as a carbon budget (Figure 2.2). The total stock size in the detrital organic carbon and bacteria compartment is the sum of the measured carbon summed over a depth of 20 cm, plus the bacteria integrated to 20 cm. The

first step in creating the budget is to calculate respiration rates and growth rates, based on allometric relationships established in the literature (see Methods). Once the respiration and growth rates are calculated for each size group, the trophic transfers are calculated from the steady state equations by forward elimination. The input term is assumed to be the sum of all the loss terms (respiration and burial). The mean rate was $10.4 \text{ mg C m}^{-2}\text{d}^{-1}$.

The largest total stock sizes were located in the smaller organisms at the bottom of the food web. The smallest size group, the bacteria, was almost an order of magnitude larger in total mass than the other size groups. As mean organism size increased, total biomass decreased. Likewise, as size increased, the metabolic rates decreased. In this particular budget, the microbiota have been lumped with the detrital organic matter because it is not possible to separate the relative contributions of detritus and bacteria in the food web. Almost 50% of the total input was remineralized by the microbial component. A close second was meiofauna respiration. By comparison, the other respiration flows were relatively low. Predation by the megafauna and the fishes was estimated to be extremely small orders of magnitude lower than the fluxes that characterize the bacteria, meiofauna and macrofauna.

Burial of organic carbon was calculated from long-term rates of sediment accumulation. Approximately one to two meters of Holocene pelagic sediments, composed primarily of foram ooze, are spread over the entire Sigsbee Deep. Thus, the rate of accumulation is ca. 100 to 200 cm per 13,000 years; at the time scales of our budget this is ca. 0.0115 cm y^{-1} . Multiplying this by the concentration in a 1 cm thick layer ($22.4 \text{ g C m}^{-2}\text{-cm}$) gives a burial rate of ca. $0.7 \text{ mg C m}^{-2} \text{ d}^{-1}$. This is about 7% of the total estimated flux remineralized by the biota.

Deming and Baross (1993) reviewed the relationships between sediment bacteria and depth, organic carbon and POC input. They found that the best predictor of total bacterial biomass was POC input. Based on their regression we would estimate that the input of POC at our site would be approximately $22 \text{ mg C m}^{-2} \text{ d}^{-1}$. These estimates can also be compared with values of Relexans *et al.* (1996), who measured metabolic rates of sediment bacteria in 3 areas off NW Africa. They introduced trace quantities of ^{14}C labelled dissolved free amino acid (DFAA) mixtures at in situ pressures and temperatures. Utilization rates increased from approximately 2 to $6 \text{ mg C m}^{-2}\text{d}^{-1}$ as a function of biomass increases of 150 up to $650 \text{ mg C m}^{-2}\text{-20 cm}$. Our biomass (ca. $408 \text{ mg C m}^{-2}\text{-20 cm}$) would equate to approximately $3.7 \text{ mg DFAA-C m}^{-2}\text{d}^{-1}$ in their regression. This estimate however does not include other compound classes (lipids and carbohydrates) presumed to be available to the bacteria in the DOM pool.

A fair number of trawls have been taken across several other continental margins, thus making it possible to compare densities and biomass of megafauna and fishes with the gulf. Lampitt *et al.* (1986) for example plotted \log_{10} biomass of total invertebrate megafauna as a function of depth in the NE Atlantic. Their regression line predicts that $0.31 \text{ g wet weight m}^{-2}$ should be encountered at 3.7 km depth. Haedrich *et al.* (1980) measured a wet preserved weight of ca. 0.08 g m^{-2} of fishes and 0.05 g m^{-2} of megafaunal invertebrates (echinoderms and crustaceans) between depths of 3.2 and 3.7 km in NW Atlantic, suggesting that the abundance and biomass of these groups is lower there than in the east Atlantic. The lower value above is appreciably higher than our estimate in the gulf ($0.006 \text{ g wet preserved weight m}^{-2} = \text{ca. } 0.16 \text{ mg C m}^{-2}$, Figure 2.2); thus, compared to the Atlantic, the deep gulf appears to be relatively depauperate.

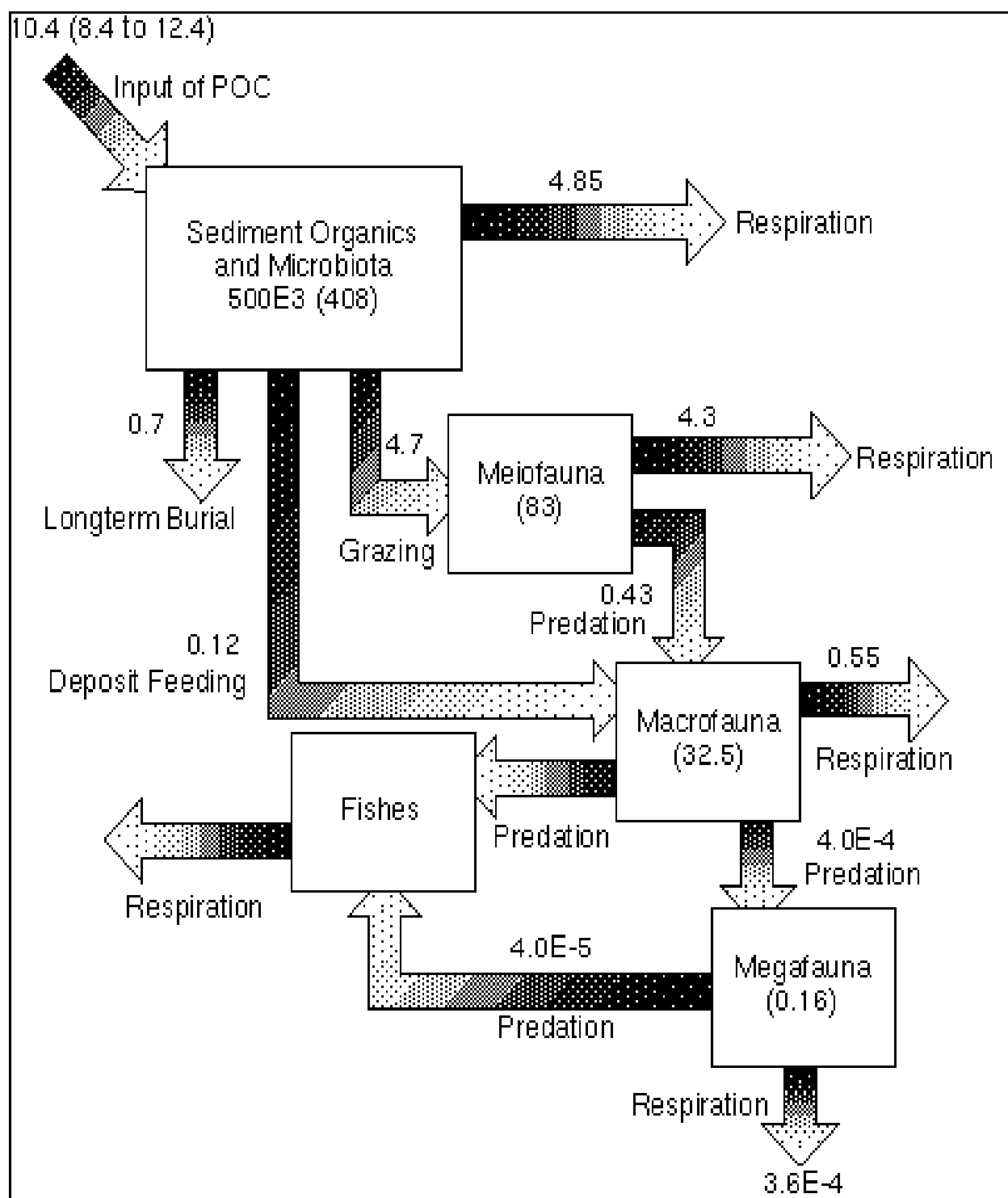

Figure 2.2. Conceptual model and carbon budget of the benthic food web on the western Sigsbee Deep abyssal plain, at a depth of 3.65 km. Values in parentheses are the biomass of each variable in (mg C m^{-2}) integrated over a sediment depth of 20 cm. No values are given for the fish because no data are available. Fluxes between boxes are flows of carbon in units of $\text{mg C m}^{-2} \text{d}^{-1}$.

SOC has been measured at a site on the deep abyssal plain in the eastern gulf, and the rate measured was approximately 1.5 times what we measured (Hinga *et al.* 1979), which is within the usual experimental error for this type of measurement. These two gulf values are in general near the low end of comparable sites (Smith and Hinga 1983), being above the west Atlantic (Rowe *et al.* 1994), but below the east Pacific (Jahnke and Jackson 1991; Smith 1992; Pilskalin *et al.* 1996) at comparable depths.

Total carbon residence time in both the living and non-living components can be estimated by dividing the stock size by the flux rate. This gives residence times of 54 days for the living biota and 118 years for the detrital organic carbon, using the sum of the respiration rates based on the size and temperature model. Based on the lander value, the residence times increase to 131 days for the biota and 307 years for the non-living fraction because the lander value is less than half model estimates.

Time-Dependent Simulation

The carbon budget above can be put into a set of coupled time-dependent differential equations. The input term can then be varied in order to investigate the responses of the stock sizes and the fluxes to changes in the input term. The changes in the input might be natural temporal or spatial variability or new perhaps alien sources of organic matter such as drilling mud, dredge spoils, etc.

Each state variable (stock or box) is represented by a differential equation in which the concentration (stock size) is equal to the flows (arrows) into the stock minus the flows out of the stock. At steady state, the flows in (+) equal the flows out (-). Because these equations are coupled, they can be solved simultaneously to estimate the size of each stock over time. Experiments can be run to estimate the effects of changes in input, growth efficiencies, predation rates, etc., on the biomass of each stock as a function of time. This includes transient storage as living biomass, transfer between trophic levels and remineralization into metabolic CO₂. A term is also included for long-term burial. As in the budget above, all units for stocks are mg C m⁻² and fluxes are mg C m⁻²-d⁻¹. Equations for each stock are

$$d[\text{Macrofauna}]/dt = \text{Deposit feeding} + \text{Predation (on meiofauna)} - \text{Respiration (by macrofauna)}$$

$$d[\text{Megafauna}]/dt = \text{Predation (on macrofauna)} - \text{Predation (by fishes)} - \text{Respiration (by megafauna)}$$

$$d[\text{Meiofauna}]/dt = \text{Grazing} - \text{Predation (by macrofauna)} - \text{Respiration (by meiofauna)}$$

$$d[\text{Sediment organics and Microbiota}]/dt = \text{Input of POC} - \text{Longterm burial} - \text{Deposit feeding by macrofauna} - \text{Grazing by meiofauna} - \text{Respiration (by microbiota)}$$

Initial conditions are defined as the mean values of the stocks represented in Table 2.1 and the boxes in Figure 2.2. Respiration rates are parameterized as first order decay rates dependent on the size

of the stock. Respiration constants, with units of d^{-1} , are calculated by dividing the rate by the stock size.

$$\text{Megafauna Respiration} = [\text{Megafauna}] * k_{\text{megafauna respiration}}$$

$$\text{Microbiota Respiration} = [\text{Sediment organics and microbiota}] * k_{\text{OC\µbes}}$$

$$\text{Macrofauna Respiration} = [\text{Macrofauna}] * k_{\text{macrofauna respiration}}$$

$$\text{Meiofauna Respiration} = [\text{Meiofauna}] * k_{\text{meiofauna respiration}}$$

The respiration rate constants were calculated by dividing the stock size into the flux. The values follow:

$$k_{\text{megafauna respiration}} = 0.0019$$

$$k_{\text{OC\µbes}} = 0.01189$$

$$k_{\text{macrofauna respiration}} = 0.0169$$

$$k_{\text{meiofauna respiration}} = 0.0518$$

The units are days (d^{-1}).

Fluxes attributable to trophic transfers such as predation, deposit feeding, etc., are first-order fluxes that are functions of donor stock size and a coefficient (listed below) having units of days (d^{-1}), as follows:

$$\text{Deposit feeding} = [\text{Sediment organics and microbes}] * k_1$$

$$\text{Grazing} = [\text{Sediments organics and microbes}] * k_2$$

$$\text{Predation of macrofauna on meiofauna} = [\text{Meiofauna}] * k_3$$

$$\text{Predation of megafauna on macrofauna} = [\text{Macrofauna}] * k_4$$

$$\text{Predation of fishes on megafauna} = [\text{Megafauna}] * k_5$$

with the following feeding rate coefficients:

$$k_1 = 2.966E-4$$

$$k_2 = 0.01159$$

$$k_3 = 0.00482$$

$$k4 = 1.23E-5$$

$$k5 = 1.91E-4$$

The largest stock size by far is the detrital carbon in the surficial 20 cm of sediment (approx. 400 to 500 g C m⁻²-20 cm; Figure 2.2). This is about what would be expected along any continental margin, based on similar studies (Rowe *et al.* 1991). The widely-recognized problem with this stock is that little quantitative information is available on what fraction of the pool can be utilized by the heterotrophic biota. The assumption was made in earlier models that only a small fraction of the stock is available, and in earlier models this small fraction was used in the calculation of the donor-dependent rate constants. If the entire stock is used, then the rate constants are very small and the effects of variations in the input term on community dynamics are very small. The large pool of carbon effectively dampens the responses to variations in input. One alternative has been to assume that the reactive carbon is found only in the top few centimeters of sediment (Khripunoff and Rowe 1985). At our site however nitrate declines continuously throughout the top 20 cm (Figure 2.1), thus suggesting that degradation of organic matter is not limited to the surface but is continuing to depth via denitrification (Christensen and Rowe 1984). In the models for our site a full spectrum of possibilities was run, with the extremes being a pool of detrital carbon in which the entire stock (400-500 g C m⁻²-20 cm) was reactive, albeit at extremely low rates, versus a condition in which only the living carbon (the bacteria) in this stock was reactive. In the latter case the detritus is effectively non-existent because it is completely unreactive or refractory. We present the results of the latter extreme, in which the assumption is made that the standing stock of the reactive organic matter is limited to living bacterial biomass (408 mg C m⁻²-20 cm).

As in previous models (Rowe *et al.* 1997; Rowe 1998), a time-varying function has been used to represent seasonal changes in primary production in surface waters. The POC input varies over a 365 day cycle from a minimum of 8.4 up to a maximum of 12.4 mg C m⁻²d⁻¹. The equation for the input in the STELLA II code is the following:

$$\text{Rain of Organic Particles} = \text{IF}(\text{Seasonal Variation} < 0) \text{ THEN}(8.4) \text{ ELSE}(8.4 + \text{Seasonal Variation} * 12.4)$$

where Seasonal Variation = Sine($\pi * \text{days} / 182.5$). This means that during 6 months of the year the rain into the bottom is 8.4 mg C m⁻² d⁻¹, whereas during other 6 months the rain follows a sine curve, with a maximum of 12.4 mg C m⁻² d⁻¹.

Each standing stock has been plotted as a function of time (Figure 2.3). The results suggest that organic matter input (mg C m⁻²-d⁻¹) that varies on a seasonal basis will be reflected throughout the food web. The largest variation is seen in the smallest animals, which also have the highest respiration and feeding rates. The changes in the larger organisms are small by comparison. A lag on the order of several weeks can be seen between organic matter in sediments and bacterial biomass. The lag cascades through the food web such that the largest group, the megafauna, has peak biomass values at the times when the organic matter in the sediments is lowest. Most of the organic matter is recycled into CO₂, rather than being transferred up the food chain. The mean input of organic carbon needed to balance the simulated utilization [based on calculated respiration rates]

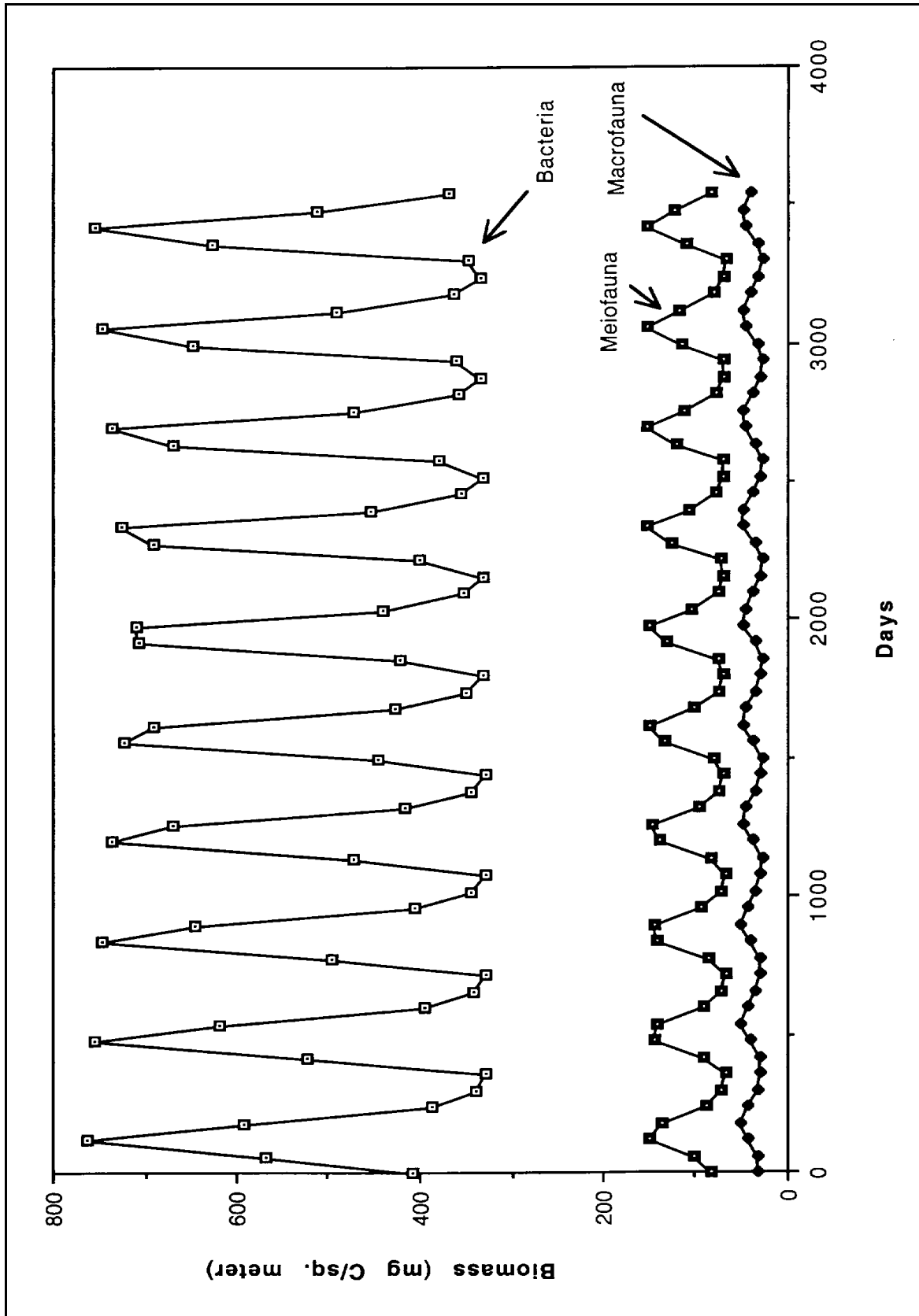

Figure 2.3. Variations in biomass of the bacteria (top), meiofauna (middle), and macrofauna (bottom) as a function of time in response to a seasonal input of organic matter (POC) from the water column. Units are mg C m^{-2} .

reflects values that might be encountered at equivalent depths along many continental margins where similar studies have been conducted.

The lags in response to the input of organic matter and the translation of lags along the food web suggest that predicting the times of the year that highest biomass or greatest community respiration rates will be encountered will not be simple. The works of Muller Karger *et al.* (1990) and Walsh *et al.* (1989) have documented that highest plant biomass occurs in the winter when mixing is greatest. Thus, according to our analysis, highest biomass and respiration values in deep water would be encountered during the following summer.

Experiments have also been run to estimate the effects of constant step-like increases. These result in a ramp up of all rates and biomass values with steady state being reached for each group at various time periods. The smaller organisms reach steady state in relatively short periods (weeks to months), but the larger organisms take months to years, depending on the increase in the input term. This type of shift up could be used to investigate the effects of organic loading from alien sources such as drilling mud, dredge spoils, etc.

The model can be validated by measuring changes in biomass over time or by measuring respiration rates. The lander incubation value can be regarded as an independent assessment of the combined respiration of the organisms living within and on the sediments. In our single measurement, we discovered that the mean rate of POC utilization predicted from the simulation is approximately 2.2 times higher than the direct measurements of sediment community respiration obtained using the benthic lander at this site (9.7 vs. 4 mg C m⁻²d⁻¹). Thus, the indirect estimates of respiration based on mean biomass, total biomass and temperature need adjustment.

ACKNOWLEDGMENTS

We thank the Department of Oceanography for support of the Texas-based portion of this project, as well as for the use of the R/V GYRE. The *Instituto Ciencias del Mar y Limnologia* studies were supported by the *Universidad Nacional Autonoma de Mexico* and the *Consejo Nationale de Ciencias y Tecnologia* of Mexico. CONACyT. We thank Rodolfo Dirzo for insightful comments. The crews of the GYRE and the JUSTO SIERRA deserve our sincere appreciation for conducting the collaborative studies in close proximity, along with providing hospitable and enlightening exchanges of samples, students and staff between the ships at sea.

REFERENCES

- Booker, R. 1971. Some aspects of the biology and ecology of the deep-sea echinoid *Phormosoma placenta* Wyv. Thompson. M.S. thesis, Texas A&M University.
- Bright, T. 1968. A survey of the deep-sea bottom fishes of the Gulf of Mexico below 350 meter. Ph.D. dissertation, Dept. of Oceanography, Texas A&M University.
- Buffler, R. 1978. Deformation and origin of the Sigsbee Scarp-Lower Continental Slope, northern Gulf of Mexico. Offshore Technology Conference, Proceedings, 1978, 3,1425-1433.

- Carney, R. and A.G. Carey. 1980. An evaluation of the effectiveness of metered wheels in measuring the distance sampled by beam trawls. *Fish. Bull.* 78(3): 791-796.
- Carney, R. 1971. Some aspects of the ecology of *Mesothuria lactea* Theel, a common bathyal holothurian in the Gulf of Mexico. M.S. thesis, Texas A&M University.
- Christensen, J. and G. Rowe. 1984. Nitrification and oxygen consumption in Northwest Atlantic deep-sea sediments. *Journal of Marine Research* 42: 1099-1116.
- Cruz-Kaegi, M.E. 1998. Latitudinal variations in biomass and metabolism of benthic infaunal communities. Ph.D. dissertation, Texas A&M University.
- Deming, J. and J. Baross. 1993. The early diagenesis of organic matter: Bacterial activity. Pp. 119-144. *In* M. Engel and S. Macko, eds. *Organic Geochemistry*. Plenum, New York.
- Deming, J. and J. Baross. 2000. Survival, dormancy and non-culturable cells in deep-sea environments. *In* R. Colwell and D. Grimes, eds. *Non-Culturable Microorganisms in the Environment*. ASM Press, Washington.
- Escobar-Briones, E.G., M. Signoret and D. Hernandez. 1999. Variacion de la densidad de la infauna macrobentica en un gradiente batimetrico: oeste del Golfo de Mexico. *Ciencias Marinas* 25: 1-20.
- Escobar-Briones, E., M. Lopez, L. Soto, and M. Signoret. 1997. Comparacion de la densidad y biomasa de la meiofauna del talud continental superior en dos zonas del Golfo de Mexico. *Ciencias Marinas* 23: 463-487.
- Escobar-Briones, E.G. and L. Soto. 1997. Continental shelf benthic biomass in the western Gulf of Mexico. *Continental Shelf Research* 17: 585-604.
- Firth, R. 1971. A study of the deep-sea lobsters of the families Polychelidae and Nephropidae (Crustacea, Decapoda). Ph.D. dissertation, Texas A&M University.
- Gallaway, B., ed. 1988. Northern Gulf of Mexico Continental Slope Study, Final Rept.: Year 4. Vol. II: Synthesis Rept. Final report submitted to the Minerals Management Service, New Orleans, LA Contract No. 14-12-0001-30212.
- Gallaway, B., L. Martin and R. Howard, eds. 1988. Northern Gulf of Mexico Continental Slope Study. Annual Rept.: Year 3. Vol. I-III: Executive Summary, Technical Report and Appendices. Submitted to the Minerals Management Services, New Orleans, LA. Contract No. 14-12-0001-30212.
- Grant, J. and P. Schwinghamer. 1987. Size partitioning of microbial and meiobenthic biomass and respiration on Brown's Bank, Southwest Nova Scotia. *Estuarine, Coastal and Shelf Science* 25: 647-661.

- Haedrich, R. and G. Rowe. 1977. Megafaunal biomass in the deep sea. *Nature* 269: 141-142.
- Haedrich, R., G. Rowe and P. Polloni. 1980. The megabenthic fauna in the deep sea south of New England. *Marine Biology* 57: 165-179.
- Hinga, K., J. McN. Sieburth and G. R. Heath. 1979. The supply and use of organic material at the deep-sea floor. *Journal of Marine Research* 37: 557-579.
- Hubbard, F. 1977. A quantitative analysis of benthic polychaetous annelids from the northwestern Gulf of Mexico. M.S. thesis, Texas A&M University.
- Hubbard, F. 1995. Benthic polychaetes from the northern Gulf of Mexico continental slope. Ph.D. dissertation, Texas A&M University.
- James, B. 1972. Systematics and biology of the deep-water Palaeotaxodonata (Mollusca: Bivalvia) from the Gulf of Mexico. Ph.D. dissertation, Texas A&M University.
- Jahnke, R. and G. Jackson. 1991. The spatial distribution of sea floor oxygen consumption in the Atlantic and Pacific Ocean. Pp. 295-307. *In* G. Rowe and V. Pariente, eds. *Climate Change and the Deep-Sea Carbon Cycle*. NATO Adv. Res. Workshop. Kluwer, Boston.
- Kennedy, E. A., Jr. 1976. A distribution study of deep-sea macrobenthos collected from the western Gulf of Mexico. Ph.D. dissertation, Texas A&M University.
- Khripounoff, A. and G. Rowe. 1985. Les apports organiques et leur transformation en milieu abyssal a l'interface eau-sediment dans l'Ocean Atlantique tropical. *Oceanologica Acta* 8: 293-301.
- Lampitt, R., D. Billett and A. Rice. 1986. Biomass of the invertebrate megabenthos from 500 to 4100 m in the northeast Atlantic Ocean. *Marine Biology* 93: 69-81.
- Lohse, A. 1999. Variation in species diversity within macrobenthic invertebrate communities in the western Gulf of Mexico. M.S. thesis, Texas A&M University.
- MacDonald, I. 1990. Spatial ecology of hydrocarbon seeps in the northern Gulf of Mexico. Ph.D. dissertation, Texas A&M University.
- Mahaut, M., M. Sibuet and Y. Shirayama. 1995. Weight-dependent respiration rates in deep-sea organisms. *Deep-Sea Research* 42, 1575-1582.
- Muller-Karger, F., J. Walsh, R. Evans and M. Meyers. 1991. On the seasonal phytoplankton concentration and sea surface temperature cycles of the Gulf of Mexico. *Journal of Geophysical Research* 90:12645-12665.
- Mukai, L. 1974. The species composition and distribution of the Asteroidea of the Gulf of Mexico and the Caribbean. M.S. thesis, Texas A&M University.

- Pequegnat, L. 1970. A study of deep-sea caridean shrimps (Crustacea: Decapoda: Natantia) of the Gulf of Mexico. Ph.D. dissertation, Texas A&M University.
- Pequegnat, W. 1983. The ecological communities of the continental slope and adjacent regimes of the northern Gulf of Mexico. U. S. Minerals Management Service, Dept. of the Interior. Contract No AA851-CT1-12. 398 p. plus 3 appendices.
- Pequegnat, W., T. Bright and Bela James. 1970. The benthic skimmer, a new biological sampler for deep-sea studies. Pp. 17-20. *In* W. Pequegnat and F. Chace, Jr., eds. Contributions on the Biology of the Gulf of Mexico. Gulf Publishing, Houston.
- Pequegnat, W., B. Gallaway and L. Pequegnat 1990. Aspects of the ecology of the deep-water fauna of the Gulf of Mexico. *American Zoologist* 30: 45-64.
- Pilskaln, C., J. Paduan, F. Chavez, R. Anderson and W. Berelson. 1996. Carbon export and regeneration in the coastal upwelling system of Monterey Bay, central California. *Journal of Marine Research* 54: 1149-1178.
- Rayburn, R. 1975. Food of deep-sea fishes of the northwestern Gulf of Mexico. M.S. thesis, Texas A&M University.
- Relexans, J.-C., J. Deming, A. Dinet, J.-F. Gaillard and M. Sibuet. 1996. Sedimentary organic matter and micro-meiobenthos with relation to trophic conditions in the tropical northeast Atlantic. *Deep-Sea Research I*, 43: 1343-1368.
- Rex, M. 1983. Geographic patterns of species diversity in the deep-sea benthos. Pp. 453-472. *In* G. Rowe, ed. *Deep-Sea Biology*, Vol. 8, *The Sea*. Wiley, Interscience.
- Rex, M. 1983. Species diversity in the deep sea. *In* G. Rowe, ed. *Deep-Sea Biology*, Vol. 8, *The Sea*. Wiley, New York.
- Rezak, R., A. Bouma, and L. Jeffrey. 1969. Hydrocarbons cored from knolls in southwestern Gulf of Mexico. *Transactions – Gulf Coast Association of Geological Societies* 19: 115-118.
- Roberts, T. 1970. A preliminary study of the family Penaeidae and their distribution in the deep water of the Gulf of Mexico. M.S. thesis, Texas A&M University.
- Roberts, T. 1977. An analysis of deep-sea benthic communities in the northeast Gulf of Mexico. Ph.D. dissertation, Texas A&M University.
- Rowe, G. 1971. Benthic biomass and surface productivity. Pp. 441-454. *In* J. Costlow, ed. *The Fertility of the Sea* (vol. 2). Gordon and Breach, New York.

- Rowe, G. and D. Menzel. 1971. Quantitative benthic samples from the deep Gulf of Mexico with some comments on the measurement of deep-sea biomass. *Bulletin of Marine Science* 21: 556-566.
- Rowe, G., P. Polloni and S. Hornor. 1974. Benthic biomass estimates from the northwest Atlantic Ocean and the northern Gulf of Mexico. *Deep-Sea Research* 21: 641-650.
- Rowe, G. 1983. Biomass and production in deep-sea macrobenthos. Pp. 97-121. *In* G. Rowe, ed. Vol 8, *The Sea, Deep-Sea Biology*. Wiley, New York.
- Rowe, G., M. Sibuet, J. Deming, A. Khripounoff, J. Tietjen, S. Macko, and R. Theroux. 1991. 'Total' sediment biomass and preliminary estimates of organic carbon residence time in deep-sea benthos. *Marine Ecology Progress Series* 79: 99-114.
- Rowe, G., G. Boland, W. Phoel, R. Anderson and P. Biscaye. 1994. Deep sea-floor respiration as an indication of lateral input of biogenic detritus from continental margins. *Deep-Sea Research II* 41: 657-668.
- Rowe, G., G. Boland, E. Escobar Briones, M. Cruz-Kaegi, A. Newton, D. Piepenberg, I. Walsh, and J. Deming. 1997. Sediment community biomass and respiration in the northeast water polynya, Greenland: a numerical simulation of benthic lander and spade core data. *Journal of Marine Systems* 10: 497-515.
- Rowe, G. 1998. Organic carbon cycling in abyssal benthic food chains: numerical simulations of bioenhancement by sewage sludge. *Journal of Marine Systems* 14: 337-354.
- Schmidt, J., J. Deming, P. Jumars and R. Keil. 1998. Constancy of bacterial abundance in surficial marine sediments. *Limnology & Oceanography* 43: 976-982.
- Smith, K. L., Jr. and K. Hinga 1983. Sediment community respiration in the deep sea. Pp. 331-370. *In* Rowe, G., ed. *The Sea*, Vol. 8, *Deep-Sea Biology*. Wiley, New York.
- Smith, K. L., Jr. 1992. Benthic boundary layer communities and carbon cycling at abyssal depths in the central North Pacific. *Limnology & Oceanography* 37: 1034-1056.
- Soto, L. and E. Escobar-Briones. 1995. Coupling mechanisms related to benthic production in the southwestern Gulf of Mexico. Pp. 233-242. *In* A. Eleftheriou, A. Ansell and C. Smith, eds. *Proc. 28th Eur. Mar. Biol. Symp.* Olsen and Olsen, Copenhagen.
- Suess, E. 1980. Particulate organic carbon flux in the oceans-surface productivity and oxygen utilization. *Nature* 288: 260-263.
- Vargas, J. 1996. Oil and gas. A legal dispute brewing in the Gulf of Mexico. *Voices of Mexico*. 36: 76-80.

Walsh, J., D. Dieterlie, M. Meyers and F. Muller-Karger. 1989. Nitrogen exchanges at the continental margin: A numerical study of the Gulf of Mexico. *Progress in Oceanography* 23: 245-301.

Williams, P. M. and A. Carlucci. 1976. Bacterial utilization of organic matter in the deep sea. *Nature* 262: 810-811.

**DISTRIBUTION AND ABUNDANCE OF PHYTOPLANKTON ZOOPLANKTON,
ICHTHYOPLANKTON, AND MICRONEKTON IN
THE DEEPWATER GULF OF MEXICO**

Douglas C. Biggs
Patrick H. Ressler
Department of Oceanography
Texas A&M University

Phytoplankton distribution and abundance in Gulf of Mexico (GOM) waters has been reviewed at decadal intervals over the last 30 years, first by Bjornberg (1971), then by Iverson (in Iverson and Hopkins 1981), and most recently by Vargo (in Vargo and Hopkins 1990). Most of the primary literature these reviewers cited focused on the continental shelf. Moreover, Vargo, in particular, noted that much of the information for his review came from studies conducted 10 to 20 years before 1990. In fact, data collected by expeditions in the 1960s and 1970s remain the basis for the general paradigm that standing stocks and productivity of phytoplankton are both quite low seaward of the shelf-slope break in the Gulf of Mexico. In the review for this Fish and Fisheries Workshop, we support that description of the mean state but we also show that research carried out since 1987 indicates “hot spots” in primary production occur when/where nutrient availability is locally enhanced, even in deepwater seaward of the shelf-slope break.

In the late 1960s, Soviet scientists characterized the deepwater GOM as very low in standing plankton biomass and with mean primary productivity of just 100-150 mg C m⁻² d⁻¹ (Koblenz-Mishke *et al.* 1970). A few years later, extensive surveys of phytoplankton chlorophyll and primary production that span the period 1964-1971 were summarized by El-Sayed (1972) in atlas format, as averages within 2° squares of latitude and longitude. In the atlas, low values of primary production (< 0.25 mg C m⁻³ h⁻¹) are typical. When integrated from surface to base of the photic zone, most 2° squares total < 10 mg C m⁻² h⁻¹. If there are on average 12 h of sunlight per day, this rate is equivalent to < 120 mg C m⁻² d⁻¹ and so is in good agreement with characterization by Koblenz-Mishke *et al.* Allowing for primary production to proceed 300 days a year in the GOM because of its subtropical climate, this rate of primary productivity is < 36 g C m⁻² y⁻¹. As a consequence, the deepwater GOM is usually placed at the low end of the estimated range of 50-160 g C m⁻² y⁻¹ that is generally accepted for the annual gross primary production in open-ocean ecosystems (Smith and Hollibaugh 1993).

When essential plant nutrients are limiting, any process that increases the nutrient concentrations available to the phytoplankton in the deepwater GOM will increase primary productivity. It is well known that freshwater inputs carry high nutrient loads, but in the GOM these high nutrient inputs are usually measurable only close-in to rivers and estuaries (Lohrenz *et al.* 1999). An exception occurs, however, when surface currents set up off-shelf flow that carries the river water seaward past the shelf-slope break and into deepwater. In mid-summer 1998, low salinity Mississippi River water was entrained and wrapped clockwise around the periphery of a warm slope eddy that altimetry showed was centered near 28.5°N, 87°W. A comparison of the salinity and chlorophyll fields shows that surface chlorophyll concentrations in this river water exceeded 2 mg m⁻³ and that the patches

of highest surface chlorophyll corresponded spatially to the patches of lowest surface salinity. In fact, NEGOM fieldwork documented similar situations in subsequent summers 1999 and 2000 and GulfCet II fieldwork documented entrainment of low salinity “green water” and its transport off-shelf in the previous summer 1997. We suggest entrainment and transport off shelf may be the rule, rather than the exception, when/where a warm slope eddy is present in the NE Gulf.

Recently, Wiseman & Sturges (1999) reviewed some large and mesoscale motions that might enhance the availability of nutrients for primary production. They pointed out that the high velocity periphery of slope eddies (and other eddies) are regions of high vertical shear and thus might be expected to be areas of nutrient upwelling as well as regions of nutrient-rich river water entrainment. In fact, direct measurements of ^{14}C uptake confirm that anomalous high primary production occurs at stations in the high velocity periphery of warm slope eddies sampled west of the NEGOM field area. Gonzalez-Rodas (1999), who summarized primary productivity measurements that he made on six LATEX cruises, reported two prominent hot spots in deepwater primary production ($> 2.5 \text{ g C m}^{-2} \text{ d}^{-1}$) on these six cruises. In August 1993 and again in November 1994, productivity near 27.5°N and 92°W was 10-fold or more higher than typical for the oceanic Gulf over the upper continental slope. In summer 1993, the northern edge of Loop Current Eddy (LCE)-W was interacting with the continental margin between 91° and 93°W ; the locally high shear there apparently fueled a region of anomalously high deepwater primary production. This eddy had a diameter of some 250 km; at the location where the productivity was measured, the geopotential anomaly was about +20 cm and current speeds were about 60 cm sec^{-1} (see Table 5 in Gonzalez-Rodas 1999). In fall 1994, the northern edge of another anticyclone, LCE-Y, was interacting with the continental margin again between 91° and 92°W . This eddy was even larger in diameter (320 km) and presented a geopotential anomaly of +36 cm (from Table 5 in Gonzalez-Rodas 1999).

The deepwater Gulf of Mexico has been considered a biologically impoverished ocean in terms of zooplankton, ichthyoplankton, and micronekton as well as phytoplankton, since on average the standing stocks of plankton and fish seaward of the shelf break are lower than those found in temperate and higher latitude regions. Previous reviewers have reinforced this perception (*e.g.* Hopkins, writing in Iverson and Hopkins 1981, and in Vargo and Hopkins 1990).

However, relegating secondary production in the GOM to oligotrophic status is an oversimplification, because standing stock levels are not uniformly low but are instead punctuated by spatial and temporal variation greater than that found in most other oligotrophic oceans. This variability may be manifested as spatial and temporal “hot spots” of increased biomass. For example, Khromov (1969a, 1969b) reported that while zooplankton standing stocks in the tropical oligotrophic Caribbean Sea were almost always low and did not exceed 10 ml wet displacement volume (WDV) per 100 m^3 in waters offshore of the shelf/slope break, GOM stocks exhibited more seasonal, interannual, and spatial variability, with biomass levels as high as 35 ml WDV per 100 m^3 (range $< 5 - 35$). Hopkins and Lancraft (1984), who compared integrated wet weight biomass of zooplankton and micronekton in three tropical-subtropical oceans (Caribbean Sea near Puerto Rico, Gulf of Mexico at $27^\circ\text{N} \times 86^\circ\text{W}$, and Pacific Ocean near Hawaii), found that GOM levels were the highest in both categories (if large medusae were included in the micronekton total). Although more recent studies of GOM biomass do generally reveal low standing stocks, reported estimates can vary

by a factor of 10 or more from the minima within a given study (Biggs *et al.* 1988; Richards *et al.* 1993; Wormuth *et al.* 2000).

Finally, the deepwater ichthyoplankton community includes the larvae of commercially important species such as tuna, mackerel, billfishes, and swordfishes (Vargo and Hopkins 1990), and commercial fisheries do exist for the adults in the Gulf of Mexico. The deepwater GOM is also habitat for substantial populations of marine mammals, sea turtles, and seabirds (Davis *et al.* 2000). The presence of sizeable populations of such apex predators in the deepwater GOM implies a reliable supply of lower trophic level prey resources (Biggs *et al.* 1988) and suggests that underlying physical processes allow “oases” of biological productivity to develop in the mostly oligotrophic deepwater GOM.

We suggest that these deepwater “hot spots” of zooplankton, micronekton, and ichthyoplankton occur when primary production is enhanced by coarse to mesoscale eddies, as described above. Lamkin (1997) showed that larval fish were associated with the Loop Current and periphery regions of companion cyclones and anticyclones, and recently Wormuth *et al.* (2000) documented that deepwater cyclones had locally higher standing stocks of zooplankton and micronekton than did LCEs. These features may not be revealed by coarse sampling or averaging of measurements across large temporal and spatial scales. However, combining alternative techniques such as acoustical and optical techniques with traditional direct sampling with nets can provide zooplankton-micronekton-ichthyoplankton data with sufficient resolution to examine temporal and spatial trends in a manner impossible with net sampling at single discrete locations. This capacity is also useful given the growing amount of coarse to mesoscale oceanographic data available from satellites. A combination of net, acoustical, and optical techniques appears to be the optimum way to study variations in zooplankton and micronekton standing stock biomass, and such a unification of technologies will lead to better understanding of the interaction of hydrography and ecology in the deepwater Gulf of Mexico.

In summary, expeditions in the 1960s and 1970s are the basis for the general paradigm that standing stocks and productivity of phytoplankton are both low ($< 0.1 \text{ mg chl m}^{-3}$; $< 150 \text{ mg C m}^{-2} \text{ d}^{-1}$) seaward of the shelf-slope break in the Gulf of Mexico. The present review supports this description of the mean state (stable state) but also shows “hot spots” in primary production ($> 2 \text{ g C m}^{-2} \text{ d}^{-1}$) occur when/where nutrient availability is locally enhanced seaward of the shelf-slope break (Biggs and Ressler, in review). Fundamental nutrients-phytoplankton-zooplankton (NPZ) food chain theory (summarized by Lalli and Parsons 1997) forecasts that enhanced primary production, if sustained, will support increased zooplankton, ichthyoplankton, and micronekton production. Available evidence from the GOM is that deepwater “hot spots” that are temporally persistent have higher stocks of zooplankton and micronekton, even when the specific locations of such “oases” are spatially variable along the continental margin. Continued study and assessment of plankton and micronekton within these “hot spots” is warranted, since these organisms ultimately serve as food for higher trophic level predators, including commercially important fish species, federally protected marine mammals, and seabirds.

REFERENCES

- Biggs, D.C., and P.H. Ressler (*in review*). Distribution and abundance of phytoplankton, zooplankton, ichthyoplankton, and micronekton in the deepwater Gulf of Mexico. Submitted to Gulf Mex. Sci.
- Biggs, D. C., A. C. Vastano, R. A. Ossinger, A. G. Zurita, and A. P. Franco. 1988. Multidisciplinary study of warm and cold-core rings in the Gulf of Mexico, *Memorias Sociedad de Ciencias Naturales La Salle*, 48(3): 11-31.
- Björnberg, T. K. S. 1971. Distribution of plankton relative to the general circulation system in the area of the Caribbean Sea and adjacent regions. *In* Symposium on Investigations and Resources of the Caribbean Sea and Adjacent Regions, Willemstad, Curaçao, Netherlands Antilles, 18-26 November 1968, pp. 343-356, United Nations Educational, Scientific, and Cultural Organization (UNESCO), Paris, France.
- Davis, R. W., W. E. Evans, and B. Würsig, eds. 2000. Cetaceans, Sea Turtles and Seabirds in the Northern Gulf of Mexico: Distribution, Abundance and Habitat Associations. Volume II: Technical Report. Prepared by Texas A&M University at Galveston and the National Marine Fisheries Service. U.S. Department of the Interior, Geological Survey, Biological Resources Division, USGS/BRD/CR-1999-0006 and Minerals Management Service, Gulf of Mexico Region, New Orleans, LA. OCS Study MMS 2000-003 346 pp.
- El-Sayed, S.Z. 1972. Primary productivity and standing crop of phytoplankton. pp 8-13. *In* V.C. Bushnell, ed. Chemistry, Primary Productivity, and Benthic Algae of the Gulf of Mexico. American Geographical Society, New York.
- Gonzalez-Rodas, G.E. 1999. Physical Forcing of Primary Productivity in the Northwestern Gulf of Mexico. Ph.D. dissertation, Department of Oceanography, Texas A&M University, College Station, TX. 149 pp.
- Hopkins, T. L., and T. M. Lancraft. 1984. The composition and standing stock of mesopelagic micronekton at 27°N 86°W in the eastern Gulf of Mexico, *Contrib. In Mar. Sci.*, 27: 143-158.
- Iverson, R. L. and T. L. Hopkins. 1981. A Summary of Knowledge of Plankton Production in the Gulf of Mexico: Recent Phytoplankton and Zooplankton Research. *In* Proceedings of a Symposium on Environmental Research Needs in the Gulf of Mexico (GOMEX), Key Biscayne, Florida, 30 September – 5 October 1979, vol. IIA, pp. 147-211, Atlantic Oceanographic and Meteorological Laboratories, Miami, FL.
- Khromov, N. S. 1969a. Distribution of plankton in the Gulf of Mexico and some aspects of its seasonal dynamics, pp 36-55. *In* Soviet-Cuban Fishery Research (A. S. Bogdanov, ed.). Translated from Russian by Israel Program for Scientific Translation, Jerusalem, for the U.S. Department of the Interior and the National Science Foundation (TT 69-59016), U.S.

Department of Commerce, Clearinghouse for Federal Scientific & Technical Information, Springfield, VA.

- Khromov, N. S. 1969b. Distribution of plankton in the Caribbean Sea, pp 57-61. *In* Soviet-Cuban Fishery Research (A. S. Bogdanov, ed.). Translated from Russian by Israel Program for Scientific Translation, Jerusalem, for the U.S. Department of the Interior and the National Science Foundation (TT 69-59016), U.S. Department of Commerce, Clearinghouse for Federal Scientific & Technical Information, Springfield, VA.
- Koblenz-Mishke, O.J., V.K. Volkovinsky, and J.C. Kabanova. 1970. Plankton primary production of the world ocean. *In* W.W. Wooster, ed. Scientific Exploration of the South Pacific, National Academy of Science, Washington, D.C., pp. 183-193.
- Lalli, C.M., and T.R. Parsons. 1997. Biological Oceanography: An Introduction. Second edition, Butterworth-Heinemann, UK. 314 pages.
- Lamkin, J. 1997. The Loop Current and the abundance of *Cubiceps pauciradiatus* (Pisces: Nomeidae) in the Gulf of Mexico: evidence for physical and biological interaction, *Fish. Bull.*, 95: 250-266.
- Lohrenz, S.A., D.A. Wiesenburg, R.A. Arnone, and X. Chen. 1999. What controls primary production in the Gulf of Mexico? pp. 151-170. *In* The Gulf of Mexico Large Marine Ecosystem (H. Kumpf, K. Steidinger, and K. Sherman, eds.). Blackwell Science, Inc.
- Richards, W.J., M.F. McGowan, T. Leming, J.T. Lamkin, and S. Kelley. 1993. Larval fish assemblages at the Loop Current boundary in the Gulf of Mexico, *Bull. Mar. Sci.*, 53: 475-537.
- Smith, S. and J.T. Hollibaugh. 1993. Coastal metabolism and the oceanic organic carbon balance. *Rev. Geophys.* 31: 75-89.
- Vargo, G. A. and T. L. Hopkins. 1990. Chapter 6: Plankton. *In* Synthesis of Available Biological, Geological, Chemical, Socioeconomic, and Cultural Resource Information for the South Florida Area. Report OCS/MMS90/0019 to the Minerals Management Service by Continental Shelf Associates (PB90-266685), pp. 195-230, National Technical Information Service (NTIS), Springfield, VA.
- Wiseman, W.J. and W. Sturges. 1999. Physical oceanography of the Gulf of Mexico: Processes that regulate its biology. Pp. 77-92. *In* The Gulf of Mexico Large Marine Ecosystem (H. Kumpf, K. Steidinger, and K. Sherman, eds.). Blackwell Science, Inc.
- Wormuth, J.H., P.H. Ressler, R.B. Cady, and L.H. Harris. 2000. Zooplankton and micronekton in cyclones and anticyclones in the northeast Gulf of Mexico. *Gulf Mex. Sci.* 18(1): 23-34.
-

Dr. Douglas Biggs and Mr. Patrick Ressler are both in the Department of Oceanography at Texas A&M University. Professor Biggs received the Ph.D. in oceanography from the MIT-WHOI Joint Program in Oceanography in 1976 and since 1987 he has been PI or co-PI for various MMS-sponsored field programs in the Gulf of Mexico, including SOOP, GulfCet II, NEGOM, and DGoMB. Mr. Ressler received the B.A. *summa cum laude* in biology from Bucknell University in 1996 and is making acoustic estimates of zooplankton and micronekton stocks in the Gulf of Mexico with an ADCP as part of his Ph.D. dissertation research at TAMU.

DEEPWATER PETROLEUM STRUCTURES AS FISH AGGREGATING DEVICES: AN IN-PROGRESS PROJECT REPORT

Randy E. Edwards
Kenneth J. Sulak
Doug Weaver
U.S. Geological Survey
Biological Resources Division
Florida Caribbean Science Center

ABSTRACT

Fish aggregating devices (FADs) have recently been utilized around the world and have been shown to have large effects on fish and fisheries, particularly tunas and tuna fisheries. Other pelagic fish species also are aggregated and impacted by FADs. Fishery problems and potential problems have been identified with FADs, primarily increased relative catch of smaller/younger fish and potential changes in distribution and migration. FADs also can have positive effects, primarily making fishing more effective and efficient. Important and valuable commercial and recreational fisheries have been established by deployment of FADs. The offshore oil and gas industry in the Gulf of Mexico (GOM) recently has been expanding into deep waters of the outer continental shelf and slope where petroleum structures have the potential to act as FADs. A project is being conducted by the U.S. Geological Survey – Biological Resources Division (USGS-BRD) in collaboration with the Minerals Management Service (MMS) to assess and anticipate potential impacts of increased numbers of deepwater petroleum structures on highly migratory fish species in the GOM. Preliminary review of scientific literature on FADs suggests that processes and factors involved in fish aggregation by objects are complex and that the current scientific understanding of FADs is insufficient for prediction of the potential fish aggregating impacts of deepwater petroleum structures in the GOM. Although present understanding of FADs suggests that deepwater structures are likely to have measurable impacts, direct research and study may be needed to assess fully and to estimate such impacts.

INTRODUCTION TO THE IN-PROGRESS PROJECT

The project described below is designed to assist the MMS in assessing the degree to which petroleum structures in deep waters of the northern GOM may function as FADs and thus may result in biological impacts on highly migratory species (HMS) and other pelagic fish species in the Gulf. The project was described at the *Gulf of Mexico Fish and Fisheries: Bringing Together New and Recent Research* workshop to disseminate information about project's existence and its goals, to contact other GOM fishery scientists and managers, and to involve, in our ongoing work, those with pertinent information and experience.

WHAT ARE FADs?

The term fish aggregating device (FAD) is usually applied to two categories of floating objects that attract and aggregate fish. The first is comprised of floating objects that are moored or anchored,

while the second consists of those objects that are free drifting. The functioning of the two categories of FADs, in terms of aggregating fish, is similar, but may be different because of many factors by which the two types of FADs are inherently different. A complete discussion of FADs is beyond the scope of this paper. In this paper, we focus on deepwater FADs and associated pelagic fish species, although FADs in coastal waters may function differently and attract different species. The following summary is presented to provide context and perspective for our current project.

The use by fishermen of objects to attract and aggregate fish probably extends back to ancient times. The earliest FADs were probably anchored, floating rafts of bamboo, locally called payaws, that were traditionally deployed by artisanal fishermen in the Philippine Islands in the early 1900s (Anderson and Gates 1996). Payaws were commercialized around 1975, when purse seiners began to set nets around them (Dickson 1999). The use of anchored FADs similar to payaws soon spread throughout the region and around the world. Recent moored FADs are constructed of man-made materials and are often highly engineered. They have been used particularly in oceanic island nations, where they can be deployed in depths shallow enough for mooring, yet be close to deep pelagic environments. In places like Hawaii, where there currently are 52 FADs moored at locations around the island state, FADs are used by both commercial and recreational fishermen (Higashi 1994; Holland 1999). Moored FADs are also widely used in the Mediterranean (D'Anna, Badalamenti and Riggio 1999). With the exception of experimental midwater FADs studied in coastal waters (Klima and Wickham 1971; Whickham and Russell 1974) and experimental moored FADs on the NW coast of Cuba, which were successful in aggregating skipjack tuna (Martin 1999), the GOM is probably the only large area in which deepwater FADs have not been purposely utilized.

The other category of FADs, free-floating objects, has become exceedingly important over the last decade. Tuna fisheries, particularly purse seine fisheries, like those in the eastern tropical Pacific, have taken advantage of the propensity of tunas to aggregate around floating objects. Originally, such fisheries caught tunas from around natural objects like logs or even dead marine mammals. In the Pacific, a large part of the purse seine landings were taken by setting on pods of dolphins, to which tunas, for still unknown reasons, are attracted and aggregate. Because of concerns about mortality of dolphins and the advent of so called "dolphin-safe" tuna, the eastern Pacific tuna fleet shifted away from setting on dolphins and began to concentrate on natural "logs" starting around 1992. At the same time, fishermen began to deploy artificial objects in the open ocean in order to aggregate tunas (Lennert-Cody, Garcia and Hall 1999). Recently, man-made drifting FADs technology has become very sophisticated, and some FADs even have radio transmitters, echo sounders (for detecting schools of tuna) computers (for storing echo sounding data and controlling radio transmissions to fishing vessels), underwater lights, and satellite tracking (Fonteneau *et al.* 1999).

The use of FADs (natural and man-made) has accelerated to the point that in 1998, 55% of the eastern Pacific tuna purse seine effort was expended in setting on schools around FADs or logs (Tillman 1999). Exact catch statistics are difficult to obtain, but because catch success is much higher around floating objects, it is clear that the largest part of the eastern Pacific tuna catch presently comes from around FADs.

FISH SPECIES ASSOCIATED WITH FADS

The fish species that are attracted and aggregated by FADs in deepwater environments are primarily pelagic species. They can be further subdivided into highly migratory species (HMS) and coastal pelagic species.

The term HMS is used by the National Marine Fisheries Service to include tunas, marlins, swordfish and certain pelagic sharks (NMFS 1999). The most important group of fish associated with FADs are the tunas, particularly skipjack (*Euthynnus pelamis*), yellowfin (*Thunnus albacares*), and to a lesser extent, bigeye (*Thunnus obesus*) tuna (Freon and Misund 1999). Marlins are considered to be associated with FADs (Hall *et al.* 1999), and in places like Hawaii and Australia, moored FADs are favored areas for recreational billfishing. Swordfish, however, have not been reported to be aggregated by FADs. Several species of sharks have been noted to associate with FADs. Other oceanic, migratory species (not included in the NMFS HMS definition) such as dolphin (*Coryphaena hippurus*) (Leonart *et al.* 1999) and wahoo (*Acanthocybium solandri*) (Hall *et al.* 1999) are known to associate with FADs.

There are many other species of fish that associate with FADs that can be classified as coastal pelagics—species that are usually found in coastal and continental shelf environments. They include several carangids, particularly scads (*Decapterus* sp.) and amberjacks (*Seriola* sp.) (D’Anna, Badalamenti, and Riggio 2000; Deudero *et al.* 2000). Most of these species or groups and others (*e.g.*, cobia, *Rachycentron canadum*; king mackerel, *Scomberomorus cavalla*) are abundant in the GOM and may be affected by FADs (Franks 1999).

PROBLEMS WITH FADS

Unfortunately, several issues or potential problems are connected with FADs. The first is that tunas caught from around FADs tend to be much younger and smaller than those caught from free-swimming schools. This is particularly true for yellowfin tuna. Polovina (1991) was one of the first to point out this problem. He noted that the Philippines tuna fisheries around payaws resulted in an over 20 times increase in landings, but that over 90% of the tunas caught around those FADs are less than one year old. He pointed out that reductions in size at entry result in very substantial reductions in yield estimates made from standard yield models. This problem is well recognized today. Fonteneau *et al.* (1999) recently concluded that the current massive use of FADs in worldwide tuna fisheries is “probably an unsafe fishing mode which needs to be limited to reasonable biological levels.” In the European Union – Japan High Level Fisheries Consultations, 14-15 October 1999, the parties expressed their differences in opinions about the use of FADs and discussed developing a joint research program aimed at improving selectivity of FADs.¹ The International Commission for the Conservation of Atlantic Tunas (ICCAT), because of concern about the high take of juveniles, has issued recommendations for restrictions on the use of FADs.²

¹ European Union press release, 20 October 1999. http://europa.eu.int/com/fisheries/news_corner/press/info65-en.htm.

² Gary Matlock, NOAA, National Marine Fisheries Service, U.S. House of Representatives, House Resources Subcommittee testimony, 15 July 1999.

There are other potential problems with FADs. One concern is whether FADs might disrupt normal movement and aggregation patterns (Kleiber and Hampton 1994). How such changes might impact stocks, through effects such as changes in spawning area and resultant effects on larval survival and recruitment are largely speculative at the present time. A related potential general problem is that of increased catchability of fish associated with FADs and the resultant impact on population dynamics and stock status. Also, fishing around FADs may result in increased bycatch, because of simultaneous aggregation of non-target species (Hall *et al.* 1999). Conflict between user groups (*e.g.*, between hook-and-line fishermen and purse seiners) is a common, practical problem (Anon. 1982).

POTENTIAL POSITIVE EFFECTS OF FADS

Some of the very same issues that, under some circumstances, might be considered to be problems can be viewed positively under different circumstances. The main advantage of FADs is that they do aggregate fish and make them easier to catch than if they were dispersed widely in an oceanic environment. Similarly, the same factors that result in aggregation of species that may be considered to be unwanted bycatch in commercial fisheries (*e.g.*, billfishes), under some circumstances can be viewed by recreational fishermen as highly positive, because they enhance opportunities for offshore gamefishing.

FADs, including GOM petroleum structures, might even be able to contribute to reduction of the important problem of commercial bycatch of billfish and undersize swordfish. This could take place through longline fisheries shifting to fishing around FADs, where tunas are more concentrated relative to billfish and juvenile swordfish. Also, they may shift their fishing techniques to utilization of gears (*e.g.*, vertical longlines; or shorter, more-frequently hauled horizontal longlines) that may significantly reduce bycatch and bycatch mortality (less mortality when fish are on the line for shorter periods (Berkeley and Edwards 1998)). A situation has been described for the Mediterranean, where seasonal shift to fishing for dolphin (*Coryphaena hippurus*) around FADs could reduce longline catch of juvenile swordfish (Cannizzaro *et al.* 1999).

Presence of FADs can make commercial and recreational fishing much more dependable, and often more economical, because less time and fuel is expended searching for fish, and because smaller vessels can be used to fish around FADs located close to shore. It is for those kinds of reasons that moored FADs have been deployed so widely around the world.

DEEPWATER PETROLEUM ACTIVITIES IN THE GULF OF MEXICO

A major development in offshore petroleum exploration and production in the GOM has occurred recently. It is detailed in a recent MMS publication titled *Deepwater Gulf of Mexico: America's Emerging Frontier* (Baud *et al.* 2000). The following discussion is summarized from that publication.

MMS defines “deepwater” as water deeper than 1,000 ft. Over the latter part of the last decade, three factors have come together to result in expansion of petroleum industry activities into deep water:

1. discovery that deepwater wells often had enormously high flow rates and, therefore, great economic return;
2. technological advances, including development of new types of structures that are able to be used in deeper water, and the use of subsea well completions in deeper water; and
3. economic incentive arising from the passage of the *Deepwater Royalty Relief Act of 1995* in the U.S. Congress.

Deepwater petroleum production has expanded to the point that by 1999, deepwater production exceeded that of all the shallow water. Because of this expansion, the number of permanent, deepwater structures in the GOM has currently grown to 27 platforms in 1,000 ft or deeper, with another 24 platforms in depths between 500 and 1,000 ft. The number of deepwater platforms is increasing rapidly.

In view of the large number of deepwater structures of various types that are expected to be deployed in the next few years, MMS convened the *Workshop on Environmental Issues Surrounding Deepwater Oil and Gas Development* (Carney 1997). One of the results from that workshop was that MMS wisely identified the potential for deepwater petroleum structures to function as FADs.

PROJECT DESCRIPTION

The U.S. Geological Survey, Biological Resources Division accepted the task of assisting MMS in assessing this potential situation in which deepwater structures might act as FADs. The project is in progress and is described briefly below.

The major elements of the project include:

1. survey of existing literature and information on FADs and related topics,
2. synthesis of FADs literature and available information,
3. survey of existing literature on HMS and other important pelagic fish species that potentially could be impacted by FADs in the GOM,
4. synthesis of HMS literature and available information, and
5. synthesis of FADs and HMS best available information into conclusions and recommendations.

We are conducting this work by the following main approaches:

1. comprehensive search of existing literature (published and gray, including international and foreign language references) on FADs,
2. development of a computerized, searchable, bibliographic data base, including annotations and key words created directly for the GOM FADs issue,
3. comprehensive search of existing literature on GOM HMS and other potentially impacted pelagic fish species, and
4. development of a HMS bibliographic data base similar to that for FADs.

Additionally, we have organized a technical session and expert panel discussion (to be held at the 22-25 February 2001 Midyear Meeting of the Southern Division of the American Fisheries Society in Jacksonville, FL) on deepwater structures and FADs. The goals of the session and panel discussion are to obtain new or unpublished information, bring in researchers with expertise in FADs from other regions, integrate appropriate fishery management agencies into the process, and to develop a broad-based consensus of expert opinion about the potential importance of the issue and about the needs for additional information and research.

PRELIMINARY FINDINGS – FADS

We have found that there is a very large and diffuse body of literature and information on FADs. Desurmont (1996) listed 134 references in a bibliography of FADs-related literature. The literature has grown recently, and currently we have over 500 technical references in our bibliographic database. We also have found several hundred secondary references that are of some, but not first order, pertinence to FADs, or which have other biological/environmental issues pertinent to deepwater structures as their subject. The secondary references will be collected opportunistically, but exhaustive collection and compilation is beyond the scope of this project.

Despite this large body of literature, a good scientific understanding of why fish aggregate around objects has yet to be developed. It seems that the literature has so far only begun to dissect the problem, and that there has been little progress in synthesizing and understanding the phenomenon of fish aggregation around FADs. This is not surprising, because this is a very complex issue that is logistically and technically difficult to study.

Kingsford (1999) recently reviewed and listed 19 factors that may affect the affinity of fish for FADs, and he suggested that they could be the basis of testable hypotheses. We added 13 additional (20-32) factors. The factors are:

1. Availability of food
2. Availability of juvenile fish
3. Presence of conspecifics (spawning, cannibalism, density effects)
4. Presence of other species (competition, predation, potential prey)
5. Availability and nature of shelter (FAD design)
6. Substrate for undergoing behavioral change
7. Day versus night
8. Predation (by residents and vagrants)
9. Intraspecific and interspecific competition
10. Larval/juvenile drift to “suitable” areas
11. Disturbance, natural (*e.g.*, storms) and anthropogenic (*e.g.*, boat noise)
12. Proximity to shore
13. Location and time (due to larval supply and movements of fishes)
14. Water quality and visibility
15. Design of FADs
16. Size of FADs. (For floating FADs, there seems to be a complicated relationship for medium size objects (1-6 m max dimension), there seems to be little or no relationship between fish

density and size, while smaller and larger objects are less attractive (Hall *et al.* 1992; Akishige *et al.* 1996).)

17. Cluster of FADs
18. Soak time of FADs
19. Combination of pelagic and benthic FADs
20. Visibility of structure (visual reference)
21. Shadow and other natural lighting effects
22. Artificial lighting
23. Movement of moored FADs
24. Oceanographic conditions (currents, and vertical structure of T/S/DO, Langmuir circulation, potential for upwelling due to structure)
25. Hydrodynamics (vorticity and current fields induced by structure)
26. Visual appearance of FADs (color/patterns/reflectivity)
27. Spatial distribution of FADs (density/nearest neighbor/orientation relative to bathymetry)
28. Anchored versus drifting FADs
29. Species behavior and habitat utilization patterns [intranatants (<0.5 m away), extranatants (0.5-2.0 m), circumantants (up to 5 –7 nmi) (Fedorayako 1992)
30. Movement of drifting FADs (current or wind)
31. Marine mammals (especially dolphins) presence (association with objects developed through previously developed association with marine mammals)
32. Sea state (can affect fish's ability to detect objects by visual or auditory mechanisms, can affect other factors such as local availability of prey)

It is clear that this list is in no way exhaustive. Very few of these many factors have ever been rigorously studied.

Similarly, Freon and Misund (1999) reviewed and listed the major hypotheses explaining the association between fish and floating objects. They included:

1. Concentration of food supply hypothesis (Kojima 1956).
2. Schooling companion hypothesis (Hunter and Mitchell 1967).
3. Substitute environment hypothesis (Hunter and Mitchell 1967).
4. Cleaning station hypothesis (Gooding and Magnuson 1967).
5. Shelter from predator hypothesis (Suyehiro 1952; Soemarto 1960; Gooding and Magnuson 1967).
6. Spatial reference hypothesis (Klima and Wickham 1971).
7. Comfortability stipulation hypothesis (Batalyants 1992).
8. Generic-log hypothesis (and related hypotheses) (Hall 1992).
9. Meeting point hypothesis (Soria and Dagorn 1992; Dagorn 1994, Freon and Misund 1999).

However, after more than three decades of work on this issue, there still is little or no agreement as to which hypotheses are valid and as to which of them may apply jointly under different circumstances. Perhaps only one of these has been generally discounted. The concentration of food hypothesis has been found to be unlikely to explain aggregation of fish like yellowfin tuna around FADs. Buckley and Miller (1994) found that the diets of FADs associated yellowfin tuna showed

little differences between non-FADs yellowfin and pre-FADs yellowfin, and Holland, Brill and Chang (1990) found that movements of yellowfin around FADs indicated that they fed away from the FADs. Additionally, hydroacoustic surveys have found that the biomass of prey-size fish is almost always insufficient to support the biomass of predator-size fish normally associated with FADs (Josse, Bach and Dagorn 1998). Other than the food supply hypothesis being discounted, the reasons for fish association with FADs remains very uncertain. Factors involved in attractiveness of floating objects have not been determined. Hall *et al.* (1992) concluded that as long as objects were at least one meter in minimum dimension they could not detect significant differences in the number of fish aggregated to the object. In view of this uncertainty, it seems unlikely that these factors, hypotheses and the general state of understanding of fish-FADs interactions are adequate to assess or predict the degree to which various types of deepwater petroleum structures are likely to act as FADs for various pelagic fish species in the GOM.

PRELIMINARY FINDINGS – GULF OF MEXICO HMS

Yellowfin tuna are abundant in the GOM. An extensive Japanese longline fishery operated in the GOM between 1963 and 1981, before leaving the GOM due to severe reductions in CPUE (Wilson 1988). These declines may have been attributable to factors other than the stock being fished down, such as shift in migratory path, poor year classes, or other unknown factors (Wilson 1998). In any event, the declines suggest that yellowfin tuna stocks in the GOM can be substantially impacted. Recently, U.S. longliners have continued to harvest yellowfin tuna from the Gulf, with landings in 1998 totaling 3,784,786 lb with dockside value of \$9,263,471 (Table 1). Yellowfin tuna accounted for 93% of the catch (lb) and 94% of the value of the total tuna catch (including wahoo) from the GOM in 1998. For all of these reasons, yellowfin tuna should be considered the primary species in any considerations of FADs effects of deepwater structures.

Surprisingly, GOM skipjack tuna landings are very small, amounting to only slightly over one thousand pounds landed on the Florida Gulf coast. However, Sakagawa (1986) suggested that the GOM appeared to be a promising area for development of new skipjack tuna fisheries. Experimental FADs deployed on the NW coast of Cuba have been found to be effective in aggregated harvestable concentrations of skipjack, that were caught on pole and line (Martin 1999). Therefore, the extent to which skipjack tuna are likely to be aggregated and affected by GOM deepwater petroleum structures is an open question.

The GOM is the only known spawning area for the western Atlantic stock of bluefin tuna (*Thunnus thynnus*) (Mather, Mason and Jones 1995). Because its stock status may be precariously low (Safina 1993), even small effects on bluefin tuna could be important. Although bluefin tunas have not been reported to highly attracted by FADs in other parts of the world, it may be notable that in the western Atlantic, there is a population of bluefin off of Cape Hatteras, N.C. that seem to aggregate near wrecks, where they are caught in large numbers (most released) by recreational anglers. The question as to whether bluefin tuna might be attracted to GOM deepwater structures, and hence might change migration, and spawning patterns is speculative but is worth consideration. Additionally, any aggregation could result in increased bycatch of bluefin by fisheries targeting other species.

Table 2.2 Landings of tunas and wahoo from the Gulf of Mexico in 1998 (Source: NMFS).

"Species"	Florida			Louisiana			Texas		
	Pounds	Value	Price	Pounds	Value	Price	Pounds	Value	Price
Tuna, Albacore	NR			5,838	\$ 3,079	\$0.53	NR		
Tuna, Bluefin	2,871	\$7,316	\$2.55	26,868	\$113,605	\$ 4.23	NR		
Tuna, Little Tunny	119,169	\$35,829	\$0.30	108,221	\$39,241	\$ 0.36	NR		
Tuna, Yellowfin	523,708	\$1,233,885	\$2.36	2,958,087	\$7,338,444	\$2.48	302,991	\$691,142	\$2.28
Tunas, Misc.							12,627	\$23,555	\$1.87
Tuna, Bigeye	9,677	\$24,569	\$2.54	19,634	\$71,281	\$3.63	NR		
Tuna, Blackfin	27,701	\$27,015	\$0.98	46,011	\$22,425	\$0.49	6,424	\$5,864	\$0.91
Wahoo	37,554	\$67,699	\$1.80	137,983	\$143,740	\$1.04	NR		

NR – None Reported.

Given the unresolved status of FADs science, and given the fact that there are already 27 deepwater structures in the GOM and a total of 51 structures in depths over 500 ft, one reasonable conclusion may be that direct study around existing and future structures is the best and perhaps only way to assess the degree to which deepwater structures will affect fish. Many methods and approaches have been used to study fish association with FADs, and most could be adapted to GOM deepwater structures. Previous studies can be categorized (with examples of each type of study) as follows:

1. Tagging: Hunter and Mitchell (1968); Itano and Holland (1999).
2. Hydroacoustic survey: Stanley and Wilson (1996); Bach *et al.* (1998); Josse, Dagorn and Bertrand (1999); Josse, Bertrand and Dagorn (1999).
3. Telemetry, acoustic tracking: Holland, Brill and Chang (1990); Klimley and Holloway (1996); Marsac, Cayre and Conand (1996); Marsac and Cayre (1998); Brill *et al.* (1999).
4. Telemetry, network of automated acoustic receivers: Klimley and Holloway (1996).
5. Fishery dependent methods, including recreational catch surveys: Love and Westphal (1990); Stanley and Wilson (1990 & 1991); Cillaurren (1994).
6. Fishery independent hook-and-line fishing CPUE: Friedlander, Beets, and Tobias (1994).
7. Experimental net fishing: Massuti, Morales-Nin and Deudero (1999).
8. Modeling: Hilborn and Medley (1989); Kleiber and Hampton (1994); Daghorn, Bach and Josse (1997); Sibert and Holland (1999).

Kingsford (1999) makes a strong case for sampling before and after to determine the impact of FADs. This may be something to consider in view of the potential extensive and intensive deployment of deepwater oil and gas structures in the GOM. In a few years, once petroleum structures are abundant throughout deepwater areas of the northern Gulf, it may be too late to directly estimate their effects, because conditions prior to introduction of deepwater structures will not be able to be estimated.

PRELIMINARY CONCLUSIONS

Based on existing scientific knowledge of FADs and fish attraction, it is not reasonable to discount the possibility that deployment of large numbers of petroleum structures in the GOM will have significant and substantial impacts on HMS. Conversely, the state of knowledge is not adequate to determine or predict that large effects will in fact occur, to estimate the extent to which they will occur, or to predict what species will be affected. However, the existing knowledge does clearly show that FADs can have large effects on fish and fisheries.

With this in mind, and the growing number of deepwater structures in the GOM, the preliminary conclusion is that the situation will probably have to be assessed by direct study of existing and future structures. There are several research approaches that have been used productively to study FADs and that could be applied to deepwater oil and gas structures. It is likely that adequate understanding will require a combination of several of these approaches.

REFERENCES

- Akishige, Y., H. Yoshimura, H. Nashida, T. Kuno, Y. Morii, and T. Aoshima. 1996. Flotsam in the equatorial counter current region of the western Pacific with reference to tuna purse seine fishing. *Bulletin of the Faculty of Fisheries, Nagasaki University* 77:97-102.
- Anderson, J. and P.D. Gates. 1996. South Pacific Commission fish aggregating device (FAD) manual. South Pacific Commission, Noumea.
- Anonymous. 1982. Report of the SWIOP workshop on monitoring, control and surveillance. RAF/79/065/WP/4/82, FAO, Rome.
- Bach, P., L. Dagorn, E. Josse, F.-X Bard, R. Abbes, A. Bertrand and C. Misselis. 1998. Experimental research and fish aggregating devices (FADs) in French Polynesia. *SPC Fish Aggregating Device Information Bulletin* 3:3-18.
- Batalyants, K.Y. 1992. On the hypothesis of comfortability stipulation of tuna association with natural and artificial floating objects. *ICCAT Rec. Doc. Sci.* 40:447-453.
- Baud, R.D., R.H. Peterson, C. Doyle and G.E. Richardson. 2000. Deepwater Gulf of Mexico: America's emerging frontier. OCS Report MMS 2000-022. U.S. Dept. of Interior, Minerals Management Service, Gulf of Mexico OCS Region, New Orleans.

- Berkeley, S.A. and R.E. Edwards. 1998. Factors affecting billfish capture and survival in longline fisheries: Potential application for reducing bycatch mortality. International Commission for the Conservation of Atlantic Tunas ICCAT-SCRS/97/63.
- Brill, R. W., B.A. Block, C.H. Boggs, K.A. Bielow, E.V. Freund, and D.J. Marcinek. 1999. Horizontal movements and depth distribution of large adult yellowfin tuna (*Thunnus albacares*) near the Hawaiian Islands, recorded using ultrasonic telemetry: implications for the physiological ecology of pelagic fishes. *Marine Biology* 133:395-408.
- Buckly, T.W. and B.S. Miller. 1994. Feeding habits of yellowfin tuna associated with fish aggregating devices in American Samoa. *Bulletin of Marine Science* 55:445-459.
- Cannizzaro, L.G. Bono, P. Rizzo, A. Potoschi and A. Celesti. 1999. Diversifying fishing effort: the case of fish aggregating devices in western Mediterranean Sea. Pp. 72-73. *In* J.-Y. Le Gall, P. Cayre and M. Taquet, eds. International Symposium on Tuna Fishing and Fish Aggregating Devices Book of Abstracts. IFREMER, Plouzane.
- Carney, R.S. 1997. Workshop on environmental issues surrounding deepwater oil and gas development: Final report. OCS study MMS 98-0022. U.S. Dept. of Interior, Minerals Management service, Gulf of Mexico OCS Region, New Orleans, LA. 163 p.
- Cillaurren, E. 1994. Daily fluctuations in the presence of *Thunnus albacares* and *Katsuwonus pelamis* around fish aggregating devices anchored in Vanuatu, Oceania. *Bulletin of Marine Science* 55:581-591.
- Dagorn, L. 1994. Le comportement des thons tropicaux modelise selon les principes de la vie artificielle. These de l'Ensar. TDM 133, Orstrom Editions, Paris.
- Daghorn, L., P. Bach, and E. Josse. 1997. Modeling effects of anchored FADs and prey distribution on horizontal and vertical movements of tuna in the French Polynesia EEZ. Proceedings of the 48th Annual Tuna Conference.
- D'Anna, G.D., F. Badalamenti. and S. Riggio. 1999. Traditional and experimental floating fish aggregating devices in the Gulf of Castellammare (NW Sicily): results from catches and visual observations. *Scientia Marina* 63:209-218
- Desurmont, A. 1996. A preliminary bibliography of FAD-related literature. SPCD Fish Aggregating Device Information Bulletin 2:
- Deudero, S.P. Merella, B. Morales-Nin, E. Massuti and F. Alemany. 1999. Fish communities associated with FADs. *Scientia Marina* 63:199-207.
- Dickson, J. 1999. A review of "payaw": the Philippines FAD. Pp. 26-27. *In* J.-Y. Le Gall, P. Cayre and M. Taquet, eds. International Symposium on Tuna Fishing and Fish Aggregating Devices Book of Abstracts. IFREMER, Plouzane.

- Fedorayako, B.I. 1982. Langmuir circulation as a possible mechanism of formation of fish association around floating objects. *Oceanology* 22: 228-232.
- Fonteneau, A.M. Hall, J. Hampton, P. Pallares, and R. Pianet. 1999. Development of FADs by the tropical tuna purse seine fisheries: A worldwide review. Pp. 14-15. *In* J.-Y. Le Gall, P. Cayre and M. Taquet, eds. International Symposium on Tuna Fishing and Fish Aggregating Devices Book of Abstracts. IFREMER, Plouzane.
- Franks, J. 1999. A review: pelagic fishes at petroleum platforms in the northern Gulf of Mexico; diversity, interrelationships, and perspective. Pp. 94-95. *In* J.-Y. Le Gall, P. Cayre and M. Taquet, eds. International Symposium on Tuna Fishing and Fish Aggregating Devices Book of Abstracts. IFREMER, Plouzane.
- Friedlander, A., J. Beets, and W. Tobias. 1994. Effects of fish aggregating device design and location on fishing success in the Virgin Islands. *Bulletin of Marine Science* 55:592-601.
- Freon, P. and O.A. Misund. 1999. Dynamics of pelagic fish distribution and behavior: effects on fisheries and stock assessment. Fishing News Books, Blackwell Science, Ltd., Oxford. 338 p.
- Gooding, G.W. and J.J. Magnuson. 1967. Ecological significance of a drifting object to pelagic fishes. *Pacific Science* 21:486-497.
- Hall, M. A., M. Garcia, C.E. Lennert-Cody, P. Arenas, and F. Miller. 1999. The association of tunas with floating objects and dolphins in the eastern Pacific Ocean: a review of the current purse-seine fishery. Pp. 87-194. *In* M. D. Scott, W. H. Bayliff, C. E. Lennert-Cody and K. M. Schaefer, eds. Proceedings of the International Workshop on the Ecology and Fisheries for Tunas Associated with Floating Objects. Inter-American Tropical Tuna Commission, Special Report 11. La Jolla.
- Hall, M., M. Garcia, C. Lennert, and P. Arenas. 1992. The association of tunas with floating objects and dolphins in the eastern Pacific Ocean. III. Characteristics of floating objects and their attractiveness for tunas. *In* M. Hall, ed. International workshop on the ecology and fisheries for tunas associated with floating objects and on assessment of issues arising from the association of tunas with floating objects. Inter-American Tropical Tuna Commission, La Jolla.
- Higashi, G.R. 1994. Ten years of fish aggregating device (FAD) design device in Hawaii. *Bulletin of Marine Science* 55:651-666.
- Hilborn, R. and P. Medley. 1989. Tuna purse seine fishing with fish aggregating devices (FAD): models of tuna FAD interactions. *Canadian Journal of Fisheries and Aquatic Science* 46:28-32.
- Holland, K.N. 1999. The FAD system in Hawaii. Pp. 18-19. *In* J.-Y. Le Gall, P. Cayre and M. Taquet, eds. International Symposium on Tuna Fishing and Fish Aggregating Devices Book of Abstracts. IFREMER, Plouzane.

- Holland, K.N., R.W. Brill, and K.C. Chang. 1990. Horizontal and vertical movements of yellowfin and bigeye tuna associated with fish aggregating devices. *Fishery Bulletin* 88:493-507.
- Hunter, J. and C.T. Mitchel. 1968. Field experiments on the attraction of pelagic fish to floating objects. *J. Cons. Perm. Int. Explor. Mer.* 31:427-434.
- Itano, D. and K. Holland. 1999. Tags and FADs – Movement and vulnerability of bigeye and yellowfin tunas in relation to FADs and natural aggregation points. Pp. 90-91. *In* J.-Y. Le Gall, P. Cayre and M. Taquet, eds. *International Symposium on Tuna Fishing and Fish Aggregating Devices Book of Abstracts*. IFREMER, Plouzane.
- Josse, E.L., A. Bertrand and L. Dagorn. 1999. An acoustic approach to study tuna aggregated around fish aggregating devices in French Polynesia: methods and validation. *Aquatic Living Resources* 12:303-313.
- Josse, E.L., L. Dagorn, and A. Bertrand. 1999. Typology and behaviour of tuna aggregations around fish aggregating devices from acoustic surveys in French Polynesia. Pp. 84-85. *In* J.-Y. Le Gall, P. Cayre and M. Taquet, eds. *International Symposium on Tuna Fishing and Fish Aggregating Devices Book of Abstracts*. IFREMER, Plouzane.
- Josse, E., P. Bach, and L. Dagorn. 1998. Simultaneous observations of tuna movements and their prey by sonic tracking and acoustic surveys. *Hydrobiologia* 371/372: 61-69.
- Kingsford, M.J. 1999. Fish attraction devices (FADs) and experimental designs. *Scientia Marina* 63(3-4):81-190.
- Kleiber, P. and J. Hampton. 1994. Modelling effect of FADs and islands on movement of skipjack tuna (*Katsuwonus pelamis*): estimating parameters from tagging data. *Canadian Journal of Fisheries and Aquatic Science* 51:2642-2653.
- Klima, E.F. and D.A. Wickham. 1971. Attraction of coastal pelagic fishes with artificial structures. *Transactions of the American Fisheries Society* 100:86-99.
- Klimley, A.P and C. Holloway. 1996. Automated monitoring of yellowfin tuna at Hawaiian FADs. *Proceedings of the 47th Annual Tuna Conference*.
- Kojima, S. 1956. Fishing for dolphins in the western part of the Japan Sea. II. Why do the fish take shelter under floating materials? *Bulletin of the Japanese Society of Scientific Fisheries* 21:1049-1052.
- Lennert-Cody, C.M. Garcia and M. Hall. 1999. The development of FAD fishery in the Eastern Pacific Ocean: 1992-1998. Pp. 22-22. *In* J.-Y. Le Gall, P. Cayre and M. Taquet, eds. *International Symposium on Tuna Fishing and Fish Aggregating Devices Book of Abstracts*. IFREMER, Plouzane.

- Leonart, J.B. Morales-Nin, E. Massuti, S. Deudero and O. Renones. 1999. Population dynamics and fishery of dolphinfish (*Coryphaena hippurus*) in the western Mediterranean. *Scientia Marina* 63:447-457.
- Love, M.S. and W. Westphal. 1990. Comparison of fishes taken by a sportfishing party vessel around oil platforms and adjacent natural reefs near Santa Barbara, California. *Fishery Bulletin* 88:599-695.
- Marsac, F., P. Cayre and F. Conand. 1996. Analysis of small-scale movements of yellowfin tuna around fish-aggregating devices (FADs) using sonic tags. Pp. 151-159. *In* A.A. Aganuzzi, K.A. Stobberup, and N.J. Webb (eds.) Proceedings of the expert consultation on Indian Ocean tunas, 6th session, Colombo, Sri Lanka, September 1995.
- Marsac, F. and P. Cayre. 1998. Telemetry applied to behaviour analysis of yellowfin tuna (*Thunnus albacares*, Bonnaterre, 1788) movements in a network of fish aggregating devices. *Hydrobiologia* 371-372:155-171.
- Mather, F.J., J.M. Mason and A.C. Jones. 1995. Historical document: life history and fisheries of Atlantic bluefin tuna. NOAA Technical Memorandum NMFS-SEFC -370.
- Martin, C.C. 1999. Results of the use of FADs in the pole and line skipjack (*Katsuwonus pelamis*) fishery in the North-West coast of Cuba. Pp. 38-39. *In* J.-Y. Le Gall, P. Cayre and M. Taquet, eds. International Symposium on Tuna Fishing and Fish Aggregating Devices Book of Abstracts. IFREMER, Plouzane.
- Massuti, E., Morales-Nin, B., and S. Deudero. 1999. Fish fauna associated with floating objects sampled by experimental and commercial purse nets. *Scientia Marina* 63:219-227.
- National Marine Fisheries Service (NMFS). 1999. Final fishery management plan for Atlantic tuna, swordfish, and sharks. NOAA-NMFS, Silver Spring.
- Polovina, J.J. 1991. Assessment of biological impacts of artificial reefs and FADs. FAO RAPA Report 11:258-263.
- Safina, C. 1993. Bluefin tuna in the West Atlantic: negligent management and the making of an endangered species. *Conservation Biology* 7:220-234.
- Sakagawa, G.T. 1986. Skipjack fisheries in the western Atlantic. Pp. 99-103. *In* P.E.K. Symons, P.M. Miyake and G.T. Sakagawa, eds. Proceedings of the ICCAT Conference on the International Skipjack Year Program. ICCAT, Madrid.
- Sibert, J. and K. Holland. 1999. Exchange rates of yellowfin and bigeye tunas and fishery interaction between Cross seamount and near-shore FADs in Hawaii. Pp. 92-93. *In* J.-Y. Le Gall, P. Cayre and M. Taquet, eds. International Symposium on Tuna Fishing and Fish Aggregating Devices Book of Abstracts. IFREMER, Plouzane.

- Soemarto. 1960. Fish behaviour with special reference to pelagic schooling species: Lajang (*Decapterus* sp.). 8th Proceedings of the Indo-Pacific Fisheries Council 3:89-93.
- Soria, M. and L. Dagorn. 1992. Rappels sur le comportement gregaire. Pp. 5-9. In J.-M. Stretta, ed. Action Incitative Comportement Agregatif (AICA), Montpellier, June 1992. Doc. Inter. Centre, Orstom, Montpellier.
- Stanley, D.R. and C.A. Wilson. 1990. A fishery-dependent based study of fish species composition and associated catch rates around oil and gas structures off Louisiana. Fishery Bulletin 88:719-730.
- Stanley, D.R. and C.A. Wilson. 1991. Factors affecting the abundance of selected fishes near oil and gas platforms in the northern Gulf of Mexico. Fishery Bulletin 89:149-159.
- Stanley, D.R. and C.A. Wilson. 1996. Abundance of fishes associated with a petroleum platform as measured with dual-beam hydroacoustics. ICES Journal of Marine Science 53:473-475.
- Suyehiro, Y. 1952. Textbook of ichthyology (in Japanese). Iwanami Shoten, Tokyo.
- Tillman, M.F. 1999. Director's report to the 50th tuna conference on tuna and tuna-related activities at the Southwest Fisheries Science Center for the period May 1 to 30 April 30, 1999. SWFSC Admin. Rep. LJ-99-05, La Jolla.
- Wickham, D.A. and G.M. Russell. 1974. An evaluation of mid-water artificial structures for attracting coastal pelagic fishes. Fishery Bulletin 72:181-191.
- Wilson, C.A. 1988. Longlining for yellowfin tuna in the Gulf of Mexico. Louisiana Sea Grant College, Baton Rouge.

HABITAT USE OF SHELF-EDGE TOPOGRAPHIC HIGHS IN THE NORTHWESTERN GULF OF MEXICO BY SHARKS AND RAYS (SUBCLASS ELASMOBRANCHII)*

Jeff Childs
Center for Coastal Studies
Texas A&M University-Corpus Christi

ABSTRACT

The continental shelf of the northwestern Gulf of Mexico includes an array of submerged hard-banks and reefs in addition to a great concentration of offshore petroleum platforms that provide significant vertical and structural relief in an otherwise level landscape, and are defined as “topographic highs”. This study investigates the habitat use of shelf-edge topographic highs by wide-ranging sharks and rays occurring in the northwestern Gulf of Mexico. Three topographic highs (East and West Flower Garden Banks and the High Island A-389A offshore production platform) located near the shelf-edge (200 m isobath) were visited from July 1992 through April 1998. Underwater surveys on SCUBA were conducted to gather information on the species composition, abundance, life history stages, sexes, and social groups of elasmobranchs occurring at the study sites. Thirteen species were identified that include *Ginglymostoma cirratum* (nurse shark), *Rhincodon typus* (whale shark), *Galeocerdo cuvier* (tiger shark), *Carcharhinus falciformis* (silky shark), *Carcharhinus obscurus* (dusky shark), *Carcharhinus perezii* (Caribbean reef shark), *Carcharhinus plumbeus* (sandbar shark), *Sphyrna lewini* (scalloped hammerhead), *Dasyatis americana* (southern stingray), *Aetobatis narinari* (spotted eagle ray), *Mobula hypostoma* (lesser devil ray), *Mobula tarapacana* (sicklefin devil ray), and *Manta birostris* (manta ray). These species form three assemblages (winter, summer, and resident) at the Flower Garden Banks. *Carcharhinus falciformis* was the only species found utilizing the High Island platform throughout the year. Data gathered in this study show the Flower Garden Banks function as nursery areas, adult feeding areas, and possibly as a mating area to these elasmobranch species, while the High Island platform functions as a secondary nursery area to *C. falciformis*. Seasonal movements relative to other habitat areas in the region are also modeled for the sharks and rays observed at shelf-edge topographic highs.

*This abstract is provided although the presentation was canceled.

**LIFE ALONG THE EDGE: THE WHALE SHARK (*RHINCODON TYPUS*)
IN THE NORTHERN GULF OF MEXICO***

Jeff Childs
Center for Coastal Studies
Texas A&M University-Corpus Christi

Carolyn M. Burks
Keith D. Mullin
Southeast Fisheries Science Center
National Marine Fisheries Service
NOAA Mississippi Laboratories

John D. Hewitt IV
Aquarium of the Americas
New Orleans

ABSTRACT

The whale shark (*Rhincodon typus*) occurs in the northern Gulf of Mexico though little is known regarding the behavior and ecology of the largest living fish species. Whale shark sightings amassed in three independent surveys conducted from the air, sea surface, and underwater, were compiled with historic sightings and analyzed using geographic information system technology (ArcView). Sightings data show whale sharks utilize neritic (< 200 m isobath) and oceanic (> 200 m isobath) waters of the northern Gulf during warmer months (June thru November), however, during colder months (December thru May) whale sharks chiefly utilize oceanic waters. The majority of sightings are located in neritic and oceanic waters out to the 2000 m isobath, between Pensacola, Florida and Brownsville, Texas. The greatest concentration of sightings occurs south of Louisiana and southeast of Texas in the vicinity of the shelf edge (200 m isobath) where sampling effort is considered greatest. No sightings were made within the hypoxic zone located south of Louisiana and Texas during months that hypoxic conditions are known to exist. Solitary sightings were common, however, 18 % of sightings were of aggregated animals, the largest aggregation consisting of 30 whale sharks. Aggregations occur in the vicinity of shelf-edge banks during August and September when mass spawning events occur at the Flower Garden Banks, the northernmost hermatypic tropical coral reefs located on the continental plate of North America. Aggregations also occur along the shelf-edge and seaward in the vicinity of the Loop Current frontal boundary, indicating that whale sharks may optimize their foraging effort in areas where plankton is often known to be abundant.

*This abstract is provided although the presentation was canceled.

POTENTIAL CONFLICTS BETWEEN DEEPWATER FISHING AND OIL AND GAS OPERATIONS IN THE GULF OF MEXICO

David B. Snyder
Luis Lagera
Continental Shelf Associates, Inc.

Peter Arnold
Mandeville, LA

LeRay de Wit
Concord, CA

George H. Burgess
Florida Museum of Natural History
University of Florida

Chris Friel
Florida Marine Research Institute

INTRODUCTION

The fishing and offshore energy industries have coexisted amicably for many years in shelf waters of the northern Gulf of Mexico (GOM). Recently, the offshore energy industry in the GOM has shifted its interest beyond the shelf and into deeper waters (>200 m). This is evidenced by over 3,800 active leases and about 50 development/production facilities in water depths greater than 200 m. Existing and future structures represent new and evolving technology that could interact with deepwater (bluewater) fisheries. All phases of industry-geophysical surveys, exploratory drilling, development/production, and abandonment-could interact with current deepwater fishing practices. In the northern GOM these practices include trapping for golden crab, trawling for royal red shrimp, bottom longlining for groupers, snapper, and tilefishes, and surface longlining for sharks, swordfish, and tunas.

The potential for interactions between bluewater fishing and deepwater energy industry was raised as a primary concern by a fisheries subcommittee during a recent deepwater workshop (Carney, 1998) sponsored by the Minerals Management Service (MMS). In 1999, Continental Shelf Associates, Inc. was awarded a contract to investigate this problem for MMS. The project team consists of independent consultants with experience in fisheries, oil and gas technology, space-use problems, and Geographical Information Systems (GIS).

OBJECTIVES

We are assessing actual and potential interactions between the two industries through the following objectives:

- Determine bluewater fishing endeavors and practices and deepwater outer continental shelf (OCS) energy development activities;
- Describe and map bluewater fishing and deepwater OCS energy development activities;
- Describe current GOM and relevant worldwide interactions and predict future situations that may occur in the GOM between bluewater fishing and deepwater OCS energy development activities; and
- Recommend proactive mitigation measures for MMS and for the fishing and OCS energy industries.

METHODS

The first two objectives are being addressed by gathering descriptive information and "mappable" data from a variety of sources for the two industries. Past and current information on the OCS energy industry will be obtained from MMS data sets that contain active leases, filed Plans of Exploration (POEs), existing development facilities, and existing pipelines. Existing facility descriptions will come from filed Development Operations Coordination Documents (DOCDs) or POEs, U.S. Coast Guard files, and industry operators. Descriptions of exploratory drilling rigs will come from various drilling rig contractors. Future OCS activity will be projected from the MMS data sets that include active leases with filed POEs or DOCDs, announced discoveries with filed POEs or DOCDs, and future pipelines. In addition, an analysis of lease bonuses paid on existing leases will be made to determine which lease block received high bids.

The bluewater commercial fishing industry will be described from data obtained from National Marine Fisheries Service (NMFS) data sets. Several data sets will be examined, including the longline logbook data set, the shrimp data set, and the reef fish logbook data set. These data sets provide varying levels of spatial resolution, ranging from latitude/longitude (degrees and minutes) to large scale (kms) NMFS statistical grids. Catch and effort information will be extracted from the data sets to characterize spatial and temporal patterns in the northern GOM. Species composition and life history characteristics will be described for primary deepwater fisheries species.

Current domestic conflicts are being gathered from U.S. Coast Guard, Fishermen's Contingency Fund, and California Fisheries Liaison Office. Information on international interactions will be compiled from a variety of sources including Canada-Nova Scotia Offshore Petroleum Board, Fisheries and Offshore Consultative Group (North Sea), and United Kingdom Offshore Operators Association Compensation Fund.

RESULTS

The most common facilities used in deepwater operations are fixed platforms, semi-submersible floating production systems, compliant towers, tension leg platforms, spars, and subsea completions (Figure 2.4). The spatial preclusion of seafloor or water column by these facilities depends upon the

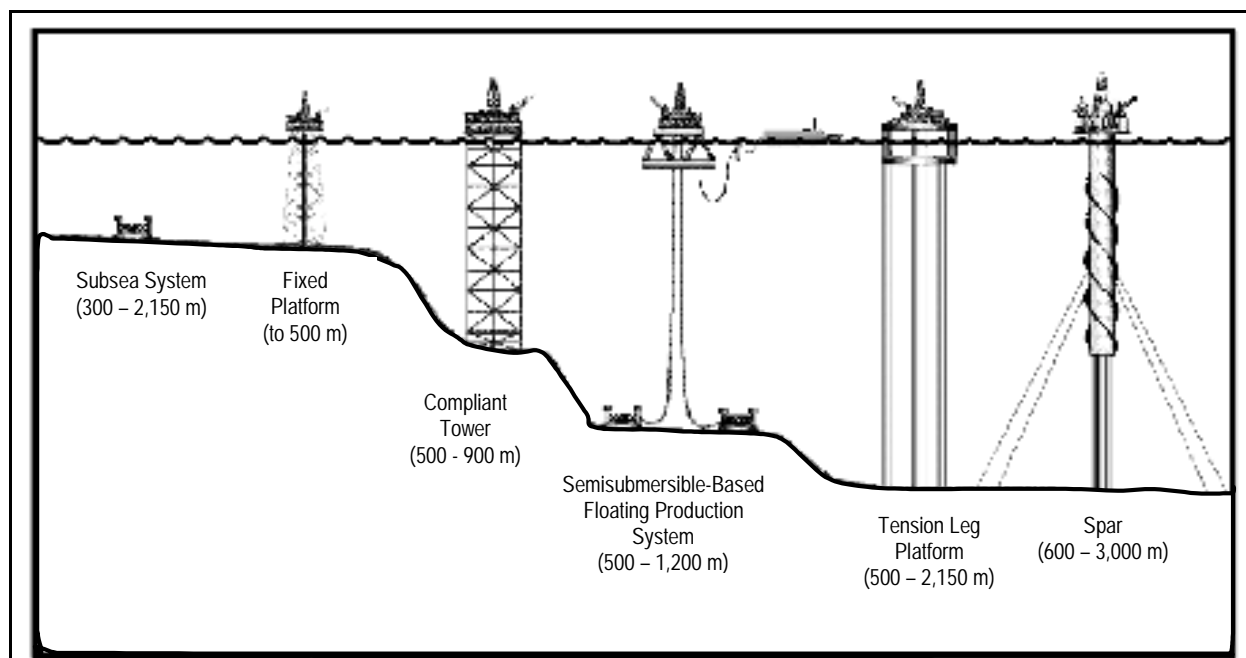

Figure 2.4. Deepwater production systems in the Gulf of Mexico.

type of mooring system used and the water depth. For example, catenary moored systems cover much greater portions of the seafloor than do tension leg systems.

Presently there are about 3,800 active leases in waters greater than 200 m deep, with approximately 50 platforms currently operating in these water depths. Areas with the future activity are in Mississippi Canyon, Green Canyon, Garden Banks, and Viosca Knoll lease block areas. Of the 3,800 leases, about 800 received bonus bids exceeding \$1 million. With the exception of Corpus Christi and Port Isabel, where there has been little if any drilling success to date, all OCS areas with less than 60 leased blocks are either relatively small in overall extent in the deepwater study area or have experienced legal constraints on leasing. The remaining eight areas have hundreds of leased blocks each. In most of these areas, between approximately 3 and 6 percent of leased blocks received bonus bids in excess of \$500 per acre. Interestingly, these include both the relatively nearshore area of East Breaks and Green Canyon, as well as the more distant and deeper water areas of Alaminos Canyon, Atwater Valley, Keathley Canyon, and Walker Ridge. In fact, the two bluewater blocks which received bonus bids in excess of \$5,000 per acre are of recent vintage (1998) and are in water depths of approximately 1,500 and 3,000 m. In the Garden Banks area, which saw the first development in over 600 m, and Mississippi Canyon, which boasts several developments beyond 900 m, twice the percentage of leases received bonus bids in excess of \$500 per acre.

Current deepwater fishing practices in the northern GOM include trapping for golden crab; trawling for royal red shrimp; bottom longlining for groupers, snappers, and tilefishes; and surface longlining for sharks, swordfish, and tunas. The areal extent of these fisheries varies greatly, from widespread to localized. The royal red shrimp fishery appears to be concentrated in the area south of Alabama/Mississippi corresponding to statistical grid 10, with minimal effort expended in areas off the Florida Keys and Texas. Golden crab trapping is most prevalent off of southwestern Florida and

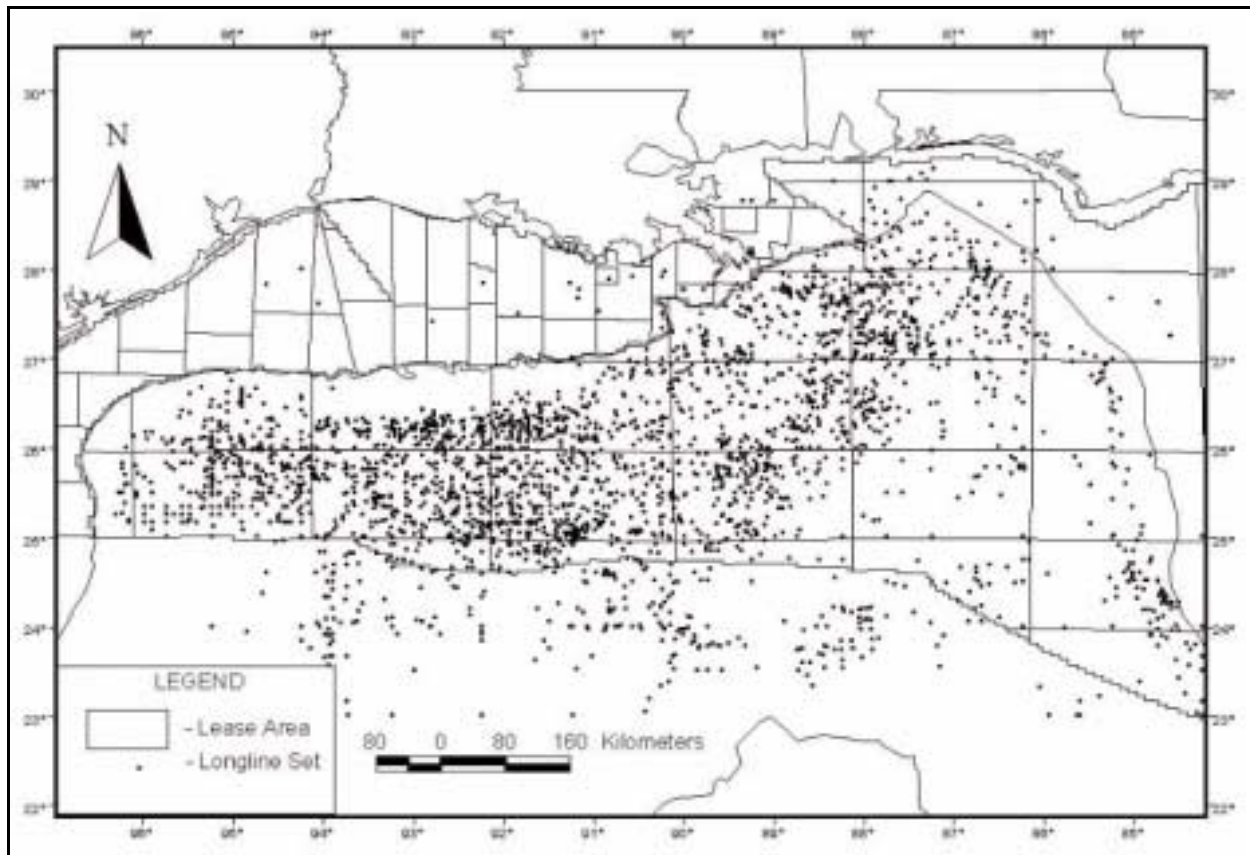

Figure 2.5. Spatial distribution of surface longline sets made in the Gulf of Mexico during 1998 (Source: National Marine Fisheries Service longline logbook data 1999).

the Florida Keys, with very few fishers actually participating in this fishery. There is some speculation that the deepwater crab fishery will expand in the future. The bottom longline fishery occurs near the shelf break, and is legislatively mandated to remain offshore of the 102 m depth contour. Most effort by reef fish permit holders for deepwater groupers and tilefishes occurs offshore of west Florida; however, appreciable effort has been expended offshore of Louisiana and Texas as well. The pelagic longline fishery is widespread in the open GOM (Figure 2.4). Of these gear types, the pelagic longline presents the greatest possibility for interactions or space-use conflicts.

REFERENCES

- Carney, R.S. 1998. Workshop on Environmental Issues Surrounding Deepwater Oil and Gas Development: Final Report. U.S. Department of the Interior, Minerals Management Service, Gulf of Mexico OCS Region, New Orleans, LA. OCS Study MMS 98-0022. 163 pp.
- NMFS. 1999. Pelagic longline logbook data, NMFS, Miami, FL.

SESSION 3: OFFSHORE PLATFORMS AND THEIR MULTIPLE USER GROUPS

Moderators: Ron Lukens
Villere Reggio

Date: October 24, 2000

Presentation	Author/Affiliation
Commercial Fishing Perspective (Document not submitted)	Jerald Horst
Charter Fishing Perspective (Document not submitted)	Steve Tomeny
Recreational Fishing Perspective (Document not submitted)	William Bass
Integration of Offshore Oil & Gas Platforms and Cage Aquaculture in the Gulf of Mexico	Christopher J. Bridger Institute of Marine Sciences Gulf Coast Research Laboratory University of Southern Mississippi Barry A. Costa-Pierce Mississippi-Alabama Sea Grant Consortium Clifford Goudey Massachusetts Institute of Technology Sea Grant College Program Robert R. Stickney Texas Sea Grant College Program J. D. (Dan) Allen Chevron USA, Inc.
Texas Artificial Reef Programs 2000 Review	J. Culbertson D. Peter J. Embesi P. Hammerschmidt Artificial Reef Program Texas Parks and Wildlife Department
Rigs-to-Reefs from an Operator's Viewpoint	Dave Dougall Agip Petroleum Co.

INTEGRATION OF OFFSHORE OIL & GAS PLATFORMS AND CAGE AQUACULTURE IN THE GULF OF MEXICO

Christopher J. Bridger
Institute of Marine Sciences
Gulf Coast Research Laboratory
University of Southern Mississippi

Barry A. Costa-Pierce
Mississippi-Alabama Sea Grant Consortium

Clifford Goudey
Massachusetts Institute of Technology Sea Grant College Program

Robert R. Stickney
Texas Sea Grant College Program

J. D. (Dan) Allen
Chevron USA, Inc.

ABSTRACT

In response to an U.S. Department of Commerce Aquaculture Policy, the Gulf of Mexico Offshore Aquaculture Consortium (OAC) was formed to create a collaborative, Gulf-wide, interdisciplinary research and development program to generate primary scientific data and conduct studies in marine policy, ocean environmental, marine biology and ocean engineering aspects of offshore aquaculture (www.masgc.org/offshoreconsortium.html). Permission has been provided to moor a 600 m³ Ocean Spar Sea Station (OSSS) in U.S. federal waters near a Chevron gas platform off the coast of Mississippi (29° 58.649'N, 88° 36.297'W). To decrease user conflicts, unintentional damage and vandalism to grow-out systems, a currently producing gas platform was chosen as the site for the consortium's experimental offshore aquaculture operation. The OSSS is not attached to the gas platform but is moored to the continental shelf on a single-point mooring (SPM) and allowed to move in a 'watch circle' near the Chevron platform. Although providing no investment, Chevron is a cooperator to the project as a field observer to structural damage and provides passive navigation protection. Increased liabilities and dependence on oil and gas operations exist with integration of these industries. An alternative solution to design and manufacture a lift-boat specifically for offshore aquaculture operations has been proposed to alleviate offshore aquaculture logistics. An aquaculture lift-boat would eliminate oil and gas liability issues, create complete independence for the offshore aquaculture operations, and compares economically to integration strategies of aquaculture with the oil and gas industry. From a preliminary analysis of options, the OAC research team has concluded that for offshore aquaculture to succeed in the Gulf of Mexico (GOM): (1) an OSSS design will be required; (2) cobia may be the best candidate species; and (3) a lift-boat strategy may be most appropriate to alleviate offshore logistics, and is economically comparable to aquaculture integration with the oil and gas industry.

INTRODUCTION

Aquaculture is expanding rapidly in freshwater environments, land-based recirculation facilities, coastal bays and fjords, and, more recently, in the exposed open ocean. Freshwater expansion is limited in the U.S. due to the quantity of freshwater resources required for inland aquaculture and declining groundwater resources of many U.S. areas (Postel 2000). U.S. aquaculture expansion will likely be limited either to ponds, lakes or reservoirs, or require development of high-cost recirculation technologies (Ebeling 2000).

Expansion of coastal aquaculture, both land-based and net pen culture in protected bays and fjords, is also limited. Unlike other regions of the world, such as Norway, Scotland, Chile and Canada, the U.S. lacks unpopulated bays and fjords that allow expansion of coastal aquaculture, with the exception of Alaska where commercial fish culture is currently prohibited. Rapid increase of the nation's coastal population has formed mega-cities, creating increased pollution and stress to the environment, all of which limit coastal aquaculture expansion (Edwards 1989). In addition, currently used U.S. coastal areas will eventually have bottlenecks to future expansion of net pen aquaculture due to threats of self-pollution by the aquaculture facility (Lumb 1989). As a result, it has been recognized that perhaps the most appropriate option for expansion of U.S. aquaculture production is in the open ocean environment within the exclusive economic zone (EEZ). This area has fewer user conflicts and provides a consistent flow of high quality water for successful aquaculture operations. In addition, offshore waters may buffer fluctuating temperatures and have more stable salinities than inshore waters (Waldemar Nelson International Inc., 1997). However, offshore operations will require large infusions of knowledge, research, capital and logistic support to ensure success.

On 10 August 1999, the U.S. Department of Commerce approved an Aquaculture Policy to promote the development of an environmentally sustainable and economically feasible aquaculture industry with a vision:

“To assist in the development of a highly competitive, sustainable aquaculture industry in the United States that will meet growing consumer demand for aquatic foods and products that are of high quality, safe, competitively priced and are produced in an environmentally responsible manner with maximum opportunity for profitability in all sectors of the industry.” (U.S. Department of Commerce Aquaculture Policy 2000)

Specific DOC objectives, by 2025, are to

- Increase the value of domestic aquaculture production from the present \$900 million annually to \$5 billion, which will help offset the \$6 billion annual U.S. trade deficit in seafood.
- Increase the number of subsequent jobs in aquaculture from the present estimate of 180,000 to 600,000.

- Develop aquaculture technologies and methods both to improve production and safeguard the environment, emphasizing where possible, those technologies that employ pollution prevention rather than pollution control techniques.
- Develop a Code of Conduct for responsible aquaculture by the year 2025 and have 100 percent compliance with the code in federal waters.
- Double the value of non-food products and services produced by aquaculture to increase industry diversification.
- Enhance depleted wild fish stocks through aquaculture, thereby increasing the value of both commercial and recreational landings and improving the health of our aquatic resources.
- Increase exports of U.S. aquaculture goods and services from the present value of \$500 million annually to \$2.5 billion.

This long-term approach for aquaculture development, spanning a minimum of three generations of operators and researchers, will require adherence to the principles of sustainability (Goodland and Daly 1996). Sustainable development of aquaculture will ensure that an economically and environmentally sound industry exists for future generations. In addition, development of new sustainable aquaculture industries will require appropriate levels of market access, high product demand and supportive government agencies with goal-oriented research (Aarset 1999).

MARINE AQUACULTURE OPERATIONS

Marine aquaculture may be classified into four categories according to the degree of protection afforded the operation by the site characteristics (Table 3.1). Land-based operations pump the water to tanks, on-shore, thereby being protected from storm surges and adverse weather conditions. These operations require large capital investments in infrastructure and are restricted by coastal development to the extent that future land-based operations may be focused only on hatchery and processing facilities to complement open ocean grow-out facilities. Similarly, coastal aquaculture sites are located in protected, remote bays or fjords, away from populated areas and presumably anthropogenic sources of pollution associated with coastal communities.

In coastal aquaculture, as in the oil and gas industry, farm workers typically rotate in shifts, upwards of a week, living on-site throughout. Farm workers have their quarters in a cabin either floating on the water near the cages or on-shore in line-of-sight of the cage flotilla. This close proximity to the cages and fish stock provides security against losses to vandalism, theft, predators, or adverse weather. Most logistical issues have been overcome with barges designed to hold large quantities of feed, regular site visits to change crew and replenish fuel and food, and constant communication maintained through VHF/UHF radios or cellular telephone. Site protection to the cages allows farm operators to perform necessary tasks, such as multiple daily feeding, net changing, size grading and stock sampling, with minimal dependence on mechanization. Such aquaculture does not require the same degree of infrastructure as more exposed sites.

Table 3.1. Comparison of marine aquaculture strategies as categorized by degree of exposure operation to natural oceanographic and storm events.

Location	Advantages	Disadvantages
Land-based Facility	<ul style="list-style-type: none"> - Control water quality - Isolation of operation from populated areas not required - Complete protection from storm surges 	<ul style="list-style-type: none"> - Limited space - Expensive capital investment
Coastal Environments (protected bays and fjords)	<ul style="list-style-type: none"> - Less capital investment - Protected from much of the natural elements - Surveillance possible with minimal investment 	<ul style="list-style-type: none"> - Possible self-pollution - Limited space for expansion - Isolation more desirable to be free of anthropogenic coastal pollution - User conflicts exist close to shore
Exposed Sites	<ul style="list-style-type: none"> - Utilizing environment previously unexploited - Consistent and high quantity water supply - Visual protection still possible from nearby land 	<ul style="list-style-type: none"> - Exposed to destructive natural elements - Limited space near-shore - User conflicts exists close to shore - Increased infrastructure necessary with increased exposure - Rely more on mechanization
Offshore Sites	<ul style="list-style-type: none"> - Decreasing user conflicts with increasing distance from shore - Very consistent water supply - Large potential for industry expansion 	<ul style="list-style-type: none"> - Truly exposed with no protection from either side - Increased capital costs associated with increased technology and mechanization - Large investments require to ensure economic feasibility - Complete isolation from shore bases with no land in sight

A simple move of the farm to a more exposed environment increases the logistical demands of the operation. Land is still not far away but the degree of exposure increases the risk of storm damage to the cage infrastructure and complicates routine farming operations. The aquaculturist must now rely more heavily on mechanization to allow feeding at set times during the day. Routine operations, taken for granted in protected sites, now becomes a substantial chore. Exposed sites, not far from a land base, still enjoy the luxury of visual observation of the cages and stock, and quick response time to emergency situations that are not present in the offshore environment.

Offshore aquaculture operations have all the logistical challenges of both remote coastal and exposed aquaculture but at an escalated scale. In such instances, the degree of exposure from all directions is substantial, with the farm being truly exposed to any and all natural elements. Operators require large infrastructure to produce fish in quantity for economic feasibility. In addition, excellent husbandry practices are required to ensure a stress free, healthy stock that is growing in a uniform fashion. Routine operations such as medication and size grading may be impermissible in this exposed offshore environment. Finally, because of the extreme remote conditions, offshore aquaculture will require innovative technologies to allow appropriate levels of feeding, long-distance communication in the absence of cellular phone coverage, and carefully planned levels of response to emergency situations.

U.S. Open Ocean Aquaculture Development

Truly open ocean aquaculture in highly exposed sites some distance from shore is still a pioneering enterprise throughout the world. To allow open dialogue and promote international development of open ocean aquaculture, three symposia have been dedicated to issues and advancements associated with the development of a sustainable open ocean aquaculture industry. A fourth meeting is set to convene in St. Andrews, New Brunswick, Canada, 18-19 June 2001 <http://www-org.usm.edu/~ooa/ooa_iv.html> (Table 3.2).

Table 3.2. Open Ocean Aquaculture (OOA) Symposia allowing open dialogue and promotion of international development of open ocean aquaculture.

Symposium Themes	Locations	Major Discussions	References
Open Ocean Aquaculture	Portland, Maine, U.S.A.	Engineering, Prospects and Challenges for Industry	Polk (1996)
Charting the Future of Ocean Farming	Maui, Hawaii, U.S.A.	Technological, Biological, Policy and Industry Successes	Helsley (1998)
Joining Forces with Industry	Corpus Christi, Texas, U.S.A.	Alternative Uses of Oil and Gas Platforms and Candidate Species	Stickney (1999)
Taking Open Ocean Aquaculture to a Commercial Reality	St Andrews, New Brunswick, Canada	Policy, Environmental, Engineering and Candidate Species	To convene 17-20 June 2001

In addition to these international open ocean aquaculture symposia, two regional open ocean aquaculture projects have been implemented to develop an environmentally sustainable and economically feasible industry. The University of New Hampshire is currently involved in an open ocean demonstration project to develop and commercialize aquaculture off the coast of New Hampshire near the Isles of Shoals. This project is an integrated, multidisciplinary effort covering biology, oceanography, engineering, sociology, economics, outreach and education (Bucklin and Howell 1999; Bub 2000). A comparable research project has been implemented in Hawaii and has

successfully grown Pacific threadfin (*Polydactylus sexfilis*) to a market size off the south shore of Oahu (Helsley 2000).

In 1999, a third U.S. regional open ocean aquaculture research program was implemented in the GOM. This program resulted in the formation of the Gulf of Mexico Offshore Aquaculture Consortium (OAC) <<http://www.masgc.org/oac>>, creating a collaborative, Gulf-wide interdisciplinary research and development plan to ensure sustainable—economic, social and environmental—development of an open ocean aquaculture industry for the GOM.

The Gulf of Mexico and Open Ocean Aquaculture

In most aquaculture development projects throughout the world, it has been fairly easy to accomplish the mere task of raising fish to a marketable size. However, in almost all cases, sustainable development of these industries, without environmental concerns and threats of self-pollution, have been nearly non-existent. In most cases, environmental and management decisions have been based upon primary scientific data collected from other regions of the world or models in an attempt to describe and predict impacts. The OAC plans not only to develop an economically feasible open ocean aquaculture sector, but also to defend the sustainability of the industry based on primary scientific data, collected throughout its development and subsequent commercialization, from the GOM. Primary data collection and industry development will be performed using a proactive approach from the outset, learning from mistakes made by previous aquaculture development elsewhere, and in consultation with all GOM stakeholders, regardless of their perspective.

As with other U.S. regions, the GOM has comparable bottlenecks to development and expansion of coastal aquaculture. The GOM is the seventh largest marine area in the world and may be considered a very productive eutrophic sea, described as the “fertile fisheries crescent” (Gunter 1963). This productivity increases the assimilative capacity of the water, thereby reducing the environmental impacts associated with aquaculture effluents from offshore farms. In addition, numerous indigenous species to the GOM have been identified as candidate species for aquaculture with excellent grow-out and market potential characteristics, including red drum (*Sciaenops ocellatus*), red snapper (*Lutjanus campechanus*), cobia (*Rachycentron canadum*), and greater amberjack (*Seriola dumerili*). Numerous criteria are used to select candidate species for aquaculture, including the growth rate to a market size. A growth performance index (Φ' ; Longhurst and Pauly 1987), using L_{∞} and K values from wild stock literature for each of these species in the northern GOM provide favorable growth attributes for economically feasible grow-out (Table 3.3). With the subtropical growing conditions, fingerlings for all of these species are anticipated to reach a consumer-driven market size within a 1-2 year grow-out cycle, increasing the economic feasibility of open ocean aquaculture ventures in the GOM.

The offshore GOM area appropriate for aquaculture may be very limited. Water depths between 30-50 m are most desirable. Depths in this range are considered adequate to sink the cages in an attempt to avoid hurricane damage but remain within safe diving limits to inspect mooring and connections. Use of remote operated vehicles (ROV) may be economically feasible for such inspections, extending the water depth (Willoughby 1999). To keep within 30-50 m, much of the GOM is

Table 3.3. Growth performance index (Φ')^a calculated from cited L_{∞} (cm) and K values for potential aquaculture species indigenous to the northern Gulf of Mexico. Values shown in parentheses are standard errors.

Species	Sex	L_{∞} (cm)	K	Φ'	Source
<i>Rachycentron canadum</i>	male	117.07 (2.808)	0.432 (0.046)	3.77	Franks <i>et al.</i> (1999) ^b
	female	155.50 (3.514)	0.272 (0.017)	3.82	
<i>Lutjanus campechanus</i>	combined	95.0 (1.35)	0.175 (0.005)	3.20	Nelson and Manooch (1982) ^c
<i>Sciaenops ocellatus</i>	combined	91.8 (2.1)	0.422 (0.023)	3.55	Doerzbacher <i>et al.</i> (1988) ^d
<i>Seriola dumerili</i>	combined	127.2 (N.P.) ^e	0.227 (N.P.)	3.57	Manooch and Potts (1997) ^f

^a $\Phi' = \log_{10}K + 2\log_{10}L_{\infty}$ (Longhurst and Pauly 1987)

^b Cobia were caught from northeastern Gulf of Mexico within the recreational hook-and-line fishery and aged with sagittal otoliths (male N=170; female N=395)

^c Red snapper were caught in the commercial hook-and-line fishery off Louisiana and aged with scales (N=403)

^d Tagged red drum returns from recreational and commercial fishery off Texas and growth determined from tag and release measures (N=2010)

^e N.P. = not provided

^f Greater amberjack captured from headboats operating in the Gulf of Mexico from Naples, Florida, to Port Aransas, Texas and aged with sagittal otoliths (N=340)

excluded from open ocean aquaculture, and may be as far as 40 km from land. In addition to limitations associated with desirable depth, some areas of the GOM are prone to experience seasonal hypoxia (Rabalais *et al.* 1994, 1996). Although this hypoxic layer is generally restricted to the lower one-third of the water column, large cages or submerged operations may be impacted. An additional layer commonly experienced in GOM waters is the nepheloid layer developed from resuspension of fine sea-floor sediment generated from bottom turbulence (Shideler 1981). Little is known of this layer's impact on fish health or its seasonal extent in much of the GOM.

Complete hurricane avoidance is unlikely in the northern GOM. However, it may be possible to decrease hurricane impacts to aquaculture ventures by sinking cages to avoid such storms. With this strategy comes the risk of exposing the fish stock to larger sediment resuspension that may

subsequently irritate the gills, create secondary bacterial infections and result in mass mortality (Sherk *et al.* 1974, Brown 1993) and subsequent economic loss to the operation. Finally, much of the GOM has long supported both commercial and recreational fishing. User conflicts must be carefully considered and dealt with to ensure success of a future open ocean aquaculture industry. All of these issues limit appropriate sites for open ocean aquaculture in the GOM to some degree.

THE GULF OF MEXICO OFFSHORE AQUACULTURE CONSORTIUM RESEARCH PLAN

A site was chosen in 26 m of water approximately 35 km off the coast of Mississippi, in federal waters (29° 58.649'N, 88° 36.297'W). This distance logistically separates the OAC from the previously discussed U.S. open ocean aquaculture initiatives by extending operations outside the sight of land from the aquaculture site. This site is adjacent to a Chevron gas platform, placing the cage within the minerals lease. During the first year, both the cage and environment will be monitored to determine the movement and behavior of the cage in the local oceanographic conditions and to ensure that the selected site is somewhat appropriate for successful aquaculture.

An Ocean Spar Sea Station (OSSS) was chosen for the experimental cage to sustain high energies in the offshore environment (Loverich and Gace 1998). The OSSS is 600 m³ volume that is retained by its rigid structure and netting. Recent open ocean aquaculture projects have opted to use the more common submerged grid mooring system for exposed, open ocean applications (Fredriksson *et al.* 2000). To decrease mooring costs, system complexity and potential environmental impact, the OAC OSSS will be moored to the Outer Continental Shelf (OCS) on a single-point mooring (SPM) (Figure 3.1; Goudey *et al. in press*). This cage/mooring configuration will be subsequently monitored with GPS and current meter units to determine the degree of motion with ambient oceanographic conditions. Specific environmental monitoring will determine the seasonal influence on the nepheloid layer and hypoxia, and the impact of hurricanes and storm surges on sediment resuspension. Following this first year of baseline research, one of the candidate species summarized in Table 3.3 will be stocked in the cage and grown to a market size. It is apparent that this first year

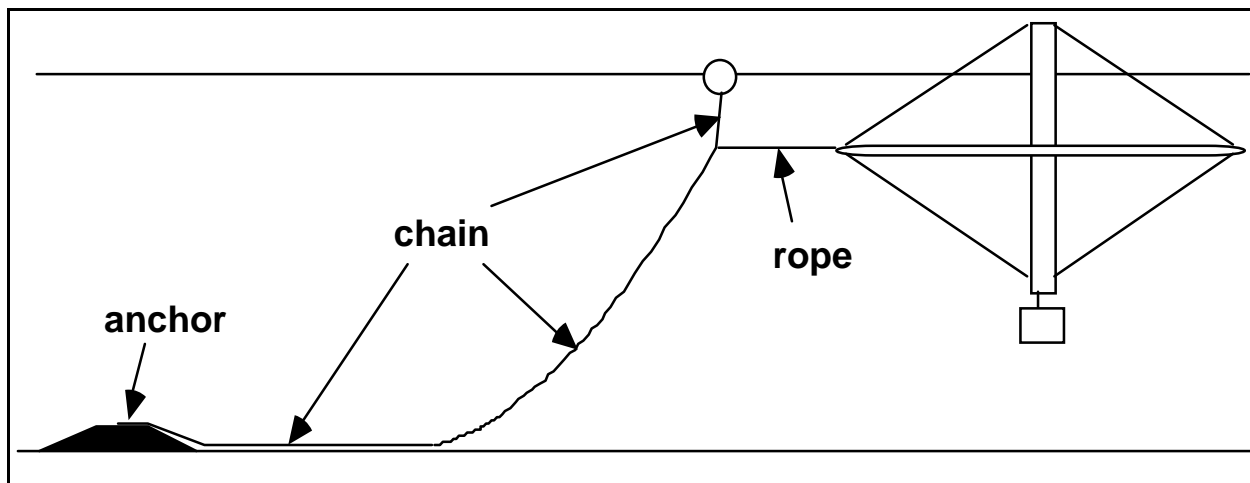

Figure 3.1. Representation of the Gulf of Mexico Offshore Aquaculture Consortium Ocean Spar Sea Station and single-point mooring (SPM) design.

is not an aquaculture project, but focused more as an oceanographic and environmental study. Table 3.4 lists the agencies and permits required for Year 1 (oceanographic) and leading into Year 2 (aquaculture) OAC research.

Table 3.4. Permits acquired to deploy an aquaculture cage on a single-point mooring (SPM) in Gulf of Mexico federal U.S. waters and conduct Year 1 oceanographic research (upper portion of table) and potentially necessary for Year 2 aquaculture research (lower portion of table).

Agency	Permit/Letter
U.S. Coast Guard	Private Aids to Navigation CG-2554
Gulf of Mexico Fisheries Management Council	Letter of Support
U.S. Army Corps of Engineers	Nationwide Permit
National Marine Fisheries Service	Letter of Acknowledgment
U.S. Environmental Protection Agency	National Pollutant Discharge Elimination System (NPDES)
National Marine Fisheries Service	Exempted Fishing Permit (EFP)
MS Department of Environmental Quality	Letter of Acknowledgement
MS Department of Marine Resources	Coastal Zone Consistency

The OAC cage and Chevron platform are perhaps extended to the outer limit of a relationship with the current leasing and permitting system imposed on the offshore oil and gas (O&G) industry. In the absence of models and a legal framework to acquire and maintain a Marine Aquaculture Zone (MAZ), the relationship consists of the cage having passive protection from nearby marine vessels and limited visual surveillance to prevent vandalism and storm damage. For Chevron, the benefits of cooperating with the OAC in this project are minimal, and in fact, their participation might best be viewed as altruistic. This leads us to pose the questions: would such a relationship exist if this project were at a commercial scale? and what would it entail? We see four specific scenarios to the development of offshore aquaculture in the GOM, each with its own set of advantages and disadvantages (Table 3.5).

INTEGRATION OF OFFSHORE OIL/GAS PLATFORMS AND CAGE AQUACULTURE

With the presence of around 4,000 oil and gas structures in the GOM, it would seem that the use of the existing platform structures (removing single-well caissons due to lack of appropriate space) would offset most of the logistic limitations of isolated offshore aquaculture. These platforms could

Table 3.5. Comparison of scenarios for integration of oil and gas (O&G) platforms in the development of offshore aquaculture in the Gulf of Mexico.

Offshore Aquaculture Operations Strategy	Advantages	Disadvantages
O&G Invest into and Integrate Offshore Aquaculture Within Operations	<ul style="list-style-type: none"> - Increase economic potential of O&G structure 	<ul style="list-style-type: none"> - Leasing modifications required - Current platform design will not allow mooring offshore cages to the structure and not designed for safe aquaculture operations - Future platform design criteria modified for safe operations - Potential interference with O&G operations
Offshore Aquaculture Investors Lease Abandoned O&G Structures	<ul style="list-style-type: none"> - Offset costs associated with structure removal - O&G industry not direct investors to offshore aquaculture 	<ul style="list-style-type: none"> - Current platform design will not allow mooring offshore cages to the structure and not designed for safe aquaculture operations - O&G industry will still have liability issues: <ol style="list-style-type: none"> 1. Maintenance of aids to navigation 2. Structural integrity of the structure for its life 3. Injuries or property damage associated with the structure - O&G original operator may be responsible for removal if new operator neglects removal
Near O&G Platform <i>but</i> as a Separate Operation	<ul style="list-style-type: none"> - No transfer of ownership required - Passive protection to the cage facility - Visual surveillance offered to vandalism and storm damage 	<ul style="list-style-type: none"> - No benefits of platform to the aquaculture operator as a 'shore-base' - Potentially interfere with O&G operations - O&G operator potentially liable for aquaculture mortality near its structure
Lift-boat within Marine Aquaculture Zone	<ul style="list-style-type: none"> - Eliminates all O&G concerns to aquaculture - Specifically designed for aquaculture operations - Avoids storm impact 	<ul style="list-style-type: none"> - Increased user conflicts if competing for new space with traditional use

provide a stable work base to conduct the day-to-day operations required for an aquaculture venture. In addition, they could provide deck space for feed storage, lodging for farm workers, necessary utilities and communications, surveillance against vandalism and storm damage, and passive protection from other, more traditional, users of the GOM. However, such platforms are built well above the water column to protect them from storm surges and are designed to last for years following the expected life of an oil and gas well, approximately 25 years, with 100-year storm manufacture criteria. With such obvious benefits to the aquaculture sector, is this a logical integration of two industries? What could be some of the potential constraints to prevent such an industry 'marriage'?

Investment by Oil and Gas Companies

Of course, the OAC is not the first organization to attempt offshore aquaculture in the GOM, and with this, we are not the first to realize existing oil and gas structures could be a valued asset to expansion of an industry (Stickney 1999). Following placement of a structure on the OCS, it may also be readily available for alternative uses to enhance the economic potential and offset the costs of design, construction and deployment. These costs, dependent on the size and water depth, could range from \$10-30 million (Chambers 1998). With the prospects of large economic returns associated with the economies of scale of offshore aquaculture, such an integration could become enticing. Previously trained oil and gas employees could also become trained aquaculturists, armed with advanced technologies and innovation for successful farm production.

Such visions for integration have several constraints to overcome before attaining commercial reality. Current leasing mechanisms within the Minerals Management Service (MMS) authorize companies to explore for, develop, produce and transport oil and gas from the OCS. The involvement of aquaculture will complicate such a lease and add several new layers to this program in the form of additional approvals required from several other regulatory agencies (Table 3.4). Platform design would also have to be altered substantially for safe operations as a fish farm facility. Current designs are appropriate to hold and conduct necessary operation for successful oil and gas production in a safe and responsible manner. Aquaculturists will require modifications for deployment of boats, personnel and feed on a regular operational basis. In addition, structures will have to be modified to provide sufficient deck space for storage of large quantities of feed and work boats. Current structures are also designed for very specific vertical and horizontal loads that would have to account for additional stresses associated with mooring cages and net pens to the structure. An alternative approach, of course, would be to moor the cage system to the OCS as the OAC has done. However, aquaculture benefits associated with decreased costs for expensive mooring systems required for holding the cages on the OCS in a very exposed and harsh environment are now absent. In addition, mooring systems to the OCS may be limited to within 50 m depth to ensure safe diving limits are adhered to. Finally, aquaculture operations may interfere with routine oil and gas operations for which the structures are primarily intended.

Use of Abandoned Oil and Gas Structures

A second scenario for use of existing structures for offshore aquaculture involves abandoned structures from the oil and gas industry. Within one year of production completion, oil and gas

operators are required to remove the production equipment and return the site to pre-production conditions. Such an endeavor in 30-50 m depth averages about \$1 million. These costs may be offset somewhat by acquiring a permit to drop the platform in its place to create an artificial reef, or those with excellent structural integrity may be hauled to another oil or gas field and reused. Aquaculture investors could view these costs and regulations as a reason to lease the existing structure where it is and maintain it as an aquaculture facility. In this case, cages may still not be attached to the structure due to increased loads associated with its movement and drag.

For the oil and gas company, issues of liability are paramount in this scenario. Although the structure may be used by another operator, the original company is still liable for maintenance of aids to navigation and structural integrity of the structure for the life of the facility. In addition, the original operator may be held liable for all injuries or property damages arising from the offshore structure except in cases where gross negligence or willful misconduct by the injured party could be proven, regardless of whether the oil and gas company is actively operating the structure or not. Finally, in instances where the structure may be sold to an offshore aquaculture investor, the original oil and gas company is responsible for structure removal if the new operator fails to do so upon completion of their work. The MMS has implemented a Supplemental Bonding Program requiring an oil and gas operator to post a bond to offset the cost of abandonment liability of the lease including structure removal (Kruse 1999). For a future to exist for the use of oil and gas abandoned structures for offshore aquaculture, the original oil and gas company would have to be released from its responsibility for structure removal. However, it has yet to be determined whether aquaculture investors could afford the cost of such bonds from the outset.

Neighboring but Separate Operations

To offset issues regarding transfer of ownership and future status, a third scenario may be utilized in that the aquaculture investor moors its cage systems near an existing oil and gas company structure. A comparable situation exists between the OAC cage and the Chevron platform. In this instance, the benefits for the aquaculture operation would be passive protection from abundant vessel traffic in the GOM and perhaps surveillance from vandalism and storm damage as discussed above. However, operating near an oil and gas platform does not benefit the aquaculture operation by providing an offshore working and storage platform. As previously discussed, the oil and gas company may not wish to store feed or house aquaculturists on the platform to eliminate liability risks. In addition, such associations may become unsafe and interfere with the day-to-day operations of the oil and gas operators, or vice versa, and decrease the time spent for the aquaculture operations (Wilson and Stanley 1999). Finally, the operating oil and gas company could be held liable for any tainting, mortality, or other loss of the caged fish stock associated with their operations.

Following this exhaustive list of liabilities and hurdles associated with a relationship between the oil and gas industry and offshore aquaculture, one has to wonder whether such a future could exist. Is there another option for the development of offshore aquaculture?

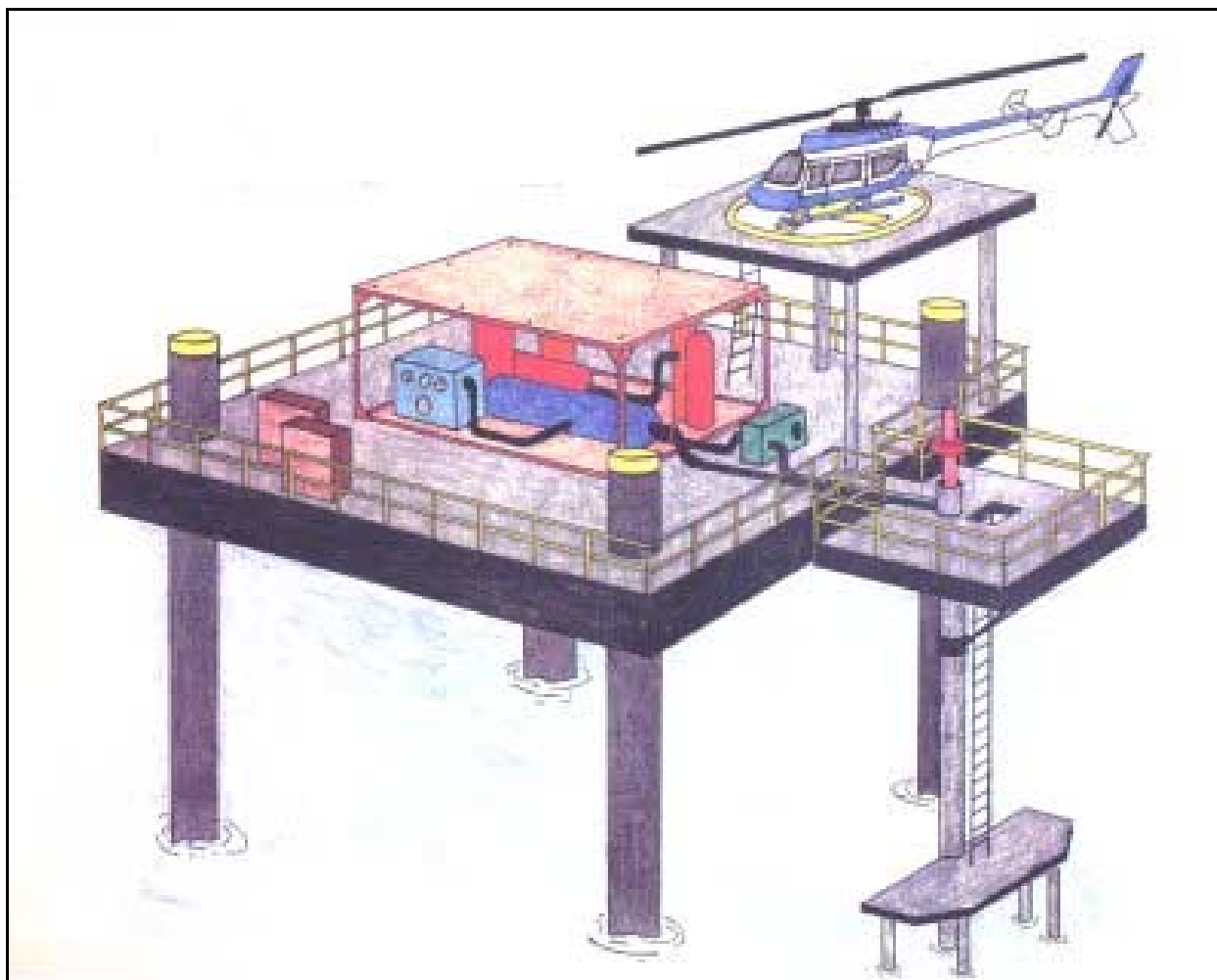

Figure 3.2. Hypothetical illustration of a lift-barge potentially designed for offshore aquaculture operations (courtesy of Dennis Good, Goodstreak Marine, Slidell, LA).

ALTERNATIVE SOLUTIONS TO OFFSHORE AQUACULTURE LOGISTICAL CHALLENGES

How is an offshore aquaculture industry to develop without an accessible working platform to serve as a ‘shore-base’? One such alternative is the creation of a Marine Aquaculture Zone (MAZ) with a lift-boat, specifically designed for aquaculture operations, as its focal point (Figure 3.2). A lift-boat strategy would alleviate all concerns associated with aquaculture and the oil and gas industry and does not introduce any new technology to the GOM. A lift-boat would be designed, with environmentally sustainable criteria, to create a safe working platform for offshore aquaculture. Such a barge could possess sufficient living quarters for the workers, deck space for feed storage and a crane capable of lowering and raising a farm work boat and feed. In addition, power could be supplied with a hybrid system of wind turbines, and photovoltaic cells and wastes could be collected and disposed of on-shore to minimize the risks of tainting or losing the fish stock. Regular operational mode would see the lift-boat jacked-up from the water surface, perhaps to 7 m height,

to provide a stable working platform. In severe stormy or hurricane conditions, workers would sink the cages before raising the lift-boat legs and moving to shore.

A concept involving future offshore aquaculture and MAZs cause some concern to other user groups. Such user groups may include recreational boaters and fishers, traditional wild fishers and even the oil and gas industry by preventing access to future oil and gas fields. Most use conflicts may simply be avoided through active dialogue and careful planning and consideration of all stakeholders. Lift-boats and associated MAZs may be placed in the same zone of a previous minerals rights lease immediately following removal of the oil and gas structure. This alleviates concerns from the oil and gas sector as this area has been exploited for its mineral value. In addition, during operation, the previous oil and gas structure would have prevented successful wild commercial fisheries. With its immediate replacement by offshore aquaculture, this new industry is not removing currently utilized and precious space from wild fishers. Finally, following structure removal, recreational fishers lose a large and valued fish aggregating device (FAD). However, replacement by offshore aquaculture and a lift-boat will essentially continue the presence of this valued FAD effect. A strategy could be negotiated whereby recreational fishers could fish near the lift-boat while respecting the operations of the aquaculturist and not vandalize the cages.

SELECTION OF THE MOST APPROPRIATE OFFSHORE AQUACULTURE STRATEGY

A list of associated expenses is provided in Table 3.6 to compare the economic environment for each of the proposed offshore strategies. Such a simplistic analysis is warranted at this time with the current state of factual knowledge associated with offshore aquaculture operations and the grow-out of the candidate species considered. With the exception of red drum, knowledge of the biological aspects – nutrition, stocking density, food conversion ratio, feed quantity, etc. – and feasibility of raising each of these candidate species is currently limited. In addition, each of these species, including red drum, has minimal collected data regarding offshore grow-out and associated costs and returns at a commercial scale. Finally, several of these species either have closed fisheries or no commercial value and a minimum commercial size limit above the anticipated market demand size. These factors will alter the expected revenue for an aquaculture product—harvested at a consumer derived size, of the highest quality possible, and at the time of the highest market demand—thereby fetching premium prices. Throughout OAC research development, costs and returns associated with offshore aquaculture will be carefully documented and extrapolated to a commercial scale to gain better insight of the economic feasibility of commercial offshore operations.

With increased independence from the oil and gas industry and decreased liabilities (Table 3.5) and a comparable expense list to the oil and gas investment strategy (Table 3.6), perhaps use of the ‘alternative’ lift-boat solution to the logistical challenges may indeed be the most desirable route for industry development. This notion is based on the independence of the ‘alternative’ solution, without the liabilities associated with the oil and gas industry and specific design for the needs of offshore aquaculture operations. To further substantiate use of a lift-boat, an economic comparison revealed that each of these strategies, with the exception of using an abandoned oil and gas structure, appear somewhat comparable with respect to the level of investment required. Direct investment by the oil

Table 3.6. Simplistic outline of potential expenses experienced for each of the offshore aquaculture strategies outlined in Table 3.4.

	Offshore Aquaculture Strategy			
	O&G Investment	Abandoned Structure	Separate but Nearby	Aquaculture Lift-boat
Capital Expenses				
Platform Abandonment Bond		1,500,000		
Platform Refurbishment	500,000	500,000		
Lift-boat Manufacture				1,000,000
Large Work Boat ^a			500,000	
Small Service Boats	100000	100,000	100,000	100,000
Cages (6 x 3000 m3) + mooring systems	600000	600,000	600,000	600000
Total Capital Expenses	1,200,000	2,700,000	1,200,000	1,700,000
Operating Expenses				
Supply Boat Runs	150,000	150,000	750,000 ^b	150000
Feed ^c	315,000	315,000	315,000	315,000
Crew ^d	315,000	315,000	400,000	315000
Maintenance (platform + equipment)	200000	200,000	100,000 ^f	200000
Insurance (4% of revenue ^e)	72,000	72,000	72,000	72,000
Total Operating Expenses^h	1,052,000	1,052,000	1,637,000	1,052,000
Contingencies (10% of operating costs)	105,200	105,200	163,700	105,200
TOTAL EXPENSES	2,357,200	3,857,200	3,000,700	2,857,200

^a It is assumed that the strategy of being near a current structure would purchase a large work boat due to increased dependency on it. Other strategies would contract this service out on a weekly basis.

^b The strategy of being near a structure but operating from a land-base would require numerous more trips to the cage, upwards of 3 times per week for security and maintenance operations.

^c Quantity of feed delivered is based on a food conversion ratio of 2:1 remaining constant throughout the grow-out cycle and total growth per year of 450,000 kg, regardless of species, and multiplied by a feed cost of \$350 ton-1.

^d Crew is typically calculated from annual salaries of a manager (\$75,000), supervisor (\$50,000 x 2), and farm crew (\$35,000 x 4).

^e More salary would be required for supply boat crew annual salaries of captain (\$50,000) and deck hand (\$35,000).

^f Fewer maintenance costs required in the absence of a platform to maintain.

- ^g Revenue is based upon an estimated ex-vessel price of \$4.00 kg⁻¹ of 450,000 kg from the 6 x 3000 m³ cages with a stocking density of 25 kg m⁻³. Other assumptions include 100% survival and constant growth giving a 1-year grow-out cycle for each of the species.
- ^h Total Operating Expenses are exempt of additional anticipated expenses, such as office rental, personnel and supplies, that are considered identical regardless of the strategy used and therefore not required for this simplistic economic illustration.
-

and gas company into the aquaculture sector has the greatest economic merit. However, this is dependent on the degree of interference caused by aquaculture to the oil and gas operations for production. With a reasonable cost of investment and operations and increased independence, design and manufacture of a lift-boat specifically for offshore aquaculture seems to be most desirable.

CONCLUSIONS

In the 21st century, offshore aquaculture will be required to grow the necessary biomass of fish to meet global consumer demands for seafood. This new industry will require substantial efforts, research, collaboration, and investment to become a commercial reality. Enormous logistical challenges are present for aquaculture operations with increasing distance from shore. For the GOM, an obvious solution to such challenges could include the use of currently operating, abandoned, or future oil and gas structures. However, an aquaculture logistics solution involving the oil and gas industry will require substantial modifications in both the design of the offshore structure and the permitting mechanism to allow fish grow-out with oil and gas production. An alternative solution to enormous offshore aquaculture logistics is the design of a lift-boat for safe aquaculture operations. A lift-boat would alleviate potential constraints associated with oil and gas industry liabilities and independence of the aquaculture venture. In addition, following the simplistic economic analysis, design and manufacture of a lift-boat specifically for offshore aquaculture may be considered economically comparable to the offshore aquaculture strategies involving the oil and gas industry.

ACKNOWLEDGMENTS

This research is supported by a NOAA/Sea Grant award, contract #NA06RG0071. The GOM Offshore Aquaculture Consortium would like to express sincere gratitude to Chevron USA for collaborating during this research. In addition, the authors would like to thank Dennis Good (Good Streak Marine, Slidell, LA) and George White (Marine Consultant, Slidell, LA) for insight on the capabilities and design criteria necessary to alleviate some logistical challenges for offshore aquaculture in the GOM and Ben Posadas for reviewing the economic analysis.

REFERENCES

- Aarset, B. 1999. Aquacultural development, institution building and research and development policy: Norwegian salmon and Arctic char farming as cases. *Aquaculture Economics and Management* 3: 177-191.
- Brown, L. 1993. *Aquaculture for veterinarians: fish husbandry and medicine*. Pergamon Press, New York.

- Bub, F. 2000. Development of an open-ocean aquaculture demonstration project: Progress report – February 2000. <http://ekman.sr.unh.edu/Aquaculture/Progress_FEB00/OOA_Prog_Feb00_Front.html>. Revised 29 February 2000.
- Bucklin, A., and H. Howell. 1999. Progress and prospects from the University of New Hampshire open ocean aquaculture demonstration project. Pages 7-30. *In* R.R. Stickney, compiler. Joining forces with industry. Proceedings of the Third International Conference on Open Ocean Aquaculture. 10-15 May 1998. Corpus Christi, Texas. TAMU-SG-99-103.
- Chambers, M.D. 1998. Potential offshore cage culture utilizing oil and gas platforms in the Gulf of Mexico. Pages 77-87. *In* C.E. Helsley, ed. Open Ocean Aquaculture '97, Charting the Future of Ocean Farming. Proceedings of an International Conference. 23-25 April 1997. Maui, Hawaii. University of Hawaii Sea Grant College Program #CP-98-08.
- Doerzbacher, J.F., A.W. Green, H.R. Osburn, and G.C. Matlock. 1988. A temperature compensated von Bertalanffy growth model for tagged red drum and black drum in Texas bays. *Fisheries Research* 6: 135-152.
- Ebeling, J.M. 2000. Engineering aspects of recirculating aquaculture systems. *Marine Technology Society Journal* 34: 68-78.
- Edwards, S.F. 1989. Estimates of future demographic changes in the coastal zone. *Coastal Management* 17: 229-240.
- Franks, J.S., J.R. Warren, and M.V. Buchanan. 1999. Age and growth of cobia, *Rachycentron canadum*, from the northeastern Gulf of Mexico. *Fisheries Bulletin* 97: 459-471.
- Fredriksson, D.W., M.R. Swift, E. Muller, K. Baldwin, and B. Celikkol. 2000. Open ocean aquaculture engineering: System design and physical modeling. *Marine Technology Society Journal* 34: 41-52.
- Goodland, R., and H. Daly. 1996. Environmental sustainability: Universal and non-negotiable. *Ecological Applications* 6: 1002-1017.
- Goudy, C., G. Loverich, H. Kite-Powell, and B.A. Costa-Pierce. *In press*. Mitigating the environmental effects of mariculture through single-point moorings (SPMs) and drifting cages. *ICES Journal of Marine Science*.
- Gunter, G. 1963. The fertile fisheries crescent. *Journal of the Mississippi Academy of Sciences* 9: 286-290.
- Helsley, C.E., editor. 1998. Open Ocean Aquaculture '97, Charting the Future of Ocean Farming. Proceedings of an International Conference. 23-25 April 1997. Maui, Hawaii. University of Hawaii Sea Grant College Program #CP-98-08.

- Helsley, C.E. 2000. Hawaii open ocean aquaculture demonstration project. Pages 15-22. *In* C.C.-T. Tamaru, C.S. Tamura, J.P. McVey and K. Ikuta, eds. Spawning and Maturation of Aquaculture Species. Proceedings of the Twenty-Eighth U.S.-Japan Natural Resources Aquaculture Panel. 7-16 November 1999. Hawaii.
- Kruse, B.J. 1999. MMS liability issues and bonding associated with offshore platforms. Page 46. *In* R.R. Stickney, compiler. Joining forces with industry. Proceedings of the Third International Conference on Open Ocean Aquaculture. 10-15 May 1998. Corpus Christi, Texas. TAMU-SG-99-103.
- Longhurst, A.R., and D. Pauly. 1987. Ecology of Tropical Oceans. Academic Press, Inc. London.
- Loverich, G.F., and L. Gace. 1998. The effect of currents and waves on several classes of offshore sea cages. Pages 131-144. *In* C.E. Helsley, editor. Open Ocean Aquaculture '97, Charting the Future of Ocean Farming. Proceedings of an International Conference. 23-25 April 1997. Maui, Hawaii. University of Hawaii Sea Grant College Program #CP-98-08.
- Lumb, C.M. 1989. Self-pollution by Scottish salmon farming. *Marine Pollution Bulletin* 20: 375-379.
- Manooch III, C.S., and J.C. Potts. 1997. Age, growth, and mortality of greater amberjack, *Seriola dumerili*, from the U.S. Gulf of Mexico headboat fishery. *Bulletin of Marine Sciences* 61: 671-683.
- Nelson, R.S., and C.S. Manooch III. 1982. Growth and mortality of red snappers in the west-central Atlantic Ocean and northern Gulf of Mexico. *Transactions of the American Fisheries Society* 111: 465-475.
- Polk, M., ed. 1996. Open ocean aquaculture. Proceedings of an international conference. May 8-10, 1996. Portland, Maine. New Hampshire/Maine Sea Grant College Program Rpt.# UNHMP-CP-SG-96-9.
- Postel, S.L. 2000. Entering an era of water scarcity: The challenges ahead. *Ecological Applications* 10: 941-948.
- Rabalais, N.N., W.J. Wiseman, Jr., and R.E. Turner. 1994. Comparison of continuous records of near-bottom dissolved oxygen from the hypoxia zone along the Louisiana coast. *Estuaries* 17: 850-861.
- Rabalais, N.N., R.E. Turner, D. Justic, Q. Dortch, W.J. Wiseman, Jr., and B.K. Sen Gupta. 1996. Nutrient changes in the Mississippi River and system responses on the adjacent continental shelf. *Estuaries* 19: 386-407.

- Sherk, J.A., J.M. O'Connor, D.A. Neumann, R.D. Prince, and K.V. Wood. 1974. Effects of suspended and deposited sediments on estuarine organisms, Phase II Final Report. United States Army Corps of Engineers Contract No. DACW72-71-C-0003.
- Shideler, G.L. 1981. Development of the benthic nepheloid layer on the south Texas continental shelf, western Gulf of Mexico. *Marine Geology* 41: 37-61.
- Stickney, R.R., compiler. 1999. Joining forces with industry. Proceedings of the Third International Conference on Open Ocean Aquaculture. 10-15 May 1998. Corpus Christi, Texas. TAMU-SG-99-103.
- U.S. Department of Commerce Aquaculture Policy. 2000. <[http://www.nmfs.noaa.gov/trade.DOCAQpolicy.htm](http://www.nmfs.noaa.gov/trade/DOCAQpolicy.htm)>. Revised 15 March 2000.
- Waldemar Nelson International Inc. 1997. Feasibility study – Offshore mariculture. A report of Waldemar International Inc. National Oceanic and Atmospheric Administration (NOAA) Award No. NA77FL0150.
- Willoughby, S. 1999. Manual of Salmonid Farming. Fishing News Books, London.
- Wilson, C.A., and D.R. Stanley. 1999. Constraints of operating on petroleum platforms as it relates to mariculture: lessons from research. Page 60. *In* R.R. Stickney, compiler. Joining forces with industry. Proceedings of the Third International Conference on Open Ocean Aquaculture. 10-15 May 1998. Corpus Christi, Texas. TAMU-SG-99-103.

TEXAS ARTIFICIAL REEF PROGRAM 2000 REVIEW

J. Culbertson
D. Peter
J. Embesi
P. Hammerschmidt
Artificial Reef Program
Texas Parks and Wildlife Department.

ABSTRACT

In 1989, the 71st Legislature of Texas directed Texas Parks and Wildlife to develop a State Artificial Reef Plan to create and enhance reef fish habitat offshore of Texas. The Texas Artificial Reef Plan provides guidance and flexibility to allow for changes in policy as new information is presented or becomes available. The goals of the Texas Artificial Reef Plan are to enhance the fishery resources biologically, commercially, and recreationally. The Program utilizes a ten-person citizen advisory committee, representing major interest groups in the Gulf of Mexico to create new sites, evaluate material donations, and minimize user conflicts.

One of the main criteria for the Program is to actively pursue complex, stable, and durable structures in a form as close to their current form as possible. Oil and gas platforms are the primary reef building material of choice, since they already serve as artificial reefs in the Gulf of Mexico and also meet the material criteria of the Program. The Texas Program promotes the use of "partially mechanically removed" structures to minimize damage to the benthic communities attached to the structure, and to minimize loss of reef fish from the use of explosives when toppling structures in place to create artificial reefs. These standing structures allow the maximum biological profile to remain higher in the water column and still meet safe navigational clearances.

RIGS-TO-REEFS FROM AN OPERATOR'S VIEWPOINT

Dave Dougall
Agip Petroleum Co.

ABSTRACT

Oil and gas platforms offshore of the U.S. presently number around 4,000 and some date as far back as the 1950s. As these structures come to the end of their economic lives, they must be decommissioned. Since 1988, decommissioning of platforms has occurred at a rate of 100 to 150 per year.

This paper reviews the alternatives available to owners of offshore oil and gas structures for retirement of these structures and examines the attractiveness of donating those structures to an artificial reef program.

BACKGROUND

Oil and gas development in the Gulf of Mexico (GOM) began in the 1930s in the tidal lands of Louisiana. The first oil well out of sight of land was placed in 1947 in about 18 feet of water. Since then, technology has more or less continuously improved, and development has continued to move farther from shore and into deeper water. GOM oil and gas platforms are located from shoreline to 200 miles from land and in water depths near 5,000 feet. Figure 3.3 provides insight into the distribution of platforms in the GOM. This map shows the relatively high density of structures on the broad shelf area off the coast of Louisiana and Texas.

Although deepwater drilling and development are currently the focus of substantial attention in the GOM, the vast majority of existing platforms are located in relatively shallow water (see Figure 3.4). These are the older sites and, therefore, the locations where most of the removal activity will occur over the next several years.

DECOMMISSIONING

Steel platforms generally have a useful life of 10 to 30 years; productive oil and gas reservoirs, of course, may be substantially less: Thus, the need to remove oil and gas structures.

Oil and gas platforms represent a substantial liability to the owner, in terms of removal cost and potential damage claims. Removal costs may range into the tens of millions of dollars, depending on a number of circumstances, such as water depth, platform location, size, complexity, and market for reclaimed equipment and structure at the time of removal. Damage claims may arise from personal injury, environmental damage, or property damage. These liabilities are only relieved upon complete removal of the platform or the transfer of ownership to another responsible party.

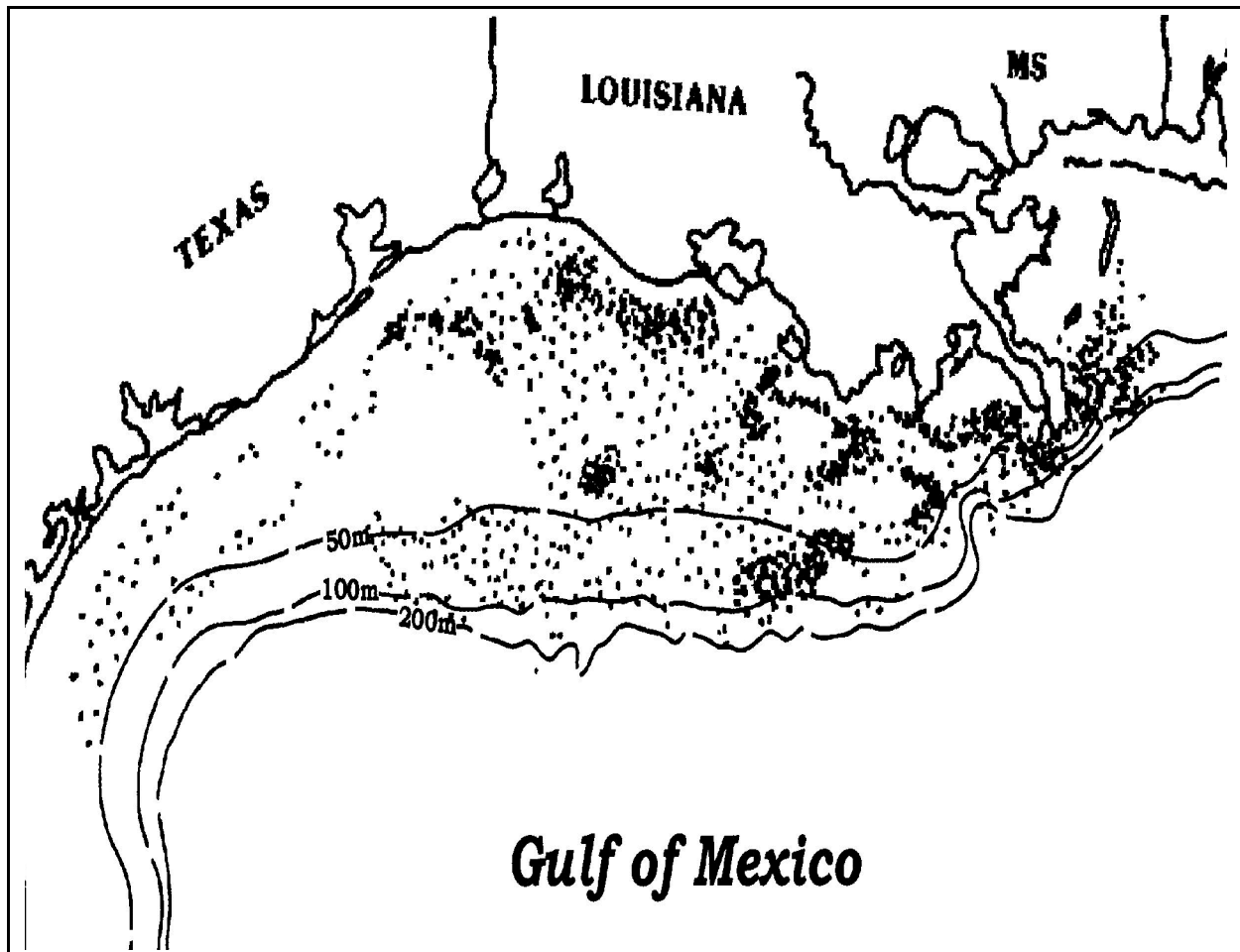

Figure 3.3. Platform distribution in the northern Gulf of Mexico.

Generally speaking, platforms offshore of the U.S. must be removed within 12 months after lease production ceases. Present requirements specify that companies must permanently plug and abandon all the wells, sever all wellheads, casings, pilings, and any other obstructions to a depth at least 15 feet below mudline, remove everything from the lease, and then verify that the site is clean either by having an independent contractor trawl 100% of the area (twice) or by conducting a sonar survey, the choice depending on circumstances. Either way, the survey is precisely prescribed, and a written report must be submitted.

A review of MMS records from 1986 through 1998 shows that a total of 1,255 structures were removed during that period (an average of 116 per year). Figure 3.5 depicts the distribution of platforms removed by water depth and confirms that most of the platform removals are from shallow water. (The spike in 1993 is a reflection of damages caused by hurricane Andrew in August 1992, and the spike in 1997 of a large removal program by one of the major operators).

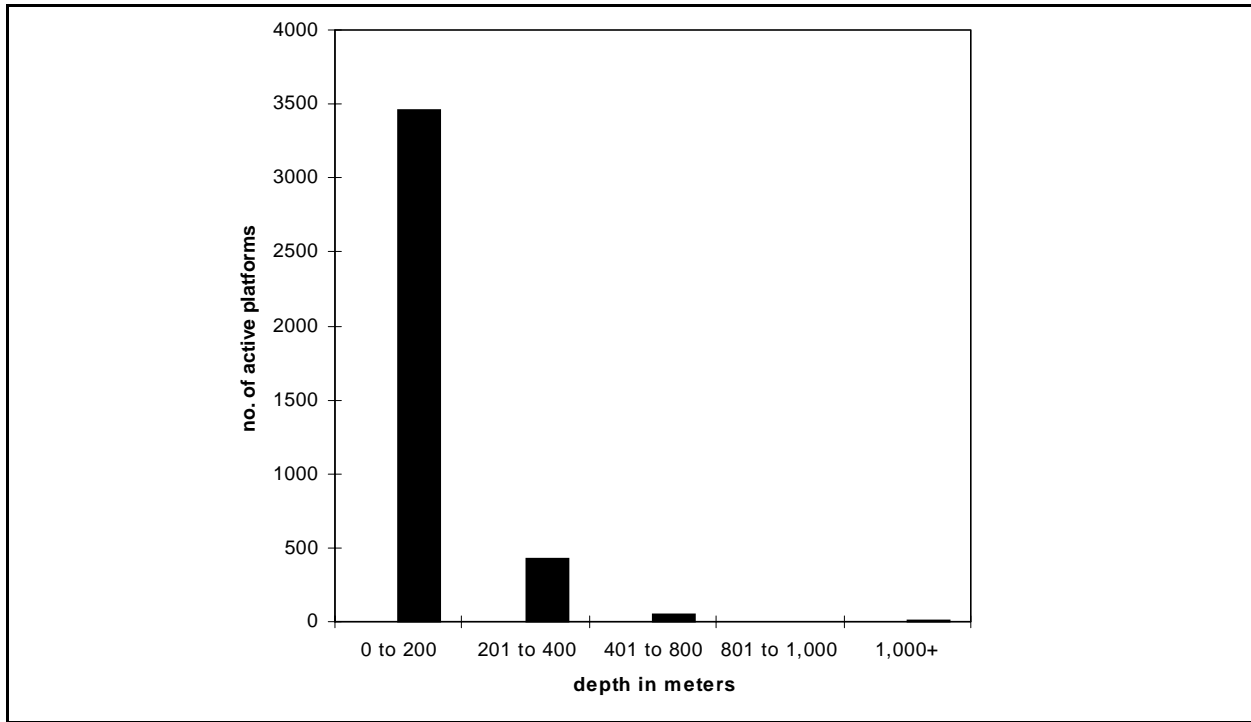

Figure 3.4. Gulf of Mexico platform distribution by depth.

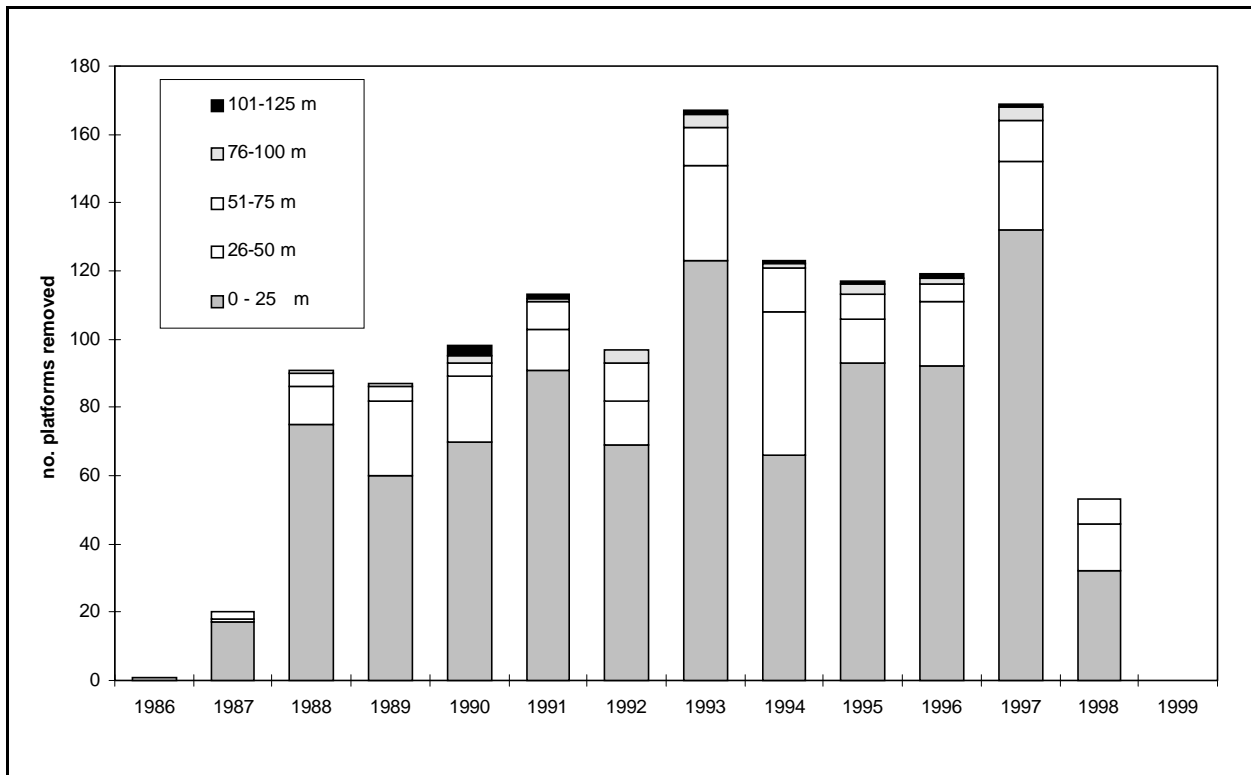

Figure 3.5. Gulf of Mexico platform removals by depth.

RIGS-TO-REEFS

Current rules and liability considerations generally encourage complete removal of platforms at the end of their useful lives. Top deck structures and equipment are often removed and reused elsewhere, with remaining decks, equipment, and jacket brought to shore, cut up, and recycled as scrap. Some offshore structures, however, are donated to the rigs-to-reefs program. These programs are managed by state agencies to take advantage of the reef-like ecosystems fostered by these offshore oil and gas structures.

The northern GOM seafloor is predominately mud and sand, with relatively little hard bottom or natural reef areas. Oil and gas platforms have long been recognized as havens for fish and are favorites for recreational and commercial fishermen and divers as well. The hard surfaces of platform members provide attachment for a variety of invertebrates such as barnacles, corals, sponges, mussels, and anemones. They also provide cover for smaller species of fish. These structures create ideal communities, supporting populations of reef fish such as snapper and grouper, and attract transient species like mackerel and shark.

Particularly active rigs-to-reefs programs are in waters offshore of Louisiana and Texas and are managed by the Louisiana Department of Wildlife & Fisheries and the Texas Parks & Wildlife Department. These programs include:

- Planning for areas where placement of artificial reef materials are encouraged or excluded.
- Technical evaluation of the configuration the structure will have after it is in place on the bottom. Of particular concern is adequate clearance above the structure for vessel traffic; generally at least 85 feet are required. The platform and all piping and equipment left on board must be thoroughly cleaned and certified by a qualified third party.
- Funding procedures for management of the program and purchase and maintenance of marker buoys. The owner of the structure provides a comparison of costs associated with the reefing proposal versus the alternative of transport to shore and disposition. The owner then makes a monetary donation to the program in the amount of 50% of the estimated savings.
- Transfer of ownership of the structure to the state. The program includes a permit program and execution of a formal transfer of ownership. Transfer of ownership relieves the previous owner of further liability.

As indicated above, oil and gas structures generally must be severed below the mud line. However, beginning in 1987, the state program managers, in consultation with MMS and the U.S. Coast Guard, began actively to consider and approve “partial removal” of platforms under some circumstances. In this procedure, the topsides are removed and either placed on the bottom or transported offsite for reuse elsewhere, and the jacket is cut off at an agreed water depth necessary to assure vessel traffic safety. Leaving the jacket members partially in place maximizes the amount of available attachment surface remaining within the depth of biological activity.

BENEFITS & LIMITATIONS

Donation of all or part of platforms that are no longer of use is a win/win for everyone.

- Conversion of the structure to an artificial reef decreases that expense that would be involved in complete removal.
- The owner/operator is released from further liability from the structure.
- A rich habitat area is retained for the benefit of fishing, diving and species propagation.

Given the obvious benefits of donating structures into the rigs-to-reefs program, it would seem that every decommissioned structure would go into the program. Yet the majority of structures are removed. As discussed above, by far most of the structures removed are from relatively shallow water, too shallow to provide the clearance required for safe navigation.

CONCLUSION

Given the number and age of oil and gas structures in the GOM, platform removal activity will continue to be substantial in the foreseeable future. Wherever feasible, reuse of structures as artificial reefs is an economic and beneficial alternative to removal and transport to shore.

David A. Dougall is Manager of Environmental Affairs & Safety for Agip Petroleum Company, with drilling and production operations in the Gulf of Mexico. Mr. Dougall's background includes environmental consulting on risk assessments, compliance audits and permitting. His background also includes corporate and field assignments for a major oil company, including several years coordinating permitting and compliance efforts in California. He received his M.S. in environmental science and B.S. degree from the University of Oklahoma. He is a registered professional engineer.

SESSION 4: PRESENT AND FUTURE FISHERIES MANAGEMENT I

Moderators: Hal Osborne
Bob Shipp

Date: October 25, 2000

Presentation	Author/Affiliation
The Artificial Reef Debate: Are We Asking the Wrong Questions	Robert L. Shipp Department of Marine Sciences University of South Alabama
Artificial Reefs: Habitat for Marine Resources	Ronald R. Lukens Gulf States Marine Fisheries Commission
Fishery Resources and Oil and Gas Operations: Potential Conflicts	Christopher C. Koenig Felicia C. Coleman Institute for Fishery Resource Ecology Department of Biological Science Florida State University Kathryn M. Scanlon U.S. Geological Survey
The Role of Fishermen and Other Stakeholders in the North Sea Rigs-to-Reefs Debate	Mark Baine Jon Side International Centre for Island Technology Heriot-Watt University Orkney Islands, Scotland
Fishing Demand, Catch and Effort Data, and Economic Impacts Associated with Recreational Fishing Near Oil and Gas Structures in the Gulf of Mexico	Robert L. Hiatt QuanTech, Inc. J. Walter Milon Department of Economics University of Central Florida
Importance of Geology to Fisheries Management: Examples from the Northeastern Gulf of Mexico	Kathryn M. Scanlon U.S. Geological Survey Christopher C. Koenig Felicia C. Coleman Florida State University Margaret Miller National Marine Fisheries Service

THE ARTIFICIAL REEF DEBATE: ARE WE ASKING THE WRONG QUESTIONS?

Robert L. Shipp
 Department of Marine Sciences
 University of South Alabama

In the last several decades, and especially the last five years, an enormous amount of literature has been published on artificial reef ecology (e.g., Fifth International Conference on Aquatic Habitat Enhancement, *Bulletin of Marine Science* 55: 265-1360, 1994; Special Issue on Artificial Reef Management, *Fisheries* 22:17-36, 1997; Bortone 1998; Technology and Management of Artificial Reefs: An Update, *Gulf of Mexico Science* 16:31-105, 1998). Although numerous aspects of the issue have been addressed in these works, such as materials of construction, critical minimum size of area, and rates of recruitment, the one persistent question that appears to dominate all the synoptic treatises is do reefs simply attract fishes (and other organisms), or is an actual increased production of biomass attributable to reefs (Bohnsack 1989; Bohnsack *et al.* 1997)?

The relevance of this question seems obvious. If the former is true, then reefs may be detrimental to fish populations, making certain species easier to harvest, thus accelerating the decline of stressed stocks. This opinion is held by many workers, at least in certain instances (Bohnsack *et al.* 1997; Grossman *et al.* 1997; Lindberg 1997). Therefore, the utility of reefs as a management tool is discouraged and deemed counterproductive. With the latter hypothesis, increased biomass productivity is generally regarded as a positive, and unless the productive benefits are overwhelmed by increased fishing activity, artificial reefs are viewed as a viable and positive management tool.

The current status of the debate seems to have reached a partial “resolution” of sorts, with the general acceptance that much depends on location. The general agreement seems to be that in areas with little natural hard bottom, reefs may be beneficial in providing habitat that is limited (Grossman *et al.* 1997; Bortone 1998). But in areas where abundant hard bottom is available, thus habitat is not limiting, placement of additional reefs is, at best, neutral and, perhaps, counterproductive.

ATTRACTION VS PRODUCTION: DOES IT REALLY MATTER?

Although I do not disagree with this consensus, I think it fails to address the attraction vs production question. For what we really see in the location solution is not that production is necessarily increased where hard bottom is limited but that there is a fundamental modification of habitat. And with this, there is a concurrent transformation of biota. For instance, in a flat sandy mud environment such as is found in the north central Gulf of Mexico shelf, placement of artificial reefs displaces a fish fauna dominated by small benthic species with larger reef-related forms. A net change in fish biomass may or may not occur, but does that really matter from a management perspective? I am not so naïve that I don't realize that for many workers the production aspect really means production of desirable reef species (Grossman *et al.* 1997), but to many, it is a matter of production per se. Hard bottom is thought to support primary and secondary production, with the successional sequence of encrusting organisms, increased refuge habitat for prey species, and actual

increase in biomass the result (Carter *et al.* 1985; Pamintuan *et al.* 1994; also see Stone *et al.* 1979; Bohnsack 1989; Lindberg 1997).

THE ALABAMA SHELF: A CASE STUDY

For a case study, I will use the expansive flat inner shelf of the north central Gulf of Mexico off Alabama. A large portion (4,000 km²) has been prepermitted for placement of artificial reef structure. This area has been previously referenced and its history and current fishery status are well documented (Szedlmayer and Shipp 1994; Minton and Heath 1998).

Because this is probably the largest unified artificial reef site in the United States, and possibly in the world, it lends itself well to this discussion. During the decade of the 1970s, before establishment of the 4000 km²⁺ reef area, we conducted a series of trawling surveys on this portion of the shelf. The study, designated SAMERI (South Alabama Marine Environmental Resource Investigation) included nearly 100 trawl samples, of 15-min tow time, with a 30-foot semi balloon trawl, at 15 fathoms. The sampling was conducted over 3 years. Although the detailed seasonal and spatial variation and species composition are beyond the scope of this commentary, the fish faunal elements were dominated by relatively diminutive soft bottom species, reflecting the near total lack of hard bottom in the area. The few reef species collected were juveniles or subadults (e.g., red snapper, *Lutjanus campechanus*).

The trawled species are almost exclusively of no current economic importance. The dominant groups are flounders and other flatfishes, cusk-eels, sea robins, and small species of sea basses. The flounder species all mature at very small sizes (maximum of 200 mm) and are not exploited. The cusk-eels are a dominant faunal component, primarily fossorial diurnally, but are important prey species when they forage nocturnally. The other species are also too small to have any commercial value other than as minor components of the ground fish harvest. All of these species have extensive ranges over the entire Gulf of Mexico shelf, and many also on the United States Atlantic coast, thus are in no danger of any imaginable substantial stock depletion.

This trawled bottom now is contained mostly within the heart of the reef permit area. Approximately 20,000 artificial structures have been placed there, constructed of various materials (Minton and Heath 1998). Included are 100 decommissioned army tanks, cement bridge rubble resulting from hurricane damage, thousands of buses and automobiles, prefabricated cement modules, and a variety of other structures. Early in the program, little restraint was placed on materials for reef deployment, and thousands of reef sites have been removed or destroyed by hurricanes and other natural events. Nevertheless, because of recent more stringent regulations on reef materials, many thousand likely remain.

When reef structure is placed in these areas, the reef biota is in sharp contrast to the preexisting fauna. Previous to the reef building effort, few reef fishes were taken off the Alabama shelf (Minton and Heath 1998). Although historically Mobile was considered a major market for red snapper, these fish were harvested primarily from Pensacola southeastward to Tampa (McEachran and Fechhelm 1998) or from the Campeche Banks off Mexico (Albert King, pers. comm.). But Schirripa (1998) reported that recently more than a third of recreationally caught red snapper from the Gulf of Mexico

came from off Alabama, although this area represents less than 5% of the U.S. Gulf shelf. Similar statistics are provided by the 1993-96 Southeast Area Monitoring and Assessment Program (SEAMAP). Thus, the ichthyofauna of a quarter of a century ago has been transformed from an economically depauperate biomass to one supporting an industry, which, according to Minton and Heath (1998), is valued at 60 million dollars annually. Has the total biomass increased? We don't know. Does it matter in terms of management decisions? I think the citizens of Alabama's coastal communities would offer a strong negative.

RESEARCH NEEDS

Other questions are relevant, even if those regarding absolute biomass changes are not. If, in fact, there is some dependence on surrounding forage species for the reef residents, this would eventually become limiting to the carrying capacity of the reefs. Bioenergetic studies to address carrying capacity are strongly warranted and, in fact, are currently under way in the Alabama setting (James Cowan, pers. comm.). Likewise, if these large areas do approach maximum carrying capacity, or if these micro population concentrations centers are disturbed or even destroyed, do the reef residents move to nearby or even more distant sites, thus becoming de facto emigration resources for other areas? This latter question was partially answered by Watterson et al. (1998) for the Alabama stocks. Their data strongly indicated hurricane impacts on the reef structures off Alabama resulted in near unidirectional migration of red snappers eastward, with many tagged fish from Alabama taken off the Florida panhandle as far east as Apalachee Bay.

ARTIFICIAL REEFS AS MARINE SANCTUARIES

The issue of marine reserves or marine protected areas (MPAs) is emerging rapidly as a possible management tool for marine fish stocks. Several papers have addressed this issue recently (Bohnsack 1994, 1998). The South Atlantic Fishery Management Council is considering creating reserves in habitat not currently used by fishers. Such a decision seems well founded on the basis of the Alabama experience. And the success of such an action is not likely to depend on whether artificial reefs attract fish or actually produce biomass.

SUMMARY

The production-attraction debate has become central to much of the discussion of the utility of artificial reefs as management tools. This debate seems to have little relevance in areas where natural hard bottom is sparse or lacking. Rather, in these areas, biomass transformation from "less valuable" to "more valuable" species is indicated. Nevertheless, in my experience, the preeminence of the production-attraction issue has often clouded the issue and reflected negatively on artificial reef benefits. Care should be taken that this debate be clearly reserved for habitats where additional hard bottom may be of little or no value because of recruitment limitations.

REFERENCES

- Bohnsack, J.A. 1989. Are high densities of fishes at artificial reefs the result of habitat limitation or behavioral preference? *Bull. Mar. Sci.* 44:631-645.

- Bohnsack, J.A. 1994. How marine fishery reserves can improve reef fisheries. In: Proceedings of the 43rd Gulf and Caribbean Fisheries Institute 43:217-241.
- Bohnsack, J.A. 1998. Application of marine reserves to reef fish management. *Aust. J. Ecol.* 23:298-304.
- Bohnsack, J.A., A. Ecklund, and A. M. Szmant. 1997. Artificial reef research: is there more than the attraction-production issue? *Fisheries* 22:14-16.
- Bortone, S.A. 1998. Artificial reef management perspective – resolving the attraction-production dilemma in artificial reef research: some yeas and nays. *Fisheries* 22:6-10.
- Carter, J.W., A.L., Carpenter, M. S. Foster, and W. N. Jessee. 1985. Benthic succession on an artificial reef designed to support a kelp-reef community. *Bull. Mar. Sci.* 37:86-113.
- Grossman, G.D., G.P. Jones, and W. Seaman. JR. 1997. Do artificial reefs increase regional fish production? A review of existing data. *Fisheries* 22:17-23.
- Lindberg, W.J. 1997. Can science resolve the attraction-production issue? *Fisheries* 22:10-13.
- McEachran, J.D., and J.D. Fechhelm. 1998. *Fishes of the Gulf of Mexico*. Vol. Univ. Texas Press, Austin.
- Minton, V., and S.R. Heath. 1998. Alabama's artificial reef program: building oases in the desert. *Gulf Mex. Sci.* 16:105-106.
- Pamintuan, I.S., P.M. Alino, E.D. Gomez, and R.N. Rollon. 1994. Early successional patterns of invertebrates in artificial reefs established at clear and silty areas in Bolinao, Pangasinan, northern Philippines. *Bull. Mar. Sci.* 55:867-877.
- Schirripa, M.J. 1998. Status of the red snapper in U.S. waters of the Gulf of Mexico: updated through 1997. NOAA/NMFS Sustainable Fisheries Division Contribution, SFD-97/1911181-30:15-18.
- Stone, R.B., H.L. Pratt, R.O. Parker, and G.E. Davis. 1979. A comparison of fish populations on an artificial and natural reefs in the Florida Keys. *Mar. Fish. Rev.* 41:1-11.
- Szedlmayer, S.T., and R.L. Shipp. 1994. Movement and growth of red snapper, *Lutjanus campechanus*, in the north central Gulf of Mexico: potential effects of hurricanes. *Gulf Mex. Sci.* 16:92-104.

ARTIFICIAL REEFS: HABITAT FOR MARINE RESOURCES-NATIONAL POLICY?

Ronald R. Lukens
Gulf States Marine Fisheries Commission

THE NATIONAL FISHING ENHANCEMENT ACT AND PLAN IMPLEMENTATION

The National Fishing Enhancement Act of 1984 (Act) established artificial reef development as a national priority. In doing so, it made a case for the positive benefits from creating habitat for fisheries and established a number of broad guiding principles that are expected to positively impact the way in which artificial reefs are developed. The Act directed the U.S. Army Corps of Engineers (COE) to institute a permitting and regulatory framework within which artificial reefs would be developed. In addition, the Act mandated that the National Marine Fisheries Service (NMFS) develop the *National Artificial Reef Plan* (1985) (Plan), intended to establish national standards and provide broad national guidance for creating regional and state plans for artificial reef development. Implementation of the Act and the Plan resulted in a permit and regulatory program under the COE dredge and fill program. The sole authority provided to the NMFS was development of the Plan, which was completed one year after enactment of the Act in 1985. True implementation, however, occurred at the state level, evidenced by the magnitude of artificial reef development activity undertaken by state programs over the last 16 years, including development of state artificial reef plans.

IMPETUS FOR NATIONAL PLAN REVISION

Why should the Plan be revised? The Plan itself calls for periodic revisions, recognizing that progress, including plan development, research, and data collection, would reveal new and better ways to conduct programs. Such progress has been evident through the variety and frequency of research and policy publications, periodic international conferences, and regional and local meetings dealing with all aspects of artificial reef development and management. In addition, since the mid 1980s, the Gulf and Atlantic States Marine Fisheries Commissions have been providing a regional forum for state artificial reef programs to come together to work on regional and national scope issues. Finally, the recognition that artificial reefs are tools for fisheries management has contributed to the need to re-evaluate our current national guidance and policies for artificial reefs.

The combination of these and other factors led the Gulf, Atlantic, and Pacific States Marine Fisheries Commissions to request from the NMFS in 1996 that the states, through the Commissions, be given the responsibility to take the lead in revising the Plan. In December 1996, the NMFS agreed, and by letter encouraged the states to begin revising the Plan. Through a series of meetings, some sponsored by the NMFS and some sponsored by the Commissions, the revision was completed in December 1998. Soon thereafter, the three Interstate Marine Fisheries Commissions submitted the document to the NMFS for consideration to replace the 1985 Plan and establish new national policy on artificial reef development and management. In addition, the three Interstate Marine Fisheries Commissions adopted the document as interstate policy, entitling the document *Coastal Artificial Reef Planning Guide (1998)*.

REVISED NATIONAL PLAN

During the process of revising the Plan, the states and commissions recognized the high quality of the work done by the original plan writers, such that much of the original Plan is embodied in the revision. Of significance, the National Standards were established by the Act and continue as the broad principles under which all other policies and recommendations are established. Those National Standards are as follow:

- enhance fishery resources to the maximum extent practicable;
- facilitate access and utilization by US recreational and commercial fishermen;
- minimize conflicts among competing uses of waters covered under this title and the resources in such waters;
- minimize environmental risks and risks to personal health and property; and
- be consistent with generally accepted principles of international law and not create any unreasonable obstruction to navigation.

While the first National Standard admonishes us to “enhance fishery resources,” the primary focus of artificial reef programs over the past 16 years, and prior, has been enhancing fishing success through the creation of known locations where fish would be accessible. The revision places a greater emphasis on the habitat implications of artificial reef development. It should be noted that the revision does not diminish enhancement of fishing success as an important goal of artificial reef development, but rather elevates the importance of the habitat implications.

The original plan established four criteria that should be considered when determining the kinds of materials that should be used in artificial reef development. Those criteria include the following:

1. function-effective habitat for marine organisms;
2. compatibility-compatible with the marine environment;
3. durability and stability- materials should be able to withstand the marine environment for a desired length of time and remain stable on the bottom where placed; and
4. availability-readily available for use.

These criteria were deemed generally to be applicable, with the exception of “availability.” While it is important that materials be readily available for use by artificial reef programs, it is inaccurate to think of availability as a criteria for consideration of using a material, since if it is not available, it will not be used. The revision has deleted “availability” as a criterion, while continuing to recognize the importance of availability of suitable materials. In addition, the revision splits “durability” and “stability,” because it was determined that, while the two are associated, they are significantly different and should be treated separately. For example, a material can be quite durable and be inherently unstable in salt water, such as an automobile tire. Conversely, it is possible for a material to lack durability and yet be relatively stable.

As described above, materials used to create artificial reefs constitute an important programmatic issue. In recent years, the issue of materials selection has also become quite controversial. Many have heard the criticisms that artificial reef programs are nothing more than waste disposal

programs. Years ago, that criticism had a kernel of truth in it; however, more recently state programs have strived to move to materials that follow the established criteria. The original Plan went to great lengths to identify selected materials and describe their attributes. Today, the variety of materials has increased to the point that it would be unwieldy to continue to address them all within the text of the Plan. As a result, the revision incorporates, by reference, the document entitled *Guidelines for Marine Artificial Reef Materials (1997)*, developed by the Gulf and Atlantic States Marine Fisheries Commissions. That document is currently under revision.

One of the most important issues addressed in the revision is qualifications for holding an artificial reef permit. Currently, under the COE permitting program, any citizen of the United States can request and receive an artificial reef permit by following established procedures and showing proof of liability coverage. Unfortunately, the liability criterion has not been applied in most cases; consequently, individuals with no capability to withstand a liability suit have been granted permits. In addition, a fishing organization may be able to qualify, but could easily disband well before the life expectancy of the reef they build has run its course. Who then is liable? This issue has not been addressed. The revision recommends that the COE issue permits only to the state agency with responsibility to manage marine resources. The drafters consider this appropriate because the state agency 1) is legislatively authorized to exercise stewardship responsibility over marine resources, 2) can ensure compatibility with fishery management planning, and 3) can assume liability for the life of the artificial reef. The language in the Act does not allow the COE to make this a requirement; however, its appearance in the revision elevates it as an important issue that the COE should consider and identifies it as an issue that should be addressed in any future amendments of the Act.

Mitigation has continued to be an issue that involves artificial reef development. Many cases have emerged in which artificial reefs have been proposed as a way to mitigate for the destruction of dissimilar habitats. The revision attempts to put in perspective the position of the states in this regard, stating that if mitigation is to be considered necessary, it should be in kind/in place. The revision recognizes that this cannot always be done; consequently, the revision strongly recommends caution when applying artificial reefs as mitigation. For example, an offshore, high salinity artificial reef should not be acceptable as mitigation for the loss of estuarine marsh.

The revision recommends that the COE require project objectives as a part of the permitting process. All artificial reef projects should have well defined objectives that are consistent with fishery management objectives. In addition, in order to determine if projects are successful in meeting stated objectives, baseline evaluation and monitoring should be conducted, with follow-up evaluation and monitoring to assess the change brought about by the project. The revision recognized the importance of specifying compliance monitoring and performance monitoring, as found in the original Plan. Compliance monitoring is required to assure that program activities do not significantly vary from permit requirements. Performance monitoring, while not required by most permits, is equally important in determining whether stated objectives are being met, and equally importantly to assess the overall impact of artificial reef development.

The revision emphasizes the importance of recognizing that artificial reefs should be fishery management tools. Artificial reefs can be used to restore damaged habitats or can be used to enhance habitats for selected species. There have been many discussions recently about using artificial reefs

to establish sanctuaries, or marine protected areas, as a way of addressing the criticism that establishing a no-take area penalizes the citizenry by taking away reef areas historically open to commercial and recreational fishing. In addition, we have many examples of using artificial reefs as special management areas in which effort control and spatial and use conflict management measures can be applied.

As mentioned above the draft Plan revision was submitted to the NMFS in late 1998. The draft has undergone internal review by NMFS, and has been reviewed by the relevant federal agencies. Currently, NOAA General Counsel is holding approval of the document until the new administration has had an opportunity to evaluate its impact on federal fisheries policy. The next step is to publish the document in the *Federal Register* and get public comment. It is not known when this might take place.

REFERENCES

- Atlantic, Gulf, and Pacific States Marine Fisheries Commissions. 1998. Coastal Artificial Reef Planning Guide. Gulf States Marine Fisheries Commission, P.O. Box 726, Ocean Springs, Mississippi 39566-0726. 45pp.
- Gulf States Marine Fisheries Commission. 1997. Guidelines for Marine Artificial Reef Materials. Gulf States Marine Fisheries Commission, P.O. Box 726, Ocean Springs, Mississippi 39566-0726. 118pp.
- Stone, Richard B. 1985. National Artificial Reef Plan. NOAA Technical Memorandum NMFS OF-6. USDOC, NOAA, NMFS. 39pp. + appendices.

REEF FISH RESOURCES AND GAS PIPELINES ON THE WEST FLORIDA SHELF: POTENTIAL CONFLICTS

Christopher C. Koenig
Felicia C. Coleman
Institute for Fishery Resource Ecology
Department of Biological Science
Florida State University

Kathryn M. Scanlon
U.S. Geological Survey

ABSTRACT

Marine protected areas (MPAs) placed appropriately provide promising options for the management of exploited populations by protecting critical habitat, community structure and function, and spawning populations. They also provide the unique opportunity to experimentally evaluate the effects of anthropogenic impacts (particularly fishing) on the biotic and physical components of ecosystems. Recently (19 June 2000), the Gulf of Mexico Fishery Management Council established two MPAs in the northeastern Gulf of Mexico (GOM). The impetus for establishing these reserves was strong evidence of fishing-induced changes in the demographics (especially changes in sex ratio) of several economically important reef fish species. Herein, we discuss proposed construction of two gas pipelines that would run through both MPAs. We are particularly concerned about the effects of construction on essential fish habitat (EFH) both within and outside of the reserves. The pipeline contractors must accurately show the degree of impact from construction activities. We suggest that the ecological impact study provided by one of the pipeline construction companies has not adequately shown this impact. Further, we find that in both cases, pipeline construction would destroy critical habitat, compromise the ecological structure and function of resident biotic communities, and undermine an otherwise unique opportunity to evaluate fishing effects on shelf-edge reef fish populations.

We recommend that the pipelines be rerouted to areas outside of the reserves, and that particular attention be paid to avoid live-bottom and high-relief habitat to the extent possible. We recommend that new environmental impact studies be done to provide more realistic profiles of habitat. Further, we suggest that a team of scientists develop for the Federal Energy Regulatory Commission (FERC) and the Mineral Management Service (MMS) a standardized format for conducting such studies so that valid comparisons can be made among different projects and different areas.

INTRODUCTION

Concern over extreme demographic changes in gag (*Mycteroperca microlepis*) populations of the southeastern United States—including declines in the proportion of males, declines in the size and age structure of spawning groups (Coleman *et al.* 1996, McGovern *et al.* 1998), and the apparent occurrence of inbreeding (Chapman *et al.* 1999)—prompted the Gulf of Mexico Fishery

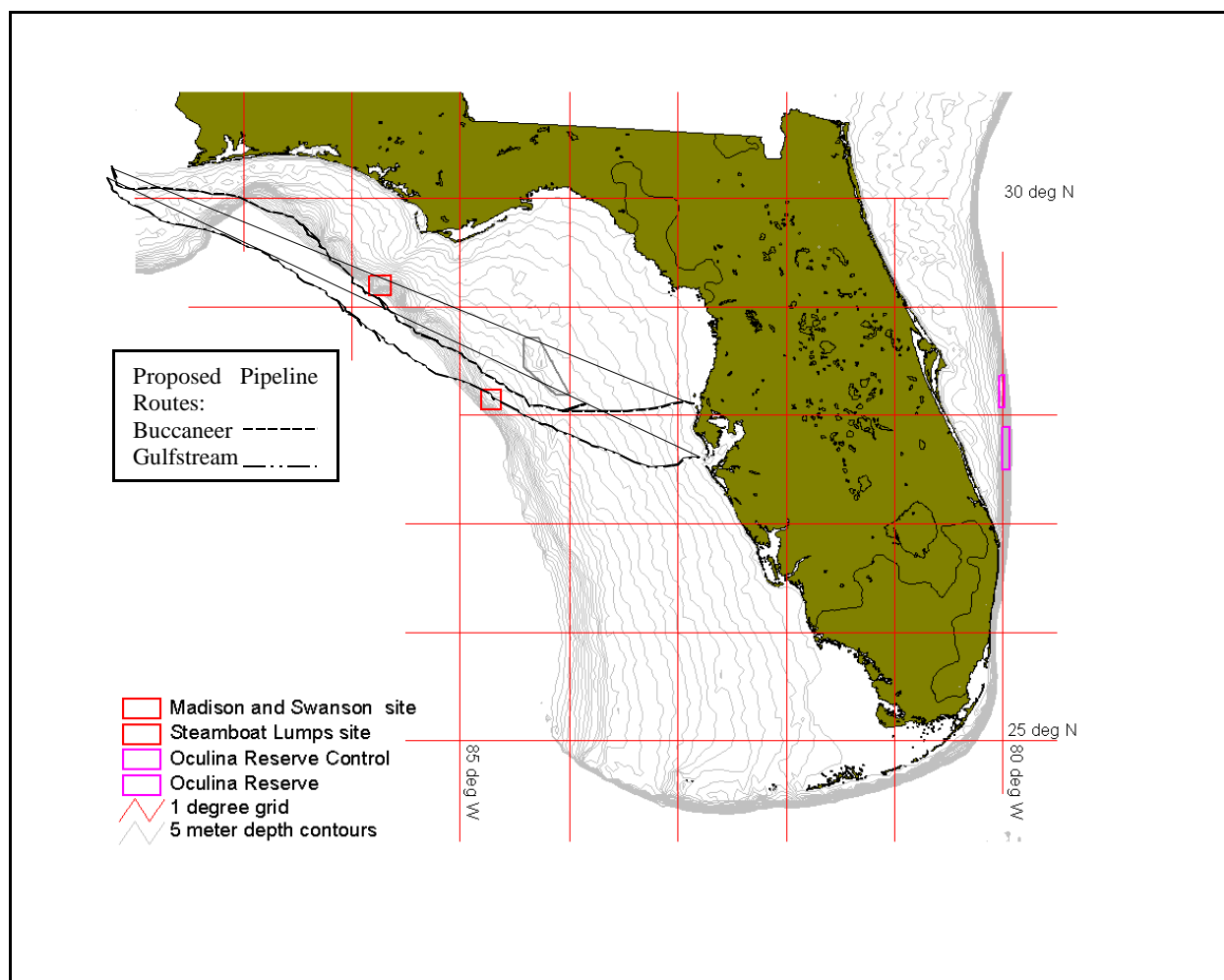

Figure 4.1. Map of Florida and shelf waters showing the location of Madison-Swanson, Steamboat Lumps, and Oculina MPAs and the proposed routes for Buccaneer and Gulfstream gas pipelines.

Management Council to recommend closing portions of the west Florida shelf edge (50-120 m depths) to fishing. On 19 June 2000, the National Marine Fisheries Service officially established two marine protected areas (MPAs) in gag spawning habitat, known as the Madison-Swanson MPA and the Steamboat Lumps MPA (Figure 4.1). The two areas combined cover over 200 nm² and will remain closed for a period of four years.

Studies within the newly-formed Madison-Swanson and Steamboat Lumps MPAs and associated control sites are already underway by scientists at a number of different state, federal, and academic institutions. These studies include side-scan sonar and multibeam mapping, ROV (remotely operated vehicle) video transect work, and studies of the community and behavioral ecology of resident populations. Because the whole intent of MPAs is to exclude as many confounding anthropogenic effects as possible, the reserve and control sites are being monitored to evaluate recovery from fishing effects.

Gas pipelines proposed to transit the northeastern GOM from Mobile Bay, Alabama, to near Tarpon Springs, Florida, could cross both MPAs. We reviewed the draft environmental impact statements that describe the potential effects of construction on Outer Continental Shelf (OCS) habitat. We were particularly interested in the extent to which construction could disrupt the integrity of critical shelf-edge habitat and the evaluation of fishing effects in these regions. We first describe the pipeline construction process, as outlined by the construction companies—Buccaneer Gas Pipeline Company and Gulfstream Natural Gas System—and then critique those portions of the Draft Environmental Impact Statements (DEIS) provided by each company’s subcontracting firm, Continental Shelf Associates (CSA) for Buccaneer, and Sea Byte, Inc., for Gulfstream. The intent of this paper is to provide recommendations to these companies and to future oil and gas construction projects on the OCS.

SHELF-EDGE REEF FISH POPULATIONS: A BRIEF REVIEW

Most of the economically-important reef fish species of the southeastern United States are overfished (Coleman *et al.* 2000). Many of them are protogynous hermaphrodites—fish that change sex from female to male—and a great many of them co-occur in shelf-edge habitat (Koenig *et al.* 2000). Among the factors hindering effective management of these species are poor catch records, poor collective memories of the historical state of fished populations, inadequate records of the unfished condition (Jackson 1997), and a lack of political will to implement appropriate management practices.

The reductionist approach of single-species management compounds this problem because it typically limits inquiry to the population dynamics of one stage in the life cycle of an exploited species (the adults). It rarely considers other stages (larvae, juveniles, subadults) that are equally important to population persistence and ignores the fact that exploited species form part of a complex interacting ecosystem.

The Magnuson-Stevens Fishery Management and Conservation Act of 1996 (NMFS 1996) provided for substantive changes to this approach by suggesting that EFH and ecosystem-level processes are important components of effective fisheries management. Admittedly, the definition of EFH is broad—defined in the act as “those waters and substrate necessary to fishes for spawning, breeding, feeding, or growth to maturity” (NMFS 1996). But the mandate is clear that EFH *must* be protected and that potentially adverse effects on EFH from fishing and non-fishing activities (which would include pipeline construction or other oil and gas-related activities) *must* give way to actions that encourage habitat conservation.

One important step toward management in the framework of ecological realities is the use of MPAs (NMFS 1999, NRC 2000, Bulletin of Marine Science 2000). MPAs not only provide the opportunity to observe reef fish population parameters and community structure in an unfished state, but they also provide opportunities to experimentally evaluate the effects of fishing on specific behaviors, demographics, ecological interactions, and habitat. For example, an MPA allows evaluating the extent to which fishing that targets gag spawning aggregations selects for males and disrupts the sex change process.

Of particular interest in the GOM are the shelf-edge (50 – 120 m depth) reefs of west Florida, reefs that have been fished for over 100 years (Camber 1955). As important as these areas are, neither the direct nor the indirect effects of fishing on habitat or the associated reef communities have been evaluated. Direct effects of fishing, in addition to removal of targeted species, include mechanical damage to habitat due to mobile fishing gear, trapping, and anchoring. Indirect effects include trophic cascades resulting from the removal of top-level predators (Hughes 1984, Hughes *et al.* 1987) and potential habitat loss resulting from removal of species that act as geologic agents (Scanlon *et al. in review*, Coleman and Williams *in review*). One need look no further than the EORR (Experimental Oculina Research Reserve) MPA off central east Florida (Figure 4.1) for an example of extensive fishing-induced habitat destruction and the effects on benthic communities (Koenig *et al.* 2000).

Gag spawning aggregations occur in these shelf-edge regions from the eastern GOM to North Carolina (Koenig *et al.* 1996, McGovern *et al.* 1998, Koenig *et al.* 2000). Yet, the area in the northeastern Gulf between latitudes 28^o and 29^o 30' N at depths ranging from 50 to 120 m is considered both the gag population center of abundance and the heart of the commercial fishery (Schirripa *et al.* 1999). Many other economically important reef fish species also spawn in this region, including scamp (*Mycteroperca phenax*), red grouper (*Epinephelus morio*), gray snapper (*Lutjanus griseus*), red snapper (*Lutjanus campechanus*), vermilion snapper (*Lutjanus rhomboplites*), red porgy (*Pagrus pagrus*), and others (Coleman *et al.* 1996, Koenig *et al.* 2000). Thus, locating MPAs in this region is particularly important.

PROPOSED PIPELINES ON THE WEST FLORIDA SHELF

Buccaneer's proposed pipeline is approximately 411 miles long. It passes through roughly 200 miles of critical shelf-edge habitat (but see comments below), including some 12 miles in the southwest portion of the Madison-Swanson MPA. Gulfstream's proposed pipeline is approximately 420 miles long, crosses roughly 59 miles of shelf-edge habitat (~53 miles on the west Florida shelf edge and ~6 miles on the Alabama shelf-edge), 3.5 miles of which are in the northeast corner of the Steamboat Lumps MPA (Figure 4.1). The Buccaneer pipeline is in somewhat shallower water than the one proposed by Gulfstream.

Pipeline occurring at depths less than about 61 m must be buried in the substrate. This is an expensive process with destructive effects on habitat. Pipeline occurring at depths greater than 61 m is neither buried nor anchored to the bottom. However, this does not mean that construction is a low-impact process at those depths. In order for the 1.0 m diameter pipeline to maintain a smooth sigmoidal shape as it is laid from the barge to the seafloor, the barge must be secured in place by 12 anchors, eight forward of the barge and four aft. Each anchor measures about 5 x 6 m and weighs at least 13 tons. The anchors are distributed radially from the barge by cables 7.6 cm in diameter; the anchors and cables together cover a swath approximately one nautical mile wide. The barge progresses along the pipeline route by drawing in the fore anchor cables, letting out the aft anchor cables, and subsequently repositioning the anchors for another round. This action is repeated twice within each mile, such that there are 24 anchor strikes per mile.

The extent of the habitat damage caused by this process is related to the compounded effects of anchor-cable sweep (the extent to which anchor cables contact the bottom), anchor drag, and sea-state. The anchor-cable sweep is greatest near the anchors as the barge is drawn forward due to the considerable catenary in the cable line. When cables sweep the bottom, they act like trawls or dredges, but with far greater force, literally raking away all habitat structure. Anchor strikes affect less area than cable sweep, but an increased sea state will likely increase the damaging effects of both. Neither company has considered the effects of sea state.

Each company was responsible for conducting photo-video surveys along portions of the proposed route and then comparing those videos to geophysical data (side-scan sonar imagery and seismic reflection profiles) to determine the degree of relationship between the two. The MMS required that the photo documentation surveys be conducted at depths shallower than 100 meters, even though the proposed pipelines would cross habitat at greater depths. In the side-scan sonar data, dark, medium, and light areas correspond to the acoustic properties of the seafloor. For example, a hard rocky bottom would produce a dark image, and a soft-grained, sediment-covered bottom would produce a light image. However, other factors (e.g., small-scale roughness of the seafloor, angle of slope, and state of compaction of sediments) also affect the acoustic properties of the seafloor, and hence complicate the interpretation of the acoustic image produced.

CRITIQUE OF ESTIMATED IMPACTS TO SHELF-EDGE HABITAT.

Because we are most interested in the effects of construction on habitat important to reef fish, we confine our comments to estimates of hard-bottom (carbonate rock either exposed or covered by a thin veneer of sediment), and specifically “live-bottom” (hard-bottom with sessile epifauna) coverage made by Sea Byte, Inc., (for Gulfstream) and CSA (for Buccaneer).

The ground-truthing exercises conducted by Sea Byte at both shelf (15 – 50 m) and shelf-edge (50 – 100 m, the greatest depth required by MMS for habitat delineation) depths revealed: (1) that areas with light acoustic reflectivity had 15% live-bottom coverage, (2) that areas with moderate reflectivity had 21% live-bottom coverage, and (3) that areas with dark reflectivity had 53% live-bottom coverage. Although the percentage of live-bottom increased with the degree of reflectivity—that is, the lower the reflectivity, the lower the percentage of live-bottom—the relationship was a poor indicator of the presence of live-bottom. For instance, when similar studies were conducted inshore by Seabyte (1999), they found a high degree of correlation between dark reflectivity and the presence of live-bottom. This was not the case on the OCS. Based on that finding, Sea Byte decided that the geophysical data did not adequately represent the extent of live-bottom in the OCS. Thus, they relied upon a series of parallel photo-video transects made along the entire pipeline route (to 100 m depths), interpolating the extent of live-bottom between the transects. This approach provided nearly 100% coverage of the proposed impact area and gave more realistic estimates of live-bottom coverage.

The proposed route of the pipeline relative to shelf-edge habitat is ambiguous in the documents prepared for Buccaneer by CSA. In fact, the documents provide three different proposed pipeline paths relative to depth: one in which the pipeline appears to be shallower than the 100 meter isobath over all of its length (CSA 1999, 2000a), one in which it deeper than 100 m in several places (CSA

2000b), and yet a third in which the 300 ft. (91 m) isobath and the 100 m (328 ft.) isobath are indistinguishable (CSA 2000c). If the first route is correct, then the pipeline route covers about 200 miles in shelf-edge depths. If the second route is correct, then it covers about 100 miles. For purposes of discussion, we used the first map presented in the series for evaluation. This choice was completely arbitrary because the maps are so confusing.

Continental Shelf Associates, Inc., (Buccaneer) performed photo-video documentation surveys over 75 miles of the shallower pipeline route across the west Florida shelf (from shore to about 50 m depths). However, they only surveyed about 8% (15 of the nearly 200 miles) of the route through the more critical shelf-edge habitat, sampling only six sites, four of which were clustered in a 20-mile segment midway along that line and none of which were deeper than 100 m. Unlike Sea Byte, CSA found, as stated in their summary, an “exceptionally high degree of correlation” between the geophysical data and their photo-documentation of live-bottom (CSA 1999) and that the geophysical data, if anything, overestimated the amount of live-bottom (CSA 2000a).

This interpretation by CSA is in part due to their assumption that live-bottom only occurred in geophysically-determined hard-bottom habitat. However, closer examination of their maps shows that the correlation—much like that found by Sea Byte—is not particularly good for predicting how much live-bottom exists in an area. Live-bottom exists to some extent in all geophysically-determined zones. For instance, in one segment (plot 4 of segment 2 on shelf edge habitat in CSA 1999), live-bottom was found in video transects in “light” areas (not identified in the map legend, but presumably sediments ranging in texture from silty to fine or medium grained sand, based on the text), while very little live-bottom is found in “dark” areas,

We found interpreting CSA’s maps difficult because the terminology in the text and the maps was unclear. For instance, the self-contradictory phrase “carbonate (limestone) sediment” is used repeatedly. Limestone, by definition, is a rock, not a sediment. One can only guess what this term is meant to describe, because it is not defined in the map legend or in the text. Furthermore, the map legend contains a number of units (e.g., “exposed carbonate (limestone) sediment,” “sediment veneer over carbonate (limestone) sediment,” “sand covering carbonate (limestone) sediment with scattered outcrops,” “exposed carbonate (limestone) sediment with areas of outcrops and sand pockets,” and “scattered outcrops”) which appear to have considerable overlap, are ambiguous or contradictory, are contrary to common geological usage, and are never defined. As a result, these maps are of little use either for delineating or for quantifying benthic habitats.

Considering CSA’s inadequate photo coverage of the shelf-edge habitat and the apparently low concurrence between the geophysical patterns and their photo-documentation data, we consider that their report grossly underestimates the extent of shelf-edge live-bottom coverage. Although it is not unreasonable to quantify bivalve coverage and sessile invertebrates potentially impacted, it is more important to determine construction impacts to the actual habitat, regardless of the density (or bivalve coverage) of the individual benthic species. For example, CSA’s (2000c) quantitative survey states that about 8% of the construction route is live-bottom habitat, but that only 12.5% of that is covered by sessile invertebrates. They have interpreted this to mean that 1% (.08 x .125) of the live-bottom habitat would be destroyed. We caution that the emphasis should be placed on the areal coverage

of the habitat, and not on the areal coverage of the individual organisms. The latter leads to an erroneous perception that vastly underestimates the impact on habitat of pipeline construction.

DISCUSSION AND RECOMMENDATIONS

Considerable concern exists among scientists and conservationists about the rate of habitat loss worldwide. In fact, habitat loss is considered the primary reason for declines in biodiversity (Wilcove and Wilson 2000). The litany of agents responsible for the declines include water diversion projects, hydropower dams, agricultural practices, and urbanization. To these can be added habitat destruction caused by mobile fishing gears—trawls and dredges—which have devastated many low-relief live-bottom habitats (Dayton et al 1995, Auster *et al.* 1996, Watling and Norse 1998). There is strong interest in monitoring these effects and limiting them to the extent possible. Pipeline construction is just one more effect that should be closely evaluated. Such construction is not constrained in the same way that mobile fishing gear is because (1) it can affect areas typically inaccessible to trawls; and (2) it has the potential through sheer force of impact to cause far more damage to habitat, reducing high relief structure to rubble.

We are very concerned by the methods used to delimit habitat in the reports of proposed pipeline construction in the northeastern GOM. The reason that accurate estimates of different habitat types are so critical is that these numbers are used to evaluate the extent of damage caused by pipeline construction. For purposes of these studies, the MMS applied the “low-relief live-bottom stipulation,” which is that those applying for oil and gas leases conduct photo-documentation surveys of the sea floor within the project area only at depths of 100 m or less (Gulfstream 2000). The MMS considers live-bottom to be “seagrass communities or those areas which contain biological assemblages consisting of sessile invertebrates (such) as sea fans, sea whips, hydroids, anemones, ascidians, sponges, bryozoans, or corals living upon and attached to naturally-occurring hard or rocky formations with rough, broken, or smooth topography; or areas whose lithotope favors the accumulation of turtles, fishes, and other fauna.” No surveys are required in areas of greater depth.

We find the depth restriction of 100 m not only arbitrary, but exclusive of a number of important types of marine habitat. Of particular concern are exclusions of deep-water reef fish habitat and coral and sponge communities. For instance, important reef fish habitat exists at depths greater than 100 m, including essential habitat for tilefish *Lopholatilus chamaeleonticeps*, blueline tilefish *Caulolatilus microps*, Warsaw grouper *Epinephelus nigritus*, snowy grouper *E. niveatus*, speckled hind *E. drummondhayi*, and yellowedge grouper *E. flavolimbatus* (Parker and Mays 1998). All four of the groupers are considered at risk of extinction by the American Fisheries Society (Musick *et al.* 2000), and two of them—Warsaw grouper and speckled hind—are now considered threatened (Coleman *et al.* 2000), thus requiring special management attention. Extensive live-bottom (65% coverage) exists at depths of 120 to 160 m off the southwest Florida shelf (Phillips *et al.* 1990). Further, beds of the deep-water coral *Lophelia pertusa* (= *L. prolifera*) occur in water depths of 439 to 512 m some 40 miles east of the Mississippi delta. Similar banks off Norway and the Faeroe Islands, which support enormously diverse biota, have suffered tremendous losses (Roberts 1997). Although little is known of these habitats—or perhaps *because* so little is known—they should be quantified in estimates of habitat impacts from oil and gas construction projects. Thus, we

recommend that photo-documentation surveys include all depths at which any oil and gas activities are to occur.

The most significant source of habitat damage during pipeline construction is due to anchor cable sweep. Buccaneer (2000) estimated the damage to range from one to one-and-a-half acres per anchor strike, or about 24 to 36 acres per construction mile. Gulfstream (2000), on the other hand, estimated that habitat damage would be on the order of 114 acres per construction mile at depths ranging from 61 m (200 ft) to 100 m (328 ft). It would be much greater at shallower depths because the lower angle of the anchor cable causes more of it to touch the bottom. Thus, the two estimates of habitat damage due to cable sweep differ three- to nine-fold, depending on the construction depth. The estimated area of damage provided by Gulfstream is more realistic because it is based on engineering considerations (e.g., sweep features of each anchor cable and relationship to depth) and historical observations.

How could these companies, running parallel analyses along parallel routes, come to such disparate conclusions about the relationship between the geophysical data and photo ground-truthing, in estimating anchor-cable sweep damage, and in estimating habitat coverage? Further, why did both companies choose routes that went specifically through marine protected areas?

We found it difficult to make comparisons between the habitat quantification documents provided by the two pipeline construction companies because the methodologies used were not standardized. In fact, CSA did not even follow standard survey or statistical methodologies, making comparisons impossible in most cases. To avoid problems of interpretation, we recommend that a team of scientists develop standard methods and terminology for use by the FERC and the MMS. Subcontractors should also be required to provide statistically-sound error values in their estimates of areal habitat coverage.

It is unclear why both Buccaneer and Gulfstream chose pipeline routes that transit MPAs. They either were wholly unaware of the Gulf Council's July 1999 recommendation that these sites be set aside as MPAs or they categorically chose to ignore these boundaries. Regardless which of these scenarios is true, there is little doubt that significant damage in critical habitat would occur and experimental studies of reef fish reproductive behavior and the effects of fishing on habitat and ecosystem function would be compromised. If the boundaries of these MPAs are not respected a rare opportunity to evaluate fishing effects might be lost. Thus, we recommend that oil and gas construction projects hold MPAs as sacrosanct and avoid all anthropogenic disruption.

MPAs likely will form an important component of future fisheries management plans. To wit, on 26 May 2000, President Clinton signed an Executive Order calling for the expansion of the system of MPAs throughout the United States (Federal Register vol. 65, no. 105, pp. 34909-34911). The intent is to "(a) strengthen the management, protection, and conservation of existing marine protected areas and establish new or expanded MPAs; (b) develop a scientifically based, comprehensive national system of MPAs representing diverse U.S. marine ecosystems, and the nation's natural and cultural resources; (c) *avoid causing harm to MPAs through federally conducted, approved, or funded activities*" (italics ours). This Executive Order sets the tone for

future conservation of living marine resources. Our respect for these resources and the MPAs that contribute to their sustainability translates into a respect for future generations.

REFERENCES

- Auster, P.J., R.J. Malatesta, R.W. Langton, L. Watling, P.C. Valentine, C.L.S. Donaldson, E.W. Langton, A.N. Shepard, I.G. Babb. 1996. The impacts of mobile fishing gear on seafloor habitats in the Gulf of Maine (northwest Atlantic): implications for conservation of fish populations. *Rev. Fish. Sci.* 4:185-202.
- Buccaneer Gas Pipeline Company. 2000. Buccaneer gas pipeline project draft environmental impact statement. FERC Docket No. CP 00-14-000. FERC/EIS-0130D.
- Bulletin of Marine Science. 2000. Proceedings of the Second William R. and Lenore Mote International Symposium in Fisheries Ecology, November 4-6, 1998, Sarasota, Florida. Volume 66, Number 3.
- Camber, C.I. 1955. A survey of the red snapper fishery of the Gulf of Mexico, with special reference to the Campeche Banks. State of FL. Brd. Conserv. Tech. Series No.12, 64 pp.
- Chapman, R.W., G.R. Sedberry, C.C. Koenig and B.M. Eleby. 1999. Stock identification of gag, *Mycteroperca microlepis*, along the southeast coast of the United States. *Mar. Biotechnol.* 1: 137-146.
- Coleman, F.C., C.C. Koenig, and L. A. Collins. 1996. Reproductive styles of shallow-water grouper (Pisces: Serranidae) in the eastern Gulf of Mexico and the consequences of fishing spawning aggregations. *Environmental Biology of Fishes* 47:129-141.
- Coleman, F.C., C.C. Koenig, A.M. Eklund, and C. Grimes. 1999. Management and Conservation of Temperate Reef Fishes in the Grouper-Snapper Complex of the Southeastern United States. pp. 233-242. *In* Life in the Slow Lane, J.A. Musick ed, American Fisheries Society. Symposium 23.
- Coleman, F.C., C.C. Koenig, G.R. Huntsman, J.A. Musick, A.M. Eklund, J.C. McGovern, R.W. Chapman, G.R. Sedberry, and C.B. Grimes. 2000. Long-lived reef fishes: the grouper-snapper complex (American Fisheries Policy Statement). *Fisheries* 25(3):14-21.
- Coleman, F.C., and S. Williams (*in review*). Trends in Evolution and Ecology.
- Continental Shelf Associates. 1999. Results of comparison between Geophysical hazards survey results and photodocumentation groundtruthing. Report to Williams Gas pipelines.
- Continental Shelf Associates. 2000a. Comparison of Photodocumentation Survey and geophysical survey data from segments of the proposed Buccaneer gas pipeline route off the west coast of Florida. Report to Williams Gas Pipeline.

- Continental Shelf Associates. 2000b. Qualitative assessment of benthic communities and habitats along representative segments of the proposed Buccaneer pipeline corridor. Report to Williams Gas Pipeline.
- Continental Shelf Associates. 2000c. Quantitative characterization and assessment of hard bottom communities and habitat along the proposed Buccaneer pipeline corridor with estimates of potential impact from pipeline construction. Report to Williams Gas Pipeline.
- Dayton, P. K., S. F. Thrush, M. T. Agardy, and R. J. Hofman. 1995. Environmental effects of marine fishing. *Aquatic Conservation: Marine and Freshwater Ecosystems*. 5: 1-28.
- Gulfstream Natural Gas System LLC. 2000. Benthic Habitat Survey, federal waters of the OCS. FERC Docket No. CP00-6-00.
- Hughes, T.P. 1984. Catastrophies, phase shifts, and large scale degradation of Caribbean coral reefs. *Science* 265:1547-1551.
- Hughes, T.P., D.C. Reed, M.J. Boyle. 1987. Herbivory on coral reefs: community structure following mass mortality of sea urchins. *J. Exp. Mar. Biol.* 113:39-59.
- Jackson, J.B.C. Reefs since Columbus. 1997. *Coral Reefs*. 16. Suppl.: S23-S32.
- Koenig, C. C., F. C. Coleman, L. A. Collins, Y. Sadovy, and P. L. Colin. 1996. Reproduction in gag, *Mycteroperca microlepis*, in the eastern Gulf of Mexico and the consequences of fishing spawning groups. Pages 307-323. *In* F. Arreguin-Sanchez, J. L. Munro, M. C. Balgos and D. Pauly, eds. *Biology, fisheries and culture of tropical groupers and snappers*. ICLARM (International Center for Living Aquatic Resources Management) Conference Proceedings 48.
- Koenig, C.C., F.C. Coleman, C.B. Grimes, G.R. Fitzhugh, K.M. Scanlon, C.T. Gledhill and M. Grace. 2000. Protection of fish spawning habitat for the conservation of warm-temperate reef-fish fisheries of shelf-edge reefs of Florida. *Bull. Mar. Sci.* 66(3):593-616.
- McGovern, J. C., D. M. Wyanski, O. Pashuk, C. S. Manooch, III, and G. R. Sedberry. 1998. Changes in the sex ratio and size at maturity of gag, *Mycteroperca microlepis*, from the Atlantic Coast of the southeastern United States during 1976-1995. *Fishery Bulletin* 96:797-807.
- Moore, D.R. and H. R. Bullis, Jr. 1960. A deep-water coral reef in the Gulf of Mexico. *Bull. Mar. Sci. of the Gulf and Caribbean*. 10(1):125-128.
- Musick, J. A., M. M. Harbin, S. A. Berkeley, G. H. Burgess, A. M. Eklund, L. Findley, R. G. Gilmore, J. T. Golden, D. S. Ha, G. R. Huntsman, J. C. McGovern, S. J. Parker, S. G. Poss, E. Sala, T. W. Schmidt, G. R. Sedberry, H. Weeks and S. G., Wright. 2000. Marine, estuarine, and diadromous fish stocks at risk of extinction in North America (exclusive of Pacific Salmonids). *Fisheries*. 25(11):6-30.

- NMFS. 1996. The Magnuson-Stevens Fishery Conservation and Management Act. United States Department of Commerce, National Oceanic and Atmospheric Administration, NMFS, Technical Memorandum NMFS-F/SPO-23.
- NMFS. 1999. Ecosystem-based fishery management: a report to Congress by the Ecosystem Principles Advisory Panel. U. S. Department of Commerce, National Oceanic and Atmospheric Administration, National Marine Fisheries Service.
- NRC. 2000. Marine protected areas: tools for sustaining ocean ecosystems. Ocean Studies Board. National Academy Press, Washington DC
- Parker, R.O., Jr. and R.W. Mays. 1998. Southeastern U.S. deepwater reef fish assemblages, habitat characteristics, catches, and life history summaries. U.S. Dep. Commer. NOAA Tech. Rep. NMFS 138, 41p.
- Phillips, N.W., D.A. Gettleton, and K.D. Spring. 1990. Benthic biological studies of the southwest Florida shelf. *Amer. Zool.* 30:65-75.
- Roberts, M. 1997. Coral in deep water. *New. Sci.* 155(2100):40-43.
- Scanlon, K.M., C.C. Koenig, F.C. Coleman, M.W. Miller (*in review*, this issue). Importance of geology to fisheries management: examples from the northeastern Gulf of Mexico. MMS meeting, New Orleans, Oct. 2000.
- Schirripa, M.J., C.M. Legault, and M. Ortiz. 1999. The red grouper fishery of the Gulf of Mexico: Assessment 3.0. Report to the Gulf of Mexico Fisheries Management Council.
- Sea Byte, Inc. 1999. Gulfstream Natural Gas Pipeline, Benthic Habitat Survey, Florida State Waters. Prepared for ENSR, Tallahassee, FL. 48 pp.
- Watling, L. and E. A. Norse. 1998. Disturbance of the seabed by mobile trawling gear: a comparison to forest clearcutting. *Conservation Biology* 12(6):1180-1197.
- Wilcove, D. S., and E. O Wilson. 2000. *The Condor's Shadow: The Loss and Recovery of Wildlife in America*. Bantam Doubleday Dell Publishing, New York.

THE ROLE OF FISHERMEN AND OTHER STAKEHOLDERS IN THE NORTH SEA RIGS-TO-REEFS DEBATE

Mark Baine
Jon Side
International Centre for Island Technology
Heriot-Watt University
Orkney Islands, Scotland

ABSTRACT

The North Sea rigs-to-reefs debate has moved forward with the creation of a multi-stakeholder steering group to oversee development of independent research. Given the sharp division in stakeholder opinion, this group represents a proactive approach to assessing the potential for the formation of reefs using redundant oil and gas platforms. This paper examines the historical approach to the concept adopted by major North Sea stakeholders against a background of political landmarks including the 1995 Brent Spar incident. It examines in detail the reaction of fishermen to calls for offshore and nearshore reefs, noting in particular the importance of liability, loss of access, and safety concerns. The fishing industry remains neutral about the benefits of inshore reefs; the industry remains, however, committed in opposition to offshore reef creation, especially when combined with a no fishing policy. The environmental group Greenpeace is opposed to any rigs-to-reefs initiative, seeing this as a means by which offshore operators can circumvent the OSPAR Decision 98/3, which requires complete removal of offshore installations. The importance of cost and the existence of willing reef beneficiaries are highlighted as important to the acceptance and success of a nearshore rigs-to-reefs venture. Offshore reef creation faces numerous political hurdles. The importance of a genuine stakeholder dialogue to integrate scientific and political thinking and avoid the recurrence of an event similar to the Brent Spar, is stressed, the paper concluding that fishermen hold the key to the success of rigs-to-reefs ventures in the North Sea, their co-operation and participation essential in the promotion of a concept that has for so long been promoted to them.

INTRODUCTION

The potential for the 'rigs-to-reefs' concept to be implemented in the North Sea has always been a source of contention between scientific, environmental, fishing and offshore sectors. In the wake of the Brent Spar incident, the concept has come under increasing scrutiny from all stakeholders. The investigative effort has not been a proactive one amid the more general debate on North Sea abandonment and sea disposal, but instead a reactionary link among all stakeholders on an issue that has not been thoroughly evaluated and that is shrouded in suspicion and mistrust.

This concept's applicability in a North Sea context has been subject to scientific appraisal and speculation over the past two decades (ICIT 1991; Picken 1992; Side 1992; Aabel *et al.* 1997; Baine 1995, 1998; Soldal *et al.* 1999) showing that fish are attracted to platforms, although only with cautiously mooted biomass estimates (ICIT 1991; Soldal *et al.* 1999; Picken *et al.* 2000). Thorough programs of scientific research have been promoted to bridge the gaps in knowledge (Aabel *et al.*

1997); however, scientific research to date does not induce the confidence needed to justify the initiation of a rigs-to-reefs program (in any form) against a background of political scepticism.

Many of the social and political issues inherent in the North Sea rigs-to-reefs debate have been ignored or devalued, much to the dismay of fishermen who see these issues as important as and perhaps more crucial than any program of scientific research. The concerns of fishermen regarding any form of sea disposal of offshore platforms, for example, have been publicly stated since the early 1970s, yet these concerns are often ignored in contemporary limited scientific evaluation of a conceptual abandonment option. Indeed, such a concept if it were to proceed would have significant ramifications for fisheries and environmental management throughout the north-east Atlantic region.

This paper addresses the socio-political issues involved in the debate, concentrating on the relationship between Scottish fishermen (through the Scottish Fishermen's Federation [SFF]) and offshore operators. Information here is from direct contact with stakeholder representatives and output from working groups and workshops. This primary research is supplemented by the analysis of published literature on abandonment and environmental management, stakeholder policies and legislation. The paper ends with a discussion of the present status of the rigs-to-reefs debate in the North Sea.

FISHERMEN, OFFSHORE OPERATORS AND THE GOVERNMENT – A HISTORICAL PERSPECTIVE

With the emergence of petroleum activity in the North Sea in the early 1970s, it was recognized that fishermen would be inconvenienced. The government, however, assured the fishing industry that once the oil companies had completed their operations, all installations would be removed and the seas returned to the fishermen in the condition in which the oil industry had found them. The 1958 Geneva Convention on the Continental Shelf backed this assurance, and fishermen accepted it (Allan 1986, 1992, 1994).

As the years passed, however, the fishing industry looked on with mounting concern, as assurance of complete removal began to evaporate. The industry was informed that complete removal might not be possible for reasons including cost, the technical plausibility of complete removal operations, and the perceived uncertainty of future legislation regulating the abandonment of offshore oil and gas installations. In response, the fishing industry maintained its argument that promises had been made as to the complete removal of installations and that those promises should be kept.

The development of the International Maritime Organisation's 1989 Guidelines¹ and other international and UK legislation² gradually led to the general acceptance of toppling and partial removal

¹ Guidelines and Standards for the Removal of Offshore Installations and Structures on the Continental Shelf and in the Exclusive Economic Zone (developed in response to Article 60(3) of the 1982 United Nations Law of the Sea Convention).

² Oslo Commission Guidelines for the Disposal of Offshore Installations at Sea 1991, OSPAR Convention for the Protection of the Marine Environment of the Northeast Atlantic 1992, UK Petroleum Act 1987, UK Food and Environment Protection Act 1985.

as abandonment options. The fishing industry, while committed to complete removal, believed it had been forced into instigating a damage limitation exercise. Accordingly, the fishing industry proposed that it would press for six minimum safeguards (Allan 1994) in the event of a case-by-case approach to abandonment. In summary, these address the witnessing of removal operations by the fishing industry; debris clean-up operations; confirmation of debris clearance by side-scan and trawl operations; regular inspection of abandonment sites; establishment of a compensation fund by the government for loss of access to fishing grounds; and establishment of an additional compensation fund for specific gear losses/vessel damage caused by oil debris.

A shift in SFF policy on abandonment, however, occurred in 1994, the main determinant being the cost to the UK taxpayer of abandonment operations (ICIT 1994). This policy was developed before the Brent Spar incident and before the “Westhaven” tragedy. In the UK, the percentage of total abandonment costs borne by the state is estimated to be in the region of 50-70%. From available estimates of total costs of partial and complete removal of North Sea installations ICIT (1994) concludes that the government may be able to make savings in the region of £1.25-1.75 billion in tax revenue if partial removal is adopted as the main abandonment route. There is, therefore, an obvious economic incentive in considering partial removal options compared with complete removal. ICIT (1994a) further considers the implications of the above savings in a wider remit involving the likely cost to fishermen of installations remaining partly in place, namely through loss of access and damage to fishing gear. In doing so the study utilizes the compensation criterion suggested by the economists Kaldor (1939) and Hicks (1939), which in summary suggests that a project is only worthwhile if the financial gain is able to compensate those who lose out from the project, thus ensuring that no one is worse off as a result of the project (the study notes that the Kaldor-Hicks principle does not take account of any moral obligation). In this instance ICIT (1994) postulates that “it is highly unlikely that the cost of loss of access or future losses of gear by fishermen would exceed £1.25 billion,” the estimated (lower) cost of requiring complete rather than permitting partial removal. Include the original assurance by the government that the structures would be entirely removed, the prospect that certain areas of the seabed will be unavailable to the fishing industry and the potential for damage to fishing gear that may result from the migration of debris as the partially abandoned structures degrade, it seems reasonable to conclude that by operating a program of partial removal as opposed to complete removal the government and offshore operators are set to gain financially to the detriment of the fishing industry. It therefore seems reasonable that the fishing industry would expect compensation not only from the offshore operators, but also from the government, bearing in mind that they both gain financially from the situation.

Despite the strong moral argument for complete removal of offshore installations, the SFF have no wish to see the majority of abandonment (complete removal) costs being met by the taxpayer in the form of lost revenues from Petroleum Revenue and Corporation Tax (ICIT 1994). Whereas previously the SFF sought complete removal and nothing else, their change in policy recognizes the financial burden to the taxpayer and accordingly establishes a number of objectives that recognize partial removal as a possibility. These are:

- To minimize risk to fishermen, to their vessels and gear and to minimize the areas of the seabed that will be lost to fishing in perpetuity as the result of the abandonment of partially removed structures.
- To ensure adequate compensation to fishermen for any damages or losses incurred as a result of the abandonment of partially removed structures and to seek the establishment of simple mechanisms for such settlements.
- To ensure that fishermen, government, the offshore industry and the public understands the reasons for its change in policy.

A number of principles have also been established to guide all aspects of this policy (ICIT 1994) including:

a) The “Polluter Pays Principle”

In this instance the premise is that any costs to the fishermen should be recovered from the polluter. This policy will depend upon the transfer of liability for abandonment; if to the government then it should accept responsibility for compensation; however, if not then the polluter pays principle should apply.

b) Compensation for damage and loss should be in accordance with the “General Principle of Strict Liability” and should be adequate and no more than adequate

In this instance a call is made for the avoidance of costly and lengthy court actions for claims in favor of a “formal arrangement...for the consideration of such claims that accords with the principles of strict civil liability” where the incident has occurred in areas where fishing is legal. Any encroachment of the safety zone, for example, should not be dealt with in this manner.

c) That equity between the present and all future generations of fishermen should be a guiding principle

Any compensation accepted for loss of access in perpetuity must be accepted on behalf of fishermen now and of fishermen of the future.

FISHERMEN, ARTIFICIAL REEFS, LOSS OF ACCESS AND SAFETY

It is difficult to glean the attitude of fishermen about the prospects of an artificial reef created from an abandoned offshore facility without the politics of offshore abandonment in general clouding the issue. It is also apparent that fishermen’s actions often do not reflect their words, unsurprising in view of the very contentious nature of the issues involved.

At the 1994 conference on “Managing the Environmental Impacts of Decommissioning and Abandonment Offshore,” Aberdeen, a representative from the Scottish Fishermen’s Federation, made the following statement:

“We are also somewhat bemused and amused to hear of suggestions that toppled platforms may become artificial reefs. The main experiences of these have been in warm climates. The North Sea is totally different in climatic and fishing terms. However, it is fair to state that one or two Constituent Association members of the SFF have been prepared to co-operate with artificial reef projects targeted for nearshore locations.”

This statement is fairly representative of North Sea fishermen’s views on artificial reefs. They do not recognize any potential benefits from offshore reef creation, whereas in certain situations they may see some value in placing a reef nearshore. This view reflects recognition of the general concept of artificial reefs and is not specifically geared towards dismantled offshore installations. The formation of nearshore reefs has readily identifiable benefits in its nearshore location, most notably easier accessibility for nearshore fishermen and the greater potential for targeting specific resources such as lobster and crab. Fishermen also recognize the role that artificial reefs may play in conservation of nearshore resources, in providing safe havens and/or the exclusion of mobile fishing gear from an area. Artificial reefs exist in Poole Bay, England and Torness, Scotland, and have two general points in common: (1) they were both constructed from waste material, and (2) they were both research-orientated. The Poole Bay artificial reef has shown distinct fisheries enhancement properties particularly in relation to lobster populations (Jensen and Collins 1995); however, the program of research has been discontinued on the Torness reef (Todd *et al.* 1992). Picken (1992) and Picken *et al.* (2000) also refer to the attempts to place a reef in the Moray Firth, Scotland. In 1987, a potential project entitled SPARE (Scottish Pilot Artificial Reef Experiment) was developed by Aberdeen University with the support of the Scottish Fishermen’s Federation and the Scottish White Fish Producers Association to research the use of redundant mud modules as artificial reefs with particular emphasis on the fisheries implications. The project, however, did not proceed because funds were not sufficient. Aberdeen University is presently still pursuing, with the support of the same fisheries organizations, the possibility of placing a high-profile steel reef to mimic the potential effects of placement of dismantled parts of offshore installations nearshore. The support of fishermen is therefore available for such experimental projects.

The situation becomes confusing when we take a closer look at offshore reef creation. There is very little support from fishermen for offshore reef deployment. Their doubt in any benefits to fish or fishermen is normally expressed in response to comparisons between the North Sea and the Gulf of Mexico, in particular the differences in fishing activity and environmental and climatic factors. There is a valid argument against such comparison, but the available information from North Sea studies indicates quite strongly that fish are attracted to offshore installations (ICIT 1991; Picken 1992; Side 1992; Aabel *et al.* 1997; Baine 1995, 1998; Soldal *et al.* 1999). This information should provide a basis for analyzing the prospects of offshore reef creation in the North Sea. Fishermen have also been known deliberately to fish close to offshore installations and along pipeline routes to take advantage of what they know is a fish aggregation response to their presence. Picken *et al.* (2000) quote one example of the financial benefits associated with such aggregation in the North

Sea, when “a fishermen was fined £8,000 for repeatedly fishing within the 500m zone around platforms, during which time over £200,000 worth of fish were caught.”

Fishermen are aware of the fish aggregating properties of offshore installations in the North Sea. Their distinct opposition to the formation of offshore artificial reefs, however, is based more on safety and political considerations, and represents a defiant opposition to the offshore industry. Fishermen also see offshore artificial reef creation as a potential excuse or additional reason offshore operators could use in their arguments for partial abandonment or toppling of individual installations. The fact that the structures do attract fish does not help their situation, and has probably been recognized as such for many years.

Reef creation, especially offshore, has the same issues of liability associated with partial removal and toppling, such as loss of access and potential damage to fishing gear and personnel from impact on abandonment residues. If a platform is toppled or partially removed, the government has proposed that a 500m “no fishing zone” remain in place for safety purposes (Select Committee 1996). This proposal was made in advance of the recent OSPAR Decision [July 1998]³, but is still of relevance in certain scenarios. During the operational lifetime of platforms, fishermen were excluded from the 500m safety zones, and in the instance of partial removal they will have lost access in perpetuity to such prescribed zones. The government and offshore operators do not consider the loss of access claim to be proven (ICIT 1994). The SFF stated to the Select Committee of 1996 “Where the SFF believes it reasonable it will pursue a claim on behalf of present and future generations of fishermen for adequate compensation for the loss of access to fishing grounds in perpetuity...Any settlement will be made into a fund established on the principle of equity for all fishermen of present and future generations.” The United Kingdom Offshore Operators’ Association (UKOOA), however, did not favor compensation for loss of access, stating, “we do not see from our admittedly non-fishing background the problem with the North Sea as being lack of access; we see the problem as being lack of fish.” The Committee, in its conclusions, agreed with the government and offshore operators that loss of access was not proven, going so far as to state that “some fishing free areas, however small, may help to protect dwindling fish populations; in the North Sea the decline of fish populations is a serious concern.”

It is very difficult to prove the ‘loss of access’ argument, as noted by ICIT (1994). This difficulty results from the variability of fisheries that are natural systems and the associated variation in fishermen’s earnings as a result of these fluctuations, but also skill, market price and level of effort. ICIT (1994) identify that the only possible way of proving ‘loss of access’ is through a process of argument, related to:

1. the occupation of different grounds by fish throughout a season; these variations are known to fishermen who then utilize their knowledge to fish grounds which yield the greatest catch per unit effort;
2. the fact that no loss of earnings will occur through no lack of access;

³ OSPAR Decision 98/3 on the Disposal of Disused Offshore Installations 1998

3. the fact that loss of access to an entire fishing ground will result in loss of earnings represented by the loss of catch associated with this ground; and
4. postulations surrounding the grey area that lies between points two and three, which suggests that loss of earnings correlates with the proportion of grounds lost.

One of the major arguments against the ‘loss of access’ claims is that fish move and fishermen merely need to redirect their effort. The problem with this argument is that although an equivalent level of catch may be achieved, there may be an increase in effort expended to achieve it, with fishermen thus fishing at a net loss compared with the situation where there is no ‘loss of access.’ If fishermen expend the same level of effort, it can equally be maintained that there may be a reduction in catch which again results in a net loss compared with the situation where there is no ‘lack of access.’ ICIT (1994) do, however, warn that given the natural fluctuations that occur in fisheries, it is again very difficult to relate loss of earnings to ‘loss of access’ and that a “substantial loss of access would have to occur before this was demonstrable...,” there always existing the possibility that in some years natural fluctuations will be responsible for loss of earnings.

Other arguments against the ‘loss of access’ claim (ICIT 1994) include the following:

- fishermen achieve their EC quotas so there is no loss of catch. This argument becomes invalid in light of the above discussions regarding effort;
- platform remains provide a ‘reef effect’ and are a gift either through conservation promise or aggregation properties. However, fishermen are skeptical of this notion, believing that fishing such areas, if legal, would present increased risk to personnel and equipment. Secondly, any aggregation may also be viewed as removing fish from surrounding fishery and this constitutes an argument for loss of access; and
- platforms create obstacles to fishermen but also provide potential breeding and nursery areas for fish stocks that have a conservation value which will ultimately benefit the fishermen. They may provide additional sustainability to a fishery in the same way that prohibition areas do, but the scale and degree to which this would occur is subject to much speculation, particularly given the small areas that will exist around platforms.

The SFF also argued to the Select Committee (1996) that compensation was due for damage to fishing gear and boats and injury or death as a result of offshore installations and associated residues. The government believes this to be a matter for affected parties and owners. The SFF also reiterated the difficulty in proving that such debris was responsible for any damage and that it preferred the establishment of a simple mechanism to deal with compensation. The Select Committee (1996) agreed with the government that it was a matter for affected parties and owners; however, it did “agree in principle with the claims for compensation by fishermen.”

The basis for such claims is the ‘polluter pays principle’ and relates to the two situations whereby such damages and losses occur in areas where fishing remains lawful and those areas where fishing is illegal, i.e. within the 500m safety zones that are likely to be established upon abandonment.

With the government refusing to accept liability for abandonment residues, the operator becomes responsible for any damages or losses occurring in areas outside the safety zone, and under the general principles of strict liability, fishermen need only prove the cause of damage. Compensation would be sought, therefore, if previous assurances regarding the risk of movement of residues outside the safety zone were found to be wanting in practice (ICIT 1994). The pursuit of such a compensation claim through the courts is generally seen as an unfavorable option, both in the attendant publicity to offshore operators and in the likely event that the cost to fishermen would be grossly disproportionate to the damage. This explains the preferred establishment of a simple mechanism to deal with such claims, a mechanism, which at its simplest would involve the provision of compensation by the operator where such damage is shown to be attributable to abandonment residues. In the event that no one operator is found attributable such a claim would be best directed to a collective operator's fund handled by UKOOA.

Regarding claims for damage within a 500m safety zone, a different process would apply, as fishing within such zones would be illegal and the vessel skipper would be subject to prosecution. There are possible defenses of safety zone infringements, including adverse weather conditions, but it is highly unlikely that a claim would be pursued by fishermen for damage incurred as a result of infringement especially if a compensatory mechanism was in place for loss of access. Such a claim would therefore need to be pursued through the courts.

A compensation fund for fishermen was established in 1975 by UKOOA for loss and damage to gear arising from the presence of non-attributable oil-related debris. This fund also provides for loss of fishing time as a result of any such damage depending upon the circumstances. When the debris is attributable to a specific operator, the claim is made directly to the oil company; however, where non-attributable the claim is made to the fund which is administered by fishing industry representatives. The average number of claims settled between 1975 and 1990 by the fund was 90%. In general, the greatest portion of claims is for damage to gear. The value of claims increased from £15,000 in 1976 to £193,000 in 1990, although much of this can be related to inflationary factors. Average settlement was approximately £2,000 per claim. No known examples of settled claims arising from safety zone infringement exist (ERT 1993).

The safety risk posed to fishermen by the presence of abandonment residues is perhaps best envisaged when we consider the events surrounding the "Westhaven" tragedy in March 1997 (Side 1999). Four fishermen died after the fishing vessel "Westhaven" capsized while trying to free itself after its trawl boards slipped under a gap between the seabed and the pipeline running from the Piper field to Flotta oil terminal in Orkney. The incident, which occurred 100 miles northeast of Aberdeen, has raised a number of questions regarding the risks posed to fishermen by free-standing areas of pipeline (spanning). Fishermen called for a wide-ranging review of oil safety in the North Sea after a sheriff's inquiry into the disaster, even though the sheriff concluded that no one was to blame for the tragedy. The sheriff's recommendations included the initiation of talks between the HSE and oil and fishing industries on fishing vessel safety around pipelines. Although this was an incident involving a North Sea pipeline, it is relevant to the issues discussed here, as an indication of the level of potential risk posed to fishermen from the presence of a structure abandoned at sea.

OSPAR DECISION 98/3

On 20 June 1995, Shell UK decided to abandon its plans for the deepwater disposal of the Brent Spar. The proposed deepwater disposal operation, vindicated by the completion of a Best Practicable Environmental Option statement as required by UK law, had become “untenable” against a background of activity by environmental activists. Three years were to pass, seeing a moratorium on the disposal at sea of decommissioned offshore installations, before agreement was reached on Decision 98/3 under the auspices of the Oslo and Paris Commissions. It entered into force in February 1999 and is representative of a hardening attitude towards marine pollution and sea disposal in the northeast Atlantic by member states. Decision 98/3, as we will see however, still leaves much open to debate, and has perhaps served to focus even greater attention on the option of rigs-to-reefs.

The preamble to the decision contains an affirmation that disposal should be governed by the precautionary principle, which takes into account potential effects on the environment; and the recognition that reuse, recycling or final disposal on land will generally be the preferred option for the decommissioning of offshore installations.

In definition, the decision describes a disused offshore installation as “an offshore installation, which is neither:

- a. serving the purpose of offshore activities for which it was originally placed within the maritime area, nor
- b. serving another legitimate purpose in the maritime area authorised or regulated by the competent authority of the relevant Contracting Party”

Point (b) of this definition means that an offshore platform which, upon the end of its productive life, is utilized for some other legitimate purpose (such as an artificial reef), is not classified as a disused offshore installation and would therefore not be subject to this decision. The OSPAR Convention 1992 under Article 8, becomes the relevant guiding legislation, requiring that the contracting party must authorize any placement of a disused installation or pipeline in the maritime area for a purpose other than that for which it was originally designed or constructed. Such authorizations is required to be in accordance with relevant applicable criteria, guidelines and procedures adopted by the Commission, with a view to preventing and eliminating pollution.

The Oslo and Paris Commissions have taken a much stronger position on sea disposal than was previously envisaged. Although an alternative reuse is still possible, sea disposal in any other form is tightly restricted. Point 2 of the decision states that “The dumping, and the leaving wholly or partly in place, of disused offshore installations within the maritime area is prohibited.” Derogation is possible (Annex 1) provided that the competent authority of a relevant contracting party is satisfied that an assessment procedure (Annex 2) has provided “significant reasons why an alternative disposal is preferable to reuse or recycling or final disposal on land.” Categories of alternative disposal are listed as:

- all or part of the footings of a steel installation in a category listed in Annex 1 (i.e. weighing more than ten thousand tons in air), placed in the maritime area before 9 February 1999;
- a concrete installation in a category listed in Annex 1 (i.e. gravity based concrete installations, floating concrete installations) or constituting a concrete anchor base; and
- any other disused offshore installation, when exceptional and unforeseen circumstances resulting from structural damage or deterioration, or from some other cause presenting equivalent difficulties, can be demonstrated.

The Brent Spar incident has added a new dimension to the decision-making process of abandonment, that of the power of public opinion; there is a growing view within Europe that the North Sea should not be used as a ‘dump’ by the offshore oil and gas industry. The decision strongly indicates that sea disposal has become the least favored option, and will only be allowed to proceed in the strictest of circumstances. Given this legislative shift towards complete removal, it is not impossible that the offshore industry and government may well see artificial reefs as a potential “solution” (Baine 1998), a viable alternative use that will involve little extra expenditure over the partial removal/toppling options, a situation more pronounced in the creation of an offshore reef. Indeed, even if there were not a shift towards complete removal, the management of partially removed/toppled structures such as artificial reefs may well provide a way of alleviating the fears of those against partial removal and toppling, particularly as abandonment is now fixed in the public eye. It is difficult to envision the situation where such a change in tactics by the operators and government will be viewed as genuine, and not just as a cost efficient means of disposal under a different guise. The ‘dumping in a different guise’ perception is an argument that will almost certainly be used in the event of reef creation by its opponents. This was highlighted at the Oslo and Paris Commission/s 1996 Working Group on Sea-Based Activities (SEBA) meeting when Greenpeace International informed SEBA of the possibility of artificial reefs becoming a “tactic to circumvent OSCOM Decision 95/1⁴,” even though the OSPAR Convention 1992 clearly states in Article 1 (g ii) that ‘dumping’ does not include: “placement of matter for a purpose other than the mere disposal thereof, provided that, if the placement is for a purpose other than that for which the matter was originally designed or constructed, it is in accordance with the relevant provisions of the Convention.” This perception is unfortunate, as the option of artificial reef creation is a viable one. Kjeilen *et al.* (1995), for example, well in advance of the Brent Spar incident, studied the possible deployment of the Odin platform, in the Norwegian sector of the North sea, as an artificial reef.

In a debate held in March 1997 hosted by the Institution of Civil Engineers (Press Release, 13 March 1997) artificial reefs were on the agenda with the motion, “In the search for sustainability, abandoned oil platforms are an enhancement to the sea bed,” being passed by delegates 27 to 23 with 4 abstentions. What was remarkable about this debate was that in response to the argument that a small number of designated reef sites may help in offsetting the decline in North Sea fish stocks, the Greenpeace representative stated that they were in favor of measures to improve North Sea fish

⁴ A precursor to OSPAR Decision 98/3

stocks and they were not “averse to the utilization of cleaned structures in designated areas but oppose toppling platforms *in situ*.”

This opposition clearly reiterates Greenpeace’s argument that reef creation may well become an excuse for toppling, which they would view merely as ‘dumping in a different guise.’ However, it does lend some weight to the argument of utilizing decommissioned structures or parts thereof as nearshore artificial reefs or indeed in a specially designated area of the North Sea, similar to the designated reef zones in the Gulf of Mexico. Greenpeace International, in collaboration with SustainAbility, also developed the “Beyond Sparring” project, a consultation exercise that aimed to help in the process of formulating an Integrated Removal Strategy (IRS) for oil and gas installations (SustainAbility 1997). The lack of participation from the oil and gas industry in this consultation exercise is notable. Other primary stakeholders were identified as engineering contractors, local authorities and environmental campaigners. In the consultation document the authors note the growing perception that offshore sea disposal “whether involving in-site toppling or by another name (e.g. rigs-to-reefs) – is politically and socially unacceptable.” This position is very much in contrast to the comments highlighted above. The “Beyond Sparring” project did not aim to debate the merits of onshore vs. offshore disposal but instead began from the standpoint of developing onshore re-use and recycling options, bringing all stakeholders together to discuss the development of a more environmentally, economically and socially sound approach to onshore disposal. The lack of interest from the oil and gas industry, however, led to Greenpeace’s handing control of the project early in 1998 to what was perceived as a more neutral organization, the European Commission.

The Oslo and Paris Commission’s meeting at Sintra, Portugal which discussed the disposal of disused installations as one item of a wide-ranging agenda, has been viewed as an historic meeting. In general, all parties agreed to strive towards zero concentrations of man-made hazardous substances and artificial radioactive substances in the marine environment. A cessation of discharges, emissions and losses has a delivery year of 2020. The agreement has been welcomed by such “green” oriented countries as Denmark and Sweden, and Greenpeace has seen the agreement as a ‘vindication of decades of campaigning’ (Anon 1998). Indeed, in a press release dated 23 July 1998, Greenpeace stated that it was confident that the decision means no installation will be dumped and no footings will remain. In the wake of Decision 98/3, Anon (1998) indicates that only 41 stumps of platforms will now even be considered to be covered by the derogation. The UK oil and gas industry has expressed concern at the deal which it said “appeared to have been based on political expediency.” Thus, while the OSPAR Decision’s exclusion of legitimate re-uses of offshore installations from the definition of a “disused offshore installation” leads the way for the consideration of artificial reef creation as a perfectly viable and legal proposition, the spirit of the recent Sintra meeting suggests that implementing such a re-use option would require an exceptional degree of political maneuvering to win acceptance from the remaining members of the Commission through the procedural and consultation process prescribed in Annexes 2 and 3 of OSPAR Decision 98/3.

NEARSHORE AND OFFSHORE REEF CREATION FOR COMMERCIAL FISHERIES

The common issue of liability remains one of the largest stumbling blocks in the pathway towards any rigs-to-reefs initiative. The issue of liability (and ownership) in the event of damage caused by abandonment residues to other sea users, most notably fishermen is a contentious one. As noted in the 1989 IMO Guidelines and Standards, legal title to installations and structures that have not been completely removed must be unambiguous, and responsibility for maintenance and liability for future damages must be clearly established. More recently, OSPAR Decision 98/3 in its preliminaries acknowledges that the national legal and administrative systems of the relevant contracting parties need to make adequate provision for establishing and satisfying legal liabilities in respect of disused offshore installations.

As discussed by Side *et al.* (1993), UKOOA's position as highlighted in the Fourth Report of the House of Commons Select Committee (Select Energy Committee 1991) is that the government should assume liability. This position relates to the probable influencing of operator's borrowing power by such a continued liability, the practicality of such a long-term risk and the possible sidelining of environmental factors when considering disposal options. The Select Committee agreed, recommending that the offshore industry "set up a fund to indemnify the government against civil claims and to cover legal and administrative costs" (Side *et al.* 1993). The government, however, was not prepared to act as "defendant in perpetuity." Liability is certain, therefore, to rest with the operators with the establishment of an abandonment fund into which all UKOOA members pay. Mr Eggar, however, addressing the House of Lords Select Committee on the Decommissioning of Oil and Gas Installations (Select Committee 1996), indicated that the government did not have a "closed mind on this" but that "we have not seen any compelling reasons as to why they [offshore operators] should not retain that responsibility." The Select Committee (1996) in its conclusions and recommendations, acknowledging that installation remains may survive in the sea for hundreds of years, noted that if an operator and partners were to disappear then no-one would be responsible for liability. Also acknowledging the existence of problems associated with quantifying liability in perpetuity for a structure, the Committee recommended further discussion between government and the offshore industry on this matter. In Norway, the government will undertake ownership of an abandoned installation with remuneration for such liability being supplied by the licensee (Petroleum Committee 1993).

In the event of reef creation, a third possibility arises: the transfer of liability to the reef beneficiaries. This is more likely to occur with respect to nearshore reef creation, or a designated offshore site managed by a specific body, as reef beneficiaries or managers will need to be clearly defined before such a placement occurs. In this instance, the user or manager could assume ownership with the offshore operator providing some remuneration in lieu of any possible future liability. This is unlikely to occur with offshore reef creation by toppling *in situ* (unless in a designated reef area) as there are no readily identifiable reef beneficiaries who would wish to assume such liability. In the present climate it is extremely doubtful that commercial fishermen would consider such a move.

Nearshore Reef Creation

Steering away from scientific validation, the placement of any artificial reef for nearshore fisheries management begs the question of its need, in line with existing and potential future management options, restrictions and goals. The real benefits will accrue in a habitat-limited fishery where an increase in biomass may result; through the combination of reef placement and a program of stock enhancement whereby the reef provides suitable additional habitat to support the potential increase in exploitable biomass; and where the reef helps as a central area to remove individuals from a fishery, acting as a reservoir or safe haven, helping to mitigate against over-pressurized fisheries.

In a nearshore UK context, the main fisheries of concern will be those for shellfish such as the European lobster and edible crab, although one must not forget the recreational fin-fishing industry. In many studies it has been shown that bottom reefs are the most appropriate for these shellfish species (e.g. Jensen and Collins 1995) with the provision of adequate space for shelter. The use of offshore platforms in this context is debatable, particularly with respect to lattice jackets, and one would again acknowledge the merits of utilizing reefs consisting of e.g. concrete blocks which can be designed and placed in an optimum way to meet the specific needs of the management situation. One example of this use of artificial reefs is a proposal to deploy blocks of stabilized quarry aggregate by-product (from Argyll, Scotland) with cement and fly ash in the creation of an artificial reef for research and, amongst other possible options, the future management of the local lobster fishery (Wilding and Sayer 1997).

A nearshore rigs-to-reefs initiative will require a beneficiary who is willing to assume ownership and liability for the structure. This is amplified by its location, the costs of nearshore reef creation needing to be at most equal to the cost of onshore disposal (otherwise donation of the structure to a rigs-to-reefs scheme by an offshore operator has little benefit to operator in comparison with onshore disposal). The risk of interaction with other sea users also increases in a nearshore context. Without a beneficiary, a rigs-to-reefs project will have no grounds on which to proceed. The demand for a nearshore reef and a demonstration of potential environmental and socio-economic benefits will also be central to:

- its identification as a BPEO (as required by UK law) for the abandonment of a particular structure;
- the agreement of OSPAR Contracting Parties of its acceptability; and
- the counteracting of any environmental campaign opposed to the use of an offshore structure as the reef.

Nearshore reef creation does not produce as strong a response from environmental groups and fisheries representatives as offshore reef creation does. Greenpeace has expressed its opposition to nearshore reef creation. Although they do not condemn nearshore reef creation in general, they condemn the use of high-grade steel in their construction, which they maintain would be more appropriately brought onshore for reuse and recycling.

Offshore Reef Creation

The only potential purpose of an offshore rigs-to-reefs program is in a fisheries management context, be it to enable fish aggregation for a sustainable gear-specific fishery or as a conservation area where fishing is prohibited. There are obvious cost saving incentives for offshore operators through such an abandonment route, however, fishermen and environmental campaigners strongly oppose to this option, and the prospects for formation of an offshore artificial reef be it toppled *in situ*, moved to a designated site or utilized in combination with a no fishing policy, are not good.

In terms of an individual offshore rigs-to-reefs scenario or small cluster of reefs, such a proposition faces the following political hurdles, the first being most critical:

- an offshore reef is seen as an impediment and danger to fishermen and their fishing methods, not a benefit, and even if there is a marginal fishery benefit, the risk posed to safety would far outweigh these in the overall picture;
- opposition to the concept from fishermen which would almost certainly prevent the adoption of the concept as the BPEO in a given situation(s) and which ultimately could be used by other contracting parties to the OSPAR Convention 1992 as a significant reason for not proceeding;
- opposition to the concept from environmental organizations, most notably Greenpeace, who see artificial reefs as a “weak link” in abandonment legislation, which could set dangerous precedents for industrial waste disposal. They also see the rigs-to-reefs option as a panacea for the offshore industry’s abandonment problems, undermining its responsibility to clean up its own waste;
- opposition to the concept from contracting parties to the OSPAR Convention who will view this plan as being in conflict with the spirit of the Sintra agreement; and
- lack of a beneficiary (both the fishing and environmental sectors are opposed to offshore reef creation) and therefore potential transfer of liability.

A no-fishing area (sanctuary) to help conserve stocks in combination with a rigs-to-reefs program is also faced by the following hurdles:

- opposition from fishermen centering on:
 - (i) opposition to the mere presence of a no-fishing zone, never mind the combined instance;
 - (ii) the implications for the North Sea fishing industry as it is an area that supports a mixed fishery; and
 - (iii) the general imposition of another damaging set of regulations and level of bureaucracy;

- opposition from Greenpeace and OSPAR Contracting Parties (many of which are members of the EU) to the rigs-to-reefs aspects of the scheme;
- the impracticalities that will exist as a result of the maze of international, EU and national legislative and administrative procedures that will be required, including the integration of such a concept within the Common Fisheries Policy;
- lack of sufficient scientific data to justify the use of reefs when a closed zone to fishing may be enough;
- lack of a beneficiary and therefore transfer of liability;
- difficulty of enforcement; and
- problems with the decommissioning of such a scheme if ineffective or unworkable; or indeed, if successful, there is the question of access provision and whether the reefs should be removed or left in place.

STAKEHOLDER DIALOGUE

The International Association of Oil and Gas Producers (OGP), formerly the E & P Forum, initiated stakeholder dialogue in 1997 to take into account broader interests when shaping future research initiatives. A workshop held in Brussels in 1997 saw the participation of European fisheries industry representatives, non-governmental research institutes, offshore industry, environmental interest groups, EU administration, governmental research bodies and departments, all working together to identify key issues and questions that need to be addressed in determining the potential for rigs-to-reefs in the North Sea (Environment Council 1997). Prioritized questions under the heading of “social and political aspects” were:

- What are the criteria for [determining] success of artificial reefs?
- How can the objectivity and independence of the research be assured?
- How can we measure direct and indirect benefits compared with other options?
- How could we have rigs-to-reefs without setting a precedent for general dumping?
- How can we ensure that the dialogue continues with all parties and active participation in existing regulatory processes and management issues?
- Who would own artificial reefs and who would be responsible or liable in perpetuity?

The second point above is of particular note. There has been mistrust over some of the scientific research as a result of the relationship between main academic rigs-to-reefs proponents and the oil industry. As a result of the workshop, an independent rigs-to-reefs “steering group” was formed,

whose main task is to assess the potential for rigs-to-reefs in the North Sea and to guide ongoing independent research into need and suitability. The steering group is composed of members from the fishing industry, academia, research institutions, environmental groups and the European Commission, who report back to those workshop attendees who expressed a wish to remain in the dialogue process.

The steering group designed the study process to examine the rigs-to-reefs concept and choose the most appropriate organization to undertake the research. The OGP's only input is through funding. The study process is composed of three stages. Stage one sets two parallel questions: What are the management, environmental and economic needs of the United Kingdom's eastern and Norway's eastern seaboard (including nearshore and offshore waters)? What functions might artificial reefs be able to perform in the North Sea context? This research has been completed (Baine and Kerr 2000), and the Steering Group is reviewing the results to determine to what extent the deliverables identified in the answer to the second question meet the needs identified in the answers to the first, compared to the other management options available (stage two). If the steering group finds sufficient evidence to justify further investigation, two more parallel questions will be investigated (stage three). Firstly, can redundant offshore installations be reused as artificial reefs and if so, at what cost, and how could the attendant legal, political and environmental issues be resolved? Secondly, how else might the benefits of artificial reefs be achieved, using what materials, involving what issues and at what cost?

At present, therefore, there is a way forward in the rigs-to-reefs debate, one that involves all stakeholders, although Greenpeace has distanced itself from the steering group. Greenpeace has declined to join on the basis that the outcome appears, in their eyes, to have been predetermined, with little quality discussion on whether or not the concept should have been considered any further before defining research strategies. Their stand embraces the precautionary principle; however, given that UK waters already feature artificial reefs constructed from waste material, combined with the informed assumption that any North Sea rigs-to-reefs program will never approach the levels witnessed in the Gulf of Mexico and the fact that stringent legislative control would be imposed, there must be scope for Greenpeace to enter the dialogue.

CONCLUSION

The implications of the Brent Spar incident are still being resolved with the emergence of a landmark OSPAR Decision on abandonment. Although more focused, the future of North Sea abandonment is still not entirely clear, with the possibility of derogation, the uncertainty over the disposal of concrete installations, and the momentum that has gathered concerning the rigs-to-reefs debate. The rigs-to-reefs concept is by no means a trivial one and requires further close examination, but this can only be achieved through discussion, negotiation and proactive participation from all the stakeholders involved. Firstly this discussion will enable an integration of scientific and social thinking, admittedly on a controversial subject, but nonetheless a valid one. An opportunity exists to comprehensively to examine the deployment of steel lattice jackets (waste material) as a fisheries management tool in the North Sea. The success of such ventures in the Gulf of Mexico does not ensure a similar outcome in the North Sea, but it does provide food for thought. Secondly, the discussion will help us avoid recurrence of the Brent Spar incident. The relationship between science

and political motivation is central to the rigs-to-reefs debate; a trusted independent and authoritative evaluation has to be the preferred goal.

There is no doubting the attractiveness of the rigs-to-reefs concept to offshore operators and the opposition of a major environmental group. It is fishermen, though, who are the most likely to be directly affected by the implications of current abandonment legislation. The possibility of steel platform footings and concrete installations remaining behind on the seabed will entail further consultation on loss of access and potential damage to fishermen and their gear. Fishermen may well feel aggrieved at the historical chain of events that resulted in an about-face on the promise of complete removal. They may well feel that the latest OSPAR Decision 98/3 has gone some way to alleviate those grievances, but has it gone far enough? Fishermen find themselves in the midst of contention. They strive for complete removal, yet still find themselves represented on bodies such as the rigs-to-reefs steering group, an indication of their willingness to participate in dialogue but also recognition of the instability of their situation. Greenpeace may be pleased with the direction that the OSPAR Decision has taken, the offshore industry may be dismayed, but it is fishermen who still require clarification of the future. It is the very nature of this position that provides them with the key to the success of any rigs-to-reefs venture in the North Sea. Their co-operation and participation is essential in the promotion of a concept that has been for so long promoted to them.

ACKNOWLEDGMENTS

The author sincerely recognizes the contribution of M. Sutherland of the Scottish Fishermen's Federation, S. Reddy of Greenpeace, S. Hain of the Oslo and Paris Commissions and P. Prasthofer, formerly of the E & P Forum, to discussions regarding rigs-to-reefs in the North Sea. The author also recognizes the members of the rigs-to-reefs Steering Group, and the International Association of Oil and Gas Producers, which funded Stage 1 of the rigs-to-reefs study process.

REFERENCES

- Aabel, J.P., S.J. Cripps, A.C. Jensen, and G. Picken. 1997. Creating artificial reefs from decommissioned platforms in the North Sea: review of knowledge and proposed programme of research, ISBN 82-7220-837-7.
- Allan, R. 1986. Abandonment: a fishing industry perspective. Offshore Decommissioning Conference, London, 25-26 November 1986.
- Allan, R. 1992. Abandonment of offshore installations: the Scottish perception. Second International Conference on Fisheries and Offshore Petroleum Exploitation, Bergen, Norway, 6-8 April, 1992.
- Allan, R. 1994. Managing the environmental impacts of decommissioning and abandonment offshore. Decommissioning Conference, Aberdeen, 18-19 May, 1994.
- Anon. 1998. Historic marine protection deal signed. ENDS Daily, 23.07.98.



- Baine, M. 1995. Rigs to reefs in the North Sea. Proceedings of the International Conference on Ecological Systems Enhancement Technology for Aquatic Environments, Tokyo, October 1995, Volume 2: 507-512.
- Baine, M. 1998. Rigs to reefs, the North Sea Perspective. Pages 275-280 *In* L.E. Hawkins *et al.*, eds. The Responses of Marine Organisms to Their Environments, proceedings of the 30th European Marine Biology Symposium. ISBN 0-904175-31-61.
- Baine, M., and S. Kerr. 2000. Research into coastal management of areas in the North Sea. Report 5: Integrated report including stakeholder responses. Report of Heriot-Watt University to the International Association of Oil and Gas Producers.
- Environment Council. 1997. Rigs to reefs: researching the option. Workshop proceedings, 29 September 1997, Brussels.
- ERT. 1993. An assessment of the legislative and fisheries implications of abandonment of the Brent Spar anchor blocks. Report 93/013 of Environment and Resource Technology Ltd to Shell UK.
- Hicks, J.R. 1939. The foundation of welfare economics. *Economic Journal* 49: 692-712.
- ICIT. 1991. Survey of fish distribution and contamination. Report of Heriot-Watt University's International Centre for Island Technology to the Scottish Fishermen's Federation.
- ICIT. 1994. Review of the background to and development of the Scottish Fishermen's Federation's policy on the abandonment of offshore oil and gas installations. Report of Heriot-Watt University's International Centre for Island Technology to the Scottish Fishermen's Federation.
- Jensen, A.C., and K.J. Collins. 1995. The Poole Bay artificial reef project 1989-1994. *Biol. Mar. Medit.* 2 (1): 111-122..
- Kalder, N. 1939. Welfare propositions of economics and inter-personal comparisons of utility. *Economic Journal* 49: 549-552.
- Kjeilen, G., J.P. Aabel, V. Hoyvangli, M. Baine, G. Picken, and L. Heaps. 1995. Odin – an artificial reef study. Report by RF-Rogaland research, Heriot-Watt University and Aberdeen University to Esso Norge AS.
- Petroleum Committee. 1993. Report and proposed new chapter IV in the Petroleum Act, relating to closing down petroleum operations on the continental shelf.
- Picken, G. 1992. Rigs to reefs in the North Sea. Pages 49-52 *In* M. Baine, ed. Artificial Reefs and Restocking, proceedings of the 1st British conference held in Stromness, Orkney, 12 September 1992.

- Picken G., M. Baine, L. Heaps, and J. Side. 2000. Rigs to reefs in the North Sea. Pages 331-342 *In* A. Jensen, K. Collins, and A. Lockwood, eds. Artificial reefs in European seas. ISBN 0-7923-5845-7. Kluwer Academic Publishers.
- Select Committee. 1996. Decommissioning of oil and gas installations. House of Lords Select Committee on Science and Technology, Session 1995-96, 3rd Report.
- Side, J. 1992. Rigs to reefs: obstacles, responses and opportunities. Pages 53-59 *In* M. Baine, ed. Artificial Reefs and Restocking, proceedings of the 1st British conference held in Stromness, Orkney, 12 September 1992.
- Side, J. 1999. Issues arising from the Westhaven tragedy concerning fishing gear and pipeline interactions. *Underwater Technology* 29(1): 3-10.
- Side, J., M. Baine, and K. Hayes, K. 1993. Current controls for abandonment and disposal of offshore installations at sea. *Marine Policy* 17(5): 354-362.
- Soldal, A.V., O. Humborstad, S. Lokkeborg, I. Svellingen, and T. Jorgensen. 1999. Etterlatte oljeplattformer som kunstige fiskerev. Published by the Institute of Marine Research. ISSN 0071-5638.
- SustainAbility. 1997. Decommissioning of offshore oil and gas installations: towards an integrated removal strategy. A sustainable development consultation paper.
- Todd, C.D., M.G. Bentley, and J. Kinnear. 1992. Torness Artificial Reef Project. Pages 15-21 *In* M. Baine, ed. Artificial Reefs and Restocking, proceedings of the 1st British conference held in Stromness, Orkney, 12 September 1992.
- Wilding, T.A., and M.D.J. Sayer. 1997. Artificial marine habitats: sustainable community-led fisheries using aggregate by-products. Programme of research prepared by Dunstaffnage Marine Laboratory, 20pp.



The Role of Fishermen and Other Stakeholders in the North Sea Rigs-to-Reefs Debate

M. Baine and J. Side

Slide Sponsored by the Orkney Tourist Board!



Scientific Appraisal and Speculation



The food chain

- The Ekofisk Complex (past and present)
- The Videotapes
- The Transocean 3 Survey
- The Fish Distribution Sonar Survey
- The Odin Artificial Reef Plan
- The ODCP Review
- The North Sea Coastal Management Study

Scientific Failings



- Accurate estimates of aggregation and distribution
- Interaction b/w reef sub-stocks and background stock
- Retention of juvenile fish populations
- Fish residency and other behavioural traits
- Scope for a gear specific reef fishery
- Fish tainting
- Fate of drill cuttings piles
- Fate of the reef upon deterioration

Fishermen, Offshore Operators and the Government

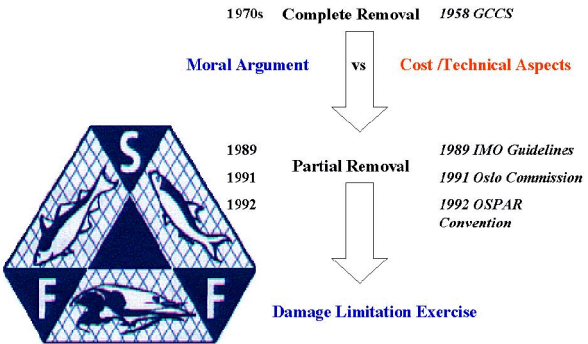

1970s **Complete Removal** 1958 *GCCS*

Moral Argument vs **Cost/Technical Aspects**

1989 **Partial Removal** 1989 *IMO Guidelines*

1991 1991 *Oslo Commission*

1992 1992 *OSPAR Convention*

Damage Limitation Exercise

Damage Limitation Exercise



- Witness of removal operations
- Debris clean-up operations
- Confirmation by side-scan and trawl operations
- Regular inspection of abandonment sites
- Compensation fund for loss of access
- Compensation fund for gear loss/vessel damage

1994 SFF Policy on Abandonment

Cost to the UK Tax-payer
 UK bear 50-70% of abandonment costs
 £ 1.25-1.75 billion savings in tax revenue

Offshore Operators gain financially
 Government gain financially

To the detriment of the Fishing Industry



Compensation?



Objectives

- Minimise risk to fishermen, vessels and gear
- Minimise areas of seabed that will be lost to fishing
- Ensure adequate compensation for any damages or losses
- Ensure public knowledge of why the change in policy has occurred



Polluter Pays Principle
 General Principle of Strict Liability

Equity b/w present and future generations of fishermen



Loss of Access: Arguments For

Gutted Haddock



Fish occupy different grounds throughout a season

No loss of earnings through no loss of access

Loss of access to an entire fishing ground will result in loss of earnings (loss of catch)

Loss of earnings seen as correlating with the proportion of grounds lost

Loss of Access: Arguments Against

- Fish move and fishermen redirect their effort (effort?)
- Natural fluctuations
- Achieve their EC quotas (effort?)
- Reef effect is a "gift" !!!!!!!!!!!!!!!
- Conservation value

Herring



Not proven
 Problem is lack of fish

Safety

- Compensation due as a result of platforms and residues
- Government refuses to accept liability
- Polluter Pays: legal fishing (outside safety zone)
- Fishermen need only prove the cause of damage



1975 UKOOA fund

Westhaven Tragedy



March 1997
 Loss of 4 lives
 Trawl boards slipped under a gap b/w seabed and free standing area of pipeline
 Sheriff's inquiry concluded no one to blame
 Indicates levels of risk of abandonment residues

OSPAR Decision 98/3

The dumping, and the leaving wholly or partly in place, of disused offshore installations within the maritime area is prohibited

HOWEVER

Derogation exists for

- Some steel installation footings
- Some concrete installations
- Installations with exceptional circumstances

The definition of a 'disused offshore installation' does not include

"an offshore installation which is serving another legitimate purpose in the maritime area authorised or regulated by the competent authority of the relevant Contracting Party"



ARTIFICIAL REEFS

Rigs-to-Reefs/Dumping at Sea

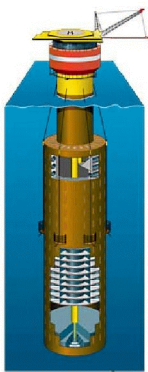

- Sea disposal - least favored option
- Artificial reefs - potential "solution"
- Dumping in a different guise
- Tactic to circumvent the Decision

Opposition to toppling platforms *in situ*

Sets a dangerous precedent



Greenpeace web-site

Liability

Mackerel



Government

Offshore Operators

Reef Beneficiary (with remuneration)

Nearshore Reef Creation



Brown crab





European lobster

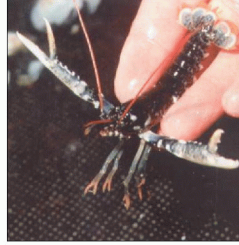

Inshore Fisheries (?)

Habitat Protection and Mitigation

Recreational Fishing

Recreational Diving

Biodiversity

Coastal Protection

Nearshore Reef Creation

Acceptance by OSPAR Contracting Parties

Counteraction of Opposing Campaign

Identification as BPEO

Demand

- Beneficiary (ownership and liability)
- Demonstration of potential environmental and socio-economic benefits
- Costs, at the most, equal to onshore disposal

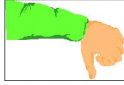

- Opposition from Greenpeace
- Fishing sector scepticism (although not as emotive)
- Potential emergence of cheaper onshore disposal routes
- Availability of other materials

Offshore Reef Creation

Fish aggregation for a sustainable gear specific fishery

Conservation area where fishing is prohibited

Political Opposition

Safety

Ownership





Bureaucracy

Industry Opposition

Decommissioning

Enforcement

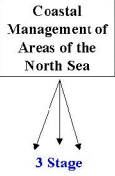

<p style="text-align: center;">Individual/Small Cluster of Reefs</p> <p>Prawn</p>  <ul style="list-style-type: none"> Impediment and danger to fishermen and their methods Opposition from fishermen would probably deny BPEO adoption OSPAR Contracting Parties would therefore be opposed Opposition from environmental organisations such as Greenpeace Lack of a beneficiary and potential transfer of liability 	<p style="text-align: center;">No Fishing Area</p> <p>Small haddock</p>  <ul style="list-style-type: none"> As before Opposition from fishermen to the mere presence of a no fishing zone Implications for mixed fishery Imposition of another damaging set of regulations Integration with the Common Fisheries Policy Lack of scientific backing Enforcement Problems with decommissioning of the scheme if ineffective or unworkable (If successful: questions of access and removal)
<p style="text-align: center;">Stakeholder Dialogue 1997 Workshop</p> <div style="display: flex; justify-content: space-around;"> <div data-bbox="207 919 488 1276"> <p><i>Group 1: Priorities</i></p> <ul style="list-style-type: none"> * What are the criteria for 'success' of artificial reefs? * How can the objectivity + independence of the research be assured? * How can we measure direct + indirect benefits compared with other options? </div> <div data-bbox="505 919 786 1276"> <p><i>Group 2: Priorities</i></p> <ul style="list-style-type: none"> * How could we have rigs to reefs without setting a precedent for general dumping? * How to ensure dialogue process continues with all parties & active participation in existing regulatory process & management issues? * Who would own artificial reefs and who would be responsible & liable in perpetuity? </div> </div>	<p style="text-align: center;">Rigs-to-Reefs Steering Group</p> <p><i>DGXVII - Energy Bellona Foundation Scottish Fishermen's Federation Dunstaffnage Marine Laboratory Istituto di Ricerche Sulla Pesca Marittima Centre for Economics and Management of Aquatic Resources</i></p> <p style="text-align: right;">No Greenpeace</p> <p>Whiting</p>  <div style="text-align: right;"> <p>Independent Research</p> <p>Coastal Management of Areas of the North Sea</p>  <p>3 Stage</p> </div>
<p>Sprat</p>  <p style="text-align: center;">Research (3 stages)</p> <p>Management, environmental and economic needs of Norway's western and the UK's eastern seaboard</p> <p>Functions of artificial reefs</p> <p>Do the functions meet the needs, compared to other available management options?</p> <p>If so, can redundant platforms be reused as reefs (cost, resolution of legal, political and environmental issues)?</p> <p>What other materials could be used (cost etc)?</p>	<p style="text-align: center;">Moving Forward</p>  <div style="display: flex; justify-content: space-between; align-items: center;"> <div data-bbox="889 1583 1008 1696"> <p>A contentious, divisive situation with potential for the re-occurrence of the Brent Spar incident</p> </div> <div data-bbox="1024 1514 1214 1793"> <div style="text-align: center;"> <p>Independent Research</p> <div style="border: 1px solid black; padding: 2px; margin: 2px;">Scientific Validation</div> <div style="border: 1px solid black; padding: 2px; margin: 2px;">Dialogue</div> <p>Political Progress</p> </div> </div> <div data-bbox="1230 1535 1382 1745"> <p>Are rigs-to-reefs projects viable?</p> <p>An integrated proactive evaluation of the rigs-to-reefs concept</p> <p>Are rigs-to-reefs projects needed?</p> </div> </div>

Concluding Remarks

Discussion, negotiation and proactive participation
Integration of scientific and social thinking
Avoidance of a Brent Spar re-occurrence

Attractive to operators

Opposition from an influential environmental pressure group

Fishermen directly affected
Loss of access/safety issues
Historical grievances
Willingness to participate



OSPAR Decision

Greenpeace - pleased
Operators - dismayed
Fishermen - ?

Rigs-to-Reefs

The co-operation and participation of fishermen is essential in the promotion of a concept that has for so long been promoted to them

FISHING DEMAND, CATCH AND EFFORT DATA, AND ECONOMIC IMPACTS ASSOCIATED WITH RECREATIONAL FISHING NEAR OIL AND GAS STRUCTURES IN THE GULF OF MEXICO

Robert L. Hiett
QuanTech, Inc.

J. Walter Milon
Department of Economics
University of Central Florida

ABSTRACT

The purpose of this research project, performed under a Minerals Management Service contract, was to estimate demand, expenditures, and economic impact associated with recreational fishing and diving near GOM-based oil and gas structures and artificial reefs created from such structures. The primary research approach involved a series of sample surveys during 1999 of recreational fishermen and divers along the Gulf coast including the states of Alabama, Mississippi, Louisiana, and Texas. Because detailed species information was collected, results are available on target species and catch. The results of the surveys of recreational fishermen and divers strongly indicated that the availability of oil and gas structures as well as artificial reefs created from such structures are extremely important to the coastal counties of the Gulf states. Of the 4.5 million recreational fishing trips estimated in the Gulf states from Alabama through Texas in 1999, 21.9% were within 300 feet of an oil or gas structure. Of the 83,780 estimated diving trips, 93.6% were within 300 feet of such a structure. The economic activity associated with these visits was substantial. According to the analyses performed, there were \$172.9 million in direct expenditures during 1999 associated with recreational visits to oil and gas structures in the Gulf states plus another \$640.0 million in annual equipment-related expenditures. The total economic output in coastal areas associated with recreational fishing and diving near oil and gas structures in the Gulf was \$324.6 million, including \$164.1 million in the value added component and employment estimated at 5,560 full-time equivalents.

INTRODUCTION

Oil and gas structures, and artificial reefs created from such structures, have proven to provide shelter and contribute food for benthic, demersal, and pelagic fish. The nearly 5,000 such structures located in the Gulf of Mexico (GOM) probably constitutes the largest assemblage of artificial reefs in the world. These structures have influenced the behavior of fishermen as well as fish. To facilitate decision-making about the future of older structures, MMS contracted for this study of recreational fishermen and divers.

This research addressed three study objectives. The first was to assess recreational demand for fishing and diving associated with offshore oil and gas-related structures and with artificial reefs resulting from the “rigs-to-reef” programs in Texas, Louisiana, Mississippi, and Alabama. The

second objective was to assess the economic impacts resulting from this recreational demand on the economies of Texas, Louisiana, Mississippi, and Alabama. The last objective was to analyze the incremental expenses associated with recreational fishing and diving that would not have been incurred if anglers had no offshore structure fishing or diving opportunities. Although it was not specifically an objective of the research, information was obtained from recreational fishermen on their target species and actual catch. These results are also provided in this paper.

The study area covered the states of Alabama, Mississippi, Louisiana, and Texas for the period January through December of 1999. Recreational activities covered by the project included private boat fishing, charter boat fishing, party boat fishing, and recreational diving in GOM waters.

METHODS

The data collection methodology for meeting these objectives combined in-person interviewing of recreational fishermen and divers in the field with follow-up telephone interviewing from a central dialing facility. The research design involved two basic data collection methods. The first was *in-person field interviews* in which trained data collectors stationed along coastal areas of the GOM visited predetermined boat launch sites and conducted interviews with fishermen and divers as they returned from the day's activities. The in-person field interviews were conducted with private boat fishermen, charter boat fishermen, party boat fishermen, and divers. The second method involved a telephone *follow-up interview* to collect detailed expenditures information from qualified respondents identified during the field interviewing.

The field interviews were used to estimate the proportion of fishing and diving trips taken near GOM oil and gas structures or artificial reefs created from such structures. The follow-up telephone interviews were used to estimate trip-related costs and capital expenditures associated with recreational fishing and diving.

A key methodological issue was that of converting proportions and mean values per individual recreational fishing and diving trip into total estimates of demand and economic impact. Such estimates require knowledge of the total number of fishing and diving trips taken. The approach in this study was not to attempt to make such estimates of total demand as part of this project, but to rely on estimates developed independently by the National Marine Fisheries Service (NMFS) of the U.S. Department of Commerce. The NMFS conducts an annual survey of marine recreational fishing in Alabama, Mississippi, and Louisiana with sample sizes considerably larger than the level of effort available for the MMS study. The NMFS survey is referred to as the Marine Recreational Fishery Statistics Survey (MRFSS) and has been conducted in the GOM since 1980. In addition, Texas conducts its own survey of recreational fishing, and NMFS incorporates the Texas data into its own estimates. The approach taken in this study, therefore, was to rely upon estimates of total fishing trips and numbers of participants provided by NMFS and to apply those estimates to the results of the 1999 MMS data collection to meet the project objectives.

Trip expenditure data were collected during follow-up phone interviews with oil and gas structure users who were engaged in recreational fishing from private boats, charter or party boats, or who participated in recreational diving. Average trip expenditure data for oil and gas structure users were

combined with estimates of the total number of trips to oil and gas structures to produce estimates of the annual expenditures associated with trips near oil and gas structures for each mode of fishing or diving in the four GOM states.

Annual equipment expenditure data were also collected during the follow-up phone interviews with oil and gas structure users. These data were extrapolated by multiplying the average expenditures for each mode and state times the estimated number of participants using oil and gas structures. Because equipment expenditures may not be solely related to trips to oil and gas structures, the expenditure and corresponding impact estimates may overstate the economic activity generated by fishers and divers who participated in trips near oil and gas structures.

Trip and equipment data were evaluated to estimate the economic impact in coastal counties of each state.

RESULTS

The first objective of the study was to estimate demand by recreational fishermen and divers associated with oil and gas structures in the GOM and with artificial reefs constructed from such structures. These demand estimates were generated by combining results of the field survey with data obtained from the National Marine Fisheries Service MRFSS. Overall, it is estimated that a total of 980,264 fishing trips were taken within 300 feet of an oil or gas structure or an artificial reef created from such structures during 1999 out of a total of 4,484,080 marine recreational fishing trips in the Gulf from Alabama through Texas. In addition, there were 83,780 dive trips near oil and gas structures out of a total of 89,464 dive trips taken from Alabama through Texas.

A total of 6,845 interviews were obtained in the field with private boat fishermen as they returned from their fishing trips. Analysis of data for these respondents indicated that, overall, the proportion of private boat trips taken within 300 feet of oil or gas structures was 20.2%. That is, of the 4.1 million private boat fishing trips taken in these states during 1999, 823,075 were within 300 feet of an oil or gas structure. This information is shown separately by state in Table 4.1.

Table 4.1. Total estimated private boat fishing trips near oil and gas structures.

State	Total Trips	Proportion of Trips	
		Near Oil/Gas Structures	Trips Near Oil/Gas Structures
Alabama	505,635	.414	209,333
Mississippi	507,545	.197	99,986
Louisiana	2,067,076	.166	343,135
Texas	986,250	.173	170,621
Total	4,066,506	.202	823,075

A total of 1,287 interviews were obtained in the field with charter boat fishermen as they returned from their fishing trips. Analysis of data for these respondents indicated that, overall, the proportion of charter boat trips taken within 300 feet of oil or gas structures was 32.3%. That is, of the 298,023 charter boat fishing trips taken in these states during 1999, 96,337 were within 300 feet of an oil or gas structure. This information is shown separately by state in Table 4.2.

Table 4.2. Total estimated charter boat fishing trips near oil and gas structures.

State	Total Trips	Proportion of Trips Near Oil/Gas Structures	Trips Near Oil/Gas Structures
Alabama	71,394	.210	14,993
Mississippi	49,426	.217	10,725
Louisiana	73,770	.231	17,041
Texas	103,433	.518	53,578
Total	298,023	.323	96,337

A total of 378 interviews were obtained in the field with party boat fishermen as they returned from their fishing trips. Analysis of data for these respondents indicated that, overall, the proportion of party boat trips taken within 300 feet of oil or gas structures was 50.9%. That is, of the 119,551 party boat fishing trips taken in these states during 1999, 60,852 were within 300 feet of an oil or gas structure. This information is shown separately by state in Table 4.3.

Table 4.3. Total estimated party boat fishing trips near oil and gas structures.

State	Total Trips	Proportion of Trips Near Oil/Gas Structures	Trips Near Oil/Gas Structures
Alabama	15,386	.000	0
Mississippi	0	—	0
Louisiana	7,913	1.000	7,913
Texas	96,252	.550	52,939
Total	119,551	.509	60,852

A total of 150 interviews were obtained in the field with divers as they returned from their trips. Analysis of data for these respondents indicated that, overall, the proportion of dive trips taken within 300 feet of oil or gas structures was 93.6%. That is, of the 89,464 dive trips taken in these states during 1999, 83,780 were within 300 feet of an oil or gas structure. This information is shown separately by state in Table 4.4.

Table 4.4. Total estimated dive trips near oil and gas structures.

State	Total Trips	Proportion of Trips Near Oil/Gas Structures	Trips Near Oil/Gas Structures
Alabama	11,124	.489	5,440
Mississippi	11,166	1.000	11,166
Louisiana	45,476	1.000	45,476
Texas	21,698	1.000	21,698
Total	89,464	.936	83,780

The second objective of the study was to assess the total economic impact associated with recreational fishing and diving. Trip expenditure data were collected during follow-up phone interviews with oil and gas structure users who were engaged in recreational fishing from private boats, charter or party boats, or who participated in recreational diving. Average trip expenditure data for oil and gas structure users were combined with estimates of the total number of trips to oil and gas structures to produce estimates of the annual expenditures associated with trips near oil and gas structures for each mode in the four GOM states. Trip and equipment data were evaluated to estimate the economic impact in coastal counties of each state.

Overall, the survey accounted for a total of \$172.9 million in trip related costs for fishing and diving near oil and gas structures in the Gulf states from Alabama through Texas. Of this number, \$13.2 million were trip expenditures for diving with the balance of \$159.7 million associated with trip expenses for recreational fishing.

Annual equipment expenditure data were also collected during the follow-up phone interviews with oil and gas structure users. These data were extrapolated by multiplying the average expenditures for each mode and state times the estimated number of participants using oil and gas structures. Because equipment expenditures may not be solely related to trips to oil and gas structures, the expenditure and corresponding impact estimates may overstate the economic activity generated by fishers and divers who participated in trips near oil and gas structures.

The survey accounted for a total of \$640.0 million in equipment costs associated with recreational fishing and diving activities by those who visited oil or gas structures in the Gulf states from Alabama through Texas during the survey year. Of this number, \$0.6 million was equipment expenditures for diving with the balance associated with equipment expenditures for recreational fishing.

The expenditure data, distributed according to whether the respondent lived in coastal or noncoastal areas and according to the location of the expenditure, were then used in the IMPLAN (Impact analysis for PLANning) input-output modeling framework to produce estimates of economic

impacts generated by oil and gas structure users in each state. These impacts include total output, employment, and personal income (value added) effects in the coastal regions of each state.

This analysis (Table 4.5) indicated that there was a total of \$324.6 million in economic output in coastal counties of the Gulf region associated with fishing and diving activities near oil and gas structures during the year. The value added component of this number was \$164.1 million, with employment estimated at 5,560 full-time equivalents.

Table 4.5. Total economic impact of combined annual trip and equipment expenditures for fishing and diving near oil/gas structures in coastal counties by state and mode.

State	Mode	Economic Output (in\$)	Value Added (in \$)	Employment (in FTEs)
Alabama	private	42,644,863	17,771,068	609.1
	charter	16,853,979	7,860,816	343.0
	party	0	0	0.0,
	dive	287,090	205,600	7.0
	TOTAL	59,785,933	25,837,848	959
Louisiana	private	119,975,000	55,735,257	1,822.5
	charter	3,149,849	1,507,707	75.5
	party	1,431,121	722,706	35.5
	dive	10,367,078	6,928,205	249.3
	TOTAL	134,923,108	64,893,875	2,183
Mississippi	private	24,651,800	14,743,784	459.9
	charter	4,630,674	2,924,368	116.6
	party	0	0	0.0
	dive	2,981,544	1,908,667	56.6
	TOTAL	32,264,018	19,576,820	633
Texas	private	67,882,962	39,657,080	1,167.6
	charter	20,783,038	9,637,829	435.2
	party	8,944,989	4,473,820	182.2
	dive	0	0	0.0
	TOTAL	97,610,989	53,768,348	1,785
Gulf Region	TOTAL	324,584,048	164,076,527	5,560

The third major objective was to estimate incremental expenses associated with recreational fishing and diving that would not have been incurred if anglers had no offshore structure fishing or diving opportunities. In order to estimate this *incremental* effect of oil/gas structures on angler expenditures in the GOM region, it is necessary to account statistically for the variety of factors that may influence these decisions. In evaluating incremental effects, it is important to recognize that statistical procedures can only establish an *association* between expenditures and fishing near oil/gas structures; they can not determine causation.

The sample data indicated that the difference in annual trip and equipment expenditures between users and nonusers of oil and gas structures was \$3,232 per angler across the Gulf region. After correcting for nonnormality in the distribution of expenditures and self-selection in the choice of fishing sites, predicted values from a selection model indicated that the difference in expenditures between the two groups was much smaller. The predicted average expenditures for users were \$4,691 with a 95% confidence interval of \$4,198 to \$5,183. For non-users, predicted average expenditures were \$3,159 with a 95% confidence interval of \$2,721 to \$3,597. The resulting difference of \$1,532 per angler is the most reliable estimate of the difference in annual expenditures between users and non-users of oil and gas structures across the GOM region.

Respondents were asked to provide information on the particular species of fish they were targeting during their fishing trips. There were important differences observed in the results for those who fished near oil and gas structures and those who did not. As shown in Table 4.6, those fishing near oil and gas structures were somewhat more likely to report they were fishing for Red Snapper and King Mackerel. Those not fishing near such structures were more likely to list Spotted Seatrout and Red Drum as their target species.

Table 4.6. Target species for fishermen.

Fishing Near Oil/Gas Structure		Not Fishing Near Oil/Gas Structure	
Target Species	Percent	Target Species	Percent
Spotted Seatrout	29.6	Spotted Seatrout	45.8
Red Snapper	28.1	Red Drum	26.8
King Mackerel	20.3	Southern Flounder	7.6
Cobia	5.1	Sand Seatrout	2.3
Red Drum	4.9	Spanish Mackerel	2.3

Information was also obtained on actual catch of fish by the respondents. These data are reported separately for those who fished near oil and gas structures in Tables 4.7 through 4.10. In general, it can be observed that the particular species caught were somewhat different for those fishing near structures, but the numbers of total fish caught were relatively comparable.

Table 4.7. Average catch per trip for selected species: Private boats in Alabama.

Species	Near Structure	Not Near Structure
Silver Seatrout	1.85	2.26
Red Snapper	0.98	1.08
S. Mackerel	1.18	0.64
Red Drum	0.69	0.21
Bluefish	2.26	0.20
Total	12.02	7.51

Table 4.8. Average catch per trip for selected species: Private boats in Mississippi.

Species	Near Structure	Not Near Structure
Red Snapper	2.78	0.24
K.Mackerel	1.04	0.01
Cobia	0.38	0.02
Spotted Seatrout	0.37	1.80
Sand Seatrout	0.32	6.01
Total	6.95	10.88

Table 4.9. Average catch per trip for selected species: Private boats in Louisiana.

Species	Near Structure	Not Near Structure
Spotted Seatrout	5.80	5.99
Red Snapper	1.49	0.01
Sand Seatrout	0.99	0.71
Red Drum	0.77	1.86
Hardhead Catfish	0.59	1.01
Total	12.79	13.40

Table 4.10. Average catch per trip for selected species: Private boats in Texas.

Species	Near Structure	Not Near Structure
Red Snapper	5.05	0.34
K.Mackerel	0.77	0.04
Atlantic Spadefish	0.22	0.00
Spotted Seatrout	0.19	2.55
Sand Seatrout	0.08	1.77
Total	8.23	8.43

DISCUSSION

The results of the surveys of recreational fishermen and divers strongly indicated that the availability of oil and gas structures as well as artificial reefs created from such structures are extremely important to the coastal counties of the Gulf states. Of the 4.5 million recreational fishing trips estimated in the Gulf states from Alabama through Texas in 1999, 21.9% of them were within 300 feet of an oil or gas structure. Of the 83,780 estimated diving trips, 93.6% were within 300 feet of such a structure.

The results also indicated that multiple structures were generally visited during these recreational trips. On average, more than two structures were visited per trip, with the total annual structure-visits estimated at 2.2 million annually.

The economic activity associated with these visits was substantial. According to the analyses performed, there were \$172.9 million in direct expenditures during 1999 associated with recreational visits to oil and gas structures in the Gulf states plus another \$640.0 million in annual equipment-related expenditures. The total economic output in coastal associated with recreational fishing and diving near oil and gas structures in the Gulf was \$324.6 million, including \$164.1 million in the value added component and employment estimated at 5,560 full time equivalents.

An analysis of the incremental value of oil and gas structures for recreational activities indicated that the typical angler who visited such structures spent more than those who did not. The most reliable estimate is that anglers who visited oil and gas structures spent an additional \$1,532 annually.

In summary, it can be concluded as a result of this study that there is substantial recreational activity associated with the presence of oil and gas structures in the GOM from Alabama through Texas and these activities have a substantial economic impact. Several issues are raised by these findings:

- Because the presence of oil and gas structures is important to recreational fishing and diving in the Gulf, consideration should be given to assuring the continued availability of at least some of these structures across the range of the Gulf Coast area, even after they are no longer used for oil or gas extraction.
- Decisions on structure removal must take into account the effects on recreational activities and the economic value they represent. It is uncertain how fishermen and divers would respond to the removal of oil and gas structures that are targets of frequent visits. If participants simply went to other locations, then the impact would be minimal. The decision to fish and dive at other places, however, may be a complex one involving such factors as distance from shore, size of structure, number of other participants at the location (i.e., crowdedness), and availability of acceptable alternatives (both at other structures and at nonstructure locations). It is possible that structure removal would result in reduced demand with a corresponding negative economic impact.
- Fishing and diving occur at oil and gas structures in large part because of the availability of marine life near such structures. While beyond the scope of the present study and not included in this report, preliminary indications from the surveys indicated that fishing success, particularly for preferred species, near oil and gas structures was at least equal to and in many cases greater than at other locations. There is, therefore, the question of the effect on marine life of the removal of structures that have been in place for decades. It is likely that any loss of marine life, or at least a reduction in its density such that fishing or diving is no longer rewarding, would have a negative impact on recreational fishing and diving coupled with the loss of economic value associated with those activities.
- The process by which fishermen and divers select the specific oil and gas structures to visit is not understood. Both the incremental value which was established in this research and the fact that fishermen and divers visit multiple structures on each trip suggest that there is a decision process which underlies the selection of particular structures for recreational activities. If a decision about removal of a specific structure is being considered, it would be extremely useful to have in hand a set of variables which are known to be associated with structure recreational usage. These might include such elements as ease of access, distance from shore, distance from boat launch sites, water depth, size and configuration of structure, history of “success” at the site, perceptions of safety, availability of recreational alternatives, and site popularity. Without an understanding of the variables that affect participants’ decisions to use a particular site, decisions on structure removal cannot fully take into account the needs of recreational fishermen and divers.
- It is important that government and private interests develop and utilize decision-making processes for structure removal that include consideration of the needs of recreational fishermen and divers. Fishing and diving interests across the Gulf should be kept informed about the processes of structure removal and given opportunity to participate in such decisions. There is considerable potential for local opposition to removal of popular fishing and diving sites, especially if there are no alternatives available.

- Additional research may be required to answer questions raised by the current study:
 - How many oil and gas structures can be removed in a particular area without resulting in a decline in the number of recreational fishing and diving trips being taken?
 - Which of the existing structures, if any, are most frequently visited by fishermen and divers for their recreational activities?
 - What are the characteristics of the most preferred structures?
 - In the event of selective removal of oil and gas structures, how will the behavior of fishermen and divers change? Will they shift to other available structures, to nonstructure locations, or withdraw from the activity?

<p style="text-align: center;">Economic Impact of Recreational Fishing and Diving Associated with Offshore Oil and Gas Structures in the Gulf of Mexico</p> <p> Robert L. Hiett J. Walter Milon <small><i>Quantitative Technologies for Research and Analysis</i></small></p>	<p>Project Objectives</p> <ul style="list-style-type: none"> • Estimate Demand • Determine Economic Impacts • Evaluate Incremental Expenses
<p>Scope of Study</p> <ul style="list-style-type: none"> • Gulf of Mexico from Alabama through Texas • January through December 1999 • Private Boat Fishermen • Charter Fishermen • Party Boat Fishermen • Recreational Divers 	<p>Study Approach</p> <ul style="list-style-type: none"> • On-site field interviews with fishermen and divers returning from their trips • Follow-up telephone interviews with fishermen and divers who did and did not visit oil and gas structures • Expansion of data using NMFS and state projections • Economic analysis using IMPLAN

<p>Completed Interviews</p> <table border="1"> <thead> <tr> <th></th> <th>Private Boat</th> <th>Charter Boat</th> <th>Party Boat</th> <th>Divers</th> <th>Total</th> </tr> </thead> <tbody> <tr> <td>Field</td> <td>6,845</td> <td>1,287</td> <td>378</td> <td>150</td> <td>8,660</td> </tr> <tr> <td>Follow-Up</td> <td>609</td> <td>167</td> <td>37</td> <td>26</td> <td>839</td> </tr> </tbody> </table>		Private Boat	Charter Boat	Party Boat	Divers	Total	Field	6,845	1,287	378	150	8,660	Follow-Up	609	167	37	26	839	<p>Method of Data Expansion</p> <ul style="list-style-type: none"> • Used MRFSS for private and charter boats (Alabama through Louisiana) • Used NMFS data for party boats • Used state data for Texas • Used incidence of divers from private boat survey to estimate total dive trips 																									
	Private Boat	Charter Boat	Party Boat	Divers	Total																																							
Field	6,845	1,287	378	150	8,660																																							
Follow-Up	609	167	37	26	839																																							
<p>Total Gulf Trips</p> <table border="1"> <thead> <tr> <th></th> <th>Private Boat</th> <th>Charter Boat</th> <th>Party Boat</th> <th>Dive Trips</th> </tr> </thead> <tbody> <tr> <td>AL</td> <td>505,635</td> <td>71,394</td> <td>15,386</td> <td>11,124</td> </tr> <tr> <td>MS</td> <td>507,545</td> <td>49,426</td> <td>0</td> <td>11,166</td> </tr> <tr> <td>LA</td> <td>2,067,076</td> <td>73,770</td> <td>7,913</td> <td>45,476</td> </tr> <tr> <td>TX</td> <td>986,250</td> <td>103,433</td> <td>96,252</td> <td>21,698</td> </tr> </tbody> </table>		Private Boat	Charter Boat	Party Boat	Dive Trips	AL	505,635	71,394	15,386	11,124	MS	507,545	49,426	0	11,166	LA	2,067,076	73,770	7,913	45,476	TX	986,250	103,433	96,252	21,698	<p>Fishing Near Oil/Gas Structures: Private Boats</p> <table border="1"> <thead> <tr> <th></th> <th>Percent</th> <th>Total Trips</th> </tr> </thead> <tbody> <tr> <td>AL</td> <td>41.4</td> <td>209,333</td> </tr> <tr> <td>MS</td> <td>19.7</td> <td>99,986</td> </tr> <tr> <td>LA</td> <td>16.6</td> <td>343,135</td> </tr> <tr> <td>TX</td> <td>17.3</td> <td>170,621</td> </tr> <tr> <td>Total</td> <td>20.2</td> <td>823,075</td> </tr> </tbody> </table>		Percent	Total Trips	AL	41.4	209,333	MS	19.7	99,986	LA	16.6	343,135	TX	17.3	170,621	Total	20.2	823,075
	Private Boat	Charter Boat	Party Boat	Dive Trips																																								
AL	505,635	71,394	15,386	11,124																																								
MS	507,545	49,426	0	11,166																																								
LA	2,067,076	73,770	7,913	45,476																																								
TX	986,250	103,433	96,252	21,698																																								
	Percent	Total Trips																																										
AL	41.4	209,333																																										
MS	19.7	99,986																																										
LA	16.6	343,135																																										
TX	17.3	170,621																																										
Total	20.2	823,075																																										
<p>Fishing Near Oil/Gas Structures: Charter Boats</p> <table border="1"> <thead> <tr> <th></th> <th>Percent</th> <th>Total Trips</th> </tr> </thead> <tbody> <tr> <td>AL</td> <td>21.0</td> <td>14,993</td> </tr> <tr> <td>MS</td> <td>21.7</td> <td>10,725</td> </tr> <tr> <td>LA</td> <td>23.1</td> <td>17,041</td> </tr> <tr> <td>TX</td> <td>51.8</td> <td>53,578</td> </tr> <tr> <td>Total</td> <td>32.3</td> <td>96,337</td> </tr> </tbody> </table>		Percent	Total Trips	AL	21.0	14,993	MS	21.7	10,725	LA	23.1	17,041	TX	51.8	53,578	Total	32.3	96,337	<p>Fishing Near Oil/Gas Structures: Party Boats</p> <table border="1"> <thead> <tr> <th></th> <th>Percent</th> <th>Total Trips</th> </tr> </thead> <tbody> <tr> <td>AL</td> <td>0.0</td> <td>0</td> </tr> <tr> <td>MS</td> <td>0.0</td> <td>0</td> </tr> <tr> <td>LA</td> <td>100.0</td> <td>7,913</td> </tr> <tr> <td>TX</td> <td>55.0</td> <td>52,939</td> </tr> <tr> <td>Total</td> <td>50.9</td> <td>60,852</td> </tr> </tbody> </table>		Percent	Total Trips	AL	0.0	0	MS	0.0	0	LA	100.0	7,913	TX	55.0	52,939	Total	50.9	60,852							
	Percent	Total Trips																																										
AL	21.0	14,993																																										
MS	21.7	10,725																																										
LA	23.1	17,041																																										
TX	51.8	53,578																																										
Total	32.3	96,337																																										
	Percent	Total Trips																																										
AL	0.0	0																																										
MS	0.0	0																																										
LA	100.0	7,913																																										
TX	55.0	52,939																																										
Total	50.9	60,852																																										

<h3 style="text-align: center;">Diving Near Oil/Gas Structures</h3> <table border="1" style="width: 100%; border-collapse: collapse;"> <thead> <tr> <th></th> <th style="text-align: center;">Percent</th> <th style="text-align: center;">Total Trips</th> </tr> </thead> <tbody> <tr> <td>AL</td> <td style="text-align: center;">48.9</td> <td style="text-align: center;">5,440</td> </tr> <tr> <td>MS</td> <td style="text-align: center;">100.0</td> <td style="text-align: center;">11,166</td> </tr> <tr> <td>LA</td> <td style="text-align: center;">100.0</td> <td style="text-align: center;">45,476</td> </tr> <tr> <td>TX</td> <td style="text-align: center;">100.0</td> <td style="text-align: center;">21,698</td> </tr> <tr> <td>Total</td> <td style="text-align: center;">93.6</td> <td style="text-align: center;">83,780</td> </tr> </tbody> </table>		Percent	Total Trips	AL	48.9	5,440	MS	100.0	11,166	LA	100.0	45,476	TX	100.0	21,698	Total	93.6	83,780	<h3 style="text-align: center;">Total Structures Visited Per Trip</h3> <table border="1" style="width: 100%; border-collapse: collapse;"> <thead> <tr> <th></th> <th style="text-align: center;">Private Boats</th> <th style="text-align: center;">Charter Boat</th> <th style="text-align: center;">Party Boats</th> <th style="text-align: center;">Dive Trips</th> </tr> </thead> <tbody> <tr> <td>AL</td> <td style="text-align: center;">1.19</td> <td style="text-align: center;">1.24</td> <td style="text-align: center;">-</td> <td style="text-align: center;">1.5</td> </tr> <tr> <td>MS</td> <td style="text-align: center;">1.37</td> <td style="text-align: center;">1.18</td> <td style="text-align: center;">-</td> <td style="text-align: center;">2.24</td> </tr> <tr> <td>LA</td> <td style="text-align: center;">3.01</td> <td style="text-align: center;">2.57</td> <td style="text-align: center;">3.37</td> <td style="text-align: center;">2.10</td> </tr> <tr> <td>TX</td> <td style="text-align: center;">2.10</td> <td style="text-align: center;">2.21</td> <td style="text-align: center;">2.03</td> <td style="text-align: center;">2.00</td> </tr> </tbody> </table>		Private Boats	Charter Boat	Party Boats	Dive Trips	AL	1.19	1.24	-	1.5	MS	1.37	1.18	-	2.24	LA	3.01	2.57	3.37	2.10	TX	2.10	2.21	2.03	2.00
	Percent	Total Trips																																										
AL	48.9	5,440																																										
MS	100.0	11,166																																										
LA	100.0	45,476																																										
TX	100.0	21,698																																										
Total	93.6	83,780																																										
	Private Boats	Charter Boat	Party Boats	Dive Trips																																								
AL	1.19	1.24	-	1.5																																								
MS	1.37	1.18	-	2.24																																								
LA	3.01	2.57	3.37	2.10																																								
TX	2.10	2.21	2.03	2.00																																								
<h3 style="text-align: center;">Economic and Fiscal Impacts Modeling Strategy</h3> <ul style="list-style-type: none"> ● IMPLAN – 528 sector impact models available for each state ● Model can be used for any categorization of impacted area: county (parish), SMSA, or groups of counties (coastal/noncoastal) ● Output, employment, and income multipliers by sector and area categorization 	<h3 style="text-align: center;">Structure-Related Recreation: Output, Employment, and Income</h3> $\left(\begin{matrix} \text{Average} \\ \text{Annual} \\ \text{Expenditures} \\ \text{by} \\ \text{Sector }_{ijk} \end{matrix} \right) \times \left(\begin{matrix} \text{Total} \\ \text{Number} \\ \text{of} \\ \text{Users }_{ij} \end{matrix} \right) \times \left(\begin{matrix} \text{Economic} \\ \text{impact} \\ \text{Multiplier }_{jk} \end{matrix} \right)$ <p style="text-align: center;"> <i>i</i> = usergroup <i>j</i> = state (county) <i>k</i> = industry sector </p>																																											
<h3 style="text-align: center;">IMPLAN Industry Sectors and Related Expense Categories</h3> <table border="1" style="width: 100%; border-collapse: collapse;"> <thead> <tr> <th style="text-align: left;">IMPLAN Sector</th> <th style="text-align: left;">Expense Category</th> </tr> </thead> <tbody> <tr> <td>xxx-Charter/Party Boat</td> <td>Charter/Party Fees</td> </tr> <tr> <td>357-Motors and Generators</td> <td>Motors</td> </tr> <tr> <td>383-Electrical Equipment, N.E.C.</td> <td>Auxillary Equipment</td> </tr> <tr> <td>393-Boat Building and Repairing</td> <td>Boats</td> </tr> <tr> <td>399-Transportation Equipment, N.E.C.</td> <td>Trailers</td> </tr> </tbody> </table>	IMPLAN Sector	Expense Category	xxx-Charter/Party Boat	Charter/Party Fees	357-Motors and Generators	Motors	383-Electrical Equipment, N.E.C.	Auxillary Equipment	393-Boat Building and Repairing	Boats	399-Transportation Equipment, N.E.C.	Trailers	<h3 style="text-align: center;">IMPLAN Industry Sectors and Related Expense Categories (Continued)</h3> <table border="1" style="width: 100%; border-collapse: collapse;"> <thead> <tr> <th style="text-align: left;">IMPLAN Sector</th> <th style="text-align: left;">Expense Category</th> </tr> </thead> <tbody> <tr> <td>421-Sporting and Athletic Goods, N.E.C.</td> <td>Baits Tackles Other Rentals Rods and Reels Lines Lures Other Fishing Equipment Camping Equipment Boat Outfitting-Diving Dive Equipment Other Dive Equipment Boat Outfitting-</td> </tr> </tbody> </table>	IMPLAN Sector	Expense Category	421-Sporting and Athletic Goods, N.E.C.	Baits Tackles Other Rentals Rods and Reels Lines Lures Other Fishing Equipment Camping Equipment Boat Outfitting-Diving Dive Equipment Other Dive Equipment Boat Outfitting-																											
IMPLAN Sector	Expense Category																																											
xxx-Charter/Party Boat	Charter/Party Fees																																											
357-Motors and Generators	Motors																																											
383-Electrical Equipment, N.E.C.	Auxillary Equipment																																											
393-Boat Building and Repairing	Boats																																											
399-Transportation Equipment, N.E.C.	Trailers																																											
IMPLAN Sector	Expense Category																																											
421-Sporting and Athletic Goods, N.E.C.	Baits Tackles Other Rentals Rods and Reels Lines Lures Other Fishing Equipment Camping Equipment Boat Outfitting-Diving Dive Equipment Other Dive Equipment Boat Outfitting-																																											

IMPLAN Industry Sectors and Related Expense Categories (Continued)

IMPLAN Sector	Expense Category
441-Communications, Except Radio and TV	Books
450-Food Stores	Groceries
451-Automotive Dealers and Service Stations	Transportation Gasoline
4512-Apparel & Accessory Stores	Fuel Costs
454-Eating and Drinking	Clothing
455-Miscellaneous Retail	Food Stuffs (Restaurants and Bars)
	Other Trip Expenses

IMPLAN Industry Sectors and Related Expense Categories (Continued)

IMPLAN Sector	Expense Category
463-Hotels/Lodging	Lodging Costs
477-Car Rental/Leasing	Car Rental
488-Amusement and Recreation Services, N.E.C.	Boat Rental
	Launch Fees
	Docking Fees
	Trip Repairs
	Dive Fees
	Guide Fees
	Capital Repairs
	Air Fees
489-Sports/Recreation Membership	Dive Lessons
	Membership
523-State/Local Govt	Fishing Licenses
	Licenses

Total Economic Impact: Alabama

Mode	Economic Output (In \$)	Value Added (In \$)	Employment (In FTE)
PR	42,644,863	17,771,068	609.1
CH	16,853,979	7,860,816	343.0
PB	0	0	0.0
Dive	287,090	205,600	7.0
Total	59,785,933	25,837,484	959.0

Total Economic Impact: Louisiana

Mode	Economic Output (In \$)	Value Added (In \$)	Employment (In FTE)
PR	119,975,060	55,735,257	1,822.5
CH	3,149,849	1,507,707	75.5
PB	1,431,121	722,706	35.5
Dive	10,367,078	6,928,205	249.3
Total	34,923,108	4,893,875	2,183.0

Total Economic Impact: Mississippi

Mode	Economic Output (In \$)	Value Added (In \$)	Employment (In FTE)
PR	24,651,800	14,743,784	459.9
CH	4,630,674	2,924,368	116.6
PB	0	0	0.0
Dive	2,981,544	1,908,667	56.6
Total	32,264,018	19,576,820	33.0

Total Economic Impact: Texas

Mode	Economic Output (In \$)	Value Added (In \$)	Employment (In FTE)
PR	67,882,962	39,657,080	1,167.6
CH	20,783,038	9,637,829	435.2
PB	,944,989	4,473,439	182.2
Dive	0	0	0.0
Total	97,610,989	53,768,348	1,785.0

<p>Total Economic Impact: Gulf</p> <table border="1"> <thead> <tr> <th>Mode</th> <th>Economic Output (In \$)</th> <th>Value Added (In \$)</th> <th>Employment (In FTE)</th> </tr> </thead> <tbody> <tr> <td>PR</td> <td>255,154,685</td> <td>127,907,189</td> <td>4,059.1</td> </tr> <tr> <td>CH</td> <td>45,417,540</td> <td>21,930,720</td> <td>970.3</td> </tr> <tr> <td>PB</td> <td>10,376,110</td> <td>5,196,145</td> <td>217.7</td> </tr> <tr> <td>Dive</td> <td>13,635,712</td> <td>9,042,472</td> <td>312.9</td> </tr> <tr> <td>Total</td> <td>324,584,048</td> <td>164,076,527</td> <td>5,560.0</td> </tr> </tbody> </table>	Mode	Economic Output (In \$)	Value Added (In \$)	Employment (In FTE)	PR	255,154,685	127,907,189	4,059.1	CH	45,417,540	21,930,720	970.3	PB	10,376,110	5,196,145	217.7	Dive	13,635,712	9,042,472	312.9	Total	324,584,048	164,076,527	5,560.0	<p>Incremental Effects of Structures on Fishing Expenditures</p> <ul style="list-style-type: none"> • Effects of structures on fishing expenditures must consider variety of factors that influence expenditure decisions. • Expenditures by users and nonusers cannot simply be compared • Methodology developed to account for self-selection in structure use decisions due to target species preference, residency status, and prior investments in boating/fishing equipment. • Results indicate that structure users annually spend about \$1,532 more than nonusers, but this difference varies from a low of \$719 in Texas to \$5,446 in Mississippi. 																		
Mode	Economic Output (In \$)	Value Added (In \$)	Employment (In FTE)																																								
PR	255,154,685	127,907,189	4,059.1																																								
CH	45,417,540	21,930,720	970.3																																								
PB	10,376,110	5,196,145	217.7																																								
Dive	13,635,712	9,042,472	312.9																																								
Total	324,584,048	164,076,527	5,560.0																																								
<p>Target Species</p> <table border="1"> <thead> <tr> <th><u>Near Structure</u></th> <th><u>Not Near Structure</u></th> </tr> </thead> <tbody> <tr> <td>Spotted Seatrout (29.6%)</td> <td>Spotted Seatrout (45.8%)</td> </tr> <tr> <td>Red Snapper (28.1%)</td> <td>Red Drum (26.8%)</td> </tr> <tr> <td>King Mackerel (20.3 %)</td> <td>Southern Flounder (7.6%)</td> </tr> <tr> <td>Cobia (5.1 %)</td> <td>Sand Seatrout (2.3%)</td> </tr> <tr> <td>Red Drum (4.9%)</td> <td>Spanish Mackerel (2.3%)</td> </tr> </tbody> </table>	<u>Near Structure</u>	<u>Not Near Structure</u>	Spotted Seatrout (29.6%)	Spotted Seatrout (45.8%)	Red Snapper (28.1%)	Red Drum (26.8%)	King Mackerel (20.3 %)	Southern Flounder (7.6%)	Cobia (5.1 %)	Sand Seatrout (2.3%)	Red Drum (4.9%)	Spanish Mackerel (2.3%)	<p>Average Catch/Trip: Alabama Private Boats</p> <table border="1"> <thead> <tr> <th></th> <th>Near Structure</th> <th>Not Near Structure</th> </tr> </thead> <tbody> <tr> <td>Silver Seatrout</td> <td>1.85</td> <td>2.26</td> </tr> <tr> <td>Red Snapper</td> <td>0.98</td> <td>1.08</td> </tr> <tr> <td>S. Mackerel</td> <td>1.18</td> <td>0.64</td> </tr> <tr> <td>Red Drum</td> <td>0.69</td> <td>0.21</td> </tr> <tr> <td>Bluefish</td> <td>2.26</td> <td>0.20</td> </tr> <tr> <td>Total</td> <td>12.02</td> <td>7.51 (.0001)</td> </tr> </tbody> </table>		Near Structure	Not Near Structure	Silver Seatrout	1.85	2.26	Red Snapper	0.98	1.08	S. Mackerel	1.18	0.64	Red Drum	0.69	0.21	Bluefish	2.26	0.20	Total	12.02	7.51 (.0001)									
<u>Near Structure</u>	<u>Not Near Structure</u>																																										
Spotted Seatrout (29.6%)	Spotted Seatrout (45.8%)																																										
Red Snapper (28.1%)	Red Drum (26.8%)																																										
King Mackerel (20.3 %)	Southern Flounder (7.6%)																																										
Cobia (5.1 %)	Sand Seatrout (2.3%)																																										
Red Drum (4.9%)	Spanish Mackerel (2.3%)																																										
	Near Structure	Not Near Structure																																									
Silver Seatrout	1.85	2.26																																									
Red Snapper	0.98	1.08																																									
S. Mackerel	1.18	0.64																																									
Red Drum	0.69	0.21																																									
Bluefish	2.26	0.20																																									
Total	12.02	7.51 (.0001)																																									
<p>Average Catch/Trip: Mississippi Private Boats</p> <table border="1"> <thead> <tr> <th></th> <th>Near Structure</th> <th>Not Near Structure</th> </tr> </thead> <tbody> <tr> <td>Red Snapper</td> <td>2.78</td> <td>0.24</td> </tr> <tr> <td>K.Mackerel</td> <td>1.04</td> <td>0.01</td> </tr> <tr> <td>Cobia</td> <td>0.38</td> <td>0.02</td> </tr> <tr> <td>Spotted Seatrout</td> <td>0.37</td> <td>1.80</td> </tr> <tr> <td>Sand Seatrout</td> <td>0.32</td> <td>6.01</td> </tr> <tr> <td>Total</td> <td>6.95</td> <td>10.88 (.0001)</td> </tr> </tbody> </table>		Near Structure	Not Near Structure	Red Snapper	2.78	0.24	K.Mackerel	1.04	0.01	Cobia	0.38	0.02	Spotted Seatrout	0.37	1.80	Sand Seatrout	0.32	6.01	Total	6.95	10.88 (.0001)	<p>Average Catch/Trip: Louisiana Private Boats</p> <table border="1"> <thead> <tr> <th></th> <th>Near Structure</th> <th>Not Near Structure</th> </tr> </thead> <tbody> <tr> <td>Spotted Seatrout</td> <td>5.80</td> <td>5.99</td> </tr> <tr> <td>Red Snapper</td> <td>1.49</td> <td>0.01</td> </tr> <tr> <td>Sand Seatrout</td> <td>0.99</td> <td>0.71</td> </tr> <tr> <td>Red Drum</td> <td>0.77</td> <td>1.86</td> </tr> <tr> <td>Hardhead Cat</td> <td>0.59</td> <td>1.01</td> </tr> <tr> <td>Total</td> <td>12.79</td> <td>13.40 (n.s.)</td> </tr> </tbody> </table>		Near Structure	Not Near Structure	Spotted Seatrout	5.80	5.99	Red Snapper	1.49	0.01	Sand Seatrout	0.99	0.71	Red Drum	0.77	1.86	Hardhead Cat	0.59	1.01	Total	12.79	13.40 (n.s.)
	Near Structure	Not Near Structure																																									
Red Snapper	2.78	0.24																																									
K.Mackerel	1.04	0.01																																									
Cobia	0.38	0.02																																									
Spotted Seatrout	0.37	1.80																																									
Sand Seatrout	0.32	6.01																																									
Total	6.95	10.88 (.0001)																																									
	Near Structure	Not Near Structure																																									
Spotted Seatrout	5.80	5.99																																									
Red Snapper	1.49	0.01																																									
Sand Seatrout	0.99	0.71																																									
Red Drum	0.77	1.86																																									
Hardhead Cat	0.59	1.01																																									
Total	12.79	13.40 (n.s.)																																									

Average Catch/Trip:
Texas Private Boats

	Near Structure	Not Near Structure
Red Snapper	5.05	0.34
K.Mackerel	0.77	0.04
Atlantic Spadefish	0.22	0.00
Spotted Seatrout	0.19	2.55
Sand Seatrout	0.08	1.77
Total	8.23	8.43 (n.s.)

Conclusions

- Oil/Gas Structures Important to Recreational Fishing and Diving in Terms of Demand and Economic Impact
- Considerable Potential for Local Opposition to Structure Removal
- Appropriate Criteria for Structure Removal Must Be Developed Which Take Recreational Fishing and Diving Needs into Account

IMPORTANCE OF GEOLOGY TO FISHERIES MANAGEMENT: EXAMPLES FROM THE NORTHEASTERN GULF OF MEXICO

Kathryn M. Scanlon
U.S. Geological Survey

Christopher C. Koenig
Felicia C. Coleman
Florida State University

Margaret Miller
National Marine Fisheries Service

ABSTRACT

Seafloor mapping of shelf-edge habitats in the northeastern Gulf of Mexico (GOM) demonstrates how sidescan-sonar imagery, seismic-reflection profiling, video data, geologic mapping, sediment sampling, and understanding the regional geologic history can enhance, support, and guide traditional fisheries research and management. New data from the Madison-Swanson and Steamboat Lumps Marine Protected Areas (MPAs) reveal complex benthic habitats consisting of high-relief calcareous pinnacles, low-relief karstic hard-bottom, rocky outcrops several kilometers in length, and variable thickness of fine-grained and apparently mobile coarse-grained sediments. Our data also show that certain fish alter the landscape by clearing sediment from hard-bottom areas (e.g., red grouper, *Epinephelus morio*) and by burrowing extensively in fine-grained sediment (e.g., tilefish, *Lopholatilus chamaeleonticeps*).

The seafloor imagery and geologic maps show that (a) sea-level fluctuations played a dominant role in the development of the present day regional geology and (b) habitats (and benthic communities) are closely tied to geologic character. Understanding the geological setting allowed for efficient and representative sampling of the biology. The geologic data can be used to set meaningful boundaries for fishery reserves and to help predict habitats in areas that are not well mapped. This interdisciplinary work added value to traditional research disciplines by providing management with integrated tools to make better decisions.

INTRODUCTION

Why should marine biologists and fishery managers care about sidescan-sonar mosaics, geologic maps, and the geologic history of a region? They should care because fishery resources do not exist in a vacuum. Habitat is crucial to the viability of the resource, and geology is the framework within which the habitat exists. Many modern marine geology tools, techniques, and interpretations have great value to fisheries management, but they are often overlooked by scientists trained in non-geological specialties. Our work in the northeastern GOM shelf-edge habitats demonstrates how sidescan-sonar imagery, seismic-reflection profiling, geologic mapping, and understanding the

regional geologic history can enhance, support, or guide traditional fisheries research and management.

TOOLS OF MARINE GEOLOGY

Some commonly used marine geological research tools (such as sidescan-sonar, multibeam bathymetry, seismic reflection profiling, and sediment sampling) are directly useful to marine biologists and fishery managers.

Sidescan-Sonar

Sidescan-sonar systems use sound to provide aerial-photograph-like acoustic imagery swaths of the seafloor. When collected, processed and mosaicked properly, these systems are perhaps the most useful geologic tool for fisheries management and research. There are many types of sidescan-sonar systems with varying resolutions and optimized for a variety of water-depth ranges. In each case, a trade-off must be made between resolution and the area covered in a given amount of time. For habitat mapping in shelf-edge areas (water depths 50 to 150 meters), we have found systems such as the SIS 1000^{*****} and the EdgeTech DF1000^{*} to be a good compromise. In about seven days, these instruments can cover a 100-square-mile area with enough overlap of adjacent swaths for mosaicking. They can resolve features such as boulders and burrows as small as 1 meter across. Elongate features, such as trawl marks, also show even if they are less than a meter across, because they are long in one dimension.

Repeated sidescan-sonar surveys can show changes in seafloor character and habitat. This technique can be used to monitor changes in the areal extent of certain types of habitat after an event such as a storm or closure to fishing. These surveys are also useful in assessing impact from human activities such as bottom trawling or waste disposal.

Multibeam Bathymetry

Multibeam bathymetry systems collect swaths of water-depth data, which can be used to create bathymetric contour maps. Like sidescan-sonar systems, multibeam systems are available in a wide variety of resolutions and for various water-depth ranges. These data can be used for three-dimensional renderings of seafloor morphology. Software has been developed for some multibeam systems to allow creation of backscatter maps, similar to sidescan-sonar imagery, as well as depth contour maps. Backscatter gives information about the seafloor that is not contained in the depth information, such as hardness, sediment texture, and surface roughness. Multibeam data can be much more expensive to collect than sidescan-sonar and sometimes requires a dedicated ship. We have not collected multibeam data in the northeastern GOM, but proposals are pending to do so in the near future.

Seismic-Reflection Profiles

***** Use of trade names is for descriptive purposes only and does not imply endorsement by the U.S. Geological Survey.

Seismic-reflection profilers provide a cross-sectional view of the seafloor and the sediment and rock layers beneath it. Higher-frequency sound sources result in higher-resolution profiles; lower-frequency sources penetrate more deeply into the substrate but provide less resolution. Seismic profiles reveal the shapes of and relationships between past seafloor environments. This information is invaluable to understanding the geologic history of a region. It also has direct utility to habitat studies because it allows us to map the thickness of unconsolidated sediment. In the eastern GOM, for example, this is important because hard-bottom habitat can be exposed or buried by variable amounts of mobile sediment, thereby changing the distribution of habitats through time.

Sampling

Sediment sampling can be carried out remotely from a ship with a grab sampler or directly by divers or submarine. Representative sediment or rock samples must be collected from a study area to adequately characterize a habitat. Sampling is also a critical “ground truth” for interpreting sidescan-sonar data. Differences in sediment composition and texture and the presence and roughness of rock outcrops are among the factors that can affect the intensity of backscatter signal in sidescan-sonar data. These factors also have a direct effect on the biological community that will inhabit an area.

Putting It All Together: Mapping

Although mapping is not, strictly speaking, a “tool,” maps produce visualizations that are used to further our understanding of the geologic history of an area. Mapping of the surficial geology of the seafloor is done by combining interpretation of the sidescan mosaics and seismic profiles with analyses of sediment and rock samples and observations from ROV or submarine. These maps provide, for example, the areal extents of sediment of different compositions and hard-bottom habitats, and are valuable for determining percentages of various habitat types as well as for setting the boundaries of fishery management reserves.

GEOLOGIC HISTORY AS A FISHERY MANAGEMENT TOOL

While the utility of the traditionally “geologic” tools discussed above for fishery management applications is straightforward, fisheries managers may not understand why the geologic history of a region is important. Beyond the direct uses to fisheries management discussed here these types of geologic data can be used to provide an understanding of the geologic evolution of an area through time. Although fisheries management is rooted in the present and affects the future, the past can be a valuable key to more effective and less expensive management.

A Case History

In March 2000, we collected sidescan-sonar data in the Madison and Swanson MPA and the Steamboat Lumps MPA and in 1997 in an intervening area we call Twin Ridges. In each case the sidescan swaths overlap, providing continuous coverage. Using near-real-time processing and mosaicking techniques developed at the USGS Woods Hole Field Center (Danforth 1997; Danforth *et al.* 1991, Paskevich 1992 and 1996), digital mosaics were available within 24 hours to use for fish

sampling and siting of video observations. This information provided for more accurate positioning of the ship, saved time, and most importantly, allowed selection of specific habitat types for station work.

Using these sidescan-sonar data in conjunction with seismic-reflection profiles, sediment and rock samples (which give information about past environments of deposition and age) and direct or video observations, we are now reconstructing the evolution of the shelf-edge habitats through time. We discovered several long arcuate rocky ridges in 60 to 90 meters of water (Scanlon 2000). Previous work (Locker *et al.* 1996) has shown that about 15,000 years ago sea level was 80 meters lower than it is today. This sea level history has played an important role in the evolution of the West Florida continental shelf (e.g., Doyle and Holmes 1985; Hine *et al.* 1988; Hine 1997; Mullins *et al.* 1988; Roberts *et al.* 1999). We interpret our rocky ridges to be the lithified remains of paleo-beaches, called beachrock, from this sea level lowstand (Scanlon 2000; Thieler *et al.* 1999). Seaward of the beachrock outcrops, we found limestone pinnacles, which may be built on drowned patch reefs. The beachrock and the limestone pinnacles differ not only in the chemical composition of the rocks themselves and the surrounding sediments derived from them but also in the morphology of the outcrops. Beachrock is cemented sandstone and tends to occur in tabular slabs with widely spaced cracks and crevices. The limestone pinnacles are composed of agglomerations of numerous species of coral and algae and the remains of many sessile and encrusting benthic organisms. The limestone has dissolved and has been bored by clams and other organisms. These outcrops are replete with nooks and crannies and holes of all sizes and shapes.

Each of these two rock types (beachrock and pinnacle limestone) afford distinct types of habitat and can be expected to support distinct benthic communities. Gag (*Mycteroperca microlepis*) and scamp (*Mycteroperca phenax*) are known to spawn near high-relief outcrops at the edge of the present continental shelf (Coleman *et al.* 1996; Koenig *et al.* 2000). We do not yet know whether they prefer beachrock or limestone pinnacle sites, but our on-going studies should reveal this. These beachrock and limestone pinnacle sites are distinctive features associated with changes in sea level and are expected to be widespread in the GOM near the shelf edge. By understanding the geologic history, we will be able to predict where the preferred type of outcrop will be found in areas that have not been well mapped.

In our study areas, we noted that fine-grained sediments correlate with areas shown by the sidescan data to be extensively pitted by fish burrows (presumed to be made by tilefish, *Lopholatilus chamaeleonticeps*). Inexpensive sediment grab sampling could be used to map the extent of the habitat of this food fish. We also mapped areas using sidescan-sonar data and verified by video where holes have been excavated under small boulders and sediment has been cleared from small (a few meters square) hard-bottom areas, presumably by the red groupers (*Epinephelus morio*) we observed occupying some of the excavations. Here, a heavily targeted commercially valuable fish species (*E. morio*) is acting as a geologic agent and creating a habitat that is attractive to numerous other species. Repeated sidescan surveys of this area would readily show whether the recent closure of the area to fishing results in an increase in the areal extent or density of this type of habitat.

By understanding the geologic history of the region, we are now able to make reasonable predictions about where particular habitats are likely to occur in less well-mapped parts of the eastern GOM.

We can also estimate the quantities and areal extents of modern habitats which we know evolved from particular ancient environments by comparison with modern environments that are similar to the ancient ones. These estimations are useful for making management decisions. For example, if we know that an economically important fish species spawns only around beachrock outcrops in a certain water depth, and that a sea level stillstand occurred at that depth for a long enough time to produce beachrock, and we know the width of beachrock in modern environments, then we can estimate the areal extent of beachrock outcrops in the region in question. If protection of this fish's spawning habitat is needed, a rational management decision could be made, based on the geologic history, to create reserves encompassing a certain percentage of the estimated habitat.

CONCLUSIONS

Modern marine geologic tools and maps are directly useful to marine biologists, ecologists, and fisheries managers. Imagery data can be used to choose sampling and study sites and to document changes in areal extents of habitats. These data are also valuable for setting meaningful boundaries for fishery reserves. Seismic-reflection data show thicknesses of unconsolidated sediments and provide information about the character of the sediment-water interface. Sediment or rock composition can be correlated with species assemblages.

Even more powerful for fisheries management is understanding the geologic history of a region. This understanding can be used to predict where certain benthic communities may exist or where they could be successfully restored. Understanding the geologic history also allows us to make realistic estimates of the areal extents of certain types of habitat in unexplored areas.

“Multi-disciplinary,” “inter-agency,” and “cooperative” are popular buzzwords and we are encouraged to use them in our research plans. Although we may agree that since the environment is naturally “multi-disciplinary,” it makes sense to study it in a multi-disciplinary way, sometimes it is not so clear whether there is any real benefit to our research in doing so. In our work in the northeastern GOM, interdisciplinary collaboration has greatly enhanced our research and provided management with tools to make better decisions. Traditional organization of institutions by discipline often separates potential collaborators, but the benefits of cross-disciplinary research are well worth the necessary extra effort. In the case of marine geology and fish ecology/fisheries management, the benefits are real and can result in better management practices.

REFERENCES

- Coleman, F.C., C.C. Koenig, and L.A. Collins. 1996. Reproductive styles of shallow-water grouper (Pisces: Serranidae) in the eastern Gulf of Mexico and the consequences of fishing spawning aggregations. *Environmental Biology of Fishes* 47:129-141.
- Danforth, W.W., T.F. O'Brien, and W.C. Schwab. 1991. Near real-time mosaics from high-resolution sidescan-sonar - an image processing technique to produce hard-copy mosaics 'on site' proved successful during USGS survey, *Sea Technology*, V.32, no.1, pp. 54-59.

- Danforth, W.W. 1997. Xsonar/ShowImage: A complete system for rapid sidescan sonar processing and display, USGS Open-File Report 97-686, pp. 77.
- Doyle, L.J. and C.W. Holmes. 1985. Shallow Structure, Stratigraphy, and Carbonate Sedimentary Processes of West Florida Upper Continental Slope: Bul. AAPG, v. 69, no. 7, pp. 1133-1144.
- Hine, A.C. 1997. Structural and paleo-oceanographic evolution of the margins of the Florida platform. *In* Randazzo, A.F. and D.S. Jones, eds. 1997. *The Geology of Florida*. Gainesville: University Press of Florida. pp. 169 – 194.
- Hine, A.C., D.F. Belknap, J.G. Hutton, E.B. Osking, and M.W. Evans. 1988. Recent geological history and modern sedimentary processes along an incipient, low-energy, epicontinental-sea coastline: northwest Florida. *Journal of Sedimentary Petrology*, v.58, no. 4, pp. 567-579.
- Koenig, C.C., F.C. Coleman, C.B. Grimes, G.R. Fitzhugh, K.M. Scanlon, C.T. Gledhill, M Grace. *In press*. Protection of fish spawning habitat for the conservation of warm temperate reef fish fisheries of shelf-edge reefs of Florida: *Bulletin of Marine Science*.
- Locker, S.D., A.C. Hine, L.P. Tedesco, and E.A. Shinn. 1996. Magnitude and timing of episodic sea-level rise during the last deglaciation. *Geology*, 24: 827-830.
- Mullins, H.T., A.F. Gardulski, E.J. Hinchey, and A.C. Hine. 1988. The modern carbonate ramp slope of central west Florida. *Journal of Sedimentary Petrology*, v. 58, no. 2, pp.273-290.
- Paskevich, V. 1992. Digital mapping of side-scan sonar data with the Woods Hole Image Processing System software: U.S. Geological Survey Open-File Report 92-536, 87p.
- Paskevich, V. 1996. MAPIT: An improved method for mapping digital sidescan-sonar data using the Woods Hole Image Processing System (WHIPS) Software: U.S. Geological Survey Open-File Report 96-281, 73p.
- Roberts, H.H., R.A. McBride, and J.M. Coleman. 1999. Outer shelf and slope geology of the Gulf of Mexico: An overview. *In* Kumpf, Herb, K.A. Steidinger, and Kenneth Sherman, eds. *The Gulf of Mexico Large Marine Ecosystem*, Blackwell Science, Inc, Malden MA, U.S.A. pp. 93-112.
- Scanlon, K.M. 2000. Surficial Seafloor Geology of a Shelf-edge Area off West Florida. *In* Briere, P.R., K.M. Scanlon, Gary Fitzhugh, C.T. Gledhill, and C.C. Koenig. 2000. *West Florida Shelf: Sidescan-sonar and sediment data from shelf-edge habitats in the northeastern Gulf of Mexico*, U.S. Geological Survey Open-file Report 99-589. CD-ROM.
- Thieler, E.R., W.C. Schwab, P.T. Gayes, O.H. Pilkey, Jr., W.J. Cleary, and K.M. Scanlon. 1999. Paleoshorelines on the U.S. Atlantic and Gulf Continental Shelf: Evidence for sea-level stillstands and rapid rises during deglaciation. Non-steady state of the inner shelf and shoreline: coastal change on the time scale of decades to millennia. (abs) Hawaii University, 11/8-12/99.

SESSION 5: OFFSHORE PLATFORM COMMUNITIES I

Moderators: Benny Gallaway
Gregg Gitschlag

Date: October 25, 2000

Presentation	Author/Affiliation
A Preliminary Evaluation of the Effects of Ethylene Glycol Exposure on the Swimming Performance of Juvenile Florida Pompano	M. K. Hymel Department of Oceanography and Coastal Sciences Louisiana State University D. M. Baltz Department of Oceanography and Coastal Sciences and Coastal Fisheries Institute Louisiana State University E. J. Chesney Louisiana Universities Marine Consortium Chauvin, LA M. A. Tarr Department of Chemistry University of New Orleans A. S. Kolok Biology Department University of Nebraska at Omaha
Effects of the Nepheloid Layer on Biofouling Communities on Coastal Petroleum Platforms in the Northwestern Gulf of Mexico	Thomas W. Bates Q.R. Dokken Center for Coastal Studies Texas A&M University-Corpus Christi
Vertical Distribution and Habitat Association of Four Blenniidae Species on Gas Platforms in the Northcentral Gulf of Mexico	Marek R. Topolski Department of Fisheries Auburn University Stephen T. Szedlmayer Department of Fisheries Auburn University Gulf Coast Experimental and Research Center

(continued on next page)

Presentation	Author/Affiliation
Vertical and Within Platform Spatial Variability of Larval and Juvenile Fishes Associated with Petroleum Platforms off Louisiana	Frank J. Hernandez, Jr. Department of Oceanography and Coastal Sciences Louisiana State University Richard F. Shaw Department of Oceanography and Coastal Sciences and Coastal Fisheries Institute Louisiana State University
The Across-Shelf Larval, Postlarval, and Juvenile Fish Community Associated with Offshore Oil and Gas Platforms and a Coastal Rock Jetty West of the Mississippi River Delta	Frank J. Hernandez, Jr. ¹ Richard F. Shaw ^{1,2} Joseph S. Cope ² James G. Ditty ³ Talat Farooqi ² Mark C. Benfield ^{1,2} ¹ Department of Oceanography and Coastal Sciences, Center for Coastal Energy and Environmental Resources, Louisiana State University ² Coastal Fisheries Institute, Louisiana State University ³ NOAA/NMFS, Southeast Fisheries Science Center
Red Snapper Recruitment to and Disappearance from Oil and Gas Platforms in the Northern Gulf of Mexico	David L. Nieland Coastal Fisheries Institute Charles A. Wilson Coastal Fisheries Institute and Department of Oceanography and Coastal Sciences Center for Coastal, Energy, and Environmental Resources Louisiana State University

A PRELIMINARY EVALUATION OF THE EFFECTS OF ETHYLENE GLYCOL EXPOSURE ON THE SWIMMING PERFORMANCE OF JUVENILE FLORIDA POMPANO

M. K. Hymel

Department of Oceanography and Coastal Sciences
Louisiana State University

D. M. Baltz

Department of Oceanography and Coastal Sciences and
Coastal Fisheries Institute
Louisiana State University

E. J. Chesney

Louisiana Universities Marine Consortium
Chauvin, LA

M. A. Tarr

Department of Chemistry
University of New Orleans

A. S. Kolok

Biology Department
University of Nebraska at Omaha

ABSTRACT

Exposure to ethylene glycol, which is used in the production of crude petroleum, may not be immediately lethal to fishes, but may affect individual fish through reduced growth, reproduction, and survival. Florida pompano are common in the Gulf of Mexico (GOM) where petroleum production platforms or transport pipelines occur, putting them at risk of exposure in the event of a spill or leakage. Using Blazka-type respirometers, the critical swimming performance of juvenile Florida pompano was evaluated before and after exposure to a 3.0% ethylene glycol concentration in 30 ppt sea water at 25 °C. The mean critical swimming speed (U_{crit}) was reduced by 14% in treatment fish from $96.0 \pm 1.13 \text{ cm s}^{-1}$ ($9.4 \pm 0.17 \text{ BL s}^{-1}$) in the pre-exposure trial to $83.0 \pm 3.45 \text{ cm s}^{-1}$ ($8.0 \pm 0.26 \text{ BL s}^{-1}$) in the post-exposure trial. The U_{crit} of control fish increased by 5%. A considerable amount of variability was observed between pre- and post-exposure performance of individuals, suggesting varying degrees of individual tolerance.

INTRODUCTION

Marine fishes face an array of risks that affect their ability to perform in ecological situations. The effects of factors producing direct mortality in populations, such as fishing, are often easier to quantify than factors producing sublethal impacts within a population. Sublethal impacts, while not

producing direct mortality, may affect the growth, reproduction, and survival of individuals, which may have implications on population dynamics. Quantifying sublethal effects at the individual level is an important step in predicting how a species may respond ecologically to these impacts.

One possible sublethal impact to marine fisheries is the use of additives in the production of deepwater petroleum resources. With the development of new petroleum production technologies, oil and gas is now being produced from waters greater than 305 m (1,000 ft) in the GOM (Minerals Management Service, www.gomr.mms.gov). The continuing expansion of petroleum exploration and drilling into deeper reaches of the GOM introduces a new array of risks of environmental impacts on marine fishes, and creates a pressing need for the ecological evaluation of new practices and chemicals used in this industry.

The possible effects of ethylene glycol, a deepwater petroleum additive, on fishes in the marine environment have yet to be assessed. Ethylene glycol is used in petroleum production and transport to prevent the formation of gas hydrates. Gas hydrates occur when water molecules crystallize around one or more guest molecules, such as helium, chlorine, or carbon dioxide, which are often present in natural gas. As the gas is pumped through deepwater pipelines changes in pressure and temperature can facilitate the formation of these hydrates, potentially clogging the pipeline permanently. One process used to inhibit hydrate formation requires large quantities of ethylene glycol, which decrease the hydrate stability and lower the temperature of hydrate formation (Anonymous 1996).

The environmental effects of ethylene glycol have been widely studied in relation to its use as an antifreeze and coolant for automobiles and as a deicing agent for bridges and runways (Barber 1999). The LC_{50} of ethylene glycol, the concentration estimated to kill half of a group of organisms in a pre-determined amount of time, has been reported for various fresh and brackish-water organisms (Greene and Kocan 1997, Abdelghani *et al.* 1989, Pillard 1995). The toxicity of ethylene glycol to fish has been assessed on only a few species, including rainbow trout (*Oncorhynchus mykiss*) and fathead minnow (*Pimephales promelas*) (Greene and Kocan 1997), bluegill sunfish (*Lepomis macrochirus*) (Abdelghani *et al.* 1989), and goldfish (*Carassius auratus*) (Bridie *et al.* 1979). Effects of ethylene glycol exposure have not been assessed for any marine fishes.

This is the first study to evaluate sublethal effects of ethylene glycol on marine fish. Non-lethal exposure levels can lead to important effects, which are often measured by diminished performance (Sprague 1971). Sublethal exposure of fish to contaminants can cause a stress response due to an altered physiological condition, such as impeded oxygen transfer across the gills. A fish under stress exhibits a diminished ability to function normally, which suggests potential death or decreased reproduction of an individual, possibly leading to a declining population (Heath 1995).

The use of performance indicators to evaluate sublethal effects assumes that the ability to perform normal life functions has been impaired (Schreck 1990).

It is important to note the difficulty in using sublethal effects seen at the individual level to extrapolate effects at the population level (Rose *et al.* 1993). Mortality can be highly dynamic in fish populations, and high levels of individual mortality from an episodic event, such as a contaminant

spill, may not necessarily have a significant effect at the population level (Houde 1989). Using individual-based modelling, Rose *et al.* 1993 found that chronic exposures to contaminants were more likely to affect recruitment of striped bass than episodic exposures. It was also found, however, that episodic exposures could potentially have a greater impact if they occurred at or shortly after a spawning peak.

Swimming performance has been used as a performance indicator in many studies to assess sublethal effects of contaminants (Beaumont *et al.* 1995, Heath 1995, Nikl and Farrell 1993). Reduced swimming performance of individuals has ecological significance through a reduced ability to avoid predators and catch prey. Vulnerability to predation is dynamic and could be increased by exposure to contaminants, due to effects on swimming speed, perception, and behavior. In an active species, such as Florida pompano, *Trachinotus carolinus*, a reduction in swimming speed may not necessarily reduce the likelihood of contact between predator and prey, but may effect the chances of escape once contact is made. For example, exposure may cause abnormal schooling behavior of a fish, thereby triggering a strike by a predator.

There is still much to learn about the effects of low-level exposure of marine organisms to petroleum-related contaminants. Most studies have concentrated on the mortality effects associated with major oil spills (Peterson *et al.* 1996, Howarth 1991, Kennicutt *et al.* 1996). Some studies have been conducted, however, regarding low-level exposures of fishes to petroleum or to areas where production platforms occur. Histological changes have been shown to occur in the gills of fishes surrounding oil production platforms (Grizzle 1986). The effects of exposure to crude oil on maximum swimming speed of coho salmon (*Oncorhynchus kisutch*) have also been examined (Thomas and Rice 1987).

The Florida pompano was chosen to assess acute and sublethal effects of ethylene glycol because it occurs in the vicinity of transport pipelines and deepwater wells in the GOM. Florida pompano is a marine fish of economic importance found in Atlantic and GOM waters from Massachusetts to Brazil (Hoese and Moore 1977). Juveniles are abundant in and near the surf zone during summer months. Adults can be found in inshore and offshore waters; however, it is unclear where spawning occurs (Gilbert 1986). The Florida pompano is a fast-swimming fish that could move quickly through an area containing sublethal levels of leaked or spilled contaminants. The short-term exposure of Florida pompano to contaminants such as ethylene glycol may have long-term consequences for individuals.

The goal of this study was to assess the sublethal effects of ethylene glycol on juvenile Florida pompano by comparing individual swimming performance before and after exposure to a sublethal concentration of ethylene glycol. This study found that the mean swimming performance was reduced by 14% in individuals following a 24 h exposure to a 3.0% concentration of ethylene glycol. These results provide valuable information on the possible ecological consequences of a low-level spill or leakage of ethylene glycol into the environment.

METHODS

Respirometer Design

Three Blazka-type swimming respirometers were used in simultaneous swimming performance tests. Each respirometer consisted of two concentric acrylic cylinders, with the inner cylinder having an inside diameter of 20.32 cm. The volume of each respirometer was 104 L, and the maximum water velocity was 1 m s^{-1} . Water flow within the cylinder was generated by a propeller at one end of the inner cylinder and was controlled by a variable-speed DC motor. A plastic honeycomb grid was placed at each end of the inner cylinder to contain fish and encourage laminar flow.

Each respirometer was individually calibrated to find the relationship of RPM (revolutions per minute) to water velocity in the flume (cm s^{-1}) using video analysis of particles moving through the inner cylinder. The regression relationship between RPM and water velocity (cm s^{-1}) was determined independently for each respirometer, and was used to solve for RPM at each desired water velocity used in the swimming trials.

Swimming Performance

Swimming performance before and after sublethal exposure to ethylene glycol was measured and compared for individual fish (Kolok *et al.* 1998). In order to keep track of individuals, 21 juvenile pompano ($23.1 \text{ g} \pm 4.73 \text{ SD}$; $102.8 \text{ mm FL} \pm 6.21 \text{ SD}$) were tagged 11 weeks before the start of the experiment. After anaesthetizing the fish with MS-222, a scheme of colored latex marks (Northwest Marine Technology, Inc.) was applied by injection to the dorsal, caudal, and anal fins of each individual. The fish were held following injection in a 5,000 L recirculating seawater system.

Several days prior to the experiment, the tagged fish were randomly separated into groups of three, to be swum simultaneously in the three respirometers. Two of seven groups were randomly designated as the 'control' groups, and the remaining five groups were designated as 'treatment' groups. Each group was randomly assigned to one of seven 60 L holding tanks, which were connected as a recirculating system with a total volume of 550 L. The holding system was equipped with a biofilter and UV sterilizer to maintain water quality. Salinity in the holding system was maintained at $30 \pm 1 \text{ ppt}$, and temperature was maintained at $25 \pm 1 \text{ }^\circ\text{C}$ using 200 W aquarium heaters in each tank. Each holding tank was individually aerated with an air stone. Amquel® ($\text{HOCH}_2\text{SO}_3\text{Na}$) was added to the holding system to control the ammonia level if it rose to 0.5 ppm. Each group of three fish was fed 0.25 g of 45% protein pellet feed daily, and uneaten feed and waste were siphoned daily from each tank.

The daily protocol for the swimming experiment ensured identical fasting, holding, and acclimation periods for each group of fish, and required 16 days (Table 5.1). This protocol allowed for a 17 h acclimation period to the respirometers following exposure and a 41 h fasting period (i.e., 24 h exposure and 17 h acclimation) before pre- and post-exposure swimming trials. Sham exposures were carried out in the same manner as actual exposures except for the addition of ethylene glycol. All fish were sham exposed before the first swimming trial, and only the two control groups were sham exposed before the second swimming trial. Each exposure was carried out in one of three

Table 5.1. Daily schedule for swimming performance tests.

Protocol for swimming performance trials	
Day 1	At ~ 1600 h, Group 1 fish were placed in the exposure tank for 24 h at 25 °C and 30 ppt for fasting and sham exposure.
Day 2	At ~ 1600 h, Group 1 fish were placed in the respirometers for acclimation (~17 h) at 5 cm s ⁻¹ in recirculating mode.
	At ~ 1600 h, Group 2 fish were fasted and sham exposed.
Day 3	At ~ 0900 h, recirculating mode was terminated and the pre-exposure swimming test of Group 1 fish was begun.
	Group 1 fish were returned to their assigned holding tank for five days.
	At ~1600 h, Group 2 fish were placed in the respirometers for acclimation.
	At ~1600 h, Group 3 fish were fasted and sham exposed.
Day 4	Repeat: Pre-exposure swimming test of Group 2, acclimation of Group 3, and sham exposure of Group 4.
Day 5	Repeat: Pre-exposure swimming test of Group 3, acclimation of Group 4, and sham exposure of Group 5.
Day 6	Repeat: Pre-exposure swimming test of Group 4, acclimation of Group 5, and sham exposure of Group 6.
Day 7	Repeat: Pre-exposure swimming test of Group 5, acclimation of Group 6, and sham exposure of Group 7.
Day 8	Repeat: Pre-exposure swimming test of Group 6 and acclimation of Group 7.
	At ~ 1600 h, Group 1 fish were fasted and exposed in a 3.0% ethylene glycol solution.
Day 9	Repeat: Pre-exposure swimming test of Group 7, acclimation of Group 1, and exposure of Group 2.
Day 10	Repeat: Post-exposure swimming test of Group 1, acclimation of Group 2, and exposure of Group 3.
Day 11	Repeat: Post-exposure swimming test of Group 2, acclimation of Group 3, and exposure of Group 4.
Day 12	Repeat: Post-exposure swimming test of Group 3, acclimation of Group 4, and exposure of Group 5.
Day 13	Repeat: Post-exposure swimming test of Group 4, acclimation of Group 5, and exposure of Group 6.
Day 14	Repeat: Post-exposure swimming test of Group 5, acclimation of Group 6, and exposure of Group 7.
Day 15	Repeat: Post-exposure swimming test of Group 6 and acclimation of Group 7.
Day 16	Repeat: Post-exposure swimming test of Group 7.

round fiberglass tanks, filled to 60 L with sea water at a salinity of 30 ppt. The temperature of each exposure tank was maintained at 25 ± 1 °C with a 200 W aquarium heater and the water was aerated with two air stones. Treatment groups were exposed to a 3.0% ethylene glycol solution before the second swimming test. To achieve the appropriate concentration, a volume of 1800 ml of ethylene glycol was added and the tank volume was adjusted up to the 60 L mark. A water sample was collected from the exposure tank at the beginning and end of each exposure period. All exposed fish were placed in a bucket of clean sea water for several minutes before being placed in the respirometers.

During the 17 h acclimation period, the three respirometers were connected to a larger recirculating system that included a UV sterilizer and biofilter. The entire swimming system was housed in a 25 °C temperature-controlled room. The total recirculating volume of the system was about 765 L. Following exposure, each fish was placed in one of the respirometers for the acclimation interval at a velocity of 5 cm s^{-1} . Before the start of each swimming trial, each respirometer was cleared of bubbles and sealed. Each fish was tested in the same respirometer for the pre-exposure and post-exposure swimming trials.

The experimental protocol tested for changes in the swimming performance of individuals before and after exposure to ethylene glycol by determining pre- and post-exposure critical swimming speeds (U_{crit}) for each individual. During swimming, the velocity of each respirometer was increased by 10 cm s^{-1} every 10 min, with no rest interval between steps. The swimming test was terminated when the fish could no longer continue swimming and made contact with the back grid for about 2-4 s.

A pre- and post-exposure U_{crit} value was calculated for each fish according to the equation described by Brett (1964):

$$U_{\text{crit}} = u_i + (t_i/t_{ii} \times u_{ii}),$$

where u_i is the highest velocity maintained for the prescribed period, u_{ii} is the velocity increment, t_i is the time that the fish swam at the fatigue velocity, and t_{ii} is the prescribed period of swimming. All fish, which failed to fatigue after 10 min of swimming at the respirometer's maximum speed (100 cm s^{-1}), were assigned a U_{crit} value of 100 cm s^{-1} . The U_{crit} values were expressed in terms of cm s^{-1} and body lengths per second (BL s^{-1}).

Although water quality was monitored in the chambers during each swimming trial, equipment problems resulted in the loss of dissolved oxygen data measured at the end of each velocity interval. A YSI Tele-Thermometer probe was used to continuously record temperature from one of the respirometers. After each post-exposure swimming test, the fish were anaesthetized with MS-222, and weights and fork lengths were measured.

RESULTS

Swimming Performance

A 14% reduction in swimming performance was observed in fish exposed to 3.0% ethylene glycol (Table 5.2, Figure 5.1). The mean (\pm SE) critical swimming speed of treatment fish was 96.0 ± 1.13 cm s⁻¹ (9.4 ± 0.17 BL s⁻¹) in the pre-exposure trial and 83.0 ± 3.45 cm s⁻¹ (8.0 ± 0.26 BL s⁻¹) in the post-exposure trial. The mean (\pm SE) critical swimming speed of control fish was 94.1 ± 3.42 cm s⁻¹ (9.2 ± 0.17 BL s⁻¹) in the pre-exposure trial, and 98.2 ± 1.28 cm s⁻¹ (9.6 ± 0.23 BL s⁻¹) in the sham post-exposure trial. These values are somewhat conservative because the fish (11 out of 21) that did not fatigue after 10 min of swimming at 100 cm s⁻¹ were assigned a U_{crit} value of 100 cm s⁻¹.

There was considerable individual variation between pre- and post-exposure performance. Of the 15 treatment fish, only one individual showed an increase in U_{crit} of 1.38 BL s⁻¹ following exposure. This change in U_{crit} , however, was greater in magnitude than the reductions of nine of the other 14 treatment fish. The reduction in performance for all other treated fish ranged from 0.24 to 4.42 BL s⁻¹, with a mean value (\pm SE) of 1.5 ± 0.36 BL s⁻¹. Of the six individuals in the control group, two individuals slightly improved their performance by 0.58 and 0.25 BL s⁻¹, and one individual greatly improved its performance by 2.07 BL s⁻¹. The fourth control fish slightly decreased its performance by 0.31 BL s⁻¹, and the final two individuals out swam the respirometers in both the pre- and post-trials.

DISCUSSION

A 24 h exposure to a 3.0% concentration of ethylene glycol was found to reduce the swimming performance of individual juvenile Florida pompano in this study by a mean of 14%. Changes in the performance of control fish were not meaningful, but mean performance did increase slightly by 5%.

While mean critical swimming speed of the treatment group was found to decrease following exposure, there was considerable individual variation in performance detected in both the treatment and control groups. A common method in swimming performance studies looking at sublethal effects of toxicants has been to compare mean performances of control and treatment groups, an approach that does not address within-group variation. An experimental design that addresses within-group variation is useful because swimming performance of individual fish has been shown to be repeatable over time (Kolok 1992, Kolok *et al.* 1998, Reidy *et al.* 2000). In a study involving the exposure of fathead minnows to a contaminated sediment, Kolok *et al.* (1998) found that a reduction in the mean post-exposure swimming performance varied widely between individuals, with two-thirds experiencing only minor reductions and the remaining fish becoming almost unable to perform.

The variation between individuals in the present study suggests that some fish may have a higher threshold of tolerance to ethylene glycol toxicity. Many studies have estimated threshold values for fish exposed to contaminants by testing swimming speed at a range of exposure concentrations (Nikl and Farrell 1993, Peterson 1974). Because this study tested fish at only one concentration of

Table 5.2. Weight (g), fork length (mm), pre-exposure U_{crit} and post-exposure U_{crit} ($cm\ s^{-1}$, $BL\ s^{-1}$) for treatment and control Florida pompano.

Treatment Fish	Weight (g)	FL (mm)	Pre-exposure U_{crit}		Post-exposure U_{crit}	
			$cm\ s^{-1}$	$BL\ s^{-1}$	$cm\ s^{-1}$	$BL\ s^{-1}$
1	26.26	109	84.98	7.80	100	9.17
2	23.4	104	94.2	9.06	82.05	7.89
3	20.13	99	100	10.10	63.65	6.43
4	21.9	102	93.67	9.18	74.55	7.31
5	36.75	116	100	8.62	94.43	8.14
6	19.93	97	93.45	9.63	63.55	6.55
7	20.51	97	90.6	9.34	88.3	9.10
8	16.1	91	94.95	10.43	54.72	6.01
9	22.25	104	100	9.62	87.75	8.44
10	21.27	102	93.75	9.19	87.43	8.57
11	19.25	96	100	10.42	80.4	8.38
12	26.54	105	95.92	9.14	93.42	8.90
13	28.28	110	100	9.09	93.47	8.50
14	21.77	104	97.73	9.40	85.58	8.23
15	21.44	108	100	9.26	95.13	8.81
Mean	23.05	102.93	95.95	9.35	82.96	8.03
SE	1.26	1.65	1.13	0.17	3.45	0.26
Control Fish	Weight (g)	FL (mm)	$cm\ s^{-1}$	$BL\ s^{-1}$	$cm\ s^{-1}$	$BL\ s^{-1}$
1	18.14	96	86.85	9.05	92.37	9.62
2	23.94	104	100	9.62	96.73	9.30
3	22.2	103	100	9.71	100	9.71
4	18.19	94	80.53	8.57	99.98	10.64
5	28.17	106	97.35	9.18	100	9.43
6	29.24	111	100	9.01	100	9.01
Mean	23.31	102.33	94.12	9.19	98.18	9.62
SE	1.94	2.59	3.42	0.17	1.28	0.23

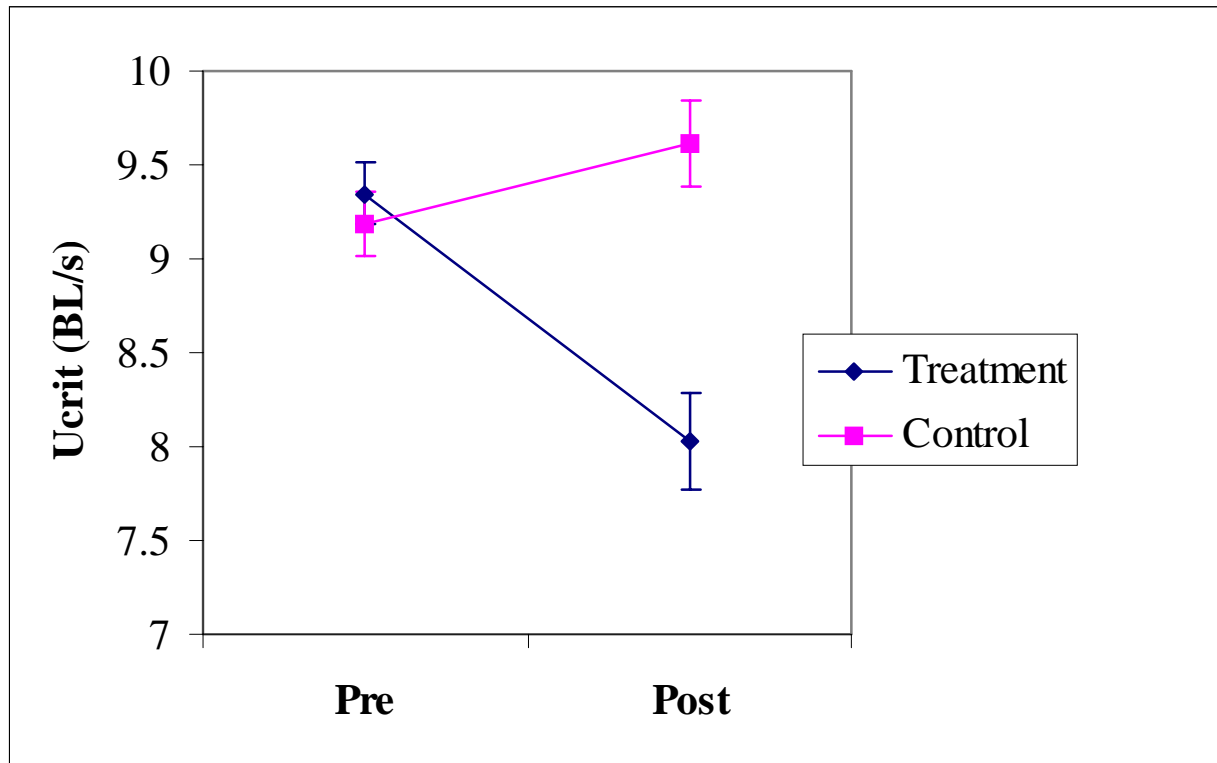

Figure 5.1. Mean U_{crit} ($BL\ s^{-1}$) of Florida pompano before and after a 24 h exposure to 3.0% ethylene glycol (treatment), and before and after sham exposure (control).

ethylene glycol, it is not possible to calculate a mean threshold value for this species. Nevertheless, we can assume from the biological meaningful reduction in swimming speed that the threshold is at or below the 3.0% ethylene glycol concentration (53% of the estimated LC_{50} for slightly smaller fish).

There are several ways in which toxicants, such as ethylene glycol, may cause a reduction in the swimming performance of fishes. Jones (1971) proposed several possible factors, including an inability to exchange enough oxygen at the gills, an inability to deliver enough oxygen to the tissues, and an inability to remove metabolic products or to activate enzymic processes. A reduction in the ability to transfer oxygen across the gills would effectively decrease the scope for active metabolism of the fish, thereby reducing the fish's capacity for sustained swimming activity. It is unclear from this study whether gill damage was a direct influence on the reduction in swimming performance of exposed individuals, due to the use of MS-222 before sacrifice.

Due to the nature of ethylene glycol, the reduction in swimming performance seen in this study may have been due to the buildup of metabolic products. Studies on mammals have shown that ethylene glycol is sequentially oxidized in the liver (Chou and Richardson 1978) and involves several metabolites, with glycolate (glycolic acid) playing a major role in ethylene glycol toxicity. The increased cost of maintenance to remove these metabolites effectively increases the basal metabolism, thereby reducing the capacity for activity. Therefore, the reduced U_{crit} of the exposed

fish in this study may have been a direct result of the increased metabolic costs to remove toxic metabolites.

The LC₅₀ values reported in other studies (Table 5.3) on ethylene glycol exposure in fish are generally considered to reflect relatively low toxicity. Fish would be most likely to be exposed to these concentrations in the event of highly localized, large-scale releases into the environment. Marine releases of considerable magnitude, however, have been reported. For example, 13,523 L (3,570 gal) of ethylene glycol leaked into the GOM from an underwater pipeline in June of 1998 (U.S. Coast Guard, National Response Center, Report # 444025). This study shows that sublethal effects can be manifested after only a short exposure (24 h) to large releases of ethylene glycol. Fish are more likely to be exposed for a short-term due to the relatively rapid biodegradation of ethylene glycol. Bio-oxidation of ethylene glycol in the laboratory was 39% in 5 days and 96% in 20 days (Conway *et al.* 1983). Dissipation of the chemical in the marine environment would be expected to be even more rapid. Other factors affecting the toxicity of ethylene glycol must also be considered, such as additive or synergistic effects when combined with other chemicals. The toxicity of ethylene glycol was found to increase in fish when sublethal levels of thiram, a component of an agricultural seed-protectant, were present (Greene and Kocan 1997), and when it was combined with other chemicals in a deicing agent (Pillard 1995).

Table 5.3. Estimated LC₅₀ values for several fish species exposed to ethylene glycol.

Reference	Species	Mean Size (g)	Test Duration	LC ₅₀ (%)
Abdelghani <i>et al.</i> 1990	Bluegill sunfish (<i>Lepomis macrochirus</i>)	0.85 ± 0.60	96 h	2.75
Pillard 1995	Fathead minnow (<i>Pimephales promelas</i>)	(≤ 7 days old)	96 h	7.29
Greene and Kocan 1997	Fathead minnow	0.10 ± 0.01	96 h	6.83
		0.13 ± 0.01	96 h	6.95
	Rainbow trout (<i>Oncorhynchus mykiss</i>)	0.71 ± 0.20	96 h	6.08
		1.50 ± 0.50	96 h	5.65
Kay 2000	Florida pompano (<i>Trachinotus carolinus</i>)	7.98 ± 3.20	24 h	5.63

There are several recommendations that can be made for future research in light of this study. First, the effects of ethylene glycol on the gills need to be examined without the use of the anaesthetic, MS-222, which may confound the results. It would also be useful to determine if a shorter exposure than our target concentration, 3.0% ethylene glycol, has significant effects on the gill structures or swimming performance of Florida pompano. The effects of a short exposure to a lethal concentration of ethylene glycol, using a range of exposure periods, could also be evaluated. Finally, by studying the effects of exposure on feeding and growth, more information would be obtained

regarding the ecological implications of ethylene glycol exposure on juvenile Florida pompano at the population level (Rose *et al.* 1993).

In summary, we have shown that a marine fish can experience reduced performance when exposed to sublethal levels of ethylene glycol. The implications of these results include adverse effects on the ability to perform in ecological situations. While normal cruising speeds of Florida pompano are not near the high critical swimming speeds observed in this study, the capacity for burst swimming and endurance are undoubtedly reduced, directly affecting the efficiency of prey capture and predator avoidance. Understanding sublethal effects such as these is important for the accurate prediction of the impacts of habitat and environmental changes on fish populations.

ACKNOWLEDGMENTS

We would like to thank Kenny Rose and Jaye Cable for their comments, Marcus Bradley for his help in conducting the experiments, and Russel Martin for constructing the respirometers. We would also like to thank the Minerals Management Service for providing the funding for this study.

REFERENCES

- Abdelghani, A.A., A.C. Anderson, G.A. Khoury, and S.N. Chang 1989. The fate of ethylene glycol in the environment. Louisiana Dept. of Transportation and Development, State Project #736-12-67, Number 87-1M(B).
- Anonymous 1996. Kinetic hydrate inhibitor provides treatment alternative. *World Oil*. Dec. 96:154-155.
- Barber, J.T., D.A. Thomas, L.Y. Yatsu, and H.E. Ensley 1999. The physiological consequences of ethylene glycol-induced changes in the frond structure of *Lemna gibba*. *Aquat. Tox.* 45:253-264.
- Beaumont, M.W., P.J. Butler, and E.W. Taylor 1995. Exposure of brown trout, *Salmo trutta*, to sublethal copper concentrations in soft acidic water and its effect upon sustained swimming performance. *Aquat. Tox.* 33:45-63.
- Bridie, A.L., C.J. M. Wolff, and M. Winter 1979. The acute toxicity of some petrochemicals to goldfish. *Water Res.* 13:623-626.
- Brett, J.R. 1964. The respiratory metabolism and swimming performance of young sockeye salmon. *J. Fish Res. Board Can.* 21(5):1183-1226.
- Chou, J.Y. and K.E. Richardson 1978. The effect of pyrazole on ethylene glycol toxicity and metabolism in the rat. *Toxicol. Appl. Pharmacol.* 43:33-44.
- Conway, R.A., G.T. Waggy, M.H. Spiegel and R.L. Berglund 1983. Environmental fate and effects of ethylene oxide. *Environ. Sci. Technol.* 17:107-112.

- Gilbert, C. 1986. Species profiles: Life histories and environmental requirements of coastal fishes and invertebrates (South Florida)—Florida pompano. U. S. Fish Wildl. Serv. Biol. Rep. 82(11.42). U. S. Army Corps of Engineers, TR EL-82-4. 14pp.
- Greene, M.W. and R.M. Kocan 1997. Toxicological mechanisms of a multicomponent agricultural seed protectant in the rainbow trout (*Oncorhynchus mykiss*) and fathead minnow (*Pimephales promelas*). Can. J. Fish. Aquat. Sci. 54:1387-1390.
- Grizzle, J.M. 1986. Lesions in fishes near drilling platforms in the Gulf of Mexico. Mar. Env. Res. 18:267-276.
- Heath, A.G. 1995. *Water pollution and fish physiology*. Second edition. CRC Press, Inc., Boca Raton, Florida.
- Hoese, H.D. and R.H. Moore 1977. *Fishes of the Gulf of Mexico*. Texas A&M U. Press, College Station, Texas. 327pp.
- Houde, E.D. 1989. Subtleties and episodes in the early life of fishes. J. Fish Biol. 35 (Supplement A): 29-38.
- Howarth, R.W. 1991. Assessing the ecological effects of oil pollution from outer continental shelf oil development. Amer. Fish. Soc. Symp. 11:1-8.
- Jones, D.R. 1971. The effect of hypoxia and anaemia on the swimming performance of rainbow trout (*Salmo gairdneri*). J. Exp. Biol. 55:541-551.
- Kay, M.E. 2000. Swimming performance of juvenile Florida pompano, *Trachinotus carolinus*, exposed to ethylene glycol. MS thesis, Louisiana State University, Baton Rouge, Louisiana, USA.
- Kennicutt II, M.C., R.H. Green, P. Montagna, and P.F. Roscigno 1996. Gulf of Mexico Operations Monitoring Experiment (GOOMEX), Phase I: Sublethal responses to contaminant exposure—introduction and overview. Can. J. Fish. Aquat. Sci. 53:2540-2553.
- Kolok, A.S. 1992. The swimming performance of individual largemouth bass (*Micropterus salmoides*) are repeatable. J. Exp. Biol. 170:265-270.
- Kolok, A.S., E.P. Plaisance, and A. Abdelghani 1998. Individual variability in the swimming performance of fish: An overlooked source of variation in toxicity studies. Env. Tox. Chem. 17:282-285.
- Nikl, D.L. and A.P. Farrell 1993. Reduced swimming performance and gill structural changes in juvenile salmonids exposed to 2-(thiocyanomethylthio) benothiazole. Aquat. Toxicol. 27: 245-264.

- Peterson, C.H., M.C. Kennicutt II, R.H. Green, P. Montagna, D.E. Harper, Jr., E.N. Powell, and P.F. Roscigno 1996. Ecological consequences of environmental perturbations associated with offshore hydrocarbon production: a perspective on long-term exposures in the Gulf of Mexico. *Can. J. Fish. Aquat. Sci.* 53:2637-2654.
- Peterson, R.H. 1974. Influence of fenitrothion on swimming velocities of brook trout (*Salvelinus fontinalis*). *J. Fish. Res. Board Can.* 31:1757-1762.
- Pillard, D.A. 1995. Comparative toxicity of formulated glycol deicers and pure ethylene and propylene glycol to *Ceriodaphnia dubia* and *Pimephales promelas*. *Env. Tox. Chem.* 14(2):311-315.
- Reidy, S.P., S.R. Kerr, and J.A. Nelson 2000. Aerobic and anaerobic swimming performance of individual Atlantic cod. *J. Exp. Biol.* 203:347-357.
- Rose, K.A., J.H. Cowan, Jr., E.D. Houde, and C.C. Coutant 1993. Individual-based modelling of environmental quality effects on early life stages of fishes: a case study using striped bass. *Amer. Fish. Soc. Symp.* 14: 125-145.
- Schreck, C.B. 1990. Physiological, behavioral, and performance indicators of stress. *Amer. Fish. Soc. Symp.* 8:29-37.
- Sprague, J.B. 1971. Measurement of pollutant toxicity to fish—III; Sublethal effects and “safe” concentrations. *Water Res.* 5: 245-266.
- Thomas, R.E. and S.D. Rice 1987. Effect of water-soluble fraction of cook inlet crude oil on swimming performance and plasma cortisol in juvenile coho salmon (*Oncorhynchus kisutch*). *Comp. Biochem. Physiol.* 87:177.

**EFFECTS OF THE NEPHELOID LAYER ON BIOFOULING COMMUNITIES
OCCURRING ON COASTAL PETROLEUM PLATFORMS IN
THE NORTHWESTERN GULF OF MEXICO**

Thomas W. Bates
Q. R. Dokken
Center for Coastal Studies
Texas A&M University-Corpus Christi

ABSTRACT

The Texas continental shelf in the Gulf of Mexico is a dynamic region influenced by winds, river, and offshore currents. The shelf is composed of terrigenous sediment that contains varying amounts of silt and clay. There is a persistent bottom layer of turbid water, a nepheloid layer, which appears to be derived from both local resuspension of fine sediment and advection in the bottom boundary layer from coastal sources. Approximately 4000 petroleum production platforms are located in the Gulf of Mexico with many lying on the shelf where the nepheloid layer is persistent. Offshore platforms act as artificial reefs, providing critical habitat on large submerged surfaces for recruitment and settlement of larval sessile organisms. The biofouling community could be directly related to fisheries associated with platform structures. The purpose of this study is to determine significant differences caused from the presence of the nepheloid layer in the structure of biofouling communities on four Texas coastal petroleum platforms. Photographic transects and biomass samples will be used to describe the biofouling community. Data loggers will be used to record temperature and light attenuation parameters. Turbidity and physiochemical properties of water will be sampled in the vicinity of the data loggers. All data will be used to create a model associating turbidity with the biofouling community of Texas coastal platforms where a nepheloid layer is persistent for much of the year.

VERTICAL DISTRIBUTION AND HABITAT ASSOCIATION OF FOUR BLENNIIDAE SPECIES ON GAS PLATFORMS IN THE NORTHCENTRAL GULF OF MEXICO

Marek F. Topolski
Department of Fisheries
Auburn University

Stephen T. Szedlmayer
Department of Fisheries
Auburn University
Gulf Coast Experimental and Research Center

ABSTRACT

The abundance of Blenniidae on platforms in the northern Gulf of Mexico may be substantially underestimated. Previous studies have reported the abundance of blenny species on platforms to range between 0.6 fish and 16 fish m⁻². In this study, we used visual surveys to quantify densities of four blenny species (*Hypsoblennius invemar*, *Hypleurochilus multifilis*, *Parablennius marmoreus*, and *Scartella cristata*) on two gas platforms 14 to 24 km southeast of Dauphin Island, Alabama in July and August 1999. Our mean Blenniidae densities were substantially higher than those in previous accounts. Densities of all four species decreased as depth increased from 3 m to 18 m: 10 fish m⁻² to 1 fish m⁻² (*H. invemar*), 23 fish m⁻² to 6 fish m⁻² (*H. multifilis*), 6 fish m⁻² to 2 fish m⁻² (*P. marmoreus*), and 89 fish m⁻² to 0 fish m⁻² (*S. cristata*). Blenny length distributions were estimated using three 51 mm total length (TL) categories. Eighty percent of *H. invemar*, 74% of *H. multifilis*, 49% of *P. marmoreus*, and 47% of *S. cristata* were < 51 mm TL. Blennies occupy crevices and cavities, so, the fouling community on the platform pilings was sampled to predict why blennies < 51 mm TL were so abundant. We measured the abundance of fouling organisms such as barnacles, mollusks, and sponges that can affect the availability of crevices and cavities. Abundance of the large barnacle *Balanus tintinabulum* decreased significantly as depth increased from 3 m to 18 m ($\chi^2 = 15$, $p < 0.05$), substantially affecting local relief and hence habitat available to blennies. However, *B. tintinabulum* abundance was not useful for predicting the abundance of *H. multifilis* ($r^2 = 0.04$, $p > 0.05$) and *P. marmoreus* ($r^2 = 0.07$, $p > 0.05$). *Balanus tintinabulum* abundance did account for 48% ($p < 0.05$) of *H. invemar* and 81% ($p < 0.05$) of *S. cristata* variability. The community structure of non-game fishes, like Blenniidae, can be used to estimate the ecological success of artificial structures as reefs.

**VERTICAL AND WITHIN PLATFORM SPATIAL VARIABILITY OF LARVAL
AND JUVENILE FISHES ASSOCIATED WITH PETROLEUM
PLATFORMS OFF LOUISIANA**

Frank J. Hernandez, Jr.
Department of Oceanography and Coastal Sciences
Louisiana State University

Richard F. Shaw
Department of Oceanography and Coastal Sciences and
Coastal Fisheries Institute
Louisiana State University

ABSTRACT

Oil and gas platforms are effective in attracting recreationally- and commercially-important fishes, but whether these structures contribute to new fish biomass is still debatable. To ascertain the habitat enhancement value of petroleum platforms, information on supply, distribution, and spatial variability of larval fishes associated with these structures is needed. We sampled ichthyoplankton at three petroleum platforms in the northern Gulf of Mexico: Green Canyon 18 (230 m depth), Grand Isle 94 (60 m depth), and South Timbalier 54 (20 m depth). Fish larvae and juveniles were collected within the structures (passive plankton net and light-trap fished at depth and near-surface) and immediately downstream of the platforms (light-trap floated downstream at surface). Overall, mean light-trap catch per unit efforts (CPUEs) were significantly higher in surface samples, particularly within the platform, than in sub-surface samples (clupeiforms excluded). Mean plankton net densities for surface samples were significantly lower than sub-surface samples at two platforms (clupeiforms excluded). Distributional differences were observed for many species within and around the platforms. Few taxa were found only in off-platform samples (4 at Green Canyon, 6 at Grand Isle, and 12 at South Timbalier). Some pelagic species, e.g., *Caranx crysos* and *C. hippos/latus* (Green Canyon) and *Euthynnus alletteratus* (Grand Isle and South Timbalier) generally had higher CPUEs in surface waters downstream from the platforms. Several species were collected only at depth, particularly mesopelagic and benthic taxa, e.g., *Chlorophthalmus agassizi* (Green Canyon), *Robia legula* (Grand Isle), and *Ophidion robinsi* (South Timbalier). Other taxa predominantly found at depth included *Mugil cephalus* (Green Canyon), *Symphurus* spp. (Grand Isle), and *Ariomma* spp. (South Timbalier). Few differences were observed between Shannon-Weiner diversity indices calculated by gear and location, with the exception of sub-surface light-trap samples, which were significantly lower in diversity at two platforms.

THE ACROSS-SHELF LARVAL, POSTLARVAL, AND JUVENILE FISH COMMUNITY ASSOCIATED WITH OFFSHORE OIL AND GAS PLATFORMS AND A COASTAL ROCK JETTY WEST OF THE MISSISSIPPI RIVER DELTA

Frank J. Hernandez, Jr.¹
Richard F. Shaw^{1,2}
Joseph S. Cope²
James G. Ditty³
Talat Farooqi²
Mark C. Benfield^{1,2}

¹Department of Oceanography and Coastal Sciences, Center for Coastal Energy and Environmental Resources, Louisiana State University

²Coastal Fisheries Institute, Louisiana State University

³NOAA/NMFS, Southeast Fisheries Science Center

ABSTRACT

The fisheries aggregation value of oil and gas platforms in the continental shelf waters of the northern Gulf of Mexico (GOM) is well recognized, but the assessment of early life stages associated with these structures has not been adequately addressed. Ichthyoplankton assemblages were sampled at three offshore platforms: Green Canyon 18 (GC 18; 230 m depth, shelf slope); Grand Isle 94 (GI 94; 60 m depth, mid-shelf); and South Timbalier 54 (ST 54; 20 m depth, inner shelf) with passive plankton nets and light-traps and at a coastal rock jetty (Belle Pass; 3-5 m depth) with a light-trap and a plankton pushnet. Family richness was highest at GC 18 (52), followed by GI 94 (43), ST 54 (42), and Belle Pass (41). At the genus level, richness was highest at Belle Pass jetty (127), followed by GI 94 (114), ST 54 (86), and GC 18 (82). At all sites, clupeiforms dominated samples, comprising 59-97% of the total catch. Gobiids and blenniids dominated the reef-associated fish assemblages at all sites. Other relatively common reef-associated fish were serranids and lutjanids (GC 18), pomacentrids and opisthognathids (GI 94), *Rhomboplites aurorubens* (ST 54), and *Lutjanus griseus* and *L. synagris* (Belle Pass). The ichthyoplankton assemblages sampled at each site were relatively dissimilar, based on Schoener's Index of Niche Overlap, with the highest index value for any two sites being 0.45 for GI 94 and ST 54 (0-1 scale; clupeiforms excluded). No significant difference was observed between mean Shannon-Weiner diversity indices calculated for plankton net samples at each site. For light-trap samples, diversity was lowest at GC 18, significantly higher at GI 94, and then decreased inshore. Canonical correlation analyses indicated that temperature and salinity explained most of the variation in larval abundance for some dominant taxa at the platforms, while at Belle Pass jetty, dissolved oxygen and turbidity were also important environmental variables.

INTRODUCTION

The GOM yields about 40% of the U.S. commercial fish landings (NOAA/NMFS 1993) and supports 33% of the country's recreational fishery (Essig *et al.* 1991; Van Voorhies *et al.* 1992). The

region also possesses the vast majority of the nation's coastal wetlands. Louisiana alone has over 3.8 million acres (>40% of the nation's total), but these areas are disappearing at an alarming rate, i.e., Louisiana land loss represents 60-80% of the nation's total annual coastal wetland loss (Boesch *et al.* 1994). The continual loss of GOM estuarine and wetland habitats that serve as the nursery grounds for a large number of commercially- and recreationally-important fisheries makes knowledge of the potential nursery function of other habitats critical. Habitat issues have received increased attention lately, in part due to the Essential Fisheries Habitat Provisions added to the Federal Sustainable Fisheries Act of 1996 that facilitate the long-term protection of waters and substrate necessary to fish for spawning, breeding, feeding or growth to maturity (USDOC 1996).

The introduction and proliferation of offshore oil and gas structures in the northern GOM has undoubtedly affected the marine ecosystem. There are approximately 4,000 oil and gas structures in the federal waters of the GOM. The central and western GOM is dominated by a mud/silt/sand bottom with little relief or hard bottom habitat. Parker *et al.* (1983) reported only 2,780 km² of natural available reef in the central and western GOM. Although Gallaway (1998) calculated that oil and gas platforms in the northern GOM provided 11.7 km² (or 4.0%) of the total "reef" habitat, the fact that platforms represent vertical artificial substrate that extends from the bottom to the surface (photic zone), regardless of location and depth, increases their significance. Since fish populations are usually limited by available energy, recruitment, or habitat, it is important to determine whether platforms: 1) provide critical habitat for early life history stages; 2) serve as new or additional spawning habitat; and 3) influence energy flow through the ecosystem by aggregating prey.

Oil and gas platforms can enhance fisheries by providing attachment substrate for habitat-limited sessile invertebrates, thereby creating food and habitat for reef-dependent species that are trophically-dependent on sessile and motile invertebrates associated with reefs (Gallaway 1981; Bohnsak and Sutherland 1985; Stephan *et al.* 1990; Bohnsak 1991). Since reef fish assemblages are among the most diverse and taxonomically rich in the aquatic biosphere (Sale 1991), platform communities may significantly enhance biodiversity. In addition, oil and gas structures may offer refugia for species which are trophically-independent of the biofouling community (i.e., reef-associated species; Choat and Bellwood 1991), but are ecologically-important resident, seasonal, or transient members of the hard substrate fish community (Gallaway *et al.* 1980). The extensive range (latitudinally and longitudinally) of this artificial substrate may also serve as migratory routes for tropical and subtropical species.

The adult fish communities around natural and artificial reefs are fairly well known (Seaman and Sprague 1992; Rooker *et al.* 1997; Stanley and Wilson, 2000) and the fisheries aggregation value of oil and gas structures is well-recognized in the GOM (CDOP 1985). Despite research efforts, however, biologists still disagree over the paradigm of whether these artificial reefs (e.g., platforms) contribute significantly to new fish production or simply attract and concentrate existing fish biomass (Pickering and Whitmarsh 1997; Bortone 1998). Existing data on adult fishes support both sides of the debate (Stone *et al.* 1979, Alevizon *et al.* 1985). Bohnsak (1989) theorized that reef effects fall along a continuum between attraction of existing organisms and production, with increased productivity occurring for reef-dependent species in areas of limited hard substrate habitat. Since the central and western GOM has little natural reef habitat, we believe that the contribution

of artificial reefs to existing reef habitat has enhanced reef fish populations, but the overall or net impact of this augmentation is not known, especially when corrected for increased fishing mortality associated with platforms (Stanley and Wilson 1990).

Few baseline ecological ichthyoplankton studies within the oil field have been published (Finucane *et al.* 1979a; Finucane *et al.* 1979b; Bedinger *et al.* 1980), and none have been published that focus upon platform infrastructure. The Southeastern Area Monitoring and Assessment Program's (SEAMAP) and the National Marine Fisheries Service's (NMFS) Gulf-wide fisheries surveys, and the Minerals Management Service Louisiana-Texas (MMS LATEX) Physical Oceanography Program have not sampled in the immediate vicinity of oil and gas platforms because of the conservative navigation/safety requirements of their ships. Thus, fisheries-independent assessment of the abundance of fish life stages within and immediately around these platforms and the role they might play as essential fisheries habitat is not being adequately addressed in federal waters where such structures exist. Clearly, additional information is needed on the early life history stages of fishes associated with petroleum platforms.

ACROSS-SHELF ICHTHYOFAUNAL ZONATION

Gallaway *et al.* (1980) and Gallaway (1981) reviewed previous descriptions of invertebrate and vertebrate faunal assemblages from the northcentral GOM's continental shelf and characterized differences largely upon different bottom types (fluvial/terrigenous sediments west of the Mississippi River Delta and carbonaceous sediments to the east), circulation patterns, and related hydrographic conditions. Climatic differences were also acknowledged as having an important role in determining faunal distributions, since the inner shelf waters of the northern GOM are warm and subtropical in the eastern GOM and along the southwestern coast near the Mexican border, but are warm-temperate from just east of the Mississippi River Delta to Matagorda Bay, Texas (Parker 1960). Reef fish fauna are generally less tolerant of the lower water temperatures that can occur in the more inshore areas during winter in the northern GOM (Chittenden and McEachran 1976). Along with temperature, topographical relief is another major factor contributing to the distribution of reef fish. Although topographical relief is described as extensive throughout the GOM (Bright *et al.* 1974), it is also disjunctly distributed, thus potentially isolating reef fish populations. Several authors attempted to classify shelf ichthyofaunal assemblages based on depth zones and invertebrate distributions. Defenbaugh (1976), for example, used macroinvertebrate data from trawls to describe three primary depth zones (4-20 m, 20-60 m, and 60-120 m). In his review, however, Gallaway (1981) adopted the zonation description of Chittenden and McEachran (1976) who observed that the distribution of major shrimp species (white shrimp grounds, 3-22 m depth and brown shrimp grounds, 22-110 m depth) matched quite closely the distribution of sediment types and used this information, along with bathymetry, to divide demersal fish assemblages into three different zones characterized primarily by depth.

Table 5.4 summarizes reef or structure-associated fish for Gallaway's (1981) analysis of previous studies that addressed demersal and pelagic adult fish off Texas (Chittenden and McEachran 1976) and adult reef species off Louisiana, including both artificial and natural reefs (George and Thomas 1974; Gallaway *et al.* 1979; Shinn 1974; Sonnier *et al.* 1976). Distinct transitions in species assemblages can be seen in the reef species when analyzed across depths. Overall, the outer shelf

Table 5.4. Summary of the commonly observed adult fish assemblages associated with natural reefs or offshore oil and gas platforms by depth zones as reported in Gallaway *et al.* (1980) and subsequently modified by Gallaway (1981). Taxa were reported from these depth zones as being affiliated with natural reefs (N) or artificial reefs (A).

Taxa	Ichthyofaunal Assemblage		
	Gallaway <i>et al.</i> (1980)		
	Coastal (3-27 m)	Offshore (27-64 m)	Blue Water or Tropical (>64 m)
	Gallaway (1981)		
	Inner Shelf (White Shrimp Ground) (3-20 m)	Intermediate Shelf (Brown Shrimp Ground) (20-60 m)	Outer Shelf (Tropical) (>60 m)
Serranidae			
<i>Epinephelus</i> spp. (grouper spp.)			N
<i>Epinephelus itajara</i> (jewfish)		A	
<i>Epinephelus nigritus</i> (warsaw grouper)		A	
<i>Mycteroperca</i> spp. (grouper spp.)			N
<i>Paranthias furcifer</i> (creole-fish)			N, A
Pomatomidae			
<i>Pomatomus saltatrix</i> (bluefish)	A	A	
Rachycentridae			
<i>Rachycentron canadum</i> (cobia)		A	
Carangidae			
<i>Caranx crysos</i> (blue runner)	A	A	N, A
<i>Caranx hippos</i> (crevalle jack)		A	
carangid spp. (jack spp.)	A	A	N
<i>Selene setapinnis</i> (moonfish)		A	
<i>Selene vomer</i> (lookdown)	A	A	
<i>Seriola rivoliana</i> (almaco jack)			N, A
Lutjanidae			
<i>Lutjanus campechanus</i> (red snapper)		A	N

Table 5.4. (continued)

Taxa	Ichthyofaunal Assemblage		
	Gallaway <i>et al.</i> (1980)		
	Coastal (3-27 m)	Offshore (27-64 m)	Blue Water or Tropical (>64 m)
	Gallaway (1981)		
	Inner Shelf (White Shrimp Ground) (3-20 m)	Intermediate Shelf (Brown Shrimp Ground) (20-60 m)	Outer Shelf (Tropical) (>60 m)
<i>Lutjanus synagris</i> (lane snapper)	A	A	
<i>Rhomboplites aurorubens</i> (vermilion snapper)			N
Haeumulidae			
<i>Haemulon melanurum</i> (cottonwick)			N
Sparidae			
<i>Archosargus probatocephalus</i> (sheepshead)	A	A	
Kyphosidae			
<i>Kyphosus sectatrix</i> (Bermuda chub)		A	
Ephippidae			
<i>Chaetodipterus faber</i> (Atlantic spadefish)	A	A	
Chaetodontidae			
butterflyfish spp.		A	N
Pomacanthidae			
<i>Holacanthus tricolor</i> (rock beauty)			A
pomacanthid spp. (angelfish spp.)		A	N, A
Pomacentridae			
damsel fish spp.		A	N, A
Cirrhitidae			
<i>Amblycirrhitus pinos</i> (redspotted hawkfish)			A
Sphyraenidae			
<i>Sphyraena barracuda</i> (great barracuda)		A	A
Labridae			
<i>Bodianus rufus</i>			A

Taxa	Ichthyofaunal Assemblage		
	Gallaway <i>et al.</i> (1980)		
	Coastal (3-27 m)	Offshore (27-64 m)	Blue Water or Tropical (>64 m)
	Gallaway (1981)		
	Inner Shelf (White Shrimp Ground) (3-20 m)	Intermediate Shelf (Brown Shrimp Ground) (20-60 m)	Outer Shelf (Tropical) (>60 m)
(Spanish hogfish)			
<i>Decodon puellaris</i> (red hogfish)			A
<i>Clepticus parrai</i> (creole wrasse)			N, A
Scaridae			
parrotfish spp.			N
Blenniidae			
blenny spp.		A	
Acanthuridae			
surgeonfish/tang spp.		A	A
Balistidae			
<i>Balistes capriscus</i> (gray triggerfish)		A	A

(>60 m depth) reefs appear to be more speciose, followed by the mid-shelf (20-60 m) and then the inner shelf (3-20 m). More tropical taxa are present on the outer shelf reefs, such as haemulids, labrids, and scarids, and similar taxa occurred on both natural and artificial reefs. There was some overlap between reef species on the outer shelf and mid-shelf (chaetodontids, pomacanthids, and pomacentrids), but the previously mentioned tropical taxa are replaced by more temperate reef species, such as serranids, *Archosargus probatocephalus*, pomatomids, and rachycentrids. Also, taxa that are common on artificial reefs on the mid-shelf are generally common on the inner shelf as well. In general, *Caranx crysos* and other jacks were noted as being relatively common reef-associated species in each zone.

Few studies have attempted to compare the ichthyofaunal assemblages specifically associated with oil and gas platforms in the northcentral GOM across wide depth zones, and the information that is available primarily concerns adult fishes and not their early life history stages. Sonnier *et al.* (1976) surveyed oil and gas platforms (18-55 m depth) as well as inshore (37-59 m) and offshore (110-155 m) reefs off Louisiana and described the offshore reefs as being more speciose than inshore reefs or platforms. This greater offshore reef species richness was primarily due to the presence of southern Gulf-Caribbean taxa (e.g., butterflyfishes, parrotfishes, and cleaning gobies) and taxa common to reefs in the northwestern GOM off Texas. The authors suggested that the lower temperatures that occur at the inshore reefs and platforms are a limiting factor in the number of species, particularly tropicals, which inhabit inshore reef habitats. As one progressed inshore, the

tropical fauna was replaced by more temperate reef fish species, including *Archosargus probatocephalus*, *Selene vomer*, and *Lutjanus griseus* (Sonnier *et al.* 1976). Twelve species, including tropicals such as *Cantherhines macrocerus*, *Melichthys niger*, and *Diodon holocanthus*, were found only at the platform sites.

ICHTHYOPLANKTON ASSOCIATED WITH OIL AND GAS PLATFORMS

We are aware of only one study that investigated the ichthyoplankton community found in proximity to petroleum platforms. Finucane *et al.* (1979b), using bongo and neuston nets, sampled within 30-90 m of two oil platforms and two satellite (well) jackets in 17 m of water within the Buccaneer Oil Field, approximately 50 km south southeast of Galveston, Texas. Two far-field, control sites were also sampled for comparison. Three 2-day cruises (13-14 July 1977; 13-14 October 1977; and 20 and 22 February 1978) collected 15,711 fish larvae, primarily engraulids, sciaenids, and bothids. Analyses were limited, but species richness was found to be greatest at the platform sites in July and October and at the satellite structures in February. Overall, of the 68 taxa identified to genus, 38 were associated exclusively with at least one of the structure sites, while another 29 were found near both structure sites and control sites. Dominant taxa at the platform sites included unidentified engraulids (26.1%), *Anchoa* spp. (8.8%), *Cynoscion* spp. (7.3%), and *Syacium* spp. (5.9%). Dominant taxa at the satellite stations were once again unidentified engraulids (32.5%) and *Anchoa* spp. (13.4%), along with *Micropogonias undulatus* (11.2%), *Cynoscion* spp. (5.5%), and unidentified clupeids (5.4%). No dominant taxa list was reported for the far-field stations. Based on eggs and larval abundance, the petroleum field was determined to be an active spawning area for anguilliforms, callionymids, clupeids, sciaenids, scombrids and soleids, but reef fish eggs and larvae were not abundant. Noteworthy reef or structure-associated taxa collected during the survey include *Etelis oculatus*, *Lutjanus campechanus*, *Centropristis* spp., *Diplectrum* spp., and *Serraniculus pumilio*, although *Etelis oculatus* and *Diplectrum* spp. were also collected in the far-field control sites.

While the Buccaneer Oil Field study did attempt to address larval fish assemblages near petroleum structures, all of the sites with structure were within a 5 km radius from each other, and all sites, including the controls, were in 17 m of water, not allowing for any comparisons of different community regimes across depth zones or large geographic areas. Also, sampling in the oil field study was limited to only three 2-day cruises. While our study has no replicate platforms within the Gallaway's (1981) depth zones, all three zones were sampled intensively, allowing for at least a preliminary characterization of ichthyoplankton assemblages associated with these artificial habitats across the continental shelf.

OBJECTIVES

This study focused on three main objectives. The first was to provide much-needed information on the role that oil and gas platforms (hard substrate habitat) may play as nursery/recruitment grounds and/or refugia for postlarval and juvenile fish, which could contribute to fish production. Secondly, we wished to respond to specific requests for more basic biological information on reef fish, e.g., larval, postlarval, and juvenile taxonomy, seasonality, lunar periodicity, distribution (vertical and across shelf), and relative abundance. Finally, as a long-term objective, we wished to evaluate the

ecological significance that this artificial habitat building, which has occurred on an unprecedented scale in the northcentral GOM, may have had on the early life history stages of fish. These objectives were accomplished by collecting a wide variety of taxa and sizes utilizing two sampling techniques, light-trap methodology and more traditional techniques (i.e., passive horizontal and hauled vertical plankton net collections). These methodologies complemented each other, since nets effectively sample yolk-sac, larval, and some postlarval fishes, whereas light-traps sample photopositive species at overlapping and larger sizes to give us more complete estimates of sizes (cohorts or inferred ages) and developmental/early life history stages present (Gregory and Powles 1988; Choat *et al.* 1993). An integral part of this study, therefore, was the development of an effective sampling strategy and its subsequent evaluation for collecting larval fish for the first time within and immediately around platform infrastructure (Hernandez and Shaw this volume).

Data collection and analyses focused on three offshore oil and gas platforms in the northcentral GOM and at a low-salinity, coastal rock jetty environment, which provided a far-field, non-platform site, end-member that was equally complex structurally and represented another artificial, reef-like, hard-substrate habitat. The resultant analyses and synthesis of these efforts and ongoing sampling efforts east of the Delta (Figure 5.2) are intended to build a practical characterization and synthesis leading to a much broader understanding of platform ecology and pertinent environment issues over a larger geographic region.

MATERIALS AND METHODS

Study Areas

Two pilot studies at oil and gas platforms off the Louisiana-Texas border were conducted, one at Mobil's West Cameron (WC) 352 during November 1991-August 1992 and the other at Mobil's WC 71D in July 1994 (Figure 5.2). West Cameron 352 is located along the Louisiana/Texas border (28°59'35"N, 93°30'15"W) in about 20 m of water. West Cameron 71D is located off western Louisiana (29°37.30' N, 93°10.54' W) in approximately 12 m of water. These exploratory studies were followed by sampling along a transect west of the Mississippi River Delta with site selection for platforms based upon the work of Gallaway *et al.* (1980), Gallaway (1981), and Continental Shelf Associates (1982), who reported that nekton communities around platforms could be categorized by water depth in the northern GOM. Three communities were characterized: a coastal assemblage (water depths <27m), an offshore assemblage (water depths 27 to 64 m), and a bluewater/tropical assemblage (water depths >64m). The platforms selected and the jetty site encompass all three zones. Mobil's Green Canyon (GC) 18, which lies in about 230 m of water on the shelf slope (27°56'37"N, 91°01'45"W), was sampled monthly during new moon phases over a two- to three-night period during July 1995-June 1996. Mobil's Grand Isle (GI) 94B, which lies in approximately 60 m of water at mid-shelf (28°30'57"N, 90°07'23"W), was sampled twice monthly during new and full moon phases over a three-night period during April-August 1996. During May, extra samples during the first-quarter and third quarter moon phases were collected, but due to inclement weather, full-moon collections were cancelled. Exxon's South Timbalier (ST) 54G, which lies in approximately 20 m of water on the inner shelf (28°50'01"N, 90°25'00"W), was sampled

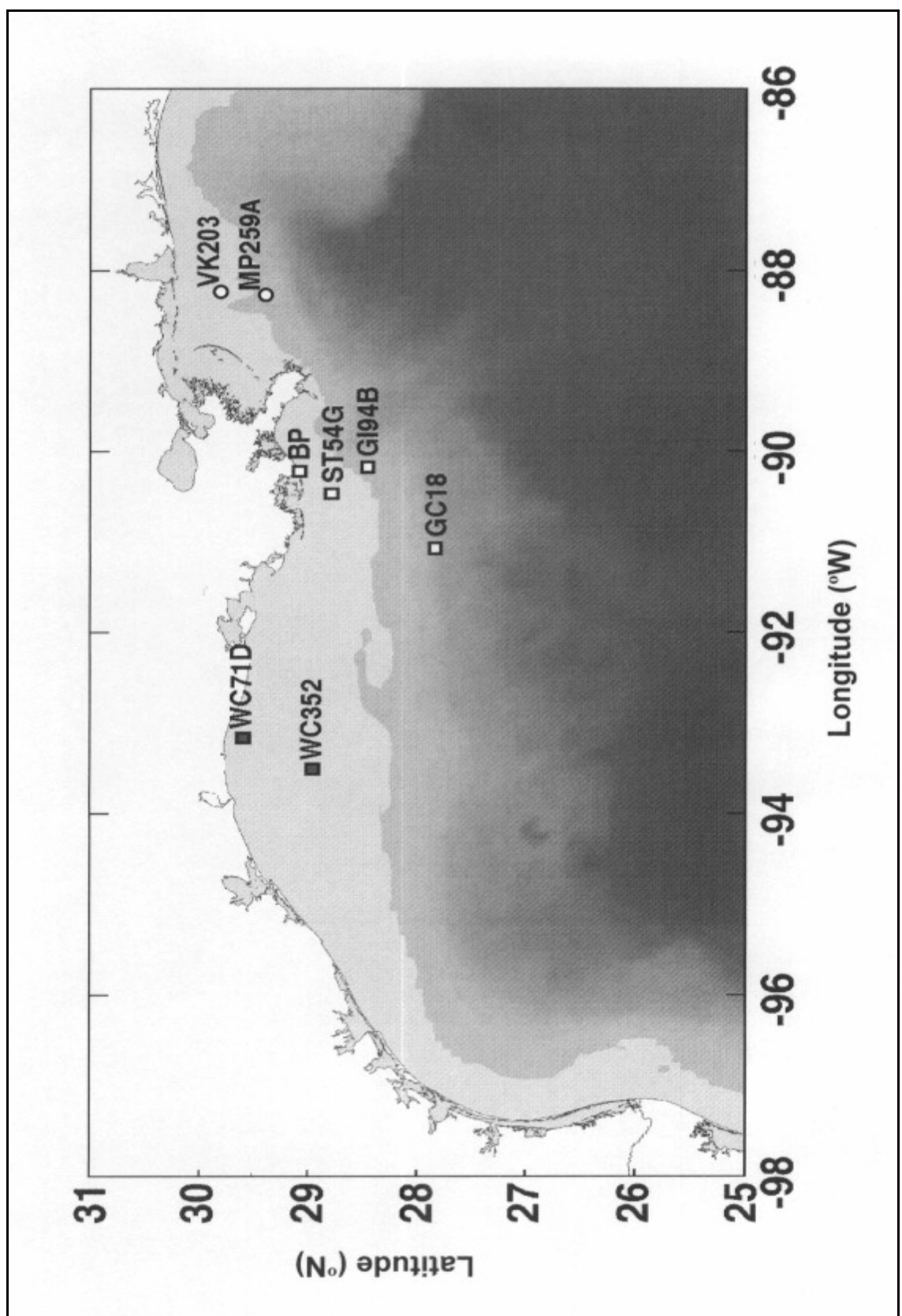

Figure 5.2. Sites sampled during and before the course of the study. Open squares are sites of the oil and gas platforms and coastal jetty sampled during the course of this study. Solid squares represent sites sampled previously during pilot studies. Open circles represent sites of ongoing sampling for future comparisons.

twice monthly during new- and full-moon periods during April-September 1997. All platforms had very similar structural complexity. GC 18 was a very large six pile (column or leg) production platform, while GI 94 and ST 54 were eight pile production platforms. The stone rubble jetties (2-3 m depth) at the terminus of Belle Pass, a major shipping channel near Fourchon, Louisiana (N 29 03.90, W 90 13.80), were also sampled over a two-night period in 1997 simultaneously with the sampling of ST 54. The two jetties are approximately 91 m apart and run in a general north-south direction. The east jetty is approximately 335 m long and the west jetty is approximately 305 m long. Depths along the jetties ranged from 3-5 m.

Sampling Procedure

Collections were made at WC 352 within the platform structure during seven sampling periods between November 1991 and August 1992. All sampling commenced and terminated at least one hour after sunset and before sunrise, respectively. Each sample was obtained by deploying a modified quatrefoil light-trap (Hernandez and Shaw this volume) for 10 to 15 minutes, although two 35-minute samples were also collected. Samples were taken concurrently at depths of 1 m (surface) and 18 m (subsurface) from February-May 1992 only. Surface samples were obtained by lowering a trap with flotation into the water. Subsurface samples were collected by lowering a trap without flotation along a stainless steel cable guideline tethered to the bottom.

Samples were collected at WC 71D over three consecutive nights (21-24 July 1994). All sampling commenced or terminated at least one hour after sunset and before sunrise. Three light-trap designs, a modified quatrefoil, a Doherty trap (Doherty 1987), and a cylindrical design (an acrylic model modified from Riley & Holt (1993), were deployed off a stainless steel cable guideline within the platform structure. Sampling depths included 1 m (surface) and 8.5 m (night 3 only). In addition, six vertical plankton haul samples (202- m mesh, 60-cm diameter net) were collected during night 2. The net, mounted on a rigid frame and attached to the central cable, was lowered to the bottom (effective depth = 8.5 m) and raised at approximately 1 m/s after a five-minute interval to allow the water column to restabilize. A set of samples included one sample by each of the three light traps, and there were six sets made each night, except for night 3 when four sets were made near the surface and four sets were taken at depth. On night 2 only, a vertical net tow was added to each set. The order of the trap (or vertical net tows) collections was randomized within each set as was the case with all subsequent platform sampling.

Sampling protocols for GC 18, GI 94, and ST 54 were similar. At GC 18, eleven monthly sampling trips were taken over a three-night period coinciding with new moon phases from July 1995-June 1996, with the exception of the month of December (adverse weather). New moon phases were targeted at this platform because they have been associated with the peak recruitment periods of many reef-associated fishes (Johannes 1978; Robertson *et al.* 1988). All sampling began one hour after sunset and was completed one hour before sunrise. The major sampling station for each platform was located in the internal central region along a stainless steel, small-diameter guidewire (monorail) tethered to the first set of the platform's underwater, cross-member, support structures. At this central station, replicate trap collections (N = 2) were taken three times each night at near-surface (1-2 m depth) and at a depth between 15 and 23m, depending upon the individual platform's underwater configuration of the first set of cross-member supports. Subsurface samples were

collected by lowering a trap without flotation. Light-traps were deployed for 10-minute periods. Passive, horizontal plankton net collections were taken three times at both depths during each night at the central station using a metered (General Oceanics flowmeter model 2030 with slow velocity rotor), 60-cm diameter, 333 μ m mesh net dyed dark green. The nets had a vane (to help orient into the current) which was fixed to a gimble attachment on the net ring, which allowed the net to be set and retrieved closed for the at-depth deployment. In addition, three collections each night were made with a floating light-trap that was tethered and free-drifted away (off-platform) from the platform (approximately 20 m) on the down-current side of the platform. For light-traps sampled at depth or off-platform, the trap was deployed with the light off, fished with the light on, and then retrieved with the light off.

Temperature ($^{\circ}$ C) and salinity (ppt), turbidity (NTU), and current speed and direction were determined during each set using either a Data Sonde 3 Hydrolab or an Inter Ocean S4 Current Meter. During each set, a vertical plankton net (20-cm diameter, 63- μ m mesh) which was held rigidly to the guidewire by a frame, was lowered codend first to the bottom of the monorail, left at depth for 5 minutes for water column restabilization, and then hauled to the surface at approximately 1m/s to ascertain macrozooplankton biomass as a measure of food availability. The samples were returned to the lab where they were dried in an oven for 24 h at 60 $^{\circ}$ C and then weighed to determine the dry weight biomass (g/m³). Also, surface water samples were collected during each set to determine total suspended sediments, an estimate of turbidity. Water samples were later filtered in the lab through a pre-weighed, microfiber filter (1.2 μ m), dried in an oven for 24 h at 60 $^{\circ}$ C, and weighed to determine the suspended sediment load (g/500 ml). Both the macrozooplankton biomass and suspended sediment (turbidity) estimates were used in the canonical correlation analyses (see below).

At GI 94, a total of 11 sampling trips were taken, and samples were collected twice monthly during new and full moons for three consecutive nights from April-August 1996 (the peak recruitment period for most reef associated species in the northern GOM). Sampling at GC 18 and GI 94, therefore, overlapped monthly from April-June 1996. In May, additional sampling trips were scheduled to coincide with the first and last quarter moon phases, but the full moon trip was cancelled due to adverse weather conditions. At ST 54 sampling also occurred twice monthly from April-September 1997 (eight trips total), during new and full moon periods. Sampling effort was modified at GI 94 and ST 54 to obtain one (rather than two) replicate subsurface and surface collection per gear, and one off-platform light-trap collection per set, with still three sets taken per night.

Samples were collected twice monthly (new and full moon phases) over two-night periods at the Belle Pass jetties from April-September 1997 (11 trips total) simultaneously with the sampling of ST 54. For sampling purposes, the sides of the two, north-south oriented channel jetties were labeled as East Exterior (EE), East Interior (EI), West Interior (WI), and West Exterior (WE). A total of four sampling stations, one on each side of each jetty, were located approximately at jetty mid-points and were identified during sampling by distinct rock outcroppings that were sprayed with fluorescent paint. Two sets of samples were taken each night. A set included a light-trap and a bow-mounted, pushnet sample at each of the four stations. The order of stations sampled within each set was chosen using a random number table. Light-traps were equipped with a submersible battery that was

secured to the top of the light-trap with bungee cords. At each station, a buoyed mooring was used to suspend the light-trap approximately 1 m below the surface as close to the jetty as possible, which was usually within 2 m of the surface-exposed rocks. Light-traps were allowed to fish for 10 minutes. A bow-mounted pushnet (1 m x 1 m, 1,000 μ m mesh net dyed green) was pushed at approximately 1 m/sec just below the surface along the edge of the jetty for 3-5 minutes, depending upon the density of plankton. A General Oceanics flowmeter (large rotor) was used to determine the volume of water filtered. Subsurface salinity (ppt), temperature ($^{\circ}$ C), dissolved oxygen (% saturation and mg/l), and turbidity (NTU) were measured at each station during each set using a DataSonde 3 Hydrolab and Multiprobe Logger.

All samples collected at WC 352 and WC 71D were preserved in 5% formalin and later changed over to ethanol. Samples collected at GC 18 and GI 94 were preserved in ethanol and had the ethanol changed over again within 12-18 hours. Samples collected at ST 54 and Belle Pass were fixed in 4% buffered formaldehyde and changed over to ethanol within 8-12 hours. Fish were removed from all samples, enumerated, measured under a dissecting microscope with the aid of an ocular micrometer, and identified to the lowest taxonomic level possible using primarily the taxonomic classification of Robins *et al.* (1991). Large samples were split using a Folsom plankton splitter (Van Guelpen *et al.* 1982). In the event that the number of fish in a sample or a split was greater than 50 for any single species, the largest, smallest and a random subsample of 50 individuals were measured. Preflexion larvae were measured to the end of the notochord (NL) and all postflexion larvae, juveniles, and adults were measured to the posterior end of the vertebral column (SL). Light-trap samples were standardized to catch-per-unit-effort (CPUE) of fish per 10 min. Plankton net and pushnet samples were standardized to the number of fish per 100 m³ (density). This core sampling schedule formed the basis of our sampling protocols at all other platforms. Sea states, adverse weather, transportation delays and platform safety concerns often forced us to suspend some sample collections. Only 7 subsurface plankton net collections were taken at ST 54 (April 7-8) because of problems with the monorail rigging. Similar gear problems reduced the number of subsurface net samples collected at GC 18. Table 5.5 summarizes the number of samples collected by trip, gear type, and depth/location for the WC 352 and WC 71D pilot studies and for GC 18, GI 94, ST 54, and Belle Pass.

Analyses of Data

Data collected at GC 18, GI 94, ST 54, and Belle Pass were used in all analyses where possible. Data collected in the pilot studies (WC 352 and WC 71D) are included here only in community structure analyses. Also, due to the very large numbers of clupeiform (Clupeidae and Engraulidae) fishes collected, particularly in light-trap samples, some analyses were run with and without these taxa, since these fish are seldom the taxa of interest in studies of hard-substrate habitats and their abundances tend to overwhelm the trends of other taxa (Choat *et al.* 1993). All ANOVA, Tukey's Studentized Range Tests, and canonical correlations were run with SAS version 6.12 (SAS 1989).

Schoener's Index of Niche Overlap (Schoener 1970) was calculated for all sites by combining fish collected by all gears within each site as an indication of the community similarity between sites. Only fish identified to at least the genus level were used in the similarity analyses. Since this type of analysis can be heavily influenced by large abundances of a single species, it was done both with

Table 5.5. Number of samples collected at each site by date, gear type, and depth/location. No lunar phase information was recorded for West Cameron 352. (Lunar phases: N, new moon; F, full moon; 1, first quarter; 3, last quarter)

	Vertical Net	Subsurface Net	Surface Net	Subsurface Light-trap	Surface Light-trap	Off-platform Light-trap	Pushnet
West Cameron 352							
Nov 21-22					23		
Dec 16				1	5		
Feb 7-9				8	12		
Mar 24-25				4	12		
Apr 9-10				7	13		
May 26-27				9	13		
August 4-6					15		
Totals				29	93		
West Cameron 71D							
Jul 21-23 (F)	6			12	48		
Totals	6			12	48		
Green Canyon 18							
Jul 26-29 (N)		0	9	18	18	5	
Aug 25-28 (N)		0	12	18	18	9	
Sep 24-25 (N)		0	12	12	12	6	
Oct 23-25 (N)		9	9	18	18	9	
Nov 21-23 (N)		9	9	18	17	9	
Jan 19 (N)		3	3	6	6	3	
Feb 17-18 (N)		5	5	10	6	4	
Apr 15-18 (N)		0	0	0	0	15	
May 17-20 (N)		2	9	5	5	18	
Jun 18-21 (N)		13	16	14	13	9	
Totals		41	84	119	113	87	
Grand Isle 94							
Apr 16-18 (N)		6	6	4	8	8	
Apr 26-29 (1)		18	18	18	18	18	
May 10-12 (3)		10	12	12	12	12	
May 17-20 (N)		18	18	18	18	18	

Table 5.5. (continued)

	Vertical Net	Subsurface Net	Surface Net	Subsurface Light-trap	Surface Light-trap	Off-platform Light-trap	Pushnet
May 24-26 (1)		12	13	12	13	11	
Jun 14-17 (N)		18	18	18	18	18	
Jun 28-Jul 1 (F)		17	17	13	12	13	
Jul 12-15 (N)		17	17	15	13	16	
Jul 29-Aug 1 (F)		11	13	11	12	12	
Aug 12-15 (N)		16	17	15	17	17	
Aug 26-29 (F)		18	19	18	18	18	
Totals		161	168	154	159	161	
South Timbalier 54							
Apr 7-8 (N)		7	7	5	6	8	
May 5-8 (N)		0	15	0	16	12	
May 20-23 (F)		0	18	12	18	10	
Jun 4-5 (N)		0	6	6	6	5	
Jun 20-21 (F)		0	8	6	9	9	
Jul 3-5 (N)		0	5	7	7	3	
Aug 17-20 (F)		0	13	4	12	14	
Sep 3-5 (N)		0	10	9	10	0	
Totals		7	82	49	84	61	
Bell Pass							
Apr 4-7 (N)					9		9
Apr 21-23 (F)					8		8
May 5-7 (N)					16		16
May 20-22 (F)					16		16
Jun 3-5 (N)					16		16
Jun 20-21 (F)					8		8
Jul 3-5 (N)					16		15
Jul 19-21 (F)					12		15
Aug 1-3 (N)					15		14
Aug 18-20 (F)					16		16
Aug 31-Sep 2 (N)					16		16
Totals					148		149

and without the most dominant taxa at each site included. At times, the sampling efforts differed temporally between sites (Table 5.5), so the samples used for comparisons were limited to only those months where samples were collected for both sites in a pairing. For example, all comparisons with WC 71D were done using only July samples from the other sites. Comparisons between the WC 352 and three across-shelf sites (GI 94, ST 54, and Belle Pass) were done using only April and May samples. Comparisons with WC 352 and GC 18 were done using samples from November, December, April, and May. Only April-August samples were used to compare GC 18 to GI 94, ST 54, and Belle Pass. Full data sets were used in comparisons between GI 94, ST 54, and Belle Pass. Shannon-Weiner diversity indices (Magurran 1988) were calculated for each sample collected at GC 18, GI 94, ST 54, and Belle Pass. Differences in mean diversity between sites were analyzed with ANOVA models using gear as a main effect. Post-ANOVA tests (Tukey's Studentized Range, $\alpha=0.05$) were used to determine which sites were significantly different. Only fish identified at least to genus level were included in the diversity analyses.

Canonical correlations were used to determine relationships at each site between plankton net or pushnet densities or light-trap CPUEs for dominant taxa and environmental variables. For GC 18 and GI 94, log-transformed densities of the top 15 taxa (excluding clupeiforms) collected in subsurface and surface plankton nets combined were analyzed along with temperature, salinity, macrozooplankton biomass, and total suspended sediments (turbidity). The same analyses were performed for log-transformed CPUEs of the top 15 taxa collected in subsurface and surface light-traps. Occasionally more than 15 taxa were analyzed for light-trap data due to ties in the ranking of CPUEs. For ST54, the same analyses were performed, but only surface plankton net data were used because very few subsurface plankton net samples were collected at this site (Table 5.4). For Belle Pass, the same analyses were performed, but included Hydrolab measurements of turbidity and dissolved oxygen, and did not include total suspended sediments or macrozooplankton biomass estimates. The importance of an environmental variable was based on the magnitude of its correlation with the environmental variate, with the sign of the correlation indicating if the variable was directly (positively) or inversely (negative) related to the variate. A species was considered to be related to the variate if the absolute value of the intersite correlation was greater than 0.387 (i.e., the variate predicted 15% or more of the species variation within the model).

RESULTS

A total of 67 families were represented in our plankton net and light-trap collections from the three platform sites (Tables 5.6–5.9). The number of families represented in passive plankton net collections decreased from 45 at GC 18 (shelf slope) to 40 at GI 94 (mid-shelf) and 34 at ST 54 (inner shelf). In contrast, the number of families represented in light-trap collections was fairly consistent, from 37 at GC 18 and GI 94 to 34 at ST 54.

Overall Abundances and Seasonality

A total of 5,057 fish were collected at GC 18 over the course of the year. Light-traps and plankton nets collected 1,114 and 3,943 fish, respectively, with a total mean plankton net density of 74.6 fish/100 m³ and a total mean light-trap CPUE of 2.06 fish/10 min. Plankton nets collected fish from 45 different families, 15 of which were not collected with light-traps (Table 5.6). Light-traps collected fish from 37 different families, seven of which were only collected with (i.e., unique to) light-traps. Plankton nets collected fish from 64 taxa (identified at least to genus level), 25 of which were not collected with light-traps, while light-traps collected fish from 59 taxa with 18 being unique to light-trap collections. Clupeiform fishes, primarily unidentified engraulids, *Opisthonema oglinum*, *Anchoa nasuta/hepsetus*, and *Engraulis eurystole*

Table 5.6. Total plankton net density (fish/100 m³) and light-trap CPUE (fish/10 min) for fish collected at Green Canyon 19 with standard error (SE), rank, percent of total catch (%), and months collected for each taxa. (N) indicates taxa collected only with plankton nets. (L) indicates taxa collected only with light-traps. For ranks, tied values received the mean of the corresponding ranks. ‡ indicates a value <1.00%.

Taxa	Months Collected	Surface Net	Bottom Net	Bottom Light-trap	Surface Light-trap	Off-platform Light-trap
		Density (SE)	Density (SE)	CPUE (SE)	CPUE (SE)	CPUE (SE)
		Rank (%)	Rank (%)	Rank (%)	Rank (%)	Rank (%)
Osteichthyes						
Unidentified	Feb, Apr, Jun, Jul, Aug, Sep, Oct, Nov	0.85 (0.39) 23 ‡	4.93 (2.73) 6 (1.54)	0.08 (0.04) 7 (3.27)	0.02 (0.01) 41.5 ‡	0.26 (0.16) 4 (8.36)
Elopiformes						
Elopidae						
<i>Elops saurus</i> (N) (ladyfish)	Oct	0 (0)	0.35 (0.35) 35 ‡	0 (0)	0 (0)	0 (0)
Anguilliformes						
Unidentified (eel)	Jul, Oct, Nov	1.57 (0.72) 13 ‡	4.32 (2.46) 9 ‡	<0.01 (0.01) 28.5 ‡	0.02 (0.01) 41.5 ‡	0.01 (0.01) 40.5 ‡
Moringuidae						
<i>Neoconger mucronatus</i> (ridged eel)	Oct	0.21 (0.21) 52 ‡	0 (0)	0 (0)	<0.01 (0.01) 55 ‡	0 (0)
Muraenidae						
Unidentified (moray eel)	Jun, Jul, Aug, Sep, Oct	0.02 (0.02) 85 ‡	0 (0)	<0.01 (0.01) 28.5 ‡	0.03 (0.02) 33 ‡	0.02 (0.02) 25 ‡
Ophichthidae						
Unidentified (snake eel)	Jul, Oct, Nov	1.09 (0.71) 19 ‡	2.87 (1.27) 11 ‡	0 (0)	0.05 (0.02) 22 (1.06)	0 (0)
<i>Myrophis punctatus</i> (L) (speckled worm eel)	Feb	0 (0)	0 (0)	0 (0)	<0.01 (0.01) 55 ‡	0 (0)
<i>Ophichthus gomesi</i> (L) (shrimp eel)	Jul	0 (0)	0 (0)	<0.01 (0.01) 28.5 ‡	0.03 (0.03) 33 ‡	0 (0)
Congridae						
Unidentified (L) (conger eel)	Jul	0 (0)	0 (0)	0 (0)	0.03 (0.02) 33 ‡	0 (0)
Clupeiformes						
Unidentified (herring/anchovy)	Jul, Sep	1.08 (0.92) 20 (1.08)	0 (0)	0 (0)	0 (0)	0.01 (0.01) 40.5 ‡
Clupeidae						
<i>Brevoortia patronus</i> (gulf menhaden)	Jan, Feb, Nov	1.12 (0.55) 18 ‡	2.44 (1.21) 12 ‡	0 (0)	0.03 (0.02) 33 ‡	0.02 (0.02) 25 ‡

Table 5.6. (continued)

Taxa	Months Collected	Surface Net	Bottom Net	Bottom Light-trap	Surface Light-trap	Off-platform Light-trap
		Density (SE)	Density (SE)	CPUE (SE)	CPUE (SE)	CPUE (SE)
		Rank (%)	Rank (%)	Rank (%)	Rank (%)	Rank (%)
<i>Etrumeus teres</i> (N) (round herring)	Jan, Feb	1.16 (1.05) 16 ‡	0.19 (0.19) 42.5 ‡	0 (0)	0 (0)	0 (0)
<i>Harengula jaguana</i> (scaled sardine)	Jul, Aug	0.06 (0.04) 71 ‡	0 (0)	<0.01 (0.01) 28.5 ‡	0.15 (0.06) 11.5 (3.01)	0 (0)
<i>Opisthonema oglinum</i> (Atlantic thread herring)	Jul, Aug, Sep	39.41 (16.26) 1 (38.40)	0 (0)	0.11 (0.06) 4 (4.73)	0.42 (0.11) 3 (8.51)	0.28 (0.11) 2.5 (8.73)
Engraulidae						
Unidentified (anchovy)	Feb, Jun, Jul, Aug, Sep Oct, Nov	39.21 (12.21) 2 (24.32)	57.18 (26.10) 1 (53.90)	0.46 (0.11) 2 (20.00)	0.51 (0.15) 1 (10.28)	0.28 (0.13) 2.5 (8.73)
<i>Anchoa</i> spp. (L) (anchovy spp.)	Jul	0 (0)	0 (0)	0.07 (0.07) 8 (2.91)	0 (0)	0 (0)
<i>Anchoa mitchilli</i> (bay anchovy)	Jul	0.03 (0.03) 79 ‡	0 (0)	0 (0)	0.15 (0.12) 11.5 (3.01)	0 (0)
<i>Anchoa nasuta/hepsetus</i> (L) (longnose/striped anchovy)	Jul, Aug, Sep, Nov	0 (0)	0 (0)	0.80 (0.31) 1 (34.91)	0.22 (0.12) 8 (4.43)	0.16 (0.10) 8 (5.09)
<i>Engraulis eurystole</i> (silver anchovy)	Jun, Jul, Aug, Sep, Oct	0.34 (0.30) 42 ‡	8.63 (8.63) 5 (9.45)	0.15 (0.04) 3 (6.55)	0.25 (0.11) 5 (5.14)	0.02 (0.02) 25 ‡
Stomiiformes						
Gonostomatidae						
<i>Cyclothone braueri</i>	Jan, May, Jun, Jul, Oct, Nov	1.01 (0.65) 21 ‡	3.05 (1.55) 10 ‡	0 (0)	0.23 (0.21) 7 (4.61)	0 (0)
<i>Diplophos taenia</i> (N)	Nov	0.29 (0.29) 44.5 ‡	0.41 (0.41) 31 ‡	0 (0)	0 (0)	0 (0)
Aulopiformes						
Chlorophthalmidae						
<i>Chlorophthalmus agassizi</i> (N) (shortnose greeneye)	Jun, Nov	0 (0)	0.70 (0.61) 24 ‡	0 (0)	0 (0)	0 (0)
Scopelarchidae						
<i>Scopelarchoides</i> spp. (N) (pearleye spp.)	Jan	0.03 (0.03) 80 ‡	0 (0)	0 (0)	0 (0)	0 (0)
Synodontidae						
Unidentified (lizardfish)	Jan, May, Jul, Oct	0.27 (0.16) 46 ‡	0.61 (0.61) 26 ‡	<0.01 (0.01) 28.5 ‡	<0.01 (0.01) 55 ‡	0 (0)
<i>Saurida brasiliensis</i> (largescale lizardfish)		<0.01 (<0.01) 92 ‡	0 (0)	0.03 (0.02) 12.5 (1.09)	0.20 (0.14) 9 (4.08)	0 (0)

Table 5.6. (continued)

Taxa	Months Collected	Surface Net	Bottom Net	Bottom Light-trap	Surface Light-trap	Off-platform Light-trap
		Density (SE)	Density (SE)	CPUE (SE)	CPUE (SE)	CPUE (SE)
		Rank (%)	Rank (%)	Rank (%)	Rank (%)	Rank (%)
<i>Synodus synodus</i> (red lizardfish)	Jun	0.29 (0.29) 44.5 ‡	0 (0)	0 (0)	0.03 (0.02) 33 ‡	0 (0)
<i>Trachinocephalus myops</i> (snakefish)	Sep, Oct	0.10 (0.10) 63 ‡	0 (0)	0 (0)	0.04 (0.02) 25 ‡	0.03 (0.02) 19 (1.09)
Paralepididae						
Unidentified (N) (barracudina)	Nov	0.26 (0.26) 47 ‡	0.41 (0.41) 31 ‡	0 (0)	0 (0)	0 (0)
<i>Paralepis atlantica</i> (L) (duckbill barracudina)	Jul	0 (0)	0 (0)	0.02 (0.01) 18 ‡	0 (0)	0 (0)
<i>Lestrolepis intermedia</i> (L)	Jul	0 (0)	0 (0)	0.02 (0.02) 18 ‡	0 (0)	0 (0)
Myctophiformes						
Myctophidae						
Unidentified (lanternfish)	Jan, Feb, Apr, May, Jun, Jul, Sep, Nov	0.83 (0.45) 24 ‡	0.31 (0.22) 36 ‡	0.03 (0.02) 12.5 (1.09)	0.04 (0.02) 27.5 ‡	0.17 (0.06) 7 (5.45)
Gadiformes						
Unidentified (N)	Sep, Oct	0.19 (0.15) 55 ‡	0 (0)	0 (0)	0 (0)	0 (0)
Bregmacerotidae						
<i>Bregmaceros cantori</i> (codlet)	Jan, May, Aug, Sep, Oct	1.80 (0.88) 11 (1.08)	2.42 (1.21) 13 ‡	0.03 (0.02) 11 (1.45)	<0.01 (0.01) 55 ‡	0.05 (0.02) 15.5 (1.45)
Merluccidae						
Unidentified (L) (whiting)	Nov	0 (0)	0 (0)	0 (0)	<0.01 (0.01) 55 ‡	0 (0)
Ophidiidae						
Unidentified (N) (cuskeel)	May	<0.01 (<0.01) 89.5 ‡	0 (0)	0 (0)	0 (0)	0 (0)
<i>Lepophidium</i> spp. (cusk-eel spp.)	Aug, Sep, Oct	0.43 (0.27) 37 ‡	1.30 (0.94) 17 ‡	0.02 (0.01) 18 ‡	0 (0)	0.01 (0.01) 40.5 ‡
Bythitidae						
Unidentified (brotula)	Oct, Nov	0.33 (0.23) 43 ‡	0.41 (0.41) 31 ‡	<0.01 (0.01) 28.5 ‡	<0.01 (0.01) 55 ‡	0.01 (0.01) 40.5 ‡
Lophiiformes						
Unidentified	May, Aug	<0.01 (<0.01) 92 ‡	0 (0)	0 (0)	<0.01 (0.01) 55 ‡	0 (0)

Table 5.6. (continued)

Taxa	Months Collected	Surface Net	Bottom Net	Bottom Light-trap	Surface Light-trap	Off-platform Light-trap
		Density (SE)	Density (SE)	CPUE (SE)	CPUE (SE)	CPUE (SE)
		Rank (%)	Rank (%)	Rank (%)	Rank (%)	Rank (%)
Gobiesociformes						
Gobiesocidae						
<i>Gobiesox strumosus</i> (L) (skilletfish)	Jul	0 (0)	0 (0)	0 (0)	0.08 (0.08) 16 (1.60)	0 (0)
Atheriniformes						
Exocoetidae						
Unidentified (flyingfish)	Jun, Aug, Sep	0.63 (0.40) 31 ‡	0.27 (0.20) 38 ‡	0 (0)	0 (0)	0.01 (0.01) 40.5 ‡
<i>Cypselurus cyanopterus</i> (L) (marginated flyingfish)	Jul	0 (0)	0 (0)	0 (0)	<0.01 (0.01) 55 ‡	0 (0)
<i>Cypselurus furcatus/heterurus</i> (L) (spotfin/Atlantic flyingfish)	May	0 (0)	0 (0)	0 (0)	0 (0)	0.01 (0.01) 40.5 ‡
<i>Parexocoetus brachypterus</i> (L) (sailfin flyingfish)	Jul	0 (0)	0 (0)	0 (0)	0.04 (0.02) 27.5 ‡	0 (0)
Beryciformes						
Holocentridae						
<i>Holocentrus</i> spp. (squirrelfish)	Jun	0.18 (0.10) 56 ‡	0 (0)	0 (0)	0.07 (0.04) 18 (1.42)	0.11 (0.05) 11 (3.64)
Melamphaidae						
<i>Melamphaes</i> spp. (N)	Jan, Jun	0.05 (0.04) 73 ‡	0 (0)	0 (0)	0 (0)	0 (0)
Scorpaeniformes						
Unidentified (N)	Oct	0.24 (0.17) 48 ‡	0 (0)	0 (0)	0 (0)	0 (0)
Scorpaenidae						
Unidentified (N) (scorpionfish)	Oct	0.08 (0.08) 68 ‡	0 (0)	0 (0)	0 (0)	0 (0)
<i>Scorpaena</i> spp. (N) (scorpionfish spp.)	Jun, Aug	0.09 (0.07) 67 ‡	0 (0)	0 (0)	0 (0)	0 (0)
Triglidae						
<i>Prionotus</i> spp. (N) (searobin)	May	0.01 (0.01) 87.5 ‡	0 (0)	0 (0)	0 (0)	0 (0)
Perciformes						
Unidentified	Jan, May, Jun, Jul, Aug, Sep, Oct	2.60 (1.27) 9 (1.11)	1.48 (0.64) 16 (1.23)	0.09 (0.05) 5.5 (4.00)	0.03 (0.02) 33 ‡	0.02 (0.02) 25 ‡

Table 5.6. (continued)

Taxa	Months Collected	Surface Net	Bottom Net	Bottom Light-trap	Surface Light-trap	Off-platform Light-trap
		Density (SE)	Density (SE)	CPUE (SE)	CPUE (SE)	CPUE (SE)
		Rank (%)	Rank (%)	Rank (%)	Rank (%)	Rank (%)
Serranidae						
Unidentified (sea bass/grouper)	Jan, Jun, Oct, Nov	0.22 (0.14) 50 ‡	1.86 (1.28) 15 ‡	0 (0)	<0.01 (0.01) 55 ‡	0 (0)
Anthinae (sea perch)	Apr, May, Jun, Nov	0.46 (0.19) 34 ‡	0.38 (0.23) 33 ‡	0 (0)	<0.01 (0.01) 55 ‡	0.02 (0.02) 25 ‡
Epinephelinae (N) (grouper)	May, Jun	0.41 (0.23) 38 ‡	0.23 (0.13) 39 ‡	0 (0)	0 (0)	0 (0)
Grammistinae (N)	Jun	0 (0)	0.14 (0.10) 48 ‡	0 (0)	0 (0)	0 (0)
Priacanthidae						
Unidentified (N) (bigeye)	May, Jun	0.10 (0.07) 64 ‡	0.08 (0.08) 53 ‡	0 (0)	0 (0)	0 (0)
<i>Priacanthus</i> spp. (L) (bigeye/glasseye spp.)	Jun	0 (0)	0 (0)	0 (0)	<0.01 (0.01) 55 ‡	0 (0)
Apogonidae						
Unidentified (N) (cardinalfish)	May	<0.01 (<0.01) 89.5 ‡	0 (0)	0 (0)	0 (0)	0 (0)
<i>Apogon</i> spp. (N) (cardinalfish spp.)	May	<0.01 (<0.01) 92 ‡	0 (0)	0 (0)	0 (0)	0 (0)
Pomatomidae						
<i>Pomatomus saltatrix</i> (L) (bluefish)	Sep, Oct	0 (0)	0 (0)	0 (0)	0 (0)	0.05 (0.03) 15.5 (1.45)
Echeneidae						
Unidentified (N) (remora)	Jun	0.14 (0.10) 59.5 ‡	0 (0)	0 (0)	0 (0)	0 (0)
Carangidae						
Unidentified (N) (jack)	May, Jun, Jul	0.41 (0.28) 39 ‡	0.23 (0.16) 40 ‡	0 (0)	0 (0)	0 (0)
<i>Caranx</i> spp. (jack spp.)	May, Jun	0 (0)	0.07 (0.07) 56 ‡	0 (0)	0 (0)	0.01 (0.01) 40.5 ‡
<i>Caranx crysos</i> (blue runner)	Jun, Jul, Aug, Sep	2.75 (1.30) 8 ‡	0.56 (0.49) 27 ‡	<0.01 (0.01) 28.5 ‡	0.24 (0.08) 6 (4.79)	0.30 (0.10) 1 (9.45)
<i>Caranx hippos/latus</i> (crevalle/horse-eye jack)	May, Jun, Jul, Aug, Oct	1.89 (0.65) 10 (1.85)	4.45 (1.62) 8 (4.31)	<0.01 (0.01) 28.5 ‡	0.08 (0.03) 16 (1.60)	0.22 (0.06) 5 (6.91)
<i>Chloroscombrus chrysurus</i> (Atlantic bumper)	Jun, Jul, Aug, Sep	0.57 (0.24) 33 ‡	0 (0)	0 (0)	0.03 (0.02) 33 ‡	0 (0)

Table 5.6. (continued)

Taxa	Months Collected	Surface Net	Bottom Net	Bottom Light-trap	Surface Light-trap	Off-platform Light-trap
		Density (SE)	Density (SE)	CPUE (SE)	CPUE (SE)	CPUE (SE)
		Rank (%)	Rank (%)	Rank (%)	Rank (%)	Rank (%)
<i>Decapterus punctatus</i> (round scad)	Jun, Jul	0.03 (0.03) 77.5 ‡	0 (0)	<0.01 (0.01) 28.5 ‡	<0.01 (0.01) 55 ‡	0 (0)
<i>Elagatis bipinnulata</i> (rainbow runner)	May	0.19 (0.12) 54 ‡	0 (0)	0 (0)	0 (0)	0.01 (0.01) 40.5 ‡
<i>Selar crumenophthalmus</i> (N) (bigeye scad)	May, Jun	0.02 (0.02) 86 ‡	0.19 (0.19) 42.5 ‡	0 (0)	0 (0)	0 (0)
<i>Selene vomer</i> (N) (lookdown)	Sep	0.24 (0.24) 49 ‡	0 (0)	0 (0)	0 (0)	0 (0)
<i>Seriola</i> spp. (jack spp.)	May, Jun, Aug, Oct	0.11 (0.06) 62 ‡	0.44 (0.36) 28 ‡	0 (0)	<0.01 (0.01) 55 ‡	0 (0)
<i>Trachurus lathami</i> (rough scad)	Jan, Feb, Apr, May	0.12 (0.07) 61 ‡	0.19 (0.19) 42.5 ‡	0 (0)	<0.01 (0.01) 55 ‡	0.02 (0.02) 25 ‡
Coryphaenidae						
<i>Coryphaena equiselis</i> (N) (pompano dolphin)	May	0.01 (0.01) 87.5 ‡	0 (0)	0 (0)	0 (0)	0 (0)
<i>Coryphaena hippurus</i> (N) (dolphin)	Jun, Sep	0.09 (0.07) 65 ‡	0.09 (0.09) 51 ‡	0 (0)	0 (0)	0 (0)
Lutjanidae						
Unidentified (snapper)	Feb, May	0.04 (0.04) 76 ‡	0.03 (0.03) 58 ‡	0 (0)	0 (0)	0.01 (0.01) 40.5 ‡
<i>Lutjanus</i> spp. (snapper spp.)	Jun	0.14 (0.10) 59.5 ‡	0.19 (0.19) 42.5 ‡	0 (0)	<0.01 (0.01) 55 ‡	0 (0)
<i>Lutjanus apodus/vivanus</i> (L) (schoolmaster/silk snapper)	Jul	0 (0)	0 (0)	0 (0)	0.02 (0.01) 41.5 ‡	0 (0)
<i>Lutjanus campechanus</i> (L) (red snapper)	Sep	0 (0)	0 (0)	0 (0)	0.02 (0.02) 41.5 ‡	0 (0)
<i>Pristipomoides aquilonaris</i> (N) (wenchman)	Jun, Oct	0.91 (0.71) 22 ‡	1.95 (0.88) 14 (2.16)	0 (0)	0 (0)	0 (0)
<i>Rhomboplites aurorubens</i> (N) (vermillion snapper)	Jul	0.05 (0.05) 72 ‡	0 (0)	0 (0)	0 (0)	0 (0)
Gerreidae						
<i>Eucinostomus</i> spp. (L) (jenny/mojarra spp.)	Jun, Jul, Sep	0 (0)	0 (0)	0 (0)	0.05 (0.02) 22 (1.06)	0.10 (0.07) 12 (3.27)
Sparidae						
Unidentified (N) (porgy)	May	0 (0)	0.07 (0.07) 56 ‡	0 (0)	0 (0)	0 (0)
<i>Lagodon rhomboides</i> (N) (pinfish)	Jan	0.17 (0.14) 57 ‡	0.38 (0.38) 34 ‡	0 (0)	0 (0)	0 (0)

Table 5.6. (continued)

Taxa	Months Collected	Surface Net	Bottom Net	Bottom Light-trap	Surface Light-trap	Off-platform Light-trap
		Density (SE)	Density (SE)	CPUE (SE)	CPUE (SE)	CPUE (SE)
		Rank (%)	Rank (%)	Rank (%)	Rank (%)	Rank (%)
Sciaenidae						
<i>Cynoscion arenarius</i> (sand seatrout)	Jul, Aug	1.51 (0.66) 14 (2.09)	0 (0)	0 (0)	0.04 (0.02) 25 ‡	0 (0)
<i>Leiostomus xanthurus</i> (spot)	Jan	0 (0)	0 (0)	0 (0)	0 (0)	0.01 (0.01) 40.5 ‡
<i>Micropogonias undulatus</i> (Atlantic croaker)	Oct	0.45 (0.23) 35 ‡	0.30 (0.30) 37 ‡	0.02 (0.01) 18 ‡	<0.01 (0.01) 55 ‡	0.02 (0.02) 25 ‡
<i>Sciaenops ocellatus</i> (red drum)	Sep	4.11 (1.92) 5 (3.70)	0 (0)	0 (0)	<0.01 (0.01) 55 ‡	0 (0)
Mullidae						
Unidentified (L) (goatfish)	Jun	0 (0)	0 (0)	0 (0)	0 (0)	0.01 (0.01) 40.5 ‡
<i>Upeneus parvus</i> (L) (dwarf goatfish)	Apr	0 (0)	0 (0)	0 (0)	0 (0)	0.01 (0.01) 40.5 ‡
Ephippidae						
<i>Chaetodipterus faber</i> (N) (Atlantic spadefish)	May, Jul	0.05 (0.04) 74 ‡	0 (0)	0 (0)	0 (0)	0 (0)
Chaetodontidae						
Unidentified (N) (butterfly fish)	Jun	0.03 (0.03) 77.5 ‡	0 (0)	0 (0)	0 (0)	0 (0)
Pomacentridae						
<i>Pomacentrus</i> spp. (L) (damsselfish spp.)	Jun, Jul	0 (0)	0 (0)	0.02 (0.01) 18 ‡	0.14 (0.08) 13 (2.84)	0.03 (0.03) 19 (1.09)
Mugilidae						
<i>Mugil cephalus</i> (striped mullet)	Jan, Feb, Oct, Nov	8.27 (4.58) 3 ‡	32.05 (15.62) 2 (5.54)	0 (0)	0.04 (0.02) 25 ‡	0.14 (0.06) 9.5 (4.36)
Sphyraenidae						
<i>Sphyraena guachancho</i> (guaguanche)	Jun, Jul	0.44 (0.39) 36 ‡	0.08 (0.08) 53 ‡	0 (0)	0.03 (0.03) 33 ‡	0.01 (0.01) 40.5 ‡
Scaridae						
Unidentified (parrotfish)	Aug, Oct, Nov	3.01 (1.35) 7 ‡	16.31 (5.64) 3 (3.08)	<0.01 (0.01) 28.5 ‡	0.06 (0.03) 19.5 (1.24)	0 (0)
Blenniidae						
Unidentified (blenny)	May, Jun, Jul, Sep, Oct	0.34 (0.19) 41 ‡	0.98 (0.98) 19 ‡	0.06 (0.06) 9.5 (2.55)	0.17 (0.15) 10 (3.37)	0.01 (0.01) 40.5 ‡

Table 5.6. (continued)

Taxa	Months Collected	Surface Net	Bottom Net	Bottom Light-trap	Surface Light-trap	Off-platform Light-trap
		Density (SE)	Density (SE)	CPUE (SE)	CPUE (SE)	CPUE (SE)
		Rank (%)	Rank (%)	Rank (%)	Rank (%)	Rank (%)
<i>Hypsoblennius invemar</i> (tessellated blenny)	Jun, Oct	0 (0) 83 ‡	0.08 (0.08) 53 ‡	0 (0)	0 (0)	(0.01) 40.5 ‡
<i>Ophioblennius atlanticus</i> (redlip blenny)	Jun, Oct	0.65 (0.47) 29 ‡	0 (0)	0 (0)	<0.01 (0.01) 55 ‡	0.01 (0.01) 40.5 ‡
Callionymidae						
<i>Foetorepus agassizi</i> (N) (spotfin dragonet)	Aug	0.05 (0.03) 75 ‡	0 (0)	0 (0)	0 (0)	0 (0)
<i>Paradiplogramus bairdi</i> (N) (lancer dragonet)	Aug	(0.02) 84 ‡	0 (0)	0 (0)	0 (0)	0 (0)
Gobiidae						
Unidentified (goby)	Jan, Feb, Apr, Jun, Jul, Aug, Oct Nov	4.63 (1.78) 4 (2.02)	11.08 (3.87) 4 (4.41)	0.09 (0.04) 5.5 (4.00)	0.44 (0.40) 2 (8.87)	0.05 (0.02) 15.5 (1.45)
Microdesmidae						
<i>Microdesmus</i> spp. (N) (wormfish spp.)	Jun, Aug	0.03 (0.03) 83 ‡	0.75 (0.52) 23 ‡	0 (0)	0 (0)	0 (0)
<i>Microdesmus lanceolatus</i> (N) (lancetail wormfish)	Jun, Jul, Aug	0.65 (0.41) 28 ‡	0.15 (0.11) 47 ‡	0 (0)	0 (0)	0 (0)
<i>Microdesmus longipinnis</i> (pink wormfish)	Jul	(0.06) 70 ‡	0 (0)	0 (0)	(0.03) 22 (1.06)	0.02 (0.02) 25 ‡
Scombridae						
Unidentified (mackerel)	May, Jun, Jul, Aug, Sep	1.75 (1.01) 12 (2.73)	0.75 (0.75) 22 ‡	0 (0)	(0.01) 41.5 ‡	(0.01) 40.5 ‡
<i>Acanthocybium solandri</i> (wahoo)	Jun	0 (0)	0.09 (0.09) 49.5 ‡	0 (0)	0 (0)	0 (0)
<i>Auxis</i> spp. (mackerel spp.)	May, Jun, Aug, Sep, Oct	1.41 (0.42) 15 (1.99)	0.94 (0.50) 20 ‡	0.02 (0.01) 18 ‡	0.40 (0.13) 4 (8.16)	0.14 (0.04) 9.5 (4.36)
<i>Euthynnus alletteratus</i> (little tunny)	May, Jun, Jul, Aug, Sep, Oct	0.65 (0.25) 30 ‡	0.09 (0.09) 49.5 ‡	0 (0)	0.06 (0.02) 19.5 (1.24)	0.18 (0.08) 6 (5.82)
<i>Scomberomorus cavalla</i> (king mackerel)	Aug	0.09 (0.07) 66 ‡	0 (0)	(<0.01) (0.01) 28.5 ‡	0.02 (0.02) 41.5 ‡	(0.03) 19 (1.09)
<i>Scomberomorus maculatus</i> (Spanish mackerel)	Jul, Aug	0.75 (0.42) 26 ‡	0 (0)	0 (0)	0.02 (0.01) 41.5 ‡	0 (0)
<i>Thunnus</i> spp. (tuna spp.)	May, Jun	(0.02) 82 ‡	0.17 (0.12) 46 ‡	0 (0)	(0.01) 41.5 ‡	(0.01) 40.5 ‡
<i>Thunnus thynnus</i> (N) (bluefin tuna)	Jun	(0.07) 69 ‡	0.18 (0.18) 45 ‡	0 (0)	0 (0)	0 (0)
Stromateidae						

Table 5.6. (continued)

Taxa	Months Collected	Surface Net	Bottom Net	Bottom Light-trap	Surface Light-trap	Off-platform Light-trap
		Density (SE)	Density (SE)	CPUE (SE)	CPUE (SE)	CPUE (SE)
		Rank (%)	Rank (%)	Rank (%)	Rank (%)	Rank (%)
<i>Ariomma</i> spp. (driftfish spp.)	Apr, May	0.77 (0.52) 25 (2.16)	0.44 (0.36) 29 ‡	0 (0)	0 (0)	0.02 (0.02) 25 ‡
Nomeidae						
<i>Cubiceps pauciradiatus</i> (N) (bigeye cigarfish)	May	0.03 (0.03) 81 ‡	0 (0)	0 (0)	0 (0)	0 (0)
<i>Peprilus burti</i> (gulf butterfish)	Jan, Jun, Aug, Oct, Nov	0.72 (0.34) 27 ‡	1.05 (0.64) 18 ‡	0.02 (0.01) 18 ‡	0.03 (0.02) 33 ‡	0.05 (0.03) 15.5 (1.45)
Tetragonuridae						
<i>Tetragonurus atlanticus</i> (N) (bigeye squaretail)	Nov	0.20 (0.20) 53 ‡	0 (0)	0 (0)	0 (0)	0 (0)
Pleuronectiformes						
Bothidae						
Unidentified (lefteye flounder)	Jul, Oct, Nov	0.59 (0.59) 32 ‡	0.81 (0.81) 21 ‡	<0.01 (0.01) 28.5 ‡	0 (0)	0 (0)
<i>Bothus</i> spp. (flounder spp.)	May, Sep, Oct, Nov	0.17 (0.17) 58 ‡	0 (0)	0.02 (0.01) 18 ‡	0 (0)	0.01 (0.01) 40.5 ‡
<i>Citharichthys spilopterus</i> (baywhiff)	Feb, Oct, Nov	1.14 (0.92) 17 ‡	4.85 (1.98) 7 (1.44)	0 (0)	<0.01 (0.01) 55 ‡	0 (0)
<i>Etropus crossotus</i> (fringed flounder)	Aug, Nov	0.39 (0.39) 40 ‡	0 (0)	0 (0)	0 (0)	0.01 (0.01) 40.5 ‡
<i>Monolene sessilicauda</i> (L) (deepwater flounder)	Feb	0 (0)	0 (0)	0 (0)	0 (0)	0.02 (0.01) 40.5 ‡
<i>Syacium</i> spp. (flounder spp.)	Jul, Aug, Sep	0.22 (0.12) 51 ‡	0 (0)	0.02 (0.01) 18 ‡	0.08 (0.05) 16 (1.60)	0.02 (0.01) 40.5 ‡
Soleidae						
<i>Symphurus</i> spp. (tonguefish spp.)	Feb, Jul, Aug, Sep, Oct	3.03 (1.16) 6 (2.02)	0.70 (0.70) 25 ‡	(0.05) 9.5 (2.55)	0.10 (0.04) 14 (1.95)	0.07 (0.03) 13 (2.18)
Tetraodontiformes						
Tetraodontidae						
<i>Sphoeroides</i> spp. (N) (puffer spp.)	May	0 (0)	(0.07) 56 ‡	(0)	0 (0)	0 (0)

Table 5.7. Total plankton net density (fish/100 m³) and light-trap CPUE (fish/10 min) for fish collected at Grand Isle 94 with standard error (SE), rank, percent of total catch (%), and months collected for each taxa. (N) indicates taxa collected only with plankton nets. (L) indicates taxa collected only with light-traps. For ranks, tied values received the mean of the corresponding ranks. ‡ indicates a value <1.00%.

Taxa	Months Collected	Surface Net	Bottom Net	Bottom Light-trap	Surface Light-trap	Off-platform Light-trap
		Density (SE)	Density (SE)	CPUE (SE)	CPUE (SE)	CPUE (SE)
		Rank (%)	Rank (%)	Rank (%)	Rank (%)	Rank (%)
Osteichthyes						
Unidentified	Apr, May, Jun, July, Aug	0.92 (0.60) 19 ‡	0.78 (0.41) 23 (1.31)	0.28 (0.26) 10 (1.13)	0.13 (0.10) 22 ‡	1.12 (0.94) 9 (4.55)
Anguilliformes						
Unidentified (N) (eel)	Jun	0.07 (0.07) 69 ‡	0 (0)	0 (0)	0 (0)	0 (0)
Muraenidae						
Unidentified (moray eel)	May, Jun, Jul	0.07 (0.05) 71 ‡	0.44 (0.23) 33 ‡	<0.01 (<0.01) 49 ‡	0 (0)	0 (0)
Ophichthidae						
Unidentified (snake eel)	Jun, Jul, Aug	0.10 (0.05) 55 ‡	0.69 (0.35) 26 ‡	0.04 (0.02) 26.5 ‡	0.02 (0.01) 51 ‡	0 (0)
<i>Ophichthus</i> spp. (snake eel)	Aug	0 (0)	0 (0)	0 (0)	0.03 (0.02) 46.5 ‡	0 (0)
<i>Ophichthus gomesi</i> (N) (shrimp eel)	Jun	(0.01) 98 ‡	0 (0)	0 (0)	0 (0)	0 (0)
Nettastomatidae						
<i>Hoplunnis macrurus</i> (L) (freckled-pike conger)	May	0 (0)	0 (0)	0 (0)	(<0.01) 61.5 ‡	0 (0)
Clupeiformes						
Unidentified (herring/anchovy)	Apr, May, Jun, Jul, Aug	2.38 (2.14) 12 ‡	0.05 (0.04) 69 ‡	<0.01 (<0.01) 58 ‡	<0.01 (<0.01) 81.5 ‡	0 (0)
Clupeidae						
Unidentified (herring)	Apr, May, Aug	0 (0)	0.52 (0.37) 30 ‡	0 (0)	(<0.01) 61.5 ‡	0 (0)
<i>Brevoortia patronus</i> (L) (gulf menhaden)	Apr	0 (0)	0 (0)	<0.01 (<0.01) 49 ‡	0 (0)	0 (0)
<i>Etrumeus teres</i> (round herring)	Apr	0.08 (0.06) 66 ‡	0.23 (0.16) 44 ‡	(0.01) 32 ‡	0.03 (0.02) 46.5 ‡	(<0.01)51.5 ‡
<i>Harengula jaguana</i> (scaled sardine)	Apr, Jun, Jul, Aug	0.61 (0.27) 25 ‡	0.31 (0.31) 38.5 ‡	0.06 (0.02) 21 ‡	0.69 (0.18) 18 ‡	0.68 (0.15) 11 (2.76)
<i>Opisthonema oglinum</i> (Atlantic thread herring)	Apr, Jun, Jul, Aug	70.99 (35.34) 2 (15.81)	4.81 (1.97) 5 (2.20)	1.26 (0.85) 6 (4.99)	6.04 (1.23) 8 (4.07)	4.11 (1.11) 1 (16.66)
<i>Sardinella aurita</i> (Spanish sardine)	Apr, Jul, Aug	0.08 (0.06) 67 ‡	0.16 (0.16) 54 ‡	0 (0)	0.04 (0.02) 41.5 ‡	0 (0)

Table 5.7. (continued)

Taxa	Months Collected	Surface	Bottom	Bottom	Surface	Off-platform
		Net	Net	Light-trap	Light-trap	Light-trap
		Density (SE)	Density (SE)	CPUE (SE)	CPUE (SE)	CPUE (SE)
		Rank (%)	Rank (%)	Rank (%)	Rank (%)	Rank (%)
Engraulidae						
Unidentified (anchovy)	Apr, May, Jun, Jul, Aug	232.66 (44.32) 1 (62.01)	66.92 (17.27) 1 (24.74)	0.41 (0.09) 7 (1.64)	0.55 (0.12) 20 ‡	0.96 (0.17) 10 (3.92)
<i>Anchoa</i> spp. (anchovy spp.)	Apr, May, Jun, Jul, Aug	14.23 (8.25) 3 (3.55)	1.21 (0.73) 21 ‡	0.18 (0.17) 15 ‡	0.02 (0.01) 51 ‡	<0.01 (<0.01) 64 ‡
<i>Anchoa hepsetus</i> (striped anchovy)	Aug	0 (0)	0 (0)	0.10 (0.08) 16.5 ‡	0.70 (0.49) 16 ‡	0.50 (0.47) 12 (2.04)
<i>Anchoa mitchilli</i> (bay anchovy)	Jun, Jul, Aug	6.24 (2.37) 6 (1.89)	2.70 (1.03) 11 ‡	0.37 (0.18) 8 (1.46)	1.89 (0.83) 10 (1.27)	0.47 (0.23) 14 (1.91)
<i>Anchoa nasuta</i> (longnose anchovy)	Aug	0 (0)	0 (0)	7.80 (6.15) 1 (30.96)	11.10 (5.93) 4 (7.47)	1.31 (0.70) 6 (5.30)
<i>Anchoa nasuta/hepsetus</i> (longnose/striped anchovy)	Apr, May, Jun, Jul, Aug	5.64 (2.80) 8 (1.87)	4.59 (1.69) 7 (3.14)	2.73 (0.52) 3 (10.88)	30.11 (12.33) 2 (20.27)	1.45 (0.53) 5 (5.86)
<i>Anchoviella perfasciata</i> (flat anchovy)	Aug	0 (0)	0 (0)	0 (0)	0.07 (0.07) 33.5 ‡	0.09 (0.09) 24 ‡
<i>Engraulis eurystole</i> (silver anchovy)	Apr, May, Jun, Jul, Aug	1.93 (1.90) 13 ‡	2.43 (1.12) 12 (1.15)	5.72 (1.41) 2 (22.79)	38.79 (13.81) 1 (26.12)	1.25 (0.48) 7 (5.08)
Stomiiformes						
Gonostomatidae						
<i>Cyclothone braueri</i> (N)	Apr, Jul	0.02 (0.02) 94 ‡	0.11 (0.08) 60 ‡	0 (0)	0 (0)	0 (0)
<i>Vinciguerria nimbaria</i> (L)	Apr	0 (0)	0 (0)	0 (0)	<0.01 (<0.01) 81.5 ‡	0 (0)
Aulopiformes						
Synodontidae						
Unidentified	Apr, May, Jun, Jul, Aug	0.22 (0.08) 40 ‡	2.11 (0.56) 15 (1.05)	0.10 (0.03) 16.5 ‡	0.90 (0.39) 14 ‡	0.12 (0.06) 21 ‡
<i>Saurida brasiliensis</i> (largescale lizardfish)	Apr, May, Jun, Jul, Aug	0.81 (0.22) 21 ‡	4.77 (1.26) 6 (4.86)	1.97 (0.42) 5 (7.84)	3.35 (0.51) 9 (2.27)	0.50 (0.14) 13 (2.01)
<i>Saurida normani</i> (L) (shortjaw lizardfish)	Apr, May	0 (0)	0 (0)	0 (0)	<0.01 (<0.01) 61.5 ‡	0 (0)
<i>Saurida normani/brasiliensis</i> (L) (shortjaw/largescale lizardfish)	May	0 (0)	0 (0)	0 (0)	<0.01 (<0.01) 81.5 ‡	0 (0)
<i>Saurida suspicio</i> (L)	May	0 (0)	0 (0)	0 (0)	<0.01 (<0.01) 81.5 ‡	0 (0)
<i>Synodus</i> spp. (lizardfish spp.)	May, Jun	0 (0)	0.03 (0.03) 72.5 ‡	<0.01 (<0.01) 49 ‡	0.06 (0.06) 37.5 ‡	0.04 (0.03) 35.5 ‡

Table 5.7. (continued)

Taxa	Months Collected	Surface Net	Bottom Net	Bottom Light-trap	Surface Light-trap	Off-platform Light-trap
		Density (SE)	Density (SE)	CPUE (SE)	CPUE (SE)	CPUE (SE)
		Rank (%)	Rank (%)	Rank (%)	Rank (%)	Rank (%)
<i>Synodus foetens</i> (inshore lizardfish)	Apr, May, Jun, Jul, Aug	0.64 (0.26) 24 ‡	2.12 (0.77) 14 (1.20)	0.20 (0.06) 12 ‡	22.11 (5.24) 3 (14.92)	0.20 (0.05) 19 ‡
<i>Synodus poeyi</i> (offshore lizardfish)	Apr, May, Jun, Jul, Aug	0.17 (0.13) 47 ‡	1.35 (0.44) 17 ‡	0.34 (0.09) 9 (1.36)	9.98 (1.78) 5 (6.74)	0.13 (0.28) 8 (4.57)
<i>Synodus synodus</i> (L) (red lizardfish)	May	0 (0)	0 (0)	0 (0)	<0.01 61.5 ‡	0 (0)
<i>Trachinocephalus myops</i> (L) (snakefish)	Apr, May, Jun, Aug	0 (0)	0 (0)	0 (0)	0.08 (0.03) 30.5 ‡	<0.01 (<0.01) 64 ‡
Paralepididae						
Unidentified (N) (barracudina)	May	0.03 (0.03) 88 ‡	0 (0)	0 (0)	0 (0)	0 (0)
<i>Lestrolepis intermedia</i>	May, Jun, Aug	0 (0)	0.15 (0.11) 56 ‡	(0.01) 32 ‡	<0.01 (<0.01) 81.5 ‡	0 (0)
<i>Lestrolepis</i> spp. (L) (barracudina spp.)	Aug	0 (0)	0 (0)	<0.01 (<0.01) 49 ‡	0 (0)	0 (0)
Myctophiformes						
Unidentified (N)	Jun	0 (0)	0.21 (0.21) 48 ‡	0 (0)	0 (0)	0 (0)
Myctophidae						
Unidentified (lanternfish)	Apr, May, Jun, Jul, Aug	0.09 (0.05) 60 ‡	0.75 (0.41) 25 ‡	0.03 (0.02) 28 ‡	0.05 (0.02) 40 ‡	0.06 (0.02) 29.5 ‡
Gadiformes						
Bregmacerotidae						
<i>Bregmaceros cantori</i>	Apr, May, Jun, Jul, Aug	1.59 (0.42) 16 ‡	16.67 (3.00) 3 (15.06)	2.18 (1.02) 4 (8.68)	0.06 (0.02) 35.5 ‡	0.03 (0.02) 38.5 ‡
Ophidiiformes						
Ophidiidae						
Unidentified (cusk-eel)	May, Jun, Jul	0.31 (0.13) 35 ‡	0.21 (0.21) 48 ‡	0 (0)	<0.01 (<0.01) 81.5 ‡	0 (0)
<i>Lepophidium</i> spp. (N) (cusk-eel spp.)	Jul	0 (0)	0.13 (0.13) 58.5 ‡	0 (0)	0 (0)	0 (0)
<i>Lepophidium profundorum</i> (N) (fawn cusk-eel)	Jun	0.03 (0.02) 84 ‡	0.23 (0.21) 45 ‡	0 (0)	0 (0)	0 (0)
<i>Lepophidium staurophor</i> (N)	May, Jun, Aug	0.09 (0.06) 59 ‡	0 (0)	0 (0)	0 (0)	0 (0)
Ophidiinae Type A (N) (cusk-eel spp.)	Jun	0 (0)	0.02 (0.02) 80 ‡	0 (0)	0 (0)	0 (0)
<i>Ophidion nocomis</i>	May, Jun	0 (0)	0.05 (0.05)	0.01 (<0.01)	0 (0)	0 (0)

Table 5.7. (continued)

Taxa	Months Collected	Surface Net	Bottom Net	Bottom Light-trap	Surface Light-trap	Off-platform Light-trap
		Density (SE)	Density (SE)	CPUE (SE)	CPUE (SE)	CPUE (SE)
		Rank (%)	Rank (%)	Rank (%)	Rank (%)	Rank (%)
			68 ‡	37 ‡		
<i>Ophidion nocomis/selenops</i> (cusk-eel spp.)	May	0.09 (0.06) 63 ‡	0.31 (0.23) 38.5 ‡	0 (0)	<0.01 (<0.01) 81.5 ‡	0 (0)
<i>Ophidion selenops</i> (N) (mooneye cusk-eel)	May, Jun	0 (0)	0.19 (0.14) 50 ‡	0 (0)	0 (0)	0 (0)
Lophiiformes						
Caulophryniidae						
<i>Robia legula</i> (N)	Jul	0 (0)	0.09 (0.08) 61 ‡	0 (0)	0 (0)	0 (0)
Atheriniformes						
Exocoetidae						
Unidentified (flyingfish)	Jun	0.14 (0.07) 51 ‡	0.07 (0.07) 64.5 ‡	0 (0)	0 (0)	0 (0)
<i>Cypselurus</i> spp. (flyingfish spp.)	May, Jun	0 (0)	0.07 (0.07) 64.5 ‡	0 (0)	<0.01 (<0.01) 81.5 ‡	<0.01 (<0.01) 64 ‡
<i>Cypselurus cyanopterus</i> (L) (marginated flyingfish)	Jul	0 (0)	0 (0)	0 (0)	<0.01 (<0.01) 81.5 ‡	0 (0)
Beryciformes						
Holocentridae						
<i>Holocentrus</i> spp. (squirrelfish spp.)	May, Jun, Jul	0.18 (0.08) 44 ‡	0 (0)	0.01 (<0.01) 40 ‡	0 (0)	<0.01 (<0.01) 64 ‡
Scorpaeniformes						
Scorpaenidae						
Unidentified (N) (scorpionfish)	May, Jun	0.01 (0.01) 95 ‡	0.16 (0.16) 54 ‡	0 (0)	0 (0)	0 (0)
<i>Scorpaena</i> spp. (scorpionfish spp.)	May, Jul, Aug	0 (0)	0.45 (0.34) 32 ‡	0 (0)	0.01 (<0.01) 61.5 ‡	0 (0)
Triglidae						
Unidentified (N) (searobin)	Jul	0.01 (0.01) 99 ‡	0 (0)	0 (0)	0 (0)	0 (0)
<i>Prionotus</i> spp. (searobin spp.)	Apr	0.21 (0.11) 42 ‡	0.09 (0.09) 62 ‡	0 (0)	<0.01 (<0.01) 81.5 ‡	0 (0)
Perciformes						
Unidentified	Apr, May, Jun, Jul, Aug	1.74 (0.69) 15 ‡	2.22 (0.76) 13 (1.41)	0.05 (0.02) 24.5 ‡	0.09 (0.05) 27 ‡	0.04 (0.02) 34 ‡
Serranidae						

Table 5.7. (continued)

Taxa	Months Collected	Surface Net	Bottom Net	Bottom Light-trap	Surface Light-trap	Off-platform Light-trap
		Density (SE)	Density (SE)	CPUE (SE)	CPUE (SE)	CPUE (SE)
		Rank (%)	Rank (%)	Rank (%)	Rank (%)	Rank (%)
Unidentified (N) (seabass/grouper)	Apr, May, Jun	0.08 (0.05) 68 ‡	0.16 (0.13) 52 ‡	0 (0)	0 (0)	0 (0)
Anthinae (sea perch)	May	0.17 (0.09) 46 ‡	0.35 (0.24) 36 ‡	0 (0)	0.01 (<0.01) 61.5 ‡	0 (0)
Epinephelinae (grouper)	May, Jun	0.07 (0.04) 72 ‡	0 (0)	0 (0)	0.03 (0.01) 43 ‡	0 (0)
Grammistinae (N)	Jun, Jul	0.04 (0.03) 80 ‡	0.01 (0.01) 81 ‡	0 (0)	0 (0)	0 (0)
Serraninae (sea bass)	Apr, May, Jun, Aug	0.36 (0.14) 31 ‡	0.95 (0.33) 22 ‡	<0.01 (<0.01) 49 ‡	0.08 (0.03) 30.5 ‡	0 (0)
Priacanthidae						
<i>Priacanthus</i> spp. (N) (bigeye/glasseye spp.)	May	0 (0)	0.03 (0.03) 74.5 ‡	0 (0)	0 (0)	0 (0)
Pomatomidae						
<i>Pomatomus saltatrix</i> (bluefish)	Apr, May	0.08 (0.06) 65 ‡	0 (0)	0 (0)	0.01 (<0.01) 61.5 ‡	0 (0)
Rachycentridae						
<i>Rachycentron canadum</i> (N) (cobia)	May, Jun, Jul	0.14 (0.07) 52 ‡	0.02 (0.02) 78 ‡	0 (0)	0 (0)	0 (0)
Carangidae						
Unidentified (jack)	Jun, Jul	0.17 (0.11) 45 ‡	0.03 (0.03) 72.5 ‡	0 (0)	0 (0)	<0.01 (<0.01) 64 ‡
<i>Caranx</i> spp. (N) (jack spp.)	Jun	0.16 (0.09) 49 ‡	0 (0)	0 (0)	0 (0)	0 (0)
<i>Caranx crysos</i> (blue runner)	Jun, Jul, Aug	1.14 (0.41) 17 ‡	0.62 (0.43) 28 ‡	0.04 (0.03) 26.5 ‡	0.08 (0.03) 30.5 ‡	0.08 (0.02) 25 ‡
<i>Caranx hippos/latus</i> (crevalle/horse-eye jack)	May, Jun, Jul, Aug	0.50 (0.31) 27 ‡	0 (0)	<0.01 (<0.01) 49 ‡	0.11 (0.03) 24 ‡	0.09 (0.03) 23 ‡
<i>Chloroscombrus chrysurus</i> (Atlantic bumper)	Jul, Aug	1.00 (0.34) 18 ‡	0.29 (0.18) 40 ‡	<0.01 (<0.01) 49 ‡	0.01 (<0.01) 61.5 ‡	0.02 (0.01) 44.5 ‡
<i>Decapterus punctatus</i> (L) (round scad)	Apr, May, Jul, Aug	0 (0)	0 (0)	0 (0)	0.06 (0.02) 35.5 ‡	<0.01 (<0.01) 64 ‡
<i>Oligoplites saurus</i> (N) (leatherjack)	Jul	0.16 (0.12) 48 ‡	0 (0)	0 (0)	0 (0)	0 (0)
<i>Selar crumenophthalmus</i> (N) (bigeye scad)	Jun, Jul	0.34 (0.15) 34 ‡	0.13 (0.13) 58.5 ‡	0 (0)	0 (0)	0 (0)

Table 5.7. (continued)

Taxa	Months Collected	Surface Net	Bottom Net	Bottom Light-trap	Surface Light-trap	Off-platform Light-trap
		Density (SE)	Density (SE)	CPUE (SE)	CPUE (SE)	CPUE (SE)
		Rank (%)	Rank (%)	Rank (%)	Rank (%)	Rank (%)
<i>Selene vomer</i> (N) (lookdown)	Jun, Jul	0.01 (0.01) 96 ‡	0.05 (0.03) 70 ‡	0 (0)	0 (0)	0 (0)
<i>Seriola</i> spp. (N) (jack spp.)	May	0.03 (0.03) 85 ‡	0 (0)	0 (0)	0 (0)	0 (0)
<i>Seriola dumerili/rivoliiana</i> (L) (greater amberjack/almaco jack)	May, Jun	0 (0)	0 (0)	<0.01 (<0.01) 49 ‡	0 (0)	0.02 (0.01) 44.5 ‡
<i>Seriola fasciata</i> (L) (lesser amberjack)	May	0 (0)	0 (0)	0 (0)	<0.01 (<0.01) 93 ‡	0 (0)
<i>Trachinotus carolinus</i> (L) (Florida pompano)	Jun	0 (0)	0 (0)	0 (0)	0 (0)	0.01 (<0.01) 51.5 ‡
<i>Trachinotus falcatus/goodei</i> (L) (permit/palometa)	May	0 (0)	0 (0)	0 (0)	0.03 (0.02) 46.5 ‡	0 (0)
<i>Trachurus lathami</i> (rough scad)	Apr, May	0.04 (0.04) 82 ‡	0.15 (0.10) 57 ‡	0.02 (0.01) 32 ‡	0.06 (0.03) 37.5 ‡	0.01 (<0.01) 51.5 ‡
Coryphaenidae						
<i>Coryphaena equiselis</i> (L) (pompano dolphin)	May	0 (0)	0 (0)	0 (0)	0 (0)	<0.01 (<0.01) 64 ‡
<i>Coryphaena hippurus</i> (dolphin)	May, Jul	0.03 (0.03) 86.5 ‡	0 (0)	0 (0)	0 (0)	<0.01 (<0.01) 64 ‡
Lutjanidae						
Unidentified (snapper)	May, Jun, Jul	0.09 (0.05) 61 ‡	0.06 (0.06) 67 ‡	<0.01 (<0.01) 49 ‡	<0.01 (<0.01) 81.5 ‡	0 (0)
<i>Lutjanus</i> spp. (snapper spp.)	May, Jun, Jul	0.67 (0.24) 22 ‡	0.02 (0.02) 78 ‡	0 (0)	0.01 (<0.01) 61.5 ‡	0.01 (0.01) 51.5 ‡
<i>Lutjanus campechanus</i> (red snapper)	May, Jun, Jul	0.02 (0.02) 93 ‡	0 (0)	0 (0)	0.02 (0.02) 49 ‡	0 (0)
<i>Rhomboplites aurorubens</i> (vermilion snapper)	May, Jun, Jul	0.40 (0.25) 30 ‡	0.37 (0.21) 35 ‡	0.20 (0.06) 13 ‡	0.07 (0.03) 33.5 ‡	<0.01 (<0.01) 64 ‡
Gerreidae						
<i>Eucinostomus</i> spp. (jenny/mojarra spp.)	May, Jun, Jul, Aug	0 (0)	0 (0)	<0.01 (<0.01) 49 ‡	<0.01 (<0.01) 81.5 ‡	0.02 (0.01) 41 ‡
Sparidae						
Unidentified (porgy)	Apr, May	0.04 (0.04) 83 ‡	0 (0)	0 (0)	0.01 (<0.01) 61.5 ‡	0.02 (0.01) 44.5 ‡
<i>Calamus</i> spp. (L) (porgy spp.)	May	0 (0)	0 (0)	0 (0)	<0.01 (<0.01) 81.5 ‡	0 (0)
Sciaenidae						

Table 5.7. (continued)

Taxa	Months Collected	Surface Net	Bottom Net	Bottom Light-trap	Surface Light-trap	Off-platform Light-trap
		Density (SE)	Density (SE)	CPUE (SE)	CPUE (SE)	CPUE (SE)
		Rank (%)	Rank (%)	Rank (%)	Rank (%)	Rank (%)
Unidentified (N) (drum spp.)	Aug	<0.01 (<0.01) 100 ‡	0 (0)	0 (0)	0 (0)	0 (0)
<i>Cynoscion arenarius</i> (sand seatrout)	Apr, May, Jul, Aug	3.12 (1.11) 11 ‡	1.25 (0.88) 19 ‡	<0.01 (<0.01) 49 ‡	0 (0)	0.01 (<0.01) 51.5 ‡
<i>Menticirrhus</i> spp. (N) (kingfish spp.)	Aug	0.15 (0.11) 50 ‡	0.63 (0.63) 27 ‡	0 (0)	0 (0)	0 (0)
<i>Stellifer lanceolatus</i> (N) (star drum)	Aug	0.09 (0.09) 64 ‡	0 (0)	0 (0)	0 (0)	0 (0)
Mullidae						
Unidentified (goatfish)	Apr, May, Jul	0.25 (0.14) 38 ‡	0 (0)	<0.01 (<0.01) 49 ‡	<0.01 (<0.01) 81.5 ‡	0.05 (0.02) 32 ‡
<i>Mullus auratus</i> (L) (red goatfish)	Apr, May	0 (0)	0 (0)	0 (0)	0 (0)	0.06 (0.02) 27 ‡
<i>Pseudupeneus maculatus</i> (L) (spotted goatfish)	Apr, May	0 (0)	0 (0)	0 (0)	0 (0)	0.06 (0.03) 28 ‡
<i>Upeneus parvus</i> (L) (dwarf goatfish)	May, Jun	0 (0)	0 (0)	0 (0)	(<0.01) 61.5 ‡	0.38 (0.09) 15 (1.58)
Chaetodontidae						
Unidentified (N) (butterflyfish)	May	0.02 (0.02) 91 ‡	0 (0)	0 (0)	0 (0)	0 (0)
Pomacentridae						
Unidentified (L) (damsel fish)	May, Jun	0 (0)	0 (0)	<0.01 (<0.01) 49 ‡	(<0.01) 61.5 ‡	0.01 (0.01) 51.5 ‡
<i>Abudefduf saxatilis</i> (L) (sergeant major)	May, Jun, Aug	0 (0)	0 (0)	0 (0)	0 (0)	0.03 (0.02) 38.5 ‡
<i>Abudefduf taurus</i> (L) (night sergeant)	May	0 (0)	0 (0)	0 (0)	(<0.01) 61.5 ‡	0 (0)
<i>Chromis</i> spp. (chromis spp.)	May, Jun	0.29 (0.29) 37 ‡	0 (0)	(<0.01) 37 ‡	0.37 (0.13) 21 ‡	0.06 (0.02) 31 ‡
<i>Pomacentrus</i> spp. (damsel fish spp.)	May, Jun, Jul, Aug	0.09 (0.05) 62 ‡	0.03 (0.03) 74.5 ‡	0.07 (0.02) 20 ‡	0.12 (0.03) 23 ‡	0.30 (0.14) 16 (1.28)
Mugilidae						
<i>Mugil curema</i> (L) (white mullet)	May, Jun	0 (0)	0 (0)	0 (0)	(<0.01) 61.5 ‡	(0.01) 41 ‡
Sphyraenidae						
<i>Sphyraena borealis</i> (L) (northern sennet)	May	0 (0)	0 (0)	0 (0)	(<0.01) 61.5 ‡	0 (0)
<i>Sphyraena guachancho</i> (guaguanche)	Jun, July, Aug	1.83 (0.60) 14 ‡	0 (0)	0 (0)	(<0.01) 61.5 ‡	(<0.01) 57 ‡

Table 5.7. (continued)

Taxa	Months Collected	Surface Net	Bottom Net	Bottom Light-trap	Surface Light-trap	Off-platform Light-trap
		Density (SE)	Density (SE)	CPUE (SE)	CPUE (SE)	CPUE (SE)
		Rank (%)	Rank (%)	Rank (%)	Rank (%)	Rank (%)
Labridae						
Unidentified (wrasse)	May, Aug	0.05 (0.05) 78 ‡	0.16 (0.16) 54 ‡	0 (0)	<0.01 (<0.01) 81.5 ‡	0 (0)
Opisthognathidae						
Unidentified (jawfish)	Apr, May, Jun	0.46 (0.14) 28 ‡	0.48 (0.33) 31 ‡	0 (0)	0.63 (0.20) 19 ‡	0.06 (0.02) 29.5 ‡
<i>Opisthognathus</i> spp. (N) (jawfish spp.)	May	0.05 (0.05) 77 ‡	0 (0)	0 (0)	0 (0)	0 (0)
<i>Opisthognathus aurifrons</i> (yellowhead jawfish)	May	0.06 (0.06) 76 ‡	0 (0)	0 (0)	0.03 (0.02) 44 ‡	0 (0)
<i>Opisthognathus lonchurus</i> (N) (moustache jawfish)	May	0.10 (0.10) 58 ‡	0 (0)	0 (0)	0 (0)	0 (0)
Blenniidae						
Unidentified (blenny)	Apr, May, Jun, Jul, Aug	4.73 (3.95) 9 (1.53)	1.22 (0.69) 20 ‡	0.05 (0.04) 24.5 ‡	0.69 (0.21) 17 ‡	0.04 (0.03) 33 ‡
<i>Hypsoblennius hentz/ionthas</i> (L) (feather/freckled blenny)	May, Jun, Jul	0 (0)	0 (0)	0.02 (0.01) 29 ‡	1.76 (0.57) 11 (1.21)	0.04 (0.01) 37 ‡
<i>Hypsoblennius invemar</i> (tessellated blenny)	Apr, May, Jun, Jul	0.04 (0.04) 81 ‡	0 (0)	0.08 (0.03) 18 ‡	6.33 (1.77) 7 (4.32)	3.58 (0.67) 2 (14.55)
<i>Ophioblennius atlanticus</i> (N) (redlip blenny)	Aug	0.42 (0.42) 29 ‡	0 (0)	0 (0)	0 (0)	0 (0)
<i>Parablennius marmoratus</i> (seaweed blenny)	Apr, May, Jun	0.02 (0.02) 92 ‡	0 (0)	0.19 (0.04) 14 ‡	7.20 (1.06) 6 (4.87)	1.62 (0.35) 4 (6.61)
<i>Scartella/Hypleurochilus</i> (blenny spp.)	Apr, May, Jun, Jul	0.06 (0.04) 74.5 ‡	0.21 (0.15) 46 ‡	<0.01 (<0.01) 49 ‡	1.14 (0.24) 12 ‡	0.11 (0.03) 22 ‡
Callionymidae						
Unidentified (N) (dragonet)	Jul	0.03 (0.03) 86.5 ‡	0 (0)	0 (0)	0 (0)	0 (0)
Gobiidae						
Unidentified	Apr, May, Jun, Jul, Aug	5.75 (0.80) 7 (1.77)	10.73 (1.76) 4 (8.53)	0.21 (0.06) 11 ‡	0.05 (0.02) 39 ‡	(<0.01) 51.5 ‡
<i>Bollmannia communis</i> (L) (ragged goby)	Jun	0 (0)	0 (0)	0.01 (0.01) 37 ‡	0 (0)	0 (0)
<i>Gobionellus oceanicus</i> (highfin goby)	Jun, Aug	0.03 (0.03) 89 ‡	0 (0)	0 (0)	<0.01 (<0.01) 81.5 ‡	0 (0)
Microdesmidae						
<i>Microdesmus</i> spp. (N) (wormfish spp.)	Apr, May, Jun, Jul	0.30 (0.11) 36 ‡	0 (0)	0 (0)	0 (0)	0 (0)
<i>Microdesmus lanceolatus</i>	Apr, May, Jun, Jul	0.89 (0.18)	0.77 (0.31)	(0.01)	<0.01 (<0.01)	(<0.01)

Table 5.7. (continued)

Taxa	Months Collected	Surface Net	Bottom Net	Bottom Light-trap	Surface Light-trap	Off-platform Light-trap
		Density (SE)	Density (SE)	CPUE (SE)	CPUE (SE)	CPUE (SE)
		Rank (%)	Rank (%)	Rank (%)	Rank (%)	Rank (%)
(lancetail wormfish)	Aug	20 ‡	24 ‡	32 ‡	81.5 ‡	51.5 ‡
<i>Microdesmus longipinnis</i> (N) (pink wormfish)	Apr, May, Jul	0.53 (0.18) 26 ‡	0 (0)	0 (0)	0 (0)	0 (0)
Trichiuridae						
<i>Gempylus</i> spp. (N) (snake mackerel spp.)	Jul	0 (0)	0.02 (0.02) 78 ‡	0 (0)	0 (0)	0 (0)
<i>Trichiurus lepturus</i> (Atlantic cutlassfish)	Apr, May, Jun, Jul, Aug	0.35 (0.13) 33 ‡	0.26 (0.13) 43 ‡	0.05 (0.02) 22.5 ‡	0.01 (0.01) 61.5 ‡	<0.01 (<0.01) 64 ‡
Scombridae						
Unidentified (mackerel)	May, Jun, Jul, Aug	0.10 (0.06) 56 ‡	0.43 (0.29) 34 ‡	<0.01 37 ‡	0.10 (0.08) 25 ‡	0.04 (0.01) 35.5 ‡
<i>Auxis</i> spp. (mackerel spp.)	Apr, May, Jun, Jul, Aug	6.61 (2.32) 5 (1.69)	1.26 (0.79) 18 ‡	0.02 (0.01) 32 ‡	0.76 (0.19) 15 ‡	0.24 (0.06) 18 ‡
<i>Euthynnus alletteratus</i> (little tunny)	May, Jun, Jul, Aug	4.55 (1.05) 10 (1.39)	4.10 (1.06) 8 (3.09)	0.08 (0.03) 19 ‡	0.92 (0.17) 13 ‡	2.83 (0.62) 3 (11.54)
<i>Katsuwonus pelamis</i> (skipjack tuna)	May	0.06 (0.04) 74.5 ‡	0 (0)	0 (0)	0.08 (0.03) 30.5 ‡	0 (0)
<i>Scomber japonicus</i> (L) (chub mackerel)	Apr	0 (0)	0 (0)	0 (0)	0 (0)	0.02 (0.02) 44.5 ‡
<i>Scomberomorus cavalla</i> (king mackerel)	May, Jun, Jul, Aug	0.13 (0.06) 54 ‡	0.07 (0.04) 66 ‡	<0.01 (<0.01) 49 ‡	0.09 (0.03) 26 ‡	0.27 (0.11) 17 (1.11)
<i>Scomberomorus maculatus</i> (Spanish mackerel)	Jun, Jul, Aug	0.36 (0.14) 32 ‡	0.21 (0.21) 48 ‡	0 (0)	0.04 (0.02) 41.5 ‡	0.17 (0.05) 20 ‡
<i>Thunnus</i> spp. (L) (tuna spp.)	Aug	0 (0)	0 (0)	0 (0)	0 (0)	0.01 (0.01) 51.5 ‡
<i>Thunnus thynnus</i> (L) (bluefin tuna)	May	0 (0)	0 (0)	0 (0)	0.01 (0.01) 61.5 ‡	0 (0)
Stromateidae						
<i>Ariomma regulus</i> (L) (spotted driftfish)	Aug	0 (0)	0 (0)	0 (0)	<0.01 (<0.01) 81.5 ‡	0 (0)
<i>Centrolophus medusophagus</i> (brown ruff)	Apr	0 (0)	0.32 (0.26) 37 ‡	0 (0)	<0.01 (<0.01) 81.5 ‡	<0.01 (<0.01) 64 ‡
<i>Peprilus burti</i> (gulf butterfish)	Apr, May	0.07 (0.05) 70 ‡	0.04 (0.04) 71 ‡	<0.01 (<0.01) 49 ‡	0.03 (0.02) 46.5 ‡	0.02 (0.01) 41 ‡
<i>Peprilus alepidotus</i> (N) (harvestfish)	May, Jul, Aug	0.21 (0.11) 43 ‡	2.79 (1.72) 10 ‡	0 (0)	0 (0)	0 (0)
Pleuronectiformes						
Unidentified (N)	Aug	0.01 (0.01)	0.08 (0.08)	0 (0)	0 (0)	0 (0)

Table 5.7. (continued)

Taxa	Months Collected	Surface Net	Bottom Net	Bottom Light-trap	Surface Light-trap	Off-platform Light-trap
		Density (SE)	Density (SE)	CPUE (SE)	CPUE (SE)	CPUE (SE)
		Rank (%)	Rank (%)	Rank (%)	Rank (%)	Rank (%)
(flounder)		97 ‡	63 ‡			
Bothidae						
Unidentified (lefteye flounder)	Apr, May, Jul	0.06 (0.05) 73 ‡	0.17 (0.13) 51 ‡	<0.01 (<0.01) 49 ‡	0 (0)	0 (0)
<i>Bothus</i> spp. (L) (flounder spp.)	May	0 (0)	0 (0)	0 (0)	<0.01 (<0.01) 81.5 ‡	0 (0)
<i>Citharichthys spilopterus</i> (bay whiff)	Apr, May, Jul	0.05 (0.04) 79 ‡	0.28 (0.20) 41 ‡	0 (0)	0 (0)	<0.01 (<0.01) 64 ‡
<i>Cyclopsetta</i> spp. (N) (flounder spp.)	Jun, Jul	0.10 (0.08) 57 ‡	0.53 (0.47) 29 ‡	0 (0)	0 (0)	0 (0)
<i>Engyophrys senta</i> (N) (spiny flounder)	Jul	0 (0)	0.02 (0.02) 76 ‡	0 (0)	0 (0)	0 (0)
<i>Etropus crossotus</i> (fringed flounder)	Apr, May, Jun, Jul, Aug	0.65 (0.19) 23 ‡	1.79 (0.54) 16 (1.57)	(<0.01) 37 ‡	<0.01 (<0.01) 81.5 ‡	(<0.01) 51.5 ‡
<i>Syacium</i> spp. (flounder spp.)	Apr, Jun, Jul, Aug	0.25 (0.12) 39 ‡	3.78 (1.14) 9 (2.82)	0 (0)	0.02 (0.01) 51 ‡	<0.01 (<0.01) 64 ‡
Soleidae						
<i>Achirus lineatus</i> (N) (lined sole)	Jun, Jul	0.21 (0.08) 41 ‡	0 (0)	0 (0)	0 (0)	0 (0)
<i>Symphurus</i> spp. (tonguefish spp.)	Apr, May, Jun, Jul, Aug	6.79 (1.18) 4 (1.69)	17.00 (3.82) 2 (14.49)	0.05 (0.02) 22.5 ‡	0.08 (0.02) 28 ‡	0.07 (0.03) 26 ‡
Tetraodontiformes						
Balistidae						
Unidentified (N) (leatherjacket)	Jul	0.03 (0.03) 90 ‡	0 (0)	0 (0)	0 (0)	0 (0)
Tetraodontiformes						
Tetraodontidae						
<i>Spherooides</i> spp. (puffer spp.)	Apr, May, Jun, Jul	0.14 (0.07) 53 ‡	0.28 (0.22) 42 ‡	0 (0)	<0.01 (<0.01) 81.5 ‡	0 (0)

Table 5.8. Total plankton net density (fish/100 m³) and light-trap CPUE (fish/10 min) for fish collected at South Timbalier 54 with standard error (SE), rank, percent of total catch (%), and months collected for each taxa. (N) indicates taxa collected only with plankton nets. (L) indicates taxa collected only with light-traps. For ranks, tied values received the mean of the corresponding ranks. ‡ indicates a value <1.00%.

Taxa	Months Collected	Surface Net	Bottom Net	Bottom Light-trap	Surface Light-trap	Off-platform Light-trap
		Density (SE)	Density (SE)	CPUE (SE)	CPUE (SE)	CPUE (SE)
		Rank (%)	Rank (%)	Rank (%)	Rank (%)	Rank (%)
Osteichthyes						
Unidentified	Apr, May	3.93 (3.66) 12 ‡	0 (0)	0 (0)	0.50 (0.50) 6 (1.20)	0 (0)
Albuliformes						
Albulidae						
<i>Albula vulpes</i> (L) (bonefish)	Apr	0 (0)	0 (0)	0 (0)	(0.01) 42 ‡	0 (0)
Anguilliformes						
Unidentified (eel)	Jun	0 (0)	0 (0)	0 (0)	0 (0)	0.02 (0.02) 50 ‡
Muraenidae						
Unidentified (L) (moray eel)	Jun	0.43 (0.41) 40 ‡	0 (0)	0 (0)	0 (0)	0.02 (0.02) 50 ‡
Ophichthidae						
Unidentified (snake eel)	Apr, May, Jun	0.20 (0.18) 52 ‡	0 (0)	0 (0)	<0.01 (0.01) 50 ‡	0.02 (0.02) 50 ‡
Clupeiformes						
Unidentified (N) (herring/anchovy)	May	1.92 (1.92) 17 ‡	0 (0)	0 (0)	0 (0)	0 (0)
Clupeidae						
<i>Brevoortia patronus</i> (L) (gulf menhaden)	Apr	0 (0)	0 (0)	0 (0)	0 (0)	0.02 (0.02) 50 ‡
<i>Etrumeus teres</i> (N) (round herring)	Apr	0.04 (0.03) 68 ‡	0 (0)	0 (0)	0 (0)	0 (0)
<i>Harengula jaguana</i> (scaled sardine)	Apr, May, Jun, Jul	1.27 (0.50) 24 ‡	0 (0)	0 (0)	0.56 (0.17) 5 (1.29)	0.55 (0.22) 8 (1.43)
<i>Opisthonema oglinum</i> (Atlantic thread herring)	Apr, May, Jun, Jul	3689.84 (1964.23) 1 (96.56)	0 (0)	0.35 (0.14) 3 (7.05)	23.26 (9.41) 1 (54.60)	25.53 (7.93) 1 (66.71)
<i>Sardinella aurita</i> (Spanish sardine)	Apr	0.03 (0.03) 74 ‡	0 (0)	0 (0)	0 (0)	0.02 (0.02) 50 ‡
Engraulidae						
Unidentified	Apr, May, Jun, Jul	146.75 (39.54)	10.73 (7.58)	0.13 (0.06)	1.13 (0.53)	0.90 (0.20)

Table 5.8. (continued)

Taxa	Months Collected	Surface Net	Bottom Net	Bottom Light-trap	Surface Light-trap	Off-platform Light-trap
		Density (SE)	Density (SE)	CPUE (SE)	CPUE (SE)	CPUE (SE)
		Rank (%)	Rank (%)	Rank (%)	Rank (%)	Rank (%)
(anchovy)		2 (1.49)	2 (46.38)	5 (2.90)	4 (2.71)	4 (2.36)
<i>Anchoa</i> spp. (anchovy spp.)	May	0.61 (0.61) 31 ‡	0 (0)	0 (0)	0 (0)	0 (0)
<i>Anchoa hepsetus</i> (L) (striped anchovy)	Jun	0 (0)	0 (0)	0 (0)	(0.01) 42 ‡	0 (0)
<i>Anchoa mitchilli</i> (bay anchovy)	Apr, May, Jun, Jul	4.23 (1.61) 11 ‡	0 (0)	0.04 (0.03) 13 ‡	0.38 (0.13) 9 ‡	0.31 (0.17) 11 ‡
<i>Anchoa nasuta</i> (L) (longnose anchovy)	May, Jun	0 (0)	0 (0)	0 (0)	0.06 (0.04) 21 ‡	(0.03) 33 ‡
<i>Anchoa nasuta/hepsetus</i> (longnose/striped anchovy)	Apr, May, Jun, Jul	2.27 (0.77) 16 ‡	0 (0)	0.57 (0.20) 2 (11.62)	9.89 (3.63) 2 (23.74)	3.66 (1.49) 2 (9.57)
<i>Anchoviella perfuscata</i> (N) (flat anchovy)	Apr	0.02 (0.02) 77.5 ‡	0 (0)	0 (0)	0 (0)	0 (0)
<i>Engraulis eurystole</i> (silver anchovy)	Apr, May, Jun, Jul	0.22 (0.15) 49 ‡	0 (0)	0 (0)	0.26 (0.07) 11 ‡	(0.02) 33 ‡
Stomiiformes						
Gonostomatidae						
<i>Cyclothone braueri</i> (N)	Apr	0.10 (0.06) 60 ‡	0 (0)	0 (0)	0 (0)	0 (0)
Aulopiformes						
Synodontidae						
Unidentified (L) (lizardfish)	Apr, May	0 (0)	0 (0)	0 (0)	(0.01) 42 ‡	0.02 (0.02) 50 ‡
<i>Saurida brasiliensis</i> (L) (largescale lizardfish)	May, Jun	0 (0)	0 (0)	(0.03) 9.5 (1.24)	0.06 (0.03) 21 ‡	0.08 (0.03) 26.5 ‡
<i>Saurida suspicio</i> (L)	May	0 (0)	0 (0)	0 (0)	0 (0)	(0.02) 50 ‡
<i>Synodus foetens</i> (inshore lizardfish)	Apr, May, Jun	0.21 (0.14) 50 ‡	0.26 (0.26) 11 (1.45)	2.88 (1.55) 1 (58.51)	3.16 (1.25) 3 (7.60)	0.27 (0.10) 12 ‡
<i>Synodus poeyi</i> (offshore lizardfish)	Apr, May	0.23 (0.19) 48 ‡	0 (0)	0 (0)	0 (0)	0.02 (0.02) 50 ‡
Myctophiformes						
Myctophidae						
Unidentified (lanternfish)	Apr, Jul	0.24 (0.13) 47 ‡	4.09 (3.52) 4 (4.35)	0 (0)	0 (0)	(0.2) 33 ‡
Gadiformes						

Table 5.8. (continued)

Taxa	Months Collected	Surface Net	Bottom Net	Bottom Light-trap	Surface Light-trap	Off-platform Light-trap
		Density (SE)	Density (SE)	CPUE (SE)	CPUE (SE)	CPUE (SE)
		Rank (%)	Rank (%)	Rank (%)	Rank (%)	Rank (%)
Bregmacerotidae						
<i>Bregmaceros cantori</i> (codlet)	Apr, May	1.85 (0.66) 20 ‡	0.26 (0.26) 11 (1.45)	0.06 (0.03) 9.5 (1.24)	(0.01) 42 ‡	0.10 (0.05) 24 ‡
Ophidiidae						
<i>Lepophidium</i> spp. (cusk-eel spp.)	Apr, May	0.41 (0.41) 42.5 ‡	0 (0)	0 (0)	0 (0)	(0.02) 50 ‡
<i>Lepophidium staurophor</i> (L)	Apr	0 (0)	0 (0)	0 (0)	0 (0)	0.02 (0.02) 50 ‡
<i>Ophidion</i> spp. (N) (cusk-eel spp.)	Apr	(0.03) 72 ‡	0 (0)	0 (0)	0 (0)	0 (0)
<i>Ophidion nocomis/selenops</i> (cusk-eel spp.)	May	3.09 (1.77) 13 ‡	0 (0)	0.02 (0.02) 18.5 ‡	0 (0)	0 (0)
<i>Ophidion robinsi</i> (L) (cusk-eel spp.)	May	0 (0)	0 (0)	0.02 (0.02) 18.5 ‡	0 (0)	0 (0)
<i>Ophidion selenops</i> (L) (mooneye cusk-eel)	May	0 (0)	0 (0)	0.02 (0.02) 18.5 ‡	(0.01) 42 ‡	0 (0)
Bythitidae						
Unidentified (N) (brotula)	May	0.41 (0.41) 42.5 ‡	0 (0)	0 (0)	0 (0)	0 (0)
Gobiesociformes						
Gobiesocidae						
<i>Gobiesox strumosus</i> (skilletfish)	Apr, May	0.03 (0.03) 69.5 ‡	0 (0)	0 (0)	0.06 (0.04) 21 ‡	0.03 (0.02) 36 ‡
Atheriniformes						
Exocoetidae						
Unidentified (N) (flyingfish)	Apr	0.03 (0.03) 71 ‡	0 (0)	0 (0)	0 (0)	0 (0)
<i>Cypselurus</i> spp. (N) (flyingfish spp.)	Apr	0.03 (0.03) 69.5 ‡	0 (0)	0 (0)	0 (0)	0 (0)
<i>Cypselurus cyanopterus</i> (L) (margined flyingfish)	Jun	0 (0)	0 (0)	0 (0)	0 (0)	(0.02) 50 ‡
<i>Cypselurus furcatus</i> (L) (spotfin flyingfish)	May	0 (0)	0 (0)	0 (0)	0 (0)	0.02 (0.02) 50 ‡
Atherinidae						
Unidentified (N) (silverside)	Apr	0.29 (0.20) 45 ‡	0 (0)	0 (0)	0 (0)	0 (0)

Table 5.8. (continued)

Taxa	Months Collected	Surface Net	Bottom Net	Bottom Light-trap	Surface Light-trap	Off-platform Light-trap
		Density (SE)	Density (SE)	CPUE (SE)	CPUE (SE)	CPUE (SE)
		Rank (%)	Rank (%)	Rank (%)	Rank (%)	Rank (%)
<i>Membras martinica</i> (L) (rough silverside)	Jun	0 (0)	0 (0)	0 (0)	0.02 (0.02) 32 ‡	0 (0)
Gasterosteiformes						
Syngnathidae						
<i>Syngnathus</i> spp. (N) (pipefish spp.)	Apr	0.03 (0.03) 74 ‡	0 (0)	0 (0)	0 (0)	0 (0)
<i>Syngnathus louisiana</i> (N) (chain pipefish)	Apr	0.02 (0.02) 80.5 ‡	0 (0)	0 (0)	0 (0)	0 (0)
Scorpaeniformes						
Scorpaenidae						
<i>Scorpaena</i> spp. (scorpionfish spp.)	Apr, Jun	0 (0)	0.26 (0.26) 11 (1.45)	0 (0)	0.02 (0.02) 32 ‡	0.02 (0.02) 50 ‡
Triglidae						
<i>Prionotus</i> spp. (searobin spp.)	Apr	0.58 (0.26) 36 ‡	0 (0)	0 (0)	0.01 (0.01) 42 ‡	0.02 (0.02) 50 ‡
Perciformes						
Unidentified	Apr, May, Jun, Jul	10.47 (3.57) 6 ‡	14.29 (14.29) 1 (10.14)	0 (0)	0.02 (0.02) 32 ‡	0.16 (0.07) 17.5 ‡
Serranidae						
Unidentified (N) (seabass/grouper)	Apr	0.06 (0.06) 65 ‡	0 (0)	0 (0)	0 (0)	0 (0)
Epinephelinae (N) (grouper)	Apr	(0.03) 74 ‡	0 (0)	0 (0)	0 (0)	0 (0)
Serraninae (seabass)	Apr, May	0.34 (0.24) 44 ‡	0 (0)	0 (0)	(0.01) 42 ‡	0 (0)
Priacanthidae						
<i>Priacanthus</i> spp. (L) (bigeye spp.)	May	0 (0)	0 (0)	0 (0)	0 (0)	0.02 (0.02) 50 ‡
Carangidae						
Unidentified (N) (jack)	Apr, Jun	0.43 (0.28) 41 ‡	0 (0)	0 (0)	0 (0)	0 (0)
<i>Caranx crysos</i> (L) (blue runner)	May, Jun, Jul	0 (0)	0 (0)	0.02 (0.02) 23.5 ‡	(0.03) 19 ‡	0.24 (0.08) 14 ‡
<i>Caranx hippos/latus</i> (crevalle/horse-eye jack)	May, Jun, Jul	2.70 (2.44) 14 ‡	0 (0)	0 (0)	0.04 (0.02) 26.5 ‡	0.61 (0.25) 6 (1.60)

Table 5.8. (continued)

Taxa	Months Collected	Surface Net	Bottom Net	Bottom Light-trap	Surface Light-trap	Off-platform Light-trap
		Density (SE)	Density (SE)	CPUE (SE)	CPUE (SE)	CPUE (SE)
		Rank (%)	Rank (%)	Rank (%)	Rank (%)	Rank (%)
<i>Chloroscombrus chrysurus</i> (Atlantic bumper)	May, Jun, Jul	30.00 (11.03) 4 ‡	0 (0)	0.02 (0.02) 18.5 ‡	0.09 (0.04) 17 ‡	0.11 (0.06) 22 ‡
<i>Decapterus punctatus</i> (round scad)	Apr, May, Jun	0.02 (0.02) 77.5 ‡	0 (0)	0 (0)	0.02 (0.02) 32 ‡	0.02 (0.02) 50 ‡
<i>Oligoplites saurus</i> (N) (leatherjack)	Jun	0.48 (0.37) 37 ‡	0 (0)	0 (0)	0 (0)	0 (0)
<i>Selar crumenophthalmus</i> (L) (bigeye scad)	May	0 (0)	0 (0)	0 (0)	0 (0)	0.02 (0.02) 50 ‡
<i>Selene</i> spp. (N) (moonfish/lookdown spp.)	May	0.61 (0.61) 31 ‡	0 (0)	0 (0)	0 (0)	0 (0)
<i>Seriola</i> spp. (L) (jack spp.)	Apr	0 (0)	0 (0)	0 (0)	(0.01) 49 ‡	0 (0)
<i>Trachinotus carolinus</i> (L) (Florida pompano)	May	0 (0)	0 (0)	0 (0)	0 (0)	0.03 (0.03) 33 ‡
<i>Trachurus lathami</i> (rough scad)	Apr, May	0.02 (0.02) 80.5 ‡	0 (0)	0 (0)	(0.05) 18 ‡	0.02 (0.02) 50 ‡
Lutjanidae						
Unidentified (N) (snapper)	Jul	0.17 (0.17) 54.5 ‡	0 (0)	0 (0)	0 (0)	0 (0)
<i>Lutjanus</i> spp. (N) (snapper spp.)	May, Jul	0.61 (0.45) 31 ‡	0 (0)	0 (0)	0 (0)	0 (0)
<i>Lutjanus campechanus</i> (red snapper)	May, Jun	0.61 (0.61) 31 ‡	0 (0)	0 (0)	0 (0)	0.02 (0.02) 50 ‡
<i>Rhomboplites aurorubens</i> (L) (vermilion snapper)	May, Jun	0 (0)	0 (0)	0.12 (0.07) 6 (2.49)	0 (0)	0 (0)
Gerreidae						
Unidentified (L) (jenny/mojarra)	May	0 (0)	0 (0)	0 (0)	0 (0)	(0.02) 50 ‡
Haemulidae						
Unidentified (N) (grunt)	May	0.61 (0.61) 31 ‡	0 (0)	0 (0)	0 (0)	0 (0)
Sparidae						
Unidentified (N) (porgy)	Apr	0.14 (0.14) 58 ‡	0 (0)	0 (0)	0 (0)	0 (0)
<i>Calamus</i> spp. (N) (porgy spp.)	Apr	0.10 (0.10) 61 ‡	0 (0)	0 (0)	0 (0)	0 (0)
Sciaenidae						

Table 5.8. (continued)

Taxa	Months Collected	Surface Net	Bottom Net	Bottom Light-trap	Surface Light-trap	Off-platform Light-trap
		Density (SE)	Density (SE)	CPUE (SE)	CPUE (SE)	CPUE (SE)
		Rank (%)	Rank (%)	Rank (%)	Rank (%)	Rank (%)
Unidentified (drum)	Apr, May, Jun	(0.15) 57 ‡	0 (0)	0 (0)	0.02 (0.02) 32 ‡	0.02 (0.02) 50 ‡
<i>Bairdiella chrysoura</i> (silver perch)	Jun	0.12 (0.12) 59 ‡	0 (0)	0 (0)	0 (0)	0.02 (0.02) 50 ‡
<i>Cynoscion arenarius</i> (sand seatrout)	Apr, May, Jun, Jul	42.16 (8.56) 3 ‡	7.99 (3.21) 3 (21.74)	(0.04) 7 (2.07)	0.42 (0.11) 8 (1.03)	0.56 (0.13) 7 (1.47)
<i>Larimus fasciatus</i> (N) (banded drum)	Apr	0.05 (0.04) 66 ‡	0 (0)	0 (0)	0 (0)	0 (0)
<i>Menticirrhus</i> spp. (kingfish spp.)	Apr, May, Jun, Jul	1.45 (0.36) 22 ‡	0 (0)	0 (0)	0 (0)	(0.02) 33 ‡
<i>Stellifer lanceolatus</i> (N) (star drum)	Apr	0.44 (0.25) 39 ‡	0 (0)	0 (0)	0 (0)	0 (0)
Mullidae						
<i>Upeneus parvus</i> (L) (dwarf goatfish)	Apr	0 (0)	0 (0)	0 (0)	0 (0)	0.02 (0.02) 50 ‡
Ephippidae						
<i>Chaetodipterus faber</i> (N) (Atlantic spadefish)	May, Jul	0.86 (0.39) 25 ‡	0 (0)	0 (0)	0 (0)	0 (0)
Pomacentridae						
<i>Abudefduf saxatilis</i> (L) (sergeant major)	May	0 (0)	0 (0)	0 (0)	0 (0)	0.10 (0.07) 24 ‡
<i>Pomacentrus</i> spp. (L) (damselfish spp.)	May	0 (0)	0 (0)	0 (0)	0 (0)	0.02 (0.02) 50 ‡
Mugilidae						
<i>Mugil cephalus</i> (L) (striped mullet)	Apr	0 (0)	0 (0)	0 (0)	0 (0)	0.02 (0.02) 50 ‡
<i>Mugil curema</i> (L) (white mullet)	May	0 (0)	0 (0)	0 (0)	(0.01) 42 ‡	0.05 (0.04) 29.5 ‡
Sphyraenidae						
<i>Sphyraena borealis</i> (L) (northern sennet)	May	0 (0)	0 (0)	0 (0)	(0.01) 42 ‡	0 (0)
Labridae						
Unidentified (L) (wrasse)	Jun	0 (0)	0 (0)	0.02 (0.02) 18.5 ‡	0 (0)	0 (0)
Scaridae						
Unidentified (N) (parrotfish)	Apr	(0.02) 77.5 ‡	0 (0)	0 (0)	0 (0)	0 (0)

Table 5.8. (continued)

Taxa	Months Collected	Surface Net	Bottom Net	Bottom Light-trap	Surface Light-trap	Off-platform Light-trap
		Density (SE)	Density (SE)	CPUE (SE)	CPUE (SE)	CPUE (SE)
		Rank (%)	Rank (%)	Rank (%)	Rank (%)	Rank (%)
Blenniidae						
Unidentified (blenny)	Apr, May, Jun, Jul	2.47 (0.90) 15 ‡	1.10 (1.10) 6 (1.45)	0.02 (0.02) 18.5 ‡	0.09 (0.03) 16 ‡	0.08 (0.05) 26.5 ‡
<i>Hypsoblennius hentz/ionthas</i> (feather/freckled blenny)	Apr, May, Jun	0.17 (0.17) 54.5 ‡	0 (0)	0 (0)	0.21 (0.08) 12 ‡	0.48 (0.22) 9.5 (1.26)
<i>Hypsoblennius invemar</i> (tessellated blenny)	Apr, May, Jun	0.61 (0.61) 31 ‡	0 (0)	0 (0)	0.11 (0.05) 15 ‡	0.48 (0.19) 9.5 (1.26)
<i>Parablennius marmoratus</i> (seaweed blenny)	May, Jul	0.20 (0.20) 53 ‡	0 (0)	0 (0)	0 (0)	0.02 (0.02) 50 ‡
<i>Scartella/Hypleurochilus</i> (blenny spp.)	Apr, May, Jun, Jul	1.89 (1.29) 19 ‡	0 (0)	0.06 (0.03) 9.5 (1.24)	0.49 (0.26) 7 (1.17)	0.16 (0.08) 17.5 ‡
Eleotridae						
<i>Dormitator maculatus</i> (N) (fat sleeper)	Apr	0.02 (0.02) 77.5 ‡	0 (0)	0 (0)	0 (0)	0 (0)
Gobiidae						
Unidentified (goby)	Apr, May, Jun, Jul	29.96 (12.71) 5 ‡	1.41 (0.96) 5 (4.35)	0.06 (0.03) 9.5 (1.24)	0.03 (0.02) 28 ‡	0.23 (0.08) 15 ‡
Microdesmidae						
<i>Microdesmus</i> spp. (wormfish spp.)	Apr, Jul	0.58 (0.43) 35 ‡	0 (0)	0 (0)	0.01 (0.01) 42 ‡	0 (0)
<i>Microdesmus lanceolatus</i> (N) (lancetail wormfish)	Jun, Jul	1.28 (0.86) 23 ‡	0 (0)	0 (0)	0 (0)	0 (0)
Trichiuridae						
<i>Trichiurus lepturus</i> (Atlantic cutlassfish)	Apr, May, Jun	0 (0)	0.52 (0.52) 8.5 (2.90)	0.18 (0.07) 4 (3.73)	0.01 (0.01) 42 ‡	0 (0)
Scombridae						
Unidentified (N) (mackerel)	Apr, Jul	0.25 (0.18) 46 ‡	0 (0)	0 (0)	0 (0)	0 (0)
<i>Auxis</i> spp. (mackerel spp.)	May, Jun, Jul	0 (0)	0 (0)	0 (0)	0.02 (0.02) 32 ‡	0.26 (0.17) 13 ‡
<i>Euthynnus alletteratus</i> (little tunny)	May, Jun, Jul	0.47 (0.27) 38 ‡	0 (0)	0.02 (0.02) 23.5 ‡	0.37 (0.23) 10 ‡	1.08 (0.47) 3 (2.82)
<i>Scomberomorus cavalla</i> (king mackerel)	Apr, May, Jun, Jul	5.39 (3.15) 10 ‡	0 (0)	0.04 (0.03) 13 ‡	0.05 (0.04) 24 ‡	0.10 (0.05) 24 ‡
<i>Scomberomorus maculatus</i> (Spanish mackerel)	Apr, May, Jun, Jul	6.56 (2.09) 9 ‡	0 (0)	0 (0)	0.18 (0.06) 13 ‡	0.81 (0.18) 5 (2.11)

Table 5.8. (continued)

Taxa	Months Collected	Surface Net	Bottom Net	Bottom Light-trap	Surface Light-trap	Off-platform Light-trap
		Density (SE)	Density (SE)	CPUE (SE)	CPUE (SE)	CPUE (SE)
		Rank (%)	Rank (%)	Rank (%)	Rank (%)	Rank (%)
Stromateidae						
<i>Ariomma</i> spp. (N) (driftfish spp.)	Apr	0.05 (0.04) 67 ‡	0.52 (0.52) 8.5 (2.90)	0 (0)	0 (0)	0 (0)
<i>Peprilus burti</i> (gulf butterfish)	Apr, May	1.65 (1.23) 21 ‡	0 (0)	0.02 (0.02) 18.5 ‡	0.14 (0.05) 14 ‡	0.13 (0.05) 20.5 ‡
<i>Peprilus alepidotus</i> (harvestfish)	Apr, May, Jul	1.92 (0.77) 18 ‡	0 (0)	0.04 (0.03) 13 ‡	0.04 (0.02) 26.5 ‡	0.15 (0.06) 19 ‡
Pleuronectiformes						
Bothidae						
Unidentified (N) (lefteye flounder)	May	0.81 (0.81) 26 ‡	0 (0)	0 (0)	0 (0)	0 (0)
<i>Citharichthys spilopterus</i> (bay whiff)	Apr, May, Jun	0.21 (0.13) 51 ‡	0 (0)	0 (0)	0 (0)	0.05 (0.04) 29.5 ‡
<i>Cyclopsetta fimbriata</i> (L) (spotfin flounder)	May	0 (0)	0 (0)	0 (0)	0 (0)	0.02 (0.02) 50 ‡
<i>Etropus crossotus</i> (fringed flounder)	Apr, May, Jun	7.59 (2.94) 8 ‡	0.89 (0.89) 7 (1.45)	0 (0)	0.05 (0.02) 24 ‡	0.13 (0.06) 20.5 ‡
<i>Syacium</i> spp. (L) (flounder spp.)	May	0.61 (0.61) 31 ‡	0 (0)	0 (0)	0 (0)	0 (0)
Soleidae						
Unidentified (sole)	Jun, Jul	0.06 (0.06) 63.5 ‡	0 (0)	0.02 (0.02) 18.5 ‡	0 (0)	0 (0)
<i>Achirus lineatus</i> (lined sole)	Apr, May, Jul	0.16 (0.10) 56 ‡	0 (0)	0 (0)	0.02 (0.02) 32 ‡	0 (0)
<i>Gymnachirus</i> spp. (N) (sole spp.)	May	0.09 (0.09) 62 ‡	0 (0)	0 (0)	0 (0)	0 (0)
<i>Trinectes maculatus</i> (N) (hogchoker)	Apr, May	0.70 (0.42) 27 ‡	0 (0)	0 (0)	0 (0)	0 (0)
<i>Symphurus</i> spp. (tonguefish spp.)	Apr, May, Jun, Jul	8.84 (3.84) 7 ‡	0 (0)	0 (0)	0.01 (0.01) 42 ‡	0.06 (0.04) 28 ‡
Tetraodontiformes						
Tetraodontidae						
<i>Sphoeroides</i> spp. (puffer spp.)	Apr, May, Jun	0.06 (0.06) 63.5 ‡	0 (0)	0 (0)	0.05 (0.03) 24 ‡	0.21 (0.12) 16 ‡
<i>Sphoeroides parvus</i> (L) (least puffer)	Apr	0 (0)	0 (0)	0 (0)	0.01 (0.01) 42 ‡	0 (0)

Table 5.9. Total mean light-trap CPUE (fish/10 min) and pushnet density (fish/100 m³) for fish collected at Belle Pass with standard error (SE), rank, percent of total catch (%), and months collected for each taxa. For ranks, tied values received the mean of the corresponding ranks. ‡ indicates a value <1.00%.

Taxa	Months Collected	Light-trap	Pushnet
		CPUE (SE) Rank (%)	Density (SE) Rank (%)
Osteichthyes			
Unidentified	Apr, May, Jun, Jul, Aug	0.14 (0.06) 17 ‡	1.23 (0.65) 20 ‡
Elopiformes			
Elopidae			
<i>Elops saurus</i> (ladyfish)	Apr, May, Jun, Jul, Aug	<0.01 (<0.01) 48 ‡	0.22 (0.06) 36 ‡
<i>Megalops atlanticus</i> (tarpon)	Aug	0 (0)	0.03 (0.01) 60 ‡
Anguilliformes			
Unidentified (eel)	Apr, May, Jun, Jul, Aug	<0.01(<0.01) 48‡	0.17(0.08) 41‡
Ophichthidae			
Unidentified (snake eel)	Apr, May, Jun	0.03(0.02) 31‡	0.03(0.03) 57‡
<i>Bascanichthys</i> spp. (sooty/whip eel spp.)	Jun, Jul, Aug	0 (0)	0.13(0.03) 44‡
<i>Myrophis punctatus</i> (speckled worm eel)	Apr, May, Jun, Jul	0.04(0.02) 28‡	0.64(0.31) 27‡
<i>Ophichthus gomesi</i> (shrimp eel)	Jul	0 (0)	0.15(0.07) 42‡
<i>Ophichthus melanoporus</i> (blackpored eel)	Aug	0 (0)	<0.01(<0.01) 82‡
Congridae			
<i>Paraconger caudilimbatus</i> (margintail conger)	Jun	0 (0)	<0.01(<0.01) 82‡
Clupeiformes			
Unidentified (herring/anchovy)	May, Jun, Jul, Aug	0.01(<0.01) 41‡	10.85(3.88) 5(2.05)
Clupeidae			
Unidentified (herring)	Apr, May, Aug	0.07(0.04) 22‡	2.48(1.42) 13‡
<i>Brevoortia</i> spp. (menhaden spp.)	Apr, Aug	0.15(0.08) 16‡	2.77(2.09) 11‡
<i>Brevoortia patronus</i> (gulf menhaden)	Apr, May, Jun, Jul, Aug	0.04(0.03) 27‡	0.60(0.37) 29‡

Table 5.9. (continued)

Taxa	Months Collected	Light-trap	Pushnet
		CPUE (SE) Rank (%)	Density (SE) Rank (%)
<i>Harengula jaguana</i> (scaled sardine)	May, Jun, July, Aug	1.12(0.36) 4‡	0.53(0.10) 30‡
<i>Opisthonema oglinum</i> (Atlantic thread herring)	May, Jun, July, Aug	0.28(0.12) 11‡	0.40(0.10) 32‡
Engraulidae			
Unidentified (anchovy)	Apr, May, Jun, Jul, Aug	16.33(7.07) 2(13.47)	138.43(21.12) 2(27.74)
<i>Anchoa hepsetus</i> (striped anchovy)	Apr, May, Jun, Jul, Aug	0.73(0.24) 6‡	1.30(0.50) 18‡
<i>Anchoa mitchilli</i> (bay anchovy)	Apr, May, Jun, Jul, Aug	95.80(37.97) 1(79.07)	153.25(33.48) 1(38.23)
<i>Anchoa nasuta</i> (longnose anchovy)	May, Jun, Jul, Aug	0.24(0.08) 13‡	0.18(0.06) 38‡
<i>Anchoa nasuta/hepsetus</i> (longnose/striped anchovy)	Apr, May, Jun, Jul, Aug	0.64(0.22) 7‡	1.90(0.45) 15‡
Siluriformes			
Ariidae			
<i>Arius felis</i> (hardhead catfish)	May, Jul	0 (0)	0.09(0.06) 48‡
<i>Bagre marinus</i> (gafftopsail catfish)	Jul, Aug	0 (0)	0.10(0.08) 46‡
Aulopiformes			
Synodontidae			
Unidentified (lizardfish)	May	0 (0)	<0.01(<0.01) 88‡
<i>Synodus</i> spp. (lizardfish spp.)	Apr, May	0 (0)	0.02(0.02) 61‡
<i>Synodus foetens</i> (inshore lizardfish)	Apr, May, Jun, Jul, Aug	0.15(0.04) 15‡	0.93(0.14) 23‡
Paralepididae			
<i>Paralepis atlantica</i> (duckbill barracudina)	Apr	0 (0)	<0.01(<0.01) 90‡
Gadiformes			
Ophidiidae			
Unidentified (cuskeel)	Apr	0 (0)	<0.01(<0.01) 89‡
<i>Lepophidium</i> spp. (cusk-eel spp.)	Jun	0 (0)	<0.01(<0.01) 108‡
Gobiesociformes			
Gobiesocidae			

Table 5.9. (continued)

Taxa	Months Collected	Light-trap	Pushnet
		CPUE (SE) Rank (%)	Density (SE) Rank (%)
<i>Gobiosox strumosus</i> (skilletfish)	Apr, May, Jun, Jul, Aug	0.47(0.13) 10‡	1.55(0.25) 16‡
Atheriniformes			
Exocoetidae			
Unidentified (flyingfish)	May, Jun	0 (0)	0.01(<0.01) 80‡
<i>Cypselurus</i> spp. (flying fish spp.)	Jun	<0.01(<0.01) 48‡	0 (0)
<i>Hyporhamphus</i> <i>unifasciatus</i> (silverstriped halfbeak)	May, Jun, Jul, Aug	<0.01(<0.01) 48‡	0.04(0.01) 55‡
Atherinidae			
Unidentified (silverside)	Apr, May, Jun, Jul, Aug	0 (0)	0.18(0.08) 40‡
<i>Membras martinica</i> (rough silverside)	Apr, May, Jun, Jul, Aug	1.30(0.56) 3(1.09)	0.98(0.22) 21‡
<i>Menidia beryllina</i> (inland silverside)	May	0 (0)	0.02(0.02) 66‡
Gasterosteiformes			
Syngnathidae			
<i>Hippocampus erectus</i> (lined seahorse)	Jun	0 (0)	<0.01(<0.01) 99‡
<i>Syngnathus</i> spp. (pipefish spp.)	Apr, May, Jun, Jul, Aug	<0.01(<0.01) 48‡	0.09(0.03) 49‡
<i>Syngnathus louisiana</i> (chain pipefish)	Jul	0 (0)	<0.01(<0.01) 111‡
Scorpaeniformes			
Triglidae			
<i>Prionotus</i> spp. (searobin spp.)	Jun	0 (0)	<0.01(<0.01) 110‡
<i>Prionotus roseus</i> (bluespotted searobin)	Jul	0 (0)	<0.01(<0.01) 101‡
<i>Prionotus tribulus</i> (bighead searobin)	Jul	0 (0)	<0.01(<0.01) 94‡
Perciformes			
Serranidae			
<i>Epinephelinae</i> (grouper spp.)	Apr	0 (0)	<0.01(<0.01) 97‡
Rachycentridae			
<i>Rachycentron canadum</i> (cobia)	May	0 (0)	<0.01(<0.01) 86‡

Table 5.9. (continued)

Taxa	Months Collected	Light-trap	Pushnet
		CPUE (SE) Rank (%)	Density (SE) Rank (%)
Carangidae			
Unidentified (jack)		0 (0)	0.02(0.02) 62‡
<i>Caranx</i> spp. (jack spp.)	Aug	0 (0)	0.64(0.26) 28‡
<i>Caranx hippos/latus</i> (crevalle/horse-eye jack)	Jun, Jul, Aug	<0.01(<0.01) 48‡	0.09(0.04) 47‡
<i>Chloroscombrus chrysurus</i> (Atlantic bumper)	Jun, Jul, Aug	0.05(0.02) 23‡	0.28(0.15) 35‡
<i>Oligoplites saurus</i> (leatherjack)	Aug	<0.01(<0.01) 48‡	0.02(<0.01) 71‡
<i>Selene vomer</i> (lookdown)	Jul	0 (0)	<0.01(<0.01) 98‡
<i>Selene setapinnis</i> (Atlantic moonfish)	Jul	0 (0)	<0.01(<0.01) 104‡
Lutjanidae			
<i>Lutjanus griseus</i> (gray snapper)	Jun, Jul, Aug	0 (0)	0.03(0.01) 59‡
<i>Lutjanus synagris</i> (lane snapper)	Jul, Aug	0.01(<0.01) 38‡	0.07(0.02) 51‡
<i>Lutjanus</i> spp. (snapper spp.)	Aug	<0.01(<0.01) 48‡	0 (0)
Gerreidae			
Unidentified (jenny/mojarra)	May, Jun, Aug	0.02(0.01) 34‡	0.19(0.07) 37‡
<i>Eucinostomus</i> spp. (mojarra/jenny spp.)	Jun, Aug	<0.01(<0.01) 48‡	0.02(0.01) 70‡
Haemulidae			
Unidentified (grunt)	Jul	0 (0)	<0.01(<0.01) 102‡
Sparidae			
Unidentified (porgy)	Apr, May	0 (0)	0.02(0.01) 63‡
<i>Sparidae</i> Type B (porgy spp.)	May	0 (0)	0.02(<0.01) 68‡
Sciaenidae			
Unidentified (drum)	May, Jun, Jul, Aug	0.02(0.01) 34‡	2.54(0.96) 12‡
<i>Bairdiella chrysoura</i> (silver perch)	Apr, May, Jun, Jul, Aug	0.12(0.08) 19‡	3.07(0.73) 10‡
<i>Cynoscion arenarius</i>	Apr, May, Jun, Jul, Aug	0.59(0.28)	40.74(8.02)

Table 5.9. (continued)

Taxa	Months Collected	Light-trap	Pushnet
		CPUE (SE) Rank (%)	Density (SE) Rank (%)
(sand seatrout)		9‡	4(7.85)
<i>Cynoscion nebulosus</i> (spotted seatrout)	Apr, May, Jun, Aug	0.01(<0.01) 38‡	0.85(0.21) 24‡
<i>Cynoscion nebulosus/arenarius</i> (spotted/sand seatrout)	Jul	0 (0)	0.01(0.01) 74‡
<i>Menticirrhus</i> spp. (kingfish spp.)	Apr, May, Jul, Aug	0.03(0.01) 29‡	0.51(0.09) 31‡
<i>Menticirrhus americanus/littoralis</i> (gulf/northern kingfish)	Jun, Aug	0 (0)	0.02(0.01) 64‡
<i>Micropogonias undulatus</i> (Atlantic croaker)	Apr, Jul	0 (0)	0.04(0.02) 56‡
<i>Pogonias cromis</i> (black drum)	May	0.01(<0.01) 38‡	0.74(0.21) 26‡
<i>Sciaenops ocellatus</i> (red drum)	Aug	<0.01(<0.01) 48‡	1.29(0.59) 19‡
<i>Stellifer lanceolatus</i> (star drum)	Apr, Jun, Jul	0 (0)	0.05(0.02) 54‡
Mullidae			
Unidentified (goatfish)	May	0 (0)	<0.01(<0.01) 87‡
Ephippidae			
<i>Chaetodipterus faber</i> (Atlantic spadefish)	Jun, Aug	0 (0)	0.05(0.02) 52‡
Mugilidae			
<i>Mugil cephalus</i> (striped mullet)	Apr	0 (0)	<0.01(<0.01) 97‡
<i>Mugil curema</i> (white mullet)	Apr, May, Jun	0 (0)	0.02(<0.01) 69‡
Polynemidae			
<i>Polydactylus octonemus</i> (Atlantic threadfin)	Aug	0 (0)	<0.01(<0.01) 93‡
Labridae			
Unidentified (wrasse)	Apr	0 (0)	0.01(<0.01) 77‡
Scaridae			
<i>Sparisoma</i> spp. (parrotfish spp.)	Apr	0 (0)	0.01(<0.01) 72‡
Uranoscopidae			
Unidentified	Jun	0 (0)	<0.01(<0.01)

Table 5.9. (continued)

Taxa	Months Collected	Light-trap	Pushnet
		CPUE (SE) Rank (%)	Density (SE) Rank (%)
(stargazer)			92‡
Blenniidae			
Unidentified (blenny)	May, Jun, Jul, Aug	0.02(0.01) 35‡	0.03(0.02) 58‡
<i>Chasmodes</i> spp. (striped/Florida blenny)	Apr	0 (0)	<0.01(<0.01) 100‡
<i>Hypleurochilus</i> <i>bermudensis</i> (barred blenny)	Aug	0 (0)	<0.01(<0.01) 95‡
<i>Hypsoblennius</i> spp. (blenny spp.)	Jul	0 (0)	<0.01(<0.01) 104(<1.00)
<i>Hypsoblennius</i> <i>hantz/ionthas</i> (feather/tessellated blenny)	Apr, May, Jun, Jul, Aug	1.04(0.27) 5‡	1.95(0.45) 14‡
<i>Scartella cristata</i> (molly miller)	Apr, May, Jun, Jul, Aug	0.03(0.02) 31‡	0.34(0.08) 33‡
Eleotridae			
Unidentified (sleeper)	Jun, Jul, Aug	0.01(<0.01) 38‡	0.02(0.01) 67‡
<i>Eleotridae</i> Type A (sleeper spp.)	Jun, Aug	<0.01(<0.01) 48‡	0.18(0.06) 39‡
<i>Dormitator maculatus</i> (fat sleeper)	Apr, May, Jun, Jul, Aug	0.12(0.06) 18‡	0.96(0.34) 22‡
Gobiidae			
Unidentified (goby)	Apr, May, Jun, Jul, Aug	0.03(0.01) 31‡	0.81(0.23) 25‡
<i>Bathygobius soporator</i> (frillfin goby)	Jun, Jul	0 (0)	0.01(<0.01) 76‡
<i>Evorthodus</i> <i>lyricus/Gobionellus</i> <i>boleosoma</i> (lyre goby/darter goby)	Jun, Jul, Aug	0 (0)	0.01(<0.01) 78‡
<i>Gobionellus oceanicus</i> (highfin goby)	Apr, May, Jun, Jul, Aug	0.11(0.06) 20‡	8.82(2.13) 6(1.97)
<i>Gobiosoma</i> spp. (goby spp.)	Apr, May, Jun, Jul, Aug	0.26(0.18) 12‡	1.48(0.43) 17‡
<i>Gobiosoma bosc</i> (naked goby)	Apr, May, Jun, Jul, Aug	0.59(0.16) 8‡	46.88(7.88) 3(10.64)
<i>Microgobius</i> spp. (goby spp.)	May, Jun, Jul, Aug	0.04(0.03) 26‡	4.17(1.30) 9(1.05)
Microdesmidae			
<i>Microdesmus longipinnis</i> (pink wormfish)	Jun, Jul, Aug	0.05(0.02) 24‡	0.14(0.04) 43‡

Table 5.9. (continued)

Taxa	Months Collected	Light-trap	Pushnet
		CPUE (SE) Rank (%)	Density (SE) Rank (%)
Trichiuridae			
Unidentified (snake mackerel)	May	0 (0)	<0.01(<0.01) 91‡
<i>Trichiurus lepturus</i> (Atlantic cutlassfish)	Apr, Jul	0 (0)	0.01(<0.01) 79‡
Scombridae			
Unidentified (mackerel)	May, Jun	0 (0)	0.01(<0.01) 73‡
<i>Scomberomorus</i> spp. (mackerel spp.)	Aug	<0.01(<0.01) 48‡	0 (0)
<i>Scomberomorus maculatus</i> (Spanish mackerel)	May, Aug	0 (0)	<0.01(<0.01) 83‡
Stromateidae			
<i>Peprilus alepidotus</i> (harvestfish)	Jun, Jul, Aug	0 (0)	0.01(<0.01) 75‡
<i>Peprilus burti</i> (gulf butterfish)	Apr	0 (0)	<0.01(<0.01) 85‡
Pleuronectiformes			
Bothidae			
Unidentified (lefteye flounder)	Apr, Jun	0 (0)	0.02(0.01) 65‡
<i>Citharichthys</i> spp. (whiff/sanddab spp.)	Apr, May, Jun, Jul, Aug	0.08(0.03) 21‡	6.53(1.02) 7(1.49)
<i>Citharichthys spilopterus</i> (bay whiff)	Jul	0 (0)	<0.01(<0.01) 81‡
<i>Etropus crossotus</i> (fringed flounder)	Jul	0 (0)	<0.01(<0.01) 104‡
Soleidae			
<i>Achirus lineatus</i> (lined sole)	Jun	0 (0)	<0.01(<0.01) 84‡
<i>Trinectes maculatus</i> (hogchoker)	May, Jun, Jul, Aug	0 (0)	0.07(0.02) 50‡
Cynoglossidae			
<i>Symphurus</i> spp. (tonguefish spp.)	Apr, May, Jun, Jul, Aug	0.05(0.02) 25‡	5.66(0.89) 8(1.27)
<i>Symphurus plagiusa</i> (blackcheek tonguefish)	Jul	0 (0)	<0.01(<0.01) 106‡
Tetraodontiformes			
Balistidae			
<i>Monacanthus hispidus</i> (planehead filefish)	Jun	0 (0)	<0.01(<0.01) 110‡

Table 5.9. (continued)

Taxa	Months Collected	Light-trap	Pushnet
		CPUE (SE) Rank (%)	Density (SE) Rank (%)
Tetraodontidae			
Unidentified (puffer)	May, Jun	0 (0)	0.05(0.02) 53‡
<i>Sphoeroides</i> spp. (puffer spp.)	Apr, May, Jun, Aug	0.01(<0.01) 38‡	0.12(0.04) 45‡
<i>Sphoeroides parvus</i> (least puffer)	Apr, May, Jun, Jul, Aug	0.17(0.06) 14‡	0.34(0.08) 34‡

dominated the total catch for both gear types, particularly the plankton nets where these fishes comprised 65% and 71% of the total numerical catch for subsurface and surface plankton net collections, respectively. Gobies, scarids, and *Mugil cephalus* were among the most common non-clupeiform fishes in the plankton net collections. While the subsurface light-trap collections were also dominated by clupeiforms (72%), other coastal pelagic taxa such as *Caranx crysos*, *C. hippos/latus*, *Euthynnus alletteratus*, and *Auxis* spp. were common in the surface and off-platform light-trap collections.

At GI 94, a total of 45,754 fish were collected with light-traps collecting 31,353 fish and plankton nets collecting 14,401 fish. The total mean plankton net density was 69.6 fish/100 m³ and the total mean light-trap CPUE was 26.2 fish/10 min. Plankton nets collected individuals from 40 different families, six of which were not collected by light-traps (Table 5.7). Light-traps sampled fish from 37 families, only three of which were not sampled by plankton nets. Plankton nets collected fish from 83 taxa (identified at least to the level of genus), 26 of which were not collected in light-traps, while light-traps collected fish from 90 taxa, 31 of which were not sampled with plankton nets. Clupeiforms dominated the total catch (66%). The most common taxa collected included *Anchoa* spp., *A. nasuta*, *Engraulis eurystole*, and *Opisthonema oglinum*. Among the most common non-clupeiform fishes were synodontids (primarily *Synodus foetens* and *S. poeyi*), blenniids (*Hypsoblennius invemar* and *Parablennius marmoratus*), and scombrids (*Auxis* spp. and *Euthynnus alletteratus*).

At ST 54, a total of 97,697 fish were collected, with light-traps collecting 6,116 fish and plankton nets collecting 91,583 fish (Table 5.8). Total mean plankton net density was 166.0 fish/100 m³ and total mean light-trap CPUE was 0.6 fish/10 min. Due to problems with deploying the subsurface net at this site (Table 5.5), the plankton net catch is almost exclusively from the surface. The plankton nets collected fish from 34 families, eight of which were unique. Light-traps also collected fish from a total of 34 families, eight of which were not collected with plankton nets. The plankton nets caught fish from 59 taxa (identified to genus), 19 of which were unique. Light-traps caught fish from 65 taxa, 27 of which were not in plankton net collections. Overall, clupeiforms, primarily clupeids, dominated the collections at ST 54, comprising 97% of the total catch for both gear types combined. The only gear and location not dominated by clupeiforms was the subsurface light-traps, in which

Synodus foetens was the most common taxon. Of the non-clupeiform fishes collected, sciaenids, synodontids, carangids, and scombrids were dominant.

At the Belle Pass jetties, the light-trap and pushnet collected 17,949 fish and 111,854 fish, respectively, with a total mean pushnet density of 136.7 fish/100 m³ and a total light-trap CPUE of 4.6 fish/10 min. Catches by both gear types were dominated by clupeiform fishes that comprised 95.3% of the light-trap total catch and 68.3% of the total pushnet catch (Table 5.9). The pushnet collected fish from 41 families with 85 taxa identifiable to at least genus. Non-clupeiform taxa collected by the pushnet that comprised over 1% of the total catch included *Gobiosoma bosc*, *Cynoscion arenarius*, *Gobionellus oceanicus*, *Citharichthys* spp., *Symphurus* spp., and *Microgobius* spp. Overall, the light-trap collected fish from 21 families with 42 taxa identifiable to at least the genus level. Only one non-clupeiform species, *Membras martinica*, comprised over 1% of the total light-trap catch. The pushnet collected fish from 20 families and 44 taxa unique to this gear type. All families and all but three taxa that were sampled with the light-trap were also collected by the pushnet.

Reef-dependent and reef-associated fish (Choat and Bellwood 1991) made up a relatively small percentage of the total plankton net and light-trap collections (with clupeiforms removed from the total catch) at the three platforms (Table 5.10). At GC 18, these groups of fish comprised 18% and 32% of the plankton net and light-trap collections, respectively. Dominant groups included gobiids, scombrids, and carangids. At GI 94, reef-dependent and reef-associated fishes comprised 10% of the plankton net catch and 17% of the light-trap catch. Blenniids were prominent in both plankton net and light-trap collections, as well as gobiids (plankton nets) and scombrids (light-traps). At ST54, these fishes comprised less than 1% of the plankton net collections and only 8% of the light-trap collections. Carangids (particularly *Chloroscombrus chrysurus*), gobiids, and scombrids dominated plankton net collections, while scombrids and blenniids dominated light-trap collections. At Belle Pass, reef-dependent and reef-associated fishes comprised approximately 15% and 2% of pushnet and light-trap collections. Samples by both gears were dominated by gobiids and blenniids, particularly *Gobiosoma bosc* and *Hypsoblennius hentz/ionthas*.

In general, trends in seasonality were consistent for taxa collected at the different sites across the shelf (Tables 5.6–5.9). Many groups (e.g., clupeiforms, carangids, and scombrids) were present throughout the sampling periods for GI 94, ST 54, and the Belle Pass jetty, and throughout the spring-summer at GC 18. At GC 18, the only site that included fall and winter sampling, few taxa were represented solely during these months, including *Etremeus teres* (January-February), *Diplophos taenia* (November) and *Mugil cephalus* (October-November and January-February), among others.

Similarity and Diversity of Ichthyoplankton Assemblages

Schoener's Index of Niche Overlap values range from 0 (no similarity) to 1 (identical taxonomic compositions). Of the 14 comparisons between the six sites (i.e., the three platforms and jetty along the transect and the two pilot studies), the Belle Pass jetty, with values ranging from 0.01-0.07, and WC 352 (inner shelf), with values ranging from 0.01-0.16, differed the most from the other sites (Table 5.11). Inexplicably, from the geographical or depth points of view, the most similar sites

Table 5.10. Total plankton net density (fish/100m³), pushnet density (fish/100m³), and light-trap CPUE (fish/10 min) for reef-dependent (RD) and reef-associated (RA) families of fish collected at each site with standard error (SE). Densities calculated for the platforms include both surface and subsurface samples. CPUEs calculated for the platforms include surface, subsurface, and offplatform samples. † indicates a value <0.01.

Taxa	Ecology	Green Canyon		Grand Isle		South Timbalier		Belle Pass	
		Plankton net density (SE)	Light-trap CPUE (SE)	Plankton net density (SE)	Light-trap CPUE (SE)	Plankton net density (SE)	Light-trap CPUE (SE)	Pushnet density (SE)	Light-trap CPUE (SE)
Anguilliformes									
Muraenidae	RA								
Unidentified (moray eel)		0.01 0.01	0.02 0.01	0.25 0.12	† †	0.40 0.38	0.01 0.01		
Beryciformes									
Holocentridae									
<i>Holocentrus</i> spp. (squirrelfish spp.)		0.12 0.07	0.06 0.02	0.09 0.04	0.01 †				
Perciformes									
Serranidae									
Unidentified (seabass/grouper)	RA	0.75 0.43		0.12 0.07		0.05 0.05			
Anthinae (sea perch)		0.43 0.15	0.01 0.01	0.25 0.12	† †				
Epinephelinae (grouper)		0.35 0.16	† †	0.03 0.02	0.01 †	0.03 0.03		† †	
Grammistinae		0.05 0.03		0.03 0.02					
Serraninae (sea bass)				0.65 0.18	0.03 0.01	0.31 0.22	0.01 0.01		
Priacanthidae									
Unidentified (bigeye)	RA	0.09 0.06	† †						
<i>Priacanthus</i> spp. (bigeye/glasseye spp.)				0.02 0.02			0.01 0.01		
Apogonidae									
Unidentified (cardinalfish)	RA	0.01 0.01							
<i>Apogon</i> spp. (cardinalfish spp.)		0.01 0.01							
Rachycentridae									
<i>Rachycentron canadum</i> (cobia)	RA			0.08 0.04				† †	

Table 5.10 (continued)

Taxa	Ecology	Green Canyon		Grand Isle		South Timbalier		Belle Pass	
		Plankton net density (SE)	Light-trap CPUE (SE)	Plankton net density (SE)	Light-trap CPUE (SE)	Plankton net density (SE)	Light-trap CPUE (SE)	Pushnet density (SE)	Light-trap CPUE (SE)
Carangidae	RA								
Unidentified (jack)		0.35 0.19		0.10 0.06	† †	0.40 0.26		0.02 0.02	
<i>Caranx</i> spp. (jack spp.)		0.02 0.02	† †	0.08 0.05				0.64 0.26	
<i>Caranx crysos</i> (blue runner)		2.03 0.89	0.17 0.04	0.89 0.30	0.07 0.02		0.11 0.03		
<i>Caranx hippos/latus</i> (crevalle/horse-eye jack)		2.72 0.69	0.09 0.02	0.26 0.16	0.07 0.02	2.49 2.25	0.21 0.08	0.09 0.04	† †
<i>Chloroscombrus chrysurus</i> (Atlantic bumper)		0.38 0.16	0.01 0.01	0.65 0.20	0.01 0.01	27.64 10.19	0.08 0.03	0.28 0.15	0.05 0.02
<i>Decapterus punctatus</i> (round scad)		0.02 0.02	0.01 †		0.02 0.01	0.02 0.02	0.02 0.01		
<i>Elagatis bipinjalata</i> (rainbow runner)		0.13 0.08	† †						
<i>Oligoplites saurus</i> (leatherjack)				0.08 0.06		0.45 0.34		0.02 †	† †
<i>Selar crumenophthalmus</i> (bigeye scad)		0.07 0.06		0.23 0.10			0.01 0.01		
<i>Selene</i> spp. (moonfish/lookdown spp.)						0.56 0.56			
<i>Selene vomer</i> (lookdown)		0.16 0.16		0.03 0.02				† †	
<i>Selene setapinnis</i> (Atlantic moonfish)								† †	
<i>Seriola</i> spp. (jack spp.)		0.22 0.12	† †	0.02 0.02			† †		
<i>Seriola dumerili/rivoliana</i> (greater amberjack/almaco jack)					0.01 †				
<i>Seriola fasciata</i> (lesser amberjack)					† †				
<i>Trachinotus carolinus</i> (Florida pompano)					† †		0.01 0.01		
<i>Trachinotus falcatus/goodei</i> (permit/palometa)					0.01 0.01				
<i>Trachurus lathami</i>		0.14	0.01	0.09	0.03	0.02	0.04		

Table 5.10 (continued)

Taxa	Ecology	Green Canyon		Grand Isle		South Timbalier		Belle Pass	
		Plankton net density (SE)	Light-trap CPUE (SE)	Plankton net density (SE)	Light-trap CPUE (SE)	Plankton net density (SE)	Light-trap CPUE (SE)	Pushnet density (SE)	Light-trap CPUE (SE)
(rough scad)		0.08	0.01	0.05	0.01	0.02	0.02		
Lutjanidae	RA								
Unidentified (snapper)		0.03 0.03	† †	0.08 0.04	† †	0.16 0.16			
<i>Lutjanus</i> spp. (snapper spp.)		0.15 0.09	† †	0.35 0.12	0.01 0.01	0.56 0.42			† †
<i>Lutjanus griseus</i> (gray snapper)								0.03 0.01	
<i>Lutjanus synagris</i> (lane snapper)								0.07 0.02	0.01 †
<i>Lutjanus apodus/vivanus</i> (schoolmaster/silk snapper)			0.01 †						
<i>Lutjanus campechanus</i> (red snapper)			0.01 0.01	0.01 0.01	0.01 0.01	0.56 0.56	0.01 0.01		
<i>Pristipomoides aquilonaris</i> (wenchman)		1.25 0.56							
<i>Rhomboplites aurorubens</i> (vermilion snapper)		0.03 0.03		0.39 0.17	0.09 0.02		0.03 0.02		
Haemulidae	RA								
Unidentified (grunt)						0.56 0.56		† †	
Sparidae	RA								
Unidentified (porgy)		0.02 0.02		0.02 0.02	0.01 †	0.13 0.13		0.02 0.01	
Sparidae Type B (porgy sp.)								0.02 0.01	
<i>Calamus</i> spp. (porgy spp.)					† †	0.09 0.09			
<i>Lagodon rhomboides</i> (pinfish)		0.24 0.16							
Mullidae	RA								
Unidentified (goatfish)			† †	0.13 0.07	0.02 0.01			† †	
<i>Mullus auratus</i> (red goatfish)			† †		0.02 0.01				
<i>Pseudupeneus maculatus</i>					0.02 0.01				

Table 5.10 (continued)

Taxa	Ecology	Green Canyon		Grand Isle		South Timbalier		Belle Pass	
		Plankton net density (SE)	Light-trap CPUE (SE)	Plankton net density (SE)	Light-trap CPUE (SE)	Plankton net density (SE)	Light-trap CPUE (SE)	Pushnet density (SE)	Light-trap CPUE (SE)
(spotted goatfish)									
<i>Upeneus parvus</i> (dwarf goatfish)					0.13 0.03		0.01 0.01		
Ephippidae	RA								
<i>Chaetodipterus faber</i> (Atlantic spadefish)		0.03 0.02				0.79 0.36		0.05 0.02	
Chaetodontidae	RD								
Unidentified (butterflyfish)		0.02 0.02		0.01 0.01					
Pomacentridae	RD								
Unidentified (damsel fish)					0.01 0.01				
<i>Abudefduf saxatilis</i> (sergeant major)					0.01 0.01		0.03 0.02		
<i>Abudefduf taurus</i> (night sergeant)					† †				
<i>Chromis</i> spp. (chromis spp.)				0.15 0.15	0.15 0.04				
<i>Pomacentrus</i> spp. (damsel fish spp.)			0.07 0.03	0.06 0.03	0.17 0.05		0.01 0.01		
Sphyraenidae	RA								
<i>Sphyraena borealis</i> (northern sennet)					† †		0.01 0.01		
<i>Sphyraena guachancho</i> (guaguanche)		0.32 0.27	0.01 0.01	0.94 0.31	0.01 †				
Labridae	RD								
Unidentified (wrasse)				0.10 0.08	† †		0.01 0.01	0.01 †	
Scaridae	RD								
Unidentified (parrotfish)		7.33 2.11	0.03 0.01			0.02 0.02			
<i>Sparisoma</i> spp. (parrotfish spp.)								0.01 †	
Opisthognathidae	RA								
Unidentified (jawfish)				0.47 0.17	0.23 0.07				
<i>Opisthognathus</i> spp. (jawfish spp.)				0.03 0.03					
<i>Opisthognathus</i>				0.03	0.01				

Table 5.10 (continued)

Taxa	Ecology	Green Canyon		Grand Isle		South Timbalier		Belle Pass	
		Plankton net density (SE)	Light-trap CPUE (SE)	Plankton net density (SE)	Light-trap CPUE (SE)	Plankton net density (SE)	Light-trap CPUE (SE)	Pushnet density (SE)	Light-trap CPUE (SE)
<i>aurifrons</i> (yellowhead jawfish)				0.03	0.01				
<i>Opisthognathus lonchurus</i> (moustache jawfish)				0.05	0.05				
Blenniidae	RA								
Unidentified (blenny)		0.55 0.34	0.08 0.05	3.02 2.05	0.26 0.07	2.36 0.83	0.07 0.02	0.03 0.02	0.02 0.01
<i>Chasmodes</i> spp. (striped/Florida blenny)								† †	
<i>Hypleurochilus bermudensis</i> (barred blenny)								† †	
<i>Hypsoblennius</i> spp. (blenny spp.)								† †	
<i>Hypsoblennius hentz/ionthas</i> (feather/freckled blenny)					0.61 0.19	0.16 0.16	0.25 0.08	1.95 0.45	1.04 0.27
<i>Hypsoblennius invemar</i> (tessellated blenny)		0.03 0.03	† †	0.02 0.02	3.35 0.64	0.56 0.56	0.20 0.07		
<i>Ophioblennius atlanticus</i> (redlip blenny)		0.44 0.32	0.01 †	0.22 0.22					
<i>Parablennius marmoreus</i> (seaweed blenny)				0.01 0.01	3.01 0.40	0.19 0.19	0.01 0.01		
<i>Scartella cristata</i> (molly miller)								0.34 0.08	0.03 0.02
<i>Scartella/Hypleurochilus</i> (blenny spp.)				0.14 0.08	0.42 0.08	1.74 1.18	0.28 0.12		
Gobiidae	RA								
Unidentified (goby)		6.73 1.75	0.20 0.14	8.18 0.96	0.09 0.02	27.7 11.7	0.10 0.03	0.81 0.23	0.03 0.01
<i>Bathygobius soporator</i> (frillfin goby)								0.01 †	
<i>Evorthodus lyricus/Gobionellus boleosoma</i> (lyre goby/darter goby)								0.01 †	
<i>Bollmannia communis</i> (ragged goby)					† †				

Table 5.10 (continued)

Taxa	Ecology	Green Canyon		Grand Isle		South Timbalier		Belle Pass	
		Plankton net density (SE)	Light-trap CPUE (SE)	Plankton net density (SE)	Light-trap CPUE (SE)	Plankton net density (SE)	Light-trap CPUE (SE)	Pushnet density (SE)	Light-trap CPUE (SE)
<i>Gobionellus oceanicus</i> (highfin goby)				0.01 0.01	† †				
Gobiosoma spp. (goby spp.)								1.48 0.43	0.26 0.18
Gobiosoma bosc (naked goby)								46.88 7.88	0.59 0.16
Microgobius spp. (goby spp.)								4.17 1.30	0.04 0.03
Scombridae	RA								
Unidentified (mackerel)		1.42 0.72	0.01 0.01	0.26 0.15	0.05 0.03	0.23 0.17		0.01 †	
<i>Acanthocybium solandri</i> (wahoo)		0.03 0.03							
<i>Auxis</i> spp. (mackerel spp.)		1.26 0.33	0.19 0.05	4.00 1.25	0.34 0.07			0.09 0.05	
<i>Euthynnus alletteratus</i> (little tunny)		0.47 0.17	0.07 0.02	4.33 0.74	1.29 0.23	0.43 0.25		0.51 0.18	
<i>Katsuwonus pelamis</i> (skipjack tuna)				0.03 0.02	0.03 0.01				
<i>Scomber japonicus</i> (chub mackerel)					0.01 0.01				
<i>Scomberomorus</i> spp. (mackerel spp.)								0.01 †	
<i>Scomberomorus cavalla</i> (king mackerel)		0.06 0.05	0.02 0.01	0.10 0.04	0.13 0.04	4.97 2.91		0.06 0.02	
<i>Scomberomorus maculatus</i> (Spanish mackerel)		0.51 0.28	0.01 †	0.28 0.12	0.07 0.02	6.05 1.94		0.33 0.07	† †
<i>Thunnus</i> spp. (tuna spp.)		0.07 0.07	0.01 0.01		† †				
<i>Thunnus thynnus</i> (bluefin tuna)		0.11 0.07			† †				
Tetraodontiformes									
Balistidae	RA								
Unidentified (leatherjacket)				0.01 0.01	† †				
<i>Monacanthus hispidus</i> (planehead filefish)								† †	

Table 5.11. Schoener's Index of Niche Overlap for all sampling sites. Values range from 0-1 and include taxa (at least to the level of genus) from all gears used at each site. Values in parentheses represent indices calculated with the most dominant taxa removed from each site. (BP) Belle Pass, (ST) South Timbalier, (GI) Grand Isle, (GC) Green Canyon, (WC71D) West Cameron 71D, (WC352) West Cameron 352

	GC 18	GI 94	ST 54	BP	WC 71D	WC 352
GC 18	1
GI 94	0.32 (0.29) ^a	1
ST 54	0.53 (0.35) ^a	0.15 (0.45)	1	.	.	.
BP	0.07 (0.15) ^a	0.07 (0.09)	0.02 (0.25)	1	.	.
WC 71D	0.52 (0.31) ^b	0.32 (0.29) ^b	0.17 (0.17) ^b	0.01 (0.06) ^b	1	.
WC 352	0.06 (0.13) ^d	0.16 (0.06) ^c	0.01 (0.12) ^c	0.03 (0.04) ^c	‡	1

^a indices computed with April-August samples only

^b indices calculated with July samples only

^c indices calculated with April, May and August samples only

^d index calculated with November, February, April, May and August samples only

‡ no seasonal overlap in sampling efforts between WC 352 and WC 71D

(0.53) were GC 18 (shelf slope) and ST 54 (inner shelf) followed by GC 18 and WC 71D (inner shelf/coastal) with a comparative value of 0.52. These relative similarities in taxonomic compositions changed when the single, dominant taxon from each site were removed from the analyses. In many cases, the similarity indices were more reasonable for adjacent sites: GI 94 (mid-shelf) and ST 54 (0.45); GI 94 and GC 18 (0.29); and ST 54 and Belle Pass jetty (0.25). In other instances, although similarities were dramatically reduced, the values were still relatively high for sites that were distant from each other or represented large depth differences: ST 54 and GC 18 (0.35); WC 71D and GC 18 (0.31); and WC 71D and GI 94 (0.29).

The diversity data, however, were much more similar along the transect of the three platforms and the jetty. There was no significant difference in the diversity of the net samples (passive plankton net or pushnet) between the sites (platforms or Belle Pass; $\alpha=0.05$; Figure 5.3). The light-trap samples at GC 18 had significantly lower mean Shannon-Weiner diversity index values, while GI 94 had significantly higher mean diversity values than the other locations (Tukey's Studentized Range test, $\alpha=0.05$; Figure 5.3). The diversity of light-trap collections at the two more coastal sites, ST 54 and Belle Pass, were intermediate and not significantly different from one another.

Environmental Variables and Larval Abundances

At GC 18, salinity and temperature were the most useful environmental parameters measured in describing trends in larval and juvenile fish abundances. For plankton net collections, densities of *Cynoscion arenarius*, *Scomberomorus maculatus*, and *Symphurus* spp. were negatively associated with the first environmental canonical variate, which was primarily influenced by salinity (Table 5.12). Densities of *Auxis* spp., *Caranx crysos*, *C. hippos/latus*, *Pristipomoides aquilonaris*, and

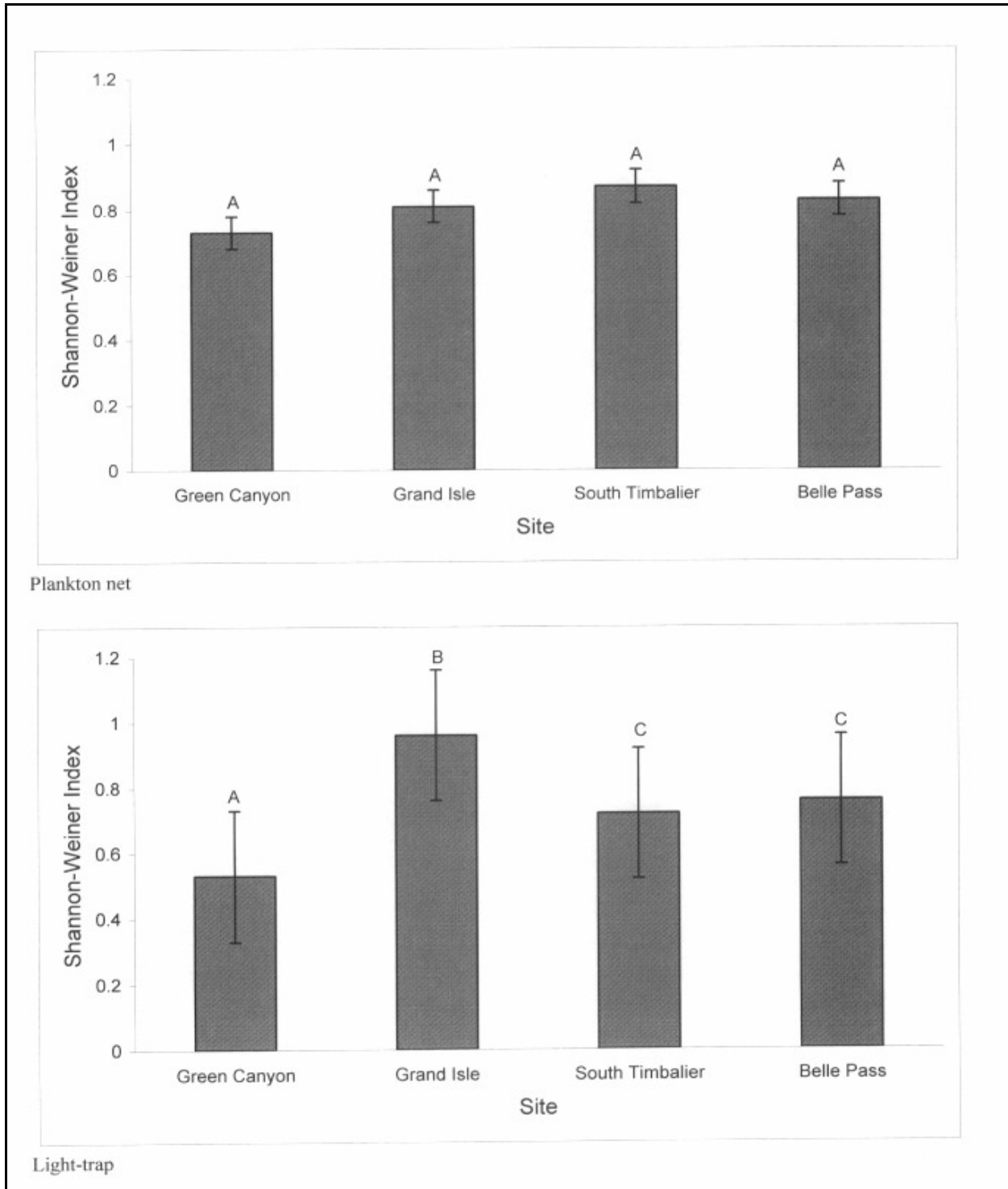

Figure 5.3. Mean Shannon-Weiner diversity indices (with standard error bars) for plankton net (GC 18, GI 94, and ST 54) or pushnet (Belle Pass) collections (upper panel) and light-trap collections (lower panel) from each sampling site. The same letter above each bar indicates no significant difference between the sites based on Tukey's Studentized Range ($\alpha=0.05$). Different letters indicate significant differences.

Table 5.12. Results of a canonical correlation analysis on log-transformed plankton net densities (15 most dominant taxa) and environmental variables for Green Canyon 18. Loadings in bold under statistically significant canonical variates V1 and V2 explain at least 15% of the variation (interset correlation of 0.387) for that taxon. Loadings in bold under the environmental canonical variates W1 and W2 indicate the most influential environmental variables.

Canonical Correlation	Likelihood Ratio	Approximate F	Pr > F
1 0.750369	0.26739839	2.8134	0.0001
2 0.502430	0.61197053	1.3766	0.0680
Taxa	Correlations between plankton net densities and their canonical variates		
	V1	V2	
<i>Ariomma</i> spp.	0.1426	-0.0114	
<i>Auxis</i> spp.	0.0857	0.5186	
<i>Bregmaceros cantori</i>	0.1748	-0.1150	
<i>Caranx crysos</i>	0.2340	0.6215	
<i>Caranx hippos/latus</i>	0.1016	0.6166	
<i>Citharichthys spilopterus</i>	0.1724	-0.4127	
<i>Cyclothone braueri</i>	0.1817	-0.1283	
<i>Cynoscion arenarius</i>	-0.7049	0.1691	
<i>Lepophidium</i> spp.	0.0850	0.0303	
<i>Mugil cephalus</i>	0.2068	-0.4356	
<i>Peprilus burti</i>	0.1115	-0.2048	
<i>Pristipomoides aquilonaris</i>	0.1901	0.4764	
<i>Sciaenops ocellatus</i>	0.0597	0.4175	
<i>Scomberomorus maculatus</i>	-0.7415	0.0507	
<i>Symphurus</i> spp.	-0.7149	-0.0638	
Environmental Variables	Correlations between environmental variables and their canonical variates		
	W1	W2	
Zooplankton Biomass	-0.3742	0.1562	
Suspended Solids	0.0640	-0.2760	
Salinity	0.9829	-0.1659	
Temperature	-0.5120	0.8549	

Sciaenops ocellatus were positively associated with the second environmental canonical variate, which was marginally significant ($p=0.068$) and primarily influenced by temperature. Densities of *Citharichthys spilopterus* and *Mugil cephalus* were negatively associated with the second environmental variate. For the dominant taxa collected with light-traps, six taxa, primarily benthic species such as *Saurida brasiliensis*, *Microdesmus longipinnis*, *Syacium* spp., and *Symphurus* spp., were positively associated with the first environmental variate, which was negatively correlated with salinity and positively correlated with macrozooplankton biomass (Table 5.13). Five taxa, comprised mostly of pelagic taxa (i.e., *Auxis* spp., *C. crysos*, *C. hippos/latus*, and *Eucinostomus* spp.) were positively associated with the second environmental variate, which was primarily explained by temperature.

At GI 94, temperature contributed substantially to our model in describing trends in larval and juvenile fish abundances. For plankton net collections, densities of *Euthynnus alletteratus* and *Symphurus* spp. were positively associated with the first environmental variate, which was positively correlated with temperature and negatively correlated with salinity, while *Synodus foetens* was inversely correlated with this variate (Table 5.14). The second environmental variate was explained primarily by salinity, and was positively associated with the scombrids *Auxis* spp. and *E. alletteratus*. For dominant taxa collected with light-traps, abundances of the blenny *Parablennius marmoratus* and the lizardfishes *S. foetens* and *S. poeyi* were positively associated with the first environmental variate, which was positively correlated with salinity and negatively correlated with temperature (Table 5.15). A third lizardfish species, *Saurida brasiliensis*, and *E. alletteratus* were negatively associated with the first environmental variate. *Synodus foetens* was also negatively associated with the second environmental variate, which was correlated with low macrozooplankton biomass. The third environmental canonical variate was only marginally significant ($p=0.067$) and was positively correlated with macrozooplankton biomass. Abundances of *Caranx crysos*, *Pomacentrus* spp., *S. foetens*, and *S. poeyi* were positively associated with this environmental variate.

At ST 54, the seasonal variables temperature and salinity were again the most correlated with the environmental canonical variates. For plankton net collections, densities of the pelagic species *Chloroscombrus chrysurus* and *Scomberomorus maculatus* were positively associated with the first environmental variate, which were marginally significant ($p=0.0552$) and positively influenced by salinity and temperature (Table 5.16). *Bregmaceros cantori* and *Etropus crossotus* were negatively associated with the first environmental variate. For light-trap collections, abundances of the carangids *Caranx crysos* and *C. chrysurus* were positively associated with the first environmental variate, which was positively correlated with temperature and salinity (Table 5.17). *Cynoscion arenarius* and *S. maculatus* were negatively associated with the first environmental variate. A second environmental canonical variate was marginally significant ($p=0.0708$) and was also influenced by salinity. Abundances of *Cynoscion arenarius* were positively associated with the second environmental variate and *Saurida brasiliensis* was negatively associated with the second environmental variate.

At Belle Pass, temperature and salinity, were still influential environmental variable, but turbidity and dissolved oxygen were also important in our models. For pushnet collections, three common coastal taxa (*Dormitator maculatus*, *Gobiesox strumosus*, and *Hypsoblennius hentz/ionthas*) were negatively associated with the first canonical variate, which was explained primarily by temperature (Table 5.18). A second environmental variate was positively correlated with dissolved oxygen and negatively correlated with turbidity. Abundances of *Citharichthys* spp., *Cynoscion arenarius*, *Cynoscion nebulosus*,

Table 5.13. Results of a canonical correlation analysis on log-transformed light-trap CPUEs (18 most dominant taxa) and environmental variables for Green Canyon 18. Loadings in bold under statistically significant canonical variates V1 and V2 explain at least 15% of the variation for that taxon. Loadings in bold under the environmental canonical variates W1 and W2 indicate the most influential environmental variables.

Canonical Correlation	Likelihood Ratio	Approximate F	Pr > F
1 0.566445	0.50304207	3.1136	0.0001
2 0.413382	0.74070398	1.8532	0.0004
Taxa	Correlations between light-trap CPUEs and their canonical variates		
	V1	V2	
<i>Auxis</i> spp.	-0.3640	0.5669	
<i>Bregmaceros cantori</i>	-0.0579	-0.0234	
<i>Caranx crysos</i>	-0.1666	0.6483	
<i>Caranx hippos/latus</i>	-0.1349	0.3970	
<i>Cyclothone braueri</i>	0.2205	0.1095	
<i>Cynoscion arenarius</i>	0.2667	0.1967	
<i>Eucinostomus</i> spp.	-0.1460	0.3976	
<i>Euthynnus alletteratus</i>	0.4647	0.3416	
<i>Gobiesox strumosus</i>	0.1569	0.0549	
<i>Holocentrus</i> spp.	-0.3507	0.4954	
<i>Microdesmus longipinnis</i>	0.3868	0.1855	
<i>Mugil cephalus</i>	-0.1229	-0.3138	
<i>Peprilus burti</i>	-0.1153	-0.0422	
<i>Pomacentrus</i> spp.	0.5047	0.2425	
<i>Saurida brasiliensis</i>	0.4637	0.2239	
<i>Syacium</i> spp.	0.4087	0.2510	
<i>Symphurus</i> spp.	0.5289	0.2751	
<i>Trachinocephalus myops</i>	-0.2060	0.2437	
Environmental Variables	Correlations between environmental variables and their canonical variates		
	W1	W2	
Zooplankton Biomass	0.5991	0.3731	
Suspended Solids	-0.1026	-0.2868	
Salinity	-0.8725	-0.4174	
Temperature	0.3657	0.9057	

Table 5.14. Results of a canonical correlation analysis on log-transformed plankton net densities (15 most dominant taxa) and environmental variables for Grand Isle 94. Loadings in bold under statistically significant canonical variates V1 and V2 explain at least 15% of the variation for that taxon. Loadings in bold under the environmental variates W1 and W2 indicate the most influential physical variables.

Canonical Correlation	Likelihood Ratio	Approximate F	Pr > F
1 0.588892	0.50402811	3.8641	0.0001
2 0.406611	0.77162236	2.0014	0.0002
Taxa	Correlations between plankton net densities and their canonical variates		
	V1	V2	
<i>Auxis</i> spp.	0.0642	0.5517	
<i>Bregmaceros cantori</i>	0.0074	0.0583	
<i>Caranx crysos</i>	0.3272	0.0475	
<i>Chloroscombrus chrysurus</i>	0.3167	-0.2754	
<i>Cynoscion arenarius</i>	0.2667	-0.1755	
<i>Etropus crossotus</i>	-0.1902	0.1164	
<i>Euthynnus alletteratus</i>	0.5109	0.5440	
<i>Microdesmus lanceolatus</i>	-0.1983	0.3366	
<i>Peprilus paru</i>	0.2351	0.0501	
<i>Saurida brasiliensis</i>	0.1278	0.0595	
<i>Sphraena guachancho</i>	0.3473	0.1880	
<i>Syacium</i> spp.	0.2955	-0.0865	
<i>Symphurus</i> spp.	0.7408	-0.1918	
<i>Synodus foetens</i>	-0.5515	-0.3527	
<i>Synodus poeyi</i>	-0.1838	0.0322	
Environmental Variables	Correlations between environmental variables and their canonical variates		
	W1	W2	
Zooplankton Biomass	0.0176	-0.3841	
Suspended Solids	-0.2643	0.0480	
Salinity	-0.7272	0.6783	
Temperature	0.9987	0.0063	

Table 5.15. Results of a canonical correlation analysis on log-transformed light-trap CPUEs (16 most dominant taxa) and environmental variables for Grand Isle 94. Loadings in bold under statistically significant canonical variates V1, V2, and V3 explain at least 15% of the variation for that taxon. Loadings in bold under environmental variates W1, W2, and W3 indicate the most influential environmental variables.

Canonical Correlation	Likelihood Ratio	Approximate F	Pr > F
1 0.727366	0.36024110	8.2854	0.0001
2 0.407126	0.76494371	2.8369	0.0001
3 0.250076	0.91692543	1.4435	0.0647
Taxa	Correlations between light-trap CPUEs and their canonical variates		
	V1	V2	V3
<i>Auxis</i> spp.	0.3411	0.3626	0.0228
<i>Bregmaceros cantori</i>	-0.1958	-0.0774	-0.0539
<i>Caranx crysos</i>	-0.2602	-0.0894	0.4223
<i>Caranx hippos/latus</i>	0.3000	-0.2098	-0.1797
<i>Chromis</i> spp.	0.1613	0.3585	0.2160
<i>Euthynnus alletteratus</i>	-0.4596	-0.0891	0.2976
<i>Hypsoblennius hentz/ionthas</i>	0.2219	0.2988	0.3527
<i>Hypsoblennius invemar</i>	0.2575	0.2320	0.2696
<i>Parablennius marmoreus</i>	0.7294	0.0392	0.1578
<i>Pomacentrus</i> spp.	-0.0228	0.3720	0.4550
<i>Rhomboplites aurorubens</i>	-0.1795	0.0404	0.1092
<i>Saurida brasiliensis</i>	-0.4268	-0.3509	0.0881
<i>Scartella/Hypleurochilus</i>	0.3028	0.2477	0.1846
<i>Symphurus</i> spp.	-0.2566	0.0372	0.1930
<i>Synodus foetens</i>	0.4688	-0.5865	0.4341
<i>Synodus poeyi</i>	0.4316	0.0227	0.5475
Environmental Variables	Correlations between environmental variables and their canonical variates		
	W1	W2	W3
Zooplankton Biomass	-0.2046	-0.5927	0.7534
Suspended Solids	0.2965	0.0269	0.1712
Salinity	0.8998	0.3507	0.2520
Temperature	-0.9412	0.3281	-0.0758

Table 5.16. Results of a canonical correlation analysis on log-transformed plankton net densities (15 most dominant taxa) and environmental variables for South Timbalier 54. Loadings in bold under the statistically significant canonical variate V1 explain at least 15% of the variation for that taxon. Loadings in bold under environmental variate W1 indicate the most influential environmental variables.

Canonical Correlation	Likelihood Ratio	Approximate F	Pr > F
1 0.695653	0.29159946	1.3663	0.0552
Taxa	Correlations between plankton net densities and their canonical variates		
	V1		
<i>Bregmaceros cantori</i>	-0.4343		
<i>Caranx hippos/latus</i>	0.0448		
<i>Chaetodipterus faber</i>	-0.2547		
<i>Chloroscombrus chrysurus</i>	0.7188		
<i>Cynoscion arenarius</i>	0.3017		
<i>Etropus crossotus</i>	-0.5026		
<i>Menticirrhus</i> spp.	-0.1820		
<i>Microdesmus lanceolatus</i>	0.2774		
<i>Ophidion nocomis/selenops</i>	-0.2217		
<i>Peprilus burti</i>	-0.1917		
<i>Peprilus paru</i>	0.3096		
<i>Scartella/Hypleurochilus</i>	-0.1934		
<i>Scomberomorus cavalla</i>	0.1881		
<i>Scomberomorus maculatus</i>	0.4750		
<i>Symphurus</i> spp.	-0.0072		
Environmental Variables	Correlations between environmental variables and their canonical variates		
	W1		
Zooplankton Biomass	0.1809		
Suspended Solids	0.4344		
Salinity	0.9623		
Temperature	0.7410		

Table 5.17. Results of a canonical correlation analysis on log-transformed light-trap CPUEs (16 most dominant taxa) and environmental variables for South Timbalier 54. Loadings under statistically significant canonical variates V1 and V2 explain at least 15% of the variation for that taxon. Loadings in bold under environmental canonical variates W1 and W2 indicate the most influential environmental variables.

Canonical Correlation	Likelihood Ratio	Approximate F	Pr > F
1 0.667016	0.38618143	2.6350	0.0001
2 0.472763	0.69571078	1.3486	0.0708
Taxa	Correlations between light-trap CPUEs and their canonical variates		
	V1	V2	
<i>Caranx crysos</i>	0.4844	0.1927	
<i>Chloroscombrus chrysurus</i>	0.3888	0.3043	
<i>Cynoscion arenarius</i>	-0.4716	0.4499	
<i>Etropus crossotus</i>	-0.1215	-0.2264	
<i>Euthynnus alletteratus</i>	0.1801	0.0141	
<i>Gobiesox strumosus</i>	-0.3192	0.3644	
<i>Hypsoblennius hentz/ionthas</i>	-0.2699	0.0054	
<i>Hypsoblennius invemar</i>	-0.1376	-0.2595	
<i>Peprilus burti</i>	-0.3591	0.1883	
<i>Saurida brasiliensis</i>	-0.1630	-0.4101	
<i>Scartella/Hypleurochilus</i>	-0.1226	-0.1717	
<i>Scomberomorus cavalla</i>	0.2114	-0.0868	
<i>Scomberomorus maculatus</i>	-0.4006	-0.1659	
<i>Sphoeroides parvus</i>	-0.0846	-0.1286	
<i>Synodus foetens</i>	-0.3693	-0.2336	
<i>Trachinocephalus myops</i>	-0.1217	-0.1479	
Environmental Variables	Correlations between environmental variables and their canonical variates		
	W1	W2	
Zooplankton Biomass	0.3169	0.1424	
Suspended Solids	0.2328	-0.2829	
Salinity	0.7209	0.6438	
Temperature	0.9880	-0.1033	

Table 5.18. Results of a canonical correlation analysis on log-transformed pushnet densities (15 most dominant taxa) and environmental variables for Belle Pass jetty. Loadings in bold under the statistically significant canonical variates V1, V2, and V3 explain at least 15% of the variation for that taxon. Loadings in bold under environmental variates W1, W2, and W3 indicate the most influential environmental variables.

Canonical Correlation	Likelihood Ratio	Approximate F	Pr > F
1 0.746141	0.12473748	3.3677	0.0001
2 0.709788	0.28140077	2.6115	0.0001
3 0.553340	0.56711076	1.5750	0.0201
Taxa	Correlations between pushnet densities and their canonical variates		
	V1	V2	V3
<i>Bairdiella chrysoura</i>	-0.1343	0.3102	-0.1418
<i>Citharichthys</i> spp.	-0.0063	0.6759	0.0738
<i>Cynoscion arenarius</i>	0.2336	0.7453	0.3118
<i>Cynoscion nebulosus</i>	0.1423	0.4605	0.1065
<i>Dormitator maculatus</i>	-0.6133	0.2318	-0.2055
<i>Gobiesox strumosus</i>	-0.7488	0.2128	-0.1829
<i>Gobionellus oceanicus</i>	0.2488	0.2903	0.0099
<i>Gobiosoma bosc</i>	-0.3128	0.5788	0.0476
<i>Gobiosoma</i> spp.	-0.2878	-0.1962	-0.4318
<i>Hypsoblennius hentz/ionthas</i>	-0.3878	-0.1485	0.0130
<i>Membras martinica</i>	-0.2631	-0.3167	0.7042
<i>Microgobius</i> spp.	0.2499	-0.3423	-0.2313
<i>Sciaenops ocellatus</i>	0.2969	0.3477	0.2035
<i>Symphurus</i> spp.	-0.1966	0.2238	0.2620
<i>Synodus foetens</i>	-0.1768	0.3649	-0.2772
Environmental Variables	Correlations between environmental variables and their canonical variates		
	W1	W2	W3
Temperature	0.9097	0.1977	-0.1327
Salinity	0.0587	-0.0616	0.9812
Dissolved Oxygen	-0.0430	0.8447	-0.5265
Turbidity	0.3061	-0.5865	-0.4929

Table 5.19. Results of a canonical correlation analysis on log-transformed light-trap CPUEs (15 most dominant taxa) and environmental variables for Belle Pass jetty. Loadings in bold under the statistically significant variate V1 explain at least 15% of the variation for that taxon. Loadings in bold under environmental canonical variate W1 indicate the most influential physical variables.

Canonical Correlation	Likelihood Ratio	Approximate F	Pr > F
1 0.679900	0.33598275	1.56599	0.0032
Taxa	Correlations between light-trap CPUEs and their canonical variates		
	V1		
<i>Bairdiella chrysoura</i>	0.2172		
<i>Chloroscombrus chrysurus</i>	0.1320		
<i>Citharichthys</i> spp.	-0.1391		
<i>Cynoscion arenarius</i>	-0.2046		
<i>Dormitator maculatus</i>	-0.1928		
<i>Gobiesox strumosus</i>	-0.8280		
<i>Gobionellus oceanicus</i>	0.1573		
<i>Gobiosoma bosc</i>	-0.1403		
<i>Gobiosoma</i> spp.	-0.1859		
<i>Hypsoblennius hentz/ionthas</i>	-0.6848		
<i>Membras martinica</i>	0.2208		
<i>Microdesmus longipinnis</i>	0.0841		
<i>Sphoeroides parvus</i>	-0.6076		
<i>Symphurus</i> spp.	0.0819		
<i>Synodus foetens</i>	-0.0705		
Environmental Variables	Correlations between environmental variables and their canonical variates		
	W1		
Temperature	0.7618		
Salinity	0.1838		
Dissolved Oxygen	-0.2384		
Turbidity	0.4234		

and *Gobiosoma bosc* were positively associated with the second canonical variate. Abundances of *Gobiosoma* spp. were negatively associated with the third environmental variate, which was positively correlated with salinity, while *Membras martinica* was positively associated with this variate. For light-trap collections, three taxa (i. e., *G. strumosus*, *H. hentz/ionthas*, and *Sphoeroides parvus*) were negatively associated with the first canonical variate, which was positively correlated with temperature, and to a lesser extent, turbidity (Table 5.19).

DISCUSSION

Overall, reef-dependent taxa (e.g., chaetodontids, pomacentrids, labrids, and scarids) were relatively rare (Table 5.10). Pomacentrids and chaetodontids were collected only at the shelf slope and mid-shelf sites, while labrids and scarids were also collected at the inshore sites. Our total of 67 families collected at oil and gas platforms throughout the course of this study is comparable with previously published surveys from the GOM (61 families, Ditty *et al.* 1988; 74 families, Richards *et al.* 1984), but is generally less than surveys that included more tropical waters (85 families, McGowan 1985; 91 families, Limouzy-Paris *et al.* 1994; 96 families, Richards 1984; 100 families, Richards *et al.* 1993). While reef-dependent fish were uncommon, reef-associated fish (e.g., carangids, scombrids, blenniids) were much more common and many times represented a significant component of the community assemblage at each site.

Ichthyoplankton Community Assemblage at GC 18

The ichthyoplankton community at GC 18 (230 m depth on the shelf slope, Gallaway's outer shelf of > 60 m) was dominated by coastal pelagic species, particularly engraulids and clupeids which accounted for 33% and 25% of the total catch by both gear types, respectively (Table 5.6). *Opisthonema oglinum* was the dominant species in the mid-to-late summer months, while unidentified engraulids peaked in November. *Engraulis eurystole* was also relatively common throughout the summer and early fall. Another pelagic species, *Mugil cephalus*, was relatively common in the fall-winter months and peaked in November. Larvae of *M. cephalus* are most commonly found over the outer to mid-shelf (Ditty and Shaw 1996), so their presence at our outer shelf sampling station is not surprising. Though the adults are common on the continental shelf and coastally (Hoese and Moore 1977), *M. cephalus* was not collected at the mid- or inner-shelf platforms. This is primarily a result of our shortened sampling efforts (April-August or September) at the other platforms, which did not encompass their spawning season (October through March; Leard *et al.* 1995), so its relative larval abundance at these platforms is unknown. The carangids *Caranx crysos* and *C. hippos/latus* were relatively common, and though they are usually considered pelagic species, they are often associated with platform structures (Table 5.4).

Some of the more abundant demersal taxa included the flatfish *Citharichthys spilopterus*, *Symphurus* spp., and *Syacium* spp., as well as the sciaenid *Sciaenops ocellatus* and bregmacerotid *Bregmaceros cantori*. While not unique to this site, the mesopelagic species, *Cyclothone braueri*, was common in subsurface net collections, and myctophids were present in subsurface light-trap collections. Though not abundant, other outer shelf species of note include *Diplophos taenia*, *Chlorophthalmus agassizi*, *Scopelarchoides* spp., *Paralepis atlantica*, and *Lestrolepis intermedia*. While the adults

are seldom observed, the planktonic nature of the early life history stages of these mesopelagic taxa made them a significant component of the outer shelf ichthyoplankton assemblage at GC 18.

The most dominant reef-associated fishes at GC 18 were unidentified gobiids. Second in abundance were serranids, most of which were from the poorly known subfamily Anthiinae. Anthiine adults are residents of rocky reefs on the outer shelf and are not usually found on shallow, inshore reefs (Thresher 1984). Other serranids included *Epinephelus* spp. and *Mycteroperca* spp. Lutjanids were also fairly common among the reef fish taxa, primarily *Pristipomoides aquilonaris*, one of the most common residents of mid- and outer-shelf reefs (Hoese and Moore 1977). Other noteworthy taxa included unidentified blennies, *Holocentrus* spp., (reef-associated) and *Pomacentrus* spp. (reef-dependent).

The relatively low abundance of reef fish larvae and juveniles compared to pelagic species at our outer platform site is in contrast to the adult community described by Gallaway (1981). However, the studies cited in Gallaway's (1981) synthesis were primarily visual surveys interested in adult fishes associated with the natural and artificial structures, and not necessarily taxa in the surrounding water column. Pelagic species, therefore, may have been underestimated in those previous studies. Also, reef fish communities are limited, in part, by the supply of pelagic larvae, usually from upstream sources rather than the resident populations (Sponaugle and Cowen 1996; Victor 1986). Reefs and platforms located on the shelf slope would theoretically have significantly fewer upstream sources of potential recruits than those on the mid-shelf, where other natural hard-bottom or reef habitats may be more abundant, or where the density of platforms is orders of magnitude greater. Therefore, the extremely remote location of GC 18 (shelf slope) is probably the limiting factor with regards to the pool of available larvae to be sampled.

Ichthyoplankton Community Assemblage at GI 94

At GI 94 (60 m depth, Gallaway's mid-shelf of 20-60 m), pelagic species dominated the catches as well, but there appeared to be a taxonomic shift in dominance. Clupeiforms again dominated the collections, but engraulids became more prominent in abundance (57%) than clupeids (9%). Unidentified engraulids were the most abundant pelagic taxa in the plankton nets, and *Engraulis eurystole* were very common in light-trap collections (Table 5.7). *Opisthonema oglinum*, which was the most dominant clupeid at GC 18, ranked third in overall abundance. *Caranx crysos* and *C. hippos/latus* were not as dominant at this site as they were at GC 18, but as a family, the carangids had more species richness at GI 94. *Oligoplites saurus*, *Seriola dumerili/rivoliana*, *S. fasciata*, *Trachinotus carolinus*, and *T. falcatus/goodei* were all present at GI 94, but absent at GC 18. Similarly, *Rachycentron canadum*, although not very common, were also collected at GI 94 and not at GC 18. As with the carangids, *R. canadum* is also considered to be a reef-associated species.

Second in abundance to the pelagic forms at GI 94 were demersal taxa, particularly synodontids which comprised 14.7% of the total catch and were approximately equal to the total catch of all perciform fishes combined (15.1%). Unidentified synodontids, *Saurida brasiliensis*, *Synodus foetens*, and *Synodus poeyi* were very common in the late spring and summer months. Like the carangids, this group was more species rich at GI 94, with seven taxa identified to species as compared to three at GC 18. Other common demersal taxa included *Symphurus* spp., *Syacium* spp.,

and *Bregmaceros cantori*. Mesopelagic species were not as speciose and abundant as those at GC 18, but some were collected, including *Cyclothone braueri*, *Vinciguerria nimbaria*, and *Lestrolepis intermedia*.

Overall, there was greater taxonomic richness among reef fish at GI 94 than GC 18. By far the most dominant reef-associated fish taxa at GI 94 were blenniids, particularly *Parablennius marmoreus* and *Hypsoblennius invemar*. These fishes are perhaps one of the most common taxa affiliated with oil and gas platforms, but are probably underestimated in visual surveys due to their small size, cryptic coloration, and tendency to hide in attached barnacle shells. Some blenniids have been found to be rather unusual compared to other common reef-associated taxa in that they have demersal eggs and pelagic, yet fairly competent larvae that appear to be able to feed immediately and are attracted to light (Thresher 1984). If the same early life history attributes are true for the blennies collected at our platform sites, then these traits may combine to form a mechanism by which these taxa are retained and concentrated around platform structures. Other reef taxa that hatch from demersal eggs and have demonstrated photopositive behavior include gobies and pomacentrids, although these larvae are not as competent upon hatching (Thresher 1984). At GI 94, unidentified gobiids and pomacentrids, primarily *Chromis* spp. and *Pomacentrus* spp., ranked next in abundance. Unique to this site was the collection of opisthognathids in surface waters (plankton nets as well as surface and off-platform light-traps) during the spring-early summer. Adult *Opisthognathus aurifrons* are reported to be tropical (south Florida, Bahamas, northern South America) and rarely collected on the mid-to-outer shelf (Hoese and Moore 1977; Robins *et al.* 1986). Adult *O. lonchurus* are also reported to inhabit the northeast GOM as well as tropical waters (Robins *et al.* 1986). The presence of these larvae reinforces the notion that oil and gas platforms may play a role in extending the ranges of more tropical forms that would otherwise be habitat limited in the northcentral GOM.

Other taxonomic differences in reef-associated fish composition were observed between GI 94 (mid-shelf) and GC 18 (outer shelf). At GI 94, lutjanids were also relatively common, with *Rhomboplites aurorubens* the dominant species, followed by *Lutjanus* spp. While *Pristipomoides aquilonaris* was the primary lutjanid at GC 18, none were collected at this mid-shelf site. With regards to serranids, the dominant group was serraniines (e.g., *Diplectrum* spp., *Centropristis* spp., and *Serranus* spp.), while relatively few anthiines were collected. Also noteworthy was the relatively high abundance of mullids collected at GI 94 (only one individual was collected at GC 18), particularly *Upeneus parvus*, a common species on the mid-to-inner shelf (Hoese and Moore 1977).

Ichthyoplankton Community Assemblage at ST 54

At ST 54, clupeiform fishes (mostly clupeids) overwhelmed the plankton net and light-trap collections, and comprised 97% of the total catch (all gears combined). The dominant clupeid was *Opisthonema oglinum*, which alone comprised 94% of the total catch (Table 5.8). *Harengula jaguana*, though present at GI 94, were more prominent at ST 54. This trend of increasing dominance of clupeiform fishes continued as our sampling efforts moved inshore. In general, it is difficult to discuss the abundances of the other taxa except in very relative terms, since no families of fishes (with the exception of clupeids and engraulids) comprised over 1% of the total catch. Among pelagic fishes, the reef-associated carangids and scombrids were relatively abundant, particularly *Caranx hippos/latus*, *Euthynnus alletteratus*, and *Scomberomorus maculatus*.

Similar to GI 94, the second most abundant group of fishes at ST 54 was composed of demersal species. However, unlike GI 94 where synodontids dominated, sciaenids were the most dominant family, primarily *Cynoscion arenarius*, which was collected throughout the sampling season. Not only did the number of sciaenids increase, but the number of their taxa increased as well, from three at GI 94 to five at ST 54. *Cynoscion arenarius* dominated the plankton net catches, but synodontids, primarily *Synodus foetens*, dominated the light-trap collections. Synodontids were not as prominent at ST 54 as they were at GI 94, and the number of taxa decreased from 7 to 4. Other demersal taxa collected included unidentified myctophiforms, *Trichiurus lepturus*, *Symphurus* spp., and *Etropus crossotus*.

The most abundant reef/structure-associated fishes were blenniids and gobiids. Unlike GI 94, *Parablennius marmoratus* was relatively uncommon. The dominant species at ST 54 were *Scartella/Hypleurochilus* spp., *Hypsoblennius hertz/ionthas*, and *H. invemar*. Difficulties in identification prevent us from confidently separating *H. hertz* from *H. ionthas* and *Scartella* spp. from *Hypleurochilus* spp., but all of these taxa are common in nearshore areas and hard-bottomed habitats, such as oyster reefs and pilings (Hoese and Moore 1977). In general, at ST 54, reef fish, although not abundant, were relatively well represented in terms of number of taxa, rivaling that of GI 94. However, other than blenniids and gobiids, abundances of other reef fish were very low (less than a total of 10 individuals collected per taxa) but included *Rhomboplites aurorubens* and unidentified pomacentrids, serranids, and ephippids.

The low reef fish abundances are not surprising, particularly for the more tropical taxa such as haemulids, labrids, and scarids. The adults of these taxa are more typical of the outer shelf assemblages (Table 5.4). Similarly with regards to reef fish larvae and juveniles, this trend of decreasing taxonomic richness towards the more inshore environments is supported somewhat by our study, particularly with regards to scarids (Tables 5.6–5.8). Even though an inner shelf platform would be downstream from potentially more offshore sources of larvae and recruits, perhaps the relatively greater distances involved necessitating extended pelagic larval durations and the potentially less favorable inshore environmental conditions result in increased mortality (Leis 1991).

Ichthyoplankton Community Assemblage at the Belle Pass Jetties

The jetty at Belle Pass, though different in its structural complexity, vertical height, and hydrodynamics shared at least one similarity with the platforms in that it was also dominated by clupeiform fishes (74% of total catch). The taxonomic composition of this group was different, however, in that engraulids, particularly *Anchoa mitchilli*, dominated catches (Table 5.9). The trend of increasing numbers of *Harengula jaguana* and *Brevoortia patronus* as the sampling sites moved progressively inshore continued as well. Another difference was the relatively high abundance of a different pelagic group, the atherinids, particularly *Membras martinica*, a common coastal pelagic species.

By far the most dominant demersal species was *Cynoscion arenarius*, and in general, the number of sciaenid taxa increased from the platform sites. *Bairdiella chrysoura* was also relatively common. *Micropogonias undulatus*, *Sciaenops ocellatus*, *Pogonias chromis*, and *C. nebulosus* were all

collected as well, none of which were collected at ST 54 and GI 94, although some *M. undulatus* and *S. ocellatus* were collected at GC 18. The jetty site also commonly had the predominantly estuarine species, *Gobiesox stromosus*. The ophichthid eels were most abundant at Belle Pass where they were also the most speciose taxonomic group, with *Myrophis punctatus* being the dominant species. The flatfish *Citharichthys* spp. and *Symphurus* spp. were also very common.

The reef/structure-associated fish group was dominated by small, estuarine/coastal species, primarily *Gobiosoma bosc*, which comprised 75% of the gobiids collected. This species is very common in coastal areas of the northern GOM, and the adults are typically found in association with weeds and oyster beds in protected bays and estuaries (Hoese and Moore 1977; Robins *et al.* 1986). The second most abundant gobiid was *Gobionellus oceanicus* (formerly *Gobionellus hastatus*) which comprised 14% of the total catch. Adults of this species are common in estuaries but are also found in deeper waters (22-40 m) on the shelf (Hoese and Moore 1977). Other common gobiid taxa were *Microgobius* spp. and *Gobiosoma* spp. Based on the dominance of estuarine species collected at Belle Pass within this family, it is likely that the individuals in these two genera are also estuarine forms, even though these genera contain tropical forms as well. Taxa from a related group, the eleotrids, were also relatively common in our jetty samples. Blenniids were also a very common group, particularly *Hypsoblennius hentz/ionthas* and *Scartella* spp. Other reef or structure-associated fish taxa collected at Belle Pass include labrids, ehippids, scarids, and sparids.

Lutjanus griseus and *L. synagris* juveniles, though not abundant, were also collected at Belle Pass. *Lutjanus griseus* juveniles are more common along the western GOM and Florida coasts where they are collected in their preferred habitat, relatively high salinity seagrass beds (Pattillo *et al.* 1997). However, they have been reported (although less frequently) in association with other structures, such as pilings, jetties and rocks (Starck 1971). Young *L. synagris* are also present in coastal areas (Hoese and Moore 1977). The presence of these species at the jetty is noteworthy because it indicates that coastal, artificial structures even in relatively low salinity environments may play a role as nursery areas in absence of other structurally-complex habitats, such as grassbeds in more high-salinity, oligotrophic estuaries. Many species of reef fish do not settle directly onto reefs but utilize other coastal habitats as nursery grounds prior to moving to offshore reefs. While habitats such as high-salinity seagrass beds are important to many reef related species (Connolly 1994), other structurally-complex habitats have been identified as nurseries (Ferrell and Bell 1991; Bennett 1989; Ross and Moser 1995). Seagrass beds are often the most common form of shelter available in certain settlement areas, but experimental evidence suggests that presettlement larvae of a number of different species select any structurally-complex habitat at the time of settlement (Bell *et al.* 1987). Due to the overwhelming influence of the Mississippi River and its distributaries, Louisiana estuarine and coastal areas are generally low salinity (18-25 ppt at Belle Pass during the course of this study), turbid, and lacking in seagrass beds and naturally-occurring hard substrate habitats (except for oyster reefs). Therefore, the role of the artificial habitats such as jetties and breakwaters may be more important as islands of refuge for individuals that would otherwise be lost to unsuitable habitat and, therefore, mortality.

Taxonomic Similarity Between Sites

In an effort to examine the relative similarity in taxonomic assemblages between the different sites (including the pilot study sites WC 71D and WC 352) we computed Schoener's Index of Niche Overlap for each site. Since all sites sampled during this study were heavily dominated by a single taxon, for the sake of this discussion we will compare only the similarity values calculated after the dominant taxa were removed. In general, the index values indicate that the sites were not very similar, with the highest similarity value between any two sites being 0.45 for GI 94 and ST 54 (mid- and inner shelf). This is not unexpected, since we purposely chose sampling sites in different depth zones across the shelf where there should be some faunal transitions (Gallaway *et al.* 1980; Gallaway 1981), and indeed there were in many instances. The Belle Pass jetty, which was heavily influenced by the presence of estuarine and coastal pelagic taxa, was very different from the mid-shelf (GI 94) and outer shelf (GC 18) platforms, where mesopelagic and tropical taxa were influential. Similarity indices for GI 94 displayed the expected cross-shelf transitional pattern, with the highest similarity values being for the adjacent sites, ST 54 and GC 18, followed by Belle Pass. The highest similarity index for GC 18, however, was with ST 54, the inner-shelf platform, whereas we might have expected GC 18 to most similar to GI 94. This somewhat unexpected result is probably due to the large number of reef taxa collected at GI 94 that were unique to that site (Table 5.7). Reef fish taxa such as *Chromis* spp., *Abudefduf taurus*, *Mullus auratus*, *Ophioblennius atlantica*, *Pseudopenaeus maculatus*, *Opisthognathus aurifrons*, and *Opisthognathus lonchurus* were collected only at the GI 94 platform. Other taxa (ehippids and scarids) were collected at GC 18 and ST 54, but not at GI 94.

The more westerly pilot study sampling sites (Figure 5.2) were also included in these analyses and yielded interesting results. WC 352 (20 m depth) was the least similar to any of the other sites with values ranging from 0.04-0.13 (April, May, and August samples only; Table 5.11). Within Gallaway's three depth zones, we would have expected this site to be relatively similar to ST 54 (approximately 20 m) in taxonomic composition. Between these two sites, 25 taxa were collected only at WC 352, including relatively large numbers of *Archosargus probatocephalus*, *Cypselurus cyanopterus*, *Microdesmus longipinnis*, and *Kyphosis* spp., whereas 41 taxa were collected only at ST54, including large numbers of *Cynoscion arenarius*, *Scomberomorus maculatus*, *Harengula jaguana*, and *Peprilus burti*. While all of these fishes are common inner shelf taxa, it would appear that the WC 352 site was influenced much more by its proximity to the Flower Gardens and the influence of the Mexican-Texas Current, which flows from Mexican waters northward along the Texas coast and seasonally progresses up along the western coast of Louisiana (Cochrane and Kelly 1986) and may be an additional source of reef or hard-substrate oriented fishes. Differences in local current and temperature regimes, as well as the timing of spawning events between different populations of the same species along the coast may have also resulted in the observed differences.

Interestingly, WC 71D (12 m) was most similar (0.31) to GC 18 (shelf slope) and least similar to ST 54 and Belle Pass (0.17 and 0.06, respectively; Table 5.11). This comparison, however, is confounded by July being the only month used for comparisons and by multiple light-trap designs being deployed at WC 71D. The dominant taxa at WC 71D were *Opisthonema oglinum* and *Anchoa* spp. (41% and 12% of total catch, respectively). These taxa were also dominant at GC 18 during July, where *O. oglinum* and *Anchoa* spp. comprised 34% and 19% of the total catch for July,

respectively, resulting in a relatively high similarity index (0.52) between the two sites initially. However, this value decreased considerably once *O. oglinum* was removed from the analysis (0.31). The dominance by *Anchoa mitchilli* at Belle Pass (91% of total catch for July) and by other coastal taxa (*Euthynnus alletteratus*, *Parexocoetus brachypterus*, and *Mentichirrus* spp.) at ST 54 (55% of total catch for July) resulted in very small similarity indices between these sites and WC 71D. Differences between the WC stations (352 and 71D) and Belle Pass and ST 54 indicate that taxonomic assemblages may differ longitudinally along the coast as well as with depth, and point out the need for replicate platform sampling within each depth zone from different geographic areas. Ongoing efforts east of the Mississippi Delta may help resolve these issues and give us a more complete picture of ichthyoplankton assemblages associated with artificial structures across the northcentral GOM.

While using a similarity index to characterize assemblages helps to synthesize large amounts of information, the analyses are confounded by several problems that can make the results difficult to interpret. First, the index is highly influenced by large numbers of individuals of a single taxon and confidence intervals can be quite large (Ricklefs and Lau 1980). This is why we chose to discuss the values from the analyses without the most dominant taxa from each site, which helped to identify trends that may have otherwise been overwhelmed in the complete data set. Secondly, in any comparison between two sites, we chose only to use samples from each data set where the seasonality overlapped in sampling efforts so that the same species pool would theoretically be available for collection. However, at times this led to large disparities in sampling effort between sites within a comparison. For example, only April, May, and August, samples were used to compare WC 352 (n=57, once monthly sampling) and GI 94 (n=331, twice monthly sampling plus the extra May lunar mini-study samples). Finally, taxa utilized in the analyses were limited by our ability to identify the many larval and juvenile forms collected over the course of the study. Since we were trying to analyze the taxonomic assemblage at the lowest level possible, we were forced to eliminate large numbers of fish that could not be identified to genus. Overall, however, we feel the index provides a good idea of the similarity in community assemblages between sites, but it should only be discussed in relative terms.

Taxonomic Diversity Between Sites

The mean diversity indices for the plankton net collections taken at the platform sites and the pushnet collections taken at Belle Pass were not significantly different from each other, ranging from 0.73-0.83 (Figure 5.3). They were, however, slightly higher than those for the light-trap collections, with the exception of GI 94. In general, observed statistical differences in Shannon-Weiner diversity indices between sites were limited to light-trap collections. The similarity between the light-trap diversity indices for ST 54 and Belle Pass is not surprising, since both sites were dominated by large numbers of photopositive clupeiform fishes, which also lowered their diversity indices. Light-trap collections were significantly more diverse at GI 94, a result of being less dominated by clupeiform fishes than ST 54 and Belle Pass, and of collecting more taxa, particularly reef fish species, than GC 18. In general, taxonomic richness in light-traps was highest at GI 94, with 90 taxa identified to genus as compared to 65 taxa at ST 54, the platform with the second highest number of taxa. Inshore (particularly estuarine) areas are generally characterized as having lower diversity than adjacent shelf waters and are dominated by a few highly abundant taxa

(Nybakken 1988). This pattern is generally attributed to the fluctuating nature of the nearshore environment, particularly with regards to salinity and temperature, and the lack of physiological specializations needed to deal with this estuarine environmental variability (Nybakken 1988). This, in part, may explain the relatively low diversity indices for ST 54 and Belle Pass, the two inshore sites. In contrast, species richness and abundance is generally relatively low on the outer shelf, due to the homogeneity of the bottom substrate (Bond 1996). As previously discussed, topographical relief is disjunct throughout the northcentral GOM (especially west of the Delta) and the sea floor is basically dominated by expanses of mud and silt. Again, this homogeneity and the previously discussed lack of a large amount of upstream supply of larvae may in part explain the low taxonomic diversity observed in the light-trap collections at GC 18.

Several studies have investigated differences in taxonomic richness between different gear types, although few, if any, actually calculated taxonomic diversity indices as a comparison. Choat *et al.* (1993) collected individuals from more families with a bongo net (63 families), a lighted-seine net (37 families), neuston net (31 families), Tucker trawl (29 families), and a purse seine (25 families) than they did with a light-trap (20 families) in a gear comparison study off Lizard Island, northern Great Barrier Reef, Australia. In the Gulf of California, more reef fish larvae and juveniles from different families were collected with a diver-steered plankton net (43 families) than with a light-trap (31 families; Brogan 1994). In Onslow Bay, North Carolina, more fish larvae and juveniles from different families were collected with a neuston net (24 families) than with either of the two light-trap designs employed (18 and 21 families; Hernandez and Lindquist 1999) in a study. In each of these studies, the authors concluded that the taxonomic assemblage collected in their respective studies was very method-dependent, and the same appears to be true in our study (Hernandez and Shaw this volume).

Environmental Variables and Larval Abundances

Canonical correlation analyses were used to determine the relationship between the dominant taxa collected at our sampling sites and measured environmental/biological parameters, i.e., temperature, salinity, turbidity, dissolved oxygen, and macrozooplankton biomass. At all of our sampling sites, temperature and salinity appeared to explain most of the variation in larval abundances in our models for the dominant taxa. This is not surprising as these physical variables change seasonally, and to some extent across the shelf, as does the availability of larval assemblages. Occasionally, both temperature and salinity were important factors within a single environmental canonical variate, which is probably a reflection of seasonality, i.e., in the northern GOM as temperatures increase during the late spring and into the months of summer and early fall, salinities tend to increase as well, due to decreased Mississippi/Atchafalaya River runoff and increased evaporation.

Many of these relationships (based primarily on the seasonal variables temperature and salinity) were consistent with known information on the seasonal occurrences of the different species. For example at GC 18, where we were able to sample nearly year-round, *Mugil cephalus* was found to be negatively associated with temperature in plankton net samples, which is consistent with their peak periods of abundance (December-February) in the northern GOM (Table 5.12; Ditty *et al.* 1988). Other species collected in plankton nets at GC 18 were positively associated with temperature and represent taxa with peak larval abundances in the spring and summer months, such as *Auxis* spp.

(May-September), *Caranx crysos* (June-August), and *C. hippos/latus* (April-August; Ditty *et al.* 1988). Relationships between seasonal variables (temperature and salinity) and larval peaks in abundance were observed at all sites. For example, positive relationships between abundances and temperature and salinity were found for species with summer peaks in larval abundance, such as *Auxis* spp. (May-September) at GI94 (Table 5.14) and *Chloroscombrus chrysurus* (June-September) and *Scomberomorus maculatus* (August-September) at ST 54 (Table 5.16). Negative relationships for species with spring or winter peaks were found as well, such as previously mentioned *Mugil cephalus* at GC 18 (Table 5.12) and *Gobiesox strumosus* (March-May) at Belle Pass (Table 5.18).

While seasonality seems to be an important factor, trends in larval abundances could also reflect the environmental optima and preferences of some species. *Membras martinica*, for example, is found primarily in more saline areas along the coast, as well as offshore areas (Hoese and Moore 1977). At Belle Pass, pushnet densities for this species were positively associated with salinity (Table 5.18). Larval and juvenile *Caranx crysos* prefer warmer, more saline waters (Patillo *et al.* 1997), and this species was often positively associated with temperature and salinity in our study (Tables 5.12–5.13 and 5.17).

Differences among relationships at the same site between plankton net and light-trap collections may be a reflection of biases towards different life history stages, since the plankton nets collected primarily younger, less competent larvae while light-traps collected larger larvae and juveniles. At ST 54, for example, net collections of *Scomberomorus maculatus* were positively associated with temperature and salinity (Table 5.16), while light-trap collections were negatively associated with these variables (Table 5.17). These associations are consistent with the known early life history preferences for this species, as larval *S. maculatus* require relatively higher temperatures and salinities than juveniles, which are generally more eurythermal and euryhaline (Patillo *et al.* 1997).

Dissolved oxygen and turbidity were also important variables at Belle Pass for some species, but little is known about these requirements or preferences for the early life history stages of many fishes. Some species which were very photopositive (i.e., *Gobiesox strumosus* and *Hypsoblennius hentz/ionthas*) were also negatively associated with turbidity in our light-trap samples, possibly because of decreased light-trap efficiency in highly turbid waters. Macrozooplankton biomass was influential at GC 18 (Table 5.13) and GI94 (Table 5.15), but only in light-trap collections. This result is not surprising as light-traps tended to collect larger, more competent postlarvae and juveniles which would be more likely to be affected by this macrozooplankton prey availability than smaller, less competent larvae. All significant taxa were positively associated with zooplankton biomass, and included larval forms such as *Euthynnus alletteratus*, *Saurida brasiliensis*, and *Synodus foetens*, which have well-developed mouths and teeth at small sizes and are able to feed on zooplankton.

While canonical correlation analyses were useful in characterizing the environmental correlates for some species, results for others were confounding. At ST 54, for example, *Cynoscion arenarius* was negatively associated with the first environmental variate and positively associated with the second environmental variate, both of which were positively correlated with salinity. In many instances, our models did not explain a large amount of the variation (15%) for many species. One possible reason

for some of these discrepancies is that spawning seasons and periods of larval abundances for many species occurred throughout our entire sampling season for many species, particularly at GI 94, ST 54, and Belle Pass, where we sampled only from April-September. This is the case for species such as *Citharichthys* spp., *Citharichthys spilopterus*, *Cynoscion nebulosus* and others (Ditty *et al.* 1988). For other species, particularly small fishes with little economic value such as many of the lizardfishes (*Synodus foetens*, *S. poeyi*, *Saurida brasiliensis*) and blennies (*Hypsoblennius hertz/ionthas*, *H. invemar*, and *Scartella/Hypleurochilus*), little information is available on peak occurrences of these taxa across the shelf. In this respect, our study provides an important contribution to the life history information on these taxa across the shelf.

CONCLUSIONS

In many respects, the community assemblages represented in our across-shelf sampling efforts are similar to the adult communities summarized in Gallaway *et al.* (1980) and Gallaway (1981). For example, while we did not collect individuals from as many reef-dependent families (i.e., no pomacanthids or acanthurids; Table 5.4), the reef-dependent taxa that were collected were primarily associated with platforms further offshore (pomacentrids and chaetodontids). Also, inner-shelf, reef-associated taxa reported for the adult assemblages, such as carangids and ephippids were present at our inner-shelf platform, as well as our other sampling sites. However, several taxa reported from the adult communities as being common primarily further offshore (mid-shelf and shelf slope), such as serranids, lutjanids, labrids, scarids, and blennies were collected at our inshore sites, ST 54 and/or the Belle Pass jetties. These results are not surprising, since many reef-associated taxa utilize estuarine and nearshore environments as nursery areas. In the case of the blenniids, several of the taxa collected in our study are common in estuarine and coastal environments and probably do not reflect the presence of more reef-like, tropical taxa.

This study represents the first comprehensive look at the ichthyoplankton assemblages associated with oil and gas platforms in the northern GOM and is also a first (yet preliminary) attempt at comparing such assemblages across different depth zones and geographical regions. It is apparent that a diverse recently spawned larvae, postlarval, and juvenile fish community can be captured in the waters within and near platforms (Hernandez and Shaw this volume) and these structures may therefore be important to reef-associated and -dependent fish. Though many taxa were represented in our collections, it is difficult to discern the reasons why some fish were present at the artificial structures. Some, like the clupeiforms, are extremely abundant, very photopositive, and may be behaviorally attracted to such structures with a large, consistent light-field. Other taxa like blennies are reef/structure-dependent, and may be attracted to the numerous habitats created by the biofouling community (e.g., barnacles) on the platform legs and cross-members, as well as the associated zooplankton food resources. Pelagic species, like carangids and scombrids, have more generalized habitat requirements, but may also be attracted to the structure (reef-associated) or to concentrations of zooplankton and forage fish that are inhabiting the platform and immediately surrounding waters. For whatever reason, based on the results from this study the oil and gas platforms serve a potentially important function as a hard-substrate habitat, and could therefore lead to increased production.

Our efforts are ongoing, as we are attempting to characterize the ichthyoplankton community at two other sites, Santa Fe-Snyder Main Pass (MP) 259A and Murphy's Viosca Knoll (VK) 203 (Figure 5.2). These platforms lie east of the Mississippi River Delta, enabling us to broaden our observations on a geographic (longitudinal) scale. Also, MP 259A (130 m depth) and VK 203 (30 m depth) gives us an offshore and mid-shelf replicate for further comparisons with the sites already sampled (Figure 5.2). Additionally, settlement traps are being deployed at VK 203 in an attempt to address questions concerning size at settlement, habitat selection, and recruitment dynamics. The additional information from platforms east of the Delta will enable us to develop a larger, more geographically meaningful and comprehensive characterization of the ichthyoplankton from continental shelf waters of the northern GOM.

ACKNOWLEDGMENTS

We gratefully acknowledge funding by the Minerals Management Service-Louisiana State University-Coastal Marine Institute (Contract Number 14-75-0001-30660, Task Order Number 19926) and by the Louisiana Sea Grant Program, part of the National Sea Grant College Program maintained by the National Oceanic and Atmospheric Administration. We thank David Bunch, Nathan Craig, Heather Haas, Ross Horton, Robin Hargroder, Sean Keenan, Gregory Lavergne, David Lindquist, Bradley McDonald, Cory New, Nick Ortego, John Plunkett, and Christopher Whatley for assistance in the field and/or laboratory. We gratefully acknowledge the assistance of Drs. Charles A. Wilson and David R. Stanley. We are further indebted to Exxon USA, Inc. and Mobil USA Exploration and Production, Inc. for access to their offshore oil and gas platforms and logistical support, and to the crews of Mobil's West Cameron 352, West Cameron 71D, Green Canyon 18, and Grand Isle 94 and Exxon's South Timbalier 54 platforms for their hospitality.

REFERENCES

- Alevizon, W.C., J.C. Gorhan, R. Richardson, and A. McCarthy. 1985. Use of man-made reefs to concentrate snapper (*Lutjanidae*) and grunts (*Haemulidae*) in Bahamian waters. *Bulletin of Marine Science* 37:3-10.
- Bedinger, C.A., J.W. Cooper, A. Kwok, R.E. Childers, and K.T. Kimball. 1980. Ecological investigations of petroleum production platforms in the central Gulf of Mexico. Volume 1: Pollutant fate and effects studies. Draft final report submitted to the Bureau of Land Management, Contract AA551-CT8-17.
- Bell, J.D., M. Westoby, and A.S. Steffe. 1987. Fish larvae settling in seagrass: do they discriminate between beds of different leaf density? *Journal of Experimental Marine Biology and Ecology* 111:133-144.
- Bennett, B.A. 1989. The fish community of a moderately exposed beach on the Southwestern Cape coast of South Africa and an assessment of this habitat as a nursery for juvenile fish. *Estuarine, Coastal, and Shelf Science* 28:293-305.

- Brogan, M.W. 1994. Two methods of sampling fish larvae over reefs: a comparison from the Gulf of California. *Marine Biology* 118:33-44.
- Boesch, D.F., and six coauthors. 1994. Scientific assessment of coastal wetland loss, restoration and management in Louisiana. *Journal of Coastal Research*, Special Issue 20:1-102.
- Bohnsak, J.A. 1991. Habitat structure and the design of artificial reefs. Pages 412-426. *In* S.S. Bell, E.D. McCoy, and H.R. Mushinsky, eds. *Habitat Structure: The Physical Structure of Objects in Space*. Chapman and Hall, London.
- Bohnsak, J.A. 1989. Are high densities of fishes at artificial reefs the result of habitat limitations or behavioral preference? *Bulletin of Marine Science* 44:632-645.
- Bohnsak, J.A. and D.L. Sutherland. 1985. Artificial reef research: a review with recommendations for future priorities. *Bulletin of Marine Science* 37:11-19.
- Bond, C.E. 1996. *Biology of Fishes*. Saunders College Publishing, Orlando, Florida.
- Bortone, S.A. 1998. Resolving the attraction-production dilemma in artificial reef research: Some yeas and nays. *Fisheries* 23:6-10.
- Bright, T.J., and nine coauthors. 1974. Biotic zonation on the West Flower Garden Bank. Pages 4-54. *In* T.J. Bright and L.H. Pequegnat, editors. *Biota of the West Flower Garden Bank*. Houston: Gulf Publication Company.
- Brogan, M.W. 1994. Two methods of sampling fish larvae over reefs: a comparison from the Gulf of California. *Marine Biology* 118:33-44.
- CDOP (Committee on Disposition of Offshore Platforms). 1985. *Disposal of offshore platforms*. Marine Board, Commission on Engineering and Technical Systems. Washington, D.C.: National Research Council, National Academy Press.
- Chittenden, M.E. and J.D. McEachran. 1976. Composition, ecology, and dynamics of demersal fish communities on the northwestern Gulf of Mexico continental shelf, with a similar synopsis for the entire gulf. Texas A&M University, Sea Grant Program, Publication Number TAMU-SG-76-2008.
- Choat, J.H. and D. R. Bellwood. 1991. Reef fishes: their history and evolution. Pages 39-66. *In* P.F. Sale, ed. *The Ecology of Fishes on Coral Reefs*. San Diego: Academic Press.
- Choat, J.H., P.J. Doherty, B.A. Kerrigan, and J.M. Leis. 1993. A comparison of towed nets, purse seine, and light-aggregation devices for sampling larvae and pelagic juveniles of coral reef fishes. *Fishery Bulletin* 91:195-209.

- Cochrane, J.D., and F.J. Kelly Jr. 1986. Low-frequency circulation on the Texas-Louisiana continental shelf. *Journal of Geophysical Research* 91:10,645-10,659.
- Connolly, R.M. 1994. A comparison of fish assemblages from seagrass and unvegetated areas of a southern Australian estuary. *Australian Journal of Marine and Freshwater Research* 45:1033-1044.
- Continental Shelf Associates. 1982. Study of the effect of oil and gas activities on reef fish populations in the Gulf of Mexico OCS area. OCS Report/MMS82-010. U.S. Dept. of the Interior, Minerals Management Service, Gulf of Mexico OCS Region, New Orleans.
- Defenbaugh, R.E. 1976. A study of the benthic macroinvertebrates of the continental shelf of the northern Gulf of Mexico. Doctoral dissertation. Texas A&M University, Galveston.
- Ditty, J.G. and R.F. Shaw. 1996. Spatial and temporal distribution of larval striped mullet (*Mugil cephalus*) and white mullet (*M. curema*, Family: Mugilidae) in the northern Gulf of Mexico, with notes on mountain mullet, *Agonostomus monticola*. *Bulletin of Marine Science* 59:271-288.
- Ditty, J.G., G.G. Zieske, and R.F. Shaw. 1988. Seasonality and depth distribution of larval fishes in the northern Gulf of Mexico above latitude 26°00'N. *Fishery Bulletin* 86:811-823.
- Doherty, P.J. 1987. Light-traps: selective but useful devices for quantifying the distribution and abundances of larval fishes. *Bulletin of Marine Science* 41:423-431.
- Essig, R.J., J.F. Witzig, and M.C. Holliday. 1991. Marine recreational fishery statistics survey, Atlantic and Gulf coasts, 1987-1989. NOAA/NMFS Current Fisheries Statistics 8904.
- Ferrell, D.J. and J.D. Bell. 1991. Differences among assemblages of fish associated with *Zostera capricorni* and bare sand over a large spatial scale. *Marine Ecological Progress Series* 72:15-24.
- Finucane, J.H., L.A. Collins, L.E. Barger, and J.D. McEachran. 1979a. Environmental Studies of the South Texas Outer Continental Shelf 1976: Ichthyoplankton/mackerel eggs and larvae. NOAA Final Report to BLM, NMFS Southeast Fisheries Center, Galveston, Contract Number AA550-TA7-3.
- Finucane, J.H., L.A. Collins, and L.E. Barger. 1979b. Determine the effects of discharges on seasonal abundance, distribution, and composition of ichthyoplankton in the oil field. Pages in W.B. Jackson, editor. *Environmental Assessment of an Active Oil Field in the Northwestern Gulf of Mexico, 1977-1978*. NOAA Report to EPA, NMFS Southeast Fisheries Center, Galveston, Contract Number EPA-IAG-D5-E693-EO, 299 pp.
- Gallaway, B.J., L. R. Martin, R. L. Howard, G. S. Boland and G. D. Dennis. 1980. A case study of the effects of gas and oil production on artificial reef and demersal fish and macrocrustacean communities in the northwestern Gulf of Mexico. Expo Chem 1980, Houston, TX.

- Gallaway, B.J. 1981. An ecosystem analysis of oil and gas development on the Texas-Louisiana continental shelf. U.S. Fish & Wildlife Service, Office of Biological Services, FWS/OBS-81/27, Washington, D.C.
- Gallaway, B.J., M.F. Johnson, R.L. Howard, L.R. Martin, and G.S. Boland. 1979. A study of the effects of Buccaneer oil field structures and associated effluents on biofouling communities and the Atlantic spadefish (*Chaetodipterus faber*). Annual report to NMFS, Galveston, LGL Limited-U.S., Inc., Bryan, Texas.
- Gallaway, B.J. 1998. Cumulative ecological significance of oil and gas structures in the Gulf of Mexico: Information search, synthesis, and ecological modeling: Phase I, Final Report. U. S. Geological Survey, Biological Research Division, Washington, D.C. USGS/BRD/CR-1997-0006.
- George, R.Y., and P.J. Thomas. 1974. Aspects of fouling on offshore oil platforms in Louisiana shelf in relation to environmental impact. Final Report, Offshore Ecological Investigations, Gulf Universities Research Consortium.
- Gregory, R.S. and P.M. Powles. 1988. Relative selectivities of Miller high-speed samplers and light traps for collecting ichthyoplankton. Canadian Journal of Fisheries and Aquatic Sciences 45:993-998.
- Hernandez, F.J., Jr. and D.G. Lindquist. 1999. A comparison of two light-trap designs for sampling larval and presettlement juvenile fish above a reef in Onslow Bay, North Carolina. Bulletin of Marine Science 64: 173-184.
- Hernandez, F.J., Jr. and R. F. Shaw (this volume). Comparison of plankton net and light-trap methodologies for sampling larval and juvenile fishes associated with offshore petroleum platforms and a coastal jetty off Louisiana.
- Hoese, H.D. and R.H. Moore. 1977. Fishes of the Gulf of Mexico: Texas, Louisiana, and Adjacent Waters. College Station: Texas A&M University Press.
- Johannes, R.E. 1978. Reproductive strategies of coastal marine fishes in the tropics. Environmental Biology of Fishes 3:65-84.
- Leard, R., and seven coauthors. 1995. The striped mullet fishery of the Gulf of Mexico, United States: a regional management plan. Gulf States Marine Fisheries Commission 33.
- Leis, J.M. 1991. The pelagic stage of reef fishes: the larval biology of coral reef fishes. Pages 183-230. In P.F. Sale, editor. The Ecology of Fishes on Coral Reefs. San Diego: Academic Press.
- Limouzy-Paris, C., M. F. McGowan, W. J. Richards, J. P. Umanan and S. S. Cha. 1994. Diversity of fish larvae in the Florida Keys: results from SEFCAR. Bulletin of Marine Science 54(3):857-870.

- Magurran, A.E. 1988. *Ecological Diversity and Its Measurement*. Princeton University Press, Princeton.
- McGowan, M.F. 1985. *Ichthyoplankton of the Flower Garden Banks, northwest Gulf of Mexico*. Doctoral Dissertation. University of Miami, Miami.
- NOAA/NMFS. 1993. *Fisheries of the United States, 1992*. Current Fisheries Statistics 9200.
- Nybakken, J.W. 1988. *Marine Biology: An Ecological Approach*. Harper and Row, New York.
- Parker, R.H. 1960. Ecology and distributional pattern of marine invertebrates, northern Gulf of Mexico. Pages 203-337. *In* F.P. Shepard, F.B. Phleger, and T.H. van Andel, eds. *Recent Sediments, Northwest Gulf of Mexico*. American Association of Petroleum Geologists.
- Parker, R.O., Jr., D. R. Colby T. P. Willis. 1983. Estimated amount of reef habitat on a portion of the U.S. South Atlantic and Gulf of Mexico continental shelf. *Bulletin of Marine Science* 33:935-940.
- Patillo, M.E., T.E. Czapla, D.M. Nelson, and M.E. Monaco. 1997. *Distribution and abundance of fishes and invertebrates in Gulf of Mexico estuaries, Volume II: Species life history summaries*. ELMR Report Number 11, NOAA/NOS Strategic Environmental Assessments Division, Silver Spring.
- Pickering, H., and D. Whitmarsh. 1997. Artificial reefs and fisheries exploitation: A review of the 'attraction versus production' debate, the influence of design and its significance for policy. *Fisheries Research* 31:39-59.
- Richards, W.J. 1984. *Kinds and abundances of fish larvae in the Caribbean Sea and adjacent areas*. NOAA Technical Report NMFS-SSRF-776.
- Richards, W.J., T. Potthoff, S. Kelley, M. F. McGowan, L. Ejsymont, J. H. Power and R. M. Olvera. 1984. *SEAMAP 1982-Ichthyoplankton*. NOAA Technical Memorandum NMFS-SEFC-144.
- Richards, W.J., M. F. McGowan, T. Leming, J. T. Lampkin and S. Kelley. 1993. Larval assemblages at the Loop Current boundary in the Gulf of Mexico. *Bulletin of Marine Science* 53(2):475-537.
- Ricklefs, R.E., and M. Lau. 1980. Bias and dispersion of overlap indices: results of some Monte Carlo simulations. *Ecology* 61:1019-1024.
- Riley, C.M., and G.J. Holt. 1993. Gut contents of larval fishes from light trap and plankton net collections at Enmedio Reef near Veracruz, Mexico. *Revista de Biología Tropical Suplemento* 41:53-57.
- Robins, C.R., G.C. Ray, and J. Douglass. 1996. *A Field Guide to the Atlantic Coast Fishes of North America*. Boston: Houghton Mifflin Company.

- Robins, C.R., and six coauthors. 1991. Common and scientific names of fishes from the United States and Canada. American Fisheries Society Special Publication 20. Bethesda: American Fisheries Society.
- Robertson, D.R., D.G. Green, and B.C. Victor. 1988. Temporal coupling of production and recruitment of larvae of a Caribbean reef fish. *Ecology* 69:370-381.
- Rooker, J.R., Q.R. Dokken, C.V. Pattengill, and G.J. Holt. 1997. Fish assemblages on artificial and natural reefs in The Flower Garden Banks National Marine Sanctuary, USA. *Coral Reefs* 16:83-92.
- Ross, S.W. and M.L. Moser. 1995. Life history of juvenile gag, *Mycteroperca microlepis*, in North Carolina estuaries. *Bulletin of Marine Science* 56:222-237.
- Sale, P.F. 1991. *The Ecology of Fishes on Coral Reefs*. New York: Academic Press.
- SAS Institute, Inc. 1989. *SAS/STAT Users Guide, Version 6*. Cary, North Carolina.
- Schoener, T.W. 1970. Non-synchronous spatial overlap of lizards in patchy habitats. *Ecology* 51:408-418.
- Seaman, W., Jr. and L.M. Sprague. 1992. *Artificial habitats for marine and freshwater fisheries*. New York: Academic Press.
- Shinn, E.A. 1974. Oil structures as artificial reefs. *In* Marine environmental implications of offshore oil and gas development in the Baltimore Canyon region of the Mid-Atlantic coast. *Estuarine Research Federation* 75(1):243-255.
- Sonnier, F., J. Teerling, and H.D. Hoese. 1976. Observations on the offshore reef and platform fish fauna of Louisiana. *Copeia* 1976:15-111.
- Sponaugle, S. and R.K. Cowen. 1996. Nearshore patterns of coral reef fish larval supply to Barbados, West Indies. *Marine Ecology Progress Series* 133:13-28.
- Stanley, D.R. and C. A. Wilson. 1990. A fishery-dependent based study of fish species composition and associated catch rates around oil and gas structures off Louisiana. *Fishery Bulletin, U.S.* 88:719-730.
- Stanley, D.R. and C. Wilson. 2000. Seasonal and spatial variation in the biomass and size frequency distribution of the fish associated with oil and gas platforms in the northern Gulf of Mexico. OCS Study MMS 2000-005, U.S. Department of Interior, Minerals Management Service, Gulf of Mexico OCS Region, New Orleans, LA.

- Starck, W.A. 1971. Biology of the gray snapper, *Lutjanus griseus* (Linnaeus), in the Florida Keys. In W. A. Starck and R. E. Schroeder, eds. Investigations on the gray snapper, *Lutjanus griseus*). Studies in Tropical Oceanography 10.
- Stephan, C.D., B.G. Dansby, G.C. Matlock, R.K. Rieckers, and R. Rayburn. 1990. Texas artificial reef fishery management plan. Texas Parks and Wildlife Department of Fisheries Management Plan Serial 3.
- Stone, R.B., H.L. Pratt, R.O. Parker, and G.E. Davis. 1979. A comparison of fish populations on an artificial and natural reef in the Florida Keys. Marine Fisheries Review 41:1-11.
- Thresher, R.E. 1984. Reproduction in Reef Fishes. T.F.H. Publications, Inc.
- USDOC (United States Department of Commerce). 1996. Magnuson-Stevens Fishery Conservation and Management Act. NOAA Technical Memorandum, NMFS-F/SPO-23.
- Van Guelpen, L., D.F. Markle, and D.J. Duggan. 1982. An evaluation of accuracy, precision, and speed of several zooplankton sampling techniques. Journal du Conseil. Conseil Permanent International pour l'Exploration de la Mer 40:226-236.
- Van Voorhies, D.A., J.F. Witzig, M.F. Osborn, M.C. Holliday, and R.J. Essig. 1992. Marine recreational fishery statistics survey, Atlantic and Gulf coasts, 1990-1991. NOAA/NMFS Current Fisheries Statistics 9204.
- Victor, B.C. 1986. Larval settlement and juvenile mortality in a recruitment-limited coral reef fish population. Ecological Monographs 56:145-160.

RED SNAPPER RECRUITMENT TO AND DISAPPEARANCE FROM OIL AND GAS PLATFORMS IN THE NORTHERN GULF OF MEXICO

David L. Nieland
Coastal Fisheries Institute

Charles A. Wilson
Coastal Fisheries Institute and
Department of Oceanography and Coastal Sciences
Center for Coastal, Energy, and Environmental Resources
Louisiana State University

ABSTRACT

The red snapper *Lutjanus campechanus* is a potentially large and long-lived species which can achieve ages approaching 60 years and weights of over 22 kg. In the northern Gulf of Mexico, oil and gas platforms provide the preponderance of both vertical relief and hard substrate habitat for red snapper and other reef associated fishes. In July 1998, we collected morphometric data and sagittal otoliths from 300 red snapper randomly selected from among the mortalities manifested subsequent to the explosive removal of an obsolete gas platform. Ages estimated from counts of otolith annuli ranged from one to nine years among these specimens. The virtual absence of age-one red snapper (0.68%) and the preponderance of age-two red snapper (53%) at the platform demonstrates that red snapper recruit to platforms sometime during their second year. Truncation of the age distribution results from natural mortality, fishing mortality, and emigration to other habitats after several years of residency. Assuming this population to be typical, the age distributions of the commercial and recreational harvests suggest that oil and gas platforms serve as essential habitats for younger red snapper. Conversely, platforms may make red snapper at ages four, five, and six year more vulnerable to fishing mortality as they are perhaps being harvested in proportions greater than their numbers in the population at large.

The management of the red snapper *Lutjanus campechanus* in the Gulf of Mexico (GOM) remains among the more problematic issues facing fishery managers of the region. Both the commercial and recreational red snapper fisheries are limited by size limits, creel or trip limits, seasonal closures, and quotas as formulated by the Gulf of Mexico Fisheries Management Council (GMFMC) in response to reports of overfishing (Schirripa and Legault 1999). Shrimp trawlers have also been required to install bycatch reduction devices in their nets to curtail mortality among juvenile red snapper. The intent of these regulations is both to achieve a 20 percent spawning potential ratio and to allow populations to recover. Thus, reliable characterizations of the age and length structure of red snapper populations in the GOM is essential to monitor year class strength, to conduct stock assessments, and to demonstrate population recovery.

Since 1995 we have collected otoliths and morphometric data of red snapper landed in the commercial harvest of the northern GOM off Louisiana. From these materials and data we have been able to characterize the age and size structure of this harvest (Wilson *et al.* 1998). However,

legitimate questions have been raised as to whether the age and size structure of the commercial catch is truly representative of the red snapper population as a whole. The regulations applied to the fishery and the very nature of the fishery itself are the source of these questions. For the past few years, the minimum legal size for red snapper in the GOM commercial fishery has been 381 mm (15 inches) total length. Furthermore, red snapper commercial fishermen have been allowed a Gulf-wide quota of 2,114 metric tons (4.65 million lb) two-thirds of which is allocated to a winter season beginning in February and one-third to an autumn season beginning in September or October. Additionally, both the winter and autumn seasons have been open to red snapper harvest only for the first 15 days (pre-1999) or ten days (1999-2000) of each successive month until the quota is achieved. A trip limit of 0.91 metric ton (2000 lb) for holders of federally issued reef fish permits and the modest number of available fishing days has resulted in a “derby” fishery that necessitates maximum catch in a minimum of time.

To compete in this derby fishery, many red snapper fishermen have concentrated their efforts at the numerous offshore oil and gas platforms of the northern GOM, particularly those closest to port. These easily located structures can hold large numbers of red snapper (Continental Shelf Associates 1982; Putt 1982; Stanley and Wilson 1990; Stanley 1994). The usual routine (called “rig hopping”) involves test fishing at successive platforms until a large and readily caught population of red snapper is found. Under the appropriate conditions and with some good fortune, a single trip may last less than one day.

As part of a continuing investigation into the stock structure of red snapper in the GOM, we also sampled the 1999 recreational harvest of the species from waters off Louisiana. The recreational fishery at this time was also restricted by regulations promulgated by the GMFMC. A Gulf-wide harvest of 2,032 metric tons (4.47 million lb) was allowed during an open season which began on 1 January 1999 and which would close when the quota was achieved or on 31 October, whichever was earlier. A daily creel limit of four red snapper over 406 mm (16 inches) total length was also mandated. As in the commercial fishery, recreational fishermen target the populations of red snapper associated with oil and gas platforms and also employ the rig hopping technique to maximize catch per effort.

Given the nature of the red snapper fisheries in the northern GOM, it is highly unlikely that the age and size structure of either harvest is representative of the entire population. Rather, it more certainly reflects the age and size distribution of only those red snapper that are both associated with oil and gas platforms and legal for fishermen to retain. Thus, the patterns of recruitment to and emigration from oil and gas platforms would also affect the size and age structures of the harvests. We have speculated that red snapper recruit to platforms at age one or two, occupy these habitats for a few years, and then emigrate to other habitats. Older, larger red snapper may avoid platforms and gravitate to other structure such as shipwrecks, sea-bottom depressions or lumps, and natural reefs. However, there are few fishery-independent studies that have allowed characterization of age and size of red snapper associated with oil and gas platforms.

Herein we report the fishery-dependent age and length distributions of the 1998 red snapper commercial and summer 1999 recreational harvests from the northern GOM off Louisiana and those of a fishery-independent “snapshot” of red snapper randomly sampled among the mortalities

resulting from the July 1998 explosive removal of an obsolete offshore gas platform. Our objectives were to infer important red snapper life history information from these data, such as age and size at recruitment to oil and gas platforms and the possibility of emigration away from the platforms to alternative habitats by older individuals later in life.

METHODS

Red snapper from the 1998 winter and autumn commercial harvests were randomly sampled as they were landed at two wholesale facilities: USA Fish in Leeville, Lafourche Parish, LA, during February and March, and at USA Fish in Cameron, Cameron Parish, LA, in October. The vessels that fish red snapper are generally manned by a captain and two crew. The heavily weighted fishing lines, which may have 20 or more baited hooks, are deployed vertically from manual, electric, or hydraulic “bandit” reels, four of which may be in use at any time. Snapper fishermen are understandably jealous of their catch localities; we asked for little specific catch information. However, we could infer that most trips took them from 50 to 80 km offshore.

Red snapper from the recreational catch were sampled sporadically from 18 April to 18 August 1999 at a charter boat dock in Port Fourchon, Lafourche Parish, LA. Through April and May the recreational fishery operated under a 381 mm minimum size; however, after 4 June and until the quota was estimated to have been achieved on 29 August, a 457 mm (18 inches) minimum size was enforced. The four vessels from which fish were obtained specialize in day trips lasting 10-12 hours. Given their maximum speed of approximately 12 knots, the vessels seldom venture more than 50 km off the coast. The platforms visited are situated in waters of 30-45 m depth; the usual angling gear is a stout fiberglass pole and a 4-0 reel with a 50 pound monofilament line. Single hooks baited with whole or cut fish are used exclusively.

To minimize hazards to navigation in the GOM, Coast Guard regulations mandate that offshore oil and gas platforms be removed once they have ceased production. A fishery-independent population of red snapper was randomly sampled from among the fish mortalities produced after the explosive removal of an obsolete oil platform located in Block 209 of the Ship Shoal oil and gas lease planning area (approx. 185 km SW of New Orleans, LA) on 30 July 1998. The four-pile platform measured 6.1 X 7.6 m at the water's surface and 12.2 X 13.7 m at the bottom. Water depth at the site was 32 m; thus, the volume of water enclosed by the platform was approximately 3,100 m³. Following detonation of plastic explosives placed at 5 m below substrate level in all four piles and in the lone well conductor, all floating fishes were collected by personnel from the National Marine Fisheries Service (NMFS) Galveston Laboratory. A representative sample of fishes that had sunk to the bottom was also retrieved by NMFS SCUBA divers.

Fork length (FL) in mm and both sagittal otoliths were taken from all specimens. Otoliths were prepared and sectioned for aging analyses as described in Beckman *et al.* (1988). Counts of increments (opaque zones) were accomplished by reading along the medial surface of the transverse section ventral to the sulcus; increments were often inconsistent in other regions of the otolith section. The appearance of the otolith margin was also coded as either opaque or transparent (Beckman *et al.* 1988; Beckman *et al.* 1990, 1991). Age estimates of red snapper were based on otolith opaque increment counts and adjusted to accommodate early or late annulus formation.

Opaque increments in red snapper otoliths have been demonstrated to be annual in their formation by Manooch and Potts (1997) and Wilson and Nieland (*in press*). Based on previous studies of red snapper reproduction (Render 1995), we assigned a uniform hatching date of 1 July. To compensate for the various times of the year when the specimens were taken, all ages were rounded to the nearer integer or, in other words, to the age at the previous or at the following hatching date, whichever was closer. Fork lengths were converted to total lengths (TL) with the equation $TL = 1.073 (FL) + 3.56$ (linear regression, $df = 1,015$, $P < 0.001$, $r^2 = 0.999$). The Komolgorov-Smirnov test was used to test for differences among distributions of TL and age ($\alpha = 0.05$).

RESULTS

The sampling of 1,109 red snapper from the commercial harvest yielded 1,109 TL measurements and 1,095 age estimates. Our efforts from the recreational harvest resulted in 666 individuals sampled; age and TL are available for 646 and 663 of these, respectively. The recovery of fish mortalities from the Ship Shoal 209 detonation produced 1,005 total specimens dominated by red snapper, gray snapper *L. griseus*, lane snapper *L. synagris*, sheepshead *Archosargus probatocephalus*, and Atlantic spadefish *Chaetodipterus faber* (*pers. comm.*, Gregg Gitschlag, National Marine Fisheries Service, Galveston, TX). Three hundred TL and 295 age estimates were obtained from a random sampling of 300 of the 373 red snapper mortalities.

Fishery-Dependent Data

Among red snapper sampled from the commercial catch, TL ranged from 352 to 883 mm (Figure 5.4) with a mean of 510 mm. Modal TL was 425 mm, and 50% of the specimens were less than 475 mm. Ages estimated for these specimens ranged from 1.3 to 48.7 years; however, the vast majority (93%) of these individuals were age three to six (Figure 5.5) and only six specimens were older than 10 years. Total lengths of the red snapper from the recreational harvest varied from 374 to 983 mm (Figure 5.4); mean TL, modal TL, and median TL were 558 mm, 475 mm, and 500 mm, respectively. Ages among the recreational catch ranged from 1.90 to 37.06 years with a mean age of 4.50 years. Individuals of ages three to six comprised 92% of the sample population (Figure 5.5).

Fishery-Independent Data

Total lengths and age estimates among the red snapper sampled from the Ship Shoal 209 population evidence radically and statistically different distributions from those seen in the commercial and recreational catches (Figure 5.4, Figure 5.5). In addition to having both a lesser minimum (255 mm) and a lesser maximum (791 mm) TL, the TL distribution is distinctly bimodal with a hint of a third mode at larger size (Figure 5.4). The distribution of ages (1.1-9.1 years) is also severely truncated and includes a large proportion (53%) of age-two individuals which are not present in the commercial or recreational landings (Figure 5.5). A plot of TL at age for the Ship Shoal red snapper population (Figure 5.6) indicates that the first two major TL modes (275-375 mm and 400-500 mm) are composed largely of individuals at age two years and age three years, respectively. The third minor mode (635-750 mm) is comprised of red snapper of age four to six years.

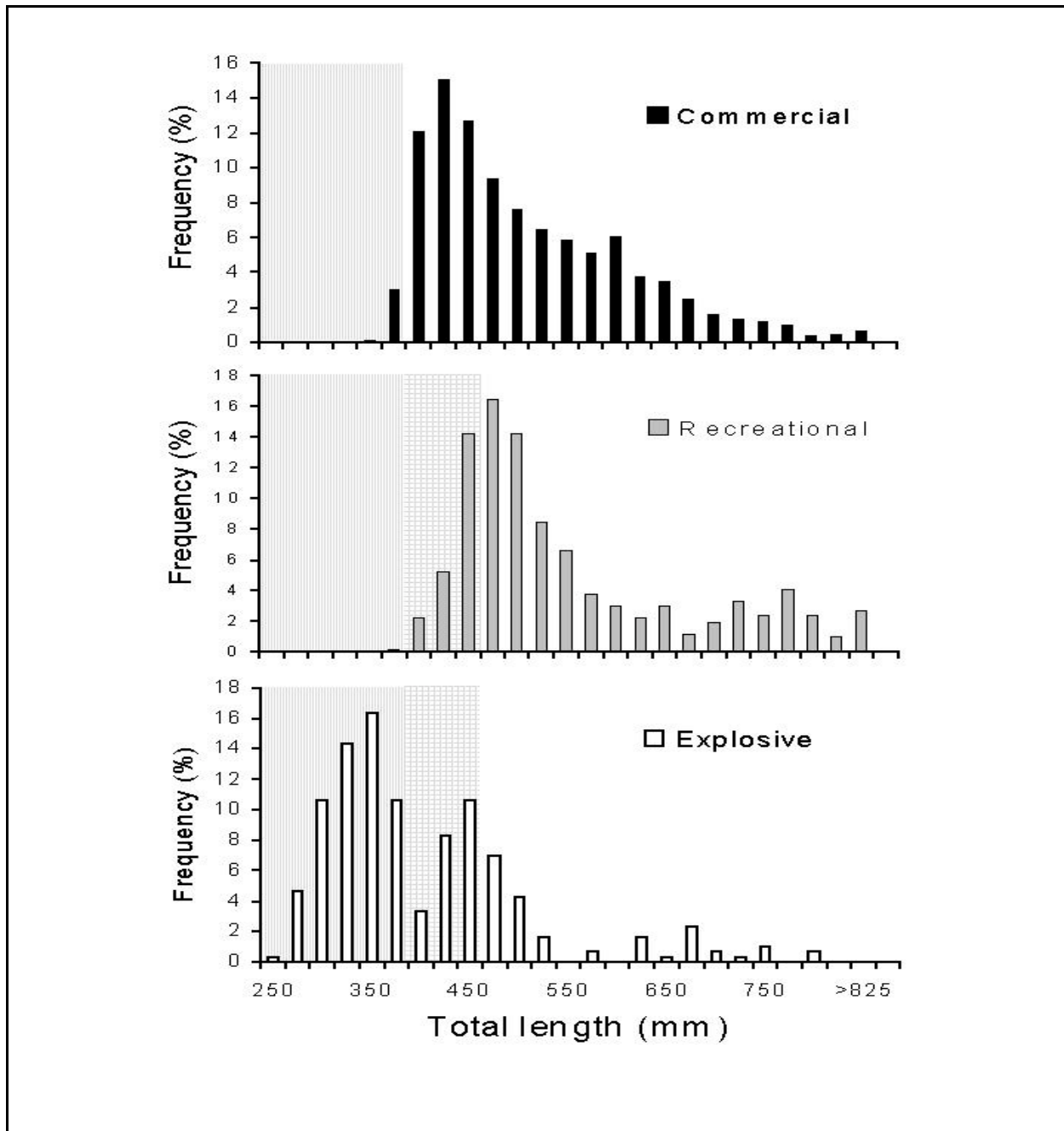

Figure 5.4. Total length frequency histograms for red snapper *Lutjanus campechanus* from the northern Gulf of Mexico: (top) 1,109 specimens from the commercial harvest of 1998; (middle) 663 specimens from the recreational harvest, April-August 1999; and (bottom) 300 specimens from among mortalities subsequent to the explosive removal of an oil and gas platform located in Ship Shoal Block 209, July 1998. The stippled area indicates those TL below the 381 mm (15 inch) TL minimum size which applied to the commercial fishery through out 1998 and to the recreational fishery through 3 June 1999. The hatched area delimits the 457 mm (18 inch) TL minimum under which the recreational fishery operated from 4 June to 29 August 1999.

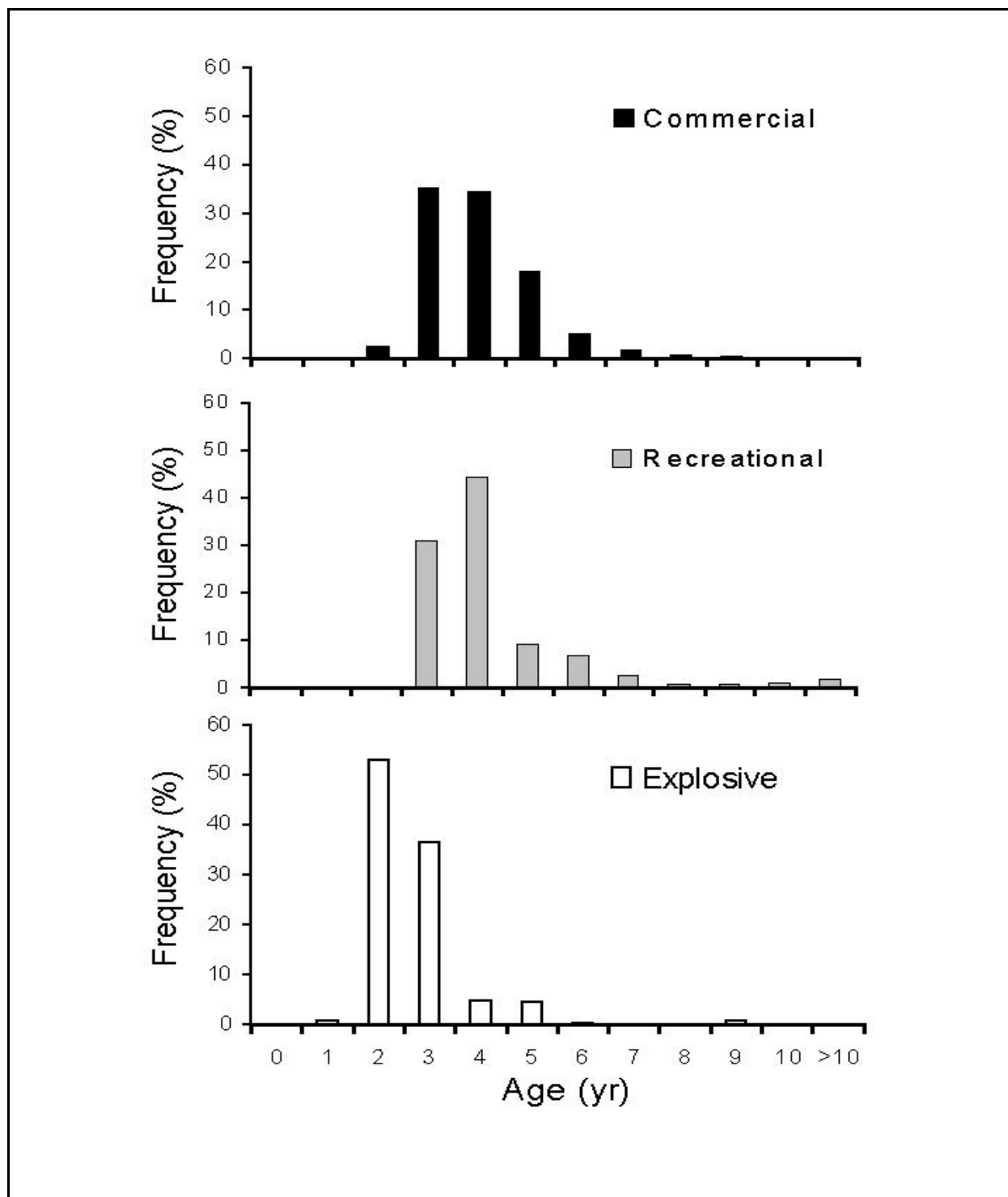

Figure 5.5. Age frequency histograms for red snapper *Lutjanus campechanus* from the Northern Gulf of Mexico: (top) 1,095 specimens from the commercial harvest of 1998; (middle) 646 specimens from the recreational harvest, April-August 1999; and (bottom) 295 specimens from among mortalities subsequent to the explosive removal of an oil and gas platform located in Ship Shoal Block 209, July 1998.

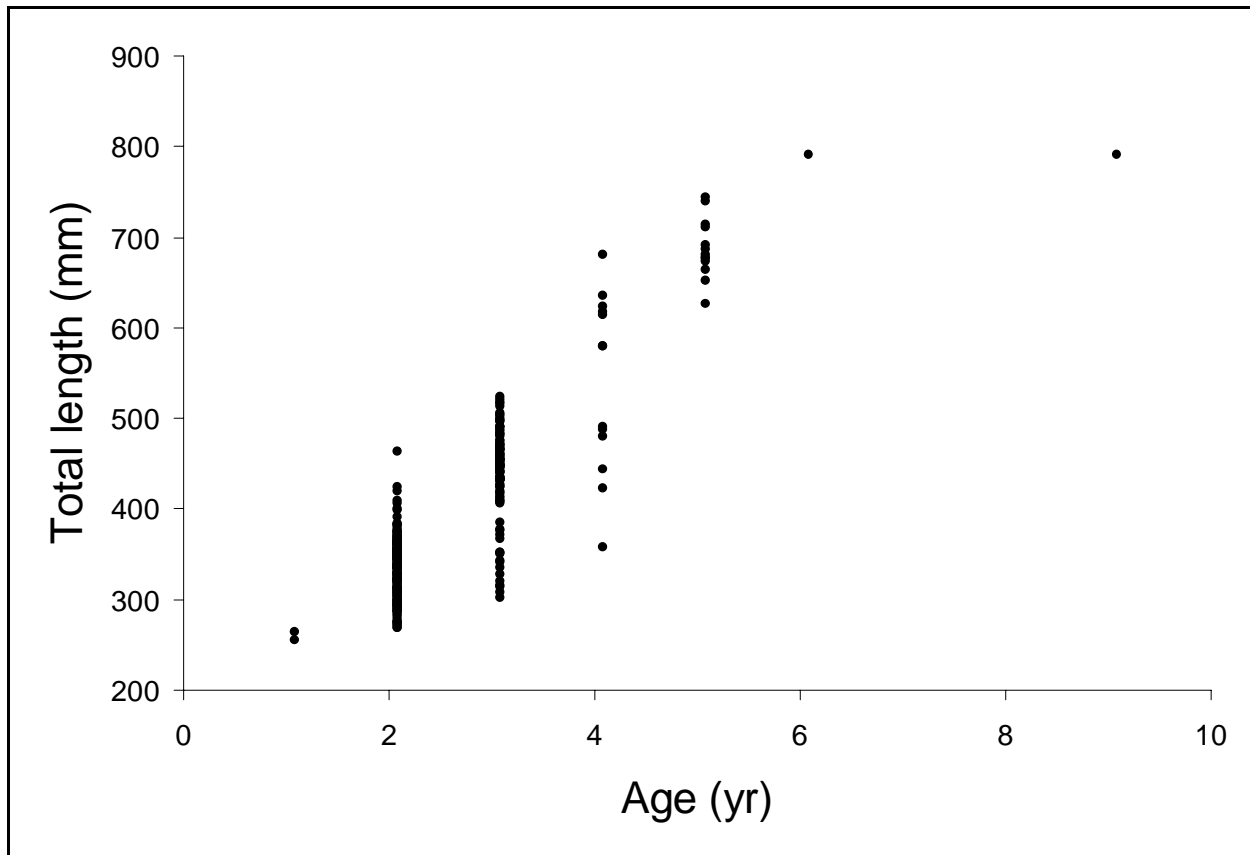

Figure 5.6. Scattergram of total length (mm) at age (yr) for 295 red snapper *Lutjanus campechanus* sampled from the mortalities subsequent to the explosive removal of an oil and gas platform located in Ship Shoal Block 209, July 1998.

DISCUSSION

Analysis of the fishery-independent red snapper data gathered from the Ship Shoal 209 detonation must be tempered with the recognition that it is indeed a chronological “snapshot” of the red snapper population. Previous reports of red snapper populations associated with oil and gas platforms have shown conclusively that numbers can vary significantly among seasons (Putt 1982; Stanley 1994). Red snapper are also known to stratify by size at different depths around platforms; further, larger individuals are less obligate in their association to platforms than are smaller individuals (Render 1995). Thus, we must assume that red snapper of all sizes and at all depths would be similarly susceptible to explosive-induced mortality and that mortality is 100% in the near vicinity of the platform.

The fishery-independent sampling of fishes at Ship Shoal 209 reveals a relatively large population of red snapper. Fully 37% of the fish mortalities recovered after the explosive detonation were red snapper. Other fishery-independent surveys of fishes around oil and gas platforms have reported red snapper populations consisting of 8-52% (Stanley 1994) and 2-4% (Putt 1982) of the total fishes inhabiting platforms. However, 79% of the Ship Shoal 209 red snapper would have been unavailable

for harvest due to the minimum length regulation enforced Gulf-wide. This is amply reflected in the virtual absence of individuals < 375 mm TL in both the recreational and commercial data sets.

The Ship Shoal 209 red snapper population is also relatively homogeneous in both age and length distribution. The individuals within the first two large modes of the TL distribution make up 92% of the total 300 individuals sampled. Further, individuals of age \leq three years totaled 90% of all red snapper sampled. This homogeneity is reflected neither in the age nor in the TL distribution of the commercial catch. Along the size spectrum of platforms in the GOM, the Ship Shoal 209 platform ranks at the lower end of this distribution. In a hydroacoustic study of the fish population around a much larger platform (45 m X 20 m; 19,800 m³ volume), Stanley (1994) reported the red snapper population varying from 1,200 to 8,200 individuals. One could speculate that among such numbers, older and larger red snapper might be present in appreciable numbers. Commercial and recreational fishing effort at such structures could provide for the diversity of ages and lengths seen in the fishery-dependent data.

The truncation of the red snapper size and length distributions at Ship Shoal 209 might also reflect the life history of red snapper. Juvenile red snapper are known to inhabit shallow water areas devoid of large structures where they are vulnerable to capture in trawls. This behavior is illustrated in fishery-independent trawl data from the GOM, specifically the Fall Groundfish Survey and the Summer SEAMAP Survey, in which the great majority of red snapper captured are age zero and one (Schirripa and Legault 1999). It has been hypothesized that the disappearance of age-one red snapper from the trawl data represents migration to structures such as oil and gas platforms which presumably provide refuge from large predators (Render 1995). It might also be postulated that oil and gas platforms, in the absence of other hard-bottom habitats, are essential habitat for young red snapper. Both the paucity of individuals of age zero and one and the bounty of age-two and -three individuals at Ship Shoal 209 assuredly support these hypotheses. The drastic decrease in numbers of individuals of age > three may represent emigration away from the structure to alternative habitats, removal from the population through fishing activities and natural mortality, or reduced recruitment among those cohorts.

The fishery-independent data from Ship Shoal 209 also provide verification of size at age for young red snapper in the northern GOM. Within the first TL mode (275-375 mm) illustrated in Figure 5.4, 90% of the 150 individuals contained therein are age two. The second mode (400-500 mm FL) in Figure 5.4 is comprised of 89% (92 of 103) age-three individuals. Such fidelity in the age at size relations for age two and age three could prove useful in two instances. Red snapper ranging from 275 to 500 mm TL can be aged with relative confidence simply from their length; time consuming and costly removal, sectioning, and reading of otoliths becomes unnecessary. Further, age determined from length could be used to confirm age estimates derived from counts of otolith increments.

Management of the red snapper in the GOM is predicated in part on estimates of relative cohort strength at age one derived from the fishery-independent trawl surveys mentioned above (Schirripa and Legault 1999) and on fishery-dependent data such as that reported herein. However, due to the virtual ubiquity of age zero and one individuals in the trawl catch and to the minimum total length regulations enforced within both the commercial and recreational fisheries, there is little information

on which to gauge cohort strength at age two. Over the past few years, the National Marine Fisheries Service has undertaken periodic assessment of the effects of explosive platform removal on the associated fish populations at select sites in the GOM. Such efforts apparently afford the sole opportunity to monitor red snapper cohort strength at age two and to bridge the data gap between existing data sources. They also prove to be crucial in our understanding of red snapper recruitment to and emigration from reefs and other structures such as oil and gas platforms. Continuation of this program would positively impact the current and future management of red snapper and help assure the future of the species in the GOM

ACKNOWLEDGMENTS

We are indebted to Jane and Lonnie Black, Joey Trosclair, and many intrepid fishermen for allowing access to the red snapper landed at the facilities of USA Fish. Captain Steve Tomeny and crews of Southerner Charters have been our good friends and obliging cooperators for many years. Our gratitude is also extended to Aly Hakam (Winmar Consulting Services), Spirit Energy, and Gregg Gitschlag (National Marine Fisheries Service Galveston Laboratory) for their cooperation in our effort to sample the red snapper population at Ship Shoal 209. Andrew Fischer and Forrest Davis of our laboratory expertly sectioned the red snapper otoliths and made all the increment counts. Finally we thank all of the colleagues and students who participated in the sampling trips. This research was funded in part by the U. S. Department of Commerce Marine Fisheries Initiative (MARFIN) Program administered by the National Marine Fisheries Service.

REFERENCES

- Beckman, D. W., C. A. Wilson, and A. L. Stanley. 1988. Age and growth of red drum, *Sciaenops ocellatus*, from offshore waters of the northern Gulf of Mexico. U. S. National Marine Fisheries Service Fishery Bulletin 87:17-28.
- Beckman, D. W., A. L. Stanley, J. H. Render, and C. A. Wilson. 1990. Age and growth of black drum in Louisiana waters of the Gulf of Mexico. Transactions of the American Fisheries Society 119:537-544.
- Beckman, D. W., A. L. Stanley, J. H. Render, and C. A. Wilson. 1991. Age and growth-rate estimation of sheepshead *Archosargus probatocephalus* in Louisiana waters using otoliths. U. S. National Marine Fisheries Service Fishery Bulletin 89:1-8.
- Continental Shelf Associates. 1982. Study of the effect of oil and gas activities on reef fish populations in Gulf of Mexico OCS area. U.S. Department of Interior, Minerals Management Service, Gulf of Mexico OCS Region, OCS Report MMS 82-10, New Orleans, Louisiana.
- Manooch, C. S., III, and J. C. Potts. 1997. Age and growth of red snapper, *Lutjanus campechanus*, Lutjanidae, collected along the southeastern United States from North Carolina through the east coast of Florida. Journal of the Elisha Mitchell Scientific Society 113:111-122.

- Putt, R. E., Jr. 1982. A quantitative study of fish populations associated with a platform within Buccaneer oil field, northwestern Gulf of Mexico. Master's thesis. Texas A&M University, College Station.
- Render, J. H. 1995. The life history (age, growth, and reproduction) of red snapper (*Lutjanus campechanus*) and its affinity for oil and gas platforms. Doctoral dissertation. Louisiana State University, Baton Rouge.
- Schirripa, M. J., and C. M. Legault. 1999. Status of the red snapper in U.S. waters of the Gulf of Mexico: Updated through 1998. National Marine Fisheries Service, Southeast Fisheries Center, Sustainable Fisheries Division, Contribution SFD-99/00-75, Miami, Florida.
- Stanley, D. R. 1994. Seasonal and spatial abundance and size distribution of fishes associated with a petroleum platform in the northern Gulf of Mexico. Doctoral dissertation. Louisiana State University, Baton Rouge.
- Stanley, D. R., and C. A. Wilson. 1990. A fishery dependent based study of fish species composition and associated catch rates around petroleum platforms off Louisiana. U. S. National Marine Fisheries Service Fishery Bulletin 88:719-730.
- Wilson, C. A., J. H. Render, and D. L. Nieland. 1998. Age and size distribution of commercially harvested red snapper *Lutjanus campechanus* in the northern Gulf of Mexico. Final report for 1995-1997 to U. S. Department of Commerce, National Marine Fisheries Service, Marine Fisheries Initiative (MARFIN), Cooperative Agreement NA17FF0383, St. Petersburg, Florida.
- Wilson, C. A., and D. L. Nieland. *In press*. Age and growth of red snapper *Lutjanus campechanus* in the northern Gulf of Mexico. U. S. National Marine Fisheries Service Fishery Bulletin.

**SESSION 6:
PRESENT AND FUTURE FISHERIES MANAGEMENT II**

Moderators: Hal Osborne
Bob Shipp

Date: October 25, 2000

Presentation	Author/Affiliation
The Attraction of Age-0 Red Snapper, <i>Lutjanus Campechanus</i> , to Artificially Placed Shell Plots Around Gas Platforms, a Possible Solution to Bycatch Mortality	Stephen T. Szedlmayer
A Comprehensive Survey of Fishes of Southwest Florida	George H. Burgess Franklin F. Snelson, Jr. David B. Snyder
Small Pelagics in the Gulf of Mexico: A Description of the Abundance, Geographic Distribution, Size, and Depth Distribution of Major Pelagic Species	Jason S. Link Terry A. Henwood Christopher T. Gledhill National Marine Fisheries Service
Distribution of Red Snapper Larvae in the Northern Gulf of Mexico, 1982-1994	D.M. Drass J. Lyczkowski-Schultz P.J. Bond National Marine Fisheries Service Pascagoula, MS
Red Snapper Discards in Texas Coastal Waters: A Fishery-Dependent Onboard Survey of Recreational Headboat Discards and Landings	Barbara Dorf Texas Parks & Wildlife Coastal Fisheries Division
Evaluation of Red Drum (<i>Sciaenops ocellatus</i>) Stocking Success: Gene-Marking of Fingerlings Released into East Matagorda Bay, Texas	Rocky Ward Ivonne R. Blandon William J. Karel Robert L. Colura Lawrence W. McEachron
High Resolution of Gulf Sturgeon Population Structure with Multilocus Microsatellite DNA Genotypes	Tim L. King Barbara A. Lubinski Issac I. Wirgin

**THE ATTRACTION OF AGE-0 RED SNAPPER, *LUTJANUS CAMPECHANUS*, TO
ARTIFICIALLY PLACED SHELL PLOTS AROUND GAS PLATFORMS,
A POSSIBLE SOLUTION TO BYCATCH MORTALITY**

Stephen T. Szedlmayer
Marine Fish Laboratory
Department of Fisheries and Allied Aquacultures
Auburn University

ABSTRACT

In 1998 and 1999, we built 30 4m⁺² reefs of shell and 30 4m⁺² reefs of shell/concrete blocks at depths of 17 to 21 m, in the Gulf of Mexico, 14 to 25 km south of Dauphin Island, Alabama. Each year there were 3 sites, 20 reefs each, placed at 20 m intervals. Sites 1 and 2 were centered around gas platforms. Total mean counts for all red snapper, *Lutjanus campechanus*, were significantly different between reef types and years: 14 fish/block, 19 fish/shell in 1998; 20 fish/block, 22 fish/shell in 1999 ($P < 0.05$). Separated into age-0 and age-1 year classes, few age-0 red snapper were observed in July, while age-1 were common. In August 1998, age-0 red snapper reached counts up to 113 fish/reef and 216 fish/reef in August 1999. In 1998, age-0 fish were significantly more abundant on shell reefs, but in 1999 age-0 fish showed no significant differences between reef types. In 1998 and 1999, age-1 fish were significantly more abundant on block reefs. In 1998, fish were significantly more abundant at Site 1, but in 1999 fish were significantly more abundant at Site 2. These results suggest that artificial shell reefs may attract young red snapper away from areas of intensive trawl fishing, e.g., gas platforms, thus enhancing survival.

A COMPREHENSIVE SURVEY OF FISHES OF SOUTHWEST FLORIDA

George H. Burgess
Florida Museum of Natural History
University of Florida

Franklin F. Snelson, Jr.
Department of Biology
University of Central Florida

David B. Snyder
Continental Shelf Associates
Jupiter, FL

ABSTRACT

Since 1975, we have sampled the ichthyofaunal community of southwest Florida. A wide variety of habitats were sampled with diverse gear types. This material is vouchered at the Florida Museum of Natural History (FLMNH). Additional comprehensive fish collections from the state of Florida recently were transferred to the FLMNH, including the renowned University of Miami holdings and those of Florida Atlantic University, University of Central Florida, and University of West Florida. These materials, added to the already extensive collections held at FLMNH, which contains the former Tropical Atlantic Biological Laboratory and Florida State University collections, constitute the most complete specimen-based data source on past and present distribution of fishes in Florida waters. We are in the process of assembling, verifying, and quantifying this database of all fishes found in brackish and marine waters of the southeastern Gulf of Mexico, Florida Bay, Florida Keys, and Dry Tortugas at depths to 350 fathoms.

The database currently documents more than 4000 stations spanning a period of 50 years. We have verified the presence of 1031 fish species in 177 families in the study region, including species not previously reported from United States continental waters. We plan to continue to verify identifications of existing materials and to update the database as new materials become available. Eventually we will incorporate data from specimens housed in other museums as well as reliable literature reports. The database will be incorporated into a GIS system for plotting distributions relative to habitat type or environmental features. These data will allow a detailed analysis of the biodiversity and distribution of all fishes in the region and will provide important information for resource managers and governmental decision-makers. The data also will be converted to an archive searchable from the web. Unlike most traditional survey results, specimen-supported data represent a unique resource in that species identification is always verifiable and vouchered specimens continually provide a rich source of historic life history and ecological information.

SMALL PELAGICS IN THE GULF OF MEXICO: A DESCRIPTION OF THE ABUNDANCE, GEOGRAPHIC DISTRIBUTION, SIZE, AND DEPTH DISTRIBUTION OF MAJOR PELAGIC SPECIES

Jason S. Link
Terry A. Henwood
Christopher T. Gledhill
National Marine Fisheries Service
Southeast Fisheries Science Center

ABSTRACT

In the 1980s, the National Marine Fisheries Service (NMFS) initiated a program to assess the distribution and abundance of small, "coastal pelagic" fish within the Gulf of Mexico (GOM), particularly those species whose range extends beyond the coverage of historical groundfish and shrimp surveys. Many of the species comprising this pelagic species complex, such as butterfishes (Stromateidae), herrings (Clupeidae), scads (Carangidae), and squids (Cephalopoda) were identified as potentially underutilized species. After examining gear and techniques to capture fast-swimming, schooling species in waters out to over 150 fathoms (278 m), standardized methods were developed. The pelagic survey cruises spanned the entire GOM and were conducted from 1988 to 1996. Here we present an analysis of the distribution, abundance, geographic range, catch frequency, and size composition of the most common species collected during these surveys. This study sampled 911 stations, with mean catch rates of 11,910.8 individuals hr^{-1} and 600.0 kg hr^{-1} . The top five organisms collected in this study were gulf butterfish (*Peprilus burti*), round herring (*Etrumeus teres*), longspine porgy (*Stenotomus caprinus*), rough scad (*Trachurus lathami*), and long-finned squid (*Loligo* sp.). Species composition varied with geographic location in the GOM; as expected, the eastern Gulf fish community was different from that of the western Gulf. These species are significant components of the groundfish and shrimp fishery bycatch, but their distributions extend beyond the range of the fishery into deeper offshore waters. Length frequency analysis demonstrated that, in general, larger fish occurred in deeper waters. This finding suggests that deeper offshore waters may serve as a refugia, especially for mature individuals. We briefly discuss the role of these species in the fisheries of the GOM.

INTRODUCTION

In the early 1980s, the NMFS initiated a program to investigate the abundance and distribution of a Gulf of Mexico species complex referred to as coastal pelagics. Interest in these species was prompted by ichthyoplankton survey abundance estimates which suggested that annual potential yield of these pelagic species in the GOM could exceed 5 million metric tons (Christmas *et al.* 1985, Flandorfer & Skupien 1980, Houde 1977a, 1977b, 1977c). Many of the species comprising this coastal pelagic complex, such as butterfishes (Stromateidae), herrings (Clupeidae), scads (Carangidae), and squids (Cephalopoda), were identified as potentially underutilized species. The distributional range of many of these species was suspected to extend well beyond the geographical

boundaries of the commercial shrimping grounds where most of NMFS trawling efforts were concentrated. Thus, specific effort was focused at surveying this pelagic species complex.

Early efforts in this program centered around the development of fishing gear effective at capturing these pelagic species. The use of standard shrimp/groundfish trawling gear and techniques (12.3 m headrope length trawls towed at 3 kts over depths ranging from 9 to 95 m) was believed to be inappropriate for capturing the schooling, fast-swimming pelagics. Trawling gear ranging in size from 12.3 to 104.6 m headrope length (both bottom and midwater) was tested over the course of this program. By the late 1980s, gear specialists had determined that large, high-opening trawls offered the best potential for capturing these fish in deeper waters (Gledhill 1989, Reese 1993).

We provide a description of the major taxonomic groups comprising this pelagic species complex. Our goal was to extend information on major species beyond the range historically surveyed for the shrimp/groundfish community to deeper waters and to the eastern GOM where very little trawl information exists. Because nearshore pelagics play a major role in the GOM fishery (e.g. *Brevoortia patronus*, NMFS 1996), we wanted to examine the geographic and depth distribution, abundance, and size of these species that may be considered as under-utilized resources, especially since they comprise an important part of the GOM ecosystem.

MATERIALS & METHODS

Trawling was done with a 27.5 m small pelagics trawl and a 37.5 m Shuman trawl from the NOAA vessel *Chapman*. The small pelagics trawl measured 27.5 m on the headrope, had a mesh size from 20 cm at the front leading down to 5 cm at the cod end, had a fish funnel preceding the cod end, a cod end containing a 0.4 to 2.2 cm mesh liner (varied by cruise), and was fished with 4.5 m² “W” doors. The Shuman trawl measured 37.5 m on the headrope, had a mesh size from 80 cm at the front to 3 cm at the cod end, had a fish funnel preceding the cod end, a cod end containing a 0.4 to 2.0 cm liner (varied by cruise), and was fished with 4.0 m² “Super V” doors.

Sampling designs were either stratified random, two dimensional systematic or systematic random, spanned the entire GOM, and are discussed in greater detail elsewhere (Gledhill 1989, Reese 1993; Table 6.1). Most trawls were approximately 30 minute tows, and total catch per unit effort was standardized to one hour. The minimum and maximum station depths were 10 and 420 m respectively. Only those trawls that were conducted during daylight hours and were on the bottom were used in this study. Echograms from acoustic surveys have demonstrated that this species complex forms compact schools proximal to bottom during daylight whereas they scatter throughout the water column at night (Gledhill 1989, Reese 1993). Cruises associated with the pelagics program that were related to gear development or that were directed sampling were also omitted from this analysis. A comparison between the two types of gear was conducted with paired trawls in 1991. The stations (26 pairs; Gledhill, unpubl. data) which compared the two gear exhibited no significant differences in catch rates. Therefore, we do not distinguish between gear types in this analysis.

Once on board, the entire trawl catch was weighed and then subsampled if the catch was greater than 150 kg. Subsamples (or the entire catch if less than 150 kg) were sorted, identified to the lowest

Table 6.1. Summary of trawling effort for this study. Latitudes and longitudes are in degrees and minutes North and West respectively. Gear size is the headrope length, in meters, of the trawl. SysRdm=systematic random, 2DSys=two-dimensional systematic, StratRdm=stratified random.

Year	88	89	90	91	92	93	94	95	96
Cruise	88-03	89-04	90-02,90-03	91-01	92-01	93-03	94-02	95-07	96-06
Months	3,4	8,9	3,4,5	1,2	3,4	3,4	3,4	10,11	10,11
Survey Design	SysRdm	StratRdm	SysRdm,2DSys	StratRdm	SysRdm	SysRdm	SysRdm	StratRdm	StratRdm
Cruise	88-08	89-05	90-08	--	92-06	93-07	--	--	--
Months	10,11	10,11	10,11	--	10,11	10,11	--	--	--
Survey Design	2DSys	SysRdm	SysRdm	--	SysRdm	SysRdm	--	--	--
Total # Stations	154	65	118	53	123	158	81	67	92
Max Latitude	30°59.46'	29°58.48'	30°59.90'	29°59.48'	30°59.84'	29°59.79'	30°59.60'	30°58.12'	29°59.48'
Min Latitude	27°00.09'	27°00.92'	27°00.15'	29°35.44'	27°00.45'	26°00.01'	27°00.00'	27°00.97'	26°00.41'
Max Longitude	96°59.95'	91°59.48'	94°58.92'	87°48.58'	93°56.85'	97°59.90'	91°58.50'	97°57.79'	97°59.11'
Min Longitude	83°00.09'	85°02.69'	85°01.73'	86°19.54'	82°00.30'	88°01.00'	83°00.40'	84°01.83'	84°00.26'
Gear Size	37.5	37.5	37.5	37.5,27.5	27.5,37.5	27.5,37.5	27.5	27.5	27.5

taxon feasible, enumerated, weighed, and measured to the nearest mm following standard NMFS and South East Area Monitoring and Assessment Program (SEAMAP) protocols.

A total of 15 cruises were conducted from 1988 to 1996, primarily during spring and fall (Table 6.1). These data are highly unbalanced both spatially and temporally (Table 6.1) due to fiscal constraints, varying cruise objectives, temporal constraints, mechanical difficulties, and similar logistical considerations. We present arithmetic means (\pm standard error) of catch per unit effort (number hr^{-1}) across depths and geographic zones. The GOM geographic zones, which roughly correspond to SEAMAP faunal zones, were arbitrarily assigned along a longitudinal gradient to partition the GOM from west to east, distinguishing the Texas Shelf, Louisiana shelf, Mississippi River region, DeSoto Canyon region, and Florida Shelf. We also examined length frequency distributions (cm) across depths and zones in the GOM.

RESULTS

There were 911 stations sampled in this study, with a mean total catch of 11,910.8 individuals hr^{-1} and 600.0 kg hr^{-1} . In total, there were 493 taxa collected in this study. The top five most abundant species in the small pelagic species complex were gulf butterfish (*Peprilus burti*), round herring (*Etrumeus teres*), longspine porgy (*Stenotomus caprinus*), rough scad (*Trachurus lathami*), and long-finned squid (*Loligo* sp.) (Table 6.2). The first 20 species accounted for more than 90% of the individuals and more than 85% of the biomass collected during this program. Other clupeids,

Table 6.2. Summary of mean CPUE (No./hr, kg/hr) of the major fish in the coastal pelagics complex.

Species	Common Name	Mean No./hr	% of Total	Mean Kg/hr	% of Total	# Stations	% Frequency	Rank
<i>Peprilus burti</i>	Gulf Butterfish	2550.3	21.4	189.6	31.6	554	60.8	1
<i>Etrumeus teres</i>	Round Herring	1852.8	15.6	38.16	6.4	348	38.2	2
<i>Stenotomus caprinus</i>	Longspine Porgy	1554.0	13.0	64.32	10.7	473	51.9	3
<i>Trachurus lathami</i>	Rough Scad	1369.2	11.5	76.10	12.7	618	67.8	4
<i>Loligo sp.</i>	Longfin Squid	472.59	3.7	9.02	1.5	754	82.8	5
<i>Steindachneria argenta</i>	Luminous Hake	385.81	3.2	4.71	0.79	94	10.3	6
<i>Decapterus punctatus</i>	Round Scad	316.28	2.7	14.28	2.4	77	8.5	7
<i>Trichiurus lepturus</i>	Atlantic Cutlassfish	315.05	2.6	21.84	3.6	347	38.1	8
<i>Diaphus sp.</i>	Lanternfish	303.48	2.5	0.816	0.14	62	6.8	9
<i>Chloroscombrus chrysurus</i>	Atlantic Bumper	287.98	2.4	17.66	2.9	131	14.4	10
<i>Engraulis eurystole</i>	Silver Anchovy	272.45	2.3	0.549	0.092	14	1.5	11
<i>Scomber japonicus</i>	Chub Mackerel	262.42	2.2	24.63	4.1	261	28.6	12
<i>Sardinella aurita</i>	Spanish Sardine	224.24	1.9	9.26	1.5	43	4.7	13
<i>Anchoa hepsetus</i>	Striped Anchovy	170.59	1.4	2.29	0.38	46	5.0	14
<i>Micropogonias undulatus</i>	Atlantic Croaker	142.40	1.2	10.41	1.7	140	15.4	15
<i>Parapenaeus sp.</i>	Shrimp	101.67	0.85	0.118	0.020	39	4.3	16
<i>Polymixia lowei</i>	Beardfish	94.81	0.80	1.88	0.31	74	8.1	17
<i>Lagodon rhomboides</i>	Pinfish	93.44	0.78	7.88	1.3	253	27.8	18
<i>Pristipomoides aquilonaris</i>	Wenchman	92.17	0.77	11.70	1.9	399	43.8	19
<i>Ariomma bondi</i>	Silver Rag	73.08	0.61	5.43	0.91	181	19.9	20
<i>Upeneus parvus</i>	Dwarf Goatfish	70.11	0.59	2.40	0.40	242	26.6	21
<i>Mullus auratus</i>	Red Goatfish	64.45	0.54	4.16	0.69	140	15.4	22
<i>Trachypeneus sp.</i>	Shrimp	62.89	0.53	0.0858	0.014	16	1.8	23
<i>Leiostomus xanthurus</i>	Spot	60.19	0.51	6.87	1.1	73	8	24
<i>Macrorhampuhosus scolopax</i>	Longspine Snipefish	44.96	0.38	0.144	0.024	26	2.9	25
<i>Anchoa mitchilli</i>	Bay Anchovy	40.13	0.34	0.230	0.038	11	1.21	26
Clupeidae	Herrings	35.58	0.30	0.004	0.001	1	0.11	27
<i>Saurida brasiliensis</i>	Largescale Lizardfish	34.70	0.29	0.608	0.101	100	10.98	28
Caridea	Unclassified Shrimp	29.09	0.24	0.027	0.005	10	1.10	29

Table 6.2. (continued)

Species	Common Name	Mean No./hr	% of Total	Mean Kg/hr	% of Total	# Stations	% Frequency	Rank
<i>Cynoscion arenarius</i>	Sand Seatrout	25.60	0.21	3.053	0.509	156	17.12	30
Unid. Fish	-	23.48	0.20	0.006	0.001	5	0.55	31
<i>Peprilus alepidotus</i>	Harvestfish	20.60	0.17	7.839	1.306	107	11.75	32
<i>Lolliguncula brevis</i>	Breif Squid	18.44	0.15	0.099	0.016	26	2.85	33
<i>Harengula jaguana</i>	Scaled Sardine	17.74	0.15	0.823	0.137	48	5.27	34
<i>Synodus foetens</i>	Inshore Lizardfish	17.73	0.15	2.536	0.423	158	17.34	35
<i>Abralia veranyi</i>	Abralia Squid	17.02	0.14	0.062	0.010	58	6.37	36
<i>Opisthonema oglinum</i>	Atlantic Thread Herring	16.48	0.14	1.122	0.187	47	5.16	37
<i>Maurollicus muelleri</i>	Atlantic Pearlsides	15.55	0.13	0.025	0.004	23	2.52	38
<i>Cynoscion nothus</i>	Silver Seatrout	14.58	0.12	1.180	0.197	66	7.24	39
<i>Rhomboplites aurorubens</i>	Vermilion Snapper	14.27	0.12	1.628	0.271	85	9.33	40

carangids, scombrids, engraulids, sparids, sciaenids, and gadids were the major organisms comprising this pelagic species complex. For more specific parameters of these major families, see Appendix A.

Distribution in the Gulf

Many of the major species were ubiquitous throughout the GOM. *P. burti*, *E. teres*, *T. lathami*, *Loligo* sp., and *S. japonicus* all occurred in most regions of the Gulf (Figures 6.4–6.5; Table 6.3). *P. burti* was most abundant in the central GOM, but was widespread throughout the entire Gulf (Table 6.3, Figure 6.1). *E. teres* was most abundant in zones 1 and 4, but was also common across the entire GOM (Table 6.3, Figure 6.2). *T. lathami* was similarly most abundant in the central GOM and was widespread across the GOM (Table 6.3, Figure 6.3). Both *Loligo* sp. and *S. japonicus* showed no major difference in abundance between regions in the GOM (Figure 6.4 and 6.5). The frequency of occurrence of *Loligo* sp. was the highest of any species in this study (Table 6.2). Other species that were widely distributed were *Lagodon rhomboides* and *Leiostomus xanthurus*, among others (Table 6.4).

S. caprinus, *C. chrysurus*, and *E. eurystole* occurred throughout the entire GOM but were more abundant in the western Gulf than other regions (Figures 6.6–6.8). *S. caprinus* was abundant in all regions except zone 5 (Table 6.3, Figure 6.6). *C. chrysurus* and *E. eurystole* were most abundant in zones 1 and 2 (Figures 6.7 and 6.8). Other species that occurred most frequently in the western GOM were *Selene setapinnis*, *Peprilus alepidotus*, and *Pristipomoides aquilonaris*, among others (Table 6.4).

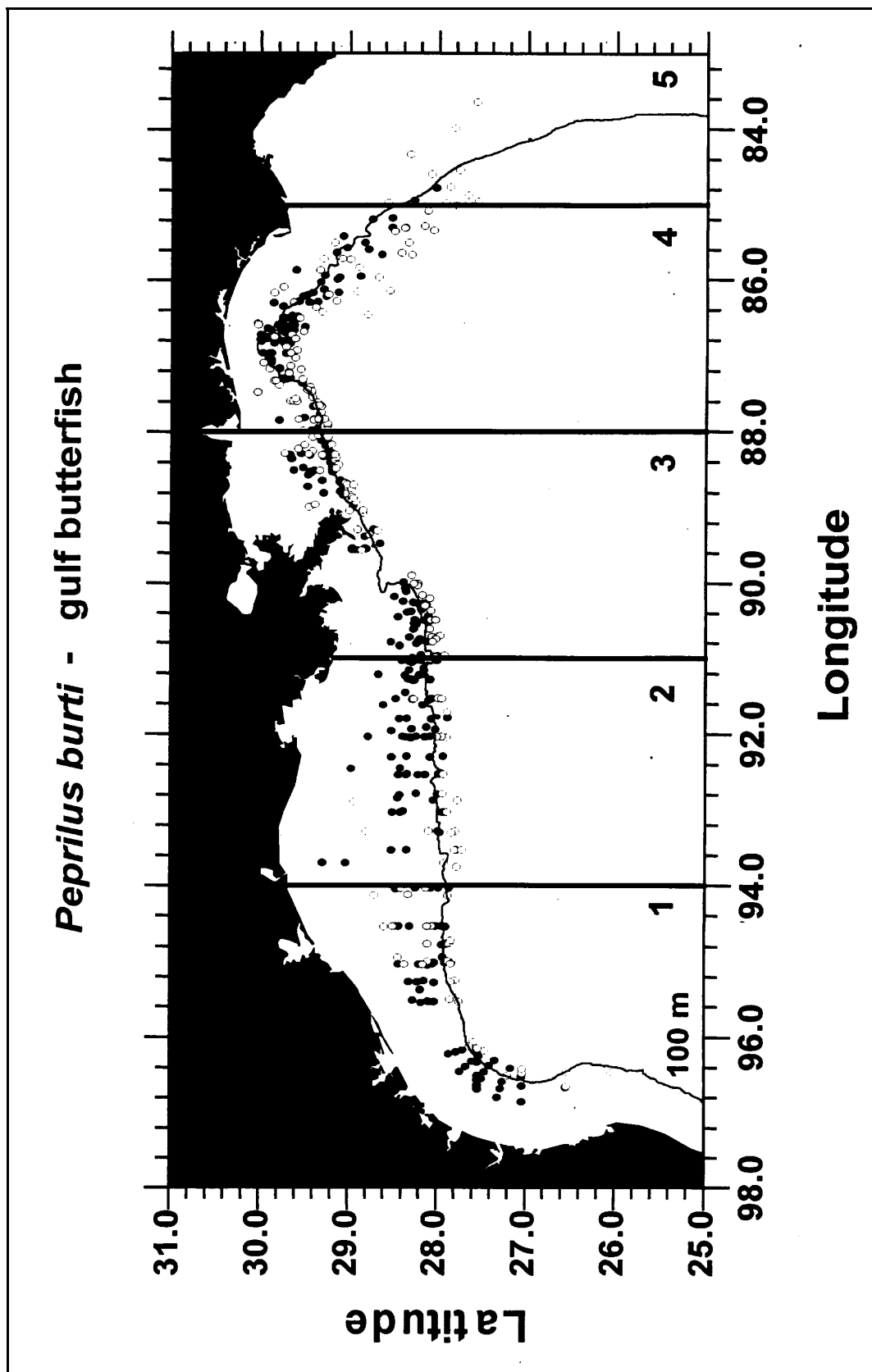

Figure 6.1. The occurrence of *Peprilus burti* at the stations sampled in this study. Solid circles indicate presence of this species; open circles indicate that a sample was taken but this squid was not present at that station. The zones (1-5) correspond to regions of the GOM, from west to east, that have roughly geographic similarities and are to assist with synthesis across the broad geographic scale of the GOM (c.f. Table 6.1). The solid line is the 100 m depth contour, approximately denoting the continental shelf region.

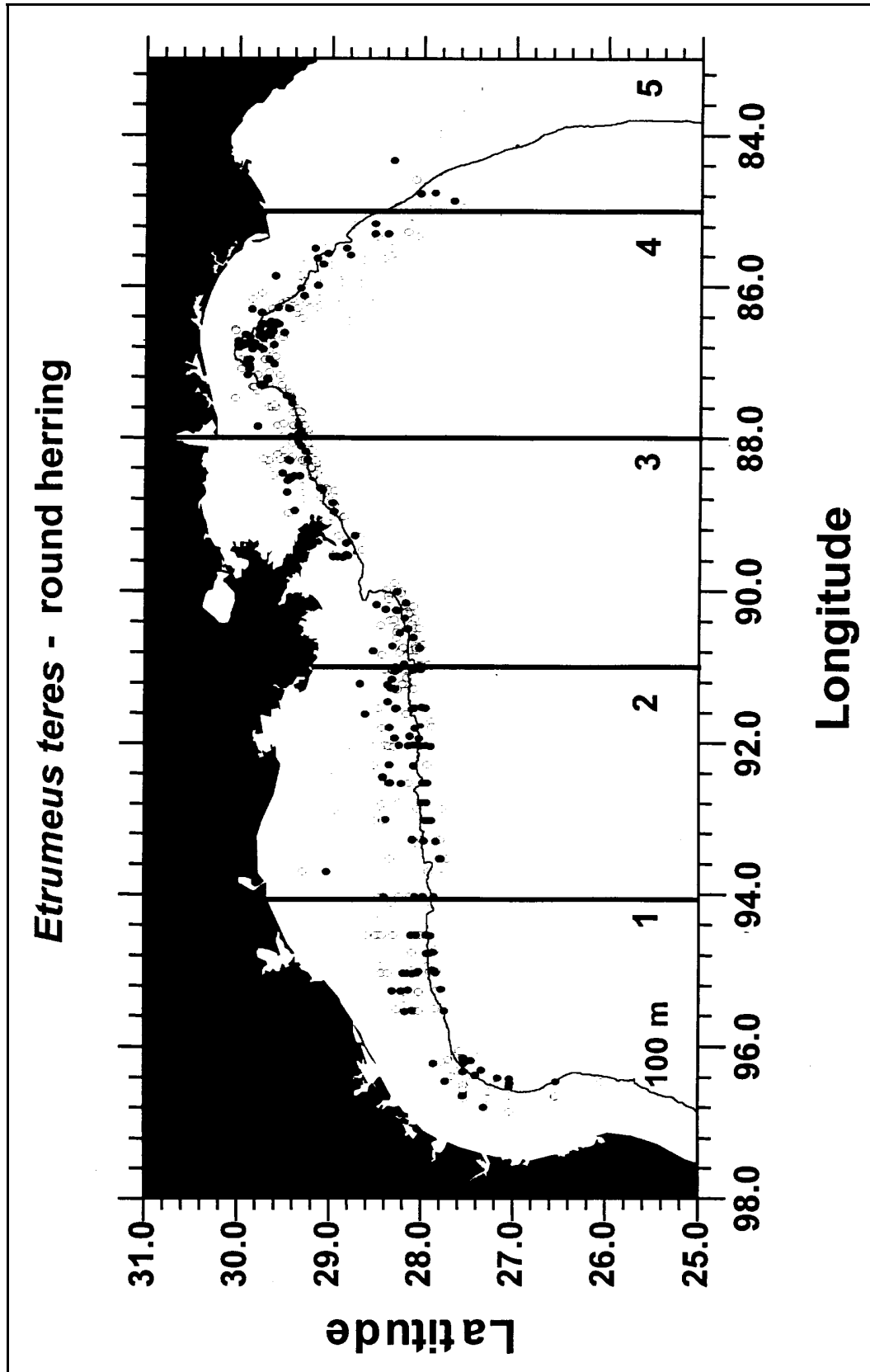

Figure 6.2. The occurrence of *Etrumeus teres* at the stations sampled in this study. Solid circles indicate presence of this species; open circles indicate that a sample was taken but this squid was not present at that station. The zones (1-5) correspond to regions of the GOM, from west to east, that have roughly geographic similarities and are to assist with synthesis across the broad geographic scale of the GOM (c.f. Table 6.1). The solid line is the 100 m depth contour, approximately denoting the continental shelf region.

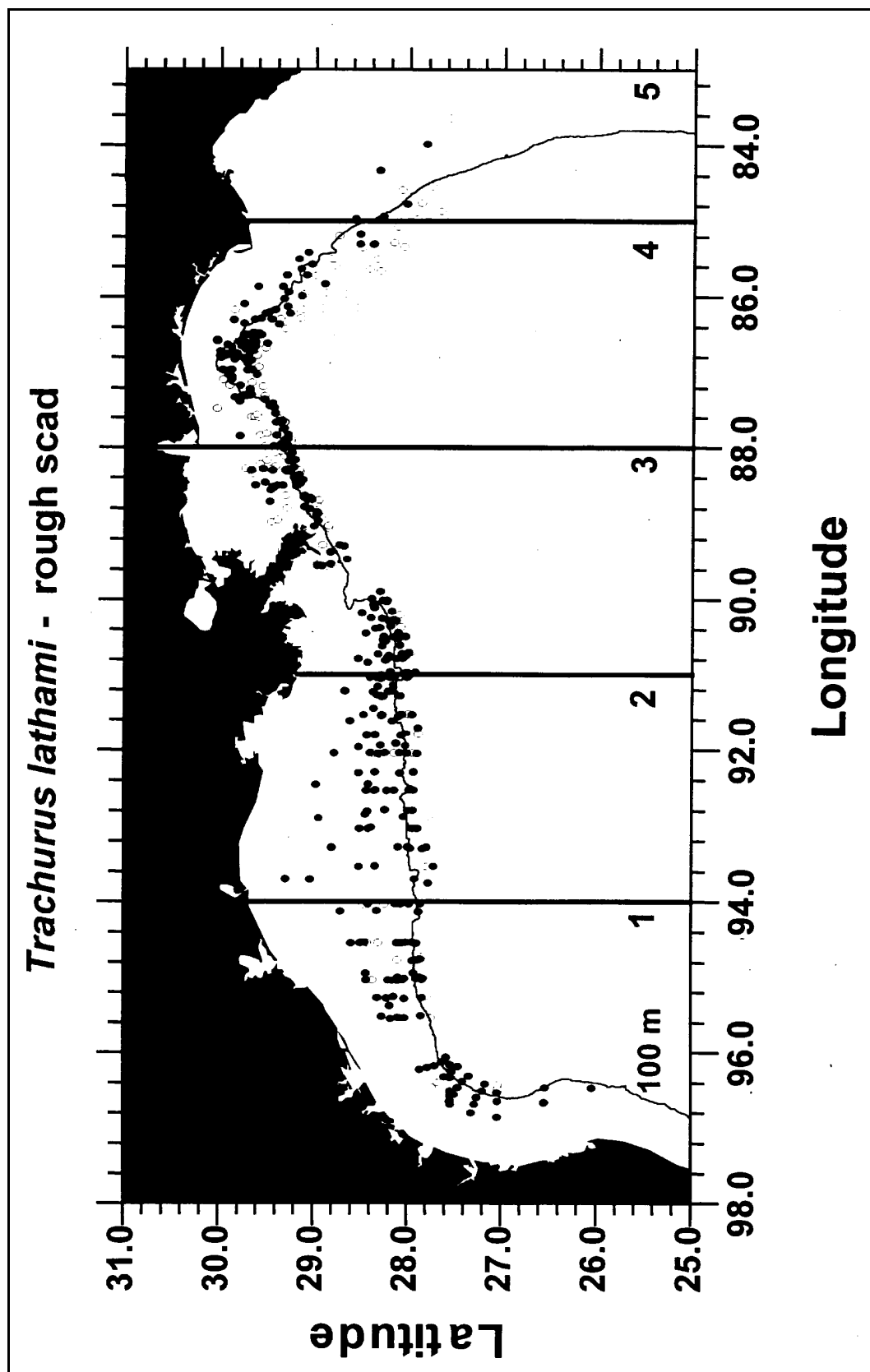

Figure 6.3. The occurrence of *Trachurus lathami* at the stations sampled in this study. Solid circles indicate presence of this species; open circles indicate that a sample was taken but this squid was not present at that station. The zones (1-5) correspond to regions of the GOM, from west to east, that have roughly geographic similarities and are to assist with synthesis across the broad geographic scale of the GOM (c.f. Table 6.1). The solid line is the 100 m depth contour, approximately denoting the continental shelf region.

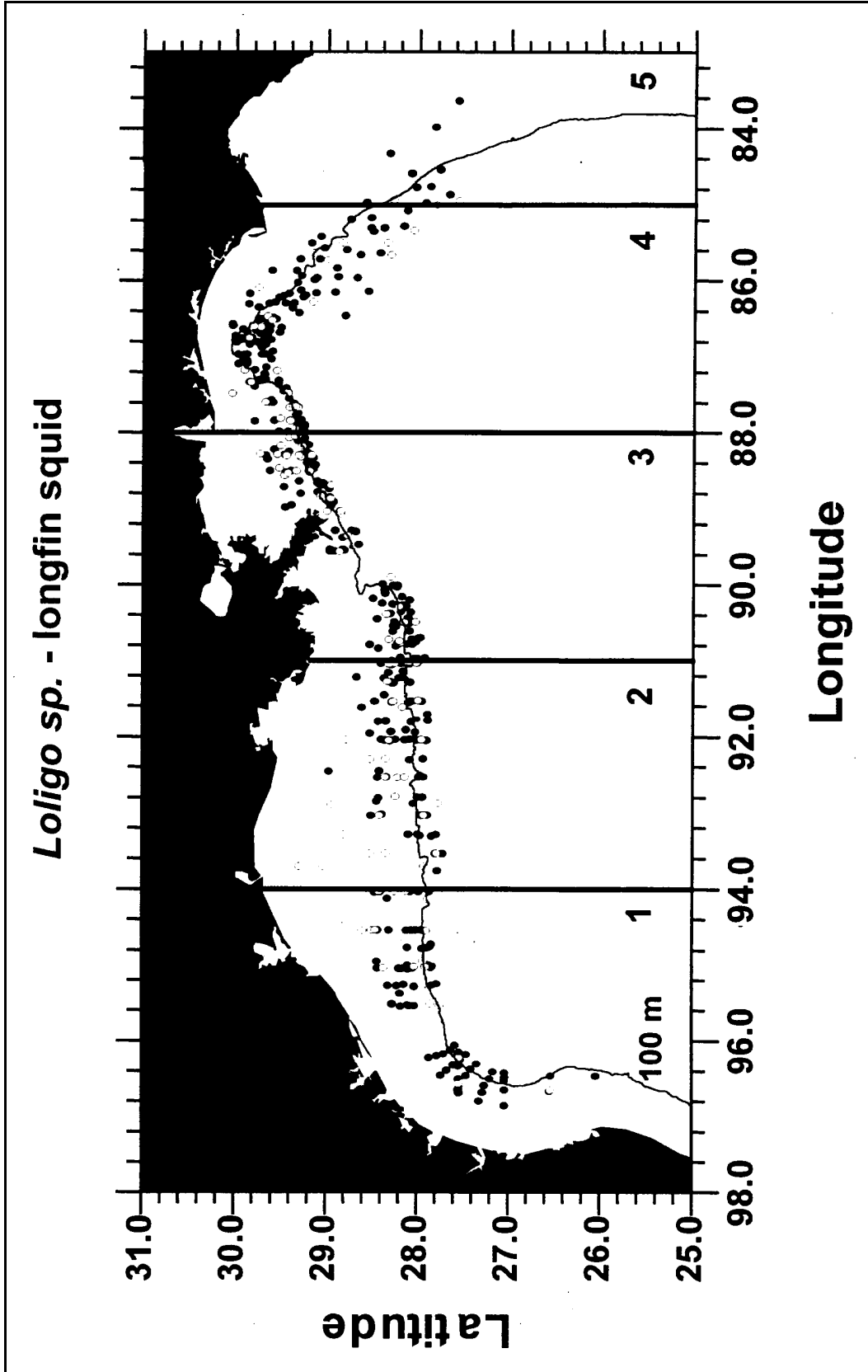

Figure 6.4. The occurrence of *Loligo* sp. at the stations sampled in this study. Solid circles indicate presence of this species; open circles indicate that a sample was taken but this squid was not present at that station. The zones (1-5) correspond to regions of the GOM, from west to east, that have roughly geographic similarities and are to assist with synthesis across the broad geographic scale of the GOM (c.f. Table 6.1). The solid line is the 100 m depth contour, approximately denoting the continental shelf region.

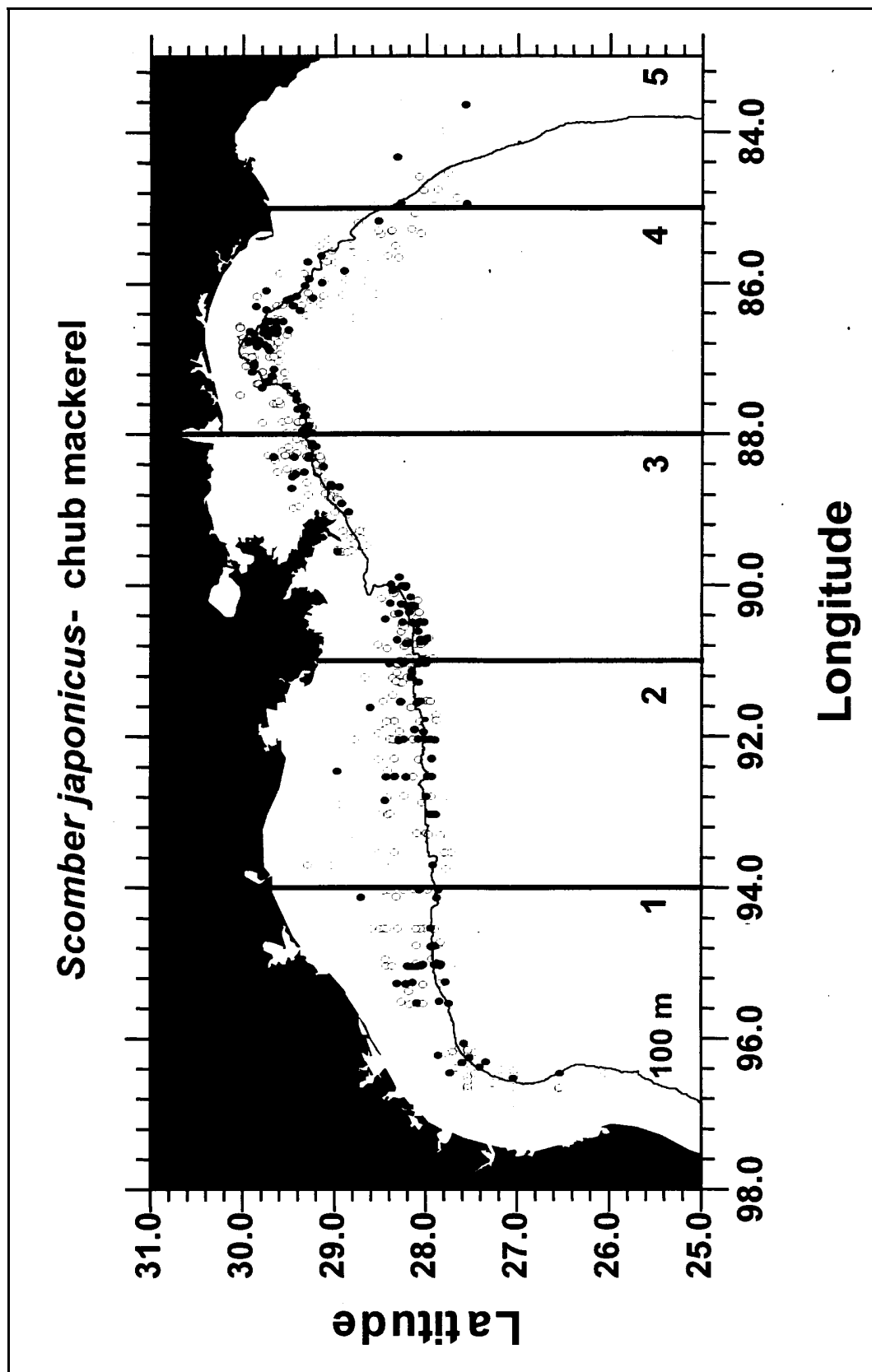

Figure 6.5. The occurrence of *Scomber japonicus* at the stations sampled in this study. Solid circles indicate presence of this species; open circles indicate that a sample was taken but this squid was not present at that station. The zones (1-5) correspond to regions of the GOM, from west to east, that have roughly geographic similarities and are to assist with synthesis across the broad geographic scale of the GOM (c.f. Table 6.1). The solid line is the 100 m depth contour, approximately denoting the continental shelf region.

Table 6.3. Mean (+/- S.E.,in No. hr⁻¹) of these species in each GOMEX zone. S.E.=std. error, n=sample size.

Zone	1	2	3	4	5
n	171	180	244	265	51
P. burti	727.3 (161.3)	2515.9 (542.1)	3646.1 (1003.8)	3213.2 (594.6)	97.5 (51.7)
E. teres	3047.5 (1493.0)	642.3 (254.4)	613.6 (195.4)	3273.3 (579.8)	667.4 (323.5)
S. caprinus	1309.2 (270.60)	1539.4 (215.2)	1698.3 (544.5)	1887.1 (470.9)	4.7 (1.8)
T. lathami	627.7 (120.4)	833.5 (185.0)	1256.8 (303.9)	2433.9 (486.5)	751.2 (251.5)
Loligo sp.	435.52 (50.557)	363.103 (48.956)	375.03 (56.968)	732.14 (159.66)	101.49 (20.137)
S. argenta	0.13 (0.13)	0.1 (0.07)	1407.2 (345.6)	30.5 (12.3)	0
D. punctatus	7.9 (3.3)	4.3 (3.2)	18.5 (9.7)	197.2 (92.1)	4494.9 (2226.5)
T. lepturus	57.8 (23.0)	358.1 (77.6)	794.4 (161.1)	71.1 (35.6)	0
Diaphus sp.	2.3 (2.3)	2.0 (1.3)	129.7 (61.7)	671.7 (357.3)	0
C. crysurus	637.9 (229.7)	466.8 (242.3)	282.7 (132.9)	1.0 (0.4)	0
E. eurystole	11.3 (10.1)	1357.7 (1102.2)	7.7 (7.7)	0	0
S. japonicus	107.7 (40.4)	58.7 (44.3)	489.8 (192.5)	312.0 (99.2)	154.5 (63.8)
S. aurita	1.65 (1.02)	1.86 (1.11)	2.67 (1.75)	260.8 (214.4)	2625.5 (1243.0)
A. hepsetus	6.9 (3.1)	56.0 (27.9)	590.6 (291.5)	0.06 (0.06)	0
M. undulatus	6.9 (3.2)	163.8 (85.3)	404.7 (116.1)	1.2 (0.7)	0

Table 6.4. Species with the most biomass or most occurrences predominating in the different regions.

Abundant Species	Rarer Species
<p>West GOM</p> <p><i>Stenotomus caprinus</i> <i>Chloroscombus chrysurus</i> <i>Engraulis eurystole</i></p>	<p>West GOM</p> <p><i>Selene setapinnis</i> <i>Pristipomoides aquilonaris</i> <i>Upeneus parvus</i> <i>Peprilus alepidotus</i> <i>Lagocephalus laevigatus</i></p>
<p>Central GOM</p> <p><i>Steindachneria argentea</i> <i>Trichiurus lepturus</i> <i>Diaphus</i> sp. <i>Anchoa hepsetus</i> <i>Micropogonias undulatus</i> <i>Polymixia lowei</i></p>	<p>Central GOM</p> <p><i>Anchoa mitchilli</i> <i>Caranx crysos</i> <i>Lolliguncula brevis</i> <i>Abralia veranyi</i> <i>Cynoscion nothus</i> <i>Cynoscion arenarius</i> <i>Pontinus longispinis</i></p>
<p>Eastern GOM</p> <p><i>Decapturus punctatus</i> <i>Sardinella aurita</i> <i>Mullus auratus</i></p>	<p>Eastern GOM</p> <p><i>Rhomboplites aurorubens</i> <i>Saurida normani</i></p>
<p>Widespread</p> <p><i>Etrumeus teres</i> <i>Loligo</i> sp. <i>Trachurus lathami</i> <i>Peprilus burti</i> <i>Scomber japonicus</i> <i>Lagodon rhomboides</i> <i>Leiostomus xanthurus</i></p>	<p>Widespread</p> <p><i>Saurida brasilia</i> <i>Maurolicus muelleri</i> <i>Synodus foetens</i> <i>Ariomma bondi</i> <i>Synagrops bella</i> <i>Synagrops spinosus</i></p>

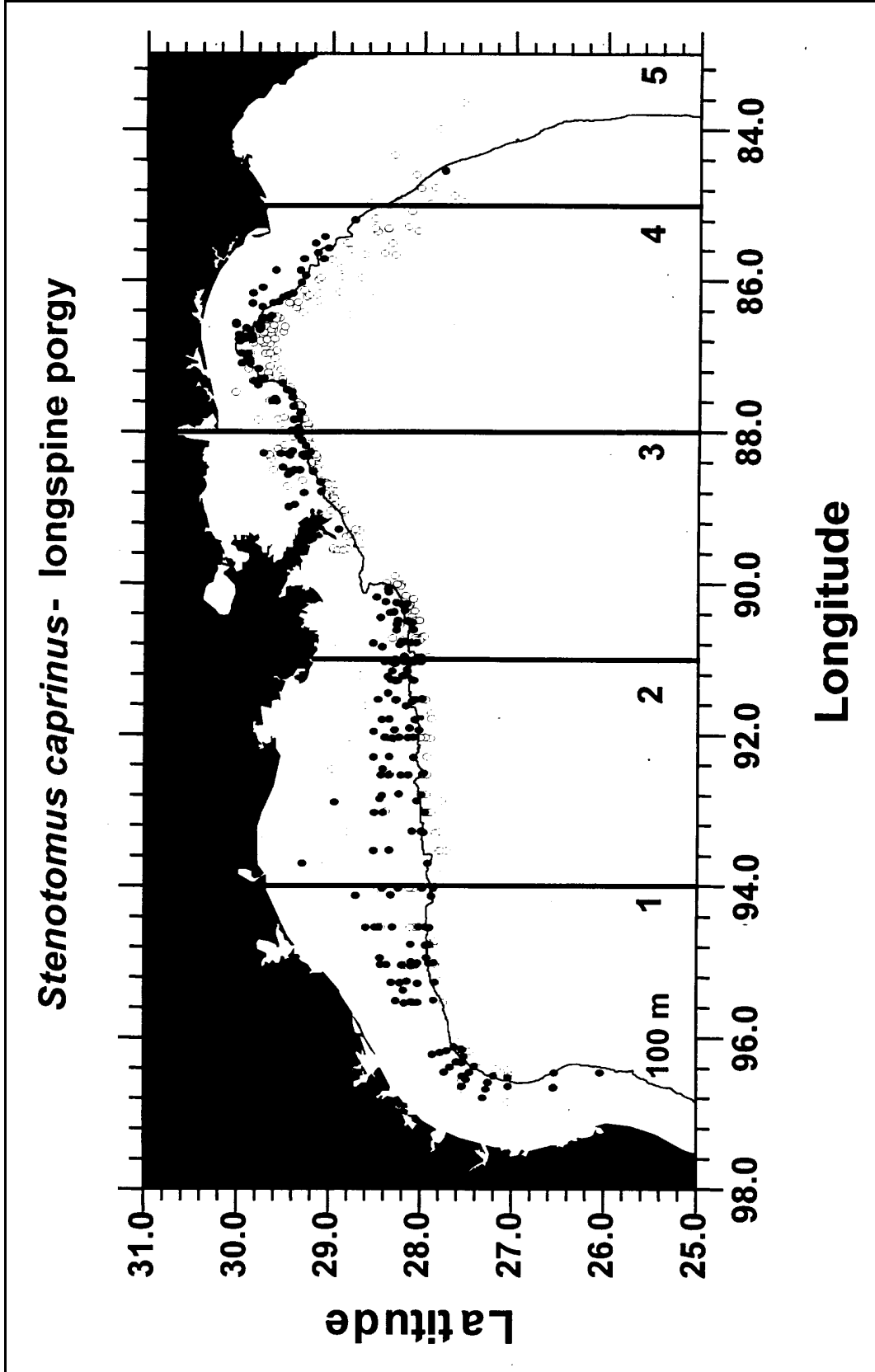

Figure 6.6 The occurrence of *Stenotomus caprinus* at the stations sampled in this study. Solid circles indicate presence of this species; open circles indicate that a sample was taken but this squid was not present at that station. The zones (1-5) correspond to regions of the GOM, from west to east, that have roughly geographic similarities and are to assist with synthesis across the broad geographic scale of the GOM (c.f. Table 6.1). The solid line is the 100 m depth contour, approximately denoting the continental shelf region.

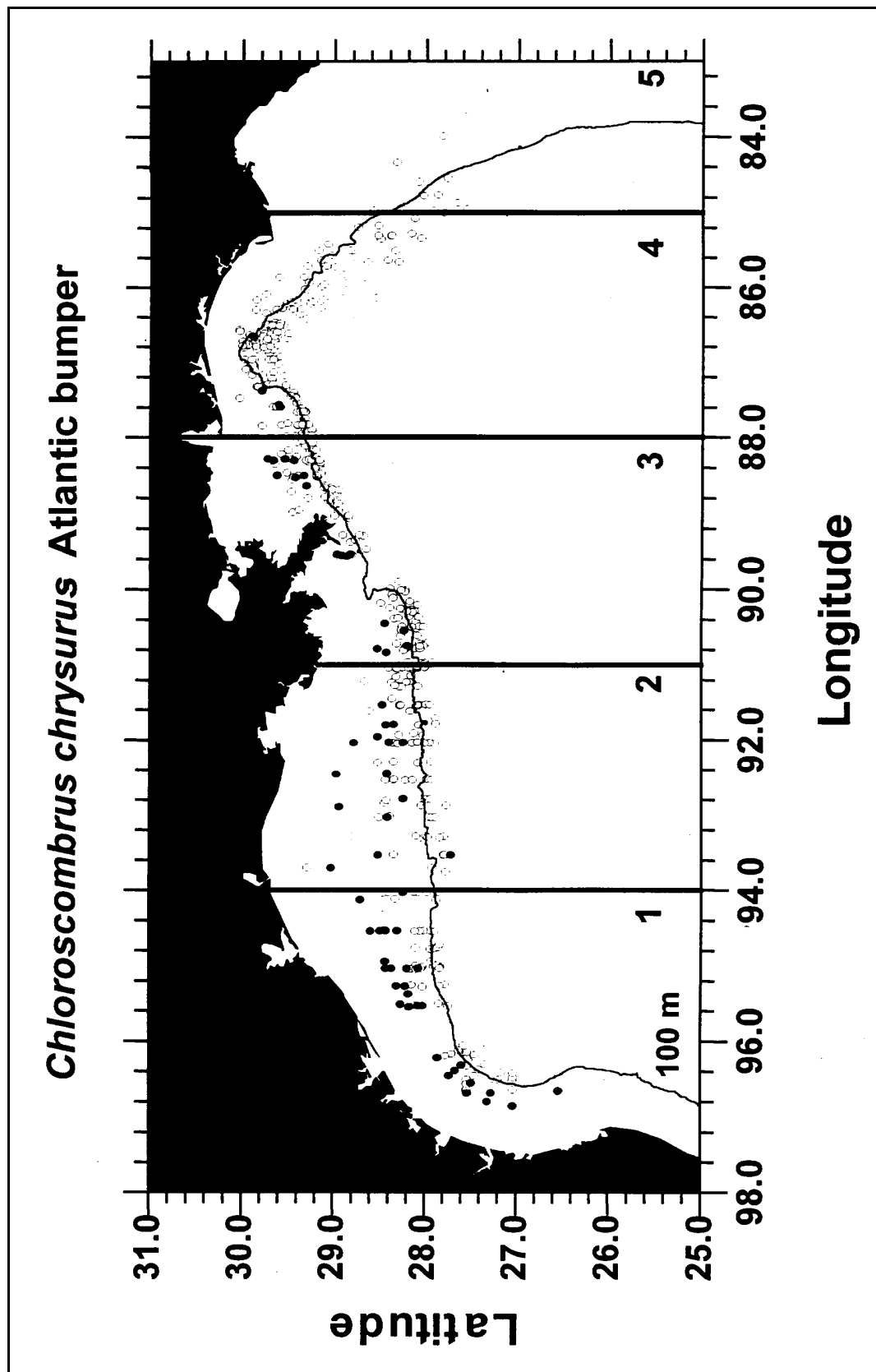

Figure 6.7. The occurrence of *Chloroscombrus chrysurus* at the stations sampled in this study. Solid circles indicate presence of this species; open circles indicate that a sample was taken but this squid was not present at that station. The zones (1-5) correspond to regions of the GOM, from west to east, that have roughly geographic similarities and are to assist with synthesis across the broad geographic scale of the GOM (c.f. Table 6.1). The solid line is the 100 m depth contour, approximately denoting the continental shelf region.

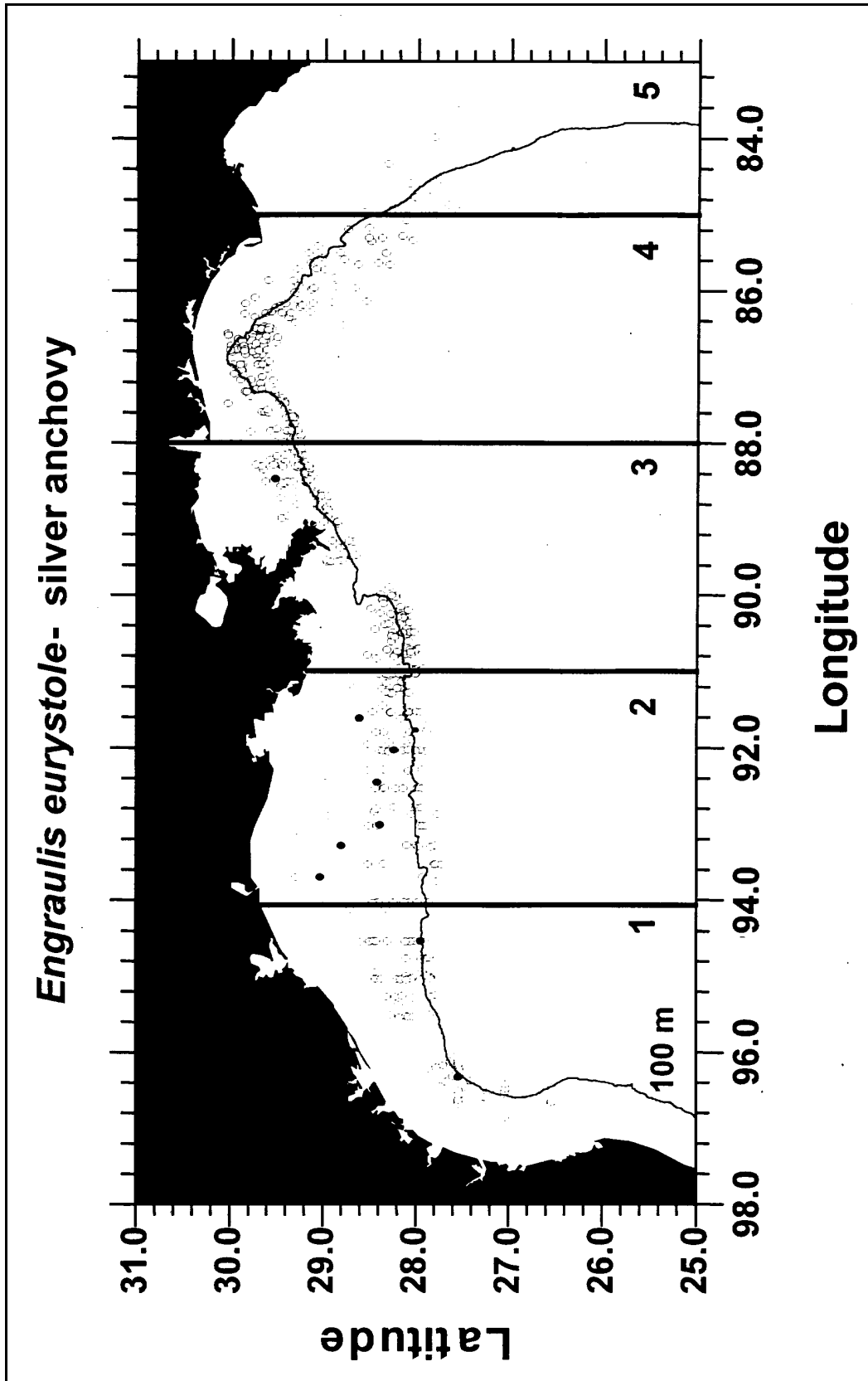

Figure 6.8. The occurrence of *Engraulis eurystole* at the stations sampled in this study. Solid circles indicate presence of this species; open circles indicate that a sample was taken but this squid was not present at that station. The zones (1-5) correspond to regions of the GOM, from west to east, that have roughly geographic similarities and are to assist with synthesis across the broad geographic scale of the GOM (c.f. Table 6.1). The solid line is the 100 m depth contour, approximately denoting the continental shelf region.

D. punctatus and *S. aurita* were most common in the eastern GOM (Figures 6.9 and 6.10). Both had their highest abundance in zone 5, with abundances there two to three orders of magnitude greater than in the rest of the GOM (Table 6.3). Other species that occurred predominantly in the eastern Gulf were *Rhomboplites aurorubens* and *Saurida normani* (Table 6.4).

The remaining pelagics were most abundant in the central GOM (Figures 6.11–6.15). *Diaphus* sp., *A. hepsetus*, and *S. argentea* had a narrow distribution and were not observed in zones 1 and 5 (Figures 6.11–6.13). *T. lepturus* and *M. undulatus* similarly were not observed in zone 5, but did have a broader distribution. All five of these species were most abundant in zone 3 (Table 6.3). Many other species occurred predominately in the central GOM, including *Caranx crysos*, *Cynoscion nothus* and *Cynoscion arenarius* (Table 6.4). This was the region with the greatest biomass and number of fish in the GOM.

Depth Gradients in the Gulf

Loligo sp. and *S. japonicus* were unique organisms in that they exhibited no peak abundance at a particular depth (Table 6.5). Both were common throughout the GOM, and occurred on either side of the shelf slope with regularity (Figures 6.4 and 6.5). *Synodus foetens* also exhibited no distinct depth preference (Table 6.6).

Practically all clupeids, all engraulids, most sparids, and most scianids were shallow-water species, abundant at depths < 50 m (Table 6.5). Many of the species in this study were concentrated at these depths (Table 6.6). However, some of these shallow water species also occurred at notable levels of abundance out to depths of 150 m.

Three of the top four most abundant species in this study were most common beyond the range of normal groundfish and shrimp surveys (Table 6.5). *E. teres*, *P. burti*, and *T. lathami* were most abundant at depths of 100-200 m. The greatest number and biomass of all pelagics was concentrated in the 100-150 m depth range.

Diaphus sp. and *S. argentea* were clearly deep-water species (Table 6.5). The greatest abundance of each species was over 300 and 200 m respectively. The abundance of *Diaphus* sp. was two to three orders of magnitude higher at depths > 200 m than at other depths. Both these species were concentrated on the abyssal side of the continental slope (Figures 6.11 and 6.13). Other deep-water species included *Ariomma bondi*, *Illex* sp., and *Synagrops* sp., among others (Table 6.6). Other than these few examples, most species were rare beyond 200 m.

Length

Mean length for all species was 14 cm. The largest fish we sampled was rough scad (Table 6.7) but many of the species were frequently less than 10 mm. Very few species averaged individual weights > 100 g. Although abundant, most of these organisms were not large.

Several of the species were only sampled at depths < 100 m (Table 6.5) and exhibited no notable change in size across depth (Figures 6.16–6.20). *S. aurita* (Figure 6.16), *C. chrysurus* (Figure 6.17)

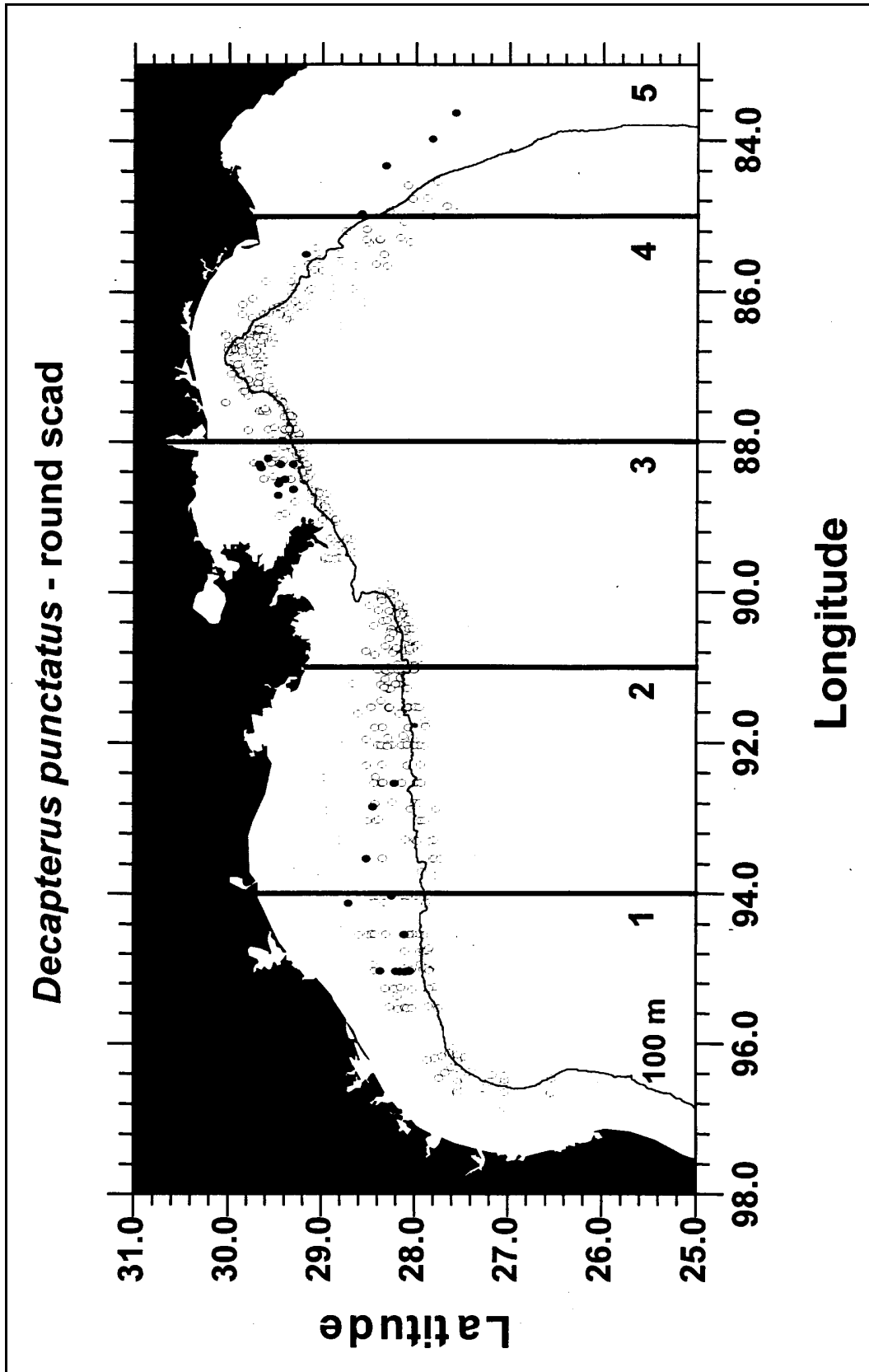

Figure 6.9. The occurrence of *Decapterus punctatus* at the stations sampled in this study. Solid circles indicate presence of this species; open circles indicate that a sample was taken but this squid was not present at that station. The zones (1-5) correspond to regions of the GOM, from west to east, that have roughly geographic similarities and are to assist with synthesis across the broad geographic scale of the GOM (c.f. Table 6.1). The solid line is the 100 m depth contour, approximately denoting the continental shelf region.

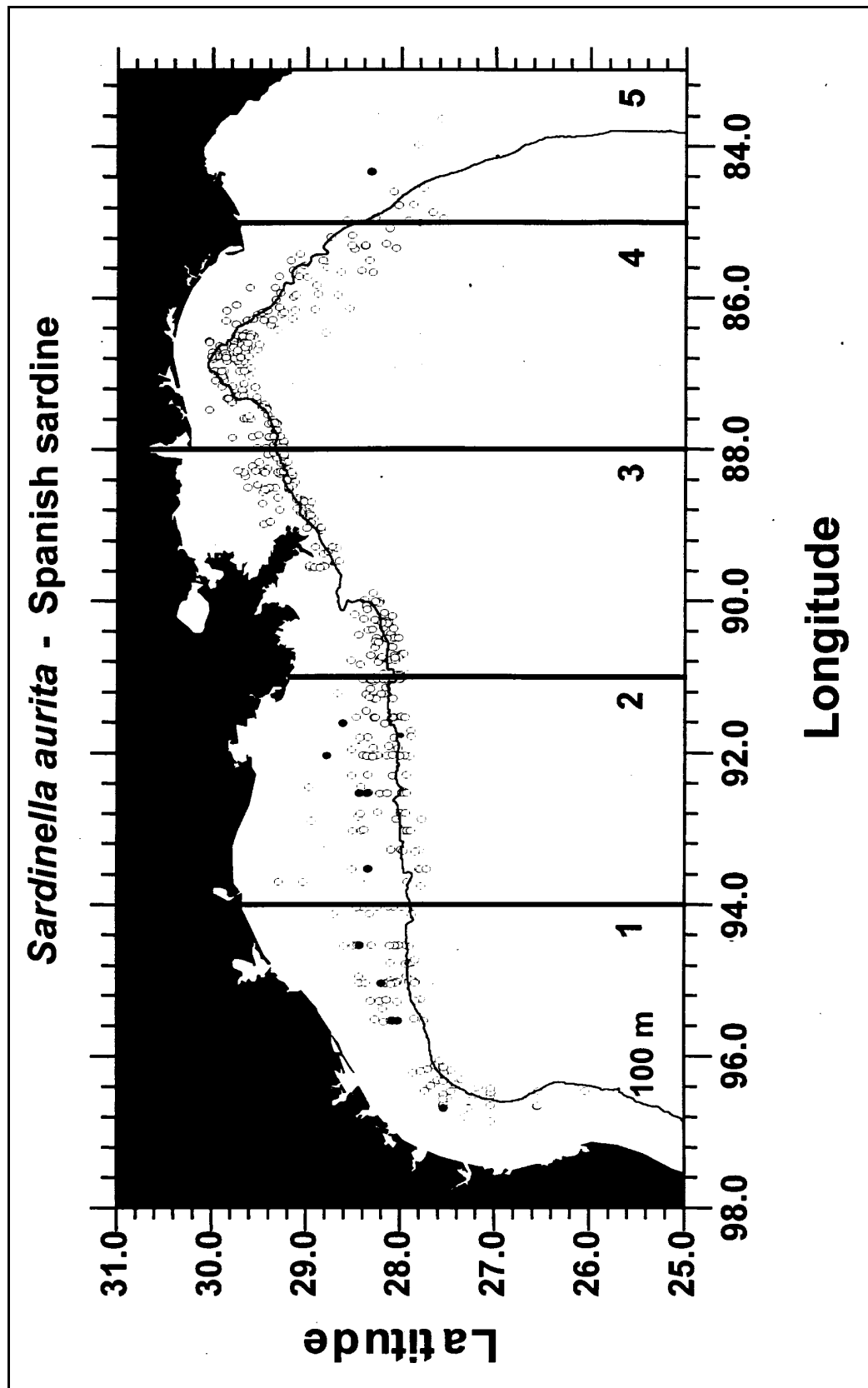

Figure 6.10. The occurrence of *Sardinella aurita* at the stations sampled in this study. Solid circles indicate presence of this species; open circles indicate that a sample was taken but this squid was not present at that station. The zones (1-5) correspond to regions of the GOM, from west to east, that have roughly geographic similarities and are to assist with synthesis across the broad geographic scale of the GOM (c.f. Table 6.1). The solid line is the 100 m depth contour, approximately denoting the continental shelf region.

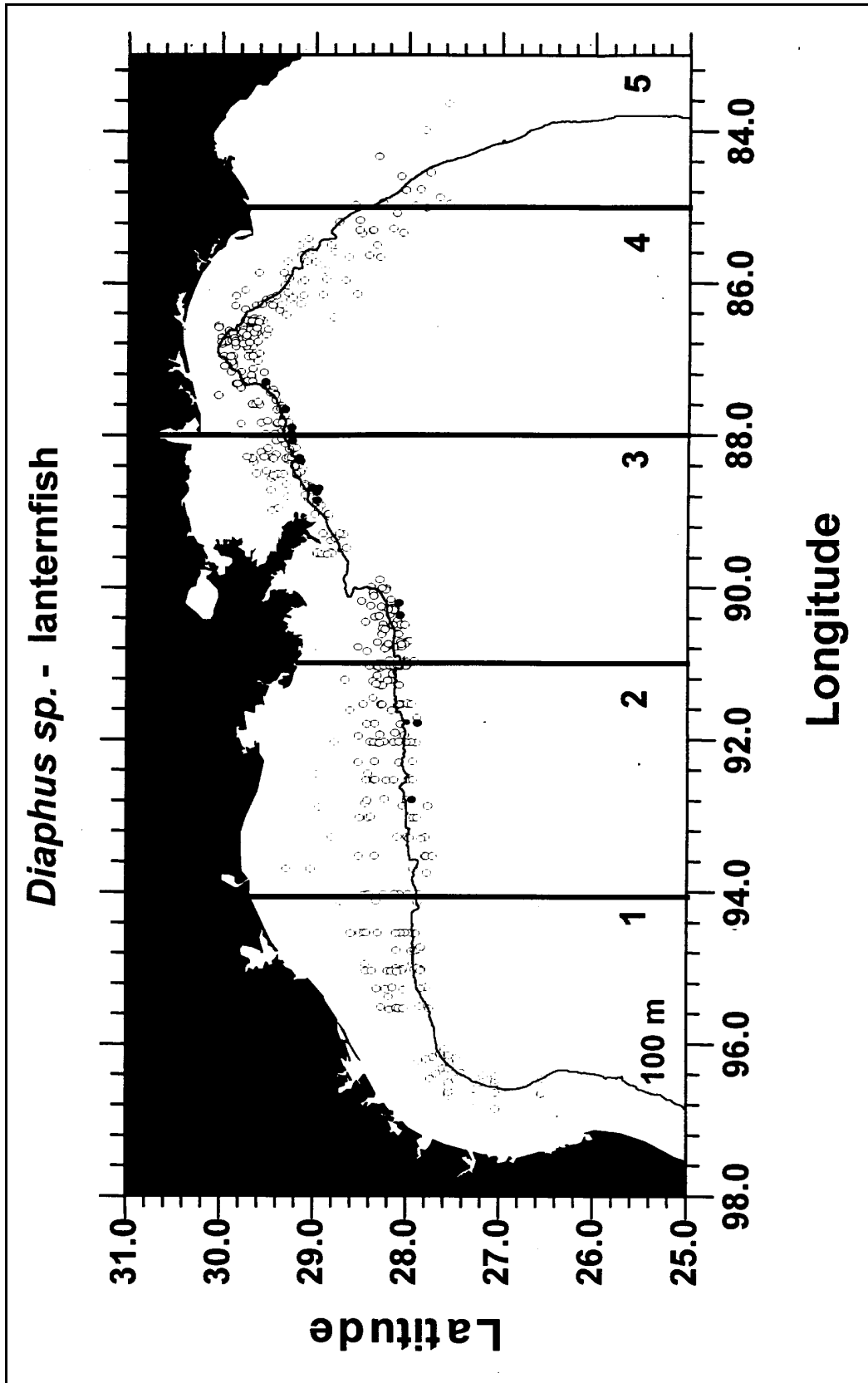

Figure 6.11. The occurrence of *Diaphus* sp. at the stations sampled in this study. Solid circles indicate presence of this species; open circles indicate that a sample was taken but this squid was not present at that station. The zones (1-5) correspond to regions of the GOM, from west to east, that have roughly geographic similarities and are to assist with synthesis across the broad geographic scale of the GOM (c.f. Table 6.1). The solid line is the 100 m depth contour, approximately denoting the continental shelf region.

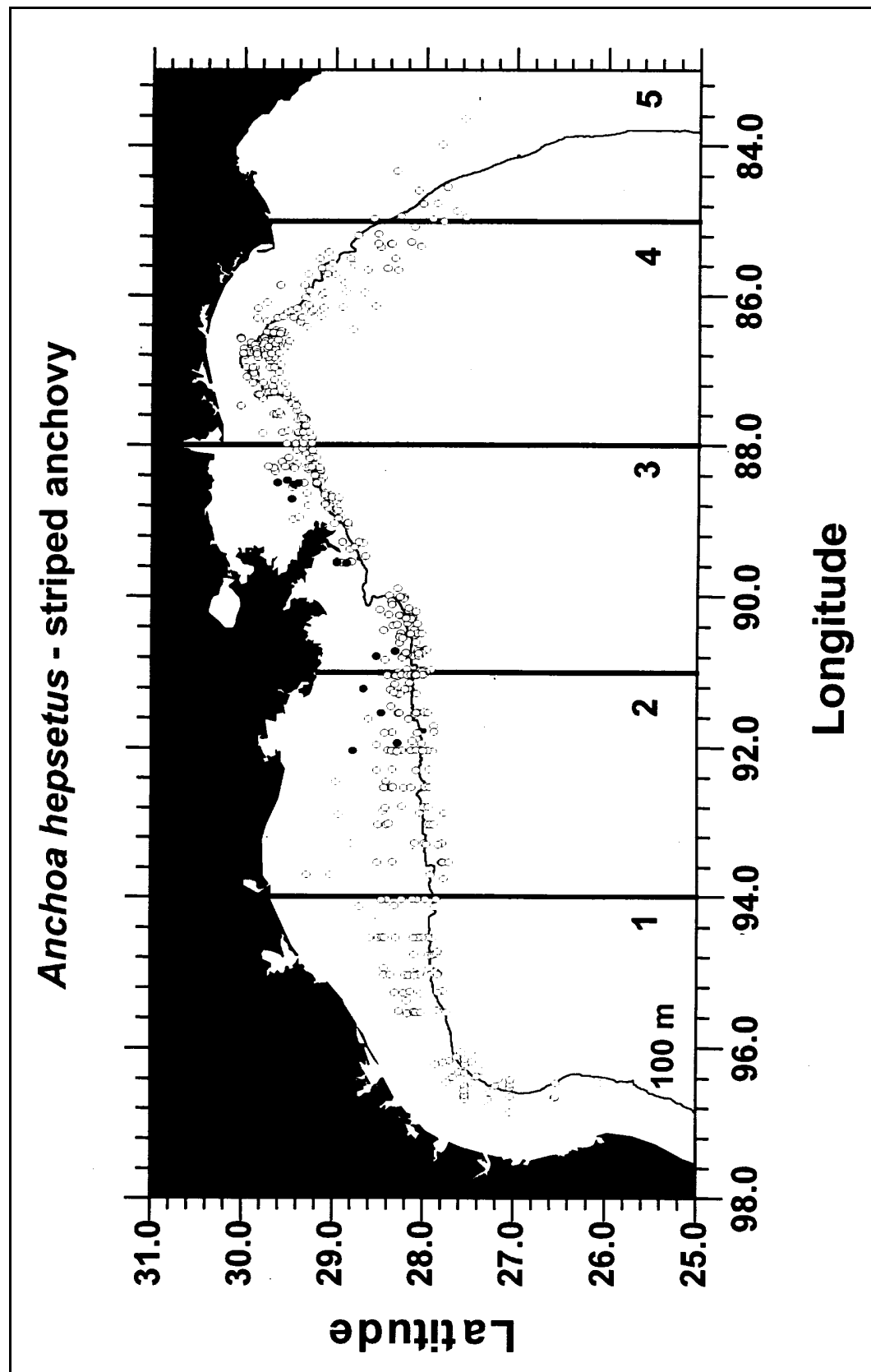

Figure 6.12. The occurrence of *Anchoa hepsetus* at the stations sampled in this study. Solid circles indicate presence of this species; open circles indicate that a sample was taken but this squid was not present at that station. The zones (1-5) correspond to regions of the GOM, from west to east, that have roughly geographic similarities and are to assist with synthesis across the broad geographic scale of the GOM (c.f. Table 6.1). The solid line is the 100 m depth contour, approximately denoting the continental shelf region.

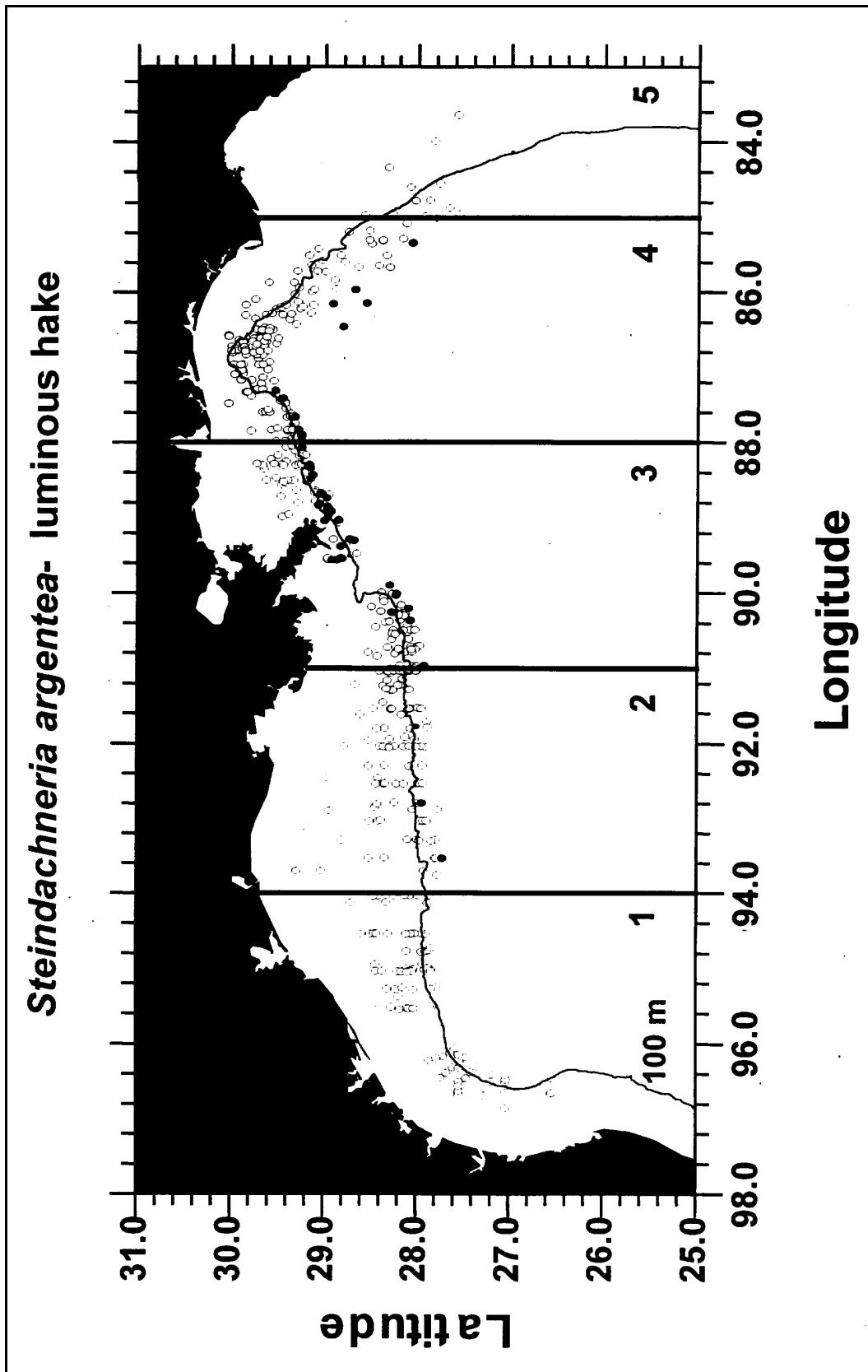

Figure 6.13. The occurrence of *Steindachneria argentea* at the stations sampled in this study. Solid circles indicate presence of this species; open circles indicate that a sample was taken but this squid was not present at that station. The zones (1-5) correspond to regions of the GOM, from west to east, that have roughly geographic similarities and are to assist with synthesis across the broad geographic scale of the GOM (c.f. Table 6.1). The solid line is the 100 m depth contour, approximately denoting the continental shelf region.

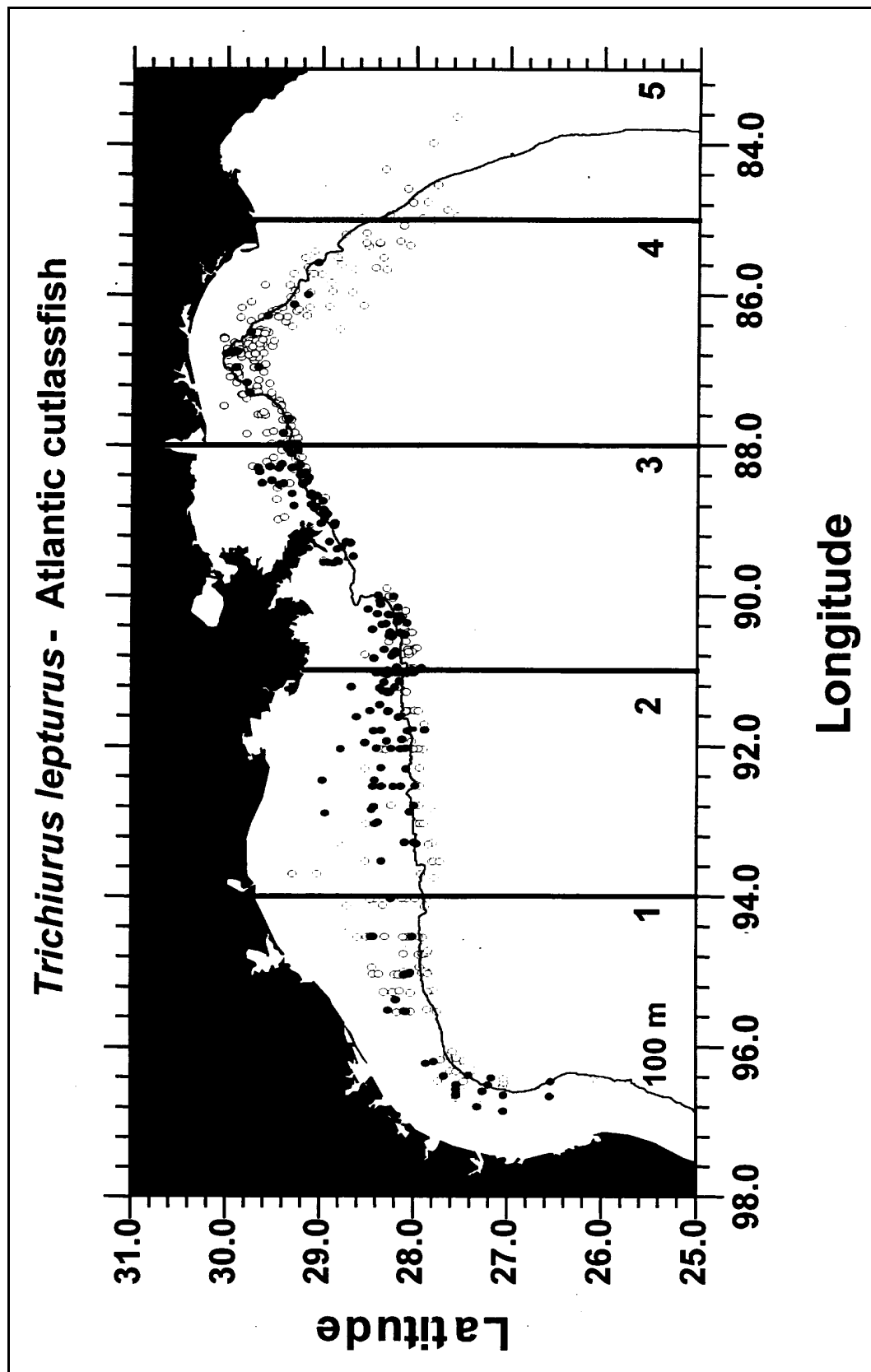

Figure 6.14. The occurrence of *Trichiurus lepturus* at the stations sampled in this study. Solid circles indicate presence of this species; open circles indicate that a sample was taken but this squid was not present at that station. The zones (1-5) correspond to regions of the GOM, from west to east, that have roughly geographic similarities and are to assist with synthesis across the broad geographic scale of the GOM (c.f. Table 6.1). The solid line is the 100 m depth contour, approximately denoting the continental shelf region.

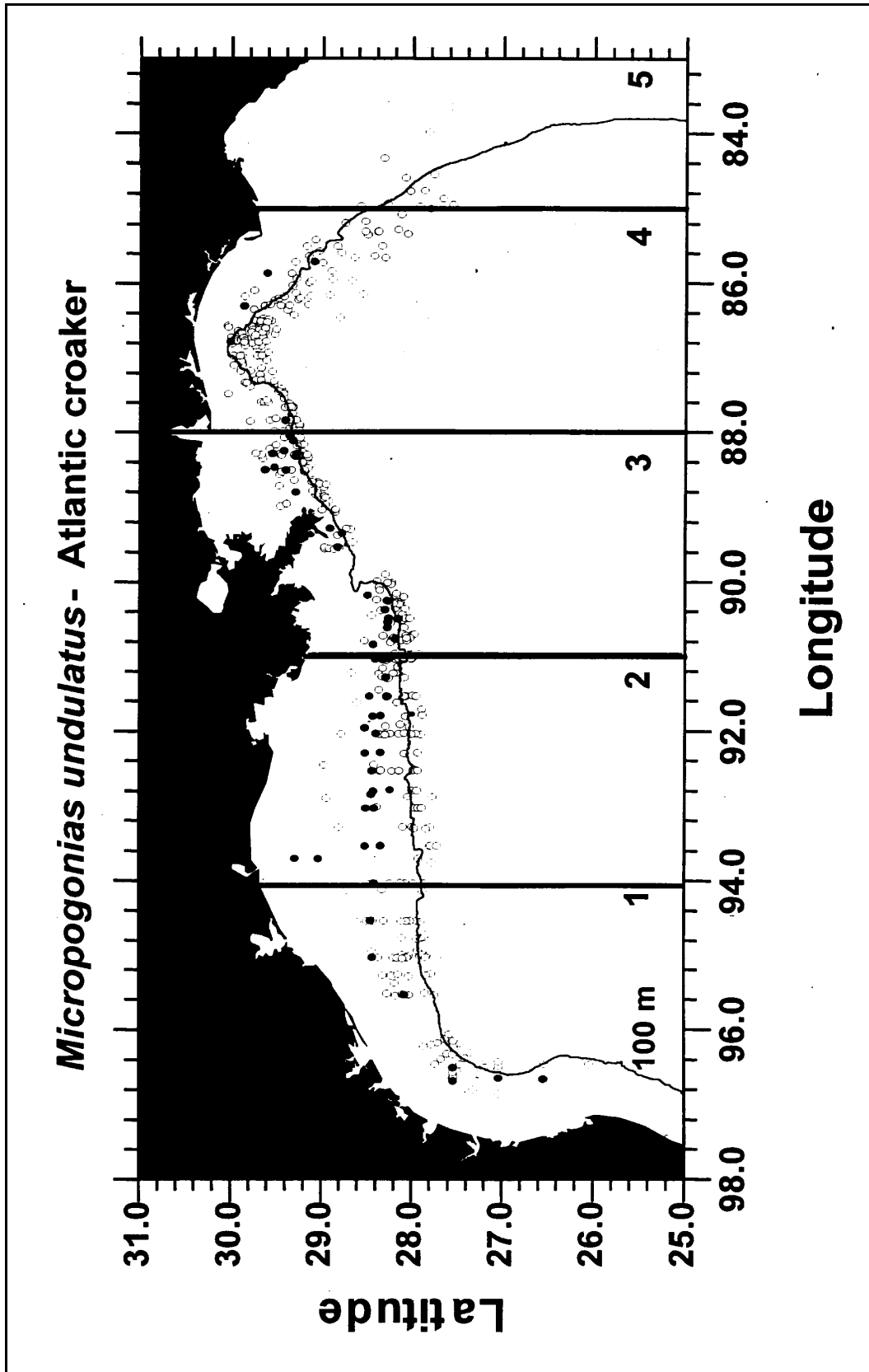

Figure 6.15. The occurrence of *Micropogonias undulatus* at the stations sampled in this study. Solid circles indicate presence of this species; open circles indicate that a sample was taken but this squid was not present at that station. The zones (1-5) correspond to regions of the GOM, from west to east, that have roughly geographic similarities and are to assist with synthesis across the broad geographic scale of the GOM (c.f. Table 6.1). The solid line is the 100 m depth contour, approximately denoting the continental shelf region.

Table 6.5. Mean catch (\pm S.E., in No. hr⁻¹) of squid across depth (m) strata. S.E.=standard error, n=sample size.

Depth	0-50	50-100	100-150	150-200	200-250	250-300	300+
n	216	249	183	118	72	54	19
P. burti	1033.5 (311.4)	2001.0 (376.9)	7701.5 (1495.4)	1518.3 (358.2)	180.0 (82.7)	6.8 (3.4)	0
E. teres	642.2 (202.6)	1972.6 (1014.9)	4190.5 (767.7)	2341.0 (731.6)	206.6 (140.8)	0.778 (0.604)	0
S. caprinus	2996.9 (648.9)	2015.7 (298.4)	1405.1 (566.1)	78.8 (55.3)	0.05 (0.05)	0	0
T. lathami	441.7 (134.1)	1326.0 (321.1)	3345.18 (664.5)	1455.7 (270.0)	509.4 (193.4)	17.7 (7.9)	10.8 (10.7)
Loligo sp.	676.86 (170.33)	376.80 (56.087)	334.81 (91.654)	598.19 (137.45)	670.24 (89.814)	179.83 (48.443)	35.789 (15.261)
S. argenta	0.5 (0.5)	103.6 (50.8)	420.0 (176.0)	827.7 (385.4)	1723.7 (880.2)	396.2 (100.7)	290.6 (113.5)
D. punctatus	1169.8 (540.3)	142.3 (79.6)	0.12 (0.12)	0	0	0	0
T. lepturus	168.2 (44.3)	658.0 (136.8)	237.2 (70.2)	260.5 (169.3)	141.3 (121.5)	46.4 (21.7)	0.74 (0.51)
Diaphus sp.	0.35 (0.35)	18.7 (18.7)	2.5 (1.7)	23.8 (22.5)	166.6 (112.0)	2162.2 (1642.1)	3877.4 (1653.2)
C. crysurus	941.0 (281.5)	237.2 (107.6)	0.13 (0.08)	0	0	0	0
E. eurystole	1111.1 (918.1)	32.9 (32.2)	0	0	0	0	0
S. japonicus	173.0 (140.9)	101.7 (39.2)	548.1 (194.4)	234.7 (115.9)	313.6	476.1 (396.0)	4.8 (4.0)
S. aurita	937.5 (397.5)	7.14 (3.49)	0.033 (0.328)	0	0	0	0
A. hepsetus	702.5 (329.3)	14.7 (11.1)	0	0	0	0	0
M. undulatus	243.8 (98.6)	223.1 (86.8)	117.6 (63.5)	0	0	0	0

Table 6.6. Species with biomass or occurrence predominant at the different depths. Shallow <100m, Mid-Depth=100-200m, Deep>200m, Widespread=all depths.

Abundant Species		Rarer Species	
Shallow		Shallow	
<i>Stenotomus caprinus</i>		<i>Lolliguncula brevis</i>	
<i>Decapterus punctatus</i>		<i>Upeneus sp.</i>	
<i>Trichiurus lepturus</i>		<i>Upeneus parvus</i>	
<i>Chloroscombus chrysurus</i>		<i>Mullus auratu</i>	
<i>Engraulis eurystole</i>		<i>Saurida brasilia</i>	
<i>Sardinella aurita</i>		<i>Lagocephalus laevigatus</i>	
<i>Anchoa hepsetus</i>		all Clupeids	
<i>Micropogonias undulatus</i>		all Engrualids	
<i>Leiostomus xanthu</i>		most Sparids	
<i>Lagodon rhomboides</i>		most Scianids	
Mid-Depth		Mid-Depth	
<i>Etrumeus teres</i>		<i>Abralia veranyi</i>	
<i>Peprilus burti</i>		<i>Saurida normani</i>	
<i>Trachurus lathami</i>		<i>Pristipomoides aquilonaris</i>	
Deep		Deep	
<i>Steindacneria argentea</i>		<i>Illex sp.</i>	
<i>Diaphus sp.</i>		<i>Ariomma bondi</i>	
<i>Polymixia lowei</i>		<i>Synagrops bella</i>	
		<i>Synagrops spinosus</i>	
		<i>Mauolicus muelleri</i>	
		<i>Pontinus longispinis</i>	
Widespread		Widespread	
<i>Loligo sp.</i>		<i>Synodus foetens</i>	
<i>Scomber japonicus</i>			

Table 6.7. Mean length (cm) and weight (g) of major pelagic species.

Species	Comman Name	Mean Length (cm)	Min Length	Max Length	Mean Wt. (g)
<i>Peprilus burti</i>	Gulf Butterfish	14.1	2.0	26.6	74
<i>Etrumeus teres</i>	Round Herring	13.2	2.3	51.2	21
<i>Stenotomus caprinus</i>	Longspine Porgy	12.0	0.2	20.8	41
<i>Trachurus lathami</i>	Rough Scad	15.3	0.4	75.8	56
<i>Loligo</i> sp.	Longfin Squid	7.3	6.0	37.2	20
<i>Steindachneria argenta</i>	Luminous Hake	14.4	1.2	30.5	12
<i>Decapterus punctatus</i>	Round Scad	14.8	4.8	21.9	45
<i>Trichiurus lepturus</i>	Atlantic Cutlassfish	16.7	2.0	53.1	69
<i>Diaphus</i> sp.	Lanternfish	5.4	2.3	8.9	2
<i>Chloroscombrus chrysurus</i>	Atlantic Bumper	14.3	1.6	31.8	61
<i>Engraulis eurystole</i>	Silver Anchovy	6.9	2.1	12.4	2
<i>Scomber japonicus</i>	Chub Mackerel	20.0	3.0	35.0	94
<i>Sardinella aurita</i>	Spanish Sardine	14.7	8.8	22.0	41
<i>Anchoa hepsetus</i>	Striped Anchovy	11.3	4.1	17.8	13
<i>Micropogonias undulatus</i>	Atlantic Croaker	18.6	1.6	50.5	73
<i>Parapenaeus</i> sp.	Shrimp	-	-	-	<1
<i>Polymixia lowei</i>	Beardfish	11.3	6.5	42.5	20
<i>Lagodon rhomboides</i>	Pinfish	16.0	9.1	46.5	84
<i>Pristipomoides aquilonaris</i>	Wenchman	16.3	0.2	29.8	127
<i>Ariomma bondi</i>	Silver Rag	16.4	5.3	21.3	74
<i>Upeneus parvus</i>	Dwarf Goatfish	12.0	2.6	24.0	34
<i>Mullus auratus</i>	Red Goatfish	15.2	2.8	28.5	65
<i>Trachypeneus</i> sp.	Shrimp	-	-	-	<1
<i>Leiostomus xanthurus</i>	Spot	19.9	11.1	30.0	114
<i>Macrorhampuhosus scolopax</i>	Longspine Snipefish	10.4	6.5	14.5	3
<i>Anchoa mitchilli</i>	Bay Anchovy	5.5	3.6	8.3	6
Clupeidae	Herrings	-	-	-	-
<i>Saurida brasiliensis</i>	Largescale Lizardfish	8.5	0.7	39.5	24
Caridea	Unclassified Shrimp	-	-	-	<1
<i>Cynoscion arenarius</i>	Sand Seatrout	22.7	6.6	40.9	119

Table 6.7. (continued)

Species	Comman Name	Mean Length (cm)	Min Length	Max Length	Mean Wt. (g)
Unid. Fish	-	-	-	-	-
<i>Peprilus alevinatus</i>	Harvestfish	14.8	2.5	20.0	381
<i>Lolliguncula brevis</i>	Breif Squid	3.6	1.2	18.5	5
<i>Harengula jaguana</i>	Scaled Sardine	13.3	6.7	20.3	46
<i>Synodus foetens</i>	Inshore Lizardfish	24.9	5.3	44.6	158
<i>Abralia veranyi</i>	Abralia Squid	3.4	0.9	13.6	4
<i>Opisthonema oglinum</i>	Atlantic Thread Herring	15.8	3.4	29.8	68
<i>Maurollicus muelleri</i>	Atlantic Pearlside	4.6	2.8	5.8	2
<i>Cynoscion nothus</i>	Silver Seatrout	20.2	7.2	41.4	81
<i>Rhomboplites aurorubens</i>	Vermilion Snapper	17.9	0.2	33.5	114

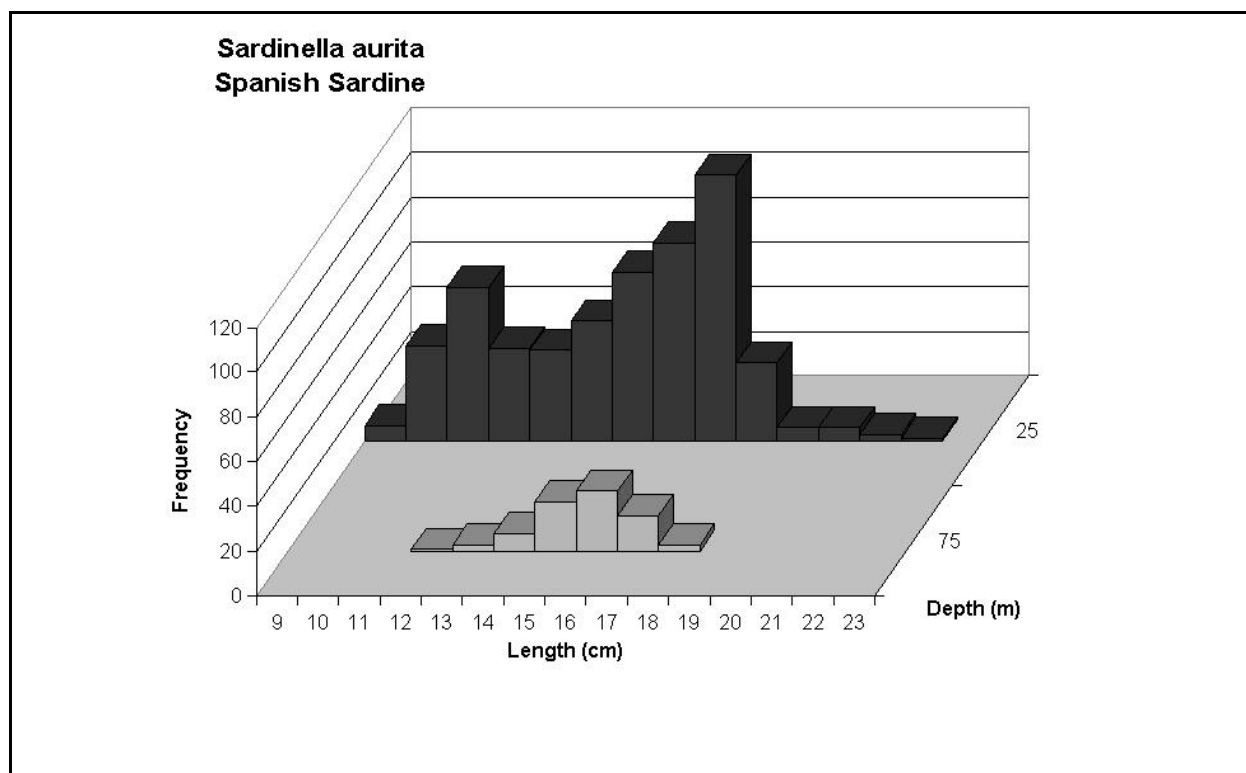

Figure 6.16. Length frequency distribution of *S. aurita* across the depth strata in this study. Depth zones are represented as the midpoint of the strata (e.g. 25 is 0-50 m, 75 is 50-100 m, etc).

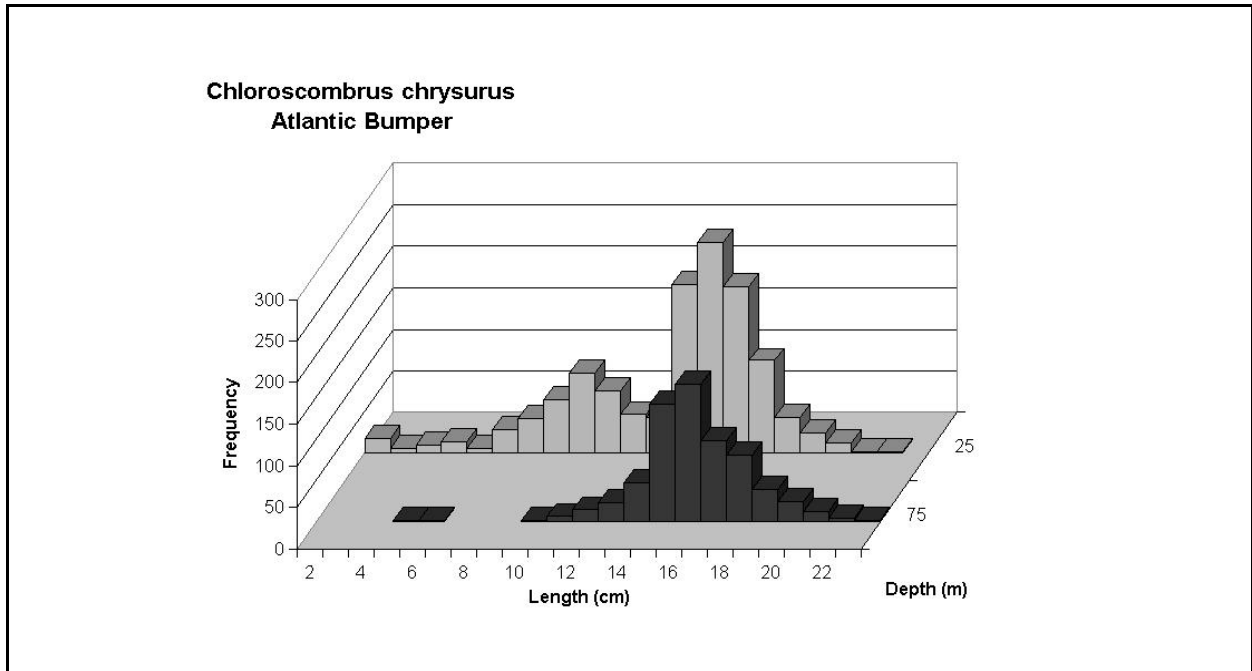

Figure 6.17. Length frequency distribution of *C. chrysurus* across the depth strata in this study. Depth zones are represented as the midpoint of the strata (e.g. 25 is 0-50 m, 75 is 50-100 m, etc.).

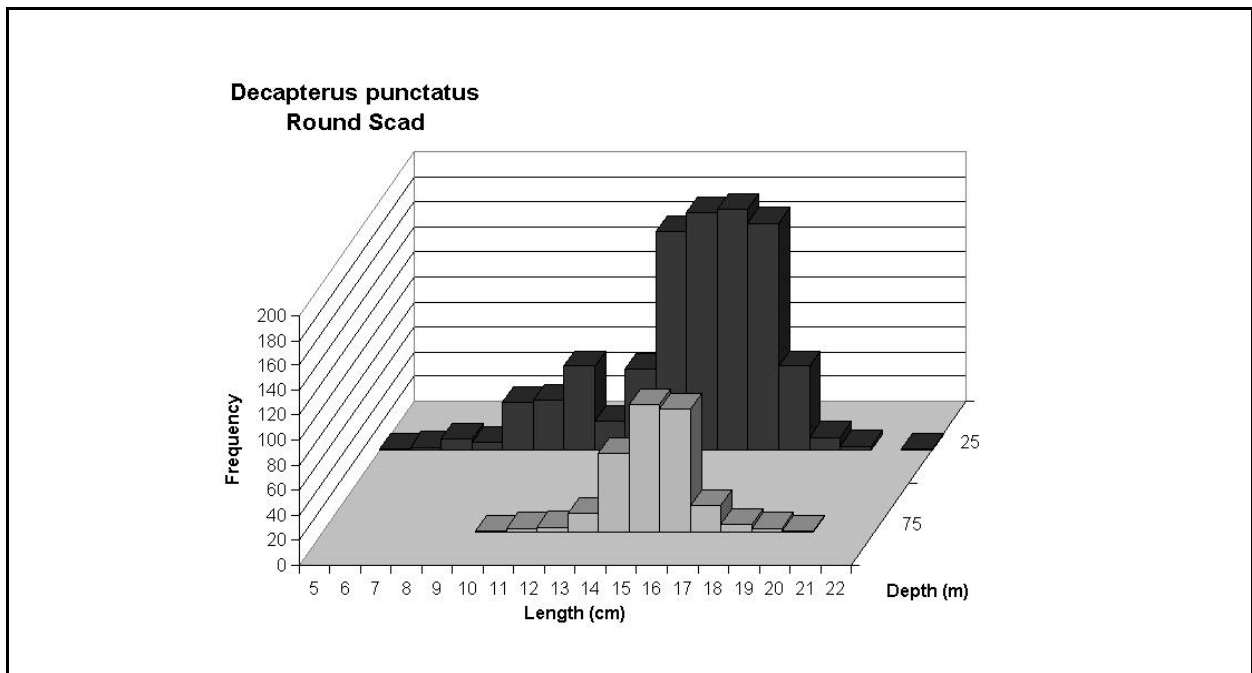

Figure 6.18. Length frequency distribution of *D. punctatus* across the depth strata in this study. Depth zones are represented as the midpoint of the strata (e.g. 25 is 0-50 m, 75 is 50-100 m, etc.).

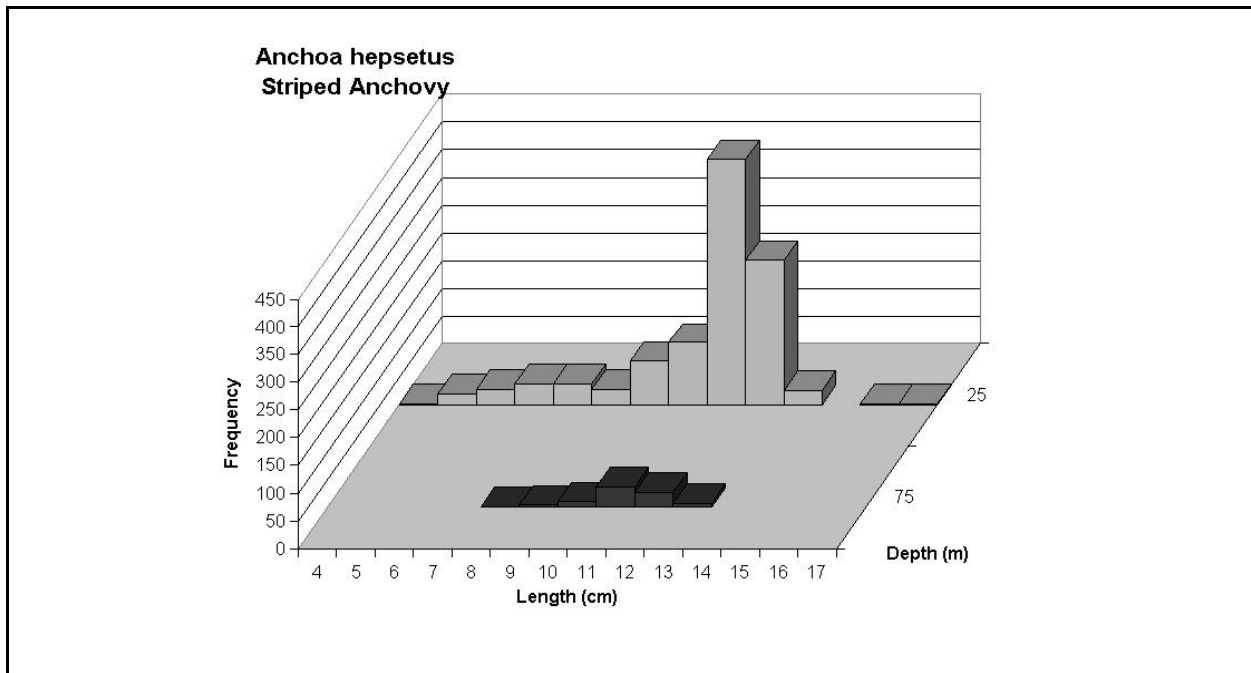

Figure 6.19. Length frequency distribution of *A. hepsetus* across the depth strata in this study. Depth zones are represented as the midpoint of the strata (e.g. 25 is 0-50 m, 75 is 50-100 m, etc.).

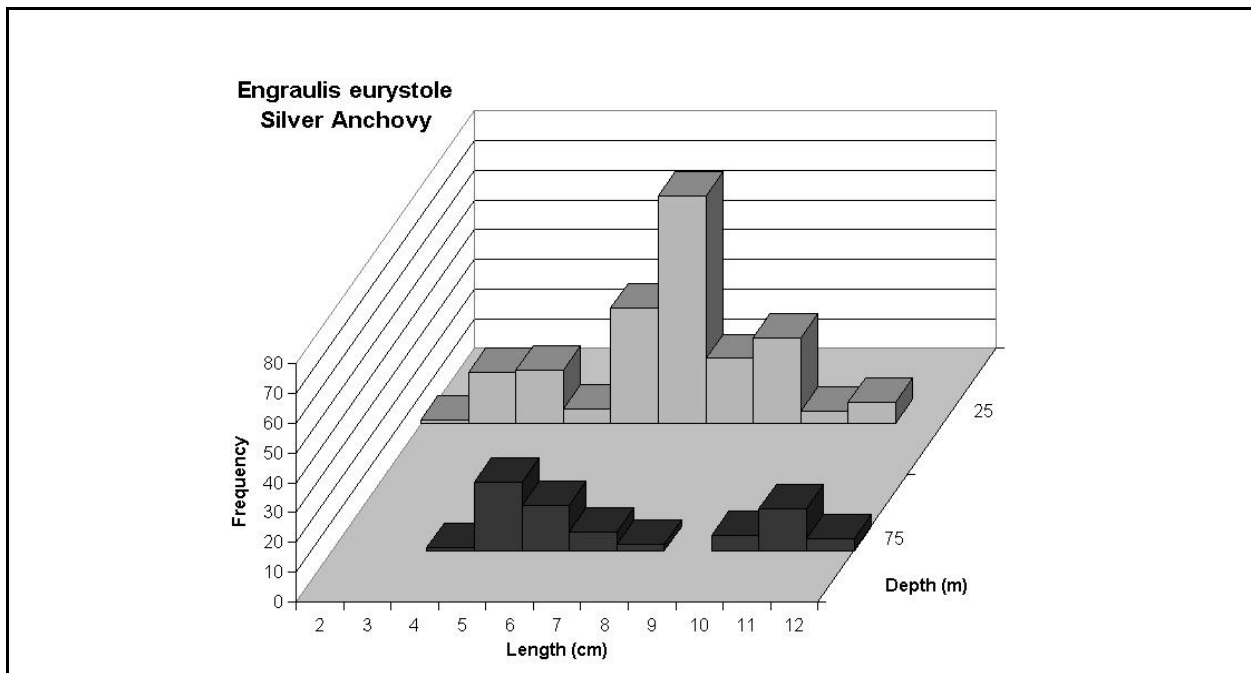

Figure 6.20. Length frequency distribution of *E. eurystole* across the depth strata in this study. Depth zones are represented as the midpoint of the strata (e.g. 25 is 0-50 m, 75 is 50-100 m, etc.).

and *D. punctatus* (Figure 6.18) showed a bimodal length distribution at shallower depths (< 50 m), but only a unimodal distribution (no smaller mode) at 50-100 m. *A. hepsetus* (Figure 6.19) and *E. eurystole* (Figure 6.20) exhibited effectively a unimodal distribution. *Diaphus* sp., *S. caprinus*, and *Loligo* sp. were present at a wide range of depths (Table 6.5), but showed no differences in size across depth (Figures 6.21–6.23). All three species were unimodal, but *Loligo* sp. did have a broad size distribution.

P. burti was also present at a wide range of depths, but showed a subtle increase in size at greater depths (Figure 6.24). Similarly, *M. undulatus*, *E. teres*, *T. lepturus*, *T. lathami*, *S. japonicus*, and *S. argentea* (Figures 6.25–6.30) showed notable increases in length at greater depths. *P. burti*, *M. undulatus*, and *E. teres* were unimodal, whereas the remaining four species were bimodal, with the smaller mode generally more frequent at shallower depths.

DISCUSSION

Many of these pelagic species are broadly distributed across numerous ecosystems (e.g. Costa & Fernandes 1993, Crawford and de Villiers 1984, Dawe *et al.* 1990, Grant 1981, Haimovici *et al.* 1996, Haimovici *et al.* 1994, Novikov 1986, Pierce & Guerra 1994, Reintjes 1980, Rountree 1990, Scoles *et al.* 1998, Whitaker 1980, Whitehead 1985, Xu & Chiu 1995). In fact, several of these species are cosmopolitan, with broad distributions across the Caribbean Sea, Mediterranean Sea, northern and southern Pacific, northern and southern Atlantic, and Indian Ocean. Thus, it is not surprising that several of these species (e.g. *T. lathami*, *S. japonicus*, *E. teres*, *Loligo* sp., etc.) are widely distributed in the GOM. These results generally concur with prior studies of GOM pelagics (e.g. Geoghegan and Chittenden 1982, Gledhill 1989, Hixon 1980, Houde 1977a, 1977b, 1977c, Murphy and Chittenden 1991, Nakumrua 1980, Reintjes 1980, Salcedo-Vargas 1991, Shaw and Drullinger 1990, Voss and Brackoniecki 1985). The pelagic fish and squid assemblage across the different regions of the Gulf are very similar, distinguished only by a few species that inhabit certain locations or depths of the Gulf.

Why are some species centered in the eastern or western Gulf? We readily admit that our sampling may have missed the occurrence of some species, particularly in the eastern GOM, due to low sample sizes or seasonal migrations. Given that possibility, we assert that the most prominent patterns observed for some of these organisms are likely more than artifact due to the persistent occurrence of certain species in certain regions year after year across multiple seasons. For instance, *C. chrysurus* is not present east of the DeSoto Canyon region (zone 4). Conversely, although present, *S. aurita* is not abundant west of the DeSoto Canyon region. Similar examples exist for other species (e.g. *E. eurystole* in the western Gulf and *D. punctatus* in the eastern Gulf; Table 6.4). Therefore, the Mississippi River/Mobile Bay physio-chemical environment appears to be a distinct biological barrier for some of these species. For example, salinity tolerances for clupeid larvae such as *H. jaguana* and *O. oglinum* are much lower than for *S. aurita* (Shaw & Drullinger 1990); hence we rarely observe the latter two species far from the Mississippi River region. Additionally, Economidis & Vogiatzis (1992) have documented a temperature induced fish kill of *S. aurita* in the Mediterranean. Thus, the distribution of these clupeids may be a function of the lower salinities and temperatures associated with the northern GOM. Other studies have demonstrated relationships between environmental factors such as salinity, temperature, thermocline depth, frontal boundaries

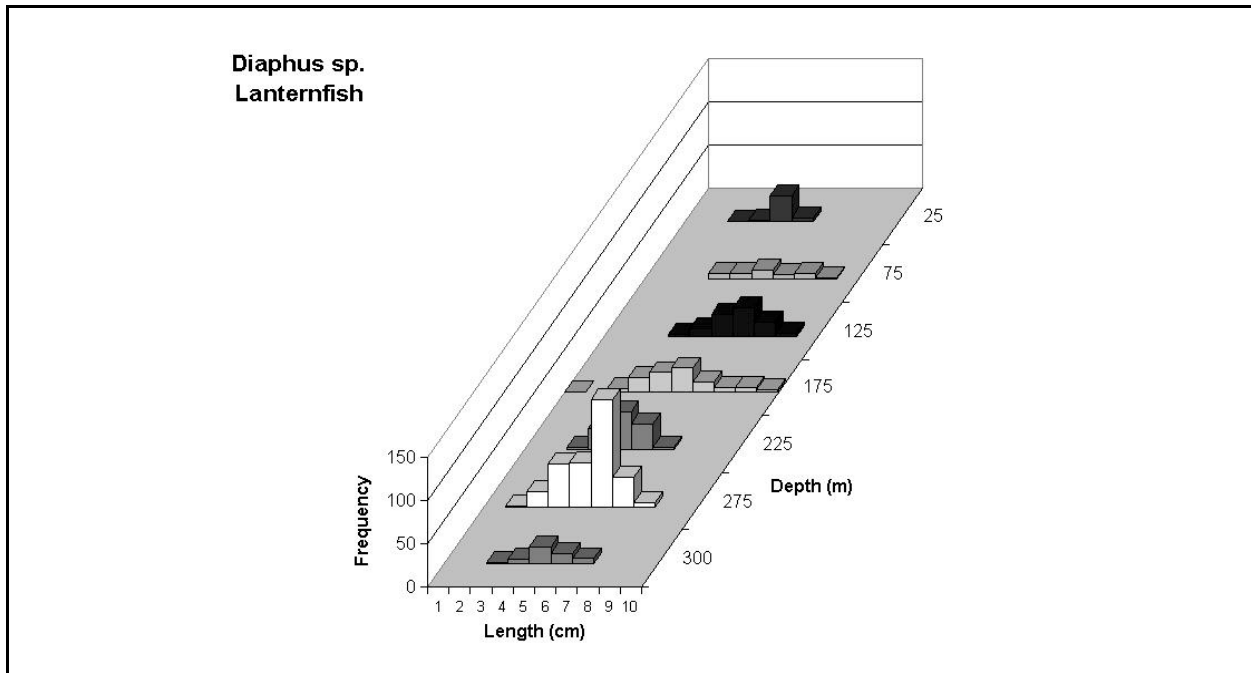

Figure 6.21. Length frequency distribution of *Diaphus* sp. across the depth strata in this study. Depth zones are represented as the midpoint of the strata (e.g. 25 is 0-50 m, 75 is 50-100 m, etc.).

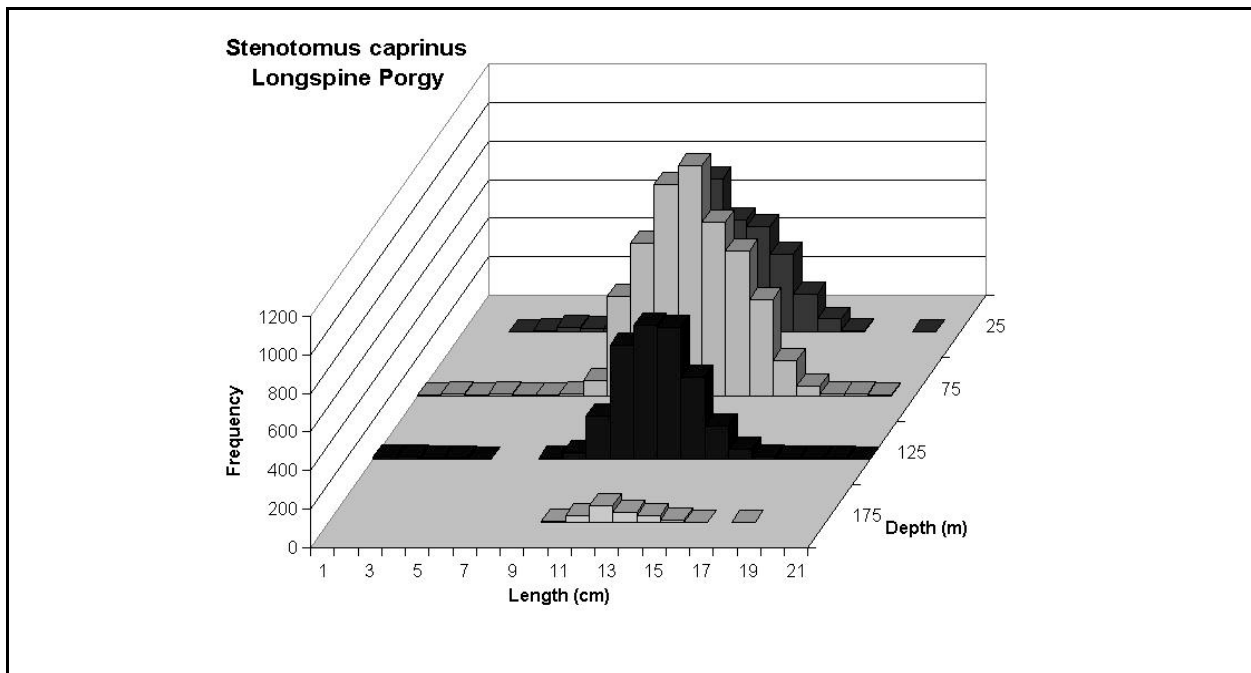

Figure 6.22. Length frequency distribution of *S. caprinus* across the depth strata in this study. Depth zones are represented as the midpoint of the strata (e.g. 25 is 0-50 m, 75 is 50-100 m, etc.).

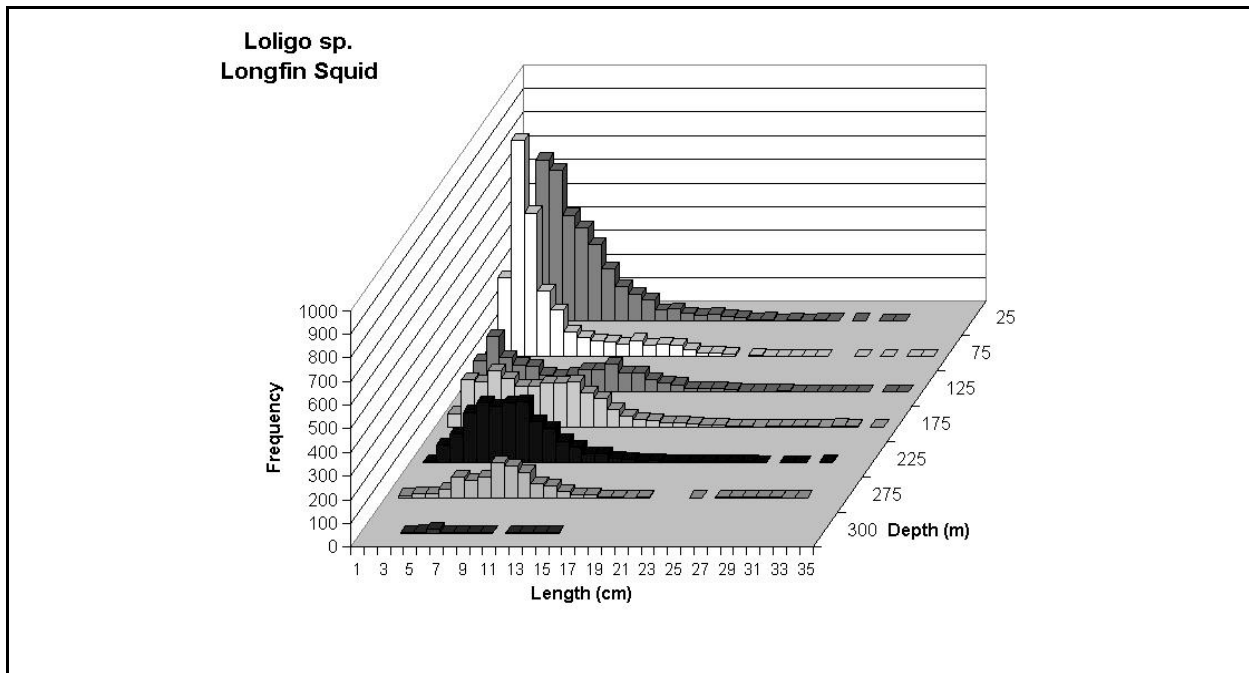

Figure 6.23. Length frequency distribution of *Loligo* sp. across the depth strata in this study. Depth zones are represented as the midpoint of the strata (e.g. 25 is 0-50 m, 75 is 50-100 m, etc.).

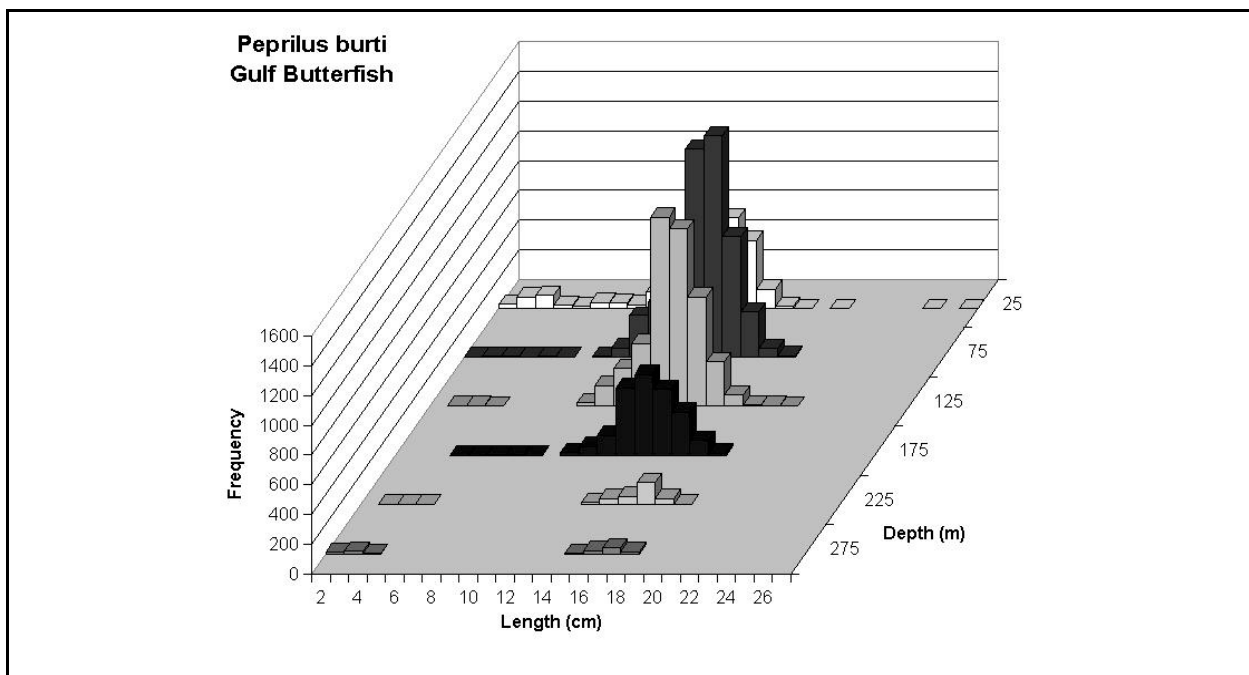

Figure 6.24. Length frequency distribution of *P. burti* across the depth strata in this study. Depth zones are represented as the midpoint of the strata (e.g. 25 is 0-50 m, 75 is 50-100 m, etc.).

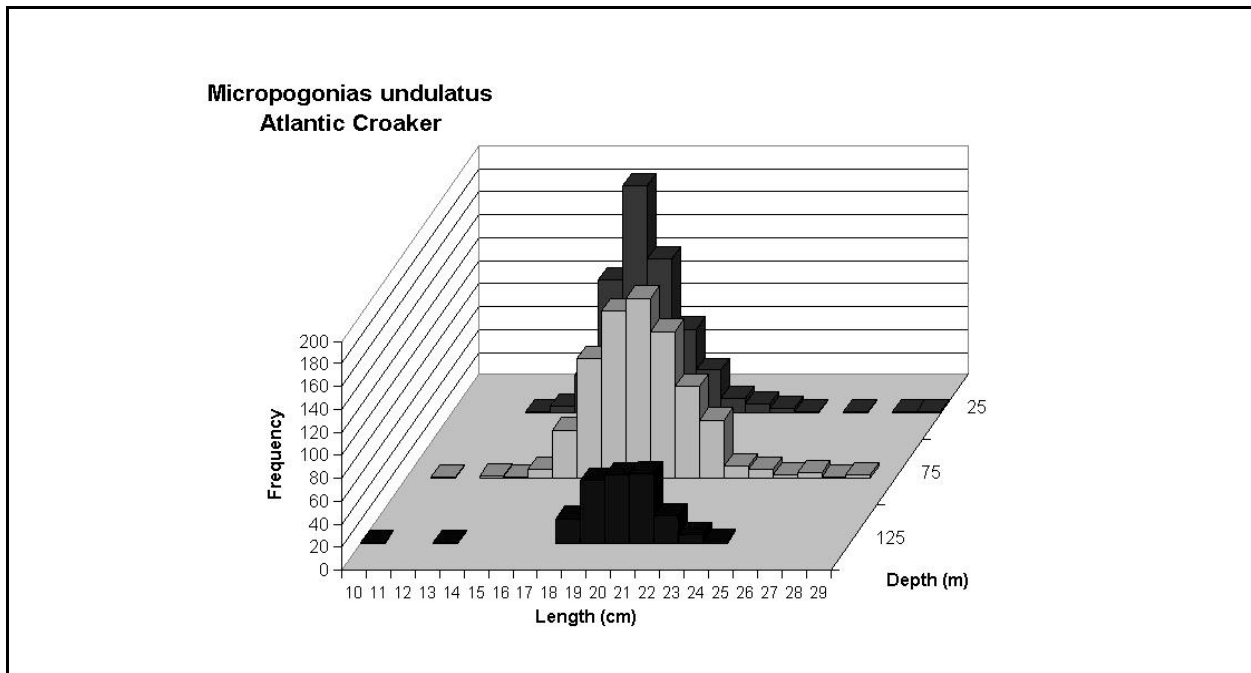

Figure 6.25. Length frequency distribution of *M. undulatus* across the depth strata in this study. Depth zones are represented as the midpoint of the strata (e.g. 25 is 0-50 m, 75 is 50-100 m, etc.).

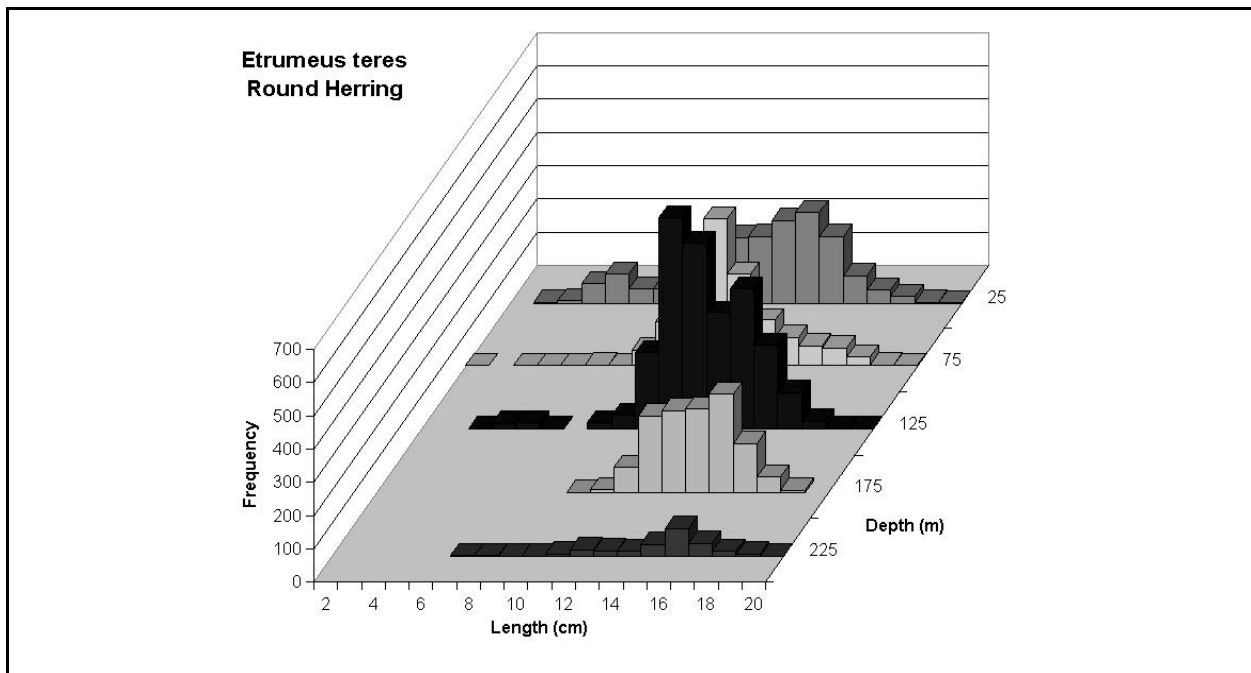

Figure 6.26. Length frequency distribution of *E. teres* across the depth strata in this study. Depth zones are represented as the midpoint of the strata (e.g. 25 is 0-50 m, 75 is 50-100 m, etc.).

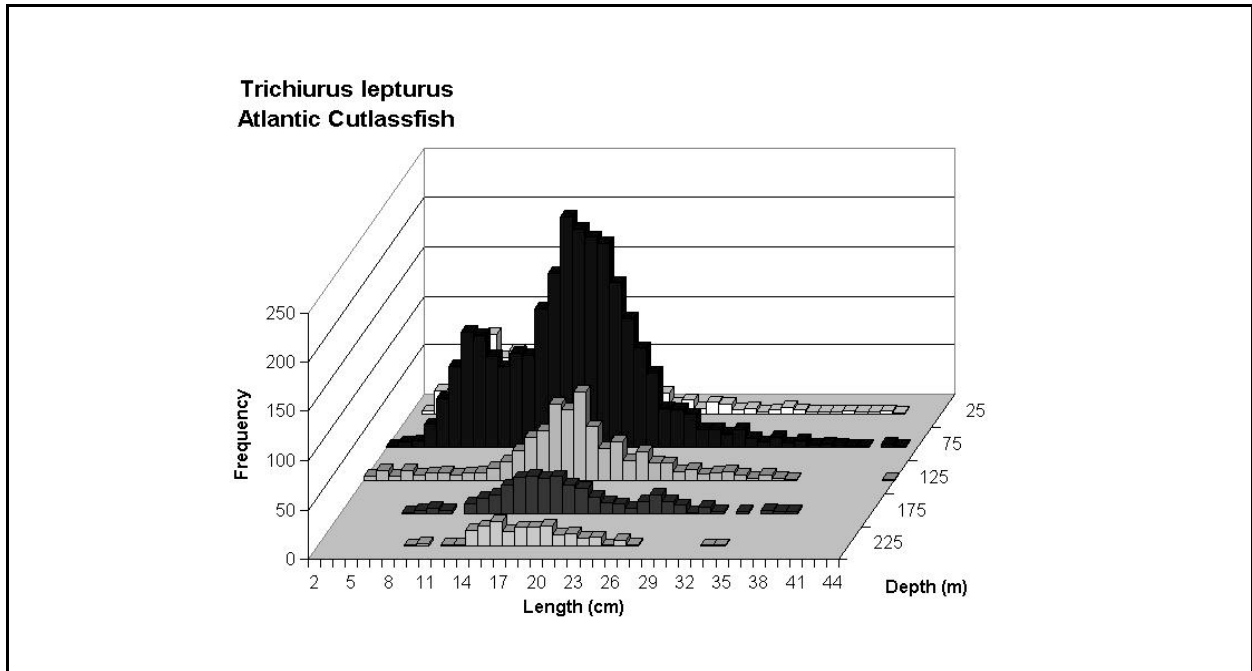

Figure 6.27. Length frequency distribution of *T. lepturus* across the depth strata in this study. Depth zones are represented as the midpoint of the strata (e.g. 25 is 0-50 m, 75 is 50-100 m, etc.).

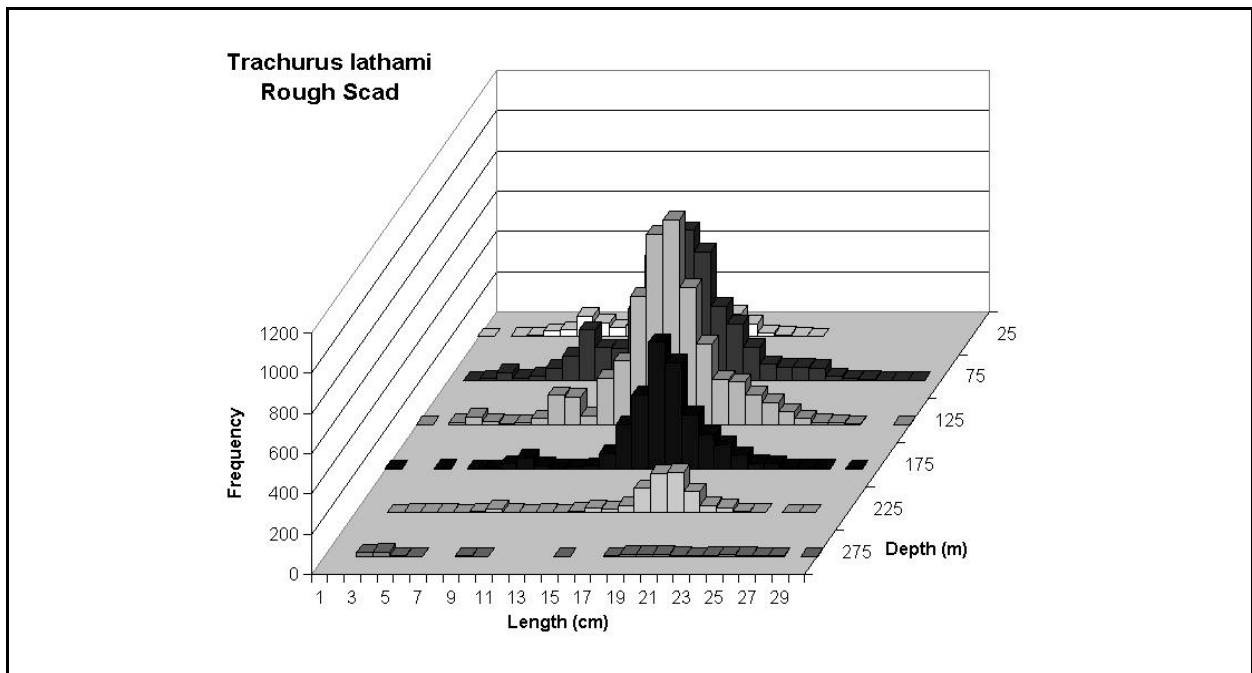

Figure 6.28. Length frequency distribution of *T. lathami* across the depth strata in this study. Depth zones are represented as the midpoint of the strata (e.g. 25 is 0-50 m, 75 is 50-100 m, etc.).

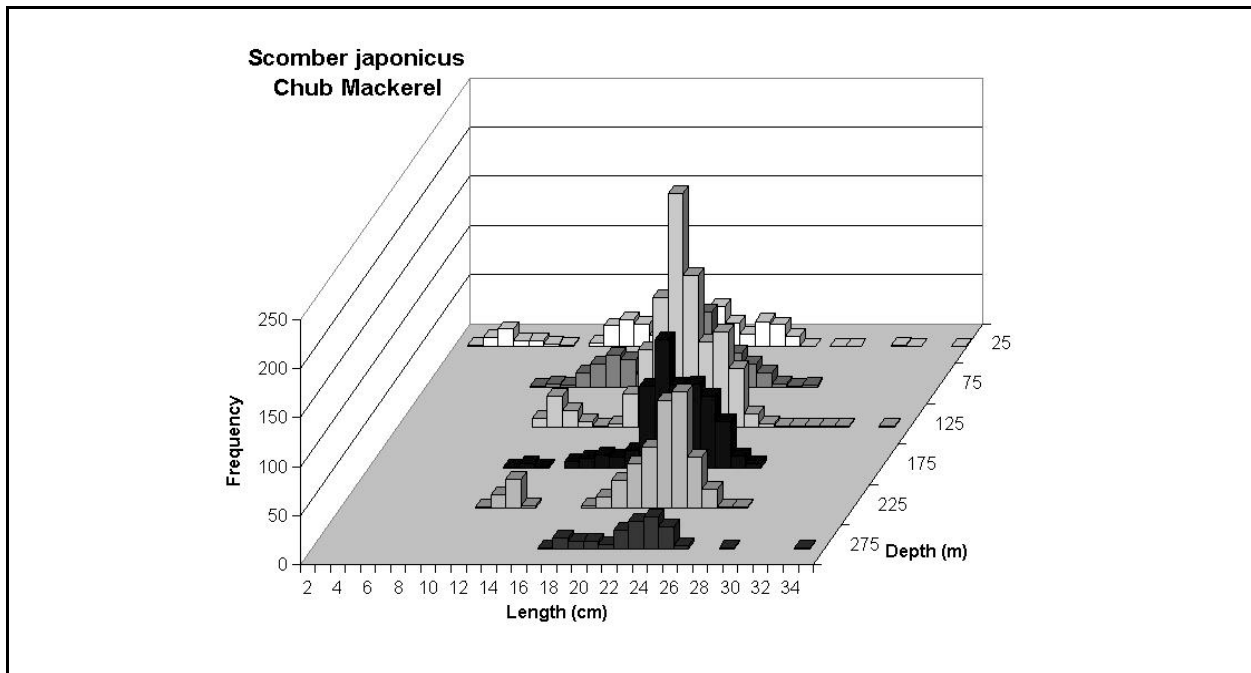

Figure 6.29. Length frequency distribution of *S. japonicus* across the depth strata in this study. Depth zones are represented as the midpoint of the strata (e.g. 25 is 0-50 m, 75 is 50-100 m, etc.).

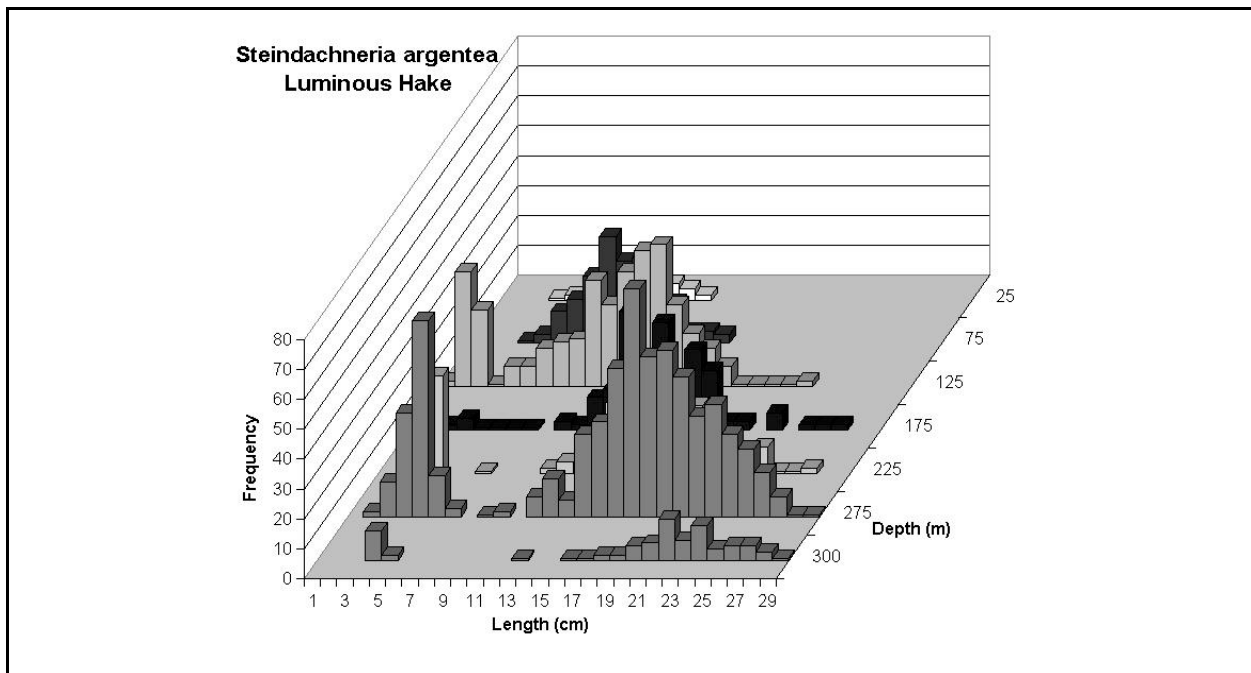

Figure 6.30. Length frequency distribution of *S. argentea* across the depth strata in this study. Depth zones are represented as the midpoint of the strata (e.g. 25 is 0-50 m, 75 is 50-100 m, etc.).

and oxygen with the distribution of many of the species in this study (e.g. Hendrix *et al.* 1981, Herron *et al.* 1989, Holliday and Larsen 1979, Laughlin & Livingston 1982, Matthews & Allen 1993, Novikov 1986, Vecchione 1991). Additionally, why is the majority of pelagic biomass and abundance concentrated near the Mississippi River delta? Very simply, the river plume and Loop Current combine to focus primary and secondary production at this locale (reviewed in Lohrenz *et al.* 1999). Several of the pelagic species are aggregated around these physical features and areas of high productivity (*sensu* Herron *et al.* 1989, Holliday and Larsen 1979).

Many of these pelagic species are concentrated on the more productive continental shelf. Collectively, the clupeids, engraulids, sparids, and scianids are generally shallow water species and, with a few exceptions, are effectively not a member of the pelagic species complex deeper than 100 m in the GOM. When caught, these fish are abundant, especially at depths < 25 m. Thus, it is likely that this group of fish is adequately sampled with the historical groundfish survey (SEFSC, MS Labs, unpubl. data). However, size overlap between the two surveys may be different due to the lack of deep water fishes collected in the groundfish survey and the larger size of *E. teres* at greater depths. Additionally, schools of herrings, squids, anchovies, porgies and sardines are likely to be captured more efficiently with the high opening (ca. 15 m) nets used in this study than the lower profile (ca. 3 m) nets in the groundfish surveys. Thus the small pelagics survey can provide more representative sampling of these stochastically distributed, schooling fish.

There are several deepwater and mid-depth species that are common in this pelagic community. *Diaphus* sp., *S. argentea*, *A. bondi*, *Illex* sp., *P. lowei*, and *M. muelleri* are most abundant at depths > 200 m and characterize the deepwater pelagic assemblage in the GOM. More notably, *E. teres*, *P. burti*, *T. lathami*, *Loligo* sp., *S. japonicus* and *A. veranyi* are most abundant at depths > 100 m. Previous reports have documented similar depth distributions of these and similar species along the continental shelf slope in the GOM and other ecosystems (e.g. Agafonova and Bukamin 1984, Bullis *et al.* 1971, Costa & Fernandes 1993, Gartner *et al.* 1987, Haimovici & Perez, 1991, Haimovici *et al.* 1994, Klima 1971, May and Blaber 1989, Vecchione 1987, Watanabe *et al.* 1999, Whitehead 1985). Because most of the pelagic community biomass occurs at depths beyond 100 m, these species are likely missed in other surveys. The importance of the shelf-break pelagic community, particularly in terms of alternate or potential fishery yields, Gulfwide fish production, and forage base available for higher trophic levels is hence under appreciated.

Several species were larger at greater depths. Certainly some species do not extend beyond 100 m, but even some of the shallow water species exhibited an increase in size with depth. It is likely that these deeper waters serve as a refugia from nearshore predators, including human harvesting, for larger individuals. It is probable that much of the spawning stock biomass for many of these species resides in this refugia. It is unclear what the population-level ramifications will be for increased removal of these offshore, deepwater organisms.

The organisms that did not exhibit any change in size either 1) had a limited depth range, 2) were mixed species (e.g. *Loligo* sp., *Diaphus* sp.), or 3) had little separation between the size of different year classes. The differences in *Loligo* size across depth may be the differences noted by Hixon (1980) between the two species, with the larger *L. pealei* in deeper waters. Also, many of the organisms in this study have broad spawning periods (e.g. Brodziak & Macy 1996, Houde 1977a,

1977b, 1977c, Jereb & Ragonese 1995, Johnson & Vaught 1986, Pierce & Guerra 1994, Shaw & Drullinger 1990). Such broad spawning periods produce year classes with a broad range of lengths. Additionally, these species mature at relatively small sizes and young ages and often have short life spans (e.g. Brodziak & Macy 1996, Hixon *et al.* 1981, Houde 1977a, Jereb & Ragonese 1995, Martinez & Houde 1975, Reintjes 1980). These considerations might mask year class strengths and produce length frequency distributions that are bi- or unimodal, which is what we observed for the all of the species in this study.

There are small, silverish, fusiform, pelagic species in every aquatic ecosystem on the planet. The sheer abundance of these small pelagics makes them an important component of intermediate trophic levels in every ecosystem. The mean length and low individual weight make these the major forage base for many other species. Charismatic megafauna and commercially valuable piscivores (e.g. numerous marine mammals, scombrids such as tunas and mackerels, coryphaenids, xiphids, etc.) prey upon these fish and squid (e.g. Bello 1991, DeVane 1978, Gonzalez *et al.* 1994, Naughton & Saloman 1981, 1984, Saloman & Naughton 1984, Vega-Candejas *et al.* 1994). To better manage organisms at higher trophic levels, understanding their feeding habits, habitat selection, and the dynamics of their prey is useful. For example, the distribution of *Illex* roughly coincides with the distribution of a major squid predator, the Risso's dolphin (*Grampus griseus*; Baumgartner 1997). Impacts to populations of these pelagics may have ramifications for marine mammals and larger piscivores.

These small pelagics are primarily planktivores yet are also known to consume fish, larger crustaceans, and cephalopods, (e.g. Chen *et al.* 1992, Henwood *et al.* 1978, Maurer & Bowman 1985, Modde & Ross 1983, Motta *et al.* 1993, Pierce *et al.* 1994, Rasero *et al.* 1996, Santos *et al.* 1998, Sheridan *et al.* 1984, Whitehead 1985). Therefore, the small pelagics play a major role in the energy transfer of an ecosystem by providing a crucial linkage between lower and upper trophic levels. Additionally, many of these species have notable, perhaps mutualistic relationships with other organisms. For example, *Lolliguncula* has strong associations with menhaden and anchovies in nearshore habitats (Matthews & Allen 1993, Laughlin & Livingston 1982, Pierce *et al.* 1994). Lange & Waring (1992) have shown a strong association between *Loligo pealei* and butterfish. Tolley (1987) has demonstrated an association between *C. chrsurus*, other carangids, other gadids, other stromateids, and the jellyfish *Aurelia aurita*. It is unclear what the ecosystem level impacts will be from a drastic change in the biomass and/or composition of the pelagic species complex in the GOM. It is clear that given the ecological importance of these pelagics, a drastic impact on them will also alter many other components of the ecosystem.

Prospects for a fishery on many of these under-utilized pelagic species remain (Christmas *et al.* 1985, Flandorfer & Skupien 1980, Gledhill 1989, Houde 1977a, 1977b, 1977c, Reese 1993, Vecchione 1987). The advantages of such a fishery are short life cycles for many of these species, their ubiquitous distributions, and their relatively consistent and high abundance. The disadvantages of establishing a fishery for these species are the hit-or-miss nature of many of these schools, the deeper set depths, processing the high number of bycatch (i.e. non-target) species, and the need to establish or expand markets for many of these organisms. Cautions against initiating a widespread, far-ranging, over-captitized fishery for these pelagics include alteration of stock structure by removing adults/spawners in the deeper refugia and removing food for higher trophic level fish,

birds and mammals. Certainly further information will be required for standard stock assessment parameters and estimates of these pelagic species; however, it is clear that a large amount of pelagic biomass needs to be considered in the management of GOM fisheries.

ACKNOWLEDGMENTS

We thank the crew and officers of the NOAA Vessel *Chapman* who served on cruises during this study. We thank M. Grace, R. Ford, and numerous other personnel at the Mississippi Laboratories who participated in collecting these data over the period of this study. G. Pellegrin provided statistical advice. J. L-Schultz and anonymous reviewers provided helpful comments on earlier versions of this manuscript.

REFERENCES

- Agafonova, T.B. and P.A. Bukamin. 1984. Distribution and some biological observations of *Ariomma bondi* (Ariommidae) from the central-eastern Atlantic. *J. Ichthyol.* 24:96-100.
- Baumgartner, M.F. 1997. The distribution of Risso's Dolphin (*Grampus griseus*) with respect to the physiology of the northern Gulf of Mexico. *Mar. Mammal Sci.* 13:614-638.
- Bello, G. 1991. Role of cephalopods in the diet of the swordfish, *Xiphias gladius*, from the eastern Mediterranean Sea. *Bull. Mar. Sci.* 49:312-324.
- Brodziak, J.K.T. and W.K. Macy. 1996. Growth of long-finned squid, *Loligo pealei*, in the Northwest Atlantic. *Fish. Bull.* 94:212-236.
- Bullis, H.R., J.S. Carpenter and C.M. Roithmayr. 1971. Untapped West-Central Atlantic fisheries. In Shapiro, S., ed. *Our Changing Fisheries*. GPO, Washington, D.C. pp. 374-391.
- Chen, W., J.J. Govoni, and S.M. Warlen. 1992. Comparison of feeding and growth of larval round herring *Etrumeus teres* and gulf menhaden *Brevoortia patronus*. *Fish. Bull.* 90:183-189.
- Christmas, J.Y., D.J. Etzold, T.D. McIlwain and L.B. Simpson. 1985. Marine Fisheries Initiative, Gulf of Mexico Phase. *Gulf States Mar. Fish. Comm. No.* 10.
- Costa, P.A.S. and F.C. Fernandes. 1993. Seasonal and spatial changes of cephalopods caught in the Cabo Frio (Brazil) upwelling system. *Bull. Mar. Sci.* 52:751-759.
- Crawford, R.J.M. and G. de Villiers. 1984. Chub mackerel *Scomber japonicus* in the South-East Atlantic- its seasonal distribution and evidence of a powerful 1977 year-class. *S. Afr. J. Mar. Sci.* 2:49-61.
- Dawe, E.G., J.C. Shears, N.E. Balch, and R.K. O'Dor. 1990. Occurrence, size, and sexual maturity of long-finned squid (*Loligo pealei*) at Nova Scotia and Newfoundland, Canada. *Can. J. Fish. Aquat. Sci.* 47:1830-1835.

- DeVane, J.C. 1978. Food of king mackerel, *Scombermorus cavalla*, in Onslow Bay, North Carolina. Trans. Am. Fish. Soc. 107:583-586.
- Economidis, P.S. and V.P. Vagiatzsis. 1992. Mass mortality of *Sardinella aurita* Valenciennes (Pisces, Clupeidae) in Thessaloniki Bay (Macedonia, Greece). J. Fish. Biol. 41:147-149.
- Flandorfer, M. and L. Skupien, eds. 1980. Proceedings of a Workshop for Potential Fishery Resources of the Northern Gulf of Mexico. New Orleans, LA. MASGP-80-012. 92 p.
- Gartner, J.V., T.L. Hopkins, R.C. Baird and D.M. Milliken. 1987. The lanternfishes (Pisces: Myctophidae) of the eastern Gulf of Mexico. Fish. Bull. 85:81-98.
- Geoghegan, P. and M.E. Chittenden. 1982. Reproduction, movements, and population dynamics of the longspine porgy, *Stenotomus caprinus*. Fish. Bull. 80:523-540.
- Gledhill, C. T. 1989. 1989 Annual Report: Latent Resources (Butterfish, Coastal Herrings, and Associated Species). NMFS, SEFSC, ML. Pascagoula, MS. 316 p.
- Gonzalez, A.F., A. Lopez, A. Guerra, and A. Barreiro. 1994. Diets of marine mammals stranded on the northwestern Spanish Atlantic coast with special reference to Cephalopoda. Fish. Res. 21:179-191.
- Grant, C.J. 1981. Gill net selectivity and catch rates of coastal pelagic fish in Jamaica. Estuar. Coast. Shelf. Sci. 12:167-175.
- Haimovici, M. and J.A. Perez. 1991. Coastal cephalopod fauna of southern Brazil. Bull. Mar. Sci. 49:221-230.
- Haimovici, M., A.S. Martins, J.L. de Figueiredo and P.C. Vieira. 1994. Demersal bony fish of the outer shelf and upper slope of the southern Brazil subtropical convergence ecosystem. Mar. Ecol. Prog. Ser. 108:59-77.
- Haimovici, M., A.S. Martin, and P.C. Vieira. 1996. Distribution and abundance of demersal bony fishes in the continental shelf of southern Brazil. Rev. Bras. Biol. 56:27-50.
- Hendrix, J.P., W.H. Hulet and M.J. Greenberg. 1981. Salinity tolerance and the responses to hypoosmotic stress of the squid *Lolliguncula brevis*, a euryhaline Cephalopod Mollusc. Comp. Biochem. Physiol. A. 69:641-648.
- Henwood, T., P. Johnson and R. Heard. 1978. Feeding habits and food of the longspined porgy, *Stenotomus caprinus* Bean. Northeast Gulf. Sci. 2:133-137.
- Herron, R.C., T.D. Leming and J. Li. 1989. Satellite-detected fronts and butterfish aggregations in the northeastern Gulf of Mexico. Cont. Shelf Res. 9:569-588.

- Hixon, R.F. 1980. Potential commercial squid resources of the Gulf of Mexico- an updated review, *in* Flandorfer, M. and L. Skupien, eds. Proceedings of a Workshop for Potential Fishery Resources of the Northern Gulf of Mexico. New Orleans, LA. MASGP-80-012. p. 54-73.
- Hixon, R.F., R.T. Hanlon and W.H. Hulet. 1981. Growth, fecundity and estimated life span of the 3 loliginid squid species in the Northwest Gulf of Mexico. *J. Shellfish Res.* 1(1):116.
- Holliday, D.V. and H.L. Larsen. 1979. Thickness and depth distribution of some epipelagic fish schools off southern California. *Fish. Bull.* 77:489-494.
- Houde, E.D. 1977a. Abundance and potential yield of the round herring, *Etrumeus teres*, and aspects of its early life history in the eastern Gulf of Mexico. *Fish. Bull.* 75:61-89.
- Houde, E.D. 1977b. Abundance and potential yield of the round herring, *Harengula jaguana*, and aspects of its early life history in the eastern Gulf of Mexico. *Fish. Bull.* 75:613-628.
- Houde, E.D. 1977c. Abundance and potential yield of the round herring, *Opisthonema oglinum*, and aspects of its early life history in the eastern Gulf of Mexico. *Fish. Bull.* 75:493-512.
- Jereb, P. and S. Ragonese. 1995. An outline of the biology of the squid *Illex coindetii* in the Sicilian Channel (Central Mediterranean). *J. Mar. Biol. Assoc. U.K.* 75:373-390.
- Johnson, A.G. and R.N. Vaught. 1986. Species profile of Spanish sardine (*Sardinella aurita*). NOAA Tech. Memo. NMFS-SEFC-187, 82 p.
- Klima, E.F. 1971. Distribution of some coastal pelagic fishes in the western Atlantic. *Commer. Fish. Rev.* 33:21-34.
- Lange, A.M. and G.T. Waring. 1992. Fishery interaction between long-finned squid (*Loligo pealei*) and butterfish (*Peprilus triacanthus*) off the northeast USA. *J. Northw. Atl. Fish. Sci.* 12:49-62.
- Laughlin, R.A. and R.J. Livingston. 1982. Environmental and trophic determinants of the spatial/temporal distribution of the brief squid (*Lolliguncula brevis*) in the Apalachicola Estuary (North Florida, USA). *Bull. Mar. Sci.* 32:489-497.
- Lohrenz, S.E., D. A. Wiesenburg, R.A. Arnone and X. Chen. 1999. What controls primary production in the Gulf of Mexico? *In* Kump, H., K. Steidinger and K. Sherman, eds. The Gulf of Mexico Large Marine Ecosystem. Blackwell Science Ltd., Malden, MA.
- Martinez, S. and E.D. Houde. 1975. Fecundity, sexual maturation and spawning of scaled sardine, *Harengula jaguana*. *Bull. Mar. Sci.* 25:35-45.
- Matthews, M. and D.M. Allen. 1993. Interactions among some dominant estuarine nekton species. *Estuaries* 16:840-850.

- Maurer, R.O. and R.E. Bowman. 1985. Food consumption of squids (*Illex illecebrosus* and *Loligo pealei*) off the northeastern United States. Biology and Ecology of Squids *Illex illecebrosus* and *Loligo pealei* in the Northwest Atlantic. NAFO Sci. Council Study No. 9. pp. 117-124.
- May, J.L. and S.J.M. Blaber. 1989. Benthic and pelagic fish biomass of the upper continental slope off eastern Tasmania. *Mar. Biol.* 101:11-25.
- Modde, T. and S.T. Ross. 1983. Trophic relationships of fishes occurring within a surf zone habitat in the northern Gulf of Mexico. *Northeast Gulf Sci.* 6:109-120.
- Motta, P.J., K.B. Clifton, P. Hernandez, B.T. Eggold, S.D. Giordano and R. Wilcox. 1993. Feeding relationships among nine species of seagrass fishes of Tampa Bay, Florida. *Bull. Mar. Sci.* 56:185-200.
- Murphy, M.D. and M.E. Chittenden. 1991. Reproduction, age and growth, and movements of the gulf butterflyfish *Peprilus burti*. *Fish. Bull.* 89:101-116.
- NMFS. 1996. Our Living Oceans. Report on the status of U.S. living marine resources, 1995. USDOC, NOAA Tech. Memo NMFS--F/SPO-19. 160 p.
- Nakamura, E.L. 1980. Carangids of the northern Gulf of Mexico. *In* Flandorfer, M. and L. Skupien, eds. Proceedings of a Workshop for Potential Fishery Resources of the Northern Gulf of Mexico. New Orleans, LA. MASGP-80-012. p. 18-33.
- Naughton, S.P. and C.H. Saloman. 1984. Food of bluefish (*Pomatomus saltratrix*) from the U.S. sought Atlantic and Gulf of Mexico. NOAA Tech. Memo. NMFS-SEFC-150, 37 p.
- Naughton, S.P. and C.H. Saloman. 1981. Stomach contents of juveniles of king mackerel (*Scomberomorus cavalla*) and Spanish mackerel (*S. maculatus*). *Northeast Gulf Sci.* 5:71-74.
- Novikov, Y.V. 1986. Some trends of distribution and migration of common pelagic fishes of the northwestern Pacific Ocean. *J. Ichthyol.* 26:161-172.
- Pierce, G.J. and A. Guerra. 1994. Stock assessment methods for cephalopod fisheries. *Fish. Res.* 21:255-285.
- Pierce, G.J., P.R. Boyle, L.C. Hastie and M. Begona-Santos. 1994. Diets of squid *Loligo forbesi* and *Loligo vulgaris* in the Northeast Atlantic. *Fish. Res.* 21:149-163.
- Rasero, M. A.F. Gonzalez, B.G. Castro, and A. Guerra. 1996. Predatory relationships of two sympatric squid, *Todaropsis eblanae* and *Illex coindetii* (Cephalopoda: Ommastrephidae) in Galician waters. *J. Mar. Biol. Assoc. U.K.* 76:73-87.
- Reese, G.B., ed. 1993. 1992 Annual MARFIN report: Small Pelagics, TED Technology Transfer, Reef Fish. NMFS, SEFSC, ML. Pascagoula, MS. 225 p.

- Reintjes, J.W. 1980. Marine herring and sardine resources of the northern Gulf of Mexico, in Flandorfer, M. and L. Skupien, eds. Proceedings of a Workshop for Potential Fishery Resources of the Northern Gulf of Mexico. New Orleans, LA. MASGP-80-012. p. 4-17.
- Rountree, R.A. 1990. Community structure of fishes attracted to shallow water fish aggregation devices off South Carolina, USA. *Environ. Biol. Fish.* 29:241-262.
- Salcedo-Vargas, M.A. 1991. Checklist of the cephalopods from the Gulf of Mexico. *Bull. Mar. Sci.* 49:216-220.
- Saloman, C.H. and S.P. Naughton. 1984. Food of crevalle jack, (*Caranx hippos*) from Florida, Louisiana, and Texas. NOAA Tech. Memo. NMFS-SEFC-134, 34 p.
- Santos, R.A. and M. Haimovici. 1998. Trophic relationships of the long-finned squid *Loligo sanpaulensis* on the southern Brazilian shelf. *S. Afr. J. Mar. Sci.* 20:81-91.
- Scoles, D.R., B.B. Collette and J.E. Graves. 1998. Global phylogeography of mackerels of the genus *Scomber*. *Fish. Bull.* 96:823-842.
- Shaw, R.F. and D.L. Drullinger. 1990. Early Life History Profiles, Seasonal Abundance, and Distribution of Four Species of Clupeid Larvae from the Northern Gulf of Mexico, 1982 and 1983. NOAA Tech. Rep. NMFS-88, 60 p.
- Sheridan, P.F., D.L. Trimm and B.M. Baker. 1984. Reproduction and food habits of seven species of northern Gulf of Mexico fishes. *Contrib. Mar. Sci., Univ. Texas.* 27:175-204.
- Tolley, S.G. 1987. Association of young *Chloroscombus chrysurus* (Pisces: Carangidae) with the jellyfish *Aurelia aurita*. *Copeia* 1:216-218.
- Vecchione, M. 1987. Commercial fishing for Gulf butterfish, *Peprilus burti*, in the Gulf of Mexico. *Mar. Fish. Rev.* 49:14-22.
- Vecchione, M. 1991. Dissolved oxygen and the distribution of the euryhaline squid *Lolliguncula brevis*. *Bull. Mar. Sci.* 49:668-669.
- Vega-Cendejas, M.E., M. Hernandez and F. Arreguin-Sanchez. 1994. Trophic interactions in a beach seine fishery from the northwestern coast of the Yucatan Peninsula, Mexico. *J. Fish. Biol.* 44:647-659.
- Voss, G.L. and T.F. Brakoniec. 1985. Squid resource of the Gulf of Mexico and Southeast Atlantic coasts of the United States. Biology and Ecology of Squids *Illex illecebrosus* and *Loligo pealei* in the Northwest Atlantic. NAFO Sci. Council Study No. 9. pp. 27-37.

- Watanabe, H. M. Moku, K. Kawaguchi, K. Ishimaru, A. Ohno. 1999. Diel vertical migration of myctophid fishes (Family Myctophidae) in the transitional waters of the western North Pacific. *Fish. Oceanogr.* 8:155-127.
- Whitaker, J.D. 1980. Squid catches resulting from trawl surveys off the southeastern United States. *Mar. Fish. Rev.* 42:39-43.
- Whitehead, P.J.P. 1985. FAO species catalogue. Vol. 7. Clupeoid fishes of the world. An annotated and illustrated catalogue of the herrings, sardines, plchards, sprats, anchovies and wolf-herrings. Part 1- Chirocentridae, Clupeidae and Pristigasteridae. *FAO Fish. Synop.* 125(7), Pt.1:303 p.
- Xu, X. and Chiu, S.Y. 1995. Population estimates with variances of Spanish sardine along the southern Fujian Coast, China, from length-based cohort analysis. *Trans. Am. Fish. Soc.* 124:437-452.

APPENDIX A

PARAMETERS OF MAJOR PELAGIC FAMILIES

Stromateidae

Peprilus burti, the gulf butterfish, averaged 2,550.3 (+/- 340.3 S.E.) individuals hr⁻¹, comprising 21.4% of the total catch by number and 31.6% of the total catch by weight. *P. burti* was the most abundant fish of all species collected in this study, and was found at 60.8% (554) of the stations sampled. Average weight of this organism was 0.07 kg, with an average length of 14.1 cm (range from <1 to 27).

Peprilus alepidotus, the harvestfish, averaged 20.6 (+/- 5.2 S.E.) individuals hr⁻¹, comprising 0.17% by number and 1.3% by weight of the total catch, ranked as the 32nd most abundant organism in this study. *P. alepidotus* was found at 11.7% (107) of the stations sampled. Average weight of this organism was 0.38 kg, with an average length of 14.8 cm (range from 3 to 20).

As a group, stomateids comprised approximately 22% of the total number and 33% of the total weight of fish caught during this study. They were by far the most dominant and one of the more ubiquitous fish of the pelagic species complex.

Clupeidae

Etrumeus teres, the round herring, averaged 1,852.8 (+/- 337.5 S.E.) individuals hr⁻¹, comprising 15.5% of the total catch by number and 6.4% of the total catch by weight. *E. teres* was the second most abundant fish of all species collected in this study, and is found at 38.2% (348) of the stations sampled. Average weight of this organism was 0.02 kg, with an average length of 13.2 cm (range from 2.3 to 51.2 cm).

Sardinella aurita, the Spanish sardine, averaged 224.2 (+/- 95.0 S.E.) individuals hr⁻¹, comprising 1.9% by number and 1.5% by weight of the total catch, ranked as the 13th most abundant organism in this study. *S. aurita* was caught at 4.7% (43) of the stations in this study. Average weight and length of this organism were 0.04 kg and 14.7 mm respectively (range from 8.8 to 22 cm).

Harengula jaguana, the scaled sardine, averaged 17.7 (+/- 7.7 S.E.) individuals hr⁻¹, comprising 0.15% by number and 0.14% by weight of the total catch, ranked as the 34th most abundant organism in this study. *H. jaguana* was found at 5.3% (48) of the stations in this study. Average weight and length of this organism were 0.046 kg and 13.4 cm respectively (range from 6.7 to 20.3 cm).

Opisthonema oglinum, the Atlantic thread herring, averaged 16.5 (+/- 6.4 S.E.) individuals hr⁻¹, comprising 0.14% by number and 0.19% by weight of the total catch in this study, ranking 37th in abundance. *O. oglinum* was found at 5.2% (47) of the stations in this study. Average weight and length of this organism were 0.068 kg and 15.8 cm respectively (range from 3.4 to 29.8 cm).

Other species of clupeids observed in this study but of negligible abundance in these trawls were *Alosa alabamae* (25 stations), *A. mediocris* (1 station), *A. crysochlorus* (1 station), *Brevoortia patronus* (15 stations), and unidentified clupeids (1 station). These smaller clupeids are an excellent example of the limitations of the mesh size used in this study and the difficulty of trying to assess fish with “hit-or-miss” abundance and schooling behavior. As a group, clupeids comprised approximately 18% of the total number and 8% of the total weight of fish caught during this study. Next to the stromateids, clupeids were the most abundant group in this study.

Sparidae

Stenotomus caprinus, the longspine porgy, averaged 1,554 (+/- 210.9 S.E.) individuals hr⁻¹, comprising 13.0% of the total catch by number and 10.7% of the total catch by weight. *S. caprinus* was the third most abundant organism of all species collected in this study, and was found at 52% (473) of the stations sampled. Average weight of this organism was 0.04 kg, with an average length of 12.0 cm (range <1 to 21 cm).

Lagodon rhomboides, the pinfish, averaged 93.4 (+/- 23.2 S.E.) individuals hr⁻¹, comprising 0.78% by number and 1.3% by weight of the total catch, ranked as the 18th most abundant organism in this study. *L. rhomboides* was caught at 27.8% (253) of the stations in this study. Average weight and length of this organism were 0.08 kg and 160 mm respectively (range from 9 to 47 cm).

Pagrus pagrus, the red porgy, averaged 3.7 (+/- 1.4 S.E.) individuals hr⁻¹, comprising 0.03% by number and 0.13% by weight of the total catch, ranked as the 77th most abundant organism in this study. *P. pagrus* was caught at 5.7% (52) of the stations in this study. Average weight and length of this organism were 0.20 kg and 223 mm respectively (range from 11 to 47 cm).

Other species of sparids observed in this study but of negligible abundance were *Calamus nodosus* (10 stations), *C. prorid* (5 stations), *Archosargus probatocephalus* (5 stations), *Calumus* sp. (4 stations) *C. leucosteus* (4 stations) and *C. bajonado* (1 station). As a group, sparids comprised

approximately 15% of the total number of organisms caught during this study, ranking 4th in total abundance.

Carangidae

Trachurus lathami, the rough scad, averaged 1369.2 (+/- 170.8 S.E.) individuals hr⁻¹, comprising 11.5% of the total catch by number and 12.7% of the total catch by weight. *T. lathami* was the fourth most abundant organism of all species collected in this study, and was found at 67.8% (618) of the stations sampled. Next to *Loligo*, this was the most ubiquitous species in the Gulf. Average weight of this organism was 0.06 kg, with an average length of 15.3 cm (range <1 to 76 cm).

Decapterus punctatus, the round scad, averaged 316.3 (+/- 130.8 S.E.) individuals hr⁻¹, comprising 2.7% of the total catch by number and 2.4% of the total catch by weight. *D. punctatus* ranked as the 7th most abundant organism of all species collected in this study, and was found at 8.5 (77) of the stations sampled. Average weight of this organism was 0.05 kg, with an average length of 14.8 cm (range 5 to 22 cm).

Chloroscombus chrysurus, the Atlantic bumper, averaged 288.0 (+/- 73.9 S.E.) individuals hr⁻¹, comprising 2.4% of the total catch by number and 2.9% of the total catch by weight. *C. chrysurus* ranked as the 10th most abundant organism of all species collected in this study, and was found at 14.4% (131) of the stations sampled. Average weight of this organism was 0.06 kg, with an average length of 14.4 cm (range 2 to 32 cm).

Selar crumenophthalmus, the bigeye scad, averaged 7.49 (+/- 1.21 S.E.) individuals hr⁻¹, comprising 0.06% of the total catch by number and 0.18% of the total catch by weight. *S. crumenophthalmus* ranked as the 55th most abundant organism of all species collected in this study, and was found at 13.6 (124) of the stations sampled. Average weight of this organism was 0.14 kg, with an average length of 19.1 cm (range 2 to 30 cm).

Caranx crysos, the blue runner, averaged 5.14 (+/- 2.46 S.E.) individuals hr⁻¹, comprising 0.04% of the total catch by number and 0.15% of the total catch by weight. *C. crysos* ranked as the 68th most abundant organism of all species collected in this study, and was found at 6.5% (59) of the stations sampled. Average weight of this organism was 0.17 kg, with an average length of 21.1 cm (range 8 to 40 cm).

Selene setapinnis, the Atlantic moonfish, averaged 4.80 (+/- 1.68 S.E.) individuals hr⁻¹, comprising 0.04% of the total catch by number and 0.07% of the total catch by weight. *S. setapinnis* ranked as the 70th most abundant organism of all species collected in this study, and was found at 8.8% (80) of the stations sampled. Average weight of this organism was 0.09 kg, with an average length of 14.5 cm (range 2 to 28 cm).

Other species of carangids observed in this study but of negligible abundance were *Selene vomer* (21 stations), *Trachinotus carolinus* (20 stations), *Seriola dumerili* (29 stations), *Decapterus tabl* (9 stations), *Alectic ciliaris* (6 stations), *Caranx hippos* (5 stations), *Seriola fasciata* (1 station), *Seriola rivoliana* (3 stations), *Uraspis secunda* (4 stations), and *Hemicaranx amblyrhynchus* (1

station). As a group, carangids comprised approximately 17% of the total number of organisms caught during this study, ranking 3rd in total abundance.

Cephalopoda

Loligo sp., both *pealei* and *plei*, averaged 473 (+/- 51.1 S.E.) individuals hr⁻¹, comprising 4.0% of the total catch by number and 1.5% of the total catch by weight. *Loligo* was the fifth most abundant organism of all species collected in this study, and is ubiquitous in the GOM, found at 83% (754) of the stations sampled. Average weight of this organism was 0.02 kg, with an average length of 7.3 cm (range 0.6 to 37.2 cm).

Lolliguncula brevis averaged 18.5 (+/- 6.9 S.E.) individuals hr⁻¹, comprising 1.5% by number and 0.16% by weight of the total catch, ranked as the 33rd most abundant organism in this study. *Lolliguncula* was found at only 3.1% (28) of the stations in this study. Average weight and length of this organism were 0.005 kg and 3.6 cm respectively (range 1.2 to 18.5 cm).

Abralia veranyi averaged 17.0 (+/- 5.9 S.E.) individuals hr⁻¹, comprising 0.14% by number and 0.01% by weight of the total catch, ranked as the 36th most abundant organism in this study. *Abralia* was found at 6.4% (58) of the stations in this study. Average weight and length of this organism were 0.004 kg and 3.4 cm respectively (range 0.9 to 13.6 cm).

Illex sp., both *coindetii* and *illecebrosus*, averaged 6.7 (+/- 2.3 S.E.) individuals hr⁻¹, comprising 0.056% by number and 0.15% by weight of the total catch in this study, ranked 57th in abundance. *Illex* was found at 9.8 % (89) of the stations in this study. Average weight and length of this organism were 0.14 kg and 13.9 cm respectively (range 3.9 to 29.2 cm).

Other species of squid observed in this study but of negligible abundance were *Ornithoteuthis* sp. (*antillarum*; 9 stations), *Rossia* sp. (5 stations), *Semirossia* sp. (*tenera*, *equalis*; 2 stations), and *Cranchia* sp. (*scabra*; 13 stations). Other cephalopods (i.e. Octopoda) were found at 6 stations. As a group, squids comprised approximately 6% of the total number of organisms caught during this study, ranking 5th in total abundance.

Gadidae

Steindachneria argenta, the luminous hake, averaged 385.8 (+/- 94.7 S.E.) individuals hr⁻¹, comprising 3.2% by number and 0.8% by weight of the total catch in this study, ranking number 6th in abundance. *S. argenta* was found at 10.3 % (94) of the stations in this study. Average weight and length of this organism were 0.01 kg and 14.5 cm respectively (range 1.2 to 31 cm).

Other gadids observed in this study but of negligible abundance were *Urophycis cirrata* (35 stations), *U. floridana* (37 stations), *U. regia* (3 stations), *Merluccius albidus* (14), and *Laemonema* sp. (1 station).

Trichiuridae

Trichiurus lepturus, the Atlantic cutlassfish, averaged 313.1 (+/- 48.2 S.E.) individuals hr⁻¹, comprising 2.6% by number and 3.6% by weight of the total catch in this study, ranking number 8th in abundance. *T. lepturus* was found at 38.1 % (347) of the stations in this study. Average weight and length of this organism were 0.07 kg and 16.7 cm respectively (range 2 to 53 cm).

Other trichiurids observed in this study but of negligible abundance were *Benthodesmus tenuis* (19 stations), *Lepidopus* sp. (12 stations), and *Evoxymetopon taenia* (3 stations).

Myctophidae

Diaphus sp., lanternfish, averaged 303.5 (+/- 105.6 S.E.) individuals hr⁻¹, comprising 2.5% by number and 0.14% by weight of the total catch in this study, ranking number 9th in abundance. *Diaphus* sp. was found at 6.8 % (62) of the stations in this study. Average weight and length of this organism were 0.002 kg and 5.4 cm respectively (range 2.3 to 8.9 cm).

Maurolicus muelleri, the Atlantic pearlside, averaged 15.6 (+/- 6.8 S.E.) individuals hr⁻¹, comprising 0.13% by number and 0.004% by weight of the total catch in this study, ranking number 38th in abundance. *M. muelleri* was found at 2.5 % (23) of the stations in this study. Average weight and length of this organism were 0.002 kg and 4.7 cm respectively (range 2.8 to 5.8 cm).

Other, unidentified myctophids (10 stations) were observed in this study but were of negligible abundance and biomass.

Engraulidae

Engraulis eurystole, the silver anchovy, averaged 272.5 (+/- 218.0 S.E.) individuals hr⁻¹, comprising 2.3% of the total catch by number and 0.09% of the total catch by weight. *E. eurystole* ranked as the 11th most abundant organism of all species collected in this study, and was found at 1.5% (14) of the stations sampled. Average weight of this organism was 0.002 kg, with an average length of 6.9 cm (range 2.1 to 21.3 cm).

Anchoa hepsetus, the striped anchovy, averaged 170.6 (+/- 78.6 S.E.) individuals hr⁻¹, comprising 1.4% of the total catch by number and 0.4% of the total catch by weight. *A. hepsetus* ranked as the 14th most abundant organism of all species collected in this study, and was found at 5.0% (46) of the stations sampled. Average weight of this organism was 0.01 kg, with an average length of 11.3 cm (range 4.1 to 17.8 cm).

Anchoa mitchilli, the bay anchovy, averaged 40.1 (+/- 22.8 S.E.) individuals hr⁻¹, comprising 0.3% of the total catch by number and 0.04% of the total catch by weight. *A. mitchilli* ranked as the 26th most abundant organism of all species collected in this study, and was found at 1.2% (11) of the stations sampled. Average weight of this organism was 0.006 kg, with an average length of 5.5 cm (range 3.6 to 8.3 cm).

Other engraulids observed in this study but of negligible abundance were *Anchoa nasuta* (7 stations), *A. lyolepis* (1 station) and *A. lamprotaenia* (1 station).

Scombridae

Scomber japonicus, the chub mackerel, averaged 262.4 (+/- 60.5 S.E.) individuals hr⁻¹, comprising 2.2% of the total catch by number and 4.1% of the total catch by weight. *S. japonicus* ranked as the 12th most abundant organism of all species collected in this study, and was found at 28.6% (261) of the stations sampled. Average weight of this organism was 0.09 kg, with an average length of 20.1 cm (range 3.0 to 35.0 cm).

Other scombrids observed in this study but of negligible abundance were *Scombermorus maculatus* (101 stations), *S. cavalla* (108 stations), *Sarda sarda* (15 stations), *Euthynnus allettenatus* (3 stations) and *Auxis thazard* (3 stations).

Scianidae

Micropogonias undulatus, the Atlantic croaker, averaged 142.4 (+/- 35.8 S.E.) individuals hr⁻¹, comprising 1.2% of the total catch by number and 1.7% of the total catch by weight. *M. undulatus* ranked as the 15th most abundant organism of all species collected in this study, and was found at 15.4% (140) of the stations sampled. Average weight of this organism was 0.07 kg, with an average length of 18.6 cm (range 1.6 to 50.5 cm).

Leiostomus xanthurus, the spot, averaged 60.2 (+/- 20.6 S.E.) individuals hr⁻¹, comprising 0.5% of the total catch by number and 1.1% of the total catch by weight. *L. xanthurus* ranked as the 24th most abundant organism of all species collected in this study, and was found at 8% (73) of the stations sampled. Average weight of this organism was 0.11 kg, with an average length of 19.9 cm (range 11.1 to 30.0 cm).

Cynoscion arenarius, the sand seatrout, averaged 25.6 (+/- 5.7 S.E.) individuals hr⁻¹, comprising 0.2% of the total catch by number and 0.5% of the total catch by weight. *C. arenarius* ranked as the 30th most abundant organism of all species collected in this study, and was found at 17.1% (156) of the stations sampled. Average weight of this organism was 0.12 kg, with an average length of 22.8 cm (range 6.6 to 40.9 cm).

Cynoscion nothus, the silver seatrout, averaged 14.6 (+/- 3.1 S.E.) individuals hr⁻¹, comprising 0.1% of the total catch by number and 0.2% of the total catch by weight. *C. nothus* was the 39th most abundant organism of all species collected in this study, and was found at 7.2% (66) of the stations sampled. Average weight of this organism was 0.08 kg, with an average length of 20.2 cm (range 7.2 to 41.4 cm).

Other scianids observed in this study but of negligible abundance were *Equetus umbrosus* (36 stations), *E. lanceolatus* (8 stations), *E. acuminatus* (3 stations), *Larimus fasciatus* (5 stations), *Menticirrhus americanus* (9 stations), *M. saxatilis* (2 stations) *Sciaenops ocellatus* (5 stations), *Stellifer lanceolatus* (3 stations) and *Pogonias cromis* (6 stations).

**DISTRIBUTION OF RED SNAPPER LARVAE IN THE
NORTHERN GULF OF MEXICO, 1982-1994**

D. M. Drass

J. Lyczkowski-Shultz

P. J. Bond

National Marine Fisheries Service

Pascagoula, MS

ABSTRACT

The red snapper, *Lutjanus campechanus*, supports important commercial and recreational fisheries in the Gulf of Mexico (GOM) where stock is managed by size limits and quotas in federal waters. The National Marine Fisheries Service, Mississippi Laboratories has been investigating the use of larval fish abundance indices in stock assessments for a number of managed species, including red snapper. Reliable estimates of abundance and analyses of occurrence data depend on accurate identifications to the species level. Identification of snapper larvae remains problematic despite recent descriptions of larval stages, yet it is now possible to consistently identify red snapper larvae ≥ 3.5 mm. We have recently examined over 10,000 snapper larvae collected during Southeast Area Monitoring and Assessment Program (SEAMAP) resource surveys and present here a subset of those results for the area between Brownsville, TX to Mobile Bay, AL.

RED SNAPPER DISCARDS IN TEXAS COASTAL WATERS: A FISHERY DEPENDENT ONBOARD SURVEY OF RECREATIONAL HEADBOAT DISCARDS AND LANDINGS

Barbara A. Dorf
Texas Parks & Wildlife
Coastal Fisheries Division

ABSTRACT

Quantity and characteristics of red snapper (*Lutjanus campechanus*) recreational headboat discards and landings from three Texas ports (Galveston, Port Aransas, and Port Isabel) were determined in a fishery dependent study using NMFS-trained onboard observers during August and September 1999. Mean fishing depth during 54 trips (199 sets) was 40.2 m (range, 13.4 – 95.4 m) with 36.5% of reels sampled. Red snapper less than the 1999 federal minimum size of 450 mm (18 inches) total length made up 93.4% of the 3,863 snapper collected. Those less than the Texas state minimum size of 375 mm (15 inches) made up 64.0% of the catch. When brought on board, 70.2% of snapper appeared normal and 26.1% had protruding stomachs. Of the discarded red snapper, 60.6% were released alive and swam down, 22.8% swam erratically, 15.2% floated, and 1.4% were discarded dead. Fish released either dead or floating were caught at greater depths than fish which swam down or erratically. Galveston had the largest discard:landing ratio (211:1) and smallest mean fish size (0.7 kg, 343 mm). Port Aransas had the lowest discard:landing ratio (5.2:1) and largest mean fish size (0.9 kg, 387 mm).

INTRODUCTION

Red snapper (*Lutjanus campechanus*) is one of the most economically important species in the Gulf of Mexico reef-fish fishery. In order to manage this widely used resource, the Gulf of Mexico Fishery Management Council implemented a Reef Fish Fishery Management Plan in 1984 to rebuild declining reef fish stocks (GMFMC 1981). Recent management measures have been publicly controversial; particularly regarding bycatch in the shrimp fishery, accuracy of stock assessments, and possible under-reporting and inaccuracy of commercial and recreational catches. As a result, an independent scientific assessment of red snapper status in the Gulf of Mexico, as well as a peer review of all National Marine Fisheries Service (NMFS) stock assessments and fisheries statistics was completed in 1997 (MRAG Americas 1997). Although supportive of the scientific evaluations, data limitations were noted.

One area of concern was monitoring the number and length frequency of discards. Another was the accurate estimate of discard mortality rates, particularly in relation to depth of capture. In 1999, the NMFS responded to the 1997 peer review and presented a research plan for red snapper in the Gulf of Mexico. The plan addressed all phases of the reef-fish fishery, including the directed commercial fishery, recreational charter boats, and headboats (MRAG Americas 1999). Onboard observers were suggested as the best way to estimate discard. To estimate discard mortality rates, a “sink or swim” approach was suggested in which onboard observers would note the short-term fate of discarded red

snapper: whether or not the fish swam down out of sight. Another suggested method to determine mortality rate involved releasing snapper into cages, then lowering them to depth. This method has been used previously, although at relatively shallow depths (Gitschlag & Renaud 1994, Render & Wilson 1994).

Discard of red snapper caught in the recreational headboat fishery are usually due to: catch during a seasonal closure while fishing for other species, smaller than minimum size, or number in excess of legal bag limits. The amount and characteristics of this recreational bycatch are poorly documented, as is its contribution to bycatch mortality in the Gulf of Mexico. Red snapper from Texas headboats account for 80% of Texas recreational red snapper landings, 85% of Gulf of Mexico headboat red snapper landings, and 25% of Gulfwide recreational red snapper landings (Schirripa & Legault 1999). Awareness of the quantity and characteristics of recreational discards from this important sector of the red snapper fishery can promote the development of improved stock assessment and management strategies for the Gulf of Mexico.

The goal of this study was to determine the quantity, characteristics, and fate of red snapper from the directed recreational headboat fishery along the Texas coast from a depth stratified perspective. Specific objectives included placing NMFS trained observers on board recreational headboats from three Texas ports (Galveston, Port Aransas, and Port Isabel) to determine the: 1) length, weight, and condition of all snapper brought on board; 2) condition and short-term fate of all snapper discards; 3) fishery-specific and environmental parameters associated with all catches.

MATERIALS AND METHODS

Headboats were based in one of three Texas ports: Galveston, Port Aransas, and Port Isabel. Sampling occurred during the months of August and early September 1999. Prior to closure of the red snapper fishery in federal waters at the end of August, sampling occurred in federal and state waters, continuing solely in state waters during September. Data were collected following protocols described in MRAG Americas (1999), FC.1 Reef fish fishery observer program, and Gitschlag & Renaud (1994). Methodology closely followed already existing NMFS methods to assure data compatibility. Either one or two NMFS-trained observers were placed aboard all available headboat trips departing from each of the three ports.

Catch specific information was collected for each trip and set: date and time, latitude and longitude, fishing depth (fathoms), bottom type, wave height (feet), fishing gear type (manual or electric reels), number of fishers and reels, and hours fished. *Biological data* included length (mm) and weight (kg) for both discards and landings, condition of snapper brought on board, hooking location, release method, and discard fate. Catch per unit effort (CPUE) was calculated as: (“#Fish Caught” / “Set Hours”) / “#Reels Sampled.”

Condition of snapper when brought on board was categorized as: live – normal appearance, stomach protruding, eyes protruding, combination of stomach & eyes protruding, dead on arrival, or not determined. *Hooking* locations were divided into: maxilla, gill, esophagus, or other. *Release* methods were described as: remove hook, cut leader, swim bladder punctured, combination of hook removal and swim bladder puncture, or combination of cut leader and swim bladder puncture.

Discard fate was recorded as: fish kept, discarded alive-swim down, erratic swimming, floating, or discarded-dead.

Because there were often more reels on an entire headboat than could be sampled effectively by one or two observers, each boat was divided into sections as necessary. A trip-specific random table of numbers was used to determine which boat section to sample during a set. Results represent all reels sampled.

RESULTS AND DISCUSSION

Forty-eight trips were made aboard four recreational headboats from three Texas fishing ports (Galveston, Port Aransas, and Port Isabel) during August 1999. Six trips were made aboard one recreational headboat (Port Isabel) during September 1999 (Table 6.8). Data were collected during 32 days and 2 nights of observations. One hundred ninety-nine sets (170 in August & 29 in September) were sampled at the locations shown in Figure 6.31.

Mean overall vessel length was 22 m, ranging from 17 to 24 m. All vessels had either fiberglass or aluminum hulls. Engine power ranged from 700 to 2,120 horsepower, with a mean of 1,232 horsepower. Crew size (not including the captain) ranged from one to six individuals, with a mean crew size of three. Reels were either manual or electric (although only the Port Aransas headboat carried electric reels), with 73% of all reels manual.

Mean depth was 40.2 m (20.7 s.d.), ranging from 13.4 to 95.4 m (Figure 6.32). Mean fishing depth was significantly different between ports in August ($F = 220.132$, $n = 169$, $df = 2$, $p < 0.0001$) with the greatest mean depth from Port Aransas (66.0 m, 14.7 s.d.). Fishing depth was shallowest in Galveston (mean 24.8 m, 6.3 s.d.), with intermediate August values from Port Isabel (mean 48.6 m, 11.9 s.d.). In September, the only samples collected were in state waters from Port Isabel (mean 21.5 m, 3.1 s.d.). Previous discard mortality studies have been carried out in waters shallower than those commonly fished by Texas headboats. Render & Wilson (1994) carried out their study on a Louisiana gas production platform in 21 m of water. Surface release studies by Gitschlag & Renaud (1994) used fish collected at 21 – 40 m depths. Render & Wilson (1996) noted a general trend of increasing mortality due to physiological stress of unvented snapper collected at depths up to 56 m. The Texas coast and the greater depths where recreational snapper fishing occurs there are currently underrepresented in management data collection efforts.

Table 6.8. Number of trips and sets sampled from Texas recreational headboats in August and September 1999 by fishing port.

	Galveston	Port Aransas	Port Isabel (Aug)	Port Isabel (Sept)	Total
Trips	20	13	15	6	54
Sets	74	50	46	29	199

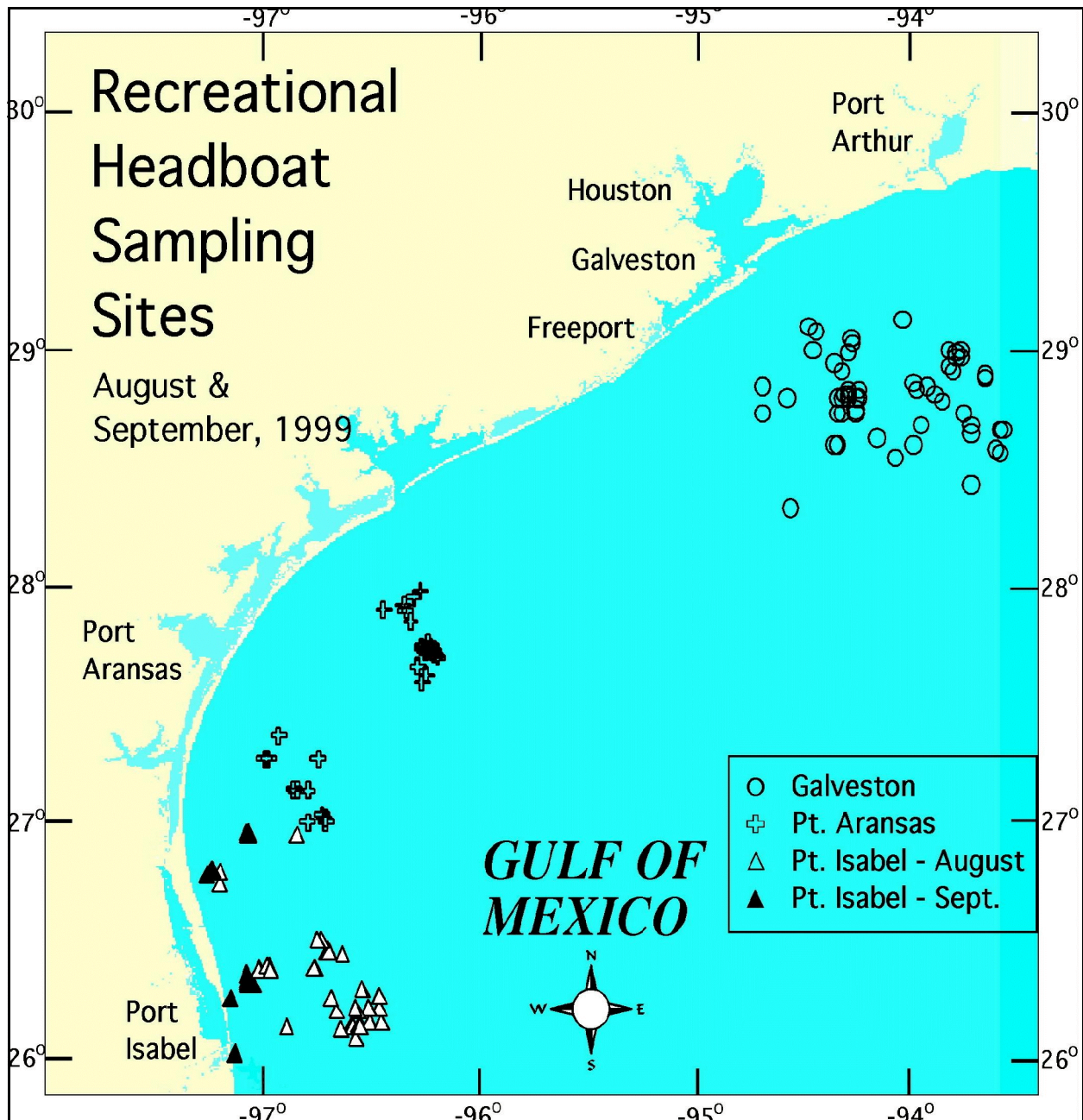

Figure 6.31. Location of Texas recreational headboat sets in August and September 1999.

The mean number of reels sampled per set was 9.8 (2.5 s.d.), with a range of 1 to 22 reels. This mean constituted 36.5% of all reels in use (29.7% s.d.). Fishing time per set varied from 0.2 to 4 hours with a mean of 0.9 hours (0.6 s.d.). The majority of fishing occurred during daylight hours, although there were 2 night fishing trips from Port Aransas. The majority of sets (62.3%) occurred in 0 to 0.6 m seas, with 37.7% in 0.9 to 1.5 m seas. Most sets took place over rock bottom (55.6%), with mud (14.8%), and coral (1.0%) comprising the remainder. Fishing often occurred near hydrocarbon production platforms and over submerged structures such as wrecks.

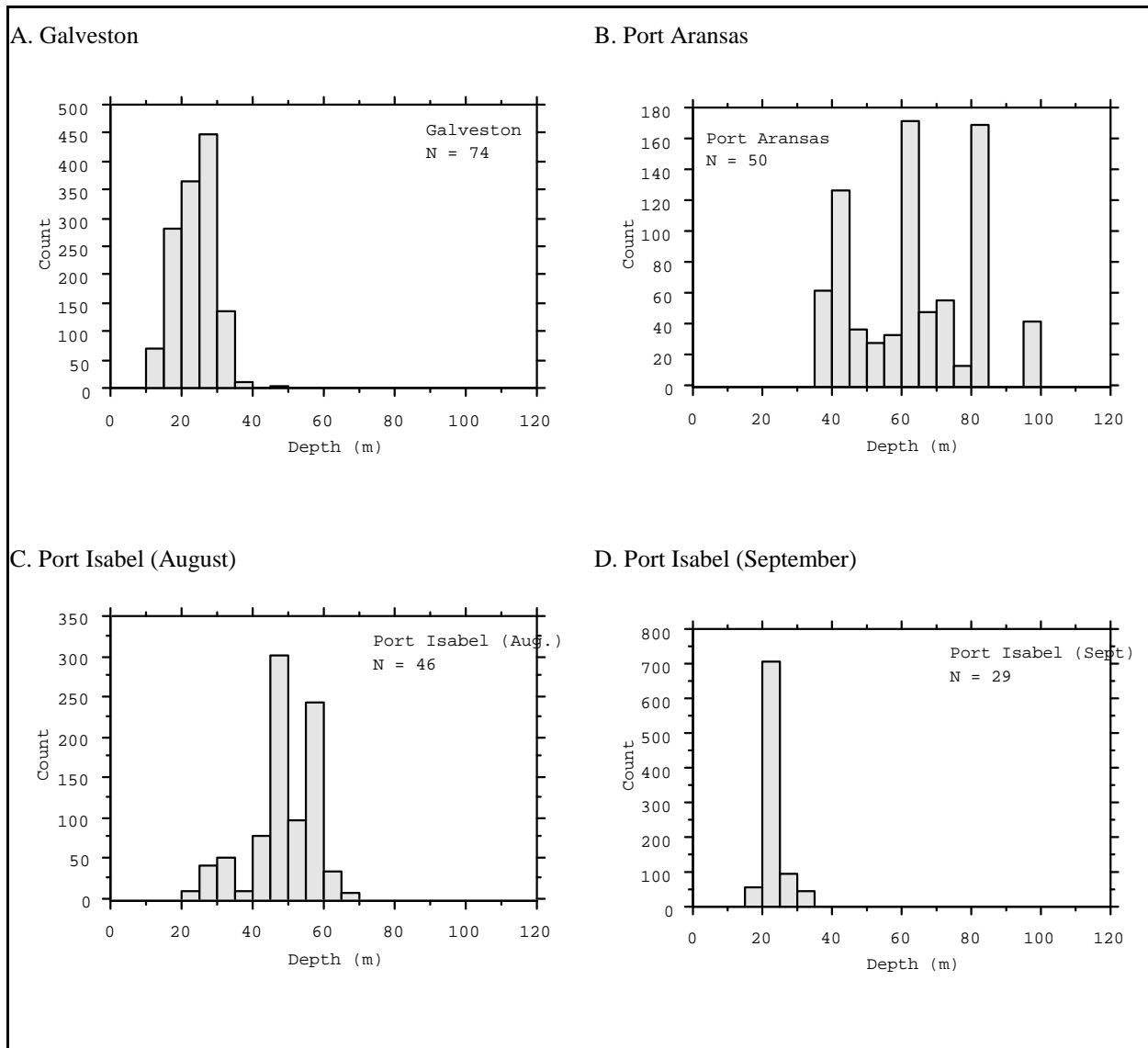

Figure 6.32. Fishing depth by port for recreational headboat sets in August and September 1999. A. Galveston; B. Port Aransas; C. Port Isabel (August); D. Port Isabel (September).

Red Snapper Size Composition

A total of 3,863 red snapper were caught on hook-and-line during the study period. Of these, 3,828 were measured and ranged from 105 to 908 mm (4 to 36 inches) total length (TL) (Table 6.9). The frequency distribution of snapper examined is shown in Figure 6.33. Mean total length was significantly different between ports in August ($F = 139.308$, $n = 2,925$, $df = 2$, $p < 0.0001$). Overall, snapper 350 – 375 mm (14 - 15-inch) TL comprised the largest proportion (18.1%) of individuals, although Port Aransas had their largest proportion of snapper (22.8%) in the 375 – 400 mm (15 – 16-inch) TL size (Figure 6.3 3, Table 6.9).

Table 6.9. Frequency distribution (A. Total %; B. Cumulative %) for total length (mm) of red snapper measured during Texas recreational headboat sets in August and September 1999.

A. Total %

From (\geq)	To ($<$)	Total Count	Total %	Galveston, August Count	Galveston, August %	Port Aransas, August Count	Port Aransas, August %	Port Isabel, August Count	Port Isabel, August %	Port Isabel, September Count	Port Isabel, September %
75	100	0	0.00	0	0.00	0	0.00	0	0.00	0	0.00
100	125	1	0.03	0	0.00	0	0.00	1	0.11	0	0.00
125	150	0	0.00	0	0.00	0	0.00	0	0.00	0	0.00
150	175	1	0.03	1	0.08	0	0.00	0	0.00	0	0.00
175	200	0	0.00	0	0.00	0	0.00	0	0.00	0	0.00
200	225	13	0.34	4	0.31	2	0.26	2	0.23	5	0.56
225	250	85	2.22	36	2.83	0	0.00	13	1.49	36	4.00
250	275	196	5.12	64	5.02	4	0.51	52	5.98	76	8.44
275	300	262	6.84	103	8.08	19	2.42	45	5.17	95	10.56
300	325	510	13.32	205	16.09	49	6.25	103	11.84	153	17.00
325	350	688	17.97	256	20.09	110	14.03	136	15.63	186	20.67
350	375	693	18.10	269	21.11	163	20.79	150	17.24	111	12.33
375	400	539	14.08	184	14.44	179	22.83	101	11.61	75	8.33
400	425	374	9.77	105	8.24	119	15.18	68	7.82	82	9.11
425	450	212	5.54	33	2.59	62	7.91	62	7.13	55	6.11
450	475	96	2.51	12	0.94	32	4.08	37	4.25	15	1.67
475	500	65	1.70	1	0.08	18	2.30	40	4.60	6	0.67
500	525	24	0.63	0	0.00	7	0.89	14	1.61	3	0.33
525	550	18	0.47	1	0.08	3	0.38	13	1.49	1	0.11
550	575	6	0.16	0	0.00	1	0.13	5	0.57	0	0.00
575	600	19	0.50	0	0.00	5	0.64	14	1.61	0	0.00
600	625	5	0.13	0	0.00	1	0.13	4	0.46	0	0.00
625	650	5	0.13	0	0.00	2	0.26	2	0.23	1	0.11
650	675	6	0.16	0	0.00	4	0.51	2	0.23	0	0.00
675	700	3	0.08	0	0.00	1	0.13	2	0.23	0	0.00
700	725	3	0.08	0	0.00	0	0.00	3	0.34	0	0.00
725	750	1	0.03	0	0.00	1	0.13	0	0.00	0	0.00
750	775	1	0.03	0	0.00	0	0.00	1	0.11	0	0.00
775	800	0	0.00	0	0.00	0	0.00	0	0.00	0	0.00
800	825	1	0.03	0	0.00	1	0.13	0	0.00	0	0.00
825	850	0	0.00	0	0.00	0	0.00	0	0.00	0	0.00
850	875	0	0.00	0	0.00	0	0.00	0	0.00	0	0.00
875	900	0	0.00	0	0.00	0	0.00	0	0.00	0	0.00
900	925	1	0.03	0	0.00	1	0.13	0	0.00	0	0.00
925	950	0	0.00	0	0.00	0	0.00	0	0.00	0	0.00
	Total	3828	100.00	1274	100.00	784	100.00	870	100.00	900	100.00

Table 6.9. (continued)

B. Cumulative %											
From (≥)	To (≤)	Total Count	Total %	Galveston, August Count	Galveston, August %	Port Aransas, August Count	Port Aransas, August %	Port Isabel, August Count	Port Isabel, August %	Port Isabel, September Count	Port Isabel, September %
75	100	0	0.00	0	0.00	0	0.00	0	0.00	0	0.00
100	125	1	0.03	0	0.00	0	0.00	1	0.11	0	0.00
125	150	1	0.03	0	0.00	0	0.00	1	0.11	0	0.00
150	175	2	0.05	1	0.08	0	0.00	1	0.11	0	0.00
175	200	2	0.05	1	0.08	0	0.00	1	0.11	0	0.00
200	225	15	0.39	5	0.39	2	0.26	3	0.34	5	0.56
225	250	100	2.61	41	3.22	2	0.26	16	1.84	41	4.56
250	275	296	7.73	105	8.24	6	0.77	68	7.82	117	13.00
275	300	558	14.58	208	16.33	25	3.19	113	12.99	212	23.56
300	325	1068	27.90	413	32.42	74	9.44	216	24.83	365	40.56
325	350	1756	45.87	669	52.51	184	23.47	352	40.46	551	61.22
350	375	2449	63.98	938	73.63	347	44.26	502	57.70	662	73.56
375	400	2988	78.06	1122	88.07	526	67.09	603	69.31	737	81.89
400	425	3362	87.83	1227	96.31	645	82.27	671	77.13	819	91.00
425	450	3574	93.36	1260	98.90	707	90.18	733	84.25	874	97.11
450	475	3670	95.87	1272	99.84	739	94.26	770	88.51	889	98.78
475	500	3735	97.57	1273	99.92	757	96.56	810	93.10	895	99.44
500	525	3759	98.20	1273	99.92	764	97.45	824	94.71	898	99.78
525	550	3777	98.67	1274	100.00	767	97.83	837	96.21	899	99.89
550	575	3783	98.82	1274	100.00	768	97.96	842	96.78	899	99.89
575	600	3802	99.32	1274	100.00	773	98.60	856	98.39	899	99.89
600	625	3807	99.45	1274	100.00	774	98.72	860	98.85	899	99.89
625	650	3812	99.58	1274	100.00	776	98.98	862	99.08	900	100.00
650	675	3818	99.74	1274	100.00	780	99.49	864	99.31	900	100.00
675	700	3821	99.82	1274	100.00	781	99.62	866	99.54	900	100.00
700	725	3824	99.90	1274	100.00	781	99.62	869	99.89	900	100.00
725	750	3825	99.92	1274	100.00	782	99.74	869	99.89	900	100.00
750	775	3826	99.95	1274	100.00	782	99.74	870	100.00	900	100.00
775	800	3826	99.95	1274	100.00	782	99.74	870	100.00	900	100.00
800	825	3827	99.97	1274	100.00	783	99.87	870	100.00	900	100.00
825	850	3827	99.97	1274	100.00	783	99.87	870	100.00	900	100.00
850	875	3827	99.97	1274	100.00	783	99.87	870	100.00	900	100.00
875	900	3827	99.97	1274	100.00	783	99.87	870	100.00	900	100.00
900	925	3828	100.00	1274	100.00	784	100.00	870	100.00	900	100.00
925	950	3828	100.00	1274	100.00	784	100.00	870	100.00	900	100.00
	Total	3828	100.00	1274	100.00	784	100.00	870	100.00	900	100.00

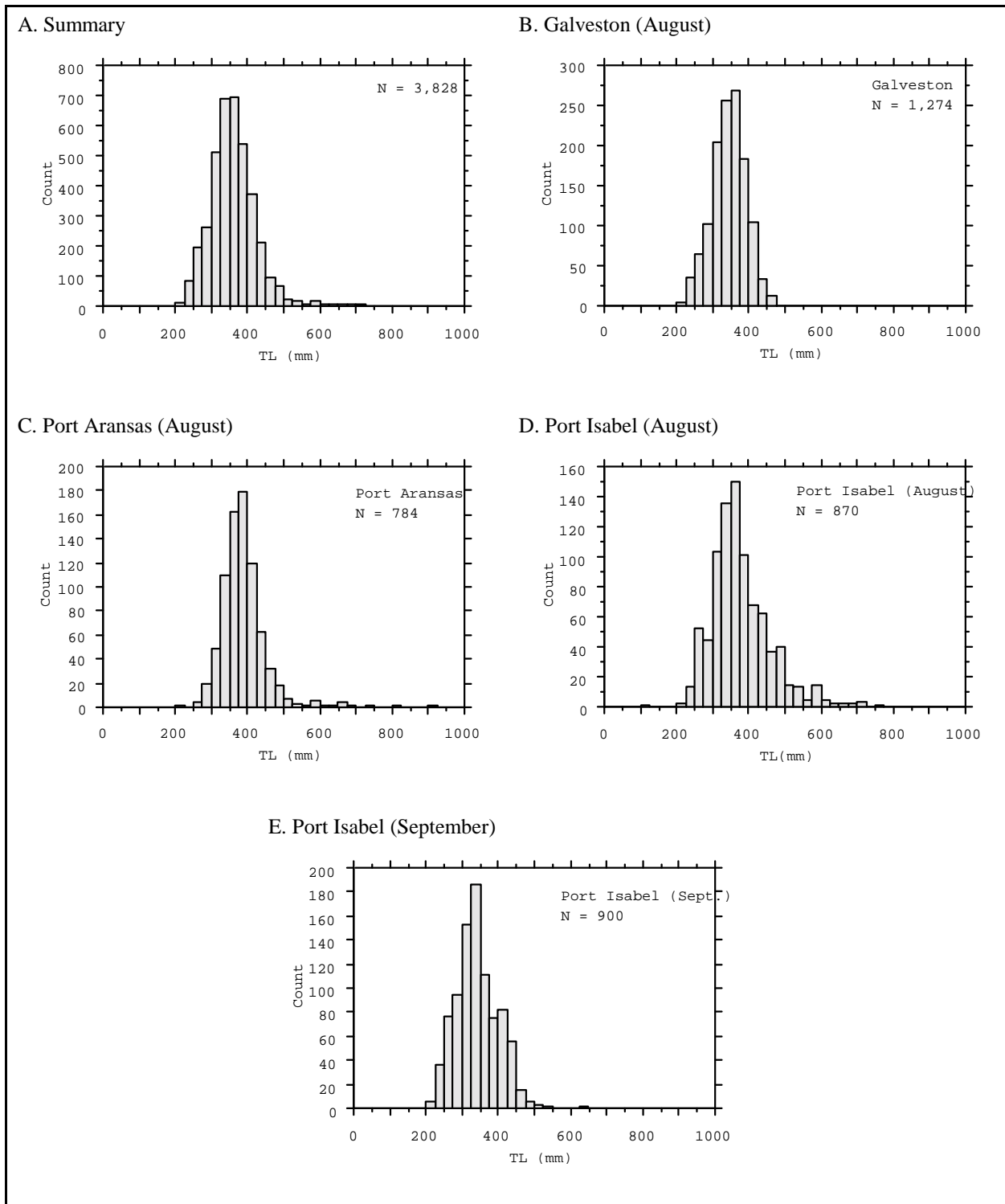

Figure 6.33. Size distribution of red snapper caught and measured during Texas recreational headboat sets in August and September 1999. A. Summary; B. Galveston (August only); C. Port Aransas (August only); D. Port Isabel (August); E. Port Isabel (September).

Red snapper < 450 mm (18 inches, federal minimum size at the time of this study) TL made up 93.4% of snapper caught. Those < 400 mm (16 inches, current federal minimum size) made up 78.1% of snapper caught. Snapper < 375 mm (15 inches, current state minimum size) constituted 64.0% of fish collected (Table 6.9). Port Isabel had the greatest proportion of snapper larger than 425 mm (17+ inches) in August samples, although Port Aransas had the largest proportion of 375 to <425 mm (15 to <17 inches) snapper (Table 6.10). There was no significant statistical relationship between depth and total length of snapper caught in this survey for any port or all ports combined ($r^2 = 0.092$).

Table 6.10. Percentage of red snapper measured greater than or equal to 450, 425, 400, and 375 mm (18, 17, 16, and 15 inches) total length caught during Texas recreational headboat sets in August and September 1999.

Total Length (mm)	Summary	Galveston %	Port Aransas %	Port Isabel (Aug) %	Port Isabel (Sep) %
450+	6.6	1.1	9.8	15.8	2.9
425+	12.2	3.7	17.7	22.9	9.0
400+	21.9	11.9	32.9	30.7	18.1
375+	36.0	26.4	55.7	42.3	26.4
N	3,828	1,274	784	870	900

Snapper collected in this study represent a greater size range than those of most previous studies, reflecting size distribution differences among locations along the Gulf coast. In the surface release study by Gitschlag & Renaud (1994), southeast of Galveston, Texas, 91% of their snapper were less than 300 mm FL (324 mm TL; (Parrack 1986)). For their cage studies, tested snapper were \leq 430 mm FL (463 mm TL), with 35% of their snapper < 300 mm FL (324 mm TL), similar to the present study where 28% of snapper were under 325 mm TL). Mortality tests by Render & Wilson (1996) were conducted south of Cameron, Louisiana on fish less than 360 mm FL (388 mm TL). In the present study, Port Aransas and Port Isabel (August) snapper \geq 375+ mm TL accounted for 33% and 31% of the catch, respectively.

Red Snapper Hooking Location and Condition When Brought on Board

Hooking location was determined for 3,849 snapper: 91.8% were hooked in the maxilla, 6.2% in the esophagus, 0.8% in the gill, and 1.3% in some other area of the body. Condition when brought on board was determined for 3,844 snapper: 70.2% were normal in appearance, 26.1% had their stomach protruding from their mouths, 2.8% had protruding eyes, 0.6% had both eyes and stomach protruding, and 0.3% were brought on board dead. There were significant differences in mean depth between conditions ($F = 109.056$, $n = 3,840$, $df = 4$, $p < 0.0001$), although there was no clear trend evident (Figure 6.34, Table 6.11). Percent of snapper brought to the surface with stomach protrusion was variable with depth and port, possibly a reflection of variable fish retrieval rates (manual vs.

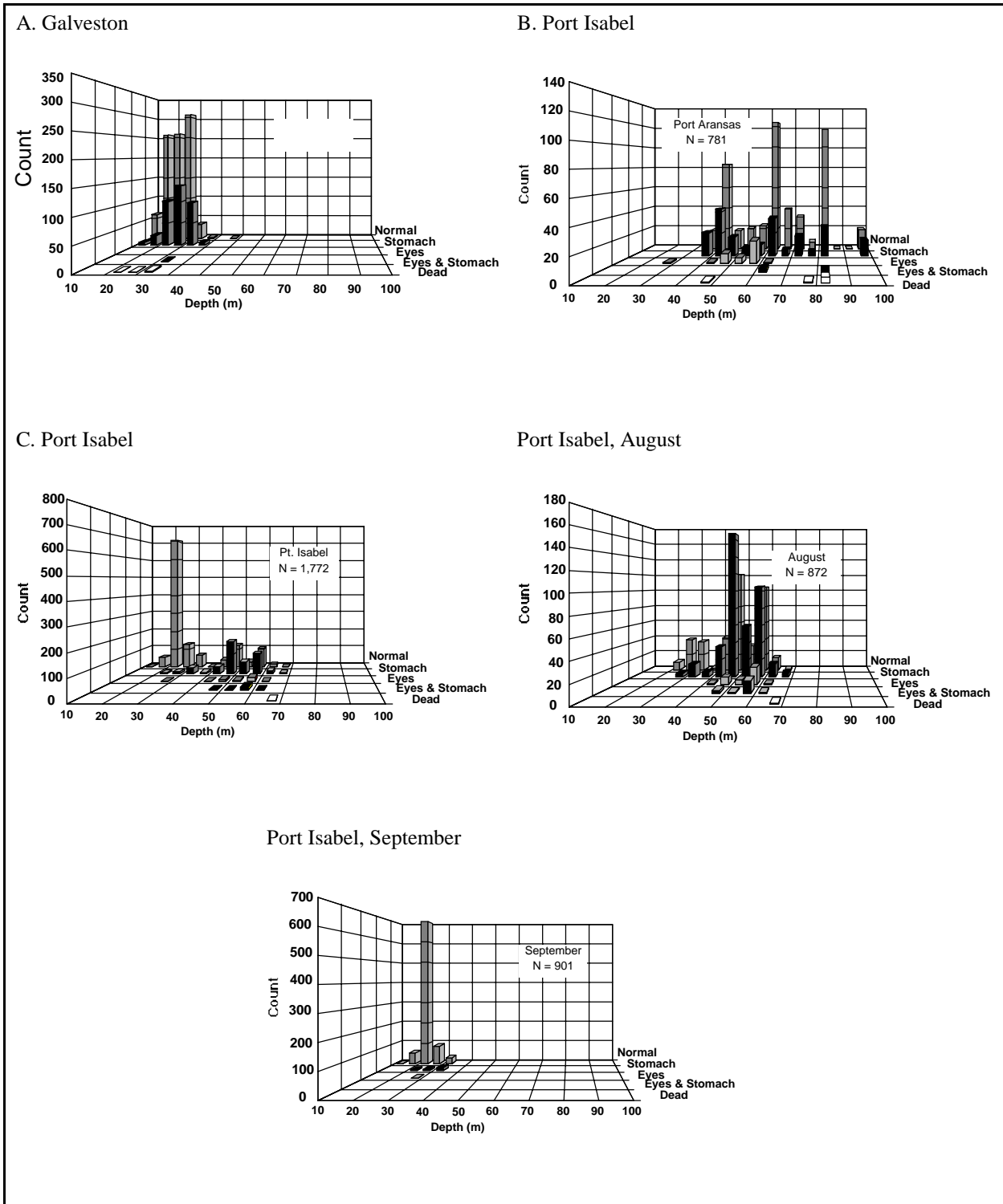

Figure 6.34. Depth and condition (when brought on board) of red snapper caught and measured during Texas recreational headboat sets in August and September 1999 by fishing port. A. Galveston; B. Port Aransas; C. Port Isabel.

Table 6.11. Mean depth (m) and frequency for condition (when brought on board) of red snapper measured during Texas recreational headboat sets in August and September 1999.

Condition	Mean Depth (m) [% of catch]				
	Summary (n = 3,844)	Galveston (n = 1,306)	Port Aransas (n = 781)	Port Isabel, Aug (n = 872)	Port Isabel, Sep (n = 901)
Normal	33.8 [70.2]	22.4 [71.1]	64.0 [64.0]	47.0 [46.4]	22.4 [97.1]
Stomach Protruding	43.1 [26.1]	26.9 [28.5]	59.8 [25.3]	50.5 [47.5]	29.1 [2.8]
Eyes Protruding	61.8 [2.8]	-	65.7 [9.3]	54.6 [3.9]	25.6 [0.1]
Eyes & Stomach	58.3 [0.6]	34.7 [0.1]	71.3 [0.6]	56.0 [2.1]	-
Dead	57.3 [0.3]	27.4 [0.3]	75.6 [0.8]	67.6 [0.1]	-

electric reels) by headboat fishers. Gitschlag & Renaud (1994) found that 33% of their cage study snapper were brought on board with everted stomachs, with 51% showing some sign of capture-related stress. For their surface release study, stomach protrusion from the mouth was noted in 1% of fish collected at 21-24 m depth, 56% at 27-30 m and 37-40 m depths.

Red Snapper Release and Discard Fate

When snapper were discarded, 62.8% were released by removing the hook without puncturing the swim bladder. The swim bladder was punctured along with hook removal for 36.2% of released snapper. Discard fate was determined for 3,851 fish, and included 12.9% of the catch that was kept. Of those that were discarded, 60.6% were released alive and swam down, 22.8% swam erratically, 15.2% floated, and 1.4% were discarded dead (Figure 6.35). There were significant differences in mean depth between discard fates ($F = 66.594$, $n = 3,353$, $df = 3$, $p < 0.0001$). Fish released either dead or floating were caught at greater depths than fish that swam down or swam erratically on release (Figure 6.36, Table 6.12).

Schirripa & Legault (1999) summarized an observer program in the Gulf of Mexico commercial reef fish fishery in 1995 that targeted several red snapper trips on handline vessels at similar depths to the present study (mean 40 m, range 33 – 62 m) located off of Louisiana and east Texas. Comparable amounts of red snapper were discarded dead (1.6%) and most discards were said to have either stomachs or eyes protruding. Gitschlag & Renaud (1994) found higher proportions of snapper swam down (99% at 21-24 m, 90% at 27-30 m, and 56% at 37-40 m) in a study based on 3 single day headboat trips. Researchers rather than headboat patrons caught snapper in their study, and onboard handling procedures and fish retrieval rates (manual vs. electric reels) may account for differences in swim down proportion on release.

There were no significant differences in mean total length between discard fates, excluding those kept ($F = 1.361$, $n = 3,324$, $df = 3$, $p = 0.2527$). The only clear trend was that all discard fates had similar total length distributions except fish > 450 mm which were legally kept (Table 6.13, Figure 6.37). Gitschlag & Renaud (1994) also found that survival of caged fish was unrelated to size.

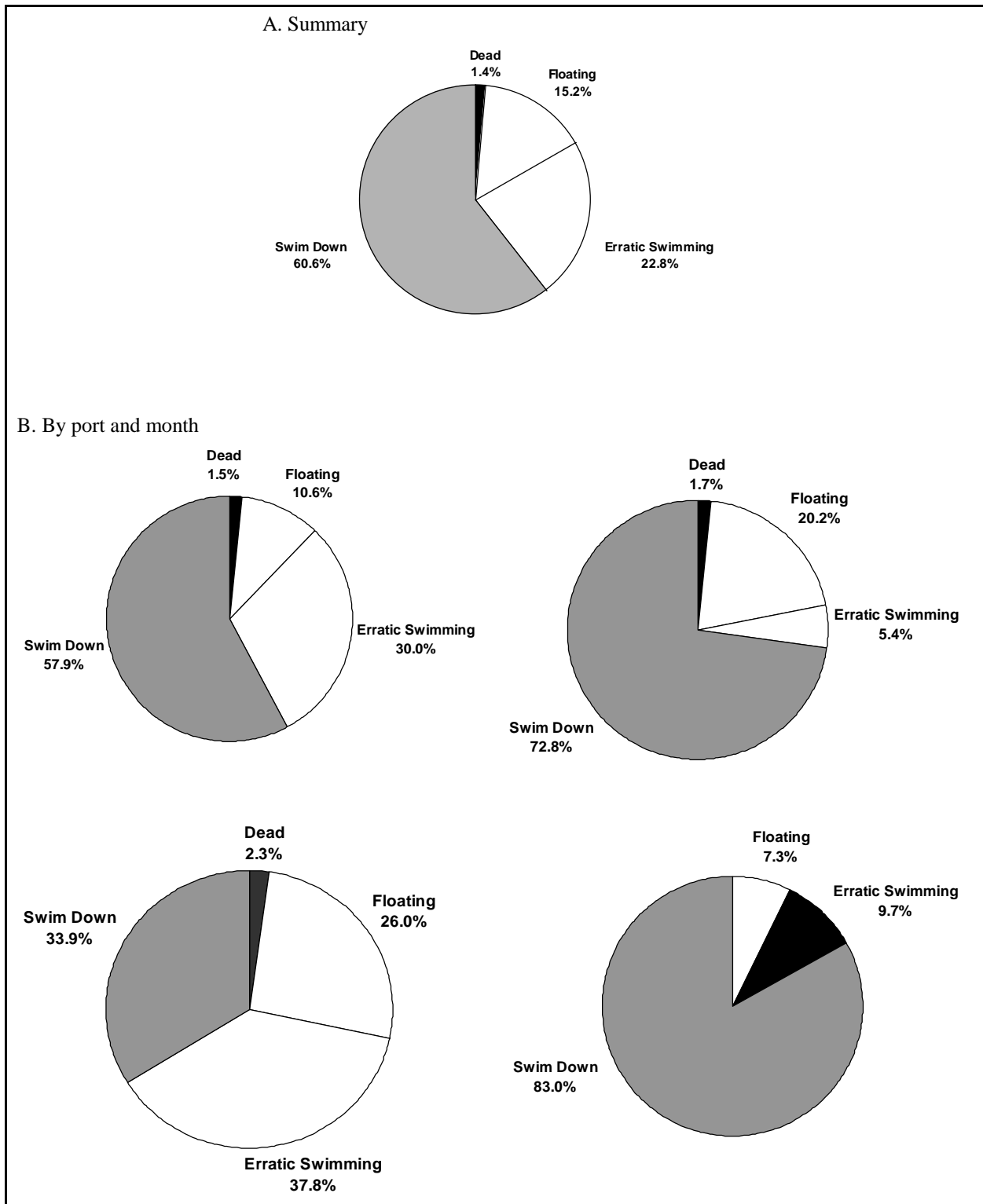

Figure 6.35. Fate of red snapper caught and measured during Texas recreational headboat sets in August and September 1999 by fishing port. A. Summary; B. By port and month.

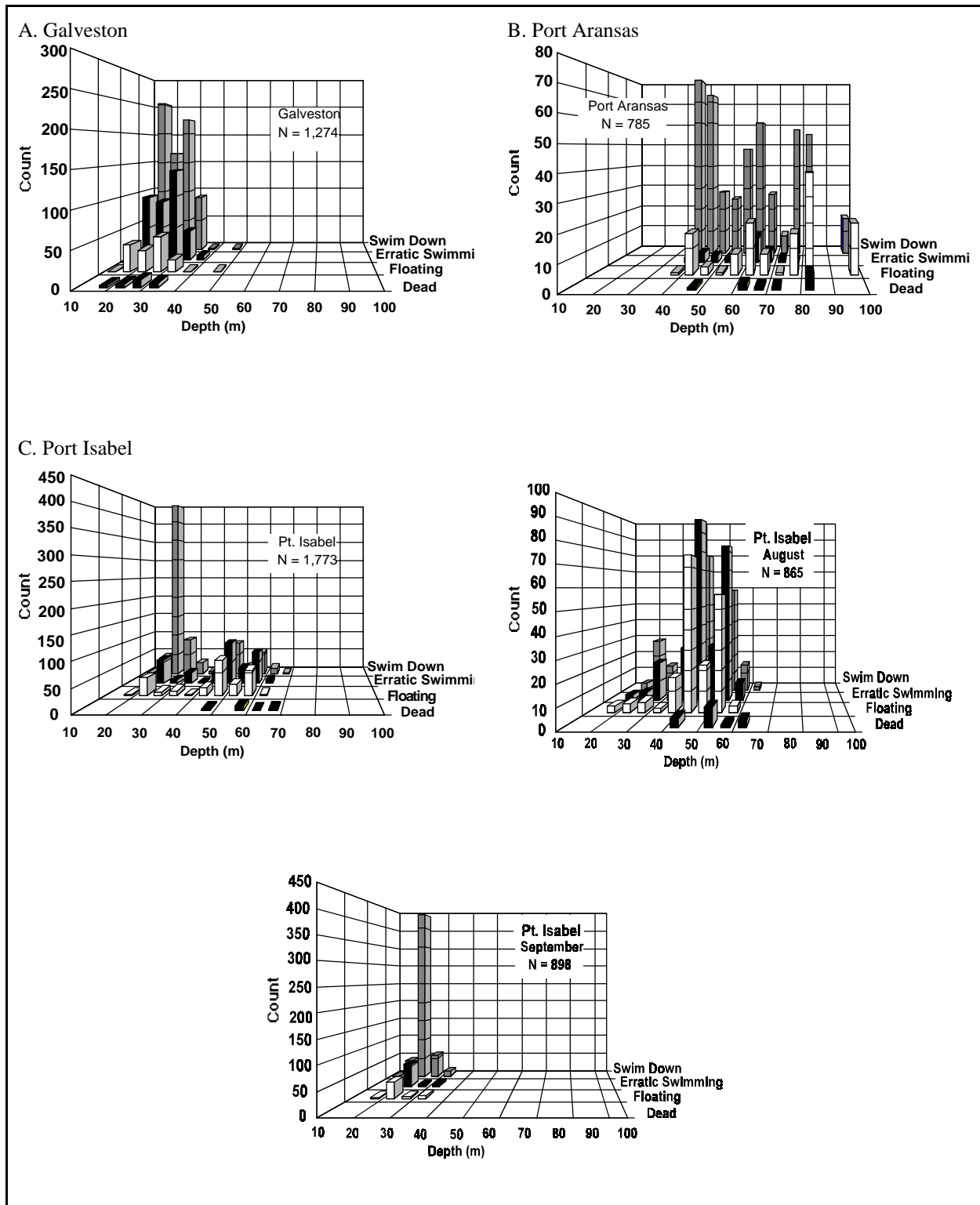

Figure 6.36. Depth and fate of red snapper caught and measured during Texas recreational headboat sets in August and September 1999 by fishing port. A. Galveston; B. Port Aransas; C. Port Isabel.

Table 6.12. Mean depth (m) and frequency for discard fate of red snapper measured during Texas recreational headboat sets in August and September 1999.

Discard Fate	Mean Depth (m) [% of catch]				
	Summary (n = 3,353)	Galveston (n = 1,298)	Port Aransas (n = 655)	Port Isabel, Aug (n = 731)	Port Isabel, Sep (n = 669)
Swim Down	34.3 [60.6]	23.3 [57.9]	59.0 [72.8]	47.2 [33.9]	22.1 [83.0]
Erratic Swimming	34.8 [22.8]	24.1 [30.0]	60.8 [5.2]	49.4 [37.8]	23.0 [9.7]
Floating	46.3 [15.2]	24.4 [10.6]	72.4 [20.3]	49.9 [26.0]	23.1 [7.3]
Dead	47.9 [1.4]	26.1 [1.5]	73.0 [1.7]	57.3 [2.3]	-

Table 6.13. Mean total length (mm) and frequency for discard fate of red snapper measured during Texas recreational headboat sets in August and September 1999.

Discard Fate	Mean Total Length (mm) [% of catch]				
	Summary (n = 3,828)	Galveston (n = 1,274)	Port Aransas (n = 784)	Port Isabel, Aug (n = 870)	Port Isabel, Sep (n = 900)
Swim Down	343 [52.6]	342 [57.7]	374 [61.1]	351 [28.4]	316 [61.6]
Erratic Swimming	344 [19.8]	345 [30.0]	366 [4.5]	349 [31.7]	305 [7.2]
Floating	348 [13.2]	339 [10.4]	364 [17.0]	352 [21.9]	314 [5.4]
Dead	339 [1.2]	330 [1.5]	350 [1.4]	342 [2.0]	-
Kept	459 [12.9]	478 [0.5]	468 [16.1]	518 [15.3]	419 [25.4]

Several snapper were kept from Port Aransas in August that were smaller than 450 mm (18-inches). These were harvested under a collecting permit for an ongoing research project. Catches from Port Isabel in September reflected the smaller minimum size requirement for snapper caught in Texas waters (380 mm, 15 inches) rather than the 450 mm (18-inch) federal minimum size. As a result, Port Isabel kept a larger proportion of fish than other locations (Table 6.13).

It is likely that large proportions of the snapper that floated or swam erratically died from physiological stress or were subject to predation soon after release. In addition, some of the snapper that swam down on release probably died later as a result of gas bladder rupture or other physiological damage, as summarized in Render & Wilson (1996). It is beyond the scope of this study to draw such a conclusion, as no specific data were available on the long-term fate of the released snapper. Survival rates from cage studies must be interpreted carefully when compared to surface release studies. Cage studies eliminate predation risk and, by forcing submergence, may enhance the survival of fish that would have otherwise remained at the surface either floating or swimming erratically.

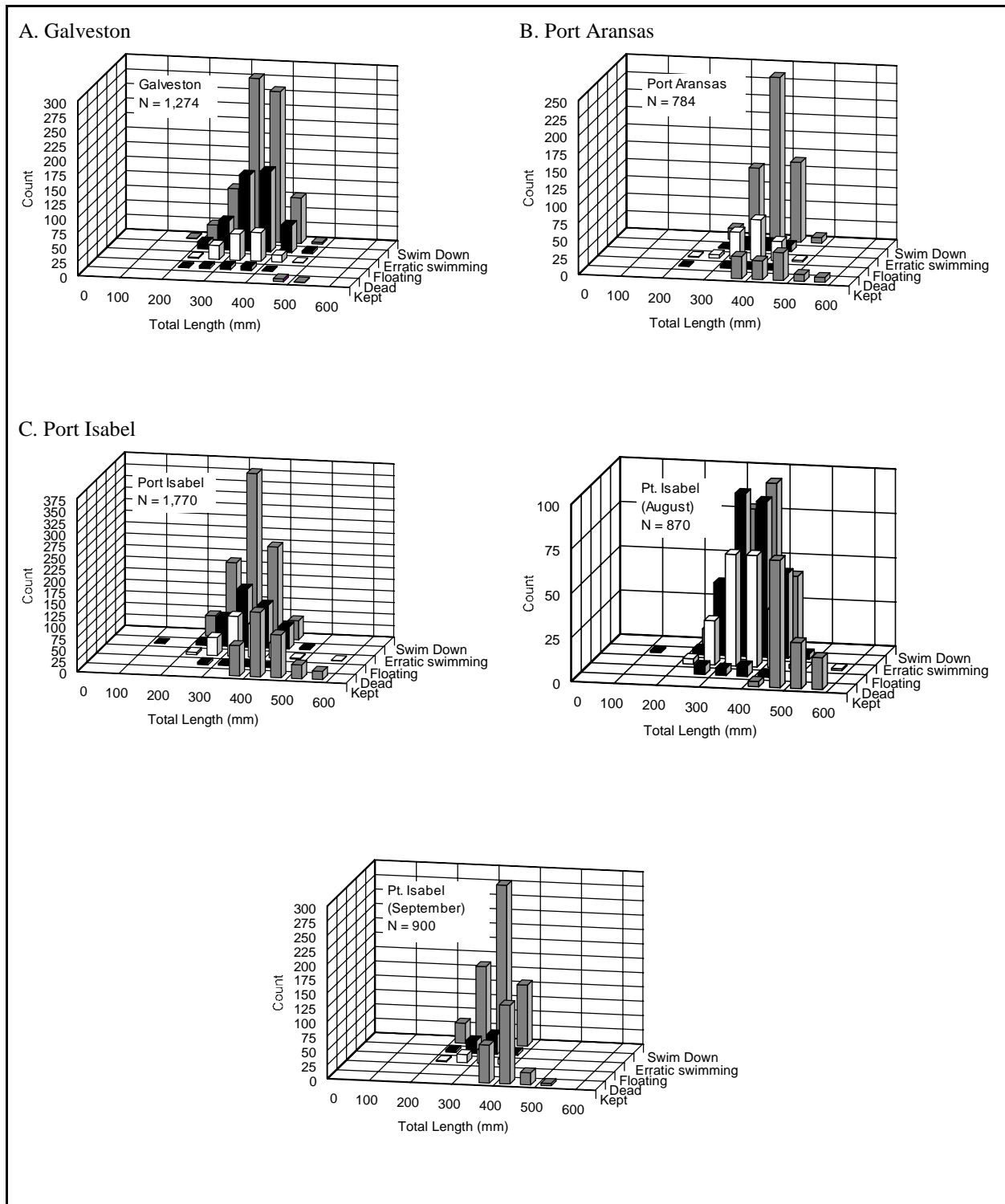

Figure 6.37. Size and fate of red snapper caught and measured during Texas recreational headboat sets in August and September 1999 by fishing port. A. Galveston; B. Port Aransas; C. Port Isabel.

Red Snapper Discards, Landings and CPUE (Catch per Unit Effort)

Overall, 87.1% of the red snapper catch was discarded (Table 6.14). By weight, discarded snapper made up 75.2% of the catch (Table 6.15). Galveston had the largest discard:landing ratio (211:1), the smallest mean weight per fish sampled (0.7 kg, 0.3 s.d.), and the smallest mean fish total length (343 mm, 47.3 s.d.; 13.5 inches, 1.9 s.d) (Table 6.16). Port Aransas had the lowest discard:landing ratio (5.2:1) along with the largest weight per fish (0.9 kg, 0.7 s.d.), and total length per fish (387 mm, 62.7 s.d.; 15.3 inches, 2.5 s.d.). Estimates of total discards per port are conservative because of the need to subdivide the boat when the number of fishers was too large for two observers to manage efficiently. Data from the 1995 commercial red snapper hand line observer program (Schirripa & Legault 1999) indicated that only 40.7% of red snapper were discarded, constituting 18.6% of the snapper catch by weight. Fish approximately 375 mm (15 inches) or larger were retained.

Mean CPUE for red snapper was 2.8 fish per angler hour (2.19 s.d.). There were no significant differences in CPUE between ports ($p > 0.0258$). CPUE from the present study is higher than all values reported in Schirripa & Legault (1999) for the Gulf of Mexico recreational fishery. Their CPUE measure is derived exclusively from the Marine Recreational Fishery Statistics Survey (MRFSS) and Texas Parks & Wildlife (TPW) harvest survey data. However, headboat sampling was discontinued by the MRFSS in 1985, and TPW does not sample headboat landings. The NMFS Headboat Survey, begun in 1985, includes Gulf of Mexico ports and estimates headboat landings. Currently, there is no direct measure of discards included in the red snapper stock assessment.

Table 6.14. Discards and landings (numbers) of red snapper measured from Texas recreational headboat sets in August and September 1999 by fishing port.

	Galveston	Port Aransas	Port Isabel (Aug)	Port Isabel (Sept)	Total
Discards	1,268	658	730	668	3,324
Landings	6	126	133	229	494
Total	1,274	784	863	897	3,818
D:L	211.3 : 1	5.2 : 1	5.5 : 1	2.9 : 1	6.7 : 1

Table 6.15. Discards and landings (whole weight, kg) of red snapper measured from Texas recreational headboat sets in August and September 1999 by fishing port. Number in parentheses is the mean weight per fish sampled.

	Galveston	Port Aransas	Port Isabel (Aug)	Port Isabel (Sept)	Total
Discards	879 (0.69)	525 (0.80)	511 (0.69)	344 (0.51)	2,259 (0.68)
Landings	10 (1.69)	207 (1.64)	275 (2.07)	254 (1.11)	746 (1.51)
Total	889 (0.70)	732 (0.93)	786 (0.90)	598 (0.67)	3,005 (0.79)

Table 6.16. Discards and landings (mean total length, mm) of red snapper measured from Texas recreational headboat sets in August and September 1999 by fishing port. Number in parentheses is the standard deviation of total length.

	Galveston	Port Aransas	Port Isabel (Aug)	Port Isabel (Sept)	Total
Discards	342 (46.5)	371 (39.6)	351 (52.4)	314.6 (37.1)	344 (48.4)
Landings	478 (23.8)	468 (91.9)	518 (66.6)	419 (31.6)	459 (74.2)
Total	343 (47.3)	387 (62.7)	376 (81.5)	341 (57.9)	359 (65.1)

This study is the first time that observers have been placed on board recreational headboats to directly document the quantity and characteristics of red snapper discards and landings on the Texas coast. Texas accounts for 85% of Gulf of Mexico headboat red snapper landings and 25% of Gulfwide recreational red snapper landings (Schirripa & Legault 1999). If current minimum size limits had been in effect during the time of this study the discard rate would still have been 78% in federal waters (400 mm, 16 inch minimum size) and 64% in Texas state waters (375 mm, 15 inch minimum size), much higher than that reported from the commercial fishery. Although limited in duration, this study demonstrates the importance of discards to the Texas red snapper fishery as well as to red snapper stock assessment in the Gulf of Mexico. It would be beneficial to continue, optimize, and expand this type of study to cover the entire red snapper season in all areas of the Gulf of Mexico where headboat sampling occurs.

ACKNOWLEDGMENTS

I thank Russell O'Brien for his work in coordinating fishery observers in the field, as well as the fishery observers, themselves. Headboat captains, crews and recreational fishers in Galveston, Port Aransas and Port Isabel were essential and voluntary participants in the study, providing willing access to fish brought on board. Joan Holt provided valuable suggestions at early project stages. The University of Texas Marine Science Institute provided institutional support. This study was made possible by the financial support of the Gulf & South Atlantic Fisheries Foundation, Inc., Tampa.

REFERENCES

- Gitschlag, G.R. & M.L. Renaud. 1994. Field experiments on survival rates of caged and released red snapper. *North American Journal of Fisheries Management* 14: 131-136.
- GMFMC. 1981. Environmental Impact Statement and Fishery Management Plan for the Reef Fish Resources of the Gulf of Mexico. Florida Sea Grant College Gulf of Mexico Fishery Management Council, Tampa, FL. 154 pp.
- MRAG Americas, I. 1997. Consolidated report on the peer review of red snapper (*Lutjanus campechanus*) research and management in the Gulf of Mexico. The Office of Science and Technology, National Marine Fisheries Service. 86 pp.

- MRAG Americas, I. 1999. NMFS Response to the 1997 Peer Review of Red Snapper (*Lutjanus campechanus*) Research and Management in the Gulf of Mexico. National Marine Fisheries Service, St. Petersburg, FL. 146 pp.
- Parrack, N.C. 1986. Review and update of Gulf of Mexico red snapper biometrics: 1. Length-weight relations, 2. Length-length conversions. NMFS, SEFC, Miami Laboratory, Miami, FL, Miami, FL. 26 pp.
- Render, J.H. & C.A. Wilson. 1994. Hook-and-line mortality of caught and released red snapper around oil and gas platform structural habitat. *Bulletin of Marine Science* 55: 1106-1111.
- Render, J.H. & C.A. Wilson. 1996. The effect of gas bladder deflation on mortality of hook-and-line caught and released red snappers: implications for management. Pp. 244-253. *In* F. Arreguin-Sanchez, J.L. Munro, M.C. Balgo & D. Pauly (eds.) *Biology and culture of tropical groupers and snappers*. ICLARM Conference Proceedings 48.
- Schirripa, M.J. & C.M. Legault. 1999. Status of the red snapper in U.S. waters of the Gulf of Mexico: Updated through 1998. SE Fisheries Science Center, Sustainable Fisheries Division, Miami, FL. 86 pp.

Barbara A. Dorf is a Natural Resource Specialist for Texas Parks & Wildlife. She can be reached at Texas Parks & Wildlife, Coastal Fisheries Division, 702 Navigation Circle, Rockport, Texas, 78382-2779. E-mail: Barbara.Dorf@tpwd.state.tx.us.

**EVALUATION OF RED DRUM (*Sciaenops ocellatus*) STOCKING SUCCESS:
GENE-MARKING OF FINGERLINGS RELEASED
INTO EAST MATAGORDA BAY, TEXAS**

Rocky Ward
Ivonne R. Blandon
William J. Karel
Robert L. Colura
Lawrence W. McEachron
Coastal Fisheries Division
Texas Parks and Wildlife Department

ABSTRACT

Stocking of artificially spawned fingerlings is an important component of the management program for red drum in Texas waters. Gene-marking, using an uncommon allele of the dimeric esterase locus, was employed to examine survival and quantify recruitment of stocked red drum to the total estuarine population. Between 1993 and 1995 2,049,747 red drum fingerlings were stocked into East Matagorda Bay, Texas. Of these, approximately 50% were heterozygous and 25% were homozygous for an uncommon allele of the dimeric esterase locus. Subsequent electrophoretic examinations of 6,081 red drum collected between 1993 and 1997 in routine resource monitoring or in creel surveys in this bay and in adjacent reaches of neighboring bays found no evidence of increases in the frequency of the marker-allele in supplemented year-classes. Previous studies have shown enhancement of red drum populations following stockings in Texas marine waters. Failure to demonstrate enhancement in the current study may be related to specific conditions under which stocking efforts were made; including physical conditions at time of stocking, quality of the stocked cohort, and density of naturally spawned conspecifics.

HIGH RESOLUTION OF GULF STURGEON POPULATION STRUCTURE WITH MULTILOCUS MICROSATELLITE DNA GENOTYPES

Tim L. King
Barbara A. Lubinski
USGS-BRD Leetown Science Center
Aquatic Ecology Laboratory
Kearneysville, WV

Isaac I. Wirgin
Nelson Institute of Environmental Medicine
New York University Medical Center

ABSTRACT

Tandemly repeated DNA simple sequence motif markers, or microsatellite loci, have become the molecular genetic tool of choice in an increasingly diverse range of studies. Microsatellite DNA markers offer the potential of high levels of allelic variation per locus, and perhaps a higher degree of population resolution, even in species of conservation concern characterized by small effective population sizes. The Gulf sturgeon (*Acipenser oxyrinchus desotoi*) was designated as a threatened species under the U.S. Endangered Species Act in 1991. Recent studies of mitochondrial DNA variation suggested the presence of significant genetic differentiation in the form of at least four regional or river-specific populations along the Gulf coast. To assess the utility of microsatellite markers for delineating population structure in Gulf sturgeon, we determined multilocus (N=7) microsatellite genotypes in over 220 fish from the Pearl, Yellow, Apalachicola, and Suwannee River drainages. Significant allelic heterogeneity was observed among all drainage systems surveyed. A maximum likelihood assignment test was used to identify population structure among Gulf sturgeon populations. These analyses correctly assigned each fish to its respective drainage in greater than 90% of comparisons. These preliminary results indicate that variation in microsatellite DNA variation can serve as a powerful discriminator of genetic stock structure among geographically proximal rivers and that little gene exchange occurs among regional drainages (i.e., the presence of strong homing fidelity). The results suggest the presence of at least four distinct management units among the Gulf sturgeon surveyed.

SESSION 7: OFFSHORE PLATFORM COMMUNITIES II

Moderators: Benny Gallaway
Gregg Gitschlag

Date: October 25, 2000

Presentation	Author/Affiliation
<p>Fisheries Impacts of Underwater Explosives Used in Platform Salvage in the Gulf of Mexico</p>	<p>Gregg Gitschlag National Marine Fisheries Service Southeast Fisheries Center Galveston, TX</p> <p>Michael J. Schirripa National Marine Fisheries Service Northwest Fisheries Science Center Newport, OR</p> <p>Joseph E. Powers National Marine Fisheries Service Southeast Fisheries Center Miami, FL</p>
<p>Fish and Epifaunal Community Observations at an Artificial Reef Near a Natural Coral Reef: Nineteen Years at High Island Platform A389-A, from Bare Steel to Coral Habitat</p>	<p>Gregory S. Boland Minerals Management Service Gulf of Mexico OCS Region</p>
<p>Fish Assemblages Around Oil and Gas Platforms in the Northeastern Gulf of Mexico: Developing a Survey Design</p>	<p>Kevin R. Rademacher Jeffery H. Render National Marine Fisheries Service Mississippi Laboratories</p>
<p>Seasonal and Spatial Variation in the Biomass and Size Frequency Distribution of Fish Associated with Oil and Gas Platforms in the Northern Gulf of Mexico</p>	<p>David R. Stanley BEAK International Ontario, Canada</p> <p>Charles A. Wilson Coastal Fisheries Institute Center of Coastal, Energy and Environmental Resources Louisiana State University</p>

(continued on next page)

Presentation	Author/Affiliation
Rigs and Reefs: A Comparison of the Fish Communities at Two Artificial Reefs and a Production Platform	Charles A. Wilson Mark Miller Department Oceanography and Coastal Sciences Louisiana State University Rick Kasprzak Louisiana Dept of Wildlife and Fisheries Dave Stanley Beak International
The Variation of Fish Community Structure Around Oil and Gas Platforms in the Northern Gulf of Mexico (Document not submitted)	James W. Heath Charles A. Wilson David Stanley

FISHERIES IMPACTS OF UNDERWATER EXPLOSIVES USED IN PLATFORM SALVAGE IN THE GULF OF MEXICO

Gregg R. Gitschlag
National Marine Fisheries Service
Southeast Fisheries Center
Galveston, TX

Michael J. Schirripa
National Marine Fisheries Service
Northwest Fisheries Science Center
Newport, OR

Joseph E. Powers
National Marine Fisheries Service
Southeast Fisheries Center
Miami, FL

INTRODUCTION

As of 31 January 2000 there were 3,967 oil and gas structures¹ in the Gulf of Mexico (GOM). Federal regulations require removal of platforms within a year of lease termination. According to data from the National Marine Fisheries Service (NMFS) Platform Removal Observer Program² that includes removals in both federal and state waters, from 1989–98 an annual average of 96 structures were salvaged using explosives. For the same period, MMS data for federal waters indicate underwater explosives were used in 64% of all removals (submerged wells not included in these data). MMS regulations require removal of structures to a minimum depth of 5 m below the seafloor.³ Since forty- to fifty-pound explosive charges are commonly used to sever platform pilings, hundreds of pounds of explosives, primarily Comp-B and C-4, are detonated at most offshore platforms.

Offshore platforms serve as excellent artificial reef habitat attracting a vast array of marine life (Dugas *et al.* 1979; Hastings *et al.* 1976; Lewbel *et al.* 1987; Scarborough-Bull 1989; Sonnier *et al.* 1976; Stanley & Wilson 1990). The use of underwater explosives can severely impact fish and other marine life during the removal process. Of special concern is the commercially and recreationally important red snapper which is already severely overfished (Goodyear and Phares 1990; Goodyear 1996; Cowan 1998; Schirripa 1998).

This report describes the first comprehensive study to quantitatively assess fisheries impacts of the explosive removal of offshore oil and gas structures. Mortality estimates from platform removals

¹ Michelle Morin, Minerals Management Service.

² Provided by first author.

³ Oil, Gas, and Sulphur Operations in the Outer Continental Shelf, 30 CFR (250 series).

were calculated and used in stock assessment analyses to determine the relative importance of this activity compared with other sources of mortality. The results of these analyses provide managers with information needed to manage fisheries.

METHODS

Between August 1993 and May 1999 data were collected at nine of ten platforms studied to estimate total fish mortality (Table 7.1, Figure 7.1). Prior to detonation of explosives fish were captured, tagged and released alive. After explosives were detonated field personnel operating from inflatable boats used dip nets to collect all dead fish that floated to the surface while divers manually sampled dead fish that sank to the sea floor. Underwater sampling techniques included transect line surveys, circular surveys, and sampling frames placed beneath the platform. To increase efficiency, procedural modifications were made early in the study and only final sampling protocols are described here (Figure 7.2). Twenty-four circular surveys measuring 6.7 m (22 ft) in diameter and four 100 m (328 ft) transect lines were sampled. At one platform (WC172), 200 m (656 ft) transect lines were surveyed. Divers collected discrete samples of dead fish in 25 m (82 ft) increments along the transect lines. Sampling width was either 1 or 2 m (3 or 6 ft) on either side of the line depending on underwater visibility. Sampling frames usually provided 20–30% coverage of the footprint area under the platform. Generally, fish smaller than 8 mm total length were not sampled. Due to time constraints and safety considerations, not all targeted samples were always collected.

Fish mortality was estimated by multiplying fish density (number of fish in sample divided by area sampled) by total area for each region of interest (i.e. 0–25 m radius around the platform, 25–50 m, 50–75 m, etc.). Total estimated mortality at each platform was calculated by adding the estimated fish mortalities at the surface, beneath the platform and in the open water around the platform to a maximum distance of 100 m. Data from transect and circular surveys were combined to provide one estimate of fish mortality in the open water area. Population size was estimated for individual species using direct proportions of tagged to untagged fish present before and after detonation of explosives:

$$N_b = N_a \times N_{tb} / N_{ta}$$

Where N_b is the number of live fish present before blasting, N_a is the number of dead fish collected after blasting, N_{tb} is the number of fish tagged and released before blasting, and N_{ta} is the number of dead, tagged fish collected after blasting.

RESULTS

Fish < 8 cm TL (Total Length)

With the exception of this section, results describe only fish greater than or equal to 8 cm in total length. This appeared to be the minimum size which divers routinely collected by hand. At one site where a large number of very small fish were observed, all fish regardless of size were painstakingly collected within a single 1.5 X 1.5 m frame on the sea floor beneath the platform. Specimens included 117 vermilion snapper (*Rhomboplites aurorubens*), 6 round scad (*Decapterus punctatus*),

Table 7.1. Estimated mortality and descriptive statistics by species and platform.

SPECIES	SMI 23	WD 30	ST 146	SS 158	WC 172	WC 173	WC 181	SS 209	GA 288	Total	Mean	Std error	Std dev	Var	95% confidence level
Almaco jack	29	0	1	0	0	0	0	0	0	30	3	3	10	92	7
Atlantic bumper	0	0	0	0	46	201	0	0	0	247	27	22	67	4471	51
Atlantic croaker	0	0	0	0	0	7	0	0	0	7	1	1	2	5	2
Atlantic spadefish	2069	631	698	1689	911	1068	2401	633	2774	12875	1431	275	824	679238	634
Atlantic thread herring	0	0	0	0	0	1	0	0	0	1	0	0	0	0	0
Belted sand bass	11	0	0	0	1	0	17	0	0	29	3	2	6	40	5
Bermuda chub	0	0	0	0	0	0	43	0	0	43	5	5	14	204	11
Black drum	0	19	6	0	2	14	0	0	3	44	5	2	7	48	5
Blue runner	611	33	1592	1069	219	0	684	13	646	4867	541	181	542	294154	417
Bluespotted searobin	0	0	0	0	1	0	0	0	0	1	0	0	0	0	0
Chub mackerel	0	0	0	0	0	0	0	0	4	4	0	0	1	2	1
Cocoa damselfish	0	0	0	0	0	0	4	0	0	4	0	0	1	2	1
Creville jack	0	0	0	0	5	0	0	0	0	5	1	1	2	2	1
Cubbyu		0	0	0	0	0	0	0	66	66	7	7	22	487	17
Gag	6	6	2	0	0	0	0	0	0	14	2	1	3	7	2
Gray triggerfish	144	1	16	116	13	0	22	43	44	399	44	17	52	2685	40
Great barracuda	5	0	0	0	0	0	0	0	0	5	1	1	2	2	1
Guaguanche	0	0	0	0	0	0	0	0	1	1	0	0	0	0	0
Gulf toadfish	0	0	0	0	0	0	0	0	24	24	3	3	8	63	6
Hardhead catfish	0	6	0	0	4	397	0	0	0	407	45	44	132	17466	101
Harvest fish	0	0	0	0	0	5	0	00	0	5	1	1	2	2	1
Ladyfish	0	3	0	0	0	0	0	0	0	3	0	0	1	1	1
Lane snapper	34	0	60	0	1	0	0	193	82	371	41	22	65	4197	50
Leopard toadfish	53	0	0	0	0	0	0	0	0	53	6	6	18	317	14
Lookdown	0	3	0	0	0	0	0	0	0	3	0	0	1	1	1
Mangrove snapper	63	364	240	44	1	1	0	324	64	1100	122	49	146	21322	112
Molly miller	0	0	0	0	0	0	4	0	0	4	0	0	1	2	1
Mullet	0	22	0	0	0	0	0	0	0	22	2	2	7	54	6
Ocean triggerfish	0	0	2	0	0	0	0	0	0	2	0	0	1	0	1
Pigfish	23	0	0	0	3	0	0	0	31	57	6	4	12	141	
Pinfish	0	0	0	0	0	3	0	0	17	20	2	2	6	33	4
Planehead filefish	44	0	0	0	0	0	0	0	0	44	5	5	15	213	11
Red drum	0	0	0	35	0	0	0	0	19	54	6	4	12	156	10

Table 7.1. (continued)

SPECIES	SMI 23	WD 30	ST 146	SS 158	WC 172	WC 173	WC 181	SS 209	GA 288	Total	Mean	Std error	Std dev	Var	95% confidence level
Red snapper	1193	24	298	296	498	709	709	418	487	4632	515	111	332	110174	255
Remora	0	0	0	0	13	0	0	0	0	13	1	1	4	19	3
Rock hind	0	0	9	0	0	0	7	0	5	22	2	1	4	14	3
Scaled sardine	0	0	0	0	8	0	0	0	0	8	1	1	3	7	2
Scamp	3	0	0	0	0	0	0	0	0	3	0	0	1	1	1
Schoolmaster	9	0	0	0	0	0	0	0	0	9	1	1	3	9	2
Scrawled filefish	0	0	0	0	0	0	4	0	0	4	0	0	1	2	1
Sergeant major	0	0	0	0	5	16	0	0	0	21	2	2	5	30	4
Sharksucker	0	0	0	0	0	3	0	0	0	3	0	0	1	1	1
Sheepshead	330	1007	120	395	457	386	968	61	370	4094	455	110	329	108436	253
Silk snapper	0	0	0	39	0	0	0	0	0	39	4	4	13	166	10
Silver trout	0	0	140	0	1	0	0	0	0	141	16	16	47	2173	36
Spanish sardine	0	0	0	0	0	1	0	0	0	1	0	0	0	0	0
Speckled trout	0	3	0	0	0	0	0	0	0	3	0	0	1	1	1
Tomtate	0	0	0	0	0	0	0	0	464	464	52	52	155	23929	119
Unknown damselfish	0	0	0	0	0	0	0	0	16	16	2	2	5	30	4
Unknown eel	0	0	0	0	0	0	0	27	0	27	3	3	9	81	7
Unknown soapfish	0	0	1	0	0	0	0	0	38	39	4	4	13	161	10
Unknown	0	6	0	0	0	0	0	46	0	52	6	5	15	231	12
Whitespotted soapfish	23	0	3	0	4	0	10	5	53	97	11	6	17	302	13
Yellow chub	1	0	0	0	0	0	0	2	5	8	1	1	2	3	1
Yellowtail snapper	6	0	0	0	0	0	0	0	0	6	1	1	2	4	2
Total	4657	2128	3188	3682	2193	2812	4874	1765	5216	30513	3390	429	1288	1658640	990

2 lane snapper (*Lutjanus synagris*), and 2 scaled sardine (*Harengula pensacolae*). Mortality of vermilion snapper measuring < 8 cm TL within the footprint area of this platform was estimated at approximately 5,900. Estimated mortality of all small fish in the footprint area alone exceeded 6,200 compared with a total estimated mortality (footprint area plus 100 m radius) of approximately 4,900 for fish measuring >8 cm.

Estimated Mortality

Total estimated finfish mortality per platform ranged from 1,765–5,216 with a mean of 3,390, standard error 429, and 95% confidence level of 990. Four species including Atlantic spadefish

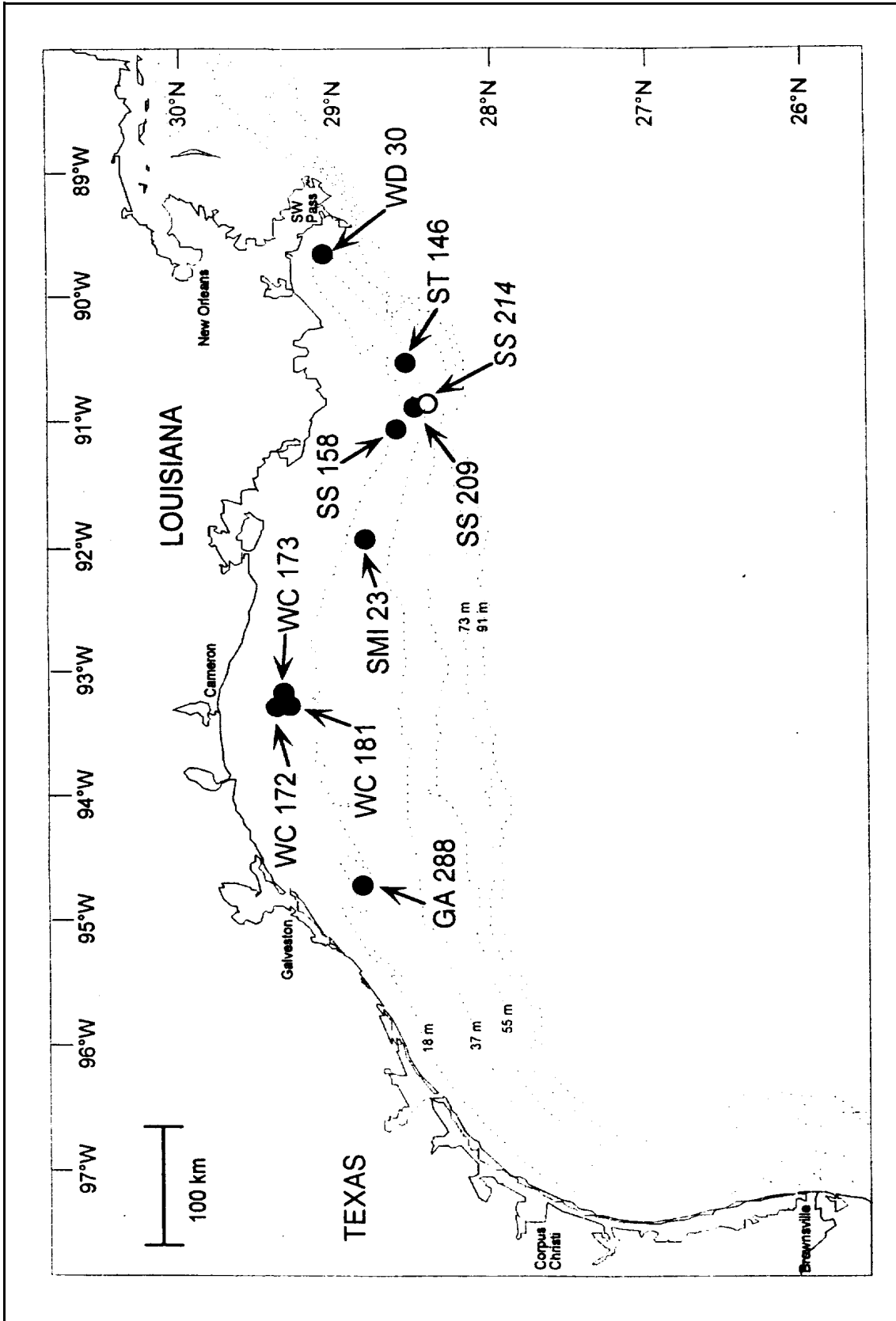

Figure 7.1. Map of study sites. Dark circles represent platforms where fish mortality was estimated from samples collected at the sea surface and bottom. The white circle represents a platform where only sea surface sampling was conducted.

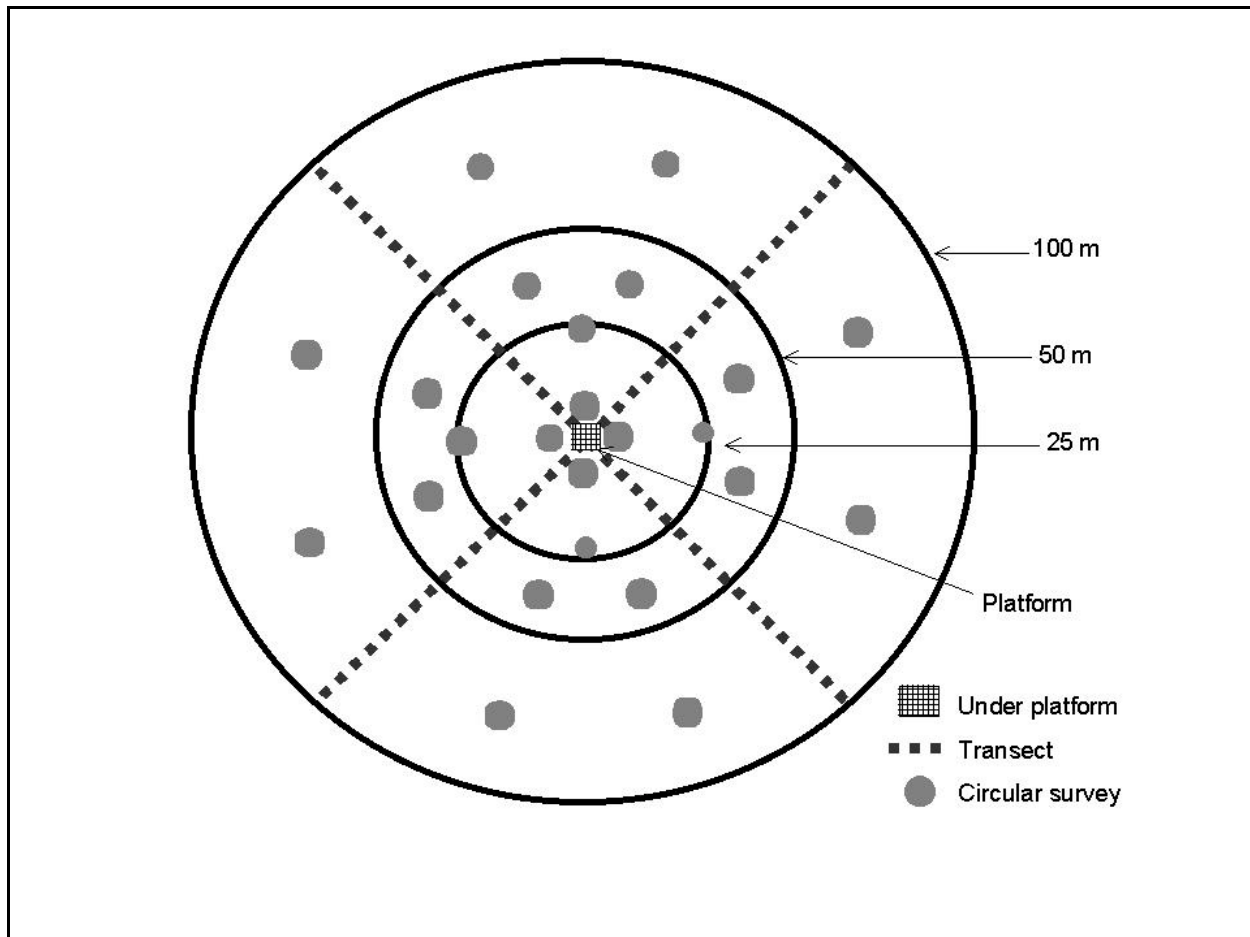

Figure 7.2. Schematic of sampling design showing transect lines, circular surveys, and sampling area under platform.

(*Chaetodipterus faber*), blue runner (*Caranx fusus*), red snapper (*Lutjanus campechanus*), and sheepshead (*Archosargus probatocephalus*) accounted for 86% of total estimated mortality (Table 7.2). Mean estimated mortality per platform was 1,431 for Atlantic spadefish, 541 for blue runner, 515 for red snapper, and 455 for sheepshead. Range in estimated mortality by platform was 631–2,774 for Atlantic spadefish, 0–1,592 for blue runner, 24–1,193 for red snapper, and 61–1,007 for sheepshead.

Fish mortality resulting from the use of underwater explosives may be affected by many factors including but not limited to water depth (<20 m vs >20 m), platform location (<=92° vs >92°), platform age (<25 year vs >25 year), season (spring vs summer), surface temperature (<30°C vs >=30°C), surface salinity (<=26 ppt vs >26 ppt), and platform size. Statistical analysis of estimated mortality by each of these parameters indicated no significant difference from the null hypothesis for each of the top four impacted species. One exception was the depth analysis for sheepshead which was marginally significant with a P value of 0.05. Longitude was used as an index of platform location, and platform size was indexed using the volume of water enclosed within the boundary of the platform.

Table 7.2. Estimated mortality of the five most impacted species.

SPECIES	Total estimated mortality	% of total estimated mortality
Atlantic spadefish	12875	42
Blue runner	4867	16
Red snapper	4632	15
Sheepshead	4094	13
Total		86

Population Estimates and Mortality Rates

Pre-detonation population estimates were calculated whenever a minimum of 10 individuals of a given species were tagged and released. The maximum number of tags released for a single species at a single platform was 502 for Atlantic spadefish. In most tag/recapture experiments using conventional techniques, recapture rates of 2–5% are anticipated. Recovery rates as high as 73% (Table 7.3) attest to the effectiveness of sampling with explosives. Red snapper estimates at 7 platforms ranged from 503–1,943 with a mean of 905 and standard error of 196 (Table 7.4). Atlantic spadefish estimates at three platforms ranged from 1,432–1,782 with a mean of 1,564 and standard error of 110. The blue runner population was estimated at 558 at one platform.

Mortality rates (estimated mortality divided by population estimate) were determined for species and platforms where pre-detonation population estimates were calculated (Table 7.5). Rates for red snapper varied from 59–88% with a mean of 71% and standard error of 4. Atlantic spadefish rates ranged from 72–135% with a mean of 108% and standard error of 19 while one rate of 123% was calculated for blue runner.

Fish Density Around Platforms

Density of fish collected along transect line surveys from eight platforms were analyzed using the two sample t-test. There was a significant difference ($P=0.000$) in fish density ($\log(\text{density} + 1)$ transformed) for samples collected at 0–25 m (0.027 fish/m^3) and 25–50 m (0.002 fish/m^3) distances from platforms. A significant difference ($P=0.003$) was also found using data from circular surveys collected at 0–6.7 m and 18.3–25.0 m from the platform. Fish density was higher closer to the platform (0.051 fish/m^3 vs 0.007 fish/m^3). Fish density for transect data collected between 50–75 m and 75–100 m from platforms averaged 0.001 and 0.000 fish/m^3 .

Table 7.3. Recapture rates (100 x number of tags recovered/number of tags released) for tag-recapture study.

SPECIES	Platform							
	SMI 23	ST 146	SS 158	WC 172	WC 173	WC 181	SS 209	GA 288
Almaco jack	25							
Atlantic spadefish			13		72	34		
Blue runner						29		
Gray triggerfish	24		13				30	
Red snapper	41	49		73	19	20	62	44

Table 7.4. Population estimates by species and platform.

SPECIES	Platform								Mean	Std error	Std dev	Std dev	Var	95% confidence
	SMI 23	ST 146	SS 158	WC 172	WC 173	WC 181	SS 209	GA 288						
Almaco jack	28								28	0				
Atlantic spadefish			1432		1477	1782			1564	110	190	36258	473	
Blue runner						558			558					
Gray triggerfish	129		93				63		95	19	33	1092	82	
Red snapper	1943	503		597	1091	1048	601	553	905	196	517	267546	478	

Table 7.5. Mortality rates (100 x estimated mortality / population estimate) by species and platform.

SPECIES	Platform								Mean	Std error	Std dev	Std dev	Var	95% confidence
	SMI 23	ST 146	SS 158	WC 172	WC 173	WC 181	SS 209	GA 288						
Almaco jack	104								104	0				
Atlantic spadefish			118		72	135			108	19	32	1044	80	
Blue runner						123			123					
Gray triggerfish	112		125				68		102	17	30	874	73	
Red snapper	61	59		83	65	68	70	88	71	4	11	121	10	

Comparison of Estimated Mortality and Size of Positively and Negatively Buoyant Fish

There was no consistent relationship between the number of red snapper carcasses collected at the surface and the estimated number of red snapper that sank to the sea floor after detonations (Table 7.6). Results for all fish species combined were also highly variable. Paired t-test of log transformed ratios of positively (floating) to negatively buoyant (sinking) fish showed a significant difference between red snapper and all species combined. More red snapper floated to the surface than sank at four of eight study sites compared with only two of nine for all fish species combined. Ratios of floating to sinking red snapper ranged from 0.03–6.74 per platform while the range for all species combined was 0.03–1.47. Extremely low values indicate that few fish floated to the surface. A ratio of 0.03 means that an estimated 33 times more fish sank to the sea floor than floated to the surface. Results indicate that more fish generally sink than float and that actual total fish mortality may be considerably more than what is observed at the surface.

GLM analysis of red snapper length by factors of platform and buoyancy showed a significant difference ($P=0.00$) for both factors and interaction. Mann-Whitney tests used to compare length of floating vs. sinking red snapper at each platform showed mixed results. A significant difference ($P<0.05$) in total length of positively vs. negatively buoyant fish was found at four platforms, but no difference was apparent at four other platforms (Table 7.7). Mean total length was larger for positively buoyant fish at all platforms except one in 15 m of water where negatively buoyant fish were significantly larger. Difference between mean lengths of positively and negatively buoyant red snapper was 2.6 cm (36.7–34.1 cm).

Estimating Red Snapper Impacts Across the U.S. Gulf of Mexico Using Stock Assessment Techniques

Since results did not show a consistently significant difference between length of positively and negatively buoyant fish at individual platforms and since the overall difference in mean length of positively and negatively buoyant fish was small (2.6 cm), it should be acceptable to utilize historical data from the NMFS Platform Removal Observer Program², which is only available for positively buoyant fish, to enhance the present data set with additional red snapper lengths. This contributed an additional 13,527 red snapper lengths for a total of 16,510 collected at 116 explosive structure removals.

Opportunistic surface collections made by the NMFS Platform Removal Observer Program lend support to the concept of fewer red snapper mortalities at single pile caissons than at multi-leg platforms which are more structurally complex. Consequently, a moderately high estimate of fish mortality was obtained by assuming red snapper mortality at all structure types was the same as that found in the present study. Since no red snapper were collected in the Observer Program at depths less than 7 m, structures shallower than this were assumed to have no red snapper mortality.

Analysis of the combined data set (present study plus NMFS data) using GLM single factor analysis and Tukey-Kramer studentized range test for paired comparisons indicated red snapper collected at platforms in 20–30 m were larger than those at platforms in shallower and greater depths. Consequently, all length records were sorted into two depth zones (7–20 m and >30 m vs. 20–30 m)

Table 7.6. Comparison of red snapper mortalities collected at the surface (floaters) with estimated mortality from the sea floor (sinkers).

Platform	Floaters	Sinkers	Total	Ratio floater/sinker	Percent floater/total	Depth (m)
WC 172	417	81	498	5.15	84	15
WC 173	120	589	709	0.20	17	15
SS 158	10	286	296	0.03	3	17
WC 181	73	636	709	0.11	10	18
GA 288	202	285	487	0.71	41	23
SMI 23	714	479	1193	1.49	60	25
ST 146	238	58	296	4.10	80	28
SS 209	364	54	418	6.74	87	32
Total	2138	2468	4606		46	

Table 7.7. Comparison of total length of positively (floater) and negatively (sinker) buoyant red snapper by platform.

Platform	Mean TL floaters	N floater	Mean TL sinker	N sinker	Mann-Whitney P	Depth (m)
WC 172	34.1	416	40.1	17	0.06	15
WC 173	44.4	120	43.1	83	0.45	15
SS 158	56.8	10	45.7	23	0.01	17
WC 181	49.6	73	30.9	138	0	18
GA 288	31.5	202	25.1	42	0	23
SMI 23	33.1	714	29.3	81	0.01	25
ST 146	44.7	238	40.2	5	0.4	28
SS 209	38.5	361	38	9	0.68	32

as were counts of explosive structure removals. Estimated annual red snapper mortality per structure (515) was multiplied by the ten year (1989–98) average annual number of explosive structure removals in each depth zone (from NMFS Platform Removal Observer Program data) to yield an estimate of red snapper mortality for each depth zone. Since stock assessment analysis requires a length for each fish record, red snapper lengths in each depth zone were expanded by replication to construct a data set with the number of records equal to the mortality estimate. To establish an upper

limit for impact assessment, this expanded data set was doubled to yield an estimated mortality of 82,400 and used in stock assessment analysis to determine the effect of mortality due to explosive structure removal on the overall red snapper stock. Despite natural variation in the data and possibly higher mortality at depths greater than study depths, doubling the moderately high estimate is expected to provide a value that far exceeds the actual mortality.

Length frequencies of red snapper were converted to age frequencies using Table 7.7.1 of Schirripa and Legault (1999), the most recent red snapper stock assessment analysis. The additional mortality at age (1989–98) implied by the doubled estimate was added to each year of the annual fishing induced mortality at age estimated from other sources: commercial, recreational, discard mortality and bycatch. The stock assessment analysis in Schirripa and Legault (1999) was then repeated using the mortality at age including explosive platform mortality for each year, 1989–98.

Impacts on Red Snapper

Results of the refitting of the red snapper assessment including platform removal estimate (arbitrary doubling of the moderately high estimate of mortality) were compared to the base case assessment from Schirripa and Legault (1999; Figure 7.3). The impact of including platform removal data was that abundance estimates were almost indistinguishable from the original assessment (Figure 7.3). The differences were well within the statistical estimation variances for the original assessment. Note that these results are for double the estimated number of fish mortalities at explosive structure removals. Actual impacts are likely to be less.

Impacts on Gag and Red Drum

Of the species encountered in these field studies, in addition to red snapper, only gag and red drum have stock assessments conducted on them by the NMFS. Annual estimated mortality of gag at explosive platform removals (using the same assumptions made in the red snapper analysis) was 256 fish per year. Comparison with results from the most recent gag stock assessment (Schirripa and Legault 1997) indicates this represents 0.04% of the average annual mortality from other sources. Current methods of assessment would not detect such small changes in magnitude. The annual estimated mortality of red drum at explosive structure removals (using the same assumptions made in the red snapper analysis) was 961 fish per year. Comparison with results from the most recent red drum stock assessment (Porch 2000) show this was 0.03% of the average annual mortality from other sources. Such a small change is indistinguishable using current methods of assessment.

Assessing Future Impacts on Red Snapper (1999–2023)

Unlike data from the NMFS Platform Removal Observer Program², the MMS data set¹ did not include subsea wells, flare piles or any removals that occurred in state waters. These two data sets were used in conjunction with Pulsipher *et al.*'s (*in press*) forecast of future platform removals to assess future impacts on red snapper. If explosives continue to be used at approximately 64% of all removals, then fish populations at 119 platforms and caissons (0.64 x 186 predicted annual platform removals) will be impacted annually. As of 31 January 2000, 8.8% (351 of 3,967) of structures present in the GOM were in depths less than about 7 m. Reducing the 119 predicted explosive

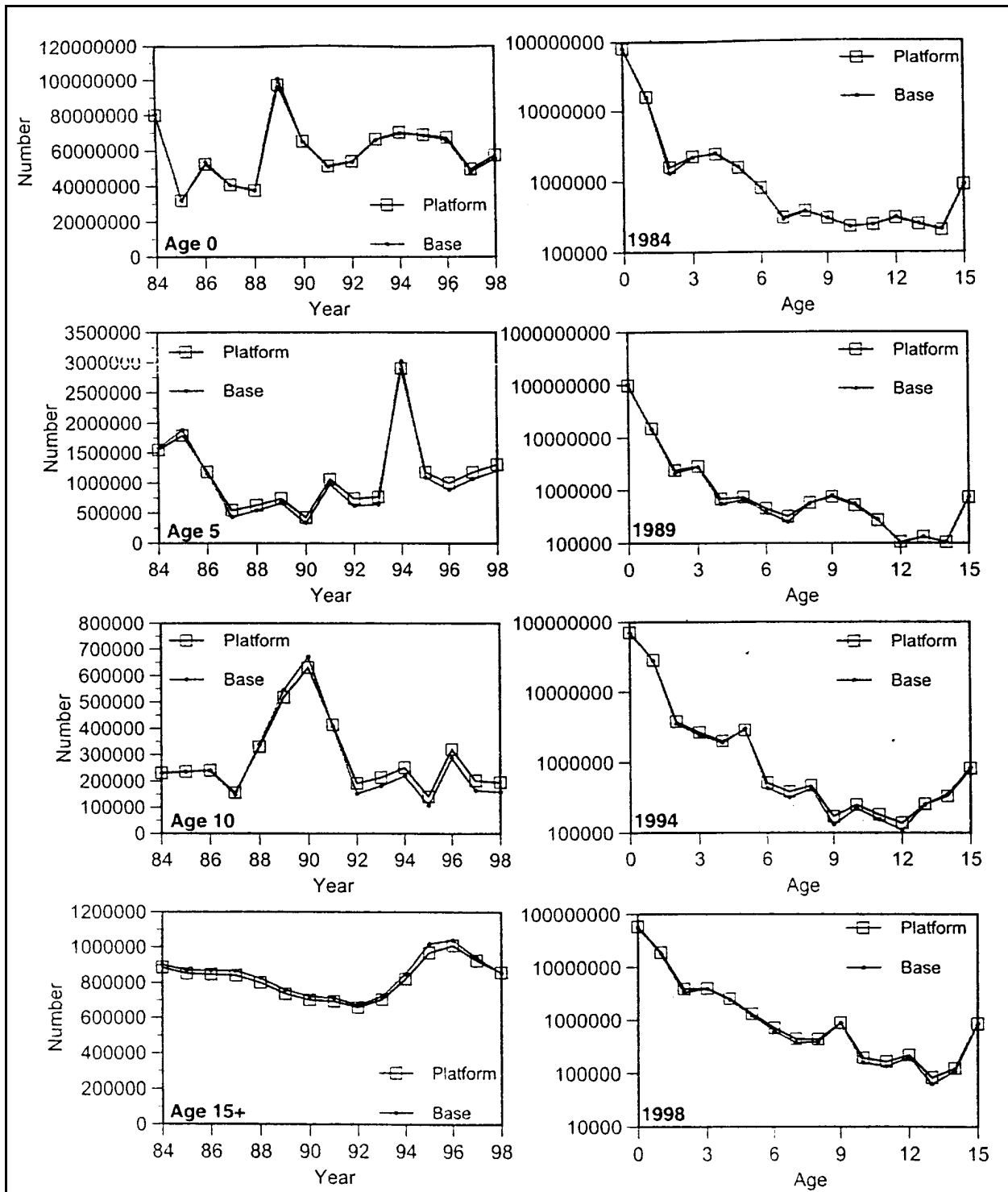

Figure 7.3. Red snapper assessment results, including platform removals, using Data Set E (represents arbitrary doubling of moderate to high estimate of red snapper mortality at *platforms*) compared to base case assessment (*base*). The left column gives numbers at selected ages by year; the right column gives numbers at age for selected years.

removals by this factor yields 109. From 1989–98 NMFS recorded an additional 126 removals in depths >7 m including submerged wells and flare piles in federal waters and structures of all types in state waters. This represents 10.8% (126/1172) of all removals (explosive and non-explosive) in the 1989–98 MMS data base. Assuming that this ratio remains constant in the future, the total number of explosive structure removals predicted annually will increase by an additional 20 (0.108 x 186) to provide a total of 129 (109 + 20) annual explosive structure removals in depths >7 m. This moderately high estimate based on all structure types having the same mortality of red snapper yields a projected annual mortality at explosive structure removals of 66,435 red snapper. This is considerably less than the 82,400 representing double the average annual estimate for 1989–98. Consequently, the impact of a projected increase in average annual explosive structure removals is not expected to be distinguishable from benchmarks assuming other influencing factors remain constant and removal forecasts are accurate.

DISCUSSION

One obvious finding from this study is the lack of significant difference in estimated mortality as a function of test parameters including depth, longitude, surface temperature and salinity. This was due to a variation in fish abundance between platforms, small sample size in some cells, and a generally narrow range observed for test parameters. For example, there was general consistency in platform complexity (except for one platform) and a fairly narrow range in depth, surface salinity and surface temperature. Estimated mortality of fish at a given platform within study depths from 14–28 m ranged from approximately 2,000–5,000 for fish measuring greater than 8 cm TL. In general, failure to detect a significant difference in various parameters tested in this study does not indicate that these factors may not affect fish distribution. It does indicate that parameter values encountered during the study were not dissimilar enough to cause differences in fish distribution given the small number of platforms studied. For at least some parameters, when a sufficient change occurs in values beyond the ranges found in this study, fish assemblages and resulting fishery impacts will undoubtedly change. For example, species distribution in general has been reported to change as fish move from shallower to deeper water in relation to changing seasons and temperatures (Bradley and Bryan 1974; Hastings *et al.* 1976)

SUMMARY

The most severely impacted fish species in terms of highest numbers of estimated mortalities were Atlantic spadefish, blue runner, red snapper, and sheepshead. These four species accounted for 86% of estimated mortality. Of all species collected, the NMFS conducts stock assessments on only three: red snapper, gag and red drum. For red snapper, even when the mortality estimate was doubled, impacts were estimated to be small, well within the variation of our current assessments, and would not alter current determinations of status or current management recovery strategies. Similarly, current methods of assessment would not detect the even smaller changes in magnitude of gag and red drum. In general, results indicated no significant difference in estimated mortality of red snapper by depth, longitude, platform age, season, surface salinity, and surface temperature in the study area (14–32 m) during May to September. Future impacts to the red snapper stock were predicted based on forecasts of future structure removals reported by Pulsipher *et al.* (*in press*). Estimates of future mortality were less than the doubled value of current red snapper mortality at explosive structure

removals and within the variation of our current assessments. Given the assumptions used in these forecasts, predicted future mortality would not alter current determinations of status or current management recovery strategies.

REFERENCES

- Bradley, E. and C.E. Bryan. 1974. Life history and fishery of the red snapper (*Lutjanus campechanus*) in the northwestern Gulf of Mexico. Proceedings of the Gulf and Caribbean Fisheries Institute 27:77-106.
- Reeffish Stock Assessment Panel. 1998. January 1998 Report of the Reef Fish Stock Assessment Panel. Gulf of Mexico Fishery Management Council Stock Assessment Report.
- Cowan, J.H., Jr. 1998. January 1998 Report of the Reef Fish Stock Assessment Panel. Gulf of Mexico Fishery Management Council Stock Assessment Report.
- Dugas, R., V. Guillory and M. Fischer. 1979. Oil rigs and offshore sport fishing in Louisiana. Fisheries 4(6):2-10.
- Goodyear, C.P. 1996. An Update to the Red Snapper Harvest in U.S. Waters of the Gulf of Mexico. National Marine Fisheries Service, Southeast Fisheries Science Center Report, SFD-95/96-60.
- Goodyear, C.P. and P. Phares. 1990. Status of Red Snapper Stocks of the Gulf of Mexico - Report for 1990. National Marine Fisheries Service, Southeast Fisheries Center, Miami Laboratory, CRD-89/90-05.
- Hastings, R.W., L. H. Ogren and M.T. Mabry. 1976. Observations on the fish fauna associated with offshore platforms in the northeastern Gulf of Mexico. Fishery Bulletin 74:2:387-402.
- Lewbel, G. S., R. L. Howard and B. J. Gallaway. 1987. Zonation of Dominant Fouling Organisms on Northern Gulf of Mexico Petroleum Platforms. Marine Environmental Research 21:199-224.
- Porch, C.E. 2000. Status of the red drum stocks of the Gulf of Mexico. Sustainable Fisheries Division, 75 Virginia Beach Drive, Miami, FL, 33149, SFD-99/00-85.
- Pulsipher, A.G., O.O. Iledare, D.V. Mesyanzhinov, A. Dupont and Q.L. Zhu. Forecasting the number of offshore platforms on the Gulf of Mexico OSC to the year 2023. Prepared by the Center for Energy Studies, Louisiana State University, Baton Rouge, LA. OCS Study MMS-2001-013. U.S. Department of the Interior, Minerals Management Service, Gulf of Mexico OCS Region, New Orleans, LA. 52 p.
- Scarborough-Bull, A. and J.J. Kendall, Jr. 1990. Mechanisms of outer continental shelf (OCS) oil and gas platforms as artificial reefs in the Gulf of Mexico. Pages 21-37 in Proceedings of the American Academy of Underwater Sciences Tenth Annual Scientific Diving Symposium.

- Schirripa, M. 1998. Status of the Red Snapper in U.S. Waters of the Gulf of Mexico. National Marine Fisheries Service, Southeast Fisheries Science Center Report, SFD-97/98-30.
- Schirripa, M.J. and C.M. Legault. 1997. Status of the Gag Stocks of the Gulf of Mexico: Assessment 2.0. National Marine Fisheries Service, Southeast Fisheries Science Center Report, SFD-98/99-6.
- Schirripa, M.J. and C.M. Legault. 1999. Status of the Red Snapper in U.S. Waters of the Gulf of Mexico: Updated Through 1998. National Marine Fisheries Service, Southeast Fisheries Science Center Report, SFD-99/00-75.
- Sonnier, F., J. Teerling and H.D. Hoese. 1976. Observations on the offshore reef and platform fish fauna of Louisiana. COPEIA 1:105-111.
- Stanley, D.R. and C.A. Wilson. 1990. A fishery dependent based study of fish species composition and associated catch rates around petroleum platforms off Louisiana. Fishery Bulletin 88:719-730.

Gregg Gitschlag has worked for NOAA's Southeast Fisheries Center, Galveston Laboratory for over 20 years as an oceanographer and fishery biologist. His research interests include sea turtle behavior and migration as well as recreational and commercial impacts on red snapper. Mr. Gitschlag completed his B.S. in zoology at the University of Michigan and his M.S. in biological oceanography at Florida State University.

FISH AND EPIFAUNAL COMMUNITY OBSERVATIONS AT AN ARTIFICIAL REEF NEAR A NATURAL CORAL REEF: NINETEEN YEARS AT PLATFORM HIGH ISLAND A389-A, FROM BARE STEEL TO CORAL HABITAT

Gregory S. Boland
Minerals Management Service
Gulf of Mexico OCS Region

ABSTRACT

Since its installation 1 October 1981, the platform High Island A389-A has progressed from a bare steel structure in 125 m of water to a climax bluewater artificial reef community including a number of hermatypic coral species. The platform is located approximately one nautical mile from the edge of the well-developed coral reef at the East Flower Garden Bank, Gulf of Mexico. Since 1981, it was expected this structure would eventually be a site for successful colonization by coral larvae from the nearby Flower Garden Banks. The platform was surveyed as part of a multidisciplinary National Marine Fisheries/EPA-funded study over four seasons between October 1981 and October 1982, beginning just three weeks after installation. Both qualitative and semi-quantitative observations of fish species and attached epifaunal community are presented from those early surveys. Additional observations have been obtained periodically between 1982 and 1999. Hermatypic corals were first observed on the platform by the author and others in November 1990, although their size indicated that settlement had occurred more than one year previously. The continued development of new coral colonies and associated thriving reef fish populations has significance for the functionality of oil and gas structures as artificial reefs and diverse coral habitats. Early observations of fish taxa of various age classes allows some important statements regarding artificial reef recruitment and attraction issues.

INTRODUCTION

Oil and gas platforms in the Gulf of Mexico comprise a substantial artificial reef complex of close to 4000 structures extending from shallow areas of the shelf into deep continental slope waters. Both epifauna and fish assemblages at structure depths of less than 30 m have been described since the early 1970s (Hastings *et al.* 1976; Gallaway *et al.* 1981; Gallaway and Lewbel 1982; Putt 1982; Continental Shelf Associates 1982; Bull and Kendall 1994; Stanley and Wilson 1996; 2000), but in the past two decades, only a few platforms in the bluewater zone described by Gallaway and Lewbel (1982) have been investigated (bluewater is defined as water depths deeper than 60 m). This report describes summaries of opportunistic observations of both fish and fouling community recruitment/succession at a newly installed bluewater platform near a natural coral reef (the Flower Garden Banks) in Federal lease block High Island A389.

During 1981 and 1982, the HI A389-A platform was utilized as a sampling station for a National Marine Fisheries/EPA-funded study, "Ecological Effects of Energy Development on Reef Fish of the Flower Garden Banks (Boland *et al.* 1983), beginning just 3 weeks after platform installation. These observations are unique due to the timing of the first sampling and repeated observations over

both the short- and long-term. Both qualitative and semi-quantitative observations of fish and attached epifaunal (fouling) community are presented from early surveys in 1981 and 1982. Additional observations were obtained periodically between 1982 and 1999. Additional observations include the first record of scleractinian corals on a platform adjacent to the Flower Garden Banks and subsequent observations of the growth and additional occurrences of corals on this structure.

MATERIAL AND METHODS

Study Site

The platform structure of HI A389-A (owned by Mobile Exploration and Production U.S. Inc. until 1998⁴) lies in 125 m of water at 27° 54' 02" North, 93° 34' 38" West, 191 Km SSE of Galveston, Texas. Gallaway and Lewbel (1982) defined this distance from shore and water depth as "bluewater." The structure lies only 1 nmi southeast of the coral reef zone of the East Flower Garden Bank (EFGB), now a part of the Flower Garden Banks National Marine Sanctuary. The platform consists of eight primary support legs (four on each side), with the three shallowest underwater horizontal support members at 9, 24, and 37 m including typical smaller diameter supplementary diagonal support structures between. Two principal boat bumper/landing areas were situated in the center section of each side with 14 small, vertical supports extending approximately 2–3 m above and below the water line. Using blueprints, the surface area provided by all major platform legs and supports from the surface to a depth of 37 m was approximately 8,255 m². The majority of small-scale structure-associated fish habitat was created by well casings and support collars or guides located at the horizontal support levels, particularly at 9 and 37 m of depth. The outside dimensions at horizontal levels were as follows: 19.8 X 44.0 m at 9 m depth; 23.6 X 48.0 m at 24 m depth; and 27.8 X 51.6 m at 37 m depth.

Surveys

Underwater observations were made using SCUBA during a variety of research projects and also during other opportunities available to the author. The original four surveys and semi-quantitative census efforts were obtained as a supplemental part of a separate larger Environmental Protection Agency-funded study to National Marine Fisheries Service, "Ecological Effects of Energy Development on Reef Fish of the Flower Garden Banks" to LGL Ecological Research Associates Inc. (LGL), Bryan, Texas (Boland *et al.* 1983). Surveys were performed on the following dates followed by the elapsed number of days after platform installation: Survey 1, 21 October 1981/21 days; Survey 2, 29 April 1982/211 days; Survey 3, 4 August 1982/308 days; and Survey 4, 24 October 1982/389. One additional fish survey reported here, Survey 5, was performed on 5 October 1992, 4020 days after original platform installation. All observations were made during daylight hours. Additional visits to the platform were made by the author throughout the remaining 1990s, but underwater time was limited and did not permit fish census efforts. However, after 1990, observations of hermatypic corals were always a primary objective.

⁴ Ownership of the platform and the HI A389 lease was transferred briefly to Vastar in 1998 (now part of British Petroleum) and later to W&T Offshore, who is the current operator.

Underwater tasks required during the original study (Surveys 1–4) did not permit typical quantitative diver fish census methods. During the five principal survey periods described above, platform fouling and fish community surveys were performed as part of other field sampling objectives. Best estimates of total numbers of fish were determined for the area inside and in very close proximity of the platform and between the surface and 37 m. These estimates were based on a variety of circumstances. As opposed to short transect line or volumetric methods, the option was chosen to attempt to observe the entire structure during each survey and estimate the number of fish for each observed taxa for the entire structure. Water clarity was generally in excess of 30 m. In the case of highly mobile pelagic species, it was sometimes evident that the same group of individuals was moving around the platform (same size individuals, numbers, etc.). In this circumstance, the estimated total number took into account this judgement and the appearance that the same group of individuals had been seen more than once. In other instances, for the same pelagic species groups, it seemed that observations were separate and appeared to be unique individuals. Of course, this was not a certainty, and as a compromise, a range of estimated numbers was recorded. Total numbers of reef-associated species were somewhat more reliable due to the limited habitat area provided by the junctions of platform legs, cross members, and well casing support structures. However, some of these more cryptic species are also more difficult to observe. Although the effectiveness of a single diver is limited, it is believed the same level of confidence for estimating total numbers was similar for all surveys. There is no intention to imply that these semi-quantitative survey results are highly accurate and it is recognized that many weaknesses are implicit in the methods. However, specific observations made were significant in context of the time and place.

Very little diving or remote video census work close to the platform was performed below the 37 m depth during the LGL study (Boland *et al.* 1983) due both to restrictions of diving depths and difficulty in maneuvering the camera frame close to platform legs. Some additional observations are reported from remote video deployments and some deeper diving opportunities after 1982.

RESULTS

The first underwater reconnaissance dive and survey on the partially completed structure was made by diving scientists (including the author) with the consulting firm, LGL, on 21 October 1981, about three weeks after its installation. At that time, there were no permanent above-water modules or superstructure and only three well casings had been installed underwater (Figure 7.4). During this first cruise, only nine species of fish were observed between the surface and 37 m of depth (Table 7.8). Five of these species were jacks, considered to be wandering, pelagic species. The larger adults of crevalle (*Caranx hippos*), almaco (*Seriola rivoliana*), and amberjacks (*Seriola dumerili*), may have been recruited from the nearby East Flower Garden Bank. The other two jack taxa (Blue runner, *Caranx crysos*, and a large numbers of unidentified Carangidae) were juveniles and could have been recruited from the passing water mass. Three of the remaining four species observed during Survey 1 were also small juveniles, and included a single sergeant major (*Abudefduf saxatilis*), two small blue tang (*Acanthurus coeruleus*), and about 200 small gray triggerfish (*Balistes caprisкус*) estimated to range between 100 and 120 mm long (Figure 7.5). The sergeant major observation was the first reported for the Flower Garden Banks area (Boland *et al.* 1983). A single greater barracuda (*Sphyraena barracuda*) was also observed. The fouling community at this time was virtually non-existent. The platform structure had obviously never been in seawater for an extended period

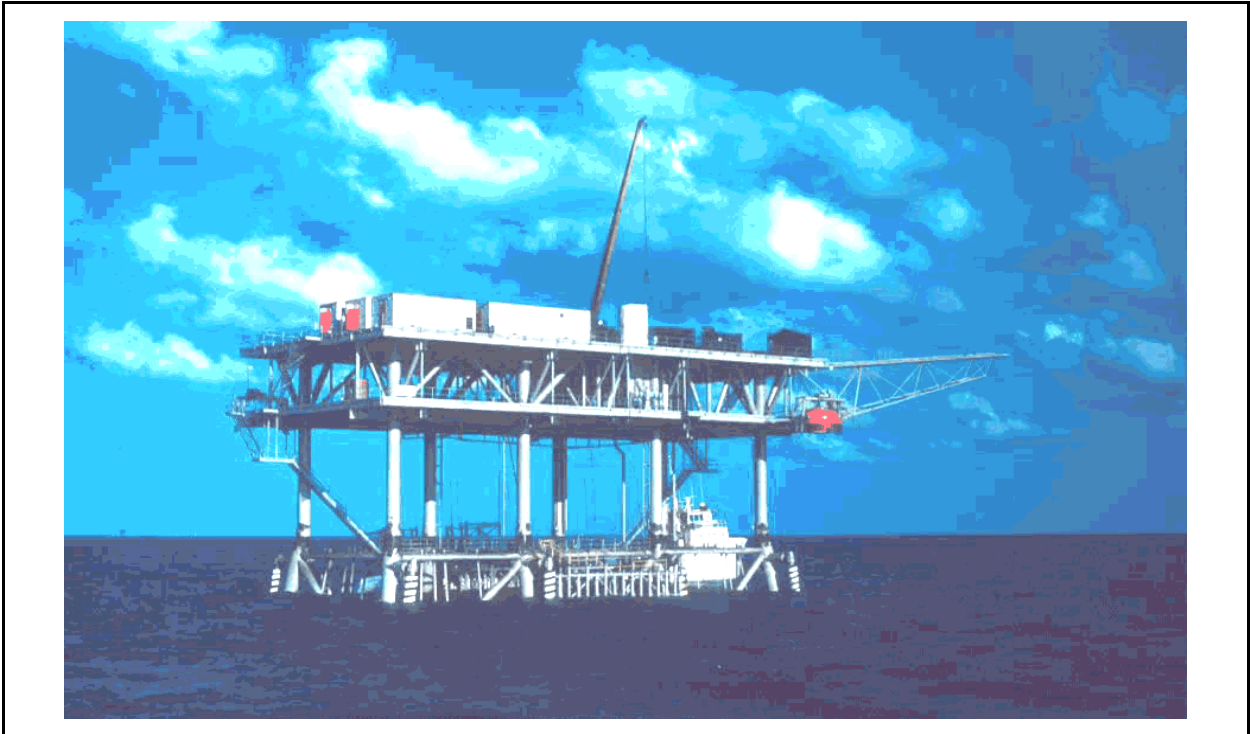

Figure 7.4. Appearance of Mobile High Island A389-A platform on 21 October 1981.

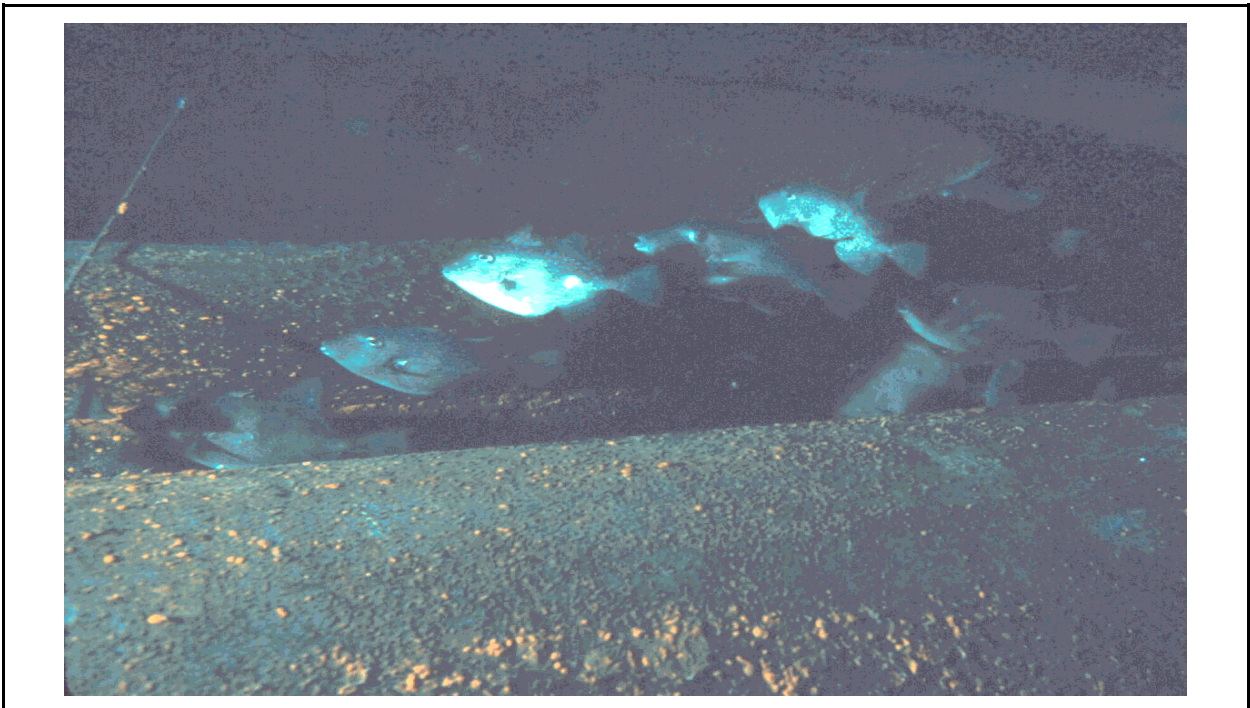

Figure 7.5. Juvenile gray triggerfish recruited to the platform prior to Survey 1.

Table 7.8. Species list and estimated abundance above 37 m depth at platform HI A389-A. All observations by diver except as noted for grouper from remote video. All adult except as noted.

Survey Number and Date Platform age since installation (days) Species*	1) 21 Oct 1981	2) 29-30 Apr 1982	3) 4-5 Aug 1982	4) 24-29 Oct 1982	5) 2-6 Oct 1992
	21	211	308	389	4,020
Silky shark (<i>Carcharhinus falciformis</i>)		1			
Frogfish (<i>Antennarius</i> spp.)				1	
Squirrelfish (<i>Holocentrus rufus</i>)			1		
Longjaw squirrelfish (<i>H. ascensionis</i>)			1		
Rock hind (<i>Epinephelus adscensionis</i>)			10-15	20-30	100+
Warsaw grouper (<i>Epinephelus nigritus</i>)		6 (video)		1 (video)	
Grouper (<i>Mycteroperca</i> spp.)			6-10	20-40	20-50
Yellowmouth grouper (<i>M. interstitialis</i>)		1 (juv.)	2 (juv.)	3 (juv.)	
Creole-fish (<i>Paranthias furcifer</i>)		50 sm	400-500 sm	500	100-500
Blue runner (<i>Caranx crysos</i>)	20-30 (juv.)			100 (juv.)	50+
Creville jack (<i>Caranx hippos</i>)	10	50		25 (juv.)	
Horse-eye jack (<i>Caranx latus</i>)					100-150
Bar jack (<i>Caranx ruber</i>)		1	6	3-6	20-30
Rainbow runner (<i>Elagatis bipinnulata</i>)		10		10	20-30
Greater amberjack (<i>Seriola dumerili</i>)	6	50	20-30		
Almaco jack (<i>Seriola rivoliana</i>)	40-50	10-20	10-20	20	
Rough scad (<i>Trachurus lathami</i>)		100-200			
Unidentified Carangidae	2 K-3 K juv?				
Yellow goatfish (<i>Mulloidichthys martinicus</i>)			3		
Chub (<i>Kyphosus</i> spp.)		14		4-10	1000+
Reef butterflyfish (<i>Chaetodon sedentarius</i>)			1	4-6	
Angelfish (<i>Holacanthis</i> spp.)				3 (juv.)	
Blue angelfish (<i>Holacanthis bermudensis</i>)					10
Sergeant major (<i>Abudefduf saxatilis</i>)	1 (juv.)	6	5	20-30	100+
Brown chromis (<i>Chromis multilineatus</i>)				10-20	
Bicolor damselfish (<i>Stegastes partitus</i>)		3		3	
Damselfish (<i>Stegastes</i> spp.)		3	6	3-6	1K+ few juv
Redspotted hawkfish (<i>Amblycirrhitus pinos</i>)				1	
Spotfin hogfish (<i>Bodianus pulchellus</i>)		10-20 (juv.)		3	
Spanish hogfish (<i>Bodianus rufus</i>)					50-100
Unidentified wrasse (<i>Halichoeres</i> spp.)		2		1	
Bluehead (<i>Thalassoma bifasciatum</i>)					100's
Greenblotch parrotfish (<i>Sparisoma automarium</i>)					8-12
Redband parrotfish (<i>Sparisoma aurofrenatum</i>)				1	
Great barracuda (<i>Sphyrnaea barracuda</i>)	1	20	30	50	10-30
Unidentified goby (Family Gobiidae)		1	10-20		
Seaweed blenny (<i>Blennius marmoreus</i>)		3	6	3	100
Crested blenny (<i>Hypoleurochilus geminatus</i>)				1	
Tesselated blenny (<i>Hypsoblennius invemar</i>)			3	3	100-500
Blue tang (<i>Acanthurus coeruleus</i>)	2 (juv.)		5 (juv.)	20-30	20-50
Surgeonfish/doctorfish (<i>Acanthurus</i> spp.)			1	30-50	50-100
Scrawled filefish (<i>Aluterus scriptus</i>)		1		1	
Orangespotted filefish (<i>Cantherhines pullus</i>)		3	2	2	3
Whitespotted filefish (<i>C. macrocerus</i>)					2
Grey triggerfish (<i>Balistes caprisacus</i>)	200 (juv.)	20-30	40-50	8	
Ocean triggerfish (<i>Canthidermis sufflamen</i>)		6	6		
Porcupinefish (<i>Diodon histrix</i>)					2
Sharpnose puffer (<i>Canthigaster rostrata</i>)		3	3	3	
Total number of taxa	9	24	23	32	22

*Common names from AFS (1991); sm = small; juv. = juvenile, year class 0 or 1

previous to its transportation and installation at the edge of the EFGB. The only obvious epifauna seen were a few scattered patches of an unidentified feathery white hydroid down to 18 m of depth and green filamentous algae present near the surface. The vast majority of the submerged structure surface area was coated in orange rust with black anoxic corrosion occurring in many areas below the superficial rust layer (Figure 7.6).

The second sampling dives (Survey 2) on the platform were made on 29 and 30 April 1982. Total dive time was 82 minutes. The structure had been in place for a total of about 211 days at that time. Drilling for the first well had begun on 26 April, three days previous to the dives. The most striking change to the platform community was the almost complete cover of the legs and cross-members by fouling organisms. Although the fouling mat was quite thin in most places, it was dramatically different from the bright orange rust layer that had covered most all the structure surfaces on the previous survey (Figure 7.7). The number of fish species observed almost tripled with 24 species represented as compared to nine species before (Table 7.8). Eighteen of these were new species not observed during Survey 1. Two of the juvenile jack species and the blue tang observed previously were not re-sighted. Number of barracuda had increased to 20 individuals; both crevalle and amberjack were represented by approximately 50 individuals each.

An estimated 20–30 moderate-sized (200–250 mm) gray triggerfish were observed during Survey 2, suggesting survivors from the 200 smaller juveniles that had been seen during Survey 1 approximately 26 weeks before. Several tropical species were first observed during Survey 2 including about 50 small creole-fish (*Paranthias furcifer*), the dominant species on the Flower Gardens coral reefs reported by Boland *et al.* 1983) and some representatives of the bicolor damselfish (*Stegastes partitus*), an unknown wrasse, 10–20 juvenile spotfin hogfish (*Bodianus pulchellus*), two species of filefish (scrawled filefish (*Aluterus scriptus*) and orangespotted filefish, *Cantherhines pullus*), sharpnose puffer (*Canthigaster rostrata*), an unknown goby, and the seaweed blenny (*Blennius marmoreus*). The first grouper species (above 37 m) was also observed during Survey 2, a single yellowmouth grouper (*M. interstitialis*).

The fouling community at this time was dominated in some areas by thick mats of filamentous algae and hydroids, both of which were teaming with several species of amphipods. Large, unidentified nudibranchs (3–5 cm long) were also seen grazing through these thick mats. These nudibranchs were never observed after this survey. In other areas, large patches of colonial tunicates dominated the fouling mat. Near the surface, several of the boat bumpers had become heavily encrusted with gooseneck barnacles. A single small colony of the octocoral, *Telesto riisei* was observed at a depth of 12 m.

Other motile invertebrates were also observed during Survey 2. Two species of sea urchins were present, small *Diadema antillarum* and *Arbacia punctulata*. Fireworms, (*Hermodice carunculata*), were abundant at both the 8-m and 37-m levels of horizontal supports. Two crab species were observed at 37 m, one an unknown xanthid crab, and the arrow crab (*Stenorhynchus seticornis*), represented by several individuals. Three small spiny lobsters (*Panulirus argus*) were seen inside a well collar surrounding a well casing at the 37-m depth level. One was very small with an estimated carapace length of about 5 cm.

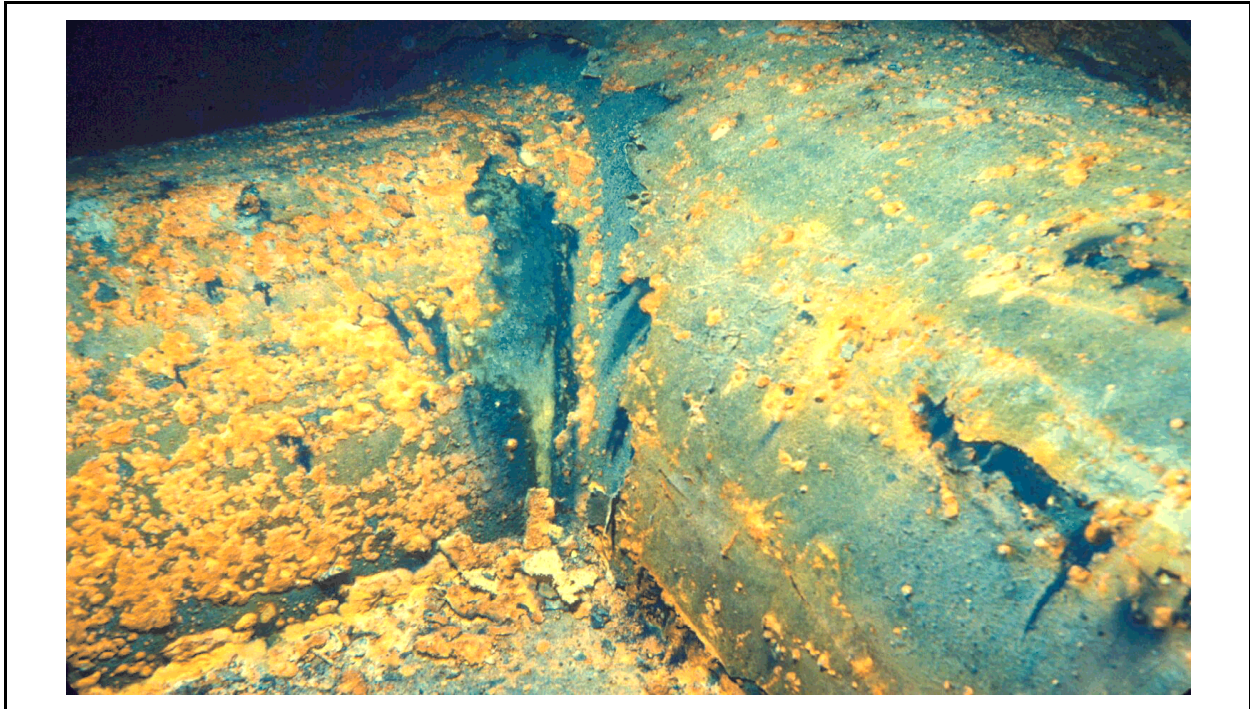

Figure 7.6. Typical appearance of platform structure three weeks after installation.

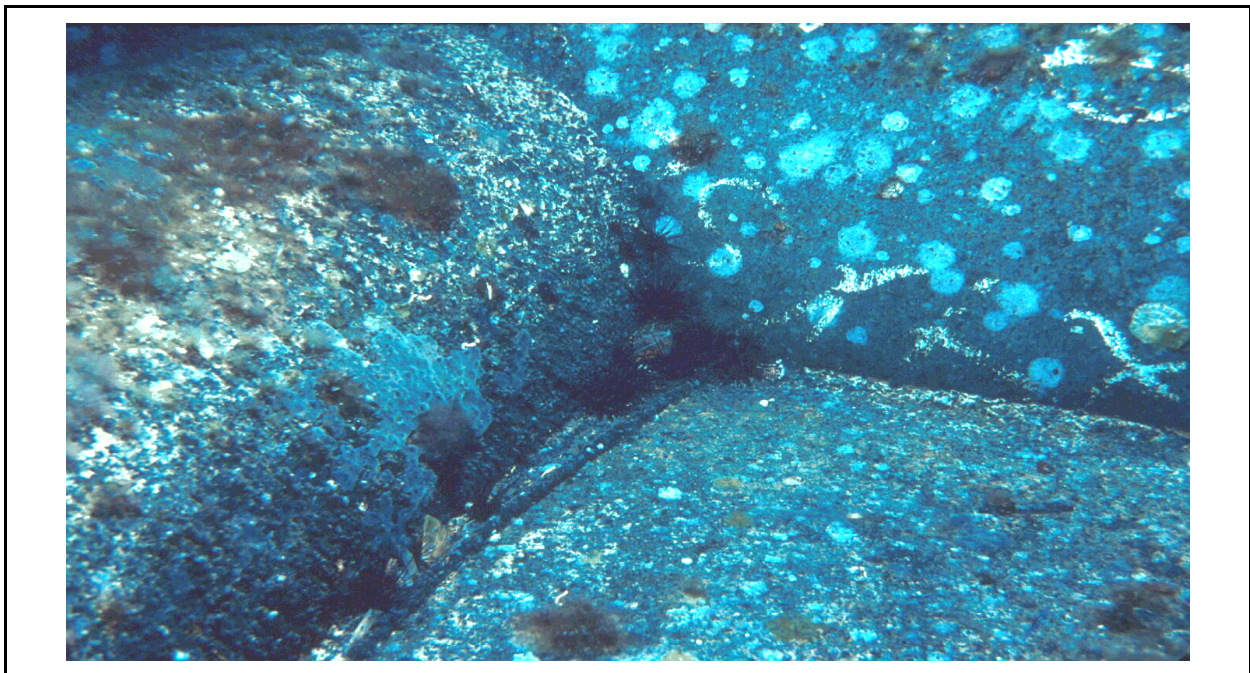

Figure 7.7. Similar location as Figure 7.6 photographed during Survey 2, seven months (211 days) after installation with now noticeable epifaunal community development evident.

Survey dives were again made on 4 and 5 August 1982 (Survey 3). Total dive time was 93 minutes. The platform had been on site for about 308 days at that time. During this survey, fewer fish species were observed than in April 1982, but the total number of individuals seen had generally increased (higher abundance, lower diversity) (Table 7.8). Of 23 total taxa, 14 species were also observed during Survey 2. Eight new species were observed during Survey 3 including the longjaw squirrelfish (*Holocentrus ascensionis*), tessellated blennies (*Hypsoblennius invemar*), and numerous tropical reef species, namely the reef butterflyfish (*Chaetodon sedentarius*), surgeon/doctor fish (*Acanthurus* spp), yellow goatfish (*Mulloidichthys martinicus*), and rock hinds (*Epinephelus adscensionis*) (Figure 7.8). Juvenile blue tang were also observed again after being first observed during Survey 1 and absent during Survey 2. A single squirrelfish (*Holocentrus rufus*) was seen for the first time at 8 m of depth.

The most notable change in the fish community during Survey 3 was the dramatic increase in the creole-fish population. A best estimate of their numbers to the depth of the 37-m horizontal structure level was between 400 and 500 individuals. All of these fish were relatively small. Specimens collected at the platform for a histopathology work unit of the larger study averaged 124 mm and ranged in size from 85–142 mm in fork length (N = 41) compared to lengths twice that size for specimens collected from the Flower Garden Banks upper coral reefs (mean = 208 mm, range 105–292 mm, N = 323) (Boland *et al.* 1983).

The fouling community during Survey 3 was becoming dominated by bivalve mollusks. The thick hydroid and algal mats were much reduced in comparison to the previous spring survey. The dominant bivalve occurring on the platform in August 1982 was the Atlantic pearl oyster (*Pinctada radiata*). Acorn barnacles (*Megabalanus antillensis*), though sparse, were prevalent from about 10 m to the surface. Many barnacles had reached approximately 3–4 cm in basal diameter, and the few which had died provided excellent habitat cavities for the newly recruited tessellated blennies and the increased numbers of seaweed blennies. Gooseneck barnacles (*Lepas* sp.) remained abundant near the surface but were not nearly as thick on boat bumper surfaces as they had been in April. Encrusting bryozoan patches had increased dramatically in size, and one red species had developed delicate branches extending several centimeters above the basal part of the colony.

Motile invertebrates observed included red-banded coral shrimp, (probably *Stenopus hispidus*) hiding inside well collars at both 8- and 37-m depths. Arrow crabs and fireworms were again observed. Spiny lobsters were seen in the same well collar where they had been seen during Survey 2 (Figure 7.9) at the 37-m level. At this time, there were at least six individuals present, and all were significantly larger than observed during Survey 2, 97 days earlier suggesting residency and growth of the former.

The final observational survey of the LGL study platform as part of the FGB study Boland *et al.* (1983) was made on 24 October, 1982 (Survey 4), some 389 days after its installation. Both the fish and fouling communities had become surprisingly well established after little more than a year of colonization beginning from a bare steel structure. The number of fish species observed had increased to thirty-two (Table 7.8). Six new species were noted during Survey 4, and 17 species were common to both Surveys 3 and 4. New species included a frogfish (*Antennarius* spp.), juvenile angelfish (*Holacanthus* spp.), brown chromis (*Chromis multilineatus*), red-spotted hawkfish

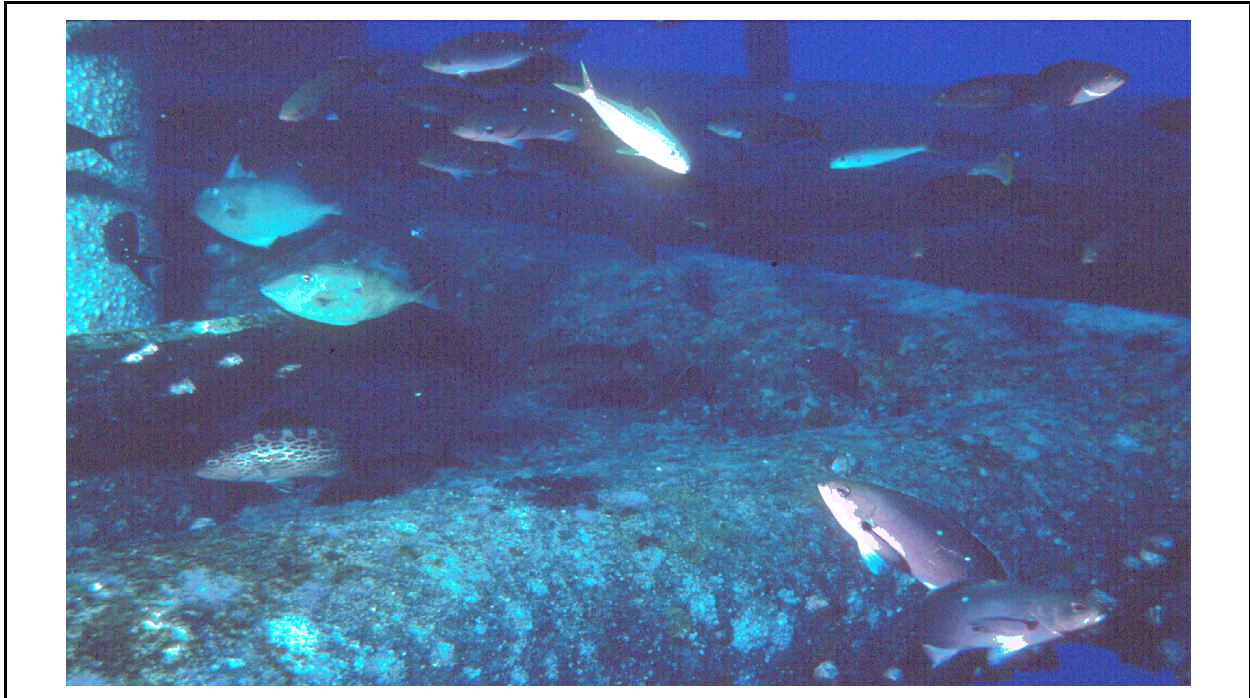

Figure 7.8. Diverse fish community around well casing area at horizontal cross member level, Survey 3, ten months (308 days) after installation.

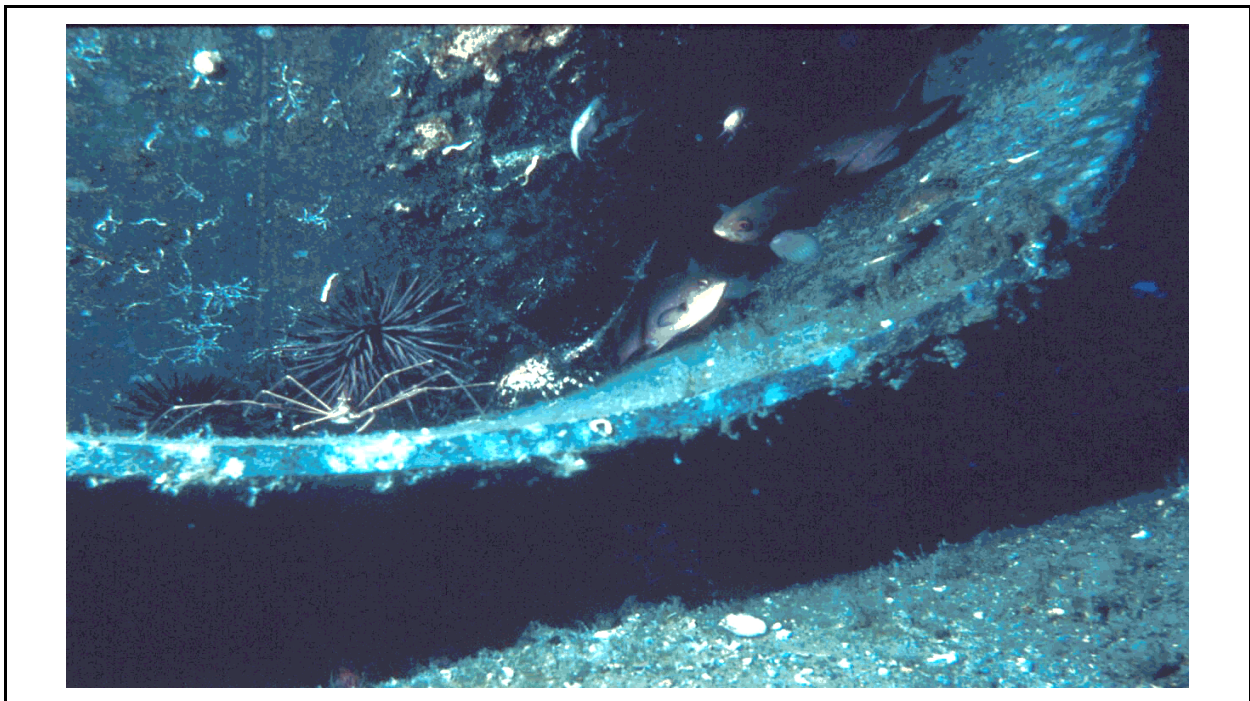

Figure 7.9. Small spiny lobster at Figure 7.8 site, Survey 3, ten months (308 days) after installation.

(*Amblycirrhitus pinos*), red band parrotfish (*Sparisoma aurofrenatum*), and one additional blenny species, the crested blenny (*Hypleurochilus geminatus*). Several species had increased substantially in numbers, including the sergeant major which had been represented by five individuals during Survey 3 as compared to between 20 and 30 individuals on Survey 4. Small groupers (*Mycteroperca* spp.) increased from around 6–10 fish to between 20 and 40 individuals.

Creole-fish remained the numerically dominant species, maintaining a similar population from Survey 3 to Survey 4 of approximately 500 individuals. Creole-fish appeared to be significantly larger during Survey 4 as compared to Survey 3. Fish collected for the larger study at this time suggests these observations were correct. Fork lengths of 23 fish collected at the platform during Survey 4 ranged from 140–181 mm, having a mean length of 153 mm. This compares to a mean length of 124 mm for the 41 fish collected during Survey 3 (Boland *et al.* 1983).

The fouling community had become quite diverse and it was impossible to describe all its components within the limited time of the few dives made on the platform. In general, the fouling community had become well established. Many species on the platform were observed for the first time during this survey. Atlantic pearl oysters had become larger and more numerous (Figure 7.10), especially on the top surfaces of the horizontal cross members. Numerous rock snails, *Thais haemastoma*, and winged oysters, *Pteria colymbus*, were also seen. The octocoral, *Telesto riisei* that had been limited to a single occurrence at 12 m during Surveys 2 and 3 was observed in small patches at six other locations ranging in depth between about 5 and 16 m. The general fouling mat consisted primarily of algae, bryozoan, and hydroids of several species. Two taxa of leafy algae abundant on the Flower Garden Banks (*Lobophora* and *Dictyota*) were prevalent on the surfaces of horizontal supports at both 9- and 37-m depths. Acorn barnacles had become larger and were now distributed to a maximum depth of about 37 m (Figure 7.11). Encrusting sponge colonies that had not been previously observed were well established, and in some areas were as large as 30 cm in diameter.

One additional fish survey is included in this report performed 2–6 October 1992, 4020 days after original platform installation and almost ten years after the first survey in 1982. Total effort utilized to obtain this Survey 5 data included nine dives and 331 minutes of dive time. A total of 22 fish taxa were observed. Seven species were observed that were not previously seen in 1981/82, all of which are common species on the Flower Garden Banks. These included the horse-eye jack (*Caranx latus*), blue angelfish (*Holacanthus bermudensis*) (Figure 7.12), Spanish hogfish (*Bodianus pulchellus*), bluehead (*Thalassoma bifasciatum*), whitespotted filefish (*Cantherhines macrocerus*), greenblotch parrotfish (*Sparisoma automarium*), and porcupinefish (*Diodon histris*). As opposed to the creole-fish reported as the dominant taxa in 1982, the damselfish, *Stegastes* spp. had become the dominant reef-associated taxa, estimated as 1000+ in numbers above the 37 m depth level. Several *Stegastes* species could not be reliably separated during this survey and were combined under one genus name.

The platform fouling community in 1992 was dramatically different than 10 years earlier. The overall community had become dominated by massive sponges (Figure 7.12). Towards the surface, shallower than about 5 m, the fouling community included high relief barnacle mollusk clusters, similar to platforms in shallower areas of the continental shelf (Figure 7.13). The fouling community had apparently reached a climax state that has persisted through more recent observations through

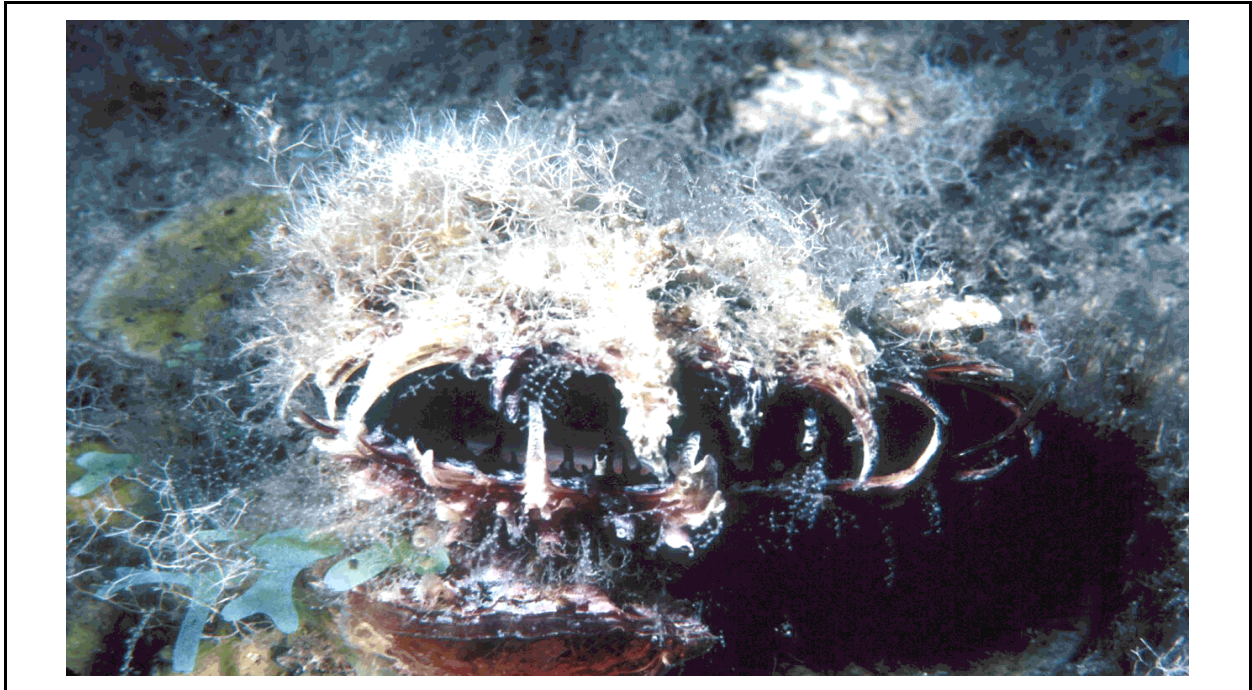

Figure 7.10. Atlantic pearl oyster (*Pinctada radiata*) with attached anemones during Survey 4, 13 months (389 days) after installation.

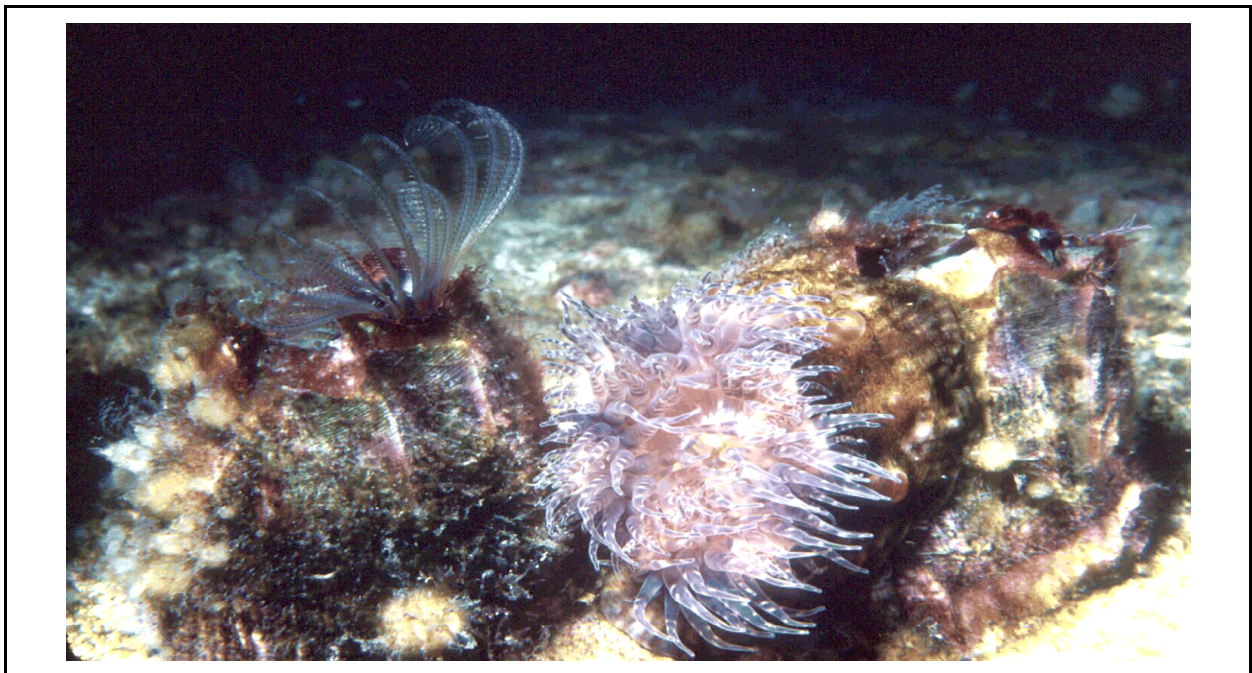

Figure 7.11. Acorn barnacles (*Megabalanus antillensis*) with attached anemones during Survey 4, 13 months (389 days) after installation.

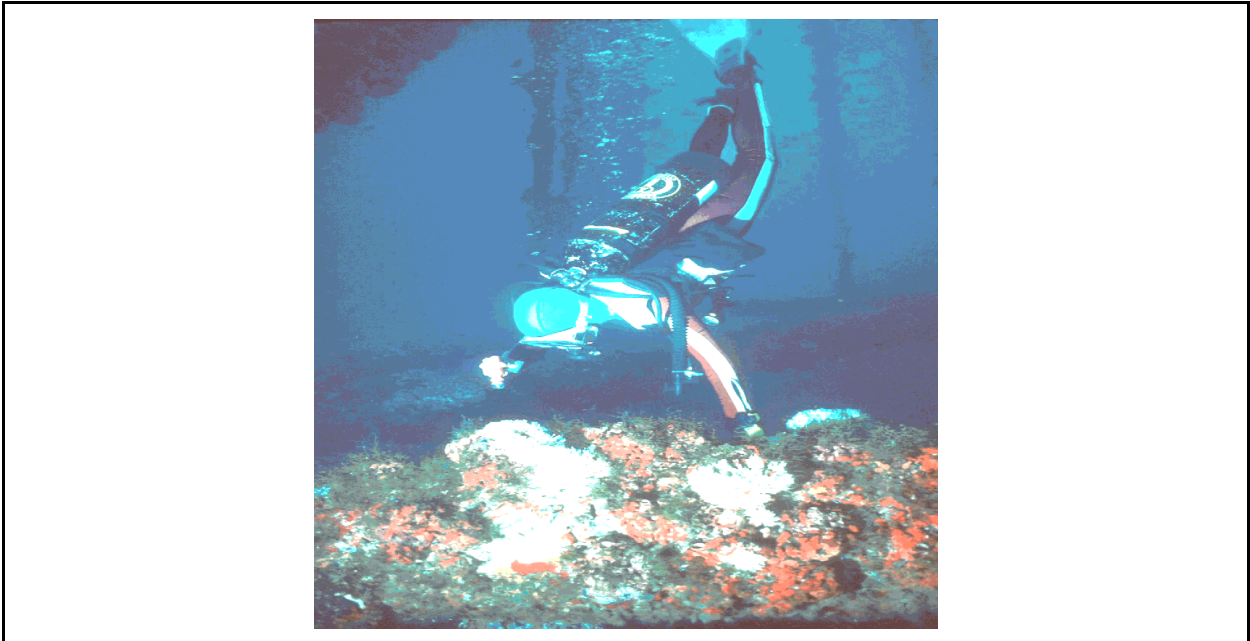

Figure 7.12. Well-developed fouling community on HI A389-A during Survey 5 in October 1992 (4,020 days after installation). Numerous taxa of massive sponges dominating the community at depth of 20.

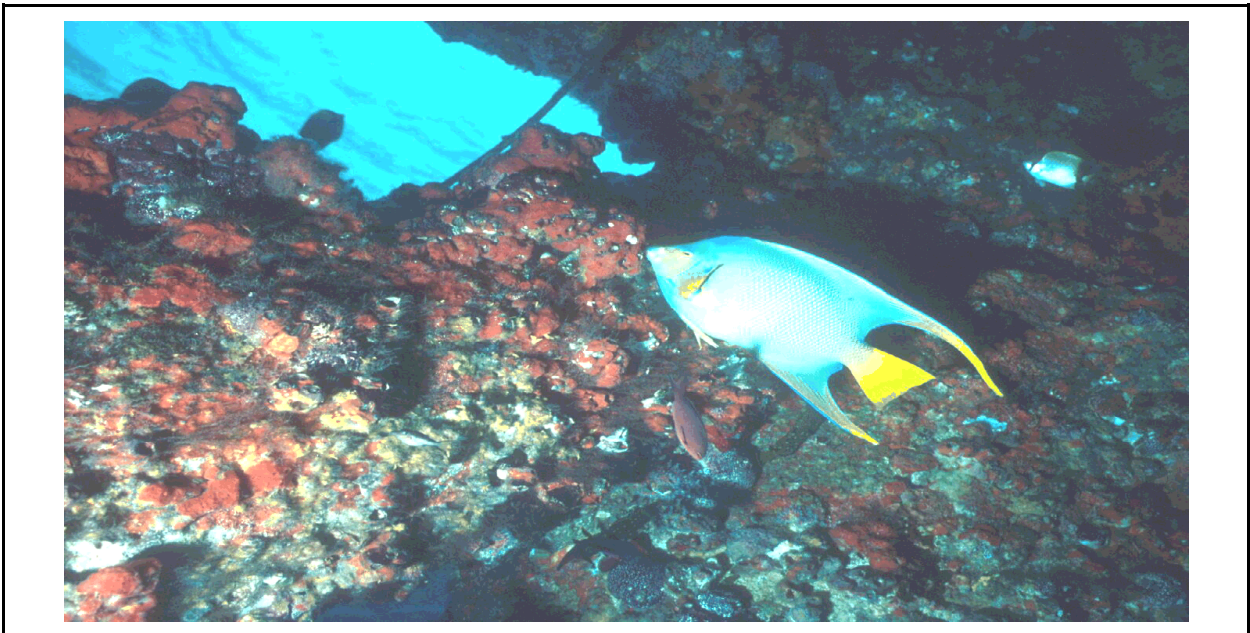

Figure 7.13. Well-developed fouling community on HI A389-A during Survey 5 in October 1992 (4,020 days after installation). High-relief mollusk and barnacle community at depths above 5 m.

1999. A detailed description of the highly complex and diverse fouling community is beyond the scope of this report. A limited investigation of just the sponges was a substantial undertaking and is published as a technical report and graduate degree thesis (Adams 1996).

Additional Observations

Scleractinian corals: Scleractinian reef-building (hermatypic) corals were expected, but not observed between 1981 and 1982 during the LGL studies at HI A389-A ending only 13 months after the platform was installed (Boland *et al.* 1983). Opportunities were not available to make observations at the platform again until 1990, several years after Survey 4 in October 1982. The author and others made two dives on HI A389-A on 11 November 1990. Four species of corals were documented including *Madracis decatis*, *M. asperula*, *Porites astreoides* and *Diploria strigosa*. These observations were reported in Bright *et al.* (1991). A single colony of *P. astreoides* (brooder) and a small colony of *D. strigosa* (broadcaster) were notable as they ranked as second and fifth in dominance of coral cover at the FGB (Gittings *et al.* 1992; Dokken *et al.* 1999). The *P. astreoides* colony was a substantial size having settled at least several years earlier. Figure 7.14 illustrates the *Porites* colony in June 1992, only eight months after its first sighting at a depth of 9 m on a horizontal cross member. The first *Diploria* colony observed on HI A389-A at a depth of 23 m was much smaller, measuring about 6 cm in diameter but certainly had settled more than one year previous. A number of *D. strigosa* and the large *Porites* were followed over the years whenever opportunities were available. One additional image of the *Porites* is shown in Figure 7.15 taken in August of 1995. Measurements were taken at this time showing the dimensions of the colony to be about 42 by 38 cm. An additional colony of *P. astreoides* was located a short distance away measuring 11.5 by 14 cm indicating probable successful reproduction of the original adjacent colony. The same colony of *D. strigosa* is shown in both Figure 7.16 and Figure 7.17. This particular colony was not the same as the first observed in 1990, but its size shown in 1995, measuring 16 by 19 cm indicates it could have been a similar size (about 6 cm diameter) as the originally sighted colony five years previous (theoretical growth rate of 1–1.3 cm in radius per year not unreasonable). Figure 7.17 depicting the same colony in August 1998, shows substantial growth over the three years. The diameter was measured in 1998 as approximately 23 cm representing a growth of between 4–7 cm over three years.

Observations below 37 meters: Although not a principal subject of this report, a number of other observations have been made by the author by remote video methods and using SCUBA below the 37-m horizontal structure support on the platform. In Boland *et al.* (1983), limited observations were made with a remote stereo-video apparatus deployed from a research vessel tied to the platform during the LGL study. Boland *et al.* (1983) reported that below a 40-m depth, fouling organisms were very sparse. Only a few fish species were reported, most not closely associated with the platform substrate. These included amberjack, rainbow runner, greater barracuda, and chub. One species was more remarkable. Large warsaw groupers were recorded on the remote video system during Surveys 2 and 4. A total of six individuals were seen during Survey 2 just above the interface of a highly turbid nepheloid layer at a depth of around 90 m. The LGL video system allowed measurement using paired, parallel cameras and a twin stereo-monitor system. Three of the fish allowed length measurement while oriented perpendicular to the cameras and had fork lengths of 810, 877 and 919 mm. A single warsaw grouper was observed during the Survey 4 cruise and was

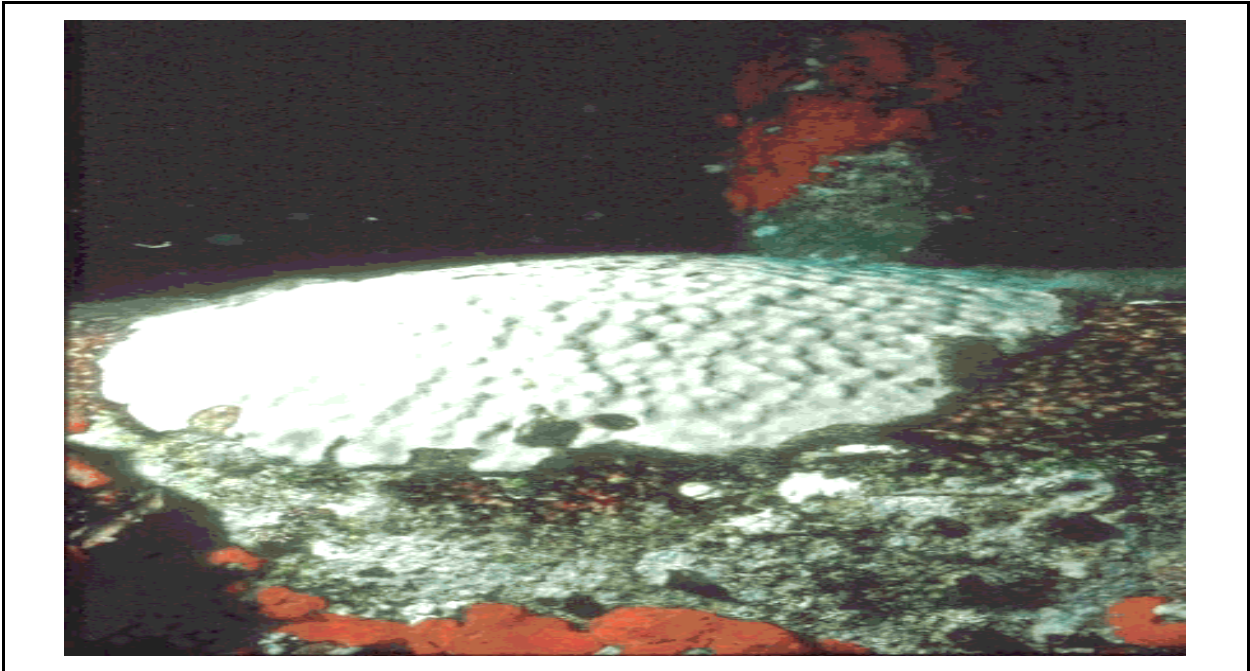

Figure 7.14. Colony of *Porites astreoides* documented from horizontal support at depth of 9 m, June 1992.

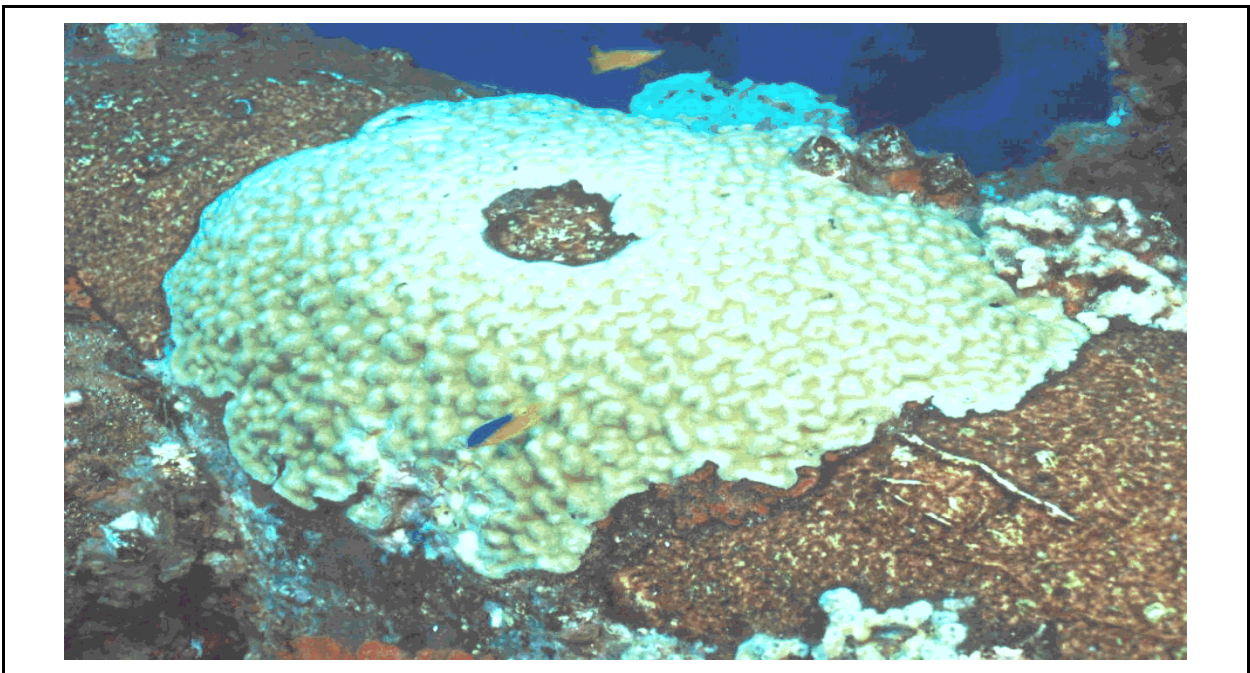

Figure 7.15. The same colony of *Porites astreoides* as in Figure 7.14, taken August 1995, colony measuring 42 by 38 cm with mortality in center approximately 8 by 6 cm. Pipe diameter is 35.5 cm.



Figure 7.16. Colony of *Diploria strigosa* at depth of 15.5 m. Photographed August 1995 when the coral measured 19 by 16 cm.



Figure 7.17. The same colony of *Diploria strigosa* as in Figure 7.16. Photographed August 1998.

also sighted just above the turbid water layer at a depth of 90 m. This grouper was also measured using the stereo video system and had a fork length of 1314 mm.

During a research opportunity in 1992, a number of deep SCUBA dives were performed by the author at HI A389-A allowing first hand observations of platform substrate as deep as 57 m. Limited time did not allow any comprehensive fish or fouling community descriptions, but it was clear that the conditions reported from 1982 were much different in 1992. The next horizontal support below the 37-m level is located at 53 m. Figure 7.18 illustrates the relatively high-relief fouling community on all structural supports to a depth of 58 m. Although observation time was very limited, structure-associated reef fish were very abundant. Both of these observations are in contrast to the limited fouling community development and very few fish seen on remote video in 1982. No attempt will be made here to provide a comprehensive description or comparison of the fish community at this depth, but one species, the yellowtail reef fish (*Chromis enchrysurus*), appeared to be the dominant species represented by many individuals along every meter of all horizontal structure supports at a depth of 53 m.

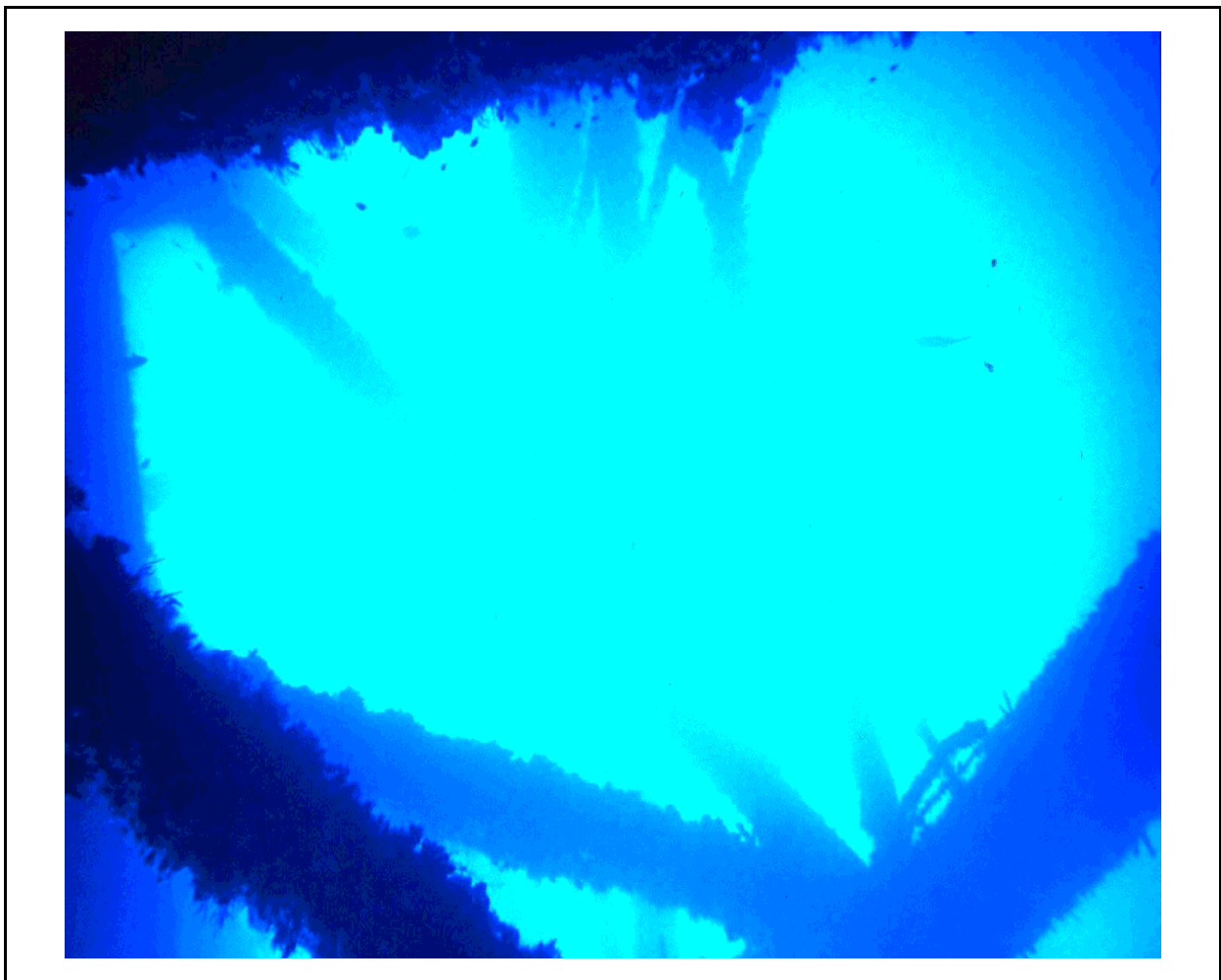

Figure 7.18. View of 53-m horizontal support and descending diagonal on HI A389-A platform from depth of 58 m. Note high relief of fouling community.

DISCUSSION

It should again be noted that the fish census data in this report is semi-quantitative at best, and affected by limited, single-diver observations. A general bias has also been reported in the literature due to the presence of divers during fish surveys. Mean density of fish declined around platforms by 41–77 percent when SCUBA divers were present during surveys as estimated by dual-beam hydroacoustics (Stanley and Wilson 1995). One significant difference with the data reported here is that virtually all observations were obtained inside the platform structure in contrast to the hydroacoustic data collected only on the outside of structures by Stanley and Wilson (1995).

Results from most investigations of platform fish assemblages have been difficult to compare due to problems with limited visibility, lack of standardized methods, diver avoidance or other sampling gear bias. Any discussion of these results is also limited by the lack of rigorous census techniques and inconsistent methodologies; however, the observations reported here still represent unique contributions describing long-term platform recruitment occurring at a Gulf of Mexico bluewater platform. Faunal studies of bluewater platforms in the Gulf have been and continue to be rare. The most notable aspect of the surveys reported here was the opportunity to periodically observe the colonization of a new structure over an extended period. The initial observations are significant due to the known date of installation and the fact that the structure was essentially new at that time. For many encrusting forms, a general indication of succession/recruitment was observed, at least for new substrates. Some insight can also be added to the ongoing debate about the production or attraction function of artificial reefs. The proximity of the platform to a thriving coral reef is also a unique situation, particularly for the United States.

After more than 13 months of recolonization in October 1982, the HI A389-A platform remained very different than the adjacent coral reef or other habitats on the EFGB. The dominant invertebrates on the reef, the reef-building corals, had not yet been observed on the platform. Coral recruits would have been very small after less than one year of development and could have easily been overlooked. Some large invertebrates were common to both habitats, but there were many exceptions. Notably, the lobster population on the platform (spiny lobster, *Panulirus argus*) was not the same species commonly seen on the coral reef at that time (spotted lobster, *Panulirus guttatus*). The majority of the 48 fish species recorded on the platform also occur on the Flower Gardens, but some did not. Several species were observed on the platform in 1981 or 1982 which had not been previously reported in the literature of the Flower Garden Banks at that time. These included the sergeant major, an unidentified frogfish, and three species of blenny, the seaweed, crested, and newly described tessellated blenny. Overall, the proximity of the HI A389-A platform to the EFGB seems to have had a limited effect on its attached epifaunal community composition through the 1982 observations. The community at this platform was basically the same as other blue water platforms well removed from any bank (Gallaway and Lewbel 1982).

In 1990, after nine years of development, the substantially different fouling community on HI A389-A remained unlike any reef habitats at the EFG. The general nature of the community had reached what appeared to be a climax community at this time and has not changed drastically since (through 1999). The visual community dominant taxa had become sponges, but mollusks were probably the biomass dominant, although no biomass samples were taken and there is no data to confirm this

statement. Gallaway and Lewbel (1982) also reported that bluewater platform fouling community biomass is generally dominated by mollusks.

Although Adams (1996) concluded that the variety of sponges found on HI A389-A were similar to coral reef systems in general, their diversity and dominance are not characteristic of the Flower Garden Banks coral reef habitat and are higher in abundance than on coral reefs in general. The platform structure provides many different types of reef environment allowing the recruitment and development of a very diverse sponge community not found on the FGB. Adams (1996) reported three dominant species; below a depth of 25 m the spherical species *Stelletta kallitetilla* was the dominant, at mid depths between 12.5 to 24.5 m, *Tedania ignis* dominated, and shallower than 12 m, *Desmacella melorata* dominated. Overall, these three species comprised nearly half of all substrate area for the platform to a depth of 37 m (Adams 1996). Interestingly, Adams (1996) reported that several common species on the Flower Garden banks did not occur on the platform, including the large vase sponge *Xestospongia muta* and the prominent bright orange sponge *Agelas* spp.

The number of fish taxa observed in five surveys totaled 48, comparable to other bluewater platform surveys. Rooker *et al.* (1997) observed a total number of 43 species above 24 m during diurnal surveys of 54 ten-meter transects at HI A389-A. The Reef Environmental Education Foundation database (REEF, <http://www.reef.org>) documents a total of 52 surveys performed at the HI A389-A platform in recent years. Using the “expert” category (test results demonstrating a high level of visual identification expertise) the number of taxa reported totaled 53. While the data in this report cannot be directly compared to any rigorous quantitative census techniques, the total number of taxa compares favorably to these other efforts.

The relevance of fish survey data in this report derives from the early timing of the initial observations and repeated surveys during the first year after platform installation. Adult fish observed in or near the structure a short period after installation were not recruited as juveniles. The first survey, three weeks after platform installation, demonstrated that adult taxa are recruited from surrounding areas. Pelagic Carangidae are examples, but the large warsaw groupers, optically measured around one meter in length, represent very mature reef-associated fish attracted to the platform.

Many observations represent evidence of species recruited as juvenile or very young individuals to this new habitat. The gray triggerfish observed during Survey 1 are the best example (Figure 7.5). There is no assurance that juveniles recruited to the platform would not have otherwise ended up at the EFGB, however, gray triggerfish are very rare on the EFGB but are common on offshore platforms. Other small individuals were observed during the first survey including a sergeant major and blue tang. Creole-fish, the numerical dominant on the FGB reported by Boland *et al.* (1983), were first seen at a platform age of seven months. Some examples of early recruits, and later observations of similar numbers but larger individuals, suggest that these groups of smaller fish remained residents. This is speculation as there was no tagging or other methodology employed to identify specific individuals. The appearance of large numbers of adult creole-fish on the platform during Survey 4 could represent recruitment from the nearby EFGB, however, this species is also reported in high numbers at other bluewater platforms well removed from natural habitat and was the dominant species at the platform GC 18, (Stanley and Wilson 2000).

Other general observations by the author at HI A389-A (annually between 1993–1998) indicate extreme variation in both seasonal and annual fish abundance for some species. As one example, more than one hundred silky sharks (*Carcharhinus falciformis*) were observed swimming in circles around the outside of HI A389-A in November of 1990 in contrast to only a single individual observed during all 5 surveys. These large numbers of silky sharks are not frequently seen. Similar to the FGB, the abundance of many species may vary substantially from one day to the next. This is particularly true for pelagic taxa such as the jacks. One notable additional observation not presented in the results section was a sergeant major tending a substantial egg mass on a horizontal projection of a platform leg in 1995.

CONCLUSIONS

The overall conclusion of this report is that this new platform structure installed in 1981, in relatively deep water adjacent to the EFGB, was colonized by a diverse community of epibiota and fishes where none existed before. Much of the development of the platform community, particularly the biofouling component, appears to be largely independent of its proximity to the Flower Garden Banks. Other significant conclusions include:

Early observations at a newly installed “bluewater” platform demonstrate that adult, sub-adult and juvenile fish are recruited or attracted to a structure within a time frame of less than three weeks, and perhaps in a matter of days after installation.

Direct observations demonstrated attraction of adult fish to the platform, but also recruitment and apparent growth of some reef fish species. One taxa, the sergeant major (*Abudefduf saxatilis*), was unarguably producing new biomass by nesting on the platform.

Fouling community development is quite rapid but continues through a variety of phases or succession, until a “climax” community is reached with very high rugosity and other structural complexity to a depth of more than 60 m.

Although a nearly complete cover of pioneer fouling taxa was present after seven months, the sponge-dominated community structure at HI A389-A took many years and probably close to ten years to become fully established.

Virtually all fish species recorded on the platform have also been recorded on the Flower Garden Banks. Notable exceptions are the lack of tessellated blenny observations and the lack of any record of sergeant majors on the FGB prior to the earliest platform surveys.

Hermatypic corals were first observed on HI A-389A in November 1990, nine years after installation. Two dominant species on the FGB, *Diploria strigosa* and *Porites astreoides*, have continued to grow.

The brooding coral species *Porites astreoides* has apparently reproduced successfully after recruitment to the platform and expanded its colonization on HI A-389A. The numerous colonies of *D. strigosa* (broadcast spawner) now growing on the platform are also likely contributing viable

larvae into the Gulf of Mexico. Direct observation of these coral heads during an annual mass spawning event could confirm the potential of artificial reef propagation of hermatypic corals. Most of the numerous older bluewater platforms located downcurrent of the Flower Garden Banks should also harbor developing colonies of reef-building corals.

ACKNOWLEDGMENTS

The initial observations at platform HI A389-A between 1981 and 1982 were a part of an EPA funded study, "Ecological Effects of Energy Development on Reef Fish of the Flower Garden Banks," through National Marine Fisheries Service, Galveston, Texas. Contract No. NA80-GA-C-00057 (Boland *et al.* 1983). Some of the latter visits to the HI A389-A platform were opportunistic during ongoing monitoring at the Flower Garden Banks efforts funded by the Minerals Management Service to Texas A&M University beginning in 1988. The deep diving opportunities were made possible by invited participation in a project at HI A389-A from Quenton Dokken at Corpus Christi State University in 1992 (now Texas A&M University at Corpus Christi). Other observations at HI A389-A were opportunistic during recreational trips or while serving as a vessel Dive Master on the Rinn Boats Inc., M/V *Fling*. Mobil Exploration and Production U.S. Inc. is gratefully acknowledged for the general permission to LGL Ecological Research Associates Inc. and National Marine Fisheries to use their new structure for their study, and also for their long-running support of numerous academic marine science studies based at the platform over many years. All images are by the author from HI A389-A.

REFERENCES

- Adams, C.L. 1996. Species composition, abundance and depth zonation of sponges (Phylum Porifera) on an outer continental shelf gas production platform, northwestern Gulf of Mexico. Final report and Master's Thesis project. Texas A&M University-Corpus Christi, Center for Coastal Studies. No. TAMU-CC-9601-CCS. 130 pp.
- AFS. American Fisheries Society. 1991. Common and Scientific Names of Fishes from the United States and Canada. Fifth edition. Bethesda, MD. 183 pp.
- Boland, G.S., B.J. Gallaway, J.S. Baker, G.S. Lewbel. 1983. Ecological effects of energy development on reef fish of the Flower Garden Banks. Volume III. *In* Ecological effects of energy development on reef fish, ichthyoplankton and benthos populations in the Flower Garden Banks of the northwestern Gulf of Mexico, 1980-1982. National Marine Fisheries Administrative Report to Environmental Protection Agency under interagency agreement EPA-79-D-X0514. 466 p.
- Bright, T.J., S.R. Gittings, and R. Zingula. 1991. Occurrence of Atlantic reef corals on offshore platforms in the northwestern Gulf of Mexico. *Northeast Gulf Science*. 12:55-60.
- Bull, A. and J.J. Kendall Jr. 1994. An indication of the process; Offshore platforms as artificial reefs in the Gulf of Mexico. *Bulletin of Marine Science*. 55:1086 - 1098.

- Continental Shelf Associates. 1982. Study of the effect of oil and gas activities on reef fish populations in Gulf of Mexico OCS area. Open File Report 82-10. New Orleans, Louisiana. US DOI, MMS, Gulf of Mexico OCS Region.
- Dokken, Q.R., I.R. MacDonald, J.W. Tunnell, Jr., C.R. Beaver, G.S. Boland and D.K. Hagman. 1999. Long-term Monitoring of the East and West Flower Garden Banks, 1996-1997. OCS study MMS 99-0005, U.S. Department of the Interior, Minerals Management Service, Gulf of Mexico OCS Region, New Orleans, Louisiana. 101pp.
- Gallaway, B.J., L.R. Martin, R.L. Howard, G.S. Boland, and G.D. Dennis. 1981. Effects on artificial reef and demersal fish and macrocrustacean communities. Pages 237-299 in B.S. Middleditch, editor. Environmental effects of offshore oil production: The Buccaneer gas and oil field study. Marine Science Volume 14. Plenum Press. New York, N.Y.
- Gallaway, B.J. and G.S. Lewbel. 1981. The ecology of petroleum platforms in the northwestern Gulf of Mexico: A community profile. USFWS Office of Biology Services, Washington, D.C. FWS 1OBS-82/27. Open File Report 82-03.
- Gittings, S.R., G.S. Boland, K.J.P. Deslarzes, and B.S. Holland. 1992. Long-term monitoring at the East and West Flower Garden Banks. OCS Study/MMS 92-0006. U.S. Department of Interior, Minerals Management Service, Gulf of Mexico OCS Regional Office, New Orleans. 206 p.
- Hastings, R.W., L.H. Ogren, and M.T. Mabry. 1976. Observations on the fish fauna associated with offshore platforms in the northeastern Gulf of Mexico. Fishery Bulletin. 54:387-401.
- Putt, R.E., Jr. 1982. A quantitative study of fish populations associated with a platform within Buccaneer oil field, northwestern Gulf of Mexico. M.Sc. Thesis. Texas A&M University. College Station, Texas.
- Rooker, J.R., Q.R. Dokken, C.V. Pattengill, and G.J. Holt. 1997. Fish assemblages on artificial and natural reefs in the Flower Garden Banks National Marine Sanctuary. Coral Reefs. 16:83-92.
- Stanley, D.R. and C.A. Wilson. 2000. Seasonal and spatial variation in the biomass and size frequency distribution of the fish associated with oil and gas platforms in the northern Gulf of Mexico. Final report to U.S. Department of the Interior, Minerals Management Service. OCS Study MMS 2000-005. 252 pp.
- Stanley, D.R. and C.A. Wilson. 1997. Seasonal and spatial variation in abundance and size distribution of fishes associated with a petroleum platform in the northern Gulf of Mexico. Canadian Journal of Fisheries and Aquatic Sciences 54:1166-1177.
- Stanley, D.R. and C.A. Wilson. 1995. Detection of the effect of scuba divers on fish density and target strength utilizing dual-beam hydroacoustics. Transactions of the American Fisheries Society 124:946-949.

FISH ASSEMBLAGES AROUND OIL AND GAS PLATFORMS IN THE NORTHEASTERN GULF OF MEXICO: DEVELOPING A SURVEY DESIGN.

Kevin R. Rademacher
Jeffery H. Render¹
National Marine Fisheries Service
Mississippi Laboratories

ABSTRACT

A pilot survey was conducted in 1995 by the National Marine Fisheries Service, Mississippi Laboratories (NMFS, ML) to develop a survey design for assessing fishes associated with the offshore oil and gas platforms in the Gulf of Mexico (GOM). Eight platforms of various sizes, configurations and depths were sampled with a pan and tilt video camera, stationary video cameras, and a remotely operated vehicle (ROV). Differences in fish species observed and their abundance measured by the different gear types were evaluated to determine an optimal sampling design for large-scale surveys.

Forty-four taxa from 19 families were observed over all platforms and all gears. The ten most frequently observed species were: blue runner, *Caranx crysos*; Atlantic spadefish, *Chaetodipterus faber*; gray (mangrove) snapper, *Lutjanus griseus*; sheepshead, *Archosargus probatocephalus*; red snapper, *Lutjanus campechanus*; great barracuda, *Sphyrna barracuda*; lookdown, *Selene vomer*; the scad complex, *Decapterus* spp. and/or *Trachurus* sp.; gray triggerfish, *Balistes capriscus*; and blue angelfish, *Holacanthus bermudensis*. More taxa were observed within the confines of the platforms and in close proximity to the platforms than were observed away from the platforms. Camera orientation was important in detecting some species, e.g., groupers were only observed within the confines of the platforms. The number of taxa observed did not vary with depth or among platforms, but there were differences in fish density with depth and among platforms. More red snappers were seen at depths > 25 m, while more gray snappers were found at depths < 20 m. Total fish densities were lower at platforms with barnacles as the dominant attached fauna and higher at platforms with higher relief epifauna (octocorals, sponges and bryozoans). Red snapper densities were higher at platforms with higher relief epifauna and gray snapper densities were higher at barnacle-dominated platforms. There was no difference observed in fish density with platform age nor any relationship between platform age and attached faunal types.

INTRODUCTION

Oil and gas platforms act as *de facto* artificial reefs, are a major destination for many commercial and recreational fishermen (Hastings *et al.* 1976; Gallaway 1984; Witzig 1986; Reggio 1987; Stanley and Wilson 1988, 1989; Render and Wilson 1994; Kasprizak 1998), and contribute to available habitat for reef fishes in the northwestern and northern GOM (Gallaway and Lewbel 1982;

¹ Deceased

Gallaway 1984; Render and Wilson 1994; Kasprizak 1998). There is controversy over the effect of platforms and artificial reefs in general on reef fish populations. Do artificial reefs increase productivity or just redistribute the available resources to known locations, making them easier for capture (Stone *et al.* 1979; Bohnsack and Sutherland 1985; Bohnsack 1989; Grossman *et al.* 1997; Borotone 1998)? As this debate continues, there is a need to assess fish populations on artificial reefs and incorporate the assessment with those obtained from natural habitats for the overall management of the reef fishes in the GOM.

In late April 1995, the Southeast Area Monitoring and Assessment Program (SEAMAP) Reef Fish Work Group sponsored a workshop on oil and gas platforms in the GOM. Presentations at the workshop provided useful information regarding data needs for conducting fisheries assessments and measuring physical processes around platforms and the types of gear required to sample these platforms. Additionally, group discussions were held after the presentations to formulate recommendations for developing a sampling methodology for oil and gas platforms (SEAMAP 1995).

Specific recommendations from the SEAMAP workshop were as follows:

- 1) Separate the study area into three zones: coastal, from the shore out to 22 m; offshore, from 23 m to 80 m, and blue water, > 80 m.
- 2) Conduct acoustic sampling: including mobile shipboard acoustic passes around a platform, stationary acoustic sampling around a platform and mobile ROV acoustic passes at depth.
- 3) Sample visually: including video data collection from an ROV at set depth strata and from a four-camera array for static visuals at set depth strata.
- 4) Sample with hook and line to collect hard parts for age, growth and reproductive studies.
- 5) Sample for plankton in and around platforms.
- 6) Measure standard hydrographic parameters, including current speed and direction, light transmissivity and photosynthetically active radiation (PAR).

Currently, reef fish assessment models used for management are based on landings data from commercial and recreational fisheries. These models are calibrated using data from NMFS fisheries independent surveys, e.g., NMFS summer and fall groundfish survey by-catch data (NMFS 1999). Data from NMFS shark and snapper long-line surveys and the reef fish trap-video survey from shelf-edge banks could provide additional tuning variables. Missing, however, is fishery independent data from surveys of oil and gas platforms.

Sample allocation must be determined to develop a broad-scale survey design that effectively assesses fish populations associated with oil and gas structures in the GOM. Should there be more intense sampling of individual structures with fewer structures sampled or more structures sampled less intensively? Determination of sample allocation requires estimates of within-platform and between-platform variability. Survey development also includes selection of methods to measure fish

abundance associated with platforms. At the SEAMAP workshop's conclusion, the NMFS ML organized a pilot study to determine the effectiveness of selected workshop recommendations and to answer questions about development of a survey design to sample fishes associated with platforms.

The objectives of this pilot study were

- 1) to determine whether a small vessel can safely maneuver around and tie up to a structure and deploy the required gear for sampling,
- 2) to determine the best gear or combination of gears for sampling fishes associated with platforms, and
- 3) to obtain preliminary estimates of fish abundance and distribution by depth, location on the structure (inside vs. outside) and by platform type.

Most studies involving fish associated with oil and gas platforms in the GOM have been conducted in the northwestern Gulf, because most oil and gas platforms are located off Louisiana and Texas (Sonnier *et al.* 1976; Gallaway 1980; Gallaway and Lewbel 1982; Gallaway 1984; Putt 1984; Witzig 1986; Reggio 1987; Stanley and Wilson 1989, 1990 a and b; Render and Wilson 1994; Stanley 1994; Scarborough-Bull and Kendall 1994; Render 1995; Stanley and Wilson 1996; Gitschlag *et al.* 1997; Rooker *et al.* 1997; Kasprizak 1998; Stanley and Wilson 1998). The platforms studied for this pilot survey, conducted in August and October 1995, were located east of the Mississippi River and represent the first attempt to develop broad-scale oil and gas platform survey protocols, as well as one of the few studies of platforms in the eastern Gulf.

METHODS

Acoustic, video and fishing experiments were conducted around eight oil platforms on the Mississippi-Alabama continental shelf (MS/AL shelf) (Table 7.9 and Figure 7.19). Only the video data from this study are presented here. The platforms varied in structural complexity from a one-pile well to large multiple-pile structures. Two platforms were located in 50 – 55 m of water, four at 30 – 39 m, and two were at 20 – 29 m.

The research platform used for this pilot study was the R/V *Caretta*, a 17.7-m single screw steel hull shrimp boat. We were able to operate the various camera systems in close proximity to the platforms; however, tides, sea state, currents, and wind played a factor in the *Caretta*'s ability to tie-off and remain tied to platforms. Typically the *Caretta* was tied-off, stern-to, on the down-current side of the structure and remained so during the experiments. We were forced to move from two platforms during the course of the study due to strong tides and currents.

Water parameter data were collected using a Seabird CTD water profiler to measure depth, water temperature, salinity and light transmissivity. Currents near the substrate can re-suspend and transport sediments in the water column, thereby reducing the visibility in the layer of re-suspended sediments. This layer of the water column has been termed the nepheloid layer (Rezак *et al.* 1983; McCave 1986; Dennis and Bright 1988; Brooks 1991). Data from the transmissivity sensor was used

Table 7.9. Location, depth and date sampled, of each oil and gas platform surveyed on the MS/AL shelf during the 1995 pilot study. Platform name abbreviations: MP = Main Pass, CA = Chandeleur Area and VK = Viosca Knoll.

Platform # and name	Rig depth (m)	Latitude	Longitude	Date Sampled
1) MP-132-C	52.4	29° 23.50' N	88° 38.75' W	8/8/1995
2) MP-108-2	21.6	29° 32.71' N	88° 39.10' W	8/9,10 & 15/95
3) MP-111-well 1	28.9	29° 30.95' N	88° 39.19' W	8/16/95
4) MP-202-A	50.6	29° 29.94' N	88° 27.05' W	8/17/1995
5) CA-38-A	35.7	29° 44.07' N	88° 28.90' W	8/18/95
6) VK-203-B	36.9	29° 47.23' N	88° 20.94' W	8/18 & 19/95
7) VK-203-A	37.8	29° 46.89' N	88° 20.01' W	8/19/95
8) VK-69	31.1	29° 55.57' N	88° 28.72' W	10/26/1995

to determine the depth of the nepheloid layer. Determination of the nepheloid layer allowed efficient use of survey time and video tapes because taping was not done in the nepheloid layer.

The video gear included a Pan and Tilt camera system (P&T), a Deep Ocean Engineering² Phantom remotely operated vehicle (ROV) and a Four-Camera Array (4-C). The P&T consisted of a black and white camera mounted on a pan and tilt mechanism housed inside a 1.2 m X 1.2 m angle-iron cage. The camera had a 0.3 lux, 12.5 mm lens with a 65° viewing angle. The sides of the cage were labeled A-D, and a fin on one corner prevented spinning at depth. The ROV had a 10 lux, 9 mm lens color camera with a 56° viewing angle. The 4-C array used four, 3 lux Hi 8 mm Sony color cameras housed in Amphibico Dive Buddy III housings with a 72.5° viewing angle. The four stationary cameras were placed orthogonally to each other, providing a nearly 360° view.

Three video experiments were conducted to examine both within-platform and between-platform variability. Quadrant-at-depth was the first experiment conducted. The P&T and the 4-C array gear were used to determine fish abundance at depth. The P&T was used at the first seven platforms and the 4-C was used at the last platform sampled (Figure 7.19). The differences between the two video gears were

- 1) the 4-C array records in four directions (quadrants) simultaneously while the P&T records only one quadrant at a time by rotation of the camera;

²Mention of trade names or commercial firms does not imply endorsement by the National Marine Fisheries Service, NOAA.

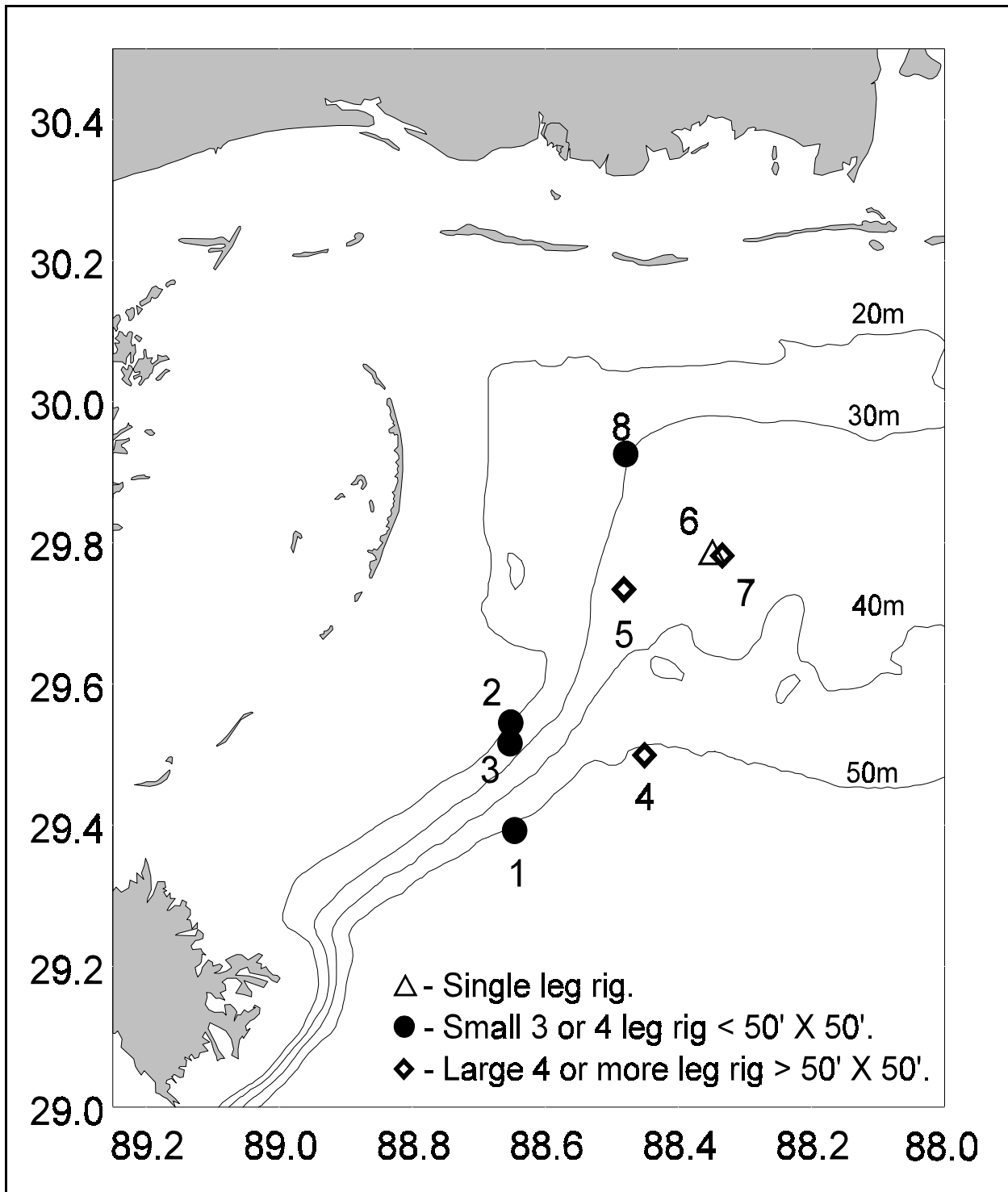

Figure 7.19. Location of eight platforms sampled on MS/AL shelf during a pilot study on fish assemblages associated with oil and gas platforms in 1995. Platform number and name were as follows: 1 (MP-132-c), 2 (MP-108-2), 3 (MP-111 well 1), 4 (MP-202-A), 5 (CA -38-A), 6(VK-203-B), 7 (VK-203-A), 8 (VK-69). Platform name abbreviations: MP = Main Pass, CA = Chandeleur Area and VK = Viosca Knoll.

- 2) the 4-C array used cameras that provided a higher quality picture; and
- 3) the P&T camera has a lower lux rating than the Hi 8 mm cameras on the 4-C array. The P&T was deployed to 6.1 m below the surface for the first sample depth.

The P&T camera recorded for 2.5 minutes in each quadrant at each depth. The camera was rotated approximately 90° before recording the next quadrant. The total time recorded for each depth was 10 minutes. The P&T cage was then lowered to the next sample depth, about 6.1 m deeper, and the process repeated until the water column was covered, or the visibility was reduced to less than 1 m. The 4-C array was the only gear deployed at platform eight (Figure 7.19) and the only platform sampled in October. The array was tied off to the *Caretta* so that one camera was pointed at the platform and could not spin during the experiment. The 4-C array sampled every 6.1 m, recording between 40 - 45 minutes per depth.

A second experiment was conducted using Aimed Video (AV) in conjunction with a Fisheries Acoustic System (FAS). The transducer for the FAS was deployed over the side of the *Caretta* opposite the side that the P&T video system was being deployed. The P&T camera was aimed to view the area that was insonified at 6.1 m intervals. The camera was generally positioned so that it was aimed to view along the side of the structure, usually between 2 – 7 m from the structure. At times, the view also included a platform leg or the edge of a leg.

In the third video experiment, the ROV was deployed and maneuvered down a platform leg. Since the ROV was maneuvered closer (0-1.5 m) to the legs and cross-members of a platform than the stationary cameras, it was stopped every 3 m to pan in and out of the platform and up and down the leg. Being this close to the leg or cross-member, the ROV camera was viewing a smaller portion of the leg at any time than the stationary video gears were. This procedure continued until the bottom of the leg or the nepheloid layer was reached. Once the ROV entered the nepheloid layer, depending upon the visibility and darkness level at depth, the external light was turned on. After viewing along one leg, the ROV was maneuvered to the next leg. ROV operations varied from platform to platform. Usually, between 27 and 43 minutes of video were collected, depending upon bottom depth, currents at depth, turbidity and complexity of the structure. We viewed between one and two legs and one and two cross-members at each platform sampled. Actual depths sampled for each platform are given in Table 7.10.

Sampling volume of each camera system was determined to estimate the density of fishes associated with oil and gas platforms. In 1994, NMFS ML scientists conducted several experiments at different depths and differing light transmissivities to determine the viewing distance of cameras (Gledhill and Lyczkowski-Shultz 1994). These experiments determined that at a transmissivity of 75% or higher, large fish (6") can be identified at least 5 m from the camera and small fishes (<6") can be identified from 3-4 m. Additionally, Rydene and Kimmel (unpublished manuscript 1994) concluded that underwater video cameras 'accurately' view for a distance of up to 5 m. A conservative estimate for the distance viewed was 5 m, and the camera's viewing angle was used to calculate the volume of the conical area sampled for each camera. The P&T camera has a viewing angle of 65°, thereby allowing it to view an estimated 53.1 m³. The cameras on the 4-C array had a 72.5° viewing angle, giving each camera an estimated 70.4 m³ of area viewed. The ROV camera had a viewing angle of

Table 7.10. Video sampling effort by depth at eight oil and gas platforms surveyed during 1995 on the MS/AL shelf. Platform name abbreviations: MP = Main Pass, CA = Chandeaur Area and VK = Viosca Knoll.

Platform # and name	Pan & Tilt depth (m)	Aimed Video depth (m)	ROV depth (m)	4-Camera depth (m)
1) MP-132-C	9.1,15.2, 24.4	-	6.1, 15.2, 24.4, 52.4	-
2) MP-108-2	3, 6.1, 9.1, 12.2, 15.2, 18.3, 21.3	4.5, 9.1, 13.7, 18.3	6.1, 9.1, 12.2, 15.2, 18.3, 21.6,	-
3) MP-111-w1	6.1, 12.2, 18.3, 24.4	6.1, 12.2, 18.3, 24.4	-	-
4) MP-202-A	6.1, 12.2, 18.3, 24.4, 30.5	6.1, 12.2, 18.3, 24.4, 30.5	6.1, 9.1, 12.2, 15.2, 18.3, 21.3, 24.4, 30.5, 33.5, 50.6	
5) CA-38-A	6.1, 12.2, 18.3, 21.3, 24.4	3, 9.1, 15.2, 21.3	3, 6.1, 9.1, 12.2, 15.2, 18.3, 21.3, 24.4, 27.4, 30.5, 35.7	-
6) VK-203-B	6.1, 12.2, 18.3, 24.4	6.1, 12.2, 18.3, 24.4	3, 6.1, 9.1, 12.2, 15.2, 18.3, 21.3, 24.4, 27.4, 30.5, 35.7, 36.9	-
7) VK-203-A	6.1, 12.2, 18.3, 24.4	6.1, 12.2, 18.3, 24.4	6.1, 9.1, 12.2, 15.2, 18.3, 21.3, 24.4, 27.4, 30.5, 35.7, 37.8	-
8) VK-69	-	-	-	6.1, 12.2, 18.3, 24.4

56°, making the volume viewed approximately 37 m³ (Table 7.11). Fish density estimates recorded on video were standardized to 100 m³ for comparing the different video gears.

Table 7.11. Sampling volume of video cameras used to survey oil and gas platforms on the MS/AL shelf, during 1995.

Video gear	Camera's Viewing Angle	Distance Viewed (m)	Volume Sampled (m³)
Pan & Tilt Camera	65	5	53.1
4 - Camera Array	72.5	5	70.4/camera
ROV	56	5	37.0

ANALYSIS

The P&T quadrant-at-depth experiment produced 10 minutes of video for each depth sampled on a platform with 2.5 minutes per quadrant. The 4-C array taped 40-45 minutes of video for each depth at platform 8, but only the first 10 minutes of video were used for analysis. Thirty 1-second randomly selected 'snapshots' were selected from the video tapes recorded at each depth from the P&T system and 4-C array, and all fish were identified to the lowest possible taxonomic level and counted. The AV experiment initially collected video footage for forty minutes at depth and later for twenty minutes at each depth. Only the first ten minutes of video for each depth at a platform were used for analyses. Data collected using the ROV were not used to obtain density estimates but were used in assemblage structure comparisons using presence/ absence of taxa. The density estimates could not be determined because the viewing volume was not consistent during ROV operations for this study. This problem was caused by parts of the platform structure (legs, cross-members, pipping, etc.) being within the volume viewed during ROV operations, thereby subtracting an unknown amount of area from the volume viewed.

RESULTS

Video data collected from the eight platforms by the P&T quadrant-at-depth, AV, and the 4-C experiments resulted in three-, four- or five-depth strata covered by each gear type. Depth strata sampled for each experiment varied with platform depth and the presence of a nepheloid layer (Table 7.10). Varying currents and tides prevented completion of some experiments at any particular platform. Additionally, stationary video data were not collected at depths within a detected nepheloid layer. The experiments using the P&T system were all conducted during August. The P&T quadrant-at-depth experiments were conducted at the first seven platforms. The AV experiment was conducted at the second through the seventh platform. The 4-C array was the only gear used at the last platform sampled, which was also the only platform sampled in October. The ROV collected data from more defined depth strata and sampled deeper than the other video gear, since it sampled

at 3 m intervals and had an external light source. The ROV was not used at platform 3 due to strong currents. CTD data were collected from the first seven platforms.

Transmissivity profiles plotted from CTD profiles at each platform indicated that nepheloid layer depth and thickness varied among platforms (Figure 7.20). An actual profile from platform number four shows a typical transmissivity trace observed during this study on the MS/AL shelf. The trace shows that from the surface to about 45 m transmissivities are greater than 80%, with a sudden drop at 47 m marking the top of the nepheloid layer (Figure 7.21). All platforms had mean transmissivities above the nepheloid layer ranging from 84% - 97% and were generally greater than 94% (Figure 7.20), while transmissivities in the nepheloid layer, when present, were more variable ranging from 35% - 86%. Thickness of the nepheloid layer ranged from approximately 1 - 12 m. The nepheloid layer at platform 2, while present, was very slight (above 75%) and not very thick (about 1 m), still providing visibility above the minimum needed for density estimates. The CTD was not available for use during the sampling of platform 8, the northern-most platform that was sampled in October. However, the video footage did not detect a discernable nepheloid layer for the entire water column.

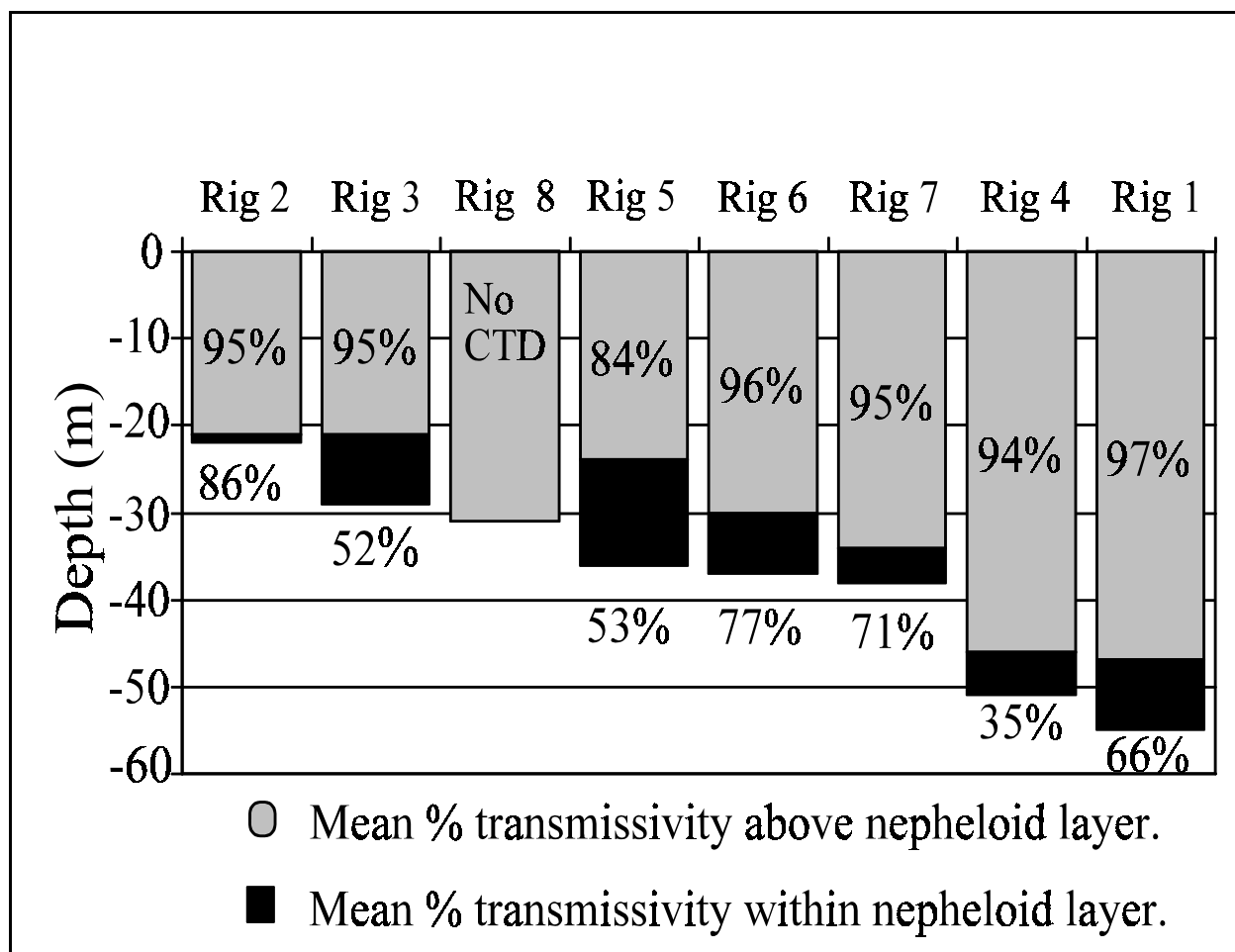

Figure 7.20. Water column transmissivity for the eight oil and gas platforms surveyed on the MS/AL shelf during 1995.

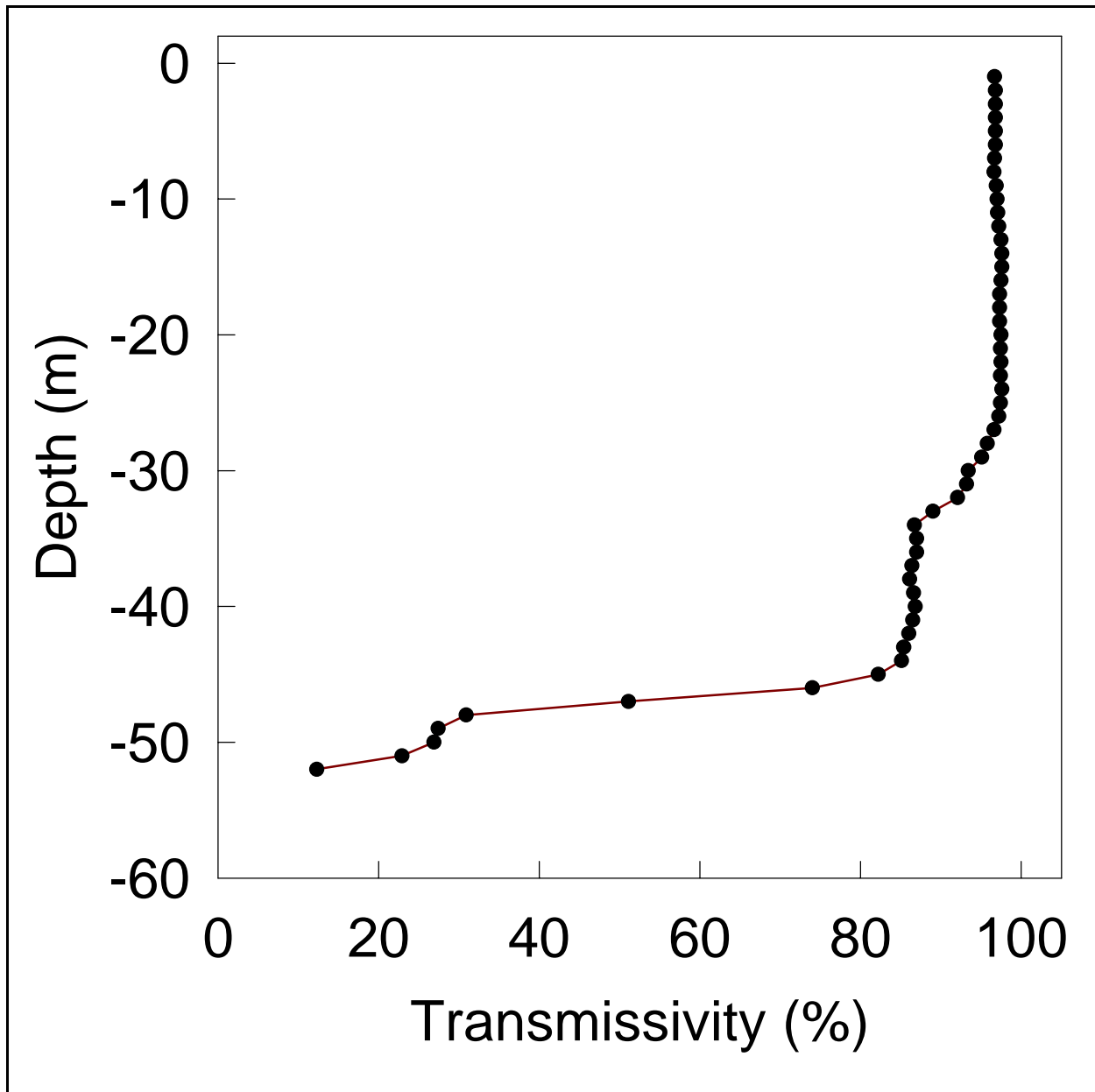

Figure 7.21. Transmissometer profile from platform 4 (MP-202-A) during a pilot study of oil and gas platforms on the MS/AL shelf in 1995.

A total of 19 families represented by 44 taxa were observed from video tapes recorded during this study (Tables 4 and 5). Observed taxa included those associated with natural reefs as well as artificial reefs such as oil and gas platforms (Sonnier *et al.* 1976; Gallaway 1980; Lukens 1981; Stanley and Wilson 1990a; Scarborough-Bull and Kendall 1994; Gitschlag *et al.* 1997; Rooker *et al.* 1997). The ten most frequently observed taxa were Atlantic spadefish, *Chaetodipterus faber*; blue runner, *Caranx crysos*; gray (mangrove) snapper, *Lutjanus griseus*; sheepshead, *Archosargus probatocephalus*; red snapper, *Lutjanus campechanus*; the scad complex, *Decapterus* spp. and/or *Trachurus* sp.; crevalle jack, *Caranx hippos*; lookdown, *Selene vomer*; great barracuda, *Sphyrna*

Table 7.12. Families observed in all video samples combined from oil and gas platform pilot study on the MS/AL shelf during 1995.

Scientific Name	Common Name
Serranidae	Groupers and Sea basses
Pomatomidae	Bluefish
Rachycentridae	Cobia
Carangidae	Jacks
Lutjanidae	Snappers
Haemulidae	Grunts
Sparidae	Porgies
Sciaenidae	Drums
Kyphosidae	Sea chubs
Ephippidae	Spadefishes
Chaetodontidae	Butterflyfishes
Pomacanthidae	Angelfishes
Pomacentridae	Damselfishes
Sphyraenidae	Barracudas
Labridae	Wrasses
Blennidae	Combtooth blennies
Acanthuridae	Surgeonfishes
Scombridae	Mackerels and Tunas
Balistidae	Triggerfishes

barracuda; and gray triggerfish, *Balistes capriscus* (Table 7.13). Six species common to all four sets of video gear were: Atlantic spadefish, blue runner, gray snapper, sheepshead, red snapper, and gray triggerfish. The ROV viewed farther into the confines of each platform and closer to the platform structure, which allowed detection of more cryptic, smaller, and more reef-associated species than any of the other video gear. More taxa (34) were observed on the video from the ROV than any other video gear (Figure 7.22). Twenty-four taxa were observed with the P&T, 14 taxa with the AV and 11 taxa with the 4-C array. The number of taxa observed inside the confines of a platform (ROV data) by depth were compared to the number seen outside (P&T, AV & 4-C data) the platform by depth. While there were more taxa observed within the platform structure, there was no relationship between the number of taxa and depth (Figure 7.23).

Density estimates for all taxa, jacks, snappers and groupers were compared from AV, P&T and the 4-C observations (Figures 7.24 and 7.25). The highest mean densities for all taxa were observed with the AV (34.8 fish/100m³) and the lowest with the 4-C (1.1 fish/100m³). The large difference in mean density between the AV and the other gears was due to the high concentrations of jacks (carangids) that schooled around the platform margins and accounted for most of the fish observed. The P&T and 4-C were viewed in all four directions while the AV observed the water column near the

Table 7.13. Percent occurrence of all taxa observed at eight oil and gas platforms with all video gears from a pilot study on the MS/AL shelf in 1995 (n = 138, where n = number of all video frames sampled from P&T, AV, 4-C and ROV).

Common Name	Scientific Name	% Occurrence	% Standard Error
Blue runner	<i>Caranx crysos</i>	60.870	4.170
Atlantic spadefish	<i>Chaetodipterus faber</i>	49.275	4.271
Gray (mangrove) snapper	<i>Lutjanus griseus</i>	43.478	4.235
Sheepshead	<i>Archosargus probatocephalus</i>	42.029	4.217
Red snapper	<i>Lutjanus campechanus</i>	20.290	3.436
Great barracuda	<i>Sphyrna barracuda</i>	18.841	3.341
Lookdown	<i>Selene vomer</i>	18.116	33.291
Scad complex	<i>Decapterus</i> spp. &/or <i>Trachurus</i> sp.	16.667	3.184
Gray triggerfish	<i>Balistes capriscus</i>	11.594	2.735
Blue angelfish	<i>Holacanthus bermudensis</i>	10.145	2.580
Sargent major	<i>Abudefduf saxatilis</i>	10.145	2.580
Crevalle jack	<i>Caranx hippos</i>	9.420	2.496
Scamp	<i>Mycteroperca phenax</i>	8.696	2.407
Blenny	Blenniidae	6.522	2.109
Damselfish	<i>Pomacentrus</i> spp.	5.072	1.875
Grouper	<i>Mycteroperca</i> spp.	4.348	1.742
Sea chub	<i>Kyphosus</i> spp.	4.348	1.742
Whitespotted soapfish	<i>Rypticus maculatus</i>	4.348	1.742
Gag	<i>Mycteroperca microlepis</i>	3.623	1.597
Bluefish	<i>Pomatomus saltatrix</i>	2.899	1.433
Reef butterflyfish	<i>Chaetodon sedentarius</i>	2.899	1.433
Cubbyu	<i>Equetus umbrosus</i>	2.899	1.433
Cobia	<i>Rachycentron canadum</i>	2.174	1.246
Blackbar drum	<i>Equetus iwamotoi</i>	2.174	1.246
Damselfishes	Pomacentridae	2.174	1.246
Wrasse	<i>Halichoeres</i> spp.	1.449	1.021
Amberjack	<i>Seriola</i> spp.	1.449	1.021
Surgeonfish	<i>Acanthurus</i> spp.	1.449	1.02
Horse-eye jack	<i>Caranx latus</i>	1.449	1.021
Bar jack	<i>Caranx ruber</i>	1.449	1.021
Spotfin butterflyfish	<i>Chaetodon ocellatus</i>	1.449	1.021
Butterflyfish	<i>Chaetodon</i> spp.	1.449	1.021
Rainbow runner	<i>Elagatis bipinnulata</i>	1.449	1.021
Molly miller	<i>Scartella cristata</i>	1.449	1.021
Spotfin hogfish	<i>Bodianus pulchellus</i>	0.725	0.725
Creole-fish	<i>Paranthias furcifer</i>	0.725	0.725
Graysby	<i>Cephalopholis cruentatus</i>	0.725	0.725
Bank butterflyfish	<i>Chaetodon aya</i>	0.725	0.725
Rock hind	<i>Epinephelus adscensionis</i>	0.725	0.725
Little tunny	<i>Euthynnus alletteratus</i>	0.725	0.725

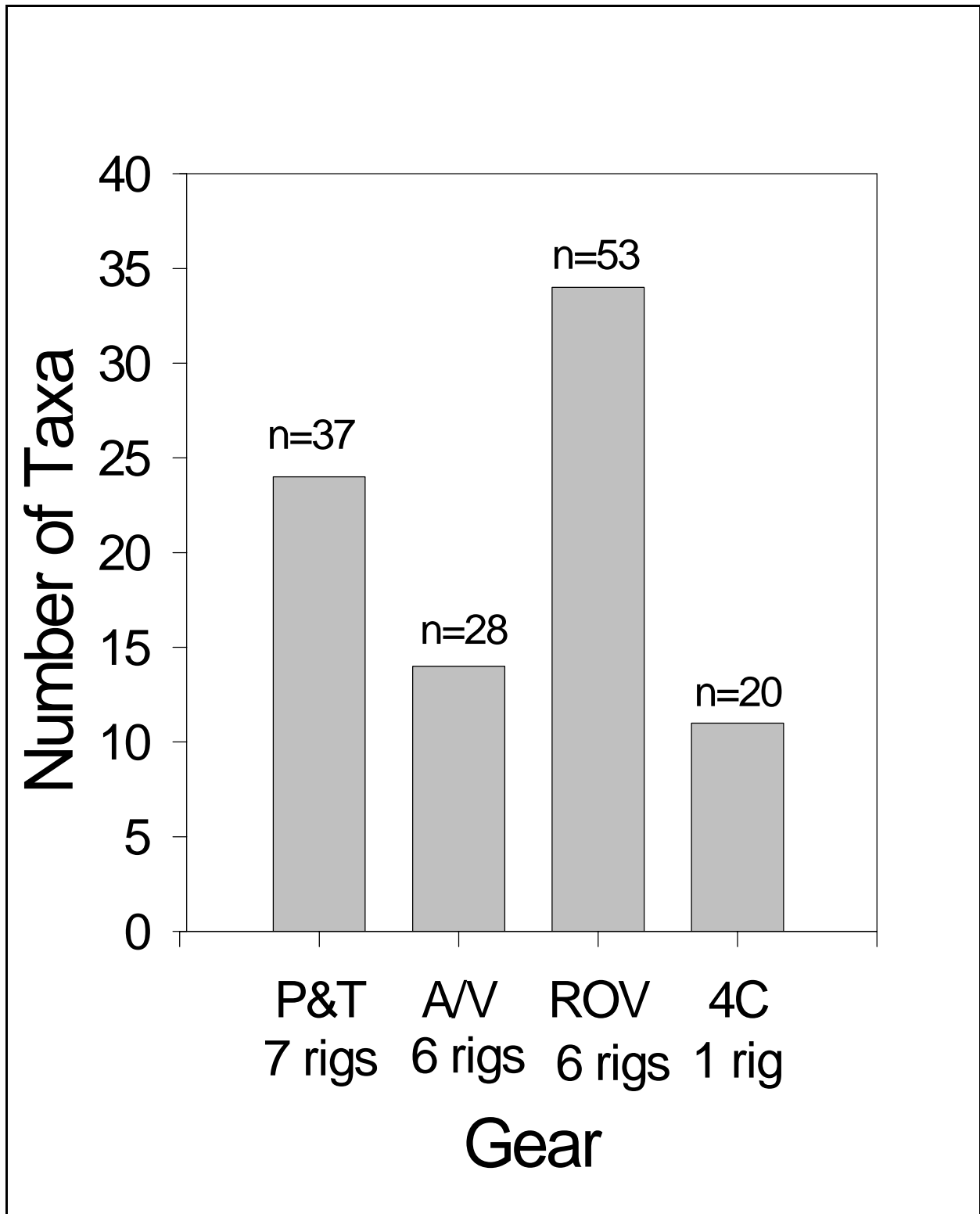

Figure 7.22. Number of taxa observed by each gear from pilot study of oil and gas platforms on the MS/AL shelf in 1995. (n = number of video samples. Number of rigs where gear was used is indicated below each gear.)

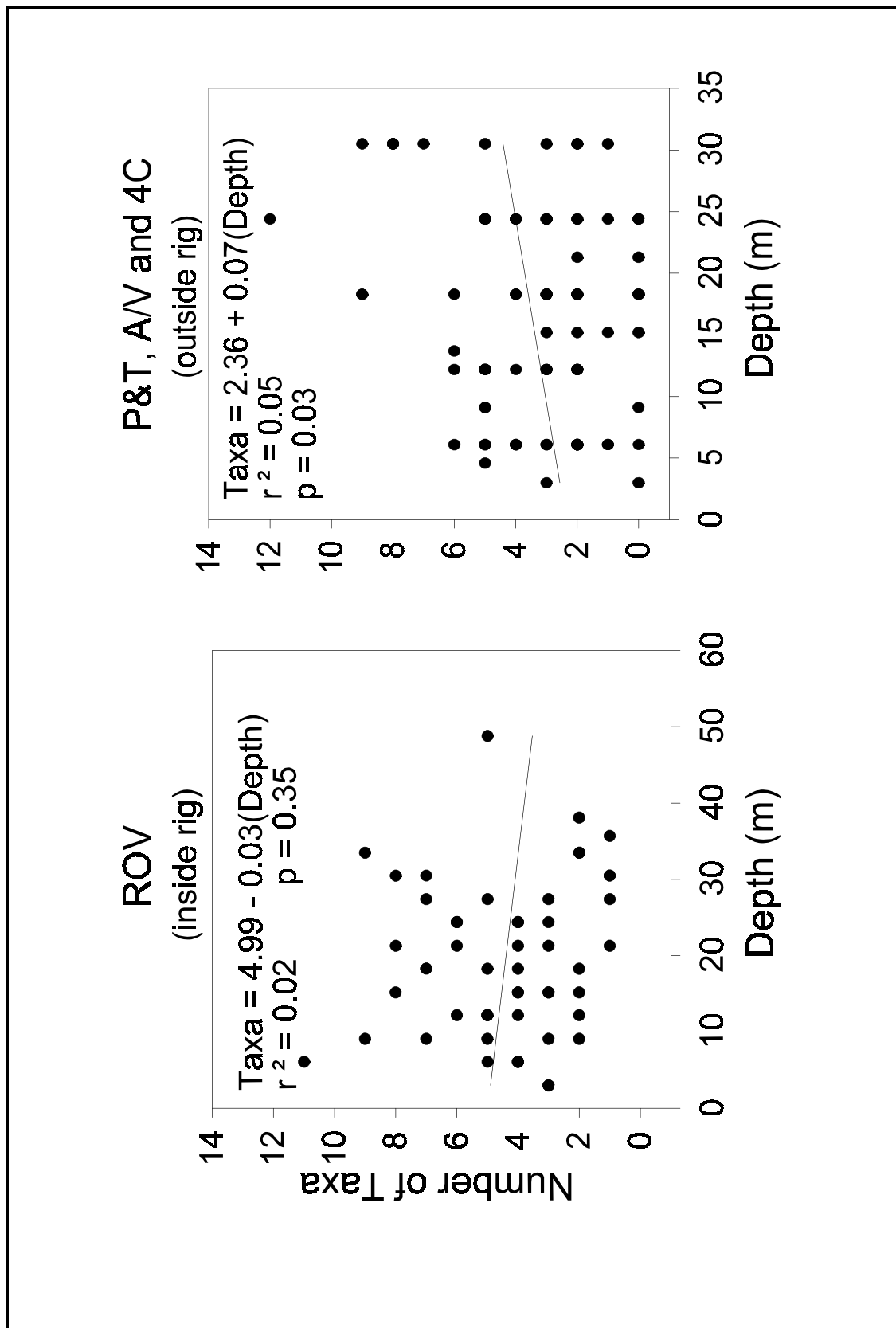

Figure 7.23. Number of taxa observed within each platform and outside each platform from pilot study of oil and gas platforms on MS/AL shelf in 1995. The drop video gears did not sample below the nepheloid layer, therefore the graph does not exceed 35 m.

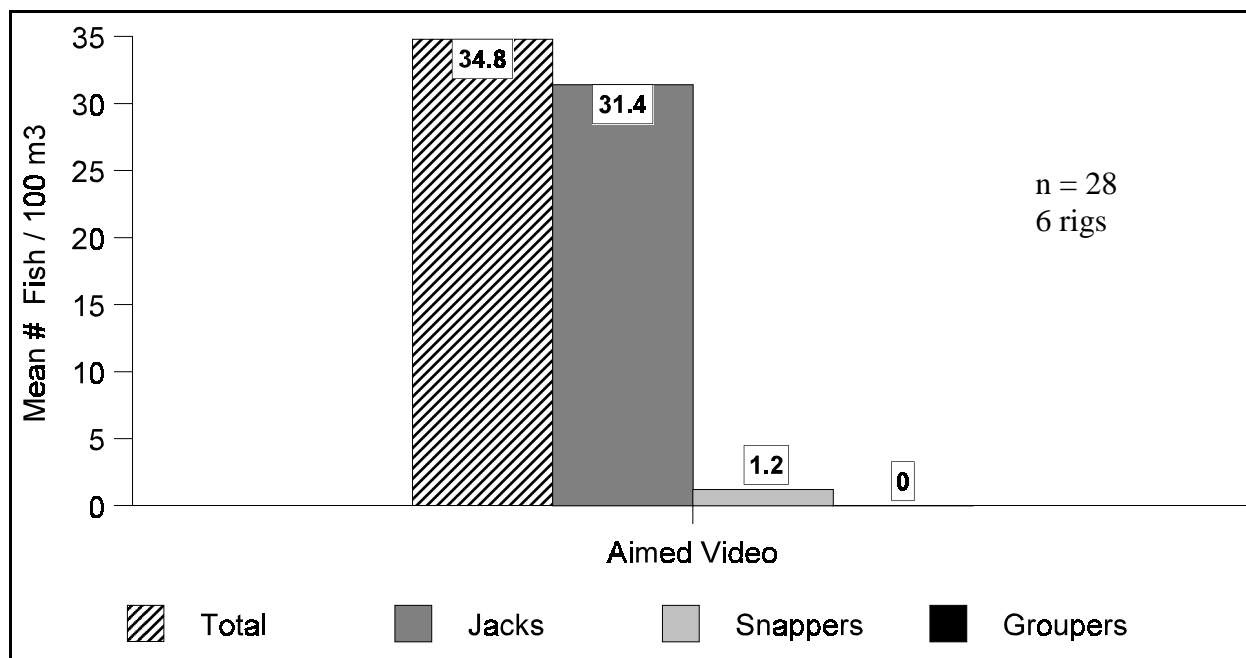

Figure 7.24. Mean density of selected taxa recorded by the Aimed Video gear during a pilot study of oil and gas platforms on the MS/AL shelf in 1995. Numbers in and above histogram are mean number of fish/100 m³ (n = number of video samples taken at the six rigs sampled with the AV).

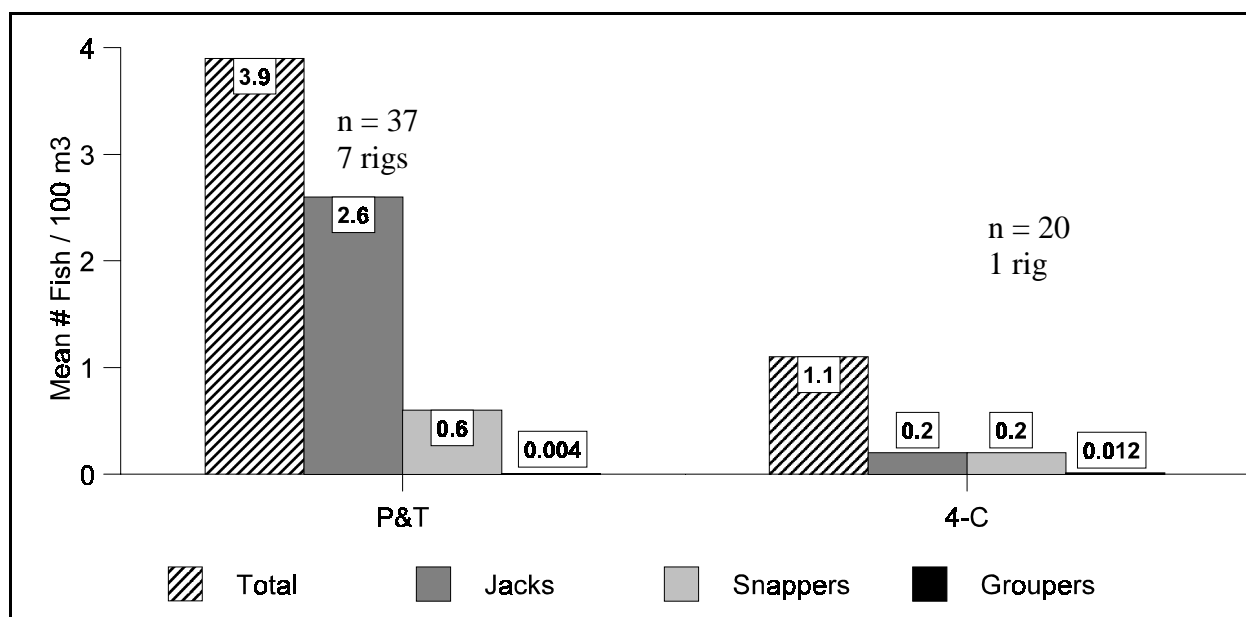

Figure 7.25. Mean density of selected taxa recorded by the Pan & Tilt and 4-Camera Array video gears during a pilot study of oil and gas platforms on the MS/AL shelf in 1995. Numbers in and above histogram are mean number of fish/100 m³ (n = number of video samples taken by each gear at the number of rigs indicated).

platform margins where the jacks were always in view. The density of snappers and groupers estimated by each video gear were similar.

Differences in total fish density were observed at different depths. There appeared to be a positive trend with depth; however, this trend was influenced by a single high density of fish observed at 30 m (Figure 7.26). Red and gray snappers also differed in depth distribution (Figures 7.27 and 7.28) on these eight platforms during this study. More red snapper were observed at depths > 25 m and typically, they were recorded on the videos at depths > 15 m. Gray snapper were observed more frequently at depths < 20 m, although they were present at all depths. Red snapper were observed to move away from the confines of the structure while gray snapper did not often range far from it.

Since differences in overall fish density among platforms were observed (Figure 7.29), the relationship between fish density and the age of the platform and between fish density and the type of fauna attached to each platform were examined. No significant differences in total fish density by gear with age of a platform were found using a two-way analysis of variance. Testing was also done for red and gray snapper, scamp, gray triggerfish, blue runner and scad with no differences found for them as well. There were differences in fish density with attached faunal type, for all taxa and some individual taxa. Attached fauna was classified into two groups using the video data: platforms with > 50% of the surface area covered by barnacles and platforms with > 50% of the surface area covered by other epifauna (octocorals, gorgonians, sponges and bryozoans). The mean density of fish was lower at platforms dominated by barnacles (Figure 7.30). Gray snapper densities were higher at platforms dominated by barnacles and red snapper densities were higher at platforms dominated by other faunal types (Figure 7.31). There was no obvious relationship from a one-way analysis of variance, testing whether faunal type varied with platform age.

DISCUSSION

Our pilot study was designed to evaluate the efficiency of various types of video gear and methodologies in assessing fish populations on oil and gas platforms. Within-platform and between-platform variability in fish assemblage composition, vertical distribution and abundance were examined to develop an optimal broad-scale survey design.

Within-platform variability was examined by three different video gears in four different configurations. The P&T and 4-C gears looked into the platform, along the margins of the platform, and away from the platform. The 4-C array viewed in all four directions simultaneously, had a greater viewing angle, and produced a higher quality image; it was, therefore, considered to be the best video gear for sampling along platform margins. The P&T and 4-C did not record images far enough into the confines of the platform to pick up cryptic and smaller species; therefore, the ROV was used to view these taxa. The AV taped only along the margins of the platforms in one direction allowing observation of fishes that occurred in close proximity to the platforms, especially those taxa that circle the platforms, such as carangids. High concentrations of fishes have been detected in close proximity to platforms using acoustical arrays (Stanley and Wilson 1990b). Survey cameras need to examine within the confines of the platform and along its margins. Although similar taxa were found at each platform, more taxa were seen inside the platform structure than outside. Our limited pilot study indicated that camera orientation was critical for accurate counts of snappers and

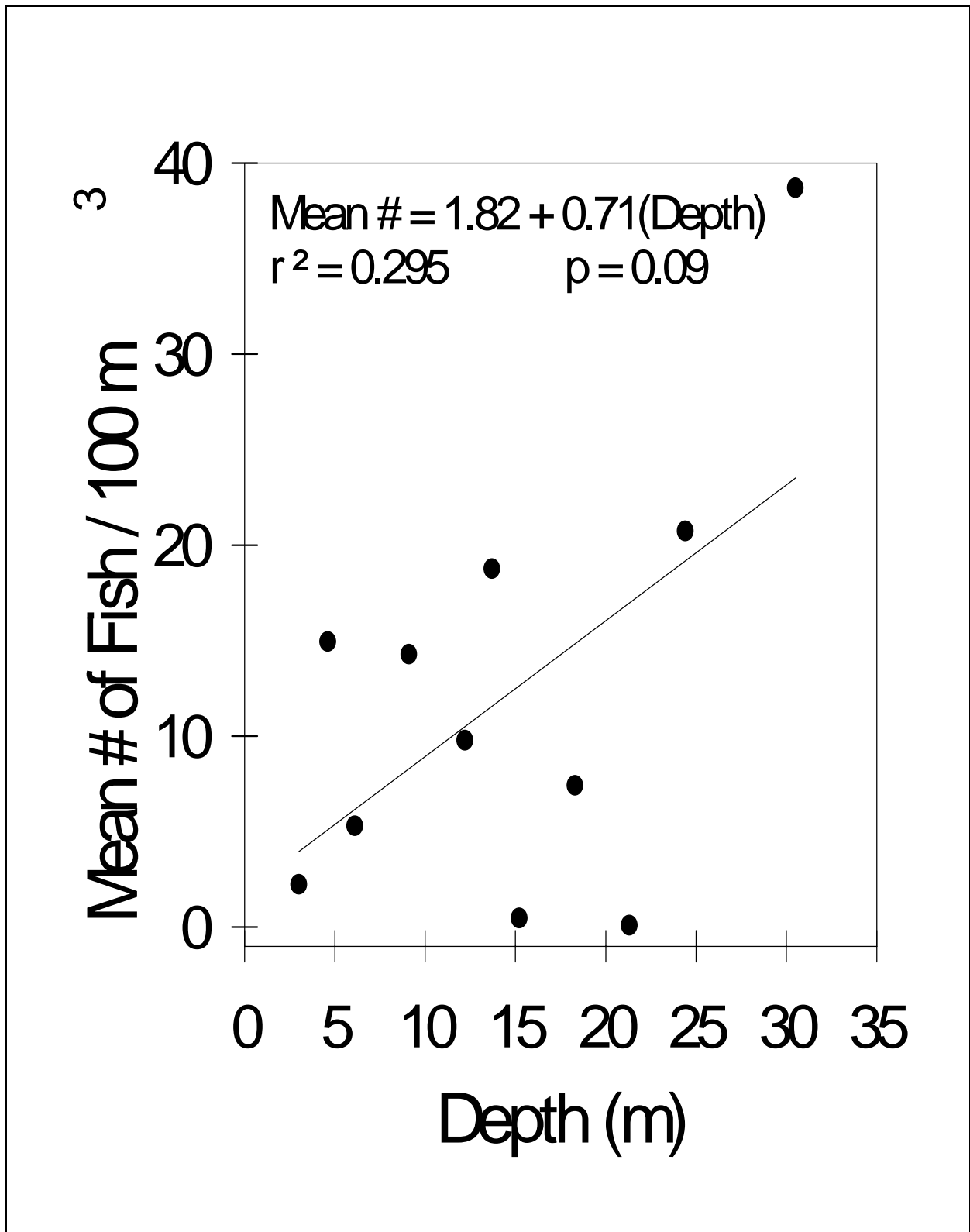

Figure 7.26. Mean density of all fish observed at each depth for P&T, AV and 4-C video gears combined, during a pilot study of oil and gas platforms on the MS/AL shelf in 1995.

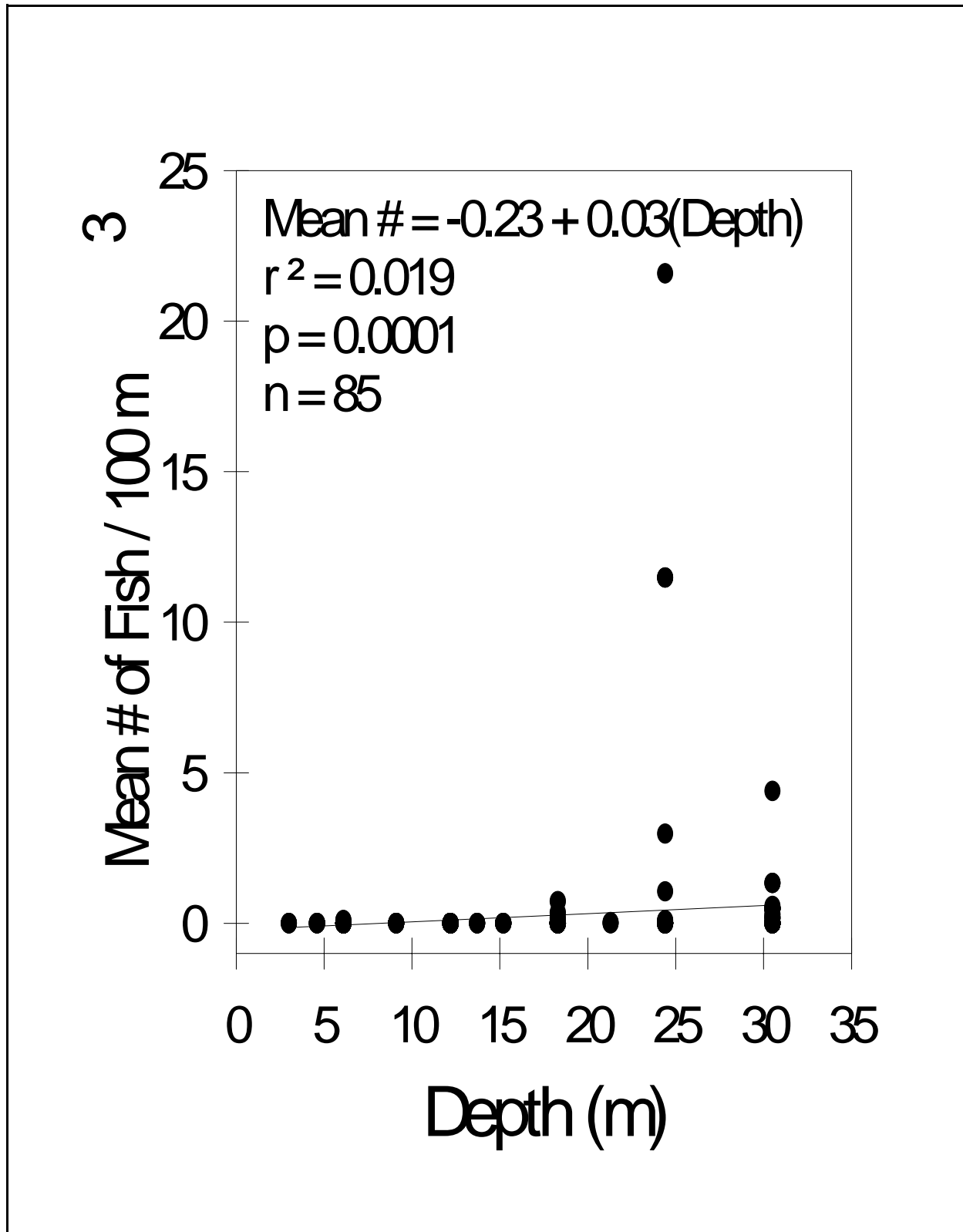

Figure 7.27. Mean density of red snapper by depth for the P&T, AV and 4-C video gears combined, during a pilot study of oil and gas platforms on the MS/AL shelf in 1995.

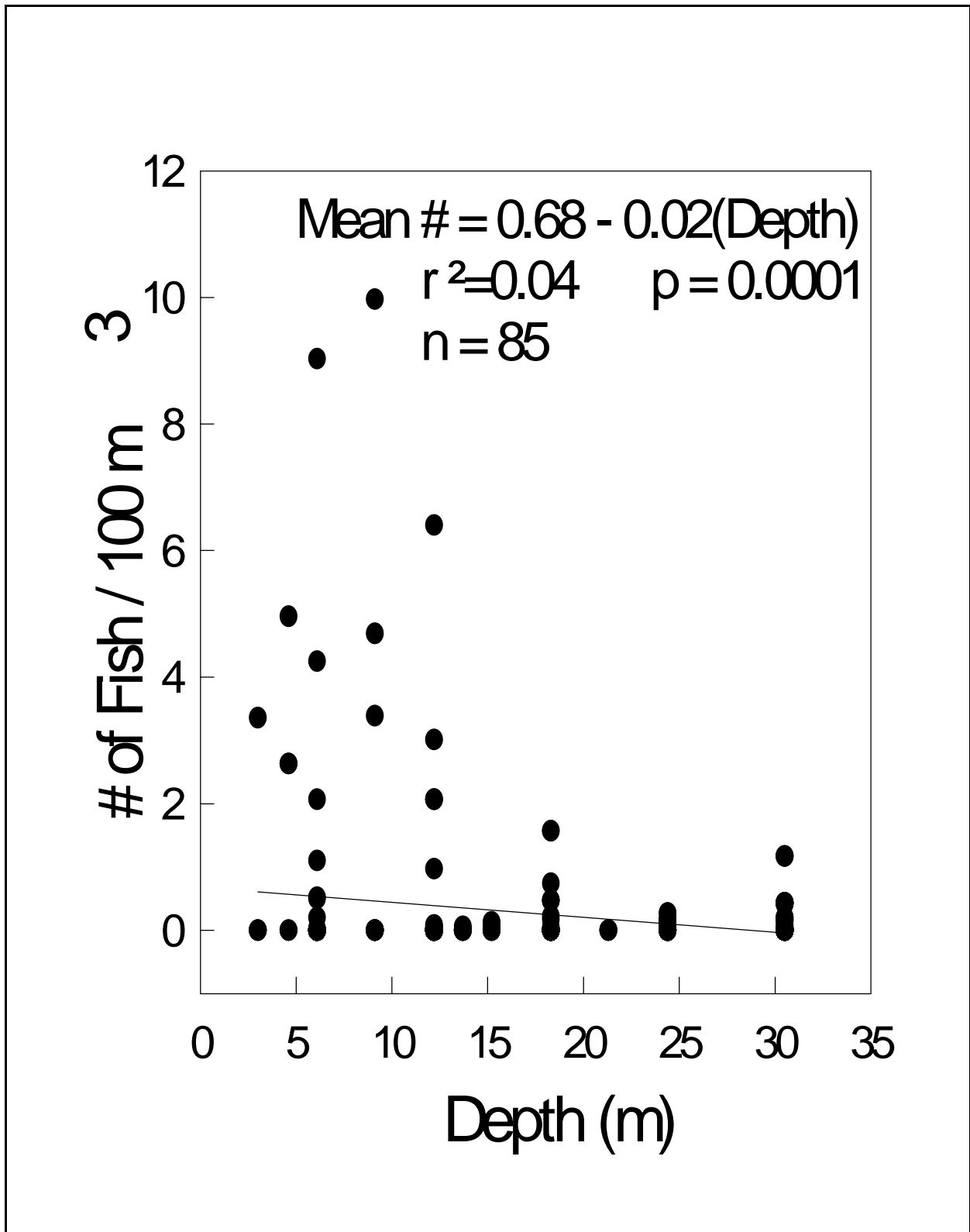

Figure 7.28. Mean density of gray snapper by depth for the P&T, AV and 4-C video gears combined, during a pilot study of oil and gas platforms on the MS/AL shelf in 1995.

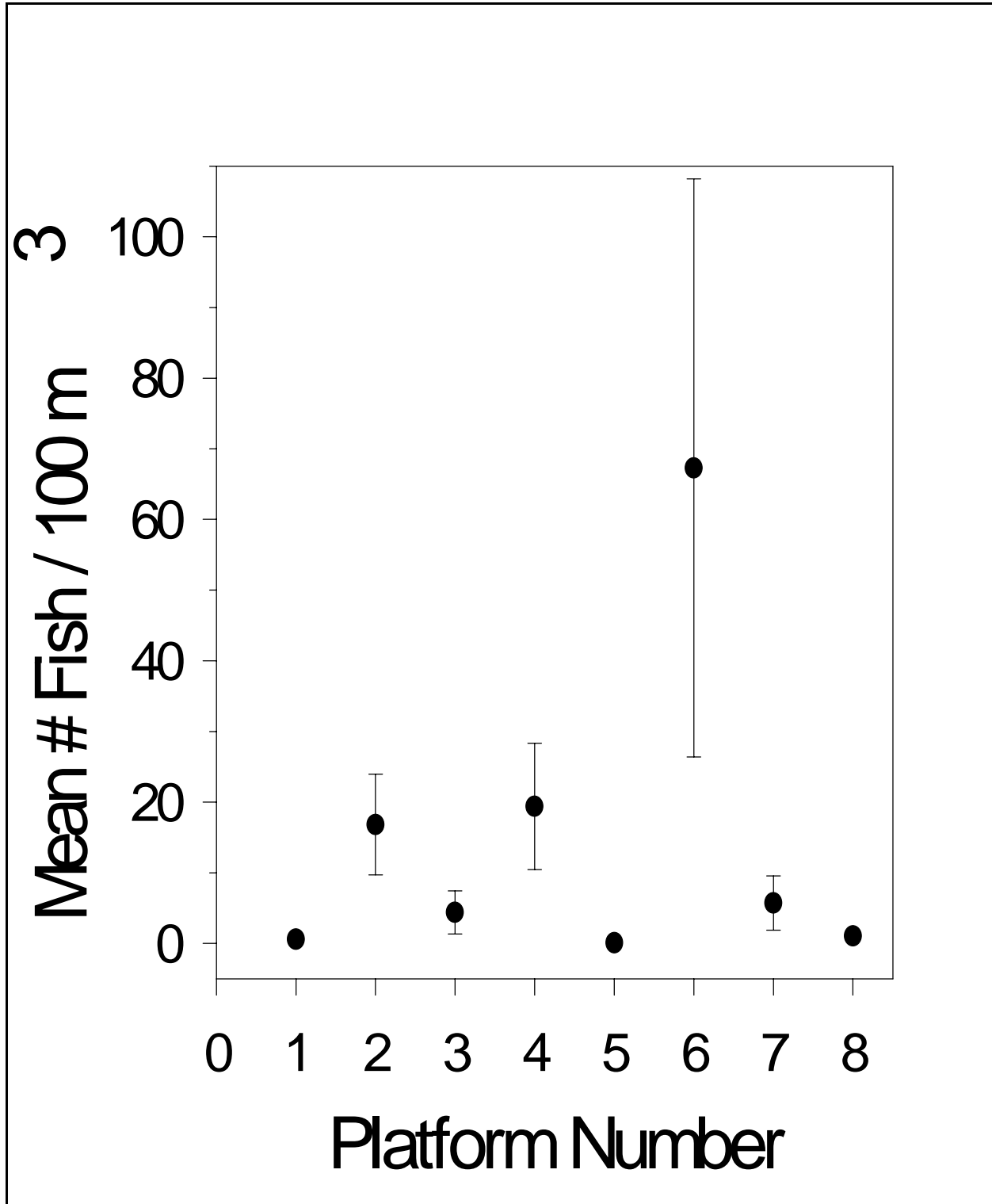

Figure 7.29. Mean number of fish per 100 m³ (+/- SE) for each oil and gas platform surveyed during a pilot study on the MS/AL shelf in 1995. Mean fish density estimates from both the P&T and 4-C video gears were combined for platforms 2 - 7. Data from only the P&T were available for platform 1 and only 4-C array for platform 8.



Figure 7.30. Mean density of total fish versus dominant attached epifauna from eight oil and gas platforms surveyed during a pilot study on the MS/AL shelf in 1995. Numbers in and above histogram are mean number of fish/100 m³.

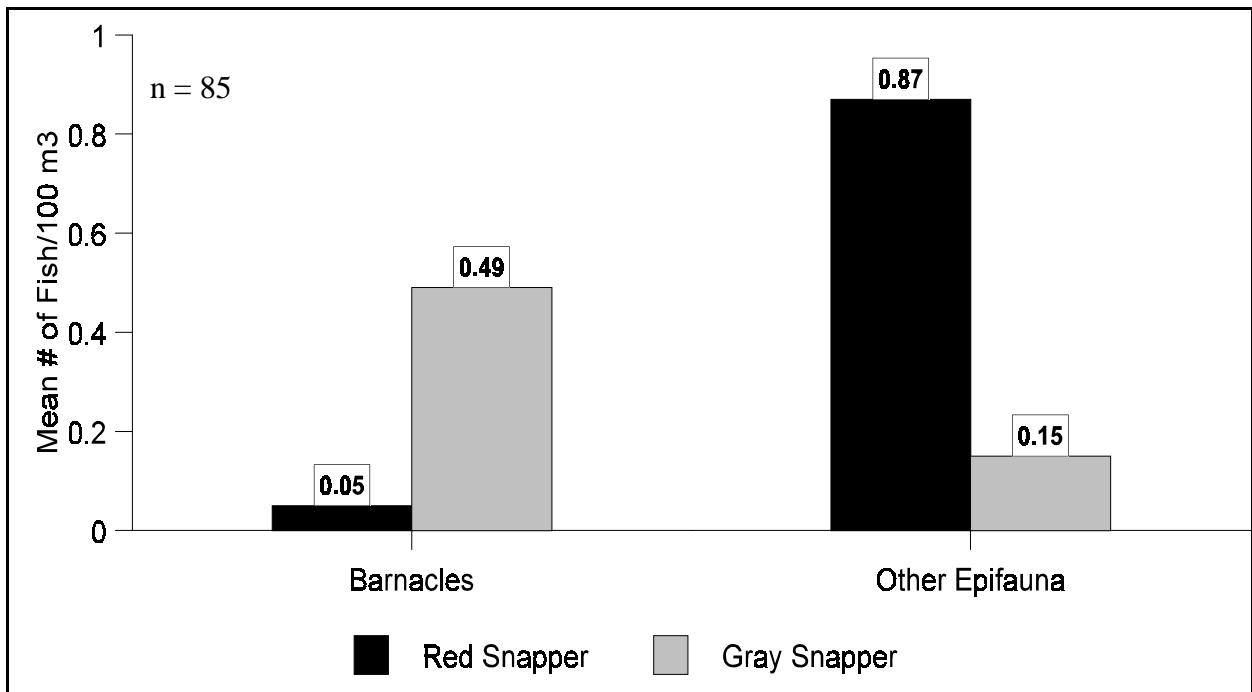

Figure 7.31. Mean densities of snappers versus dominant attached epifauna from eight oil and gas platforms surveyed during a pilot study on the MS/AL shelf in 1995. Numbers in and above histogram are mean number of fish/100 m³.

groupers. More groupers were observed within and in very close proximity to the platform than away from the platform. Few groupers were observed during our study; therefore, no broad conclusions can be made concerning their association with oil and gas platforms. More red snapper were observed outside the platforms than within, while gray snapper were observed more frequently inside the platforms than outside. No difference in the number of species present with depth was observed. Although we observed differences in the abundance of red and gray snapper with depth, we cannot make any general inferences regarding their depth distributions on all platforms in the GOM without a larger scale study. Render (1995) noted differences in the depth distributions of juvenile and adult red snapper from video observations on a single platform. Stanley and Wilson (1996), using acoustical arrays around oil and gas platforms, noted that total fish density also varied with depth. The presence of a nepheloid layer limits the ability to view fishes over the entire vertical extent of platforms and makes it difficult to draw conclusions about the depth distributions of fishes on platforms from video.

In general, all the platforms studied had similar taxa around them. The assemblages seen on these eight platforms east of the Mississippi River were similar in composition to species assemblages on oil and gas platforms west of the Mississippi River (Sonnier *et al.* 1976; Gallaway 1980; Stanley and Wilson 1990a; Gitschlag *et al.* 1997; Rooker *et al.* 1997). There were significant differences in mean fish density among platforms depending on the type of fauna attached to the platform. Total mean fish densities were lower at platforms dominated by barnacles than at platforms dominated by other epifauna. Additionally, red snapper densities were higher at platforms where the dominant fauna was higher-relief growths and gray snapper densities were higher at platforms dominated by barnacles, i.e., lower-relief growth. This difference may be due to the preferred prey items, habitat, or differences in the behavior of these two species. While both species seem to be opportunistic generalists in their feeding behavior, it appears that red snapper feed more frequently on fish than do gray snapper (Parrish 1987). Starck (1970) characterized the feeding habitat of gray snapper as being mixed low-relief bottom type and not adjacent flat areas. This is similar to the barnacle-dominated platforms seen in this survey. Red snapper are known to feed away from reef areas and platforms on the soft-bottom areas adjacent to these habitats as well as possibly off-bottom (Moseley 1966; Bradley and Bryan 1975; Gallaway 1980). Since they may feed off-bottom, red snapper may also feed on or in very close proximity to the platforms to some degree, as seen by the high catch rates of red snapper on platforms by recreational fishers (Stanley and Wilson 1990a). While there may be many possibilities that would explain these observed differences between the distribution of red and gray snapper on platforms with attached epifauna, this information needs to be known and taken into consideration for a survey design of oil and gas platforms. Just as stock assessment models use the natural history of a harvested species during analyses (NMFS 1999), the development of resource surveys needs this same understanding of the target species to provide a scientifically accurate index of abundance. Variance components for sample allocation were not adequately addressed with this limited study, but we did learn that a survey will probably not be able to take just a single 'snapshot' of a platform for assessing snappers and groupers.

The interface between the clearer surface waters and the bottom nepheloid layer as seen from video footage is dynamic, undulating at depth, potentially from subsurface currents. The thickness and mean transmissivity readings within the nepheloid layer can vary greatly, as observed from our study, even in a small geographic area and over a short time frame. These results and observations

are similar to findings from the Mississippi-Alabama Continental Shelf Ecosystem Study (Brooks 1991). Dennis and Bright (1988) stated that the bottom nepheloid layer is the most important environmental factor in determining the composition of fish assemblages and linked it to low species richness on natural hard banks in the northwestern GOM.

RECOMMENDATIONS

Additional data from platforms located both east and west of the Mississippi River and distributed across the continental shelf is required before a final survey design can be developed. Differences in fish assemblages associated with platform size, platform age, side of platform, and attached epifauna need to be better examined. Nearest neighbors (other oil platforms and shelf-edge banks) should also be considered as factors that may account for the variability in fish density among platforms. Acoustic studies indicate that estimates of total fish abundance on a platform are highly variable from month to month and seasonally (Stanley 1994; Stanley and Wilson 1996, 1998). There may also be seasonality in the presence of the nepheloid layer in this area and currents may have an effect on its presence, thickness, and density as well (Brooks 1991). Therefore, the time of year may also influence the fish assemblages observed on platforms. Another consideration in survey timing is the time when key resource species (snappers and groupers) recruit to the fishery.

Our pilot study did not adequately describe differences in fish densities inside the confines of the platform versus densities outside the platform, since the gear we used did not quantitatively sample within platform structure. We propose that densities of fish inside the platforms be estimated with the ROV, the 4-C array, and SCUBA divers in any new survey. A SCUBA census should be included in any follow-up study, since they are routinely used to sample natural and artificial reefs (Brock 1954; Hastings *et al.* 1976; Ogden and Ebersole 1981; Sale and Douglas 1981; Brock 1982; Kimmel 1985; Bohnsack and Bannerot 1986; Parker 1990; Bull and Kendall 1994; Rooker, *et al.* 2000), and since divers can get inside the structure with ease. Both point-count census and transect methods can be evaluated, and the best method for platforms can be used. However, there are limitations to SCUBA including depth, bottom time, and logistical considerations that may not make it an effective tool for a large-scale survey. Fish avoidance of divers may also be problematic (Stanley 1984) and needs to be investigated further. However, the data collected by divers is immediate. Video tapes take longer to process but can be archived for later review and confirmation of fish identifications.

A method to quantify the ROV data must be developed so that this gear can be compared to the stationary video gears or divers for density estimates in determining the best gear or combination of gears to be used for sampling. There are at least two methods for calculating volumetric densities from the ROV video. One method would hold the ROV stationary at a set depth for a period of time, imitating the stationary video gears. Submersibles have been used to conduct point-count censusing of fishes on natural hard bottoms (Shipp *et al.* 1986). The other method is a transect method. Submersibles have been used in the past to conduct transects over natural reef areas (Parker and Ross 1986) as well as oil platforms (Love *et al.* 2000). Both of these methods may be effective and necessary to calculate total densities for a platform with an ROV. Putt (1984) also suggested using ROVs in a three-dimensional sampling strategy with observations at both fixed positions and along horizontal transects at several depths on a platform. Whatever method chosen would require that the

ROV be outfitted with a pair of lasers at a known distance apart to help maintain the desired distance away from the structure and to obtain fish lengths. This adjustment would help correct the area viewed for volumetric density estimates. Fish avoidance by ROV/submersibles needs to be considered in regards to their use to examine fish abundance around platforms (Stanley 1984, Parker and Ross 1986, Shipp *et al.* 1986).

While we only presented the results of the video experiments from this small pilot study, an effective assessment of the fishes associated with oil and gas platforms will most likely involve some combination of visual, acoustic, and fishing assessment gears and techniques. A combination of gears and techniques is required due to the vertical nature of oil and gas platforms and the presence of nepheloid layers over most of the north central and northwestern GOM (Rezak *et al.* 1983). More work needs to be done with all of these gears and techniques around oil and gas structures; in addition, we need to study further ways of using the data gathered during oil and gas platform surveys in population assessment models.

ACKNOWLEDGMENTS

I would like to acknowledge the following people for their help with the pilot study and the preparation of this paper. Dr. Jeff Render designed this project but passed away before its completion. Thanks to Dr. Scott Nichols, Dr. Terry Henwood and the late Dr. Warren Stuntz for allowing me to finish this pilot survey. Additionally, thanks to Captain Drew Hopper and First Mate David Callaway for their untiring support and willingness to try new things with the R/V *Caretta*, and to Cliff Harper for piloting the ROV.

For guidance in the manuscript and presentation preparation, I am grateful to Chris Gledhill, Dr. Joanne Lyczkowski-Shultz, David Hanisko, Denice Drass and Carolyn Burks. Statistical analyses were conducted by Chris Gledhill, although I accept full responsibility for any errors. This study was funded by the NMFS ML and by MARFIN.

REFERENCES

- Bohnsack, J.A. 1989. Are high densities of fishes at artificial reefs the result of habitat limitation or behavioral preference? *Bull. Mar. Sci.* 44(2):632-645.
- Bohnsack, J.A. and D.L. Sutherland. 1985. Artificial reef research: A review with recommendations for future priorities. *Bull. Mar. Sci.* 37(1):11-39.
- Bohnsack, J.A. and S.P. Bannerot. 1986. A stationary visual census technique for quantitatively assessing community structure of coral reef fishes. NOAA Technical Report NMFS 41. 15 pp.
- Borotone, S.A. 1998. Resolving the attraction-production dilemma in artificial reef research. *Fisheries* 23(3):6-10.

- Bradley, E. and C.E. Bryan. 1975. Life history and fishery of the red snapper, *Lutjanus campechanus*, in the northwestern Gulf of Mexico: 1970-1974. Proc. Gulf Caribb. Fish. Inst. 27:77-106.
- Brock, R.E. 1982. A critique of the visual census method for assessing coral reef populations. Bull. Mar. Sci. 32(1):269-276.
- Brock, V.E. 1954. A preliminary report on a method of estimating reef fish populations. Journal of Wildlife Management 18(3):297-308.
- Brooks, J.M. ed. 1991 Mississippi-Alabama continental shelf ecosystem study: Data summary and synthesis. Vol. 2: Technical Narrative. OCS Study MMS 91-0063. U.S. Dept. Interior, MMS, GOM OCS Regional Office, New Orleans, LA. 862 pp.
- Dennis, G.D. and T.J. Bright. 1988. Reef fish assemblages on hard banks in the northwestern Gulf of Mexico. Bull. Mar. Sci. 43(2):280-307.
- Gallaway, B.J. 1980. Pelagic, reef and demersal fishers and macrocrustacean/biofouling communities. In Environmental assessment of Buccaneer gas and oil field in Northwestern Gulf of Mexico, 1975-1980, Vol. 2. W.B. Jackson and E.F. Wilkins, eds. NOAA Tech. Memo. NMFS-SEFC 48, U.S. Department of Commerce, Washington, D.C.
- Gallaway, B. J., and G.S. Lewbel. 1982. The ecology of petroleum platforms in the northwestern Gulf of Mexico: A community profile. FWS 10BS-82/87. U.S. Fish and Wildlife Service, Division of Biology Services, Washington, D.C.
- Gallaway, B.J. 1984. Assessment of platform effects on snapper populations and fisheries. In Proceedings of the 5th Annual Gulf of Mexico Information Transfer meeting. Minerals Management Service. U.S. Department of the Interior, New Orleans, LA. p. 130-137.
- Gitschlag, G. R., B.A. Herczeg and T.R. Barcak. 1997. Observations of sea turtles and other marine life at the explosive removal of offshore oil and gas structures in the Gulf of Mexico. Gulf Research Reports 9(4):247-262.
- Gledhill, C.T. and J. Lyczkowski-Shultz. 1994. Final report to MARFIN: integration of video, acoustic and larval index methods to assess reef fish populations. NOAA/NMFS MS Laboratories, Pascagoula, MS 39567. 70 p.
- Grossman, G.D., G.P. Jones and W.J. Seaman, Jr. 1997. Do artificial reefs increase regional fish production? A review of existing data. Fisheries 22(4):17-23.
- Hastings, R. W., L.H. Ogren and M.T. Mabry. 1976. Observations on the fish fauna associated with offshore platforms in the northeastern Gulf of Mexico. Fish. Bull. 74(2):387-402.

- Kimmel, J.J. 1985. A new species–time method for visual assessment of fishes and its comparison with established methods. *Env. Bio. Fish.* 12(1):23–32.
- Kasprizak, R.A. 1998. Use of oil and gas platforms as habitat in Louisiana’s artificial reef program. *Gulf of Mexico Science* 16(1):37-45.
- Love, M.S., J.E. Casselle, and L. Snook. 2000. Fish assemblages around seven oil platforms in the Santa Barbara Channel area. *Fish. Bull.* 98:96-117.
- Lukens, R.R. 1981. Ichthyofaunal colonization of a new artificial reef in the northern Gulf of Mexico. *Gulf Research Reports.* 7:41-46.
- McCave, I.N. 1986. Local and global aspects of the bottom nepheloid layers in the world ocean. *Netherlands Journal of Sea Research.* 20(2/3):167-181.
- Mosely, F.N. 1966. Biology of the red snapper, *Lutjanus aya*, Bloch, of the northwestern Gulf of Mexico. *Publ. Inst. Mar. Sci. Univ. Texas.* 11:90-101.
- NMFS. 1999. Our living oceans. Report on the status of U.S. living marine resources, 1999. U.S. Department of Commerce, NOAA Technical Memorandum NMFS-F/SPO-41, 301 p.
- Ogden, J.C. and J.P. Ebersole. 1981. Scale and community structure of coral reef fishes: A long-term study of a large artificial reef. *Mar. Ecol. Prog. Ser.* 4:97-103.
- Parker, R.O., Jr. and S.W. Ross. 1986. Observing reef fishes from submersibles off North Carolina. *Northeast Gulf Science* 8(1):31-49.
- Parker, R.O. Jr. 1990. Tagging studies and diver observations of fish populations on live-bottom reefs of the U.S. southeastern coast. *Bull. Mar. Sci.* 46(3):749-760.
- Parrish, J.D. 1987. The trophic biology of snappers and groupers. *In* Polvina, J.J. and S. Raston. eds. *Tropical snappers and groupers: Biology and fisheries management.* p. 405-463.
- Putt, R.E. 1984. Comparison of fish communities associated with natural hard-bottom areas and offshore oil and gas structures. *In* Proceedings of the 4th Annual Gulf of Mexico Information Transfer meeting. Minerals Management Service. U.S. Department of the Interior, New Orleans, LA. p. 121-124.
- Reggio, V.C. Jr. 1987. Rigs-to-reefs: The use of obsolete petroleum structures as artificial reefs. OCS Report MMS87-0015, U.S. Dept. Int., Minerals Management Service, Gulf of Mexico OCS Region, New Orleans. 17 p.
- Render, J.H. and C.A. Wilson. 1994. Hook-and-line mortality of caught and released red snapper around oil and gas platform structural habitat. *Bull. Mar. Sci.* 55(2-3):1106–1111.

- Render, J.H. 1995. The life history (age, growth and reproduction) of red snapper (*Lutjanus campechanus*) and its affinity for oil and gas platforms. Doctoral dissertation, Louisiana State University, Baton Rouge.
- Rezak, R., T.J. Bright and D.W. McGrail. 1983. Reefs and banks of the northwestern Gulf of Mexico: Their geological, biological, and physical dynamics. Northern Gulf of Mexico Topographic Features Monitoring and Data Synthesis. Contract # AA851-CT1-55. Final Report to U.S. Dept. of Interior, MMS, OCS. New Orleans, LA. 501 pp.
- Rooker, J. R., Q.R. Dokken, C.V. Pattengill and G.J. Holt. 1997. Fish assemblages on artificial and natural reefs in the Flower Garden Banks National Marine Sanctuary, USA. *Coral Reefs* 16:83-92.
- Rydene and Kimmel. 1994. A comparison of video and visual reef-fish censusing techniques at Dry Tortugas National Park, Florida. Florida Dept. of Env. Protection, FMRI, St. Petersburg, FL 33701. 15 p.
- SEAMAP. 1995. Proceedings of the reef fish workshop for SEAMAP. Gulf States Marine Fisheries Commission, Ocean Springs, MS. 76 p.
- Shipp, R. L., W.A. Tyler III and R.S. Jones. 1986. Point count censusing from a submersible to estimate reef fish abundance over large areas. *Northeast Gulf Science* 8(1):83-89.
- Sonnier, F., J. Teerling and H.D. Hoese. 1976. Observations on the offshore reef and platform fish fauna of Louisiana. *Copeia* 1:105-111.
- Sale, P.F. and W.A. Douglas. 1981. Precision and accuracy of visual census technique for fish assemblages on coral patch reefs. *Env. Biol. Fish* 6(3/4):333-339.
- Stanley, D.R. and C.A. Wilson. 1989. Utilization of offshore platforms by recreational fishermen and SCUBA divers off the Louisiana coast. *Bull. Mar. Sci.* 44:767-775.
- Stanley, D.R. and C.A. Wilson. 1990a. A fishery-dependant based study of fish species composition and associated catch rates around oil and gas structures off Louisiana. *Fish. Bull.* 88:719-730.
- Stanley, D.R. and C.A. Wilson. 1990b. Factors affecting the abundance of selected fishes near oil and gas platforms in the northern Gulf of Mexico. *Fish. Bull.* 89:149-159.
- Stanley, D.R. 1994. Seasonal and spatial abundance and size distribution of fishes associated with a petroleum platform in the northern Gulf of Mexico. Doctoral dissertation, Louisiana State University, Baton Rouge.
- Stanley, D.R. and C.A. Wilson. 1996. Abundance of fishes associated with a petroleum platform as measured with dual-beam hydroacoustics. *ICES Journal of Mar. Sci.* 53:473-475.

- Stanley, D.R. and C.A. Wilson. 1998. Spatial variation in fish density at three petroleum platforms as measured with dual-beam hydroacoustics. *Gulf of Mexico Science* 16(1):73-82.
- Starck, W.A. II. 1971. Biology of the gray snapper, *Lutjanus griseus* (Linnaeus), in the Florida Keys. In W.A. Starck, II and R.E. Schroeder, eds. Investigations on the gray snapper, *Lutjanus griseus*, p. 1-150. *Stud. Trop. Oceanogr.* (Miami) 10.
- Witzig, J. 1986. Fishing in the Gulf of Mexico 1984: Marine recreational fishing results. In Proceedings, Sixth Annual Gulf of Mexico Information Transfer Meeting. p. 103-105. OCS Study/MMS86-0073, U.S. Dept. Int., Minerals Management Service, Gulf of Mexico OCS Region, New Orleans.

SEASONAL AND SPATIAL VARIATION IN THE BIOMASS AND SIZE FREQUENCY DISTRIBUTION OF FISH ASSOCIATED WITH OIL AND GAS PLATFORMS IN THE NORTHERN GULF OF MEXICO

David R. Stanley
BEAK International

Charles A. Wilson
Coastal Fisheries Institute
Center for Coastal, Energy and Environmental Resources
Louisiana State University

INTRODUCTION

Since the first petroleum platform was placed off the Louisiana coast in 1948, the largest artificial reef complex in the world was started. To date, approximately 4,000 petroleum platforms are scattered across the outer continental shelf of the northern Gulf of Mexico (GOM), with the vast majority off the coasts of Louisiana and Texas. It is hypothesized that artificial reefs and platforms improve and/or diversify habitat, increase resources, modify the assemblages of organisms in the region or concentrate existing resources. The placement of these defacto reefs has undoubtedly impacted the regional marine community although little information is available. Only recently have assessment methods been developed to test these and other hypotheses concerning artificial reefs.

Scientific investigations of fish assemblages at petroleum platforms did not start until the mid 1970s. They consisted of visual surveys conducted by SCUBA divers, remotely operated underwater vehicles (ROV) and stationary cameras; the majority of these projects were short term, often only “snapshots” of the fishes at each site (Shinn 1974, Sonnier *et al.* 1976; Gallaway *et al.* 1981; Continental Shelf Associates 1982; Gallaway and Lewbel 1982; Putt 1982). The results of this early research provided insights into structure-associated assemblages including variations in abundance and species composition with platform, water depth, and time of the year. However, results have been difficult to compare because of problems with limited visibility, gear bias, diver avoidance, and a lack of standardized survey methodology. Although visual surveys are the method of choice to survey natural and artificial reefs (Bortone and Kimmel 1991), the presence of SCUBA divers can bias the density and possibly species composition of fishes at the site (Sale and Douglas 1981; Brock 1982; Bohnsack and Bannerot 1986; Stanley and Wilson 1995).

In response to the difficulty in assessing the fisheries resources associated with petroleum platforms and the biases inherent in visual surveys, Gerlotto *et al.* (1989) demonstrated that towed hydroacoustics could be used to measure fish density near petroleum platforms off Cameroon. We later utilized complimentary sampling methods of visual surveys and quantitative dual beam hydroacoustic surveys to document the assemblage of fishes associated with petroleum platforms in the northern GOM (Wilson and Stanley 1991; Stanley and Wilson 1995, 1996, 1997, 2000).

Despite the range of methodologies, investigators found that fish abundance and species composition change dramatically with proximity to platform, location, and time of year (Sonnier 1976; Continental Shelf Associates 1982; Gallaway and Lewbel 1982; Putt 1982; Stanley and Wilson 1996; 1997). Gerlotto *et al.* (1989) found that fish densities were 5 to 50 times higher immediately adjacent to a platform than 50 m away. Stanley and Wilson (1996, 1997, 2000) reported the near field area of influence of a platform on the continental shelf to be 16-20 m away from the platform. Fish densities within 20 m of a platform were 3 to 60 times higher than at greater distances and densities observed at distances greater than 50 m were comparable to background levels of the open waters of the northern GOM (Stanley and Wilson 1996, 1997, 2000). Long-term studies reported that fish populations at petroleum platforms were highly variable over time. Putt (1982) observed fluctuations of a factor of two from month to month in density, while Stanley and Wilson (1996, 1997, 2000) reported that monthly and seasonal abundances change by up to a factor of five.

Based on these previous research efforts, we know that significant numbers of fishes are found at these sites, although they do not exhibit a large species diversity and do not appear to have a high site fidelity. Since many of the common species at platforms are highly sought after by commercial and recreational users and a large number of platforms exist in the region, it is hypothesized that platforms have considerable importance to regional fisheries. Despite this hypothesis of the importance of platforms on the regional fish assemblages, quantifiable censuses of fish assemblages were not possible until the combined use of dual beam hydroacoustics to enumerate the fishes at these sites and visual surveys with a remotely-operated underwater vehicle (ROV) to determine species composition were applied. While the results from previous research provided insights into the species composition and abundance at platforms, the results were not comparable nor were they quantifiable. To measure the impact of the presence of platforms on the fisheries resources a standardized quantifiable methodology must be used.

The specific objectives of this research were to

- 1) Measure and compare the species composition, biomass and size frequency distribution of fish associated with three petroleum structures.
- 2) Determine the effect of temporal, physical and chemical variables on species composition, biomass and size distribution of fish associated with platforms.
- 3) Define the spatial near field influence of each platform on the abundance of fish.

METHODS

Site Descriptions

Research trips were conducted quarterly (August 1994 to April 1997) to petroleum platforms Grand Isle 94 (GI94) (located at 28°31.33 N and 90°05.52 W, water depth 60 m, installed 1975, operated by Mobil USA Inc.) and Green Canyon 18 (GC18) (located 27°56.48' N and 91°02.28' W, water depth 219 m, installed in 1988, operated by Mobil USA Inc.) and quarterly (August 1995 and April 1997) to South Timbalier 54 G (ST54) (located 28°50.01' N and 90°22.40' W, water depth 22m,

installed 1956, operated by Exxon USA Inc.). The platforms were selected to approximate a transect extending from the central portion off coastal Louisiana to a distance of 179 km.. Extraction and production of natural gas and crude oil occurred at each site during research trips. Three research trips were not completed during the project: the spring 1995 surveys to GC18 and GI94 and the fall 1996 survey to ST54.

Three arrays of stationary dual beam hydroacoustic equipment developed through our past research were used to determine the density of fishes associated with the study sites (Wilson and Stanley 1991; Stanley and Wilson 1995, 1996, 1997, 1998, 2000). Arrays 1 and 2 (Figure 7.32) were designed to measure *in situ* target strength distribution and density of fishes immediately adjacent to each side of the platform. Array 1 consisted of four upward-oriented transducers (120 kHz) suspended approximately 25 m below the surface (at ST 54 they were placed on the bottom), one on each side of the platform. The upward-facing transducers provided acoustic coverage from the a depth of 10-15 m to the surface (Figure 7.32). Array 2 consisted of four downward-oriented transducers (120 kHz) placed approximately 3 m below the surface, one on each side of the platform. The downward-facing transducers provided acoustic coverage from a depth of 10 m to within 1-5 m of the substrate depending on the site. The use of four transducers (both upward and downward orientations) enables the calculation of density throughout the water column on all sides of the platform.

Array 3 was designed to estimate the near-field density of fishes associated with the structure and consisted of four horizontally aligned dual beam transducers (120 kHz) deployed off each side of the platform at depth of 12 m (Figure 7.33). This arrangement enables relative fish density estimates to a distance of approximately 80 m from the platform and determination of the near-field area of influence of each site.

Total fish abundance estimates at each site were calculated by determining the near-field area of influence of the platform, then multiplying mean density values for sample and platform side in number of fish/m³ by the volume of water on each side of the platform. Fish density in the center of the platform was calculated by averaging the density estimates of the four sides of the platform. Fish abundance in the center of the platform was calculated by multiplying the estimated fish density at the center by the volume of water in the center of the platform. After estimates of the number of fish were made on each side and center of the structure by strata, these estimates were summed to calculate the total number of fishes at a site.

Horizontal and vertical acoustic samplings were conducted over three consecutive 24-hour intervals for each month's sampling trip; two hours of hydroacoustic data were collected encompassing four periods (dawn, noon, dusk and midnight) over each 24-hour interval. Hydroacoustic data were collected sequentially from each of the transducers in five-minute intervals for each trip.

Acoustic data were collected using a Biosonics model ES2000 scientific echosounder/multiplexer-equalizer. The source levels ranged from 218.5 to 220.5 dB re μ Pa at 1 m depending on the transducer. The 20 log R system gains ranged from -156.4 to -146.8 dB re V μ Pa and the 40-log R system gains ranged from -168.9 to -165.8 dB re V μ Pa varying with transducer. Sampling rate ranged from 2 pings s⁻¹ to 10 pings s⁻¹ depending on array and sampling depth. Pulse width was

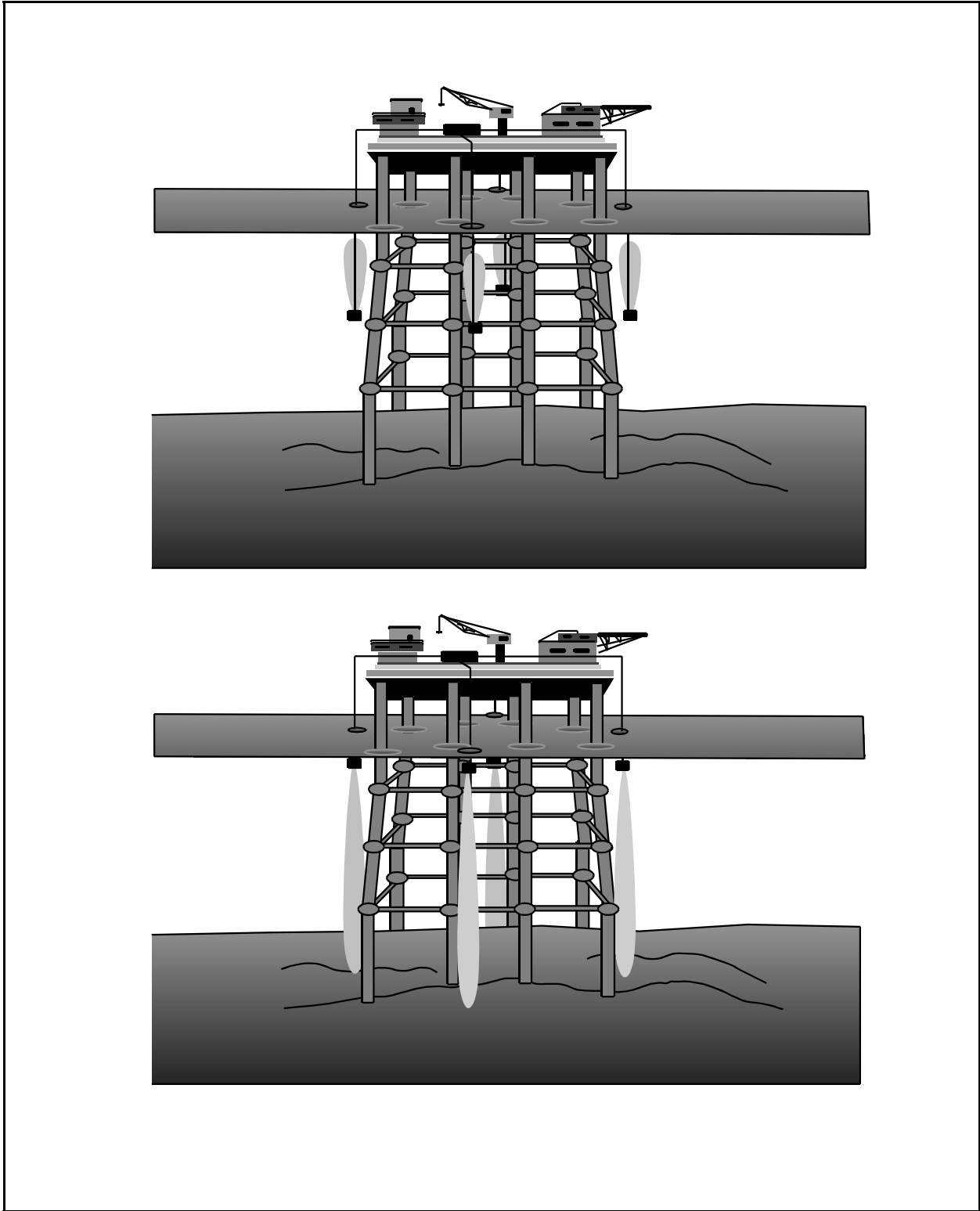

Figure 7.32. Schematic view of stationary hydroacoustic transducer deployment to measure *in situ* target strength and density of fishes throughout the water column on each side of the platform for the three study sites.

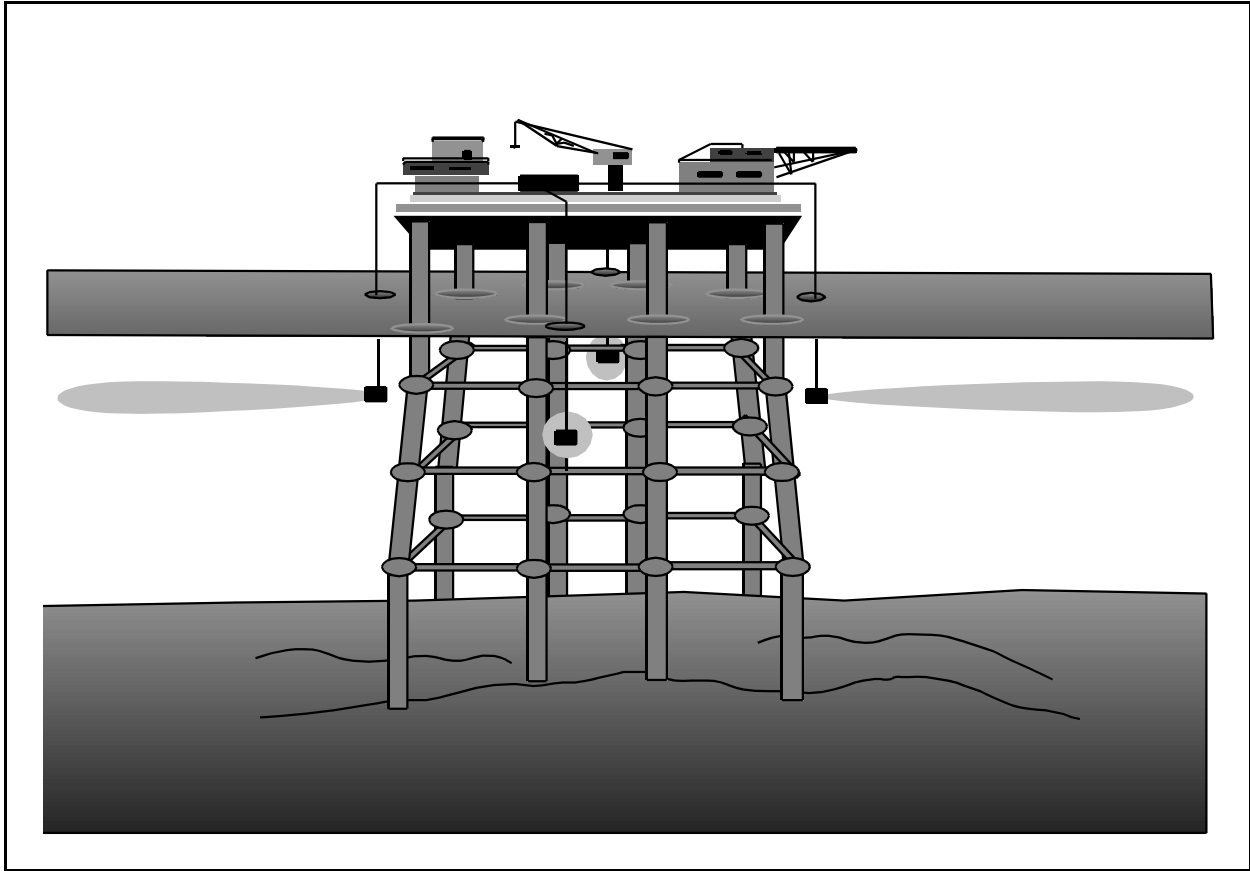

Figure 7.33. Schematic view of stationary hydroacoustic transducer deployment to measure horizontal relative density of fishes associated with petroleum platforms.

0.4 ms. Received signals were adjusted for spreading loss by applying a $40 \log R$ time varied gain, digitized and recorded on digital audio tape (DAT). Reference voltages (approximately 5 V AC) were recorded on each DAT tape and used to calibrate the acoustic system prior to echo integration and target strength analyses. During data collection, background noise levels were measured and did not exceed 40 mV. The voltage threshold used in later analyses was 100 mV corresponding to a minimum detectable target strength of -56 dB, or a fish of 2.5 cm total length according to Love (1971).

Digitized hydroacoustic data were processed by a Biosonics model 281 dual-beam processor. Target strengths and an average backscattering cross section (σ) for each depth strata were estimated using Biosonics TS software, and density estimates were calculated using Biosonics Crunch software with σ for each sample and depth strata. Fish densities were calculated for 5 to 20 m depth vertical intervals for Array 1 and 2 depending on site.

Visual point count surveys were performed on each sampling expedition on the downcurrent side of the platform using a Hydrobotics Orpheus, Benthos MiniRover, or Deep Ocean Engineering HD2 ROV. Visual surveys were performed on nektonic fishes freely swimming within the area of influence of the platform. Cryptic fishes were not included in the visual surveys since they could not

be assessed in the acoustic surveys. Visual surveys done with ROVs were recorded on videocassette and the point counts performed later identifying individual fish to the lowest taxonomic level. Estimates of percent species composition for each strata corresponding to the acoustic strata were calculated from the visual point counts. To estimate the number of fishes by species at each site by depth strata, the percent species composition data was applied to the quantitative acoustic estimates of total abundance and confidence intervals for each strata from every sampling trip.

Environmental data consisting of temperature (± 0.1 °C), salinity (± 0.1 ppt) and dissolved oxygen (± 0.5 ppm) were measured with a Seabird SBE 19 meter. Current speed (± 0.1 m/s) and direction (± 1 degree) were measured an InterOcean S4 meter during each hydroacoustic data collection period through the entire water column at each site.

Data Analysis

Fish density data (number of fish·m⁻³) from echo integration analysis contained a large number of zero values, similar to catch data from traditional fisheries sampling techniques (Pennington 1983; 1985; Shaw *et al.* 1985; Stanley and Wilson 1995; 1996; 1997; 2000). Therefore, hydroacoustic density data were transformed by $\log(\text{density} + 1)$ to approximate the normal distribution.

Two vectors describing current speed and direction to the east-west and north-south were calculated (Pond and Pickard 1982). Currents from the east and north were scaled to positive values; west and south currents were scaled to negative values. This scaling provided two vectors which represented current speed and direction in later analyses.

Randomized block ANOVAs (SAS Institute 1986) were performed for each site with horizontal $\log(\text{density} + 1)$ of density data on distance from the platform, time of day (TOD), quarter, year and their interactions, blocking on side of the platform to examine differences due to these variables. Tukey's studentized range tests (Ott 1982) were used to compare the means of significant variables for horizontal analyses. Statistical tests were reported as significant at the $\alpha \leq 0.01$ level.

Separate randomized block ANOVAs using SAS (1986) GLM procedures were performed with vertical target strength data and $\log(\text{density} + 1)$ of vertical density data for each site on depth, time of day, quarter, year, temperature, dissolved oxygen level, east and north current vectors, squared east and squared north current vectors and their interactions, blocking on side of the platform to examine differences due to these variables. Tukey's studentized range tests (Ott 1982) were used to compare the means of significant variables for vertical and horizontal analyses. Tests were reported as significant at the $\alpha \leq 0.01$ level.

The total abundance estimates at the platform were calculated by determining the near-field area of influence of the platform, then multiplying mean density values (number of fish·m⁻³) for each month and platform side by the volume of water on each side of the platform. Fish density in the center of the platform, not measured with acoustics due to interference by structural members, was assumed to be the average of the density estimates of the four sides of the platform. Fish abundance in the center of the platform was calculated by multiplying the estimated fish density of the center by the volume of water in the center of the platform.

RESULTS

South Timbalier 54

Vertical Density Distribution: Densities of fishes at the ST54 production platform (water depth 22 m) were highly variable over the study period ranging from 0 to over 5.2 fish/m³. A RBD ANOVA with platform side as a block was used to examine differences in density due to year, season, time of day, current vectors, temperature, dissolved oxygen, depth, and selected interactions. Density varied significantly with season, time of day, depth, platform side, east current vector, north squared current vector, salinity, dissolved oxygen, and the time of day * depth interaction (Table 7.14).

Temporal differences in fish density were detected between season, time of day and the interaction of season*time of day (Table 7.14, Figure 7.34). Fish density was highest in 1995 and 1997 (although only one research trip occurred in 1997) indicating annual variation in the fish density at the site (Table 7.14). Seasonally, fish densities were significantly higher in the fall than in all other seasons, and lowest densities were found in the spring and summer (Figure 7.35). No overall trend of fish densities with season and time of day could be detected over the entire study period, but overall fish densities were significantly higher at midnight than at all other times (Figure 7.36).

Spatially, fish density varied with platform side, depth and the interactions of depth*time of day and depth*season. Significantly higher densities were found on the north side of the platform than at all others (Figure 7.37). With respect to depth, densities were significantly higher in the upper 10 m of the water column than at all other depth strata, although an increase in density from 20-22 m was observed when dissolved oxygen levels were greater than 3 ppm (Figure 7.37). While the interaction of depth*time of day was significant (Table 7.14) in the overall model, examination of fish density by depth with time of day did not reveal an overall trend with exception of higher fish densities in the upper 10 m regardless of time of day. The interaction of depth*season was also significant, and examination of density values by depth for each season revealed significantly lower densities in the spring and summer from 20-22 m than in the fall and winter. This difference is likely due to the low oxygen conditions found near the bottom during these periods.

Environmental conditions also impacted density based on results from the RBD ANOVA (Table 7.14). Fish density was significantly affected by temperature, dissolved oxygen, east current vector and the north current vector squared (Table 7.14). Fish density decreased slightly with temperature although this decrease is not consistent, as the highest observed densities were from fall and winter when temperatures were lowest. A direct relationship between dissolved oxygen and density existed; highest densities were found at high levels of dissolved oxygen. During the summer 1996 sample, a hypoxic event was noted, and dissolved oxygen levels were <1 ppm below 15 m. Along with these low dissolved oxygen levels, fish density was essentially zero from 15-22 m, but higher than average densities were detected from 0-10 m. The relationship between current speed and fish density, while significant (Table 7.14), was difficult to interpret. Fish density generally increased with increasing current speed although the maximum current speeds observed were 43 cm/s. Since the mean current speed was 11.3 cm/s, most of the speeds observed were likely not high enough to influence the behavior of the fishes, as the mean size of the fishes was sufficient to negate the influence of low observed currents.

Table 7.14. RBD ANOVA (block on platform side) results of vertical log fish density log (fish density/m³) with platform side, year, season, time of day, depth, current vectors, temperature, salinity, dissolved oxygen, and selected interactions at the ST54 petroleum platform.

Source	DF	SS	MS	F	Prob > F
Model	308	129.00907430	0.41886063	14.09	0.0001
Error	1596	47.44809218	0.02972938		
Corrected Total	1904	176.45716648			
	R-Square	C.V.	Root MSE		LDENSITY Mean
	0.731107	87.90991	0.1724221		0.1961350
Variables	DF	Type III SS	Mean Square	F Value	Pr > F
Side	3	14.78826719	4.92942240	165.81	0.0001
Year	1	0.01226440	0.01226440	0.41	0.5208
Season	3	2.36471052	0.78823684	26.51	0.0001
Diel	3	1.48166178	0.49388726	16.61	0.0001
Depth	4	1.64875440	0.41218860	13.86	0.0001
Temperature	1	0.50166204	0.50166204	16.87	0.0001
Dissolved oxygen	1	0.56616923	0.56616923	19.04	0.0001
Salinity	1	0.02415845	0.02415845	0.81	0.3675
North vector	1	0.17789554	0.17789554	5.98	0.0145
East vector	1	1.28431015	1.28431015	43.20	0.0001
North squared vector	1	0.19835984	0.19835984	6.67	0.0099
East squared vector	1	0.08600079	0.08600079	2.89	0.0892
North * East	1	0.00384716	0.00384716	0.13	0.7191
Season * Diel	9	3.89885440	0.43320604	14.57	0.0001
Diel * Depth	12	4.65341619	0.38778468	13.04	0.0001
Season * Depth	12	8.31623532	0.69301961	23.31	0.0001

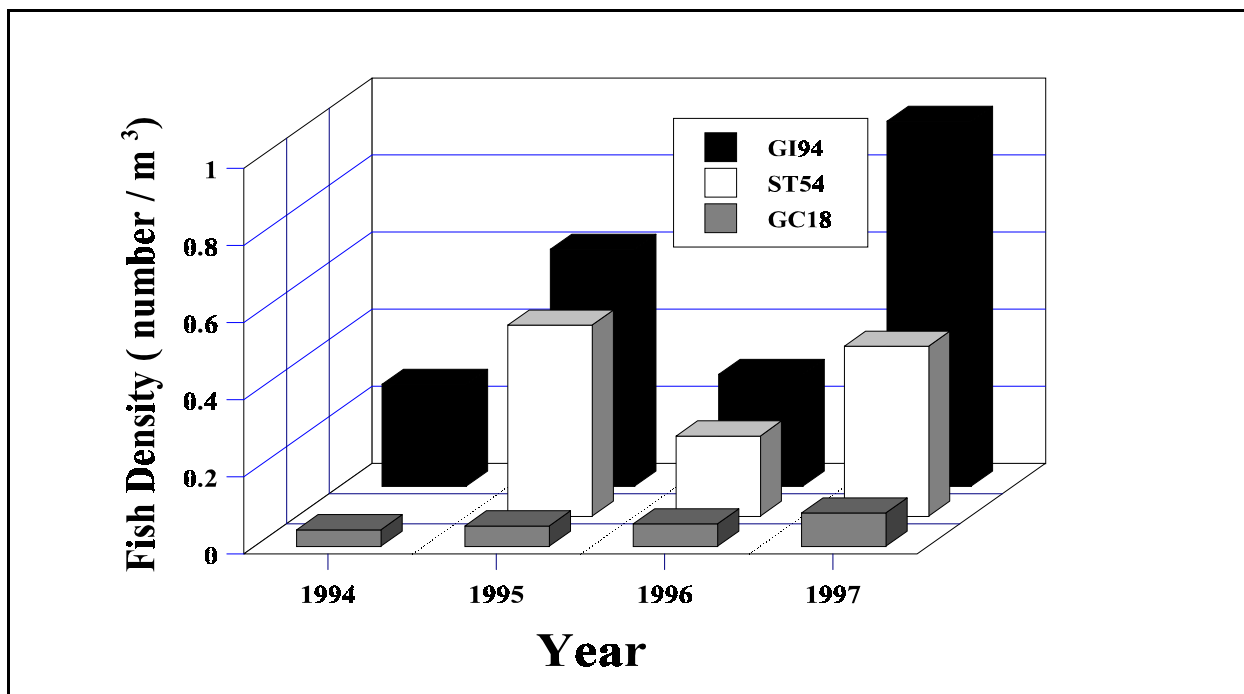

Figure 7.34. Mean fish density (number of fish/m³) by year at Green Canyon 18 (GC18) and Grand Isle 94 (GI94) from July 1994 to March 1997 and South Timbalier (ST54) from August 1995 to February 1997.

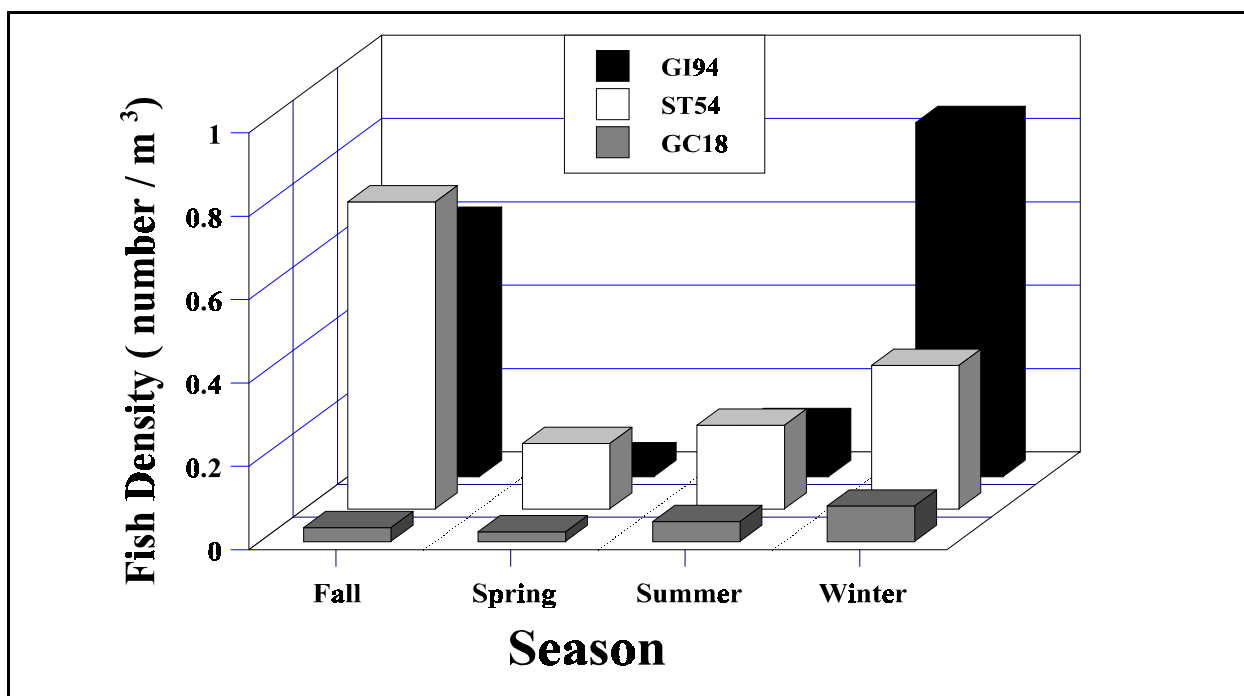

Figure 7.35. Mean fish density (number of fish/m³) by season at Green Canyon 18 (GC18) and Grand Isle 94 (GI94) from July 1994 to March 1997 and South Timbalier 54 (ST54) from August 1995 to February 1997.

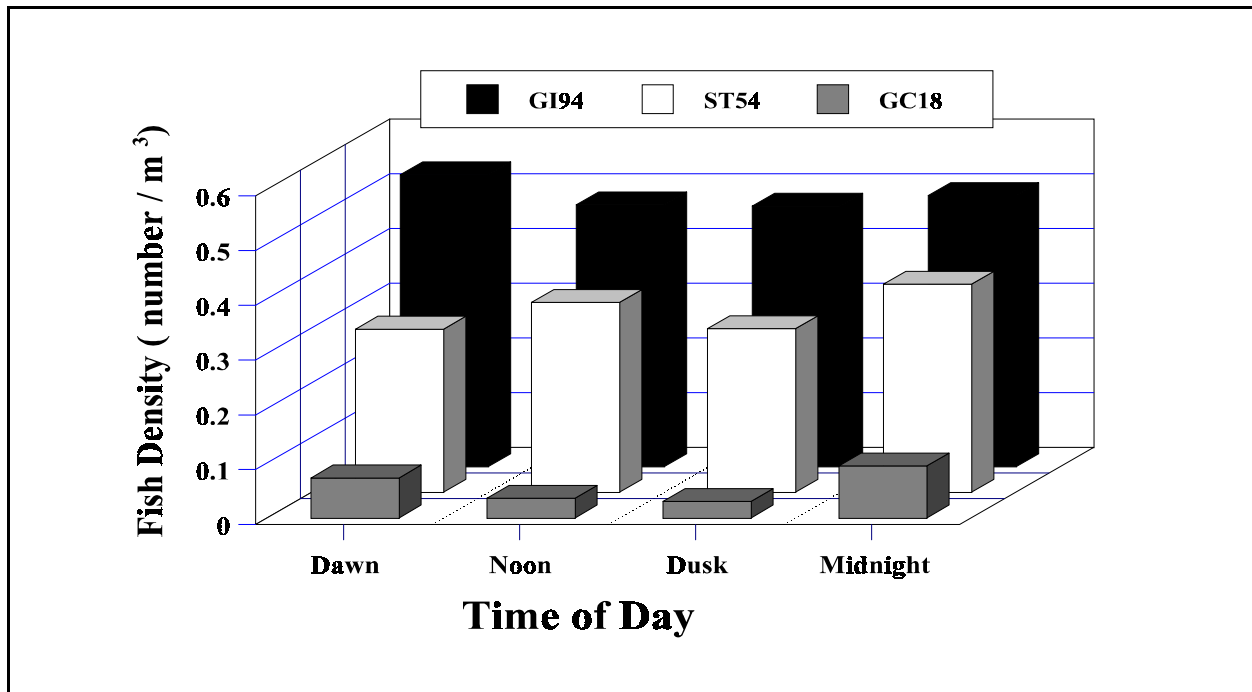

Figure 7.36. Mean fish density (number of fish/m³) by time of day from Green Canyon 18 (GC18) and Grand Isle 94 (GI94) from July 1994 to March 1997 and South Timbalier 54 (ST54) from August 1995 to February 1997.

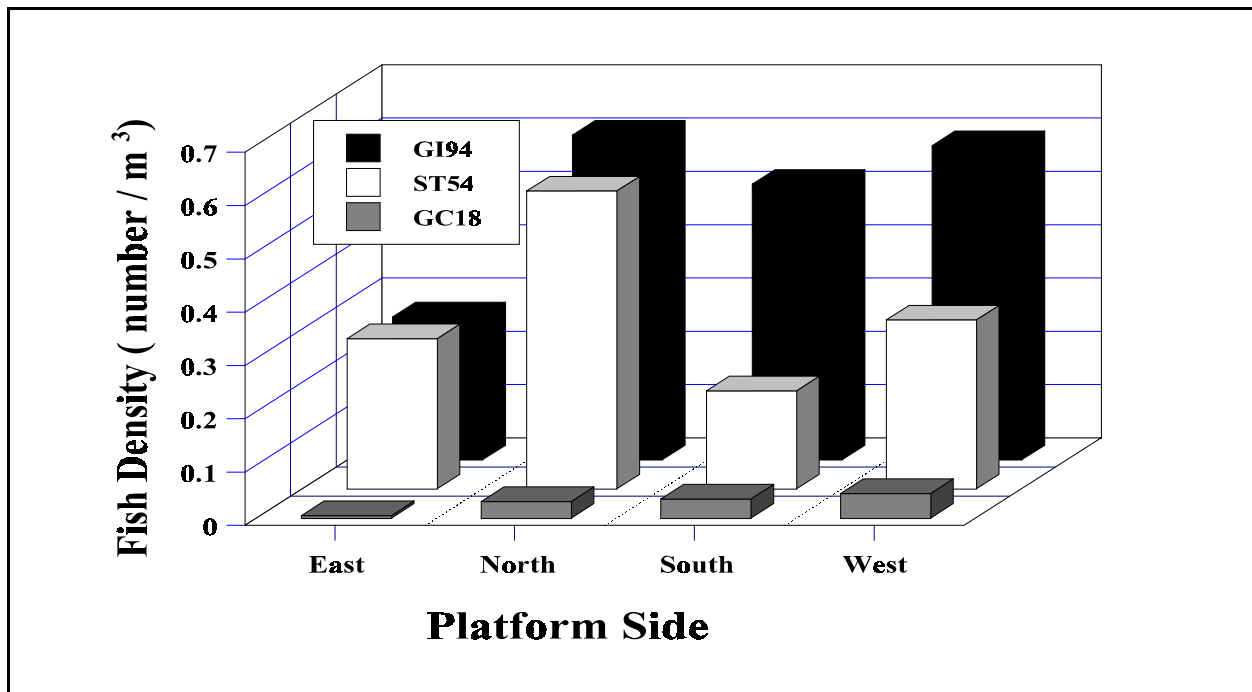

Figure 7.37. Mean fish density (number of fish/m³) by platform side from Green Canyon 18 (GC18) and Grand Isle 94 (GI94) from July 1994 to March 1997 and South Timbalier 54 (ST54) from August 1995 to February 1997.

Horizontal Density Distribution: Horizontal density of fishes varied temporally and spatially at the platform. Spatially, horizontal fish density varied with side of the platform and distance from the platform (Table 7.15). Fish densities were significantly higher in the 2-10 and 10-18m strata than all others (Figure 7.38). At distances from 18-82 m, fish densities were at only half of those nearer to the platform (Figure 7.38). Temporally, horizontal fish density varied significantly between years, seasons, and time of day, reinforcing the temporal variation observed with the vertically oriented transducer arrays (Table 7.15). Annual variation in horizontal density revealed highest horizontal density in 1995 and lowest in 1997, while seasonally highest densities were found in the fall with all other seasons not being significantly different (Table 7.15). Within a 24-hour period, significantly higher densities were found at noon, while all other times were not significantly different (Table 7.15).

Horizontal fish densities were used to measure the near-field area of influence of the platform. Based on the decrease in fish density with distance from the platform, the near-field area of influence was estimated at 18 m (Table 7.15, Figure 7.38). Beyond 18 m, fish densities dropped off significantly, and fish densities were not significantly different from 18 to 84 m (Figure 7.38).

Table 7.15. RBD ANOVA (block on platform side) results of horizontal log relative fish density ($\log(\text{fish density}/\text{m}^3)$) with platform side, year, season, time of day, distance from the platform, and selected interactions at the ST54 petroleum platform.

Source	DF	SS	MS	F	Prob > F
Model	591	67.26231465	0.11381102	32.41	0.0001
Error	4828	16.95542871	0.00351189		
Corrected Total	5419	84.21774337			
	R-Square	C.V.	Root MSE		LDENSITY Mean
	0.798672	104.4581	0.0592612		0.0567321
Variables	DF	Type III SS	Mean Square	F Value	Pr > F
Side	3	1.93480553	0.64493518	183.64	0.0001
Year	2	0.55152158	0.27576079	78.52	0.0001
Season	3	16.74014333	5.58004778	1588.90	0.0001
Diel	3	3.26312963	1.08770988	309.72	0.0001
Distance	3	2.04846570	0.22760730	64.81	0.0001
Season * Diel	9	7.20927947	0.80103105	228.09	0.0001
Diel * Distance	27	0.93008887	0.03444774	9.81	0.0001
Season * Distance	27	3.16415321	0.11719086	33.37	0.0001
Side * Season * Diel * Distance	508	34.03828042	0.06700449	19.08	0.0001

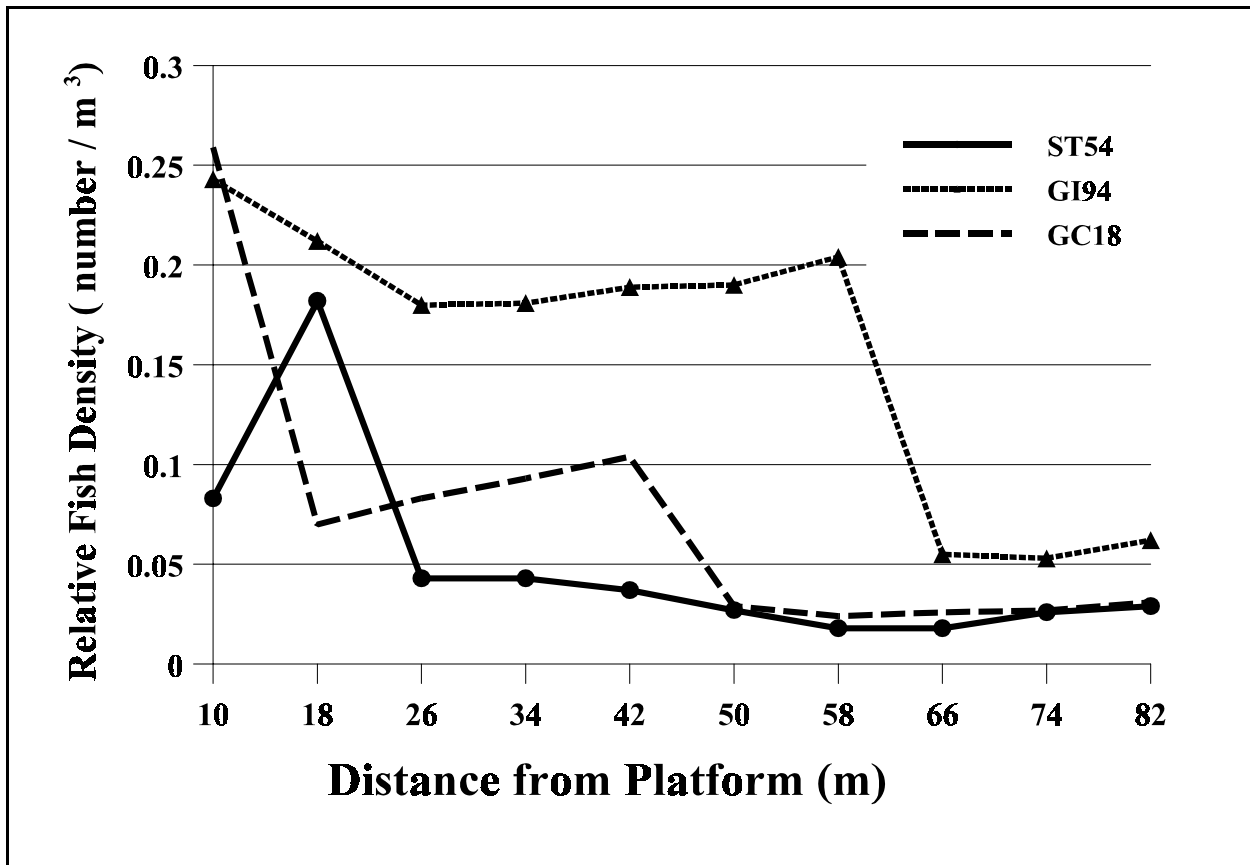

Figure 7.38. Mean relative fish density (number of fish/m³) by distance from the platform at Green Canyon 18 (GC18) and Grand Isle 94 (GI94) from July 1994 to March 1997 and South Timbalier 54 (ST54) from August 1995 to February 1997.

Estimated Number of Fish and Species Composition: Examination of visual survey results revealed interesting and consistent trends in species composition with respect to depth, season, and the dominance of a few species over the sample period (Table 7.16). A total of sixteen species were detected by the ROV during visual surveys, but six species including Atlantic spadefish, bluefish, blue runner, mangrove snapper, red snapper and sheepshead consistently comprised over 95% of the fishes enumerated at the site (Table 7.16). Less commonly observed species included seasonal migrants detected in warmer periods; barracuda, Bermuda chub, cobia and tarpon and species found during cooler water periods; Florida pompano and red drum (Table 7.16).

During all surveys, planktivores were numerically dominant and the most common species observed were Atlantic spadefish and blue runners (Table 7.16). These species typically constituted over 55% of the fishes surveyed (Table 7.16), and either species was the most numerically dominant depending on season. Blue runners were generally more abundant in the warmer surveys with the exception of the summer of 1996 when they were absent from the survey (Table 7.16).

Depth also played an important role in the distribution of species at ST54; consistent trends were observed with respect to the presence of species and depth (Table 7.16). Examination of the depth

Table 7.16. Mean estimated number of fish by species and mean number enumerated and percent species composition by depth strata at South Timbalier 54 for all research trips from July 1995 to March 1997 from hydroacoustic and visual point count surveys.

Species	Summer 95	Fall 95	Winter 96	Spring 96	Summer 96	Winter 96	Mean
Atlantic Spadefish	35.4 2880.3±377.2	34.7 13305±2611.6	43.4 3796.5±617.3	27.6 1963.4±189.5	21.5 1976.5±258.9	27.5 8327.2±1320.1	33.6 5018.6±482.2
Barracuda	0.2 8.2±1.8	-	-	-	-	-	0.0 5.7±0.4
Bermuda Chub	-	-	-	-	0.2 9.0±0.9	-	0.0 1.1±0.1
Bluefish	0.2 10.2±2.2	-	13.2 804.1±102.3	0.6 31.8±3.3	-	-	2.4 381±32.3
Bluerunner	42.6 2536.9±412.1	19.9 6946.2±1360	1.1 82.1±14.7	6.6 427.0±29.3	-	22.7 6220.5±32.7	20.6 2688.7±274.8
Cobia	0.1 8.3±0.6	0.3 44.9±10.2	0.2 45.0 ± 21.3	0.1 5.1±1.0	0.3 18.0±1.7	0.2 18.0±2.9	0.2 17.4±1.9
Florida Pompano	-	-	1.6 142.6±18.6	-	-	-	0.3 36.0±2.8
Gray Triggerfish	0.6 34.7±8.2	0.1 27.4±4.8	0.1 22.9±5.2	0.8 69.9±14.7	0.3 18.0±1.7	-	0.3 35.7±3.6
Jack Crevalle	0.2 20.4±2.5	0.4 123.7±23.3	1.1 74.5±10.9	0.3 17.8±1.7	-	0.9 203.9±29.5	0.5 67.8±6.2
Lookdown	0.8 56.3±6.8	0.4 78.6±20.7	0.1 11.1±4.5	4.1 240.3±18.9	-	0.4 30.8±5.9	0.7 95.8±9.1
Mangrove Snapper	1.1 52.8±8.4	13.6 3937.6±787.7	1.1 89.2±12.3	39.9 2411.6±321.2	49.1 2957.4±322.1	13.4 4108.5±531.0	13.1 1774.5±159.2
Red Snapper	3.9 124.6±29.4	15.5 2560.7±392.2	14.6 1240.9±383.8	1.5 268.1±61.1	3.1 2000.5±228.7	17.9 1832.4±281.9	10.8 995.3±140.5
Red Drum	-	0.1 6.4±1.1	-	-	-	0.4 -	0.1 6.4±1.2
Rockhind	0.1 10.2±2.4	0.1 47.2±7.3	-	-	-	-	0.0 5.2±0.4
Sheepshead	14.8 1404.5±139.7	14.8 4831.1±921.6	23.5 1790.2±377.5	18.4 1828.6±370.6	25.3 754.7±205.9	13.7 4329.9±661.7	17.2 2326.2±229.6
Tarpon	0.0 3.0±0.3	0.1 21.8±3.4	0.1 -	-	-	0.5 24.5±4.0	0.1 16.0±1.5
TOTAL	7159.2±992.7	28553.1±6141.3	8052.5±1566.1	7269.4±1013.9	9568.2±1316.5	18121.6±2818.1	13471.9±1346.7

distribution of the six most abundant species showed that Atlantic spadefish and bluefish were found in the upper water column; mangrove snapper and sheepshead were found throughout the water column but were most common at mid-depth; red snapper were most abundant in the lower 7 m of

the water column, and only blue runner were found evenly throughout the water column (Table 7.16). Trends in depth distribution of the less common species show that barracuda, Florida pompano and red drum were most common near the bottom while cobia, gray triggerfish, jack crevelle, lookdown, and tarpon were observed throughout the water column (Table 7.16).

Seasonal trends in species composition and depth distribution were also observed at ST54. During the winter sampling trips, bluefish abundance was highest and they were found at mid-depth; blue runners were uncommon; although overall Atlantic spadefish abundance did not change, they were found throughout the water column in contrast to their abundance near the surface during other sampling periods (Table 7.16). During warmer sampling periods, blue runner and mangrove snapper were more common and generally found in the upper water column (Table 7.16).

Extrapolating the species composition estimates with the acoustic abundance data for each depth strata provided estimates of individual species abundance throughout the water column (Table 7.16, Figure 7.39). By species, Atlantic spadefish or blue runners were the most abundant fish at ST54 with the exception of the spring and summer 1996 samples when mangrove snapper abundance was slightly higher (Table 7.16). Three- to five-fold fluctuations in abundance for individual species

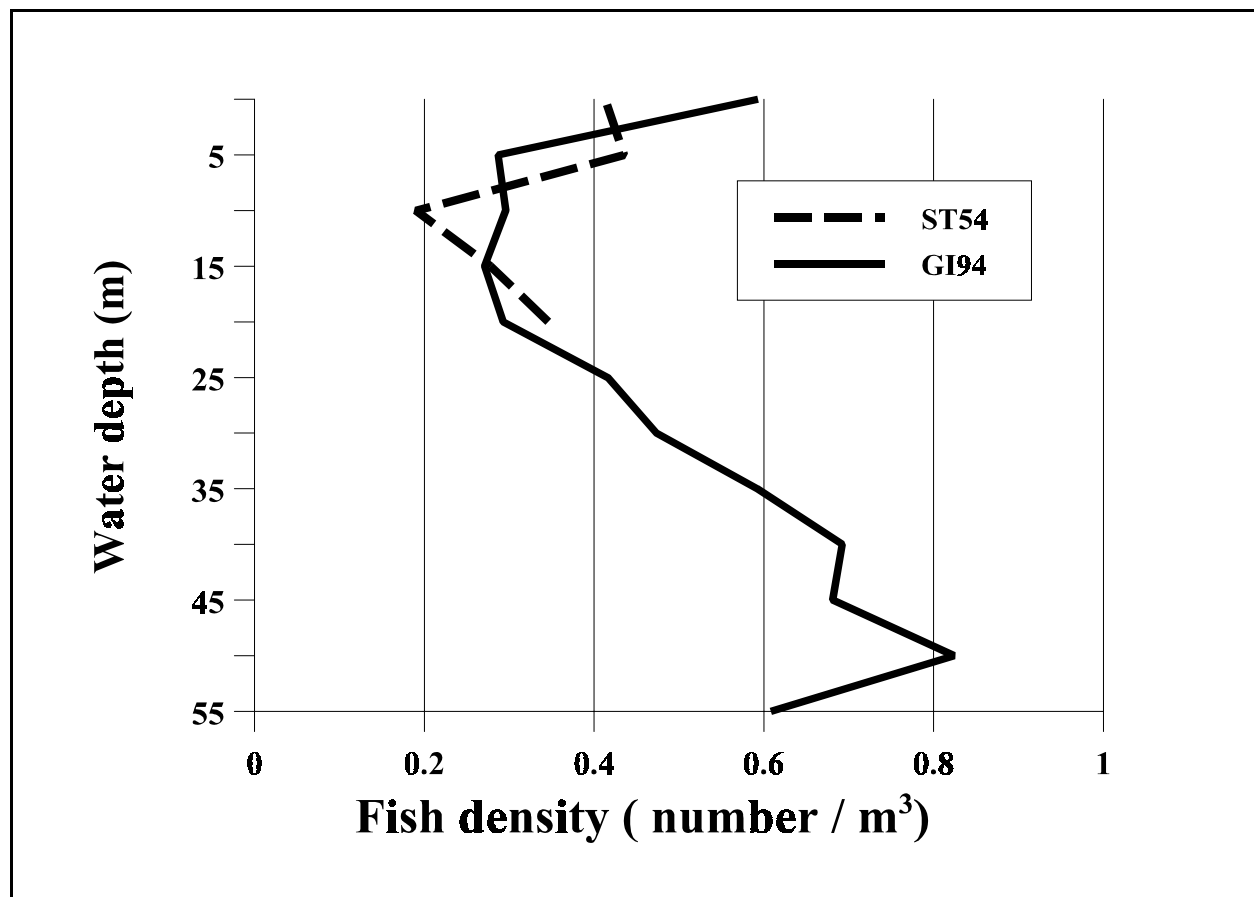

Figure 7.39. Mean fish density (number of fish/m³) by depth at Grand Isle 94 (GI94) from July 1994 to March 1997 and South Timbalier 54 (ST54) from August 1995 to February 1997.

were detected between samples (Table 7.16). The species exhibiting the largest change over the sample period was mangrove snapper, with abundances changing from approximately 80 individuals in the summer of 1995 to approximately 4,000 in the fall, then dropping to an estimated 90 fish in the winter of 1996 and increasing to 2,900 in the spring of 1996 (Table 7.16). Large fluctuations in abundance by species over longer time periods were observed; an example was the presence of over 2,400 bluefish in the winter 1996 sample while at other times of the year this species was absent (Table 7.16).

The mean abundance, with 95% confidence intervals, of fishes at ST54 by sample was variable with a low of 7,159 (+/- 993) fish at in the summer of 1995 and a high of 28,553 (+/- 6,141) fish in the fall of 1995 (Table 7.16). Averaged over all, the sample periods there were 13,472 (+/- 1,347) fish at the site (Table 7.16). By depth, 58% of the fishes were found in the upper 10 m of the water column with the lowest abundance of fish found adjacent to the substrate (Figure 7.39).

Grand Isle 94

Vertical Density Distribution: Densities of fishes at the GI94 production platform (60 m depth) were variable over the study period ranging from 0 to over 1.1 fish/m³. A RBD ANOVA with platform side as a block was used to examine differences in density due to year, season, time of day, current vectors, temperature, dissolved oxygen, depth, and selected interactions. Density varied significantly with year, season, time of day, depth, platform side, north current vector, east squared current vector, dissolved oxygen, and temperature (Table 7.17).

Temporal differences in fish density were detected between year, season, and time of day (Table 7.17). Fish density was significantly different over all years examined with significantly higher densities observed in 1997 than in all other years, although only one research trip occurred in 1997 (Figure 7.34). The lowest annual densities were found in 1996 with 1994 and 1995 having significantly higher annual densities (Figure 7.34, Table 7.17). Seasonally, fish densities were significantly higher in the winter followed by fall, then spring, and lowest in the summer (Figure 7.35, Table 7.17). Mean densities in the winter and fall were on average five to ten times higher than in the spring and summer (Figure 7.35). While fish densities varied with time of day and were significantly different (Table 7.17), the differences were much smaller than with any other temporal variable examined (Figure 7.36). Highest densities were found at dawn and significantly lower densities were detected at dusk; otherwise, densities were not significantly different (Figure 7.36).

Spatially, fish density varied with platform side and depth (Table 7.17). Significantly higher densities were found on the north and west side than on the others (Figure 7.37). Lowest densities were found on the east side of the platform (Table 7.17). Densities varied significantly with depth, with lowest densities found from 5-20 m and highest near the surface and bottom (Figure 7.39). Significantly higher densities were found immediately above the bottom (water depth 50-55 m) than at all other depth strata (Figure 7.39). Other regions of high densities included 0-5 m and 40-60 m (Figure 7.39).

Table 7.17. RBD ANOVA (block on platform side) results of vertical log fish density ($\log(\text{number of fish}/\text{m}^3)$) with platform side, year, season, time of day, depth, current vectors, temperature, salinity, dissolved oxygen, and selected interactions at the GI94 petroleum platform.

Source	DF	SS	MS	F	Prob > F
Model	719	658.51165	0.91587	9.51	0.0001
Error	7210	694.42089	0.09631		
Corrected Total	7929	1352.93255			
	R-Square	C.V.	Root MSE		LDENSITY Mean
	0.486729	94.61222	0.3103		0.3280
Variables	DF	Type III SS	Mean Square	F Value	Pr > F
Side	3	34.43292	11.47764	119.17	0.0001
Year	3	1.11	0.37	12.17	0.0001
Season	3	88.32148	29.44049	305.67	0.0001
Diel	3	1.45685	0.48562	5.04	0.0017
Depth	11	20.22683	1.83880	19.09	0.0001
Temperature	1	3.53954	3.53954	36.75	0.0001
Dissolved oxygen	1	4.91742	4.91742	51.06	0.0001
Salinity	1	0.00003	0.00003	0.00	0.9849
North vector	1	1.32898	1.32898	13.80	0.0002
East vector	1	0.23100	0.23100	2.40	0.1215
North squared vector	1	0.42743	0.42743	4.44	0.0352
East squared vector	1	1.98548	1.98548	20.61	0.0001
North * East	1	0.10200	0.10200	1.06	0.3035
Diel * Depth	33	4.48975	0.13605	1.41	0.0590
Side * Season * Diel * Depth	658	226.51339	0.34425	3.57	0.0001

Results from the RBD ANOVA of environmental variables showed significant impact on fish density due to temperature, dissolved oxygen, north current vector and the east current vector squared (Table 7.17). Fish density decreased slightly with temperature although this finding is in conflict to the highest observed overall densities, which occurred in the fall and winter when temperatures are the lowest (Figure 7.35) and highest observed densities from 40-60 m where temperatures were generally lowest (Figure 7.39). A positive relationship was detected between dissolved oxygen and density as density increased with increasing dissolved oxygen levels although hypoxic conditions were not observed at GI94. The lowest dissolved oxygen levels were found were 4.4 ppm during the fall 1994 survey. The ANOVA results indicated a positive relationship between current speed and fish density (Table 7.17). While the relationship showed an increase in density

with decreasing current speed, less than 5% of the current observations exceeded 20 cm/s, with mean current speed of 10.0 cm/s and the maximum observed current speed was 39.6 cm/s. Because of the low number of high current speed observations it is more plausible that the high densities observed at low current speeds were due to depth; the highest densities were found from 40-60 m where current speeds were typically the lowest (Figure 7.39). Due to the relatively large size of the fishes observed at the site, it is probable that the current speeds observed were not great enough to influence the behavior of the fishes.

Horizontal Density Distribution: Horizontal density of fishes varied temporally and spatially at the platform (Table 7.18). Spatially, horizontal fish density varied with side of the platform and distance from the platform while temporal variation was observed with year and season (Table 7.18). The interactions of time of day, and distance from the platform, season and time of day and time of day and distance from the site were also significant (Table 7.18). The spatial relationship of horizontal density differing with side of the platform reinforced a similar relationship observed in the significant change in fish density between sides also observed in the vertical density distributions (Figure 7.38, Table 7.18). With respect to side, the horizontal results were similar to the vertical density results. Highest densities were found on the north, west, and south sides for both transducer arrays (Figure 7.37, Table 7.18).

Table 7.18. RBD ANOVA (block on platform side) results of horizontal relative log fish density ($\log(\text{number of fish}/\text{m}^3)$) with platform side, year, season, time of day, distance from the platform, and selected interactions at the GI94 petroleum platform.

Source	DF	SS	MS	F	Prob > F
Model	612	186.43939327	0.30463953	11.84	0.0001
Error	8327	214.25821327	0.02573054		
Corrected Total	8939	400.69760654			
	R-Square	C.V.	Root MSE		LDENSITY Mean
	0.465287	175.7350	0.1604074		0.0912780
Variables	DF	Type III SS	Mean Square	F Value	Pr > F
Side	3	13.25275329	4.41758443	171.69	0.0001
Year	3	17.72176044	5.90725348	229.58	0.0001
Season	3	17.15944638	5.71981546	222.30	0.0001
Diel	3	0.28291537	0.09430512	3.67	0.0118
Distance	9	6.20883438	0.68987049	26.81	0.0001
Season * Diel	9	3.42185811	0.38020646	14.78	0.0001
Diel * Depth	27	2.01761618	0.07472653	2.90	0.0001
Season * Depth	27	9.13703402	0.33840867	13.15	0.0001
Side * Season * Diel * Distance	528	84.63035253	0.16028476	6.23	0.0001

The close association of fishes with platforms observed at shallower depths was not observed at GI94 (Figure 7.39). Relative fish density was significantly higher from 0-58 m away from the site than at all other distances examined (Figure 7.38). Lowest observed densities were at distances greater than 58 m from the site and beyond 58 m fish densities were similar to those acoustically measured in the open waters of the northern GOM (Figure 7.38).

Temporally, variation in relative density was found with year and season. Again, the temporal horizontal density results were similar to the vertical results with significantly higher densities found in 1997 and 1995 as compared to 1994 and 1996 (Table 7.18, Figure 7.34). With respect to season highest densities were found in the winter and fall for densities measured with both horizontal and vertical transducer arrays (Table 7.18, Figure 7.36). The significant interaction terms of distance, and season, time of day and distance and season and time of day emphasize the variability in the density of fishes associated with the site.

Horizontal fish densities were used to measure the near-field area of influence of the platform. The highest horizontal densities measurements were from 0-18 m, but these densities were not significantly higher than those from 18-58 m (Figure 7.38). Despite measurement of high relative densities from 18 to 58 m at GI94, we estimated the near-field area of influence at 18 m. While the relationship of fish density with distance from the site was difficult to resolve, we feel that a conservative area of influence of 18 m best reflects a true population size of fishes at the site (Table 7.18, Figure 7.38). Increased water clarity and pelagic species composition at GI94 likely increased distance the fishes ranged from the site. However, based on the visual data from the ROV, 18 m best reflects the distance fishes typically ranged from the site based on the visual observation. Beyond 58 m relative fish densities measured at GI94 decreased dramatically to levels found at other sites (Figure 7.38).

Estimated Number of Fish and Species Composition: Examination of visual survey results demonstrated interesting trends in species composition with respect to depth, season, and the dominance of one species over the sample period (Table 7.19). A total of twenty-four species were detected by the ROV during visual surveys, but one species, blue runner, comprised on average 87% of all observed fishes (Table 7.19). By grouping blue runners with the next five most abundant species, horseeye jack, red snapper, mangrove snapper gray triggerfish, and barracuda, over 95% of the fishes observed at the site were accounted for (Table 7.19).

Seasonality in the abundance of fishes was detected at GI94 with cobia, red snapper, almaco jack and amberjack more common in the spring and summer than during cooler periods (Table 7.19). During fall and winter we found an increase in the abundance of barracuda and blue runner (Table 7.19). Blue runners exhibited the most dramatic seasonality. Few were found during summer samples when they constituted <30% of the fishes observed, however during fall, winter, and spring samples, blue runners were the dominant fish observed and composed 71% to 94% of the fishes found at the site (Table 7.19). While most other species were found at a relatively narrow depth range, blue runners were found throughout the water column, although they were slightly more abundant near the surface. Fishes with higher abundance from mid-depth to the bottom included greater amberjack, red snapper and scamp. Surface-oriented species included bar jack, Bermuda chub and rainbow runner while species found throughout the water column included almaco jack, barracuda, gray triggerfish, horseeye jack, jack crevelle, and mangrove snapper.

Table 7.19. Mean estimated number of fish by species and mean number enumerated and percent species composition by depth strata at Grand Isle 94 for all research trips from July 1994 to March 1997 from hydroacoustic and visual point count surveys.

Species	Summer 94	Fall 94	Winter 95	Summer 95	Fall 95	Winter 96	Spring 96	Summer 96	Fall 96	Winter 97	Mean
Almaco Jack	0.1 7.7±1.6	0.2 55.8±7.9	0.1 58.5±5.2	1.4 119.0±16.4	0.5 219.8±35.2	0.2 43.4±3.6	0.0 0.0±0.0	0.6 27.7±8.3	0.2 87.9±14.1	0.1 67.0±4.7	0.2 57.9±3.6
Atlantic Spadefish	-	-	0.0 0.0±0.0	-	-	0.5 108.5±8.9	0.1 2.38±0.7	-	0.6 263.8±42.3	-	0.1 29.0±1.8
Greater Amberjack	4.3 331.7±69.0	5.4 1507.0±214.6	0.1 58.5±5.2	0.7 59.5±8.2	0.8 351.7±56.4	3.0 651.0±53.4	0.7 16.7±5.2	0.6 27.7±8.3	2.4 1055.1±169.1	0.6 402.2±28.2	1.0 289.5±18.1
Bar Jack	0.8 61.7±12.8	0.4 111.6±15.9	0.1 58.5±5.2	2.1 178.5±24.5	-	-	-	-	-	-	0.1 29.0±1.8
Barracuda	0.6 46.3±9.6	3.9 1088.4±155.0	0.4 234.0±20.7	1.1 93.5±12.9	2.9 1274.9±204.3	0.6 130.2±10.7	0.2 4.8±1.5	1.5 69.4±20.9	4.6 2022.3±324.0	1.0 670.2±47.0	1.0 289.5±18.1
Bermuda Chub	3.8 293.1±61.0	8.1 2260.5±322	0.1 58.5±5.2	-	1.2 527.6±84.5	0.2 43.4±3.6	0.1 2.4±0.7	1.5 69.4±20.9	-	0.7 469.2±32.9	0.7 202.7±12.6
Bigeye	-	-	0.0 0.0±0.0	-	-	-	-	-	-	-	0.0 0.0±0.0
Black Grouper	-	-	0.0 0.0±0.0	-	-	-	-	-	-	-	0.0 0.0±0.0
Bluerunner	44.9 3463.2±720.4	27.6 7702.6±1097.0	94.3 55161.5±4879.3	79.5 6757.4±929.1	71.0 3121.3±5001.5	85.0 18446.2±1512.8	94.2 2242.0±697.6	71.9 3324.5±999.5	71.9 31609.0±5064.9	93.0 62334.8±4367.4	87.0 25188.4±1571.2
Cobia	0.1 7.7±1.6	-	-	-	-	-	0.0 0.0±0.0	0.2 9.2±2.8	-	-	0.0 0.0±0.0
Coney Grouper	-	-	-	-	-	-	-	-	-	-	-
Creolefish	0.1 7.7±1.6	1.7 474.4±67.6	0.0 0.0±0.0	2.1 178.5±24.5	0.1 44.0±7.0	0.0 0.0±0.0	-	-	0.2 87.9±14.1	0.1 67.0±4.7	0.1 29.0±1.8
Gag	-	-	-	-	-	-	-	-	-	0.0 0.0±0.0	0.0 0.0±0.0

Table 7.16 (continued)

Species	Summer 94	Fall 94	Winter 95	Summer 95	Fall 95	Winter 96	Spring 96	Summer 96	Fall 96	Winter 97	Mean
Gray Triggerfish	2.2 169.7±35.3	12.0 3349.0±477.0	1.7 994.4±88.0	6.1 518.5±71.3	0.5 219.8±35.2	0.4 86.8±7.1	0.1 2.4±0.7	0.2 9.2±2.8	1.0 439.6±70.4	0.1 67.0±4.7	1.0 289.5±18.1
Horseye Jack	0.2 15.4±3.2	9.0 2511.7±357.7	-	0.2 17.0±2.3	13.4 5891.0±943.9	2.9 629.3±51.6	3.1 73.8±23.0	7.9 365.3±109.8	11.9 5231.5±838.3	1.4 938.4±65.7	3.0 868.6±54.2
Jack Crevalle	1.6 123.4±25.7	7.3 2037.3±290.2	-	0.9 76.5±10.5	0.8 351.7±56.4	0.2 43.4±3.6	0.2 4.8±1.5	8.3 383.8±115.4	2.5 1099.1±176.1	0.2 134.1±9.4	0.7 202.7±12.6
Lookdown	4.1 316.2±65.8	-	0.8 468.0±41.4	-	1.1 483.6±77.5	-	0.4 9.5±3.0	2.3 106.3±32.0	-	-	0.6 173.7±10.8
Mangrove Snapper	3.1 239.1±49.7	4.5 1255.9±178.9	0.5 292.5±25.9	1.4 119.0±16.4	2.4 1055.1±169.1	0.3 65.1±5.3	0.2 4.8±1.5	4.4 203.4±61.2	1.7 747.4±119.8	1.3 871.3±61.0	1.1 318.5±19.9
Ocean Triggerfish	-	-	-	0.9 76.5±10.5	-	-	-	-	-	-	0.0 0.0±0.0
Rainbow Runner	-	-	0.0 0.0±0.0	-	0.1 44.0±7.0	0.1 21.7±1.8	-	-	-	-	0.0 0.0±0.0
Red Snapper	33.2 2560.8±532.7	15.8 4409.5±628.0	1.1 643.5±56.9	3.4 289.0±39.7	4.7 2066.2±331.1	4.9 1063.4±87.2	0.3 7.1±2.2	0.2 9.2±2.8	2.7 1187.0±190.2	1.4 938.4±65.7	3.0 868.6±54.2
Scamp	0.8 61.7±12.8	4.1 1144.2±163.0	0.5 292.5±25.9	0.2 17.0±2.3	0.6 263.8±42.3	1.6 347.2±28.5	0.1 2.4±0.7	0.1 4.6±1.4	0.3 131.9±21.1	0.1 67.0±4.7	0.5 144.8±9.0
Vermillion Snapper	-	-	0.2 117.0±10.3.00	-	-	-	-	-	-	-	0.0 0.0±0.0
Yellowfin Grouper	-	-	0.0 0.0±0.0	-	-	-	-	-	-	-	0.0 0.0±0.0
TOTAL	7713.2±160.4	27908.0±3974.7	58495.8±5174.2	8499.9±1168.7	43962.5±7044.3	21701.4±1779.8	2380.0±740.5	4623.8±225.2	43962.5±7044.3	67026.7±4696.1	28952.2±1806.0

Extrapolating the species composition estimates with the acoustic abundance data for each depth strata provided estimates of individual species abundance throughout the water column (Table 7.19). The total number of fish at the GI94 ranged from a low of 2,380 (+/- 740, 95% confidence interval, Table 7.19, Figure 7.40) during the spring 1996 sample period to a high of 67,027 (+/- 4,696, Table 7.19, Figure 7.40) during the winter 1997 period with a mean of 28,952 (+/- 1,806) fishes averaged over all the sample periods. The seven most abundant species (highest to lowest) were blue runner, red snapper, horseeye jack, mangrove snapper, greater amberjack, barracuda, and grey triggerfish (Table 7.19). Blue runner dominated the number of fishes observed at the site with an average of 25,188 (+/- 1,571, 95% confidence interval). Their abundance was highly variable with a low of 2,242 (+/- 698) observed in the spring 1996 sample (Table 7.19) to a high of 62,335 (+/-4,367) from the winter 1997 sample (Table 7.19). The estimated number of blue runner was also variable with a five- to six-fold change in abundance observed from the fall of 1994 to spring 1995 (Table 7.19). Generally, their abundance would peak in fall or winter and then drop during other surveys (Table 7.19).

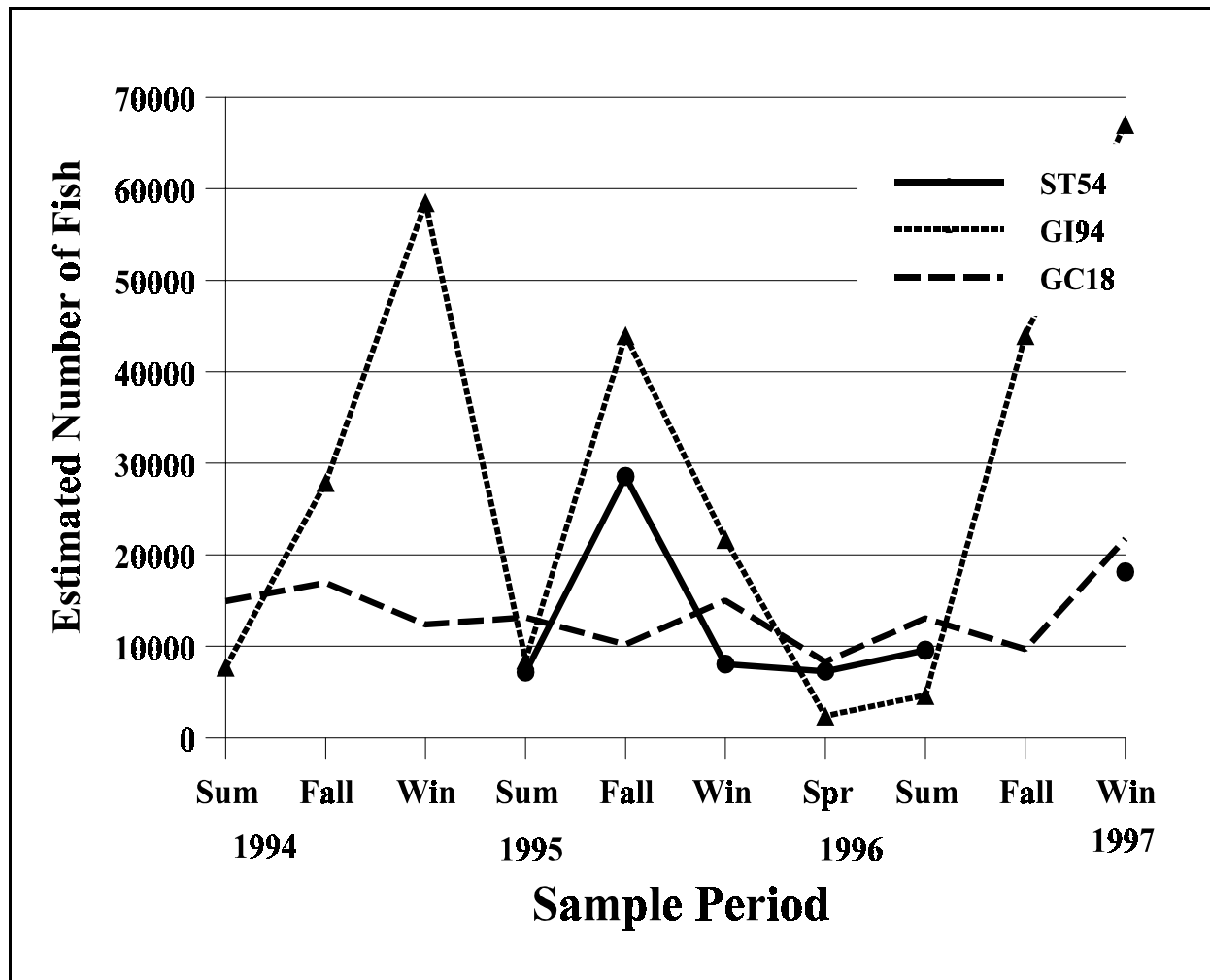

Figure 7.40. Estimated number of fishes for each quarterly sample period at Green Canyon 18 (GC18) and Grand Isle 94 (GI94) from July 1994 to March 1997 and South Timbalier (ST54) from August 1995 to February 1997.

The abundance of greater amberjack, horseeye jack, mangrove snapper, and red snapper was typically highest in fall and winter and lower during spring and summer samples (Table 7.19), although the second highest number of red snapper observed over the study period was found during the summer 1994 research trip. Significant changes in the abundance of other individual species were also noted. Three- to five-fold differences in estimated abundance between sample periods were common for greater amberjack, horseeye jack, mangrove snapper, and red snapper (Table 7.19).

Green Canyon 18

Vertical Density Distribution: Densities of fishes at the GC18 production platform (water depth 219 m) were variable over the study period ranging from 0 to over 1.44 fish/m³. A RBD ANOVA with platform side as a block was used to examine for differences in density due to year, season, time of day, current vectors, temperature, dissolved oxygen, depth, and selected interactions. Density varied significantly with platform side, season, depth, north current vector squared, and the interactions of time of day and depth and season and depth (Table 7.20).

The only significant temporal differences in fish density were detected with season and the interaction between depth and time of day (Table 7.20). Seasonally, fish densities were significantly higher in the winter and summer than the fall and spring (Figure 7.35, Table 7.20). Mean densities in the winter and summer were on average two to five times higher than in the spring and fall (Figure 7.35). Other differences observed in temporal variables examined (e.g., year and time of day) were not significant (Figures 3 and 5, Table 7.20).

Spatially, fish density varied with platform side and depth (Table 7.20). Significantly higher densities were found on the west side of the platform than at all others, and densities were not significantly different on the north and south sides (Figure 7.37). Densities on the east side were five to eight times lower than those on other sides of the platform (Table 7.20, Figure 7.37). The most dramatic results of the research project was the relationship between fish density and depth at GC18. A significant and spectacular drop in density with depth was observed at GC18 below 100 m (Table 7.20, Figure 7.41). Fish densities from 0-15 m were significantly higher than all other depth strata and were 4 to 68 times higher than all other depths (Figure 7.41). Densities from 15 to 95 m were not significantly different but were 3 to 12 times higher than depths from 115 to 210 m (Figure 7.41). From 115 to 210 m fish density was less than 0.002 fish/m³, essentially zero, and lower than densities in the open waters of the GOM on the continental shelf (Figure 7.41).

Environmental conditions did little to impact fish density at GC18 based on results from the RBD ANOVA (Table 7.20). Fish density was significantly affected only by the north current vector squared, although temperature and dissolved oxygen were close to significant with a probability of a greater F of 0.0206 and 0.0283, respectively (Table 7.20). There was an inverse relationship between fish density and north vector squared as fish density decreased slightly as north vector squared increased. This decrease is likely due to observations from the summer 1995 sample when relatively high-current speeds with a northerly component were found. The close to significant relationship between density and temperature is likely correlated to the significant seasonal

Table 7.20. RBD ANOVA (block on platform side) results of vertical log fish density ($\log(\text{number of fish}/\text{m}^3)$) with platform side, year, season, time of day, depth, current vectors, temperature, salinity, dissolved oxygen, and selected interactions at the GC18 petroleum platform.

Source	DF	SS	MS	F	Prob > F
Model	90	2.0053289	0.0222814	20.93	0.0001
Error	5985	6.3729412	0.0010648		
Corrected Total	6075	8.3782700			
	R-Square	C.V.	Root MSE		LDENSITY Mean
	0.476178	252.0003	0.0284		0.0113
Variables	DF	Type III SS	Mean Square	F Value	Pr > F
Side	3	0.2220276	0.0740092	69.50	0.0001
Year	3	0.0115176	0.0382392	3.61	0.0128
Season	3	0.0352252	0.0117751	11.06	0.0001
Diel	3	0.0030421	0.0010140	1.25	0.2884
Depth	10	0.3454644	0.0354464	33.29	0.0001
Temperature	1	0.0051256	0.0051256	4.81	0.0283
Dissolved oxygen	1	0.0051131	0.0051131	5.37	0.0206
Salinity	1	0.0010461	0.0010461	0.98	0.3216
North vector	1	0.0011174	0.0011174	1.05	0.3057
East vector	1	0.0007499	0.0007499	0.07	0.4014
North squared vector	1	0.0079050	0.0079050	7.42	0.0065
East squared vector	1	0.0005933	0.0005933	0.56	0.4554
North * East	1	0.0035980	0.0035680	3.38	0.0661
Diel * Depth	30	0.1210778	0.0040359	3.79	0.0001
Season * Depth	30	0.3375548	0.0112518	10.57	0.0001

relationship documented earlier (Table 7.20, Figure 7.35) with highest densities found in the winter, although this relationship is confounded by the low densities at depths where temperatures were lowest (Figure 7.41). The observation of declining density with low dissolved oxygen levels is probably due to the low fish densities observed below 95 m where dissolved oxygen levels were lowest (Table 7.20, Figure 7.41). However, no hypoxic events were detected at GC18.

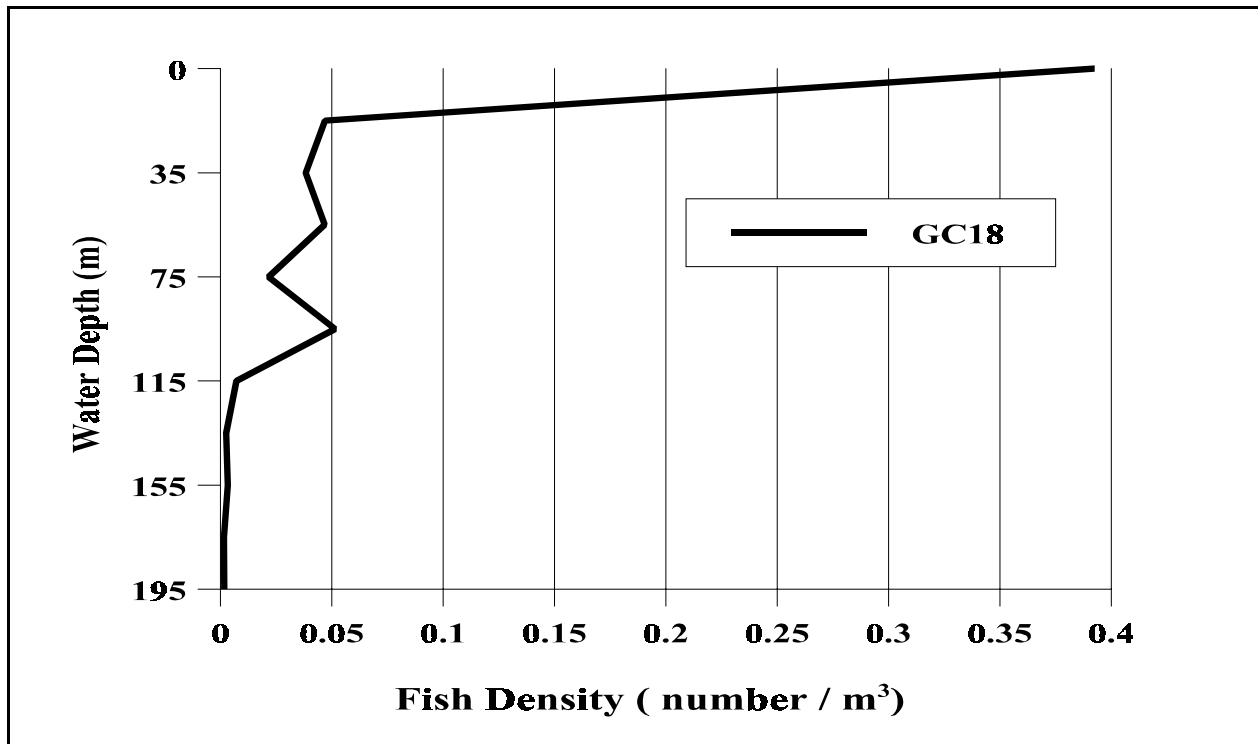

Figure 7.41. Mean fish density (number of fish/m³) by depth at Green Canyon 18 from October 1994 to March 1997.

Horizontal Density Distribution: Horizontal density of fishes varied temporally and spatially at the platform (Table 7.21). Spatially, horizontal fish density varied with side of the platform and distance from the platform. Temporal variation was observed with season, time of day, and the interactions of time of day and distance from the platform (Table 7.21). The differences in fish density with side of the platform observed with the horizontally-oriented transducers reinforces the observed variation in fish density with platform side from the vertically oriented arrays (Figure 7.37, Table 7.21). The close spatial association of fishes with platforms at sites on the continental shelf (e.g., ST54) was more evident at GC18 than GI94 (Figure 7.38). Fish density was significantly higher from 2-10 m away from the site than at all other distances examined (Figure 7.38). Densities from 10-42 m were not significantly different from each other, and lowest observed densities were from 50-82 m from the site (Figure 7.38).

Temporally, the variation in horizontal fish density found with respect to season is similar to the variation in fish density with season observed from the vertical density arrays (Table 7.21). Diel variation was observed in the horizontal density of fish with highest densities found at noon (Table 7.21). This was the only case during this research project where diel variation was observed, and because it was not observed with the vertical transducer array, it is presumably due to off-site behavior of fishes in the upper water column since the maximum deployment depth of the horizontal transducers was 13 m and would not reflect behavior of fishes throughout the water column.

Table 7.21. RBD ANOVA (block on platform side) results of horizontal log relative fish density ($\log(\text{number of fish}/\text{m}^3)$) with platform side, year, season, time of day, distance from the platform, and selected interactions at the GC18 petroleum platform.

Source	DF	SS	MS	F	Prob > F
Model	1159	84.788167	0.073156	5.68	0.0001
Error	4870	62.705195	0.012876		
Corrected Total	6029	147.493362			
	R-Square	C.V.	Root MSE		LDENSITY Mean
	0.574861	180.3045	0.1135		0.0629
Variables	DF	Type III SS	Mean Square	F Value	Pr > F
Side	3	21.033569	7.011190	544.52	0.0001
Year	3	0.080941	0.026980	2.10	0.0986
Season	3	3.245408	1.081803	84.02	0.0001
Diel	3	1.460569	0.486856	37.81	0.0001
Depth	9	0.166086	0.018454	1.43	0.1676
Diel * Depth	27	1.195570	0.044280	3.44	0.0001
Year * Season	1	0.35030	0.035030	2.72	0.0991
Side * Year * Season * Diel * Depth	1110	50.150390	0.045181	3.51	0.0001

Horizontal densities were used to measure the near-field area of influence of the platform. Densities were significantly higher within 10 m of the site, and while densities from 10-42 m were high, we feel that a conservative area of influence of 10 m best reflects a true population size of the fishes at the site (Table 7.21, Figure 7.38). Beyond 50 m the relative fish densities measured at GC18 decreased dramatically to levels found in the open shelf waters of the GOM (Figure 7.38).

Estimated Number of Fish and Species Composition: Examination of visual survey results revealed a fairly stable species assemblage at the site with interesting and consistent trends in species composition with respect to depth, season, and the dominance of a few species over the sample period (Table 7.22). A total of eighteen species were detected by the ROV during visual surveys but six species including creolefish, blue runner, Bermuda chub, almaco jack, amberjack, and barracuda consistently comprised over 90% of the fishes enumerated at the site (Table 7.22). Other species observed included bar jack, black jack, blackfin tuna, grey triggerfish, horseeye jack, lesser amberjack, marbled grouper, ocean triggerfish, rainbow runner, scamp and yellowtail snapper. Due to their scarcity, it is difficult to discern any seasonal patterns (Table 7.22).

Creolefish was the most common species enumerated at GC18 ranging from a maximum of 67% of the fishes detected in the summer of 1995 (Table 7.22) to a minimum of 40% in the winter of

Table 7.22. Mean estimated number of fish by species and mean number enumerated and percent species composition by depth strata at Green Canyon 18 for all research trips from August 1994 to March 1997 from hydroacoustic and visual pointcount surveys.

Species	Summer 94	Fall 94	Winter 95	Summer 95	Fall 95	Winter 96	Spring 96	Summer 96	Fall 96	Winter 97	Mean
Almaco Jack	18.1 476.5±51.4	2.8 506.0±201	5.7 1069.7±222.9	3.8 308.7±226.1	5.0 1618.6±510.9	3.5 2383.3±691	6.2 2913.3±1321.4	2.9 119.7±58.2	8.3 275.6±63.8	6.0 6130.4±1424.4	5.7 2260.6±315.1
Bar Jack	5.5 111.9±77.6	4.8 249.4±106.8	6.4 809.2±138.4	0.9 176.6±23.1	2.0 163.3±33.7	1.6 146.4±25.3	0.2 3.5±1	0.5 60±10	0.3 75. ±1.1	0.3 47.5±7.8	2.0 231.1±17.8
Barracuda	2.9 676.1±86.5	2.0 707.9±218	6.1 554.9±112.1	1.2 334.3±37.5	2.4 176.1±38.9	2.8 252.8±44.3	3.3 102.6±36	1.6 397.3±67.5	6.8 699.9±186.1	4.8 652.4±133.3	3.2 403.0±29.0
Bermuda Chub	4.1 2165.5±206.9	2.8 2193.8±460.8	8.7 1335.3±202.4	4.9 2598±260.6	10.1 1104.4±172.6	11.4 955.2±178.7	6.0 182.3±60.9	4.3 1143.4±187.7	7.4 811±132.5	3.6 574.7±94.2	6.4 1156.3±67.1
Black Jack	0.1 -	2.7 135.8±59.7	0.4 42.5±9.5	0.3 7.4±3.4	0.4 32.2±7	-	0.2 34.7±12.9	0.3 8.2±2.5	2.4 121.1±40.6	0.3 25.7±8.5	0.4 37.4±4.5
Blackfin Tuna	8.6 -	-	5.1 705.1±182.2	-	-	-	-	-	-	-	1.2 196.4±26.5
Bluerunner	16.5 8981.9±858	-	4.7 193.7±59.3	15.4 3342.9±387.8	14.3 1311.7±244.2	22.0 1971.3±349.4	33.0 1056.6±388.4	37.3 4289±926.9	16.9 1850.6±302.3	30.9 3794.6±732.8	20.5 2462.3±182.0
Creolefish	31.7 2314.4±308.4	63.9 11424.3±3030.1	39.9 3715.3±885.3	67.3 5464.5±894.9	59.4 4559.9±1059.5	52.1 8034.1±1253.8	43.0 2608.8±965.6	44.8 6065.6±1202.4	45.4 4067.7±1080.2	44.5 6221.9±1319.8	50.2 4924.2±445.4
Gray Triggerfish	0.7 60.7±7.3	1.7 86.5±37.6	1.1 211.9±44.6	0.5 7.7±3.5	1.5 103.9±20	0.6 138.2±33.8	0.1 62.1±34.7	0.6 17.8±5.5	0.3 7.5±1.1	0.6 428.3±107.3	0.8 152±17
Greater Amberjack	7.6 1.4±0.6	12.2 471.6±248.4	7.5 2342.5±618	1.9 100.2±69.9	2.1 295.2±103.3	1.1 571.5±155.5	2.1 1020.9±513.5	4.2 483.3±330.4	6.2 368.2±133.7	2.6 2367.7±508.2	4.0 1052.1±145.2
Horseye Jack	4.0 145.4±66.2	4.6 625.3±186.1	8.6 702.7±139.3	2.9 780.2±84.8	1.6 83.2±19.1	1.1 92.6±16.7	5.4 188.9±70.8	2.3 350.7±78	2.1 253±67.2	5.7 798.4±155.8	3.7 392.5±31.3

Table 7.22 (continued)

Species	Summer 94	Fall 94	Winter 95	Summer 95	Fall 95	Winter 96	Spring 96	Summer 96	Fall 96	Winter 97	Mean
Lesser Amberjack	-	-	-	-	0.3 21.8±3.3	-	-	-	-	-	0.1 8.6±0.9
Marbled Grouper	-	-	-	-	-	-	-	0.0 1.2±0.4	-	-	0.0 1.7±0.2
Ocean Triggerfish	-	-	-	-	-	0.2 23.1±3.8	-	0.1 19.6±3.2	-	-	0.1 12.2±0.7
Rainbow Runner	0.3 7.5±5.2	-	0.2 28.9±4.4	0.4 10.2±4.7	0.2 17.7±27.8	3.1 153.2±42.7	0.2 3.5±1	0.2 70.3±10.4	0.6 64.7±10.6	0.2 45.0±9.7	0.4 24.2±1.3
Scamp	0.1 -	1.4 122.4±30.8	3.4 494.2±123.5	0.4 41.2±31	0.7 705.5±38.3	0.5 231.3±61.1	0.4 143.9±63.4	0.7 19.1±5.9	3.0 136.1±42.9	0.5 26.4±4.3	0.9 185.9±26.8
Unidentified Grouper	-	-	-	-	-	- 43.9±10	-	-	- 36.7±16.6	- 654.1±149	0.0 78.3±13.1
Yellowtail Snapper	-	1.1 421.1±104.5	2.0 182.7±35.5	-	-	-	-	-	-	-	0.5 40.4±1.6
TOTAL	14941.3±1668.1	16944.1±4683.8	12388.6±2777.4	13171.9±2027.3	10193.5±2278.6	14996±2866.1	8321.1±3469.6	13045.2±2889	8699.5±2078.7	21767.1±4655.1	13855.5±1324.1

1995 (Table 7.22); on average, they made up 50% of the fishes observed (Table 7.22). With respect to depth, creolefish were concentrated in the mid- to upper-water column with approximately 90% of the individuals found above 60 m (Table 7.22). Seasonally, no consistent trends in creolefish abundance were found although their numbers tended to increase during fall and winter surveys (Table 7.22). The next most common species detected was usually blue runner (Table 7.22) making up an average of 20.5% of the fishes (Table 7.22). However, during the fall 1994, sample blue runners were absent (Table 7.22) and during the winter 1995 survey, they made up less than 5% of the fishes observed (Table 7.22). After creolefish and blue runner, no other species observed made up more than 10% of the fishes at GC18. The next most commonly observed species were Bermuda chub, almaco jack, greater amberjack, and barracuda (Table 7.22). While Bermuda chub typically were the third most abundant species observed, there was a large amount of fluctuation in the fourth through sixth positions (Table 7.22). Within these species it was difficult to discern any seasonal patterns with the exception of barracuda, as their presence increased during cooler periods (Table 7.22). With respect to depth, barracuda and Bermuda chub were predominately found above 40 m (Table 7.22). Almaco jack were found from the surface to 160 m but approximately 90% of these fishes were found from 40 to 100 m (Table 7.22). Greater amberjack were almost exclusively found from 40 to 100 m with few observed outside of this depth range (Table 7.22).

The ROV survey results below 100 m supported the acoustic findings with almost a complete lack of fishes (a total of 38 fishes of 4 species) were observed in eleven surveys below 100 m. Almaco jacks showed the widest depth range of any of the fishes observed at GC18, as they were common from the surface to mid-depth and one of the few fishes found below 100 m. Typically, most species exhibited a specific depth range and were less frequently found outside that range. Surface oriented species included bar jack, barracuda, Bermuda chub, blue runner and horseeye jack. Species common from 20 to 60 m included black jack, blackfin tuna, creolefish, grey triggerfish, rainbow runner and yellowtail snapper. Species commonly found from 60 to 100 m were almaco jack, greater amberjack and scamp, although, as previously mentioned, almaco jack had the widest depth range of any of the observed species.

Extrapolating the acoustic abundance data using the species composition estimates for each depth strata provided estimates of individual species abundance throughout the water column (Table 7.22). The total number of fish at the site ranged from a low of 8,321 (+/- 3,470, 95% CI, Table 7.22) during the spring 1996 sample to a high of 21,767 (+/- 4,655, Table 7.22) during the winter 1997 sample. Averaged over all sample periods 13,855 (+/- 1,206) fishes were found at GC18 and the six most abundant species (highest to lowest) were creolefish, blue runner, Bermuda chub, almaco jack, greater amberjack, and barracuda (Table 7.22). Creolefish dominated the observed fishes at the site. An average of 4,924 (+/- 445) were estimated at GC18 over the study period, which was twice as abundant as any other species on average (Table 7.22). The next most abundant species was blue runner (Table 7.22). As with the other sites, the abundance of blue runner was variable over the study period ranging from a high of 8,962 in the summer 1994 (Table 7.22) to a low of 0 during the Fall 1994 survey (Table 7.22). After the initial variability during the summer and fall 1994 surveys, blue runner abundance appeared to level off and the earlier heterogeneity decreased (Table 7.22).

Examination of the abundance of other dominant species over the study period showed large changes in the abundance of amberjack, almaco jack and Bermuda chub between sample periods

(Table 7.22). The only dominant species that did not undergo extreme changes in abundance over time was barracuda; however a two-fold decrease in abundance was observed from spring 1996 to summer 1996 samples (Table 7.22). With respect to a seasonal pattern in abundance, highest numbers of amberjack and almaco jack were consistently found in the fall and winter surveys while Bermuda chub estimates were highest during spring and summer surveys (Table 7.22). Barracuda estimates, as pointed out earlier, were much more stable than the other dominant species, but their abundance was typically higher in the cooler sampling periods (Table 7.22).

South Timbalier 54

Target Strength Distribution: The target strengths of the fishes at the ST54 production platform were variable over the study period and a RBD ANOVA with platform side as a block was used to test for differences in target strength due to year, season, time of day, current vectors, temperature, dissolved oxygen, depth, and selected interactions. Target strength varied significantly with season, time of day, depth, platform side, temperature, east current vector, north current vector, north squared current vector, east squared current vector, and the interaction terms (Table 7.23).

Temporal differences in target strength were detected between season, time of day, and the interaction of season and time of day (Table 7.23). Seasonally, target strengths were significantly larger in summer, decreased in spring and winter and lowest in the fall (Table 7.24). Two groupings of target strength with time of day were found with largest target strengths in the dawn and noon samples and significantly smaller target strengths in dusk and midnight samples (Table 7.25). No overall trend of target strength with season and time of day could be detected over the entire study period.

Spatially, target strength varied with platform side, depth, and the interactions of depth and time of day and depth and season. Target strengths were significantly different on all sides of the platform (Table 7.26). Significantly larger target strengths were found on the south side of the platform and smallest on the west (Table 7.26). With respect to depth, target strengths were larger near the surface and above the substrate than at mid-depth and immediately adjacent to the bottom (Table 7.27). While the interactions of depth and time of day and season and depth were significant (Table 7.23), no consistent trends were observed in these interactions.

Environmental variables that significantly affected target strength included temperature, northeast current vector, north squared, and east squared current vectors (Table 7.23). The relationship between temperature and target strength showed a slight increase in target strengths as temperature increased. Target strength also increased with north and east current vector and north and east squared vectors suggesting that at high current speeds, larger fishes were more common.

Grand Isle 94

Target Strength Distribution: Target strengths of fishes at the GI94 production platform were variable over the study period and a RBD ANOVA with platform side as a block was used to examine differences in target strength due to year, season, time of day, current vectors, temperature, dissolved oxygen, depth, and selected interactions. Target strength varied significantly with year,

Table 7.23. RBD ANOVA (block on platform side) results of vertical target strength (dB) with platform side, year, season, time of day, depth, current vectors, temperature, salinity, dissolved oxygen, and selected interactions at the ST54 petroleum platform.

Source	DF	SS	MS	F	Prob > F
Model	206	56386.345015	273.720121	34.40	0.0001
Error	1198	9532.903189	7.957348		
Corrected Total	1404	65919.248205			
	R-Square	C.V.	Root MSE		MEANTS Mean
	0.855385	-7.065331	2.8208772		-39.925621
Variables	DF	Type III SS	Mean Square	F Value	Pr > F
Side	3	6671.413209	2223.804403	279.47	0.0001
Year	1	40.001821	40.001821	5.03	0.0251
Season	2	603.144775	301.572388	37.90	0.0001
Diel	3	367.667924	122.555975	15.40	0.0001
Depth	4	2717.156715	679.289179	85.37	0.0001
Temperature	1	136.785653	136.785653	17.19	0.0001
Dissolved oxygen	1	14.260933	14.260933	1.79	0.1809
Salinity	1	26.135930	26.135930	3.28	0.0702
North vector	1	386.735952	386.735952	48.60	0.0001
East vector	1	70.694892	70.694892	8.88	0.0029
North squared vector	1	203.938224	203.938224	25.63	0.0001
East squared vector	1	352.882525	352.882525	44.35	0.0001
North * East	1	14.301287	14.301287	1.80	0.1803
Season * Diel	6	841.199710	140.199952	17.62	0.0001
Diel * Depth	12	1487.257674	123.938140	15.58	0.0001
Season * Depth	7	2822.349465	403.192781	50.67	0.0001

Table 7.24. Mean target strengths (dB), with Tukey's studentized means test results by season at South Timbalier 54.

Season	Mean Target Strength	Tukey's Means Test
Summer	-36.9	A
Spring	-39.5	B
Winter	-44.8	C
Fall	-46.4	D

Table 7.25. Mean target strengths (dB) with Tukey's studentized means test results by time of day at South Timbalier 54.

Time of Day	Mean Target Strength	Tukey's Means Test
Dawn	-39.9	A
Noon	-40.1	A
Midnight	-42.1	B
Dusk	-42.2	B

Table 7.26. Mean target strengths (dB) with Tukey's studentized means test result by platform side at South Timbalier 54.

Platform Side	Mean Target Strength	Tukey's Means Test
South	-38.5	A
East	-40.9	B
North	-41.6	C
West	-43.2	D

Table 7.27. Mean target strength (dB) with Tukey's studentized means test by water depth (m) at South Timbalier 54.

Depth (m)	Mean Target Strength	Tukey's Means Test
5-10	-39.7	A
15-20	-39.8	A
0-5	-40.2	A
10-15	-42.3	B
20-22	-46.2	C

season, time of day, depth, platform side, north current vector, east squared current vector, north current vector squared, north*east interaction, dissolved oxygen, temperature, season*time of day, time of day*depth, and season*depth (Table 7.28).

Temporal differences in target strength were detected between year, season, time of day, the interactions of season*time of day, time of day*depth, and season*depth (Table 7.28). Target strength was significantly different between three of the four years examined with significantly larger target strengths found in 1995 than all other years (Table 7.29). Target strengths from 1994 and 1996 were not significantly different from one another and the smallest target strengths were found in 1997 (Table 7.29). Target strengths were also significantly different with season (Table 7.30). Largest target strengths were found in the winter, followed by the spring and summer and smallest target strengths were found in fall (Table 7.30). While target strengths were significantly different with time of day, the contrasts were much smaller than in any other temporal variable examined (Table 7.31). Largest target strengths were found at midnight and dusk; dusk and noon samples were not significantly different from each other, and noon and dawn samples were not significantly different (Table 7.31).

Spatially, fish density varied with platform side and depth (Table 7.28). Target strength varied significantly on each side of the platform (Table 7.32). Largest target strengths were found on the south side, followed by the west and north with smallest target strengths on the east side (Table 7.32). Target strength varied significantly with depth and the largest target strengths were found from 40 to 60 m and from 0 to 5 m (Table 7.33). Intermediate target strengths were detected in the middle of the water column from 5 to 35 m, while smallest target strengths were found from 15 to 25 m (Table 7.33).

Environmental conditions also impacted target strengths based on results from the RBD ANOVA (Table 7.28). Target strengths were significantly affected by temperature, dissolved oxygen, north current vector, north squared, and east squared current vector (Table 7.28). Target strengths decreased slightly with temperature indicating larger fishes were found during fall and winter. Increases in dissolved oxygen, slightly increased target strengths. Target strengths increased with

Table 7.28. RBD ANOVA (block on platform side) results of vertical target strength (dB) with platform side, year, season, time of day, depth, current vectors, temperature, salinity, dissolved oxygen, and selected interactions at the GI94 petroleum platform.

Source	DF	SS	MS	F	Prob > F
Model	670	156624.55	233.77	19.54	0.0001
Error	6954	83185.95	11.96		
Corrected Total	7624	239810.49			
	R-Square	C.V.	Root MSE		MEANTS Mean
	0.653118	-7.857822	3.4587		-37.015
Variables	DF	Type III SS	Mean Square	F Value	Pr > F
Side	3	7030.663	2343.554	195.91	0.0001
Year	3	15542.064	5180.688	433.08	0.0001
Season	3	24760.063	8253.354	689.95	0.0001
Diel	3	385.026	128.342	10.73	0.0001
Depth	11	5357.266	487.024	40.71	0.0001
Temperature	1	6116.911	6116.911	511.35	0.0001
Dissolved oxygen	1	2419.286	2419.286	202.24	0.0001
Salinity	1	49.542	49.542	4.14	0.0419
North vector	1	377.012	377.012	31.52	0.0001
East vector	1	7.174	7.174	0.60	0.4387
North squared vector	1	491.833	491.833	41.12	0.0001
East squared vector	1	959.615	959.615	80.22	0.0001
North * East	1	453.694	453.694	37.93	0.0001
Season * Diel	9	801.514	89.057	7.44	0.0001
Diel * Depth	33	2909.926	88.180	7.37	0.0001
Season * Depth	31	6949.762	224.186	18.74	0.0001

Table 7.29. Mean target strength (dB) with Tukey's studentized means test by year at Grand Isle 94.

Year	Mean Target Strength	Tukey's Means Test
1995	-34.7	A
1994	-36.4	B
1996	-36.9	B
1997	-39.4	C

Table 7.30. Mean target strength (dB) with Tukey's studentized means test by season at Grand Isle 94.

Season	Mean Target Strength	Tukey's Means Test
Winter	-32.4	A
Spring	-34.7	B
Summer	-36.5	C
Fall	-38.6	D

Table 7.31. Mean target strength (dB) with Tukey's studentized means test by time of day at Grand Isle 94.

Time of Day	Mean Target Strength	Tukey's Means Test
Midnight	-35.7	A
Dusk	-36.0	B
Noon	-36.1	B
Dawn	-36.3	B

Table 7.32. Mean target strength (dB) with Tukey's studentized means test by platform side at Grand Isle 94.

Platform Side	Mean Target Strength	Tukey's Means Test
South	-34.3	A
West	-35.3	B
North	-36.7	C
East	-37.6	D

Table 7.33. Mean target strength (dB) with Tukey's studentized means test by water depth (m) at Grand Isle 94.

Depth (m)	Mean Target Strength	Tukey's Means Test
50-55	-34.1	A
40-45	-34.6	A B
55-60	-34.9	B
0-5	-35.0	B
45-50	-35.2	B
5-10	-35.3	B C
10-15	-36.0	C D
35-40	-36.3	D E
30-35	-36.9	E F
25-30	-37.2	F
15-20	-38.0	G
20-25	-38.4	G

the north current vector but decreased with north and east squared current vectors. These results show an increase in fish size with current speed; however, at excessive current speeds when currents over 40 cm/s were common, it is likely that fish size increased along with density.

Green Canyon 18

Target Strength Distribution: Target strength of fishes at the GC18 production platform varied over the study period and a RBD ANOVA with platform side as a block was used to examine for differences in target strength due to year, season, time of day, current vectors, temperature, dissolved oxygen, depth, and selected interactions. Target strength was significantly different with platform side, time of day, depth, north current vector, north current vector squared, and the interaction of time of day and depth (Table 7.34).

Temporal differences in target strength at GC18 were found with time of day and the interaction of time of day and depth (Table 7.34). Largest target strengths occurred at dawn, target strengths at dusk and noon were not significantly different, and smallest target strengths were found at midnight (Table 7.35). While the differences in target strengths were significant with respect to time of day the difference in dB was 1.5 dB or approximately 3.5 cm based on estimated fish lengths (Love 1971). With interaction of time of day and depth, no consistent trends were found except that the largest target strengths were found near the surface at all times.

Spatially, target strength varied with platform side and depth (Table 7.36). Significantly larger target strengths were found on the south side of the platform, with the west side second and the east and north sides smallest and not significantly different from each other (Table 7.36). The target strength differences between largest and smallest platform side at GC18 was the greatest observed at any of

Table 7.34. RBD ANOVA (block on platform side) results of vertical target strength (dB) with platform side, year, season, time of day, depth, current vectors, temperature, salinity, dissolved oxygen, and selected interactions at the GC18 petroleum platform.

Source	DF	SS	MS	F	Prob > F
Model	314	28349.978141	90.286555	12.56	0.0001
Error	3050	21933.357355	7.191265		
Corrected Total	3364	50283.335496			
	R-Square	C.V.	Root MSE		MEANTS Mean
	0.563805	-5.393938	2.6816534		-35.716060
Variables	DF	Type III SS	Mean Square	F Value	Pr > F
Side	3	7498.586156	2499.528719	347.58	0.0001
Year	3	13.604398	4.534799	0.63	0.5952
Season	3	46.340784	15.446928	2.15	0.0921
Diel	3	1059.419025	353.139675	49.11	0.0001
Depth	4	5300.963064	1325.240766	184.28	0.0001
Temperature	1	0.105401	0.105401	0.01	0.9036
Dissolved oxygen	1	0.000581	0.000581	0.00	0.9928
Salinity	1	0.464315	0.464315	0.06	0.7994
North vector	1	69.697543	69.697543	9.69	0.0019
East vector	1	14.455526	14.455526	2.01	0.1564
North squared vector	1	45.138318	45.138318	6.28	0.0123
East squared vector	1	0.069053	0.069053	0.01	0.9219
North * East	1	2.222840	2.222840	0.31	0.5783
Season * Diel	9	20.728956	2.303217	0.32	0.9687
Diel * Depth	12	531.820136	44.318345	6.16	0.0001
Season * Depth	12	92.638315	7.719860	1.07	0.3781

Table 7.35. Mean target strength (dB) with Tukey's studentized means test by time of day at Green Canyon 18.

Time of Day	Mean Target Strength	Tukey's Means Test
Dawn	-37.0	A
Dusk	-37.5	B
Noon	-37.8	B
Midnight	-38.5	C

Table 7.36. Mean target strength (dB) with Tukey's studentized means test by platform side at Green Canyon 18.

Platform Side	Mean Target Strength	Tukey's Means Test
South	-35.5	A
West	-37.2	B
East	-39.2	C
North	-39.4	C

the sites and was 4 dB or approximately 12 cm based on estimated fish lengths (Love 1971). Target strengths were significantly different at all depths examined, and the largest target strengths were found near the surface (Table 7.37). No target strength data were found below 95 m, in agreement with the low or zero estimated densities from the same region.

Table 7.37. Mean target strength (dB) with Tukey's studentized means test by water depth (m) at Green Canyon 18.

Depth (m)	Mean Target Strength	Tukey's Means Test
0-15	-35.5	A
55-75	-37.0	B
15-35	-37.7	C
75-95	-38.3	D
35-55	-39.9	E

Target strengths increased with the north current vector and north squared current vectors. These results show an increase in fish size with current speed; however, currents speeds rarely exceeded 40 cm/s, and it is unlikely that currents of this scale would alter the size distribution of fishes.

DISCUSSION

This study demonstrated the utility of merging hydroacoustics and visual survey techniques to study the fish assemblages at petroleum platforms. The combination of these techniques enabled us to measure the area of influence of these defacto artificial reefs, estimate abundance, size distribution and species composition throughout the water column over extended time periods.

Our results demonstrate the variability in the abundance, size distribution, and species composition of fishes associated with petroleum platforms. Our results were similar to earlier studies as

variability in the abundance of fishes is typical at both natural and artificial reefs (Gallaway 1980, De Martini *et al.* 1981, Gallaway *et al.* 1982, Putt 1982, Sale *et al.* 1984, Chang 1985, Shinn and Wicklund 1989, Bohnsak *et al.* 1991, Doherty 1991, Sale 1991, Bull and Kendall 1994, Stanley and Wilson 1996, 1997, 2000). The variability in density and the size distribution of fishes at petroleum platforms in this project was linked to temporal, spatial, and environmental variables.

Spatial variability was consistently observed at all study sites. Fish density and size distribution of fishes varied significantly with depth, platform side, and distance from the platform at ST54, GI94 and GC18. These results were similar to results from our past research (Stanley and Wilson 1995, 1996, 1997, 2000), findings by Morgan (1996), Gerlotto (1989) and Valdermarsen (1979). During mobile acoustic surveys of platforms sited as artificial reefs (Morgan 1996) and production platforms near Cameroon (Gerlotto *et al.* 1989), densities within 50 m of the sites were three to 10 times higher than in nearby open water. The results of this study showed that the highest densities of fishes were also observed within 50 m of all study sites; however, differences in the rate of decline with distance were found between sites of different water depths. At the shallowest site, ST54, the decline in fish density with distance was precipitous; at distances greater than 18 m, fish densities were similar to that of the open waters of the northern GOM. Results from this study at ST54 are similar to those of our earlier work at a site of similar water depth but geographically separated by over 300 km (Stanley and Wilson 1995, 1996, 1997, 2000). At the deeper sites a drop in fish density with distance from the site existed; however, fish density was higher to greater distances from the platform. A decline in fish density with distance did exist at both GI94 and GC18 as after a distance of approximately 50 m density approached those found in the open waters of the GOM.

The differences in the relationship of fish density with distance from site to site are likely due to the change in species composition and water clarity between shallow and deeper sites. At deepwater sites, the water clarity was much greater, allowing visually-oriented species the capacity to range farther away from the site while maintaining visual contact. Also, carangids were one of the dominant groups of fishes observed at the deeper sites. While these fishes associate with reefs, they are pelagic animals and thus much more likely to range farther away from a site. Despite these complications, hydroacoustics again illustrated its effectiveness in defining "area of influence" of the platform defined as the effective size of the artificial reef to the fish assemblage. As we defined it, the area of influence extended 10 m at GC18 and 18 m at GI94 and ST54 as fish densities within these distances were significantly higher than densities at greater distances. While these figures may lead to a conservative estimates of total abundance we feel that they more accurately reflect the true abundance of fishes at the sites.

The spatial variation observed with target strength and platform side revealed that target strengths were greatest on the south side of each of the study sites. Otherwise no uniformity was detected with target strength and platform side. Largest target strengths on the south side were also consistent with our past research (Stanley and Wilson 1997); however, we are at a loss to explain the rationale for larger fishes on one side of the platform. In an attempt to decipher the variation in fish density and target strength with platform side, current speed and direction data were modeled with these variables. While significant relationships were detected between density, target strength and current vectors, they did little to clarify the relationships. With respect to target strength, there was a

positive relationship at all sites with the north current vector. This relationship suggests that as current speed from the north increased than target strength would increase. However, based on our findings that the south side of the platform had significantly larger targets, one would expect a negative relationship between target strength and north current vectors, indicating that larger targets were found with southerly oriented currents. A more likely explanation of the larger target strengths on the south side of the platform may be due to platform design and their influence on fish behavior. That the most complex construction of structures is found at the north end, the well bay area, suggests that this area may be a refuge for smaller fishes and explains the smaller target strengths found on these sides. Past research has demonstrated a relationship between hole size and/or reef complexity with fish size (Shulman 1984, Hixon and Beets 1989) and since the construction of platforms on the south end is open with little shelter, larger fishes appear to be more common.

The last spatial variable examined, and one of the primary questions to be addressed by the research, was the effect of depth on the density and size distribution of fishes. Similar results with respect to density and water depth were found for the two sites on the continental shelf, ST54 and GI94. Highest densities were found adjacent to the surface and the bottom. These results were similar to those of our earlier research (Stanley and Wilson 1995, 1996, 1997, 2000) and those of Chang (1985), Shinn and Wicklund (1989) and Rooker *et al.* (1997). The most dramatic result of the project was the change in density with depth at the site on the continental slope, GC18. A significant and striking decrease in fish density with depth was found below 100 m, where only very low fish densities were detected. Previous research supports these findings as species richness in the Pacific was negatively correlated with depth, especially in tropical latitudes (Stevens 1996) and bottom trawl data from the shelf break in the GOM (water depth > 110 m) documented the presence of 69 species; however, low abundances were found and few reef dependent species were captured (Chittenden and Moore 1977). The concentration of fishes at GC18 near the surface is reflected in the fact that 88% of the fishes were found in the upper 60 m of the water column. While near-surface fish densities at GC18 were significantly higher than those below 60 m, the near surface densities were only one-half to two-thirds of values found at sites on the continental shelf. The decrease is likely due to the location of GC18 and its distance from the highly productive waters of the Mississippi River. Both ST54 and GI94 are regularly influenced by the highly productive waters from the Mississippi River as reflected in the lower surface salinities observed at these sites. The high salinities observed at GC18 varied little from surface to the bottom, indicative of low-productivity oceanic waters, and the oligotrophic conditions appear to be reflected in lower fish densities even near the surface.

Water depth also influenced the size distribution of fishes represented by low mean target strengths at the shallowest site (ST54) and largest at the deepest site (GC18). Target strength also varied with depth at each site. Significantly larger target strengths were found near the surface and then generally decreased significantly with depth at each site. These results are different than our earlier research where target strength was shown not to be significantly different with depth (Stanley and Wilson 1996, 1997). The variation in size distribution with depth is likely due to the change in species composition with depth detected at each site.

The environmental variables influenced the density and target strength of fishes at the sites examined but not to the extent of the spatial and temporal factors. Environmental variables,

including temperature, dissolved oxygen, current speed and direction, had their greatest impact on density and target strength at ST54 and least influence at GC18. The large impact at ST54 may be due to the large variation in environmental variables observed at the site. Temperatures varied by over 10 °C from summer to winter, and while a positive relationship existed between temperature and density, the highest observed densities were found during cooler periods suggesting a bell shaped relationship where an optima is reached at a middle value with lower density values at the extremes. A similar relationship between temperature and density existed at GI94. Where a significant relationship existed between temperature and target strength (ST54 and GI94), divergent results were found. At ST54, a positive relationship existed between temperature and target strength. This relationship may be due to the presence of larger migratory species during the summer, including cobia and tarpon. At GI94, a negative relationship existed between target strength and temperature, most likely because of the large influx of blue runner, a small carangid, during winter.

Dissolved oxygen had a significant effect on density at ST54 and GI94 and target strength on GI94. Due to the location of ST54, it is typically impacted by the hypoxic events common during the warmer months off Louisiana coast (Rabalais *et al.* 1985). During sampling trips in early June and late July of 1996, hypoxia was found at ST54. During June 1996, dissolved oxygen levels were less than 1 ppm from 20 to 22 m, and in July the hypoxic zone was substantially larger as dissolved oxygen levels were less than 0.5 ppm from 15 to 22 m. Not surprisingly, fish densities were zero in these areas and an overall positive relationship existed between dissolved oxygen and density at ST54. This relationship was reinforced during the winter when high dissolved oxygen levels were present and densities were highest. An interesting observation during the hypoxic events at ST54 were the elevated fish densities found above the hypoxic layers. When overall fish abundance was compared between hypoxic and oxic summer sample periods, no significant difference in abundance was detected. This result suggests that a vertical compression of the fishes into the oxygenated water column occurred with little or no migration away from the site. Dissolved oxygen also significantly affected fish density and target strength at GI94. While hypoxia was not observed at GI94 a positive relationship was found between dissolved oxygen and density. This observation may be due to the highest densities observed in the winter when dissolved oxygen levels were highest.

The relationships between current speed and direction with density and target strength were not consistent and varied with site. At ST54, a positive correlation was found with current speed and density while at GI94 and GC18, negative relationships were observed. Past research has found that highest fish densities were up current of petroleum platforms (Continental Shelf Associates 1982, Putt 1982), while Chang (1985) and Lindquest and Pietrafesa (1989) observed that fishes oriented down current of artificial reefs. Our earlier research (Stanley and Wilson 1996, 1997) did not identify a consistent relationship of fishes orienting up or down current of a petroleum platform and it would appear that results from this project support the conclusion that no consistent relationship existed between fish orientation and platform side. Since median current speeds ranged from 8 to 19 cm/s at all the sites, observed current speeds were not strong enough to influence the behavior of nektonic fishes with respect up or down current aggregations (Baxter 1969).

The temporal variation of density and target strength of fishes demonstrated the lack of consistent response to these variables. The longest temporal scale variable examined was between years and was only found to be significant at GI94 for both density and target strength. Highest densities were

found in 1997 (although only one sampling trip occurred in 1997) and largest target strengths in 1995 at GI94. Seasonal differences in density and target strength were observed at all sites where highest fish densities were found during cooler periods, specifically fall and winter. This finding is similar to our earlier research (Stanley and Wilson 1996, 1997) but contrary to other research at platforms and artificial reefs in the northern GOM (Gallaway 1980, Lukens 1981, Gallaway and Lewbel 1982, Putt 1982). These differences as outlined in Stanley and Wilson (1997) are presumably due to the differing sampling techniques between our research and others. Prior to our use of hydroacoustics to assess abundance of fishes at petroleum platforms, only visual surveys were performed. While visual surveys are effective in high-visibility conditions, they can be biased and underestimate abundance in low visibility conditions (Bohnsak and Bannerot 1986, Charbonnel *et al.* 1996). Since visibilities are generally poor during cooler periods in the northern GOM, it is probable that the earlier visual surveys underestimated the abundance of fishes and did not accurately reflect the total number of fishes at the sites.

The seasonal variation in target strengths observed at ST54 and GI94 was not consistent. Largest target strengths were found in the summer and smallest in the winter at ST54 while the reverse were detected at GI94. The results from ST54 were similar to those of our earlier research and were presumably due to the influx of large seasonal migrants such as cobia and tarpon in the summer. Unlike our earlier research (Stanley and Wilson 1996, 1997) variation due to time of day was observed at ST54 and GI94 in this study. At ST54, highest densities were found at midnight indicating some attraction to the site may have occurred due to the presence of high-intensity artificial lights at the site. At GI94 highest densities were found at dawn and lowest at noon and dusk. It is difficult to explain our results with classic crepuscular activity of fishes observed at natural and artificial reefs with highest densities during the day and lowest at night. On natural and artificial reefs it is hypothesized that as light level decreases, the attraction to sites by fishes may decrease due to a loss of visual acuity; also off-reef feeding at night is common and would cause a decrease in abundance of fishes at night (Munz and MacFarland 1973, Hobson 1975, McFarland *et al.* 1979, Heffman *et al.* 1982, Collins and Pettigrew 1988, Thorne *et al.* 1989). Target strengths were largest at ST54 during dawn and noon samples while at GI94 the target strengths were largest at midnight. The presence of high-intensity artificial lights at these sites may influence the behavior of fishes at these sites and cause the changes from expected patterns common at natural and unlit artificial reefs.

Despite the range of depths of the sample sites, many species were common to all the sites. While approximately 20 species were observed at a site over the study period, 6 species made up over 90% of the fishes observed on any survey. The dominant six species by site (highest to lowest abundance) were GC18: creolefish, blue runner, Bermuda chub, almaco jack, greater amberjack, and barracuda; GI94: blue runner, horseeye jack, red snapper, mangrove snapper, gray triggerfish, and barracuda; ST54: Atlantic spadefish, bluefish, blue runner, mangrove snapper, red snapper, and sheepshead. The species observed during this project agreed with the past research in the northern GOM (Sonnier *et al.* 1976; Gallaway 1980; Continental Shelf Associates 1982; Gallaway and Lewbel 1982; Putt 1982; Stanley and Wilson 1990, Rooker *et al.* 1997). Past research (Sonnier *et al.* 1976, Stanley and Wilson 1990, Rooker *et al.* 1997) noted that over 35 species were associated with platforms in the northern GOM, while we detected a total of 36 species over the three study sites. Despite the

disparate methods and temporal differences, there is general agreement in the species composition between this and past research indicating that platform assemblages are fairly predictable.

A unique observation from this study was the presence of yellowtail snapper at GC18. It is a common species on natural reefs in the Caribbean and southern GOM, but it has been rarely reported on natural reefs and platforms in the northern GOM (Darnell *et al.* 1982). During research trips in fall 1994, winter 1995 and spring 1995, yellowtail snapper were relatively common at GC18 but were not observed on any subsequent surveys. This finding suggests these fishes either migrated away or experienced significant natural mortality, became extinct at the site and did not recolonize.

The species observed at ST54 were very similar to those found at platforms of similar depth by Putt (1982) and Stanley and Wilson (1996, 1997). An exception was the observation of tarpon at ST54, a species not previously reported during any visual observation research at platforms. These fish are targeted by anglers, however, and caught near petroleum platforms (Stanley and Wilson 1990, 1991).

Seasonal migrations were common at each of the study sites. Since this research took place throughout the year, we were able to document the seasonality alluded to by past research but not well documented (Sonnier *et al.* 1976, Putt 1982, Rooker *et al.* 1997). Common seasonal migrations observed in the winter included an increase in the abundance of Florida pompano and bluefish at ST54; blue runner and barracuda at GI94 and GC18. Increased abundances during the summer season included the tarpon and cobia at ST54, cobia, red snapper, greater amberjack, and almaco jack at GI94, while no summer migrants were observed at GC18.

Since only six species made up over 90% of individuals at each site on any survey, platform assemblages could be characterized as not specious but as dominated by a few species. While the species found at each site were somewhat unique and the dominant species at each site was different, overlap of observed species existed between sites, especially adjacent sites. Previous researchers have noted a zonation of the assemblage of fishes associated with platforms and have divided the shelf waters of the northern GOM into three zones, coastal (water depth < 27 m), offshore (water depth 27 to 64 m) and bluewater (water depth > 64 m) (Gallaway 1980, Gallaway *et al.* 1981, Gallaway and Lewbel 1982). While our results generally agree with the outlined zonation, we feel that there is a larger crossover between zones than previously described, especially seasonally. These conclusions were also echoed by Rooker *et al.* (1997), during a survey of the platform High Island A389. While Rooker *et al.* (1997) generally agreed with the zonation as defined by Gallaway (1980) there are significant differences and considerable overlap with shallower sites, indicating that it is problematic to define species composition only by depth. Comparison of our research with species composition from the High Island A389 site (water depth 125 m) surveyed by Rooker *et al.* (1997) found the overall species composition was most similar to GC18 (water depth 219 m) including the dominance of creolefish. Rooker *et al.* (1997) documented the presence of a large number of midwater carangids, but due to their study design and emphasis on cryptic reef fishes, they were not directly enumerated.

Based on our research and examination of the results from past platform studies, there generally is a keystone species that dominates the composition of fishes at a site, e.g., Atlantic spadefish at

ST54, blue runner at GI4 and creolefish at GC18, but after the dominant species, overlap of species existed between sites. Additionally, large fluctuations in abundance of species were common at all the sites over the study period. Due to the apparent migration of many of the fishes common at platforms in the northern GOM, and because of the range of depths and geographical location of these sites, it is difficult to assign species to a certain zone. It may be more accurate to assign most species to a platform assemblage grouping with a secondary category on depth.

The trophic structure of the fishes at all three study sites was similar to results at natural reefs due to the dominance of planktivorous omnivores (Shaffer and Rosen 1961, Smith and Tyler 1972, Hobson 1974, 1992). However, while the trophic structure was similar between natural reefs and platforms, the species composition of planktivores at natural reefs is different from those found at platforms. At natural reefs, planktivorous Serranids, Chaetodontids, Pomacentrids, Holocentrids, Priacanthids and Balistids typically dominate the taxa (Starck and Davis 1966, Randall 1967, Hobson 1974, 1991), while at platforms, only a planktivorous serranid, creolefish, was found only at GC18. At the other sites planktivores dominate but the species were Atlantic spadefish at ST54, an Ehippid, and GI94 the dominant planktivore was blue runner, a Carangid. While the species composition at platforms in the northern GOM is generally different from that of natural reefs, the trophic structure is similar, as planktivores made 55 to 87% of the fishes observed at a site. This is similar to the results from natural reefs as planktivores can make up to 98% of the fishes found at natural reef (Hobson 1974, 1991, Sale *et al.* 1991). Another similarity between the trophic structure natural reefs and petroleum platforms is the relatively small proportion of piscivores. At natural reefs, piscivores make up 10 to 20% of the fishes at a site. This compares favorably with our results as piscivorous Serranids, Lutjanids and Carangids made up 10 to 24% of the fishes observed. At the trophic scale it would appear that the assemblage of fishes at petroleum platforms function similarly to the community of fishes at natural reefs with respect to the dominance of planktivores and the relative low numbers of piscivores.

Comparison of our results with other petroleum platform studies from the northern GOM revealed similarities and significant differences in density and abundance. Comparison of acoustically derived estimates of density from our past research showed similar density values with those from this project, especially at ST54 and GI94. Mean densities from our earlier work (Stanley and Wilson 1995, 1996, 1997) at a site in 24 m of water were 0.244 (+/- 0.062, 95% confidence interval) fish·m⁻³, while mean densities found during this project were 0.333 (+/- 0.034) fish·m⁻³ at ST54, 0.496 (+/- 0.017) fish·m⁻³ at GI94 and 0.029 (+/- 0.003) fish·m⁻³ at GC18. With the exception of GC 18, these values are consistent with those from Putt (1982) for a platform in 22 m of water off the Texas coast and an order of magnitude higher than the results of Continental Shelf Associates (1982) from four platforms surveyed in June 1980. Both Putt (1982) and Continental Shelf Associates (1982) used only visual surveys, Putt employed stationary cameras, and Continental Shelf Associates used a ROV for visual surveys. While the densities from previous studies are comparable to those estimated from our earlier and current research using hydroacoustics, the visual techniques utilized are of limited value in low visibility by the authors' admission; their conclusions are limited to characterizations of fish populations under high-visibility conditions. The densities found at platforms also are much higher than those from the open waters of the GOM. Morgan (1996) acoustically measured fish densities at artificial reefs in water depths from 20 to 35 m on the continental shelf off the Louisiana coast and found mean fish densities were approximately 0.01

fish·m⁻³. Based on all the results to date, it is apparent that large concentrations of fishes are found around these structures in the northern GOM but the debate continues as to the exact function of these structures on whether they increase productivity or attract existing organisms.

Total fish abundance estimates from the platforms in this project fall within the range of estimates at platforms from our earlier research in the GOM but are higher than those derived by visual-only surveys. Stanley and Wilson (1995, 1996, 1997) calculated that there were on average a total of 12,473 (+/- 6,522, 95% confidence interval) fishes at a site in 24m of water, while during this project, estimates of the total number of fish per site were 13,472 (+/- 1,346) at ST54, 28,952 (+/- 1,806) at GI94 and 13,856 (+/- 1,324) at GC18. Visual survey estimates were consistently lower than those derived using combined hydroacoustics and visual surveys. Putt (1982) estimated that a platform in 22 m of water had an average of 1,924 fish from July through September while single point count estimates by Continental Shelf Associates (1982) at four platforms off the Louisiana coast found 283 to 3,955 fish associated with individual platforms, in water depths from 28 to 31 m. Rooker *et al.* (1997) performed visual surveys in the upper 24 m of a platform in 125 m of water and estimated 3,586 fishes were found at the site; however, this number included many cryptic and reef-associated fishes that we did not include in our results. Moreover, these numbers did not include the large number of carangids and scombrids observed. The study by Rooker *et al.* (1997) would appear to be the best visual estimate of fishes directly associated with a platform as water clarity was not an issue, and their methodology was superior to that of earlier visual surveys. However, it is apparent that due to the open construction of platforms, visual surveys alone underestimate the large number of schooling species at these sites. Other differences may result from the larger near-field area of influence measured in this study. Earlier researchers did not directly measure the near-field area of influence and assumed it to be 5 m (Continental Shelf Associates 1982, Putt 1982). The near-field area of influence measured at ST54 and GI94 was 18 m while at GC18 it was defined as 10 m. The relationship between density and distance was well defined statistically at ST54 and GI94. Densities within 18 m of the site were significantly higher than at all other distances measured. At GC18 the relationship was not as well defined, but based on acoustic-derived density data and visual observations, the fishes remained close to the structure; 10 m was chosen as the near-field area of influence. Another possible explanation for the higher total fish abundance estimates from our research than those of Putt (1982) and Continental Shelf Associates (1982) may be size of the platform. Previous research (Rousenfell 1972, Ogawa *et al.* 1973, Grove and Sonu 1983; Rountree 1989; Stanley and Wilson 1990) indicated that fish abundance increased with increasing artificial reef size. That ST54 and GI94 were larger than three of the four platforms compared in other studies may explain some of the variation. Another likely explanation of the higher abundances detected during our research is the utilization of dual-beam hydroacoustics which did not influence fish behavior, was not limited by visibility, and could determine the area of influence of the reef. The combination of these factors allows for more accurate assessments of the abundance of fishes at these sites.

One of the most interesting results of the project was the comparison of abundance between the sites. GC18 was three to 10 times larger than the others, but the total abundance estimates were not significantly different than those of the smallest site (ST54), while the abundance estimates from GI94 were twice that of the other sites. Since structure size has been shown to affect fish density and the observation of higher density and abundance at the mid-size platform, it would appear that an

optimal reef size may exist. This is consistent with results from our earlier research (Stanley and Wilson 1991). Previous studies have shown that fish abundance is directly correlated with reef size to a maximum reef volume of 4,000 m³ (Ogawa *et al.* 1973) or 25,000 - 50,000 ft² (Rousenfell 1972). While the platform with the highest abundance, GI94, is larger than the optima from a reef volume perspective, due to the open construction of platforms, it is comparable to the optimal surface areas estimate from Rousenfell (1972). The low abundances observed at GC18 are likely as a result of its location and the water depth at the site. Fish abundance was essentially zero below 100 m and densities above 100 m were lower than the other sites. These two factors combined to produce the low abundances observed at the site. Because of the location of GC18, it is not influenced by the eutrophic waters on the continental shelf and the outflow from the Mississippi River. It is most influenced by oligotrophic oceanic waters from the Caribbean. The combination of water depth and oligotrophic conditions likely reduce the abundance of fishes at the GC18.

The 4,000 petroleum platforms in the northern GOM, provide an estimated 12.1 km² of additional hard substrate (Stanley 1997) to a ecosystem that is dominated by a mud/sand substrate (Parker *et al.* 1983). The total area of the Minerals Management Service (MMS) No Activity Zones (which includes known natural reefs and hard-bottom areas on the continental shelf in the northern GOM) is 292.81 km² (Dr. Ann Bull, personal comm). The additional hard substrate provided by the petroleum platforms acting as defacto artificial reefs increases the amount of hard-bottom habitat by 4.1% from Destin, FL to Brownsville, TX. Off Louisiana, the contribution is greater as the 3,600 platforms off the coast provide an estimated 10.9 km². The total area of the seventeen MMS No Activity Zones off the Louisiana coast is 104.5 km². Based on these estimates, platforms increase the hard bottom by 10.4%. The expansion of hard substrate habitat, especially habitat in the upper water column, has undoubtedly changed the dynamics of energy flow and influenced the utilization of marine resources, but it has proved difficult to quantify the impact of these structures. Since 1990, over 90% of the commercial red snapper harvest has occurred off the Louisiana and Texas coasts (Shirripa and Legault 1997), and while statistics do not exist on the percentage of red snapper caught at petroleum platforms, it is assumed to be a significant portion. Additional support of the importance of petroleum structures to fisheries was found in the highest published angler catch rates at petroleum platforms (Stanley and Wilson 1990). Fishes important to recreational and commercial fishing were common at the each of our study sites.

In recognition of the benefits of artificial reefs to marine fisheries in the northern GOM, Louisiana and Texas created artificial reef programs where retired petroleum platforms are the material of choice (Wilson *et al.* 1986, Stephan *et al.* 1990). The standard deployment of these structures as reefs involves placing the jacket on its side. However, this deployment minimizes vertical relief. If a platform such as GC18 were deployed in this manner, it would extend approximately 80 m off the bottom. Based on our results, a toppled deepwater artificial reef would be utilized by few fishes; a structure sited in this manner would have limited value as an artificial reef. This project is the first demonstrating the importance of vertical relief in maximizing the effectiveness of platforms as artificial reefs, especially with respect to deep water environments.

There are few assessments of the abundance of fishes at platforms in other areas of the world, despite the fact that over 2,500 of these structures are found outside the GOM (Aabel *et al.* 1997). Estimates of fish abundance at structures in the North Sea based on experimental netting and visual

surveys with ROVs have revealed high abundances of platform associated fishes (Valdermarsen 1979, AUMS 1987, ICIT 1991, Cripps and Aabel 1995, Cripps *et al.* 1995, Aabel *et al.* 1997). Mean density and abundance values were comparable to those from the northern GOM as $0.3 \text{ fish}\cdot\text{m}^{-3}$ were detected by Cripps and Abel 1995 and total abundance estimates in the region range from 9,000 to 80,000 fishes varying with water depth, platform size and location (Valdermarsen 1979, AUMS 1987, ICIT 1991, Cripps and Aabel 1995, Cripps *et al.* 1995, Aabel *et al.* 1997). These results along with those from the GOM and the west coast of Africa (Gerlotto *et al.* 1989) clearly demonstrate that petroleum platforms are effective artificial reefs in a variety of climates and with various species assemblages.

This research confirms the variability of fish assemblages associated with petroleum platforms and reinforces the need to sample on each side and throughout the water column to obtain an accurate estimate of fish abundance. It also demonstrates the importance of petroleum platforms to the marine environment of the northern GOM due to the high abundance of fishes found at the sites. Although some variance was observed, 10,000 to 30,000 fishes were found at a site at any one time, and since over 1,000 platforms are found in similar water depths, it is clear that these structures impact the fisheries of the region.

This study continues to demonstrate the utility of merging hydroacoustics and visual survey techniques to study the assemblage of fishes associated with petroleum platforms. The combination of these techniques allows for the measurement of the area of influence of these defacto artificial reefs, estimates of abundance, size distribution and species composition throughout the water column and over long time periods.

REFERENCES

- Aabel, J.P., T. Rasmussen, P. Jensen, B. Uppstad, U. Endresen, O. Ringdal, O. Grahl-Nielsen, and E. Solheim. 1990. Tissue hydrocarbon analysis and taste assessment in cod caught near the Oseburg field centre. RF-Rogaland Research Report No. RF-90/113. Stavanger, Norway. 56p.
- AUMS. 1987. Fish activity around North Sea oil platforms. Aberdeen University Marine Studies Ltd. Report. 46p.
- Avanti Inc. 1991. Environmental assessment for the regulatory impact analysis of the offshore oil and gas extraction industry proposed effluent guidelines. Volume 1 - Modeled impacts. U.S. EPA Contract No. 68-C8-0015. 225 p.
- Blaxter, J.H.S. 1969. Swimming speeds of fish. *FAO Fisheries Reports* 62:71-100.
- Bohnsack, J.A. and S.P. Bannerot. 1986. A stationary visual technique for quantitatively assessing community structure of coral reef fishes. *NOAA Tech. Rep. NMFS* 41:1-15.
- Bohnsack, J.A., D.L. Johnson, and R.F. Ambrose. 1991. Ecology of artificial reef habitats. Pp. 61-108. *In* W. Seaman Jr. and L.M. Sprague, eds. *Artificial habitats for marine and freshwater fisheries*. Academic Press. New York, N.Y.

- Bortone, S.A. and J.J. Kimmel. 1991. Environmental assessments and monitoring of artificial habitats, pp. 177-236. *In* W. Seaman, Jr. and L.M. Sprague, eds. *Artificial Habitats for Marine and Freshwater Fisheries*. Academic Press, New York, New York. 285 p.
- Brock, R.E. 1982. A critique of the visual census method for assessing coral reef fish populations. *Bull. Mar. Sci.* 32:269-276.
- Chang, K. 1985. Review of artificial reefs in Taiwan: emphasizing site selection and effectiveness. *Bull. Mar. Sci.* 37:143-150.
- Charbonnel, E., P. Francour, and J.G. Harmelin. 1996. Finfish population assessment techniques on artificial reefs: a review of the European union. Pp. 261-278. *In* A.C. Jensen, ed. *European Artificial Reef Research. Proceedings of the 1st EARRN Conference*, Southampton Oceanography Centre. Southampton, U.K.
- Chittenden, M.E., Jr. and D. Moore. 1977. Composition of the ichthyofauna inhabiting the 110 m bathymetric contour of the Gulf of Mexico, Mississippi River to the Rio Grande. *N.E. Gulf Sci.* 1:106-114
- Collins, S.P. and J.D. Pettigrew. 1988. Retinal topography in reef fishes. I. Some species with well developed areae but poorly developed streaks. *Brain Behavior and Evolution* 31:282-295.
- Continental Shelf Associates. 1982. Study of the effect of oil and gas activities on reef fish populations in Gulf of Mexico OCS area. Open File Report 82-10. New Orleans, Louisiana. US DOI, MMS, Gulf of Mexico OCS Region.
- Cripps, S.J. and J.P. Aabel. 1995. DP1 - Fish survey using R.O.V. data. RF-Rogaland Research Report No. RF-95/301. Stavanger, Norway. 12p.
- Cripps, S.J., G. Kjeilen, and J.P. Aabel. 1995. Ekofish - artificial reef. RF-Rogaland Research Report No. RF-95/205. 77p.+app.
- DeMartini, E.E., D.A. Roberts, and T.W. Ambrose. 1989. Contrasting patterns of fish density and abundance at an artificial reef and cobble bottom kelp forest. *Bull. Mar. Sci.* 44:881-892.
- Doherty, P.J. 1991. Spatial and temporal patterns in recruitment. Pp 261-293. *In* P.F. Sale, ed. *The ecology of fishes on coral reefs*. Academic Press. New York, N.Y.
- Gallaway, B.J. 1980. Pelagic, reef and demersal fishes and macrocrustacean / biofouling communities. Volume 2. *In* W.B. Jackson and E.F. Wilkens, eds. *Environmental assessment of Buccaneer gas and oil field in northwestern Gulf of Mexico, 1975-1980*. NOAA Technical Memorandum NMFS-SEFC 48.

- Galloway, B.J. and G.S. Lewbel. 1982. The ecology of petroleum platforms in the northwestern Gulf of Mexico: A community profile. USFWS Office of Biology Services, Washington, D.C. FWS 10BS-82/27. Open File Report 82-03.
- Galloway, B.J., L.R. Martin, R.L. Howard, G.S. Boland, and G.D. Dennis. 1981. Effects on artificial reef and demersal fish and macrocrustacean communities. Pp. 237-299. *In* B.S. Middleditch, ed. Environmental effects of offshore oil production: The Buccaneer gas and oil field study. Marine Science Volume 14. Plenum Press. New York, N.Y.
- Gerlotto, F., C. Bercy, and B. Bordeau. 1989. Echo integration survey around offshore oil extraction platforms off Cameroon: Observations of the repulsive effect on fish of some artificially emitted sounds. *Proceedings of the Institute of Acoustics* (19):79-88.
- Grove, R.S. and C.J. Sonu. 1983. Review of Japanese fishing reef technology. Southern California Edison Company. Rosemead, California. Technical Report 83-RD-137.
- Heffman, G.S., J.L. Meyer, and W.N. McFarland. 1982. The ontogeny of twilight migration patterns of grunts (Pisces: Haemulidae). *Animal Behavior* 30:317-326.
- Hobson, E.S. 1972. Activity of Hawaiian reef fishes during the evening and morning transitions between daylight and darkness. *Fishery Bulletin* 70:715-740.
- Hobson, E.S. 1974. Feeding patterns among tropical reef fishes. *American Scientist* 63:389-392.
- Hobson, E.S. 1991. Trophic relationships of fishes specialized to feed on zooplankters above coral reefs. Pp. 69-95. *In* P.F. Sale, ed. The ecology of fishes on coral reefs. Academic Press. New York, N.Y.
- Hixon, M.A. and J.P. Beets. 1989. Shelter characteristics and Caribbean fish assemblages: Experiments with artificial reefs. *Bull. Amr. Sci.* 44:666-680.
- ICIT. 1991. UKOOA survey of fish distribution and contamination. Report by the International Centre for Island Technology in association with Aberdeen University Research and Industrial Services Ltd. for UKOOA (90/1212), 94p.
- Lindquist, D.G. and L.J. Pietrafesa. 1989. Current vortices and fish aggregations: The current filed and associated fishes around a tugboat wreck in Onslow Bay, North Carolina. *Bull. Mar. Sci.* 44:533-544.
- Love, R.H. 1971. Dorsal aspect target strength of an individual fish. *J. Acoust. Soc. Am.* 62:1397-1403.
- Lukens, R.R. 1981. Ichthyofaunal colonization of a new artificial reef in the northern Gulf of Mexico. *Gulf Research Reports* 7:41-49.

- McFarland, W.N., J.C. Ogden, and J.N. Lythgoe. 1979. The influence of light in the twilight migrations of grunts. *Environmental Biology of Fishes* 4:9-22.
- Morgan, T.C. 1996. Hydroacoustic survey of fish distribution and abundance around an artificial reef and a standing platform in the northern Gulf of Mexico. M.Sc. Thesis. Louisiana State University. 26p.
- Munz, F.W. and W.N. McFarland. 1973. The significance of spectral position in the rhodopsins of tropical marine fishes. *Vision Research* 13:1829-1874.
- Ogawa, Y., S. Takeuchi, and S. Hatton. 1977. An estimate for the optimum size of artificial reefs. *Bull. Jpn. Soc. Fish. Oceanogr.* 30:39-45.
- Ott, L. 1982. *An introduction to statistical methods and data analysis*. 2nd edition. Duxbury Press. Boston, Mass. 774 p.
- Parker, R.O., Jr., D.R. Colby, and T.P. Willis. 1983. Estimated amount of reef habitat on a portion of the U.S. South Atlantic and Gulf of Mexico continental shelf. *Bull. Mar. Sci.* 33:935-940.
- Pennington, M. 1983. Efficient estimators of abundance for fish and plankton. *Biometrics* 39:281-286.
- Pennington, M. 1985. Estimating the relative abundance of fish from a series of trawl surveys. *Biometrics* 41:197-202.
- Pond, S. and G.L. Pickard. 1983. *Introductory dynamical oceanography*. Pergamon Press. 2nd edition. New York, N.Y.
- Putt, R.E., Jr. 1982. A quantitative study of fish populations associated with a platform within Buccaneer oil field, northwestern Gulf of Mexico. M.Sc. Thesis. Texas A&M University. College Station, Tex.
- Rabalais, N., M.J. Dagg, and D.F. Boesch. 1985. Nation wide review of oxygen depletion and eutrophication in estuarine and coastal waters: Gulf of Mexico.
- Reggio, V.C., Jr. 1987. Rigs-to-reefs: the use of obsolete petroleum structures as artificial reefs. OCS Report MMS 87-0015. New Orleans, LA. U.S. Department of the Interior. Minerals Management Service. 17p.
- Rooker, J.R., Q.R. Dokken, C.V. Pattengill, and G.J. Holt. 1997. Fish assemblages on artificial and natural reefs in the Flower Garden Banks National Marine Sanctuary. *Coral Reefs*. 16:83-92.
- Rountree, R.A. 1989. Association of fishes with fish aggregation devices: Effects of structure size on abundance. *Bulletin of Marine Science* 44:950-959.

- Rounsefell, G.A. 1972. Ecological effects of offshore construction. *J. Mar. Sci.* 2:1-28.
- Sale, P.F. 1984. The structure of communities of fish on coral reefs and the merit of an hypothesis testing manipulative approach to ecology. Pp. 478-490. *In* D.R. Strong, D. Simberloff, L.G. Abele, and A.B. Thistle. *Ecological communities: Conceptual Issues and the Evidence*. Princeton Univ. Press. Princeton, N.J.
- Sale, P.F. 1990. Recruitment of marine species: Is the bandwagon rolling in the right direction? *Trends in Evolutionary Ecology* 5:25-27.
- Sale, P.F. 1991. Reef fish communities: Open nonequilibrium systems. Pp. 564-600. *In* P.F. Sale, editor. *The ecology of fishes on coral reefs*. Academic Press. New York, N.Y.
- Sale, P.F. and W.A. Douglas. 1981. Precision and accuracy of visual census technique for fish assemblages on coral patch reefs. *Env. Biol. Fish.* 6:333-339.
- Schaffer, B. and D.E. Rosen. 1961. Major adaptive levels in the evolution of the actinoterygian feeding mechanism. *Am. Zool.* 1:187-204.
- SAS Institute Incorporated. 1986. SAS user's guide: Statistics. Version 6. SAS Institute. Cary, NC. 1290 p.
- Scarborough-Bull, A. and J.J. Kendall, Jr. 1994. An indication of the process: Offshore platforms as artificial reefs in the Gulf of Mexico. *Bull. Mar. Sci.* 55:1086-1098.
- Schirrapa, M.J. and C.M. Legault. 1997. Status of the red snapper in U.S. waters of the Gulf of Mexico updated through 1996. National Marine Fisheries Service, Southeast Fisheries Science Center, Miami. Contribution MIA-97/98-5. 37p
- Shaw, R.F., J.H. Cowan, Jr., and T.L. Tillman. 1985. Distribution and density of *Brevoortia patronus* (Gulf menhaden) eggs and larvae in the continental shelf waters off western Louisiana. *Bull. Mar. Sci.* 36:96-103.
- Shinn, E.A. and R.I. Wicklund. 1989. Artificial reef observations from a manned submersible off southeast Florida. *Bull. Mar. Sci.* 44:1051-1057.
- Shulman, M.J. 1984. Resource limitation and recruitment patterns in coral reef assemblage. *J. Expt. Mar. Biol. Ecol.* 74:85-109.
- Smith, C.L. and J.C. Tyler. 1972. Space resolution sharing in a coral reef fish community. *Bull. Nat. Hist. Mus.* 14:125-170.
- Sonnier, F., J. Teerling, and H.D. Hoese. 1976. Observation on the offshore reef and platform fish fauna of Louisiana. *Copeia* 1976:105-111.

- Stanley, D.R. and C.A. Wilson. 1997. Seasonal and spatial variation in abundance and size distribution of fishes associated with a petroleum platform in the northern Gulf of Mexico. *Canadian Journal of Fisheries and Aquatic Sciences* 54:1166-1177.
- Stanley, D.R. and C.A. Wilson. 1996. The use of hydroacoustics to determine abundance and size distribution of fishes associated with a petroleum platform. *International Council on the Exploration of the Sea, Journal of Marine Science* 202:473-475.
- Stanley, D.R. and C.A. Wilson. 1995. Detection of the effect of scuba divers on fish density and target strength utilizing dual-beam hydroacoustics. *Transactions of the American Fisheries Society* 124:946-949.
- Stanley, D.R. and C.A. Wilson. 1991. Factors affecting the abundance of selected fishes near oil and gas platforms in the northern Gulf of Mexico. *Fishery Bulletin* 89:149-159.
- Stephan, C.D., B.G. Dansby, H.R. Osburn, G.C. Matlock, R.K. Riechers, and R. Rayburn. 1990. Texas Artificial Reef Fishery Management Plan. Fisheries Management Plan Series Number 3. Texas Parks and Wildlife Department, Coastal Fisheries Branch, 4200 Smith School Road, Austin, Tex.
- Stevens, G.C. 1996. Extending Rapoport's rule to Pacific marine fishes. *J. Biogeogr.* 23:149154.
- Thorne, R.E., J.B. Hedgepeth, and J.A. Campos. 1989. The use of stationary hydroacoustic transducers to study diel and tidal influences of fish behavior. *Bull. Mar. Sci.* 44:1058-1064.
- Valdemarsen, J.W. 1979. Behaviour aspects of fish in relation to oil platforms in the North Sea. *ICES C.M. B:27*.
- Wilson, C.A., V.R. Van Sickle, and D.L. Pope. 1987. Louisiana Artificial Reef Plan. Louisiana Department of Wildlife and Fisheries. Bulletin 41. 130p.
- Wilson, C.A. and D.R. Stanley. 1991. Technology for assessing the abundance of fish around oil and gas structures. Pp. 115-119. *In* M. Nakamura, R.S. Grove and C.J. Sonu, eds. Recent advances in aquatic habitat technology. Southern California Edison Company. Environmental Research Report Series 91-RD-19.
- Witzig, J. 1986. Fishing in the Gulf of Mexico 1984 marine recreational fishing results. Proceedings: Sixth annual Gulf of Mexico Information Transfer Meeting. OCS Study MMS 86-0073. New Orleans. U.S. Department of the Interior. Minerals Management Service. Pp. 103-105.

RIGS AND REEFS: A COMPARISON OF THE FISH COMMUNITIES AT TWO ARTIFICIAL REEFS AND A PRODUCTION PLATFORM

Charles A. Wilson

Mark Miller

Department Oceanography and Coastal Sciences
Louisiana State University

Rick Kasprzak

Louisiana Department of Wildlife and Fisheries

Dave Stanley

Beak International

There are approximately 5,500 oil and gas platforms (platforms) in the northern Gulf of Mexico (GOM), most of which are off the Louisiana coast. Although there is some debate about the significance of these “artificial reefs”, platforms have a total surface area estimated to be a fraction (4%) of the 2800 km² of naturally occurring hard bottom found in the otherwise silty environment of the northern Gulf (Parker et al. 1983; Stanley and Wilson 1990, 1991, 1997). However, platforms constitute a larger percentage of the hard substrate off Louisiana due to the general absence of natural hard substrate. It is safe to say that the oil and gas industry in the GOM has created the most extensive de facto artificial reef system in the world.

Stanley and Wilson (1996, 1997, 1998, 2000) documented species compositions and abundances of fishes at several platforms off Louisiana; they concluded that each standing platform seasonally serves as critical habitat for 10,000-20,000 fishes, many of which are of recreational and commercial importance. Undoubtedly, this new habitat has influenced fish populations in the GOM. Habitat provided by petroleum platforms has likely affected processes such as energy (food) availability, habitat, recruitment, competition, and predation (Menge and Sutherland 1987; Doherty and Williams 1988; Bohnsack et al. 1991; Stanley and Wilson 2000).

The concept of using oil and gas platforms as artificial reefs is generally held in high regard and is strongly supported by recreational fishers and their respective organizations. However, the scientific community still questions the real “habitat” value of artificial reefs in general, and the practical value of retaining platforms as artificial reefs. There are many management oriented questions involving the effect of water depth, geographic location, and general reef configuration; more perplexing scientific questions concern attraction versus production and the comparison of artificial reef fish communities to natural reef fish communities (Seaman and Jensen 2000). These and other issues must be addressed to determine both the effectiveness of these structures as artificial reefs and their impacts on the marine ecosystem in the region.

The general practice for incorporating platforms into reef programs involves two options. The Louisiana Artificial Reef Program (LARP) has configured many reef sites by laying a platform on its side (by toppling in place or moving a platform from another location). More recently LARP has

followed the Texas Artificial Reef Program by removing the upper 30 m portion of a platform to comply with Coast Guard regulations (partial removal). Stanley and Wilson (1997) raised questions about the habitat importance of vertical profile leading us to further examine the practice of partial removal of platforms for reef site creation as opposed to the more common practice of toppling (Stanley and Wilson 1997, 1998).

The proximity of the several artificial reef projects in similar water depth afforded us the opportunity to compare several platform configurations to one another. Therefore the purpose of this study was to compare the fish communities associated with three platform/artificial reef configurations. Reef configurations included a production platform, toppled in place as an artificial reef (West Cameron (WC) 617A), a nearby partially removed platform (HI A355), and an operating production platform (HI A350). The goals of this study were to identify species composition at each site; to estimate the fish density/biomass associated with each site; to determine the effects of platform side, depth, and distance from each site on fish biomass .

MATERIALS AND METHODS

This research project was designed to compare the fish resources associated with a standing platform and two artificial reefs located in a similar geographic region in the northern GOM off the Texas/Louisiana border (Figure 7.42). The standing platform, HI A350 (High Island), owned by Shell Corporation, is located at 28° 1.130' north latitude and 93°27.512' west longitude. This eight pile structure was installed in 1976 in 90 m of water. This standing platform occupies an area in the water column measuring 90 m in height and has a 68m x 40m footprint.

The toppled platform, WC 617A, formerly owned by Mobil Corporation, is located at 28° 3.664' north latitude and 93° 18.805' west longitude at a depth of 98 m. It was installed as an eight pile structure in 1976. In July 1992, the upper deck was removed approximately 3 m above the waterline, then the jacket was severed below the mudline with explosives, and the remaining structure was toppled in place. This toppled platform occupies an area in the water column measuring 31 m in height and has an 84 m x 60 m footprint.

The partially removed platform, HI A355, formerly owned by Occidental Petroleum, is located at 28° 2.491' north latitude and 93° 42.551' west longitude in 90 m water depth. It was installed as an eight pile structure in 1978. In January 1996 it was partially removed mechanically cutting it at -27.5 m. The upper jacket was split vertically, and a four pile portion (½ of the upper portion) was placed on the southeast side of the main structure. This partially removed platform occupies a volume in the water column measuring 68m high and has a 60m x 40m footprint; the four pile section on the south side measures 32 m high with a 24m x 18m footprint.

Survey Designs

Dual beam hydroacoustic surveys (Stanley and Wilson 1997) were accomplished with a stationary array of four transducers at the standing platform and with towfish mounted single transducer mobile

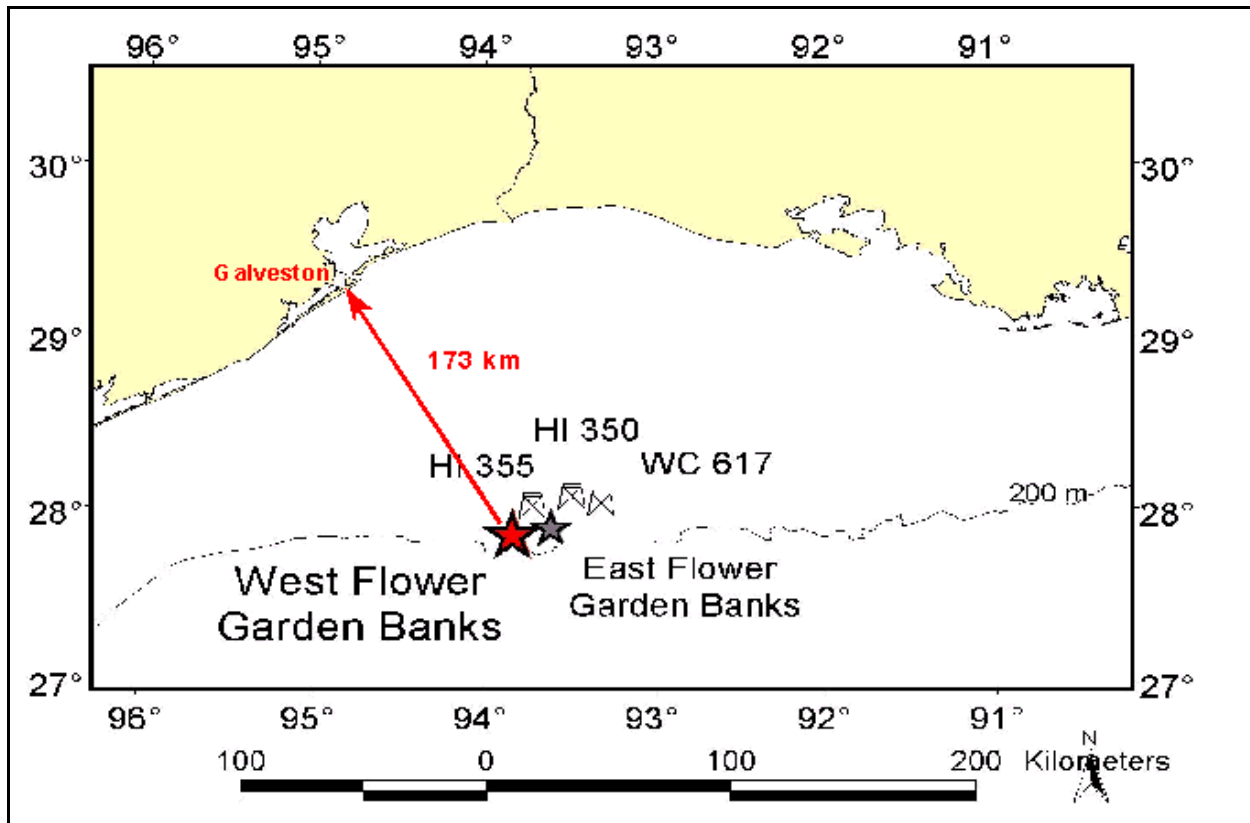

Figure 7.42. Map of the sites surveyed in June 1999 and 2000.

surveys at the two reef sites. The standing platform was surveyed in June 1999 with stationary dual beam hydroacoustic equipment developed during past research (Wilson and Stanley 1991; Stanley and Wilson 1995, 1996, 1997, 1998, in press). Sampling consisted of three downward-oriented transducers (120 kHz) placed approximately 3 m below the surface, one on each side of the platform except the west side due to an equipment failure as described in Stanley and Wilson (1998). The downward facing transducers provided acoustic coverage from a depth of 5 m to within 1 m of the substrate. The use of three transducers enabled the calculation of density throughout the water column on three sides of the platform. Acoustic sampling consisted of two hour time blocks over a 24 hour interval encompassing four periods (dawn, noon, dusk and midnight). Hydroacoustic data were collected sequentially from each transducer in five minute intervals.

A towed transducer was used to estimate the acoustic biomass, density, and size frequency distribution of fishes associated with the two artificial reef sites. A 120 kHz downward oriented transducer, mounted on a v-fin tow body was towed from the R/V Pelican (June 1999) and the M/V Epic Mariner (June 2000). The towfish was held in place 5 m out from the hull and flown 3 m below the surface at a speed of approximately 2 m/sec. The use of a towed downward oriented transducer enabled the calculation of density and size distribution of fishes from a depth of 5 m to 1 m from the bottom or within 1 m of the each structure. Data were georeferenced with a Garmin GPS III global positioning system (GPS) and a Garmin GB 21 differential beacon receiver. The navigation data stream, updated once per second, was incorporated into the acoustic data string and then stored on a PC.

Mobile surveys at the two artificial reef sites consisted of alternating east-west then north south transects over the target area. In June 1999, a total of 100 transects (50 east-west and 50 north-south) occurred over each of the artificial reef sites. In June 2000, efforts were reduced to a total of 40 transects (20 east-west and 20 north-south) which produced the same statistical power as the 1999 survey. Transects were conducted out to a distance of 100m from each side of the artificial reef. Each transect covered a linear distance of approximately 300 m, passing over the top of the artificial reef site in the center of each transect.

Acoustic data were collected with 120 kHz transducers which had been factory calibrated to a - 42 dB tungsten sphere and a Biosonics model DT5000 scientific echosounder/multiplexer. All data were collected with source levels at 223 dB / Pa at 1 m. Sampling rate was 5 pings /sec with a pulse width of 0.4 ms. Received signals were adjusted for spreading loss by applying a 40 log R time varied gain, digitized and recorded on the computer hard drive. The data collection threshold was -55 dB, corresponding to a minimum detection of a 2.5 cm fish (Love 1971).

Digitized hydroacoustic data were processed with Biosonics Visual Analyzer 4.02. Recent software advances allowed simultaneous estimates of sigma (target strength) and mean volume backscatter (reflected acoustic energy) for each depth strata. These parameters are used to estimate fish size and fish density/m³. Ten meter depth strata were assigned for processing data from each site. Data files were replayed through Visual Analyzer with the bottom tracking feature turned on; the bottom was then manually inspected and adjusted to insure that neither the bottom and/or platform were included in the analyzer window. Bottom correction was not necessary for the standing site as the transducers were fixed and digitized to exclude the structure during the collection process.

The standing platform data were analyzed in 5 minute blocks for each side as in previous studies (Stanley and Wilson 1997). Analyzer outputs for the standing platform included volume backscatter/m³, fish density/m³, and mean target strength/m³. A Visual Basic program was used to extract data of interest from analysis outputs and to compile the results into a site specific database for statistical analysis (Stanley and Wilson 1997).

Mobile transects were analyzed at one second resolution (corresponding to a 2 meters linear distance) to determine the volume backscatter/m³ and target strength/m³ within each depth stratum along the transect. Analysis of each one second block of data provided location specific mean volume back scatter. Individual target strength information was acquired by extracting ping specific data which could be selectively output as a text file. A Visual Basic program was used to calculate an average target strength for each target, by strata, and location.

Data Analysis

Fish density (number/m³) was calculated based on the volume backscatter (reflected acoustic energy) of a known volume (cubic meter) of water divided by the average target strength (reported as sigma) from that same volume of water. Density estimates are dependent upon accurate estimates of the mean sigma of the targets within that same volume of water. Analysis of standing platform data with Visual Analyzer version 4.02 produced useful density estimates. However, analysis of the mobile data required refinement of TS for accurate density comparisons. The accuracy of target

strength increases with repeated acoustic hits on the same target (Jim Dawson, pers. com.¹). Since research operations were from a vessel moving at 2 m/s and transmitting acoustic pulses (pings) at a rate of 4-5 pings per second, the chance of hitting a target multiple times was very low. In many cases data processing resulted in a volume backscatter, but no sigma for that same volume of water. In estimating fish densities for mobile surveys, a mean sigma (proxy sigma) was calculated for a 30 m linear distance by stratum. We assumed, that fish size was similar in the same stratum for 30 linear meters. If sigma was missing, but a volume backscatter volume was available, the proxy sigma was substituted to estimate density.

Statistical Analysis

Statistical analysis of these data included volume backscatter (reflected acoustic energy-volume backscatter or SV) as a dependent variable. Volume backscatter is an exponential number provided by the Biosonics Visual Analyzer and is a per “ping” average of acoustic energy/m³. For regression analysis and calculation of means, SV is converted into a “arithmetic form,” called “Fish Energy,” with the relationship,

$$\text{Fish Energy} = 10^{sv/10}$$

where SV is volume backscatter (reflected acoustic energy) of a known volume of water (cubic meter) “Fish Energy” should be considered to be an acoustic measurement of fish biomass as it is based on the average acoustic reflectance/m³. The second dependent variable in our analysis was density/m³, which was generated from the Visual Analyzer analysis for HI A350 and calculated for the mobile surveys of two reef sites using the equation,

$$10^{SV/10} / 10^{TS/10} = \text{fish/m}^3$$

where SV is the volume backscatter/m³ and TS is the mean sigma assigned (or the proxy sigma discussed above).

A randomized block analysis of variance (RBA) was used to examine the main effects of SV and log transformed density ($\log_{10}(\text{fish density} + 1)$) at HI A350 and TS at all sites as described by Stanley and Wilson (1997). Class variables included time of day (time of day (TOD): dawn, noon, dusk, midnight), platform side (north, south, east) ten meter depth strata (strata), and their interactions. RBA's were also used to examine the main effects of TS at all sites. Class variables for TS RBA's include TOD, strata, platform side, and all two-way interactions. Class variable for WC 617A and HI A355 include TOD, depth strata, reef side, horizontal 10 meter distance intervals away from the reef structure (away), and all two-way interactions. Tukey's standardized range tests (Ott 1982) were used to compare the means of significant variables. Statistical tests were reported as significant at the alpha < 0.01 level.

¹Jim Dawson, BioSonics, Inc., personal communication.

Logistic Regression

Traditional parametric analyses were not used for analysis of mobile acoustic data due to the large number of zero values and the problem of autocorrelation that occurs in mobile acoustic data (Trexler and Travis 1993). Analysis consists of converting the dependent variable into a discrete form (e.g. presence/absent, agree/disagree, etc). The regression model then assumes a binomial distribution of errors (Trexler and Travis 1993, Garrison et al. 2000). A binomial logistic model was constructed for each site using the presence or absence of "fish energy" to evaluate the probability, or chance, of finding fish. This analysis was performed on the primary output of acoustic data analysis which was reported in 1 second intervals. Class variables for the artificial reef sites included orientation (over the platform, and north, south, east, and west sides), depth strata, away, TOD, year (1999 or 2000), site (standing or toppled) and transect (ordinal transect number).

The Statistical Analysis System (SAS 2000) includes a program called Proc Logistic that uses logistic analysis. When run with the intercept option, it produces a Type III analysis of main effects, which provides an estimate of the significance of class variables, based on a maximum likelihood test (Chi Square test of significance $p=0.01$) that we used to compare class variables. When run without the intercept, Proc Logistic provides an odds ratio estimate, which is the probability of finding fish in a given class variable cell compared to another cell.

Fish Abundance Estimation

Total fish abundance estimates at each site were calculated by determining a 20m near-field area of influence of each reef site or platform, then multiplying mean density ($\#/m^3$) values by stratum and side by the volume of water on each side of or over the platform (Stanley and Wilson 1998). Fish density within the centers of each platform was not measured with acoustics due to interference by structural members and was assumed to be the average of the density estimates of the four sides of the platform; it was estimated by multiplying the estimated fish density of the center by the volume of water in the center of the platform.

VISUAL SURVEYS

Visual surveys were conducted with a Deep Ocean Engineering Phantom HD2 ROV with standard visual census techniques and recording video on S-VHF tape (Bohnsack and Bannerot 1986). Cryptic fishes were not included in the video surveys results since they could not be assessed in the acoustic surveys. Point counts were conducted to identify individual fish to the lowest taxonomic level. Results were expressed as percent composition by stratum at each site.

During mobile surveys, an ROV was deployed from the research vessel anchored near each artificial reef site. During the survey of HI A355, the ROV was flown down to the bottom, stopping every 10 m for approximately 1 minute. During the survey of WC 617A, the ROV was flown down to the top of the artificial reef complex and then run along the south side, east side, west side, and over the top of the toppled platform. Video surveys of HI A350 were conducted directly from the standing platform. The ROV was flown from the surface to the bottom, stopping every 10 m for approximately 5 minutes.

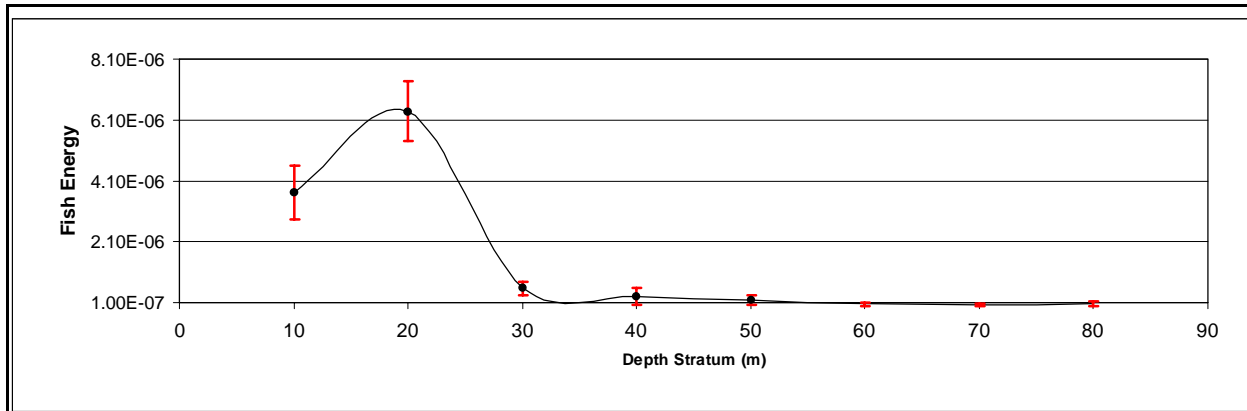

Figure 7.43. Mean fish energy/m³ (antilog of volume backscattering) by depth stratum for HI A350. Error bars are 95% confidence intervals.

RESULTS

HI A350 Results (Standing Platform)

The stationary hydroacoustic survey of HI A350 was conducted in June 1999. A five-day trip was made to the platform where acoustic data and ROV data were collected.

Volume Backscatter (SV), the measure of the amount of reflected acoustic energy, or fish biomass /m³, varied with several of the modeled parameters based on RBAs. SV values ranged from 0.0 to 2.2 x 10⁻⁴ /m³; the mean value at HI A350 was 1.2 x 10⁻⁶ /m³. SV was affected by depth and time of day and the interactions of side and depth. SV was highest at the surface and lowest near the bottom. The upper two strata were statistically different from one another and both were significantly higher than the remaining strata (3 - 8) (Figure 7.43). Fish biomass also varied significantly with TOD and was highest at dusk followed by noon, morning, and midnight.

Estimates of fish density were based on SV divided by the average target strength (TS) of the fish in the same volume of water and in general followed SV patterns. Based on RBAs, estimated density was affected by depth and TOD and their interactions. Estimated fish densities ranged from 0.0 to 0.7 fish/m³; the mean fish density at HI A350 was 0.015 ± .003 (mean ± std error) fish/m³. Densities were highest in the upper part of the water column and generally decreased with depth (Figure 7.44). Density also varied with time of day and was highest at dusk and lowest at midnight.

Target Strength

Target strength (TS) is an acoustic measure of fish size which was used as a dependent variable to test for relationships between fish size with TOD, orientation, and depth and their interactions. TS ranged from -52.46 to -30.75 dB; the average TS at HI A350 was -40.73 dB which is equivalent to a 12.5 cm fish. Based on the RBAs, TS at the standing platform was affected by depth and time of day. Fish were significantly larger near the surface and smaller near the bottom and were significantly larger in the morning than at noon, dusk, and midnight.

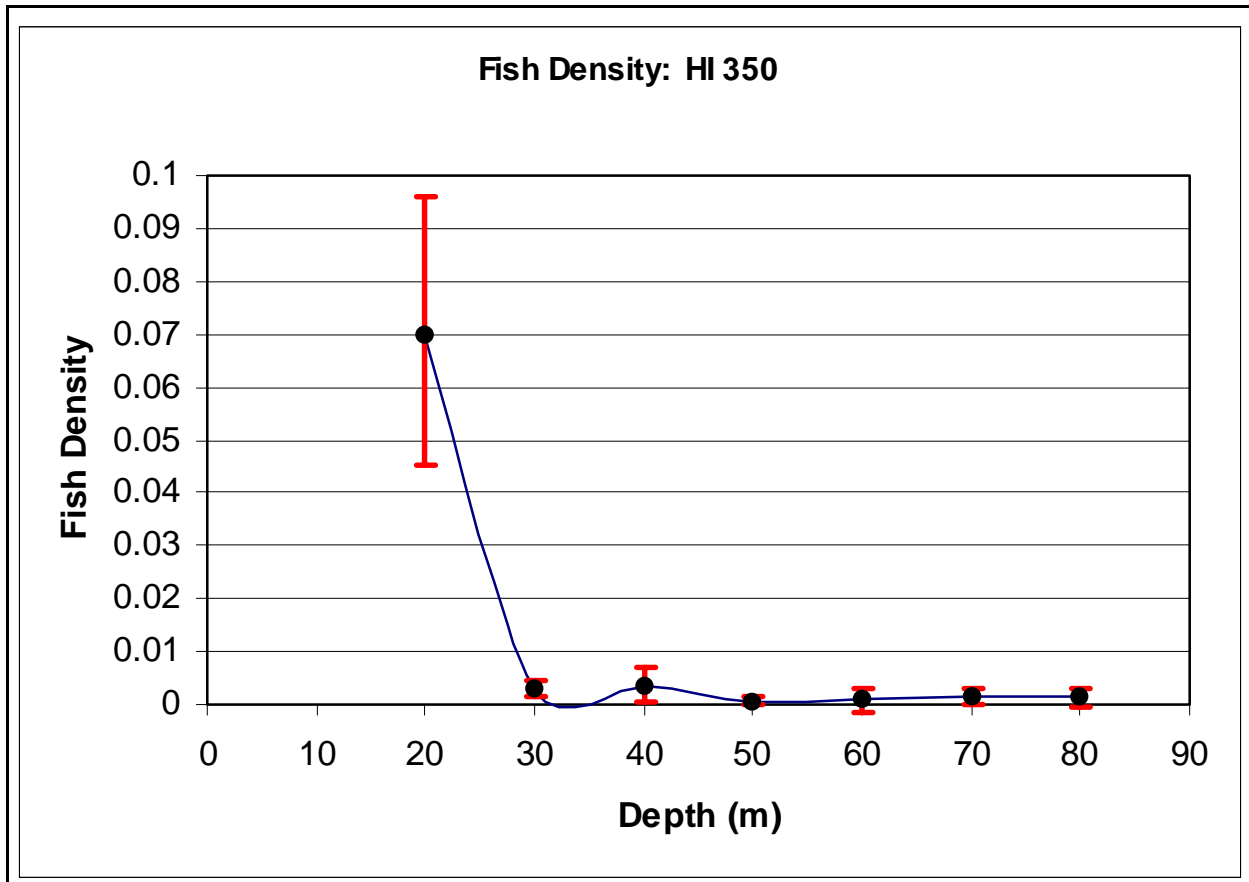

Figure 7.44. Estimated mean fish density (fish/m³) at depth for HI A350. Error bars are 95% confidence intervals.

SPECIES COMPOSITION AND ABUNDANCE

The fish community at HI A350 was very similar to previous studies and consisted of pelagic planktivores near the surface and reef-associated species near the bottom (Table 7.38). Bermuda chub and blue runner were the most abundant species making up more than 50 percent of the fish observed on the ROV survey; they were most common near the surface (Table 7.38). Creole-fish, scamp, and red snapper also were fairly abundant and made up approximately one-third of the species present. Red snapper and scamp were most numerous near the bottom and creole-fish were most abundant at mid-depth (Table 7.38).

Total fish abundance at HI A350 within a 20 m area of influence was estimated to be 7,100. Based on the percent composition, there were approximately 2,100 blue runner, 1,000 bermuda chub, 1,000 creole fish, 500 scamp, and 400 red snapper. Although the numbers are not absolute, they provide a relative scale of fish abundance.

Table 7.38. Species common names and scientific names, numbers of individuals by stratum, totals, and percent composition from visual point counts using video from a remotely operated vehicle (ROV) from High Island A350, June 1999.

Common Name	Scientific Name	0 m	10 m	20 m	30 m	40 m	50 m	60 m	70 m	Totals	% Comp
Almaco jack	<i>Seriola rivoliana</i>	5	1	22	9	-	1	-	-	38	3.6
Bermuda chub	<i>Kyphosus sectatrix</i>	280	-	-	-	-	-	-	-	280	26.8
Bar jack	<i>Caranx ruber</i>	1	-	-	-	-	-	-	-	1	0.1
Great barracuda	<i>Sphyraena barracuda</i>	6	10	2	-	-	-	-	-	18	1.7
Blue angelfish	<i>Holacanthus bermudensis</i>	-	6	10	5	-	-	-	-	21	2.0
Blue runner	<i>Caranx crysos</i>	92	33	182	-	-	-	-	-	307	29.4
Blue tang	<i>Acanthurus coeruleus</i>	-	2	4	1	-	-	-	-	7	0.7
Creole-fish	<i>Paranthias furcifer</i>	-	-	94	53	-	-	-	-	147	14.1
Creville jack	<i>Caranx hippos</i>	-	9	-	-	-	-	-	-	9	0.9
French angelfish	<i>Pomacanthus paru</i>	-	-	4	3	-	-	-	-	7	0.7
Gag	<i>Mycteroperca microlepis</i>	-	-	1	-	-	1	-	-	2	0.2
Greater amberjack	<i>Seriola dumerili</i>	-	2	4	4	2	8	1	-	21	2.0
Gray triggerfish	<i>Balistes capriscus</i>	1	-	1	2	4	-	-	-	8	0.8
Rainbow runner	<i>Elagatis bipinnulata</i>	-	-	11	-	-	-	-	-	11	1.0
Red snapper	<i>Lutjanus campechanus</i>	-	-	-	-	11	50	-	-	61	5.8
Rock beauty	<i>Holacanthus tricolor</i>	-	-	-	1	-	-	-	-	1	0.1
Reef butterflyfish	<i>Chaetodon sedentarius</i>	-	-	-	-	1	-	-	-	1	0.1
Scamp	<i>Mycteroperca phenax</i>	-	-	2	17	7	37	10	-	73	7.0
Sergeant major	<i>Abudefduf saxatilis</i>	6	1	7	-	-	-	-	-	14	1.3
Spanish hogfish	<i>Bodianus rufus</i>	-	-	9	1	1	-	-	-	11	1.0
Squirrelfish	<i>Holocentrus adscensionis</i>	-	-	3	-	-	-	-	-	8	0.8

WC 617A AND HI A355 RESULTS (TOPPLED AND PARTIALLY REMOVED PLATFORMS)

Acoustic surveys of these sites (Figure 7.45) were tracked with differential GPS which was incorporated into the acoustic database; resultant track lines over each site are shown in Figure 7.46. The actual track lines are evidence that we were successful in keeping the vessel transects over the

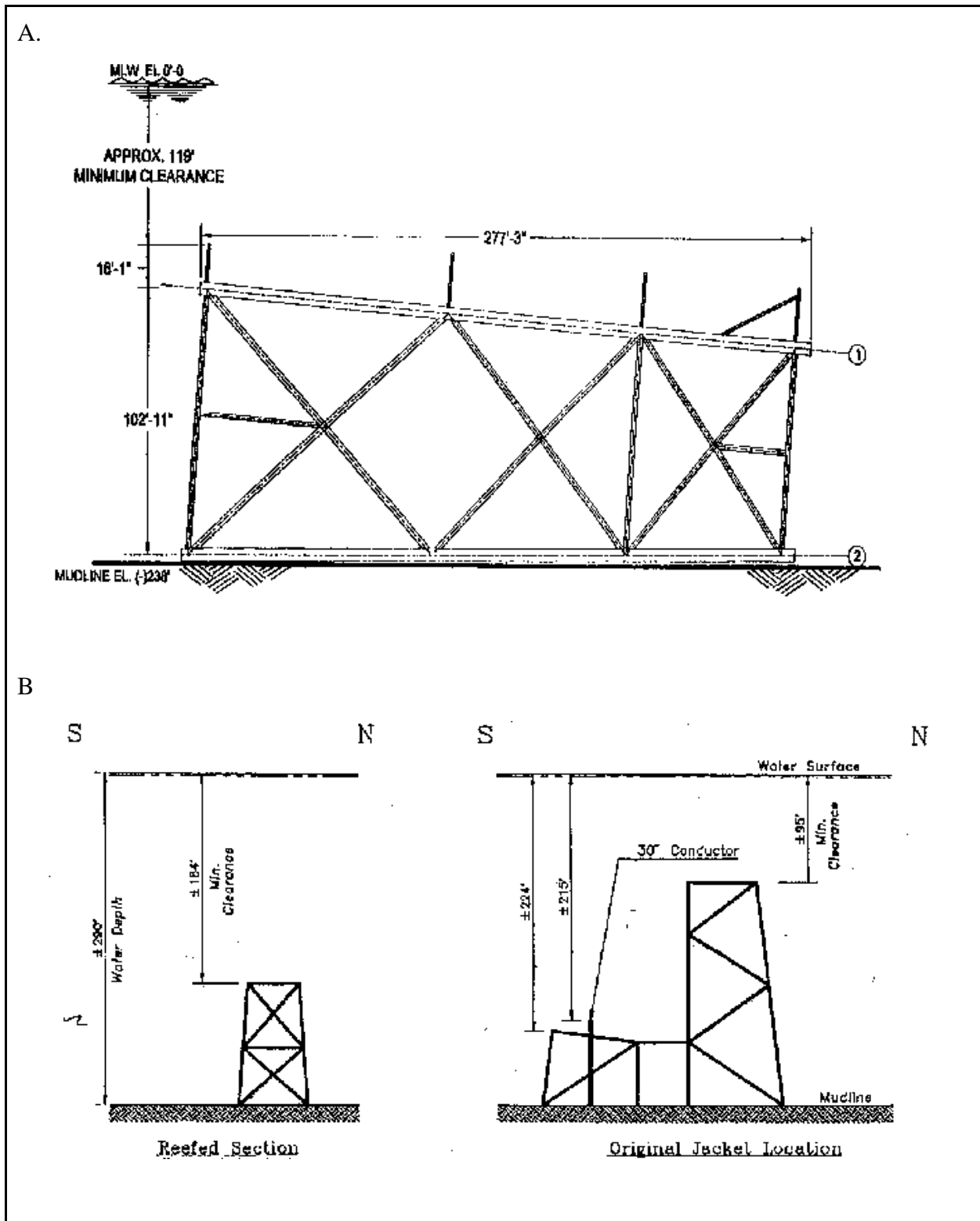

Figure 7.45. Line drawings of WC 617A (toppled platform) and HI A355 (partially removed platform with a small four leg section to the southwest).

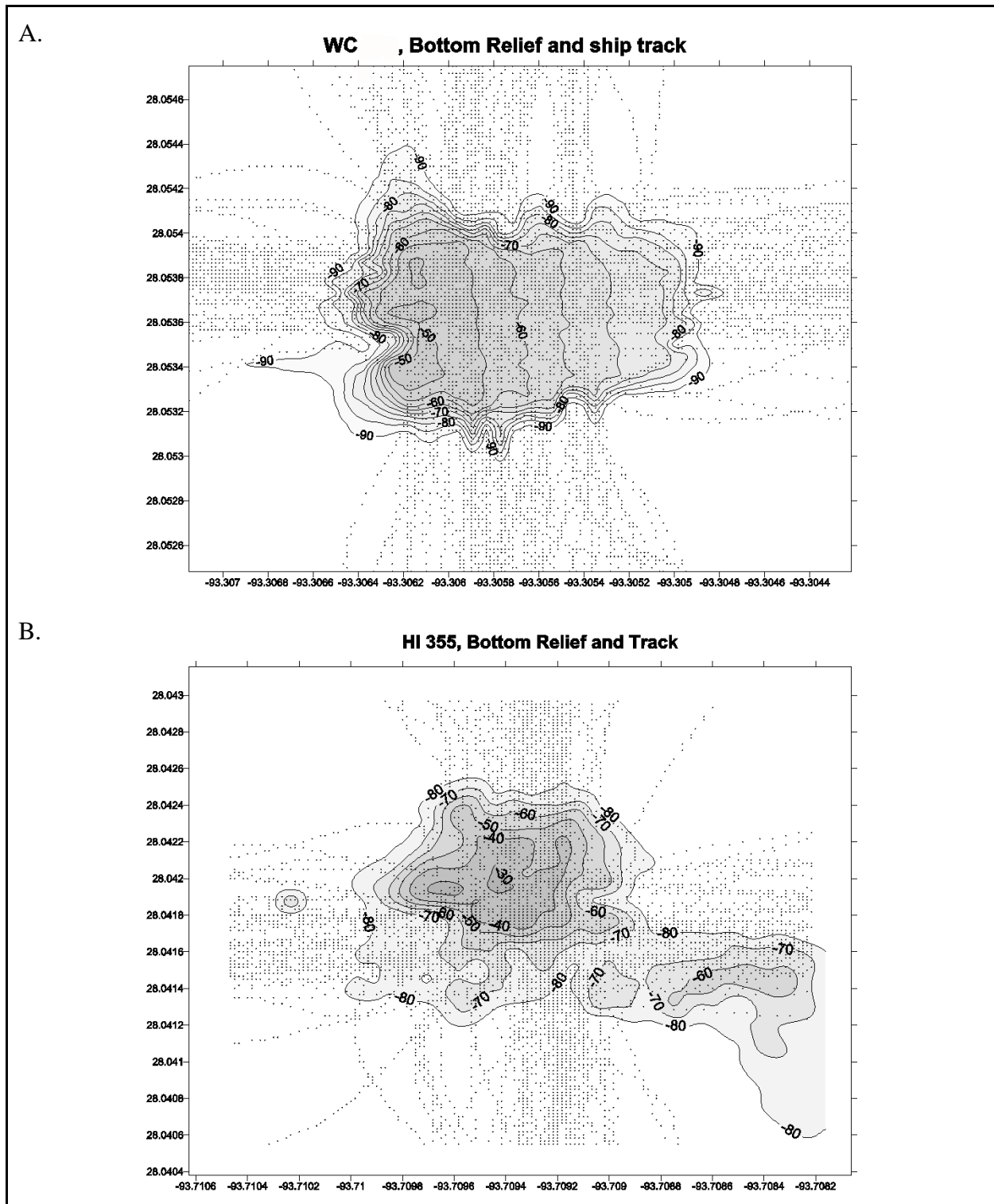

Figure 7.46. Plot of vessel track (dotted lines) over WC 617A (A) and HI A355 (B) for surveys conducted June 1999 and June 2000. Bathymetry contour show depths at each reef site and indicate the platforms. North is up in both figures.

tops of the target sites. A plot of recorded bottom depth of repeated transects at each site resulted in a detailed 3-dimensional outlines of the platform profile (Figure 7.47) and illustrates the precision of positioning as well as current reef site bathymetry.

Acoustic data were used to determine fish presence based on SV, to estimate fish density/m³, and to estimate fish size above, in proximity to, and away from the reef sites. One concern was that transect number might lead to a decrease in fish density as multiple passes of the vessel over each site might scare away fish. Including transect number (n=100) as a class variable in the logistics regression for the 1999 data at both sites indicated a significant effect; however, there was no pattern indicating a decrease or increase or change in the probability of finding fish with consecutive transects. We concluded that there was no predictable change in the probability of fish occurring during consecutive passes of the vessel, so all transects were combined for analysis.

WC 617A (TOPPLED PLATFORM)

A binomial logistic model was constructed for WC 617A with presence/absence of SV (hence fish) as the dependent variable with class variables, orientation, stratum, away, TOD, and year and all two way interactions. All class variables were significant indicating that orientation, time of day, away, and year influenced the probability of fish occurring. Two-way interactions were evaluated and determined to be either insignificant or of no biological meaning, then were removed from the model as they confounded class variable interpretation.

Odds ratio estimates produced in Proc Logistic calculated without an intercept provided insight into the probability of finding fish varied within each class variable. From the analysis outputs it was concluded that there was a difference between years as the chance of finding a fish in 1999 was approximately 2.5 times that in 2000. In addition, there was no influence of orientation as the probability of finding a fish was the same over and away from the platform. However, there was higher mean biomass (measured as SV) over the platform than on the sides indicating that when fish were present, there was greater biomass over the reef site than on any of its sides. Analysis also indicated that fish occurred more frequently near the bottom along the sides of the platform.

The biological significance of these differences was best appreciated by plotting mean SV (fish energy) and estimated fish density (+/- 95% confidence intervals) for each significant class variable. The mean values plotted on these graphs are greatly influenced by the larger number of zero values, but they allow for comparisons of trends. Mean SV was highest over the platform and declined with distance from the 617A reef site (Figure 7.48a); mean SV varied with side (orientation), and was lower on all sides than over the platform. Mean SV reached a minimum beyond 30 m away from the platform, so we assigned a 20 meter area of influence of this site. Mean SV also varied with depth and time of day as it tended to be higher near the bottom and higher at midnight.

Target Strength

The relationship between TS and associated class variables was modeled with RBD ANOVAs. TS was affected by side, depth stratum, and TOD and all interactions. The meaningful part of this analysis is that fish were, on average, larger over the platform and smallest on the south side. Fish

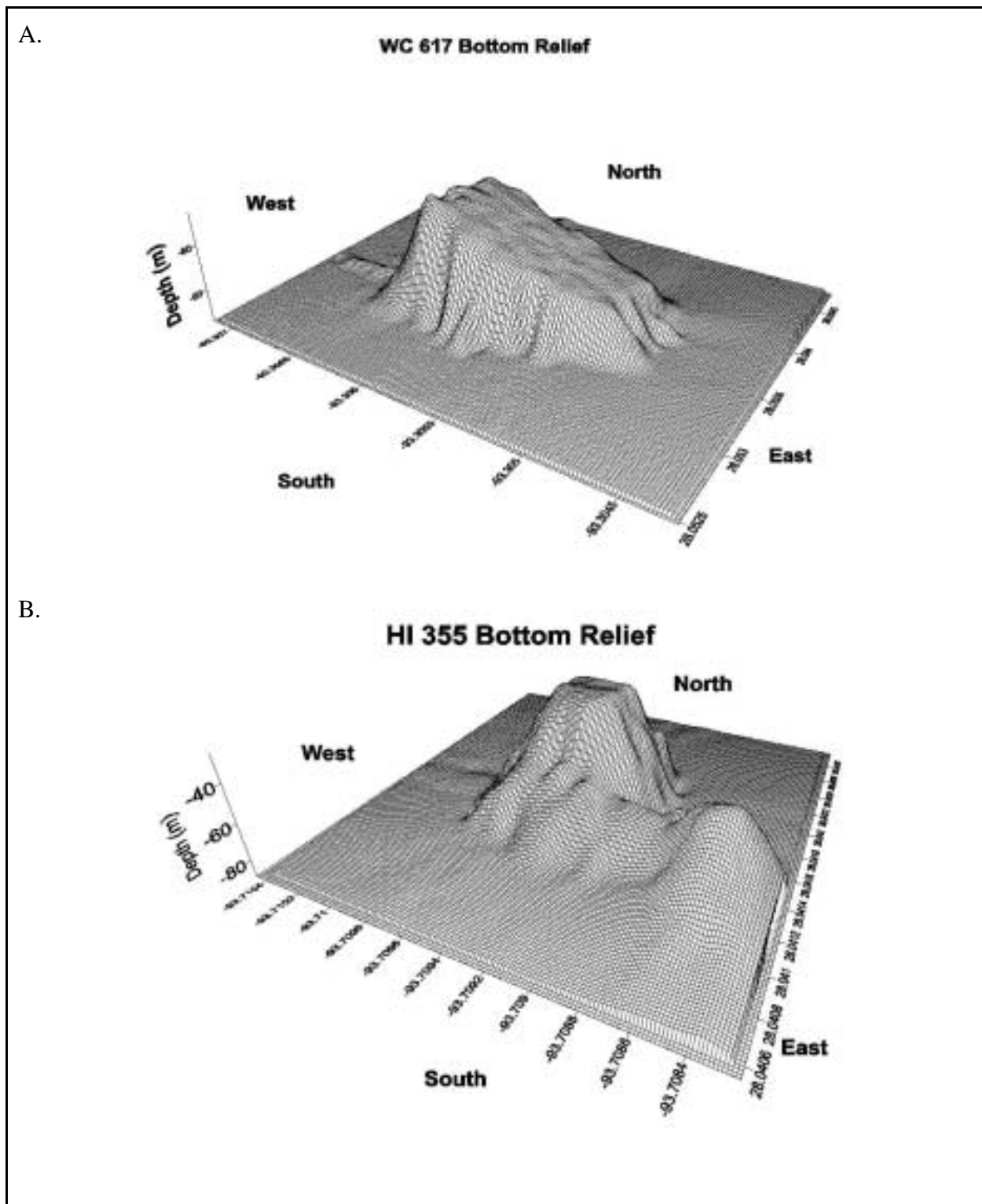

Figure 7.47. Acoustic depth profiles of WC 617A and HI A355 based on a geo-referenced plot of depth from the hydroacoustic survey conducted in June 1999 and 2000. Outlines of both structures are evident based on bottom depth.

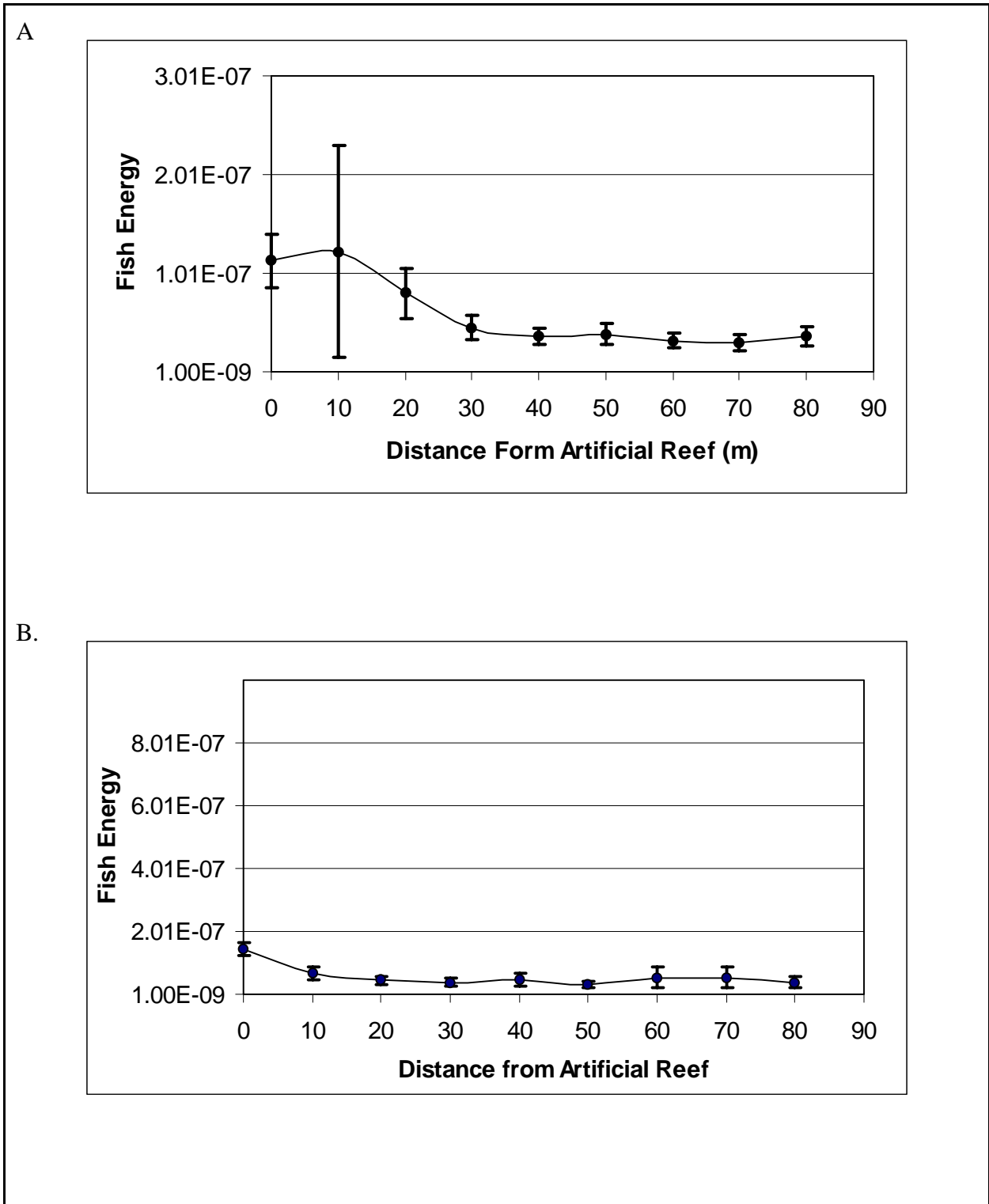

Figure 7.48. Estimated mean fish energy /m³ (antilog of volume backscatter) at distance from reef site for WC 617A (A) and HI A355 (B). Error bars are 95% confidence intervals.

size decreased with increased distance from the site (Figure 7.49a). Fish size also varied with depth and targets tended to be larger near the surface and immediately above the structure. Average acoustic size at WC 617A was -46 dB (8.6 cm) and ranged from -62 to -26 dB (1.2 to 96 cm) (Love 1971). Target size changed with TOD, and fish were larger at dawn followed by midnight, dusk, and noon.

Density Estimates

Fish density was calculated based on acoustic volume backscatter and TS (mean target strength/m³ or its proxy described in Materials and Methods). Plots of the mean density values provide actual density estimates for comparison to earlier studies. Density over and away from WC 617A ranged from 0 to 0.5 fish/m³ and the overall mean density of the site within 20 m was 0.0015 fish/m³. Mean density decreased slightly beyond 30 meters and did not vary much. Mean density was slightly higher over the platform compared to the east, west, north and south sides. Density also varied with depth and was highest at the surface and immediately above the bottom (Figure 7.50a). Density varied with time of day and was highest during midnight followed by dusk, noon and morning. Although density did not vary much, it should be noted that SV was higher over WC 617A where the fish were also larger.

Species Composition and Abundance

Species present at WC 617A were indicative of a reef-associated community. Seven species made up 90% of the community (Table 7.39). Red snapper were the most abundant and made up over 45% of the population followed by greater amberjack, Spanish hogfish, gray triggerfish, and creole-fish.

Total fish abundance at WC 617A within a 20 m area of influence was estimated at 2,700. There were roughly 1,220 red snapper, and 405 amberjack, followed by 270 Spanish hogfish and 216 gray triggerfish.

HI A355 (PARTIALLY REMOVED PLATFORM)

A binomial logistic model was constructed for HI A355 with presence/absence of SV (hence fish) as the dependent variable with class variables orientation, stratum, away, time of day, year and all two-way interactions. Based on a binomial logistic regression with SV as the dependent variable, significant effects were found with orientation, away, time of day, and year. Two way interactions were evaluated and determined to be either insignificant or of no biological meaning, so they were removed from the model as they confounded the class variables interpretation.

Odds ratio estimates from Proc Logistic run without an intercept provided insight into the probability of finding fish and then varied within each class variable. From the analysis outputs it was concluded that there was a difference between years as the chance of finding a fish in 1999 was roughly 1.3 times higher than that in 2000. A difference in orientation was also found with the probability of a fish presence was highest on the south side. There was a slightly greater chance of finding fish within 30 m rather than immediately over the platform. Analysis also indicated that fish occurred more frequently near the bottom and closer to the platform.

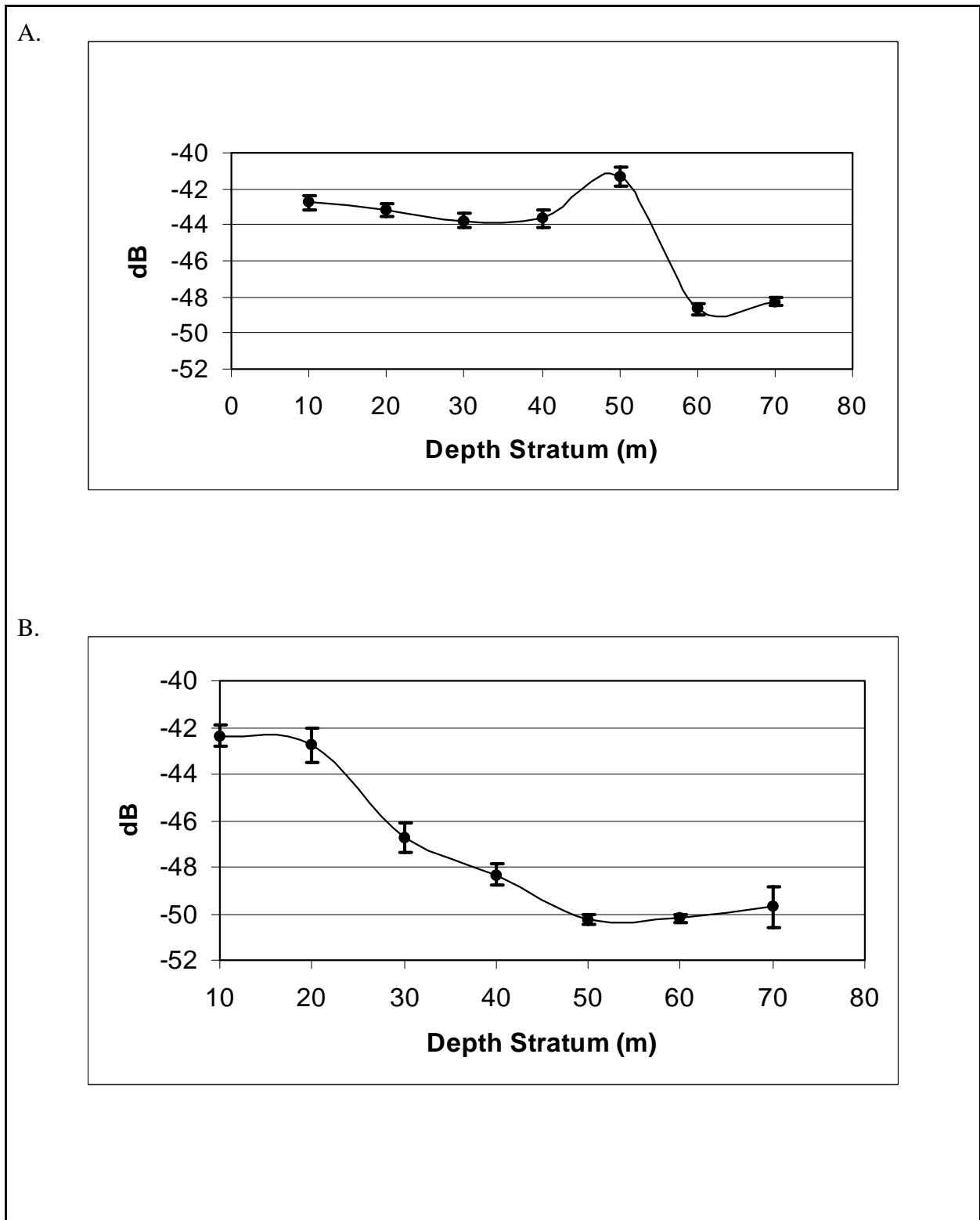

Figure 7.49. Estimated mean target strength (dB) at depth stratum for WC 617A (A) and HI A355 (B). Error bars are 95% confidence intervals.

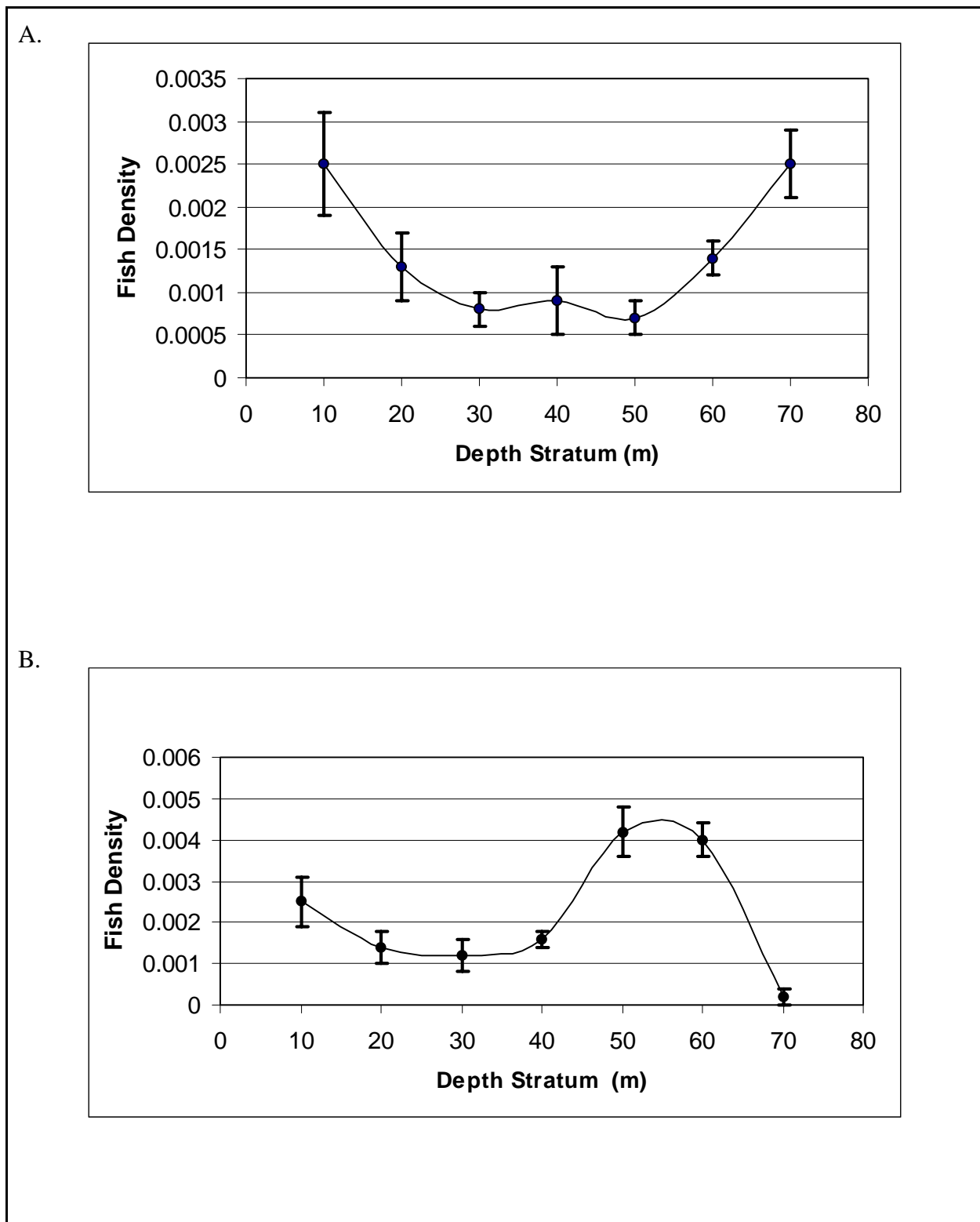

Figure 7.50. Estimated mean fish density (fish/m³) by depth stratum for WC 617A (A) and HI A355 (B). Error bars are 95% confidence intervals.

Table 7.39. Species common names and scientific names along with numbers of individuals by stratum, totals, and percent composition from visual point counts using video from a remotely operated vehicle (ROV) from a toppled platform (West Cameron 617A) June 1999.

Common Name	Scientific Name	0m	10m	20m	30m	40m	50m	60m	70m	Totals	% comp
Almaco jack	<i>Seriola rivoliana</i>	-	-	-	-	1	9	4	-	14	7.4
Creole-fish	<i>Paranthias furcifer</i>	-	-	-	-	-	-	9	-	9	4.8
Gag	<i>Mycteroperca microlepis</i>	-	-	-	-	-	-	3	-	3	1.6
Greater amberjack	<i>Seriola dumerili</i>	-	-	-	-	2	25	2	-	29	15.4
Gray triggerfish	<i>Balistes capriscus</i>	-	-	-	-	-	8	7	-	15	8.0
Red snapper	<i>Lutjanus campechanus</i>	-	-	-	-	7	32	46	-	46	45.2
Reef butterflyfish	<i>Chaetodon sedentarius</i>	-	-	-	-	-	-	1	-	1	0.5
Scamp	<i>Mycteroperca phenax</i>	-	-	-	-	-	6	6	-	12	6.4
Spanish hogfish	<i>Bodianus rufus</i>	-	-	-	-	-	6	14	-	20	10.6

The biological significance of these differences was best appreciated by plotting mean fish energy and estimated fish density (with 95% confidence intervals) for each class variable. Mean fish energy was highest over HI A355 and reached a minimum beyond 30 meters away from the platform; we assigned a 20 meter area of influence to this site. Mean fish energy declined with distance from the reef sites and was highest over the platform followed by south, west, east, and north. Mean fish energy also varied with depth and time of day as it tended to be higher near the surface of the water column and was higher in the morning.

Target Strength

The relationship between TS and associated class variables was modeled with RBD ANOVAs. TS was affected by orientation, depth, TOD and all two way interactions. The meaningful part of this analysis is that fish were, on average, larger over the platform and smallest on the south side. Mean TS, within 20 meters of HI A355, was -48 dB (equivalent to a 6.7 cm fish); TS ranged from -62 to -25 dB (1.2 to 108 cm) (Love 1971). Fish size decreased with increased distance from the site. Size also varied with depth as targets tended to be larger near the surface and decreased in size toward the bottom. Target size changed with TOD and was greatest in the morning followed by midnight, dusk, and noon.

Density Estimates

Fish density was calculated based on acoustic volume backscatter and TS (mean target strength /m³ or its proxy value described in Materials and Methods). The results of the density estimates were basically the same as SV in the previous section, but plots of the mean density values provide actual density estimates for comparison to this and earlier studies. Density over and away from HI A355 ranged from 0 to 0.55 fish per cubic meter and averaged 0.002 fish per cubic meter within 20 meters

of the platform. Mean density varied little with distance. Mean density was slightly higher on the west side of the platform than the other sides, but there was little difference in mean density among its four sides. Density also varied with depth and was highest 10 to 20 m above the bottom (Figure 7.50b). Highest density occurred at dusk when compared to noon, morning, and midnight even though there was little difference among times of day.

Species Composition and Abundance

Species compositions in June 1999 and June 2000 are given in Table 7.40. During both surveys greater amberjack were the most abundant species. In 1999 greater amberjack made up almost 60% of the fish community compared to 30% in 2000. Red snapper were the second most abundant species both years and ranged from 13% in 1999 to 27% in 2000 (Table 7.40).

Table 7.40. Species common names and scientific names along with numbers of individuals by stratum, totals, and percent composition from visual point counts using video from a remotely operated vehicle (ROV) from a partially removed platform (High Island A355), June 1999 and 2000.

High Island A355		June 1999									
Common Name	Scientific Name	0m	10m	20m	30m	40m	50m	60m	70m	Totals	% comp
Almaco jack	<i>Seriola rivoliana</i>	-	-	-	-	-	17	-	-	17	12.9
Blue angelfish	<i>Holacanthus bermudensis</i>	-	-	-	-	-	7	-	-	7	5.3
Creole-fish	<i>Paranthias furcifer</i>	-	-	-	-	-	2	-	-	2	1.5
Greater amberjack	<i>Seriola dumerili</i>	-	-	-	-	-	78	-	-	78	59.1
Gray triggerfish	<i>Balistes capriscus</i>	-	-	-	-	-	3	-	-	3	2.3
Red snapper	<i>Lutjanus campechanus</i>	-	-	-	-	-	17	-	-	17	12.9
Scamp	<i>Mycteroperca phenax</i>	-	-	-	-	-	5	-	-	5	3.8
Spanish hogfish	<i>Bodianus rufus</i>	-	-	-	-	-	3	-	-	3	2.3
High Island A355		June 2000									
Common Name	Scientific Name	0m	10m	20m	30m	40m	50m	60m	70m	Totals	% comp
Almaco jack	<i>Seriola rivoliana</i>	-	-	2	7	2	-	2	-	13	6.9
Blackfin tuna	<i>Thunnus atlanticus</i>	-	-	9	-	-	-	-	-	9	4.8
Blue angelfish	<i>Holacanthus bermudensis</i>	-	-	-	2	5	1	2	1	11	5.9
Creole-fish	<i>Paranthias furcifer</i>	-	-	-	11	7	-	-	-	18	9.6
Crevalle jack	<i>Caranx hippos</i>	-	-	2	1	-	-	-	-	3	1.6
Greater amberjack	<i>Seriola dumerili</i>	-	-	-	1	6	22	17	10	56	29.9
Gray triggerfish	<i>Balistes capriscus</i>	-	-	-	-	-	-	3	-	3	1.6
Ocean surgeon	<i>Acanthurus bahianus</i>	-	-	-	2	-	-	-	-	2	1.1
Red snapper	<i>Lutjanus campechanus</i>	-	-	-	-	3	12	28	7	50	26.7
Spanish hogfish	<i>Bodianus rufus</i>	-	-	-	-	18	3	-	-	21	11.2
Warsaw grouper	<i>Epinephelus nigritus</i>	-	-	-	-	-	-	1	-	1	0.5

Total fish abundance at HI A355 within a 20 m area of influence was estimated at 2,850 individuals. The most abundant fishes at HI A355 were greater amberjack and red snapper. Averaging percent species compositions for both years, we estimate there were approximately 1,200 greater amberjack and 500 red snapper followed by 250 Spanish hogfish and 225 creole-fish.

DISCUSSION

This project again demonstrates the utility of dual beam hydroacoustics coupled with visual survey techniques to study fish assemblages associated with standing platforms and artificial reefs. The choice of survey sites, which are in close geographical proximity, provided us an opportunity to use stationary and mobile acoustic survey methods to compare species composition, fish biomass, and fish densities within and among a standing platform and two artificial reef configurations of retired oil and gas platforms. Future refinements in the approach to stationary and mobile acoustic studies will lead to even more accurate assessments of fish habitat. Furthermore, integration of results into a GIS databases will enable improved management of these resources.

Our results provided direct evidence that fish densities and biomass around standing oil and gas platforms are the highest per unit area of their artificial sites studied to date. We found fish density around a standing platform to be greater than the two artificial reef sites. Fish were not only more abundant around standing platforms, but also they were larger than those found in the open water habitats. Our results are in support of the findings reported by Stanley and Wilson (2000), that when a platform is converted into an artificial reef by toppling in place or by partial removal, it loses a significant portion of the fish community. Most of this "lost" portion is pelagic planktivores such as blue runner and Bermuda chub.

Traditional parametric analyses were not used for analysis of mobile acoustic data, due to the large number of zero values and the problem of autocorrelation that occurs in mobile surveys. The use of logistic regression in ecological sampling was described by Trexler and Travis (2001) as a nonlinear way of expressing ecological data. Logistic regression has been shown to be useful with data sets that have a large number of zero values which are usually not normally distributed. For regression analysis, the dependent variable was converted into a binomial array of presence/absence of acoustic reflectance (fish measured as acoustic energy)/m³ to evaluate the probability or chance of finding a fish in a given cell. The cell was a one second block (at 2m liner distance) of time divided into 10 m depth strata. Volume backscatter (SV) was used as a dependent variable in performing logistic regression because SV is the mean measured amount of acoustic energy returned from each acoustic ping, averaged for a cubic meter of water column. Stanley and Wilson (1997) used fish density (number of fish/m³) as the dependent variable, but this value is very sensitive to cross-sectional backscatter also known as sigma (fish size). Sigma accuracy increases with the number of times a single target is pinged. In our mobile surveys, the chance of hitting a single target, numerous times, was low. Due to the uncertainty of the accuracy of TS, the accuracy of density becomes uncertain. This made SV a better proxy for fish presence, hence the primary dependent variable in our models. If there was a statistically significant affect by a class variable indicated in the logistic regression analysis, then the procedure was re-run using a no intercept option. The resultant Odds Ratio Estimates provide a comparison of probabilities of fish occurring within that class variable. The

effect of each class variable was visualized by plotting SV and estimated fish density by significant class variables.

Many factors play an important role in determining fish biomass, density, and species composition for any fish habitat; certainly oil and gas platforms are no exception. The standing platform, HI A350, was characterized by the same type of community of fish that Wilson and Stanley (2000) observed at other structures in similar water depths such as Grand Isle 94. Time of day and depth stratum affected the fish community as had been reported previously (Stanley and Wilson 2000), however the density patterns exhibited at different times of day do not follow a predictable pattern and are likely site-specific. We continue to observe fish density and size being greater near the surface than the bottom of standing oil and gas platforms. Our results revealed approximately 7,000 fish around HI A350, which is consistent with the estimates of fish communities reported by Stanley and Wilson (2000, 1997) for platforms in similar water depths, where reports of 10,000 to 20,000 fish inhabiting each of the four oil and gas platforms studied. Species composition at HI 350 was also similar to that reported by Stanley and Wilson (2000) and included important to recreational and commercial species such as greater amberjack, red snapper, creole fish, trigger fish, and almaco jack. Like the results reported herein, Stanley and Wilson (2000) also found a significant pelagic planktivore community at these high vertical profile sites.

The mobile acoustic surveys of a toppled platform (WC617A) and a partially removed platform (HIA355) were conducted in 1999 and in 2000. Previous acoustic studies at platforms, as in our study of HI350 employed a stationary array of transducers. Hence data collection techniques were different. However the acoustic data are averaged on a per ping basis so data at HI350 in this study and previous studies by Stanley and Wilson (2000) and Stanley (1994) are comparable to the mobile acoustic data.

There was a general pattern at both reef sites of higher probabilities of finding fish in 1999 when compared to the 2000 survey. We offer no explanation for the between year difference in these results other than it supports Stanley and Wilson (1997) that fish densities vary seasonally.

Density at the two artificial reef sites ranged from 0 to 0.7 fish/m³. The partially removed platform had a slightly higher mean fish density than the toppled platform; mean values (within 20m of each site) of 0.002 vs. 0.0015 respectively. Both sites had highest fish densities near the bottom, which is opposite the pattern reported at the standing platform. However, the partially removed platform, HI A355, also had higher estimated densities near the surface resembling fish distribution at a standing platform. There was little difference in species composition between the two reef configurations. ROV surveys of HI A355 in June 1999 and in June 2000 indicated that red snapper and amberjack were the two most abundant species both years, and together they made up over 70 percent of the fish community. Similarly, the survey of WC 617A, conducted in only June 1999, indicated that greater amberjack, almaco jack, and red snapper were the most abundant species. Species composition at the two reef sites were similar to species composition at the lower portion of HI A350 and to previous studies by Stanley and Wilson (1997, 2000). It is of interest that the red snapper and amberjack populations at the two reef sites were similar in number to the populations estimated to be at the standing platform in similar water depths. These artificial reef sites, like their platform predecessors, have significant fishing value since a majority of the species associated with

these reef sites are targeted by commercial and recreational fisherman. When a standing platform is converted into an artificial reef site, it appears that the pelagic planktivores which make up the greatest biomass is lost; while recreational and commercially important species are retained.

Target strength data revealed information on the size distribution of fishes associated with all these sites. In general, slightly larger fish are associated with a standing platform, particularly near the middle water column, compared to a partially removed or toppled platforms, where they are larger over the reef sites and near the surface (Stanley 1994). The larger species were shown to be pelagic planktivores and piscivores by Stanley and Wilson (1997).

We found significant effects of orientation and distance with both artificial reefs. The probability of finding a fish at WC 617A was highest over the platform and within 30 m of the reef; which is similar to the survey of EI 366 done by Stanley and Wilson (Unpublished report). This is similar to a reported 16 m area of influence by Stanley (1994) at platforms from 50-100m depths. Platforms appear to have a finite reef effect that does not extend beyond visual range of the associated species. The probability of finding a fish at HI A355 was highest around the sides of the platform and within 30 m of the structure, although fish biomass, and therefore density, were highest directly over the reef site. Stanley and Wilson (Unpublished report) reported higher numbers of fish directly over another artificial reef (EI 366), and reported the same high fish densities within 30 m of the artificial reef. The difference in orientation (north, south, east, and west) at HI A355 could be related to a section of the jacket being placed roughly 30m away from the partially removed platform on the southeast side. It is also possible that the small foot print of HI A355 confounded analysis.

According to survey results from HI A355 and WC 617A, we estimate a loss of approximately 50-80 percent of the fish population when a standing platform is converted into an artificial reef site in 100 m of water. Each artificial reef site harbored approximately 2500 fishes compared to 7000 fishes around the HI A350 and the 10,000- 20,000 reported by Stanley and Wilson 1998. This decline of fish numbers was also observed during the survey of EI 313 and EI 367 done by Stanley and Wilson (Unpublished report). Artificial reef configuration and orientation definitely influence the size of and species composition of the associated fish community.

Acoustic surveys have been conducted at many artificial reef sites. As mentioned in the introduction, Stanley and Wilson (2000) conducted a mobile acoustic survey of the Penrod drilling jack-up rig at EI 313. Although their data were not published, they found approximately 7,000 fish around the Penrod drilling jack-up rig in EI 313 (Stanley and Wilson 2000). The Penrod drilling rig was located in shallower water (71.5 m) than these sites reported herein and had a more complex inner-structure of decking and cross-member material; this more complex structure likely influenced fish populations. For example, five sections of the Tenneco II platform were deployed off of southern Florida, the solid deck portion of the platform did not contain the diversity and abundance of fishes found on the grated surface section of the platform deployed 30m away (Seaman et. al. 1989). The grating likely afforded more hiding places for small fishes, thereby increasing diversity of small species and also food supply for predatory species. Also, openings in the grated surface would permit access to the upper surface for animals living in protected areas under the deck (Seaman et al 1989). It is likely that the greater number of fish around the Penrod drilling rig was due to the different type of material such as decking and shallower water depths. Studies suggest that optimal

artificial reef configurations exist, but vary, depending on the target species (Stanley and Wilson 1990).

Our results again emphasize the variability in abundance, size distribution, and species composition of fishes associated with petroleum platforms, particularly those that have been configured as artificial reefs. Results of previous studies have been well documented in earlier reports done by Stanley (1994) and Stanley and Wilson (2000), and in general this variability is associated with both temporal, spatial, and to some extent environmental variables. This research continues to support the working hypothesis that platforms do make useful artificial reefs since they tend to support a population of fish that can be 10 to over 1000 times greater in density than the adjacent sand and mud bottom habitats.

Completion of this research has provided quantitative data on the effect of vertical profile on fish abundance, assessed the effectiveness of retired platforms sited as artificial reefs, and presented the differences in abundance and species composition among sites. Since the reef sites are of similar age and size, and are located within a radius of 48 km, comparison of the production platform and the partial removal with the toppled platform has provided valuable insight into the effect of platform configuration on the assemblage of fishes while minimizing confounding effects.

To date over 150 retired petroleum platforms from Texas to the Atlantic coast of Florida have been converted to artificial reefs. A variety of removal techniques and placement configurations have been employed in siting these reefs. While numerous qualitative studies documenting the colonization and relative abundance of organisms associated with production platform have been undertaken, it has proven difficult to conduct quantitative studies at artificial reefs; consequently, little was known regarding the biotic communities associated with these artificial reefs. Development of artificial reefs has been advocated by all levels of government and within the Reef Fish Fishery Management Plan of the Gulf of Mexico Fishery Management Council (GMFMC 1989). Several research needs and goals have been outlined including the following: encouraging general research on the effects of artificial reefs, improving the quantitative assessment techniques used to describe artificial reef communities, monitoring biological changes at reef sites, assessing the importance of fish attraction versus fish production, and quantifying the relationships between reef fish production and habitat.

REFERENCES

- Bohnsack, J.A. and S.P. Bannerot. 1986. A Stationary Visual Census Technique for Quantitatively Assessing Community Structure of Coral Reef Fishes. NOAA Technical Report NMFS 41. 15 pp.
- Bohnsack, J.A., D.L. Johnson, and R.F. Ambrose. 1991. Artificial habitats for marine and freshwater fisheries. *Ecology of Artificial Reef Habitats*. Academic Press. New York, New York. 61-108 pp.
- Doherty, P.J. and D. McB. Williams. 1988. The Replenishment of Coral Reef Fish Populations. *Oceanography and Marine Biology*. 26:487-551 pp.

- Garrison, L.P., W. Michaels, J.S. Link, and M.J. Fogarty. 2000. Predation Risk on Larval Gadids by Pelagic Fish in the Georges Bank Ecosystem. I. Spatial overlap associated with hydrographic features. *Canadian Journal of Fisheries and Aquatic Sciences*. 57:2455-2469.
- GMFMC (Gulf of Mexico Fisheries Management Fisheries Council). 1989. Amendment 1 of the Reef Fisheries Management Plan for the Fisheries Resources of the Gulf of Mexico. GMFMC. Tampa FL. 420pp.
- Love, R.H. 1971. Dorsal Aspect Target Strength of an Individual Fish. *Journal of Acoustic Society of America*. 62:1397-1403.
- Menge, B.A. and J.P. Sutherland. 1987. Community Regulation: Variation in Disturbance Competition and Predation in Relation to Environmental Stress and Recruitment. *American Naturalist*. 130:730-757.
- Ott, L. 1982. *An Introduction to Statistical Methods and Data Analysis*. 2nd Edition. Duxbury Press. Boston, Mass. 774 pp.
- Parker, Jr., R.O. D.R. Colby, and T.P. Willis. 1983. Estimated Amount of Reef Habitat on a Portion of the U.S. South Atlantic and Gulf of Mexico Continental Shelf. *Bulletin of Marine Science*. 33:935-940 pp.
- SAS Institute Incorporated. 2000. *SAS user's guide: Statistics*. Version 8. SAS Institute. Cary, NC. 1290 pp.
- Seaman, W. Jr. and Antony C. Jenson. 2000. Purposes and Practices of Artificial Reef Evaluation. *In Artificial Reef Evaluation with Application to Natural Marine Habitats*. William Seaman, Jr., ed. CRC Press, Boca Raton, p. 1-19.
- Seaman, W. Jr., William J. Lindberg, Carte R. Gilbert and Thomas K. Frazer. 1989. Fish Habitat Provided by Obsolete Petroleum Platforms off Southern Florida. *Bulletin of Marine Science*. 44(2): 1014-1022.
- Stanley, D.R. 1994. Seasonal and Spatial Abundances and Size Distribution Associated with a Petroleum Platform in the Northern Gulf of Mexico. Dissertation. Louisiana State University.
- Stanley, D.R. and C.A. Wilson. 1990. A Fishery-Dependent Based Study of Fish Species Composition and Associated Catch Rates Around Oil and Gas Structure off Louisiana. *Fishery Bulletin* 88(4):719-730.
- Stanley, D.R. and C.A. Wilson. 1991. Factors Affecting the Abundance of Selected Fishes Near Oil and Gas Platforms in the Northern Gulf of Mexico. *Fishery Bulletin* 89(1):149-159.
- Stanley, D.R., and C.A. Wilson. 1995. Detection of the Effect of Scuba Divers on Fish Density and Target Strength Utilizing Dual-Beam Hydroacoustics. *American Fisheries Society*. 124:946-949.

- Stanley, D.R., and C.A. Wilson. 1996. Abundance of Fishes Associated with a Petroleum Platform as Measured with Dual-Beam Hydroacoustics. *ICES Journal of Marine Science*. 53: 473-475.
- Stanley, D.R., and C.A. Wilson. 1997. Seasonal and Spatial Variation in Abundance and Size Distribution of Fishes Associated with a Petroleum Platform in the Northern Gulf of Mexico. *Canadian Journal of Fisheries and Aquatic Sciences*. 54: 1166-1176.
- Stanley, D.R., and C.A. Wilson. 1998. Spatial Variation in Fish Density at Three Petroleum Platforms as Measured with Dual-Beam Hydroacoustics in the Northern Gulf of Mexico. *Proceedings 1997 AFS Artificial Reef Symposium, American Fisheries Society, Monterey CA. Gulf of Mexico Science*.73-82.
- Stanley, D.R. and C.A. Wilson. 2000. Variation in the density and species composition of fishes associated with three petroleum platforms using dual beam hydroacoustics. *Fisheries*. 47: 161-172.
- Stanley, D.R., and C.A. Wilson. Unpublished. Survey of the Fisheries Resources at the Toppled Jackup Drilling Rig in Eugene Island 313. A report to Texaco Inc.
- Trexler, J.C. and J. Travis. 1993. Nontraditional Regression Analysis. *Ecology*. 74(6): 1629-1637.
- Wilson, C.A. and D.R. Stanley. 1991. Technology for Assessing the Abundance of Fish Around Oil and Gas Structures. *In* M. Nakamura, R.S. Grove and C.J. Sonu, eds. 115-119 pp.

**SESSION 8:
EVALUATION OF NATURAL AND/OR
ARTIFICIAL REEF PRODUCTIVITY I**

Moderators: Kathy Scanlon
Quenton Dokken

Date: October 26, 2000

Presentation	Author/Affiliation
Zooplanktivory by Blue Runner: An Energetic Subsidy to Gulf of Mexico Fish Populations at Petroleum Platforms	Sean F. Keenan Department of Oceanography and Coastal Sciences Louisiana State University Mark C. Benfield Coastal Fisheries Institute Louisiana State University
Comparison of Plankton and Light-Trap Methodologies for Sampling Larval and Juvenile Fishes Associated with Offshore Petroleum Platforms and a Coastal Jetty off Louisiana	Frank Hernandez Department of Oceanography and Coastal Sciences Center for Coastal Energy and Environmental Resources Louisiana State University Richard Shaw Coastal Fisheries Institute Louisiana State University
Occurrence and Pelagic Habitat of Reef Fish Larvae in the Gulf of Mexico	David Hanisko Joanne Lyczkowski-Shultz National Oceanic and Atmospheric Administration National Marine Fisheries Service Southeast Fisheries Science Center
Comparison of the Fisheries Value of Platforms Used as Artificial Reefs: Standing, Toppled, and Partially Removed	Aaron Pierce Charles A. Wilson Department of Oceanography and Coastal Sciences and Coastal Fisheries Institute Louisiana State University

(continued on next page)

Presentation

Author/Affiliation

A Hydroacoustic Assessment of Fish
Density at the Flower Garden Banks with
Emphasis on the West Flower Garden
Bank

Mark W. Miller
Coastal Studies Institute
Louisiana State University
Charles A. Wilson
Coastal Fisheries Institute and
Department of Oceanography and Coastal
Sciences
Louisiana State University

ZOOPLANKTIVORY BY BLUE RUNNER: AN ENERGETIC SUBSIDY TO GULF OF MEXICO FISH POPULATIONS AT PETROLEUM PLATFORMS

Sean F. Keenan

Department of Oceanography and Coastal Sciences
Louisiana State University

Mark C. Benfield

Louisiana State University
Coastal Fisheries Institute

ABSTRACT

The feeding habits of blue runner, *Caranx crysos* (Carangidae), were evaluated near offshore petroleum platforms in the northern Gulf of Mexico (GOM). Fish and plankton samples were collected at a mid-shelf platform located west of the Mississippi delta (Grand Isle 94B) from June to August 1996 and at a mid-shelf platform (Main Pass 259A) located east of the delta from June to September 1999. Meso- and macro-zooplankton comprised a large proportion of blue runner diets at the two platforms. Decapod crustaceans, chaetognaths, amphipods, other invertebrates as well as small fishes made up the majority of prey items. Variations in the diet over the sampling periods may have been due to shifts in predator preference and prey availability. Stomach fullness revealed that blue runner fed most intensely during night and pre-dawn hours with lower levels of feeding during the day. Blue runner appeared to select for larger sized prey relative to size distributions found in our plankton samples. Our hypotheses are that platforms are acting as large plankton accumulators through hydrodynamic and illumination effects, which provide blue runner with food and also extends foraging time.

INTRODUCTION

There are over 4,000 offshore petroleum platforms in the northern GOM (Stanley and Wilson 1996), and the majority of the substrate off the coast of Louisiana and Texas consists of sand and silt (Parker *et al.* 1983). The petroleum platforms in the same region have been estimated to provide roughly 5,000 km² of hard substratum (Kasprzak 1998), substantially increasing available reef-like habitat. This large amount of vertical relief, termed vertical benthos, extends into the photic zone and serves as a reef habitat for encrusting organisms and many fish species. The platforms in the northern GOM have been described as the largest unplanned artificial reef complex in the world (Stanley *et al.* 1998). High concentrations of fishes around these structures have stimulated attempts to quantify the distribution and abundance of platform fish assemblages. Stanley and Wilson (1996, 1998, 2000) have utilized hydroacoustics to estimate densities and distributions of fishes associated with platforms. These latter surveys confirmed the high densities of fishes and estimated that 10,000 to 30,000 fishes were associated with the manned platforms they examined.

Artificial reef design and management is centered on the often controversial "attraction versus production" issue (e.g. Grossman *et al.* 1997; Lindberg 1997; Bohnsack *et al.* 1997). Do platforms

merely attract fish from existing natural reefs to an area where they are susceptible to elevated fishing pressure, or do the platforms serve as functional productive habitat capable of supporting their high fish biomass? This issue remains an important question in evaluating the relationship between platforms and fishes. While data exists on densities and distribution of platform-associated fish, relatively little is known of how these populations are sustained. Understanding the trophic ecology of platform associated fishes may help us to evaluate the degree to which platform production is transferred to fish and to develop strategies for converting decommissioned platforms into productive artificial reefs.

One of the most common pelagic fish species in the GOM is the blue runner, *Caranx crysos*. This coastal pelagic species is found in the western Atlantic from Nova Scotia to Brazil (McKenney *et al.* 1958), throughout the eastern Atlantic and Mediterranean and has recently been recorded in British waters (Swaby *et al.*). This medium-sized fish (common to 350 mm fork length (FL)) may be found singly or more commonly in large schools in open waters. Blue runner appear to be the most abundant species in the surface waters around offshore platforms. Stanley and Wilson (2000) reported that blue runner numerically constituted up to 94% of the fishes found at a mid-shelf platform off Louisiana.

Blue runner are likely major dietary components of larger predatory fish associated with platforms (e.g. barracudas, groupers, cobia and other large jacks) as well as predators that frequently visit platforms (e.g. mackerals, billfish and tunas). Blue runner are likely important trophic links in platform food webs; however, relatively little is known about the diets of blue runner themselves. Some data exist on feeding habits of larval and juvenile blue runner, but accounts of adult feeding habits are anecdotal. McKenney *et al.* (1958) and Schekter (1972) stated that blue runner less than 160 mm standard length (SL) were carnivorous plankton feeders feeding primarily on copepods. Larger juveniles of the genus *Caranx* were noted to have larger organisms in the diets such as hyperiid amphipods, pontellid copepods, and juvenile natantida. Randall (1967) recorded the stomach contents of 17 mature (190-520mm FL) blue runner from reef habitats in the West Indies. All but two of these had "small silvery schooling" fish in their stomachs, while two fish (222 and 250 mm FL) reportedly contained 40% planktonic organisms with the remaining contents being fish. The stomachs of two adult male blue runner (365 and 370mm SL), collected in Mississippi coastal waters, were noted to contain anchovies and two mantis shrimp (*Squilla empusa*) (Christmas *et al.* 1974).

Observations of adult blue runner apparently feeding on zooplankton at night beneath a mid-shelf petroleum platform were the motive for the research reported in this paper. Our research was designed to quantify the diet of blue runner at mid-shelf petroleum platforms off the coast of Louisiana. The objectives of our study were to (a) describe the food habits of and monthly variability in the diet of *C. crysos* over the summer; (b) evaluate the diel periodicity in feeding; and (c) compare sizes of prey in the diets of blue runner with size distributions of prey in the environment.

METHODS

Study Sites

The diets of *Caranx crysos* were investigated at two offshore platforms located west and east of the Mississippi delta. Grand Isle 94B (GI94B) (28.5267°N, 90.0983°W) is a mid-shelf platform located west of the Mississippi River in 63 m of water. Samples were collected from Grand Isle 94B during 28-30 June, 28 July, 1 August, and 12-15 August 1996. Main Pass 259A (MP259A) (29.2833°N, 88.0333°W) is a mid-shelf platform located east of the Mississippi River standing in approximately 130 meters of water. Monthly sampling trips were made to Main Pass 259A during 11-14 June, 9-12 July and 24-27 September 1999.

Fish Sampling

Each trip lasted approximately three days during which time fish were collected opportunistically using hook and line with artificial lures. Mass, length, sex, and time of capture were recorded for each fish. Blue runner were anesthetized in an ice bath, which also served to arrest digestion, and then sacrificed by severing the spinal cord. Stomachs were removed by severing the esophagus and the duodenum below the pyloric sphincter, injected with 95% ethanol, and stored in ethanol preservative until they were transported to our laboratory.

Enumeration of Stomach Contents

Stomach contents were examined with a microscope and identified to the following taxonomic categories: fish, decapod/stomatopod, hyperiid amphipods, chaetognaths, other invertebrates, and unidentified material. The number of prey in each category were counted and wet masses recorded to the nearest milligram. These parameters provided numerical and mass based estimations of the contributions of each prey category to the diet.

Plankton Sampling

A surface zooplankton sample was collected beneath MP259A using a passively fished 0.28 m² ring net equipped with a 333 mm mesh net and a General Oceanics Model 2030 flow meter. The net was attached to a vertical monorail and mounted within a gimbaled frame fitted with a current vane so that the mouth of the net faced the prevailing current. The net was fished for 30 minutes from 17:45-18:15 hours on 12 June 1999. Plankton were preserved in 5% formalin for 24 hours before being transferred to 95% ethanol. Samples were sorted and classified into the same groups as for the dietary analysis.

Data Analysis

The Index of Relative Importance (IRI) was used to evaluate monthly variation in blue runner feeding. Relative importance (IRI) (Pinkas *et al.* 1971; Cortes 1997) values were estimated for each prey category (i) using

$$IRI_i = (N_i + G_i) \times F_i \quad (1)$$

Where N_i is the numerical proportion (%) of the i^{th} prey category in the stomach, G_i is the gravimetric proportion (%) of the i^{th} prey item and F_i is the frequency of occurrence expressed as the number of stomachs containing prey category (i) divided by the number of stomachs containing at least one prey item of any category. Percent IRIs for each prey item were then converted to %IRI using

$$\%IRI = IRI_i / \sum IRI \times 100 \quad (2)$$

Size Selection

Size selection was evaluated from the Main Pass 259A platform during the June trip by comparing zooplankton collected from surface currents to those found in blue runner stomachs. After identification and enumeration, photographs were taken of all prey items and samples from the net using a digital camera system. These were analyzed with image processing software (NIH Image 1.62) to determine zooplankton body lengths. Fragmentation of zooplankton in stomachs generally precluded direct measurement of length. Certain body sections were more resistant to digestion, and the relationship between the lengths of body parts and total length (Table 8.1) was used to estimate their original dimensions. Zooplankton from the net sample were binned into 0.25 millimeter size classes and compared with prey from the stomach of four fish collected within an hour of the net sample. These distributions allowed a qualitative evaluation of the size-selection for prey of different sizes.

Table 8.1. Regressions fitted for three prey categories commonly consumed by blue runner. These relationships were used to reconstruct whole body lengths (B.L.) from characteristic body sections of organisms taken from stomachs.

Taxa/Organism	Body Section	Equation	R ²
Hyperiid amphipods	Eye depth (ED)	B.L. = 2.353 x ED + 0.481	0.64
<i>Lucifer</i> spp.	Eye Length (EL)	B.L. = e ^{1.523} x EL ^{1.01}	0.92
Small shrimp	Carapace Length (CL)	B.L. = e ^{1.31} x CL ^{0.63}	0.75

Diel feeding periodicity was estimated using a stomach fullness index modified from Juanes and Conover (1994). Stomach fullness was computed for each fish by dividing the wet weight of all prey items in each stomach by the wet weight of the empty stomach. A gut fullness index was estimated by dividing the fullness value for each fish by the maximum fullness value observed from all fish collected at the particular platform sampled. It was not possible to capture blue runner from all hours of the day on any single trip. A composite pattern of the daily feeding periodicity of blue runner was developed by grouping all fish collected at each platform into two-hour time bins.

RESULTS

The stomachs of 37 of 38 fish collected from Grand Isle 94B in 1996 contained prey items, while 79 of the 88 blue runner from Main Pass 259A in 1999 contained prey items. Blue runner ranged in size from 255 \pm 445 mm FL at the Grand Isle platform and 165 \pm 499 mm FL at the Main Pass platform. This size range indicates most were at or approaching sexual maturity (Goodwin and Finucane 1985). Further, many fish contained developing or mature gonads.

Dietary analysis indicated a high degree of zooplanktivory in blue runner collected from both platforms (Figure 8.1). Zooplankton constituted approximately 86% numerically of the identifiable diet contents at Grand Isle 94B in 1996 and 94% numerically at Main Pass 259A in 1999. Zooplankton were dominated by decapod and stomatopod crustaceans and chaetognaths. When diets were evaluated on the basis of prey mass, zooplankton made up 15% of the diet at Grand Isle 94B and 18% of the diet at Main Pass 259A. The large proportion of invertebrates at Main Pass 259A was contributed primarily by cephalopods. The stomachs of fish from both platforms contained unidentifiable amorphous tissue which constituted 33% and 8% of the overall diet at Grand Isle 94B and Main Pass 259A, respectively.

The diets of blue runner changed over the course of the summer, based on shifts in their IRI values. Adult and larval forms of decapod and stomatopod larvae were a substantial component of the diet at Grand Isle 94B during June and July (Figure 8.2). In August, the IRI indicates that fish, primarily *Bregmaceros* spp., replaced decapods and stomatopods in the diet. Chaetognaths and a variety of hyperiid amphipods contributed to the diets of blue runner at Grand Isle 94B in June and declined in importance over the summer. Fish and decapod/stomatopods were both important in the diets during June at the Main Pass platform (Figure 8.2). Unlike the pattern observed at Grand Isle 94B, decapods and stomatopods continued to predominate in the diet during July and September at Main Pass 259A. Fish declined in importance over the summer, while other invertebrates (primarily cephalopods) assumed greater importance during July.

Blue runner appear to feed at low levels throughout the day and exhibit a peak in feeding activity in the pre-dawn and early morning hours (Figure 8.3). They are also capable of feeding after dark at levels comparable to those observed during the day. The number of fish collected at Grand Isle 94B was insufficient to construct a complete picture of the feeding periodicity of blue runner. The pattern at GI94B, however, was similar to that observed at Main Pass 259A where a larger number of fish produced a better estimate of feeding periodicity. The nocturnal peak feeding at Grand Isle 94B was based on a single fish; however, the presence of a feeding pulse beginning sometime after midnight and extending past dawn was supported by the data from Main Pass 259A (Figure 8.3).

Blue runner appear to preferentially select for large zooplankton and in some cases, the length of prey exceeded the size ranges that were present in our net sample (Figures 8.4 and 8.5). The size distributions of decapod prey in the stomach overlapped the upper end of the size distribution for this group in the net and extended past the upper range collected by the net (Figure 8.4). Small zooplankton such as crab megalopae and crab zoea were absent from or rare in stomach. Similarly, blue runner appeared to consume the largest size fractions of hyperiid amphipods present in the net and also foraged on amphipods larger than those collected in the net.

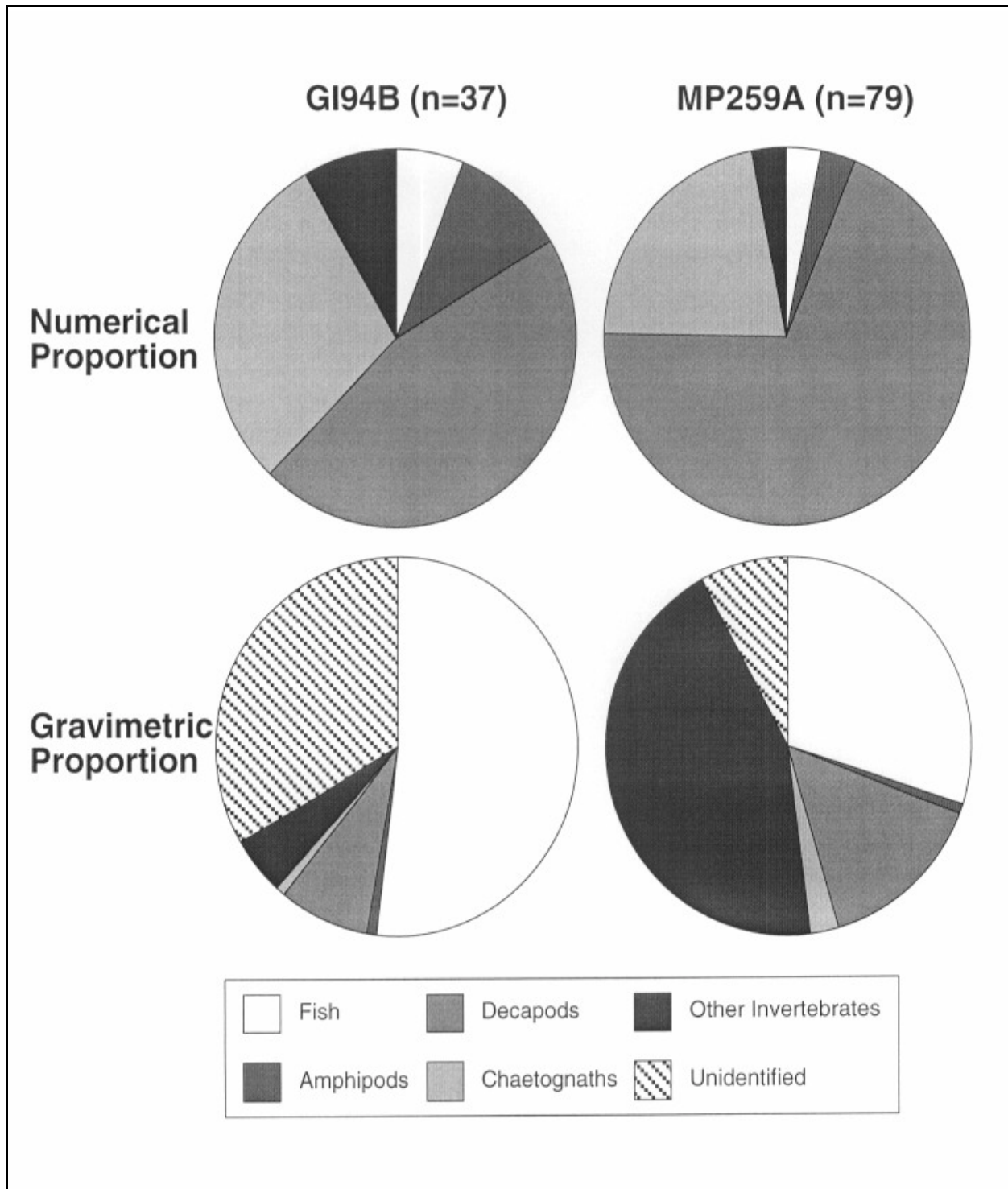

Figure 8.1. Numerical proportion (upper row) and gravimetric proportion (bottom row) for the prey items in the diets of blue runner from the two platforms sampled. The proportions are pooled over the three trips to each of the platforms: June, July and August 1996 (Grand Isle 94B) and June, July and September 1999 (Main Pass 259A).

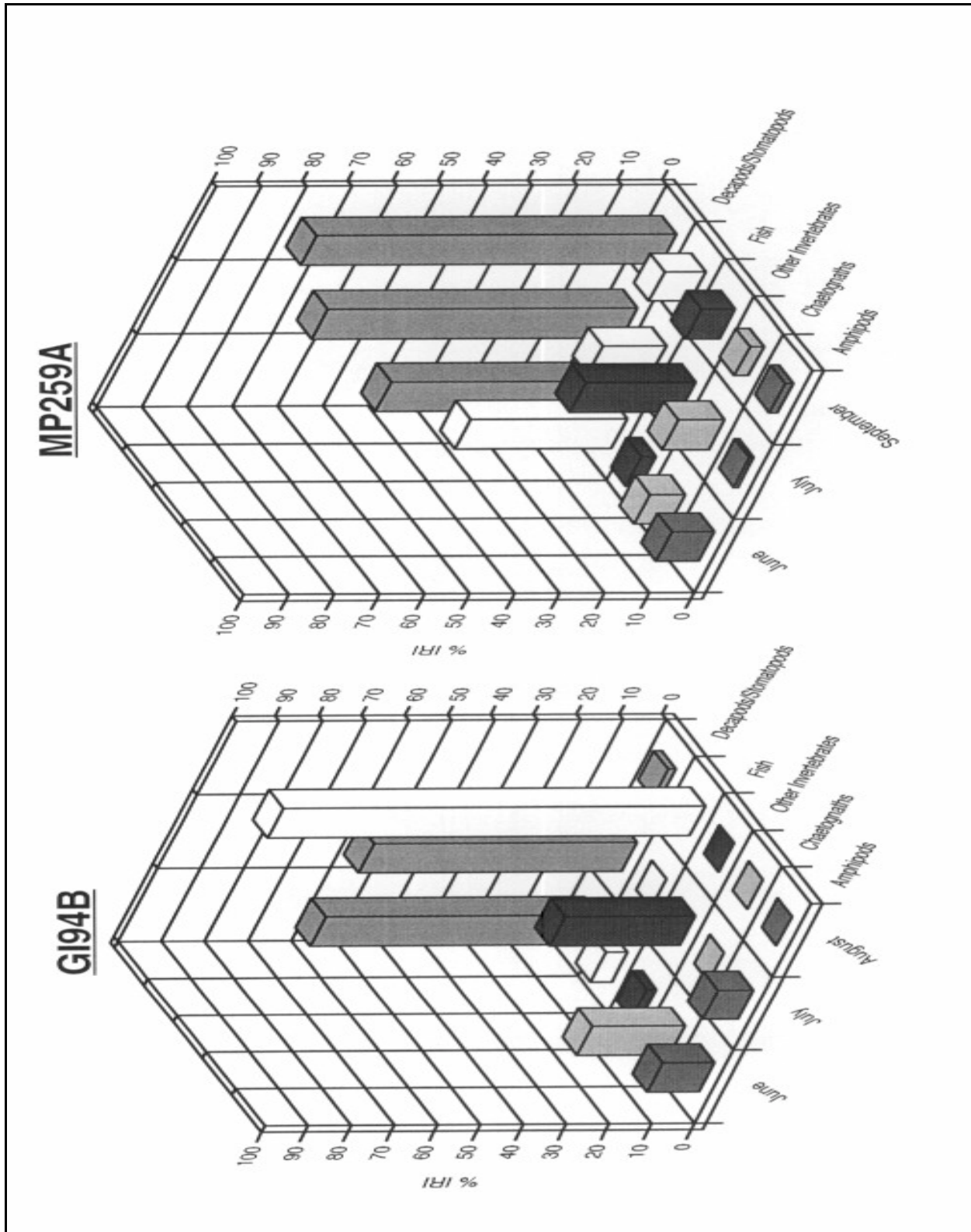

Figure 8.2. Monthly variation in Index of Relative Importance (IRI) for dominant prey taxa from the two platforms.

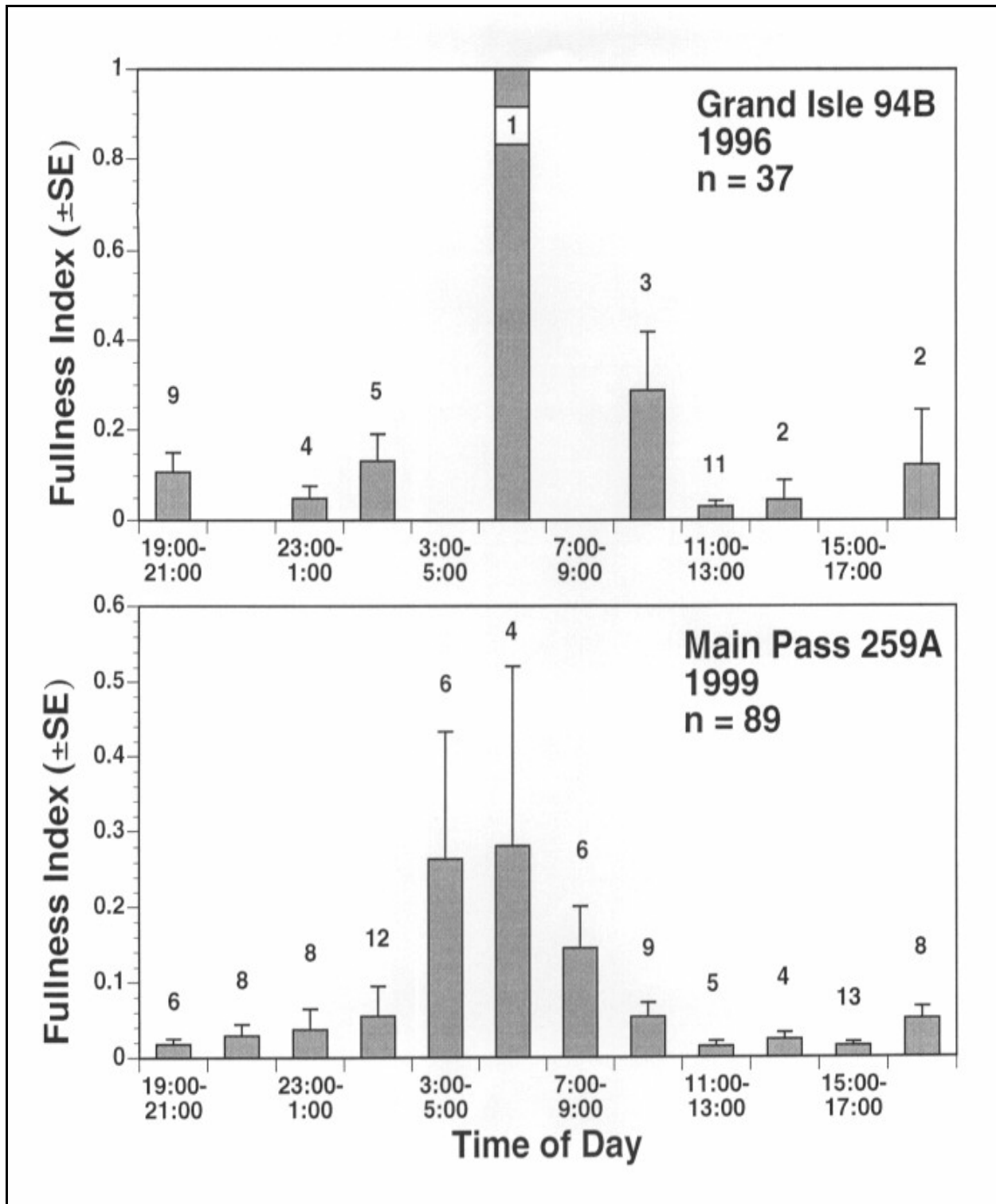

Figure 8.3. Stomach fullness values for blue runner collected over the summer at GI94B (top) and MP259A (below). Fish were pooled over all months and binned into two hour time blocks. The number of fish caught in hour block appears above the bars. Error bars indicate ± 1 S.E. on the mean.

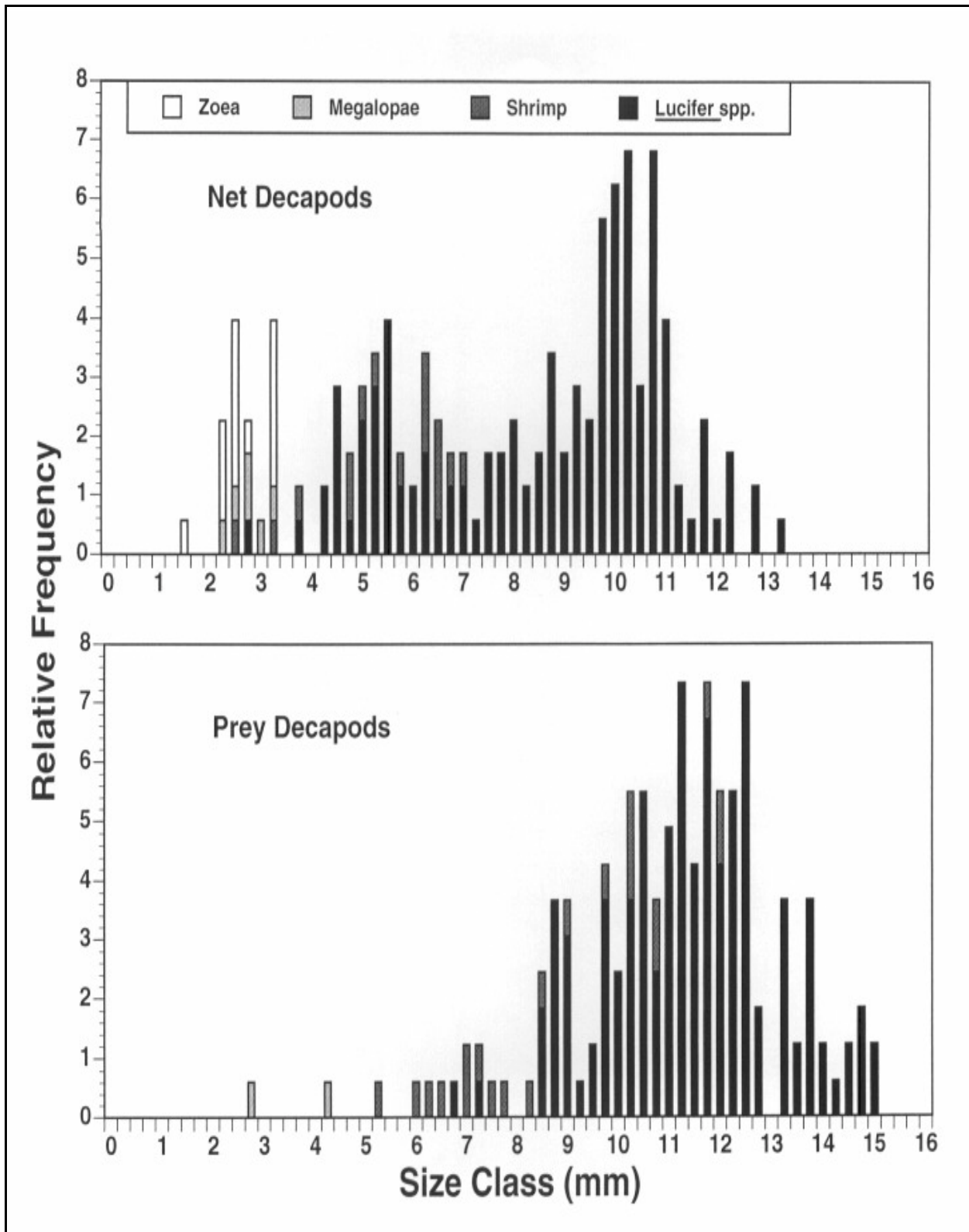

Figure 8.4. Length frequency distributions for decapods taken from surface plankton net and stomachs of concurrent captured blue runner (n=4) during June 1999.

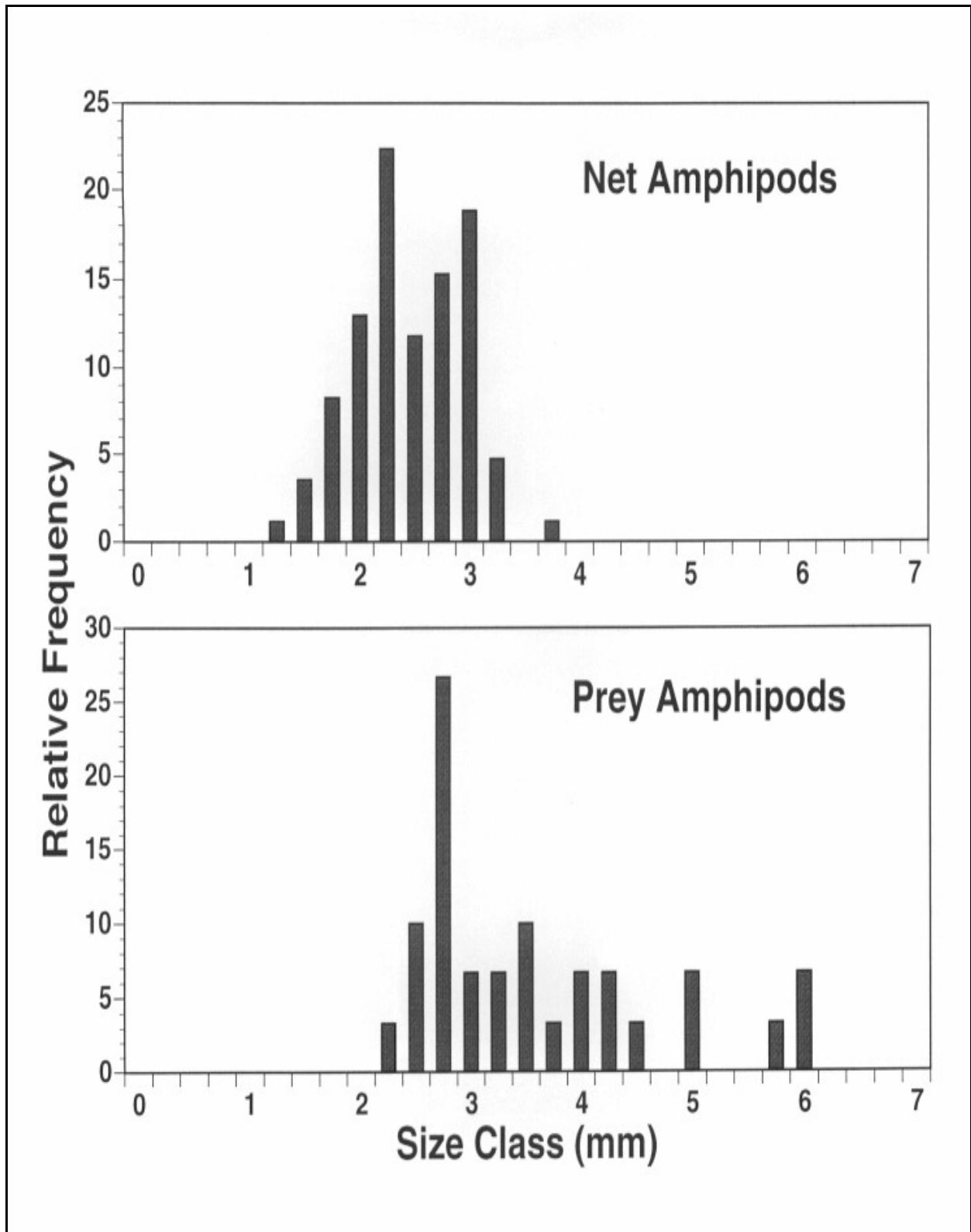

Figure 8.5. Length distributions of hyperiid amphipods collected from a surface plankton net and from blue runner stomachs in June 1999 at Main Pass 259A.

DISCUSSION

Zooplankton appear to comprise a large amount of the diets of blue runner during the summer months. There appeared to be a seasonal shift in diet over the course of the study at both platforms that may reflect changes in the abundance of prey, shifts in preference by blue runner, or both phenomena. While the dietary patterns displayed by blue runner differed among the two sites, the presence of relatively large zooplankton in the form of hyperiid amphipods, chaetognaths, decapods and stomatopod larvae was a consistent feature. Blue runner are likely opportunistic feeders and the shift towards the fish *Bregmaceros* spp. at Grand Isle 94B in August may have been a response to a local increase in the abundance of favorable prey.

The contribution of zooplankton to the diet may be underestimated due to the rapid digestion rates of these organisms. Gut evacuation rates increase with temperature in temperate fish (Popova and Sierra 1985; Buckel and Conover 1996). Increased digestion rates in the warm surface waters of the Gulf may have rapidly rendered the zooplankton unidentifiable and caused an underestimate of their gravimetric contribution to the diet. Haywood (1995) examined the digestion rates of penaeid postlarvae by a small carangid *Monocanthus chinensis* and estimated that after 3 h, rapid digestion could lead to a 33% underestimate in the number of postlarval prey in the stomach and a 75% underestimate in their dry mass. Rapid digestion may also lead to underestimation of the nutritional value of zooplankton prey in fish diets (Cortes 1997). Some fraction of the unidentifiable matter from blue runner stomachs that could not be associated with either zooplankton or fish prey likely came from zooplankton that were in advanced stages of digestion.

Blue runner appear to consume relatively larger zooplankton. We could not conduct a quantitative evaluation of size-based electivity because many of the largest zooplankton that typically appeared in blue runner stomachs were able to avoid our passively-fished net. Hyperiid amphipods and the larger decapods are relatively strong swimmers and their absence from the net was likely due to avoidance. Large chaetognaths were also common in both the stomachs and our net; however, they were usually fragmented in the gut and we were not able to develop a reliable allometric regression to reconstruct their intact lengths from fragments. Small zooplankton such as ostracods, pteropods and copepods were present in the net samples but absent from stomachs, further suggesting that blue runner were actively selecting for large prey. Given that our size selection data are based on a single net and just four fishes, it is clear that further work using different sampling gear will be required to address the issue of size selection more rigorously.

At both platforms there was evidence that blue runner feed during the night and begin their maximum feeding activity after dark. This phenomenon is unusual and is probably apparent only in the vicinity of illuminated petroleum platforms because blue runner are visual predators. Other comparably-sized, zooplanktivorous visual predators such as Atlantic mackerel *Scomber scombrus* reduce feeding rates with diminishing light intensity (Macy et al 1998). Most manned and the larger satellite platforms in the GOM are equipped with large floodlights that illuminate the surrounding waters. This artificial light field appears to permit blue runner to extend their feeding into the night, since gut fullness values at night were comparable with those observed during the day. We did not quantify the light field around platforms because we were restricted to the platforms; however, based

on observations of fishing lures and other objects in the water, the illuminated volume of water is likely restricted to the near-surface region and a radius of 50-100m around the platform.

The appearance of zooplankton in the diets of blue runner does not establish a trophic linkage between the platform and the pelagic species. Most of the plankton in the diet were from holoplanktonic or meroplanktonic groups. Hyperiid amphipods are known for their association with gelatinous zooplankton (perhaps one of the keys), but not with fouling communities. Little is known about the responses of amphipods and other zooplankton to the structure of a platform when they encounter one in the pelagic zone. Comparisons of the catch per unit effort of hyperiid amphipods in light traps placed beneath, and down-current from a large platform suggest that this group can accumulate beneath the platform at night (Keenan *et al.* 1998).

While the predominant taxa in the diets of blue runner are not direct associates of platforms, there may still be a connection between the platforms and the prevalence of zooplankton in the diets of blue runner. Flotsam, *Sargassum*, and foam frequently accumulate beneath platforms. This accumulation is probably due to a reduction in the current velocity and an increase in flow complexity as the prevailing current interacts with the platform. Forristall (1996) measured the degree of current blockage near the Bullwinkle (GC65) platform with acoustic Doppler current profilers arranged in an outward looking horizontal plane at 18 m depth. His findings indicated that the mean current velocity inside the platform structure could be about 80% that unimpacted up-current velocity and that reductions were even lower directly behind dense conductor casings. Decreases in current velocities coupled with an increase in eddy formation could allow zooplankton to extend residence time beneath a platform, which would lead to an increase in the concentrations.

The lights of manned platforms may further increase zooplankton concentrations and enhance the effect due to currents at night. Many zooplankton, such as amphipods, display positive phototaxis and actively swim towards light. Light traps are commonly used as collection gear for animals around platforms by colleagues (Ditty *et al.* 1998) and the same groups that predominate in blue runner stomachs (decapods, hyperiid amphipods, chaetognaths and small fish) are the dominant constituents of light trap samples. The combined influence of the artificial light field and the current alterations may cause platforms to act as large, passive zooplankton accumulators. Thus the platforms may provide blue runner with enhanced densities of prey and an opportunity to feed continuously. Such conditions may explain how such large densities of blue runner can be sustained by the waters around platforms.

To address these hypotheses, we are in the process of analyzing data from research cruises taken during the summer of 2000. Plankton net tows from a vessel were used to evaluate the zooplankton distribution on the up-current and down-current sides of different sized platforms. Hydroacoustics were used to quantify the flow field around platforms and to examine patterns of backscatter from zooplankton. If plankton are accumulating beneath the structure, we would expect to see lower densities on the down-current side relative to open water densities. Blue runner were collected both around platforms and in open waters away from platforms. The results from these studies will likely provide more information on the trophic linkages between blue runner and zooplankton at offshore platforms.

REFERENCES

- Benfield, M.C., R.F. Shaw and S.F. Keenan. 1996. Importance of zooplankton secondary production to fishes at offshore petroleum platforms. Pp 220-227. *In Proceedings: Sixteenth Annual Gulf of Mexico Information Transfer Meeting*. Dec. 1996. New Orleans, Louisiana.
- Bohnsack, J.A., A. Ecklund, and A.M. Szmant. 1997. Artificial reef research: Is there more than the attraction-production issue? *Fisheries* 22(4):14-16.
- Bowman, T.E. and H.ÐE. Gruner. 1973. The families and genera of Hyperiidia (Crustacea: Amphipoda). *Smithsonian Contribution to Zoology* 146:1-64.
- Buckel, J.A. and D.O. Conover. 1996. Gastric evacuation rates of piscivorous young-of-the-year Bluefish. *Transactions of the American Fisheries Society* 125:591-599.
- Christmas, J.Y., A. Perry, and R.S. Waller. 1974. Investigations of coastal pelagic fishes, Completion Report. Gulf Coast Research Laboratory, Ocean Springs, Mississippi.
- Cortes, E. 1997. A critical review of methods of studying fish feeding based on analysis of stomach contents: application to elasmobranch fishes. *Canadian Journal of Fisheries and Aquatic Sciences* 54:726-738.
- Fleminger, A. and R.I. Clutter. 1965. Avoidance of towed nets by zooplankton. *Limnology and Oceanography* 10:96-104.
- Forristall, G.Z. 1996. Measurements of current blockage by the Bullwinkle platform. *Journal of Atmospheric and Oceanic Technology* 13:1247-1266.
- Goodwin, IV., J.M. and J.H. Finucane. 1985. Reproductive biology of blue runner, *Caranx crysos*, from the eastern Gulf of Mexico. *Northeast Gulf Science* 7(2):139-146.
- Grossman, G.D., G.P. Jones, and Seaman, Jr., W. J. 1997. Do artificial reefs increase regional fish production? A review of existing data. *Fisheries* 22(4):17-23.
- Haywood, M.D.E. 1995. Rates at which post-larval prawns are digested by a small predator fish and the implications for predation studies. *Journal of Fish Biology* 47: 337-340.
- Haury, L.R., D.E. Kenyon, and J.R. Brooks. 1980. Experimental evaluation of the avoidance reaction of *Calanus finmarchicus*. *Journal of Plankton Research* 2(3):187-202.
- Kasprzak, R.A. 1998. Use of oil and gas platforms as habitat in Louisiana's artificial reef program. *Gulf of Mexico Science* 1:37-45.

- Keenan, S.F., M.C. Benfield, R.F. Shaw, and H.L. Haas. 1998. Importance of zooplankton to platform productivity. Pp. 33-41. *In* Proceedings: Eighteenth Annual Gulf of Mexico Information Transfer Meeting, December 1998. New Orleans, Louisiana.
- Lindberg, W.J. 1997. Can science resolve the attraction-production issue? *Fisheries* 22(4):10-13.
- Macy, W.K., S.J. Sutherland, E.G. Durbin. 1998. Effects of zooplankton size and concentration and light intensity on the feeding behavior of Atlantic mackerel *Scomber scombrus*. *Marine Ecology Progress Series* 172:89-100.
- McKenney, T.W., E.C. Alexander, G.L. Voss. 1958. Early development and larval distribution of the carangid fish, *Caranx crysos* (Mitchill). *Bulletin of Marine Science of the Gulf and Caribbean* 8(2):167-200.
- Parker, Jr., R.O., D.R. Colby, T.D. Willis. 1983. Estimated amount of reef habitat on a portion of the U. S. South Atlantic and Gulf of Mexico Continental Shelf. *Bulletin of Marine Science* 33(4):935-940.
- Pinkas, L. 1971. Bluefin tuna habits. *In* Food habits of albacore, bluefin tuna and bonito in California waters. L. Pinkas, M. S. Oliphant, and I. K. Iverson, eds. California Dept. of Fish and Game, *Fishery Bulletin* 152:47-63.
- Popova, O.A. and L.M. Sierra. 1985. Feeding of Black Jack, *Caranx ruber*, in the Gulf of Batabano on the Cuban Shelf. II. Digestion Rates and Daily Rations. *Journal of Ichthyology* 25(6):105-118.
- Randall, J.E. 1967. Food Habits of Reef Fishes of the West Indies. *Studies in tropical oceanography* 5:867pp.
- Schekter, R.C. 1972. Food habits of some larval and juvenile fishes from the Florida Current, near Miami, Florida. Rosenstiel School of Marine and Atmospheric Science University of Miami, Miami, Florida. 1-85.
- Stanley, D.R. and C.A. Wilson. 2000. Seasonal and spatial variation in the biomass and size frequency distribution of fish with oil and gas platforms in the northwestern Gulf of Mexico. OCS Study MMS 2000-005. U.S. Dept. of the Interior, Minerals Mgmt. Service, Gulf of Mexico OCS Region, New Orleans, Louisiana.
- Stanley, D.R. and C.A. Wilson. 1998. Spatial variation in fish density at three petroleum platforms as measured with dual-beam hydroacoustics. *Gulf of Mexico Science* 16(1):73-82.
- Stanley, D.R. and C.A. Wilson. 1996. Abundance of fishes associated with a petroleum platform as measured with dual-beam hydroacoustics. *ICES Journal of Marine Science* 53:473-475.

Swaby, S.E., G.W. Potts, J. Lees. 1996. The first records of the Blue Runner *Caranx crysos* (Pisces: Carangidae) in British waters. *Journal of the Marine Biological Association of the United Kingdom* 76(2):543-544.

COMPARISON OF PLANKTON NET AND LIGHT-TRAP METHODOLOGIES FOR SAMPLING LARVAL AND JUVENILE FISHES ASSOCIATED WITH OFFSHORE PETROLEUM PLATFORMS AND A COASTAL JETTY OFF LOUISIANA

Frank J. Hernandez, Jr.
Department of Oceanography and Coastal Sciences
Center for Coastal Energy and Environmental Resources,
Louisiana State University

Richard F. Shaw
Coastal Fisheries Institute
Louisiana State University

ABSTRACT

While sampling ichthyoplankton associated with artificial structures across the continental shelf (3-230 m depth) of the northern Gulf of Mexico (GOM), we compared passive, 60 cm diameter plankton net and light-trap methodologies at three offshore petroleum platforms (continental shelf slope, mid-shelf, and inner shelf) and a 1m x 1m plankton pushnet and a light-trap at a coastal jetty. Clupeiform fishes dominated collections for all gears (59%-97% of the total catch for nets and light-traps combined). Plankton nets collected more fish than light-traps at the shelf slope and inner platforms (plankton net vs. light-trap: 1,404 vs. 659; 3,076 vs. 12,474; and 1,689 vs. 1,193), and the pushnet collected more fish than the light-trap (33,1477 vs. 849) at the jetty. Plankton nets collected individuals from more families than light-traps at the shelf slope and mid-shelf platforms (plankton net vs. light-trap: 43 vs. 35; 38 vs. 35; and 32 vs. 32), but only collected more taxa (genus level) than light-traps at the shelf slope platform (plankton net vs. light-trap: 56 vs. 47; 75 vs. 78; and 50 vs. 56). At the jetty, the pushnet collected more families (39 vs. 19) and taxa (77 vs. 34) than the light-trap. Results of Kolmogorov-Smirnov length-frequency comparisons of fish collected in plankton nets vs. light-traps indicated light-traps generally overlapped the net's smaller sizes, but also collected significantly larger individuals. At the jetty, greater overlap in size distributions was observed for comparisons of the pushnet and light-trap. Schoener's Index of Niche Overlap values for light-trap and plankton net samples indicated low similarity between gears at two platforms (0.32-0.38), but higher similarity (0.63) at the inner shelf platform which was most dominated by clupeiforms. At the jetty, pushnet and light-trap samples had relatively high taxonomic similarity (0.61). Few significant differences were detected between Shannon-Weiner Diversity Indices for platform light-trap and plankton net samples, while at the jetty, pushnet samples had significantly higher diversity than light-trap samples. When significant differences in mean total densities and mean total CPUEs were found between new vs. full moon phases, four out of five instances had greater new moon catches.

INTRODUCTION

Most marine fishes, particularly structure-associated or reef-dependent fishes, have a pelagic early life history stage (Moser *et al.* 1984; Leis 1991). Previous studies have indicated that larval source,

supply, recruitment, and settlement patterns can greatly influence the adult population dynamics of reef fish on both natural (Victor 1983 1986; Sponaugle and Cowen 1996) and artificial reefs (Lukens 1981; Stephens *et al.* 1994). In response to the need for crucial information on reef fish early life history stages, several methods have been developed to collect larval and juvenile fishes in a variety of environments. Many reef fish juveniles are at some time associated with structurally-complex habitats, either while in a nursery area (mangroves, seagrass meadows, oyster reefs) or on the reef environment itself. While towed sampling gears are effective in open waters, these methods are usually not suitable for shallow or structurally complex habitats (Brogan 1994).

Different methodologies have been developed to collect fish early life history stages in complex environments including plankton pumps (Taggert and Legget 1984; Brander and Thompson 1989), visual censuses (Kingsford and Choat 1989), moored channel nets (Keener *et al.* 1988; Shenker *et al.* 1993), larval purse seines (Murphy and Clutter 1972; Choat *et al.* 1993), and diver-steered plankton tows (Marliave 1986; Brogan 1994). Other methods have used light sources to aggregate fish for collection and include lighted purse seines (Choat *et al.* 1993), light lift-nets (Dennis *et al.* 1991; Rooker *et al.* 1996) and light-traps of various designs (Doherty 1987; Thorrold 1992; Choat *et al.* 1993; Brogan 1994; Sponaugle and Cowen 1996; Hernandez and Lindquist 1999; Hickford and Schiel 1999; Reyns and Sponaugle 1999). All of these methods have different biases, advantages, and disadvantages and should be chosen to best suit the environment being sampled and the questions being addressed.

To date, few studies have investigated the ichthyoplankton assemblages associated with oil and gas platforms in the northern Gulf, in part due to the difficulties in sampling within the complex, mostly vertical infrastructure of the platforms. Although Gallaway (1998) calculated that oil and gas platforms in the northern Gulf provided 11.7 km² (or 4.0%) of the total “reef” habitat. The fact that platforms represent vertical artificial substrate that extends from the bottom to the surface (photic zone), regardless of location and depth, increases their significance (Parker *et al.* 1983). These and other artificial structures (e.g., jetties, breakwaters) could represent significant habitats for reef fish, since the northern Gulf is dominated by a mud/silt/sand bottom with little relief or hard-bottom habitat. In our attempt to characterize the across-continental shelf ichthyoplankton communities associated with artificial structures (three offshore oil and gas platforms and a coastal jetty) in the northern Gulf, we used a variety of gear types to sample the widest range of taxa, size classes, and cohorts available. This paper reports the results of gear comparisons between a passive plankton net and light-trap used at the petroleum platforms, and between a bow-mounted, plankton pushnet and light-trap (the same design) used at the coastal jetty. In our comparisons, we examined the taxa collected by the different gears, the similarity and diversity of the catches, as well as the size selectivities of the gears. Our findings will be useful to those designing similar sampling efforts for larval and juvenile fishes in the vicinity of complex structures.

STUDY SITES

Data collection and analyses focused on three oil and gas platforms in the northern Gulf and at a low-salinity, coastal rock jetty environment, which provided a far-field, non-platform site end-member that was equally complex structurally and represented another artificial reef-type, hard-substrate habitat. Site selection for the three study platforms (west of the Mississippi River Delta)

was based upon the work of Gallaway *et al.* (1980), Gallaway (1981), and Continental Shelf Associates (1982) who reported that nekton communities around platforms could be categorized by water depth in the northern Gulf. Three communities were characterized: a coastal assemblage (water depths <27m), an offshore assemblage (water depths 27 to 64 m), and a bluewater/tropical assemblage (water depths >64m). The platforms selected and the jetty site encompass all three zones. Mobil's Green Canyon (GC) 18, which lies in about 230 m of water on the shelf slope (27°56'37"N, 91°01'45"W), was sampled monthly during new moon phases over a two to three night period during July 1995-June 1996. Mobil's Grand Isle (GI) 94B, which lies in approximately 60 m of water at mid-shelf (28°30'57"N, 90°07'23"W), was sampled twice monthly during new and full moon phases over a three night period during April-August 1996. In addition, during May, extra samples during the first quarter and third quarter moon phases were collected, but due to inclement weather, full moon collections were cancelled. Exxon's South Timbalier (ST) 54G, which lies in approximately 20 m of water on the inner shelf (28°50'01"N, 90°25'00"W), was sampled twice monthly during new and full moon periods in during April-September, 1997. The stone rubble jetties (2-3 m depth) at the terminus of Belle Pass, a major shipping channel near Fourchon, Louisiana (N 29 03.90, W 90 13.80), were also sampled over a two-night period in 1997 simultaneously with the sampling of ST 54.

METHODS

Sampling protocols are described in detail elsewhere (Hernandez *et al.* this volume). In general, passive plankton nets (60-cm diameter; 333mm mesh dyed green) were used to collect ichthyoplankton at the three platform sites, both at depth (10-20 m for 10-20 min, set and retrieved closed) and near surface (1-2 m for 10-15 min) within the platform structure. Quatrefoil light-traps were deployed for 10 minutes at depth and near surface within the platform structure, and in addition were also floated downstream (approximately 20 m) from the platform for off-platform collections. Both the subsurface and off-platform light-traps were deployed with the light off until the sampling depth/location was reached, fished, and then retrieved with the light off. At Belle Pass, light-traps were fished along the jetty walls, as well as a bow-mounted plankton pushnet (1 m x 1 m; 1000 µm mesh net dyed green; 3-5 min samples).

The quatrefoil light-trap (Figure 8.6) was modified from Floyd *et al.* (1984) and Secor *et al.* (1993). The main modifications are as follows: acrylic tubes in the main body of the trap were enlarged to 15.24 cm (6") outer diameter; the collection assembly at the bottom of the trap was replaced with short conical plankton-net (202 µm) and cod-end assembly; four vertical, stainless steel bars were added to the corners of the trap for additional support; the light source was a Brinkman Starfire II 12-volt halogen fishing light (250,000 candlepower); for surface samples, power was supplied through an umbilical cord by a 12-volt marine battery located on the lower deck of the platform; for subsurface collections, either an umbilical cord connected to a 12-volt battery or a submersible battery was used; the battery was made by placing a 7.0 amp/h rechargeable sealed lead battery in a 1/4" thick PVC tube with a watertight connector on one end and a complimentary pig-tail on the end of the cable supplying power to the light.

Due to the very large numbers of clupeiform (Clupeidae and Engraulidae) fishes collected, particularly in light-trap samples, statistical analyses were run without these taxa, unless otherwise

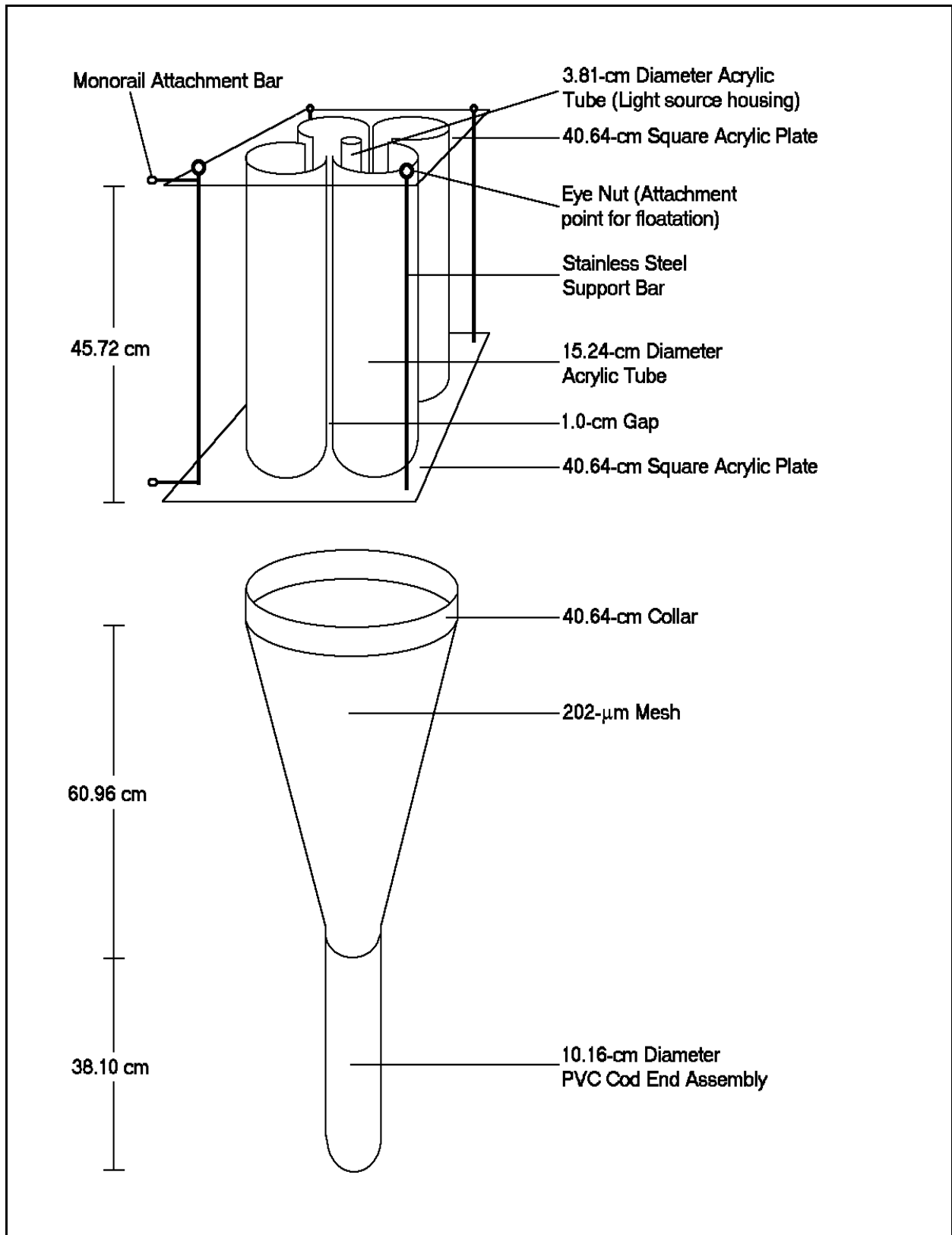

Figure 8.6. Specifications for the modified quatrefoil light-trap used in this study.

noted. Clupeiform fishes are seldom the taxa of interest in studies of hard substrate habitats, i.e., (artificial) reefs, and their abundances tend to overwhelm the trends of other taxa (Choat *et al.* 1993). All ANOVA, Tukey's Studentized Range Tests, and Student's t-tests were run with SAS version 6.12 (SAS 1989).

Studentized t-tests ($\alpha=0.05$) were used to compare overall plankton net densities between locations (subsurface and surface) within the GC 18, GI 94, and ST 54 sites. Light-trap CPUEs were compared between locations (subsurface, surface, and off-platform) within each of the platform sites using an ANOVA model with gear as a main effect. Tukey's Studentized Range tests were used to determine which light-trap collections were significantly different. Before testing, plankton net densities were log transformed ($\log_{10}(x+1)$) to conform to normality and homogeneity of variances. Analyses on light-trap CPUEs were run on ranked-transformed data.

Kolmogorov-Smirnov (K-S) length-frequency analyses ($\alpha=0.05$) were performed for selected species from GC 18, GI 94, ST 54, and Belle Pass to determine if there were any significant differences between the size distribution of fish collected with light-traps vs. plankton nets (Sokal and Rohlf 1981). Taxa from each platform site and Belle Pass were chosen for these analyses if at least 10 individuals were collected by each gear type. All K-S analyses were performed using SYSTAT version 4 (SPSS 1999).

Lunar periodicity (full and new moon) was examined for plankton net and light-trap samples collected at GI 94, ST 54, and Belle Pass using Student's t-tests ($\alpha=0.05$). An ANOVA model and Tukey's Studentized Range tests were used to analyze the densities and CPUEs of samples collected in May of 1996 at GI 94 (third quarter, new, and full moon periods).

Schoener's Index of Niche Overlap (Schoener 1970) was calculated for comparisons of fish collections within the platform structure (surface net and surface light-trap) and farfield collections (off-platform light-trap) and total net collections vs. total light-trap collections. This same gear analysis was performed to compare the similarity of light-trap and pushnet collections at Belle Pass. Only fish identified to at least the genus level were used in the analyses. Shannon-Weiner diversity indices (Magurran 1988) were calculated for each sample collected at GC 18, GI 94, ST 54, and Belle Pass. Differences in diversity between gear types at each site were analyzed with ANOVA models using gear as a main effect. Post-ANOVA tests (Tukey's Studentized Range, $\alpha=0.05$) were used to determine which gear types were significantly different. Only fish identified at least to the level of genus were included in these analyses. Also, since the intent of the similarity and diversity indices was to characterize the taxonomic assemblages sampled by each gear type, clupeiform fishes were included in these analyses.

RESULTS

Overall Abundances

At GC 18, plankton nets and light-traps collected 1,404 and 659 fish, respectively, with a mean total density of 74.6 fish/100m³ and a mean total CPUE of 2.1 fish/10 min (Table 8.2). Plankton nets collected fish from more families than light-traps, 15 of which were exclusively collected with

Table 8.2. Number of samples, total individuals, families, and taxa collected at each site with a passive plankton net, light-trap, and plankton pushnet. Mean total densities (nets) or CPUEs (light-traps) are also provided for each gear at each site. Values in parentheses indicate the number of families or taxa (at least to genus level) unique to that gear type.

Gear Type	Number of samples	Number of fish	Mean Total Density and CPUE	Number of families	Number of taxa
Green Canyon 18					
Passive Plankton Net	125	1,404	74.6 fish/100m ³	43 (15)	56 (25)
Light-trap	319	659	2.06 fish/10 min	35 (7)	47 (14)
Grand Isle 94					
Passive Plankton Net	329	3,076	69.6 fish/100m ³	38 (6)	75 (26)
Light-trap	474	12,474	26.2 fish/10 min	35 (3)	78 (27)
South Timbalier 54					
Passive Plankton Net	89	1,689	166.0 fish/100m ³	32 (8)	50 (16)
Light-trap	194	1,193	0.6 fish/10 min	32 (8)	56 (24)
Belle Pass Jetty					
Plankton Pushnet	149	33,147	136.7 fish/100m ³	39 (20)	77 (44)
Light-trap	148	849	4.6 fish/10 min	19 (0)	34 (3)

plankton nets. Light-traps collected fish from seven families which were not collected in plankton nets. Plankton nets collected fish from 56 taxa (identified at least to genus level), 25 of which were not collected with light-traps, while light-traps collected fish from 47 taxa with 14 being unique to light-trap collections. Mean plankton net densities ranged from 3.3-318.0 fish/100 m³, while light-trap CPUEs ranged from 0-12.2 fish/10 min (Figure 8.7). *Sciaenops ocellatus*, *Caranx hippos/latus*, and *Mugil cephalus* were among the most common non-clupeiform fishes in the plankton net collections (Table 8.3). Coastal pelagic taxa such as *Auxis* spp., *Caranx crysos*, and *C. hippos/latus* were common in the surface and off-platform light-trap collections.

At GI 94, plankton nets collected 3,076 fish while light-traps collected 12,474 fish, with a mean total density of 69.6 fish/100 m³ and a mean total CPUE of 26.2 fish/10 min (Table 8.2). Plankton nets collected individuals from more families than light-traps, but light-traps collected fish from more different taxa than plankton nets. Twice as many unique families were collected by plankton nets, while the number of unique taxa collected by each gear type was nearly identical. Mean plankton net densities ranged from 16.6-201.0 fish/100 m³, while mean CPUEs ranged from 1.2-197.1 fish/10 min (Figure 8.8). Benthic taxa such as *Symphurus* spp. and *Bregmaceros cantori* were common in plankton net collections, as well as coastal pelagic species such as *Auxis* spp. and *Euthynnus alletteratus* (Table 8.3). Among the most common fishes collected in light-traps were synodontids (primarily *Synodus foetens* and *S. poeyi*) and blenniids (primarily *Hypsoblennius invemar* and *Parablennius marmoreus*).

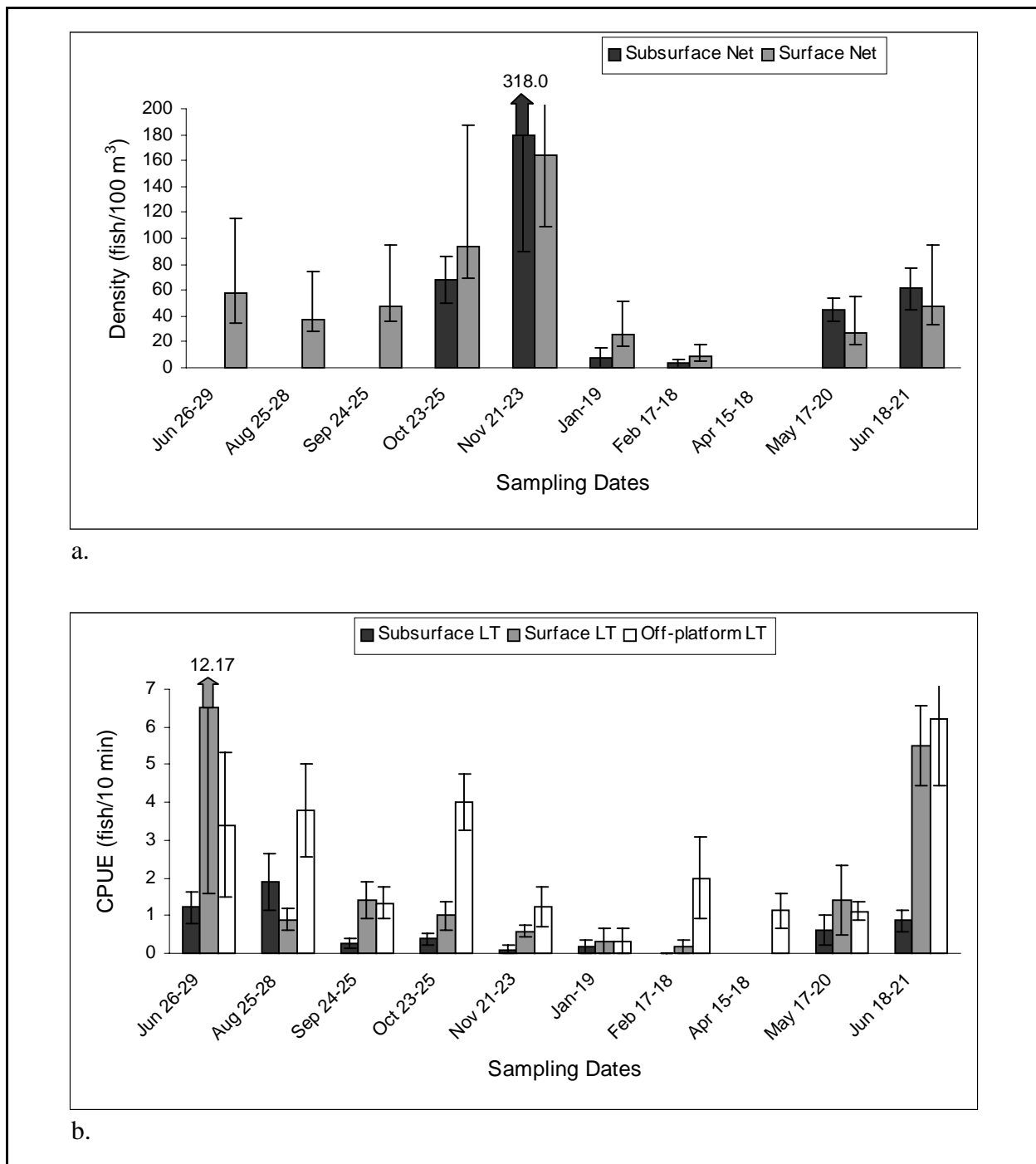

Figure 8.7. Mean plankton net densities (a) and light-trap CPUEs (b) with standard errors for each sampling trip at Green Canyon 18 (1995-96). Arrows above bars point toward the off-scale mean for that gear. No subsurface plankton net samples were taken during 26-29 June, 25-28 August, 24-25 September, or 15-18 April. No surface net, surface light-trap, or subsurface light-trap samples were taken during 15-18 April. No fish were present in subsurface light-trap samples ($n=10$) during 17-18 February.

Table 8.3. Size ranges (SL in mm) and percent of the total catch by gear for dominant taxa (>1%) collected by at least one gear type. Note the preponderance of recently-spawned larvae, late stage postlarvae, or juveniles collected with both gears. Also note the overlap in sampling efforts for GC 18 and GI 94, and ST 54 and Belle Pass.

Taxon	Light-trap		Plankton net	
	Size Range	%	Size Range	%
Green Canyon 18 (July 1995-June 1996)				
<i>Cyclothone braueri</i>	3.2-7.2	5.8	4.0-13.0	1.8
<i>Saurida brasiliensis</i>	3.2-9.8	5.8		
<i>Trachinocephalus myops</i>	16.2-35.0	1.8		
<i>Bregmaceros cantori</i>	1.5-6.7	2.0	1.3-6.8	4.5
<i>Gobiesox strumosus</i>	2.6-3.2	2.0		
<i>Holocentrus</i> spp.	6.0-37.5	4.0		
<i>Caranx crysos</i>	5.0-65.0	12.0	2.5-16.5	3.3
<i>Caranx hippos/latus</i>	3.0-54.0	6.4	2.0-32.0	10.9
<i>Chloroscombrus chrysurus</i>			1.9-7.0	1.6
<i>Elagatis bipinnulata</i>			2.0-3.5	1.3
<i>Pristipomoides aquilonaris</i>			2.3-40.0	3.9
<i>Eucinostomus</i> spp.	6.5-11.2	3.3		
<i>Cynoscion arenarius</i>	2.5-4.5	1.1	2.0-4.4	6.9
<i>Micropogonias undulatus</i>	3.2-4.5	1.1		
<i>Sciaenops ocellatus</i>			1.8-3.9	12.3
<i>Pomacentrus</i> spp.	9.0-19.3	4.7		
<i>Mugil cephalus</i>	2.4-21.5	3.8	2.2-5.0	9.0
<i>Microdesmus lanceolatus</i>			2.0-11.0	1.5
<i>Microdesmus longipinnis</i>	2.4-4.9	1.8		
<i>Auxis</i> spp.	3.3-59.0	13.3	2.2-10.5	7.6
<i>Euthynnus alletteratus</i>	6.2-87.0	5.1	3.0-12.0	2.5
<i>Scomberomorus cavalla</i>	3.0-4.5	1.3		
<i>Scomberomorus maculatus</i>			2.0-10.1	2.1
<i>Ariomma</i> spp.			2.1-2.5	7.8
<i>Peprilus burti</i>	1.7-4.2	2.0	1.4-3.3	1.2
<i>Citharichthys spilopterus</i>			3.0-8.0	2.1

Table 8.3. (continued)

Taxon	Light-trap		Plankton net	
	Size Range	%	Size Range	%
<i>Syacium</i> spp.	3.5-6.5	2.7		
<i>Symphurus</i> spp.	2.2-8.0	5.3	2.8-9.0	6.9
Grand Isle 94 (April-August 1996)				
<i>Saurida brasiliensis</i>	4.5-55.0	7.9	2.7-22.5	6.2
<i>Synodus foetens</i>	6.0-43.0	30.6	4.2-22.5	1.8
<i>Synodus poeyi</i>	5.3-45.0	15.6	2.0-16.5	1.2
<i>Bregmaceros cantori</i>	2.0-29.0	3.0	2.0-15.5	16.6
<i>Caranx crysos</i>			2.5-15.0	2.1
<i>Chloroscombrus chrysurus</i>			2.1-16.5	1.5
<i>Lutjanus</i> spp.			3.0-5.5	1.0
<i>Cynoscion arenarius</i>			1.9-5.2	2.2
<i>Sphyraena guachancho</i>			2.6-7.3	2.7
<i>Hypsoblennius henz/ionthas</i>	4.3-12.0	2.5		
<i>Hypsoblennius invemar</i>	3.5-14.5	13.8		
<i>Parablennius marmoreus</i>	4.4-23.7	12.3		
<i>Scartella/Hypleurochilus</i>	3.6-12.5	1.7		
<i>Microdesmus lanceolatus</i>			2.4-25.0	2.2
<i>Auxis</i> spp.	4.0-36.0	1.4	2.5-10.3	10.3
<i>Euthynnus alletteratus</i>	3.1-60.0	5.3	2.7-8.7	10.7
<i>Etropus crossotus</i>			2.5-9.0	2.6
<i>Syacium</i> spp.			2.1-8.5	3.0
<i>Symphurus</i> spp.			2.0-12.8	22.5
South Timbalier 54 (April-September 1997)				
<i>Saurida brasiliensis</i>	26.4-43.0	1.2		
<i>Synodus foetens</i>	9.0-44.5	38.9		
<i>Bregmaceros cantori</i>			2.2-11.7	2.1
<i>Caranx crysos</i>	6.5-24.5	2.0		
<i>Caranx hippos/latus</i>	5.5-35.0	3.8		
<i>Chloroscombrus chrysurus</i>			2.1-16.5	1.5
<i>Lutjanus</i> spp.			3.0-5.5	1.0
<i>Menticirrhus</i> spp.			2.4-5.0	1.9

Table 8.3. (continued)

Taxon	Light-trap		Plankton net	
	Size Range	%	Size Range	%
<i>Hypsoblennius hentz/ionthas</i>	3.4-12.5	4.4		
<i>Hypsoblennius invemar</i>	5.7-13.8	3.6		
<i>Scartella/Hypleurochilus</i>	2.0-14.3	5.0		
<i>Microdesmus lanceolatus</i>			3.2-20.8	1.3
<i>Microdesmus</i> spp.			2.0-3.3	1.3
<i>Auxis</i> spp.	4.9-25.0	1.7		
<i>Euthynnus alletteratus</i>	7.0-22.5	9.1		
<i>Scomberomorus cavalla</i>	3.5-20.0	1.1	2.4-4.2	2.9
<i>Scomberomorus maculatus</i>	2.5-40.5	6.0	1.9-10.2	4.4
<i>Peprilus burti</i>	3.5-22.0	1.9	2.1-12.0	1.0
<i>Peprilus alepidotus</i>	2.5-24.7	1.3	1.8-5.0	1.6
<i>Etropus crossotus</i>	2.8-12.7	1.1	3.0-13.1	2.1
<i>Symphurus</i> spp.			2.0-14.5	2.3
<i>Sphoeroides</i> spp.	6.7-16.0	1.6		
Belle Pass (April-September 1997)				
<i>Synodus foetens</i>	20.0-36.0	2.7		
<i>Gobiesox strumosus</i>	7.5-10.1	8.7	4.1-10.6	1.1
<i>Chloroscombrus chrysurus</i>			2.1-16.5	1.5
<i>Lutjanus</i> spp.			3.0-5.5	1.0
<i>Bairdiella chrysoura</i>	2.9-5.1	2.2	2.4-125.0	2.1
<i>Cynoscion arenarius</i>	3.2-8.2	10.8	2.5-41.0	27.5
<i>Hypsoblennius hentz/ionthas</i>	8.3-12.0	19.1	5.1-13.5	1.7
<i>Dormitator maculatus</i>	7.2-10.7	2.2		
<i>Gobionellus oceanicus</i>	11.0-13.5	2.0	7.5-35.0	6.9
<i>Gobiosoma bosc</i>	7.7-9.6	10.9	6.5-17.0	37.3
<i>Gobiosoma</i> spp.	4.2-7.6	5.0	4.7-8.1	1.3
<i>Microgobius</i> spp.			4.7-10.1	3.7
<i>Citharichthys</i> spp.	7.9-11.6	1.5	5.2-13.0	5.2
<i>Symphurus</i> spp.			7.3-42.0	4.5
<i>Sphoeroides parvus</i>	9.1-12.5	3.1		

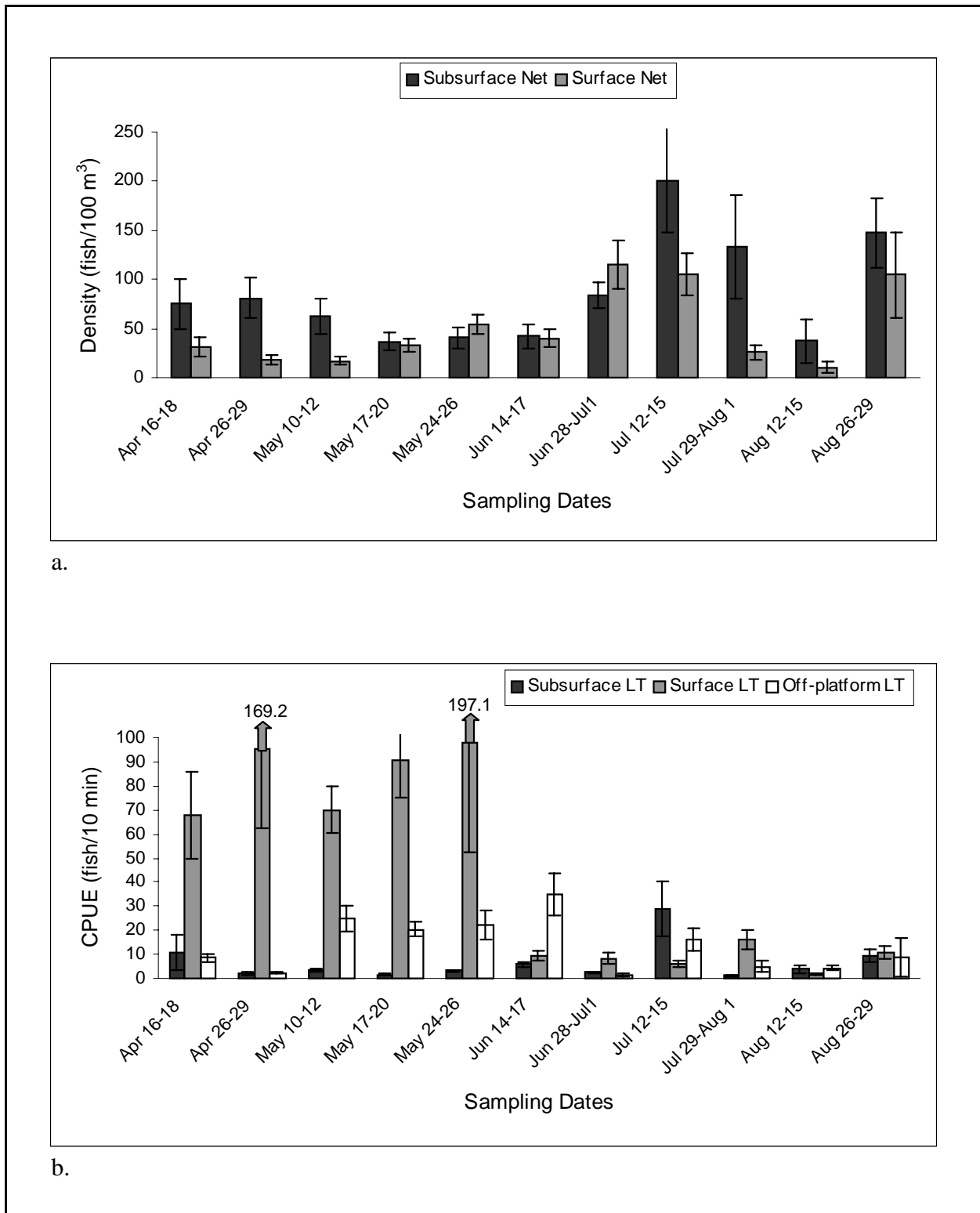

Figure 8.8. Mean plankton net densities (a) and light-trap CPUEs (b) with standard errors for each sampling trip at Grand Isle 94 (1996). Arrows above bars point toward the off-scale mean for that gear.

At ST 54, plankton nets and light-traps collected 1,689 and 1,193 fish, respectively, with a mean total density of 166.0 fish/100 m³ and a mean total CPUE of 0.6 fish/10 min (Table 8.2). Due to problems with the deploying the subsurface net at this site (Hernandez *et al.* this volume), the plankton net catch is almost exclusively from the surface. Plankton nets and light-traps collected fish from an equal number of families, but light-traps collected fish from more taxa, including unique taxa, than plankton nets (Table 8.3). Mean plankton net densities ranged from 15.7-809.7 fish/100 m³, while mean CPUEs ranged from 0-18 fish/10 min (Figure 8.9). *Cynoscion arenarius* and *Chloroscombrus chrysurus* were the most dominant taxa in plankton net samples (Table 8.3). Light-trap collections were dominated by *Synodus foetens* and scombrids, particularly *Euthynnus alletteratus* and *Scomberomorus maculatus*.

At Belle Pass, the pushnet and light-trap collected 33,147 and 849 fish, respectively, with a mean total density of 136.7 fish/100m³ and a mean total CPUE of 4.6 fish/10 min (Table 8.2). The pushnet collected fish from approximately twice as many families as the light-trap, including 20 unique families. The same trend was evident in the number of taxa collected by each gear type. No fish were collected from families unique to light-traps and only three unique taxa were collected with light-traps. Mean pushnet densities ranged from 18.7-288.7 fish/100 m³, while mean CPUEs ranged from 0-9.7 fish/10 min (Figure 8.10). Pushnet samples were dominated by gobiids, primarily *Gobiosoma bosc*, and the sciaenid, *Cynoscion arenarius* (Table 8.3). Dominant taxa in light-trap collections included *Membras martinica*, *Hypsoblennius hentz/ionthas*, *Gobiosoma bosc*, and *Cynoscion arenarius*.

Within-Site Comparisons of Sampling Gears

No significant differences were detected in mean total plankton net densities between surface and subsurface collections at GC 18 and GI 94 (Tukey's Studentized Range Test, $\alpha=0.05$), although subsurface densities were generally higher (Figure 8.11). At ST 54, surface nets had significantly higher mean total densities than subsurface nets. In contrast, light-trap collections from surface waters (surface and off-platform light-traps) had significantly greater total CPUEs at all three platforms (Figure 8.11). At GI 94, overall means by depth and location ranged from 0.7-3.2 fish/10 min, with means from surface and off-platform locations being significantly greater than the subsurface mean (Tukey's Studentized Range Test, $\alpha=0.05$). At GI 94 overall light-trap CPUEs were the greatest of the three platform sites and ranged from 6.5-58.2 fish/10 min with significant differences detected between all light-trap depths/locations. At ST 54, overall mean CPUEs ranged from 3.8-7.2 fish/10 min with the off-platform collections being the greatest followed by the mid-platform surface then by subsurface collections.

Length-Frequency Analyses

Six taxa from GC 18 met the required criteria for K-S analyses involving the differences in size frequency distributions between sampling gears (i.e., at least 10 specimens collected by each gear). In all instances, differences between size distributions for the two gear types were found to be statistically significant (K-S tests, $p \leq 0.05$; Figure 8.12). In general, there was some size overlap in all gear comparisons, although the degree of overlap and shapes of the size distributions differed. For *Auxis* spp., *Caranx crysos*, and *Mugil cephalus*, the plankton net samples caught predominantly

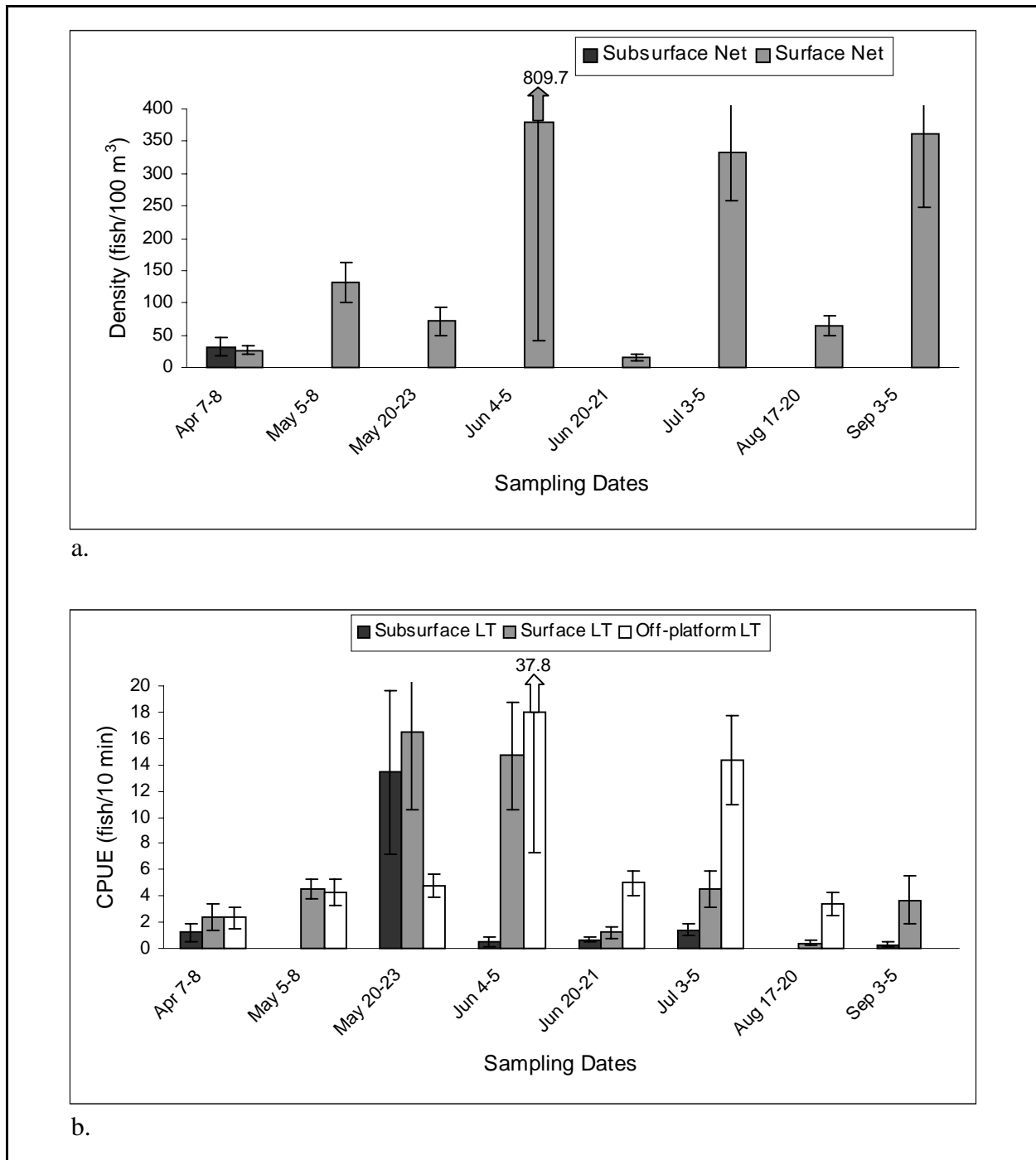

Figure 8.9. Mean plankton net densities (a) and light-trap CPUEs (b) with standard errors for each sampling trip at South Timbalier 54 (1997). Arrows above bars point toward the off-scale mean for that gear. Subsurface net samples were only taken during 7-8 April. No subsurface light-traps were taken during 5-8 May. No off-platform light-trap samples were taken during 3-5 September. No fish were present in subsurface light-trap samples ($n=4$) during 17-20 August.

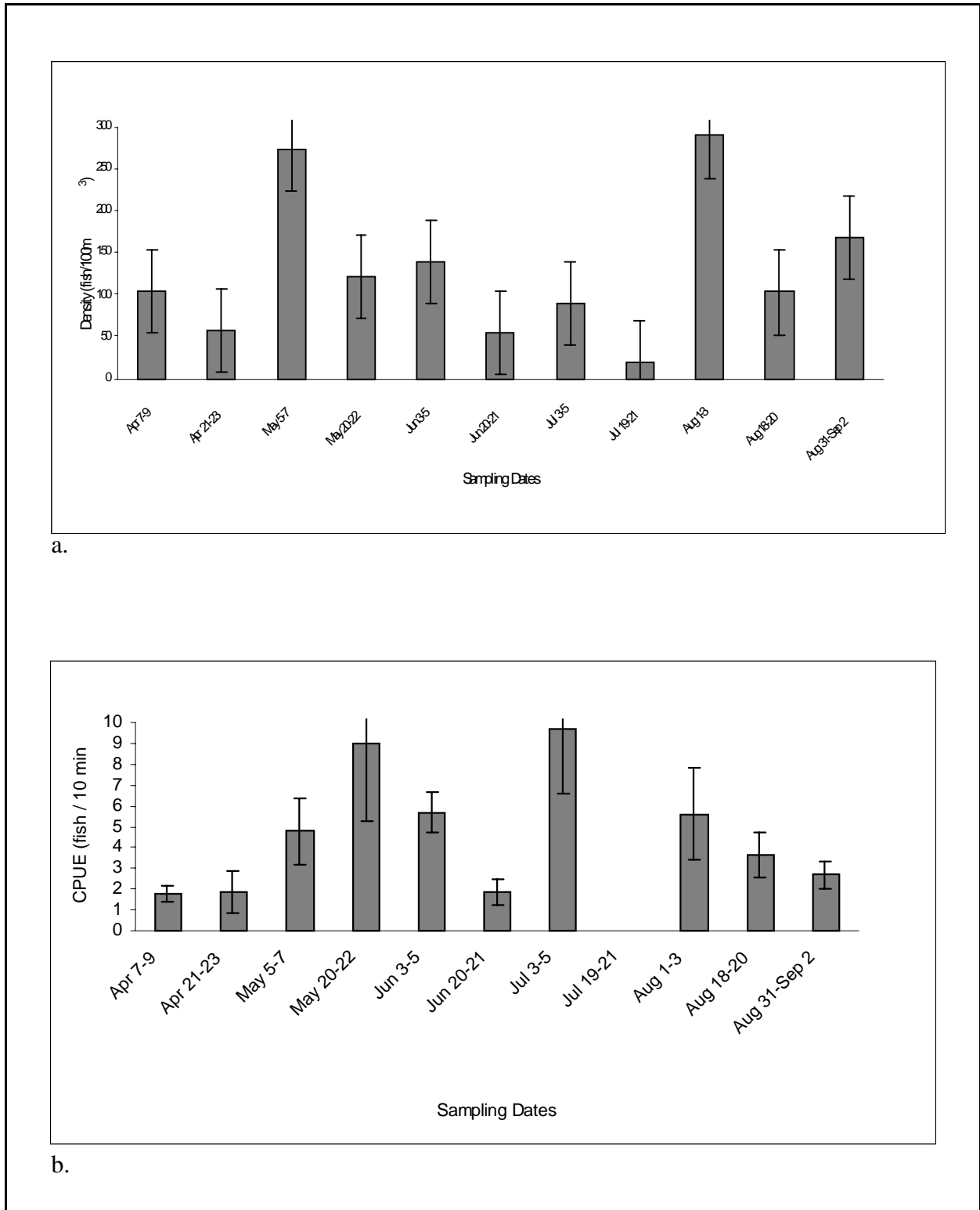

Figure 8.10. Mean pushnet densities (a) and light-trap CPUEs (b) with standard errors for each sampling trip at Belle Pass (1997). No fish were present in light-trap samples during 19-21 July.

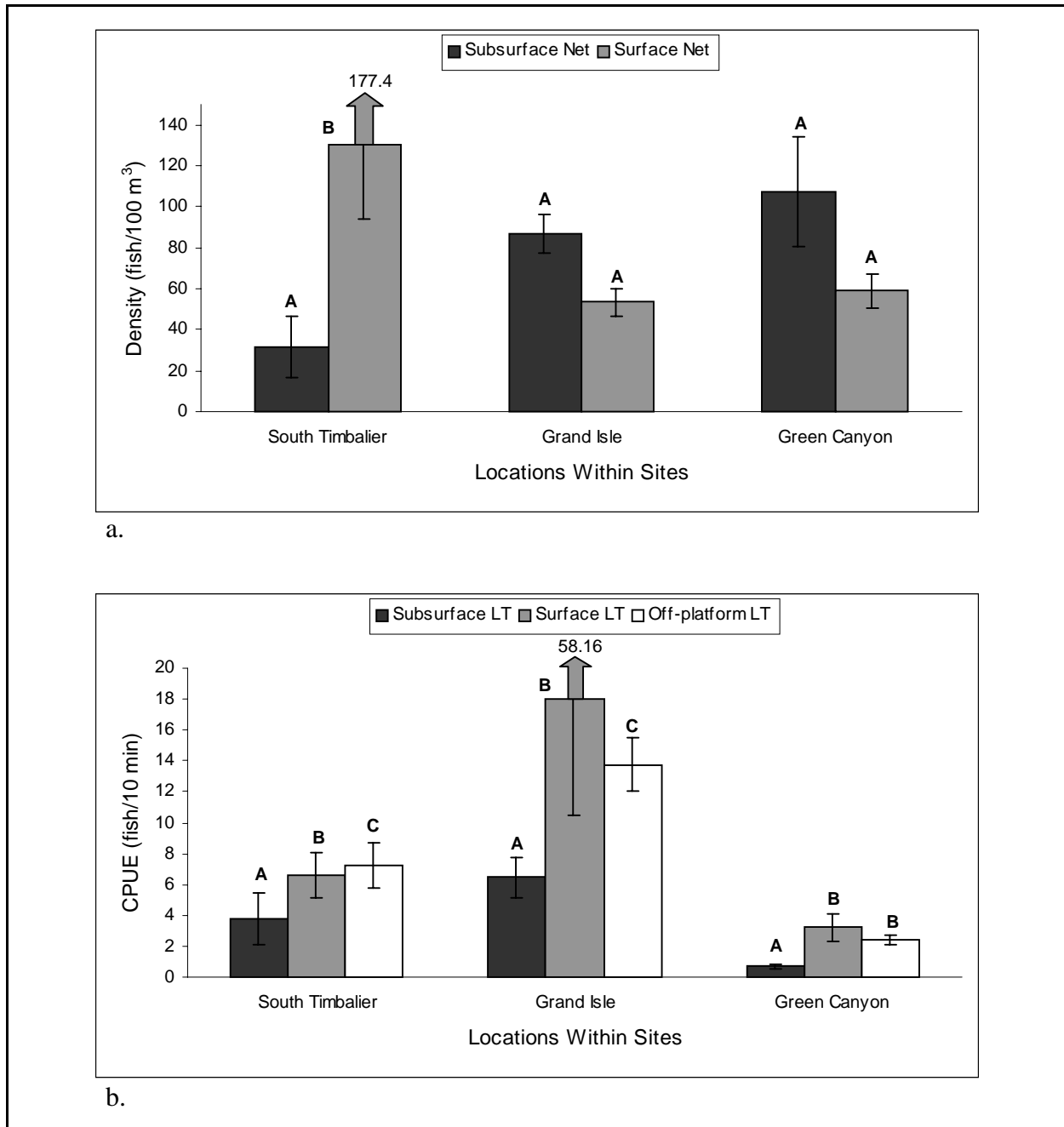

Figure 8.11. Mean plankton net densities (a) and light-trap CPUEs (b) with standard error bars for depths/locations within each platform site. Arrows point toward the off-scale mean for that gear. For mean densities within each location, the same letter above each bar indicates no significant difference between depths based on t-tests on log-transformed data ($\alpha=0.05$). For mean CPUEs within each location, the same letter above each bar indicates no significant difference between depths/locations based on Tukey's Studentized Range test on ranked data ($\alpha=0.05$). Different letters designate significant differences.

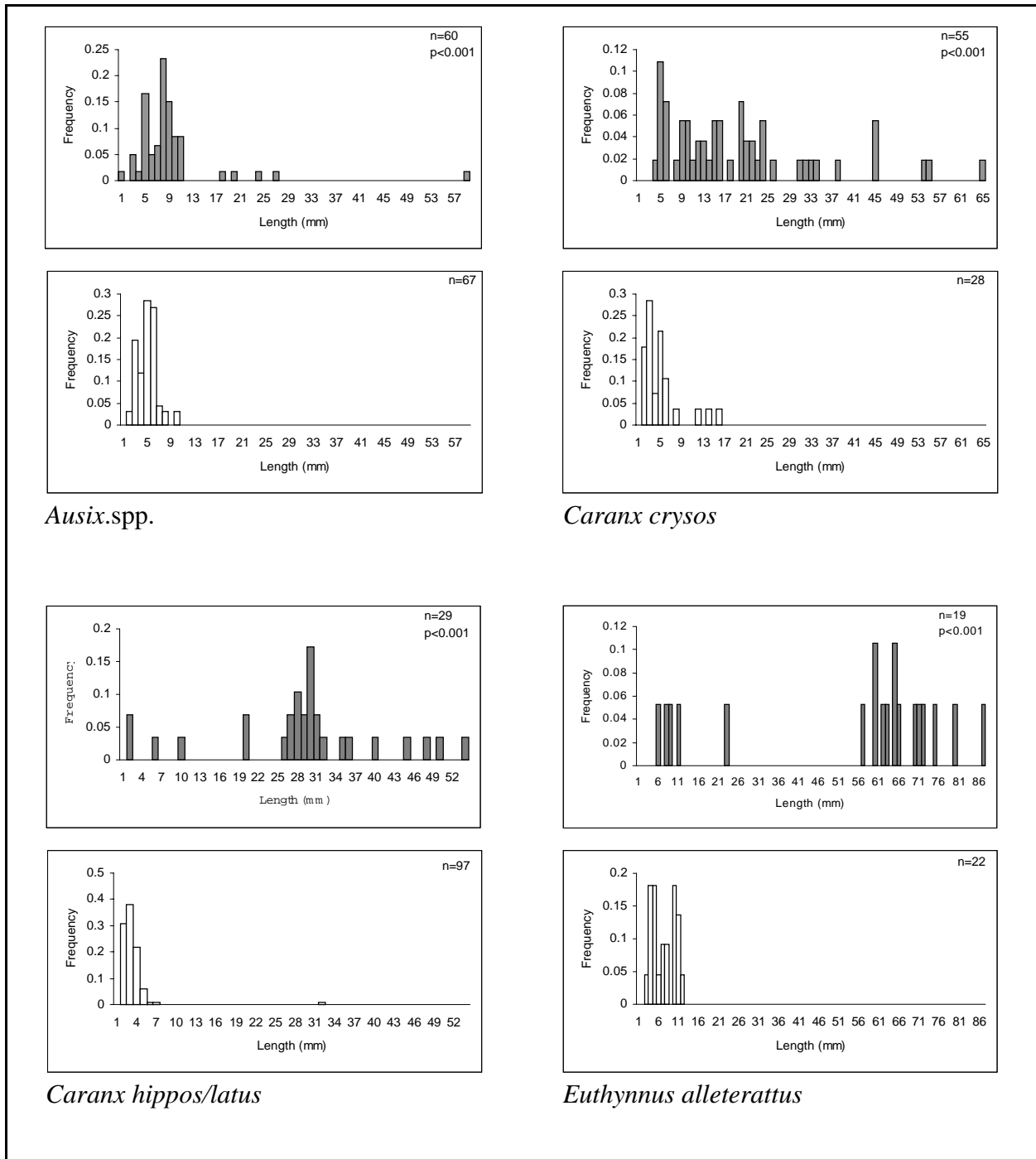

Figure 8.12. Size distributions of fish collected with light-traps (shaded bars) and plankton nets (open bars) at the Green Canyon site (1995-1996). Fish length-frequency distributions were analyzed with Kolmogorov-Smirnov tests (p-values are represented in the upper panel of each gear pairing along with each sample size).

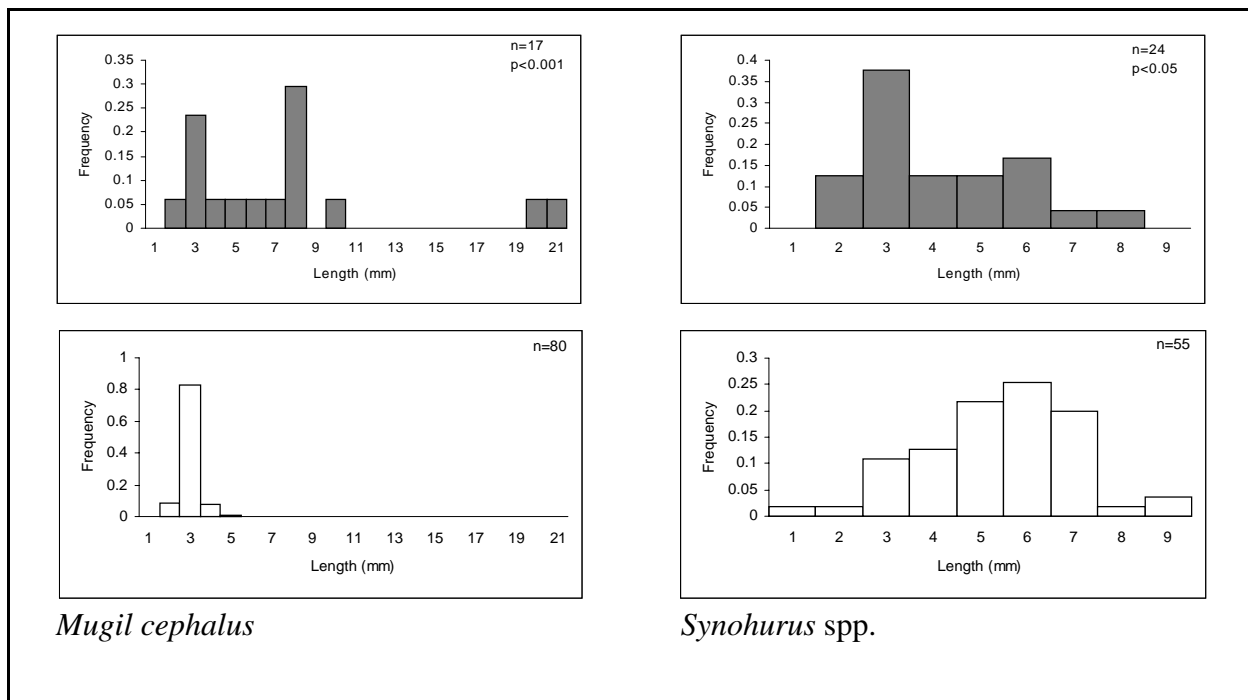

Figure 8.12. (continued)

smaller individuals, while the light-trap samples generally encompassed these smaller sizes as well as larger larvae and juveniles. For *C. hippos/latus* and *Euthynnus alletteratus* there was less overlap at the smaller sizes and modal size classes for the light-trap samples were generally near the larger sizes. Only for *Symphurus* spp. was the modal length of light-trap samples smaller than that for net collections ($p \leq 0.05$).

At GI 94, 10 of the 11 taxa analyzed for differences between the two gear types' size distributions were highly significant (K-S tests, $p \leq 0.001$; Figure 8.13). For *Auxis* spp., *Caranx crysos*, and *Synodus poeyi* there was some overlap in size distributions between gears, with the plankton net capturing smaller larvae, but modal sizes for light-trap samples were always larger. Size distributions for *Bregmaceros cantori*, *Scomberomorus cavalla*, *Synodus foetens*, and *Trichiurus lepturus* appeared to overlap much more at the smaller sizes, but in each instance the light-trap samples encompassed a significantly broader range of size classes. Although significantly different, size distributions for *Rhomboplites aurorubens* exhibited a similar bimodal distribution for each gear type. For *Scomberomorus maculatus* there was no overlap at all in the sizes of larvae captured with the two gears. With only one taxon, *Saurida brasiliensis*, were plankton nets able to better catch small sizes, but also larger size classes as well. Only one dominant taxa, *Symphurus* spp., did not exhibit a significant difference in size distribution between gears ($p = 0.385$).

At ST 54 differences between the two gear types' size distributions for five of the seven taxa analyzed were highly significant (K-S tests, $p \leq 0.01$; Figure 8.14). In general, light-trap size-frequency distributions for *Peprilus burti*, *P. paru*, and *Scomberomorus maculatus* encompassed that of the plankton net distributions, but also included larger sizes. Little overlap in size distributions was observed for *Euthynnus alletteratus*, with light-trap collections being much larger. Distributions for

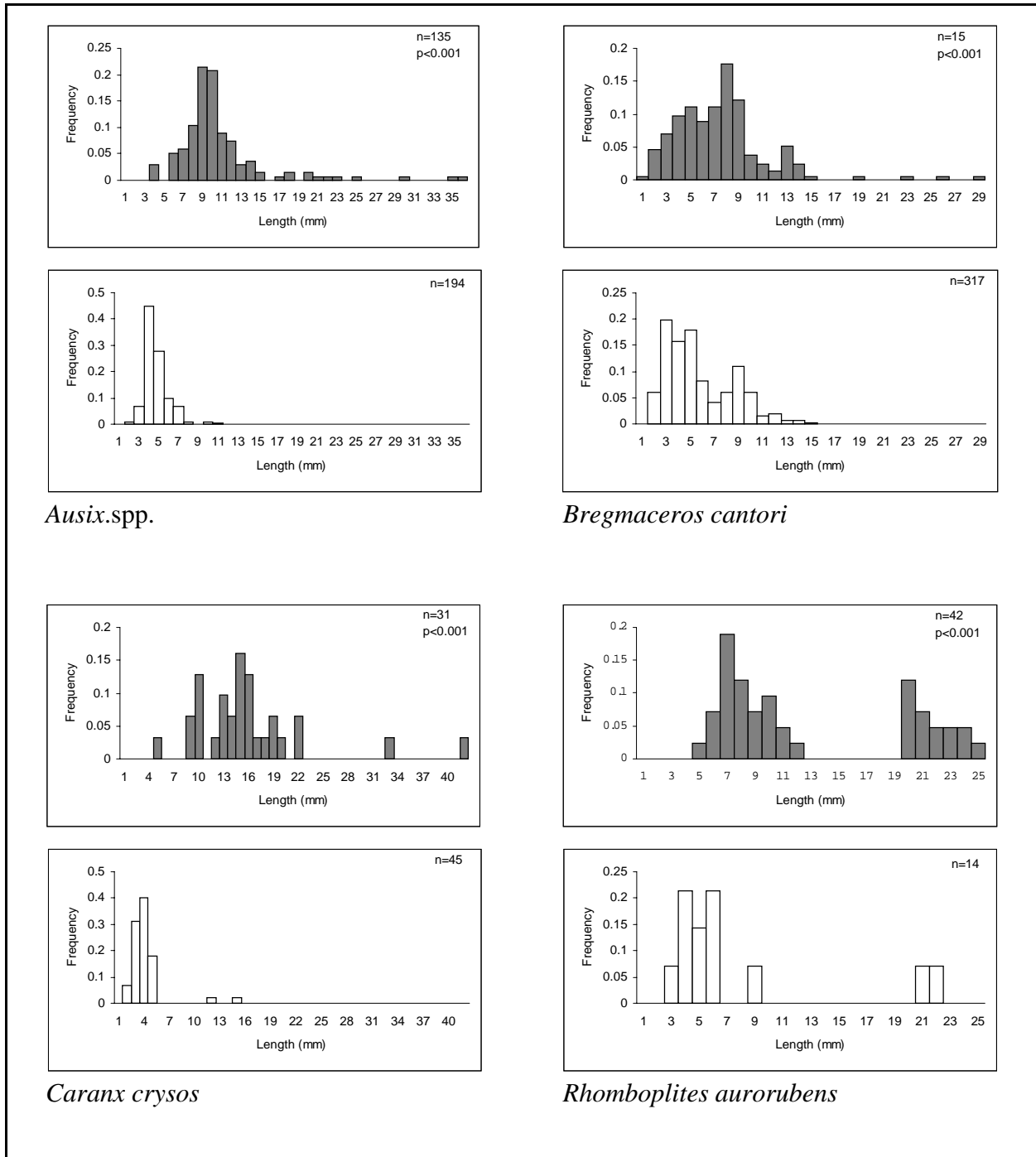

Figure 8.13. Size distributions of fish collected with light-traps (shaded bars) and plankton nets (open bars) at the Grand Isle site (1996). Fish length-frequency distributions were analyzed with Kolmogorov-Smirnov tests (p-values are represented in the upper panel of each gear pairing along with each sample size).

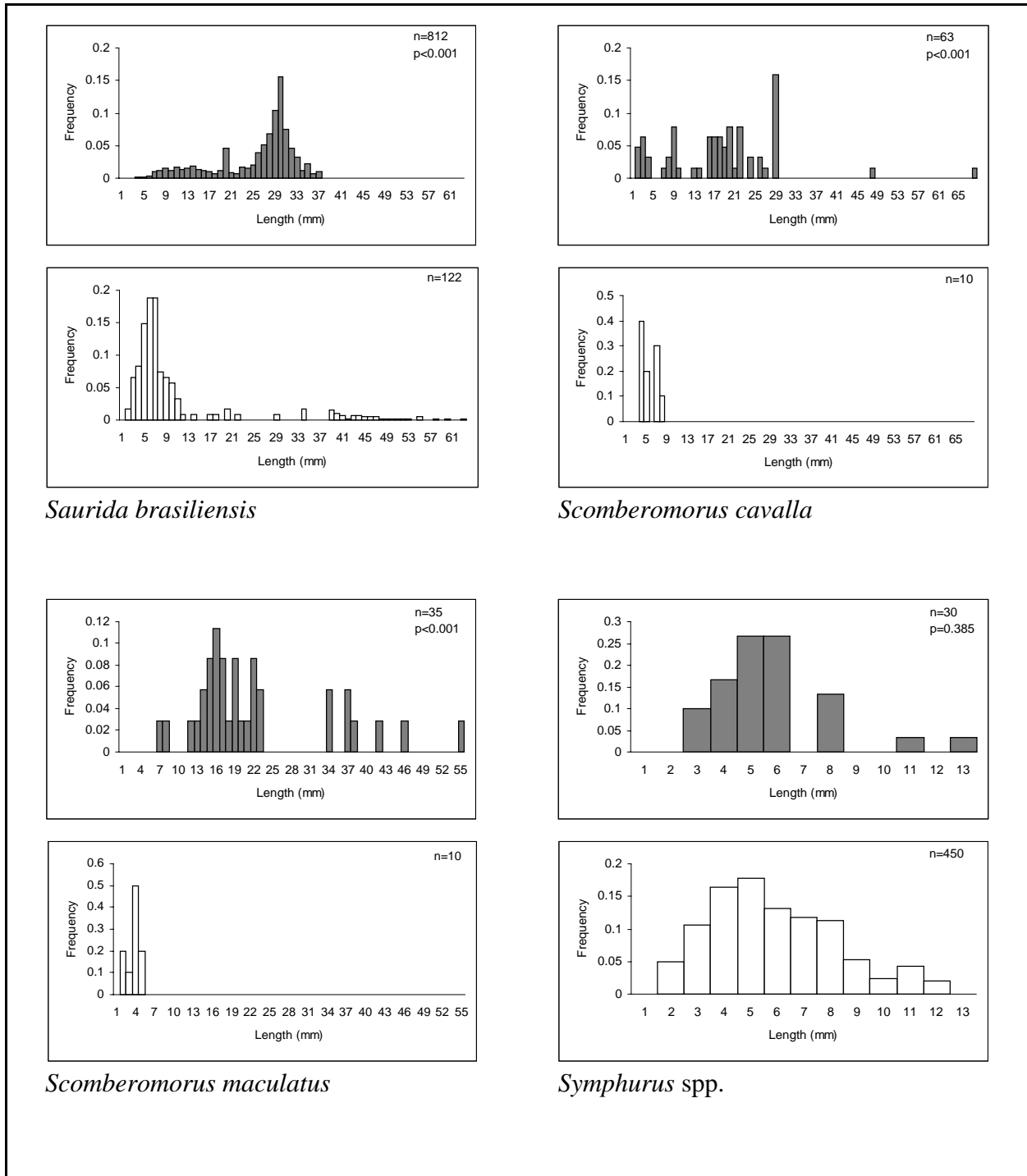
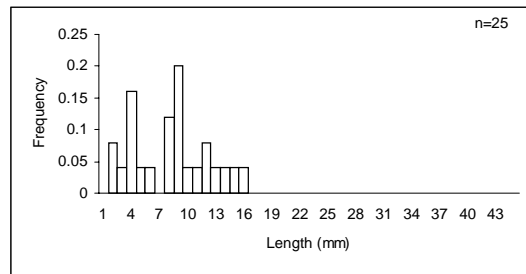
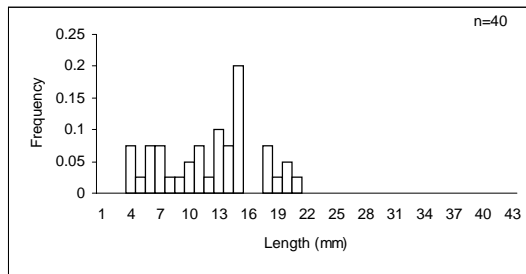
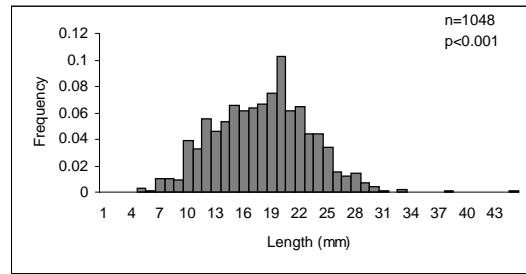
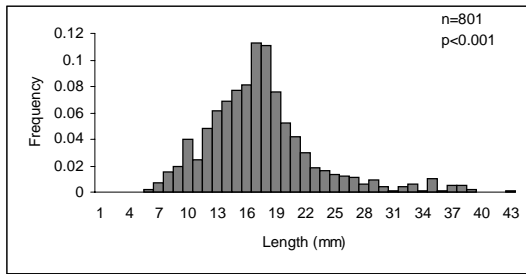
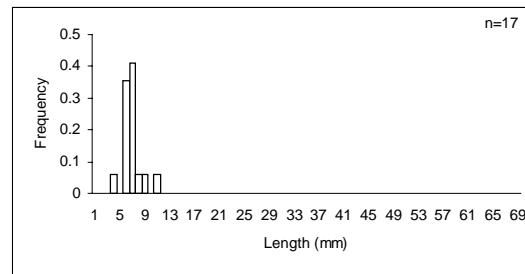
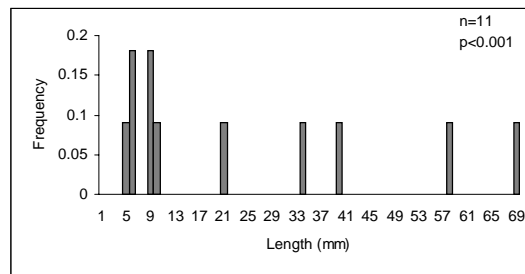

Figure 8.13. (continued)



Synodus foetens

Synodus poeyi



Trichiurus lepturus

Figure 8.13. (continued)

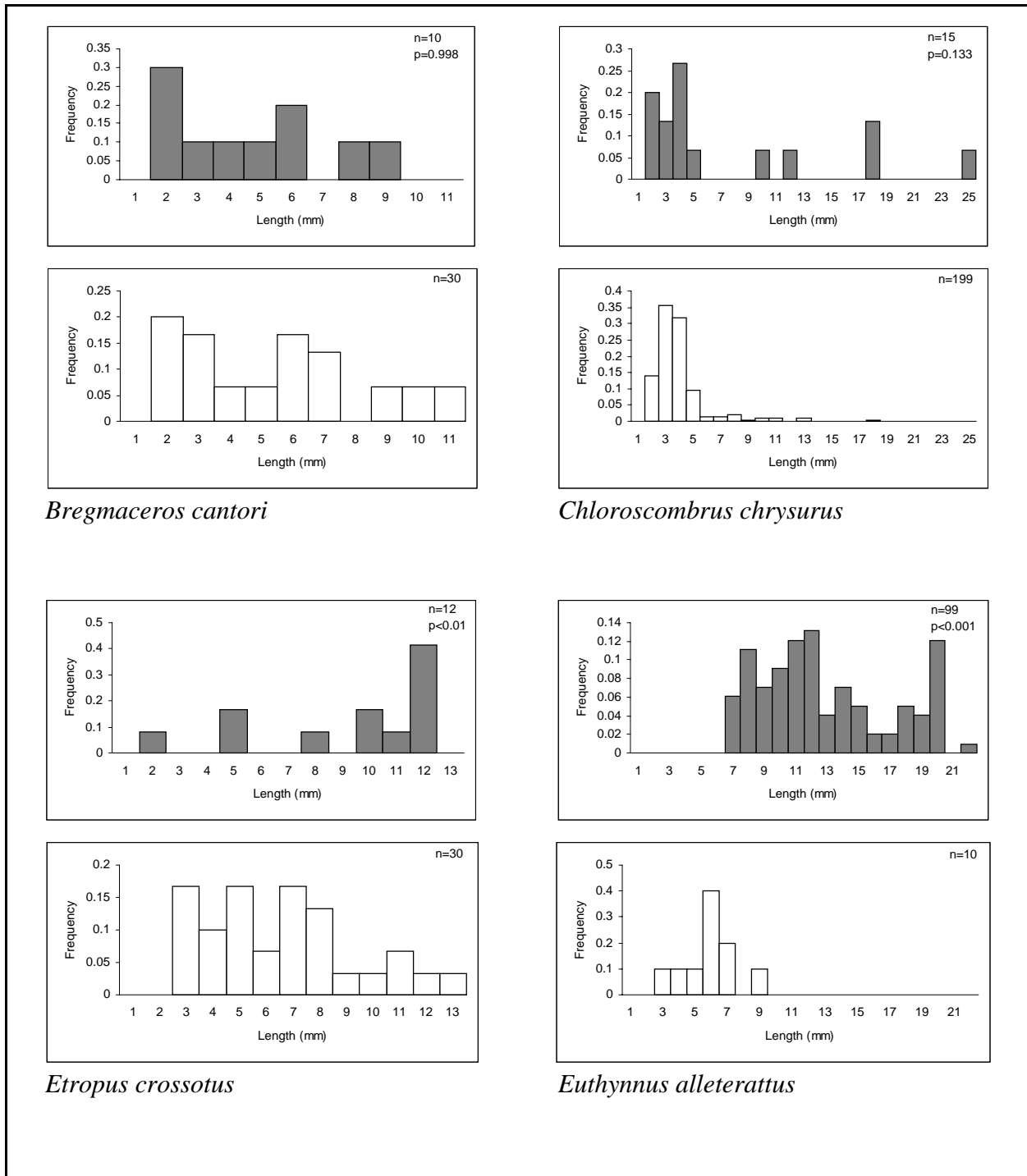
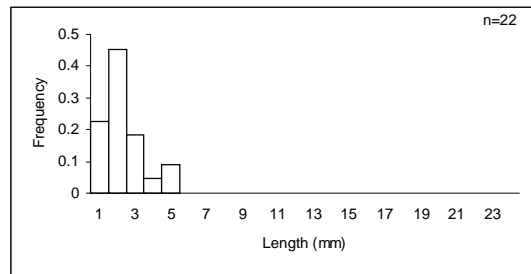
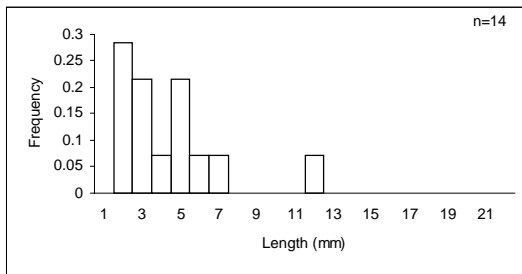
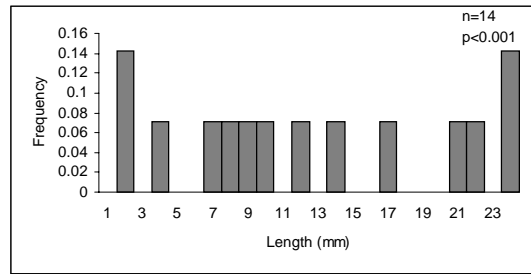
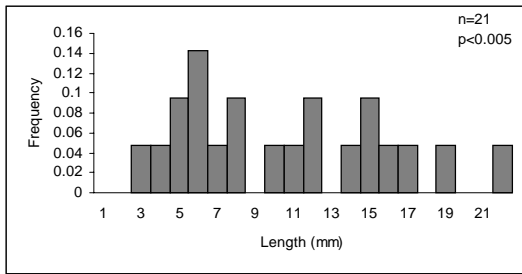
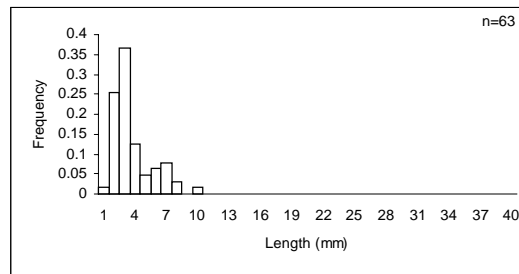
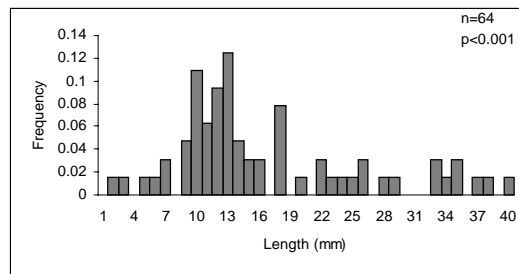

Figure 8.14. Size distributions of fish collected with light-traps (shaded bars) and plankton nets (open bars) at the South Timbalier site (1997). Fish length-frequency distributions were analyzed with Kolmogorov-Smirnov tests (p-values are represented in the upper panel of each gear pairing along with each sample size).



Peprilus burti

Peprilus paru



Scomberomorus maculatus

Figure 8.14. (continued)

Etropus crossotus broadly overlapped but plankton nets collected a wider range of smaller size classes more frequently. Two species, *Bregmaceros cantori* and *Chloroscombrus chrysurus* did not exhibit a significant difference in size distributions between the two gear types ($p=0.998$ and $p=0.133$, respectively).

In contrast to the platform sites, size distributions at the Belle Pass jetty for pushnet vs. light-trap collections were significantly different (K-S tests, $p<0.05$) for only three of the 11 taxa analyzed (Figure 8.15). There was a good degree of overlap in the size distributions for *Gobiosoma* spp. and *Hypsoblennius hertz/ionthas*, but in each instance the pushnet samples collected larger individuals with greater frequency. In contrast, the light-trap size distribution for *Membras martinica* had an intermediate dominant mode. The other seven taxa analyzed did not have significant differences in size distributions between gears.

By using multiple gears and methodologies, we were able to confirm the presence of a number of taxa with a full range of life history stages, ranging from recently-spawned larvae to juveniles, associated with the platforms. For example, at GC 18 the plankton net collected *Euthynnus alletteratus* individuals within a smaller size range (3.0-12.0 mm) than the light-trap (6.2-87.0 mm). If our plankton net collections were not supplemented with light-trap catches, we would have not been able to confirm the presence of larger juveniles at this site.

Lunar Periodicity

At GI 94 during new moon phases, mean total CPUEs for light-traps were significantly higher than during full moons (Student's t-test, $p\leq 0.0001$; Figure 8.16), while mean plankton net densities had the opposite trend ($p\leq 0.01$). The special lunar study conducted at GI 94 which compared three lunar phases (first quarter, new, and third quarter moon phases sampled in May 1996), however, yielded no significant differences in mean light-trap CPUEs or mean plankton net densities between the three phases (Tukey's Studentized Range test, $p\leq 0.05$; Figure 8.17). At ST 54 there were no significant difference in CPUEs between new and full moon phases ($p=0.5635$; Figure 8.18), but mean total density during new moon phases was significantly higher than full moons ($p\leq 0.05$); both results are in contrast to our findings at GI 94. At Belle Pass mean CPUEs and pushnet densities were significantly higher during new moon periods (Student's t-tests, $p<0.0003$ and $p<0.0001$, respectively; Figure 8.19). Therefore, when significant lunar differences were found, four out of five instances had greater new moon catches.

Similarity and Diversity of Ichthyoplankton Assemblages Within Sites

Schoener's Index of Niche Overlap values range from 0 to 1 (no similarity to identical species compositions). Within-site comparisons of gears and surface sampling locations indicated that off-platform and surface light-trap collections were more similar to each other (0.45-0.76) than each was to surface plankton net collections (0.27-0.71), although the disparity between the index gear comparisons is smaller at ST 54 (0.59-0.71; Table 8.4). Overall, total light-trap collections were relatively different from total plankton net samples at GC 18 and GI 94 (0.38 and 0.32), but much more similar at ST 54 and Belle Pass (0.63 and 0.61), the two coastal sites.

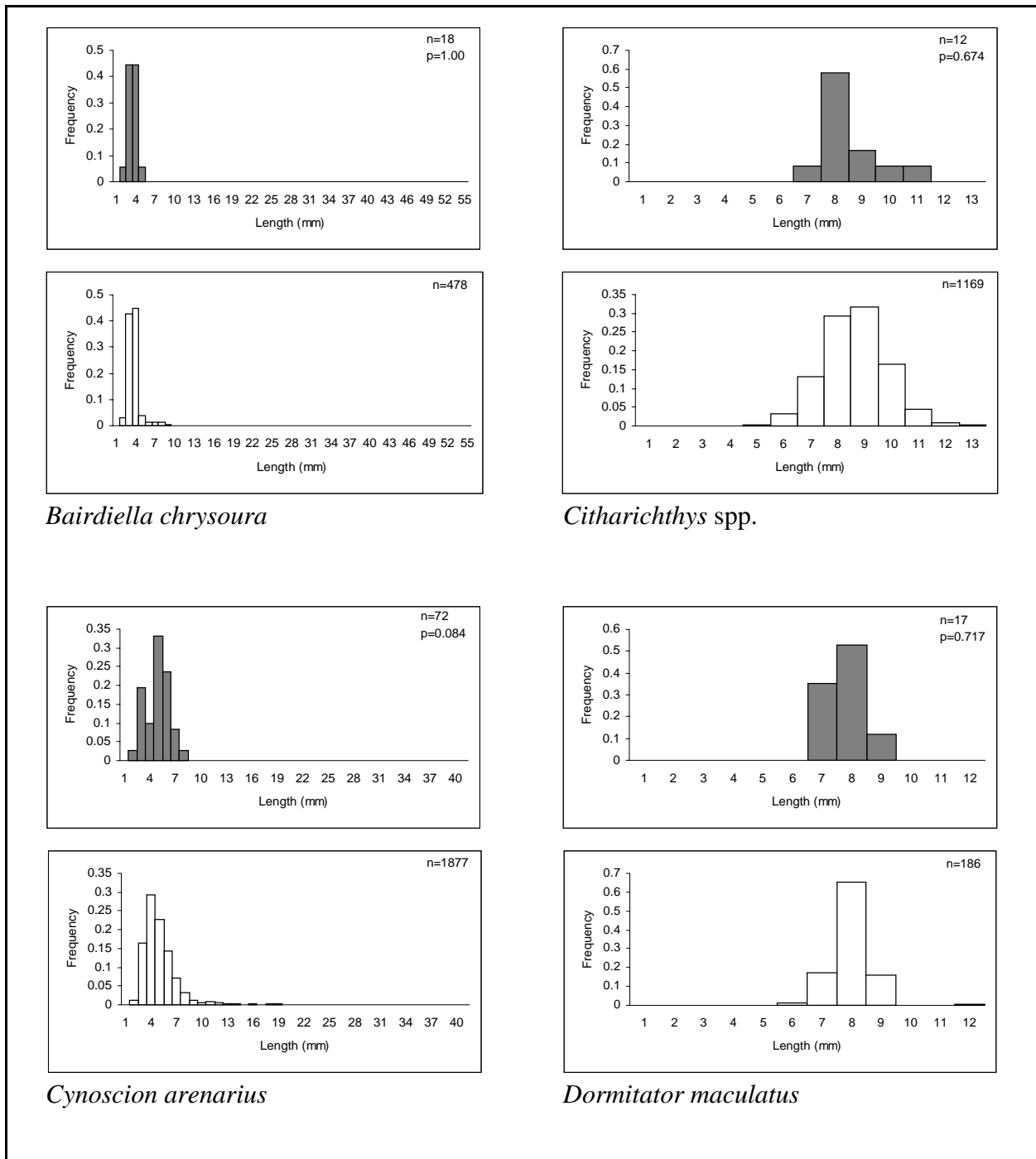
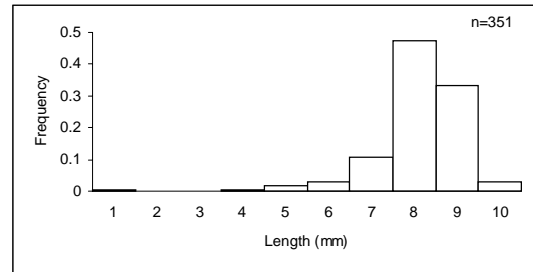
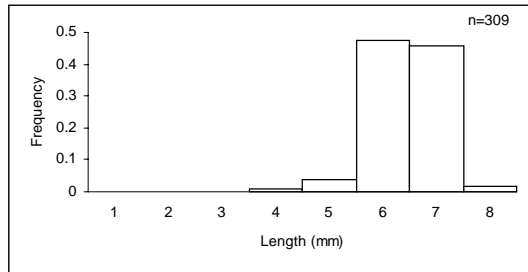
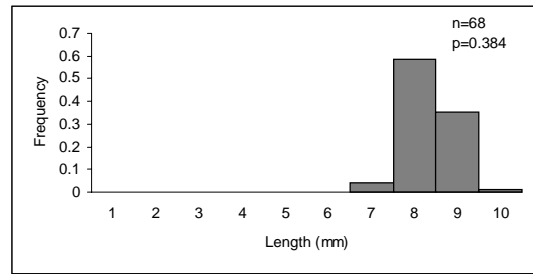
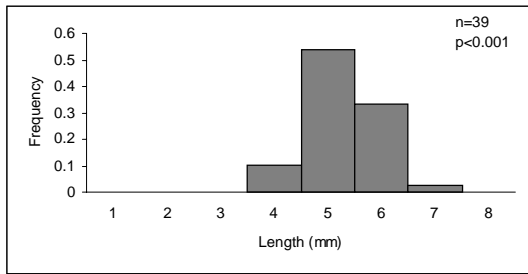
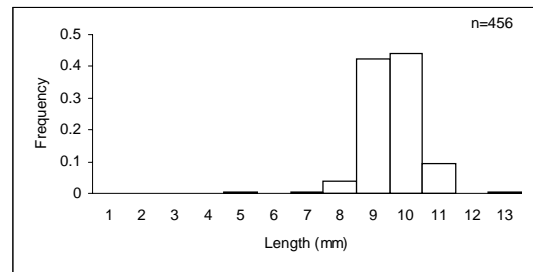
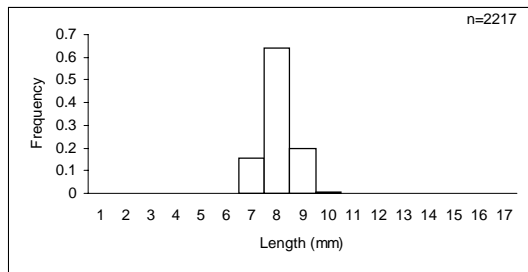
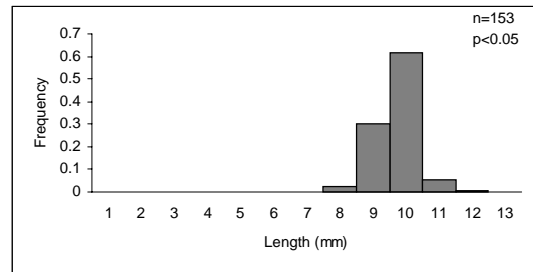
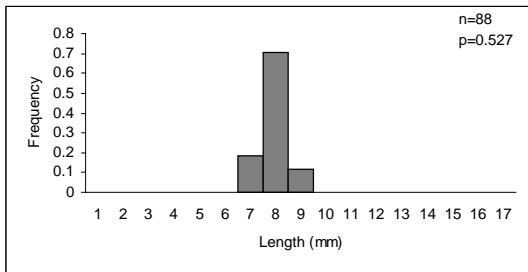

Figure 8.15. Size distributions of fish collected with light-traps (shaded bars) and a pushnet (open bars) at the Bell Pass site (1997). Fish length frequency distributions were analyzed with Kolmogorov-Smirnov tests (p-values are represented in the upper panel of each gear pairing along with each sample size).



Gobiosoma spp.

Gobiosox stromosus



Gobiosoma bosc

Hypoblennius hertz/ionthas

Figure 8.15. (continued)

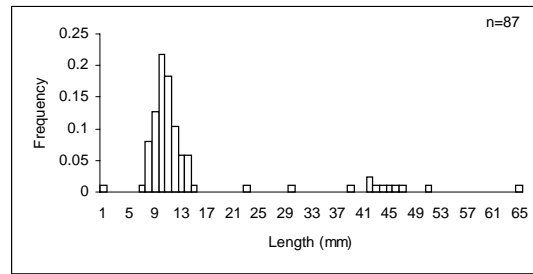
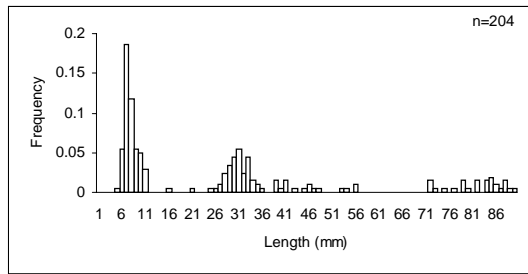
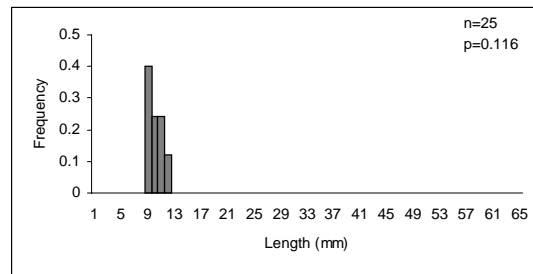
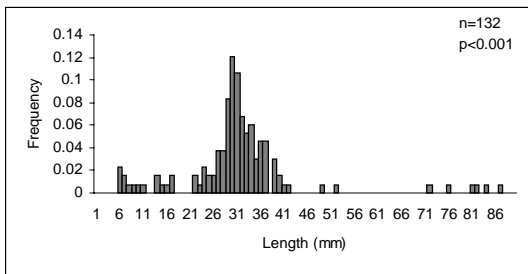

Membras martinica

Sphoeroides parvus

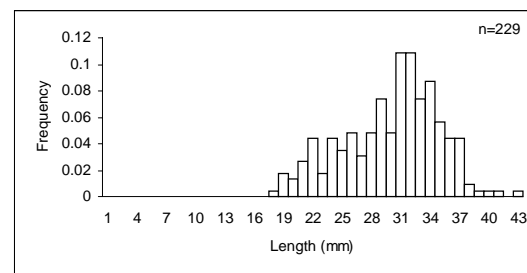
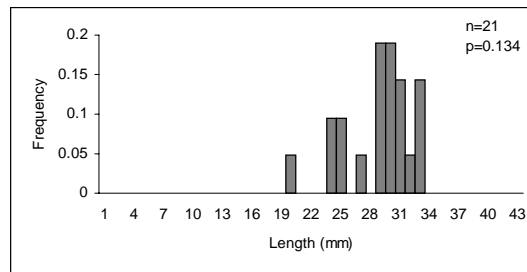

Synodus foetens

Figure 8.15. (continued)

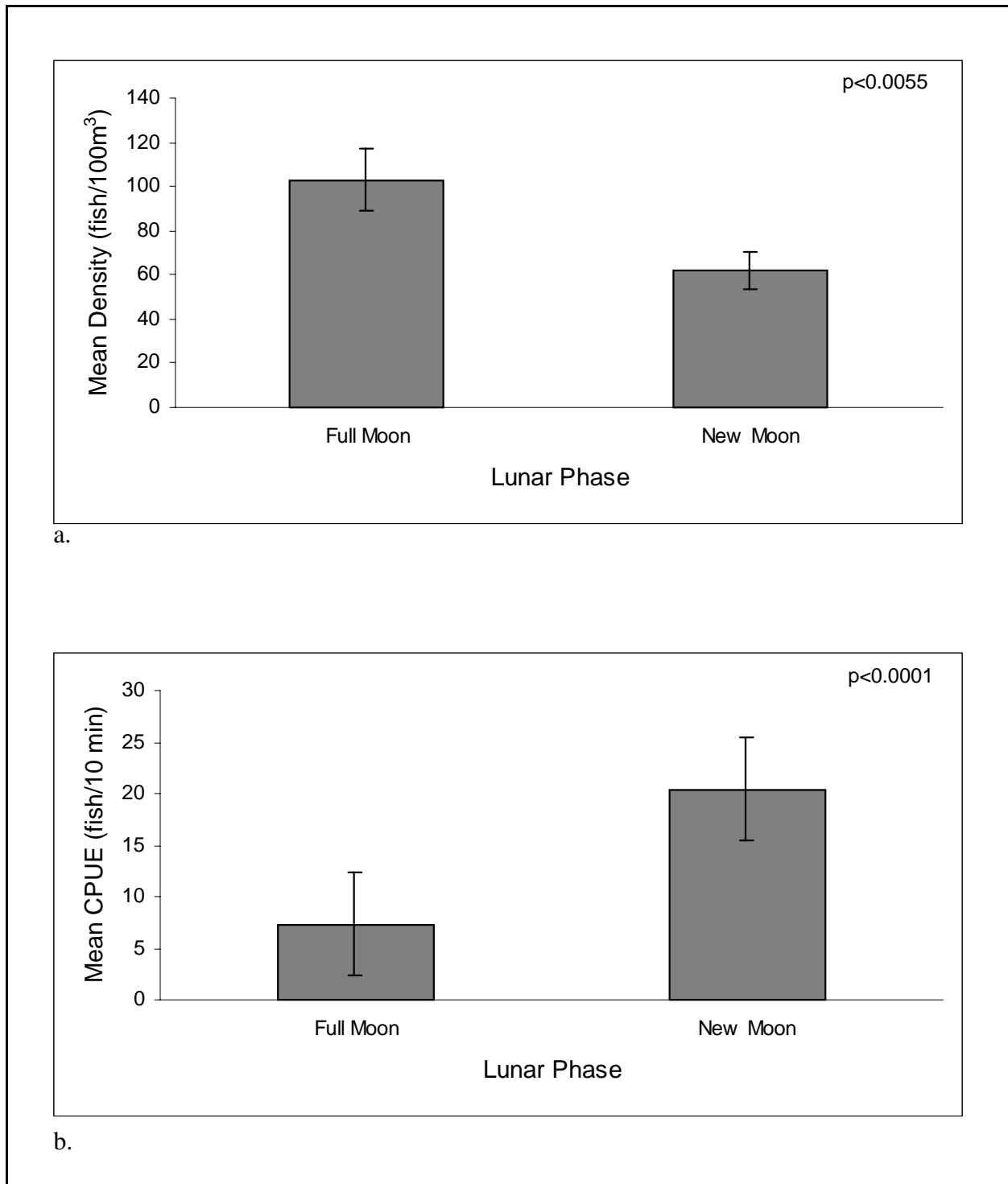

Figure 8.16. Mean plankton net density (a) and light-trap CPUE (b) with standard error bars for each lunar phase sampled at Grand Isle 94 (Apr-Sep 1996). The p-values indicate statistical significance from t-tests.

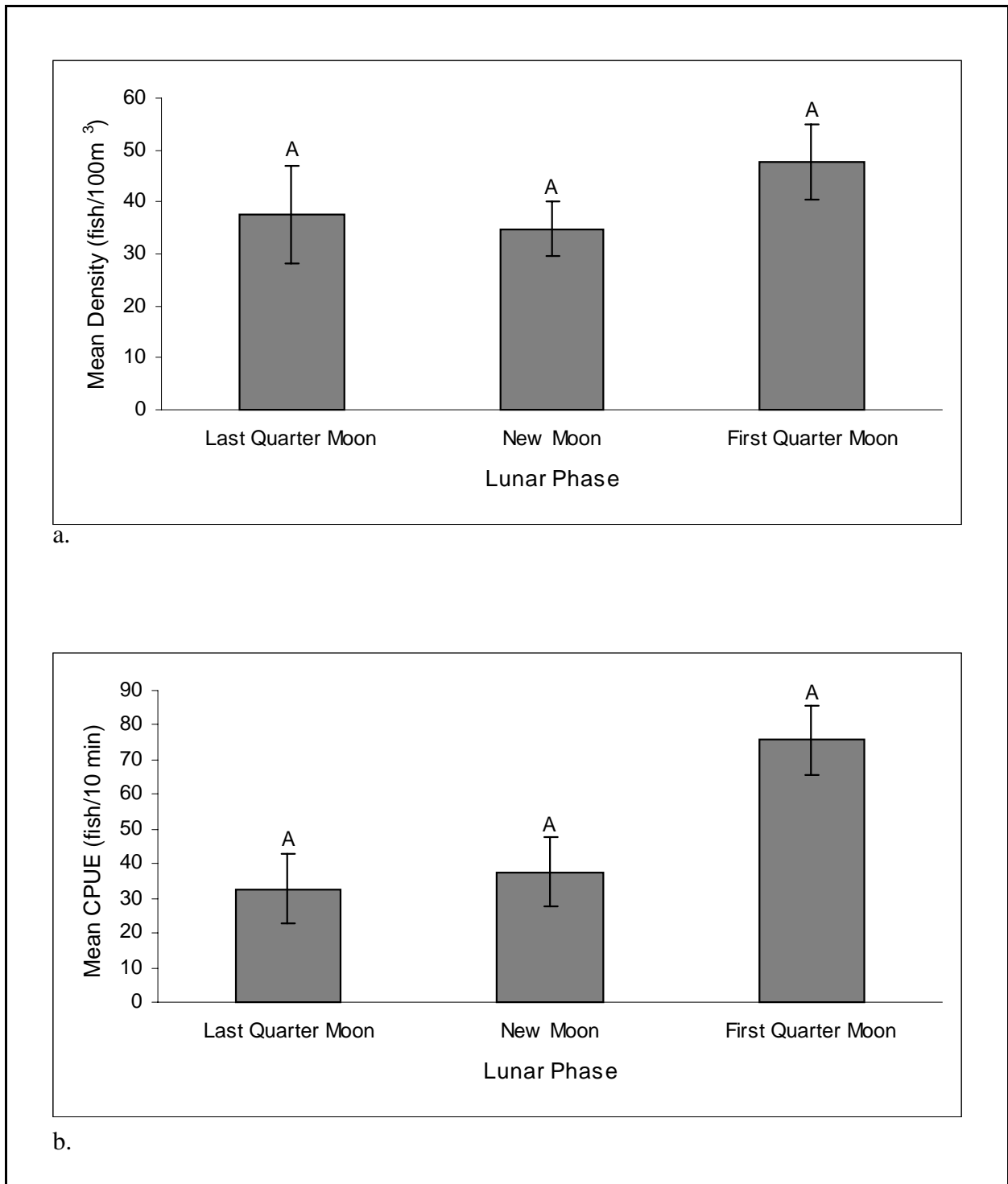

Figure 8.17. Mean plankton net density (a) and light-trap CPUE (b) with standard error bars for each lunar phase sampled in May 1996 at Grand Isle 94. The same letter above each bar indicates no significant difference between the lunar phases based on Tukey's Studentized Range tests on ranked data ($\alpha=0.05$).

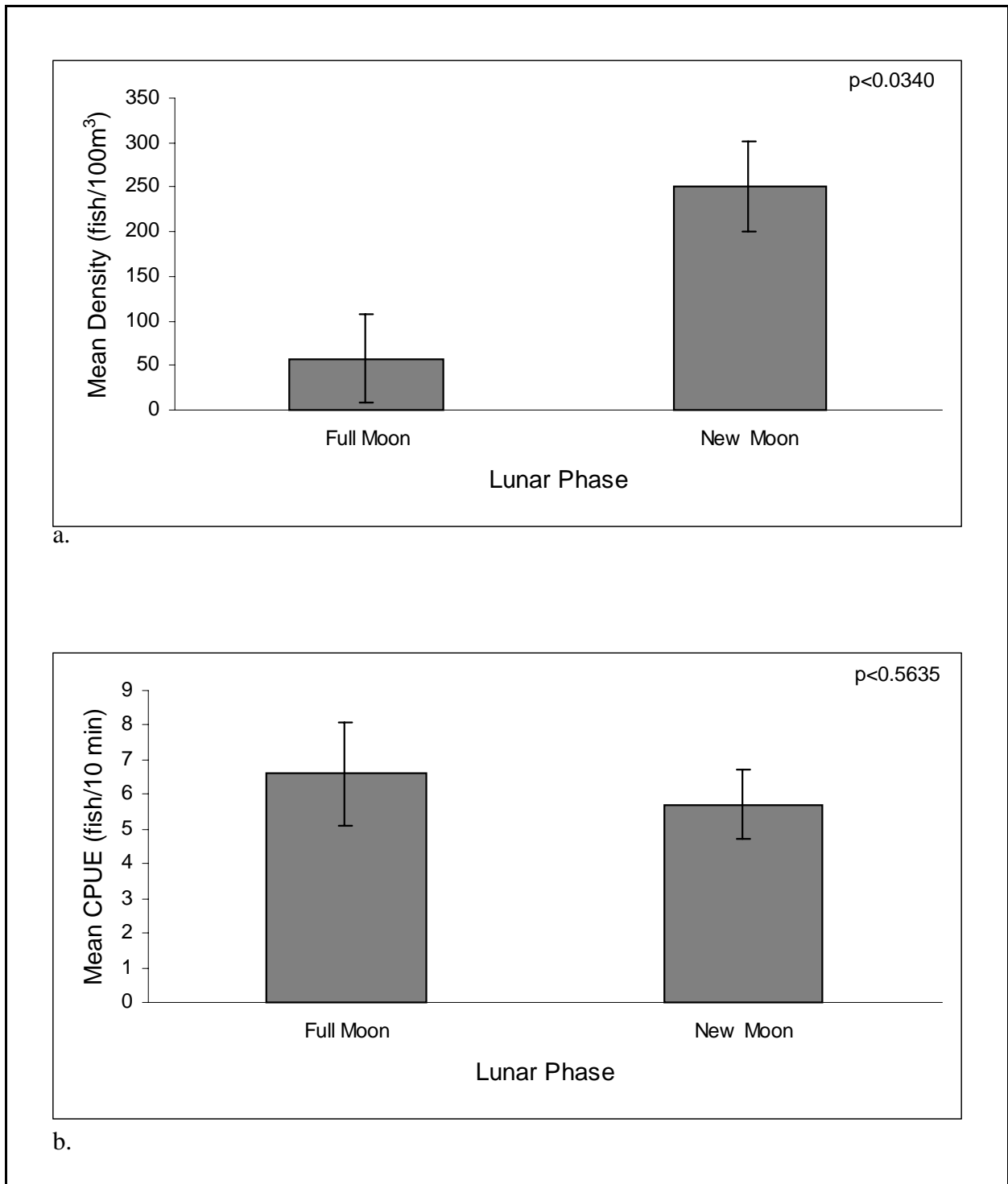

Figure 8.18. Mean plankton net density (a) and light-trap CPUE (b) with standard error bars for each lunar phase sampled at South Timbalier 54 (Apr-Sep 1997). The p-values represent statistical significance from t-tests.

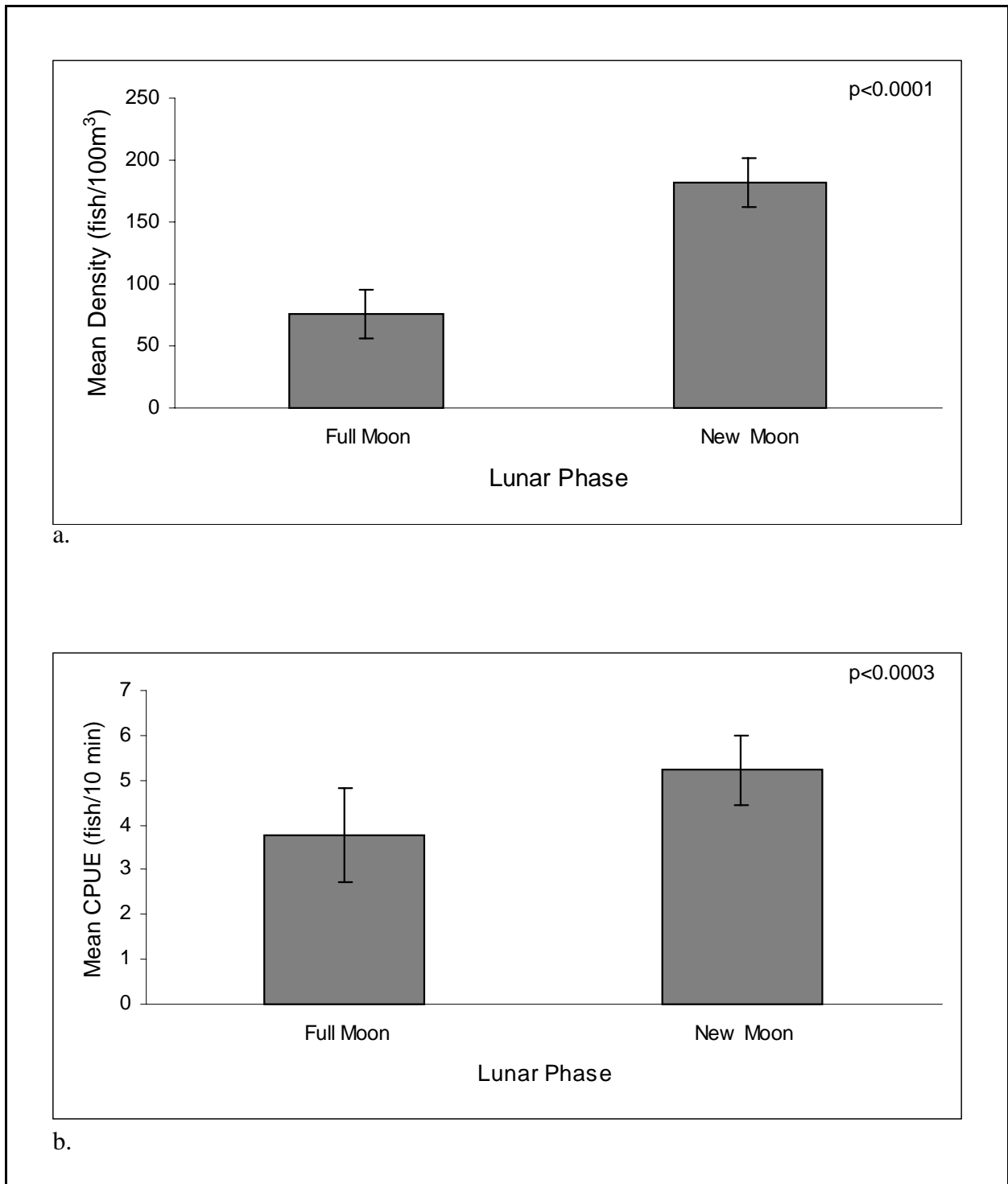

Figure 8.19. Mean pushnet density (a) and light-trap CPUE (b) with standard error bars for each lunar phase sampled at Belle Pass (Apr-Sep 1997). The p-values represent statistical significance from t-tests.

Table 8.4. Schoener's Index of Niche Overlap values for different surface gear and location comparisons. (OL) off-platform light-trap, (SL) surface light-trap, (SN) surface net, (TL) total light-traps, (TN) total nets.

	OL vs. SL	OL vs. SN	SL vs. SN	TL vs. TN
Green Canyon 18	0.53	0.32	0.31	0.38
Grand Isle 94	0.45	0.37	0.27	0.32
South Timbalier 54	0.76	0.71	0.59	0.63
Belle Pass			0.61	0.61‡

‡Calculation is the same as with SL vs. SN since only a surface pushnet and surface light-trap were used.

There was little difference in the Shannon-Weiner diversity index values from gear and depth/location samples collected at GC 18 and ST 54 (Figure 8.20). In both instances, only subsurface light-trap samples had significantly lower diversity values than the other gear and depth/location combinations ($\alpha=0.05$). No clear pattern in diversity was discernable at the GI 94 site other than surface net collections were significantly different from light-trap collections and that off platform light-trap collections were different from net collections regardless of depth. At the Belle Pass site, pushnet samples were significantly more diverse than the light-trap samples.

DISCUSSION

Gear Selectivity

The most obvious trend observed during this study was the overwhelming presence of engraulids and clupeids at all sites, even on the shelf slope site (Hernandez *et al.* this volume). Light-trap and plankton net collections (total catch) were dominated by clupeiform fishes at GC 18 (59%), GI 94 (66%), ST 54 (97%), and Belle Pass (74%). The dominance of these taxa in our collections is not unexpected, particularly considering the abundances of these fishes in the northern Gulf and the sampling gears utilized. Clupeiform fishes are often among the most abundant in plankton surveys of the northern Gulf and are present year-round in shelf waters (Ditty 1986; Ditty *et al.* 1988; Finucane *et al.* 1979). Light-traps are selective sampling devices, and previous studies have demonstrated that often the catches are dominated by a single taxonomic group (Brogan 1994; Choat *et al.* 1993; Sponaugle and Cowen 1996; Thorrold 1992). Clupeiform fishes have been shown to be particularly photopositive and have dominated the total catches in several studies utilizing light-aggregating collection techniques (Brogan 1994; Choat *et al.* 1993; Dennis *et al.* 1989; Rooker *et al.* 1996). The pushnet used in this study actively collects fish and was relatively large (1m x 1m). It has also been shown to be an effective collector of clupeiforms in previous studies (Herke 1969; Kriete and Loesch 1980; Raynie and Shaw 1994). While the light-trap collects fish based on taxon-specific, photopositive behaviors, and the pushnet actively strains the water mass it samples, the plankton nets in our platform study collected fish passively with tidal currents. Even so, it was also

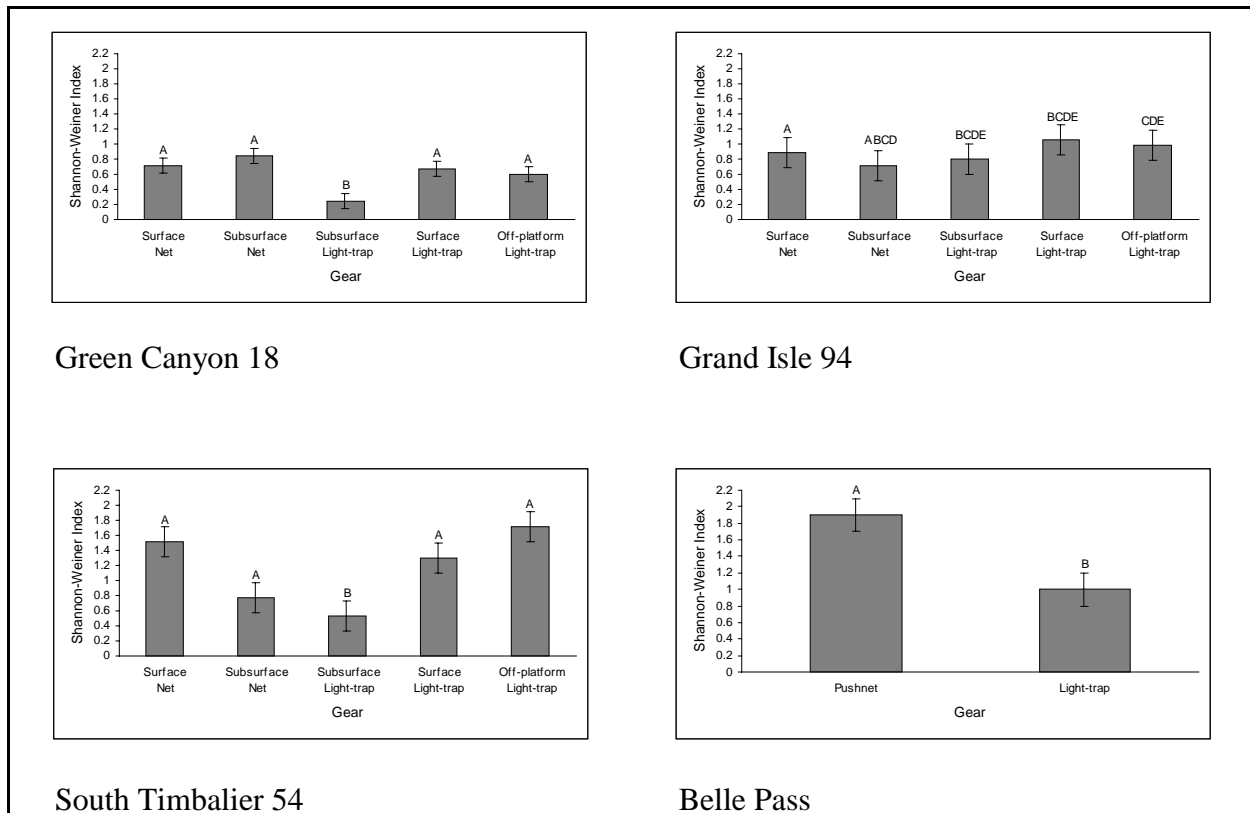

Figure 8.20. Mean Shannon-Weiner diversity indices (with standard error bars) for each gear type and sampling location for each sampling site. The same letter above each bar indicates no significant difference between the gear types/sampling locations based on Tukey's Studentized Range tests ($\alpha=0.05$). Different letters indicate significant differences.

very effective in sampling these fishes. This catchability was undoubtedly aided by our nocturnal sampling design.

These three sampling techniques clearly displayed gear selectivity as evident by differences in taxonomic richness between gear types (Table 8.2). Passive plankton nets collected fish from more unique families than light-traps at GC 18 (15 vs. 7) and GI 94 (6 vs. 3), but not ST 54 (8 families unique to each gear). At Belle Pass, the pushnet collected individuals from 20 unique families, as well as fish from all families sampled by light-traps. Previous studies comparing light-traps and plankton nets in marine waters have found similar results (i.e., light-traps collected fewer families than plankton tows) with only a few instances where light-traps collected unique families. Brogan (1994) collected 16 unique families with a diver-steered pushnet and only four unique families with light-traps, but the latter four families, when combined, comprised a very small proportion ($<0.08\%$) of his total light-trap catch. Likewise, more unique families were collected with a neuston net (10) than with light-traps (4) when fished simultaneously in Onslow Bay, North Carolina, but the unique light-trap families comprising only 10% of the total light-trap catch (Hernandez and Lindquist 1999). These results are similar to ours, where unique light-trap families usually made up less than 1% of the total catch at each platform site. However, whereas the previously cited studies each

collected only four unique families with their light-traps, we collected seven (GC 18) and eight (ST 54). Neither Choat *et al.* (1993) nor Hickford and Schiel (1999) reported any families in light-trap samples that were not present in plankton net samples.

In addition, the large numbers of unique taxa (at least to genus level) collected by light-traps was also surprising, since this gear is usually considered to be very taxon-specific, and therefore limited in its sampling scope (Table 8.2). At the genus level, light-traps collected more unique taxa than plankton nets at GI 94 (27 vs. 26) and ST 54 (24 vs. 16), but not at GC 18 (14 vs. 25). At Belle Pass, however, the light-traps collected far fewer unique taxa (3) than did the pushnet (44). Such large numbers of unique taxa have not been previously reported for light-traps in gear comparison studies. Two studies reported data at the genus level, but found either that all taxa collected by light-traps were collected by nets (Hickford and Schiel 1999), or that there were more unique taxa in the net collections than light-trap collections (Hernandez and Lindquist 1999). In our study, light-traps proved very useful in sampling available taxa that were not collected by plankton nets.

The diversity indices for the plankton net collections taken at the platform sites and the pushnet collections taken at Belle Pass were not significantly different from each other, but were slightly higher than those for the light-trap collections, with the exception of GI 94 (Figure 8.20). Several studies have investigated differences in taxonomic richness between different gear types, although few, if any, actually calculated taxonomic diversity indices as a comparison. Choat *et al.* (1993) collected individuals from more families with a bongo net (63 families), a lighted-seine net (37 families), neuston net (31 families), Tucker trawl (29 families), and purse seine (25 families) than with a light-trap (20 families) in a gear comparison study off Lizard Island, northern Great Barrier Reef, Australia. In the Gulf of California, Brogan (1994) collected more reef fish larvae and juveniles from different families with a diver-steered plankton net (43 families) than with a light-trap (31 families). Hernandez and Lindquist (1999) collected more fish larvae and juveniles from different families with a neuston net (24 families) than with either of the two light-trap designs employed (18 and 21 families) in a study in Onslow Bay, North Carolina. In each of these studies, the authors concluded that the taxonomic assemblage collected in their respective studies was very method-dependent, and the same appears to be true in our study.

Trends in taxon selectivity by gear were supported in the similarity indices between the gear types within a given site (Table 8.4). At GC 18 and GI 94, there was greater similarity between the light-trap samples, regardless of location, than there was between the surface light-trap collections (either off platform or central location) and the surface net collections. Again, this indicates that the behavioral or developmental responses of different fish taxa influence their susceptibility to different sampling gears (Hernandez and Lindquist 1999). The trend was not as evident at ST 54, but this is not surprising as 97% of the total catch by both gears was comprised of clupeiform fishes, which are very susceptible to both gear types (Schoener's Similarity Index for total light-trap vs. total net collections = 0.63). There was also a relatively high similarity index value (0.61) for the pushnet vs. light-trap comparison at Belle Pass. Again, this site was dominated by clupeiform fishes (74% of total catch), and light-traps are effective in sampling these fishes.

Since the three sampling gears operate on different sampling principles, differences may be observed not only between species, but also between different size classes of the same species. Of the 24

length-frequency comparisons between passive plankton nets and light-traps involving the dominant taxa, 21 exhibited statistically significant differences (Figures 7-9). In the instances where no significant differences were found, the distributions either overlapped substantially (*Symphurus* spp., Figure 8.13 and *Bregmaceros cantori*, Figure 8.14) or suffered from too few individuals in the larger size classes for a significant statistical difference to be found (*Chloroscombrus chrysurus*, Figure 8.14). In general, the light-trap was more effective in sampling larger size classes of the same species at each location, depth, or site. In some cases, the light-trap collections did not encompass a significant portion of the plankton net's smaller sizes, but clearly excelled at capturing the larger sizes. This was the case, for example, with *Caranx crysos* and *Scomberomorus maculatus* (Figure 8.13) and for *Euthynnus alletteratus* (Figures 7 and 9). In other instances, the light-trap collections appeared to significantly overlap the smaller sizes of the net collections, but also augmented the size-frequency distribution with much larger sizes, or in some cases, even additional cohorts, as was the case for *C. crysos* (Figure 8.12) and *S. cavalla* (Figure 8.13). These results further illustrate the benefits that multiple gear types can bring to ichthyoplankton studies by sampling a more complete range of size classes, cohorts, ages, and life history stages (Brogan 1994; Choat *et al.* 1993; Hernandez and Lindquist 1999).

Previous studies have demonstrated that pushnets are effective in sampling larger juveniles and small fishes as well, particularly in coastal areas (Herke 1969; Kriete and Loesch 1980; Raynie and Shaw 1994). Herke (1969) used a pushnet in Louisiana tidal marshes to collect small estuarine fishes, primarily in the 25-100 mm range, and emphasized the maneuverability of the gear and its bow-mounting (free of propeller wash) as major advantages. Kriete and Loesch (1980) used a different design to collect juvenile pelagic fishes in lower Chesapeake Bay and found the gear was easy to deploy and able to fish in a controlled manner within shallow water (minimum depth of 1.2 m). These advantages were traits we considered for the edges of the jetty environment which is structurally complex. We were able to maneuver the boat and pushnet very close to the shallow slope of the rock wall with relative ease. In general, net avoidance is reduced with pushnets compared to towed nets (Raynie and Shaw 1994), and we chose a large mesh size (1,000 mm) and net opening (1 m x 1 m) to minimize the pressure wave in front of the net, minimize net clogging, and collect larger larvae and postsettlement juveniles. As a result, many of the size distributions sampled with the pushnet and light-trap at Belle Pass overlapped considerably (Figure 8.15). Only three of the 11 species analyzed exhibited significant size differences between the gear types. In one instance, the pushnet collections clearly had a larger size mode than the light-trap (Figure 8.15, *Gobiosoma* spp.). While we were targeting the same size classes with the pushnet, its usefulness was in sampling different taxa. The number of families (39) and taxa identified to the genus level (77) was approximately double that of the light-traps (19 and 34, respectively), which generated a taxon diversity for the pushnet collections that was significantly higher than that for the light-trap (Figure 8.20). Once again, multiple gear types allowed for the collection of a more complete representation of the ichthyoplankton and juvenile communities at the jetty site as well.

Lunar Periodicity

We investigated lunar periodicities because there are many hypotheses on larval biology concerning lunar reproductive patterns pertaining to propagule dispersal and predation rates that occur both at the beginning (spawning) and end (settlement) of the planktonic phase (Robertson 1991). Many reef

fish, for example, time their spawning events with different lunar cycles (Thresher 1984). Previous studies have also documented higher rates of fish settlement during darker, new moon periods than full moon periods (Victor 1986; Rooker *et al.* 1996), presumably a response to mortality associated with visual predators. These patterns of spawning, transport, recruitment, and settlement in association with the local physical oceanographic regime, often result in variable larval supply and settlement patterns with distinct lunar periodicities. It should be noted, however, that in the northern GOM tides are dominantly diurnal and their range in tidal height is not often in synchrony with the phase of the moon (i.e., new and full moon maximum tide ranges vs. first quarter and third quarter minimums); rather, the total range is in synchrony with the tropical and equatorial phases of the moon's elevation (i.e., Tropic of Cancer and/or Capricorn crossing maximum tidal ranges vs. equatorial crossing minimums; McLellan 1965). In addition, we wanted to investigate the effects on gear selectivity with respect to ambient light. Since light-traps rely on illumination in the surrounding water mass to attract fish, then theoretically the contrast in trap-generated illumination should be greater when there is less ambient light, such as during a new moon phase as opposed to a full moon (all larval and postlarval supply/availability issues being equal).

Few studies utilizing light-aggregating devices have addressed gear efficiency within the framework of lunar periodicities in fish spawning, larval supply (transport) and settlement. Gregory and Powles (1985) observed higher catches during new moon phases in a freshwater system but didn't report a statistical difference. Rooker *et al.* (1996) used a nightlight lift-net in nearshore habitats in Puerto Rico and reported that new moon abundances of larval fish were four times higher than the next most abundant phase (last quarter) during the summer months, and suggested that ambient light intensities might have played a factor in gear efficiency. The competitive interaction of lunar vs. light-trap illumination may have played a role in the collection of fish at Belle Pass where significantly higher CPUEs were observed during new moons (Figure 8.19). Belle Pass pushnet collections also had significantly more fish during new moons, possibly due to decreased visual avoidance under lower ambient light conditions. It is difficult, however, to separate the effects of ambient illumination and gear performance from the supply and/or settlement patterns of the fishes, so lunar periodicity may still play a role in the occurrence of fishes at this site.

In addition, the situation at petroleum platforms may be equally difficult to discern since the platforms have many bright lights throughout the structure to illuminate the work areas at night and to aid ship navigation, which may in effect be attracting fish to the structure (i.e., we are fishing a light-trap within a giant "light-trap"). We tried to address this issue by sampling away from the structure (i.e., 20 m downstream), but even these off-platform light-trap collections could still be within the "halo influence" of the platform's light field. Still, when significant differences in mean total densities and mean total CPUEs were found between new vs. full moon phases, four out of five instances had greater new moon catches (Figure 8.16). The analysis of the May samples at GI 94 taken over three lunar phases was disappointing, however, since it showed very little difference between the lunar phases for both gears (Figure 8.17). Although these platform results on lunar periodicity are less than conclusive, there may be several explanations for the lack of a consistently strong pattern. First of all, the previously mentioned potential competitive interference of large ambient light-fields may sometimes override any lunar effect that would otherwise be present. Secondly, some of the species may be responding differently to lunar cues. For example, some peak recruitment events have also been linked to full moon periods (Johannes 1978; Robertson *et al.*

1988). In addition, the light-traps generally caught more larger sized (and presumably older, more competent) larvae, whereas plankton net collections were dominated by smaller sized larvae that could have been displaying different behavioral capabilities. Finally, it is possible that the abundances of these fish are related to more localized factors such as water mass supply, particularly at the mid- and inner shelf sites where the coastal current regime can dynamically affect salinity, temperature, and food patchiness, and where the geographical concentration of upstream platforms is greatest when compared to the relative isolated shelf slope site.

CONCLUSIONS

In summary, both the light-trap and the passive plankton net were effective in collecting fish larvae and juveniles within the complex infrastructure of the oil and gas platforms sampled in the north central GOM. Surprisingly, the light-trap collected individuals from a wide range of taxa, including many unique taxa that were not collected with the plankton net. As in previous studies, the light-trap generally collected larger individuals (postflexion larvae and juveniles) than the plankton net but also performed very well at the smaller sizes. Pushnet collections from Belle Pass were more taxonomically rich and diverse than light-trap collections, and the pushnet was equally effective in capturing large individuals as the light-trap. The use of multiple gear types in ichthyoplankton studies is becoming more common and, in some instances, provides the researcher with a more complete view of larval fish assemblages. For example, the combination of sampling gears at the platforms allowed for the collection of a wider range of taxa, size classes, and cohorts (life stages) than either gear would have provided individually. This enabled us to confirm the presence of both recently-spawned larvae and larger, near-settlement size postlarvae and juveniles at our sampling sites.

At the Belle Pass jetties, however, the pushnet collections contained many more families and taxa than the light-trap collections, including nearly all of the taxa collected by that gear type, as well as the same size ranges. In this coastal tidal pass, the light-trap was not as useful as a supplemental gear type. The differences in the relative performance of the gear types in different habitats stresses the need for the development of sampling strategies specific to each environment sampled.

ACKNOWLEDGMENTS

We gratefully acknowledge funding by the Minerals Management Service-Louisiana State University-Coastal Marine Institute (Contract Number 14-75-0001-30660, Task Order Number 19926) and by the Louisiana Sea Grant Program, part of the National Sea Grant College Program maintained by the National Oceanic and Atmospheric Administration. We thank Mark Benfield, David Bunch, Joseph Cope, Nathan Craig, James Ditty, Talat Farooqi, Heather Haas, Ross Horton, Robin Hargroder, Sean Keenan, Gregory Lavergne, David Lindquist, Bradley McDonald, Cory New, Nick Ortego, John Plunket, and Christopher Whatley for assistance in the field and/or laboratory. We gratefully acknowledge the assistance of Drs. Charles A. Wilson and David R. Stanley. We are further indebted to Exxon USA, Inc. and Mobil USA Exploration and Production, Inc. for access to their offshore oil and gas platforms and logistical support, and to the crews of Mobil's West Cameron 352, West Cameron 71D, Green Canyon 18, and Grand Isle 94 and Exxon's South Timbalier 54 platforms for their hospitality.

REFERENCES

- Brander, K. and A.B. Thompson. 1989. Diel differences in avoidance of three vertical profile sampling gears by herring larvae. *Journal of Plankton Research* 4:775-784.
- Brogan, M.W. 1994. Two methods of sampling fish larvae over reefs: a comparison from the Gulf of California. *Marine Biology* 118:33-44.
- Choat, J.H. and D. R. Bellwood. 1991. Reef fishes: their history and evolution. Pp. 39-66. *In* P. F. Sale, ed. *The Ecology of Fishes on Coral Reefs*. Academic Press, San Diego.
- Choat, J.H., P.J. Doherty, B.A. Kerrigan, and J.M. Leis. 1993. A comparison of towed nets, purse seine, and light-aggregation devices for sampling larvae and pelagic juveniles of coral reef fishes. *Fishery Bulletin* 91:195-209.
- Continental Shelf Associates. 1982. Study of the effect of oil and gas activities on reef fish populations in the Gulf of Mexico OCS area. OCS Report/MMS82-010. U.S. Dept. of the Interior, Minerals Management Service, Gulf of Mexico OCS Region, New Orleans.
- Dennis, G.D., D. Goulet, and J.R. Rooker. 1991. Ichthyoplankton assemblages sampled by night lighting in nearshore habitats of southwestern Puerto Rico. NOAA/NMFS Technical Report U.S., Department of Commerce 95.
- Ditty, J.G. 1986. Ichthyoplankton in neritic waters of the northern Gulf of Mexico off Louisiana: composition, relative abundance and seasonality. *Fishery Bulletin* 84:935-946.
- Ditty, J.G., G.G. Zieske, and R.F. Shaw. 1988. Seasonality and depth distribution of larval fishes in the northern Gulf of Mexico above latitude 26°00'N. *Fishery Bulletin* 86:811-823.
- Doherty, P.J. 1987. Light-traps: selective but useful devices for quantifying the distribution and abundances of larval fishes. *Bulletin of Marine Science* 41:423-431.
- Finucane, J.H., L.A. Collins, L.E. Barger, and J.D. McEachran. 1979. Environmental Studies of the South Texas Outer Continental Shelf 1976: Ichthyoplankton/mackerel eggs and larvae. NOAA Final Report to BLM, NMFS Southeast Fisheries Center, Galveston, Contract Number AA550-TA7-3.
- Floyd, K.B., W.H. Courtenay, and R.D. Holt. 1984. A new larval fish light trap: the quatrefoil trap. *Progressive Fish-Culturist* 46:216-219.
- Gallaway, B.J., L.R. Martin, R.L. Howard, G.S. Boland and G. D. Dennis. 1980. A case study of the effects of gas and oil production on artificial reef and demersal fish and macrocrustacean communities in the northwestern Gulf of Mexico. Expo Chem 1980, Houston, TX.

- Gallaway, B.J. 1981. An ecosystem analysis of oil and gas development on the Texas-Louisiana continental shelf. U.S. Fish & Wildlife Service, Office of Biological Services, FWS/OBS-81/27, Washington, D.C.
- Gallaway, B.J. 1998. Cumulative ecological significance of oil and gas structures in the Gulf of Mexico: Information search, synthesis, and ecological modeling: Phase I, Final Report. U. S. Geological Survey, Biological Research Division, Washington, D.C. USGS/BRD/CR-1997-0006.
- Gregory, R.S. and P.M. Powles. 1985. Chronology, distribution, and sizes of larval fish sampled by light traps in macrophytic Chemung lake. *Canadian Journal of Zoology* 63:2569 – 2577.
- Herke, W.H. 1969. A boat-mounted surface push-trawl for sampling juveniles in tidal marshes. *Progressive Fish-Culturist* 31:177-179.
- Hernandez, F.J., Jr. and D.G. Lindquist. 1999. A comparison of two light-trap designs for sampling larval and presettlement juvenile fish above a reef in Onslow Bay, North Carolina. *Bulletin of Marine Science* 64: 173-184.
- Hernandez, F.J., Jr., R.F. Shaw, J.S. Cope, J.G. Ditty, T. Farooqi and M. C. Benfield (this volume). The across-shelf larval, postlarval, and juvenile fish community associated with offshore oil and gas platforms and a coastal rock jetty west of the Mississippi River Delta.
- Hickford, M.J. H. and D.R. Schiel. 1999. Evaluation of the performance of light traps for sampling fish larvae in inshore temperate waters. *Marine Ecology Progress Series* 186:293-302.
- Johannes, R.E. 1978. Reproductive strategies of coastal marine fishes in the tropics. *Environmental Biology of Fishes* 3:65-84.
- Keener, P., G.D. Johnson, B.W. Stander, E.B. Brothers and H. R. Beatty. 1988. Ingress of postlarval gag *Mycteroperca microlepis* (Pisces: Serranidae), through a South Carolina Barrier island inlet. *Bulletin of Marine Science* 42(3):376-396.
- Kingsford, M.J. and J. H. Choat. 1989. Horizontal distribution patterns of presettlement reef fish: are they influenced by the proximity to reefs? *Marine Biology* 101:285-297.
- Kriete, W.H., Jr. and J.G. Loesch. 1980. Design and relative efficiency of a bow-mounted pushnet for sampling juvenile pelagic fishes. *Transactions of the American Fisheries Society* 109:649-652.
- Leis, J.M. 1991. The pelagic stage of reef fishes: the larval biology of coral reef fishes. Pp. 183-230. *In* P.F. Sale, ed. *The Ecology of Fishes on Coral Reefs*. Academic Press, San Diego.
- Lukens, R.R. 1981. Ichthyofaunal colonization of a new artificial reef in the northern Gulf of Mexico. *Gulf Research Reports* 7(1):41-46.

- Magurran, A.E. 1988. *Ecological Diversity and Its Measurement*. Princeton University Press, Princeton.
- Marliave, J.B. 1986. Lack of planktonic dispersal of rocky intertidal fish larvae. *Transactions of the American Fisheries Society* 115:149-154.
- McLellan, H.I. 1965. *Elements of Physical Oceanography*. Pergamon Press, Oxford.
- Moser, H.G., W.J. Richards, D.M. Cohen, M.P. Fahay, A.Kendall and S. L. Richardson, editors. 1984. *Ontogeny and systematics of fishes*. Special Publication Number 1, American Society of Ichthyologists and Herpetologists, Lawrence, Kansas.
- Murphy, G.I. and R. I. Clutter. 1972. Sampling anchovy larvae with a plankton purse seine. *Fishery Bulletin* 70(3):789-798.
- Parker, R.O., Jr., D.R. Colby T. P. Willis. 1983. Estimated amount of reef habitat on a portion of the U.S. South Atlantic and Gulf of Mexico continental shelf. *Bulletin of Marine Science* 33:935-940.
- Raynie, R.C. and R.F. Shaw. 1994. Ichthyoplankton abundance along a recruitment corridor from offshore spawning to estuarine nursery ground. *Estuarine, Coastal and Shelf Science* 39:421-450.
- Reyns, N. and S. Sponaugle. 1999. Patterns and processes of brachyuran crab settlement to Caribbean coral reefs. *Marine Ecology Progress Series* 185:155-170.
- Robertson, D.R., D.G. Green, and B.C. Victor. 1988. Temporal coupling of production and recruitment of larvae of a Caribbean reef fish. *Ecology* 69:370-381.
- Robertson, D.R. 1991. The role of adult biology in the timing of spawning of tropical reef fishes. Pp. 356-386. *In* P.F. Sale, editor. *The Ecology of Fishes on Coral Reefs*. Academic Press, San Diego.
- Rooker, J.R., G.D. Dennis, and D. Goulet. 1996. Sampling larval fishes with a nightlight lift-net in tropical inshore waters. *Fisheries Research* 26:1-15.
- SAS Institute, Inc. 1989. *SAS/STAT Users Guide, Version 6*. Cary, North Carolina.
- Schoener, T.W. 1970. Non-synchronous spatial overlap of lizards in patchy habitats. *Ecology* 51:408-418.
- Secor, D.H., J.M. Dean, and J. Hansbarger. 1993. Modification of the quatrefoil light trap for use in hatchery ponds. *Progressive Fish Culturist* 54:202-205.

- Shenker, J.M., E.D. Maddox, E. Wishinski, A. Pearl, S. Thorrold and N. Smith. 1993. Onshore transport of settlement-stage Nassau grouper *Epinephelus striatus* and other fishes in Exuma Sound, Bahamas. *Marine Ecology Progress Series* 98:31-43.
- Sokal, R.R., and F.J. Rohlf. 1981. *Biometry: the principles and practice of statistics in biological research*. W.H. Freeman and Co., New York.
- Sponaugle, S. and R.K. Cowen. 1996. Nearshore patterns of coral reef fish larval supply to Barbados, West Indies. *Marine Ecology Progress Series* 133:13-28.
- SPSS, Inc. 1999. *SYSTAT 9: Getting started*. SPSS, Inc., Chicago.
- Stephens, J.S., Jr., P.A. Morris, D.J. Pondella, T.A. Koonce and G. A. Jordan. 1994. Overview of the dynamics of an urban artificial reef fish assemblage at King Harbor, California, USA, 1974-1991: a recruitment driven system. *Bulletin of Marine Science* 55(2-3):1224-1239.
- Taggart, C.T. and W. C. Leggett. 1984. Efficiency of large-volume plankton pumps, and evaluation of a design suitable for deployment from small boats. *Canadian Journal of Fisheries and Aquatic Sciences* 41:1428-1435.
- Thorrold, S.R. 1992. Evaluating the performance of light traps for sampling small fish and squid in open waters of the central Great Barrier Reef lagoon. *Marine Ecology Progress Series* 89:277-285.
- Thresher, R.E. 1984. *Reproduction in Reef Fishes*. T.F.H. Publications, Inc.
- Victor, B.C. 1983. Recruitment and population dynamics of a coral reef fish. *Science* 219:419-420.
- Victor, B.C. 1986. Larval settlement and juvenile mortality in a recruitment-limited coral reef fish population. *Ecological Monographs* 56:145-160.

OCCURRENCE AND PELAGIC HABITAT OF REEF FISH LARVAE IN THE GULF OF MEXICO

David S. Hanisko
Joanne Lyczkowski-Shultz
National Oceanic and Atmospheric Administration
National Marine Fisheries Service
Southeast Fisheries Science Center

ABSTRACT

Examination of 3560 ichthyoplankton samples taken during 15 years of annual Southeast Area Monitoring and Assessment Program (SEAMAP) resource surveys in the U.S. Gulf of Mexico (GOM), 1982 to 1996, yielded 208 holocentrid, 524 priacanthid, 6606 labrid and 2609 scarid larvae. Larvae were found more frequently and in higher abundances over the continental shelf of the eastern Gulf where most reef fish habitat exists. Labrid and scarid larvae were consistently associated with higher salinity and clearer water on the mid to outer shelf during all seasons. Increased river discharge in 1993 appears to have limited labrid and scarid larvae to the outer shelf of the western Gulf, as compared to their more widespread distribution over the shelf in 1992 when river discharge was near mean levels. A more unexpected result was the consistent and frequent occurrence of labrid and scarid larvae in open Gulf waters in numbers comparable to abundances observed at shelf locations. Abundances of labrid and scarid larvae plotted over dynamic sea surface height measured from satellite imagery in winter and spring of 1993 revealed their apparent relationship with open Gulf hydrography. In the western Gulf, the highest abundances of labrid and scarid larvae were associated with the frontal boundary of a Loop Current anticyclone. In the eastern Gulf, labrid and scarid larvae were found in higher abundances along the frontal boundaries of the Loop Current (LC), LC/cyclonic eddy confluences and within the interior of the LC. The consistent occurrence and relative abundance of labrid and scarid larvae in the open Gulf implies that an exchange and transport of larvae may occur among reefs systems throughout the GOM and from upstream sources such as the Caribbean Sea.

INTRODUCTION

The GOM is best known for the richness and productivity of its salt marshes, estuaries, and broad continental shelf, especially west of the Mississippi River. Yet areas of natural hardbottom, and the diverse reef fauna that they support occur throughout the Gulf. Additionally, in the northwestern and north-central Gulf the presence of offshore oil and gas production structures and the placement of artificial reefs has increased the amount of hard substrate and available reef habitat (Galloway 1984; Kasprzak 1998).

The biota associated with natural and artificial reef habitat is a mix of western Atlantic temperate and insular tropical species, which becomes increasingly tropical in the more offshore areas (Dennis and Bright 1988). The tropical nature of these reef communities in the north-central and western Gulf is dependent upon; geological characteristics of the substrate; regional and local hydrography;

winter temperature minimum; riverine influence on salinity and turbidity; depth of substrate; and depth and thickness of the nepheloid layer (Smith 1976 and Rezak *et al.* 1990).

The majority of adult reef fishes are sedentary and have an obligate (dependent) relationship with their habitat. This relationship concentrates them to relatively small areas of suitable habitat. Since the adult phase of most species are sedentary, populations of reef fishes are established and maintained by the continuous settlement of pelagic larvae to reef habitat (Sale and Ferrell 1988; Leis 1991).

Sale (1991) and Cowen and Sponaugle (1997) have noted that there is little information on the planktonic and early life stages of reef fishes. Although there have been numerous ichthyoplankton studies from the broad range of marine habitats found in the Gulf of Mexico (Richards *et al.* 1993), none have focused on the larvae of reef fishes on a Gulf-wide basis. Ichthyoplankton samples have been collected since 1982 during Southeast Area Monitoring and Assessment Program (SEAMAP) ichthyoplankton surveys of the GOM (SEAMAP 2000). Data from these collections on the distribution and abundance of the larvae of 4 obligate reef fish families: Holocentridae (squirrelfishes); Priacanthidae (bigeyes); Labridae (wrasses); and Scaridae (parrotfishes) are summarized. We present data that reveal apparent relationships between larval reef fish distributions and hydrography in the northwestern and open GOM.

MATERIALS AND METHODS

Data were taken during four annual SEAMAP surveys: Summer Groundfish, Fall Plankton and Fall Groundfish in continental shelf waters; and Spring Plankton in the open GOM (Figure 8.21, Table 8.5). Stations are 30 to 60 nautical miles apart in a fixed grid, and sampled at all times of day or night. Additionally, Oregon II Cruise 203, a marine mammals/plankton survey conducted only in January and February of 1993 was examined to investigate possible larval associations with hydrographic features in the open Gulf (Table 8.5). Plankton collections from this cruise were taken every 10 nm along a transect between the shortest route to the next day's starting position during nighttime hours. Larvae for all cruises were captured in oblique tows from near bottom to surface using a 61-cm bongo net with 0.333 mm mesh nets following standardized SEAMAP collection procedures (SEAMAP 2000).

Surface measurements of salinity and turbidity were taken with a SEABIRD SBE25 conductivity temperature depth (CTD) profiler. Surface salinity contours were generated from the data for the 1992, 1993 and 1994 Summer Groundfish, Fall Plankton and Fall Groundfish cruises. Surface turbidity (water clarity) contours were generated from data for the Summer and Fall Groundfish cruises in 1992 and 1993. Contour plots were generated by Surfer[®] 6 using a Kriging function with a linear variogram. Labrid and scarid distributions were plotted over the composite salinity and transmissivity contours to examine possible relationships. TOPEX/ERS1 merged dynamic sea surface height plots were obtained from the GOM historical data server at the Colorado Center for Astrodynamics Research: http://www-ccar.colorado.edu/~realtime/gom-historical_vel/

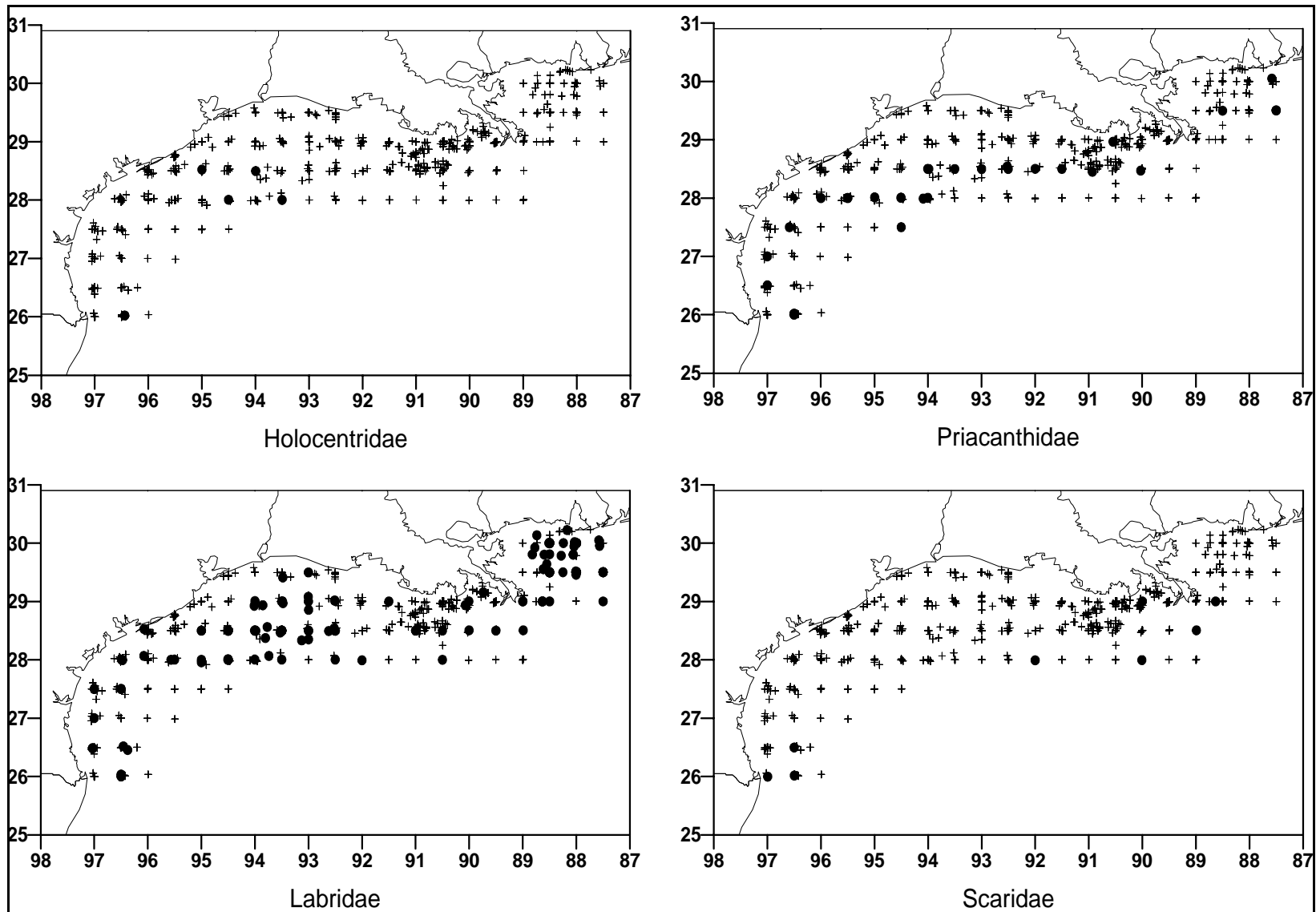

Figure 8.21. Southeast Area Monitoring and Assessment Program (SEAMAP) survey areas sampled during Summer Groundfish, Fall Plankton, Fall Groundfish and Spring Plankton cruises.

Table 8.5. SEAMAP surveys sampling effort. Western Gulf of Mexico (West), Texas-Louisiana Shelf (TX-LA), Mississippi-Alabama Shelf (MS-AL), Florida Shelf (FL) and Eastern Gulf of Mexico (East). (*) Indicates area not sampled.

Survey	Time Frame	Years	Number of samples by area					Total
			West	TX-LA	MS-AL	FL	East	
Summer Groundfish (SG)	June-July	1982-96	*	330	39	*	*	369
Fall Plankton (FP)	Aug.-Oct.	1986-94, 1996	*	507	84	551	*	1142
Fall Groundfish (FG)	Oct.-Nov.	1986-95	*	607	95	*	*	702
Spring Plankton (SP)	April-June	1982-84, 1986-96	511	*	*	*	836	1,347
Winter Plankton (WP)	Jan.-Feb.	1993	*	*	*	*	*	102

Labrid and scarid abundances were plotted over sea surface height to examine possible relationships. Abundance data was subsetted into 30 day periods and plotted over the sea surface height map corresponding to the mid point of the 30 day sampling period.

Larvae from SEAMAP collections were sorted and identified by the Polish Sorting and Identification Laboratory in Szczecin, Poland. Species descriptions of larval development for tropical reef fishes is lacking but most are identifiable to the family level (Leis and Rennis 1983; Richards 1985). The families; Holocentridae, Priacanthidae, Labridae and Scaridae were chosen for this study because they are obligate reef species with pelagic larvae. These larvae are morphologically distinct from other larvae thus minimizing misidentifications, at least to the family level. Many species within the families Holocentridae, Priacanthidae and Labridae are known to have protracted larval stages that could be entrained and transported in ocean currents and eddies. Although little is known of the ontogeny of the family Scaridae, it is likely that some scarids also have protracted larval periods similar to the closely related to labrids (Leis and Rennis 1983).

RESULTS

Examination of 3560 bongo net samples yielded 208 holocentrid, 524 priacanthid, 6606 labrid and 2609 scarid larvae from annual SEAMAP resource surveys in the GOM, 1982 to 1996 (Table 8.5). Presence and absence plots generated for each survey depict the pelagic habitat of these families throughout the GOM (Figure 8.22 through Figure 8.25). Distinct annual and regional differences in the occurrence and abundance of these larvae were revealed among five regions: TX-LA, MS-AL and FL shelves, and the western and eastern open GOM. Ranges in percent frequency of occurrence and abundances show similar annual and regional patterns, therefore only plots of frequency of occurrence are presented.

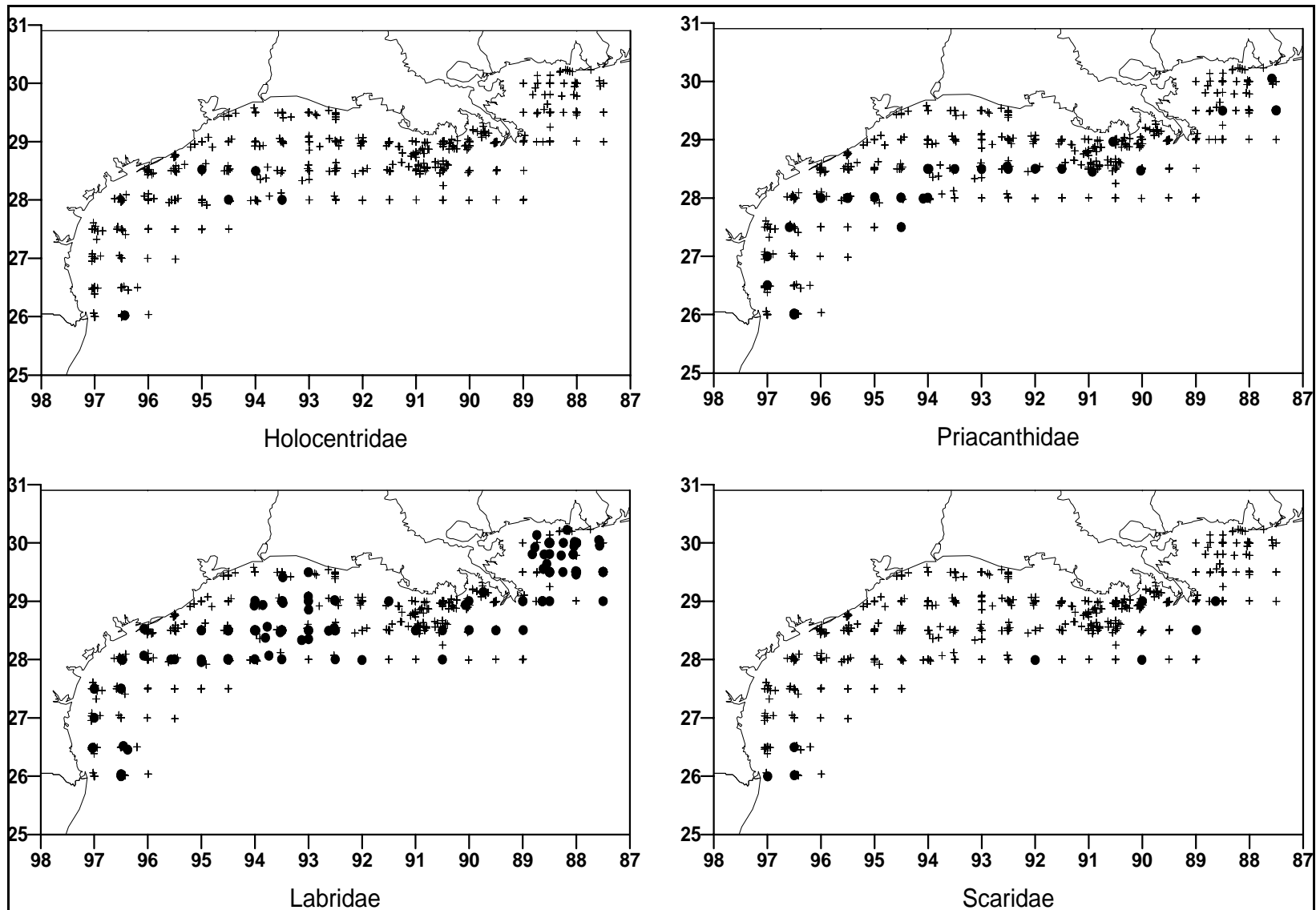

Figure 8.22. Occurrence of holocentrid, priacanthid, labrid and scarid larvae taken during the 1982 to 1996 Summer Groundfish Surveys. Filled circles (•) indicate positive catches of larvae; plus signs (+) indicate zero catch.

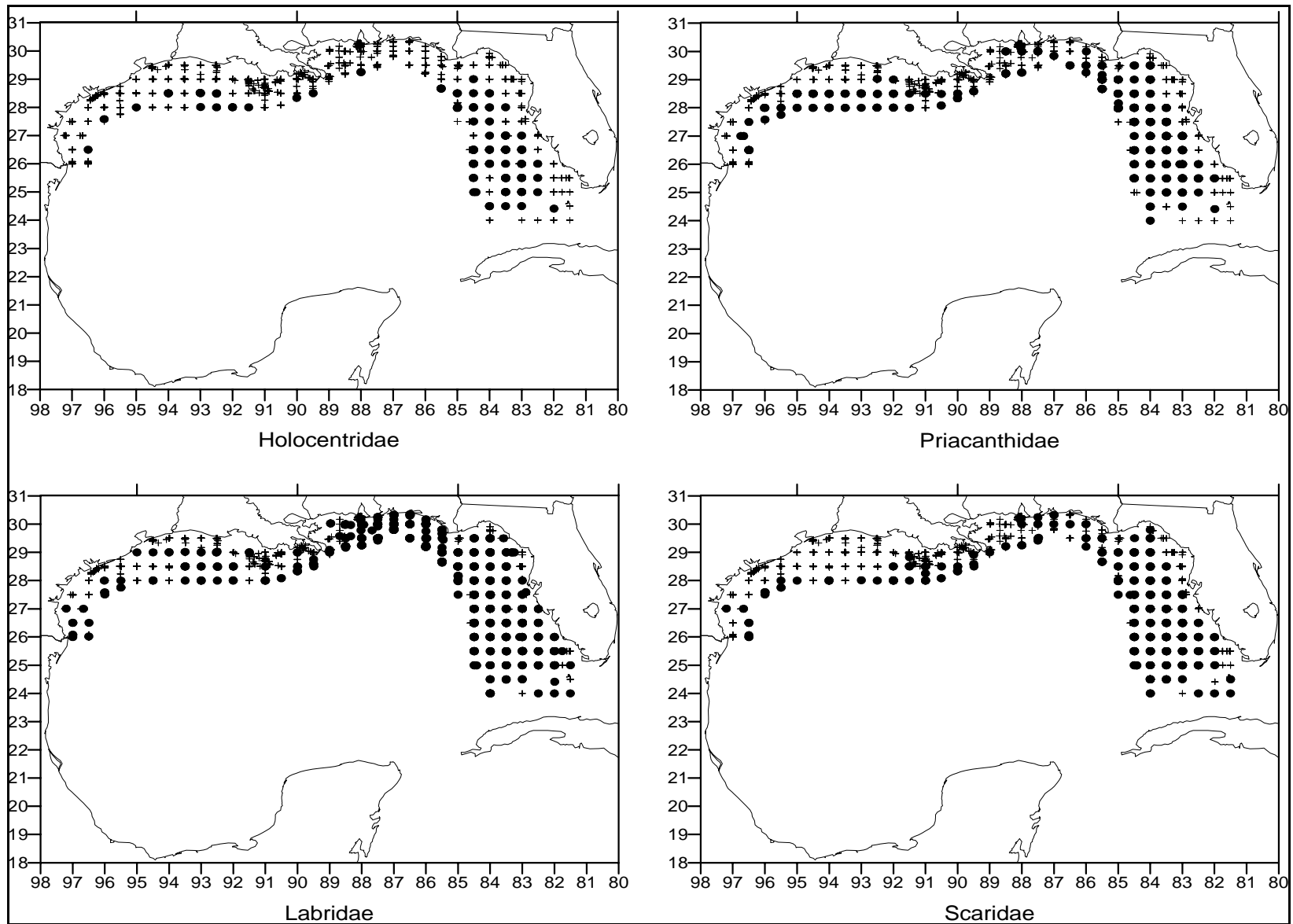

Figure 8.23. Occurrence of holocentrid, priacanthid, labrid and scarid larvae taken during the 1986 to 1994 and 1996 Fall Plankton Surveys. Filled circles (•) indicate positive catches of larvae; plus signs (+) indicate zero catch.

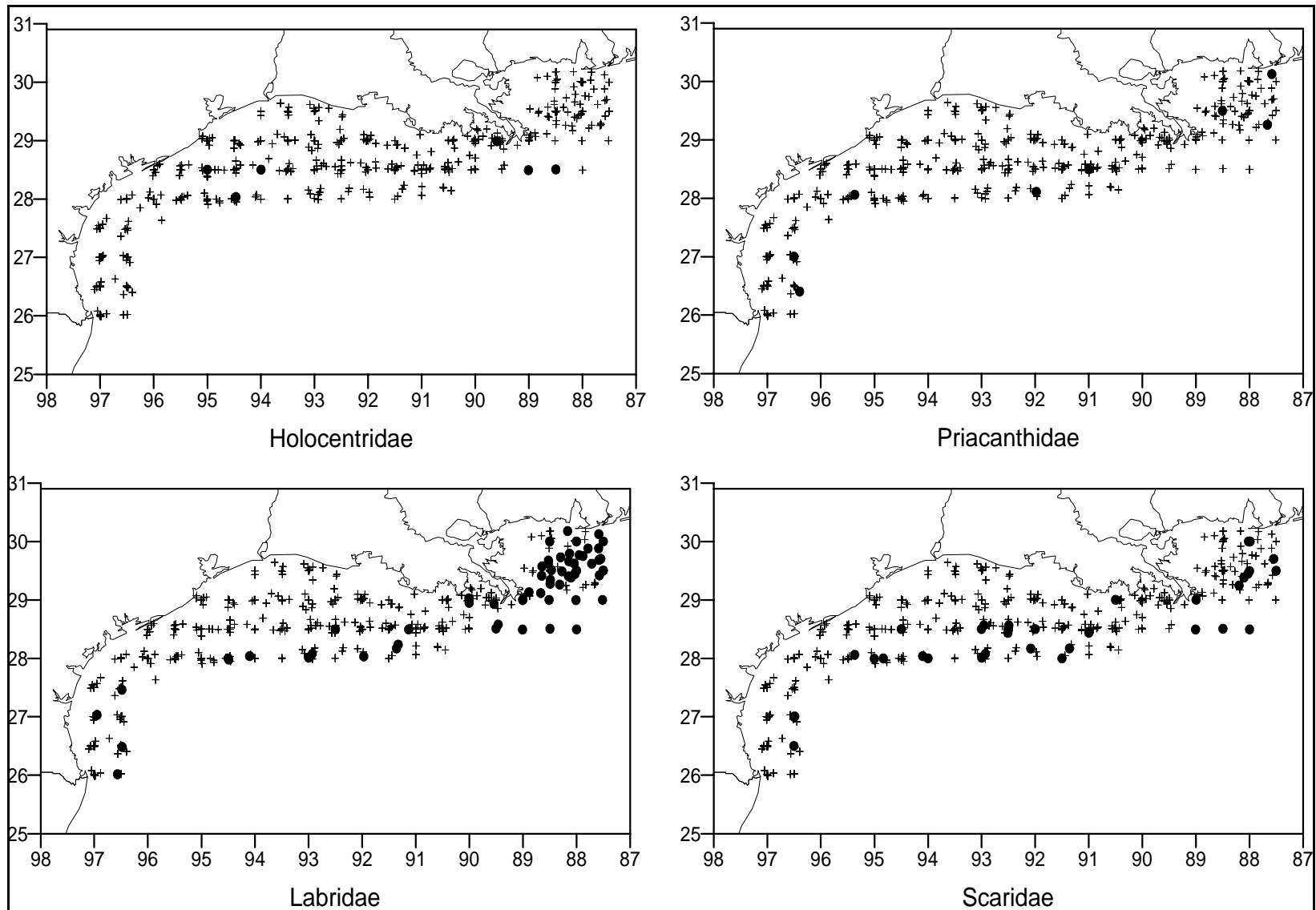

Figure 8.24. Occurrence of holocentrid, priacanthid, labrid and scarid larvae taken during the 1986 to 1995 Fall Groundfish Surveys. Filled circles (•) indicate positive catches of larvae; plus signs (+) indicate zero catch.

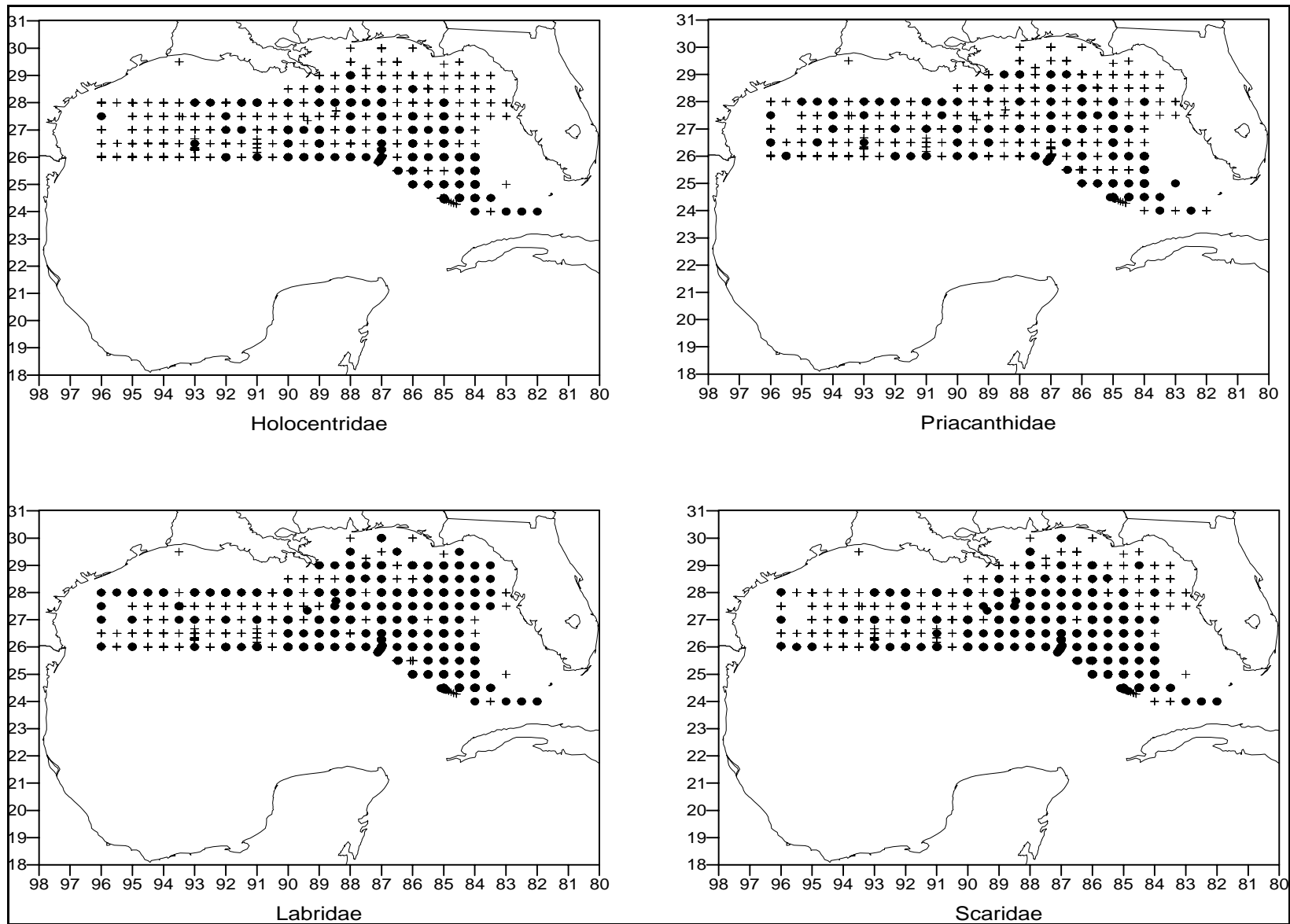

Figure 8.25. Occurrence of holocentrid, priacanthid, labrid and scarid larvae taken during the 1982 to 84 and 1986 to 1996 Spring Plankton Surveys. Filled circles (•) indicate positive catches of larvae; plus signs (+) indicate zero catch.

The Summer Groundfish surveys (15 years) took samples from Mobile, AL to Brownsville, TX on the continental between 10 and 110 m generally in the months of June and July (Figure 8.26). Holocentrids were taken in only 3 years on the TX-LA shelf, and were never collected on the MS-AL shelf. Annual frequency of occurrence (FO) ranged from 0 to 2%; and annual abundance ranged from 0 to 0.13 larvae/10 m² on the TX-LA shelf. Priacanthids were collected in 12 years on the TX-LA shelf and only 1 year on the MS-AL shelf. Annual FO ranged from 0 to 7% on the TX-LA shelf, and 0 to 8% on the MS-AL shelf. Annual abundance ranged from 0 to 0.27 larvae/10 m² on the TX-LA shelf and 0.30 larvae/10 m² on the MS-AL shelf. Labrids were collected during 14 years on the TX-LA shelf and 12 years on the MS-AL shelf. Annual FO ranged from 0 to 29% on the TX-LA shelf and 0 to 100% on the MS-AL shelf. Annual abundance ranged from 0 to 0.13 larvae/10 m² on the TX-LA shelf, and 0 to 91.30 larvae/10 m² on the MS-AL shelf. Scarids were collected during 3 years on the TX-LA shelf and 1 year on the MS-AL shelf. Annual FO ranged from 0 to 4% on the TX-LA shelf and 0 to 8% on the MS-AL shelf. Annual abundance ranged from 0 to 0.48 larvae/10 m² on the TX-LA shelf, and 0 to 1.50 larvae/10 m² on the MS-AL shelf.

The Fall Plankton surveys (11 years) took samples throughout the GOM over the continental shelf from 10 to 200 m generally in the month of September (Figure 8.27). Holocentrids were collected during 4 years on the TX-LA shelf, never on the MS-AL shelf, and 8 years on the Florida (FL) shelf. Annual FO ranged from 0 to 8% on the TX-LA shelf and from 0 to 10% on the FL shelf (Figure 8.27). Annual abundance ranged from 0 to 0.42 larvae/10 m² on the TX-LA shelf and from 0 to 1.21 larvae/10 m² on the FL shelf. Priacanthids were collected during 9 years on the TX-LA shelf, 2 years on the MS-AL shelf, and 8 years on the FL shelf. Annual FO ranged from 0 to 15% on the TX-LA, 0 to 14% on the MS-AL and 4 to 42% on the FL shelf. Annual abundance ranged from 0 to 0.80, 0 to 1.63 and 0.18 to 8.5 larvae/10 m² respectively for the TX-LA, MS-AL and FL shelves. Labrids were collected every year on the TX-LA, MS-AL, and FL shelves. Annual FO ranged from 4 to 16%, 22 to 83% and 47 to 83% on the TX-LA, MS-AL and FL shelves respectively. Annual abundance ranged from 0.22 to 3.72, 2.91 to 38.10 and 4.57 to 44.25 larvae/10 m² on the TX-LA, MS-AL and FL shelves respectively. Scarids were collected during 9 years on the TX-LA shelf, 3 years on the MS-AL shelf, and all 10 years on the FL shelf. Annual FO ranged from 0 to 11%, 0 to 25% and 10 to 50% on the TX-LA, MS-AL and FL shelves respectively. Annual abundances ranged from 0 to 4.67, 0 to 3.13 and 1.42 to 14.97 larvae/10 m² on the TX-LA, MS-AL and FL shelves.

The Fall Groundfish surveys (9 years) took samples from Mobile, AL to Brownsville, TX on the continental between 10 and 110 m generally in the months of October and November (Figure 8.28). Holocentrids were never collected on the TX-LA or MS-AL shelves. Priacanthids were collected during 4 years on the TX-LA shelf, and 1 year on the MS-AL shelf. Annual FO ranged from 0 to 6% on the TX-LA shelf, and from 0 to 20% on the MS-AL shelf. Annual abundance ranged from 0 to 0.29 larvae/10 m² on the TX-LA shelf, and 0 to 0.87 larvae/10 m² on the MS-AL shelf. Labrids were collected during 8 years on the TX-LA shelf, and 6 years on the MS-AL shelf. Annual FO ranged from 0 to 11% on the TX-LA shelf and 0 to 33% on the MS-AL shelf. Annual abundance ranged from 0 to 2.51 larvae/10 m² on the TX-LA shelf, and 0 to 5.37 larvae/10 m² on the MS-AL shelf. Scarids were collected during 7 years on the TX-LA shelf, and 2 years on the MS-AL shelf. Annual FO ranged from 0 to 13% on the TX-LA and 0 to 20% on the MS-AL shelf. Annual abundances ranged from 0 to 1.27 larvae/10 m² on the TX-LA shelf, and 0 to 1.46 larvae/10 m² on the MS-AL shelf.

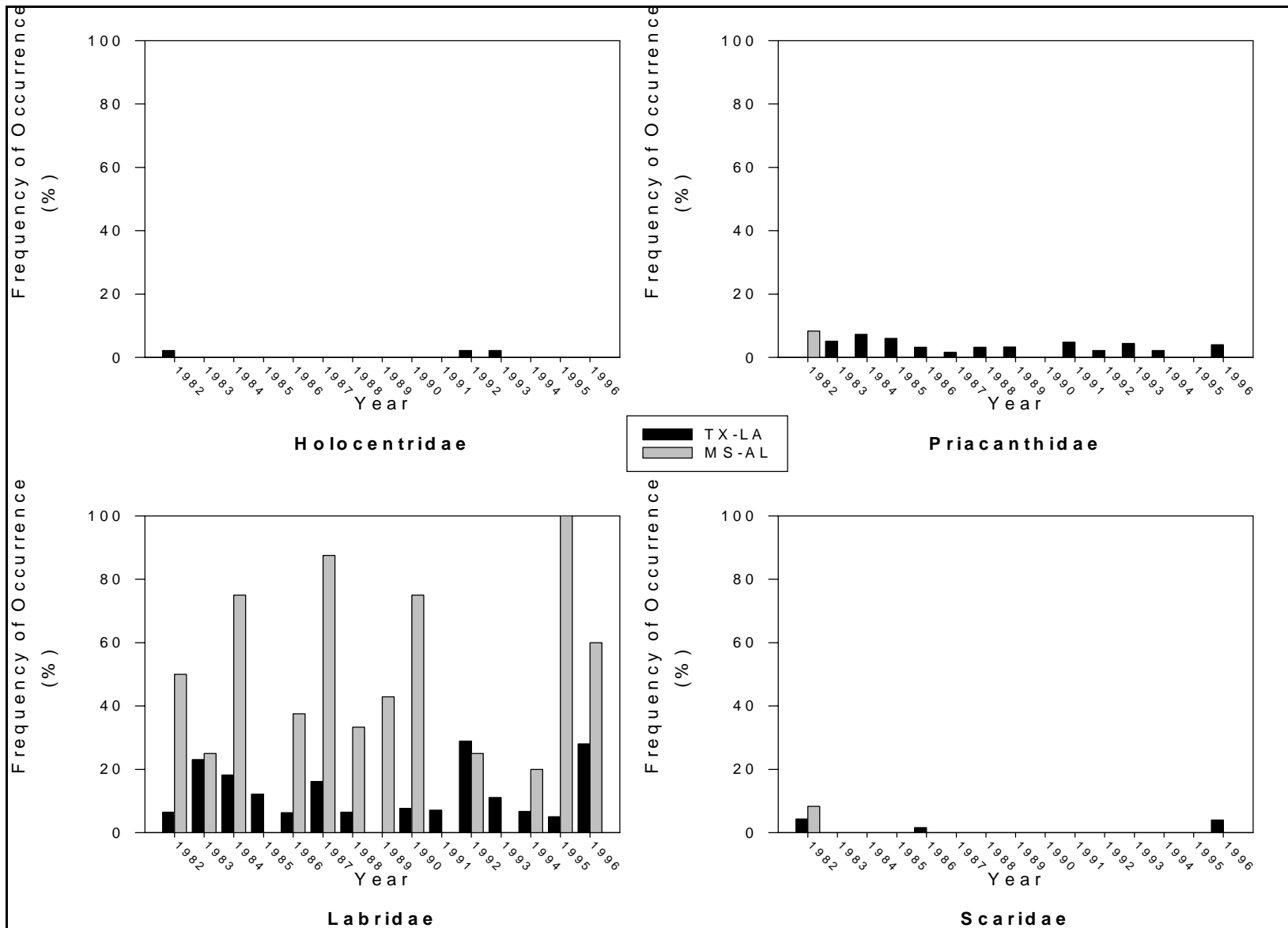

Figure 8.26. Annual frequency of occurrence (%) of holocentrid, priacanthid, labrid and scarid larvae by year and area for the 1982 to 1996 Summer Groundfish Surveys.

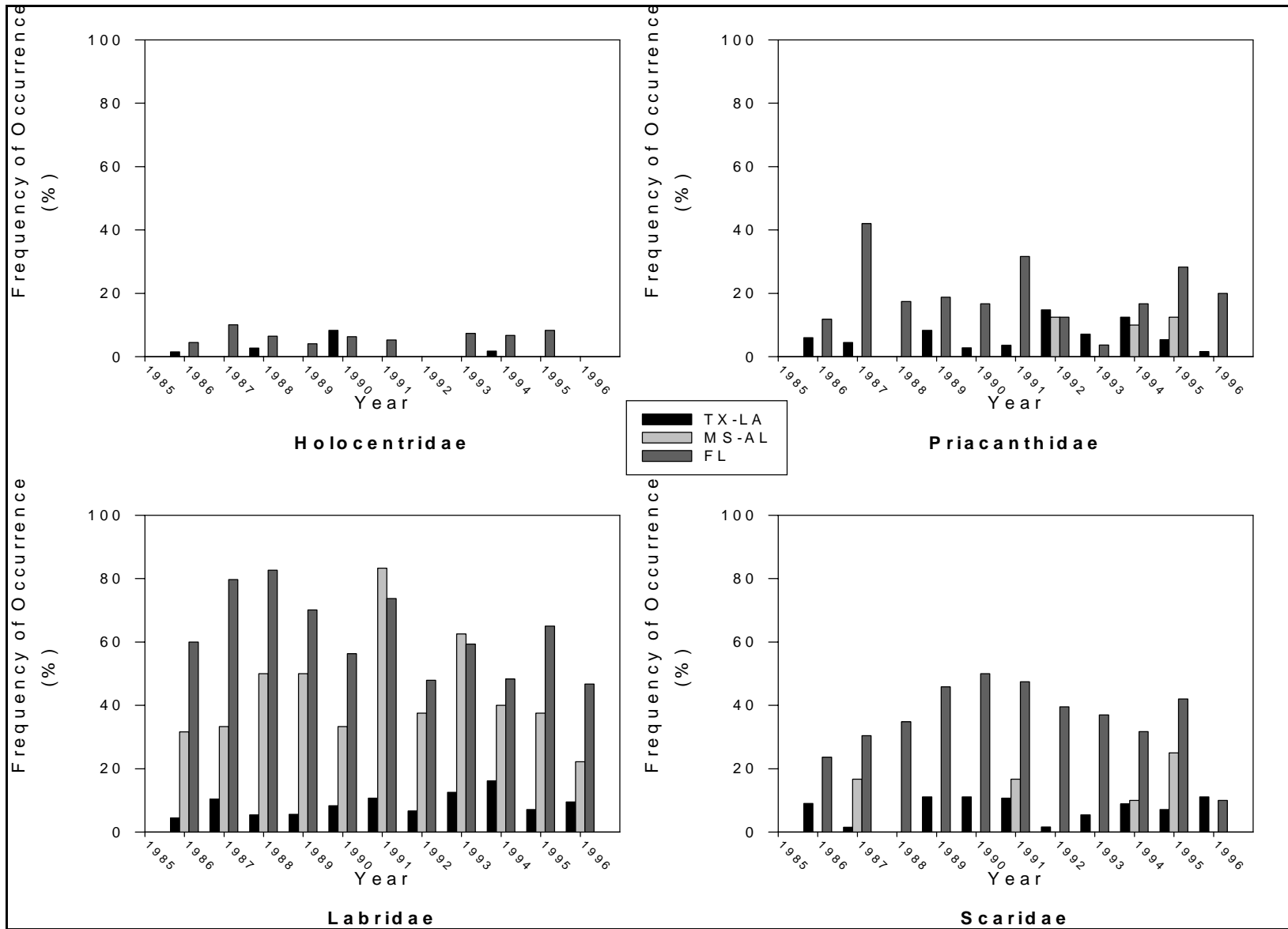

Figure 8.27. Annual frequency of occurrence (%) of holocentrid, priacanthid, labrid and scarid larvae by year and area for the 1986 to 1994 and 1996 Fall Plankton Surveys.

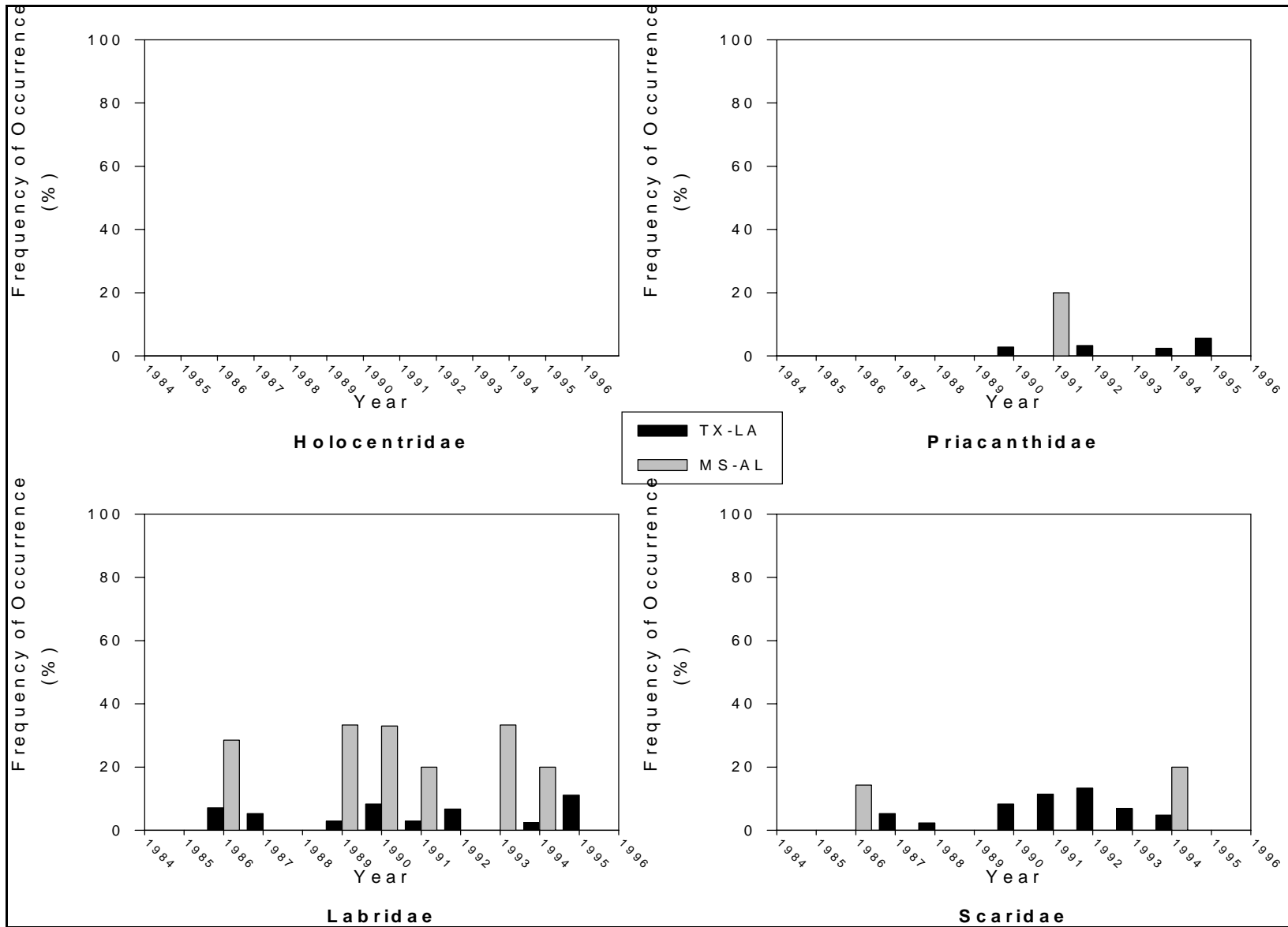

Figure 8.28. Annual frequency of occurrence (%) of holocentrid, priacanthid, labrid and scarid larvae by year and area for the 1986 to 1995 Fall Groundfish Surveys.

The Spring Plankton surveys (14 years) took samples throughout the open GOM generally from April to June (Figure 8.29). Holocentrids were collected during 6 years in the western and all 14 years in the eastern Gulf (Figure 8.29). Annual FO ranges from 0 to 7% in the west, and 0 to 18% in the east. Annual abundance ranged from 0 to 0.73 larvae/10 m² in the west and 0 to 4.42 larvae/10 m² in the east. Priacanthids were collected during 9 years in the western, and all 14 years the eastern Gulf. Annual FO ranges from 0 to 11% in the west, and 2 to 18% in the east. Annual abundance ranged from 0 to 0.61 larvae/10 m² in the west, and 0.08 to 2.42 larvae/10 m² in the east. Labrids were collected during 11 years in the western and all 14 years in the eastern Gulf. Annual FO ranged from 0 to 29% in the west and 15 to 57% in the east. Annual abundance ranged from 0 to 7.08 larvae/10 m² in the west, and 5.22 to 13.58 larvae/10 m² in the east. Scarids were collected during 13 years in the western and all 14 years in eastern Gulf. Annual FO ranged from 0 to 40% in the west and 15 to 50% in the east. Annual abundance ranged from 0 to 2.56 larvae/10 m² in the west, and 2.72 to 22.66 larvae/10 m² in the east.

Observations over the entire time series were combined in order to get a clearer picture of regional differences in distribution (Figure 8.30). Overall FO and abundance of all four taxa of reef fishes was highest on the FL shelf. Labrid occurrence and abundance on the MS-AL shelf were comparable to observations on the FL shelf, but were low on the TX-LA shelf. The FO and abundance of holocentrids, priacanthids and scarids was extremely low on the TX-LA and MS-AL shelves. Distinct differences were also seen in open waters between the western and eastern GOM. Overall FO and abundance of all four taxa of reef fishes were higher in the eastern than the western GOM (Figure 8.30). The frequency of occurrence and abundance on the FL shelf and in the eastern gulf were often greater by an order of magnitude than the TX-LA, MS-AL shelves and the western Gulf. The frequency of occurrence and abundances of all families were similar in continental shelf and open ocean waters for both the western and eastern GOM.

Seasonality of larval reef fish occurrence could not be fully evaluated because of uneven regional sampling over the seasons. However, during the six month time period from early June to late November labrids decreased in frequency of occurrence and abundance on both the TX-LA and MS-AL shelves, while scarids generally increased.

Labrid and scarid distributions were plotted over contoured surface salinity and water clarity (transmissivity) in order to examine relationships with shelf hydrography (Figure 8.31 and Figure 8.32). A salinity contour of 30 was used to delineate the westward and offshore extent of lower salinity shelf waters for 1992-1994 Summer Groundfish, Fall Plankton and Fall Groundfish surveys. Larvae were consistently associated with higher salinity (>30) water on the shelf during all surveys. The westward and offshore extent of lower salinity (<30) was most variable during Summer Groundfish surveys, and less so during Fall Plankton and Fall Groundfish surveys. A salinity of 30 generally defined the inshore limit of labrid and scarid occurrence. Turbidity of 60% was used to delineate the onshore extent of offshore waters for the 1992 and 1993 Summer and Fall Groundfish surveys. The onshore extension of clear offshore water was variable in both years and both surveys. However, the presence of larval labrids and scarids was consistently associated with the clearer offshore waters.

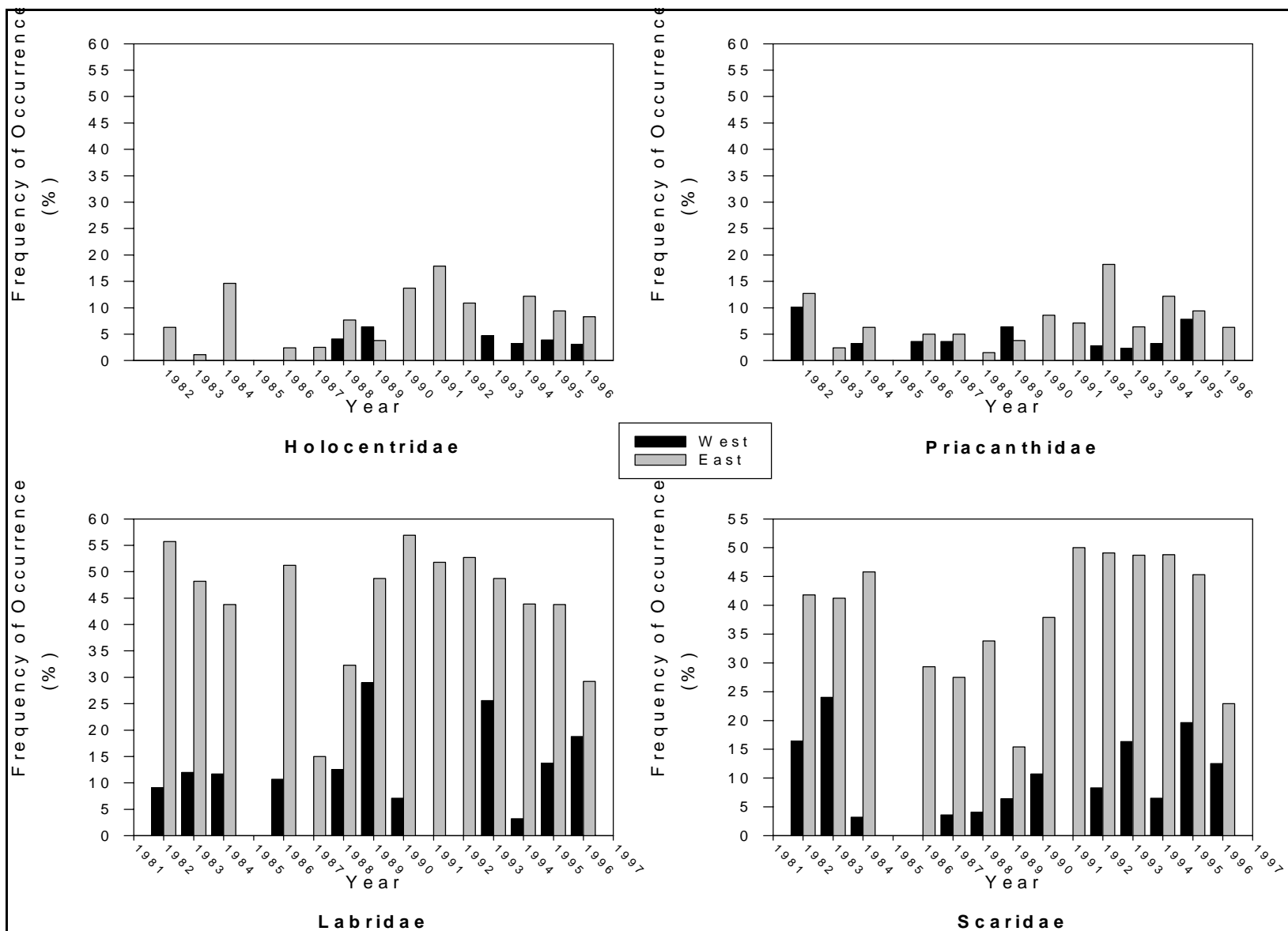

Figure 8.29. Annual frequency of occurrence (%) of holocentrid, priacanthid, labrid and scarid larvae by year and area for the 1982 to 1984 and 1986 to 1996 Spring Plankton Surveys.

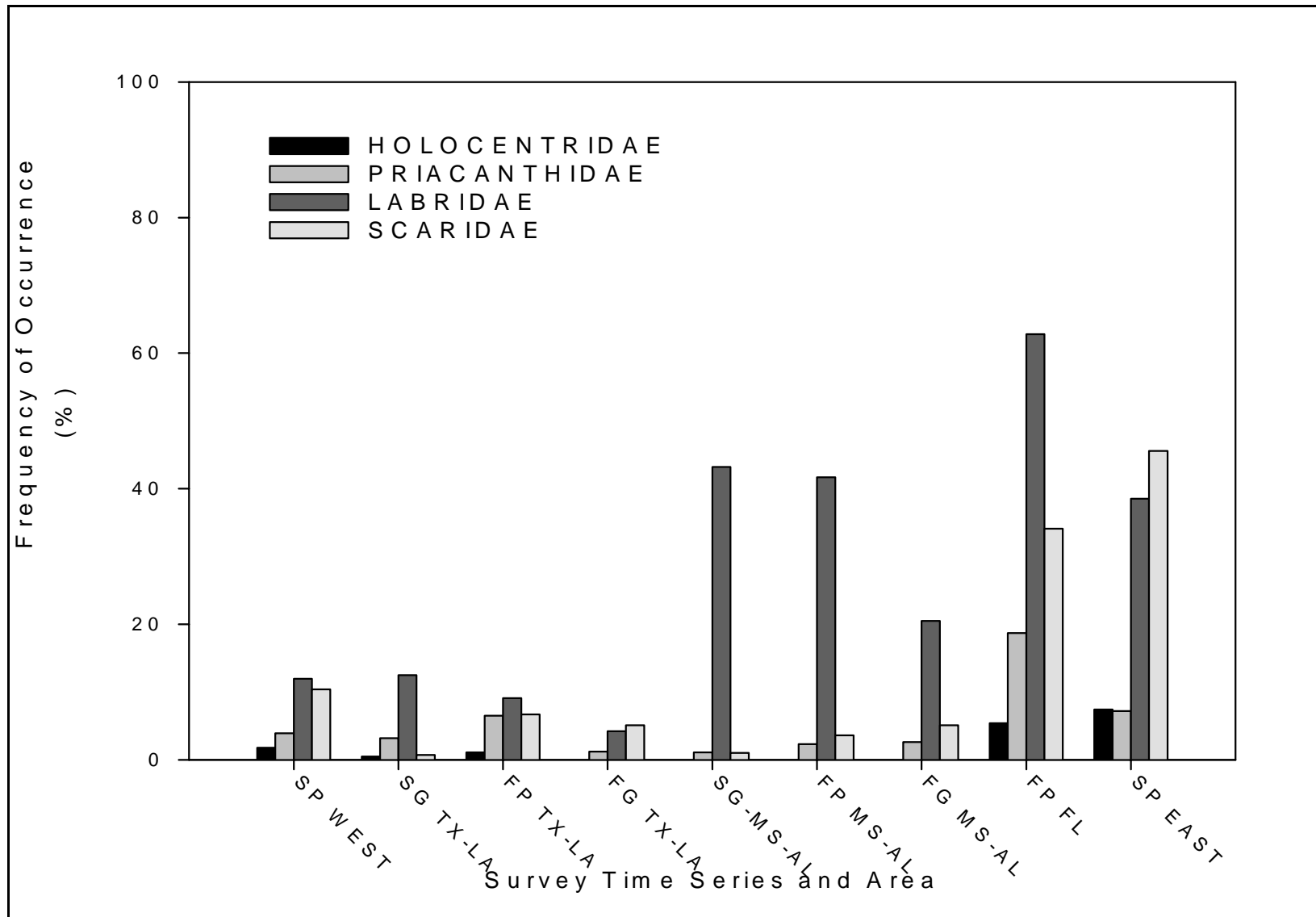

Figure 8.30. Overall frequency of occurrence (%) of holocentrid, priacanthid, labrid and scarid larvae by SEAMAP survey and area. Plankton Survey designations: Summer Groundfish (SG), Fall Plankton (FP), Fall Groundfish (FP) and Spring Plankton (SP).

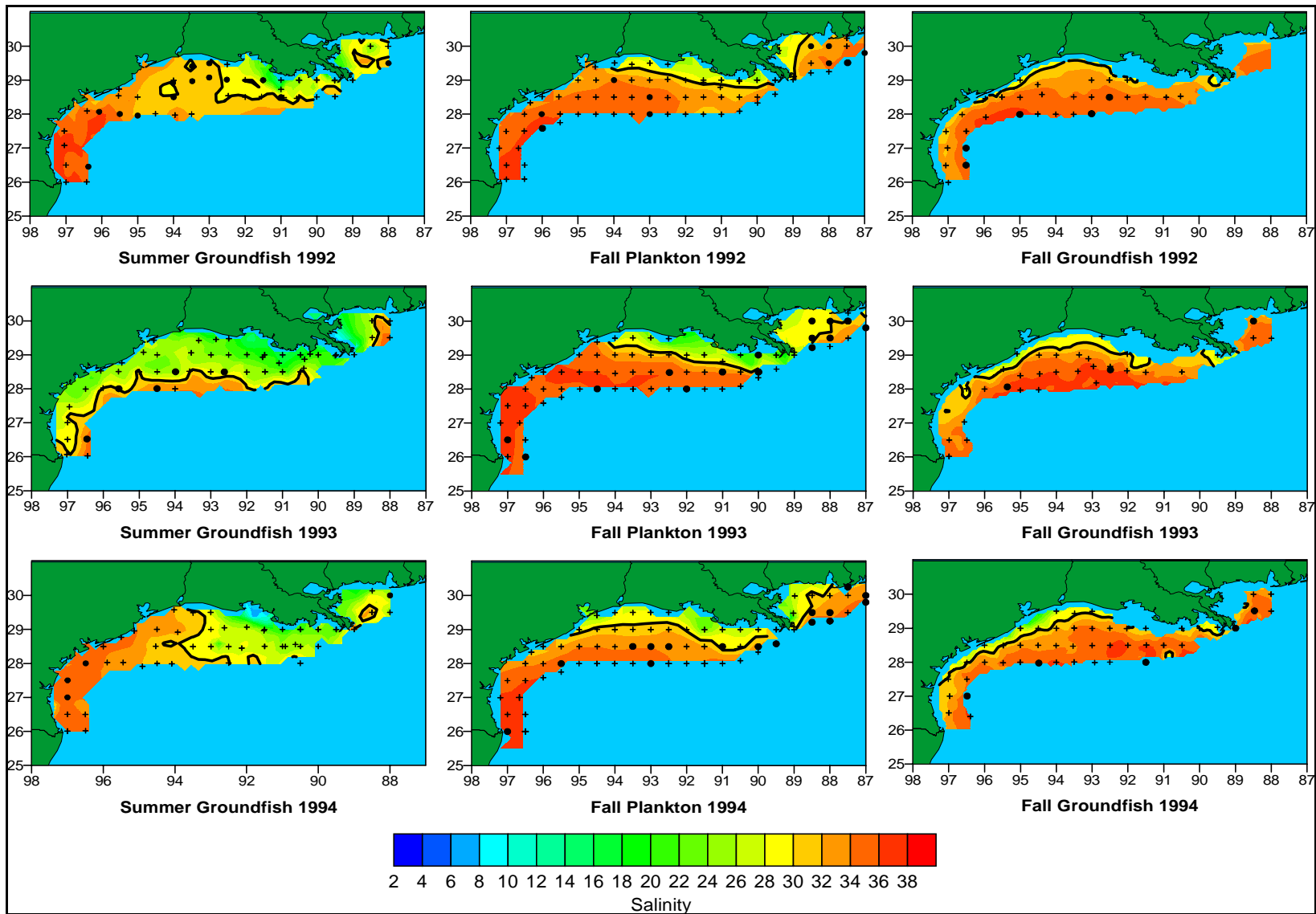

Figure 8.31. Occurrence of labrid and scarid larvae in relation to surface salinity for the 1992 to 1994 Summer Groundfish, Fall Plankton and Fall Groundfish surveys. Solid black line delineates a salinity of 30. Filled circles (•) indicate positive catches of larvae; plus signs (+) indicate zero catch.

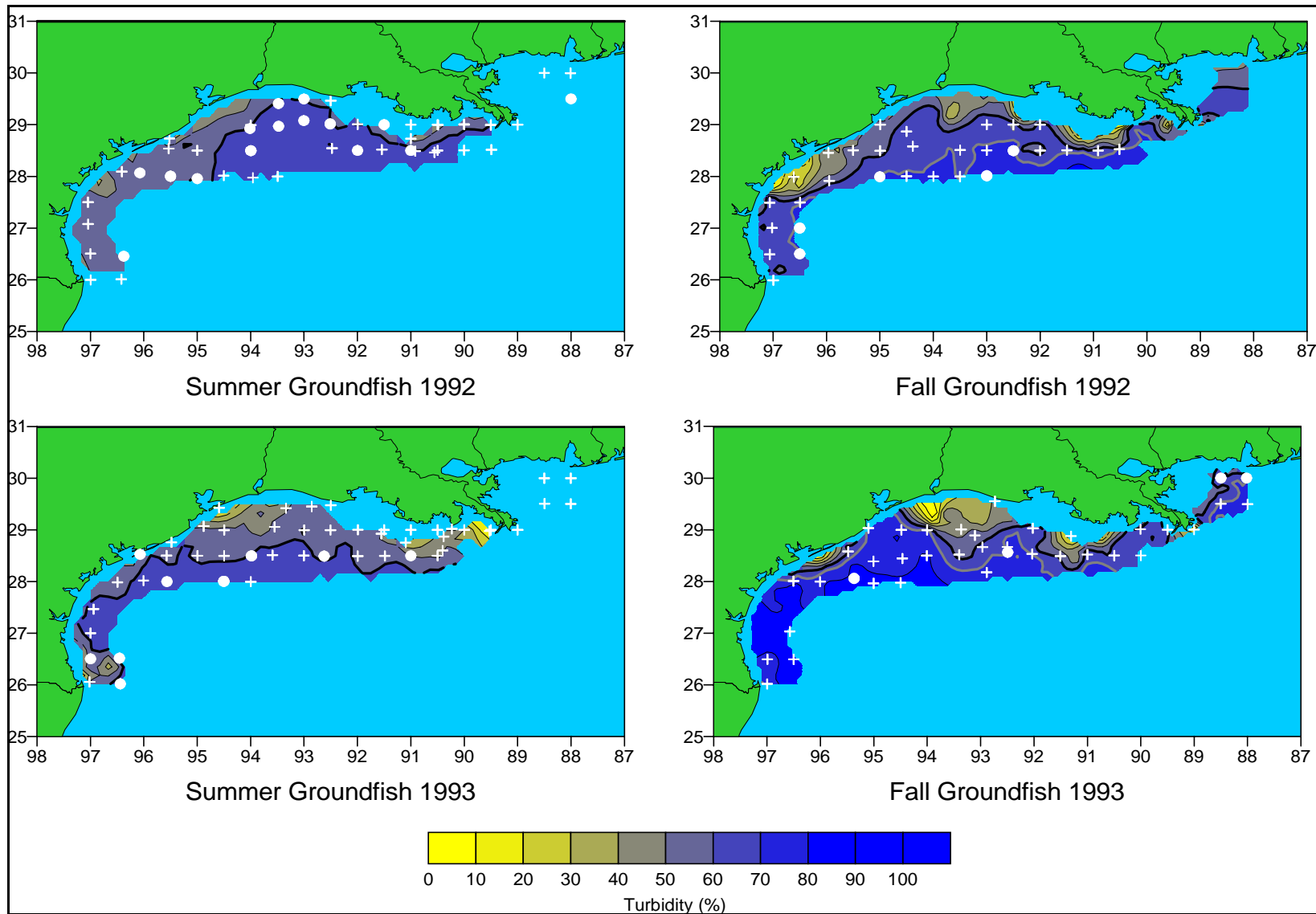

Figure 8.32. Occurrence of labrid and scarid larvae in relation to surface transmissivity for the 1992 to 1993 Summer and Fall Groundfish surveys. Solid black line delineates a transmissivity of 60%. Filled circles (•) indicate positive catches of larvae; plus signs (+) indicate zero catch.

Abundances of labrid and scarid from larvae were plotted over dynamic sea surface height in order to examine relationships with open GOM hydrography. A single 30 day sampling period was examined from Oregon II Cruise 203 (Figure 8.33). The dominant features in the survey area were an anticyclone (Eddy "V")/cyclone (WC) eddy pair centered at 26.5° N, 96° W and a second anticyclone (EA)/cyclone (EC) pair near 26.5° N, 88° W. Labrid and scarid larvae were seldom taken at stations along the 200 m iso-bath, but were taken frequently at deeper water stations. Larvae were found more frequently and in higher abundances along the periphery of the anticyclonic eddy in the western gulf and in the confluence of the EA/EC eddy pair off the mouth of the Mississippi River.

Two 30 day sampling periods were examined from the 1993 Spring Plankton survey (Figure 8.34 and Figure 8.35). The dominant feature in the western GOM was the Eddy "V"/WC pair off the Texas coast. Dominant features in the eastern GOM survey area were the northern extension of the Loop Current (LC), a cyclonic eddy (EC1) centered at 28° N and 88° W and a cyclonic eddy (EC2) along the eastern margin of the LC. In the western GOM labrid and scarid larvae were found more frequently and in higher abundances along the northern edge of the anticyclonic eddy or within the confluence of the Eddy "V"/WC pair. In the eastern GOM, labrid and scarid larvae were more frequently found in higher abundances along the frontal boundaries of the LC and cyclonic eddies or within the confluence of these features.

DISCUSSION

Reef habitat between 18 m and 91 m in the U.S. GOM has been estimated to be 38% of the shelf area between Pensacola and Key West, Florida and 5% of the shelf between Pensacola, Florida and the Rio Grande River (Parker *et al.* 1983). The occurrence and abundance of larval reef fishes in the families Holocentridae, Priacanthidae, Labridae and Scaridae taken during SEAMAP surveys reflected this pattern in GOM reef habitat. These larvae were taken throughout the SEAMAP survey area over continental shelf waters but occurred more frequently and in higher numbers in the eastern than in the western GOM where more reef fish habitat exists.

Distinct regional differences in the occurrence and abundance of these larvae were revealed among the Texas-Louisiana, Mississippi-Alabama and Florida continental shelves. Annual occurrence of larval holocentrids and priacanthids in the western GOM was highly variable compared to the occurrence of labrids and scarids in the same region. Although holocentrid and priacanthid larvae were never as abundant as labrid and scarid larvae, larvae of all four families consistently occurred in higher numbers in the eastern than in the western GOM. Labrid and scarid larvae occurred 4 to 6 more frequently, and were 3 to 10 more abundant in the eastern than in the western GOM.

Riverine influence on salinity and turbidity has been identified as an important biological control with regard to establishing and maintaining adult reef fish communities (Smith 1976; Rezak *et al.* 1990). The inflow of fresh water predominantly from the Atchafalaya, Mississippi and Mobile River drainages significantly alters salinity and turbidity gradients over the continental shelf of the northwestern and north-central GOM. This was illustrated in the summer of 1993 when discharge from the Atchafalaya and Mississippi Rivers reached a 100 flood stage. In contrast, river discharge in 1992 was near historical means (Arcement *et al.* 1992; Dantin *et al.* 1993 and Nowlin *et al.* 1998a). Increased river discharge in 1993 appears to have confined labrid and scarid larvae to the

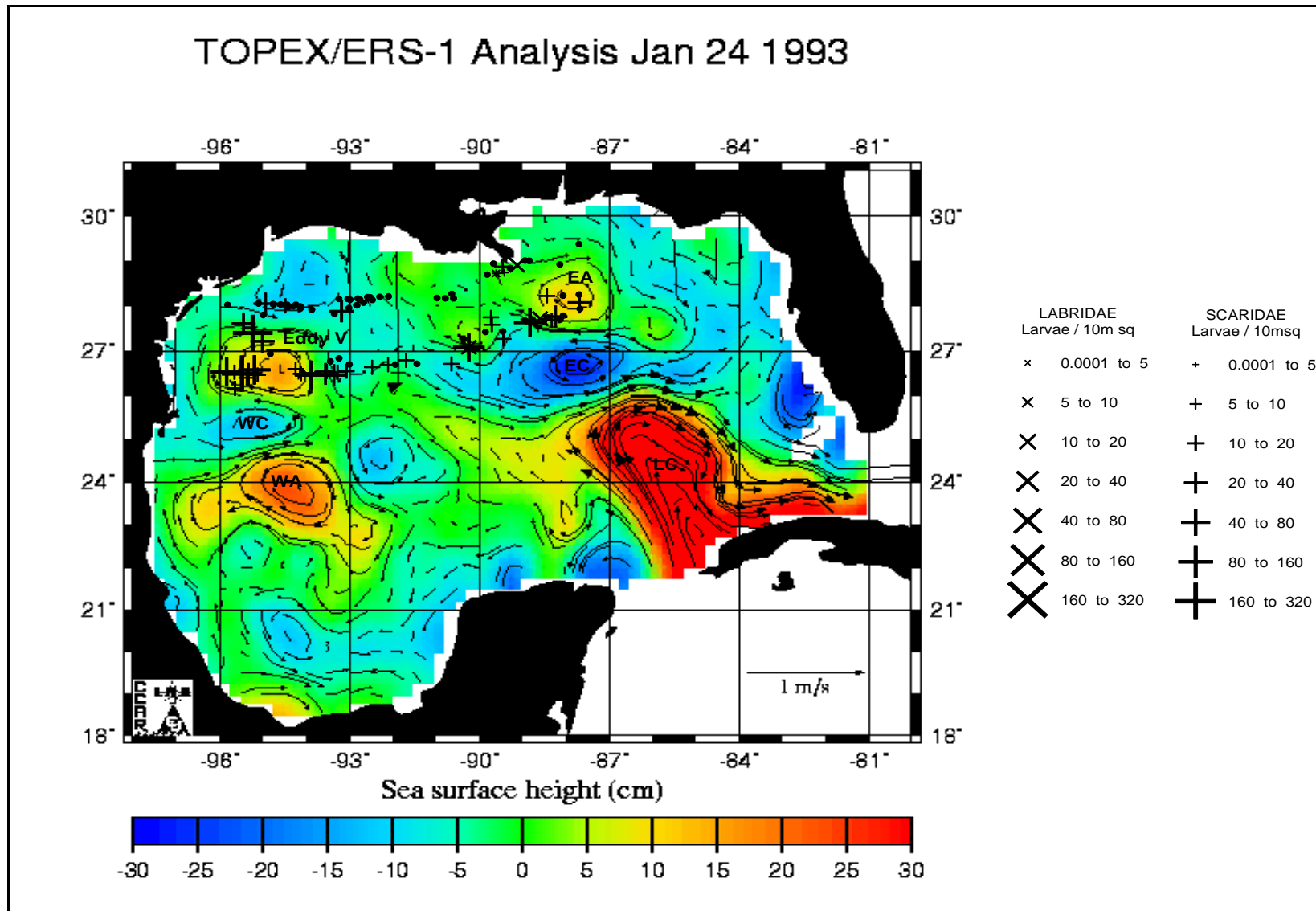

Figure 8.33. Distribution and abundance of labrid and scarid larvae during Oregon II, Cruise 203 in relation to sea surface height. Black vectors are relative geostrophic currents. Dominant features are labeled: Eddy "V", western cyclone (WC), western anticyclone (WA), eastern anticyclone (EA), eastern cyclone (EC) and the Loop Current (LC).

TOPEX/ERS-1 Analysis May 4 1993

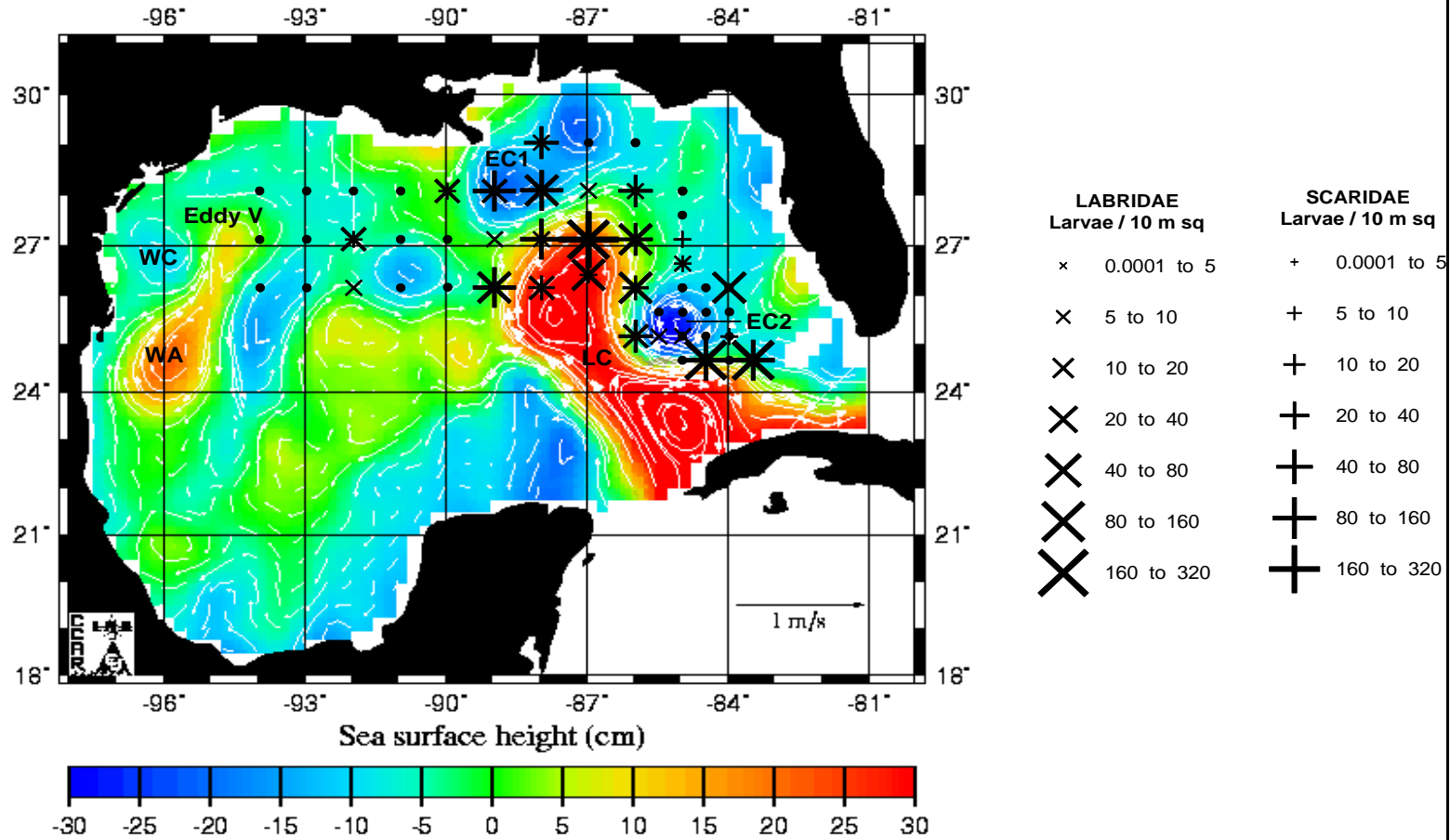

Figure 8.34. Distribution and abundance of labrid and scarid larvae in relation to sea surface height during the Spring Plankton survey from April 19 to May 19, 1993. White vectors represent relative geostrophic currents. Dominant features are labeled: Eddy “V”, western cyclone (WC), western anticyclone (WA), eastern cyclones one and two (EC1 and EC2) and the Loop Current (LC).

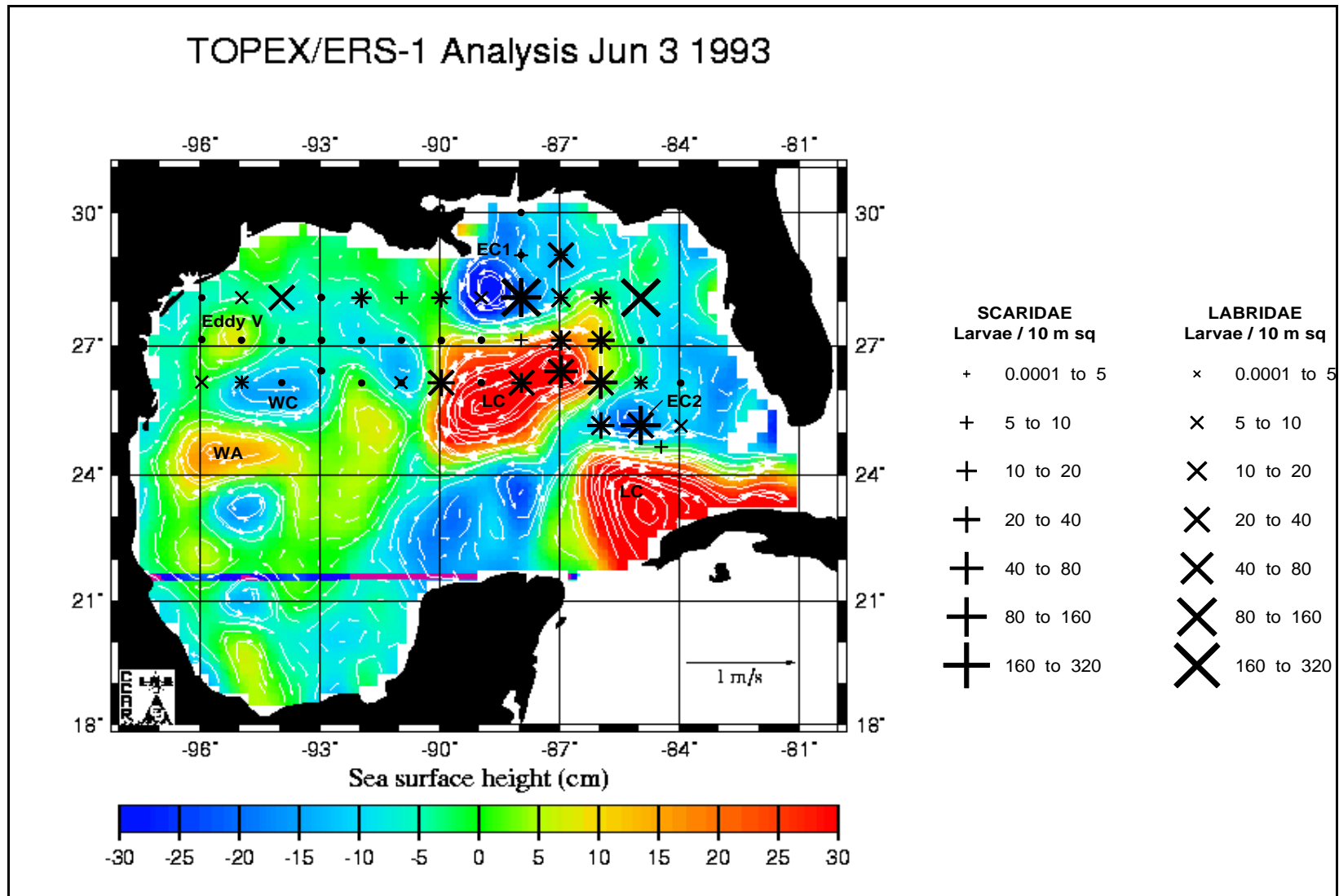

Figure 8.35. Distribution and abundance of labrid and scarid larvae in relation to sea surface height during the Spring Plankton survey from May 20 to June 19, 1993. White vectors represent relative geostrophic currents. Dominant features are labeled: Eddy “V”, western cyclone (WC), western anticyclone (WA), eastern cyclones one and two (EC1 and EC2) and the Loop Current (LC).

outer shelf as compared to their more widespread distribution on the shelf in 1992. Labrid and scarid larvae were consistently associated with higher salinity and clearer water on the mid to outer shelf during all seasons. Salinity and turbidity distributions are useful indicators to delineate outer shelf and oceanic water masses on the shelf, and therefore the pelagic habitat of larval labrid and scarids.

The Loop Current (LC) is the major driving force of circulation in the open GOM. Large anticyclonic (clockwise rotation) eddies detach from the LC, migrate westward across the Gulf where they eventually end up in the western GOM and decay (Vukovic and Crissman 1986, Hamilton 1992). Associated with these large LC eddies are smaller anticyclonic and cyclonic (counter-clockwise rotation) eddies and rings which form by the degradation of larger eddies, interaction with other eddies and/or the continental slope and shelf (Vukovich and Crissman 1986; Vidal *et al.* 1992; Hamilton 1992).

An unexpected result of our examination of the SEAMAP ichthyoplankton data was the consistent and frequent occurrence of labrid and scarid larvae in open GOM waters. These larvae were found in numbers comparable to abundances observed at continental shelf locations. Winter and spring SEAMAP plankton sampling coincided with two episodic intrusions by LC "Eddy V" on the Texas shelf in January and May of 1993 (Nowlin *et al.* 1998a; Nowlin *et al.* 1998b). The highest abundances of labrid and scarid larvae captured during the winter and spring SEAMAP surveys in 1993 were associated with the frontal boundary of Eddy "V." Eddy "V" and its associated cyclonic ring persisted off the south Texas shelf and slope from December through the summer of 1993 and was well studied by the oceanographic community (Berger *et al.* 1996; Sahl *et al.* 1997; Nowlin *et al.* 1998a; Nowlin *et al.* 1998b and Hamilton *et al.* 1999). The May intrusion of Eddy "V" transported Texas/Mexico shelf waters offshore in the convergence of a cyclone (WC)/anti-cyclone (WA) ring pair located near 23° N and 96° W (Figure 8.35). Shelf water was wrapped around the southeastern quadrant of the cyclone and was transported onto the Texas shelf by the convergence of the cyclone and Eddy "V" (Sahl *et al.* 1997). The water mass then rotated around the northern portion of Eddy "V" and was transported offshore across the shelf slope break on the eastern side of the eddy. The January episode was not as well studied, but the eddy system was in a similar configuration (Figure 8.33). Reef fish larvae may have been transported on or off the shelf in a 'conveyor-belt' fashion by these geostrophic flows or larvae may have been entrained in the eddy depending on their location within the eddy system.

Eddies in the western GOM also drive shelf edge currents and affect shelf waters through exchanges of mass, energy, and water properties. (Nowlin *et al.* 1998a). Interaction of counter-rotating eddies is the major mechanism for water exchange between the shelf and slope (Berger *et al.* 1996). Nowlin *et al.* (1998a) also state that eddies episodically impact the inner shelf, and during such episodes the exchange between the shelf and open Gulf is substantial. This exchange could be a mechanism for the transport and/or retention of larvae spawned on reefs located on the mid and outer continental shelf. Entrainment within an eddy could keep larvae on or near the shelf. Hamilton *et al.* (1999) found that the mean rotational period for LC eddies in the northwestern GOM was 10 to 11 days. A broad survey of 25 reef families indicated that pelagic larval duration of most ranged between 20 to 60 days (Richards and Lindeman 1987). Therefore, entrainment and subsequent transport along the eddy periphery could result in the return of at least some larvae to shelf edge reefs as they reach settlement stage.

The transient nature and infrequent occurrence of some reef fishes in the northwestern GOM may be caused by unpredictable and variable recruitment from outside the region (Dennis & Bright 1988). In winter months of 1993, labrid and scarid larvae were rarely taken at stations along the shelf edge but were frequently taken at stations along open GOM transects. The configuration of the EA/EC eddy pair located southeast of the Mississippi River between 89° and 87° W longitude resulted in westward flowing currents (Figure 8.33). Most labrid and scarid larvae were collected at stations within this westward flow and may have eventually recruited to reefs in the western GOM.

Labrid and scarid larvae were also associated with the LC and cyclonic eddies in the eastern GOM in the spring of 1993. Larvae were taken at the majority of stations and were found in higher abundances along the frontal boundaries of the LC and LC/cyclonic eddy confluences. Higher abundances of labrids and scarids were also found within the interior of the LC than at stations outside the eddy system.

Labrid and scarid abundances were higher in conjunction with the LC, anticyclonic and cyclonic eddies, and associated frontal boundaries than elsewhere in the open GOM. This may be related to increased productivity at the fronts. Cyclonic eddies may lead to high productivity due to the increased upward nutrient flux along their periphery (Biggs 1992; Biggs and Muller-Karger 1994). Recently, Wormuth *et al.* (2000) found zooplankton and micronekton biomass to be higher in cyclones than in anticyclones, and highest or intermediate in the confluence of an anticyclonic/cyclonic eddy pair. Lamkin (1997) also found plankton biomass and larval abundance to be larger in the confluence of the LC and cyclones. Additionally, nutrient rich shelf water may be entrained by these features, thereby enhancing local production. Biggs and Muller-Karger (1994) observed the entrainment and seaward transport of high productivity shelf water up to 200 km offshore by eddy pair confluences, and hypothesized enhanced fisheries production in these areas. Similar conditions also exist in the northern GOM with the occasional entrainment of high productivity shelf and Mississippi River plume water by the LC (Muller-Karger *et al.* 1991).

The LC and associated eddies and rings exert a coherent and dynamic influence not only in the open GOM but on the continental shelf and slope as well. The consistent occurrence and relative abundance of labrid and scarid larvae in the open GOM implies that reef fish larvae produced on distant reefs such as the Florida Keys and the Caribbean Sea could supply recruits to reefs in the northwestern GOM. The probable mechanism of this apparent advection and transport is the Loop Current and its westward tending system of eddies and rings. Entrainment of larvae produced on GOM reefs in the Florida Keys, the Flower Gardens in the northwestern Gulf, and off south Texas and Mexico could also be entrained in Gulf eddies that have arrived in the western Gulf. Locally produced larvae entrained in eddy systems in the southeastern Gulf (off Florida) or the northwestern Gulf (off Texas) could lead to either retention and local recruitment or advection to the open Gulf. Survival and return to favorable habitats may still be possible for reef fish larvae advected offshore depending on species-specific duration of the precompetent stage and the position of larvae relative to circulation of the eddy or ring.

We undertook this examination of the SEAMAP ichthyoplankton database in an attempt to identify patterns in larval reef fish production and potential 'sources and sinks' of recruits to GOM reefs. Initial data summaries have shown that the larvae of at least two major groups of reef fishes, the

wrasses and parrotfishes, may regularly or episodically be transported across the Gulf and become available as recruits to northern Gulf reefs. Differences between Caribbean and northern GOM reefs in species composition of labrids and scarids may yield insights into the origin of reef fish larvae found in the open GOM. We will, therefore, reexamine and attempt species-level identification of labrid and scarid larvae in these SEAMAP collections. Otolith analysis and age determination of archived specimens will also be undertaken. Together these new data may yield a less ambiguous depiction of the source and fate of reef fish larvae. Finally, we plan to utilize Geographic Information Systems to examine the SEAMAP time series in relation to hydrographic features in the open GOM; and determine if a significant statistical relation exist between reef larvae, the Loop Current, eddies, rings and fronts.

REFERENCES

- Arcement, G.J., L.J. Dantin, C.R. Garrison, and W.M. Lovelace. 1992. Water resource data Louisiana water year 1992. U.S.G.S. Water-Report LA-92-1.
- Berger, T.J., P. Hamilton, J.J., and R.R. Leben. 1996. Louisiana/Texas Shelf Physical Oceanography Program: Eddy Circulation Study, Final Synthesis Report. OCS Study MMS 96-0051. United States Department of the Interior, Minerals Management Service, Gulf of Mexico OCS Region, New Orleans, Louisiana.
- Biggs, D.C. 1992. Nutrients, Plankton and Productivity in a warm-core ring in the western Gulf of Mexico. *Journal of Geophysical Research* 97(C2):2143-2154.
- Biggs, D.C., and F.E. Muller-Karger. 1994. Ship and satellite observations of chlorophyll stocks in interacting cyclone-anticyclone eddy pairs in the western Gulf of Mexico. *Journal of Geophysical Research* 99(C4):7371-7384.
- Cowen, R.K. and S. Sponaugle. 1997. Relationships between early life history traits and recruitment among coral reef fishes. Pages 423-449 *In* C. Chambers and E. A. Trippel, eds. *Early life history and recruitment in fish populations*. Chapman and Hall, London.
- Dantin, L.J., C.R. Garrison, and W.M. Lovelace. 1993. Water resource data Louisiana water year 1993. U.S.G.S Water-Report LA-93-1.
- Dennis, G.D. and T.J. Bright. 1988. Reef fish assemblages on hard banks in the Northwestern Gulf of Mexico. *Bulletin of Marine Science* 43:280-307.
- Gallaway, B.J. 1984. Assessment of platform effects on snapper populations and fisheries. *In* Proceedings of the 5th Annual Gulf of Mexico Information Transfer meeting. Minerals Management Service. United States Department of the Interior, New Orleans, LA. p. 130-137.
- Hamilton, P. 1992. Lower continental slope cyclonic eddies in the central Gulf of Mexico. *Journal of Geophysical Research* 97(C2):2185-2200.

- Hamilton, P., G.S. Fargion, and D.C. Biggs. 1999. Loop Current eddy paths in the western Gulf of Mexico. *Journal of Physical Oceanography* 29:1180-1207.
- Kasprizak, R.A. 1998. Use of oil and gas platforms as habitat in Louisiana's artificial reef program. *Gulf of Mexico Science* 16(1):37-45.
- Lamkin, J. 1997. The Loop Current and the abundance of larval *Cubiceps pauciradiatus* (Pisces: Nomeidae) in the Gulf of Mexico: evidence for physical and biological interaction. *Fishery Bulletin* 95:250-266.
- Leis, J.M. 1991. The pelagic stages of reef fishes: The larval biology of coral reef fishes. Pages 183-227 *In* P.F. Sale, ed. *The ecology of fishes on coral reefs*. Academic Press Inc., San Diego, California.
- Leis, J.M. and D.S. Rennis. 1983. *The larvae of Indo-Pacific coral reef fishes*. New South Wales University Press, Sydney, Australia.
- Muller-Karger, F.E., J.J. Walsh, R.H. Evans, and M.B. Meyers. 1991. On the seasonal phytoplankton concentration and sea surface temperature cycles of the Gulf of Mexico as determined by satellites. *Journal of Geophysical Research* 96(C7):12,645-12,665.
- Nowlin Jr., W.D., A.E. Jochens, R.O. Reid and S.F. DiMarco. 1998a. Texas-Louisiana shelf circulation and transport processes study: Synthesis Report, Volume I: Technical Report. OCS Study MMS 98-0035. United States Department of the Interior, Minerals Management Service, Gulf of Mexico OCS Region, New Orleans, Louisiana.
- Nowlin Jr., W.D., A.E. Jochens, R.O. Reid and S.F. DiMarco. 1998b. Texas-Louisiana shelf circulation and transport processes study: Synthesis Report, Volume II: Appendices. OCS Study MMS 98-0036. United States Department of the Interior, Minerals Management Service, Gulf of Mexico OCS Region, New Orleans, Louisiana.
- Parker, R.O., Jr., D.R. Colby, and T.D. Willis. 1983. Estimated amount of reef habitat on a portion of the U.S. South Atlantic and Gulf of Mexico continental shelf. *Bulletin of Marine Science* 33:935-940.
- Rezak, R., S.R. Gittings, and T.J. Bright. 1990. Biotic assemblages and ecological controls on reefs and banks of the Northwest Gulf of Mexico. *American Zoologist* 30:23-35
- Richards, W.J. 1985. Status of the identification of the early life stages of fishes. *Bulletin of Marine Science* 37:756-760.
- Richards, W.J. and K.C. Lindeman. 1987. Recruitment dynamics of reef fishes: Planktonic processes, settlement and demersal ecologies, and fishery analysis. *Bulletin of Marine Science* 41(2):392-410.

- Richards, W.J., M.F. McGowan, T. Leming, J.T. Lamkin, and S. Kelly. 1993. Larval fish assemblages at the Loop Current boundary in the Gulf of Mexico. *Bulletin of Marine Science* 53: 475-537.
- Sahl, L.E., D.A. Wiesenburg, and W.J. Merrell. 1997. Interactions of mesoscale features with Texas shelf and slope waters. *Continental Shelf Research* 17(2):117-136.
- Sale, P.F. 1991. Introduction. Pages 3-11 *In* P.F. Sale, ed. *The ecology of fishes on coral reefs*. Academic Press Inc. San Diego, CA. Academic Press Inc., San Diego.
- Sale, P.F. and D.J. Ferrell. 1988. Early survivorship of juvenile coral reef fishes. *Coral Reefs* 7:117-124. SEAMAP (Southeast Area Monitoring and Assessment Program). 2000. Environmental and biological atlas of the Gulf of Mexico 1998, Number 75. Gulf States Marine Fisheries Commission, Ocean Springs, Mississippi.
- Smith, G.B. 1976. Ecology and distribution of Eastern Gulf of Mexico reef fishes. Florida Department of Natural Resources Marine Research Laboratory, Florida Marine Research Publications Number 19, St. Petersburg, FL.
- Vidal, V.M. V., F.V. Vidal and J.M. Perez-Molero. 1992. Collision of a Loop Current anticyclonic ring against the continental shelf slope of the western Gulf of Mexico. *Journal of Geophysical Research* 97(C2):2155-2172.
- Vukovich, F.M. and B.W. Crissman. 1986. Aspects of warm rings in the Gulf of Mexico. *Journal of Geophysical Research* 91(C2):2645-2660.
- Wormuth, J.H., P.H. Reesler, R.B. Cady, and E.J. Harris. 2000. Zooplankton and micronekton in cyclones and anticyclones in the northeast Gulf of Mexico. *Gulf of Mexico Science* 2000(1):23-34.

COMPARISON OF THE FISHERIES VALUE OF PLATFORMS USED AS ARTIFICIAL REEFS: STANDING, TOPPLED, AND PARTIALLY REMOVED

Aaron Pierce
Charles A. Wilson
Department of Oceanography and Coastal Sciences and
Coastal Fisheries Institute
Louisiana State University

ABSTRACT

Artificial reefs have been embraced as a management tool by a wide range of user groups (recreational and commercial fishers, recreational divers, and environmental advocacy organizations), and federal and state resource managers. While these groups view artificial reefs positively, little information exists on associated nekton assemblages, particularly at deepwater artificial reefs.

The purpose of this project is to measure and compare the species composition, abundance and size frequency distribution of fishes associated with a toppled platform, a partially removed platform and a standing production platform in the Northern Gulf. Comparison of acoustically derived fish densities at the artificial reef sites and the open waters of the GOM will answer this question using a Biosonics model DT5000 scientific echosounder/multiplexer-equalizer and a remotely operated underwater vehicle for visual census techniques.

Fish density around the standing platform (HI350) varied with both depth and side. We found lowest densities near the bottom and adjacent to the platform where mean fish density was 0.0001 fish per cubic meter (FPCM) and highest densities near the surface at .05 fish per cubic meters. Fish densities around partial removed platform (HI 355) were roughly 2-3 orders of magnitude higher over the top of the platform. Mean fish density over HI355 was 0.26 fish/m³. Densities around the toppled platform (WC617), produced similar results to HI355, except that the density at WC 617 was roughly ½ that of HI355.

We conclude that fish abundance around oil and gas platforms is much higher than adjacent soft bottom sediment. The platforms provide critical habitat for many important commercial and recreational species for Louisiana citizens. Our general impression remains that standing platforms are the most desirable configuration. We continue to support partial removal in water depths greater than 200 feet and toppling in place in shallower depths.

A HYDROACOUSTIC ASSESSMENT OF FISH DENSITY AT THE FLOWER GARDEN BANKS WITH EMPHASIS ON THE WEST FLOWER GARDEN BANK

Charles A. Wilson

Mark Miller

Department of Oceanography and Coastal Sciences and
The Coastal Fisheries Institute
Louisiana State University

The use of oil and gas platforms (platforms) as artificial reefs has been well established. As mentioned in Wilson *et al.* (this publication), the basis for this practice is the common user group knowledge that platforms support superior recreational fishing. This public perception has been supported through scientific investigations. However, there is little data to suggest that the reef configurations employed to date are as productive as natural reefs. Stanley and Wilson (1997) suggested that both toppled and partially removed platforms may not be as productive as standing platforms or as natural reef systems. The fisheries value of the various artificial reef configurations needs further investigation with emphasis on their comparison to natural reefs.

The largest natural reef in the northern GOM is the Flower Garden Banks. This complex is composed of coral reefs that have grown up on top of natural geological formations known as salt domes. Although fishermen have known about the Flower Garden Banks since the late 1800s, it was not until 1936 that the banks were officially discovered by the U.S. Coast and Geodetic Survey during surveys in the GOM to map pinnacles. In 1961 Dr. Thomas E. Pulley documented that the Flower Gardens were viable coral communities (Elders and Hill 1985). After nearly two decades of effort the Flower Garden Banks were designated a marine sanctuary in 1992 (Gittings and Hickerson 1998). Although several fisheries surveys have been conducted around these geological features, few scientific investigations have considered a holistic account of the fish population and fish density beyond the cryptic reef fishes.

To date the most extensive survey of fish assemblages on the Flower Garden Banks was conducted by LGL Ecological Research Associates during a period from 1980 to 1982. The report (Boland *et al.* 1983), funded by the National Marine Fisheries Service, was based on 357 hours of video data recorded at 1 minute intervals which were used to estimate standing stock of 16 reef fish taxa. The investigators reported characteristic fish assemblages zoned primarily by depth and/or habitat types delineated as upper coral reef, algal-nodule sponge zone, shallow drowned reef, deep drowned reef, and soft bottom. Investigators also estimated species abundance; for example, they estimated that the population size for creole-fish *Paranthias furcifer* ranged from 400,000 to 993,948, red snapper *Lutjanus campechanus* from 4,000 to 20,000, and groupers *Mycteroperca spp.* from 20,000 to 47,000 at the Flower Garden Banks.

Biotic zonation of the West Flower Garden Bank (WFGB) was first described by Bright *et al.* (1974) who were followed by previous other investigators. They reported on the major biotic elements of the bank and provided a quantitative baseline assessment of the reef community. They utilized divers, towed video systems, and manned submersibles to collect seventy days of data during 17

cruises between July 1970 and December 1972. Their report included a thorough catalog of fauna. Bright and C.W. Cashman (1974) reported that 101 fish species were found at the WFGB.

Dennis and Bright later reported three distinct reef fish assemblages at the WFGB (1988) in association with three major biotic zones (coral reef, algal-sponge, and drowned reef). Species composition was similar to outer slope Caribbean reefs, but the WFGB exhibited much lower diversity (253 primary species reported at Caribbean reefs versus 84 found at the WFGB). Cluster analysis of fish assemblages yielded three depth zonations with a distinct species composition in each of the three zones. Dennis and Bright (1988) reported twenty-eight fish species in the upper zone (<45m), 45 species in the middle zone (45-85m), and 20 species in the lower zone (>85m). Rooker *et al.* (1997) compared fish species richness between the WFGB and a nearby oil platform (High Island A389A), a marked difference. They reported 54 species and 39 species, respectively, at the WFGB and HI A389A. Rooker *et al.* (1997) reported that midwater pelagics such as carangids and scombrids accounted for over 50% of all taxa enumerated at the platform; 50% of the observed total fish population at the WFGB was composed of species in the family Pomacentridae.

The proximity of the several artificial reef projects to the natural coral formations of the Flower Gardens afforded us the opportunity to compare these fish communities to that of a neighboring natural system. The goals of this study were to identify species composition; and to estimate the fish density/biomass at the WFGB. We intended to describe the fish community associated with the WFGB and to compare it to previous studies of fish communities conducted at nearby platforms and reefs. Reef configurations targeted for comparison included a production platform toppled in place as a deep water artificial reef (West Cameron (WC) 617A), a nearby partially removed platform (HI A355), and an operating production platform (HI A350); these are described elsewhere in this publication (Wilson *et al.*, this publication).

MATERIALS AND METHODS

The WFGB is located approximately 173 km southeast of Galveston, Texas, on the edge of the outer continental shelf at 27° 52.4' north latitude and 93° 48.8' west longitude (Figure 8.36). The WFGB was created by the uplift of a salt dome of Jurassic, Louann origin. (Rezak 1981, as in Dokken *et al.* 1999). It represents the largest charted calcareous bank in the northwestern GOM and (Bright *et al.* 1985 as in Dokken *et al.* 1999) and the northernmost coral reef on the continental shelf of North America (Bright *et al.* 1984 as in Dokken *et al.* 1999). The living coral cap varies in depth from approximately 18 to 36 meters. (Rezak *et al.* 1985 as in Dokken *et al.* 1999). The major features of the 137 km² WFGB are three crests aligned along an east-west axis. The middle crest rises from a depth of 100 –150 meters to within 18 meters of the surface and supports a coral reef community. (Rezak *et al.* 1985 as in Dokken *et al.* 1999).

A towed 120 kHz transducer was used to estimate the density and size frequency distribution of fishes associated with the two artificial reef sites. The downward oriented transducer was towed from the starboard hip of the research vessel R/V Pelican (June 1999) or the M/V Epic Mariner (June 2000). The towfish was held in place 5 m out from the hull with a telescoping mast and flown 3 m below the surface at approximately 2 m/sec. The use of a towed downward oriented transducer enabled the calculation of density and size distribution of fishes from a depth of 5 m to 1 m from

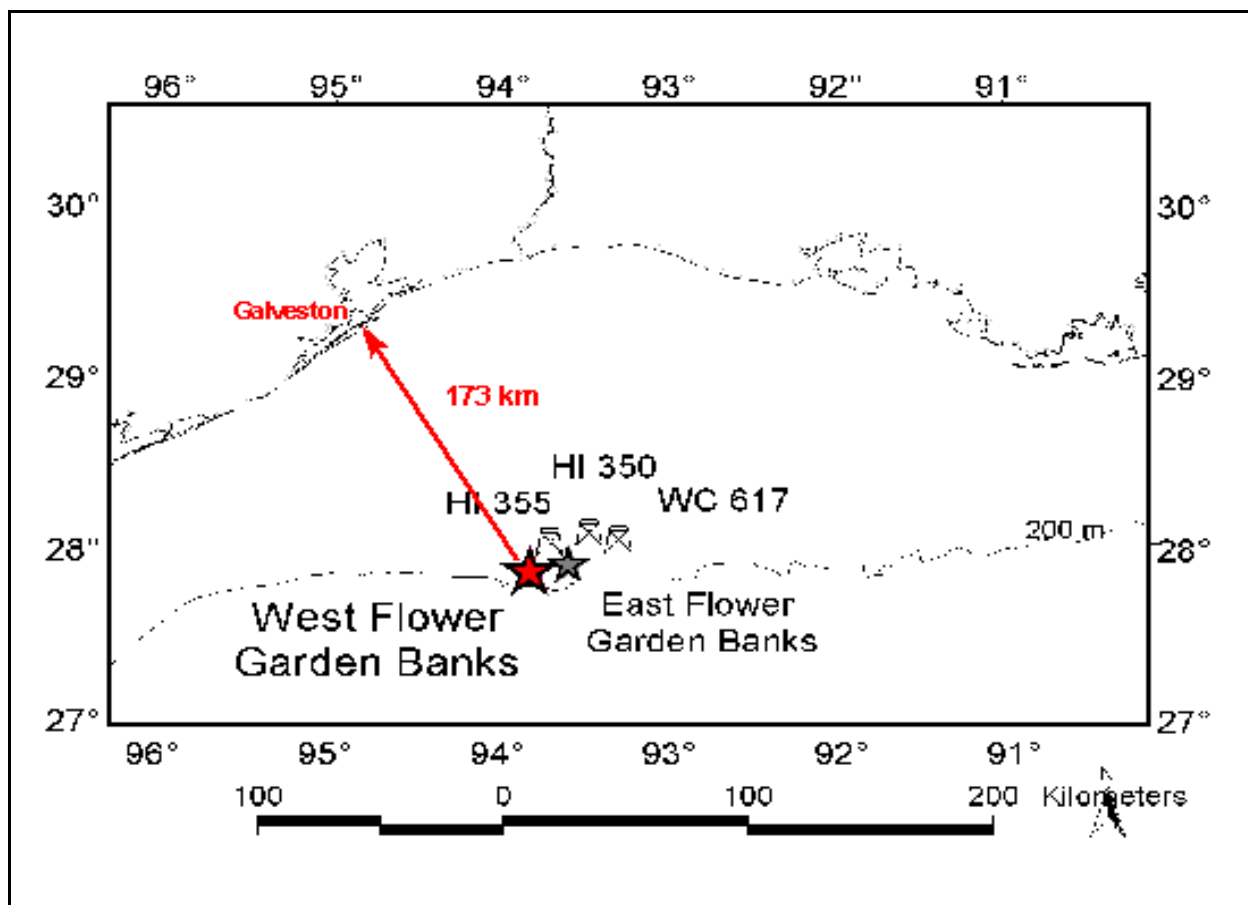

Figure 8.36. Map of the sites surveyed in June 1999 and 2000.

the bottom. Navigational data were collected with a Garmin GPS III global positioning system (GPS) with a Garmin GB 21 differential beacon receiver. The navigation data stream, which updated once per second, was incorporated into the acoustic data string and then saved on laptop computer. In order to optimize the navigation accuracy, the antenna for the GPS was mounted directly above the tow body, thus allowing the data to be processed in a two meter horizontal resolution that was posted to a GIS database.

The mobile survey of WFGB consisted of twenty-seven transects spaced 500 meters apart running along the long axis of the WFGB, from northeast to southwest. Transect lines were planned to begin and end near the outer boundaries of the Marine Sanctuary along the 120 m depth curve. This design allowed an open water control area to be surveyed at the beginning and ending of every transect line. The lines varied in length from 2.5 kilometers to 13.5 kilometers. Data were collected along these transects continuously over a 29 hour period 21-23 June 2000. For analysis purposes, the WFGB was separated into three biological community “terraces” based on water depth and specified as upper (20-50 meters), middle (80- 100 meters), and lower (> 100 meters) (Bright and Boland 1985). A high resolution multi-beam side scan survey assisted the determination of the terraces (Gardner *et al.* 1998). These geological terraces have been related to distinct biological zonations (Dennis and Bright 1998).

Acoustic data were collected with a Biosonics model DT5000 scientific echosounder/multiplexer. All data were collected with a 120 kHz transducer which had been factory calibrated to a - 42 dB tungsten sphere. Source levels were 223 dB / Pa at 1 m. Sampling rate was 5 pings /sec with a pulse width of 0.4 ms. Received signals were adjusted for spreading loss by applying a 40 log R time varied gain, digitized and recorded on the computer hard drive and later transferred to CD digital media. The data collection threshold was -55 dB, corresponding to a minimum detection of a 2.5 cm fish (Love 1971).

Digitized hydroacoustic data were processed with a Biosonics' Visual Analyzer 4.02. Recent advances in the software allowed simultaneous estimates of sigma (target strength) and mean volume backscatter (reflected acoustic energy) for each depth strata. These parameters are used to estimate fish density/m³ and fish size. Ten meter depth strata were assigned for processing all data. Data files were replayed through Visual Analyzer with the bottom tracking feature turned on; the bottom was then manually inspected and adjusted to insure that the bottom was not included in the analyzer window.

Mobile transects were analyzed at one second resolution (@ 2 meters linear distance) to determine the volume backscatter and target strength/m³ within each depth stratum along each transect. Analysis of each one second block of data provided geographic position and mean volume backscatter. Individual target strength information was acquired by extracting ping specific data, which could be selectively output as a text file. A Visual Basic program was used to calculate an average target strength for each target, by strata, and location.

Processing of acoustic data yields several parameters of interest. Fish density is calculated based on the volume backscatter (reflected acoustic energy) of a known volume (cubic meter) of water divided by the average target strength (TS reported as sigma) from that same volume of water. Density is reported as density/m³ in this study. Density estimates are dependent upon accurate estimates of the mean sigma of the targets within that same volume of water. The accuracy of target strength increases with repeated acoustic hits on the same target (Jim Dawson, Biosonics Inc, pers com). Given that research operations were from a vessel moving at 4 knots and transmitting acoustic pulses (pings) at a rate of 5 pings per second, the chance of hitting a target multiple times was very low. In many cases data processing resulted in a volume backscatter, but no sigma for that same volume of water. A mean sigma (proxy sigma) was calculated for a 30 m linear distance by stratum, and used as a proxy for target strength to calculate density. The assumption, in this case, was that fish size was similar in the same stratum for 30 linear meters. If sigma was missing, but a volume backscatter volume was available, the proxy sigma was substituted to estimate density.

Statistical analysis of these data included as volume backscatter (SV), a proxy for fish biomass, as a dependent variable in our analysis. Volume backscatter is an exponential number provided by the Biosonics Visual Analyzer and is a per ping average of energy/m³. For regression analysis and calculation of means, SV is converted into a "arithmetic form", called "Fish Energy", with the relationship,

$$\text{Fish Energy} = 10^{\text{sv}/10},$$

where SV is volume backscatter (reflected acoustic energy) of a known volume of water (cubic meter)

The use of volume backscattering avoided the uncertainty of target strength error in density calculations. “Fish Energy” should be considered to be an acoustic measurement of fish biomass as it is based on the average acoustic reflectance/m³. The second dependent variable in our analysis was density/m³, which was calculated with the equation,

$$10^{SV/10} / 10^{TS/10} = \text{fish/m}^3$$

where SV is the volume backscatter/m³ and TS is the mean target size assigned (or the proxy sigma discussed above).

A randomized block analysis of variance was used to examine the main effects of TS as described by Stanley and Wilson (1997). Due to the larger number of zero values in the mobile survey, logistic regression was used to analyze the mobile data (Trexler and Travis 2001).

Logistic Regression

Traditional parametric analysis was not used for analysis of mobile acoustic data given the large number of zero values for SV and the problem of autocorrelation that occurs in mobile acoustic data. A binomial logistic model was constructed using the presence or absence of “fish energy” to evaluate the probability, or chance, of finding fish. This analysis was performed on the primary output of acoustic data analysis which was reported in 1 second intervals. Class variables for the WFGB were depth or terrace, stratum, and time of day (TOD).

The use of logistic regression in ecological sampling was described by Trexler and Travis (2001). It has been shown to be useful with data that have a large proportion of zero values when error is usually not normally distributed. In most cases analysis consists of converting the dependent variable into a discrete form (e.g. presence/absent, agree/disagree, etc). The regression model then assumes a binomial distribution of errors (Trexler and Travis 2001, Garrison *et al.* 2000).

The Statistical Analysis System (SAS 2000) includes a program called Proc Logistic that runs a logistic analysis. When run with the intercept option, it produces a Type III analysis of main effects, which provides an estimate of the significance of class variables, based on a maximum likelihood test (Chi Square test of significance $p = 0.01$) that is used for comparing within class variables. When run without an intercept, Proc Logistic provides an odds ratio estimate, which is the probability of the dependent variable being above zero in a given class variable cell compared to another cell. The output also includes percent concordance, which is the percent of the time that the model correctly predicts the outcome.

Visual Surveys

Visual surveys were conducted with a Deep Ocean Engineering Phantom HD2 ROV with standard visual census techniques and recording video on S-VHS tape. (Bohnsack and Bannerot 1986).

Cryptic fishes (fish length < 10 cm) were not included in the video surveys results since they could not be assessed in the acoustic surveys. Point counts were conducted to identify individual fish to the lowest taxonomic level. Results and data were expressed as percent composition by stratum at each site.

During mobile surveys the ROV was deployed from the M/V Epic Mariner. Video data from the WFGB were collected along random transects designed to represent the three major terrace regions and geologic features located throughout the WFGB. The ROV was flown to the bottom where it traveled at a speed of 1 knot for 45 minutes along a transect through each of the three major terraces.

RESULTS

The acoustic survey of the West Flower Garden Bank provided valuable insight into the fish community associated with this unique natural bottom habitat. Twenty-seven survey lines covering a linear distance ranging from 2.5 to 13.5 km were sufficient to cover the WFGB at 500 m intervals. The survey took 29 hours to cover approximately 160 km of survey lines (Figure 8.37). Survey lines were generally parallel, but variable sea state, wind and currents caused some slight variations from the intended track lines. In addition to challenging environmental conditions we also experienced an equipment malfunction with the transducer cable that caused a corruption of the data collected along one of the transects over the eastern edge of the upper terrace.

Analysis of the acoustic data produced some very interesting results reflecting topography, fish community composition, and general geology. Figure 8.38A is an echogram showing a transition from the middle to the upper terrace. Figure 8.38B is an enlargement of the area indicated in Figure 38A which shows a dense fish community just above the bottom. The acoustic system, not only provided quantification of the fish community, but also both provided insight about geological properties of the bottom (Figure 8.39A) and location natural gas seeps as in Figure 8.39B. Visual analysis of the echograms would the flat sandy sections of bottom as smooth with high energy returns and the coral features were equally easy to identify by shape and slightly lower energy returns. For the purpose of analysis we divided WFGB into three terraces; upper = 20 – 50 m, middle = 51 – 80 m, lower = 81 – 100 m. Depths greater than 100 m were considered to be open water in our analysis.

A binomial logistic regression with the presence/absence of SV as the dependent variable was used to model the relationship between fish presence and class variables: Terrace, time of day, and stratum (Table 8.6). All class variables were significant. Using logistic procedures without an intercept provided insight into the relative differences within the class variables. The chance of encountering a fish was highest over the upper terrace and lowest over open water. Stratum and TOD were not significantly different in the variables, but were significant in the model. Illustrations of the change in acoustic energy with depth can be seen in the horizontal volume backscatter (sum of mean SV) throughout the water column. Figure 8.40 shows the horizontal backscatter (HSV) to be highest over the upper terrace and middle terrace areas. When corrected for depth, (HSV/water depth) as in Figure 8.41, is clear that the highest fish biomass occurs in the shallowest areas. Based on logistic regression (without intercept), there was a 35 to 100 times greater chance of finding fish over the upper terrace than over the middle or lower terraces.

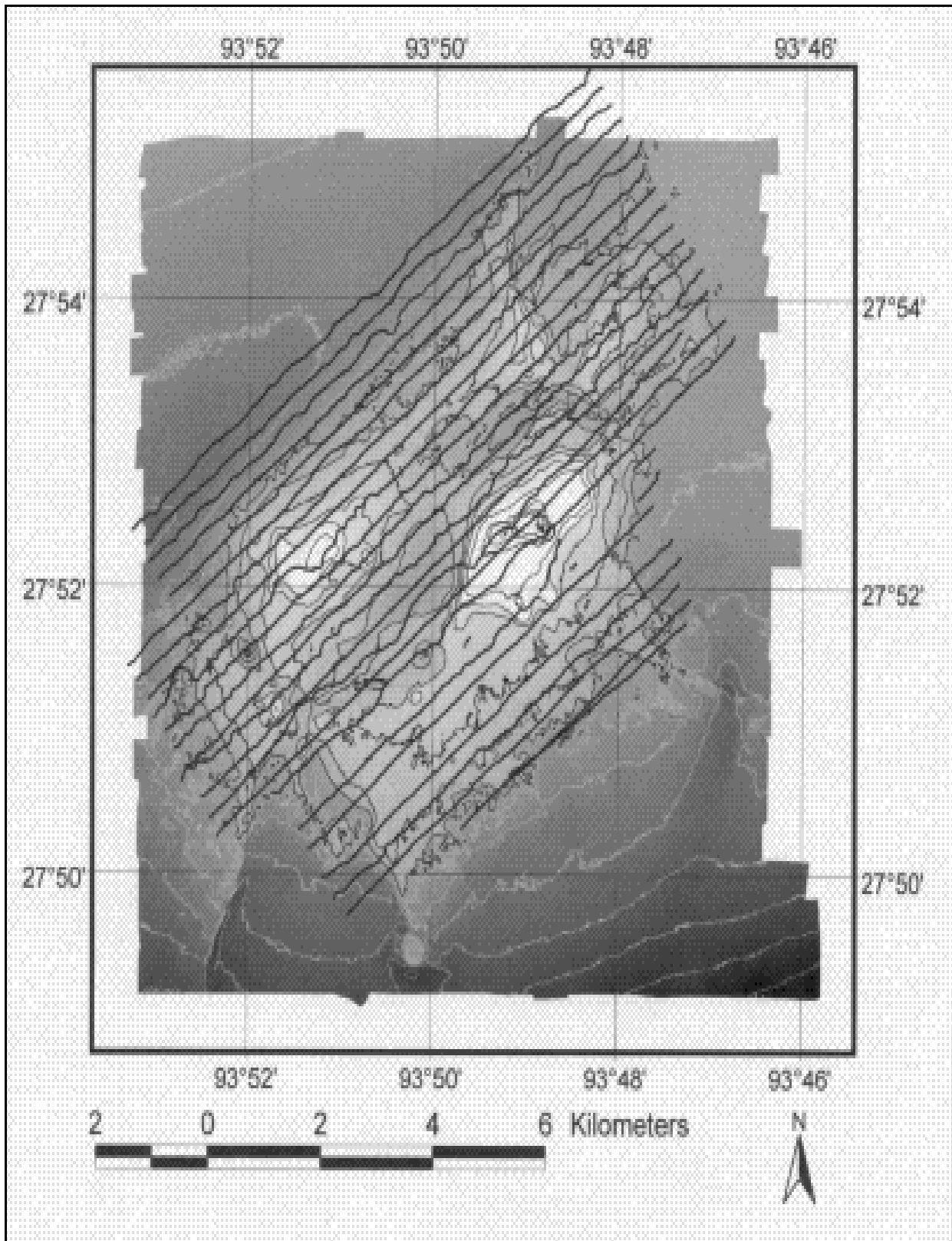

Figure 8.37. Recorded track lines of the WFGB hydroacoustic survey conducted in June 2000.

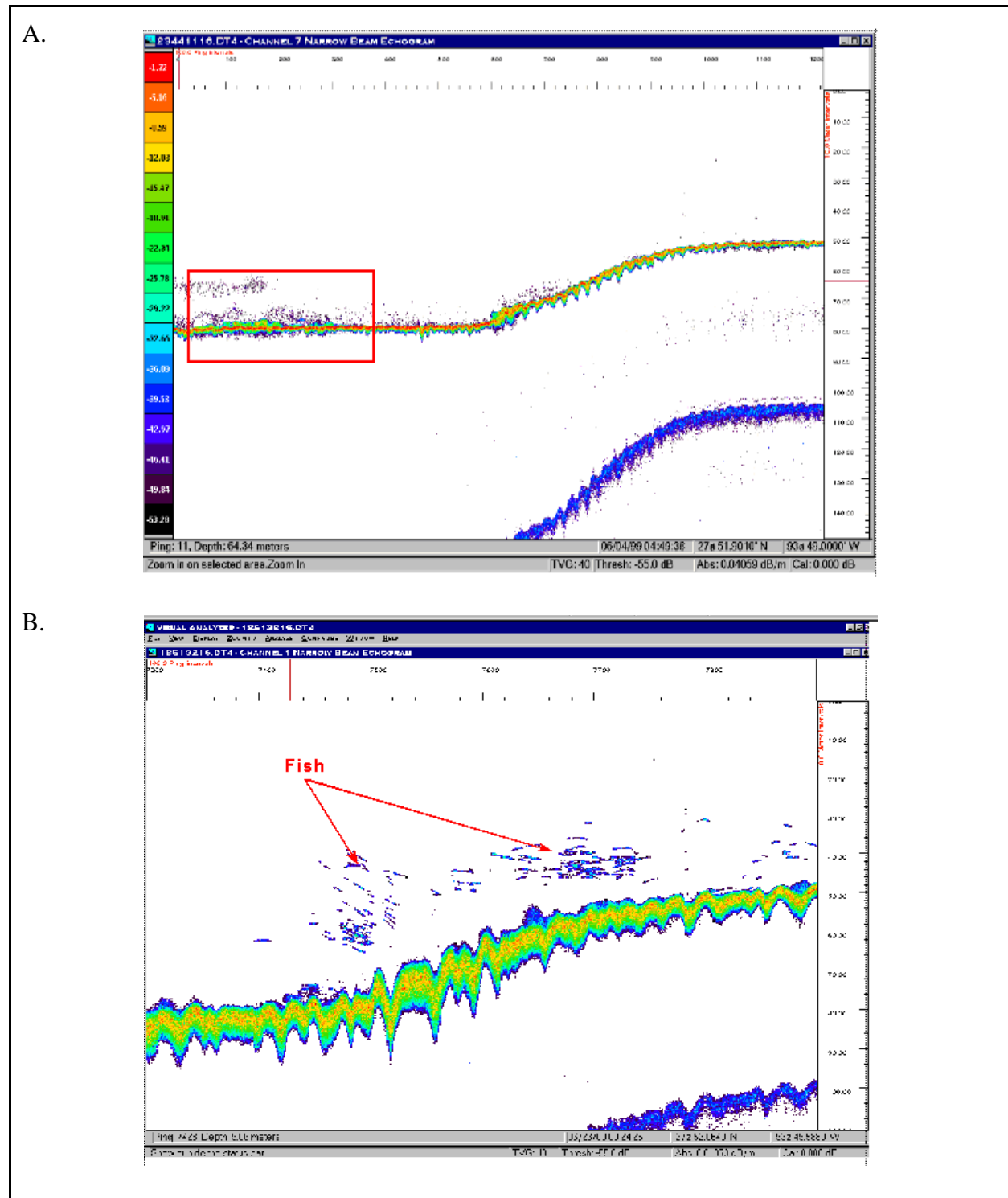

Figure 8.38. Echogram of WFGB survey conducted June 2000. (A). Screen image includes dB color scale on left and depth on the right side; red box highlights an area of high acoustic reflectance presumed to be fish and plankton. (B). Magnified image of a gentle slope onto the upper Terrace (@40m); arrows highlight fish targets.

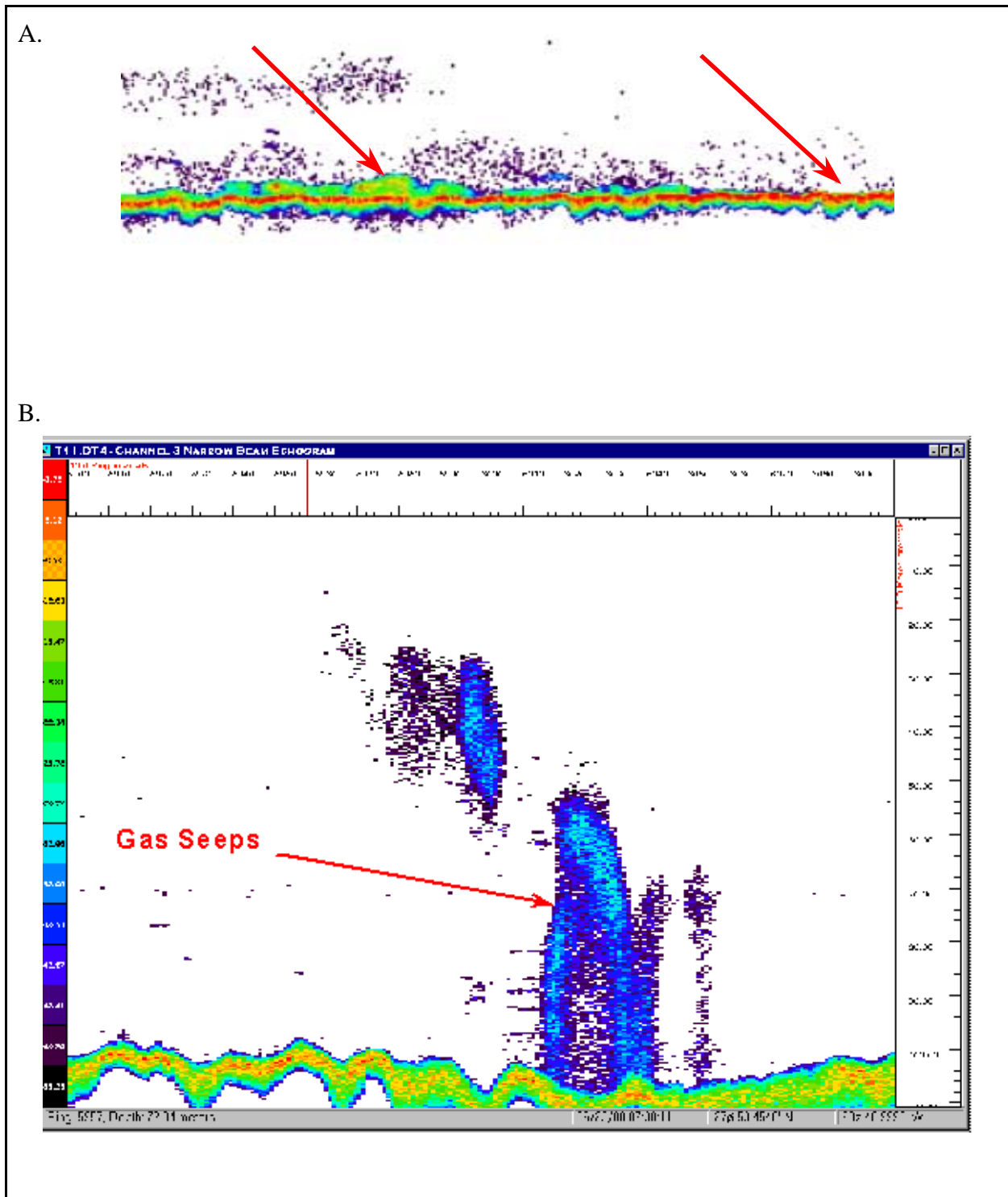

Figure 8.39. Echograms from June 2000 hydroacoustic survey of the WFGB. (A) Linear changes in reflectance illustrate the value of hydroacoustics in characterizing bottom type. (B) Large areas of low reflectance on the bottom are thought to be gas seeps on the lower terrace.

Table 8.6. Logistic analysis results of fish energy (antilog of volume backscatter) with class variables terrace level (Terrace), depth stratum (Stratum), and time of day (TOD) at WFGB.

The Logistic Procedure						
Type III Analysis of Effects						
Effect		DF	Wald Chi-Square	Pr > ChiSq		
TERRACE		3	5778	<.0001		
Stratum		9	4852	<.0001		
TOD		3	122	<.0001		
Stratum*TOD		27	9329	<.0001		
Analysis of Maximum Likelihood Estimates						
Parameter		DF	Estimate	Standard Error	Chi-Square	Pr > ChiSq
Intercept		1	-3.82	1.49	6.56	0.0104
TERRACE	1	1	0.39	0.01	1313.54	<.0001
TERRACE	2	1	0.66	0.01	3116.01	<.0001
TERRACE	3	1	0.18	0.01	273.18	<.0001

Mean fish energy was an order of magnitude higher over the upper terrace compared to the middle and lower terrace and over open water (Figure 8.42). Fish energy also varied with TOD as energy over the WFGB was an order of magnitude lower at noon than at other times of day.

Estimated fish density ranged from 0 to 0.005 fish/m³ over the WFGB. When broken down by terrace, fish densities were highest over the upper terrace (Figure 8.42) just above the bottom at a depth of about 30 meters and just above the bottom of the middle terrace at a depth of about 70 meters. Similarly, densities on the lower terrace peaked just above the bottom at a depth of 90 meters but were almost an order of magnitude less than the highest densities observed on the upper terrace.

Using RBD ANOVA to model the effect of class variables on fish size, fish size varied with terrace and depth and their interactions. Fish were significantly larger over the upper terrace and near the surface (Figure 8.43). Mean fish size over the WFGB was -47dB (6.7 cm), and ranged from -65 to -25 dB (1 to 108 cm) (Love 1971).

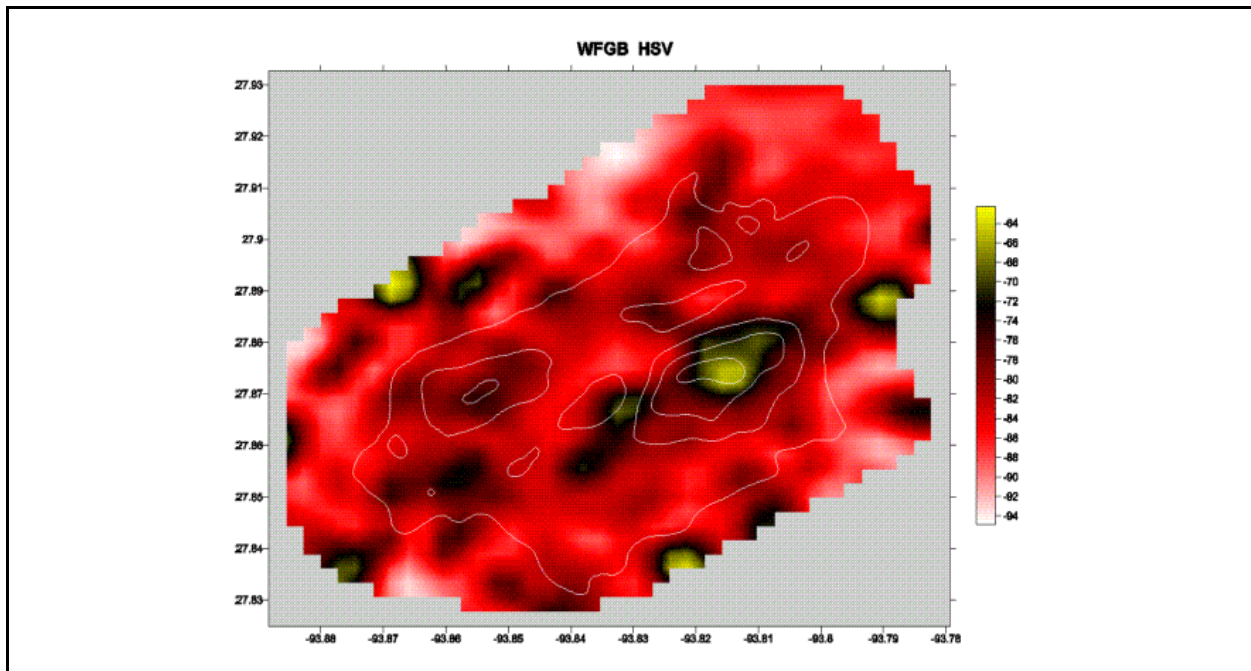

Figure 8.40. An image of the relative horizontal acoustic reflectance over a bathymetry outline of the WFGB. These data are not corrected for depth as HSV is the sum of energy from the surface to the bottom.

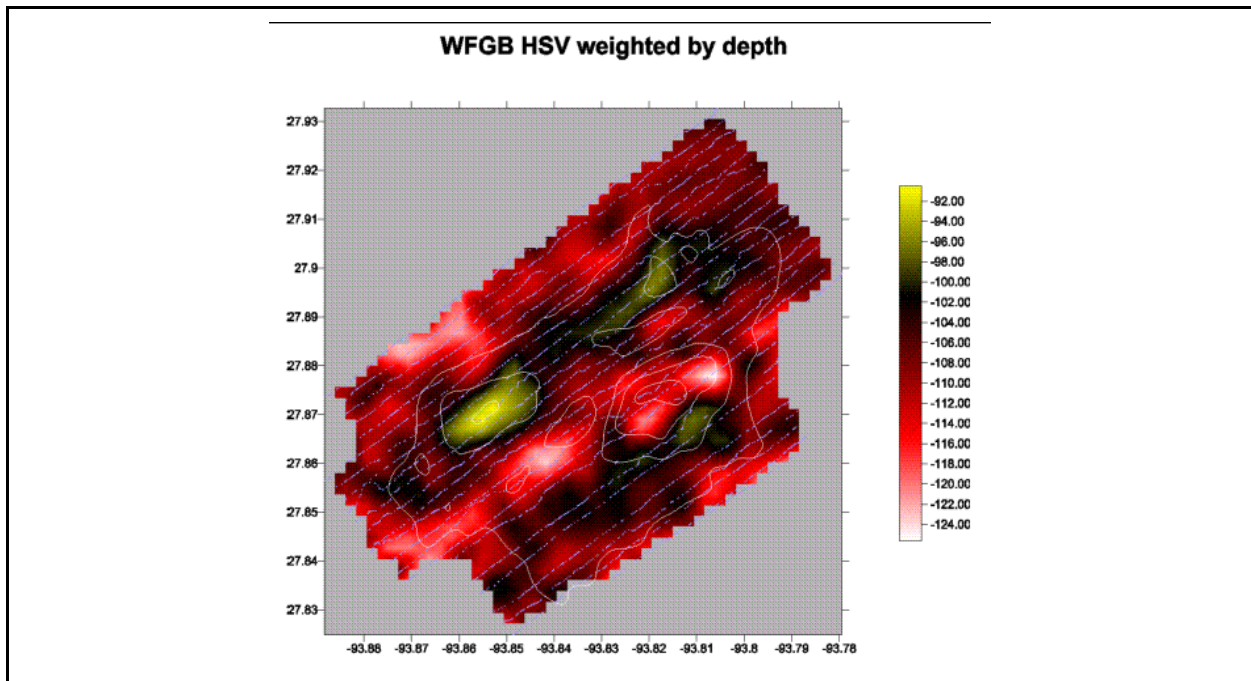

Figure 8.41. An image weighted by depth of the relative horizontal acoustic reflectance over a bathymetry outline of the WFGB. Data are corrected for depth (HSV/depth in meters).

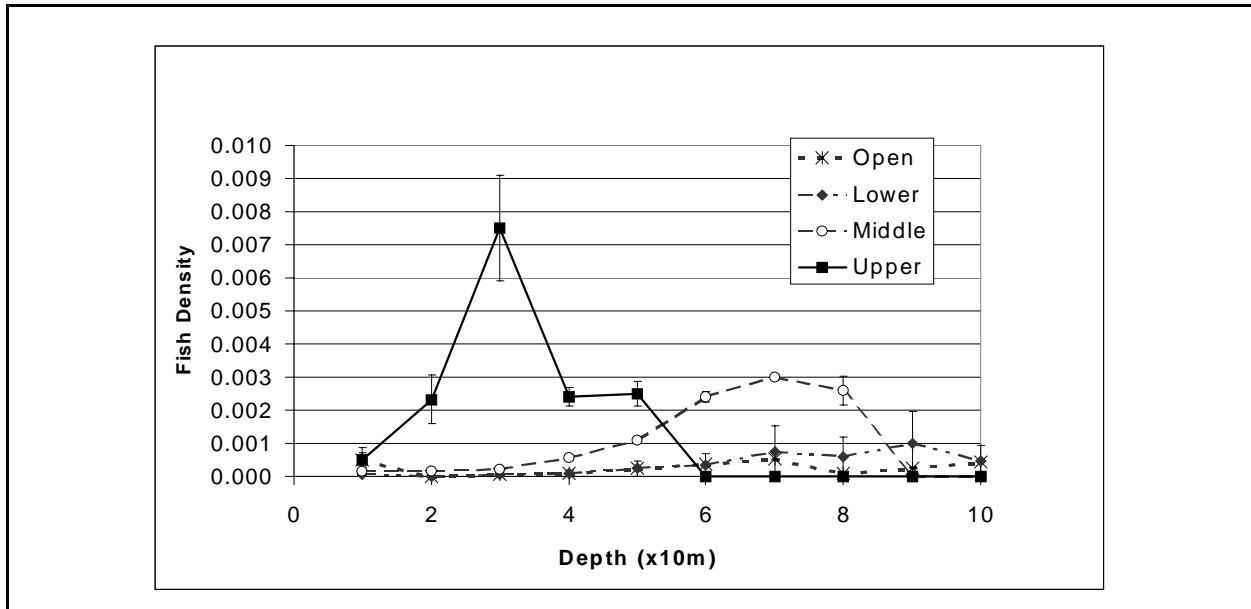

Figure 8.42. Estimated density of fish (fish/m³) over the West Flower Garden Bank based on a dual beam hydroacoustic survey conducted in June 2000. Error bars are 95% confidence intervals.

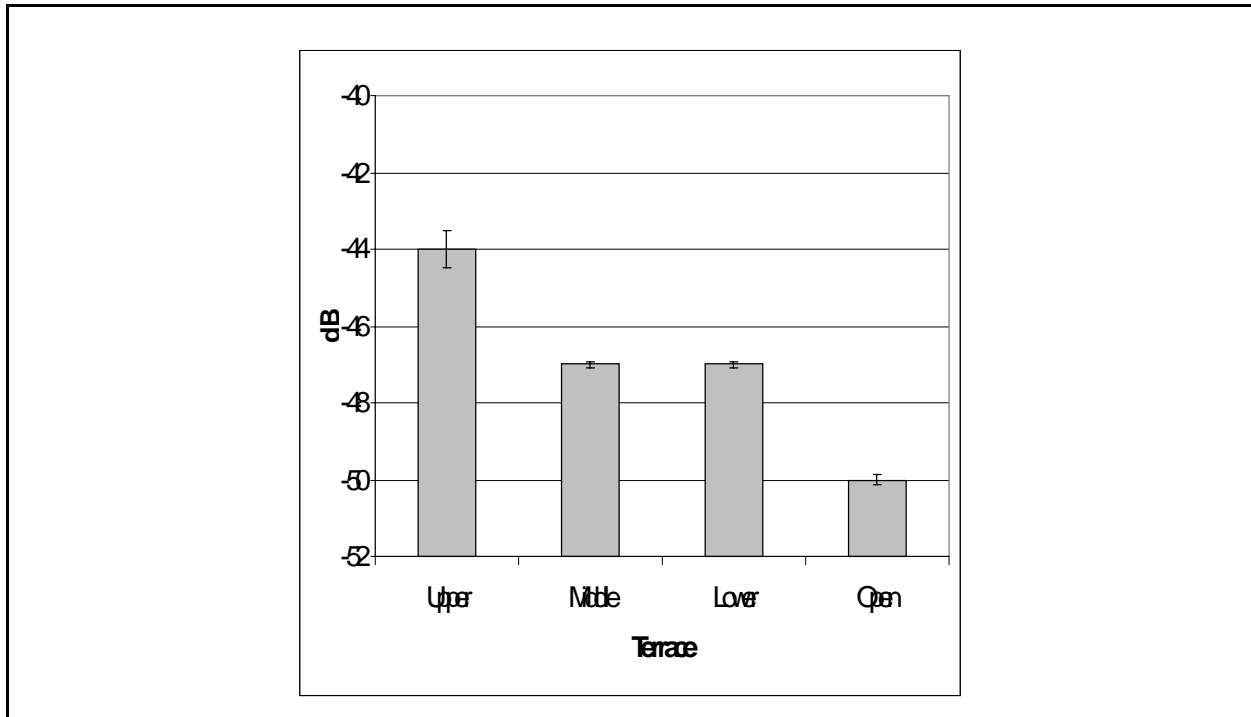

Figure 8.43. Mean target strength (dB) by Terrace over the West Flower Garden Bank based on a dual beam hydroacoustic survey conducted in June 2000. Error bars are 95% confidence intervals.

Species Composition and Abundance

The fish community at the WFGB was very diverse and reflected that of a typical coral reef community. Creole-fish and Bermuda chub were the most abundant species present followed by great barracuda and black durgon (Table 8.7). The ROV survey results likely represent only a small cross-section of the total species present because we did not include cryptic species in the visual survey.

Fish abundance at the WFGB was estimated around 2,500,000 (Table 8.8). The most abundant fishes at the WFGB were Bermuda chub and creole-fish. There was roughly 630,000 bermuda chub and 485,000 creole-fish followed by 261,000 great barracuda 130,000 and black durgon.

DISCUSSION

This project again demonstrates the utility of dual beam hydroacoustics coupled with visual survey techniques to study fish assemblages. The close geographical proximity of several previously studied platforms, two artificial reef sites, and the WFGB provided us an opportunity to compare stationary and mobile acoustic survey methods and to compare species composition, fish biomass, and fish densities within and between platforms, artificial reefs, and a natural reef. Dual beam hydroacoustics coupled with video surveys provide an efficient tool that is both economical and environmentally friendly for assessing fisheries resources at these sites.

Given the large number of zero values and the problem of autocorrelation that occurs in mobile surveys Traditional parametric analyses were not used for analysis of mobile acoustic data. The use of logistic regression in ecological sampling was described by Trexler and Travis (2001) as a nonlinear way of expressing ecological data. Logistic regression has been shown to be useful with data sets that have a large number of zero values which are usually not normally distributed. For regression analysis, the dependent variable was converted into a binomial array of presence/absence of acoustic reflectance (fish measured as acoustic energy)/m³ to evaluate the probability or chance of finding a fish in a given cell. Each cell was defined as a one second block of time divided into 10 m depth strata. One second of time equals 2m of linear distance. Volume backscatter (SV) was used as a dependent variable in performing logistic regression because SV is the mean measured amount of acoustic energy returned from each acoustic ping, averaged for a cubic meter of water column. Stanley and Wilson (1997) used fish density (#/m³) as the dependent variable, but this value is very sensitive to crosssectional backscatter also known as sigma (fish size). Sigma accuracy increases with the number of times a single target is pinged which works well for the standing platform survey where the transducer is stationary. During the WFGB survey the transducer was towed along at 2m/sec which significantly reduced the chance of pinging a single target several times in a row.

Due to the uncertainty of the accuracy of TS, the accuracy of density becomes uncertain. This made SV a better proxy for fish presence, hence the dependent variable in our models. If there was a statistically significant affect by a class variable indicated in the logistic regression analysis, then the procedure was re-run using a no intercept option. The resultant Odds Ratio Estimates provide

Table 8.7. Species common names and scientific names along with numbers of individuals by stratum, totals, and percent composition from visual point counts using video from a remotely operated vehicle (ROV) from the West Flower Garden Banks, June 2000.

West Flower Garden Banks					June 2000								
Common Name	Scientific Name	0 m	10 m	20 m	30 m	40 m	50 m	60 m	70 m	80m	90 m	Totals	%
Almaco jack	<i>Seriola rivoliana</i>	-	-	-	-	-	-	2	-	-	-	2	1.1
Bermuda chub	<i>Kyphosus sectatrix</i>	-	56	1	-	-	-	-	-	-	-	57	32.0
Bar jack	<i>Caranx ruber</i>	-	1	1	-	-	-	-	-	-	-	2	1.1
Great Barracuda	<i>Sphyraena barracuda</i>	-	22	-	-	-	-	-	-	-	-	22	12.4
Black durgon	<i>Melichthys niger</i>	-	-	11	-	-	-	-	-	-	-	11	6.2
Black jack	<i>Caranx lugubris</i>	-	1	-	-	-	-	-	-	-	-	1	0.6
Bluehead	<i>Thalassoma bifasciatum</i>	-	-	1	-	-	-	-	-	-	-	1	0.6
Blue runner	<i>Caranx crysos</i>	-	-	-	8	-	-	-	-	-	-	8	4.5
Blue tang	<i>Acanthurus coeruleus</i>	-	-	-	4	-	-	-	-	-	-	4	2.2
Cocoa damselfish	<i>Pomacentrus variabilis</i>	-	-	3	-	-	-	-	-	1	-	4	2.2
Creole-fish	<i>Paranthias furcifer</i>	-	-	38	-	-	-	-	-	-	3	41	23.0
Dog snapper	<i>Lutjanus jocu</i>	-	-	1	-	-	-	-	-	-	-	1	0.6
French angelfish	<i>Pomacanthus paru</i>	-	-	-	-	2	-	-	-	-	-	2	1.1
Grey triggerfish	<i>Balistes capriscus</i>	-	-	-	-	1	-	-	-	-	-	1	0.6
King mackerel	<i>Scomberomorus cavalla</i>	-	-	-	-	-	-	-	-	1	-	1	0.6
Knobbed porgy	<i>Calamus nodosus</i>	-	-	-	-	1	-	-	-	-	-	1	0.6
Ocean triggerfish	<i>Balistes vetula</i>	-	1	-	-	-	-	-	-	-	-	1	0.6
Bank butterflyfish	<i>Chaetodon aya</i>	-	-	-	-	-	-	-	-	-	6	6	3.4
Scamp	<i>Mycteroperca phenax</i>	-	-	-	-	-	-	2	-	-	-	2	1.1
Short bigeye	<i>Pristigenys alta</i>	-	-	-	-	-	-	-	-	1	4	5	2.8
Spanish hogfish	<i>Bodianus rufus</i>	-	-	-	1	-	-	-	-	-	-	1	0.6
Squirrelfish	<i>Holocentrus adscensionis</i>	-	-	-	-	-	-	-	-	-	2	2	1.1
Trumpetfish	<i>Aulostomus maculatus</i>	-	-	-	-	1	-	-	-	-	-	1	0.6

a comparison of probabilities of fish occurring within that class variable. The effect of each class variable was visualized by plotting SV and estimated fish density by significant class variables.

Our survey of the WFGB affords the first direct acoustic comparison of fish communities between natural reefs and artificial reefs in the same geographic region. The utilization of hydroacoustics for this survey allowed data collection around the clock with a minimal use of labor resources thus allowing the completion of the survey in a relatively short amount of time. The non-invasive manner of the sonar system enabled comprehensive data of the fisheries population with the least environmental impact. We recognize some that the absolute estimates of fish numbers are likely skewed due to the uncertainty of target strength estimates. However these data do provide a basis for comparisons between the two types of habitats. The highest densities were found over the upper terrace of the WFGB where they were two to three orders of magnitude greater than the middle or lower terraces. The fish size was also larger over the upper terrace and smallest over the open water areas of the WFGB. It is now clear that the fish densities around a standing platform, and the resultant artificial reef configurations of toppled in place or partially removed platforms, are greater than that nearby WFGB habitat on a per unit area basis. The WFGB supports well over 2 million fish that can be detected by acoustics, this fish biomass appears to be rivaled by the fish populations of some 150 platforms in water depths ranging from 100 to 300 m water depth based on our survey of HI 350 and the previous surveys.

Not only are we interested in comparing the natural reef to an artificial reef but we also wished to compare our results to previous studies of the WFGB. The most extensive study of the fish community and WFGB was conducted by Boland *et al.* (1983). Boland *et al.* (1983) utilized divers and video surveys to document species composition at the both Flower Garden Banks. Most of their efforts were focused on the more cryptic reef species near the bottom. Of great interest is that our estimates of the fish populations at WFGB are along the same order of magnitude as those reported in Boland *et al.* (1983). For example, Boland *et al.* (1983) reported from 400,000 - 900,000 creole-fish on the WFGB. We estimate that there was 23% of 2,500,000, or 575,000 creole-fish at the time of our survey. Note that these studies were nearly 20 years apart. Given the techniques used by Boland *et al.* (1983), they identified more than twice the number of species that we found as they included the numerous cryptic reef species. We found 8 of the 16 primary species reported by Boland *et al.* (1983) from the WFGB of these 16, seven were cryptic and not targeted in our study.

Fish populations near reefs, both natural and artificial, are highly variable over time and space, and these variations in abundance are the result of many factors which include, but are not limited to, competition, seasonality, physical perturbation, ontogenetic changes, predation, recruitment, emigration and immigration (Sale 1990; Bohnsak *et al.* 1991; Sale 1991). Reefs are thought to be nonequilibrium systems with their occupants constantly changing (Sale 1991) thus population estimates often vary by an order of magnitude over monthly surveys (Sale 1990; Bohnsak *et al.* 1991; Sale 1991; Stanley 1994) and are equally divergent over spacial scales. A reef's size, structure, depth, and location all play an important role in the heavily disputed attraction verses production issue and are also important in determining fish densities at artificial reef sites and natural reefs.

This research continues to support the working hypothesis that platforms do make useful artificial reefs since they tend to support a population of fish that can be 10 to over 1000 times greater in

density than the adjacent sand and mud bottom habitats and are equal to or even exceed that of the limited coral reef habitat in the Gulf of Mexico. Densities of fishes away from platforms, the lower terrace of the WFGB, and open water range from 0 to 0.0001 FPCM and adjacent to standing platforms and over reef sites range from 0 to 10 FPCM depending upon site.

REFERENCES

- Bohnsack, J.A. and S.P. Bannerot. 1986. A Stationary Visual Census Technique for Quantitatively Assessing Community Structure of Coral Reef Fishes. NOAA Technical Report NMFS 41. 15 pp.
- Bohnsack, J.A., D.L. Johnson, and R.F. Ambrose. 1991. Artificial habitats for marine and freshwater fisheries. *Ecology of Artificial Reef Habitats*. Academic Press. New York, New York. 61-108 pp.
- Boland, G. S., B. J. Gallaway, J. S. Baker and G. S. Lewbel. 1983. Ecological Effects of energy development on reef fish of the Flower Garden Banks. Ecological Research Associates, Inc., Bryan, Texas. 466 pp.
- Bright, Thomas J., John W. Tunnell, Linda H. Pequegnat, Thomas E. Burke, Cara W. Cashman, Dennis A. Cropper, James P. Ray, R. Christopher Tresslar, Joyce Teerling and J.B. Wills. 1974. Biotic zonation on the West Flower Garden Bank. Texas A&M University, University of Southwestern Louisiana and University of Houston. 1-54.
- Bright, Thomas J. and Cara W. Cashman. 1974. Fishes. Biotic zonation on the West Flower Garden Bank. Texas A&M University, University of Southwestern Louisiana and University of Houston. pp. 340-409.
- Brock, R.E. 1982. A Critique of the Visual Census Method for Assessing Coral Reef Fish Populations. *Bulletin of Marine Science*. 32:269-276 pp.
- Dennis, George D. and Thomas J Bright. 1988. Reef fish assemblages on hard banks in the northwestern Gulf of Mexico. *Bulletin of Marine Science*. 43(2): 280-307.
- Dokken, Q.R., I.R. MacDonald, J.W. Tunnell, C.R. Beaver, G.S. Boland, and D.K. Hagman. 1999. Long- Term Monitoring at the East and West Flower Garden Banks, 1996-1997. U.S. Department of the Interior, Minerals Management Service, OCS Study/ MMS 99-0005. 1-7.
- Elvers, Douglas J. and Charles W. Hill, Jr. 1985. History of Activities at the Flower Garden Banks. Pages 3- 10 *in* The Flower Gardens: A Compendium of Information. U.S. Department of the Interior, Minerals Management Service, OCS Study/ MMS 85-0024. Bortone, S.A. and J.J. Kimmel. 1991. Environmental Assessments and Monitoring of Artificial Habitats. *Artificial Habitats for Marine and Freshwater Fisheries*. Academic Press, New York, New York. 177-236 pp.

- Gardner, J. V., Larry A. Mayer, John E. Hughes Clarke , Art Kleiner.1998. High- Resolution Multibeam Bathymetry of East and West Flower Gardens and Stetson Banks, Gulf of Mexico. Gulf of Mexico Science. Vol.16 No. 2:131-143.
- Garrison, L.P., W. Michaels, J.S. Link, and M.J. Fogarty. 2000. Predation Risk on Larval Gadids by Pelagic Fish in the Georges Bank Ecosystem. I. Spatial overlap associated with hydrographic features. Canadian Journal of Fisheries and Aquatic Sciences. 57: 2455-2469.
- Gittings, Steve R. and Emma L. Hickerson. 1998. Introduction. Gulf of Mexico Science. Vol.16 No. 2: 128.
- Grossman, G.D., G.D. Jones, and W.J. Seaman Jr. 1997. Do Artificial Reefs Increase Regional Fisheries Production? A Review of Excising Data. Fisheries. 22: 17-23.
- Love, R.H. 1971. Dorsal Aspect Target Strength of an Individual Fish. Journal of Acoustic Society of America. 62:1397-1403.
- Rooker, J. R., Q. R. Dokken, C. V. Pattengill and G. J. Holt. 1997. Fish assemblages on artificial and natural reefs in the Flower Garden Banks National Marine Sanctuary, USA. Coral Reefs. 16: 83-92.
- Sale, P.F. 1990. Recruitment of Marine Species: Is the Bandwagon Rolling in the Right Direction? Trends in Evolutionary Ecology 5:25-27 pp.
- Sale, P.F. 1991. Reef Fish Communities: Open Nonequilibrium Systems. 564-600pp.
- Sale, P.F. editor. The ecology of fishes on coral reefs. Academic Press. New York, N.Y.
- SAS Institute Incorporated. 2000. SAS user's guide: Statistics. Version 8. SAS Institute. Cary, NC. 1290 pp.
- Stanley, D.R. 1994. Seasonal and Spatial Abundances and Size Distribution Associated with a Petroleum Platform in the Northern Gulf of Mexico. Dissertation. Louisiana State University.
- Trexler, J.C. and J. Travis. 2001. Nontraditional Regression Analysis. Ecology. 74(6): 1629-1637.

**SESSION 9:
EVALUATION OF NATURAL AND/OR
ARTIFICIAL REEF PRODUCTIVITY II**

Moderators: Kathy Scanlon
Quenton Dokken

Date: October 26, 2000

Presentation	Author/Affiliation
Secondary Productivity Within Biotic Fouling Community Elements of Artificial Reef Structures in the Northwestern Gulf of Mexico	Carl Beaver Susan Childs Quenton Dokken Center for Coastal Studies Texas A&M University-Corpus Christi
Settlement of a Colonial Ascidian on an Artificial Reef in the Gulf of Mexico	Jan Culbertson Donald E. Harper, Jr. Artificial Reef Program Texas Parks and Wildlife Department and Department of Marine Biology Texas A&M University at Galveston
Reef Balls™: How Combining Designed Reefs with Oil Superstructures Used as Artificial Reefs Can Help the Overall Reef System to Better Mimic Natural Reef Systems	Todd Ryan Barber President, Reef Ball Development Group, Ltd. Chairman, Reef Ball Foundation, Inc.
Red Snapper Site Fidelity to, and Speed of Movement from, Artificial Reef Sites off Alabama in the Northern Gulf of Mexico	William F. Patterson James H. Cowan Robert L. Shipp Department of Marine Sciences University of South Alabama
Abundance, Age Distribution, Growth Rate, and Mortality Estimations for Red Snapper, <i>Lutjanus Campechanus</i> , Around Gas Platforms and Other Artificial Structures in the Northeast Gulf of Mexico	Stephen T. Szedlmayer Carol Furman Dustin Moss Marine Fish Laboratory Department of Fisheries and Allied Aquacultures Auburn University

(continued on next page)

Presentation	Author/Affiliation
Movement, Growth, and Survival of Gray Triggerfish, <i>Balistes Capriscus</i> , Inhabiting Artificial and Natural Reefs in the Northcentral Gulf of Mexico	G. Walter Ingram, Jr. Robert L. Shipp
Red Snapper (<i>Lutjanus Campechanus</i>) Diet on Alabama Artificial Reefs	Jessica R. McCawley Robert L. Shipp University of South Alabama/ Dauphin Island Sea Lab James H. Cowan, Jr. Louisiana State University Coastal Fisheries Institute

**SECONDARY PRODUCTIVITY WITHIN BIOTIC FOULING COMMUNITY
ELEMENTS ON TWO ARTIFICIAL REEF STRUCTURES IN
THE NORTHWESTERN GULF OF MEXICO**

Carl Beaver
Susan Childs
Quenton Dokken
Center for Coastal Studies
Texas A&M University-Corpus Christi

ABSTRACT

Secondary productivity of two platform artificial reefs was examined seasonally. The study examined seasonal differences and annual secondary productivity of epifaunal elements associated with the fouling community, known to be specific to the diets of selected reef fishes. Examination of the fouling community using cohort-size analysis revealed the annual amphipod production of 3-4 cohorts per species/yr⁻¹. Seasonal variations in amphipod density were striking, ranging from 600 to nearly 12,680 individuals/m². Densities were correlated with water temperature and depth.

Mean standing stock in mgDW/m² was used as a measure of productivity and also varied significantly depending on season and species. Mean standing stock ranged from 16.33 to 1024.6 mgDW/m². Annual production ranged between 64 and 4100 mgDW·m⁻²·yr⁻¹.

This study has implications for the placement of platform structures for the purpose of productivity enhancement. It is clear that secondary productivity from the platform structures is significant and does supplement the diets of reef dependent finfish.

INTRODUCTION

There is little debate as to the ability of artificial reef to increase productivity of sessile invertebrate organisms. Several authors (Smith *et al.* 1979; Gallaway and Lewbell 1982; Jessee *et al.*; 1985; Bull 1990) have noted and/or described the diverse assemblages of organisms associated with artificial reef fouling communities, however none have examined the secondary productivity of these communities. An examination of productivity of fouling community organisms contributing to the diets of fishes is critical to defining the potential contribution of these reef systems to fish stocks.

The idea that platform reefs increase fouling community biomass in an area is one that generates little argument. The amount of energy production contributing to or potentially contributing to the diets of fishes is a point of contention. It is the purpose of this research to characterize composition and estimate the biomass and energy content of the fouling community potentially contributing to the diets of selected fishes on platform reefs in the western Gulf of Mexico.

This research has identified those elements of the fouling community that comprise a sizeable portion of the diet of selected reef-dependent fishes and determined the annual production and energy levels of these elements.

METHODS

Data pertaining to fouling community composition was collected quarterly for seven quarters from the EB165A platform. Company down-sizing and unmanning of the HI389A by Mobil Exploration and Production precluded continued sampling at the platform, consequently only five quarterly samples were collected from this site.

Fouling-community development was quantitatively assessed seasonally using photographic transect techniques. Photographic transects, as described by Liddell and Ohlhorst (1991), were taken using a Nikonos V underwater camera and 28mm Nikonos lens mounted on a frame that supports twin Nikonos SB 102 strobes. Attached to the camera is a steel rod holding a standard of measure and an electronic depth meter. The standard of measure and depth meter are clearly visible in each image. This device ensures each image is taken at a predetermined distance from the substrate. The standard of measure allows for calibrating image size while the depth meter provides a record of depth for each image. All photo transects were shot using Fujichrome 100 slide film at a fixed distance of 0.4 m from the substrate. This system produces color transparency images of approximately 0.20 m² of platform substrate. Vertical transects followed the platform structure from the surface to a depth of 53 m. A photograph was taken approximately every 1.5 m. Transparencies were projected at a size ratio of 1:1 onto a screen marked with 25 randomly located points. The image superimposed on each point was identified to the lowest possible taxon and recorded. Images that were difficult to identify when projected were examined under a stereoscopic microscope. This technique improves resolution and often aids in identification of the organism in question. A total of 533 (369 for HI389A and 164 for EB165A) transparencies were analyzed providing 13,325 data points.

A diversity index was computed for every transparency at each depth on each transect using the Shannon Diversity Index (Shannon 1948). The diversity of each depth across all transects was subjected to Analysis of Variance (ANOVA) procedures to determine significant differences in fouling community diversity along the depth gradient. Tukey's Mean Separation Test was used to determine differences in mean species diversity between depth zones.

Rugosity measurements (linear measurements of the relief created by fouling community organisms) were taken at 2.86 m intervals for all depths from the surface to 53 m. Rugosity was determined by measuring the relief created by the fouling community organisms between two points set 1m apart. A mean rugosity was calculated for each 2.86 m depth increment. Rugosity for each increment is defined as:

$$R = \frac{\sum 3(X+1)}{3} - 1$$

These data were analyzed to determine species diversity, density, richness and evenness of the sessile fouling community. These data were also used to identify zones of significantly differing diversity of cryptic fauna within the sessile fouling-community.

Standing stock of benthic invertebrates within the fouling-community was quantitatively assessed seasonally by examination of biomass samples. Samples were taken every 3 m from a depth of 53 m to the surface at both HI389A and EB165A. Sampling at HI389A was conducted from February 1995 through March 1996. Sampling at EB165A was conducted from September 1995 through July 1997. Seventy-two, 100 cm² samples of the fouling community were scraped from the EB165A platform and forty-seven, 100 cm² samples were collected from the HI 389A platform.

All samples were scraped from the steel structure and placed into plastic bags. On the surface, samples were drained of most of the seawater and preserved in a 45% isopropyl alcohol solution for later examination in the laboratory. Light and water temperature were recorded using Light-Tab recording light meters and Hobo-Temp thermisters (Onset Instruments Corporation 1995)

In the laboratory, samples were rinsed in tap water and decanted through a 0.4 mm sieve. Samples were then sorted under a dissecting microscope to remove remaining non-sessile organisms. Invertebrate organisms were identified and divided into prey organisms and non-selected organisms through comparison to data obtained from analysis of reef fish stomach contents. An additional 27 samples, 12 from HI389A and 15 from EB165A, were collected and frozen for caloric analysis of cryptic fouling community diet organisms. Prey organisms were identified, enumerated and measured to the nearest 0.5 mm. All samples were dried at 60° C until a stable weight was obtained.

Population levels per m² for prey organisms were extrapolated from counts obtained from the samples. Annual production estimates were calculated using the cohort biomass increment method (Crisp 1971). This method requires that the number of cohorts be established by size frequency analysis and that each cohort be analyzed separately. Total production (mgDW • m⁻² • yr⁻¹) is estimated as the sum of production values calculated separately for each cohort based on growth increments over the life of the cohort such as:

$$P = \sum f_i w_i G_i \Delta t$$

where n = the number of size classes;

f_i= the mean number of individuals in the size class i for the period Δt,

w_i= the mean weight of individuals of size class i and

G_i= the weight specific growth rate of individuals of the size class i in period Δt.

Caloric values of diet elements were determined from direct calorimetry or by comparison to published caloric values when available. Direct calorimetry employed the use of a Phillipson Microbomb Calorimeter. Available energy was determined by multiplying the sum of production estimates (gDW • m⁻² • yr⁻¹) by the caloric value (kcal/gDW) for each prey organism.

RESULTS

Secondary Productivity of Sessile Fouling Community

Four sessile fouling community organisms were found to comprise more than 1% of the diets of any of the reef fish examined. The bivalves *Isognomon bicolor* and *Pteria colymbus* as well as the barnacles *Balanus amphitrite* and *Balanus reticulata* were found in the stomachs of the gray triggerfish *Balistes capricus*. Densities of *Isognomon bicolor* ranged from 1014 to 4112 individuals/m² (mean=2931). Using an ash weight of 10.5% of dry weight and a caloric value of 4.24 kcal/gDW (calculated from Dauvin and Johncourt 1989) we have calculated a standing stock energy value for *I. bicolor* of 7692.1 kcal/m². *Pteria colymbus* densities were 0.4 /m² and standing stock energy values were 11.1 kcal/m².

For the barnacles *Balanus amphitrite* and *Balanus reticulata*, densities were estimated at 312 and 114 individuals/m², respectively. Using a measured ash weight of 8.8% dry weight and a caloric value of 4.39 kcal/gDW, we estimate standing stock energy values to be 3661.7 kcal/m² for *B. amphitrite* and 1340.7 kcal/m² for *B. reticulata*.

Secondary Productivity of the Motile Fouling Community

Several species of amphipods were the only organisms among the motile fouling community fauna to show significant variation in population densities and standing stock levels. Most species displayed increasing densities throughout the spring and early summer, reaching maximum population densities by late summer. Densities generally displayed a distinct correlation with water temperature, with greatest population densities occurring near maximum or minimum annual water temperatures dependent on species (Figure 9.1, Figure 9.2, and Figure 9.3).

Production Estimates for Amphipods

Length frequency analysis of amphipods suggests that, in all species, several generations are produced during the year. For *Gammarus* sp. the life span is approximately 3-4 months during warmer months and between 4 and 6 months during colder periods. Gammarideans exhibit three generations per year with one each during the spring and summer then a fall generation that overwinters. Spring and summer cohorts display rapid growth and experience heavy mortality. The cool-water generation is longer-lived, but slow growing.

Population levels also exhibited a negative correlation with depth. Population levels for *Gammarus* sp. were greatest within 5m of the surface and decreased with increasing depth to 30m. Population levels of this amphipod ranged from 390–12,680 individuals/m² with a mean of 5887 individuals/m² (sd 1268). Population levels were greatest during late spring when more than one cohort was present. Population levels were lowest during late winter-early spring, when a single cohort at the end of its life span was present.

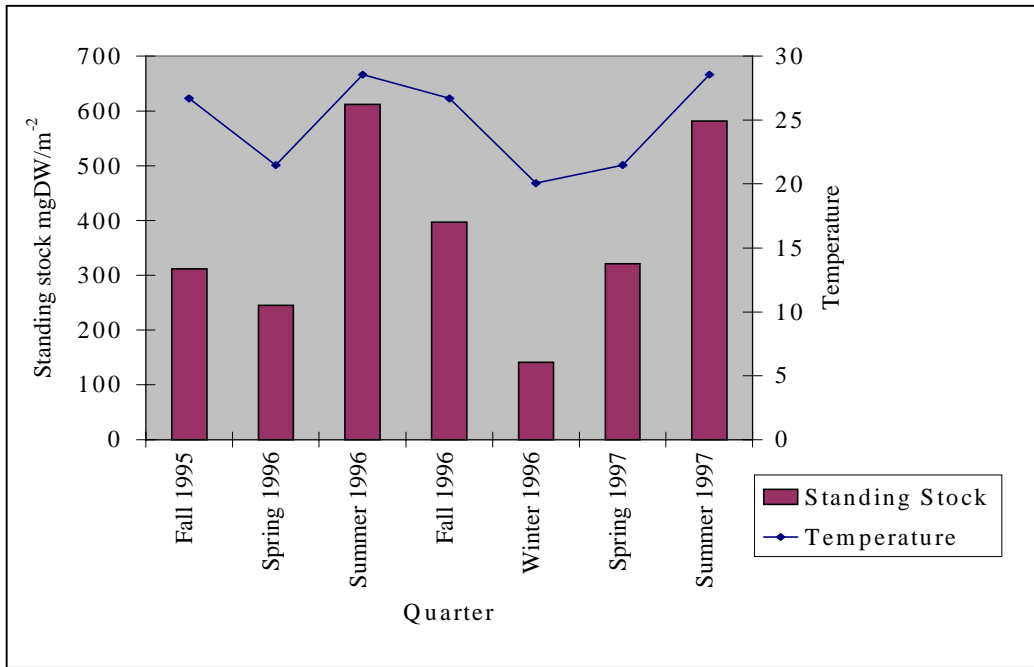

Gammarus sp.

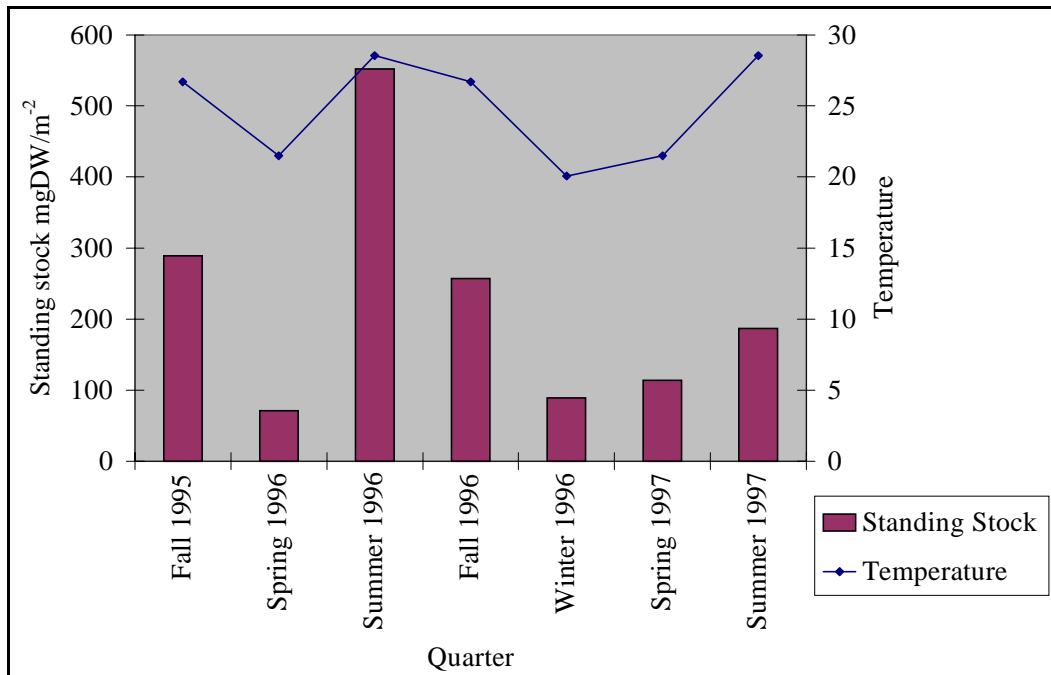

Corophium sp.

Figure 9.1. Relationship between temperature and standing stock for the amphipods *Gammarus sp.* and *Corophium sp.* at EB165A and HI389A.

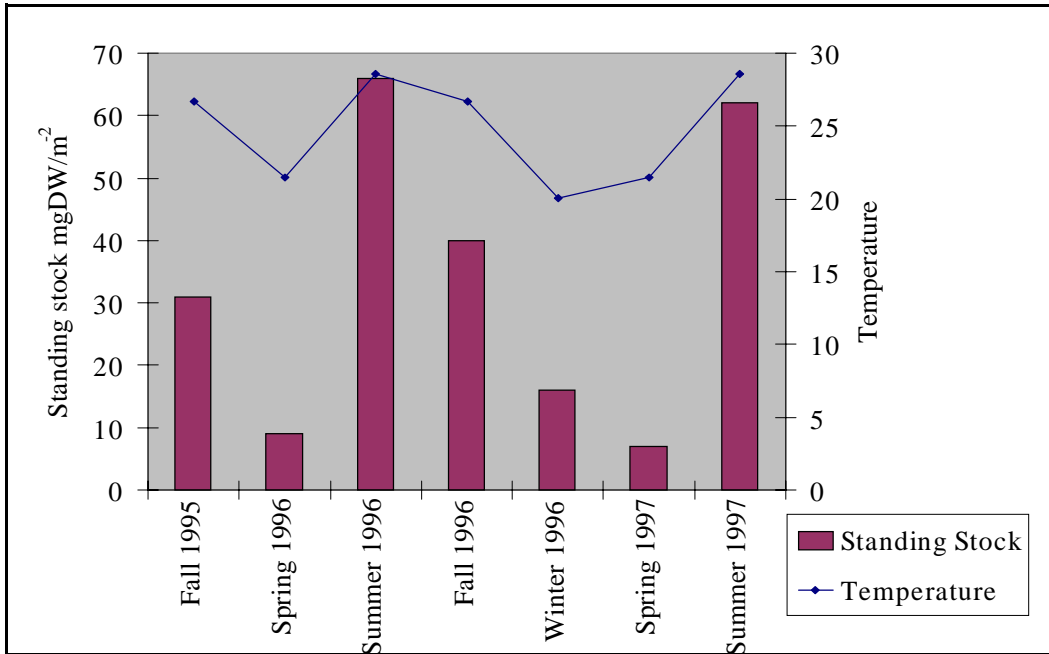

Corophium biglovia

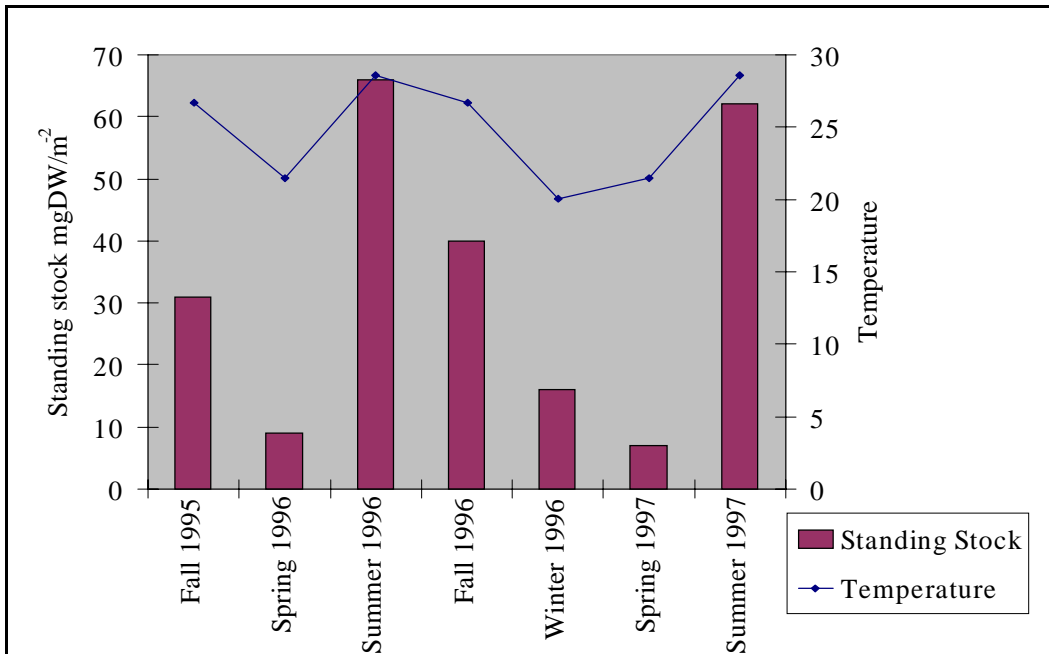

Corophium louisiana

Figure 9.2. Relationship between temperature and standing stock for the amphipods *Corophium biglovia* and *Corophium louisiana* at EB165A and HI389A.

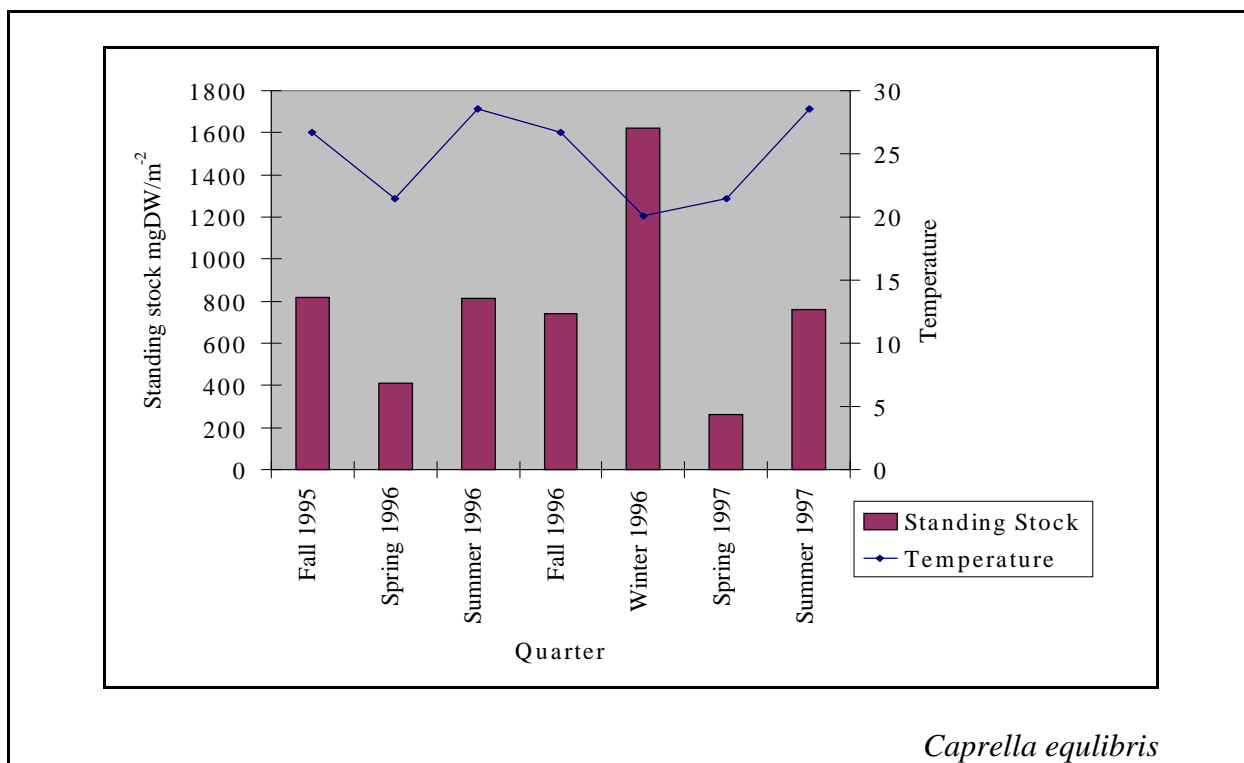

Figure 9.3. Relationship between temperature and standing stock for the amphipod *Caprella equilibris* at EB165A and HI389A.

Mean standing stock was 372.85 mgDW/m², and total annual production was estimated at 38,791.3 mgDW • m² • yr⁻¹ or 38.79 gDW • m² • yr⁻¹. Caloric content for this species ranged between 3.6 and 4.12 with a mean value of 3.87 kcal/g (Table 9.1).

There were 3 distinct cohorts of *Corophium* sp. observed in samples. This species has a life span of 3-4 months during the warmer months and 4-5 months during colder months. Densities ranged from 600–11,010 individuals/m² with a mean 4082 individuals/m² (sd 1417). Greatest numbers occurred during late summer when the spring and summer cohorts were both present. Lowest numbers were observed during late winter prior to the appearance of the spring cohort. A fall cohort that apparently over-winters appears between mid October and early November.

This species displayed a disposition for horizontal structure with population levels being significantly greater on horizontal substrate of the reef structure above 10m depth. Mean standing stock was estimated to be 222.8 mgDW/m² (sd 89.4). Three cohorts per year are produced with two fast growing cohorts appearing in the late spring and another in late summer. A slower growing, longer-lived, over-wintering cohort appearing in late fall. Estimated annual production of *Corophium* sp. was 5467.9 mgDW • m² • yr⁻¹. Population levels of *Corophium* sp. varied significantly between summer sampling periods. During the summer of 1996 population levels were estimated to be 552 individuals/m², while summer 1997 levels were estimated at 187 individuals/m² (Table 9.2). *Corophium biglovia* displayed a density range of 183–1425 individuals/m² (mean 785,

sd 164). Mean standing stock was estimated to be 33 mgDW/m² (sd 9.2). *C. biglovia* is estimated to produce 3-4 cohorts each year with one each in spring, summer and fall and a slow growing overwintering cohort in the winter. Estimated annual production for this species was the lowest of all amphipod diet elements at 534.4 mgDW •m⁻² •yr⁻¹ (Table 9.3).

Populations of the amphipod *Corophium louisiana* ranged from 2395–5725 individuals/m² with a mean of 4189 (sd 498). Mean standing stock was estimated to be 570.1 mgDW/m² (sd 132.7). Three cohorts are produced yearly. Annual production is estimated at 4379.3 mgDW •m⁻² •yr⁻¹. This species displayed a significant difference in population levels within fall sampling periods. Fall 1995 population levels were estimated at 443 individuals/m² while population levels during the fall 1996 sampling period were estimated to be 213 individuals/m² (Table 9.4).

Two species of *Corophium* displayed a positive correlation in standing stock levels with temperature. *Corophium* sp. and *Corophium biglovia* standing stock levels and populations were greatest during summer and fall sampling periods. *Corophium* sp. ranged from 3.3 mgDW/m² in the spring of 1996, immediately after mean low water temperature to 718 mgDW/m² during the summer of that same year, immediately prior to mean maximum water temperature. *Corophium biglovia* standing stocks ranged from 7.5 mgDW/m² during the spring of 1996 to 110 mgDW/m² immediately following mean maximum water temperature. *Corophium louisiana* displayed a negative correlation with water temperature with standing stocks being greatest during the period of mean minimum water temperature.

Caprella equilibris, the largest of platform amphipods, had a density range of 612–1,746 individuals/m² (mean 1105, sd 139). Mean standing stock was estimated to be 775.1 mgDW/m² (sd 165.0). This large, longer-lived species produces 3 cohorts/yr¹. Estimated annual production is 39,927.8 mgDW •m⁻² •yr⁻¹ or 39.98 gDW •m⁻² •yr⁻¹. *Caprella equilibris* displayed a significant negative correlation with temperature with the greatest numbers being present prior to minimum annual water temperatures (Table 9.5).

Total production for the five species was estimated at 89,100.7 mgDW •m⁻² •yr⁻¹ or 89.1 gDW •m⁻² •yr⁻¹. No significant difference in caloric content was determined between the five species of amphipods except in the case of gravid females. Mean kcal/g of non-gravid amphipods was 4.31 (N= 11, sd 0.74). Annual amphipod production was determined to be 384.38 kcal •m⁻² •yr⁻¹. Caloric content of gravid female amphipods were not determined due to small sample size.

DISCUSSION

Although similarities existed between the types and species of sessile fouling community organisms, the degree of development was very different. Both rugosity and diversity were greater at the HI389A platform mainly due to the presence and numbers of large bodied sponges. The lower diversity and lack of development of large sponges at the EB165A platform may be due to relatively strong currents. No data exists on water currents at these two platforms, however on several occasions, underwater work at EB165A had to be halted or postponed due to the dangers associated with working in strong currents. It is likely that these strong currents have an adverse effect in the

Table 9.5. Cohort Statistics for the amphipod *Caprella equilibris* at EB165A, September 1996-April 1997. Production estimated using biomass increment method (Crisp 1974).

Cohort 1	Date	Days	Length (mm)	SD	Estimated Density	Mean mgDW	Estimated mgDW/m ²	Growth Rate	Production
	25-Sep		6.5	1.5	1,407	0.49	689.4		
	15-Oct	21	7.0	1.7	1,312	0.57	747.8	3.23	2,416.76
	21-Oct	6	8.8	1.5	1,586	0.62	1221.2	28.08	27,611.58
	20-Dec	61	12.5	1.8	1,746	0.98	1711.1	2.89	4,954.31
	7-Feb	49	14.0	2.8	685	1.09	746.65	1.89	1,411.29
Total		137							36,393.94
Cohort 2	Date	Days	Length (mm)	SD	Estimated Density	Mean mgDW	Estimated mgDW/m ²	Growth Rate	Production
	20-Dec	61	4.2	0.75	1,012	0.38	384.6		
	7-Feb	49	5.9	1.2	867	0.47	407.5	1.55	630.18
	15-Mar	36	8.2	2.75	612	0.67	410.0	0.47	191.51
	23-Apr	39	10.0	2.5	723	0.87	629.0	4.31	2,712.23
Total		185							3,533.92

degree of development of the sessile fouling community. Population levels of certain diet elements within the sessile fouling community were affected by the presence of sponges as well. Certain species of encrusting sponges, mainly *Neofibularia nolitangere* display seasonal growth patterns. During warmer months this species would encrust large areas of the structure effectively choking out low relief members of the community such as barnacles and small bivalves. During cooler months this species would disintegrate leaving large patches of substrate exposed. These areas would generally be recolonized by faster growing elements such as hydroids, which would then be displaced if the sponge colony regenerated during the next warming period. Consequently, the original community of slow growing bivalves and barnacles would be permanently displaced.

The species composition of the sessile fouling community has a direct effect on the production of certain cryptic faunal diet elements. No amphipods were found in scraping samples that contained greater than 80% siliceous sponges. Presumably the lack of amphipods in this type of sponge can be explained by the presence of silicone spicules that give the sponge its structural strength. These spicules can become lodged between the plates of the carapace of crustaceans causing irritation and possibly death (Personal observation).

Diversity among the platform's sessile fouling community is also affected by the configuration of the structural supports. In both platform communities a significant decrease in diversity was observed at the level of horizontal supporting structures. Significantly differing diversity was

observed approximately 1m above and below the horizontal supports. This reduction occurred at 23m at EB165A and 36.5m at HI389A. The decrease in diversity at these horizontal members is presumed to be caused by grazing animals associated with the horizontal structure. It is important to note however, that the diversity of motile invertebrates increased at the horizontal members. These areas are important to small motile and semi-motile animals as they provide protection from currents and collect detritus and other food materials as they settle out of the water column (Gallaway and Lewbell 1982; Bull and Kendall 1994).

Annual production for the three species of *Corophium* at the platforms ranged from 0.53 gDW \cdot m⁻² \cdot yr⁻¹ (*C. biglovia*) to 5.5 gDW \cdot m⁻² \cdot yr⁻¹ (*Corophium* sp). These estimates are somewhat lower than production estimates from published studies. Franz and Tanacredi (1992) estimated annual rates of secondary production of the amphipod *Ampelisca abdita* (12 -22 gDW \cdot m⁻² \cdot yr⁻¹) for Jamaica Bay, New York, suggesting these levels are higher than most other marine amphipods. Mossman (1978) and Moller and Rosenberg (1982) estimated the secondary production of the amphipod *Corophium volutator* to be 13.4 gDW \cdot m⁻² \cdot yr⁻¹, while Birklund (1977) estimated secondary production of *Corophium insidiosum* to be 8-60 gDW \cdot m⁻² \cdot yr⁻¹. Although these published estimates are higher, it should be noted that these were monotypic populations from temperate waters.

All three *Corophium* species on the platforms are benthic, facultative, tube-dwelling amphipods that showed a distinct preference for horizontal structure. This is likely related to the difficulty associated with maintaining a hold on vertical surfaces. Generally *Corophium* tubes are constructed of fine-grained sediments bound together by mucus in a hollow tube shape. The tubes are not cemented to the substrate, but instead, are buried in fine-grained sediments. On platform artificial reefs, these sediments are generally only found on horizontal structures protected from waves, surge and current.

The lack of suitable habitat i.e., protected, horizontal structure in shallow water covered with fine grained sediment, make platform artificial reefs a marginal habitat for tube dwelling amphipods.

Conversely, high diversity fouling communities appear to be suitable for the development of other species of amphipods. *Gammarus* sp. produced an estimated 38.79 gDW \cdot m⁻² \cdot yr⁻¹, while *Caprella equilibris* produced an estimated 39.98 gDW \cdot m⁻² \cdot yr⁻¹. High levels of production in both species were common in areas with a moderate to high diversity of fouling community organisms other than sponges.

Weather conditions and company scheduling negated sampling during the winter of 1995-1996. Consequently, maximum population levels of winter spawning amphipods i.e. *Caprella equilibris* and *Corophium louisiana*, were based on a single sampling period. We therefore expect error in these estimates to be higher than for other species in this study.

Two species of amphipods, *Corophium* sp. and *Corophium louisiana* displayed significant differences within a sampling period between years. During the summer of 1996, population levels of *Corophium* sp. were nearly three times the estimated levels for that species during the summer of 1997. Sampling during the summer quarter of 1996 occurred during late August while the summer 1997 sampling was conducted during mid July. Likewise population levels for *Corophium*

louisiana during the fall of 1995 were twice that of the fall 1996 sample. In this example, sampling occurred three weeks later in 1995 than in 1996. We suspect that the increased population levels were evidence of the presence of two or more cohorts during the period.

REFERENCES

- Birklund, J. 1977. Biomass, growth and production of the amphipod *Corophium insidiosum* Crawford and preliminary notes on *Corophium volutator* (Pallas). *Ophelia* 16:187-203.
- Bull, A.S. 1990. Fish assemblages at oil and gas platforms, compared to natural hard/live bottom areas in the Gulf of Mexico. *Coastal Zone* 90:979-987.
- Bull, A.S. and J.J. Kendall. 1994. An indication of the process: Offshore platforms as artificial reefs in the Gulf of Mexico. *Bull. Mar. Sci.* 55:1086-1098.
- Crisp, D.J. 1971. Energy flow measurements. Pages 197-279. In N. A. Holme and A.D. McIntyre eds. *Methods for the study of marine benthos*. IBP handbook 16, Blackwell Publ. Oxford, U.K.
- Dauvin, J.C. and M. Joncourt. 1989. Energy values of marine benthic invertebrates from the western English Channel. *J. Mar. Biol. Assoc. of the U. K. Plymouth.* 69:589-595.
- Franz, D.R. and J.T. Tanacredi. 1992. Secondary production of the amphipod *Ampelisca abdita* and its importance to the diet of juvenile winter flounder (*Pleuronectes americanus*) in Jamaica Bay, New York. *Estuaries.* 15:193-203
- Gallaway, B.J. and G.S. Lewbell. 1982. The ecology of petroleum platforms in the northwestern Gulf of Mexico: a community profile. U.S. Fish Wildl. Serv., Gulf of Mexico OCS Reg.Off., Open-file Rept. 82-03. 93 pp.
- Jessee, W.N., J.W. Carter, A.L. Carpenter, and E.E. DeMartini. 1985. Density estimates of five warm-temperate reef fishes associated with an artificial reef, a natural reef, and a kelp forest. In F. D'Itri, ed. *Artificial reefs: marine and freshwater applications*. Lewis Publishers, Inc. Chelsea, Minnesota.
- Liddell, D.W. and S.L. Ohlhorst. 1991. Sessile community sampling. Pages 2473-2479. In Magill's survey of science: Life science series.
- Mossman, D. 1978. Energetics of *Corophium volutator*. Ph.D. Thesis, University of London.
- Onset Instruments Corp. 1998. P.O. Box 3450, Pocasset MA. 02559
- Shannon, C.E. 1948. A mathematical theory of communication. *Bell Syst. Tech.J.* 27:379-423.
- Smith, G.B., D.A. Hensley, and H.H. Mathews. 1979. Comparative efficacy of artificial and natural reefs as fish attractants. *Florida Mar. Res. Publ.* 35:1-7.

SETTLEMENT OF A COLONIAL ASCIDIAN ON AN ARTIFICIAL REEF IN THE GULF OF MEXICO

Jan Culbertson
Donald E. Harper, Jr.
Artificial Reef Program
Texas Parks and Wildlife Department and
Department of Marine Biology
Texas A&M University at Galveston

An obsolete oil production platform, located in 58 m water depths in High Island A- 532, 12 nautical miles west of Stetson Bank, was converted into an artificial reef in 1997. The upper 27 m of the structure was mechanically cut off and placed on the sea floor, next to the undisturbed lower section of the rig. During “pre-construction” biological monitoring, divers observed a thin white encrusting ascidian colonizing most of the structure below the water line. Divers confirmed that between 1998 and 2000 this ascidian colonized the majority of both portions of the structure from 27 m to below 42 meter depths. Divers have recently observed this same species colonizing other platforms, within 12 nautical miles of this reef site.

Samples of this ascidian were collected and compared to other species found in the Gulf of Mexico (GOM) and the Pacific. The High Island A-532 Reef’s species was identified by ascidian expert, Dr. Gretchen Lambert, as *Didemnum perlucidum*, in the family Didemnidae. This ascidian forms a thin tunic layer over the colony, less than 1 mm thick, and appears white due to the aster-like spicules in the tunic. This species of ascidian can colonize structures through sexual reproduction of gametes and settlement of larvae or through asexual budding of itself. It appears to settle or grow over other encrusting organisms such as sponges, corals, bryozoans, hydroids, and mollusks.

Monitoring stations on the structure have been set up at this reef site to determine how quickly *Didemnum perlucidum* colonizes and what other factors may influence its growth and/or reproduction. First-quarter observations show that this ascidian can completely re-colonize 100 cm surfaces that were cleared of all attached organisms. This monitoring study is still in progress, and environmental as well as seasonal factors are being considered.

INTRODUCTION

There have been few zoogeographical studies of the distribution of ascidians in the GOM. Less than 25 ascidian species have previously been documented for the GOM by Van Name (1945), Rabalais (1975), and Plough (1978). These benthic encrusting species are not readily observed, unless they can be differentiated from other epifauna attached to both artificial substrates and natural hard-bottom communities. They provide competition for corals, sponges, and other invertebrates and appear to be an important component of hard-bottom communities (Rabalais 1975, Monniot and Monniot 1991, and Bak *et al.* 1996). Rabalais (1975) described 15 new ascidian species forming a dense mat covering the polychaete tube cases of *Physillochaetopterus socialis* at Seven and One-Half Fathom banks on the south coast of Texas. She also described additional species observed on jetty

complexes along the Texas coast, in the bays, and on oil production platforms offshore of Port Aransas, Texas. These 21 previously documented species are from three zoogeographical regions: Texas Transitional Zone (after Van Name 1945, 1954, and Millar 1971); Caribbean Transitional or Carolinian Zone (after Hedgepeth 1953, and Williams 1951); and West Indian or Eastern American Tropical Zone (after Valentine 1963). Although many biological surveys on oil and gas platforms and natural banks have been done in the offshore waters of this third zone (Dokken *et al.* 2000, Bright 1985), little information exists on new ascidian species found in the GOM over the past 20 years.

As the range and numbers of oil and gas platform installations have grown since 1945, there has also been an increase in the available hard-bottom substrate for benthic encrusting organisms in the GOM. In addition to the numbers of platforms installed, there has also been an increase in the numbers of platforms removed, towed to shore, reinstalled at other locations, or converted into artificial reefs (Dauterive per. comm. and MMS database). These platforms provide the perfect vector for transferring epifauna from one location to another. They also provide available substrate for settlement of new species passing through the water currents or from ships releasing ballast water on their way through fairways to major ports (Coles *et al.* 1999).

This paper documents observations of a new colonial species, identified as *Didemnum perlucidum*, in the Didemnidae family in the GOM. Its origins are unknown at present, but it appears to have been introduced in the GOM, and is currently dominating a state artificial reef site 74 nautical miles offshore. Samples of this species were compared with pacific species, collected by Scott Godwin (Bishop Museum of Natural History), and verified by Dr. Gretchen Lambert (University of Washington). A full description of this species may be found in Monniot (1983) and Monniot and Monniot (1987, 1995). These authors have documented its presence in the Caribbean West Indian Oceans in Guadelope; and from the Pacific Ocean in Micronesia and Papua-New Guinea. This species has also been documented in the harbor areas near the Hawaiian Islands (Godwin and Lambert per. comm. 2000). The introduction of this ascidian species in the GOM meets the criteria for a non-indigenous species described by Chapman (1988) as a “new appearance in a local region, in association with human mechanisms of dispersal, or in association with other introduced species, restricted to artificial or disturbed habitat, and from widespread, disjunct geographic ranges.” Species not demonstrably introduced or native to previously known geographic ranges are considered to be cryptogenic species.

This colonial ascidian was first observed to be covering the entire surface area of an eight-leg (pile) structure from the water surface interface down to at least 42 m water depth and beyond. Divers completed a pre-artificial reef construction survey in May 1997 and found a thin white encrusting organism to be dominating and smothering previously established epifauna. Divers conducted a post-construction survey 14 months later in August 1998, after the top portion of the jacket was cut off at 27 m and placed on the bottom next to the standing portion of the jacket to create two reef structures. They also found this ascidian covering both structures from 27 m down to at least 40 m and beyond. The upper portion of the original jacket, including 15 m of bare metal previously not exposed to sea-water, was also covered with the ascidian in that time period. Divers conducted another post-monitoring survey in September 1999, and found that this organism was so effective in maintaining dominance that it had covered nearly all living and attached encrusting organisms, preventing them from normal nutrient uptake and respiration.

However, the continued dominance of this colonial ascidian at a Texas artificial reef over the past three years has piqued the interest and concern of state and federal agencies. Its ability to out-compete native species may be a potential concern if it is transferred to other artificial reefs, either through currents or by direct movement of surrounding platforms to other areas in the GOM. This study is a preliminary account of what monitoring protocols have been implemented to estimate the growth and settlement rates of this species. Further investigation into the factors controlling this ascidian's continued dominance and further documentation of its invasion of surrounding artificial reefs are in progress.

SPECIES DESCRIPTION

A key feature of this species is that it appears to be white due to the white aster-like spicules embedded in its translucent tunic, covering the entire colony. There appears to be some color variation, however, when it is in a growth mode. Then, it appears to be a yellow to gray color due to the lack of spicules on the surface of the tunic. Each zooid adult has four rows of branchial sacs, with seven to eight stigmata in each row, similar to other Didemnids in the GOM. Each zooid in the colony has a six-star shaped, oral siphon, where water is pumped from the external environment to their branchial sacs for respiration and nutrient uptake. Each zooid adult also has a broad cloacal aperture, that exposes its branchial sacs to the colony's common areas, where waste is released through a common exterior siphon.

Each zooid adult is hermaphroditic, and can produce male gametes through a single testis with eight coiled sperm ducts and oocytes from a single ovary. These gametes are released to the common areas where fertilization occurs. The tadpole-like larvae are stored in these common areas until they are mature and ready to be released to the water column. These colonial ascidians can also reproduce and extend the growth of their colony through asexual reproduction, or budding of their mid-section. Each colonial unit consists of a "system" of zooids, which share a large exterior siphon, the most notable morphological feature of each colonial unit. Cloacal canals, which appear as dark meandering lines in this species, connect the individuals in these colonies to common areas and exterior siphons.

STUDY SITE

The study site is located 74 nautical miles offshore of Freeport, Texas, in OSC leasing block High Island A-532 at 28° 05' 56.551"N Latitude, and 94° 30' 43.377"W Longitude. This artificial reef structure is standing in 58 m of water. In 1997, this obsolete eight-leg jacket structure was converted into an artificial reef. The upper 27 m of this artificial reef structure was mechanically cut off and placed on the sea floor, next to the undisturbed lower section of the rig to create two reef structures. Figure 9.4 shows the location of the High Island A-532 reef and its relative distance from shore and other Texas Parks and Wildlife artificial reefs. This artificial reef site is also located 12 nautical miles west of Stetson Bank, a natural hard bottom community, under the protection of the NOAA Flower Garden Bank National Marine Sanctuary Program. We have also identified this species at other artificial reef sites within a 12-mile radius of the study site.

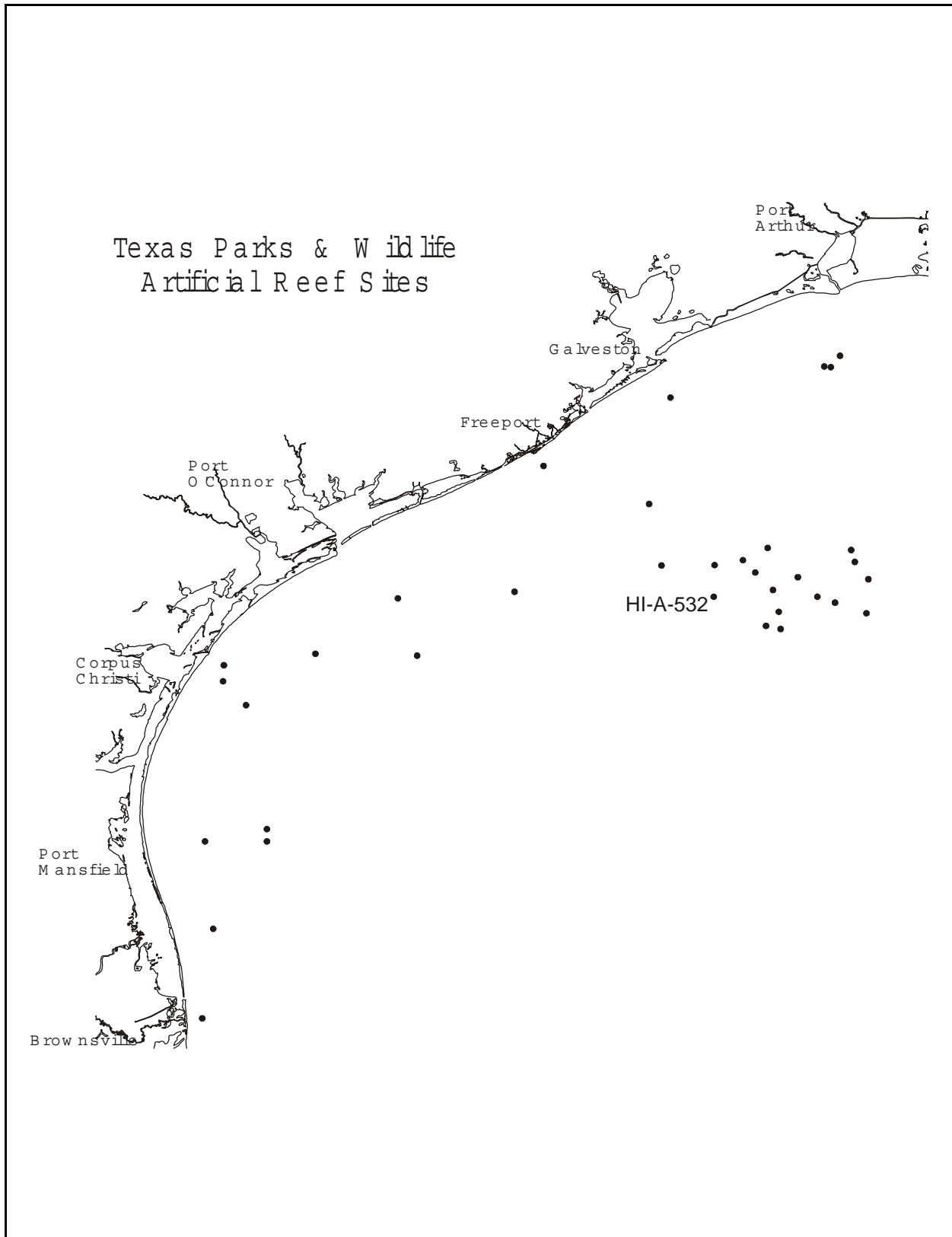

Figure 9.4. Artificial Reef Study Site. High Island A-532.

METHODS

In May 2000, divers established two growth-monitoring areas—stations 1 and 3 (see Figure 9.5). Plastic cable ties (1.5 cm wide) were installed approximately 100 cm apart on two 61 cm diameter horizontal cross-members of the structure. A digital video camera (Sony TRV900) inside a Stingray II Light in Motion Underwater Housing was used to record the apparent growth at each station before and after each sampling effort. Four different colored (10 cm) plastic cable ties were installed through the end markers to denote north, east, south and west geographic quadrants, to account for any differences from currents flowing past the rounded surfaces of each station. Four square plastic station markers (6.4 cm²) were also established on a middle cable tie in the center of each quadrant, at approximately 50 cm from upper and lower end markers as a reference point for digital video records. All ascidian growth or settlement between these end markers was removed. Established colonies above and below these scraped areas remain undisturbed so that any growth into scraped areas could be measured over time.

In August 2000, the apparent growth of these undisturbed colonies was recorded using the previously described digital video camera. Digital images were transferred with an AUTOCAD 14.0 program, used for measuring the distance these colonies had grown from the top and bottom edges of each station. Figure 9.6 shows the digital images of the upper 50 cm of all five monitoring stations. Only station 5 shows 100 cover because it was left undisturbed. Ten measurements were drawn on each image in AUTOCAD in each quadrant, starting at the top edge and working down to the center marker. Ten measurements were also recorded in each quadrant starting at the bottom edges of each marked area, working up to the center marker. These measurements taken of upper and lower apparent growth in each quadrant, were compared with each other and between stations.

In August 2000, two additional monitoring stations (see Figure 9.5 for stations 2 and 4 reference locations) were also set up on other horizontal cross members. These stations were marked using the same procedures previously established for marking monitoring stations. A control station was also established and marked with cable ties, 100 cm apart (see Figure 9.5 for station 5 reference location). This control station will remain undisturbed for the remainder of this study to monitor continued dominance of this ascidian on the structure. Once video images were recorded, divers removed all epifauna and ascidian growth from stations 1 through 4.

In addition to scraping these monitoring stations, temperature gauges (OnSet Computers) were attached to the top of each monitoring station. A YSI-6600-M (Yellow Springs Instruments) multi-parameter data sonde, calibrated to record temperature, salinity, pH, dissolved oxygen, turbidity, and total chlorophyll was installed on an outer vertical leg near station 4. This YSI-6600-M data sonde will be replaced every three months to transfer water quality data from the study site and to determine if there are any distinguishing hydrographic features at the 27 meter sampling depth.

In September 2000, the apparent growth at all four stations was recorded using the same digital video camera previously described. Digital images were transferred into an AUTOCAD 14.0 program for measuring the distance these colonies had grown from the top and bottom edges at each station. The same procedures were used to measure each quadrant to compare upper and lower apparent growth at each geographic quadrant and between stations.

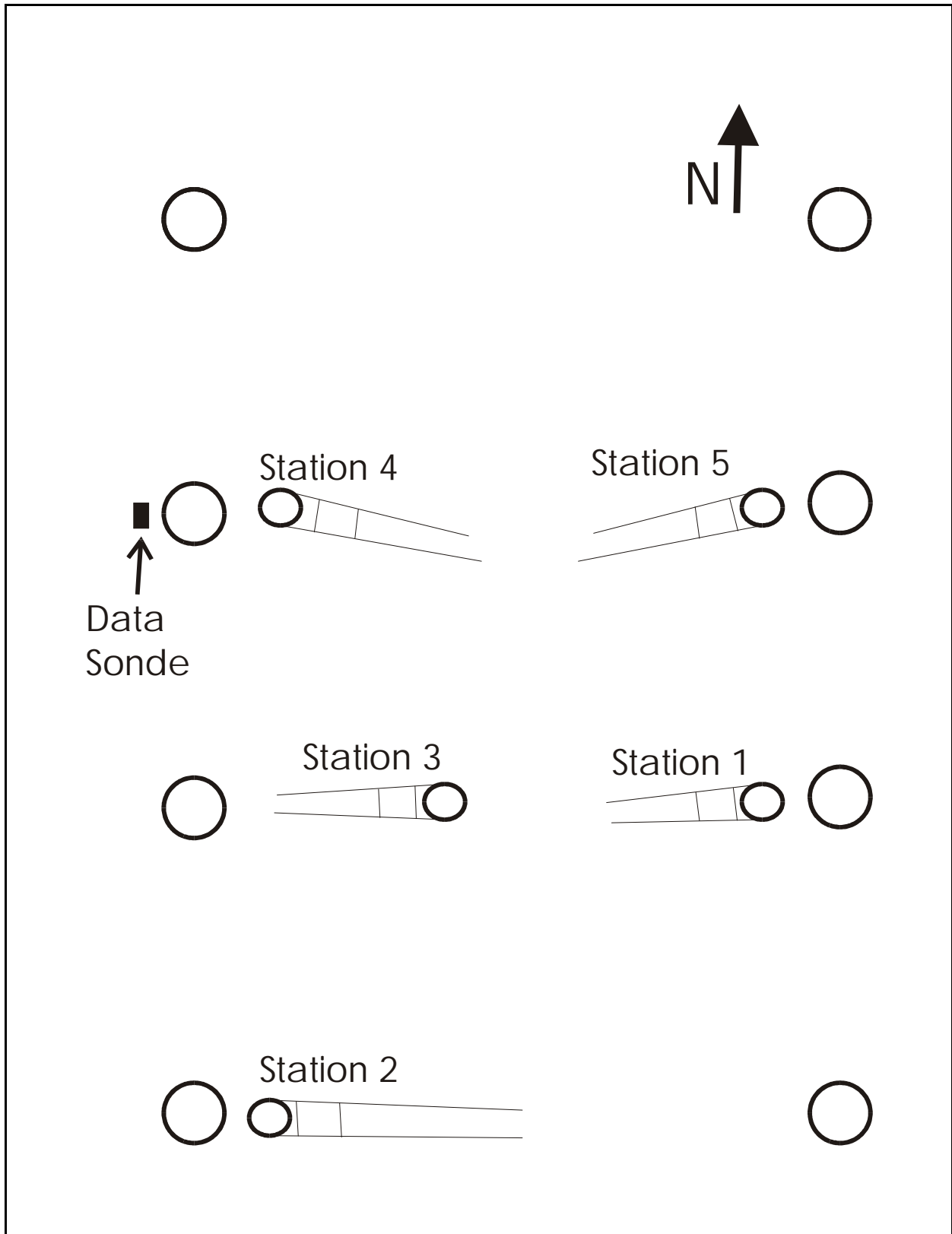

Figure 9.5. Monitoring station locations: stations 1 through 5.

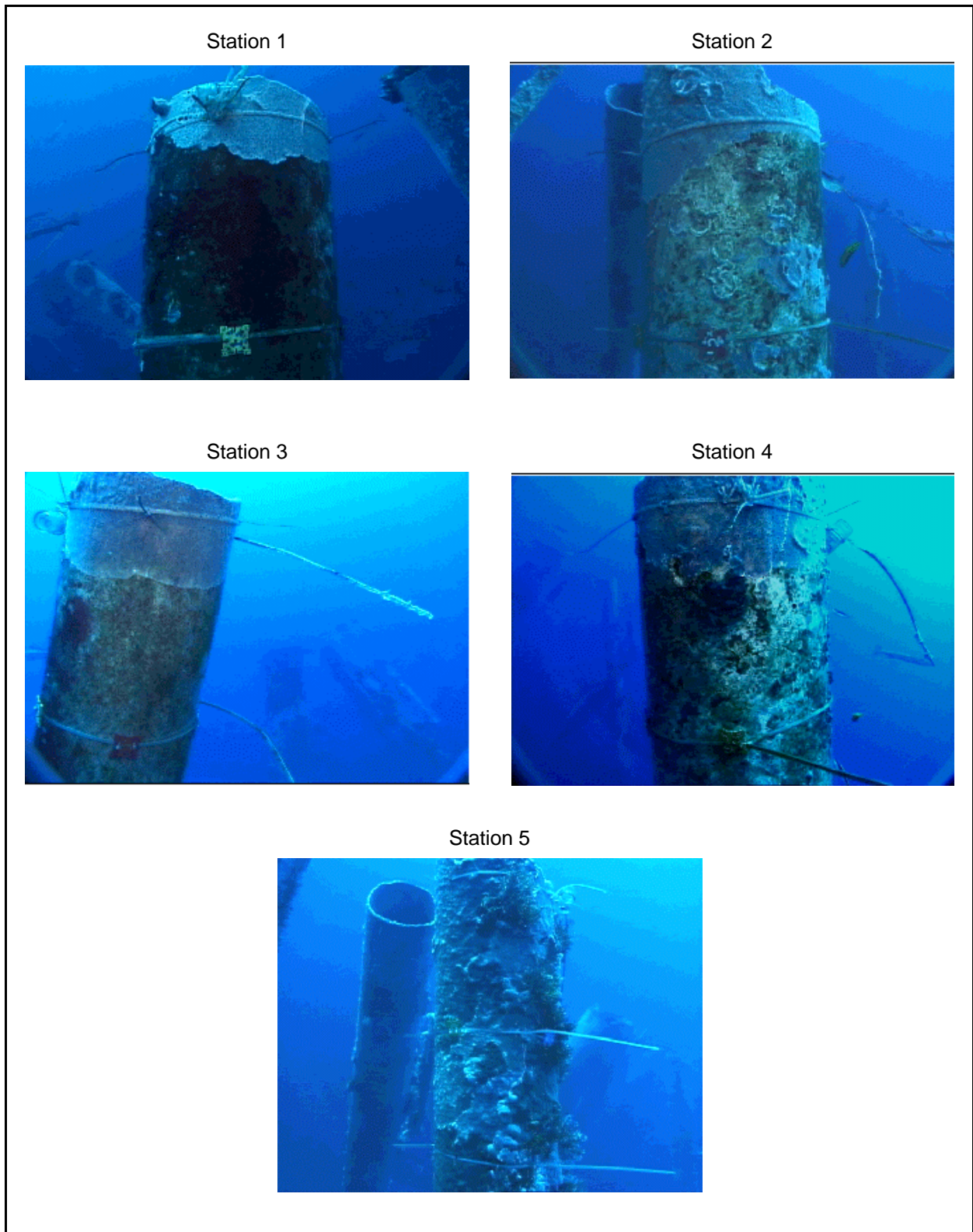

Figure 9.6. Digital images of upper 50 cm of stations 1 through 5.

In October 2000, digital video images from each station at each quadrant were recorded using the same procedures previously discussed. These images will be transferred into AUTOCAD for measurement of growth in the near future. Monitoring apparent growth at this study site will continue on a quarterly basis, until an established pattern has been established. Plans to establish ascidian larval settlement traps at each station to distinguish settlement versus growth rates are also being explored. Other biotic factors as well as environmental and hydrological factors will be evaluated for influences on apparent growth at this study site. Additional stations may also be installed in the future at platforms in the area to evaluate this ascidian's growth at other locations.

RESULTS

Three months after the first removal of all growth and encrusting organisms at stations 1 and 3, the first growth data was recorded. This time period occurred between 11 May and 8 August 2000. Figures 9.7 and 9.8 show a comparison of the upper and lower growth averages of ten measurements taken in each quadrant at station 1 and 3 over this time period. Each lightly shaded upper area of the cylinders in these figures indicates an average of 10 measurements of apparent growth of the colony down from the undisturbed upper part of the monitoring station in each quadrant. Each dark shaded area of the cylinders in these figures indicates the average of 10 measurements of apparent growth of the colony up from the undisturbed lower part of the monitoring station in each quadrant. The white portion of each cylinder, labeled "other," denotes data that contains both discontinuous patches of colonial ascidians and unsettled areas between upper and lower growth areas. These discontinuous patches of ascidians cannot be specifically identified at this time as growth from the upper or lower undisturbed colonies, or from settlement of new larvae. These discontinuous patches have been treated as "other growth" rather than as non-growth areas on this figure and all subsequent figures.

Figure 9.7 shows that average growth between quadrants ranging between 11.4 cm (west) and 31.9 cm (south) occurred in the upper portion of station 1. Figure 9.7 also shows that average growth between quadrants ranged between 26.9 cm (south) and 36.1 cm (west) occurred in the lower portion of station 1.

Figure 9.8 shows that average growth between quadrants ranging between 31.5 cm (west) and 57.1 cm growth (north) occurred in the upper portion of station 3. Figure 9.8 also shows that average growth between quadrants ranging between 28.8 cm (south) and 43.7 cm (west) occurred in the lower portion of station 3.

The averages of 10 measurements in each quadrant is somewhat misleading because these averages conceal the irregular growth rate of the entire colony as it migrates either up or down the station leg. Figure 9.9 shows that the upper portion of the colony (solid line) grew up to 73.0 cm in some areas of the south quadrant, but had areas of zero growth in the west quadrant over this same time period. Figure 9.9 also shows that there were some areas in the lower portion (dotted line) of the west quadrant that grew up to 76.0 cm and less than 20.0 cm growth in the south quadrant over this same time period.

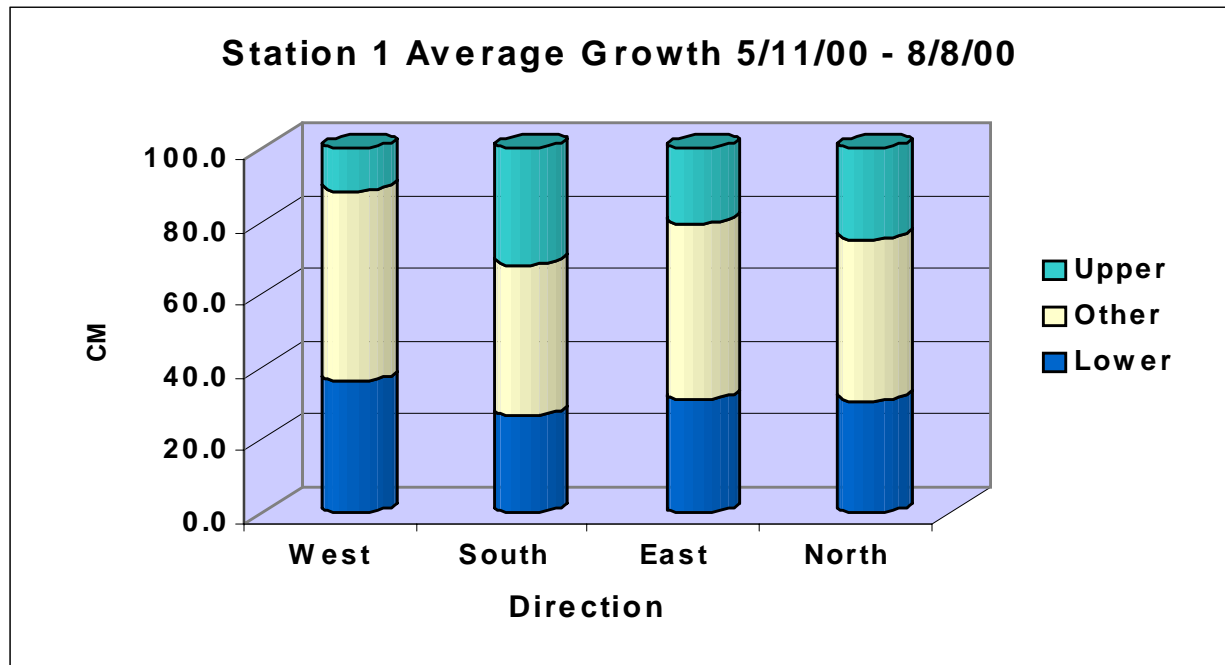

Figure 9.7. Average growth measured at station 1 from 5/11/00 - 8/8/00. Comparison shows upper and lower growth at monitoring station. X-axis indicates cm of growth over time. Y-axis indicates four quadrants where measured on each station.

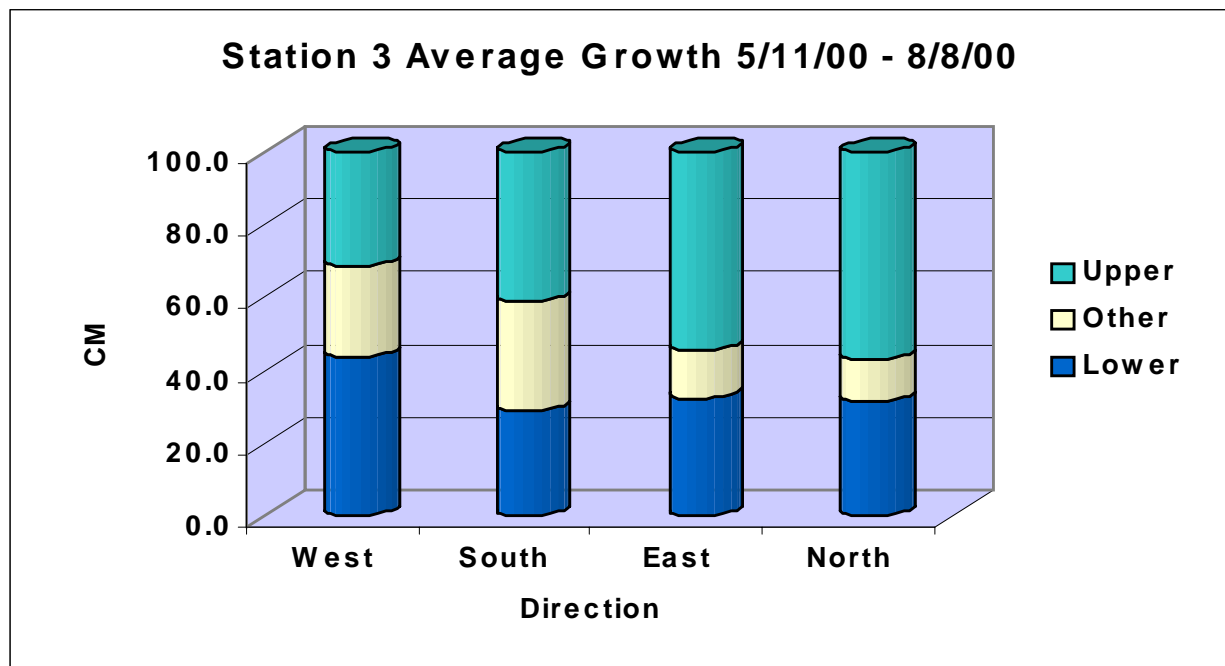

Figure 9.8. Average growth measured at station 3 from 5/11/00 - 8/8/00. Comparison shows upper and lower growth at monitoring station. X-axis indicates cm of growth over time. Y-axis indicates four quadrants where measured on each station.

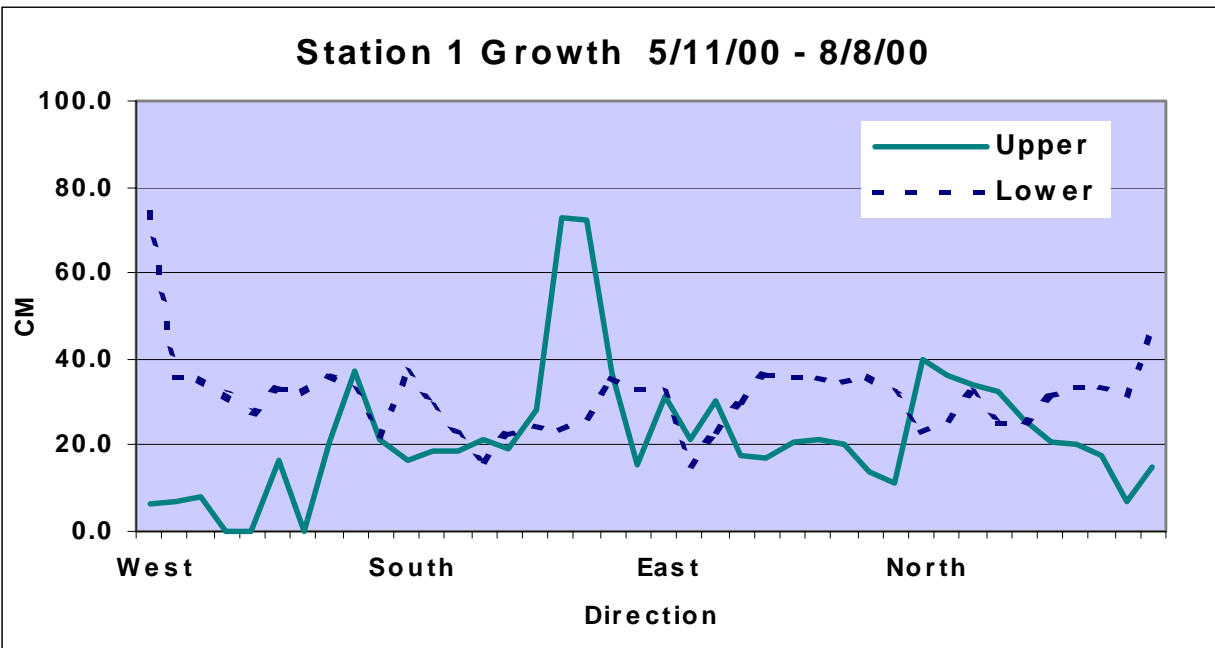

Figure 9.9. Summary of growth measurements taken at station 1 from 5/11/00 - 8/8/00. Comparison shows ten measurements of upper and lower growth at monitoring station. X-axis indicates cm of growth over time. Y-axis indicates four quadrants where measured on each station.

Figure 9.10 shows that the upper portion of the colony on station 3 (solid line) grew up to 62.7 cm on the east quadrant and 62.8 cm on the west quadrants in the first three-month time period. Figure 9.10 also shows that the lower portion of the colony on the west side of station 3 (dotted line) grew 63.4 cm, while the other quadrants did not exceed 40 cm of growth in that same time period.

A comparison of Figures 9.7 through 9.10 indicates that there is a difference between stations 1 and 3; there are also differences between quadrants measured. Station 3 appears to have had the greatest growth over the first three-month period, however, with nearly uniform growth and no specific quadrant affected by other spatial or environmental parameters. In some cases, there were areas where the colony grew over itself, and it was difficult to distinguish growth from settlement on this column.

In September, one month after the second removal of all growth and encrusting organisms at stations 1 and 3 and first removal of all growth at stations 2 and 4, growth data was recorded and evaluated as previously discussed. This time period occurred between 8 August and 13 September 2000. Figures 9.11 through 9.14 show a comparison of the upper and lower averages of apparent growth measurements taken at each quadrant at stations 1 through 4 over this one-month time period.

Figure 9.11 shows that average growth on the upper portion (lighter shaded areas) of station 1 ranged between 4.4 cm in the west quadrant and 18.4 cm in the north quadrant. Figure 9.11 also shows that average growth on the lower portion (darker shaded areas) of station 1 ranged between 5.3 cm in the south quadrant and 18.0 cm in the east quadrant.

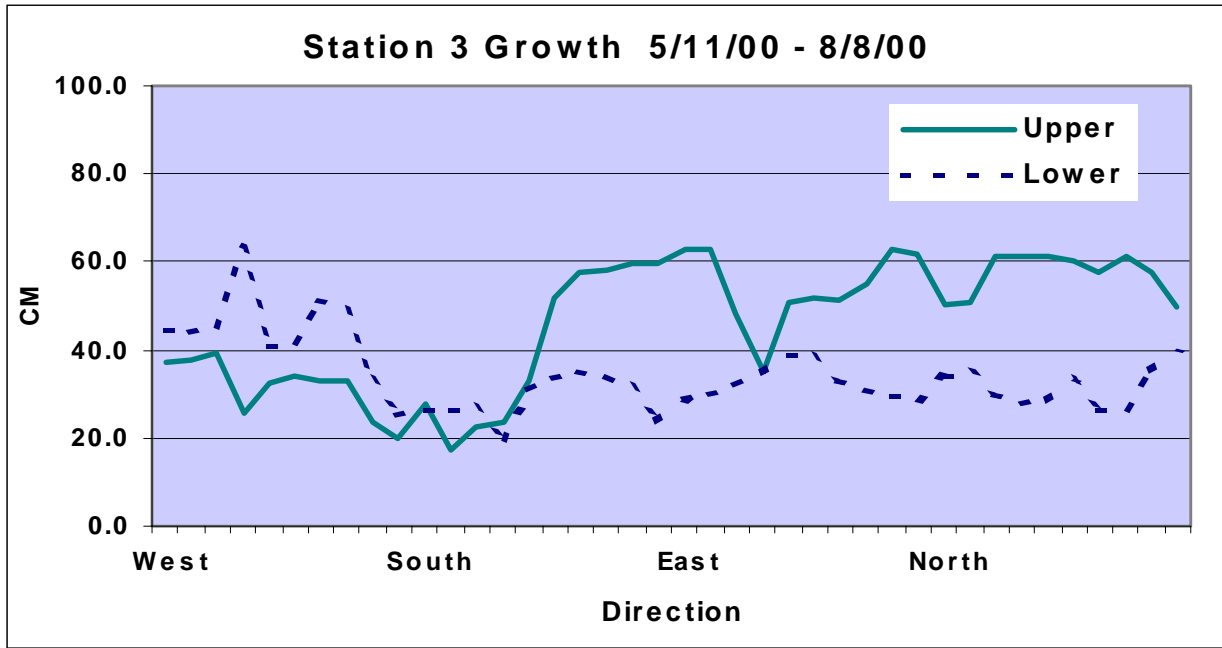

Figure 9.10. Summary of growth measurements taken at station 3 from 5/11/00 - 8/8/00. Comparison shows ten measurements of upper and lower growth at monitoring station. X-axis indicates cm of growth over time. Y-axis indicates four quadrants where measured on each station.

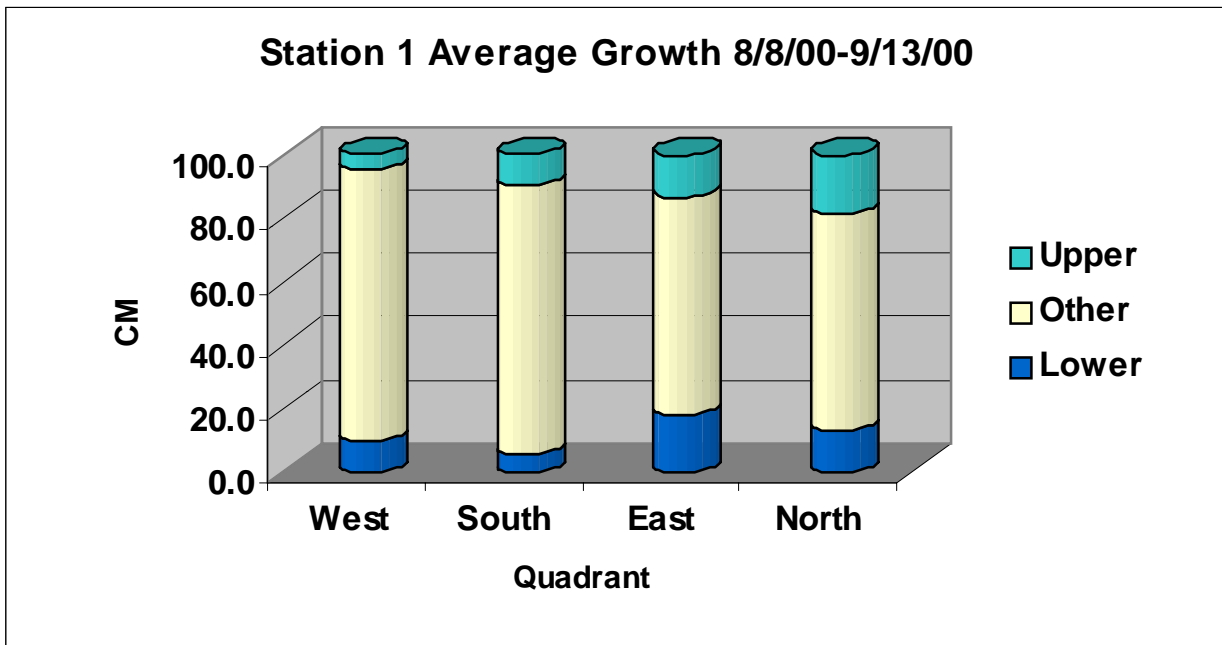

Figure 9.11. Average growth measured at station 1 from 8/8/00 - 9/13/00. Comparison shows upper and lower growth at monitoring station. X-axis indicates cm of growth over time. Y-axis indicates four quadrants where measured on each station.

Figure 9.12 shows that average growth on the upper portion (lighter shaded areas) of station 2 ranged between 7.0 cm in the south quadrant and 17.7 cm in the north quadrant. Figure 9.12 also shows that average growth on the lower portion (darker shaded areas) of station 2 ranged between 8.3 cm in the south quadrant and 17.3 cm in the north quadrant.

Figure 9.13 shows that average growth in the upper portion (lighter shaded areas) of station 3 ranged between 6.5 cm in west quadrant and 16.7 cm in east quadrant. Figure 9.13 also shows that average growth on the lower portion (darker shaded areas) of station 3 between quadrants ranged between 18.6 cm in west quadrant and 20.1 cm in east quadrant. All growth measurements at station 3 appeared to be nearly uniform between upper and lower sampling areas.

Figure 9.14 shows that average growth in the upper portion (lighter shaded areas) of station 4 ranged between 4.2 cm in the north quadrant and 19.3 cm in the south quadrant. Figure 9.14 also shows that average growth in the lower portion (darker shaded areas) of station 4 ranged between zero growth in the north quadrant and 13.0 cm in the south and west quadrants. There was less growth in all four quadrants of station 4 compared to the other three stations. There may be some other factors influencing growth at this station, which is discussed below.

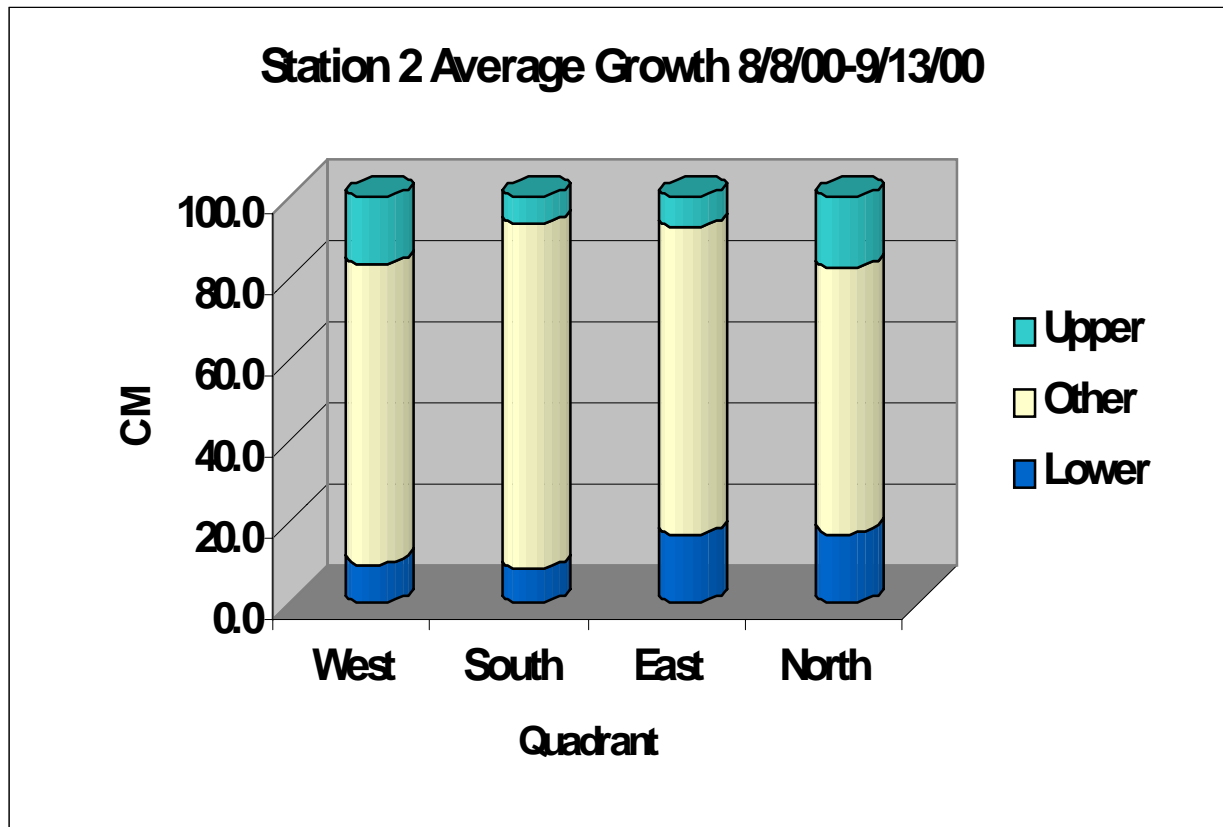

Figure 9.12. Average growth measured at station 2 from 8/8/00 – 9/13/00. Comparison shows upper and lower growth at monitoring station. X-axis indicates cm of growth over time. Y-axis indicates four quadrants where measured on each station.

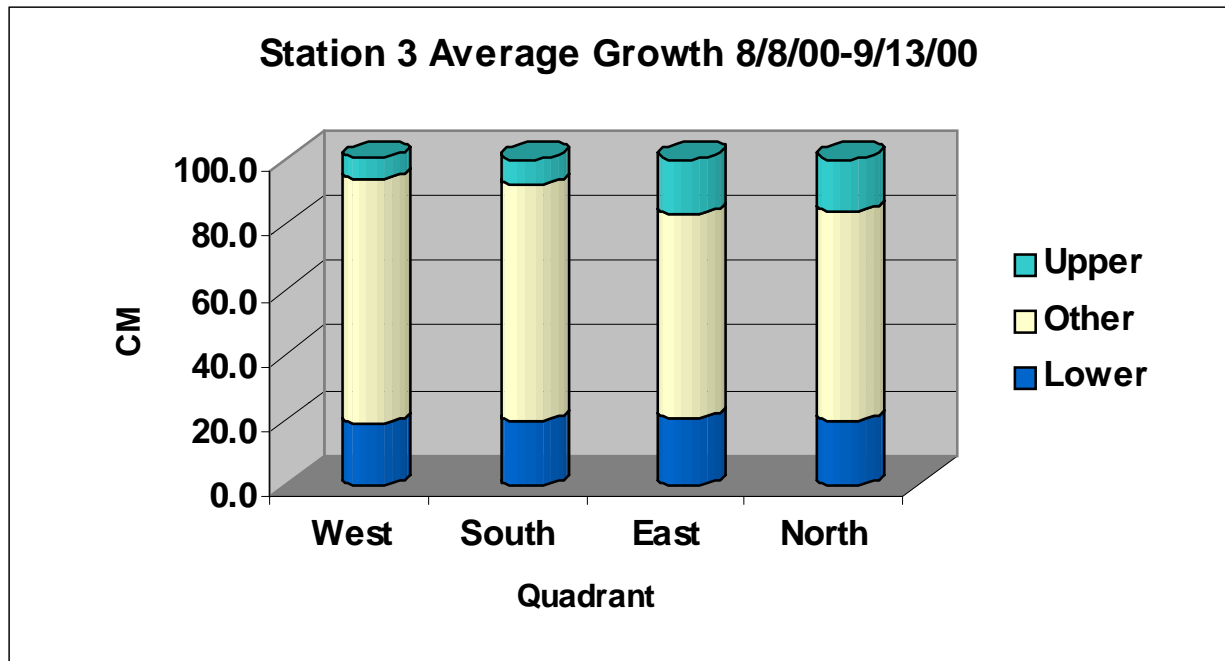

Figure 9.13. Average growth measured at station 3 from 8/8/00 – 9/13/00. Comparison shows upper and lower growth at monitoring station. X-axis indicates cm of growth over time. Y-axis indicates four quadrants where measured on each station.

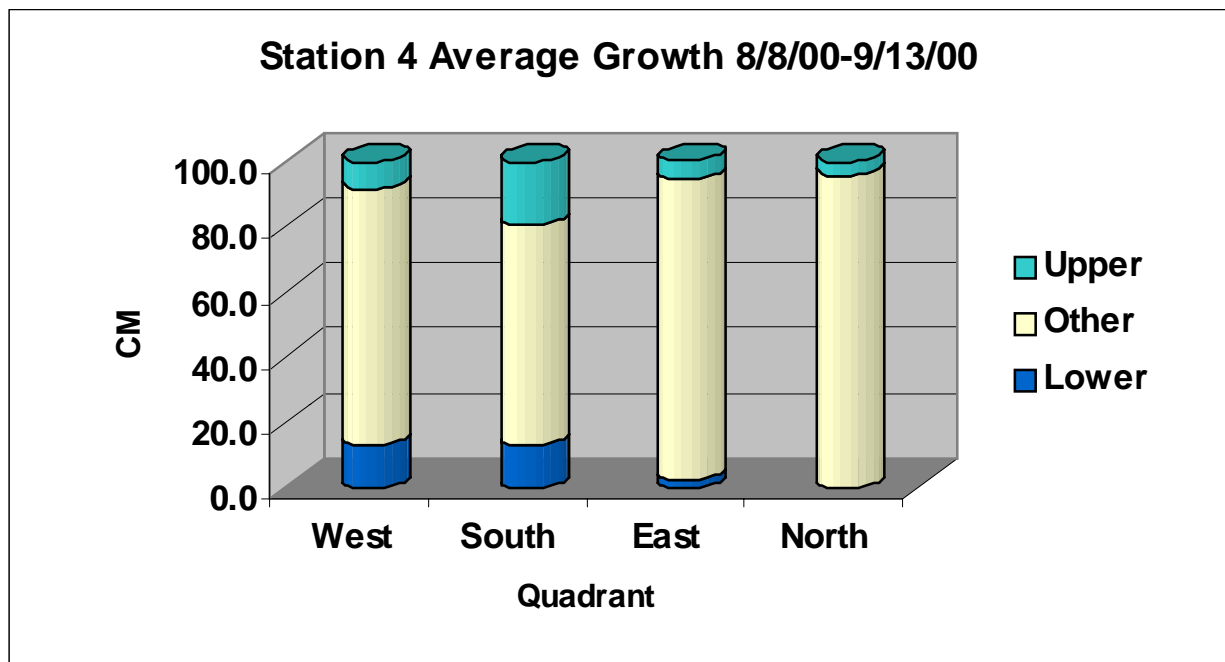

Figure 9.14. Average growth measured at station 4 from 8/8/00 – 9/13/00. Comparison shows upper and lower growth at monitoring station. X-axis indicates cm of growth over time. Y-axis indicates four quadrants where measured on each station.

DISCUSSION

Although this preliminary interpretation of the data collected to date only reflects two sampling efforts and is incomplete, there are some indications of the growth rate over time of this species at these four sampling stations set up between May and August 2000. The greatest amount of growth occurred over the three-month time period at stations 1 and 3. These results would be expected in the GOM between May and August, however, as water temperatures are highest during summer months and provide the most favorable environment for growth.

Further investigation into the actual location of each sampling station, however, appears to be causing some variation in the growth measured in each quadrant. Review of the location of each station shows that the larger diameter outer legs (91 cm in diameter) of the structure may be influencing growth rates on the quadrant nearest to this interference in current flow or available sunlight. Figure 9.3 shows that station 1 is situated on the inside horizontal cross-member near the outer vertical leg on the west side of the reef structure. Any restriction or increase in the current velocity flowing between the outer vertical leg and the inner horizontal cross-member where station 1 is situated may be magnified on the west quadrant. A review of the station 1 data from both sampling periods shows that there was less growth on the west and the south quadrants, which may or may not be attributed to influences from the outer vertical leg on the west side of the structure.

Station 3 is located somewhat further away from the influences of the outer vertical leg on the east side of the structure. Almost uniform growth or over-growth of the colonies occurred at station 3 (Figure 9.4) during the first three-month time period. A review of the data evaluated after the one-month time period between August and September at station 1 (Figure 9.11) and 3 (Figure 9.13) shows that these same trends continued.

Stations 2 and 4 are also situated in locations where the outer larger diameter (91 cm) legs of this eight-leg reef structure might be causing some variation in the growth measured in some quadrants. Growth on the south side of station 2 was less than growth in other quadrants and may be influenced by the larger diameter vertical leg on the south-east side of the reef. A comparison of all stations showed that the least growth occurred at station 4. There was almost no growth in the first month at station 4 in the north and east quadrants, which may be influenced by the larger diameter vertical leg on the north-east side of the reef structure. However, the slower growth rate at station 4 may also be influenced by other variables that we have not explored at this time.

SUMMARY

Average growth on the High Island A-532 Reef appears to be between 20 and 70 cm in all quadrants, from both upper and lower monitoring areas at stations 1 and 3 during the initial three-month sampling period. There was between 5 and 20 cm growth in each quadrant at these two stations during the following one-month sampling period. Average growth at station 2 was comparable to growth at stations 1 and 3. Station 4 had the least growth of all the stations. No change in cover or dominance was observed at the control station over the one-month sampling

period. Monitoring will continue at these five stations over the next year. Further interpretation of these data, and future data collected at this reef site will be reported as it becomes available.

ACKNOWLEDGMENTS

This monitoring study has been funded by Texas Parks and Wildlife Artificial Reef Program and began as routine pre- and post-construction surveys as per Corps of Engineers Permit requirements. However, the bulk of the underwater video recording has been carried out by Artificial Reef Biologist Douglas Peter and by Artificial Reef Research Specialist John Embesi, whose invaluable scientific diving experience and enthusiasm were essential in collecting the data for this growth study. Both of these artificial reef program staff have significantly contributed to loading the video data into AUTOCAD, assisting with figures, and providing computer and diving support for the completion of this report. We would also like to acknowledge other scientific divers from state agencies who contributed their time to this study: Bryan Eastham, James Sinclair, Chad McNutt, and Michael Weeks. We would also like to acknowledge the many scientific divers from Texas A&M University at both Galveston and Corpus Christi who have collected data offshore for the Artificial Reef Program on this study: Dr. Donald Harper, Sara Williams, Christi McDaniels, David Atkinson, Gavin Hogge, Tom Turner, Josh Harper, David Costa, Dr. Andre Landry, Dr. Jay Rooker, David Wells, Dr. Quenton Dokken, Tom Bates and Matthew Campbell. Special thanks go to Scott Godwin at the Bishop Natural History Museum in Hawaii for collecting *Didemnum perlucidum* samples for the comparisons that were made between Gulf and Pacific specimens. Special thanks also go to Dr. Gretchen Lambert from University of Washington, Friday Harbor Laboratories for her time and review of all specimens and final verification of this species. And special acknowledgement goes to Dr. Donald Harper, whose encouragement to study and investigate the effects of an introduced species to the GOM has been the basis for this study.

REFERENCES

- Bak, R.P., D.Y. Lambrechts, M. Joenje, G. Nieuwland, M.L. Van Veghel. 1996. Long-term changes on coral reef in booming populations of a competitive colonial ascidian. *Mar. Ecol. Prog. Ser.* 133: 303-306.
- Chapman, J.H. 1988. Invasions of the northeast Pacific by Asian and Atlantic gammaridean amphipod crustaceans, including a new species of *Corophium*. *J. Crustacean Biol.* 8:354-382
- Coles, S.L., R.D. Defelice, L.G. Eldredge, and J.T. Carlton. 1999. Historical and recent introduction of non-indigenous marine species in Pearl harbor, Oahu, Hawaiian Islands. *Mar. Bio.* 135:147-158.
- Dauterive, L. 2000. Personal communication from Minerals Management Service database and reports. New Orleans, LA.
- Dokken, Q., K. Withers, S. Childs, T. Riggs. 2000. Report Funded by Texas Parks and Wildlife: Characterization and comparison of platform reef communities off the Texas coast. (TAMU-CC-

- 0007-CCS) Texas A&M University, Center for Coastal Studies, Corpus Christi, TX. (September unpublished)
- Godwin, S. 2000. Personal communication on geographic information and collection of pacific samples of *Didemnum perlucidum* in Hawaiian harbors. Bishop Natural History Museum of Science. Oahu, Hawaii.
- Hedgepeth, J.W. 1953. An introduction to the zoogeography of the northwestern Gulf of Mexico with references to the invertebrate fauna. Public. Inst. Mar. Sci. Univ. Texas 3(1):107-224.
- Lambert, G. 2000. Personal communication on identity and range of *Didemnum perlucidum*. University of Washington, Friday Harbor Laboratories.
- Millar, R.H. 1971. The biology of the ascidians. Adv. Mar. Bio. 9:1-100.
- Monniot, F. 1983. Ascidiés littorales de Guadeloupe. I. Didemnidae. Bull. Mus. Natn. Hist. Nat. Paris. 4(5): 5-49.
- Monniot, F. 1995. Ascidiés de Nouvelle-Caledonie. XV. Le genre *Didemnum*. Bull. Mus. Natn. Hist. Nat., Paris. 4(16): 299-344.
- Monniot, C. and F. Monniot. 1987. Les Ascidiés de Polynésie Française. Mem. Mus. Natn. Hist. Nat., Paris. A. Zool.136:1-156.
- Monniot, C. F. Monniot, and P. Laboute. 1991. Coral Reefs of New Caledonia. Editions De L Orstom. Inst. Français de Recherche Scientifique pour le Développement en Coopération. Paris.
- Plough, H.P. 1978. Sea Squirts of the Atlantic Continental Shelf from Maine to Texas. Johns Hopkins University Press, Balt. MD.
- Rabalais, N.N. 1975. The ascidians and associated fauna in the Gulf of Mexico along a portion of the Texas Coast. Unpubl. M.S. Thesis, Texas A&I Univ. Kingsville.
- Rezak, R., T. Bright, and L. Peguegnat. 1995. Reefs and Banks of the Northwestern Gulf of Mexico, Their Geological, Biological and Physical Dynamics. John Wiley & Sons, Inc. New York.
- Valentine, J.W. 1963. Biogeographic units as biostratigraphic units. Bull. Am. Assoc. Petro. Geol. 47(3): 457-466.
- Van Name, W.G. 1945. The North and South American ascidians. Bull. Am. Mus. Nat. Hist. 84:1-474.

Van Name, W.G. 1954. The tunicata of the Gulf of Mexico. *In* Gulf of Mexico: Its origin, waters, and marine life. U.S. Fish. Bull. 55:495-497.

Williams, H.F. 1951. The Gulf of Mexico adjacent to Texas. Tx. J. Sci. 3:237-250.

REEF BALLS™: HOW COMBINING DESIGNED REEFS WITH OIL SUPERSTRUCTURES USED AS ARTIFICIAL REEFS CAN HELP THE OVERALL REEF SYSTEM TO BETTER MIMIC NATURAL REEF SYSTEMS*

Todd Ryan Barber
President, Reef Ball Development Group, Ltd.
Chairman, Reef Ball Foundation, Inc.

ABSTRACT

Reef Balls are state of the art designed artificial reefs used primarily to restore ailing reefs or to create new reefs for ecological enhancement, fishing, scuba diving, and many other specific end use goals. Reef Balls have been used in over 1,000 projects worldwide with over 100,000 Reef Balls deployed and functioning as reef ecosystems. Reef Balls are the most widely used designed artificial reef system in the world. When combined with higher profile structures, especially superstructures such as oil platforms and rigs used as artificial reefs, the resulting reef can be turned to more closely match natural reefs. Reef Balls have been used in the Arabian Gulf and Asia by several oil companies to help in this regard. Although Reef Balls have been widely used in the Gulf of Mexico, they have yet to be combined with Oil superstructures to gain the same advantages.

Reef Balls are not artificial reefs, but rather are a new category of reef enhancement called, “Designed Reefs.” Designing modules to specifically match goals and expectations of scientists, reef managers and reef builders is afforded by the flexibility of Reef Balls allowing high profile structures to be augmented to produce, rather than just attract fish. Therefore, when compared to building an artificial reef from only an oil structure, it is possible to define the expected goals of the combination of structures and designed materials to best meet specific objectives. In the past, many reefs were built simply “to improve the marine environment” under the assumption that because fish and other forms of life were present that the reefs were performing a positive function. Increasingly, reefs are built for very specific goals because the science of reef building is rapidly advancing. Even when the goal is simply “to improve the marine environment” we now know an accepted criteria of measurement is to gauge the species diversity and population densities of all life of nearby natural reefs as compared to the constructed reefs. Designed reefs combined with larger profile materials are useful tools to allow scientists, reef managers, and reef builders to achieve this goal. When used in conjunction with oil rigs and other high profile structures, Reef Balls can effectively provide the additional habitat required to service the large populations of fish that are attracted to high profile structures without the associated reef biomass. This can lead to a reef that more closely mimics natural reefs and therefore is more broadly accepted by scientists, politicians and the public.

Reef Balls are internationally patented and/or copyrighted technologies that allow nearly all natural reef features to be mimicked. Variables which can be adjusted to meet natural conditions include: 1) stability, 2) void spacing, 3) hole sizing, 4) hole complexity, 5) surface texture, 6) surface

*This abstract is provided although the presentation was canceled.

chemical composition (i.e. pH, exposed aggregates, etc.), 6) bottom features, 7) subsidence variables, 8) overall weight, 9) size of units in both height and width, 10) interconnection of holes, 12) layout or spacing on the sea floor, and 13) density of units and proportioning of sizing ratios, and many other minor factors. In addition to being highly adaptable, Reef Balls are often the least expensive alternative due to a technology that allows placement without expensive barges, tugs or cranes, high surface area, and life expectancies of well over 500 years.

RED SNAPPER SITE FIDELITY TO, AND SPEED OF MOVEMENT FROM, ARTIFICIAL REEF SITES OFF ALABAMA IN THE NORTHERN GULF OF MEXICO

William F. Patterson
James H. Cowan
Robert L. Shipp
Department of Marine Sciences
University of South Alabama

ABSTRACT

A tagging study of red snapper *Lutjanus campechanus* was conducted in an extensive artificial reef area in the northern Gulf of Mexico (GOM) to estimate their site fidelity to, and movement from, individual reefs. A total of 2,932 red snapper was tagged with internal anchor tags during 28 tagging trips made to nine artificial reef tagging sites from March 1995 to July 1998. Recaptures of tagged fish were made on subsequent tagging trips by the authors ($n = 235$) and were reported by recreational and commercial fishers ($n = 359$ through September 2000). Annual site fidelity of tagged fish to individual reefs was estimated with non-linear decay models of the decline in recaptures made at tagging sites over time; site fidelity estimates ranged from 21 to 26 % yr⁻¹. Unbiased estimates of distance and speed of movement were obtained with the delta method. Mean distance of movement was 29.1 km and mean speed of movement was 73.9 m d⁻¹. Results indicate that red snapper demonstrate lower site fidelity to reef sites than previously reported. Low site fidelity may explain spatial and temporal variability in red snapper biomass observed around artificial reefs and has important implications for managers considering marine protected areas as a means to increase red snapper spawning stock biomass.

INTRODUCTION

Red snapper *Lutjanus campechanus* are large, piscivorous reef fish that occur as far north as Massachusetts, but generally are found from North Carolina to the Yucatan Peninsula, including the waters of the GOM but not the Caribbean Sea (Hoese and Moore 1998). Red snapper are valued as both game and food fish throughout their range and are perhaps the most targeted fish in the U.S. GOM (Minton and Health 1998; Stanley and Wilson 1989,1990). In the GOM, red snapper are managed as a single stock that supports economically valuable commercial and recreational fisheries. The stock is currently estimated to be overfished and has been managed since the early 1990s intensively to rebuild spawning stock biomass. Despite overfished status, GOM red snapper total landings averaged (\pm SE) 3.96×10^3 metric tons (± 1.16) from 1995 to 1998 (Schirripa and Legault 1999).

Dating back to the 1800s, it appears that the historic center of GOM red snapper abundance was off northwest Florida (Camber 1955; Collins 1885; Goodyear 1995; Stearns 1884). The early commercial fishery followed a pattern of fishing down a given area and seeking new fishing grounds (Collins 1885; Stearns 1883). By the 1950s about half of reported U.S. commercial landings were taken from the Campeche Banks off Mexico (Camber 1955; Carpenter 1965; Goodyear 1995), a trend which continued until Mexico closed the banks to the U.S. fleet in 1980 (Goodyear 1995). The

early development of the recreational fishery is not as well documented; however, by the 1950s a significant charterboat fishery had developed in northwest Florida (reviewed in Goodyear 1995). By the early 1970s, recreational fishers GOM-wide were making nearly 4×10^5 trips per year targeting red snapper aboard private and chartered fishing boats (Nakamura 1976).

It appears from fisheries-dependent data that there are currently two centers of GOM red snapper abundance, one in the northwestern GOM off southwest Louisiana (LA) and a second in the north central GOM off Alabama and Mississippi (ALMS) (Goodyear 1995; Schirripa and Legault 1999). From 1995 to 1998, the average percentage of total GOM commercial landings (\pm SE) from waters off southwest LA was 56.5% (\pm 0.54) and the average percentage of total recreational landings from waters off ALMS was 31.1% (\pm 3.08) (Schirripa and Legault 1999). (Note: Commercial landings comprised 48% of total GOM landings from 1995 to 1998, while recreational landings comprised 52%.) What makes these two areas unusual as centers of reef fish production is that the seafloor of both is composed mostly of sand and mud sediments (Curry 1960; Fisk and McFarlane 1955; Luddick 1964; Parker *et al.* 1983). The most pronounced seafloor relief is associated with shelf-edge reef pinnacles and hardground ledges (LA and ALMS), and salt-dome uplifts (LA only), but the near-shore shelf is generally depauperate of natural reef substrate (Curry, 1960; Parker *et al.* 1983; Schroeder *et al.* 1995).

Most of the near-shore reef habitat off LA and ALMS is in the form of artificial reefs (Stanley and Wilson 1990; Szedlmayer and Shipp 1994). Therefore, the red snapper fisheries in these areas are prosecuted predominantly over artificial reefs (Minton and Heath 1998; Stanley and Wilson 1990, 1991; Szedlmayer and Shipp 1994). In the case of LA, over 3,000 offshore petroleum platforms serve as *de facto* artificial reefs and have increased the near-shore habitat available to reef fishes (Figure 9.15) (Bull and Kendal 1994; Gallaway 1984; Stanley and Wilson 1990, 1991). Reggio (1987) estimated that 70% of LA recreational fishing trips farther than three miles from shore targeted fishes at petroleum platforms. Stanley and Wilson (1990) reported the composition of catches made at petroleum platforms off LA shifted from the late 1970s from one predominated by drums (Family: Sciaenidae) to one predominated by red snapper.

Petroleum platforms are not as concentrated off ALMS as they are in the northwestern GOM (Figure 9.15), but the state of Alabama claims the largest artificial reef program in the U.S. (Minton and Heath 1998). Off the coast of Alabama exists an area of over 3,100 km² that has been designated for artificial reef construction (Figure 9.16). It is estimated that over 20,000 artificial reefs have been deployed off Alabama since the start of the program in 1953 (Minton and Heath 1998; Patterson 1999). Proponents of Alabama's artificial reef program cite high catches of red snapper and a profitable sport fishing industry as evidence of a successful and beneficial program (Minton and Heath 1998; Shipp 1999); however, little research has focused on the effect of Alabama's artificial reefs on the population ecology of red snapper.

As part of a larger research program aimed at understanding the effect of artificial reefs on the production and fisheries ecology of red snapper, we conducted a tagging study over artificial reefs off Alabama. One objective of the study was to sample fixed artificial reef sites repeatedly over a three-year period to estimate site fidelity of adult red snapper to individual reef sites. A second objective was to test what factors significantly affected the distance and speed of fish movement

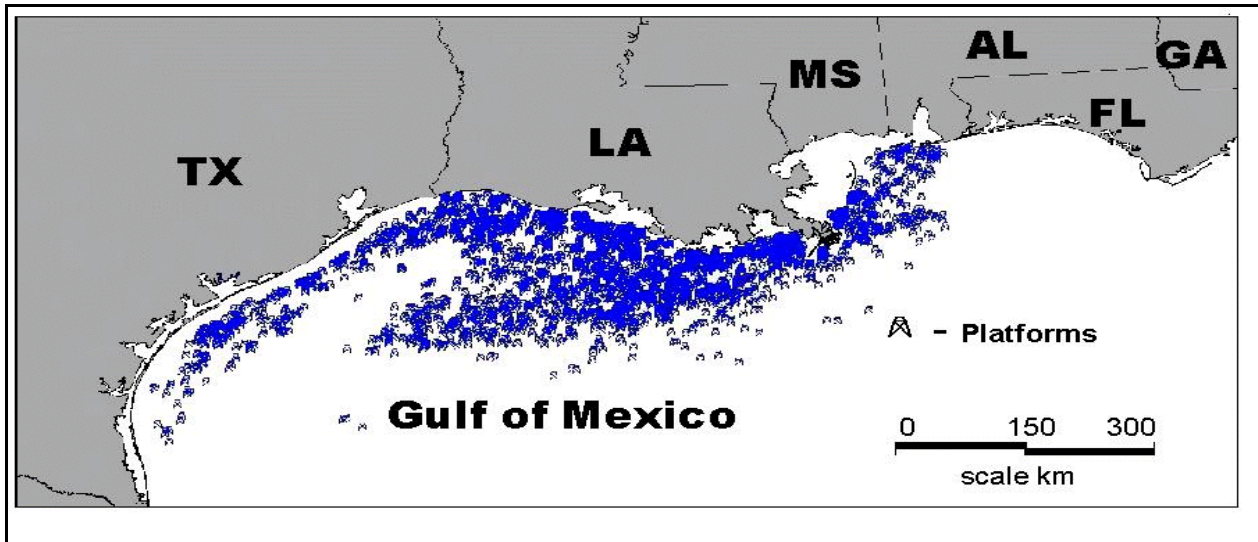

Figure 9.15. Map of existing petroleum platforms in the U.S. Gulf of Mexico (source: U.S. Department of Interior, Minerals Management Service, <http://www.mms.org>).

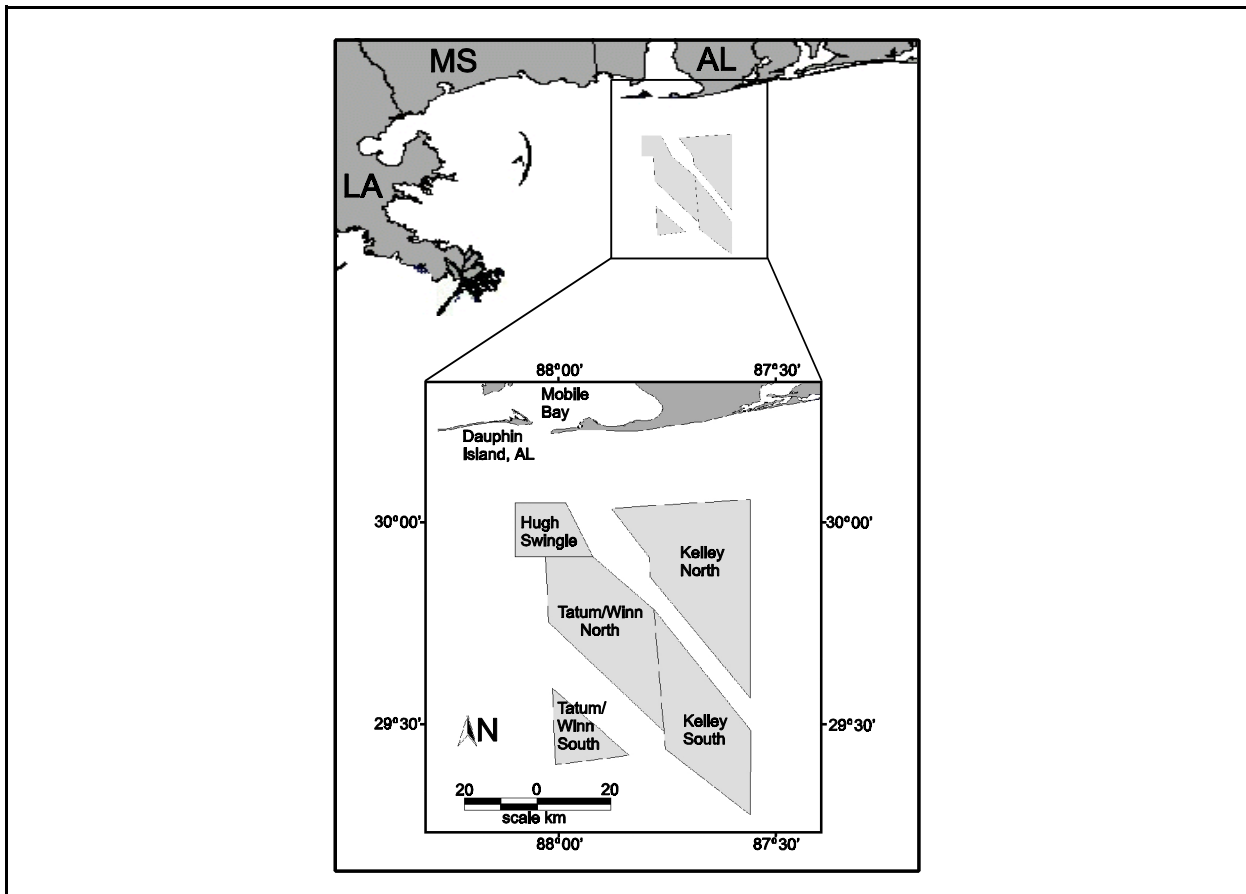

Figure 9.16. Map of artificial reef permit areas off the coast of Alabama in the northern Gulf of Mexico.

away from reef sites. Results are discussed in the context of red snapper fisheries ecology and the potential use of marine protected areas as a management tool.

METHODS

From March 1995 to July 1998, we tagged adult red snapper over artificial reef sites located in the Hugh Swingle General Permit Area off the coast of Alabama. Reef sites ($n = 9$) were located between 20 and 38 km south-southeast of Dauphin Island, Alabama (Figure 9.17). Reefs were constructed of a variety of materials by a charterboat operator 18 months prior to the start of the tagging study (Table 9.6). Reefs were deployed in a three-by-three grid, and each was designated by a compass heading that denoted its orientation within the grid (Figure 9.17). Individual sites were between 4 and 16 km apart and occupied similar depths within each row of the grid. Sites in the northern, central and southern rows were in approximately 21 m, 27 m and 32 m of water, respectively.

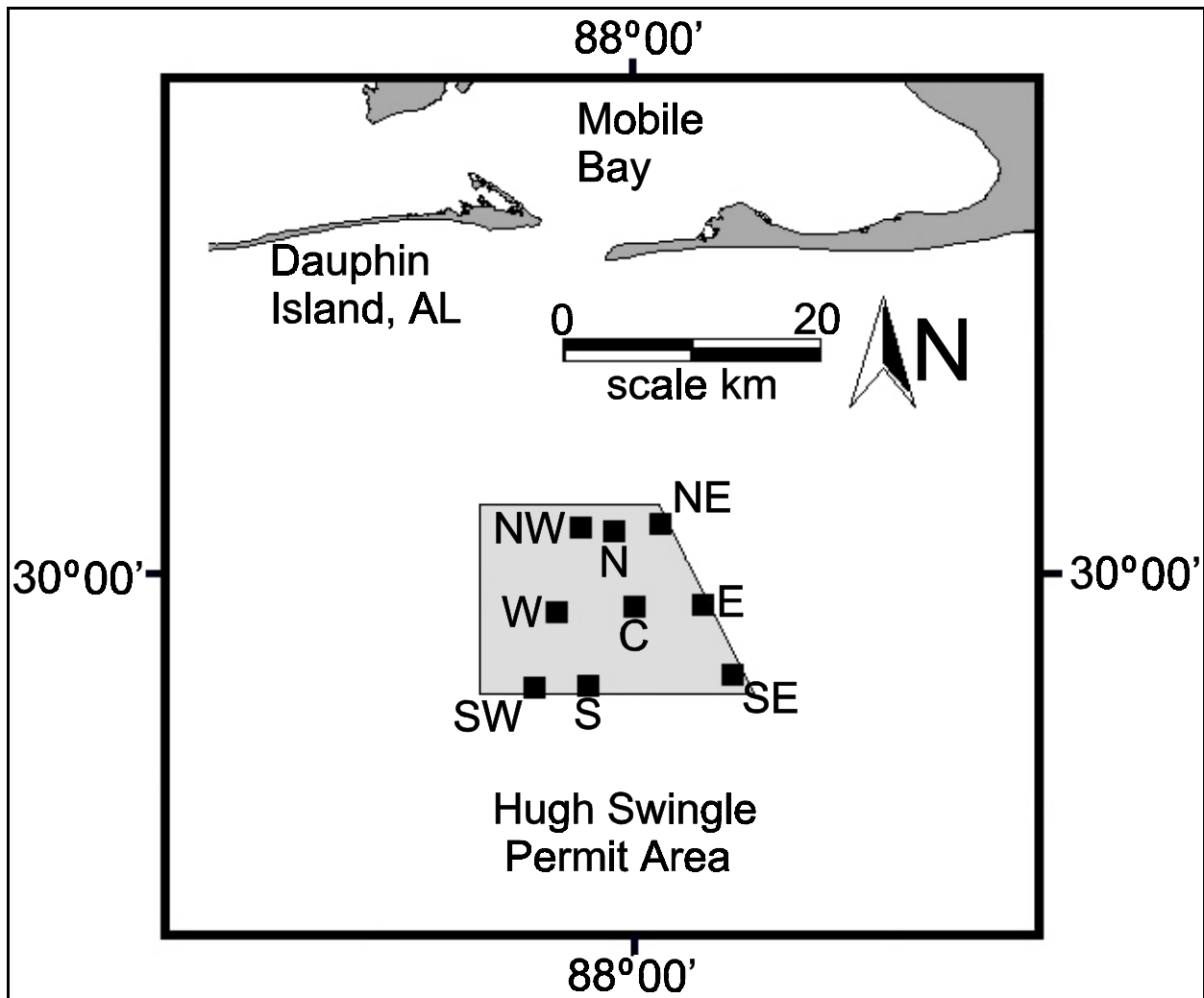

Figure 9.17. Map of the State of Alabama's Hugh Swingle permit area for artificial reef deployment with nine artificial reef sites over which red snapper were tagged.

Table 9.6. Composition and total volume of the nine artificial reef tagging sites.

Site	Composition of Artificial Reef	Volume m ³
NW	5 modules of 3, 209-l plastic drums	3.27
N	5 modules of 3, 209-l gallon plastic drums	3.27
NE	20 newspaper vending machines	3.78
W	25 newspaper vending machines	4.72
C	25 newspaper vending machines	4.72
E	24 newspaper vending machines	4.53
SW	20 newspaper vending machines	3.78
S	tractor trailer bed welded into a triangle	23.45
SE	15 washing machines	5.42

Our sampling platform was a charterboat that docked at Dauphin Island, Alabama. On each tagging trip, we attempted to visit at least three reef sites. While over each site, red snapper were captured with rod and reel and placed in holding tanks on deck. Each fish was measured (total length (TL) mm) and then tagged by inserting an internal anchor tag through a small (< 5mm) incision made with a scalpel in the abdominal cavity. Tags were yellow Floy FM-89 anchor tags and each was marked with a tag number, the word “reward,” and a phone number for fishers to report tag recoveries. We offered a \$5 reward for each tag return, with a chance to win \$500 in a drawing of tag returners. Once tagged, red snapper were either released immediately overboard or transported in holding tanks to other tagging sites for release.

Tagged fish were recaptured at tagging sites on subsequent tagging trips and were recovered by recreational and commercial fishers at sites other than tagging sites. Fish recaptured on tagging trips were measured and released, and as much information as possible was obtained from fishers’ recoveries. Data from fishers’ recoveries included tag number, date of capture, and exact location of capture (i.e., Loran C or GPS coordinates). TL at recapture also was obtained from fishers’ recoveries when it was possible to measure their carcasses.

Site Fidelity and Movement

To meet the assumption of independence, only data from terminal recaptures of fish recaptured more than once were used in statistical analyses of site fidelity and movement. *A priori*, factors of interest included TL at tagging, time at liberty, and transportation prior to release. An unplanned factor was added to the study when two strong hurricanes passed near the tagging sites. The center of Hurricane Opal with maximum winds of 200 km hr⁻¹ passed within 40 km of the tagging sites on 4 October 1995, and the center of Hurricane Georges with maximum sustained winds of 150 km hr⁻¹ passed

within 50 km of the tagging sites on 28 September 1998. It became apparent that movement of fish at liberty during the hurricanes was on a larger scale than fish not exposed to the storms. In statistical analyses of site fidelity, models were computed with and without fish that were exposed to hurricanes, and exposure to hurricanes was included as an independent variable to test the effect of hurricanes on the distance and speed of red snapper movement.

Site fidelity was estimated for all recaptures made at tagging sites, recaptures that were not at liberty during hurricanes, recaptures that were not transported prior to release, and recaptures that were not at liberty during hurricanes or transported prior to release. To estimate site fidelity, first the decline in recaptures made on tagging trips was estimated. Recaptures from all nine sites were grouped in intervals of days at liberty based on the average time between visits to individual reefs. Because there were fewer tagged fish available to be recaptured during each subsequent time interval, the number of recaptures made during a given time interval was adjusted by dividing the number of recaptures available by the total number of fish tagged. The decline in recaptures was estimated by fitting the following non-linear decay model to the adjusted distribution of recaptures with PROC NLIN in SAS (SAS, Inc. 1996):

$$N_t = N_1 e^{-Dt} \quad (1)$$

where: N_t = adjusted number of recaptures made in interval t
 N_1 = estimated number of recaptures in the initial interval
 D = instantaneous rate of decline in recaptures (d^{-1})
 t = time (d)

The units of D were converted from d^{-1} to y^{-1} by multiplying by 365 d. The instantaneous rate of decline in recaptures (D) is equal to the sum of total mortality (Z) and instantaneous emigration (Q). Total mortality (Z) is the sum of natural mortality (M) and fishing mortality (F); however, we assumed that no fishing mortality occurred at tagging sites (see discussion). Natural mortality (M) was estimated following Royce (1972) and Hoenig (1983), assuming a maximum age for GOM red snapper of 42 y (Szedlmayer and Shipp 1994).

$$M = 4.6/(\text{maximum age}) \quad (\text{Royce 1972}) \quad (2)$$

$$\ln(M) = 1.44 - 0.982 * \ln(\text{maximum age}) \quad (\text{Hoenig 1983}) \quad (3)$$

Having estimates of D and M , we solved for E by subtraction. Finally, annual site fidelity was estimated with the following equation:

$$SF = e^{-Q} \quad (4)$$

Distance of movement for fishers' recoveries was estimated as the distance between release sites and the Loran C or GPS coordinates where recoveries were made. Speed of movement was estimated as distance divided by time at liberty. In this approach, we assumed that each fish moved in a straight line from release site to recovery site and at a constant rate.

There were many zeroes in the distance of movement data (i.e., terminal recaptures made at tagging sites); therefore, the delta method was employed to obtain unbiased estimates of mean distance and mean velocity of movement (Aitchison 1955; Pennington 1983). To test the effects of time at liberty, TL at tagging, exposure to hurricanes, and transportation prior to release on distance of red snapper movement, and to test the effects of TL at tagging, exposure to hurricanes, and transportation prior to release on speed of movement, negative binomial regression models were computed with PROC GENMOD in SAS (Hilbe 1994; SAS, Inc. 1996). Distance and speed models were built using a forward stepwise approach in which regressions first were computed for each independent variable. The single variable model with the lowest significant p-value ($\alpha = 0.05$) was chosen as the base model. Individual variables were added in order of significance, and improvement of fit was assessed by testing if adding a variable significantly decreased the deviance of the model to which it was added (Agresti 1990). The model building process was complete when either no more significant variables were available to be added, or the addition of a variable did not significantly improve the fit of the model to which it was added.

RESULTS

From March 1995 to July 1998, we made 28 tagging trips and tagged 2,932 adult red snapper (Table 9.7). Of these fish, 2,053 were released at their tagging sites and 879 were transported to other tagging sites for release. Mean TL (\pm SE) of tagged fish was 335.1 mm (\pm 1.34) (Figure 9.18). From the start of the project until June 1998, the minimum legal size for possession of GOM red snapper for both commercial and recreational fisheries was 381 mm (15 inches) TL, but the size limit for the recreational fishery was increased to 457 mm TL (18 inches) TL from June through August 1998. Therefore, 80% of tagged fish ($n = 2,366$) were shorter than the legal size limit at the time of tagging.

Five hundred ninety-four recaptures of 550 red snapper were made through September 2000. Forty-two individuals were recaptured twice (23 second recaptures were made by fishers and 19 were made on tagging trips) and one individual was recaptured three times (all three recaptures were made on tagging trips). Of the 550 terminal recaptures, 264 fish were not at liberty during at least one hurricane; mean time at liberty was 623 days for fish exposed to hurricanes and 341 days for fish not exposed to hurricanes. Four hundred thirty-seven recaptures were not transported prior to release, and 113 recaptures were transported prior to release. Two hundred fourteen fish were recaptured on tagging trips, of which 191 recaptures were terminal recaptures. Three hundred fifty-nine recoveries were reported by fishers (fishers' return rate = 12.2%); however, recreational fishers reported 354 recoveries (recreational return rate = 12.0%) and commercial fishers reported only five (commercial return rate = 0.2%). Total Length at recapture was measured for all terminal recaptures made on tagging trips and for 97 (27.0%) recaptures reported by fishers (Figure 9.19).

Site Fidelity and Movement

All non-linear decay models of the decline in recaptures over time were highly significant ($p < 0.001$; $R^2 > 0.97$) (Figure 9.20). Estimated natural mortality from both the method of Royce (1972) and of Hoenig (1983) was 0.11. Estimates of annual site fidelity ranged from 21 to 26% y^{-1} (Figure 9.20).

Table 9.7. Dates of tagging trips, tagging sites samples, and number of red snapper tagged.

Date	Tagging Sites	Number Tagged	Date	Tagging Sites	Number Tagged
22Mar 1995	C, SE	94	7 Aug 1996	SE, NE, N	86
3 May 1995	N, NE, NW, C	107	31 Oct 1996	C, W, NW, SW	189
20 Jun 1995	W, S, SW	153	1 Nov 1996	NE, E, SE	152
21 Jun 1995	E, SE, C	118	12 Dec 1996	N, C, S	150
29 Aug 1995	SE, E, NE	129	9 Dec 1996	NE, E SE	122
13 Sep 1995	NW, W, SW	100	26 Mar 1997	NW, N, NE	114
14 Sep 1995	N, C, S	112	27 Mar 1997	SW, S, C	117
30 Nov 1995	S, SE, NW, C	107	29 Apr 1997	NW, N, NE	42
12 Dec 1995	N, SW	73	18 Sep 1997	NW, N, NE, E	147
27 Feb 1996	SW, W, NW	42	23 Sep 1997	C, SE, S	65
22 Mar 1996	N, C, S	41	3 Nov 1997	NW, N, NE	136
29 Mar 1996	NE, SE, E	38	5 Nov 1997	W, SW, S, C	186
1 May 1996	S, SE, C	37	25 Feb 1998	NW, N, NE	147
12 Jun 1996	SW, S, W, N, C	50	20 July 1998	NW, N, NE	104

Location of recapture was reported for 252 (70%) recoveries reported by fishers. The farthest distance an individual moved was 352 km (Figure 9.21), and the longest time at liberty was 1,501 d. Mean distance moved was 29.4 km (Figure 9.22a), and mean time at liberty was 409 d. Distance of movement single variable negative binomial regressions were significant for exposure to hurricanes ($\chi^2_{d.f=1} = 9,404.4$; $p < 0.001$), time at liberty ($\chi^2_{d.f=1} = 25.1$; $p < 0.001$) and TL at tagging ($\chi^2_{d.f=1} = 6.3$; $p = 0.013$), and not significant for transportation prior to release ($\chi^2_{d.f=1} = 0.21$; $p = 0.645$). The variable time at liberty was added to the single variable regression model testing the exposure to hurricanes' effect and lack of fit for the model was not significant ($\chi^2_{d.f=443} = 426.0$; $p = 0.711$). The addition of time at liberty to the exposure to hurricanes model significantly decreased the model's deviance ($\chi^2_{d.f=1} = 37.1$; $p < 0.001$). Total length at tagging then was added to the model, but its addition increased the model's deviance. Therefore, the final model included only exposure to hurricanes and time at liberty effects:

$$\text{Distance} = e^{-20.74 + 21.61*(\text{Cane}) + 23.99*(\text{TAL}) + \epsilon} \quad (5)$$

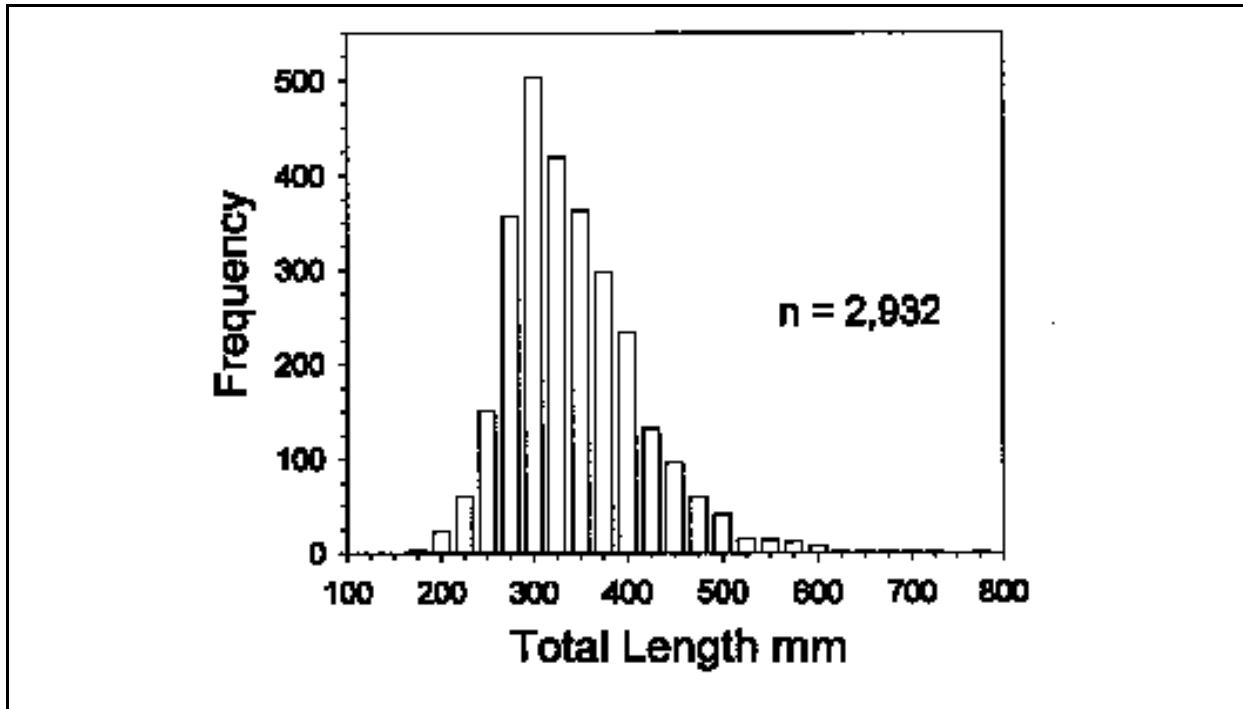

Figure 9.18. Distribution of total length at tagging of red snapper tagged in this study.

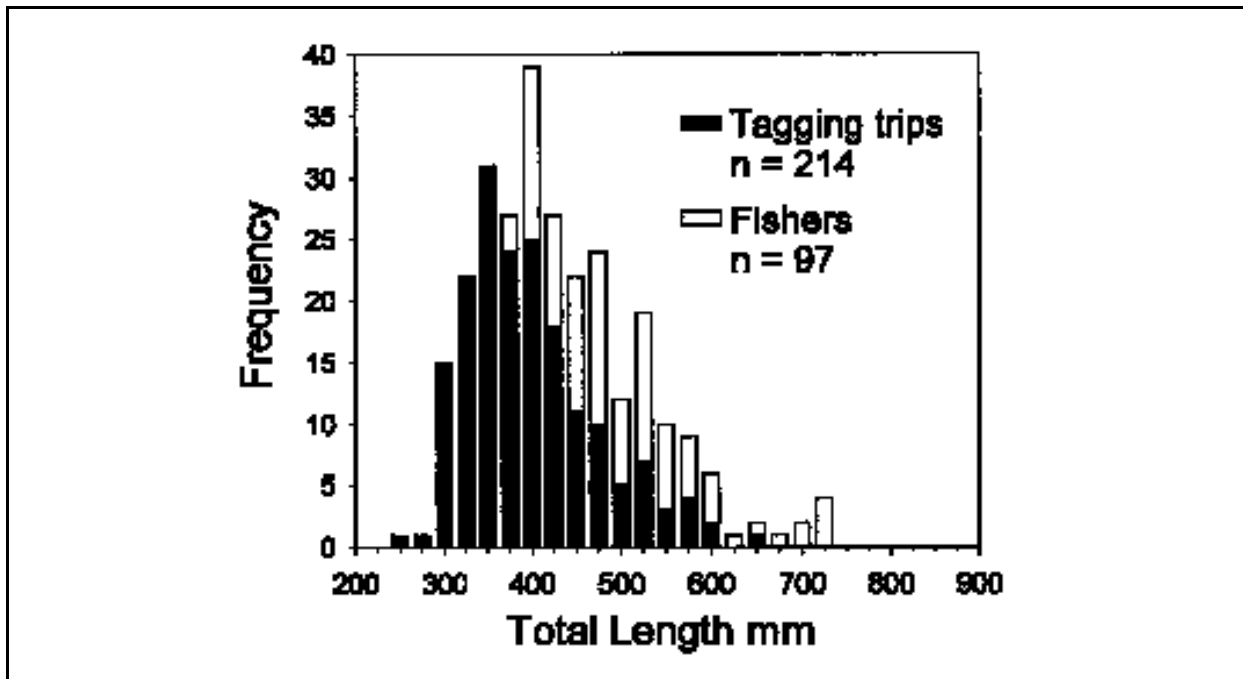

Figure 9.19. Distribution of total length at recapture of terminal recaptures at tagging sites (black bars, n = 192) and measured terminal recaptures from fishers (gray bars, n = 97).

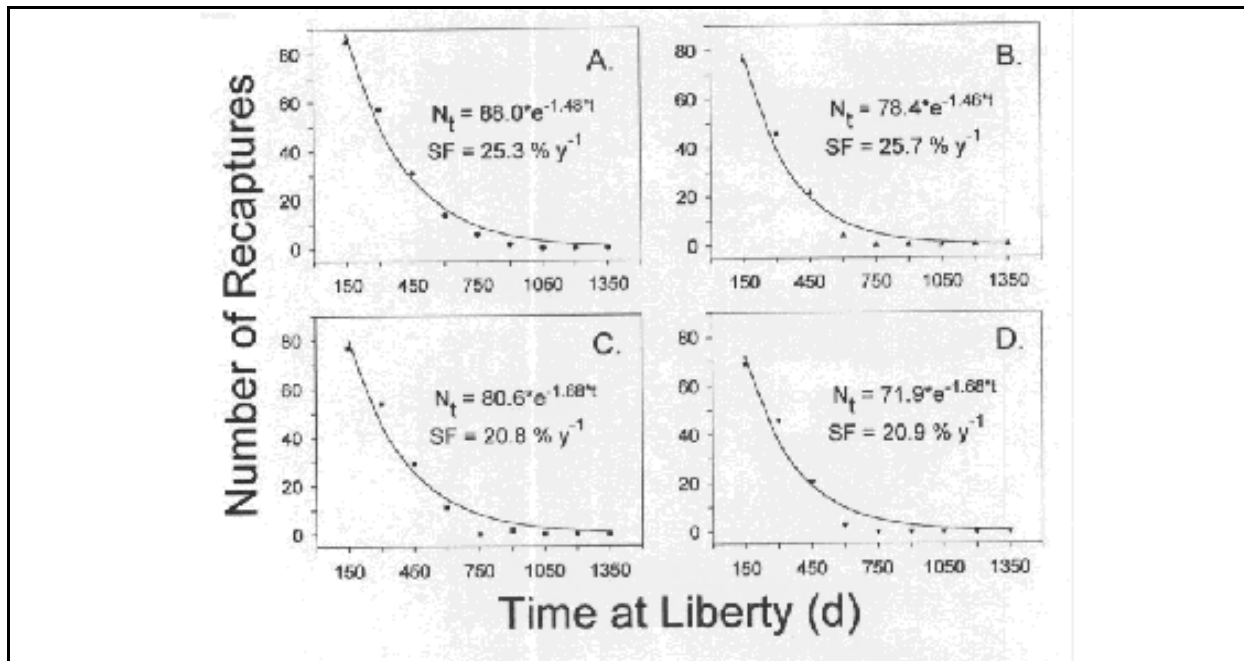

Figure 9.20. Distribution of number of recaptures made on tagging trips over time and fitted non-linear decay models for A. all terminal recaptures ($n = 191$), B. terminal recaptures not at liberty during hurricanes ($n = 149$), C. terminal recaptures not transported prior to release ($n = 172$), and D. terminal recaptures not at liberty during hurricanes or transported prior to release ($n = 139$). Fitted lines follow the model $N_t = N_0 e^{-Dt}$, where D is the instantaneous rate of decline y^{-1} and t is time in y . All models were highly significant ($p < 0.001$; $R^2 \geq 0.97$).

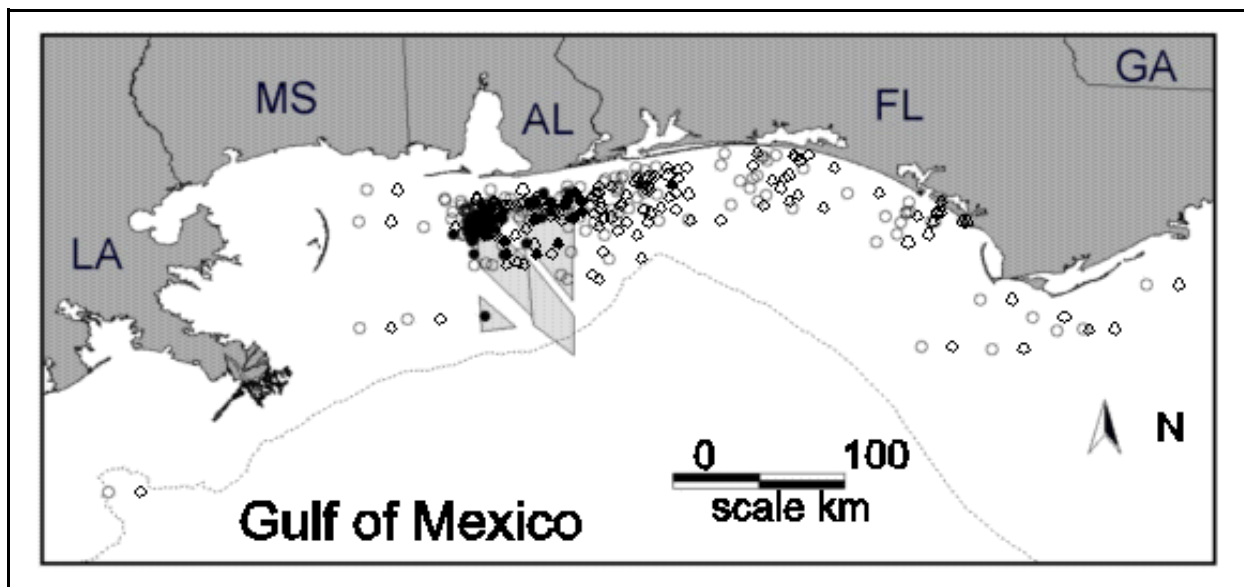

Figure 9.21. Spatial distribution of recaptures reported by fishers ($n = 251$). Open circles designate fish exposed to hurricanes ($n = 147$) and closed circles designate fish not at liberty during hurricanes ($n = 104$).

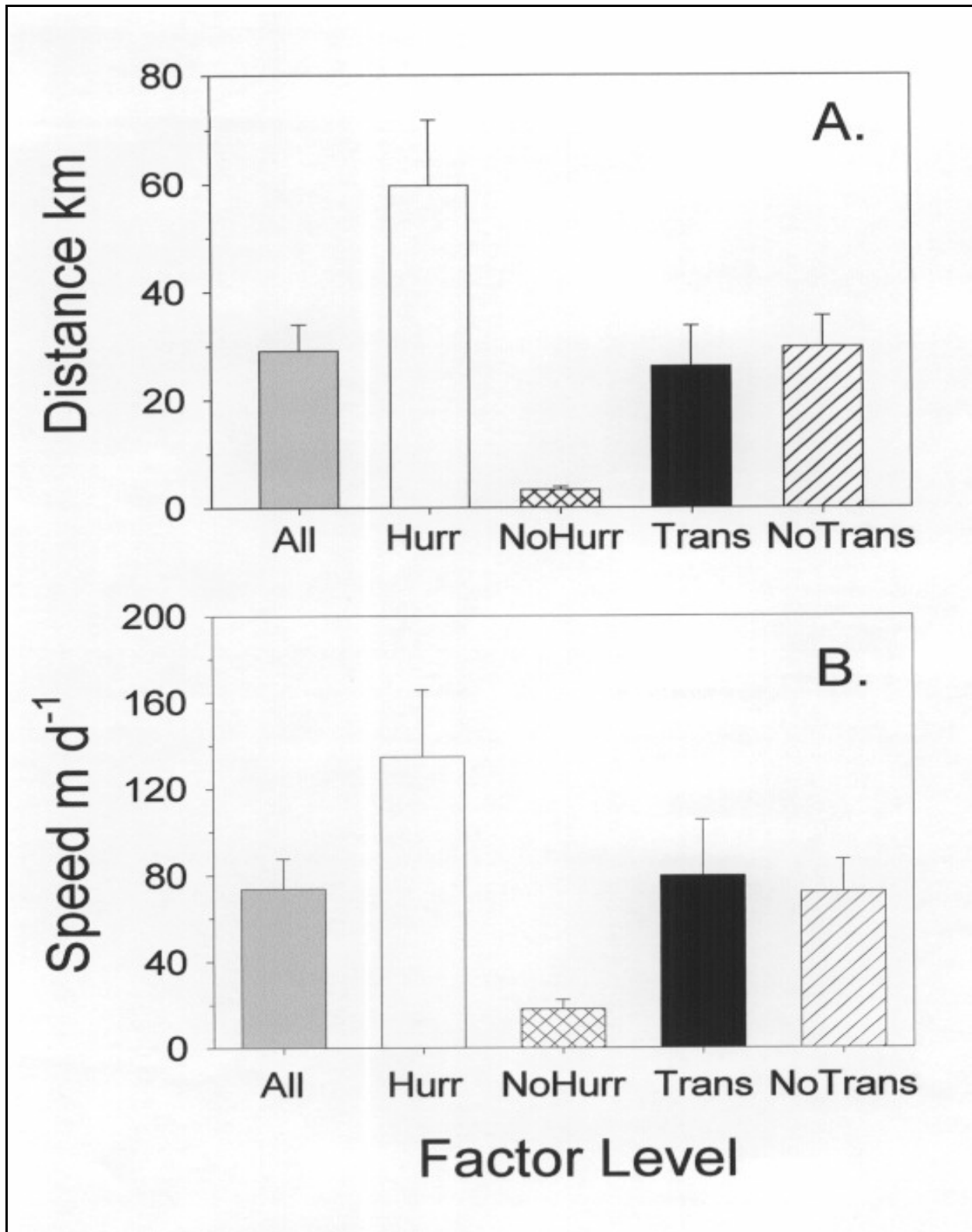

Figure 9.22. Delta method estimates of mean distance and mean velocity of movement. Error bars are standard error of the mean.

Mean speed of movement was 73.9 m d⁻¹ (Figure 9.22b). Speed of movement single variable negative binomial regressions were significant for exposure to hurricanes ($\chi^2_{d.f.=1} = 2,536.9$; $p < 0.001$) and TL at tagging ($\chi^2_{d.f.=1} = 4.0$; $p = 0.047$), and not significant for transportation prior to release ($\chi^2_{d.f.=1} = 2.7$; $p=0.102$). The addition of TL at tagging to the exposure to hurricanes model significantly increased the model's deviance. Therefore, the final model included only the hurricane effect:

$$\text{Speed} = e^{-20.78 + 18.541*(\text{Cane}) + \epsilon} \quad (6)$$

DISCUSSION

Authors of previous tagging studies of GOM red snapper generally concluded that adult red snapper displayed strong site fidelity and limited movement (Beaumariage 1969; Fable 1980; Szedlmayer and Shipp 1994; Szedlmayer 1997). Beaumariage (1969) and his colleagues tagged 1,126 red snapper off northwest Florida (FL) in the 1960s and reported tag returns from 315 fish. Mean time at liberty of reported recoveries was 113 d and most (90%) were made less than 5 km from release sites; however, several fish moved over 100 km. Fable (1980) tagged 299 red snapper at petroleum platforms off south Texas TX and reported 17 tag returns. He reported little movement away from platforms, but maximum time at liberty was only 253 days. Szedlmayer and Shipp (1994) tagged 1,155 red snapper over artificial reefs off Alabama in the early 1990s. They recovered 146 tagged fish, but were able to confirm location of recapture for only 37 returns. The greatest distance moved was 32 km and the maximum time at liberty was 430 days; mean time at liberty for all recaptures was 113 days. Szedlmayer (1997) released 26 red snapper that were tagged with ultrasonic transmitters over artificial reefs off Alabama. He was able to detect transmitters up to 1.8 km, and tracked movements of 19 fish for an average of 118 days before individuals were caught by fishers ($n = 14$), lost from the study area ($n = 5$), or the study ended. Maximum observed movement was 740 m for a fish that was tracked for 71 days before it was lost from the study area.

While many authors have reported high residence of red snapper on natural or artificial reefs, others have reported temporal variability in red snapper abundance. Moseley (1966) observed fluctuations in red snapper abundance on reefs off Texas and hypothesized that passing cold fronts effected onshore-offshore migrations. Beaumariage and Bullock (1976) reported seasonal variability of fish abundance off northwest Florida and suggested that fish migrated annually to summer forage grounds. Stanley and Wilson (1997) estimated fish abundance monthly for one year with hydroacoustics and video from a remotely operated vehicle at a petroleum platform off Louisiana, and reported significant variability in red snapper numbers between months.

Red snapper tagged in our study demonstrated relatively low site fidelity to artificial reefs off Alabama. While this finding is consistent with studies that have reported temporal variability in red snapper abundance on natural and artificial reefs (Beaumariage and Bullock 1976; Moseley 1966; Stanley and Wilson 1997), it is contrary to the widely reported conclusion that red snapper display strong site fidelity (Beaumariage 1969; Fable 1980; Szedlmayer and Shipp 1994; Szedlmayer 1997). In our approach, we assumed that no fishing mortality took place at tagging sites. This assumption was based on the fact that no recoveries were reported as being caught at Loran C or GPS coordinates that matched those of tagging sites. If fishing mortality did occur at tagging sites, our

estimates of site fidelity would be biased low. Estimated F of GOM red snapper ages 3-6 (the approximate age distribution of recaptured fish, see Szedlmayer and Shipp (1994)) during 1995-1998 was 0.36 (Schirripa and Legault 1999). If fishing mortality occurred at a similar rate at tagging sites, estimated annual site fidelity would only increase from 25.3% to 33.2% y^{-1} for the model that included all recaptures made at tagging sites.

Too few individuals transported prior to release and/or exposed to hurricanes were recaptured at tagging sites to model declines separately for these two factors. We attempted to account for the effect of these factors on site fidelity by modeling the decline in recaptures with and without fish transported prior to release and/or exposed to hurricanes. Estimated site fidelity increased slightly when transported individuals were excluded, which agrees with the findings of Watterson *et al.* (1998) and Patterson (1999) that transporting individuals increased their likelihood of movement. We expected a similar result when individuals exposed to hurricanes were excluded; however, estimated site fidelity actually decreased when fish exposed to hurricanes were omitted. This result is due to the fact that more individuals exposed to hurricanes were recaptured at tagging sites during the second and third time intervals than in the first, which resulted in a steeper function (i.e., a more rapid decline in recaptures) when fish exposed to hurricanes were omitted. This may indicate that some fish initially moved away from our reef sites following the storms but later returned.

There were two scales of movement observed for fish that moved away from tagging sites. Fish exposed to hurricanes moved significantly farther than fish that were not. Time at liberty also significantly affected the distance fish moved, and the fact that individuals exposed to hurricanes were at liberty longer than those not exposed may partially explain their greater distances of movement. However, hurricanes also significantly affected the speed at which recovered fish moved to their site of recapture. Therefore, distance of movement for fish exposed to hurricanes was not simply a function of greater time at liberty.

Goodyear (1995) reported that the rapid decline in fishers' tag recoveries with time at liberty from previous red snapper tagging studies indicated either high mortality or tag shedding, but in either case, long-term observations of movement would not be possible. Mean time at liberty was longer for reported recoveries in the present study than from previous studies, and movement also was on a larger scale (Beaumariage 1969; Fable 1980; Szedlmayer and Shipp 1994; Szedlmayer 1997). Furthermore, estimates of mean distance and speed of movement reported here are likely conservative. Patterson (1999) reported a high rate of tag shedding for red snapper tagged during the current study; therefore, fish movement may be underestimated because the longer fish were at liberty, the lower the likelihood they would be recognized as tagged fish. Size limits and other management regulations also may have caused underreporting by fishers of fish that moved away from their release sites (Patterson 1999).

Implications of Red Snapper Movement

The perception that adult red snapper demonstrate high site fidelity to artificial reef sites has driven the discussion of the effect of artificial reefs on red snapper fisheries ecology off Alabama. Szedlmayer and Shipp (1994) concluded that artificial reef areas off Alabama increased production of red snapper, rather than attracting fish from other areas, based on their findings that fish displayed

a high degree of residence on artificial reefs, and that red snapper grew faster and had higher abundances of juveniles off Alabama than other areas in the GOM. Their conclusion was tenable given the state of knowledge about GOM red snapper when it was proposed, but recent studies do not support it. Our results indicated that site fidelity of red snapper to artificial reefs was relatively low and that movement increased with time at liberty. Patterson (1999) reported that growth of red snapper captured off Alabama was similar to fish caught in the northwestern GOM. Gallaway *et al.* (1999) reported that catch per unit effort and habitat suitability index values for nursery areas off ALMS were similar to other areas in the GOM.

While it is possible that the creation of artificial reefs off Alabama and the deployment of petroleum platforms as *de facto* artificial reefs in the northwest GOM have shifted the center of GOM red snapper abundance from its historic center off the west coast of Florida (Stearns 1884; Collins 1885; Camber 1955; Carpenter 1965; Goodyear 1995), to our knowledge no data exist to support the contention that natural reef habitat currently limits GOM red snapper stock size (Cowan *et al.* 1999). The likelihood that artificial reefs have increased production of red snapper in the northern GOM is further diminished when one considers that this stock is currently estimated to be overfished (Schirripa and Legault 1999) and that year class strength appears to be driven by natural and anthropogenic (shrimp trawl bycatch) sources of mortality on juveniles, rather than by adult habitat availability (Bohnsack 1989; Goodyear 1995; Cowan *et al.* 1999). An equally plausible explanation of the role of northern GOM artificial reefs is that they serve as a net sink of red snapper production, as the period of artificial reef creation off Alabama is coincident with the fishing down of the northern GOM red snapper stock to the point where spawning potential ratio currently is estimated to be less than 5% (Schirripa and Legault 1999).

While the benefits of artificial reefs to fishing, such as aggregating fishes and increasing catch rates, are well documented (Polovina 1991; Stone *et al.* 1991), few studies have shown conclusively that artificial reefs increased production (but see Polovina and Sakai 1989; Butler and Herrnkind 1997). Pitcher and Seaman (2000), however, proposed that artificial reefs deployed in no-take areas could help mitigate overfishing and habitat degradation. Fisheries managers have begun to consider the possibility of no-take marine reserves as a management tool in the GOM (Plan Development Team, 1990; Gulf of Mexico Fishery Management Council (GMFMC) 1999a). In fact, the GMFMC has proposed creating two no-take marine reserves off the west coast of Florida to preserve and increase the spawning stock biomass of gag *Mycteroperca microlepis* and other grouper species (GMFMC 1999b). Holland and Brazee (1993) demonstrated with simulation modeling that no-take marine reserves could be implemented to increase spawning stock biomass of GOM red snapper. Estimates of red snapper site fidelity and velocity of movement from this study will benefit decision-makers faced with estimating the optimal size of marine reserves designed to maintain or increase red snapper spawning stock biomass.

ACKNOWLEDGMENTS

Funding for this project was provided by the United States National Oceanic and Atmospheric Administration through MARFIN grant number NA57FF0054 to R.L.S. The authors thank Mike and Ann Thierry for deploying artificial reefs used in this study and for allowing us to tag red snapper onboard their charter fishing vessel Lady Ann. The authors thank Walter Ingram and for advice

concerning statistical tests and Yvonne Allen for help with figure preparation. The authors acknowledge a great debt to all volunteer fishers who helped in the tagging process and to all commercial and recreational fishers who reported tag recoveries.

REFERENCES

- Agresti, A. 1990. Categorical data analysis. John Wiley and Sons. New York.
- Aitchison, J. 1955. On the distribution of a positive random variable having a discrete probability mass at the origin. *Journal of the American Statistical Association* 50:901-908.
- Beaumariage, D. S. 1969. Returns from the 1965 Schlitz tagging program including a cumulative analysis of previous results. *Florida Department of Natural Resources Technical Series* 59:1-38.
- Beaumariage, D.S. and L. H. Bullock. 1976. Biological research on snappers and groupers as related to fishery management requirements. *In* H.R. Bullis, Jr. and A.C. Jones, eds. *Proceedings: Colloquium on Snapper-Grouper Fishery Resources of the Western Central Atlantic Ocean*. Florida Sea Grant Colloquium Report 17, Gainesville, Florida.
- Bull, A.S. and J.J. Kendall, Jr. 1994. An indication of the process: offshore platforms as artificial reefs in the Gulf of Mexico. *Bulletin of Marine Science*. 55:1086-1098.
- Butler, M.J., IV and W.F. Herrnkind. 1997. A test of recruitment limitation and the potential for artificial enhancement of spiny lobster (*Panulirus argus*) populations in Florida. *Canadian Journal of Fisheries and Aquatic Sciences*. 54:452-463.
- Camber, C.I. 1955. A survey of the red snapper fishery of the Gulf of Mexico, with special reference to the Campeche Banks. *Florida Board of Conservation Technical Series* 12:1-64.
- Carpenter, J.S. 1965. A review of the Gulf of Mexico red snapper fishery. U.S. Department of the Interior, Fish and Wildlife Service, Bureau of Commercial Fisheries Circular 208. Washington, D.C.
- Collins, J.W. 1885. The red snapper grounds in the Gulf of Mexico. *Bulletin of the United States Fish Commission*. 5:145-146.
- Cowan, J.H., Jr., W. Ingram, J. McCawley, B. Sauls, A. Strelcheck, and M. Woods. 1999. The attraction vs. production debate: does it really matter from the management perspective? A response to the commentary by R.L. Shipp, *Gulf of Mexico Science*. 17:137-138.
- Curry, J.R. 1960, Sediments and history of Holocene Transgression, continental shelf, northern Gulf of Mexico. *In* Shepard, F.P., F.B. Phleger, and T.H. van Andel, eds. *Recent sediments, northwest Gulf of Mexico*. American Association of Petroleum Geologist. Tulsa, OK, p. 221-266.

- Bohnsack, J.A. 1989. Are high densities of fishes at artificial reefs the result of habitat limitation or behavioral preference. *Bulletin of Marine Science* 44:631-645.
- Fable, W.A., Jr. 1980. Tagging studies of red snapper (*Lutjanus campechanus*) and vermilion snapper (*Rhomboplites aurorubens*) off the south Texas coast. *Contributions in Marine Science*. 23:115-121.
- Fisk, H.N. and E. McFarlan. 1955. Late Quaternary deltaic deposits of the Mississippi River. *Crust of the Earth, Geological Society of America Special Paper* 62.
- Gallaway, B.J. 1984. Assessment of platform effects on snapper populations and fisheries. *In Proceedings of the fifth annual Gulf of Mexico information transfer meeting, Department of Interior, Minerals Management Service, New Orleans, Louisiana. OCS Study/MMS85-0008.*
- Gallaway, B.J., J.G. Cole, R. Meyer, and P. Roscigno. 1999. Delineation of essential habitat for juvenile red snapper in the northwestern Gulf of Mexico. *Transactions of the American Fisheries Society* 128:713-726.
- Goodyear, C.P. 1995. Red snapper in U.S. waters of the Gulf of Mexico. National Marine Fisheries Service, Southeast Fisheries Science Center, Miami Laboratory, Miami MIA-95/96-05.
- Grossman, G.D., G.P. Jones, and W.J. Seaman. 1997. Do artificial reefs increase regional fish production? A review of existing data. *Fisheries*. 22:17-23.
- Gulf of Mexico Fishery Management Council. 1999a. Regulatory amendment to the reef fish fishery management plan to set 1999 gag/black grouper management measures (revised). Department of Commerce, National Oceanic and Atmospheric Administration, Tampa, Florida.
- Gulf of Mexico Fishery Management Council. 1999b.. Marine reserves technical document: a scoping document for the Gulf of Mexico. Department of Commerce, National Oceanic and Atmospheric Administration, Tampa, Florida.
- Hilbe, J.M. 1994. Log negative binomial regression using the GENMOD procedure in SAS/STAT software. Pp. 1199-1224. *In Proceedings of Nineteenth Annual SAS Users Group International Conference, Cary, NC: SAS Institute, Inc.*
- Hoening, J.M. 1983. Estimating mortality rate from maximum observed age. *Internal Council for the Exploration of the Sea 1982 Meeting Collected Papers. ICES. Copenhagen, Denmark.*
- Hoese, H.D. and R.H. Moore. 1998. *Fishes of the Gulf of Mexico*, 2nd edition. Texas A&M University Press. College Station, Texas.
- Holland, D.S. and R.J. Brazee. 1993. Marine reserves for fisheries management. *Marine Resource Economics*. 11:157-17.1

- Ludwick, J.C. 1964. Sediments in the Northeastern Gulf of Mexico. *In* R.L. Miller, ed. Papers in marine geology: Shepard commemorative volume. MacMillan. New York.
- Minton, V. and S.R. Heath. 1998. Alabama's artificial reef program: building oases in the desert. *Gulf of Mexico Science*. 16:105-106.
- Moseley, F.N. 1966. Biology of the red snapper, *Lutjanus aya* Bloch, of the northwestern Gulf of Mexico. Publication of the Institute of Marine Science, Texas. 11:90-101.
- Parker, R.O., D.R. Colby, and T.D. Williams. 1983. Estimated amount of reef habitat on a portion of the U.S. south Atlantic and Gulf of Mexico Continental Shelf. *Bulletin of Marine Science*. 33:935-940.
- Patterson, W.F., III. 1999. Aspects of the population ecology of red snapper, *Lutjanus campechanus*, in an artificial reef area off Alabama. Doctoral dissertation. University of South Alabama, Mobile, Alabama.
- Pennington, M. 1983. Efficient estimators of abundance for fish and plankton surveys. *Biometrics*. 39:281-286.
- Pickering, H. and D. Whitmarsh. 1997. Artificial reef and fisheries exploitation. A review of the attraction versus production debate: the influence of design and its significance for policy. *Fish. Res.* 31:39-59.
- Pitcher, T.J. and W. Seaman. 2000. Petrarch's principle: how protected human-made reefs can help the reconstruction of fisheries and marine ecosystems. *Fish and Fisheries*. 1:73-81.
- Plan Development Team. 1990. The potential of marine fishery reserves for reef fish management in the U.S. Southern Atlantic. NOAA Tech. Mem. NMFS-SEFSC-261.
- Polovina, J.J. 1991. Fisheries application and biological impacts of artificial habitats. *In* W. Seaman, Jr. and L.M. Sprague, eds. Artificial habitats for marine and freshwater fisheries. Academic Press. New York.
- Polovina, J.J. and I. Sakai. 1989. Impacts of artificial reefs on fishery production in Shimarmaki, Japanese *Bulletin of Marine Science*. 44:997-1,003.
- Reggio, V.C., Jr. 1987. Rigs-to-reefs: the use of obsolete petroleum structures as artificial reefs. U.S. Department of Interior, Minerals Management Service, New Orleans, Louisiana. OCS Report MMS87-0015.
- Royce, W.E. 1972. Introduction to fishery sciences. Academic Press. New York. SAS Institute, Inc. 1996. Statistics Version 6.11. SAS Institute Inc. Cary, North Carolina.

- Schirripa, M. J. and C.M. Legault. 1999. Status of the red snapper stock in U.S. waters of the Gulf of Mexico: updated through 1998. NOAA/NMFS Sustainable Fisheries Division, Miami. SFD-99/00-75.
- Schroeder, W.W., A.W. Schultz, and O.H. Pilkey. 1995. Late Quaternary oyster shell and sea-level history, inner shelf, north east Gulf of Mexico. *Journal of Coastal Research*. 11:664-674.
- Shipp, R.L. 1999. The artificial reef debate: are we asking the right questions? *Gulf of Mexico Science*. 17:51-55.
- Stanley, D.R. and C.A. Wilson. 1990. A fishery-dependent based study of fish species composition and associated catch rates around oil and gas structures off Louisiana. 88:719-730
- Stanley, D.R. and C.A. Wilson. 1991. Factors affecting the abundance of selected fishes near petroleum platforms off Louisiana. *U.S. Fishery Bulletin*. 89:149-159.
- Stanley, D.R. and C.A. Wilson. 1997. Seasonal and spatial variation in the abundance and size distribution of fishes associated with a petroleum platform in the northern Gulf of Mexico. *Canadian Journal of Fisheries and Aquatic Sciences*. 54:1166-1176
- Stearns, S. 1883. Fluctuations in the fisheries of the U.S. Gulf of Mexico and the proposed investigation of them. *Bulletin of the United States Fish Commission*. 3:467-468.
- Stearns, S. 1884. On the position and character of the fishing grounds of the Gulf of Mexico. *Bulletin of the United States Fish Commission*. 4:289-290.
- Stone, R.B., L.M. Sprague, J.M. McGurrin and W. Seaman, Jr. 1991. Artificial habitats of the world: synopsis and major trends. *In* W. Seaman, Jr. and L.M. Sprague, eds. *Artificial habitats for marine and freshwater fisheries*. Academic Press. New York
- Szedlmayer, S.T. 1997. Ultrasonic telemetry of red snapper, *Lutjanus campechanus*, at artificial reef sites in the northeast Gulf of Mexico. *Copeia*. 1997:846-850.
- Szedlmayer, S.T. and R.L. Shipp. 1994. Movement and growth of red snapper, *Lutjanus campechanus*, from an artificial reef area in the northeastern Gulf of Mexico. *Bulletin of Marine Science* 55:887- 896.
- Watterson, J.C., W.F. Patterson, III, R.L. Shipp, and J.H. Cowan, Jr. 1998. Movement of red snapper, *Lutjanus campechanus*, in the north central Gulf of Mexico: potential influence of hurricanes. *Gulf of Mexico Science* 16:92-104.

ABUNDANCE, AGE DISTRIBUTION, GROWTH RATE, AND MORTALITY ESTIMATIONS FOR RED SNAPPER, *LUTJANUS CAMPECHANUS*, AROUND GAS PLATFORMS AND OTHER ARTIFICIAL STRUCTURES IN THE NORTHEAST GULF OF MEXICO

Stephen T. Szedlmayer
Carol Furman
Dustin Moss
Marine Fish Laboratory
Department of Fisheries and Allied Aquacultures
Auburn University

ABSTRACT

We estimated red snapper *Lutjanus campechanus*, abundance, age frequency, fecundity, and mortality, through a fishery independent survey. We tested six capture methods: bandit rigs, gill nets, fish trap, hook-and-line, drop net, and spear gun. After fishing, we used SCUBA visual counts to estimate remaining red snapper. All captured fish were weighed, measured, otoliths removed and ovaries weighed and preserved in Gilsons. We captured 1,147 red snapper at 28 different artificial reefs. Mean \pm Sd abundance per reef = 86.3 ± 69.4 . Estimated population size off Alabama from 15 to 73 m depths = 1.3 million red snapper. Mean size = 279 ± 59 mm SL, and mean age was two years. We captured 442 females with 32 % mature. Spawning duration was 142 d, with peaks from May through July. Batch fecundity = 83,870 eggs per fish, with annual fecundity = 2.9 million eggs per fish. Fish trap was the best capture method and SCUBA visual survey was the best abundance estimator. Females start maturing above 250 mm SL, and GSI peaked May to August. Total mortality was high ($Z = -2.0$) over the year classes sampled. Growth rates were 140 mm TL per year. Abundance estimates may be low, because we sampled only heavily fished reef sites, and future efforts will be directed at “unpublished” reef sites.

**MOVEMENT, GROWTH AND SURVIVAL OF GRAY TRIGGERFISH,
BALISTES CAPRISCUS, INHABITING ARTIFICIAL AND NATURAL
REEFS IN THE NORTH-CENTRAL GULF OF MEXICO**

G. Walter Ingram, Jr.
Department of Marine Sciences
University of South Alabama

Robert L. Shipp
Department of Marine Sciences
University of South Alabama

ABSTRACT

In the Gulf of Mexico (Gulf), the gray triggerfish (GTF) inhabits both natural and artificial reefs. Due to high site fidelity of GTF, the goal of this study is to determine if GTF may be better managed with respect to local demographics, including differences between GTF inhabiting natural versus artificial reefs.

This study consists of two separate tagging projects conducted off the Alabama coast. The first project (P1) was conducted between June 1995 and December 1997 over nine artificial reefs with three reefs in each of three depth strata (20, 26, and 36 m). The second and currently ongoing project (P2) began in October 1997 and is being conducted over a cluster of six natural reefs in 20 m of water and a cluster of three natural reefs in 32 m of water.

Of the 201 GTF tagged during P1, 50 have been recaptured, with 31 recaptured at the site of release. Also, of the 500 GTF tagged during P2, 65 have been recaptured, with 49 recaptured at the site of release. The distribution of fork-length at tagging was significantly different ($p < 0.00001$) between P1 ($\bar{x} \pm s = 347 \pm 57$ mm) and P2 (297 ± 41 mm), which may result from gear bias and/or differences between reef habitats. Linear and von Bertalanffy growth parameters were estimated from combined data from both projects (i.e., 0.14 mm/day and $L_{\infty} = 836$ mm and $K = 0.0998$, respectively). During both projects, both magnitude of movement (P1: $p = 0.0000998$; P2: $p = 0.050$) and velocity (P1: $p = 0.0002$; P2: $p = 0.049$) increased significantly in GTF at large during tropical cyclones. Also, a trend of decreasing site fidelity with depth was found in both projects. With the majority of recaptures occurring at the point of initial release, GTF seem to exhibit high site fidelity on both artificial and natural reefs.

RED SNAPPER (*LUTJANUS CAMPECHANUS*) DIET ON ALABAMA ARTIFICIAL REEFS

Jessica R. McCawley
Robert L. Shipp
University of South Alabama/Dauphin Island Sea Lab

James H. Cowan, Jr.
Louisiana State University
Coastal Fisheries Institute

ABSTRACT

Red snapper, *Lutjanus campechanus*, is a highly exploited reef fish in the Gulf of Mexico (GOM) snapper-grouper complex that occupies both natural hard bottom and artificial habitats throughout its range. Despite its importance, relatively little is known about its habitat preferences and feeding habits. Toward this end, I examined the size-specific diet of red snapper collected for gut content analysis from artificial reefs in the north-central GOM off Alabama between May 1999-April 2000. Thirty-nine to 86 stomachs per month were removed and prey items identified to the lowest possible taxonomic level. The relative contribution of prey items was determined using percent frequency of occurrence, percent composition by number, percent composition by weight, and index of relative importance (IRI). Results suggest that snapper selectively feed on organisms not associated with reefs, such as mantis shrimp (16% by weight) and portunid crabs (27.3% by weight). Diet changes seasonally with crabs being the most important in summer and fall (31.4-36.3% W), while mantis shrimp are important in winter (33.3% W). Pelagic zooplankton are consumed heavily in the spring (39.1% W). Diet also changes with snapper size, as red snapper get larger, more of their diet is made up of demersal crustaceans. These diet data ultimately will be used in combination with a bioenergetics budget to estimate prey demand of a red snapper population on Alabama artificial reefs.

INTRODUCTION

Red snapper, *Lutjanus campechanus*, is a highly exploited finfish in the GOM. It has been harvested both commercially and recreationally since the late 1800s (Moseley 1966, Goodyear 1995, Schirripa and Legault 1997). Thus, stocks declined throughout the GOM until the early 1990s (Szedlmayer and Shipp 1994). Since then, regulations that have been put in place by the National Marine Fisheries Service, including size and bag limits and total allowable catches, have helped the stock begin to recover (Schirripa and Legault 1997, Patterson 1999).

The recovery of the stock has also been attributed in part to an increase in structure in the form of artificial reefs and oil and gas platforms. The Alabama shelf has the largest artificial reef program in the nation with over 4000 km² of reef permit area (Shipp 1999). Perhaps as many as 20,000 artificial reefs have been deployed off the Alabama coast (Patterson 1999); these structures support red snapper and other reef associated species. However, the role that artificial reefs play in trophic dynamics is largely unknown; some have suggested that they may be energy sinks (Bortone 1998).

In addition, there has been a growing recognition that interacting species, such as those found on artificial reefs, cannot be managed individually. This idea has led to the development of multispecies ecosystem models, which has generated the need for more information about the food consumed by communities of reef fish (Munro 1987, Bohnsack 1998). This study examines the role artificial reefs may play in red snapper trophic dynamics, focusing on seasonal changes and changes with fish size.

METHODS

Monthly Sampling

Red snapper were collected by hook and line from artificial reefs in the northern GOM off the coast of Alabama between May 1999 and April 2000. Most fish were caught by recreational fishermen in the Hugh Swingle General Permit Area. However, some were collected in July 1999 and 2000 from local fishing tournaments. Knowing that red snapper are prone to regurgitation (Parrish 1987), approximately 39 to 86 fish were collected per month to ensure a significant number of fish with full stomachs. All snapper were weighed to the nearest 0.01kg, and their total length (TL) and fork length (FL) determined to the nearest mm before their stomachs were removed. Stomachs were severed at the esophagus and duodenum below the pyloric sphincter, slit to allow complete preservation, and then preserved in 10% formalin for at least 48 hours. They then were transferred to 70% isopropyl alcohol until they could be sorted. Preserved stomachs were opened and contents removed and sorted to the lowest possible taxonomic level. Prey items were then weighed by taxon to the nearest 0.01g. Empty stomachs were either labeled as genuinely 'empty' or distended according to the description of Treasurer (1988).

Enumeration of Stomach Contents

The relative contribution of each of the prey items was determined using four methods: (1) percent composition by weight, (2) percent composition by number, (3) percent frequency of occurrence, and (4) index of relative importance. The index of relative importance (IRI) was determined using the formula: $IRI = (\%N + \%W) \times \%FO$, where N = number, V = volume, and FO = frequency of occurrence (Pinkas 1971, modified by Hacunda 1981). Percent IRI (% IRI) was also calculated by dividing the IRI value for each prey category by the sum of the IRI values and multiplying by 100. These indices were used to describe the overall diet, as well as to evaluate the diet on a seasonal basis (summer= June, July, and August; fall= September, October, and November; winter= December, January, and February; and spring= March, April, and May) as well as by red snapper size class. Red snapper were divided into 5 size classes (200-299mm FL, 300-399mm FL, 400-499mm FL, 500-599mm FL, and >600mm FL). The identifiable contents of all stomachs combined were divided into 6 major prey categories; fish, crabs, adult mantis shrimp, penaeid shrimp, squid, and an 'other' category. The 'other' category was further subdivided into pelagic zooplankton and demersal/benthic associated species, with the exception of larval fish, which were included in the fish category and crab megalopae and zoea, which were included in the crab category. The diet also consisted of an 'unidentified' category, which was not used in some portions of the analysis because IRI cannot be determined for this category.

RESULTS

Monthly Sampling

Stomach contents of 656 red snapper ranging from 207 to 913mm FL were examined. Of these, 268 stomachs contained identifiable prey (40.8%), 262 were empty (39.9%), 63 contained only bait (9.6%), and 63 contained only unidentifiable prey (9.6%). Of the 262 stomachs classified as empty, 169 were considered 'truly' empty (65%) and 93 (35%) were considered distended or empty due to regurgitation.

The 'unidentified' prey category made up the largest proportion of the diet by % W. After exclusion of the unidentified category, fish, pelagic zooplankton, and crab were the principal components of red snapper diet when all stomachs were combined. However, no single group was largest by all indices. Pelagic zooplankton were the largest category by % FO (39.3%) and % N (30.2%), whereas fish was the largest category by % IRI (30.9%) and % W (28.7%). Unidentified fish, larval fish, fish of the families Ophichthidae (shrimp eels), and Triglidae (sea robins) contributed largely to the fish portion of the diet, whereas crabs of the family Portunidae and unidentified crabs were important in the crab category. Pelagic zooplankton consisted primarily of larval mantis shrimp, amphipods, and pteropods (*Cavolinia sp.*).

Seasonal Diet

An examination of gut contents by season for all stomachs (%W) indicates that while fish were present in red snapper diet in all seasons (comprising between 25-34% W), fish did not contribute the greatest amount by weight in any season. The diet in summer and fall was comprised predominately of crabs (31.4% W in summer and 36.3% W in fall). Winter diet was comprised predominately of adult mantis shrimp (33.3% W) and spring of pelagic zooplankton (39.1% W). Demersal crustaceans (crabs and adult mantis shrimp) were present in all seasons, comprising approximately 50% by weight of the diet in summer, fall, and winter. During the spring, red snapper fed on high numbers of pelagic zooplankton, which were present at some level in all seasons. However, the numbers of pelagic zooplankton consumed appeared to be inversely related to numbers of demersal crustaceans eaten by red snapper.

Size Class

All stomachs were pooled for an examination of size class differences; the same 7 prey categories as described above were used. Fish were present in the diet of all size classes of red snapper and were the largest contributor to the diet of the 200-299mm (36.4% W) and the 500-599mm (40.2% W) fish. The diet of 300-399mm fish was almost fairly equally proportioned among the prey categories, however crab made up the largest portion of the diet (25.8% W). Crab was also the most important prey item of >600mm snapper, making up 51.5% of the diet by % W. The diet of the 400-499mm snapper was comprised primarily of pelagic zooplankton (35% W). There appears to be a shift in diet with red snapper size. As snapper get larger they apparently eat more demersal crustaceans and less pelagic zooplankton and fish.

DISCUSSION

Our results show seasonal shifts in red snapper diet on Alabama artificial reefs. These findings are similar to most other studies of red snapper diet including another off Alabama (Bailey 1995) (Table 9.8). However, Bradley and Bryan (1974) found fish to be the largest category in fall, winter, and spring, but crabs contributed the most to the summer diet. Specifically in their study, spring was comprised primarily of eels, mantis shrimp, and *Sicyonia* sp. (rock shrimp); summer was comprised primarily of *Callinectes danae* and *S. dorsalis*; and winter was comprised primarily of eels. In this study, eels (Ophichthids) were found in all seasons except fall, but they were never the largest category by percent weight. In contrast, mantis shrimp contributed the largest percent by weight to the diet of red snapper off Alabama in winter, and were lowest in spring. Parrish (1987), in his literature review of snapper and grouper diet's stated that the principal food groups of snapper in most studies are fish and decapod crustaceans, which was consistent with the current study. Anguilliform fishes, like the Ophichthids that we found, were common in the snapper diets he examined. Parrish (1987) found crabs to be the second most abundant prey category, specifically with Portunid and Calappid crabs mentioned in several reports, while shrimps and other crustaceans (especially stomatopods) were the next largest diet category. He also stated that snappers often ate large plankton, which were an important part of the diet for some Lutjanid species he reviewed, specifically pteropods, which were found in our study to make up between 13-21% W of the diet in spring and summer. Larval mantis shrimp, which were also found in the current study in large amounts in all seasons (highest in summer and winter) are thought to form large swarms in tropical waters (Morgan and Provenzano 1979). Randall (1967) found that they made up a considerable portion of the diet of reef fishes in the West Indies.

Our results also show that diet shifts with the size of red snapper. Randall (1967) and Moseley (1966) found that as snapper get larger their diet is made up of proportionally more fish and less crustaceans. Our study found the opposite to be true. As red snapper got larger (>600mm), their diet was increasingly comprised of benthic crustaceans and less fish. However, our results could be attributable to the fact that many of our larger fish were collected in the summer when these crustaceans are abundant. In 500-599mm red snapper, which we collected both in spring and summer, fish did contribute largely to red snapper diet. It is also possible that the way in which we treated our gut contents data could have contributed to observed differences between our study results and those of previous studies. We treated each stomach as a replicate and found the proportion of each of the prey items for that stomach (Bowen 1996), after which we computed a mean and standard error for each season or red snapper size class across all replicates. Some of the previous studies do not provide enough information for us to determine how their indices were calculated, thus making direct comparisons impossible.

Many of the crustaceans we found in the diet are sand/mud inhabitants of the shelf. The Portunid crabs (swimming crabs such as *Portunus gibbesii*) as well as the mantis shrimp (*Squilla empusa*) inhabit mud or sand substrates (Williams 1984, Wenner and Wenner 1989, Manning and Heard 1997). Hildebrand (1954 cited in Williams 1984) found *S. empusa* to be the third most abundant crustacean in the Gulf offshore trawl fishery only following *Penaeus* sp and *Callinectes* sp. On the Alabama shelf, *S. empusa* can be collected year-round from mud bottom areas, and are the most abundant stomatopod on the Alabama shelf (Rich Aronson, pers. comm.). Rouse (1970) (cited in

Table 9.8. Literature review of some red snapper diet studies relevant to the present study.

Source	Location of study	Fish size	# Stomachs Examined (# w/ food)	Description of Results
Moseley 1966	Louisiana	juvenile	712 (187) (28)	30% FO of crustaceans, another sample had 60% <i>Squilla</i> (night sample), unidentified fish made up 27% of this sample
		adult	(46)	44% fish in one sample, 80% fish and rest crustaceans in another
	Texas	juvenile	(45)	41% crustaceans in one sample, 89% crustaceans in another
		adult	(68)	Fish dominated the diet in all samples (40-69%), crustaceans were present in small numbers
Bradley and Bryan 1974	Texas	juvenile and sub-adult	575 (258)	Summer ate shrimp and crabs, spring and winter ate squid. Mantis shrimp made up portion of diet in summer, winter had most varied diet
		adult	1139 (190)	Primarily ate fish, but in fall and winter ate more crustaceans. In spring 13% of diet was tunicates. Summer had largest variety and winter the smallest variety
Bailey 1995	Alabama	330-691 mm TL	98	Principal prey items in summer were rock shrimp and crabs, also ate some eels and unid. fish
Lee 1998	Alabama	10-280mm SL	1652 (792)	<i>Halichoeres sp.</i> , <i>Serranus sp.</i> and <i>Centropristis sp.</i>) and shrimp (<i>Lysmata sp.</i> and <i>Synalpheus sp.</i>) and squid.

Williams (1984)) stated that *P. gibbesii* was the most often collected Portunid in the GOM. Other of the Portunids found in the stomachs, such as *P. spinicarpus*, *P. ordwayii*, and *C. sapidus* were also cited by Williams (1984) as being found either on mud bottoms or a variety of bottoms, but not on reefs. Most of the crustaceans we found in the stomachs are associated with mud bottom and are abundant in the GOM. The same is true for many of the important fish prey species such as Ophichthid fishes, sea robins, and cusk eels.

Thus, red snapper foraging does not appear to be directly associated with artificial reefs; they may be gaining little nutritional support from the reefs. The prey species that are abundant on Alabama artificial reefs, such as, sea basses, tomtates and other grunts (Andy Strelcheck, pers. comm.), were not found in the diets of red snapper in this study, although they did eat in smaller numbers some organisms that are associated with reef structure such as Syngnathids (pipe fish and sea horses) and pinfish. Starck (1968) also lists species that have an affinity to reefs, such as lizardfish, gobies, and wrasses, which would be expected in the diet, but these fish were not found in the stomachs of the red snapper we sampled. Thus, we infer that red snapper are selectively or preferentially feeding on non-reef habitat.

Other studies of red snapper diet describe foraging habits that support this claim. Moseley (1966), in a red snapper diet study off of Texas and Louisiana, found that red snapper do not always feed on reef associated species. He stated that “Based on food habits, there seems to be no particular reason why red snappers should congregate on reefs or rocky areas... .” Parrish (1987) states that snapper probably remain within a few meters of the bottom because most of their prey needs to be captured from the substrate. He classifies *L. campechanus* as an intermediate depth feeder, which means they forage anywhere from relatively shallow water up to 100m. He states that such feeders probably forage widely from shelter over soft bottom to gain food, or either forage by “patrolling up to several meters off the bottom for nektonic prey as well as periodically foraging on substrate for fully benthic prey.” Supporting this idea, this study found that snapper consumed some organisms that reside higher in the water column, such as larval mantis shrimp, fish larvae, amphipods, and pteropods, and other assorted pelagic zooplankton as well as mud associated species. Davis and Birdsong (1973) describe coral reefs and other “habitat interfaces” as rich in diversity saying they “represent ‘cross roads’ between foraging and refuge areas.” Artificial reefs can be seen in much the same context, as snapper seem to supply their energetic demands from habitats other than reefs. It is still unclear if red snapper are simply leaving a reef to forage on nearby mud bottom, or if they are feeding during their transit between reefs, or both. In contrast, Lee (1998) found snapper over artificial reefs ate reef associated prey, such as fish (*Halichoeres sp.*, *Serranus sp.* and *Centropristis sp.*) and shrimp (*Lyasmata sp.* and *Synalpheus sp.*) (although he examined snapper smaller (10mm – 230mm standard length) than what we studied). Perhaps smaller red snapper, such as the ones Lee (1998) examined, are more reef dependent than their larger counterparts.

The data from this diet study will be used along with information on red snapper diel feeding patterns, and the caloric content of the prey species to present a complete picture of the foraging habits of red snapper off of Alabama. That data then will be used along with information on growth rates of snapper on artificial reefs as well as metabolism values in a bioenergetics model to obtain a first order estimate of the prey demand of a red snapper population on a reef.

ACKNOWLEDGMENTS

This study was funded by a Mississippi-Alabama Sea Grant Fellowship and the Alabama Department of Conservation, Marine Resources Division. Special thanks to Julie Prerost for her help in identifying the invertebrates.

REFERENCES

- Bailey, H.K., IV. 1995. Potential interactive effects of habitat complexity and sub-adults on young of the year red snapper (*Lutjanus campechanus*) behavior. M.S. Thesis. University of South Alabama. 55pp.
- Bohnsack, J.A. 1998. Application of marine reserves to reef fisheries management. *Australian Journal of Ecology*. 23:208-304.
- Bortone, S.A. 1998. Resolving the attraction-production dilemma in artificial reef research: Some yeas and nays. *Fisheries*. 23(3):6-10.
- Bowen, S.H. 1996. Quantitative Description of the Diet. In B.R. Murphy and D.W. Willis (eds). *Fisheries Techniques*, 2nd edition. American Fisheries Society, Bethesda, Maryland. pp. 513-532.
- Bradley, E. and C.E. Bryan. 1974. Life history and fishery of the red snapper (*Lutjanus campechanus*) in the northwestern Gulf of Mexico: 1970-1974. *Proceedings of the Gulf and Caribbean Fisheries Institute*. 27:77-106.
- Davis, W.P. and R.S. Birdsong. 1973. Coral reef fishes which forage in the water column. *Helgolander wiss. Meeresunters*. 24:292-306.
- Goodyear, C.P. 1995. Red Snapper in U.S. waters of the Gulf of Mexico. National Marine Fisheries Service, Southeast Fisheries Science Center, Miami Laboratory, Miami MIA-95/96-05.
- Hacunda, J.S. 1981. Trophic relationships among demersal fishes in a coastal area of the Gulf of Maine. *Fishery Bulletin*. 79:775-788.
- Lee, J.D. 1998. Diet shifts of red snapper, *Lutjanus campechanus*, with changes in habitat and fish size. M.S. thesis. Auburn University. 63pp.
- Manning, R.B. and R.W. Heard. 1997. Stomatopod crustaceans from the Carolinas and Georgia, Southeastern United States. *Gulf Research Reports*. 9(4):303-320.
- Morgan, S.G. and A.J. Provenzano, Jr. 1979. Development of pelagic larvae and postlarvae of *Squilla empusa* (Crustacea, Stomatopoda), with an assessment of larval characters within the Squillidae. *Fishery Bulletin*. 77(1):61-90.
- Moseley, F.N. 1966. Biology of the red snapper, *Lutjanus aya* Bloch, of the northwestern Gulf of Mexico. *Pub. Inst. Mar. Sci., TX*. 11:90-101.
- Munro, J.L. 1987. Workshop Synthesis and Directions for Future Research. in: J.J. Polovina and S. Ralston, (eds.). *Tropical Snappers and Groupers, Biology and Fisheries Management*. Westview Press.

- Murawski, S.A. 1991. Can we manage our multispecies fisheries? *Fisheries*. 16(5):5-13.
- Parrish, J.D. 1987. The trophic biology of snappers and groupers. In: J.J. Polovina and S. Ralston (eds.). *Tropical Snappers and Groupers, Biology and Fisheries Management*. Westview Press.
- Patterson, W.F. 1999. Aspects of the population ecology of red snapper *Lutjanus campechanus* in an artificial reef area off Alabama. Ph.D. Dissertation. University of South Alabama. 164pp.
- Randall, J.E. 1967. Food habits of reef fishes of the West Indies. *Studies in Tropical Oceanography*. (Miami) 5:665-847.
- Schirripa, M.J. and C.M. Legault. 1997. Status of the red snapper in U.S. waters of the Gulf of Mexico. NOAA, NMFS, Southeast Fisheries Science Center, Miami Laboratory Contribution MIA-97/98-05.
- Shipp, R.L. 1999. The artificial reef debate: Are we asking the wrong questions? *Gulf of Mexico Science*. 1:51-55.
- Starck, W.A. 1968. A list of fishes of Alligator Reef, Florida with comments on the nature of the Florida reef fish fauna. *Undersea Biol.* 1(1):5-40.
- Szedlmayer, S.T. and R.L. Shipp. 1994. Movement and growth of red snapper, *Lutjanus campechanus*, from an artificial reef area in the northeastern Gulf of Mexico. *Bull. Mar. Sci.* 55:887-896.
- Treasurer, J.W. 1988. Measurement of regurgitation in feeding studies of predatory fishes. *J. of Fish Biology*. 33:267-271.
- Wenner, E.L. and C.A. Wenner. 1989. Seasonal composition and abundance of decapod and stomatopod crustaceans from coastal habitats, southeastern United States. *Fishery Bulletin*. 87:155-176.
- Williams, A.B. 1984. *Shrimps, Lobsters, and Crabs of the Atlantic Coast of the Eastern United States, Miami to Florida*. Smithsonian Institution Press, Washington, D.C.

INDEX TO AUTHORS

Allen, J. D. (Dan)	73
Arnold, Peter	67
Baine, Mark	120
Baltz, D. M.	167, 169
Barber, Todd Ryan	631
Bates, Thomas W.	182
Beaver, Carl	601
Benfield, Mark C.	185, 499
Biggs, Douglas C.	44
Blandon, Ivonne R.	352
Boland, Gregory S.	21, 23, 372
Bond, P.J.	333
Bridger, Christopher J.	73
Bull, Ann Scarborough	3
Burgess, George H.	67, 284
Burks, Carolyn M.	66
Chesney, E. J.	167, 169
Childs, Jeff	21, 65, 66
Childs, Susan	601
Coleman, Felicia C.	109, 160
Colura, Robert L.	352
Cope, Joseph S.	185
Costa-Pierce, Barry A.	73
Cowan, James H.	633, 653
Culbertson, Jan	92, 614
de Wit, LeRay	67
Deming, Jody	21, 23
Ditty, James G.	185
Dokken, Quenton R.	182, 601
Dorf, Barbara A.	334
Dougall, Dave	93
Drass, D.M.	333
Edwards, Randy E.	50
Embesi, J.	92

Escobar-Briones, Elva	21, 23
Farooqi, Talat	185
Friel, Chris	67
Furman, Carol	651
Gitschlag, Gregg R.	357
Gledhill, Christopher T.	285
Goudey, Clifford	73
Hammerschmidt, P.	92
Hanisko, David S.	554
Harper, Jr., Donald E.	614
Henwood, Terry A.	285
Hernandez, Jr., Frank J.	184, 185, 514
Hewitt IV, John D.	66
Hiatt, Robert L.	144
Hubbard, Fain	21, 23
Hymel, M. K.	167, 169
Ingram, Jr., G. Walter	652
Karel, William J.	352
Kasprzak, Richard A.	5, 472
Keenan, Sean F.	499
Kemmerer, Andrew J.	11
King, Tim L.	353
Koenig, Christopher C.	109, 160
Kolok, A. S.	167, 169
Lagera, Luis	67
Link, Jason S.	285
Lohse, Angela	21, 23
Lubinski, Barbara A.	353
Lukens, Ronald R.	105
Lyczkowski-Shultz, Joanne	333, 554
McCawley, Jessica R.	653
McEachron, Lawrence W.	352
McManus, Roger	16
Miller, Margaret	160
Miller, Mark	472, 581
Milon, J. Walter	144

Moss, Dustin	651
Mullin, Keith D.	66
Nieland, David L.	271
Patterson, William F.	633
Peter, D.	92
Pierce, Aaron	580
Rademacher, Kevin R.	393
Render, Jeffery H.	393
Ressler, Patrick H.	44
Rowe, Gilbert T.	21, 23
Scanlon, Kathryn M.	109, 160
Schirripa, Michael J.	357
Shaw, Richard F.	184, 185, 514
Shipp, Robert L.	101, 633, 652, 653
Side, Jon	120
Snelson, Jr., Franklin F.	284
Snyder, David B.	67, 284
Stanley, David R.	3, 421, 472
Stickney, Robert R.	73
Sulak, Kenneth, J.	50
Szedlmayer, Stephen T.	183, 283, 651
Tarr, M. A.	167, 169
Topolski, Marek F.	183
Ward, Rocky	352
Weaver, Doug	50
Wilson, Charles A.	5, 271, 421, 472, 580, 581
Wirgin, Isaac I.	353

ATTENDEES

Allen, Dan
Ecologist
Chevron USA Production Co.
935 Gravier St.
New Orleans, LA 70112
allj@chevron.com

Baine, Mark
Int'l. Center for Island Tech.
Heriot-Watt University
The Old Academy, Stromness
Orkney Islands, KW163AW
ioemspb@iciv.civ.hw.ac.uk

Baltz, Donald M
Professor
LSU Coastal Fisheries Inst.
Baton Rouge, LA 70803
dbaltz@lsu.edu

Bass, William

Bates, Thomas W

Becker, Gregory T
Principal Environ. Engineer
Becker Engineering Inc.
2386 South Dairy Ashford
Houston, TX 77077

Benfield, Mark
Coastal Fisheries Inst.
LSU
Baton Rouge, LA 70803
mbenfie@lsu.edu

Benner, Lee
Oceanographer
MMS
381 Elden St
Herndon, VA 20170
lee.benner@mms.gov

Bennett, Richard
MMS
1201 Elmwood Prk Blvd
New Orleans, LA 70123

Biggs, Douglas C
Professor
Texas A&M University
Dept of Oceanography
College Station, TX 77843-3146
dbiggs@ocean.tamu.edu

Blandon, Ivonne R

Boatman, Mary
MMS
1201 Elmwood Prk Blvd, MS 5433
New Orleans, LA 70123
mary.boatman@mms.gov

Boland, Greg
Biologist
MMS
2164 Champions Dr
La Place, LA 70068
gregory.boland@mms.gov

Bradley, Marcus
Research Associate
LUMCON
8124 Hwy 56
Chauvin, LA 70344
mbradley@lumcon.edu

Brewer, Gary
Biologist
USGS Bio. Resources
1700 Leetown Rd
Kearneysville, WV 25430
gary_brewer@usgs.gov

Bull, David
Audubon Institute
1 Canal St
New Orleans, LA 70118
dlbull@compuserve.com

Burgess, George H

Burkhard, Elizabeth
Marine Biologist
MMS
381 Elden St., MS 4041
Herndon, VA 20170
Elizabeth.Burkhard@mms.gov

Chesney, Edward
Associate Professor
LUMCON
8124 Hwy 56
Chauvin, LA 70344
echesney@lumcon.edu

Chew, Dennis
MMS
1201 Elmwood Prk Blvd
New Orleans, LA 70123

Childs, Susan

Christopher, Joe
Chief, Environmental Assessment Sec
MMS
1201 Elmwood Prk Blvd
New Orleans, LA 70123
joseph.christopher@mms.gov

Codina, Caron
MMS
1201 Elmwood Prk Blvd
New Orleans, LA 70123
caron.codina@mms.gov

Contreras, Suzanne
Marine Biologist
Texas General Land Office
P.O. Box 12873
Austin, TX 78711-2873
suzanne.contreras@glo.state.tx.us

Costa-Pierce, Barry A
Director
MS-AL Sea Grant Consortium
P.O. Box 7000
703 East Beach Drive
Ocean Springs, MS 39566-7000
b.costapierce@usm.edu

Crabtree, Roy
Fishery Administrator
NOAA/NMFS, SE Regional Office
9721 Executive Ctr. Dr. North
St. Petersburg, FL 33702-2432
roy.crabtree@noaa.gov

Culbertson, Jan C
Artificial Reef Coordinator
Texas Parks & Wildlife
17629 El Camino Real #175
Houston, TX 77058
jan.culbertson@tpwd.state.tx.us

Current, Carole L
Physical Oceanographer
MMS
1201 Elmwood Prk Blvd, MS 5433
New Orleans, LA 70123
carole.current@mms.gov

Dauterive, Les
Sr. Environmental Scientist
MMS
1201 Elmwood Prk Blvd
New Orleans, LA 70123
lester.dauterive@mms.gov

David, Andrew
 NMFS
 3500 Dellwood Beach Rd
 Panama City, FL 32408
 david@bio.fsu.edu

DeBose, Jennifer
 Research Assistant
 Flower Garden Banks
 National Marine Sanctuary
 216 W 26th St #104
 Bryan, TX 77803
 jennifer.debose@noaa.gov

Dennis, George
 Research Fishery Biologist
 USGS
 7920 NW 71st St
 Gainesville, FL 32653
 george_dennis@usgs.gov

Dokken, Quenton
 Texas A&M - Corpus Christi
 Center for Coastal Studies
 6300 Ocean Dr
 Corpus Christi, TX 78412

Dorf, Barbara
 Natural Resource Specialist
 Texas P&W Coastal Fisheries Div.
 702 Navigation Circle
 Rockport, TX 78382
 barbara.dorf@tpwd.state.tx.us

Dorhauer III, Charles
 Bonnabel High School
 4508 Laudun St
 Metairie, LA 70006

Dorsett, Chris
 Program Director - Fisheries
 Gulf Restoration Network
 P.O. Box 2245
 New Orleans, LA 70176
 cdgrn@igc.org

Dougall, Dave
 HSE Mgr
 AGIP Petroleum Co. Inc.
 1201 Louisiana, Suite 3500
 Houston, TX 77002
 david.dougall@agip petroleum.agip.it

Dowdy, Danielle
 REEF Field Station of NWFL
 2521 Maureen Ln
 Meraux, LA 70075
 reefnwfl@aol.com

Drass, D. M.

Edwards, Randy E
 USGS-BRD/JC
 600 Fourth St. S.
 St. Petersburg, FL 33701-4846
 redwards@usgs.gov

Eve, Hammond
 MMS
 1201 Elmwood Prk Blvd
 New Orleans, LA 70123

Fagot, Caryl
 Staff Assistant, MMS
 1201 Elmwood Prk Blvd
 New Orleans, LA 70123
 caryl.fagot@mms.gov

Fletcher, Kristen M
 Director
 MS-AL Sea Grant Legal Prgm.
 518 Law Center
 University, MS 38677
 kfletch@olemiss.edu

Franks, Jim
 Fisheries Biologist
 USM-Institute of Marine Sciences
 P.O. Box 7000
 Ocean Springs, MS 39566
 jim.franks@usm.edu

Furman, Carol
Research Associate
Auburn University
Marine Fish Laboratory
8300 State Hwy 104
Fairhope, AL 36532
cfurman@acesag.auburn.edu

Galloway, Benny
Ecological Research Assoc.
1410 Cavitt St
Bryan, TX 77801
cole_johnson@msn.com

Gitschlag, Gregg
NOAA/NMFS
4700 Avenue U
Galveston, TX 77551
gregg.gitschlag@noaa.gov

Goeke, Gary
Chief, Eastern Gulf Info. Office
MMS
41 N. Jefferson #300
Pensacola, FL 32501
ggoeke@networktel.net

Gregg, Kurtis
Environmental Specialist
Florida Dept of Environ. Protection
3900 Commonwealth Blvd, MS 47
Tallahassee, FL 32399-3000
kurtis.gregg@dep.state.fl.us

Hanisko, David
Research Fisheries Biologist
NMFS\Johnson Controls
3209 Frederic St.
Pascagoula, MS 39567
dhanisko@triton.pas.nmfs.gov

Harmon, David J
LSU Coastal Fisheries Inst.
CCEER Wetlands Bldg
Baton Rouge, LA 70803

Heath, James W

Hernandez, Frank J
Graduate Student
LSU Coastal Fisheries Inst.
CCEER Wetlands Bldg
Baton Rouge, LA 70803-7053
fhernan@lsu.edu

Hickerson, Emma
Research Coordinator
Flower Garden Banks
National Marine Sanctuary
216 W 26th, St #104
Bryan, TX 77803
ema.hickerson@noaa.gov

Hiatt, Robert
Quan Tech, Inc.

Holder Jr., Samuel
MMS
1201 Elmwood Prk Blvd
New Orleans, LA 70123
samuel_holder@mms.gov

Horst, Jerald
Sea Grant Extension Prgm
1855 Ames Blvd
Marrero, LA 70072
jhorst@agctr.lsu.edu

Howe, Jeffrey
Research Associate
Auburn Univ. Research Ctr.
4170 Commanders Drive
Mobile, AL 36615
jchowe132@aol.com

Ingram, Jr., G. Walter
University of South Alabama
Dept of Marine Sciences
Mobile, AL 36688-0002
wingram@gulftel.com

Johnston, James B
 Supervisory General Biologist
 NWRC
 700 Cajundome Blvd
 Lafayette, LA 70506
 jimmy_johnston@usgs.gov

Kasprzak, Rick
 LA DWF
 P.O. Box 98000
 Baton Rouge, LA 70898

Kay, Melissa
 Geoscience Specialist
 LA DNR
 UNO Box 1102
 New Orleans, LA 70148
 melissak@dnr.state.la.us

Keenan, Sean
 Grad Assist
 LSU Coastal Fisheries Inst.
 218 Wetlands Resource Bldg
 Baton Rouge, LA 70803
 skeenan@lsu.edu

Kemmerer, Andrew J
 Director
 Office of Habitat Conservation
 1315 EW Hwy, Room 15147
 Silver Spring, MD 20910
 andy.kemmerer@noaa.gov

Kenny, Jan
 Offshore Coordinator
 DEMEX
 401 Whitney Ave, Suite 412
 Gretna, LA 70056
 demex-nola@msn.com

Kenny, John J
 DEMEX
 401 Whitney Ave Suite 412
 Gretna, LA 70056
 demex_nola@usa.com

King, Tim L
 USGS Bio. Resources
 Leetown Science Center
 1700 Leetown Rd
 Kearneysville, WV 25430
 tim_king@usgs.gov

Koenig, Christopher C
 Institute for Fishery Resource Ecology
 Florida State Univ.
 Dept of Biological Sciences
 Tallahassee, FL 32306-1100
 koenig@bio.fsu.edu

Landry, Connie
 Procurement Coordinator
 MMS
 1201 Elmwood Prk Blvd
 New Orleans, LA 70123
 connie.landry@mms.gov

Lang, William
 MMS
 1201 Elmwood Prk Blvd
 New Orleans, LA 70123

Lanich, Troy
 USCG
 8930 Ocean Drive
 Corpus Christi, TX 78419

Lee, J. Dobbs
 Logistics Manager
 Barry A. Vittor & Assc. Inc.
 8060 Cottage Hill Rd
 Mobile, AL 36695
 dlee@bvaenviro.com

Lindquist, David
 Research Associate
 LSU Coastal Fisheries Inst.
 204 Wetland Resources Bldg
 Baton Rouge, LA 70803
 davlind@aol.com

Link, Jason S
NOAA/NMFS
166 Water St
Woods Hole, MA 02543
Jason.Link@noaa.gov

Locke, Stephen
Grad Student
UNO Estuarine Research Lab
Lakefront Campus
New Orleans, LA 70148
slocke@uno.edu

Lopez, John
University of New Orleans
387 Carr Dr
Slidell, LA 70458

Lugo-Fernandez, Alexis
MMS
1201 Elmwood Prk Blvd
New Orleans, LA 70123

Lukens, Ronald
Gulf States Marine Fisheries Comm.
2404 Government Street
Ocean Springs, MS 39564
rlukens@gsmfc.org

Lyczkowski-Shultz, Joanne
Research Fisheries Biologist
NMFS\Johnson Controls
3209 Frederic St.
Pascagoula, MS 39567
jshultz@triton.pas.nmfs.gov

Maher, Tom
Environmental Specialist
Florida Fish & Wildlife Cons. Comm.
620 South Meridian St
Box MF-MFM
Tallahassee, FL 32399-1600
mahert@gfc.state.fl.us

Marano Briggs, Kay
Fisheries Biologist
MMS
381 Elden Street, MS 4042
Herndon, VA 20170
kay.briggs@mms.gov

McCawley, Jessica
Dauphin Island Sea Lab
101 Bienville Blvd.
Dauphin Island, AL 36258
jrmccawley@aol.com

McIlwain, Tom
NOAA/NMFS
3209 Frederic St
Pascagoula, MS 39567
tom.mcllwain@noaa.gov

McManus, Roger
Sr. Advisor for Oceans
MMS
1849 C Street NW, MS 6635
Washington, DC 20240

Meyer, Thomas
Physical Scientist
MMS
1201 Elmwood Park Blvd
New Orleans, LA 70123-2394
tom.meyer@mms.gov

Miget, Russell J
Environmental Quality Specialist
Texas Sea Grant Program
6300 Ocean Dr NRC 2800
Corpus Christi, TX 78412
rmiget@falcon.tamucc.edu

Miller, Mark W
Research Specialist
LSU Coastal Studies Inst.
3rd Floor Old Geology Bldg
Baton Rouge, LA 70803
mmill16@lsu.edu

Milon, J. Walter

Moran, David
Environmental Scientist
MMS
1201 Elmwood Prk Blvd
New Orleans, LA 70123

Morin, Michelle
Geographer
MMS
1701 40th St
Kenner, LA 70065
michelle.morin@mms.gov

Nichols, Scott
Director MS Labs
NMFS
P.O. Drawer 1207
Pascagoula, MS 39568-1207
scott.nichols@noaa.gov

Nieland, David L
Research Associate V
LSU Coastal Fisheries Inst.
CCEER Wetlands Bldg
Baton Rouge, LA 70803-7053
dniela@lsu.edu

O'Connell, Martin
Post-Doctoral Researcher
University of New Orleans
Dept of Biological Sciences
New Orleans, LA 70148
moconnel@uno.edu

Osburn, Hal
TPWD- Coastal Fisheries
4200 Smith School Rd
Austin, TX 78744
hal.osburn@tpwd.state.tx.us

Ouzts, Allyson
Auburn University
13430 County Rd #1
Fairhope, AL 36532
acouzts@hotmail.com

Patterson, William

Peter, D.

Peuler, Elizabeth
Supervisor, Physical Sci Unit
MMS
1201 Elmwood Prk Blvd
New Orleans, LA 70123
elizabeth.peuler@mms.gov

Pierce, Aaron
LSU
Dept of Oceanography and Coastal Studies
Baton Rouge, LA 70803
glis70@aol.com

Piko, Amy
Auburn University
12 N. Jackson St, Apt B
Mobile, AL 36602
apiko@hotmail.com

Plunket, John
Research Associate II
LSU Coastal Fisheries Inst.
204 Wetland Resources Bldg
Baton Rouge, LA 70803
jtplunket@aol.com

Rademacher, Kevin R
Research Fishery Biologist
National Marine Fisheries Service
P.O. Drawer 1207
Pascagoula, MS 39568-1207
krademac@triton.pas.nmfs.gov

Ray, James P
Equilon Enterprises LLC
3333 Highway 6 South
Houston, TX 77082-3101
jpray@equilon.com

Reggio, Jr., Villere
Outdoor Recreation Planner
MMS
1201 Elmwood Prk Blvd
New Orleans, LA 70123
villere.reggio@mms.gov

Ressler, Patrick H
Graduate Assistant
Texas A&M University
Dept. of Oceanography
3146 TAMU
College Station, TX 77843-3146
pressler@ocean.tamu.edu

Rigaud, Christopher
Grad Research Assist
Texas A&M University
6300 Ocean Dr
Corpus Christi, TX 78412
abysmalchris@hotmail.com

Roden, Carol
NMFS
3209 Frederic St
Pascagoula, MS 39567
croden@triton.pas.nmfs.gov

Rogers, Robert
MMS
1201 Elmwood Prk Blvd
New Orleans, LA 70123

Roscigno, Pat
MMS
1201 Elmwood Prk Blvd
New Orleans, LA 70123

Rowe, Gil
Professor
Texas A&M University
MS 3146 TAMU
College Station, TX 77843
growe@ocean.tamu.edu

Sammarco, Paul W
Professor
LUMCON
8124 Hwy 56
Chauvin, LA 70344
psammarco@lumcon.edu

Scanlon, Kathryn M
U.S. Geological Survey
384 Woods Hole Rd
Woods Hole, MA 02543
kscanlon@usgs.gov

Scarborough Bull, Ann
U.S. Fish & Wildlife Service
2493 Portola Rd, Suite B
Ventura, CA 93003
ann_s_bull@r1.fws.gov

Schexnayder, Mark
Marine Fisheries Agent
LSU Extension/Sea Grant
1855 Ames Blvd
Marrero, LA 70072
mschexnayder@agctr.lsu.edu

Shaw, Richard F
Director
LSU Coastal Fisheries Inst.
CCEER Wetlands Bldg
Baton Rouge, LA 70803-7053
rshaw@unix1.sncc.lsu.edu

Shipp, Robert
University of South Alabama
Dept of Marine Sciences
Mobile, AL 36688-0002
rshipp@jaguar1.usouthal.edu

Snyder, David B
Marine Biologist
Continental Shelf Assoc. Inc.
759 Parkway Street
Jupiter, FL 33477
dsnyder@conshelf.com

Stanley, David
Fisheries/Acoustic Specialist
Beak International
14 Abacus Rd
Brampton, ON L6T 5B7
dstanley@beak.com

Stanley, Louise
26 Hammell
Tottenham, L0G 1W0

Stead, Mark
LUMCON
104 Dr. Hugh St Martin Drive
Chauvin, LA 70344
mstead@lsu.edu

Sulak, Ken
Research Fish Biologist
U.S. Geological Project
Florida Caribbean Science Ctr.
7920 NW 71st St
Gainesville, FL 32653
ken-sulak@usgs.gov

Szedlmayer, Stephen T
Associate Professor
Auburn University
Marine Fish Laboratory
8300 State Hwy 104
Fairhope, AL 36532
sszedlma@acesag.auburn.edu

Taylor, Marilyn
Auburn University
2200 East Bay Drive, #50
Daphne, AL 36526
mytmazz@aol.com

Tomeny, Steve
P.O. Box 659
Golden Meadow, LA 70357

Topolski, Marek F
Research Assistant
Auburn University
Dept. of Fisheries
203 Swingle Hall

Auburn, AL 36849-5419
tpolmf@acesag.auburn.edu

Tsoflias, Sarah L
Physical Scientist
MMS
1201 Elmwood Prk Blvd
New Orleans, LA 70123
sarah.tsoflias

Turpin, Robert
Chief
Escambia County Marine Resources
Pensacola, FL 32534

Vigil, Debra
MMS
1201 Elmwood Prk Blvd, MS 5431
New Orleans, LA 70123
debra_vigil@mms.gov

Ward, Rocky
Genetics Program Director
Texas Parks & Wildlife
HC02 Box 385
Palacios, TX 77465
rocky.ward@tpwd.state.tx.us

Wilson, Charles
LSU Coastal Fisheries Inst.
Dept of Oceanography
Baton Rouge, LA 70803
cwilson@lsu.edu



The Department of the Interior Mission

As the Nation's principal conservation agency, the Department of the Interior has responsibility for most of our nationally owned public lands and natural resources. This includes fostering sound use of our land and water resources; protecting our fish, wildlife, and biological diversity; preserving the environmental and cultural values of our national parks and historical places; and providing for the enjoyment of life through outdoor recreation. The Department assesses our energy and mineral resources and works to ensure that their development is in the best interests of all our people by encouraging stewardship and citizen participation in their care. The Department also has a major responsibility for American Indian reservation communities and for people who live in island territories under U.S. administration.



The Minerals Management Service Mission

As a bureau of the Department of the Interior, the Minerals Management Service's (MMS) primary responsibilities are to manage the mineral resources located on the Nation's Outer Continental Shelf (OCS), collect revenue from the Federal OCS and onshore Federal and Indian lands, and distribute those revenues.

Moreover, in working to meet its responsibilities, the **Offshore Minerals Management Program** administers the OCS competitive leasing program and oversees the safe and environmentally sound exploration and production of our Nation's offshore natural gas, oil and other mineral resources. The MMS **Minerals Revenue Management** meets its responsibilities by ensuring the efficient, timely and accurate collection and disbursement of revenue from mineral leasing and production due to Indian tribes and allottees, States and the U.S. Treasury.

The MMS strives to fulfill its responsibilities through the general guiding principles of: (1) being responsive to the public's concerns and interests by maintaining a dialogue with all potentially affected parties and (2) carrying out its programs with an emphasis on working to enhance the quality of life for all Americans by lending MMS assistance and expertise to economic development and environmental protection.