

RI 9638

REPORT OF INVESTIGATIONS/1997

Distinguishing Motor Starts From Short Circuits Through Phase-Angle Measurements

UNITED STATES DEPARTMENT OF THE INTERIOR



UNITED STATES BUREAU OF MINES



U.S. Department of the Interior
Mission Statement

As the Nation's principal conservation agency, the Department of the Interior has responsibility for most of our nationally-owned public lands and natural resources. This includes fostering sound use of our land and water resources; protecting our fish, wildlife, and biological diversity; preserving the environmental and cultural values of our national parks and historical places; and providing for the enjoyment of life through outdoor recreation. The Department assesses our energy and mineral resources and works to ensure that their development is in the best interests of all our people by encouraging stewardship and citizen participation in their care. The Department also has a major responsibility for American Indian reservation communities and for people who live in island territories under U.S. administration.

Report of Investigations 9638

Distinguishing Motor Starts From Short Circuits Through Phase-Angle Measurements

**By Michael R. Yenchek, James C. Cawley, Jeffrey Shawn Peterson, and
Jeffrey L. Kohler**

**UNITED STATES DEPARTMENT OF THE INTERIOR
Bruce Babbitt, Secretary**

**BUREAU OF MINES
Rhea Lydia Graham, Director**

International Standard Serial Number
ISSN 1066-5552

CONTENTS

	<i>Page</i>
Abstract	1
Introduction	2
Background	2
Analyses of high-voltage longwall power systems	3
Approach to system analyses	3
Factors affecting short-circuit protection	4
Motor starts and short-circuit protection	4
Motor-start evaluations	5
Field tests of mine motors	5
Data acquisition hardware and software	5
Motor waveform analyses	6
Motor-start phase-angle observations	7
Motor-start detection scheme	8
Prototype circuit operation	8
Application	8
Summary and conclusions	9
Acknowledgment	9
References	9
Appendix.—Circuit description	10

ILLUSTRATIONS

1. One-line diagram of a typical longwall power system	3
2. Coordination plot for 2,400-V longwall	5
3. Coordination plot for 950-V longwall	5
4. Measuring motor-start waveforms on a 950-V continuous mining machine	6
5. Phase-to-phase voltage waveform for start of 950-V, 165-hp motor	6
6. Line-current waveform for start of 950-V, 165-hp motor	6
7. Superposition of motor-start voltage and current waveforms	7
8. Current waveform distortion of pump motor on continuous mining machine	7
9. Phase angle versus time during start of cutter motor	8
A-1. Prototype phase-angle detection circuitry	11

UNIT OF MEASURE ABBREVIATIONS USED IN THIS REPORT

A	ampere	ms	millisecond
hp	horsepower	MVA	megavolt ampere
Hz	hertz	s	second
km	kilometer	V	volt
kV	kilovolt	%	percent
kVA	kilovolt ampere	°	degree
m	meter		

Mention of any company name or product does not constitute endorsement by the National Institute for Occupational Safety and Health.

To receive other information about occupational safety and health problems, call 1-800-35-NIOSH (1-800-356-4674), or visit the NIOSH Home Page on the World Wide Web at <http://www.cdc.gov/niosh/homepage.html>

DISTINGUISHING MOTOR STARTS FROM SHORT CIRCUITS THROUGH PHASE-ANGLE MEASUREMENTS

Michael R. Yenchek,¹ James C. Cawley,² Jeffrey Shawn Peterson,¹ and Jeffrey L. Kohler³

ABSTRACT

The Pittsburgh Research Center (PRC)⁴ investigated how the starting of induction motors may cause nuisance tripping of short-circuit protection on coal mine power systems. This research had a threefold purpose: (1) to determine the range of typical values for power system characteristics that affect short circuits and motor starts on high-voltage longwalls, (2) to identify how motor-start waveforms differ from those for short circuits, and (3) to devise a method to provide short-circuit protection without intentional time delays to account for motor starts. Distribution voltage, transformer impedance, power center location, and motor size were found to critically influence the magnitude of short-circuit and motor-start currents on high-voltage longwalls. An attribute of motor-start signatures that distinguished them from short circuits was the relatively large phase angle between voltage and current. Electronic circuitry was designed to detect phase angles and react to momentarily disable circuit breaker action for motor starts. A prototype was successfully evaluated with an induction motor in the laboratory. By minimizing intentional time delays in short-circuit protection, this technology will help ensure that surface temperatures of energized electrical apparatus will not exceed gas or dust ignition thresholds when such faults occur.

¹Electrical engineer, Pittsburgh Research Center, National Institute for Occupational Safety and Health, Pittsburgh, PA.

²Supervisory electrical engineer, Pittsburgh Research Center, National Institute for Occupational Safety and Health, Pittsburgh, PA.

³Associate professor, Department of Mineral Engineering, The Pennsylvania State University, University, PA.

⁴This research originated under the U.S. Bureau of Mines prior to transferring to the National Institute for Occupational Safety and Health in 1996.

INTRODUCTION

On August 27, 1992, the Mine Safety and Health Administration (MSHA) published proposed rules for high-voltage electrical equipment used in longwall face areas of underground coal mines [57 Fed. Reg.⁵ 39036 (1992)]. The intent of these regulations is to reduce the likelihood of fire, explosion, and shock hazards by citing requirements for electrical enclosures, circuit protection, testing, and personnel protection. The operational limits for short-circuit protective devices are proposed within section 75.814 of these rules.

Short-circuit protection for electrical apparatus in underground coal mines is critical. When different phases of an electrical circuit inadvertently come in contact, thousands of amperes may flow. Currents of this magnitude can cause explosions and fires if permitted to exist even for periods as brief as 1 s. The thermal energy expended is directly related to I^2t [ANSI/IEEE standard 242, 1986]. Consequently, protective device settings must be specified with a maximum sensitivity to current (I) and a minimum reaction time (t).

Unfortunately, extremely low current settings may interfere with mining operations by inadvertently reacting to normal transient events, such as the starting of motors. In response, the proposed MSHA rules specify maximum time delays for short-circuit protection of cables extending from the power center to motor starters. In the future, the trend toward higher efficiency motors with greater peak starting currents may

necessitate even longer delays. However, in background discussion of the rules, MSHA solicits comments regarding the elimination of intentional time delays with a conjunctive increase in current settings. This reflects the dilemma of short-circuit protection, namely, that circuit protective devices should have high sensitivity to faults, but not interfere with normal mining operations. Accordingly, MSHA requested a high-priority research effort aimed at eliminating intentional time delays in short-circuit protection.

The specific objectives of this research project were to (1) determine the range of typical values for power system characteristics that affect short-circuit and motor-start current magnitudes on high-voltage longwalls, (2) identify how motor-start waveforms differ from those for short circuits, and (3) devise a method to provide short-circuit protection without intentional time delays to account for motor starts. Minimal reaction times to short circuits will help ensure that the temperatures of energized electrical apparatus will not exceed gas or dust ignition thresholds when such faults occur. Additionally, the capability of distinguishing between motor-start and short-circuit events will preclude nuisance protective device activation. Although the initial thrust of the project focused on high-voltage longwalls, the technology subsequently developed is applicable to low- and medium-voltage mine power systems as well.

BACKGROUND

Protection against short circuits on mine power circuits is typically provided by molded-case circuit breakers or vacuum interrupters. The current magnitude thresholds or settings at which these devices operate are specified either by regulation [30 CFR⁶ 75.601 (1992)] for low- and medium-voltage circuits or through the MSHA approval process [Boring and Porter 1988] for high-voltage longwalls. The initial inrush currents, demanded by large induction motors starting across the line, may exceed these settings and activate the protection devices needlessly. Consequently, to prevent nuisance tripping of the short-circuit protection, it is desirable to seek a means to momentarily disable or inhibit the protection device activation for a finite period following motor energization.

A speed-sensing switch could logically be utilized to signal motor start, but requires direct access to rotating parts, which is sometimes not feasible or economical. In addition, this sensor may be slow to operate where load inertia is high. This is also true for induction-disk impedance or distance relays used primarily for fault protection on transmission lines [Morley et al. 1982; Schulman et al. 1978; DeCastro et al. 1995]. In the late 1970's, a system was developed in the United Kingdom that monitored the phase angle between voltage and current to distinguish between faults and motor starts [Lord and Pearson 1980]. Despite promising results, this technology has not been incorporated in short-circuit protection for U.S. mines. Given the catastrophic potential of inadequate electrical protection, it is imperative to reexamine this problem to minimize any intentional time delays while maximizing current sensitivity.

⁵Federal Register. See Fed. Reg. in references.

⁶Code of Federal Regulations. See CFR in references.

ANALYSES OF HIGH-VOLTAGE LONGWALL POWER SYSTEMS

To distinguish motor starts from short circuits, it was first necessary to study the qualities of each event and identify the factors that have critical impact on the resultant current. Because the impetus for this project resulted from proposed MSHA rules involving high-voltage longwalls, the characteristics of these power systems were evaluated at the outset. These analyses enabled the construction of coordination plots that graphically illustrated the problem of motor-start interference with short-circuit settings.

A database of coal mine high-voltage longwalls was obtained from MSHA [Skorski and Checca 1993]. The electrical information pertaining to 30 power systems was scanned to gain familiarity with typical characteristics. A one-line diagram of a typical longwall power system is shown in figure 1. Shearer motor voltages were found to range from 950 to 4,160 V, with most using 2,400 V. Shearer motor ratings varied from 370 to 1,480 hp, with the average at 920 hp. The cable supplying power to the shearer motor typically was a 4/0 American wire gauge (AWG) that ranged from 152 to 549 m long.

APPROACH TO SYSTEM ANALYSES

Commercial power system analysis software was used to model these systems. In determining the factors that critically influence short-circuit and motor-start currents on high-voltage longwalls, several assumptions were made. Three-phase symmetrical and line-to-line faults were exclusively considered because ground faults are sensed by separate devices. The three-phase symmetrical fault closest to the circuit breaker represented the maximum fault current that must be interrupted, whereas the line-to-line value, at the most distant location from

the circuit breaker, represented the minimum value that must be detected. A zero value of fault impedance was used to model worst-case faults on high-voltage longwall power systems.

Under fault conditions, any motor connected to the faulted bus will behave like a generator, supplying current to the fault for a short time. As the voltage on the faulted bus collapses, the inertia of the rotor and connected load will power the motor. Induction motor contributions during faults were presumed to be equal to the full-voltage starting current of the motor for up to two cycles [Huenig 1982].

The effect of the mine power distribution system was the single most difficult issue to resolve during this study, because the same longwall system connected to two different distribution systems could perform very differently. The specific parameters of concern were the short-circuit capacity at the main mine substation and the impedance between the main substation and the longwall transformer. The size of modern longwall power systems demands that the power system be reasonably stiff (voltage regulation < 10%), and the size of main substations is such that short-circuit capacities greater than 900 MVA are not uncommon in most of the United States. Nonetheless, the impedance from the main substation to the longwall transformer will be substantially larger as the mine develops and up to 6 km of feeder cable is added.

Finally, one-third of the longwall power centers included in this study utilized a three-winding transformer, with a high-voltage secondary of 2,400 or 4,160 V and a medium-voltage tertiary. The tertiary windings of longwall power center transformers were neglected because their influence on short circuits was believed to be negligible. In addition, future systems are likely to use the tertiary winding only for ancillary equipment, such as pumps.

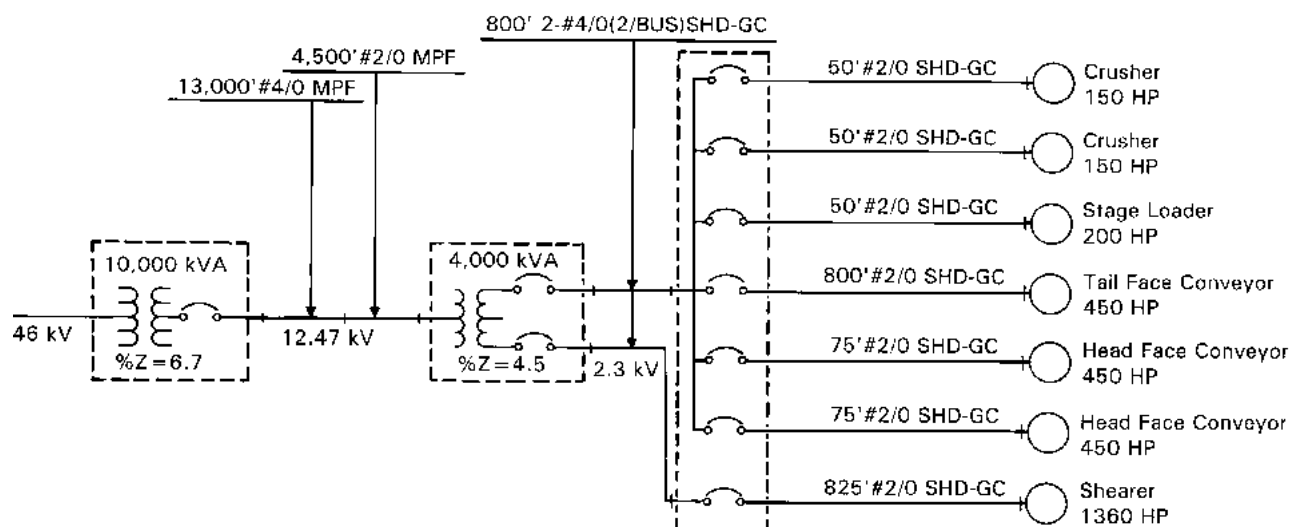

Figure 1.—One-line diagram of a typical longwall power system.

FACTORS AFFECTING SHORT-CIRCUIT PROTECTION

A primary goal of this study was to determine the range of typical values for power system characteristics that impact short-

circuit protection settings of high-voltage longwall installations. It was understood that transformer impedance and capacity, cable size and length, and motor type and size would be important factors. The variability of these parameters and their impact on short-circuit protection settings were investigated.

The available short-circuit capacity at the main substation has a major impact on the available short-circuit current at the longwall. The stiff power systems common throughout most of the United States can deliver 1,000 MVA or more. However, in some rural areas, particularly in the Western United States, capacities are as low as 100 MVA. Practically, this would more than halve the fault current in a typical coal mine, e.g., 17,500 to 8,000 A. For this study, a value of 1,000 MVA was used, not only because it is typical of a large number of mines, but also because it represents the more difficult case.

The mine distribution system to which the longwall power system is connected ultimately limits the fault current at the longwall. Any transformers between the utility connection and the longwall power center add impedance that limits current flow, as does the impedance of cables used to connect these points. Initially, there may be as little as 600 m of cable between the main substation and the longwall power center, whereas in later years 6 km may be in place before a new power borehole is required. This additional cable impedance, along with the significant transformer impedance, reduces available fault current by about 40%, e.g., 20,700 to 13,200 A at the secondary of the longwall transformer.

The impedance of the longwall transformer is the single most important variable within the longwall power system for determining short-circuit currents. Impedances as low as 3% are common, as are values up to 7%. The short-circuit current can be 25% greater for a 3% transformer impedance than for the same system with a 7% transformer impedance. The transformer capacity also affects fault current because larger transformers pass more energy. However, given the typical range of transformer sizes (3,000 to 5,000 kVA), this is a minor consideration compared with the impedance [Morley et al. 1990].

The impedance of individual cables as determined by their length, size, and type also influences the current magnitude. Type SHD-GC cable is used universally in sizes of 2/0 and 4/0 AWG for the armored face conveyor and shearer loads and often for the crusher and stage loader. Face lengths range from 230 to 365 m; however, the difference in total impedance caused by the additional few hundred meters of cable is small. The variation in fault currents, due to cable differences, is insignificant compared with variations caused by transformer impedance.

The motor size and type affects the short-circuit settings significantly. The motor's size, i.e., horsepower, and its design parameters, especially its subtransient reactance, impacts the first one to two cycles of fault current. As described earlier, the motor contribution to the faulted bus can be significant and depends on its subtransient reactance. Normally, this is only a concern when specifying the close and latch rating of a circuit breaker or in medium-voltage applications when using molded case breakers to ensure that the breaker will be capable of opening under this condition.

MOTOR STARTS AND SHORT-CIRCUIT PROTECTION

Motor size and type also impact starting current magnitude. Large, high-efficiency motors combine high breakdown torques with significant locked rotor reactances. The result is that starting currents for a 950-V motor may exceed 2,500 A, the maximum allowable instantaneous circuit-breaker setting permitted under the provisions of Title 30 without special authorization from the Secretary of Labor [30 CFR 75.601 (1992)]. A scenario can be envisioned where it becomes difficult to distinguish between starting current and fault current on a particular bus. Each of the following conditions will contribute to such a situation:

1. The transformer impedance is high, e.g., 7% rather than 3%.
2. The longwall transformer is located at its greatest distance from the mine substation.
3. The distribution voltage is 7,200 V, rather than 13 kV or higher.
4. The motor is large, of high-efficiency design, and/or has a high breakdown torque.

Conditions 1, 2, and 3 will reduce the fault current, whereas condition 4 will result in higher starting currents. Moreover, for the sake of a worst case, it is assumed that conditions 1, 2, and 3 will not limit the starting current. In reality, however, they will cause a significant voltage drop during starting, which will limit the starting current (the motor is modeled as a constant impedance load during starting and a constant power load during operation) [Novak and Martin 1996].

A coordination plot for protecting the tail motor of the armored face conveyor (AFC) will serve as an example. Figures 2 and 3 illustrate the 2,400-V and 950-V cases, respectively, in which a 500-hp AFC tail motor is connected to the motor control center via a 305-m, 4/0 AWG cable. The short-circuit protection for the 2,400-V system consists of a very-inverse time overcurrent (TOC) relay and a vacuum breaker, whereas an extremely-inverse TOC relay and molded case circuit breaker are used on the 950-V circuit. The maximum fault current results from a bolted three-phase fault at the terminals of the breaker, whereas the minimum fault

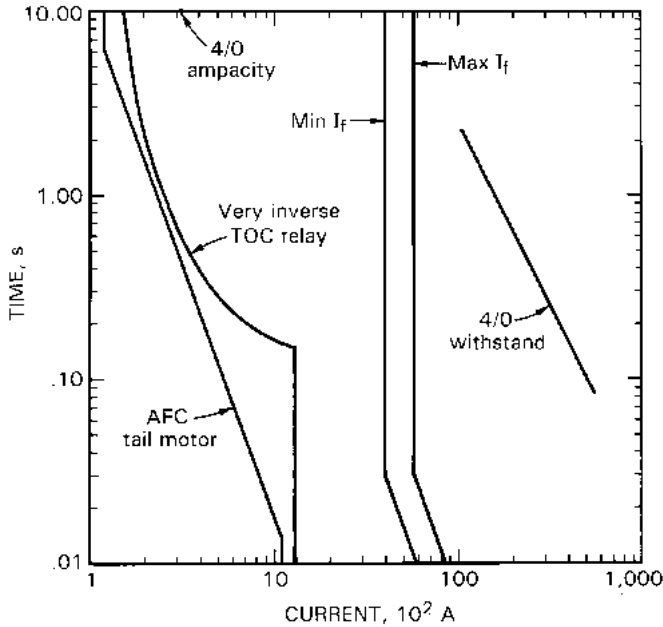

Figure 2.—Coordination plot for 2,400-V longwall.

current is a line-to-line fault at the motor bus. The motor contribution is considered for both the minimum and maximum values. The motor starting current is shown for a fully loaded conveyor.

An analysis of figure 2 shows that it is easy to achieve coordination, and even though a small time delay is introduced

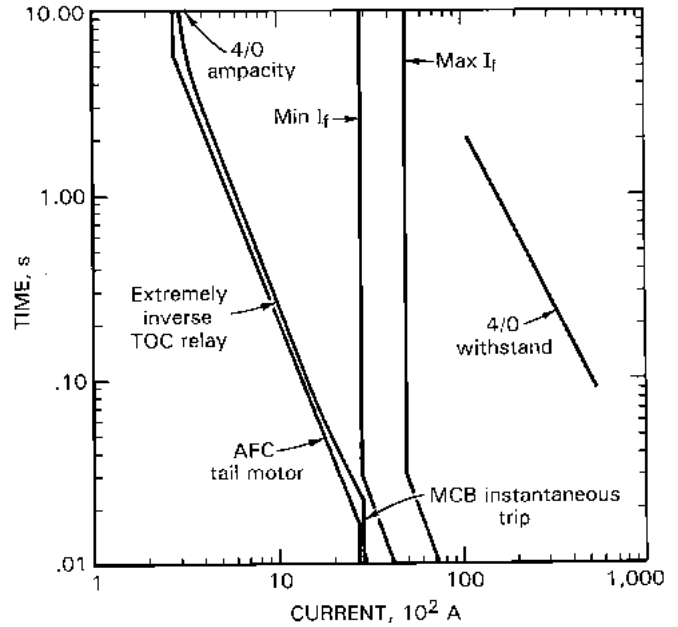

Figure 3.—Coordination plot for 950-V longwall.

to allow for starting, it is minimal. Moreover, any fault will cause an instantaneous initiation of the circuit breaker. In figure 3, the starting current due to the inrush component exceeds 2,500 A and would require a special approval from MSHA. It can also be observed that the margin between the starting current and the minimum fault current is quite small.

MOTOR-START EVALUATIONS

The nature of how the starting of induction motors may cause nuisance tripping of short-circuit protection has been analyzed. Electrical safety can be enhanced if the circuit-protection device recognizes and reacts only to short circuits. To devise a means to discriminate between motor starts and short circuits, one must first investigate how the waveforms of each event differ. Any distinguishing characteristics may then be keyed upon through the design of sensing circuitry. Accordingly, it was decided to record the voltage and current waveforms of mine induction motors of various voltages and evaluate their salient characteristics.

FIELD TESTS OF MINE MOTORS

To gain insight into motor-start signatures, field tests of a variety of mine motors were conducted. These included motors with application in both longwall and continuous mining, with voltages ranging from 440 to 4,160 V and power ratings

from 10 to 450 hp. Because mine motors are typically started across the line with full voltage, it was necessary to select test sites with this capability. These included a rebuild shop with 440- and 550-V motors up to 150 hp. At another facility, a 4,160-V conveyor motor was evaluated. Finally, the pump, conveyor, and cutter motors of a 950-V continuous miner were analyzed (figure 4). To ensure random motor energization relative to the voltage cycle, 12 successive start recordings were made of each motor. Recordings were usually made at the terminals of the motor. However, recordings of the continuous miner motors were made at both the motor terminals and in the load center that fed the 153-m trailing cable.

DATA ACQUISITION HARDWARE AND SOFTWARE

Transducers were used to record three-phase currents during motor starts. The Hall-effect current sensors featured a frequency response from direct current (dc) to 1,000 Hz to

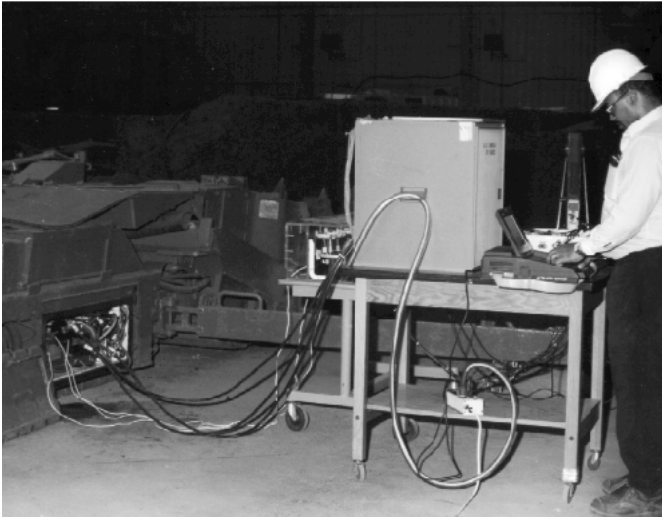

Figure 4.—Measuring motor-start waveforms on a 950-V continuous mining machine.

capture higher frequency transients that may be present. The 1,000-A split-core configurations had 5,000-V line-to-output isolation. They were used in conjunction with matched signal conditioners having ± 10 -V outputs directly proportional to the amplitude of the input signal. Tests with low-voltage motors utilized 0 to $\pm 1,000$ -V voltage transducers with a proportional 0 to ± 10 -V output. These sensors had a frequency range of dc to 5,000 Hz. At 1,000 V and above, custom potential transformers were used to acquire the voltage waveform. The current signal conditioners and voltage sensors were connected to ground-isolation boards, 1,000-Hz programmable filters, and a 12-bit analog-to-digital board. This board had the capability of scanning up to eight separate channels and was equipped with simultaneous sample-and-hold circuitry that eliminated phase shifts among channels. The output of this board was digitally recorded in a multichannel file using a 486-based laptop personal computer that was made rugged for field use. A custom computer program was written that allowed the user to choose the number of channels to record at sampling rates up to 30,720 Hz per channel. During acquisition, data were written directly to disk with data files saved in binary format.

MOTOR WAVEFORM ANALYSES

The motor-start voltage and current data were subsequently imported into a commercial data analysis package. Three-phase waveforms of voltage and current were plotted versus time for each of the motor tests. Typical plots are shown in figures 5 and 6. The inrush current following circuit energization has the potential to cause nuisance tripping of the short-circuit protection. It lasts for a time period that depends on the motor characteristics and loading. Closer examination of the time-varying signal revealed high-frequency oscillations within the

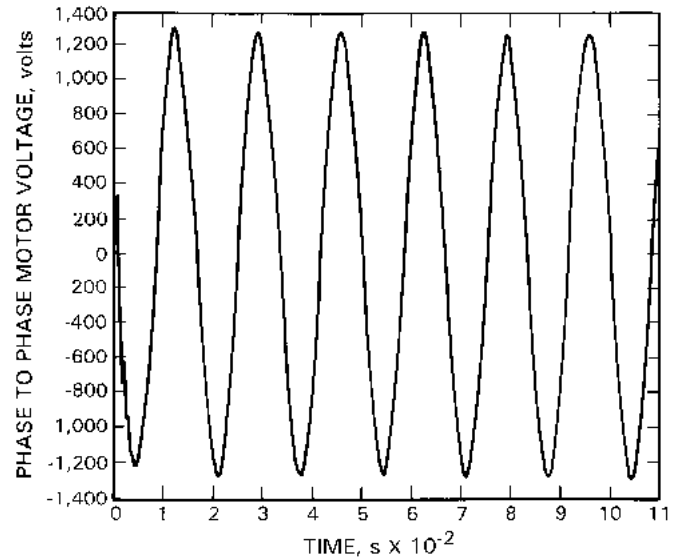

Figure 5.—Phase-to-phase voltage waveform for start of 950-V, 165-hp motor.

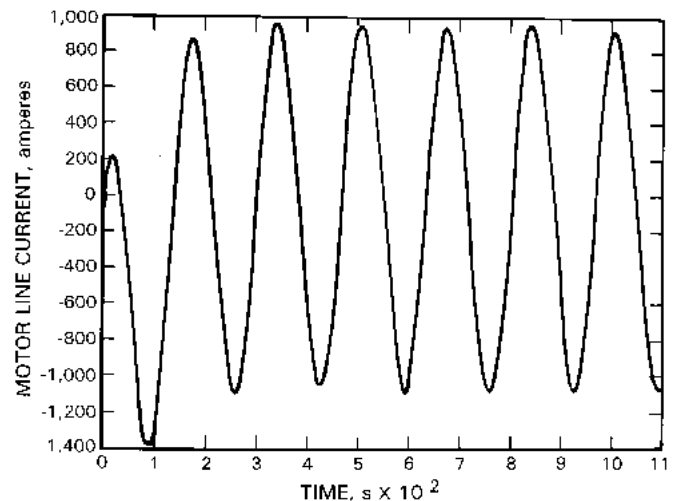

Figure 6.—Line-current waveform for start of 950-V, 165-hp motor.

first few milliseconds following energization. These perturbations were later attributed to contact bounce. A fast Fourier transform of the current waveforms displayed no frequencies other than the fundamental and its harmonics. Consequently, the examination of individual motor-start waveforms revealed no unusual characteristics upon which a motor-start detection scheme could be keyed.

Attention then turned to a study of the induction motor phase angle during starting. The phase angle may be obtained by superposing the voltage and current waveforms of a particular phase on a common time scale (figure 7) and recognizing that nominal 30° phase shifts were inherent with the phase-to-phase connections of the voltage transducers. It should be noted that the phase angles observed were not equivalent to those

associated with power factor. The angle in degrees between two corresponding points of the waveforms may be derived by considering that, at a frequency of 60 Hz, one 360° waveform cycle is completed every 0.01667 s.

Typical inductive reactance-to-resistance (X/R) ratios for induction motors, published in the Institute of Electrical and Electronics Engineers "Red Book" [ANSI/IEEE standard 141, 1993], are in the range of 10 to 20. A fault on a circuit feeding an induction motor essentially shunts that inductive load, decreasing the phase angle between the voltage and current. Further, it is known that the phase angle of an induction motor during start is larger than that at full load [Schulman et al. 1978]. Accordingly, the phase angle between the voltage and starting current must theoretically be larger on any given mine motor circuit than that resulting from a fault.

MOTOR-START PHASE-ANGLE OBSERVATIONS

Phase angles from start to full speed were derived from the motor waveforms recorded during field tests. The voltage and current waveforms were superposed and the time lag calculated at the zero crossings from energization to the point where the motor had attained full speed. Initial analyses involved nine unloaded, Class H, 440- and 550-V induction motors at a rebuild facility. The angle between voltage and current for the first and second zero crossings was found to vary by as much as 50°, not only among each of the three phases for a given test, but also for any given phase in successive tests. In addition, phase-angle variations were observed even after the motor attained full speed. A number of factors contributed to these phenomena. First, in many cases immediately following energization, the current waveforms exhibited a transient distortion that affected the exact time of the zero crossing. High-frequency oscillations due to contact bounce enhanced these irregularities. More importantly, the position of the voltage wave of a particular phase relative to the time of energization had an even greater impact on the phase angle. For example, if the voltage of a given phase was approaching a zero

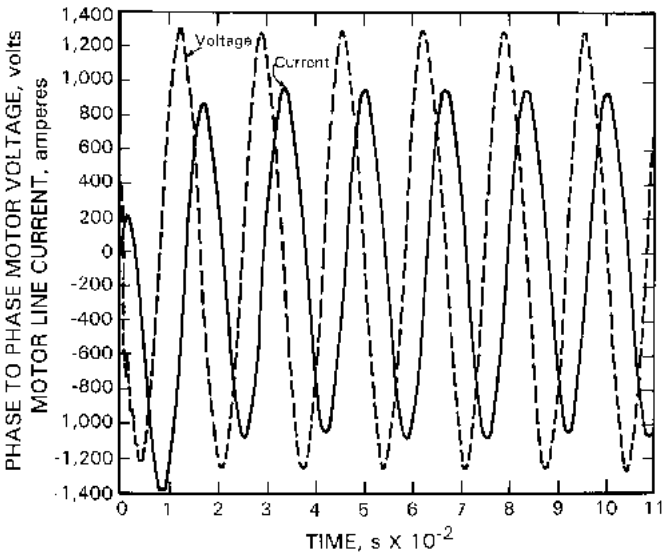

Figure 7.—Superposition of motor-start voltage and current waveforms.

crossing and about to change polarity at the moment of motor

energization, the resultant current wave for that phase would exhibit distortion during the first cycle (figures 5 and 6). Further, some of the inconsistencies may be attributed simply to the fact that all of the motors were tested on the shop floor without any mechanical load on their shafts. Repeatable phase angles were observed in subsequent tests of a loaded 4,160-V, 450-hp motor at another facility and motors under load on a continuous miner. Finally, as expected, there were differences observed in phase angles during starts with motors of different horsepower or manufacturers.

Next, the results of tests on continuous mining machine motors were analyzed. During data acquisition, considerable waveform distortion of the pump motor current was noted (figure 8). Again, there was some variation among calculated phase angles during the first two cycles, but not to the degree observed with unloaded motors. Despite the waveform distortion, following the first two cycles and continuing to running speed, phase-angle magnitude behaved much more predictably over time among phases and successive tests. Figure 9 shows that the phase angle from start to full speed for the cutter motor declined almost linearly as measured at the power center. Not surprisingly, because trailing cables exhibit a lower X/R ratio compared with that of motors, the phase angles calculated at the motor terminals during starts were on average 5° greater than those obtained from tests at the power center.

These analyses provided insight into the behavior of the phase angle between the current and voltage of a motor during start. They showed that, for a loaded motor after the first two cycles, the phase angle was relatively predictable. Consequently, the phase angle can be a reasonable basis for a methodology designed to distinguish between motor starts and short circuits on mine power systems.

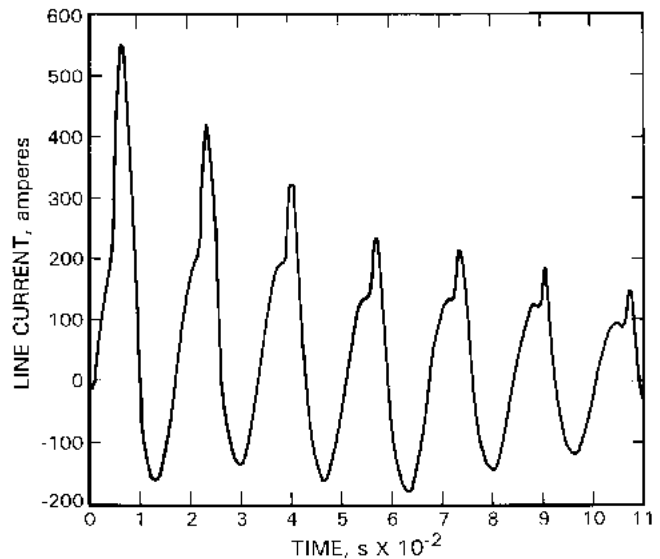

Figure 8.—Current waveform distortion of pump motor on continuous mining machine.

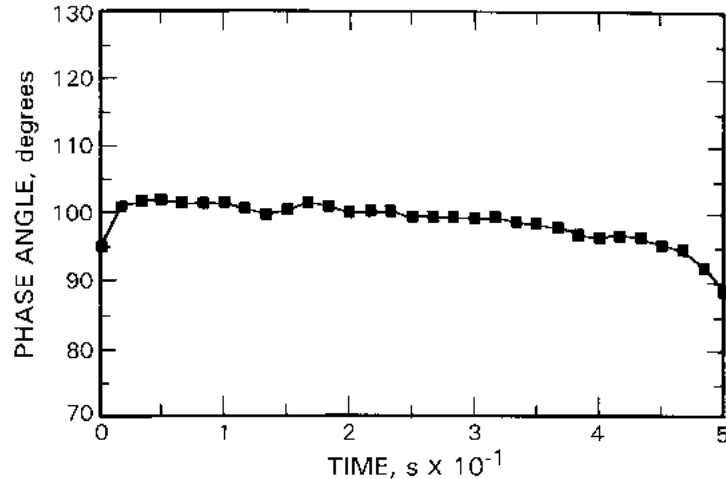

Figure 9.—Phase angle versus time during start of cutter motor.

MOTOR-START DETECTION SCHEME

The proposed MSHA rules for high-voltage longwalls permit a maximum time delay in short-circuit protection of 0.25 s or 15 cycles [57 Fed. Reg. 39036 (1992)]. To minimize electrical fire hazards, a motor-start detection scheme should react much faster, ideally with no intentional time delay. Initially, it was believed that commercial phase-angle meters might be suited for incorporation into a detection system. However, the typical response times specified for these instruments was found to be 100 ms, which is too slow for consideration. Minimal time delay is best achieved through a digital-based design that does not rely on computational processes or integration of 60-Hz-power waveforms. Accordingly, the approach was to devise a means to detect the time between each zero crossing of the voltage and current signals beginning with the first half-cycle.

PROTOTYPE CIRCUIT OPERATION

The prototype circuit is described in detail in the appendix. The circuit can monitor the current and voltage waveforms for one phase of a three-phase circuit. A suitable potential transformer is required for a phase-to-phase voltage measurement. To accurately measure electrical degrees during each half-cycle, a crystal-controlled oscillator was selected as the time reference. Clock pulses generated during zero crossings of voltage and current are counted and compared with a preset (phase-angle) delay. If the angle between voltage and current exceeds the setting of the circuit and current magnitude is high, the device sends a signal to inhibit circuit breaker action.

The detector circuit was tested using a 50-hp, 460-V induction motor in the laboratory. The motor had an unloaded generator coupled to its shaft. The detector's activation setting was adjusted to within 5° of the phase-angle characteristics recorded during prior motor starts. Once set, the detector contacts were observed to drop out during subsequent motor starts. Occasionally, they remained

closed momentarily at the outset of a test, but only for a period corresponding to the first two cycles of motor-start current. During this initial period, switching transients may be expected.

APPLICATION

The prototype detector can have utility on three-phase power systems where the starting of induction motors causes nuisance tripping of the short-circuit protection. In lieu of incorporating an intentional time delay or increasing the magnetic trip setting of the circuit breaker, the detector may be used to momentarily inhibit circuit breaker action during motor starts. It is envisioned that the detector would consist of three identical circuits, one for each phase. Located near the circuit breaker, the device would temporarily inhibit breaker action only if low phase angles *and* high currents were indicated for all phases. This would preclude disabling the circuit protection for phase shifts associated with line-to-line faults. Inherent shifts of 30° due to phase-to-phase connections of the voltage transducers would simply be added to the motor-phase shifts when setting the detector's phase-angle activation point. It is recommended that the activation point of the current magnitude detector be adjusted to the required magnetic setting of the circuit breaker. Consequently, the device would remain inactive for currents less than the circuit breaker setting. When phase currents exceed this level, a built-in two-cycle delay in detector activation (not part of the original design) would prevent false indications for the initial period of motor starts. Because the phase-angle characteristics of motors depend on motor voltage, class, manufacturer, and horsepower, presetting of the detector would be impractical. In application, the device activation point plus some margin would be determined by starting the protected

motor a dozen times. This would account for any transients resulting from the randomness of the instant of energization relative to the voltage cycle.

SUMMARY AND CONCLUSIONS

The Pittsburgh Research Center conducted an investigation to improve electrical safety in coal mines through research into short-circuit protection of mine power systems. Distribution voltage, transformer impedance, power center location, and motor size were found to critically influence the magnitude of short circuits and motor starts on high-voltage longwalls. The need for accurate and rapid fault detection was confirmed through computer models of power systems. Voltage and current waveforms of mine induction motors were recorded during field tests, and their salient characteristics were evaluated. An attribute of motor-start signatures that distinguished them from short circuits was the relatively large phase angle between voltage and current. This was the focus of subsequent efforts to devise a means to discriminate between motor starts and short circuits. Electronic circuitry was designed to differentiate between phase angles associated with

motor starts and faults and react to momentarily disable circuit breaker action for motor starts. A prototype was successfully evaluated with an induction motor in the laboratory.

By devising a method to distinguish between motor starts and short circuits, any intentional time delays in response to short circuits can be virtually eliminated. Rapid response to short circuits will help ensure that the surface temperatures of energized electrical apparatus will not exceed gas- or dust- ignition thresholds when such faults occur. In addition, the capability of differentiating motor starts from short circuits will preclude nuisance protective device activation. Ultimately, this work may lead to revisions to high-voltage longwall approval guidelines and improvements in circuit breaker designs. However, the technology should be applicable to motor circuits at all voltage levels.

ACKNOWLEDGMENT

The authors acknowledge the assistance of Elio L. Checca of the MSHA Technical Support Group, Pittsburgh, PA, who

provided the results of electrical surveys of high-voltage longwalls for use in this project.

REFERENCES

- ANSI/IEEE standard 141 [1993]. Recommended practice for electric power distribution for industrial plants (IEEE red book). Institute of Electrical and Electronics Engineers, Inc.: New York, NY.
- ANSI/IEEE standard 242 [1986]. IEEE recommended practice for protection and coordination of industrial and commercial power systems (IEEE buff book). Institute of Electrical and Electronics Engineers, Inc.: New York, NY, p. 344.
- Boring CM, Porter KJ [1988]. Criteria for approval of mining equipment incorporating on-board switching of high-voltage circuits. In: Proceedings of the Ninth WVU Mining Electrotechnology Conference. Morgantown, WV: West Virginia University, pp. 267-274.
- CFR. Code of Federal regulations. Washington, DC: U.S. Government Printing Office, Office of the Federal Register.
- DeCastro JE, Beck RT, Cai C, Yu L [1995]. Stall protection of large induction motors. In: IEEE Transactions on Industry Applications. Vol. 31, No. 5, pp. 1159-1166.
- 57 Fed. Reg. 39036 [1992]. Mine Safety and Health Administration: proposed rules.
- Huenig WC [1982]. Calculating short-circuit currents with contributions from induction motors. In: IEEE Transactions on Industry Applications. Vol. IA-18, No. 2, pp. 85-92.
- Lord H, Pearson FK [1980]. Ultra-sensitive instantaneous fault protection for cage induction motor supplies. Mining Technology 62:219-223.
- Morley LA, Tomlinson JN, Moore G, Kline DE [1982]. Portable trailing cables, splices, and couplers design and installation considerations. University Park, PA: The Pennsylvania State University. U.S. Bureau of Mines contract No. J0199106.
- Morley LA, Novak T, Davidson I [1990]. The application of 2,400 V to longwall face equipment. In: IEEE Transactions on Industry Applications. Vol. 26, No. 5, pp. 886-892.
- Novak T, Martin JK [1996]. The applications of 4,160 V to longwall face equipment. In: IEEE Transactions on Industry Applications. Vol. 32, No. 2, pp. 471-479.
- Schulman JM, Elmore WA, Bailey KD [1978]. Motor starting protection by impedance sensing. In: IEEE Transactions on Power Apparatus and Systems. Vol. PAS-97, No. 5, pp. 1689-1695.
- Skorski DF, Checca EL [1993]. High-voltage longwall database. In: Conference Record of the IEEE Industry Applications Society (IAS), 28th IAS Annual Meeting. Toronto, Ontario, Canada: pp. 2436-2441.

APPENDIX.—CIRCUIT DESCRIPTION

The circuit described here (figure A-1) can monitor the current and voltage waveforms for one phase of a three-phase circuit. A suitable potential transformer is required for a phase-to-phase voltage measurement. Referring to figure A-1, the 120-V secondary voltage is fed to pin 5 of IC1 through R11. IC1 develops an output pulse on pin 4 each time the input voltage goes through zero. Similarly, a current transducer supplies a 120-V signal that corresponds to the magnitude of the line current to pin 5 of IC7 through R12. Line current magnitude is also measured by IC's 11 and 12, which are described later. Pin 4 of IC12 develops an output pulse during each current zero crossing.

To accurately measure electrical degrees during each half-cycle, a crystal-controlled complementary-metallic-oxide-semiconductor oscillator, producing clock pulses at 32,768 Hz, was selected as a time reference. There are 21,600 (60 Hz \times 360 electrical degrees/cycle) electrical degrees per second. In a full 60-Hz cycle, there are 546 (32,768 clock cycles/second \times (1/60) second/electrical cycle) clock cycles. By proportion, the number of clock cycles corresponding to a desired time delay (or phase angle) between voltage and current waveforms is shown below:

Electrical											
degrees	150	120	90	80	70	60	45	30	20	10
Clock											
cycles	227	182	137	122	107	91	69	46	31	16

The voltage zero-crossing pulse from IC1 pin 4 sets the set-reset flip-flop, IC2. Once set, IC2 enables IC3 to gate clock pulses from IC10 into the binary counter, IC4. IC4 counts the clock pulses until a current zero-crossing pulse is received from IC7 pin 4. When the current zero-crossing pulse is generated, it resets the set-reset flip-flop, IC2, and resets the counter, IC4, to zero. In addition, when IC2 is reset, the flow of clock pulses to the counter, IC4, is stopped until a voltage zero-crossing pulse begins the process over again during the next half-cycle.

Switch SW1 is connected to the output of counter IC4. It contains eight on-off switches that can be configured to indicate when counter IC4 has reached a preselected number of clock pulses during any half-cycle. By placing any switch in the "on" position, the counter digit is constrained high. By using all eight switches in this manner, an eight-bit binary number can be formed that is the set point for the clock pulses that arrive between the voltage zero-crossing (set) pulse and the current zero-crossing (reset) pulse.

For example, to detect a delay of 45 electrical degrees, 69 clock pulses must be counted. With the switches set to 01000101 (69 in binary), IC8 delivers a pulse when the counter output equals 01000101. If the current zero-crossing (reset) pulse arrives before count 01000101, IC8 will not deliver an output pulse during that half-cycle, indicating a small (resistive) phase angle. Thus, this device measures whether some preset phase angle is equaled or exceeded during each half-cycle.

When the counter output equals the set point, the combinational logic of IC's 5, 6, and 8 causes a high pulse to be sent to the retriggerable one-shot, IC9. IC9 produces a 9-ms output pulse that holds transistor Q3 and relay RL1 latched. If the voltage zero-crossing (set) pulse and the current zero-crossing (reset) pulse arrive too closely together (small phase angle), IC4 cannot reach its set point. A retriggering pulse is not delivered to IC9 during that half-cycle, causing it to switch to a low output and Q3 and RL1 to drop out. When RL1's contacts drop out, continuity is lost in the relay holding in the main circuit protective device, causing it to drop out also.

In addition to detecting phase angle, IC's 11 and 12 measure current magnitude. Half of IC11 scales the current waveform arriving from the current transducer. This scaled waveform is full-wave rectified by IC12 and compared against an adjustable set point in the other half of IC11. Logically combined with the output of IC9, the prototype allows the circuit breaker to activate on a combination of both high current and small phase angle.

Figure 8.—Current waveform distortion of pump motor on continuous mining machine.